

Bremshydraulik

Hydraulic Components

2023

Bremsen-Ersatzteilprogramm

Brake Parts Program



Brakethrough Technology



Erstklassig First-class

Besser ist besser

Wenn es um Qualität geht, genügt uns ein „sehr gut“ noch lange nicht. Wir erfüllen hohe Ansprüche an das Qualitätsmanagement und die europäische Sicherheitsnorm ECE-R90 wird von ATE sogar übertroffen. Zudem führen wir zahlreiche zusätzliche Tests durch, unter anderem zu Verschleiß und Wärmeleistung.

Auch Nachhaltigkeit ist uns wichtig: Wir stellen die Mischungen für ATE Bremsbeläge auf kupferfreie Materialien um und setzen bei ATE Ceramic auf geringen Abrieb. Nutzen ausschließlich umweltfreundliches Material für die Beschichtung von Bremscheiben. Und bereiten Produkte wie Bremsattel wieder auf.

Better is better

When it comes to quality, “very good” is simply not good enough for us. We meet high standards of quality management – and ATE even exceeds the European safety standard ECE-R90. We also perform many additional tests, including wear and thermal performance.

Sustainability is also important to us: we convert the compounds for ATE brake pads to copperfree materials and opt for low abrasion with ATE Ceramic. We only use environmentally friendly material for the coating of brake discs – and we remanufacture products like brake callipers.

Höchste Qualität für optimale Leistung.



SUPER DOT 5.1

Der Premium-Allrounder ATE SUPER DOT 5.1 mit bester Funktionalität bei heißen wie kalten Einsatzbedingungen: 5 °C höherer Nass-Siedepunkt und höheres Wechselintervall als ATE SL.6 bei gleich guter Viskosität, ideal für Fahrzeuge mit modernen Fahrerassistenzsystemen wie ESP®, ABS und ASR.

Große Auswahl für alle Einsatzgebiete

- | ATE SL als bewährter DOT 4-Typ, ATE TYP 200 für Rennsportbegeisterte und ATE DOT 3 G für Oldtimer und Fahrzeuge, wo die Verwendung einer DOT 3-Flüssigkeit vom Fahrzeughersteller vorgeschrieben ist
- | ATE SL.6 ist optimal für ESP®, ABS und ASR: dünnflüssig auch bei niedrigen Temperaturen, schnelle Reaktionszeit
- | Siedepunkte und Viskosität übertreffen gesetzliche und technische Anforderungen
- | Schutz vor Korrosion durch hochwertige Additive

Die Eigenschaften von ATE Bremsflüssigkeiten

	Siedepunkt	Nass-Siedepunkt	Viskosität bei -40 °C	Wechselintervall
ATE SUPER DOT 5.1	min. 265 °C	min. 180 °C	max. 750 mm ² /s	bis 3 Jahre
ATE TYP 200 DOT 4 Racing-Qualität	min. 280 °C	min. 198 °C	max. 1.400 mm ² /s	bis 3 Jahre
ATE SL.6 DOT 4 Ideal für ESP®, ABS, ASR	min. 265 °C	min. 175 °C	max. 700 mm ² /s	bis 2 Jahre
ATE SL DOT 4	min. 260 °C	min. 165 °C	max. 1.400 mm ² /s	bis 1 Jahr
ATE DOT 3 G	min. 245 °C	min. 150 °C	max. 1.500 mm ² /s	bis 1 Jahr

Zur Erhaltung der Funktionssicherheit der Bremsanlage muss Bremsflüssigkeit entsprechend der vom Fahrzeughersteller vorgegebenen Qualität und in den angegebenen Wechselintervallen ausgetauscht werden.



Servicegeräte

Natürlich bieten wir auch Geräte für Tests, Entlüftung und Entsorgung von Bremsflüssigkeiten an. Sie arbeiten exakt und zuverlässig, sind leicht zu bedienen und technologisch auf dem neuesten Stand.



In unserem Expert Talk stellen wir Ihnen die verschiedenen Bremsflüssigkeiten vor:



Erfahren Sie mehr über ATE Bremsflüssigkeiten auf www.ate.de/bremsfluessigkeit sowie über unsere Servicegeräte auf www.ate-info.de

Typ	ATE Sachnummer	EAN-Nr. 4006633	Gebinde	Paletteneinheit	
SUPER DOT 5.1	SAE-Spezifikation, J1704-FMVSS 116/DOT 5.1 ISO-Klasse 5.1 – niedrigviskos	706602 03.9901-6602.2	45757 6	1 l	600 Kannen ²
		706603 03.9901-6603.2	45759 0	5 l	400 Kannen ³
		706611 03.9901-6611.2	45761 3	20 l	36 Kannen
		706620 03-9901-6620-2	48735 1	30 l	22 Kannen
		706614 03-9901-6614-2	48734 4	50 l	12 Kannen
TYP 200	SAE-Spezifikation, J1704-FMVSS 116/DOT 4	706202 03.9901-6202.2	10825 6	1 l	600 Kannen ²
		706203 03.9901-6203.2	12166 8	5 l	400 Kannen ³
		706220 03.9901-6220.2	12780 6	30 l	22 Kannen
SL 6	SAE-Spezifikation, J1704-FMVSS 116/DOT 4 ISO-Klasse 6 – niedrigviskos	706402 03.9901-6402.2	20746 1	1 l	600 Kannen ²
		706403 03.9901-6403.2	20748 5	5 l	400 Kannen ³
		706411 03.9901-6411.2	20750 8	20 l	36 Kannen
		706420 03.9901-6420.2	23120 6	30 l	22 Kannen
		706414 03.9901-6414.2	23005 6	50 l	12 Kannen
		706405 03.9901-6405.2	23121 3	200 l	1 Stück
SL	SAE-Spezifikation, J1704-FMVSS 116/DOT 4	705801 03.9901-5801.2	49001 6	1/2 l	1.200 Kannen ¹
		705802 03.9901-5802.2	49002 3	1 l	600 Kannen ²
		705803 03.9901-5803.2	49003 0	5 l	400 Kannen ³
		705811 03.9901-5811.2	29907 7	20 l	12 Kannen
		705820 03.9901-5820.2	10824 9	30 l	22 Kannen
		705814 03.9901-5814.2	10366 4	50 l	12 Kannen
		705805 03.9901-5805.2	49005 4	200 l	1 Stück
G	SAE-Spezifikation, J1703-FMVSS 116/DOT 3	700301 03-9901-0301-2	10188 2	1/2 l	1.200 Kannen ¹
		705302 03.9901-5302.2	10199 8	1 l	600 Kannen ²
		705303 03.9901-5303.2	10201 8	5 l	400 Kannen ³

Abweichende Artikelnummern für Lieferländer außerhalb Deutschlands möglich.

Paletteneinheit:

¹20 Kannen je Karton.

²10 Kannen je Karton.

³4 Kannen je Karton.



Top quality for optimum performance.



SUPER DOT 5.1

ATE SUPER DOT 5.1 with optimum performance in both hot and cold conditions: 5 °C higher wet boiling point than ATE SL.6, same excellent viscosity, longer change interval, ideal for vehicles with advanced driver assistance systems like ESP®, ABS and ASR.

Wide selection for all applications

- | ATE SL as a proven DOT 4 grade, ATE TYP 200 for racing enthusiasts and ATE DOT 3 G for classic cars and vehicles for which the manufacturer specifies a DOT 3 brake fluid
- | ATE SL.6 is optimal for ESP®, ABS and ASR: low viscosity even at low temperatures, with a fast reaction time
- | Boiling points and viscosities are better than in statutory and technical regulations
- | Protection from corrosion by high-grade additives

Properties of ATE brake fluids

	Boiling point	Wet boiling point	Viscosity at -40 °C	Change interval
ATE SUPER DOT 5.1	min. 265 °C/509 °F	min. 180 °C/356 °F	max. 750 mm ² /s	up to 3 years
ATE TYP 200 DOT 4 Racing quality	min. 280 °C/536 °F	min. 198 °C/388 °F	max. 1,400 mm ² /s	up to 3 years
ATE SL.6 DOT 4 Ideal for ESP®, ABS, ASR	min. 265 °C/509 °F	min. 175 °C/347 °F	max. 700 mm ² /s	up to 2 years
ATE SL DOT 4	min. 260 °C/500 °F	min. 165 °C/329 °F	max. 1,400 mm ² /s	up to 1 year
ATE DOT 3 G	min. 245 °C/473 °F	min. 150 °C/302 °F	max. 1,500 mm ² /s	up to 1 year

To maintain the operational reliability and safety of the brake system, you must change the brake fluid in accordance with the vehicle manufacturer's recommendations on quality and at the specified change intervals.



Service units

Of course we also offer devices for testing, bleeding and disposing of brake fluids. The devices work accurately and reliably, are easy to use and their technology is state of the art.



In our Expert Talk we introduce you to the different brake fluids:



To learn more about ATE brake fluids go to www.ate-brakes.com/brakefluid. Information on our service units is available at www.ate-info.de/en

Type	ATE item code	Language variations	Container	Pallet unit
SUPER DOT 5.1 SAE specification, J1704-FMVSS 116/DOT 5.1 ISO Class 5.1 – low viscosity	706602 03.9901-6602.2	DE, EN, ES, PT, CN, FR, IT, AR, SE, NL, JP, TH, GR	1 l	600 cans ²
	706612 03.9901-6612.2	PL, RU, CZ, SK, SLO, HU, BG, KA, HR, SR, RO	1 l	600 cans ²
	706603 03.9901-6603.2	DE, EN, ES, PT, CN, FR, IT, AR, SE, NL, JP, TH, GR, PL, RU, CZ, SK, SLO, HU, BG, KA, HR, SR, RO	5 l	400 cans ³
	706611 03.9901-6611.2		20 l	36 cans
	706620 03.9901-6620-2		30 l	22 cans
	706614 03.9901-6614-2		50 l	12 cans
TYP 200 SAE specification, J1704-FMVSS 116/DOT 4	706202 03.9901-6202.2	DE, EN, ES, PT, CN, FR, IT, AR, SE, NL, JP, TH, GR	1 l	600 cans ²
	706212 03.9901-6212.2	PL, RU, CZ, SK, SLO, HU, BG, KA, HR, SR, RO	1 l	600 cans ²
	706203 03.9901-6203.2	DE, EN, PL, ES, CN, FR, IT, RO, AR, SE, RU, HR, SR, CZ, SK, SLO, GR, HU, JP, TH, BG, NL, PT, KA, DK, FI, SQ, TR, LV, NO, LT, MS, HY	5 l	400 cans ³
	706220 03.9901-6220.2	DE, EN, PL, ES, CN, FR, IT, RO, AR, SE, RU, HR, SR, CZ, SK, SLO, GR, HU, JP, TH, BG, NL, PT, KA, DK, FI, SQ, TR	30 l	22 cans
SL 6 SAE specification, J1704-FMVSS 116/DOT 4 ISO Class 6 – low viscosity	706402 03.9901-6402.2	DE, EN, ES, PT, CN, FR, IT, AR, SE, NL, JP, TH, GR	1 l	600 cans ²
	706432 03.9901-6432.2	PL, RU, CZ, SK, SLO, HU, BG, KA, HR, SR, RO	1 l	600 cans ²
	706403 03.9901-6403.2	DE, EN, PL, ES, CN, FR, IT, RO, AR, SE, RU, HR, SR, CZ, SK, SLO, GR, HU, JP, TH, BG, NL, PT, KA, DK, FI, SQ, TR, LV, NO, LT, MS, HY	5 l	400 cans ³
	706411 03.9901-6411.2	DE, EN, PL, ES, CN, FR, IT, RO, AR, SE, RU, HR, SR, CZ, SK, SLO, GR, HU, JP, TH, BG, NL, PT, KA, DK, FI, SQ, TR, LV	20 l	36 cans
	706420 03.9901-6420.2	DE, EN, PL, ES, CN, FR, IT, RO, AR, SE, RU, HR, SR, CZ, SK, SLO, GR, HU, JP, TH, BG, NL, PT, KA, DK, FI, SQ, TR	30 l	22 cans
	706414 03.9901-6414.2		50 l	12 cans
706405 03.9901-6405.2	200 l		1 item	
SL SAE specification, J1704-FMVSS 116/DOT 4	705801 03.9901-5801.2	DE, EN, ES, AR, TH, CN	1/2 l	1,200 cans ¹
	705831 03.9901-5831.2	PL, RO, RU, HR, SLO, KA	1/2 l	1,200 cans ¹
	705802 03.9901-5802.2	DE, EN, ES, PT, CN, FR, IT, AR, SE, NL, JP, TH, GR	1 l	600 cans ²
	705832 03.9901-5832.2	PL, RU, CZ, SK, SLO, HU, BG, KA, HR, SR, RO	1 l	600 cans ²
	705803 03.9901-5803.2	DE, EN, PL, ES, CN, FR, IT, RO, AR, SE, RU, HR, SR, CZ, SK, SLO, GR, HU, JP, TH, BG, NL, PT, KA, DK, FI, SQ, TR, LV, NO, LT, MS, HY	5 l	400 cans ³
	705811 03.9901-5811.2	DE, EN, PL, ES, CN, FR, IT, RO, AR, SE, RU, HR, SR, CZ, SK, SLO, GR, HU, JP, TH, BG, NL, PT, KA, DK, FI, SQ, TR, LV	20 l	12 cans
	705820 03.9901-5820.2	DE, EN, PL, ES, CN, FR, IT, RO, AR, SE, RU, HR, SR, CZ, SK, SLO, GR, HU, JP, TH, BG, NL, PT, KA, DK, FI, SQ, TR	30 l	22 cans
	705814 03.9901-5814.2		50 l	12 cans
705805 03.9901-5805.2	200 l		1 item	
G SAE specification, J1703-FMVSS 116/DOT 3	700301 03.9901-0301-2	–	1/2 l	1,200 cans ¹
	705302 03.9901-5302.2	–	1 l	600 cans ²
	705303 03.9901-5303.2	–	5 l	400 cans ³
B SAE specification, J1703-FMVSS 116/DOT 3	700301 03.9901-0301.2	–	1/2 l	1,200 cans ²
	700302 03.9901-0302.2	–	1 l	600 cans ²

Item codes may be different for countries of delivery other than Germany.

Pallet unit: ¹20 cans per box. ²10 cans per box. ³4 cans per box.



DE Inhaltsverzeichnis

Herstellerverzeichnis
Produktdetails
Fahrzeugverwendungen
Technische Übersetzungen

8	Index of vehicles
15	Product details
137	Applications of vehicles
575	Technical translations

EN Table of contents

ES Índice

8	Índice de vehículos	8
15	Descripción del producto	15
137	Aplicaciones	137
575	Traducciones técnicas	575

FR Table des matières

Liste des véhicules
Présentation du produit
Applications
Traductions techniques

8	Indice autovetture
15	Panoramica prodotti
137	Applicazioni autoveicoli
575	Traduzioni tecniche

IT Sommario

8
15
137
575



DE Herstellerverzeichnis

EN Index of vehicles

ES Índice de vehículos

FR Liste des véhicules

IT Indice autovettura

2023

**ABARTH 138**

500 / 595 / 695	138
500C / 595C / 695C	138
GRANDE PUNTO	138
PUNTO	138
PUNTO EVO	138

ALFA ROMEO 138

145 (930_)	138
146 (930_)	138
155 (167_)	138
159 (939_)	138
159 Sportwagon (939_)	139
166 (936_)	139
BRERA (939_)	139
GIULIETTA (940_)	139
GIULIETTA Kasten/Schrägheck (940_)	139
GTV (916_)	139
MITO (955_)	140
SPIDER (916_)	140
SPIDER (939_)	140

AUDI 140

A1 (8X1, 8XK)	140
A2 (8Z0)	140
A3 (8L1)	140
A3 (8P1)	141
A3 (8V1, 8VK)	144
A3 Cabriolet (8P7)	144
A3 Cabriolet (8V7, 8VE)	144
A3 Limousine (8VS, 8VM)	145
A3 Sportback (8PA)	145
A3 Sportback (8VA, 8VF)	147
A4 Allroad B8 (8KH)	148
A4 B5 (8D2)	148
A4 B5 Avant (8D5)	149
A4 B6 (8E2)	150
A4 B6 Avant (8E5)	150
A4 B6 Cabriolet (8H7)	151
A4 B7 (8EC)	151
A4 B7 Avant (8ED)	152
A4 B7 Cabriolet (8HE)	153
A4 B8 (8K2)	153
A4 B8 Avant (8K5)	154
A5 (8T3)	154
A5 Cabriolet (8F7)	155
A5 Sportback (8TA)	155
A6 Allroad C6 (4FH)	156
A6 Allroad C7 (4GH, 4GJ)	156
A6 C4 (4A2)	156
A6 C4 Avant (4A5)	156
A6 C5 (4B2)	156
A6 C5 Avant (4B5)	158
A6 C6 (4F2)	159
A6 C6 Avant (4F5)	159
A6 C7 (4G2, 4GC)	160
A6 C7 Avant (4G5, 4GD)	160
A7 Sportback (4GA, 4GF)	161
A8 D2 (4D2, 4D8)	161
A8 D4 (4H2, 4H8, 4HC, 4HL)	161
ALLROAD C5 (4BH)	161
CABRIOLET B3 (8G7)	162
Q2 (GAB, GAG)	162
Q3 (8UB, 8UG)	162
Q5 (8RB)	162
Q5 Van (8RB)	163
Q7 (4LB)	163
Q7 Van (4LB)	164
TT (8J3)	164
TT (8N3)	165
TT (FV3, FVP)	165
TT Roadster (8J9)	165
TT Roadster (8N9)	166
TT Roadster (FV9, FVR)	166

BMW 166

1 (E81)	166
1 (E87)	167

**BMW 166**

1 (F20)	168
1 (F21)	168
1 (F40)	169
1 (F52)	169
1 Cabriolet (E88)	169
1 Coupe (E82)	170
1 Van (F20)	171
2 Active Tourer (F45)	171
2 Active Tourer Van (F45)	171
2 Cabriolet (F23)	171
2 Coupe (F22, F87)	171
2 Gran Coupe (F44)	172
2 Gran Tourer (F46)	172
2 Gran Tourer Van (F46)	172
3 (E36)	173
3 (E46)	173
3 (E90)	174
3 (F30, F80)	175
3 Cabriolet (E36)	176
3 Cabriolet (E46)	176
3 Cabriolet (E93)	177
3 Compact (E36)	178
3 Compact (E46)	178
3 Coupe (E36)	179
3 Coupe (E46)	179
3 Coupe (E92)	180
3 Gran Turismo (F34)	181
3 Touring (E36)	182
3 Touring (E46)	182
3 Touring (E91)	183
3 Touring (F31)	184
3 Touring Van (F31)	185
4 Cabriolet (F33, F83)	185
4 Coupe (F32, F82)	185
4 Gran Coupe (F36)	186
5 (E39)	186
5 (E60)	187
5 (F10)	187
5 Gran Turismo (F07)	188
5 Touring (E39)	188
5 Touring (E61)	188
5 Touring (F11)	189
6 (E63)	189
6 Cabriolet (E64)	190
6 Cabriolet (F12)	190
6 Coupe (F13)	190
6 Gran Coupe (F06)	190
7 (E38)	190
7 (E65, E66, E67)	191
7 (F01, F02, F03, F04)	191
X1 (E84)	191
X1 (F48)	191
X1 Van (F48)	192
X2 (F39)	192
X3 (E83)	192
X3 (F25)	193
X4 (F26)	193
X5 (E53)	193
Z3 Coupe (E36)	193
Z3 Roadster (E36)	193
Z4 Coupe (E86)	194
Z4 Roadster (E85)	194
Z4 Roadster (E89)	194
Z8 Roadster (E52)	194

CHEVROLET 194

ASTRA Schrägheck	194
ASTRA Stufenheck	194
AVEO Schrägheck (T300)	194
AVEO Stufenheck (T300)	195
CORSA Kombi	195
CRUZE (J300)	195
CRUZE Schrägheck (J305)	195
CRUZE Station Wagon (J308)	196
MALIBU (V300)	196
MATIZ (M200, M250)	196
ORLANDO (J309)	196
SPARK	196
SPARK Kasten/Schrägheck (M200, M250)	197

**CHEVROLET 194**

TIGRA	197
VECTRA	197

CHRYSLER 197

DELTA	197
VOYAGER / GRAND VOYAGER III (GS_, NS_)	197
VOYAGER / GRAND VOYAGER IV (RG)	197
VOYAGER IV (RG, RS)	197

CITROËN 198

AX (ZA-)	198
BERLINGO / BERLINGO FIRST Großraumlimousine (MF_, GJK_, GFK_)	198
BERLINGO / BERLINGO FIRST Kasten/Großraumlimousine (M_)	198
BERLINGO Kasten/Großraumlimousine (B9)	199
BERLINGO MULTISPACE (B9)	199
BERLINGO Pritsche/Fahrgestell (B9)	199
C1 (PM_, PN_)	199
C15 Kasten/Großraumlimousine (VD_)	207
C15 Kombi	207
C15 Pritsche/Fahrgestell (VDPD)	207
C1 II (PA_, PS_)	200
C2 (JM_)	200
C2 ENTERPRISE (JG_)	200
C3 AIRCROSS I	203
C3 AIRCROSS II (2R_, 2C_)	203
C3 AIRCROSS II Van (2C_, 2R_)	203
C3 I (FC_, FN_)	201
C3 II (SC_)	202
C3 III (SX)	202
C3 III Van (SX_, SY_)	203
C3 II Kasten/Schrägheck (SC_)	202
C3 PICASSO (SH_)	203
C3 Pluriel (HB_)	203
C4 CACTUS	204
C4 CACTUS Van (0B_, 0P_)	204
C4 GRAND PICASSO I (JA_)	204
C4 GRAND PICASSO II (DA_, DE_)	204
C4 PICASSO I Großraumlimousine (UD_)	204
C4 PICASSO II	205
C4 PICASSO II Van (DD_)	205
C4 SPACETOURER (3D_)	205
C4 SPACETOURER Van (3D_)	205
C5 III (RD_)	205
C5 III Break (RW_)	206
C6 (TD_)	207
C8 (EA_, EB_)	207
C8 Van (EA_, EB_)	207
C-ELYSEE (DD_)	208
DS3 (SA_)	208
DS3 Cabriolet	208
DS5	208
EVASION Großraumlimousine (22, U6)	209
GRAND C4 SPACETOURER (3A_, 3E_)	209
GRAND C4 SPACETOURER Van (3A_, 3E_)	209
JUMPER Bus	209
JUMPER Bus (230P)	209
JUMPER Bus (244, Z_)	211
JUMPER Kasten	211
JUMPER Kasten (230L)	212
JUMPER Kasten (244)	214
JUMPER Pritsche/Fahrgestell	214
JUMPER Pritsche/Fahrgestell (230)	214
JUMPER Pritsche/Fahrgestell (244)	215
JUMPY (U6U_)	215
JUMPY (VF7)	216
JUMPY Kasten	216
JUMPY Kasten (BS_, BT_, BY_, BZ_)	216
JUMPY Pritsche/Fahrgestell	216
JUMPY Pritsche/Fahrgestell (BU_, BV_, BW_, BX_)	216
SAXO (S0, S1)	217
SAXO Hatchback van (S3_)	217
XSARA (N1)	217
XSARA Break (N2)	218

**CITROËN 198**

XSARA Coupe (N0)	219
XSARA Kasten/Kombi	219
XSARA Kasten/Schrägheck (N3_)	220
XSARA PICASSO (N68)	220
ZX (N2)	221
ZX Break (N2)	221

CUPRA 221

ATECA (KH7, KHP)	221
------------------	-----

DACIA 221

DOKKER Express Kasten/Großraumlimousine	222
DOKKER Großraumlimousine (KE_)	222
DUSTER (HS_)	222
DUSTER Kasten/SUV	222
LODGY (JS_)	223
LOGAN (LS_)	223
LOGAN EXPRESS (FS_)	224
LOGAN II	224
LOGAN MCV (KS_)	224
LOGAN MCV II	225
LOGAN Pick-up (US_)	225
SANDERO	225
SANDERO II	226

DAEWOO 226

MATIZ (M100, M150)	226
MATIZ (M200, M250)	226
MATIZ (M300)	226
MATIZ Kasten/Schrägheck (KLA4)	226

DAIHATSU 226

CHARADE VIII	226
--------------	-----

DS 226

DS 5 (KF_)	226
------------	-----

FIAT 227

126 (126_)	227
500 (312_)	227
500 C (312_)	227
500L (351_, 352_)	227
BARCHETTA (183_)	227
BRAVA (182_)	227
BRAVO I (182_)	228
BRAVO II (198_)	228
BRAVO Van (198_)	228
CINQUECENTO (170_)	228
COUPE (175_)	228
CROMA (194_)	228
CROMA Kasten/Kombi (194_)	229
DOBLO Bus (263_)	229
DOBLO Cargo (263_)	229
DOBLO Großraumlimousine (119_, 223_)	229
DOBLO Kasten/Großraumlimousine (223_)	229
DOBLO Pritsche/Fahrgestell (263_)	230
DUCATO Bus (230_)	230
DUCATO Bus (244_)	231
DUCATO Bus (250_)	232
DUCATO Kasten (230_)	232
DUCATO Kasten (244_)	234
DUCATO Kasten (250_)	234
DUCATO Pritsche/Fahrgestell (230_)	235
DUCATO Pritsche/Fahrgestell (244_)	236
DUCATO Pritsche/Fahrgestell (250_)	236
FIORINO Kasten/Großraumlimousine (146_)	237
FIORINO Pick up (146_)	237
GRANDE PUNTO (199_)	237
GRANDE PUNTO Van (199_)	238
IDEA (350_)	238
IDEA Van (350_)	239
LINEA (323_, 110_)	239

**FIAT 227**

MAREA (185_)	239
MAREA Weekend (185_)	239
PALIO (178_, 171_)	239
PALIO Weekend (178_, 173_, 373_, 374_, 171_)	240
PANDA / PANDA CLASSIC (169_)	240
PANDA (141_)	240
PANDA (312_, 319_)	240
PANDA Kasten/Schrägheck (141_)	241
PANDA Kasten/Schrägheck (169_)	241
PANDA VAN (312_, 519_)	241
PUNTO (176_)	241
PUNTO (188_)	242
PUNTO (199_)	242
PUNTO Cabriolet (176_)	242
PUNTO EVO (199_)	242
PUNTO EVO Kasten/Schrägheck (199_)	243
PUNTO Kasten/Schrägheck (188_)	243
PUNTO Kasten/Schrägheck (199_)	243
PUNTO Van (176_)	243
SCUDO Bus (220_)	243
SCUDO Bus (270_, 272_)	243
SCUDO Kasten (220_)	244
SCUDO Kasten (270_, 272_)	244
SCUDO Pritsche/Fahrgestell (220_)	244
SCUDO Pritsche/Fahrgestell (270_, 272_)	244
SEDICI (189_)	244
SEICENTO / 600 (187_)	244
SEICENTO / 600 Kasten/Schrägheck (287_)	244
SIENA (178_, 172_)	245
STRADA Pick-up (178_, 278_)	245
TIPO Kombi (356_, 357_)	245
TIPO Schrägheck (356_, 357_)	245
TIPO Stufenheck (356_, 357_)	245
ULYSSE (179_)	245
ULYSSE (220_)	245
UNO (146_)	246

FORD 246

B-MAX (JK)	246
B-MAX Van (JK)	246
C-MAX (DM2)	246
C-MAX II (DXA/CB7, DXA/CEU)	247
C-MAX II Van	247
COUGAR (EC_)	247
ESCORT CLASSIC (AAL, ABL)	248
ESCORT CLASSIC Turnier (ANL)	248
ESCORT VI (GAL, AAL, ABL)	247
ESCORT VI Cabriolet (ALL)	247
ESCORT VI Express (AVL)	248
ESCORT VI Stufenheck (GAL, AFL)	248
ESCORT VI Turnier (GAL, ANL)	248
FIESTA III (GFJ)	248
FIESTA IV (JA_, JB_)	249
FIESTA Kasten/Großraumlimousine (J5_, J3_)	250
FIESTA Kasten/Schrägheck (JV_)	250
FIESTA Stufenheck	251
FIESTA V (JH_, JD_)	249
FIESTA VI (CB1, CCN)	250
FIESTA VI Van	250
FIESTA V Van	249
FOCUS C-MAX (DM2)	258
FOCUS I (DAW, DBW)	251
FOCUS II (DA_, HCP, DP)	252
FOCUS II Cabriolet	253
FOCUS III	257
FOCUS III Kasten/Kombi	257
FOCUS III Kasten/Schrägheck	257
FOCUS III Stufenheck	258
FOCUS III Turnier	258
FOCUS II Kasten/Kombi	254
FOCUS II Stufenheck (DB_, FCH, DH)	254
FOCUS II Turnier (DA_, FFS, DS)	256
FOCUS I Kasten/Kombi (DNW)	251
FOCUS I Stufenheck (DFW)	251
FOCUS I Turnier (DNW)	251
FUSION (JU_)	259
GALAXY I (WGR)	259

**FORD 246**

GALAXY II (WA6)	260
GALAXY MK II VAN (WA6)	261
GALAXY MK I VAN (WGR)	260
GRAND C-MAX (DXA/CB7, DXA/CEU)	261
GRAND C-MAX Van	261
KA	261
KA (RU8)	261
KUGA I	261
KUGA II (DM2)	262
KUGA II VAN	262
KUGA I VAN	262
MONDEO II (BAP)	262
MONDEO III (B5Y)	263
MONDEO III Stufenheck (B4Y)	263
MONDEO III Turnier (BWY)	264
MONDEO II Stufenheck (BFP)	263
MONDEO II Turnier (BNP)	263
MONDEO IV (BA7)	264
MONDEO IV Stufenheck (BA7)	264
MONDEO IV Turnier (BA7)	265
MONDEO IV Van	265
PUMA (EC_)	265
RANGER (ET)	265
S-MAX (WA6)	265
S-MAX VAN (WA6)	265
TOURNEO CONNECT / GRAND	266
TOURNEO CONNECT V408 Großraumlimousine	266
TOURNEO COURIER B460 Großraumlimousine	266
TRANSIT Bus (E_)	266
TRANSIT Bus (FD_, FB_, FS_, FZ_, FC_)	266
TRANSIT CONNECT Großraumlimousine	266
TRANSIT CONNECT V408 Kasten/Großraumlimousine	267
TRANSIT COURIER B460 Großraumlimousine	267
TRANSIT COURIER B460 Kasten/Großraumlimousine	267
TRANSIT Kasten (E_)	267
TRANSIT Kasten (FA_)	267
TRANSIT Pritsche/Fahrgestell (E_)	267
TRANSIT Pritsche/Fahrgestell (FM_, FN_, FF_)	268
TRANSIT Pritsche/Fahrgestell (FM_, FN_)	268
TRANSIT TOURNEO Bus	268
TRANSIT TOURNEO Bus (FC_)	268

FSO 268

126P	268
------	-----

HONDA 268

ACCORD VII (CL, CN)	268
ACCORD VII Tourer (CM, CN)	269
CIVIC VI Coupe (EJ, EM1)	269
CIVIC VI Hatchback (EJ, EK)	269
CIVIC VIII Hatchback (FN, FK)	269
CIVIC VI Stufenheck (EJ, EK, SO)	269

HYUNDAI 269

ATOS (MX)	269
GETZ (TB)	269
i10 I (PA)	269
i10 II (BA, IA)	269
i10 II Stufenheck	270
i30 (GD)	270
i30 Coupe	270
i30 Hatchback Van (GDE)	270
i30 Kombi (GD)	270
i30 Kombi Van (GDE, GD)	270
i40 I (VF)	271
i40 I CW (VF)	271
i40 I Kombi Van (VF)	271
ix20 (JC)	271
ix35 (LM, EL, ELH)	271



**HYUNDAI 269**

ix35 Van	271
MATRIX (FC)	272
TUCSON (TL, TLE)	272
VELOSTER (FS)	272

JAGUAR 272

S-TYPE II (X200)	272
XF I (X250)	272
XF SPORTBRAKE (X250)	273
XJ (X350, X358)	273
XJ (X351)	273
XK 8 Convertible (X100)	274
XK 8 Coupe (X100)	274
XK II Cabriolet (X150)	273
XK II Coupe (X150)	273

JEEP 274

COMPASS (MP, M6, MV, M7)	274
RENEGADE SUV (BU, B1, BV)	274
RENEGADE VAN (BU, B1)	274

KIA 274

CEE'D (JD)	274
CEE'D Combi Van (JD)	275
CEE'D Sportswagon (JD)	275
PRO CEE'D (JD)	275
PRO CEE'D Hatchback Van (JD)	275
SORENTO I (JC)	275
SPORTAGE III (SL)	276
SPORTAGE IV (QL, QLE)	276
SPORTAGE IV VAN (QL, QLE)	276

LADA 276

110 (2110)	276
111 (2111)	276
112 (2112)	276
1200-1600	277
NOVA (2105)	277
NOVA Kombi (2104)	277
SAMARA (2108, 2109, 2113, 2114)	277
SAMARA Schrägheck (2113, 2114)	277
SAMARA Stufenheck (21099, 2115)	277
TAIGA Geländewagen geschlossen (2121, 2131)	277

LANCIA 277

DEDRA (835_)	277
DELTA II (836_)	277
DELTA III (844_)	278
MUSA (350_)	278
PHEDRA (179_)	278
Y (840_)	278
YPSILON (843_)	278
ZETA (22_)	278

LAND ROVER 279

DISCOVERY IV (L319)	279
DISCOVERY IV VAN (L319)	279
FREELANDER 2 (L359)	279
FREELANDER 2 VAN (L359)	279
RANGE ROVER EVOQUE (L538)	279
RANGE ROVER EVOQUE Cabriolet (L538)	279
RANGE ROVER EVOQUE VAN (L538)	279
RANGE ROVER III (L322)	279
RANGE ROVER SPORT I (L320)	280

MAZDA 280

2 (DY)	280
3 (BK)	280
3 (BL)	280
3 Stufenheck (BK)	280
3 Stufenheck (BL)	280

**MAZDA 280**

6 Hatchback (GG)	281
6 Station Wagon (GY)	281
6 Stufenheck (GG)	281
BT-50 Pick-up (CD, UN)	281
BT-50 Pritsche/Fahrgestell (CD, UN)	281
CX-5 (KE, GH)	281
CX-5 (KF)	281
CX-5 Van (KE_)	282

MERCEDES-BENZ 282

A-KLASSE (W168)	282
A-KLASSE (W169)	282
A-KLASSE (W176)	282
B-KLASSE Sports Tourer (W245)	282
B-KLASSE Sports Tourer (W246, W242)	283
C-KLASSE (W202)	283
C-KLASSE (W203)	284
C-KLASSE (W204)	285
C-KLASSE Coupe (C204)	286
C-KLASSE Sportcoupe (CL203)	286
C-KLASSE T-Model (S202)	287
C-KLASSE T-Model (S203)	288
C-KLASSE T-Model (S204)	289
CLA Coupe (C117)	290
CLA Shooting Brake (X117)	290
CLC-KLASSE (CL203)	290
CLK (C208)	290
CLK (C209)	291
CLK Cabriolet (A208)	292
CLK Cabriolet (A209)	292
CLS (C218)	293
CLS (C219)	293
CLS Shooting Brake (X218)	293
E-KLASSE (W210)	294
E-KLASSE (W211)	295
E-KLASSE (W212)	295
E-KLASSE Cabriolet (A124)	296
E-KLASSE Cabriolet (A207)	296
E-KLASSE Coupe (C124)	297
E-KLASSE Coupe (C207)	297
E-KLASSE Pritsche/Fahrgestell (VF211)	298
E-KLASSE T-Model (S210)	298
E-KLASSE T-Model (S211)	299
E-KLASSE T-Model (S212)	299
G-KLASSE (W461)	300
G-KLASSE (W463)	300
G-KLASSE Cabrio (W463)	301
GLA-KLASSE (X156)	301
GLK-KLASSE (X204)	301
GL-KLASSE (X164)	302
M-KLASSE (W163)	302
M-KLASSE (W164)	302
R-KLASSE (W251, V251)	303
S-KLASSE (W140)	303
S-KLASSE (W220)	304
S-KLASSE (W221)	304
S-KLASSE Coupe (C140)	306
S-KLASSE Coupe (C215)	306
S-KLASSE Coupe (C216)	306
SL (R129)	306
SL (R230)	307
SL (R231)	307
SLC (R172)	307
SLK (R170)	307
SLK (R171)	307
SLK (R172)	308
SPRINTER 2-t Bus (B901, B902)	308
SPRINTER 2-t Kasten (B901, B902)	308
SPRINTER 2-t Pritsche/Fahrgestell (B901, B902)	308
SPRINTER 3,5-t Bus (B906)	308
SPRINTER 3,5-t Kasten (B906)	308
SPRINTER 3,5-t Pritsche/Fahrgestell (B906)	309
SPRINTER 3-t Bus (B903)	309
SPRINTER 3-t Bus (B906)	309
SPRINTER 3-t Kasten (B903)	310
SPRINTER 3-t Kasten (B906)	310
SPRINTER 3-t Pritsche/Fahrgestell (B903)	310
SPRINTER 3-t Pritsche/Fahrgestell (B906)	310

**MERCEDES-BENZ 282**

SPRINTER 4,6-t Kasten (B906)	310
SPRINTER 4,6-t Pritsche/Fahrgestell (B906)	311
SPRINTER 4-t Bus (B904)	311
SPRINTER 4-t Kasten (B904)	311
SPRINTER 4-t Pritsche/Fahrgestell (B904)	311
SPRINTER 5-t Bus (B906)	311
SPRINTER 5-t Kasten (B906)	312
SPRINTER 5-t Pritsche/Fahrgestell (B906)	312
VANEO (414)	312
VARIO Bus (B670)	312
VARIO Kasten (B667, B670, B668)	312
VARIO Kipper	313
VARIO Pritsche/Fahrgestell (B670, B668, B667)	313
VARIO Triebkopf	314
VIANO (W639)	314
VITO / MIXTO Kasten (W639)	314
VITO Bus (W638)	314
VITO Bus (W639)	314
VITO Kasten (W638)	315
V-KLASSE (638/2)	315

MINI 315

MINI (F55)	315
MINI (F56)	315
MINI (R50, R53)	315
MINI (R56)	316
MINI Cabriolet (F57)	316
MINI Cabriolet (R52)	316
MINI Cabriolet (R57)	317
MINI CLUBMAN (F54)	317
MINI CLUBMAN (R55)	317
MINI CLUBVAN (R55)	317
MINI COUNTRYMAN (F60)	317
MINI COUNTRYMAN (R60)	318
MINI Coupe (R58)	318
MINI PACEMAN (R61)	318
MINI Roadster (R59)	318

MITSUBISHI 318

CARISMA (DA_)	318
CARISMA Stufenheck (DA_)	319
COLT CZC VI Cabriolet (RG)	319
COLT Kasten/Schrägheck (Z3_V)	319
COLT VI (Z3_A, Z2_A)	319

NISSAN 319

BLUEBIRD SYLPHY / SYLPHY III (B17)	319
INTERSTAR Bus (X70)	319
INTERSTAR Kasten (X70)	319
INTERSTAR Pritsche/Fahrgestell (X70)	320
KUBISTAR Kasten (X76)	320
MICRA C+C III (K12)	320
MICRA III (K12)	320
NOTE (E11, NE11)	320
NOTE VAN (E11)	321
NP300 NAVARA (D40)	321
NP300 NAVARA Pritsche/Fahrgestell (D40)	321
NP300 PICKUP (D22)	321
PATHFINDER III (R51)	321
PATHFINDER III VAN (R51_)	321
PRIMASTAR Bus (X83)	321
PRIMASTAR Kasten (X83)	321
PRIMASTAR Pritsche/Fahrgestell (X83)	322
PRIMERA (P12)	322
PRIMERA Hatchback (P12)	322
PRIMERA Kombi (WP12)	322
QASHQAI / QASHQAI +2 I (J10, NJ10, JJ10E)	322
QASHQAI / QASHQAI +2 I VAN (J10, JJ10E)	322
QASHQAI II SUV (J11, J11_)	323
QASHQAI II VAN (J11_)	323
SENTRA VII (B17)	323
TIIDA Schrägheck (C12)	323
X-TRAIL I (T30)	323
X-TRAIL III (T32_, T32R, T32RR)	323



**NISSAN****319**

X-TRAIL VAN (T32) 324

OPEL**324**

ADAM (M13) 324
 AGILA (A) (H00) 324
 AGILA (B) (H08) 324
 ASTRA F (T92) 324
 ASTRA F Cabriolet (T92) 324
 ASTRA F Caravan (T92) 325
 ASTRA F CC (T92) 325
 ASTRA F CLASSIC Caravan (T92) 325
 ASTRA F CLASSIC CC (T92) 325
 ASTRA F CLASSIC Stufenheck (T92) 325
 ASTRA F Kasten/Kombi (T92) 325
 ASTRA G Cabriolet (T98) 326
 ASTRA G Caravan (T98) 326
 ASTRA G CC (T98) 326
 ASTRA G CLASSIC (T98) 327
 ASTRA G CLASSIC Caravan (F35) 327
 ASTRA G CLASSIC Stufenheck (T98) 328
 ASTRA G Coupe (T98) 328
 ASTRA G Kasten/Kombi (F70) 328
 ASTRA G Stufenheck (T98) 328
 ASTRA H (A04) 329
 ASTRA H Caravan (A04) 329
 ASTRA H CLASSIC Kombi (A04) 330
 ASTRA H CLASSIC Schrägheck (A04) 330
 ASTRA H CLASSIC Stufenheck (A04) 331
 ASTRA H GTC (A04) 331
 ASTRA H Kasten/Kombi (L70) 331
 ASTRA H Stufenheck (A04) 332
 ASTRA H TwinTop (A04) 332
 ASTRA J (P10) 333
 ASTRA J Caravan (P10) 333
 ASTRA J GTC 334
 ASTRA J Kasten/Kombi (P10) 334
 ASTRA J Kasten/Schrägheck (P10) 334
 ASTRA J Stufenheck 334
 CALIBRA A (C89) 335
 CASCADA (W13) 335
 COMBO Kasten/Großraumlimousine 335
 COMBO Kasten/Großraumlimousine (71_) 335
 COMBO Tour 336
 CORSA B (S93) 336
 CORSA B Kasten/Schrägheck (S93) 336
 CORSA B Kombi (S93) 336
 CORSA C (X01) 336
 CORSA C Kasten/Schrägheck (X01) 337
 CORSA D (S07) 337
 CORSA D Kasten/Schrägheck (S07) 337
 CORSA E (X15) 337
 CORSA E Kasten/Schrägheck (X15) 337
 CROSSLAND X / CROSSLAND (P17, P2Q0) 338
 CROSSLAND X Van 338
 INSIGNIA A (G09) 338
 INSIGNIA A Country Tourer (G09) 338
 INSIGNIA A Sports Tourer (G09) 339
 INSIGNIA A Stufenheck (G09) 339
 MERIVA A Großraumlimousine (X03) 340
 MOVANO A Bus (X70) 340
 MOVANO A Kasten (X70) 340
 MOVANO A Pritsche/Fahrgestell (X70) 340
 OMEGA B (V94) 341
 OMEGA B Caravan (V94) 341
 SIGNUM CC (Z03) 341
 TIGRA (S93) 341
 TIGRA TwinTop (X04) 341
 VECTRA B (J96) 342
 VECTRA B Caravan (J96) 342
 VECTRA B CC (J96) 342
 VECTRA C (Z02) 343
 VECTRA C Caravan (Z02) 343
 VECTRA C CC (Z02) 343
 VIVARO A Bus (X83) 343
 VIVARO A Kasten (X83) 344
 VIVARO A Pritsche/Fahrgestell (X83) 344
 ZAFIRA / ZAFIRA FAMILY B (A05) 344
 ZAFIRA A Großraumlimousine (T98) 345

**OPEL****324**

ZAFIRA B Kasten/Großraumlimousine (A05) 345
 ZAFIRA TOURER C (P12) 346
 ZAFIRA TOURER C VAN (P12) 346

PEUGEOT**346**

1007 (KM_) 370
 106 II (1A_, 1C_) 346
 106 Van II Kasten/Schrägheck (1S_) 347
 107 (PM_, PN_) 347
 108 347
 2008 I (CU_) 370
 2008 I Van (CU_) 370
 205 II (20A/C) 347
 205 Kasten/Schrägheck 347
 206+ (2L_, 2M_) 353
 206 CC (2D) 348
 206 Schrägheck (2A/C) 348
 206 Stufenheck 351
 206 SW (2E/K) 351
 206 Van 353
 207 (WA_, WC_) 353
 207 CC (WD_) 354
 207 Kasten/Schrägheck (WA_, WC_) 354
 207 Stufenheck 354
 207 SW (WK_) 354
 207 SW Kasten/Kombi (WK_) 355
 208 I (CA_, CC_) 355
 208 Kasten/Schrägheck (CR_) 355
 3008 Großraumlimousine (0U_) 370
 3008 Van (0U_) 371
 301 355
 306 (7B, N3, N5) 355
 306 Break (7E, N3, N5) 358
 306 Cabriolet (7D, N3, N5) 359
 306 Kasten/Kombi (N_, 7_) 359
 306 Kasten/Schrägheck 360
 306 Schrägheck (7A, 7C, N3, N5) 360
 308 II (LB_, LP_, LW_, LH_, L3_) 363
 308 Kasten/Schrägheck (LB_) 363
 308 SW II (LC_, LJ_, LR_, LX_, L4_) 363
 308 SW II Kasten/Kombi (LC_) 364
 405 II (4B) 364
 405 II Break (4E) 364
 406 (8B) 364
 406 Break (8E/F) 365
 406 Coupe (8C) 366
 407 (6D_) 366
 407 Coupe (6C_) 367
 407 SW (6E_) 367
 407 SW Kasten/Kombi (6E_) 368
 5008 (0U_, 0E_) 371
 5008 I Van (0U_) 371
 508 I (8D_) 368
 508 SW I (8E_) 368
 508 SW Kasten/Kombi (8E_) 368
 605 (6B) 369
 806 (221) 369
 807 (EB_) 369
 807 Van (EB_) 370
 BOXER Bus 371
 BOXER Bus (230P) 371
 BOXER Bus (244, Z_) 374
 BOXER Kasten 375
 BOXER Kasten (230L) 375
 BOXER Kasten (244) 377
 BOXER Pritsche/Fahrgestell 377
 BOXER Pritsche/Fahrgestell (244) 377
 BOXER Pritsche/Fahrgestell (ZCT_) 377
 EXPERT (224_) 379
 EXPERT Kasten (222) 379
 EXPERT Kasten (VF3A_, VF3U_, VF3X_) 380
 EXPERT Pritsche/Fahrgestell 380
 EXPERT Pritsche/Fahrgestell (223) 380
 EXPERT TEPEE (VF3X_) 380
 PARTNER Großraumlimousine (5_, G_) 380
 PARTNER Kasten/Großraumlimousine 381
 PARTNER Kasten/Großraumlimousine (5_, G_) 381
 PARTNER ORIGIN Großraumlimousine (G_) 382

**PEUGEOT****346**

PARTNER ORIGIN Kasten/Großraumlimou- 382
 sine (G_)
 PARTNER Pritsche/Fahrgestell 382
 PARTNER Pritsche/Fahrgestell (5_, G_) 382
 PARTNER TEPEE 383

PORSCHE**383**

911 (996) 383
 911 (997) 383
 911 Cabriolet (996) 383
 911 Cabriolet (997) 383
 911 Targa (996) 383
 BOXSTER (986) 383
 BOXSTER (987) 383
 BOXSTER Spyder (987) 384
 CAYENNE (9PA) 384
 CAYMAN (987) 384

RENAULT**384**

19 II Cabriolet (D53_, 853_) 384
 AVANTIME (DE0_) 384
 CAPTUR I (J5_, H5_) 384
 CLIO I (B/C57_, 5/357_) 385
 CLIO II (BB_, CB_) 385
 CLIO III (BR0/1, CR0/1) 387
 CLIO III Grandtour (KR0/1_) 388
 CLIO III Kasten/Schrägheck (SB_, SR_) 388
 CLIO II Kasten/Schrägheck (SB0/1/2_) 386
 CLIO I Kasten/Schrägheck (S57_) 385
 CLIO IV (BH_) 388
 CLIO IV Grandtour (KH_) 389
 CLIO IV Kasten/Kombi (KH_) 389
 CLIO IV Kasten/Schrägheck (BH_) 389
 DOKKER 389
 DUSTER (HS_) 389
 ESPACE III (JE0_) 390
 ESPACE IV (JK0/1_) 390
 EXPRESS Kasten/Großraumlimousine 390
 EXPRESS Pick-up 390
 GRAND SCÉNIC II (JM0/1_) 390
 GRAND SCÉNIC III (JZ0/1_) 391
 KADJAR (HA_, HL_) 391
 KANGOO / GRAND KANGOO II (KW0/1_) 391
 KANGOO (KC0/1_) 391
 KANGOO BE BOP (KW0/1_) 392
 KANGOO Express (FC0/1_) 392
 KANGOO Express (FW0/1_) 392
 KAPTUR (H5_) 392
 KOLEOS II (HC_) 392
 LAGUNA I (B56_, 556_) 393
 LAGUNA I Grandtour (K56_) 393
 LAGUNA II (BG0/1_) 394
 LAGUNA II Grandtour (KG0/1_) 395
 LODGY (JS_) 396
 LOGAN/STEPWAY II (L8_) 396
 LOGAN EXPRESS (US_) 397
 LOGAN I (LS_) 396
 LOGAN II Kombi (K8_) 397
 LOGAN I Kombi (KS_) 397
 MASTER I Bus (T_) 397
 MASTER II Bus (JD) 398
 MASTER III Bus (JV) 398
 MASTER III Kasten (FV) 399
 MASTER III Pritsche/Fahrgestell (EV, HV, UV) 399
 MASTER II Kasten (FD) 398
 MASTER II Pritsche/Fahrgestell (ED/HD/UD) 398
 MASTER I Kasten (T_) 397
 MASTER I Pritsche/Fahrgestell (P_) 398
 MEGANE CC (EZ0/1_) 409
 MEGANE I (BA0/1_) 400
 MEGANE I Cabriolet (EA0/1_) 401
 MEGANE I Classic (LA0/1_) 402
 MEGANE I Coach (DA0/1_) 404
 MEGANE I Grandtour (KA0/1_) 404
 MEGANE I Hatchback Van (SA0/1_) 405
 MEGANE II (BM0/1_, CM0/1_) 406



**RENAULT****384**

MEGANE II Coupé-Cabriolet (EM0/1_)	406
MEGANE II Hatchback Van (KM0/2_)	407
MEGANE III Combi Van (KZ0/1)	408
MEGANE III Coupe (DZ0/1_)	408
MEGANE III Grandtour (KZ0/1)	408
MEGANE III Hatchback Van (BZ_)	408
MEGANE III Schrägheck (BZ0/1_, B3_)	409
MEGANE II Kasten/Kombi (KM_)	407
MEGANE II Kombi (KM0/1_)	407
MEGANE II Stufenheck (LM0/1_)	407
Megane I Kombi van (KA_)	405
MEGANE Scenic (JA0/1_)	409
MODUS / GRAND MODUS (F/JP0_)	410
RAPID	410
RAPID Kasten/Großraumlimousine (F40_, G40_)	410
SAFRANE II (B54_)	411
SANDERO/STEPWAY I (BS_)	411
SANDERO/STEPWAY II (B8_)	411
SCÉNIC I Großraumlimousine (JA0/1_, FA0_)	411
SCÉNIC II (JM0/1_)	412
SCÉNIC III (JZ0/1_)	412
SCÉNIC III VAN (JZ0/1_)	412
THALIA I (LB_)	412
THALIA II (LU_)	413
THALIA III (L8_)	413
TRAFIC Bus (T_, P_, V_)	414
TRAFIC II Bus (JL)	413
TRAFIC II Kasten (FL)	414
TRAFIC II Pritsche/Fahrgestell (EL)	414
TRAFIC Kasten (T_, P_, V_)	414
TRAFIC Pritsche/Fahrgestell (T_, P_, V_)	415
TWINGO I (C06_)	415
TWINGO II (CN0_)	415
TWINGO III (BCM_, BCA_)	415
TWINGO II Kasten/Schrägheck (CNO_)	415
TWINGO I Kasten/Schrägheck (S06_)	415
VEL SATIS (BJ0_)	416
WIND (E4M_)	416

SAAB**416**

900 II	419
900 II Cabriolet	419
900 II Coupe	419
9-3 (YS3D)	416
9-3 (YS3F, E79, D79, D75)	416
9-3 Cabriolet (YS3D)	417
9-3 Cabriolet (YS3F)	417
9-3 Kombi (E50)	417
9-3X (YS3)	418
9-5 (YS3E)	418
9-5 (YS3G)	418
9-5 Kombi (YS3E)	419

SEAT**419**

ALHAMBRA (710, 711)	421
ALHAMBRA (7V8, 7V9)	419
ALHAMBRA VAN (711)	421
ALHAMBRA VAN (7V8, 7V9)	421
ALTEA (5P1)	421
ALTEA XL (5P5, 5P8)	423
AROSA (6H1)	425
ATECA (KH7, KHP)	425
CORDOBA (6K1, 6K2)	425
CORDOBA (6L2)	426
CORDOBA Vario (6K5)	426
CORDOBA VARIO Kasten/Kombi (6K5)	427
EXEO (3R2)	427
EXEO ST (3R5)	428
IBIZA II (6K1)	428
IBIZA III (6L1)	429
IBIZA IV (6J5, 6P1)	430
IBIZA IV Kasten/Schrägheck (6J1)	430
IBIZA IV SC (6J1, 6P5)	430
IBIZA IV ST (6J8, 6P8)	430
IBIZA V (KJ1, KJG)	430
INCA (6K9)	430

**SEAT****419**

LEON (1M1)	431
LEON (1P1)	432
LEON (5F1)	435
LEON Kasten/Schrägheck (5F1)	436
LEON SC (5F5)	437
LEON ST (5F8)	437
LEON ST Kasten/Kombi (5F8)	438
MARBELLA (28A)	439
MARBELLA Kasten/Schrägheck (028A)	439
Mii (KF1, KE1)	439
TOLEDO I (1L2)	439
TOLEDO II (1M2)	440
TOLEDO III (5P2)	441

SKODA**441**

CITIGO (NF1)	441
FABIA I (6Y2)	441
FABIA I Combi (6Y5)	442
FABIA II (542)	443
FABIA II Combi (545)	444
FABIA I Praktik (6Y5)	442
FABIA I Stufenheck (6Y3)	443
FELICIA Cube Van (6U5)	446
FELICIA I (6U1)	445
FELICIA II (6U1)	445
FELICIA II Kombi (6U5)	446
FELICIA I Kombi (6U5)	445
FELICIA I Pick-up (6UF, 6U7)	445
KAROQ (NU7, ND7)	446
KODIAQ (NS7, NV7, NS6)	446
OCTAVIA I (1U2)	446
OCTAVIA I Combi (1U5)	447
OCTAVIA II (1Z3)	449
OCTAVIA II Combi (1Z5)	450
OCTAVIA III (5E3, NL3, NR3)	452
OCTAVIA III Combi (5E5, 5E6)	452
OCTAVIA I Kasten/Kombi (1U5)	449
ROOMSTER (5J7)	453
ROOMSTER Praktik (5J)	453
SUPERB I (3U4)	453
SUPERB II (3T4)	454
SUPERB III (3V3)	455
SUPERB III Kombi (3V5)	455
SUPERB II Kombi (3T5)	454
YETI (5L)	455

SMART**455**

CITY-COUPÉ (450)	456
CROSSBLADE (450)	456
FORFOUR (454)	456
FORFOUR Schrägheck (453)	456
FORTWO Cabrio (450)	456
FORTWO Cabrio (451)	456
FORTWO Cabriolet (453)	456
FORTWO Coupe (450)	456
FORTWO Coupe (451)	457
FORTWO Coupe (453)	457

SUBARU**457**

JUSTY III (G3X)	457
-----------------	-----

SUZUKI**457**

IGNIS II (MH)	457
JIMNY Geländewagen geschlossen (SN)	457
JIMNY Geländewagen offen (SN)	457
SPLASH (EX)	457
SWIFT III (MZ, EZ)	457
SX4 (EY, GY)	458
SX4 Stufenheck (GY, RW)	458
WAGON R+ Schrägheck (MM)	458
WAGON R Schrägheck	458

TOYOTA**458**

AVENSIS (_T22_)	458
-----------------	-----

**TOYOTA****458**

AVENSIS (_T25_)	458
AVENSIS Kombi (_T22_)	459
AVENSIS Kombi (_T25_)	459
AVENSIS Liftback (_T22_)	459
AVENSIS Stufenheck (_T25_)	459
AYGO (B1_)	459
AYGO (B4_)	460
AYGO Kasten/Schrägheck (B1_)	460
COROLLA (_E10_)	460
COROLLA (_E11_)	460
COROLLA (_E12_)	460
COROLLA Compact (_E10_)	460
COROLLA Compact (_E11_)	461
COROLLA Kasten/Kombi (_E11_)	461
COROLLA Kombi (_E10_)	461
COROLLA Kombi (_E11_)	461
COROLLA Kombi (_E12_)	461
COROLLA LEVIN Coupe (_E10_)	461
COROLLA Liftback (_E10_)	461
COROLLA Liftback (_E11_)	461
COROLLA Stufenheck (_E12_)	462
COROLLA Verso (_E12_)	462
COROLLA Verso (ZER_, ZZE12_, R1_)	462
RAV 4 II (_A2_)	462
YARIS / VIOS Stufenheck (_P9_)	462
YARIS (_P1_)	463
YARIS (_P9_)	463

VAUXHALL**463**

ADAM (M13)	463
AGILA Mk I (A) (H00)	463
AGILA Mk II (B) (H08)	463
ASTRA Mk III (F) Cabriolet (T92)	464
ASTRA Mk III (F) CC (T92)	464
ASTRA Mk III (F) Kombi (T92)	464
ASTRA Mk III (F) Stufenheck (T92)	464
ASTRA Mk IV (G) Cabriolet (T98)	465
ASTRA Mk IV (G) CC (T98)	465
ASTRA Mk IV (G) Coupe (T98)	465
ASTRA Mk IV (G) Kombi (T98)	466
ASTRA Mk IV (G) Stufenheck (T98)	466
ASTRA Mk V (H) (A04)	467
ASTRA Mk V (H) Kombi (A04)	468
ASTRA Mk V (H) Sport Hatch (A04)	468
ASTRA Mk V (H) TwinTop (A04)	469
ASTRA Mk VI (J) (P10)	470
ASTRA Mk VI (J) GTC (P10)	470
ASTRA Mk VI (J) Kombi (P10)	470
ASTRA Mk VI (J) Stufenheck (P10)	471
ASTRAVAN Mk III (F) Kasten/Kombi (T92)	471
ASTRAVAN Mk IV (G) Kasten/Kombi (T98)	471
ASTRAVAN Mk V (H) Kasten/Kombi (A04)	472
CALIBRA (C89)	472
CASCADA Cabriolet (W13)	472
COMBO Mk I (B) (S93)	472
COMBO Mk II (C) Kasten/Großraumlimousine (F25)	472
COMBO TOUR Mk II (C) (F25)	473
CORSA Mk I (B) (S93)	473
CORSA Mk II (C) (X01)	473
CORSA Mk III (D) (S07)	473
CORSA Mk IV (E) (X15)	474
CORSAVAN Mk I (B) Kasten/Schrägheck (S93)	474
CORSAVAN Mk II (C) Kasten/Schrägheck (X01)	474
CORSAVAN Mk III (D) Kasten/Schrägheck (S07)	474
CORSAVAN Mk IV (E) Kasten/Schrägheck (X15)	474
CROSSLAND X / CROSSLAND (P17)	474
INSIGNIA Mk I (A) Country Tourer (G09)	475
INSIGNIA Mk I (A) Schrägheck (G09)	475
INSIGNIA Mk I (A) Sports Tourer (G09)	475
INSIGNIA Mk I (A) Stufenheck (G09)	476
MERIVA A (X03)	477
MOVANO Mk I (A) Chassis/Cab (X70)	477
MOVANO Mk I (A) Combi (X70)	477
MOVANO Mk I (A) Van (X70)	477
OMEGA (B) Kombi (V94)	478

**VAUXHALL 463**

OMEGA (B) Stufenheck (V94)	478
SIGNUM (Z03)	478
TIGRA Mk I (S93)	478
TIGRA TwinTop (X04)	478
VECTRA (B) CC (J96)	478
VECTRA (B) Kombi (J96)	479
VECTRA (B) Stufenheck (J96)	480
VECTRA Mk II (C) (Z02)	481
VECTRA Mk II (C) CC (Z02)	481
VECTRA Mk II (C) Kombi (Z02)	481
VIVARO A Bus (X83)	481
VIVARO A Kasten (X83)	482
VIVARO A Pritsche/Fahrgestell (X83)	482
ZAFIRA A (T98)	482
ZAFIRA Mk II (B) (A05)	482
ZAFIRA Mk III (P12)	483

VOLVO 483

850 (854)	483
850 Kombi (855)	483
940 II (944)	484
940 II Kombi (945)	484
C30 (533)	484
C70 I Cabriolet (873)	485
C70 I Coupe (872)	485
C70 II Cabriolet (542)	486
S40 I (644)	486
S40 II (544)	486
S60 I (384)	487
S60 II (134)	491
S60 II Cross Country (134)	492
S70 (874)	492
S80 I (184)	493
S80 II (124)	494
S90 I (964)	495
V40 Cross Country (526)	495
V40 Kasten/Schrägheck (525)	495
V40 Kombi (645)	495
V40 Schrägheck (525)	495
V50 (545)	496
V60 I (155)	497
V60 I Cross Country (157)	498
V60 I Kasten/Kombi (155)	498
V70 I (875, 876)	498
V70 II (285)	499
V70 III (135)	502
V70 III Kasten/Kombi (135)	503
V90 I Kombi (965)	504
XC60 I SUV (156)	504
XC60 I VAN (156)	504
XC70 I Cross Country (295)	505
XC70 II (136)	505
XC70 II VAN (136)	506
XC90 I (275)	506
XC90 I VAN (275)	507

VW 507

AMAROK (2HA, 2HB, S1B, S6B, S7A, S7B)	507
AMAROK Pritsche/Fahrgestell (S1B, S6B, S7B)	507
ARTEON (3H7, 3H8)	507
ARTEON SHOOTING BRAKE (3H9)	508
BEETLE (5C1, 5C2)	508
BEETLE Cabriolet (5C7, 5C8)	508
BORA (9M2)	509
BORA I (1J2)	509
BORA Variant (1J6)	510
CADDY ALLTRACK Großraumlimousine (SAB)	514
CADDY ALLTRACK Kasten/Großraumlimousine (SAA)	515
CADDY II Großraumlimousine (9K9B)	511
CADDY III Großraumlimousine (2KB, 2KJ, 2CB, 2CJ)	512
CADDY III Kasten/Großraumlimousine (2KA, 2KH, 2CA, 2CH)	513
CADDY II Kasten/Großraumlimousine (9K9A)	512
CADDY II Pick-up (9U7)	512

VW 507

CADDY IV Großraumlimousine (SAB, SAJ)	514
CADDY IV Kasten/Großraumlimousine (SAA, SAH)	514
CADDY Kasten/Großraumlimousine (6K9, 9E7, 9E9)	515
CALIFORNIA T5 Camper (7EC, 7EF, 7EG, 7HF)	515
CC B7 (358)	516
CRAFTER 30-35 Bus (2E_)	516
CRAFTER 30-50 Kasten (2E_)	516
CRAFTER 30-50 Pritsche/Fahrgestell (2F_)	516
EOS (1F7, 1F8)	517
FOX Schrägheck (5Z1, 5Z3, 5Z4)	517
FOX Van (5Z1)	517
GOLF ALLTRACK VII Variant (BA5, BV5)	532
GOLF III (1H1)	517
GOLF III Cabriolet (1E7)	519
GOLF III Van (1H1)	520
GOLF III Variant (1H5)	520
GOLF IV (1J1)	521
GOLF IV (9B3)	523
GOLF IV Cabriolet (1E7)	523
GOLF IV Van (1J1)	524
GOLF IV Variant (1J5)	525
GOLF Kasten/Schrägheck (1K1)	532
GOLF PLUS V (5M1, 521)	532
GOLF PLUS Van (521)	535
GOLF SPORTSVAN VII (AM1, AN1)	537
GOLF V (1K1)	525
GOLF VAN IV Variant (1J5)	538
GOLF VAN VII Variant (BA5)	539
GOLF VAN VI Variant (AJ5)	538
GOLF VI (5K1)	528
GOLF VI Cabriolet (517)	529
GOLF VII (5G1, BQ1, BE1, BE2)	530
GOLF VII Van (5G1)	531
GOLF VII Variant (BA5, BV5)	531
GOLF VI Van (5K1_)	529
GOLF VI Variant (AJ5)	530
GOLF V Variant (1K5)	527
JETTA III (1K2)	539
JETTA IV (162, 163, AV3, AV2)	540
JETTA VII Stufenheck (BU3, BU4)	540
LOAD UP (121, 122, BL1, BL2)	540
LT 28-35 II Bus (2DB, 2DE, 2DK)	540
LT 28-46 II Kasten (2DA, 2DD, 2DH)	540
LT 28-46 II Pritsche/Fahrgestell (2DC, 2DF, 2DG, 2DL, 2DM)	541
LUPO I (6X1, 6E1)	541
MULTIVAN T5 (7HM, 7HN, 7HF, 7EF, 7EM, 7EN)	541
NEW BEETLE (9C1, 1C1)	542
NEW BEETLE Cabriolet (1Y7)	543
PASSAT ALLTRACK B7 (365)	544
PASSAT ALLTRACK B8 Variant (3G5, CB5)	544
PASSAT B3/B4 Variant (3A5, 35I)	544
PASSAT B5.5 (3B3)	545
PASSAT B5.5 Variant (3B6)	546
PASSAT B5 (3B2)	547
PASSAT B5 Variant (3B5)	547
PASSAT B6 (3C2)	548
PASSAT B6 Variant (3C5)	548
PASSAT B7 (362)	549
PASSAT B7 (A32, A33)	549
PASSAT B7 Kasten/Kombi (365)	550
PASSAT B7 Variant (365)	550
PASSAT B8 (3G2, CB2)	550
PASSAT B8 Variant (3G5, CB5)	551
PASSAT CC B6 (357)	551
POLO (6N2)	552
POLO (9N_, 9A_)	552
POLO III (6N1)	553
POLO III CLASSIC (6V2)	554
POLO IV Stufenheck (9A4, 9A2, 9N2, 9A6)	555
POLO IV Stufenheck (9N4)	555
POLO Van Kasten/Kombi (6V5)	555
POLO Van Kasten/Schrägheck (6N1)	556
POLO Variant (6V5)	556
SCIROCCO III (137, 138)	556
SCIROCCO Van (137)	558
SHARAN (7M8, 7M9, 7M6)	559

VW 507

SHARAN (7N1, 7N2)	560
SHARAN VAN (7M_)	560
SHARAN VAN (7N1, 7N2)	561
TIGUAN (5N_)	561
TIGUAN (AD1, AX1)	562
TIGUAN Kasten/SUV (AD1)	562
TIGUAN VAN (5N_)	562
TOUAREG (7LA, 7L6, 7L7)	562
TOURAN (1T1, 1T2)	563
TOURAN (1T3)	564
TOURAN (5T1)	565
TOURAN VAN (1T1, 1T2)	565
TOURAN VAN (1T3)	565
TOURAN VAN (5T1)	566
TRANSPORTER T4 Bus (70B, 70C, 7DB, 7DK, 70J, 70K, 7DC, 7DJ)	566
TRANSPORTER T4 Kasten (70A, 70H, 7DA, 7DH)	568
TRANSPORTER T4 Pritsche/Fahrgestell (70E, 70L, 70M, 7DE, 7DL)	569
TRANSPORTER T5 Bus (7HB, 7HJ, 7EB, 7EJ)	570
TRANSPORTER T5 Kasten (7HA, 7HH, 7EA, 7EH)	571
TRANSPORTER T5 Pritsche/Fahrgestell (7JD, 7JE, 7JL, 7JY, 7JZ)	572
T-ROC (A11, D11)	573
T-ROC Cabriolet (AC7, AC8)	573
UP! (121, 122, BL1, BL2, BL3, 123)	573
VENTO (1H2)	573





- DE** Produktdetails
- EN** Product details
- ES** Descripción del producto
- FR** Présentation du produit
- IT** Panoramica prodotti

2023



03.2022-2624.3

010588



Hauptbremszylinder

Ø1 22,2

Ø2 20,6

2x

Gewindemaß 1: 1x M10x1

Gewindemaß 2: 1x M12x1

L1= 33,3

L2= 113,2

03.2023-0825.3

010028



Hauptbremszylinder

Ø1 23,8

Ø2 19

M10x1

3x

L1= 57,4

L2= 109,6

MERCEDES-BENZ

03.2023-0875.3

010890



Hauptbremszylinder

Ø1 23,8

Ø2 20,6

M10x1

4x

ATE

ohne Bremsflüssigkeitsbehälter

L1= 16

L2= 166

VOLVO

03.2023-1066.3

010032



Hauptbremszylinder

Ø1 23,8

Ø2 19

2x

Gewindemaß 1: 1x M10x1

Gewindemaß 2: 1x M12x1

L1= 49,8

L2= 109

MERCEDES-BENZ

03.2023-1084.3

010591



Hauptbremszylinder

Ø1 23,8

Ø2 20,6

M10x1

3x

ATE

L1= 38,3

L2= 132,5

VOLVO

03.2023-1741.3

010703



Hauptbremszylinder

Ø1 23,8

Ø2 20,6

M12x1

4x

ATE

L1= 12

L2= 169,5

MERCEDES-BENZ

03.2023-1812.3

010570



Hauptbremszylinder

Ø1 23,8

Ø2 19

3x

Gewindemaß 1: 1x M10x1

Gewindemaß 2: 2x M12x1

L1= 4

L2= 147

MERCEDES-BENZ

03.2023-2004.3

010788



Hauptbremszylinder

Ø1 23,8

Ø2 19

M12x1

4x

ATE

L1= 4

L2= 147

MERCEDES-BENZ

03.2023-2204.3

010644



Hauptbremszylinder

Ø1 23,8

Ø2 22,2

M12x1

5x

ATE

L1= 36,9

L2= 116,4

BMW

03.2023-2249.3

010869



Hauptbremszylinder

Ø1 23,8

Ø2 22,2

M12x1

4x

ATE

L1= 35,9

L2= 116,4

BMW

03.2023-2256.3

010870



Hauptbremszylinder

Ø1 23,8

Ø2 22,2

M12x1

2x

ATE

L1= 35,9

L2= 116,4

BMW

03.2023-2304.3

010646



Hauptbremszylinder

Ø1 23,8

Ø2 22,2

2x

ATE

Gewindemaß 1: 1x M10x1

Gewindemaß 2: 1x M12x1

L1= 32,8

L2= 113,2

BMW

03.2023-2344.3

010647



Hauptbremszylinder

Ø1 23,8

Ø2 22,2

2x

ATE

Gewindemaß 1: 1x M10x1

Gewindemaß 2: 1x M12x1

L1= 32,8

L2= 113,2

BMW

03.2023-2407.3

010796



Hauptbremszylinder

Ø1 23,8

Ø2 22,2

M12x1

2x

ATE

L1= 59,2

L2= 105,7

BMW

03.2025-0211.3

010034



Hauptbremszylinder

Ø1 25,4

Ø2 19

M10x1

3x

L1= 57,8

L2= 108

MERCEDES-BENZ

03.2025-1741.3

010705



Hauptbremszylinder

Ø1 25,4

Ø2 20,6

M12x1

4x

ATE

L1= 12

L2= 169,5

MERCEDES-BENZ

03.2025-1904.3

010797



Hauptbremszylinder

Ø1 25,4

Ø2 22,2

M12x1

2x

ATE

L1= 59,2

L2= 105,7

BMW

03.2025-2521.3

010959



Hauptbremszylinder

Ø1 25,4

Ø2 22,2

M12x1

2x

ATE

L1= 57,6

L2= 114,3

MERCEDES-BENZ

03.2025-5826.3

010960



Hauptbremszylinder

Ø1 25,4

Ø2 22,2

M12x1

2x

ATE

L1= 35,9

L2= 116

BMW

03.2026-0462.3

010728



Hauptbremszylinder

Ø1 27

Ø2 25,4

M10x1

2x

L1= 57,4

L2= 115,9

MERCEDES-BENZ

03.2119-3391.3**010058****Hauptbremszylinder**

Ø 19

M10x1

2x

ATE

L1= 40

L2= 114,9

PEUGEOT**03.2120-1142.3****010085****Hauptbremszylinder**

Ø 20,6

M10x1

3x

L1= 18,8

L2= 167

RENAULT**03.2120-1897.3****010103****Hauptbremszylinder**

Ø 20,6

M10x1

2x

ATE

L1= 40

L2= 114,9

PEUGEOT**03.2120-2031.3****010106****Hauptbremszylinder**

Ø 20,6

M10x1

4x

ATE

L1= 32,4

L2= 114,9

CITROËN, PEUGEOT, RENAULT, SEAT

03.2120-3943.3

010532



Hauptbremszylinder

Ø 20,6

M10x1

4x

Aluguss

ATE

L1= 35,4

L2= 109,7

SEAT, VW

03.2120-4166.3

010452



Hauptbremszylinder

Ø 20,6

M10x1

4x

ATE

L1= 29,9

L2= 115,9

CITROËN, PEUGEOT

03.2120-4221.3

010605



Hauptbremszylinder

Ø 20,6

M10x1

2x

ATE

L1= 29,9

L2= 115,9

CITROËN

03.2120-4241.3

010524



Hauptbremszylinder

Ø 20,6

M10x1

2x

ATE

L1= 29,9

L2= 115,9

PEUGEOT

03.2120-4246.3**010614****Hauptbremszylinder**

Ø 20,6

M10x1

2x

ATE

L1= 29,9

L2= 115,9

PEUGEOT**03.2120-4321.3****010525****Hauptbremszylinder**

Ø 20,6

4x

ATE

Gewindemaß 1: 2x M10x1

Gewindemaß 2: 2x M12x1

L1= 29,9

L2= 115,9

PEUGEOT**03.2120-4381.3****010526****Hauptbremszylinder**

Ø 20,6

4x

ATE

Gewindemaß 1: 2x M10x1

Gewindemaß 2: 2x M12x1

L1= 29,9

L2= 124,7

RENAULT**03.2120-4441.3****010510****Hauptbremszylinder**

Ø 20,6

M10x1

2x

ATE

L1= 31,5

L2= 115,9

RENAULT

03.2120-4461.3

010571



Hauptbremszylinder

Ø 20,6

2x

ATE

Gewindemaß 1: 1x M10x1

Gewindemaß 2: 1x M12x1

L1= 31,5

L2= 124,7

RENAULT

03.2120-4468.3

010789



Hauptbremszylinder

Ø 20,6

M12x1

2x

ATE

L1= 31,5

L2= 124,7

RENAULT

03.2120-4581.3

010915



Hauptbremszylinder

Ø 20,6

2x

ATE

Gewindemaß 1: M10x1

Gewindemaß 2: M12x1

L1= 31,5

L2= 162,5

RENAULT

03.2120-4611.3

010937



Hauptbremszylinder

Ø 20,6

M10x1

2x

ATE

L1= 22,5

L2= 133

DACIA, RENAULT

03.2120-4641.3**010932****Hauptbremszylinder**

Ø 20,6

M12x1

2x

ATE

L1= 31,5

L2= 124,7

RENAULT**03.2122-0264.3****010129****Hauptbremszylinder**

Ø 22,2

4x

ATE

Gewindemaß 1: 2x M10x1

Gewindemaß 2: 2x M12x1

L1= 33,1

L2= 118

OPEL, VAUXHALL**03.2122-1001.3****010562****Hauptbremszylinder**

Ø 22,2

4x

Gewindemaß 1: 2x M10x1

Gewindemaß 2: 2x M12x1

L1= 27,9

L2= 131,7

RENAULT**03.2122-1042.3****010137****Hauptbremszylinder**

Ø 22,2

M10x1

4x

L1= 36

L2= 109,7

SEAT, VW

03.2122-1144.3**010636****Hauptbremszylinder**

Ø 22,2

M10x1

2x

ATE

L1= 36

L2= 109,7

VW**03.2122-1331.3****010607****Hauptbremszylinder**

Ø 22,2

M10x1

2x

ATE

L1= 31,5

L2= 115,9

CITROËN**03.2122-1344.3****010593****Hauptbremszylinder**

Ø 22,2

M10x1

2x

ATE

L1= 31,5

L2= 119,6

SEAT, VW**03.2122-1351.3****010528****Hauptbremszylinder**

Ø 22,2

2x

Gewindemaß 1: 1x M10x1

Gewindemaß 2: 1x M12x1

L1= 31,5

L2= 115,9

CITROËN, PEUGEOT**03.2122-1356.3****010529****Hauptbremszylinder**

Ø 22,2

4x

Gewindemaß 1: 2x M10x1

Gewindemaß 2: 2x M12x1

L1= 27,9

L2= 115,9

CITROËN, PEUGEOT

03.2122-1461.3**010610****Hauptbremszylinder**

Ø 22,2

M10x1

2x

ATE

L1= 31,5

L2= 109,4

PEUGEOT**03.2122-1541.3****010511****Hauptbremszylinder**

Ø 22,2

M10x1

4x

L1= 27,4

L2= 119

RENAULT**03.2122-1691.3****010918****Hauptbremszylinder**

Ø 22,2

M12x10

2x

ATE

L1= 33,1

L2= 114,5

TOYOTA**03.2122-1824.3****010892****Hauptbremszylinder**

Ø 22,2

M12x1

3x

ATE

L1= 42,1

L2= 109,3

MINI**03.2122-1853.3****010893****Hauptbremszylinder**

Ø 22,2

M12x1

2x

ATE

L1= 40,9

L2= 109,3

MINI

03.2122-1888.3**010736****Hauptbremszylinder**

Ø 22,2

M12x1

3x

ATE

L1= 6,4

L2= 143,3

AUDI**03.2122-1926.3****010916****Hauptbremszylinder**

Ø 22,2

M12x1

2x

ATE

L1= 30,5

L2= 125,7

RENAULT**03.2122-1942.3****010700****Hauptbremszylinder**

Ø 22,2

M12x1

3x

ATE

L1= 30,5

L2= 117,7

PEUGEOT**03.2122-2031.3****010938****Hauptbremszylinder**

Ø 22,2

M12x1

2x

ATE

L1= 22,5

L2= 132

DACIA, RENAULT**03.2122-2129.3****010799****Hauptbremszylinder**

Ø 22,2

M12x1

2x

ATE

L1= 36,1

L2= 134,9

AUDI, SEAT, SKODA, VW

03.2122-2163.3**010800****Hauptbremszylinder**

Ø 22,2

M12x1

3x

ATE

L1= 39,8

L2= 128,2

CITROËN, FIAT, LANCIA, PEUGEOT**03.2122-2171.3****010961****Hauptbremszylinder**

Ø 22,2

M12x1

2x

ATE

L1= 43,2

L2= 125,8

PEUGEOT**03.2122-2261.3****010964****Hauptbremszylinder**

Ø 22,2

M12x1

2x

ATE

L1= 21,5

L2= 144,4

DACIA, RENAULT**03.2122-9612.3****010159****Hauptbremszylinder**

Ø 22,2

M10x1

4x

L1= 36

L2= 103,7

AUDI**03.2123-0491.3****010167****Hauptbremszylinder**

Ø 23,8

M10x1

4x

L1= 36

L2= 115,7

AUDI

03.2123-1121.3**010176****Hauptbremszylinder**

Ø 23,8

2x

Gewindemaß 1: 1x M10x1

Gewindemaß 2: 1x M12x1

L1= 29,1

L2= 118

OPEL, SAAB, VAUXHALL**03.2123-1424.3****010637****Hauptbremszylinder**

Ø 23,8

M10x1

2x

ATE

L1= 34,4

L2= 116,6

SEAT, VW**03.2123-1428.3****010476****Hauptbremszylinder**

Ø 23,8

M10x1

2x

L1= 34,4

L2= 116,6

SKODA, VW**03.2123-1484.3****010595****Hauptbremszylinder**

Ø 23,8

M12x1

2x

ATE

L1= 31,5

L2= 119,6

SEAT, VW**03.2123-1486.3****010488****Hauptbremszylinder**

Ø 23,8

M12x1

2x

L1= 31,5

L2= 119,6

RENAULT

03.2123-1526.3**010477****Hauptbremszylinder**

Ø 23,8

M12x1

2x

L1= 31,5

L2= 119,6

FORD, SEAT, VW**03.2123-1546.3****010536****Hauptbremszylinder**

Ø 23,8

M10x1

4x

ATE

L1= 27,9

L2= 114,1

RENAULT**03.2123-1548.3****010478****Hauptbremszylinder**

Ø 23,8

M10x1

4x

L1= 27,9

L2= 114,1

FORD, SEAT, VW**03.2123-1551.3****010512****Hauptbremszylinder**

Ø 23,8

M10x1

4x

L1= 27,9

L2= 114,1

RENAULT**03.2123-1581.3****010487****Hauptbremszylinder**

Ø 23,8

M12x1

2x

L1= 33,1

L2= 125,8

FORD

03.2123-1622.3

010470



Hauptbremszylinder

Ø 23,8

3x

Gewindemaß 1: 1x M10x1

Gewindemaß 2: 2x M12x1

L1= 31,5

L2= 119,6

OPEL, VAUXHALL

03.2123-1626.3

010727



Hauptbremszylinder

Ø 23,8

3x

ATE

Gewindemaß 1: 1x M10x1

Gewindemaß 2: 2x M12x1

L1= 31,5

L2= 119,6

SAAB

03.2123-1722.3

010471



Hauptbremszylinder

Ø 23,8

M12x1

2x

L1= 56

L2= 95,1

OPEL, VAUXHALL

03.2123-1741.3

010537



Hauptbremszylinder

Ø 23,8

M10x1

4x

ATE

L1= 27,9

L2= 113,1

RENAULT

03.2123-1824.3

010596



Hauptbremszylinder

Ø 23,8

M10x1

2x

ATE

L1= 31,5

L2= 119,6

VW

03.2123-2024.3

010597



Hauptbremszylinder

Ø 23,8

4x

ATE

Gewindemaß 1: 2x M10x1

Gewindemaß 2: 2x M12x1

L1= 4,1

L2= 137,8

AUDI, SEAT, SKODA, VW

03.2123-2064.3

010598



Hauptbremszylinder

Ø 23,8

M12x1

4x

ATE

L1= 12,5

L2= 128,9

AUDI, SEAT, SKODA, VW

03.2123-2146.3

010572



Hauptbremszylinder

Ø 23,8

M10x1

2x

L1= 31,5

L2= 119

RENAULT

03.2123-2164.3**010599****Hauptbremszylinder**

Ø 23,8

M12x1

2x

ATE

L1= 40,3

L2= 130

VOLVO**03.2123-2221.3****010861****Hauptbremszylinder**

Ø 23,8

M10x1

2x

ATE

L1= 13,2

L2= 143

TOYOTA**03.2123-2243.3****010748****Hauptbremszylinder**

Ø 23,8

M12x1

2x

ATE

L1= 26,5

L2= 124

FORD**03.2123-2581.3****010613****Hauptbremszylinder**

Ø 23,8

M12x1

2x

ATE

L1= 31,5

L2= 119,6

PEUGEOT**03.2123-2621.3****010701****Hauptbremszylinder**

Ø 23,8

M12x1

2x

ATE

L1= 30,5

L2= 124,8

RENAULT

03.2123-2715.3

010802



Hauptbremszylinder

Ø 23,8

M12x1

3x

ATE

L1= 34,9

L2= 121,4

AUDI, SEAT, SKODA, VW

03.2123-2751.3

011014



Hauptbremszylinder

Ø 23,8

M12x1

2x

ATE

L1= 28,2

L2= 119

RENAULT

03.2123-2761.3

010886



Hauptbremszylinder

Ø 23,8

M12x1

2x

ATE

L1= 30,5

L2= 123,7

CITROËN

03.2123-2774.3

010803



Hauptbremszylinder

Ø 23,8

M12x1

4x

ATE

L1= 26,6

L2= 130,2

AUDI, SEAT, SKODA, VW

03.2123-2781.3**010631****Hauptbremszylinder**

Ø 23,8

4x

ATE

Gewindemaß 1: 2x M10x1

Gewindemaß 2: 2x M12x1

L1= 27,9

L2= 119,6

CITROËN, PEUGEOT**03.2123-2821.3****010944****Hauptbremszylinder**

Ø 23,8

M10x1

4x

ATE

L1= 30,7

L2= 110

RENAULT**03.2123-2863.3****010790****Hauptbremszylinder**

Ø 23,8

M10x1

2x

ATE

L1= 29,2

L2= 116

NISSAN, RENAULT**03.2123-2923.3****010791****Hauptbremszylinder**

Ø 23,8

M12x1

2x

ATE

L1= 28,2

L2= 119

NISSAN, RENAULT

03.2123-2973.3**010951****Hauptbremszylinder**

Ø 23,8

M12x1

2x

ATE

L1= 34,9

L2= 120,4

SKODA**03.2123-3103.3****010781****Hauptbremszylinder**

Ø 23,8

M12x1

2x

ATE

L1= 37

L2= 116,3

FORD**03.2123-3131.3****010977****Hauptbremszylinder**

Ø 23,8

2x M12x1

2x

ATE

L1= 43,2

L2= 125,8

CITROËN, PEUGEOT**03.2123-3241.3****010882****Hauptbremszylinder**

Ø 23,8

M10x1

2x

ATE

L1= 29,2

L2= 116

RENAULT**03.2123-3421.3****010933****Hauptbremszylinder**

Ø 23,8

M12x1

2x

ATE

L1= 39,8

L2= 128,2

CITROËN, PEUGEOT

03.2123-3449.3

010808



Hauptbremszylinder

Ø 23,8

M12x1

2x

ATE

L1= 36,1

L2= 134,9

AUDI, SEAT, SKODA, VW

03.2123-3493.3

010792



Hauptbremszylinder

Ø 23,8

M12x1

2x

ATE

L1= 28,2

L2= 119

RENAULT

03.2123-3549.3

010809



Hauptbremszylinder

Ø 23,8

M12x1

2x

ATE

L1= 36,1

L2= 134,9

AUDI

03.2123-3571.3

010962



Hauptbremszylinder

Ø 23,8

M10x1

2x

ATE

L1= 35,2

L2= 132,8

ALFA ROMEO

03.2123-3593.3

010919



Hauptbremszylinder

Ø 23,8

M12x1

2x

ATE

L1= 37

L2= 116,3

VOLVO

03.2123-3624.3**010956****Hauptbremszylinder**

Ø 23,8

M12x1

2x

ATE

L1= 37

L2= 116,3

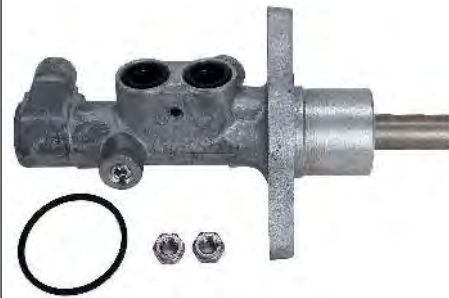
VOLVO**03.2123-3641.3****010963****Hauptbremszylinder**

Ø 23,8

M10x1

2x

ATE

L1= 36,2

L2= 127,8

PEUGEOT**03.2125-0161.3****010920****Hauptbremszylinder**

Ø 25,4

M10x1

2x

ATE

L1= 9

L2= 142

NISSAN**03.2125-0332.3****010952****Hauptbremszylinder**

Ø 25,4

M12x1

2x

L1= 38,2

L2= 108

FORD, SEAT, VW**03.2125-0373.3****010810****Hauptbremszylinder**

Ø 25,4

M12x1

2x

ATE

L1= 64,2

L2= 93,5

AUDI, SEAT, SKODA, VW

03.2125-0421.3

010934



Hauptbremszylinder

Ø 25,4

M12x1

2x

ATE

L1= 64,2

L2= 93,5

CHEVROLET, OPEL, SAAB, VAUXHALL

03.2125-0483.3

010783



Hauptbremszylinder

Ø 25,4

M12x1

2x

ATE

ohne Bremsflüssigkeitsbehälter

L1= 37

L2= 117,5

FORD, MAZDA

03.2125-0531.3

010945



Hauptbremszylinder

Ø 25,4

M12x1

4x

ATE

L1= 9

L2= 142

NISSAN

03.2125-0651.3

010935



Hauptbremszylinder

Ø 25,4

M14x1

2x

ATE

L1= 46,6

L2= 107,9

FORD

03.2125-0661.3**010917****Hauptbremszylinder**

Ø 25,4

M14x1

2x

ATE

L1= 37

L2= 117,5

FORD**03.2125-0671.3****010965****Hauptbremszylinder**

Ø 25,4

M12x1

2x

ATE

L1= 35,2

L2= 133,8

CITROËN, FIAT, PEUGEOT**03.2125-0676.3****011009****Hauptbremszylinder**

Ø 25,4

M10x1

2x

ATE

ohne Bremsflüssigkeitsbehälter

L1= 35,2

L2= 133,8

CITROËN, FIAT, PEUGEOT**03.2125-2102.3****010207****Hauptbremszylinder**

Ø 25,4

M10x1

2x

L1= 18,5

L2= 158,5

MERCEDES-BENZ**03.2125-3801.3****010215****Hauptbremszylinder**

Ø 25,4

M10x1

5x

L1= 18,5

L2= 166

RENAULT

03.2125-5016.3**011010****Hauptbremszylinder**

Ø 25,4

M12x1

2x

ATE

L1= 18,6

L2= 136,2

VOLVO**03.2125-5112.3****010966****Hauptbremszylinder**

Ø 25,4

M10x1

2x

ATE

L1= 36,1

L2= 136,1

AUDI**03.2125-7310.3****010743****Hauptbremszylinder**

Ø 25,4

M12x1

2x

ATE

L1= 11,6

L2= 141

MERCEDES-BENZ**03.2125-7637.3****010707****Hauptbremszylinder**

Ø 25,4

M12x1

2x

ATE

L1= 11,6

L2= 140,7

VOLVO**03.2125-7638.3****010738****Hauptbremszylinder**

Ø 25,4

M12x1

2x

ATE

L1= 11,6

L2= 140,7

VOLVO

03.2125-7708.3**010739****Hauptbremszylinder**

Ø 25,4

M12x1

4x

ATE

L1= 11,6

L2= 140,7

VOLVO**03.2125-7713.3****010819****Hauptbremszylinder**

Ø 25,4

M12x1

4x

ATE

L1= 11,6

L2= 140,7

VOLVO**03.2125-7743.3****010921****Hauptbremszylinder**

Ø 25,4

M10x1

2x

ATE

L1= 11,6

L2= 141

VOLVO**03.2125-8111.3****010479****Hauptbremszylinder**

Ø 25,4

M10x1

4x

L1= 31,5

L2= 120,8

VW**03.2125-8404.3****010583****Hauptbremszylinder**

Ø 25,4

M10x1

4x

ATE

L1= 34,6

L2= 108

FORD, SEAT, VW

03.2125-9604.3

010581



Hauptbremszylinder

Ø 25,4

M10x1

5x

L1= 14,6

L2= 131,5

FORD, SEAT, VW

03.2125-9704.3

010603



Hauptbremszylinder

Ø 25,4

M12x1

2x

ATE

L1= 32,9

L2= 125,5

VW

03.2125-9911.3

010883



Hauptbremszylinder

Ø 25,4

M12x1

2x

ATE

L1= 44,7

L2= 112,4

SAAB

03.2126-3014.3

010811



Hauptbremszylinder

Ø 27

M12x1

2x

ATE

L1= 18,7

L2= 133,5

PORSCHE, VW

03.2126-3063.3

010812



Hauptbremszylinder

Ø 27

M12x1

2x

ATE

L1= 23,3

L2= 128,9

AUDI

03.2126-3121.3

010967



Hauptbremszylinder

Ø 27

M12x1

2x

ATE

L1= 37,2

L2= 135,6

RENAULT

03.2126-3196.3

010968



Hauptbremszylinder

Ø 27

M12x1

2x

ATE

L1= 55,5

L2= 114,3

MERCEDES-BENZ

03.2128-1203.3

010922



Hauptbremszylinder

Ø 28,6

2x

ATE

Gewindemaß 1: M10x1

Gewindemaß 2: M14x1,5

L1= 18,5

L2= 204,5

MERCEDES-BENZ

03.3517-0101.2

390322

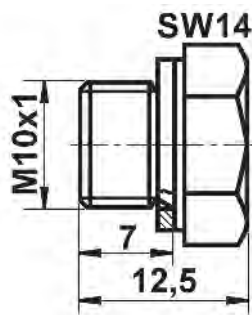

Verschlusschraube, Hauptbremszylinder

L= 12,5

M10x1

L= 7,5

Schlüsselweite 1 [mm]: 14

AUDI, SEAT, VW

03.3517-0300.1

390323

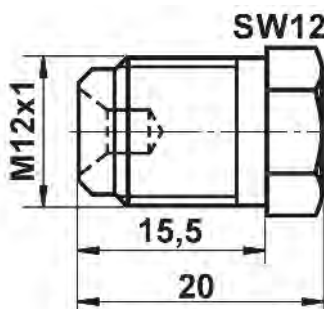

Verschlusschraube, Hauptbremszylinder

L= 20

M12x1

L= 13

Schlüsselweite 1 [mm]: 12

Bördelform: E / F

RENAULT

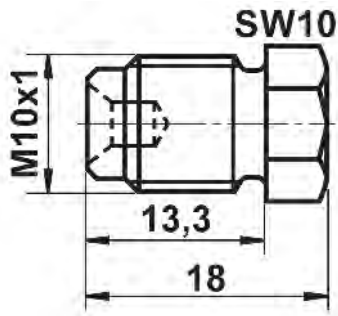
03.3517-5100.1**390326****Verschlusschraube, Hauptbremszylinder**

L= 18

M10x1

L= 11,5

Schlüsselweite 1 [mm]: 10

Bördelform: E / F

FORD, PEUGEOT, SEAT, VW**03.4055-0013.3****010793****Hauptbremszylinder**

Ø 25,4

M12x1

2x

ATE

L1= 20

L2= 106

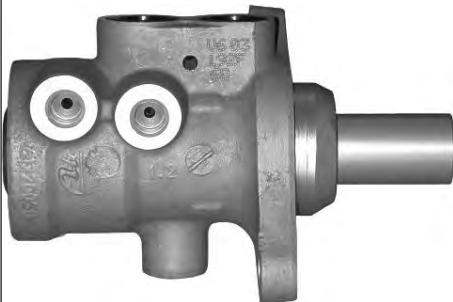
MERCEDES-BENZ**03.4122-0031.3****010611****Hauptbremszylinder**

Ø 22,2

M10x1

4x

ATE

L1= 14

L2= 85,1

PEUGEOT**03.4122-0041.3****010612****Hauptbremszylinder**

Ø 22,2

M10x1

2x

ATE

L1= 14

L2= 85,1

PEUGEOT**03.4122-0054.3****010813****Hauptbremszylinder**

Ø 22,2

M12x1

2x

ATE

L1= 13,7

L2= 87,9

PEUGEOT

03.4123-0081.3

010585



Hauptbremszylinder

Ø 23,8

M12x1

3x

ATE

L1= 5,5

L2= 102,3

RENAULT

03.4123-0153.3

010659



Hauptbremszylinder

Ø 23,8

M12x1

3x

ATE

L1= 12,8

L2= 90,3

FORD

03.4125-0014.3

010794



Hauptbremszylinder

Ø 25,4

M12x1

3x

ATE

L1= 4,2

L2= 105

RENAULT

03.4125-0021.3

010888



Hauptbremszylinder

Ø 25,4

M12x1

2x

ATE

L1= 4,2

L2= 105

RENAULT

03.4125-0032.3

010955



Hauptbremszylinder

Ø 25,4

M12x1

3x

ATE

L1= 12,4

L2= 93

JAGUAR

03.4152-0058.3

010885



Hauptbremszylinder

Ø 22,2

M12x1

2x

ATE

ohne Bremsflüssigkeitsbehälter

L1= 27,9

L2= 91

TOYOTA

03.4152-0116.3

010814



Hauptbremszylinder

Ø 22,2

M12x1

2x

ATE

L1= 27,1

L2= 117

VW

03.4152-0153.3

011006



Hauptbremszylinder

Ø 22,2

M10x1

2x

ATE

ohne Bremsflüssigkeitsbehälter

L1= 27,9

L2= 91

DAIHATSU, TOYOTA

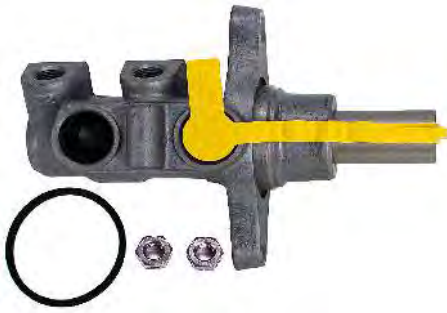
03.4152-0158.3**011007****Hauptbremszylinder**

Ø 22,2

M12x1

2x

ATE

ohne Bremsflüssigkeitsbehälter

L1= 27,9

L2= 91

DAIHATSU, TOYOTA**03.4153-0015.3****011005****Hauptbremszylinder**

Ø 23,8

4x

ATE

Gewindemaß 1: 3x M10x1

Gewindemaß 2: 1x M12x1

ohne Bremsflüssigkeitsbehälter

L1= 21,9

L2= 93

FORD, MAZDA**03.4153-0063.3****010773****Hauptbremszylinder**

Ø 23,8

M10x1

2x

ATE

L1= 9,9

L2= 105,1

RENAULT**03.4153-0173.3****010815****Hauptbremszylinder**

Ø 23,8

M12x1

2x

ATE

L1= 31,7

L2= 92,2

CITROËN, DS, PEUGEOT

03.4153-0186.3

010816



Hauptbremszylinder

Ø 23,8

M12x1

2x

ATE

L1= 27,1

L2= 117

AUDI, SEAT, VW

03.4153-5287.4

010953



Hauptbremszylinder

Ø 23,8

2x

ATE

Gewindemaß 1: 1x M10x1

Gewindemaß 2: 1x M12x1

mit Bremsflüssigkeitsbehälter

L1= 21,9

L2= 93

FORD, MAZDA

03.4155-0043.3

010795



Hauptbremszylinder

Ø 25,4

M12x1

2x

ATE

L1= 9,9

L2= 105

RENAULT

03.4155-0153.3

010927

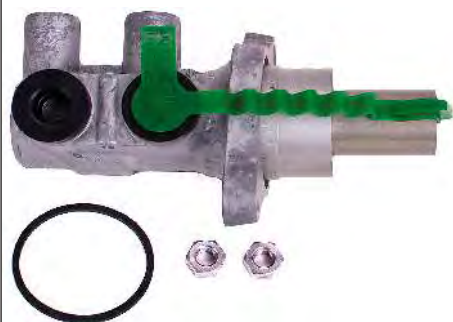

Hauptbremszylinder

Ø 25,4

2x

ATE

Gewindemaß 1: 1x M10x1

Gewindemaß 2: 1x M12x1

L1= 24,2

L2= 90,7

OPEL, VAUXHALL

03.4155-0156.3

010862



Hauptbremszylinder

Ø 25,4

M12x1

2x

ATE

L1= 24,2

L2= 90,7

OPEL, VAUXHALL

03.4155-5141.3

010969



Hauptbremszylinder

Ø 25,4

M12x1

2x

ATE

L1= 15

L2= 110,9

MERCEDES-BENZ

03.4155-5451.3

010995



Hauptbremszylinder

Ø 25,4

M14x1

2x

ATE

L1= 21,9

L2= 93

FORD

03.4156-0014.3

010930

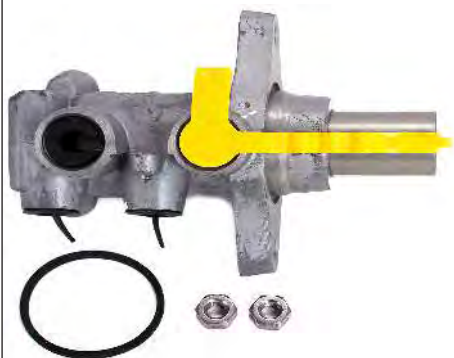

Hauptbremszylinder

Ø 27

M12x1

2x

ATE

ohne Bremsflüssigkeitsbehälter

L1= 20

L2= 89,5

MERCEDES-BENZ

03.4156-0051.3

011011



Hauptbremszylinder

Ø 27

M12x1

2x

ATE

ohne Bremsflüssigkeitsbehälter

L1= 19,8

L2= 90

JAGUAR

03.4156-0073.3

010942



Hauptbremszylinder

Ø 27

M12x1

2x

ATE

L1= 13,2

L2= 102

MERCEDES-BENZ

03.4156-5106.3

010997



Hauptbremszylinder

Ø 27

M12x1

2x

ATE

L1= 11,2

L2= 97,7

MERCEDES-BENZ

03.7740-4002.4

300108



Bremskraftverstärker

T52/4

Ø 8"

pneumatisch

ATE

CITROËN

03.7745-3003.4

300157



Bremskraftverstärker

T52 Tandem

Ø 8 / 7"

pneumatisch

ATE

OPEL, SAAB, VAUXHALL

03.7745-4402.4

300295



Bremskraftverstärker

T52/4 Tandem

Ø 8 / 7"

pneumatisch

ATE

TOYOTA

03.7745-6302.4

300261



Bremskraftverstärker

T52

Ø 8"

pneumatisch

ATE

MERCEDES-BENZ

03.7745-6502.4

300296



Bremskraftverstärker

T52/4

Ø 8"

pneumatisch

ATE

JAGUAR

03.7745-8902.4

300297



Bremskraftverstärker

T52/4A

Ø 8"

pneumatisch

ATE

MERCEDES-BENZ

03.7750-6002.4

300134



Bremskraftverstärker

T52

Ø 9"

pneumatisch

ATE

VW

03.7750-6134.4

300319



Bremskraftverstärker

T52

Ø 9"

pneumatisch

ATE

PEUGEOT

03.7750-6234.4

300320



Bremskraftverstärker

T52

Ø 9"

pneumatisch

ATE

PEUGEOT

03.7750-6332.4

300226



Bremskraftverstärker

T52/4

Ø 9"

pneumatisch

ATE

PEUGEOT

03.7750-6334.4

300321



Bremskraftverstärker

T52/4

Ø 9"

pneumatisch

ATE

PEUGEOT

03.7750-7132.4

300255



Bremskraftverstärker

T52

Ø 9"

pneumatisch

ATE

DAIHATSU, TOYOTA

03.7750-8732.4

300199



Bremskraftverstärker

T52

Ø 9"

pneumatisch

ATE

FORD

03.7750-9302.4

300116



Bremskraftverstärker

T52/4

Ø 9"

pneumatisch

ATE

CITROËN, PEUGEOT

03.7750-9402.4

300117



Bremskraftverstärker

T52/4

Ø 9"

pneumatisch

ATE

PEUGEOT

03.7755-0132.4

300265



Bremskraftverstärker

T52/4 Tandem

Ø 9 / 8"

pneumatisch

ATE

VOLVO

03.7755-1432.4

300300



Bremskraftverstärker

T52/4 Tandem

Ø 9 / 8"

pneumatisch

ATE

FORD

03.7755-1902.4

300138



Bremskraftverstärker

T52 Tandem

Ø 9 / 8"

pneumatisch

ATE

FORD, SEAT, VW

03.7755-3532.4

300290



Bremskraftverstärker

T52 Tandem

Ø 9 / 8"

pneumatisch

ATE

FORD

03.7755-4702.4

300224

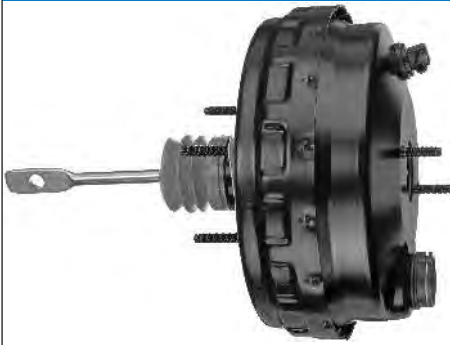

Bremskraftverstärker

Ø 9 / 8"

ATE

T52 Tandem

pneumatisch

Artikelnummer des empfohlenen Zubehörs: 03.0655-0005.2

VOLVO

03.7755-6302.4

300221



Bremskraftverstärker

T52 Tandem

Ø 9 / 8"

pneumatisch

ATE

FORD, SEAT, VW

03.7755-8202.4

300301



Bremskraftverstärker

T52/4A Tandem

Ø 9 / 8"

pneumatisch

ATE

MERCEDES-BENZ

03.7755-9703.4

300239



Bremskraftverstärker

T52 Tandem

Ø 9 / 8"

pneumatisch

ATE

VOLVO

03.7760-2232.4

300266



Bremskraftverstärker

T52

Ø 10"

pneumatisch

ATE

FORD

03.7760-2332.4

300267



Bremskraftverstärker

T52

Ø 10"

pneumatisch

ATE

FORD

03.7760-2702.4

300090



Bremskraftverstärker

T52

Ø 10"

pneumatisch

ATE

MERCEDES-BENZ

03.7760-3002.4

300120



Bremskraftverstärker

T52/4

Ø 10"

pneumatisch

ATE

FORD, SEAT, VW

03.7760-3102.4

300139



Bremskraftverstärker

T52

Ø 10"

pneumatisch

ATE

BMW

03.7760-3602.4

300176



Bremskraftverstärker

T52

Ø 10"

pneumatisch

ATE

VOLVO

03.7760-4102.4

300091



Bremskraftverstärker

T52

Ø 10"

pneumatisch

ATE

MERCEDES-BENZ

03.7760-5502.4

300151



Bremskraftverstärker

T52

Ø 10"

pneumatisch

ATE

RENAULT

03.7760-5602.4

300121



Bremskraftverstärker

T52/4

Ø 10"

pneumatisch

ATE

RENAULT

03.7760-8103.4

300240



Bremskraftverstärker

T52

Ø 10"

pneumatisch

ATE

FORD

03.7845-0103.4

300268



Bremskraftverstärker

T52

Ø 8"

pneumatisch

ATE

BMW

03.7848-2002.4

300166



Bremskraftverstärker

Ø 7 / 8"

ATE

T52/4 Tandem

pneumatisch

Artikelnummer des empfohlenen Zubehörs: 03.0655-0007.2

MERCEDES-BENZ

03.7848-4003.4

300235



Bremskraftverstärker

T52

Ø 8"

pneumatisch

ATE

BMW

03.7848-5003.4

300236



Bremskraftverstärker

T52

Ø 8"

pneumatisch

ATE

BMW

03.7850-0102.4

300180



Bremskraftverstärker

T52

Ø 9"

pneumatisch

ATE

AUDI

03.7853-0202.4

300181



Bremskraftverstärker

T52

Ø 9"

pneumatisch

ATE

AUDI

03.7853-0702.4

300195



Bremskraftverstärker

T52

Ø 9"

pneumatisch

ATE

RENAULT

03.7853-0902.4

300150



Bremskraftverstärker

T52

Ø 9"

pneumatisch

ATE

CITROËN

03.7853-2102.4

300201



Bremskraftverstärker

T52

Ø 9"

pneumatisch

ATE

FORD

03.7853-2604.4

300322



Bremskraftverstärker

T52

Ø 9"

pneumatisch

ATE

PEUGEOT

03.7853-2704.4

300323



Bremskraftverstärker

T52

Ø 9"

pneumatisch

ATE

PEUGEOT

03.7853-3203.4

300241



Bremskraftverstärker

T52

Ø 9"

pneumatisch

ATE

DAIHATSU, TOYOTA

03.7853-3402.4

300256



Bremskraftverstärker

T52

Ø 9"

pneumatisch

ATE

TOYOTA

03.7853-3902.4

300270



Bremskraftverstärker

T52

Ø 9"

pneumatisch

ATE

RENAULT

03.7853-4602.4

300302



Bremskraftverstärker

T52/5K

Ø 9"

pneumatisch

ATE

DACIA, RENAULT

03.7858-0732.4

300272



Bremskraftverstärker

T52 Tandem

Ø 9 / 8"

pneumatisch

ATE

CHEVROLET, OPEL, SAAB, VAUXHALL

03.7858-2802.4

300303



Bremskraftverstärker

T52/5 Tandem

Ø 9 / 8"

pneumatisch

ATE

RENAULT

03.7858-3302.4

300122



Bremskraftverstärker

T55/1 Tandem

Ø 9 / 8"

pneumatisch

ATE

FORD, SEAT, VW

03.7858-3632.4

300234



Bremskraftverstärker

Ø 9 / 8"

ATE

T52 Tandem

pneumatisch

Artikelnummer des empfohlenen Zubehörs: 03.0655-0005.2

VOLVO

03.7858-4432.4

300304



Bremskraftverstärker

T52/4Z Tandem

Ø 9 / 8"

pneumatisch

ATE

AUDI

03.7858-4502.4

300202



Bremskraftverstärker

T52 Tandem

Ø 9 / 8"

pneumatisch

ATE

AUDI, SEAT

03.7858-4632.4

300273



Bremskraftverstärker

T52 Tandem

Ø 9 / 8"

pneumatisch

ATE

AUDI

03.7858-4832.4

300274



Bremskraftverstärker

T55 Tandem

Ø 9 / 8"

pneumatisch

ATE

VOLVO

03.7858-5132.4

300276



Bremskraftverstärker

T55 Tandem

Ø 9 / 8"

pneumatisch

ATE

VOLVO

03.7858-9502.4

300205



Bremskraftverstärker

Ø 9 / 8"

ATE

T55 Tandem

pneumatisch

Artikelnummer des empfohlenen Zubehörs: 03.0655-0006.2

SEAT, VW

03.7860-0602.4

300141



Bremskraftverstärker

T52

Ø 10"

pneumatisch

ATE

AUDI, SEAT, VW

03.7860-2002.4

300216



Bremskraftverstärker

T52

Ø 10"

pneumatisch

ATE

CITROËN, PEUGEOT

03.7860-3734.4

300317



Bremskraftverstärker

T52

Ø 10"

pneumatisch

ATE

CITROËN, DS, PEUGEOT

03.7860-4203.4

300243



Bremskraftverstärker

T52

Ø 10"

pneumatisch

ATE

AUDI

03.7860-7802.4

300280



Bremskraftverstärker

T52

Ø 10"

pneumatisch

ATE

CITROËN, PEUGEOT

03.7860-8002.4

300258



Bremskraftverstärker

T52

Ø 10"

pneumatisch

ATE

CITROËN, PEUGEOT

03.7860-8802.4

300291



Bremskraftverstärker

T52

Ø 10"

pneumatisch

ATE

VW

03.7863-0332.4

300203



Bremskraftverstärker

T52

Ø 10"

pneumatisch

ATE

FORD

03.7863-0402.4

300124



Bremskraftverstärker

T55/1

Ø 10"

pneumatisch

ATE

AUDI, SEAT, SKODA, VW

03.7863-2002.4

300126



Bremskraftverstärker

T52/5

Ø 10"

pneumatisch

ATE

RENAULT

03.7863-2804.4

300324



Bremskraftverstärker

T52

Ø 10"

pneumatisch

ATE

PEUGEOT

03.7863-3002.4

300223



Bremskraftverstärker

T52/5

Ø 10"

pneumatisch

ATE

NISSAN

03.7863-3332.4

300308



Bremskraftverstärker

T52/6Z

Ø 10"

pneumatisch

ATE

AUDI, SEAT, SKODA, VW

03.7863-3502.4

300128



Bremskraftverstärker

T52/5

Ø 10"

pneumatisch

ATE

AUDI, SKODA, VW

03.7863-4502.4

300230



Bremskraftverstärker

T52/5

Ø 10"

pneumatisch

ATE

RENAULT

03.7863-4832.4

300289



Bremskraftverstärker

T52/5

Ø 10"

pneumatisch

ATE

VOLVO

03.7870-0602.4

300310



Bremskraftverstärker

T52/4Z

Ø 11"

pneumatisch

ATE

AUDI

03.7873-4402.4

300292



Bremskraftverstärker

T52

Ø 11"

pneumatisch

ATE

VW

03.7873-4502.4

300284



Bremskraftverstärker

T52

Ø 11"

pneumatisch

ATE

SEAT, VW

10.6123-0239.3

010335



Hauptbremszylinder

Ø 23,8

M10x1

2x

ATE

L1= 43,3

L2= 132

BMW

10.6123-0312.3

010457



Hauptbremszylinder

Ø 23,8

2x

ATE

Gewindemaß 1: 1x M10x1

Gewindemaß 2: 1x M12x1

L1= 38

L2= 133,2

RENAULT

10.6123-0674.3

010639



Hauptbremszylinder

Ø 23,8

M10x1

2x

ATE

L1= 41

L2= 127,9

SEAT, VW

10.6350-3902.4

300213



Bremskraftverstärker

T52

Ø 9"

pneumatisch

ATE

SEAT, VW

10.6350-4002.4

300285



Bremskraftverstärker

T52

Ø 9"

pneumatisch

ATE

SEAT, VW

10.6360-2002.4

300143



Bremskraftverstärker

T52

Ø 10"

pneumatisch

ATE

VW

24.2022-1601.3

010340



Hauptbremszylinder

Ø1 22,2

Ø2 17,5

M10x1

3x

L1= 58

L2= 113

MERCEDES-BENZ

24.2023-1601.3

010341



Hauptbremszylinder

Ø 23,8

M10x1

3x

TRW

L1= 50

L2= 120,5

BMW

24.2023-1701.3

010514



Hauptbremszylinder

Ø1 23,8

Ø2 19

2x

TRW

Gewindemaß 1: 1x M10x1

Gewindemaß 2: 1x M12x1

L1= 51,5

L2= 106

MERCEDES-BENZ

24.2023-1702.3

010534



Hauptbremszylinder

Ø1 23,8

Ø2 19

M12x1

3x

TRW

L1= 24

L2= 125

MERCEDES-BENZ

24.2023-1704.3

010635



Hauptbremszylinder

Ø 23,8

M12x1

3x

TRW

L1= 14

L2= 135

MERCEDES-BENZ

24.2025-1702.3

010515



Hauptbremszylinder

Ø1 25,4

Ø2 19

2x

Gewindemaß 1: 1x M10x1

Gewindemaß 2: 1x M12x1

L1= 51,3

L2= 106,2

MERCEDES-BENZ

24.2025-1703.3

010516



Hauptbremszylinder

Ø1 25,4

Ø2 19

M12x1

2x

L1= 51,3

L2= 106,2

MERCEDES-BENZ

24.2025-1704.3

010619



Hauptbremszylinder

Ø 25,4

3x

Gewindemaß 1: 1x M10x1

Gewindemaß 2: 2x M12x1

L1= 51,3

L2= 107,7

BMW

24.2025-1705.3

010624



Hauptbremszylinder

Ø1 25,4

Ø2 20,6

2x

TRW

Gewindemaß 1: 1x M10x1

Gewindemaß 2: 1x M12x1

L1= 51,5

L2= 108

BMW

24.2025-1706.3

010676



Hauptbremszylinder

Ø 25,4

2x

Gewindemaß 1: 1x M10x1

Gewindemaß 2: 1x M12x1

L1= 33

L2= 127

NISSAN, OPEL, RENAULT, VAUXHALL

24.2025-1707.3

010691



Hauptbremszylinder

Ø 25,4

M12x1

2x

L1= 51,7

L2= 108,5

BMW

24.2025-1708.3

010692



Hauptbremszylinder

Ø 25,4

5x

Gewindemaß 1: 3x M10x1

Gewindemaß 2: 2x M12x1

L1= 33

L2= 127

NISSAN, OPEL, RENAULT, VAUXHALL

24.2025-1709.3

010693



Hauptbremszylinder

Ø 25,4

M12x1

2x

L1= 51,3

L2= 108

MERCEDES-BENZ

24.2025-1710.3

010833



Hauptbremszylinder

Ø 25,4

M12x1

2x

TRW

L1= 69,3

L2= 90

BMW

24.2025-2311.3

011023



Hauptbremszylinder

Ø1 25,4

Ø2 20,6

M12x1

2x

ATE

L1= 114,3

L2= 57,6

MERCEDES-BENZ

24.2026-1701.3

010746



Hauptbremszylinder

Ø2 20,6

Ø 27

M12x1

3x

L1= 51,2

L2= 107,3

BMW

24.2026-1702.3

010850



Hauptbremszylinder

Ø2 22,2

Ø 27

M12x1

2x

TRW

L1= 69,2

L2= 90,5

BMW

24.2026-1704.3

010989



Hauptbremszylinder

Ø2 20,6

Ø 27

M14x1

2x

TRW

L1= 51,5

L2= 109

LAND ROVER

24.2026-1705.3

010992



Hauptbremszylinder

Ø2 20,6

Ø 27

M12x1

3x

TRW

L1= 51

L2= 110

BMW, LAND ROVER

24.2026-1706.3

011040



Hauptbremszylinder

Ø2 22,2

Ø 27

M12x1

2x

TRW

L1= 69,5

L2= 92

BMW

24.2119-0815.3

010347



Hauptbremszylinder

Ø 19

M10x1,25

3x

L1= 12

L2= 177,5

FIAT, FSO

24.2119-0826.3

010349



Hauptbremszylinder

Ø 19

M10x1

3x

L1= 12

L2= 178,4

FIAT, SEAT

24.2119-0827.3

010350



Hauptbremszylinder

Ø 19

M10x1

3x

L1= 12

L2= 178

FIAT

24.2119-0829.3

010351



Hauptbremszylinder

Ø 19

M10x1

3x

L1= 9

L2= 194,1

LANCIA

24.2119-0831.3

010416



Hauptbremszylinder

Ø 19
M10x1,25
3x
L1= 9,5
L2= 190
LADA

24.2119-0832.3

010417



Hauptbremszylinder

Ø 19
M10x1,25
3x
L1= 9,5
L2= 190
LADA

24.2119-0833.3

010418



Hauptbremszylinder

Ø 19
M10x1
4x
L1= 10,5
L2= 190
FIAT

24.2119-1702.3

010435



Hauptbremszylinder

Ø 19
M10x1
4x
BDX
L1= 40
L2= 115,2
PEUGEOT

24.2119-1705.3

010460



Hauptbremszylinder

Ø 19
M10x1
2x
L1= 8,5
L2= 192,5
CITROËN

24.2119-1708.3**010543****Hauptbremszylinder**

Ø 19

M10x1

4x

BDX

L1= 34,5

L2= 116,5

CITROËN, PEUGEOT**24.2119-1711.3****010911****Hauptbremszylinder**

Ø 19

M12x1

2x

ohne Bremsflüssigkeitsbehälter

L1= 41

L2= 116,5

SMART**24.2119-1712.3****010912****Hauptbremszylinder**

Ø 19

M12x1

2x

ohne Bremsflüssigkeitsbehälter

L1= 38,5

L2= 140

SKODA, VW**24.2120-0702.3****010361****Hauptbremszylinder**

Ø 20,6

4x

nicht für Delco

Gewindemaß 1: 2x M10x1

Gewindemaß 2: 2x M12x1

L1= 16

L2= 130

CHEVROLET, OPEL, VAUXHALL

24.2120-0801.3**010362****Hauptbremszylinder**

Ø 20,6

M10x1

3x

L1= 9

L2= 190,2

FIAT**24.2120-0802.3****010363****Hauptbremszylinder**

Ø 20,6

M10x1

3x

ATE

L1= 39,1

L2= 120,4

FIAT**24.2120-0803.3****010415****Hauptbremszylinder**

Ø 20,6

M10x1,25

4x

L1= 9

L2= 178,5

LADA**24.2120-1604.3****010370****Hauptbremszylinder**

Ø 20,6

2x

Gewindemaß 1: 1x M10x1

Gewindemaß 2: 1x M12x1

L1= 16,5

L2= 172,5

FORD**24.2120-1701.3****010427****Hauptbremszylinder**

Ø 20,6

M10x1

2x

L1= 38

L2= 114,2

PEUGEOT

24.2120-1704.3**010429****Hauptbremszylinder**

Ø 20,6

M10x1

4x

BDX

L1= 40

L2= 114,2

PEUGEOT**24.2120-1706.3****010262****Hauptbremszylinder**

Ø 20,6

M10x1

4x

L1= 40,1

L2= 118

RENAULT**24.2120-1710.3****010468****Hauptbremszylinder**

Ø 20,6

M10x1

4x

L1= 33,5

L2= 130

FIAT, LANCIA**24.2120-1714.3****010455****Hauptbremszylinder**

Gewindemaß 1: 1x M10x1

Ø 20,6

Gewindemaß 2: 1x M12x1

2x

L1= 16

L2= 130,5

CHEVROLET, OPEL, VAUXHALL**24.2120-1721.3****010553****Hauptbremszylinder**

Ø 20,6

3x

Gewindemaß 1: 2x M10x1

Gewindemaß 2: 1x M12x1

L1= 51,3

L2= 143,8

BMW

24.2120-1722.3**010544****Hauptbremszylinder**

Ø 20,6

M10x1

4x

L1= 34,5

L2= 116,5

CITROËN, PEUGEOT**24.2120-1723.3****010545****Hauptbremszylinder**

Ø 20,6

M10x1

2x

BDX

L1= 34,5

L2= 118

RENAULT**24.2120-1725.3****010579****Hauptbremszylinder**

Ø 20,6

M10x1

2x

BDX

L1= 34,5

L2= 118

RENAULT**24.2120-1726.3****010564****Hauptbremszylinder**

Ø 20,6

2x

BDX

Gewindemaß 1: 1x M10x1

Gewindemaß 2: 1x M12x1

L1= 33

L2= 120

PEUGEOT**24.2120-1730.3****010678****Hauptbremszylinder**

Ø 20,6

M10x1

2x

L1= 34,5

L2= 116,2

OPEL, SUBARU, SUZUKI, VAUXHALL

24.2120-1734.3**010702****Hauptbremszylinder**

Ø 20,6

M12x1

2x

L1= 38,5

L2= 139,5

SEAT, SKODA, VW**24.2120-1736.3****010732****Hauptbremszylinder**

Ø 20,6

M12x1

4x

L1= 28,1

L2= 138,2

SEAT, SKODA, VW**24.2120-1737.3****010757****Hauptbremszylinder**

Ø 20,6

4x

Gewindemaß 1: 2x M10x1

Gewindemaß 2: 2x M12x1

L1= 30

L2= 117

PEUGEOT**24.2120-1738.3****010759****Hauptbremszylinder**

Ø 20,6

4x

TRW

Gewindemaß 1: 2x M10x1

Gewindemaß 2: 2x M12x1

L1= 51

L2= 139

NISSAN, RENAULT**24.2120-1740.3****010764****Hauptbremszylinder**

Ø 20,6

M12x1

4x

TRW

L1= 51

L2= 139

NISSAN, RENAULT

24.2120-1741.3

010775



Hauptbremszylinder

Ø 20,6

M12x1

4x

L1= 24

L2= 132

CITROËN

24.2120-1742.3

010776



Hauptbremszylinder

Ø 20,6

M10x1

4x

L1= 33

L2= 125

FIAT

24.2120-1743.3

010777



Hauptbremszylinder

Ø 20,6

M10x1

2x

L1= 33

L2= 125

FIAT

24.2120-1744.3

010820



Hauptbremszylinder

Ø 20,6

M10x1

4x

L1= 36,5

L2= 132,5

FIAT

24.2120-1746.3

010835



Hauptbremszylinder

Ø 20,6

M12x1

2x

BOS

L1= 33

L2= 130,5

FIAT

24.2120-1747.3

010836



Hauptbremszylinder

Ø 20,6

M10x1

2x

BOS

L1= 36,5

L2= 134

FIAT

24.2120-1748.3

010894



Hauptbremszylinder

Ø 20,6

M12x1

2x

TRW

L1= 25

L2= 162

OPEL, RENAULT, VAUXHALL

24.2120-1749.3

010903



Hauptbremszylinder

Ø 20,6

L= 245

M10x1

2x

TRW

TOYOTA

24.2120-1751.3

010909



Hauptbremszylinder

Ø 20,6

M10x1

2x

L1= 15,5

L2= 153,5

HONDA

24.2120-1752.3

010928



Hauptbremszylinder

Ø 20,6

M10x1

2x

ATE

mit Bremsflüssigkeitsbehälter

L1= 26

L2= 157

HONDA

24.2120-1753.3

010946

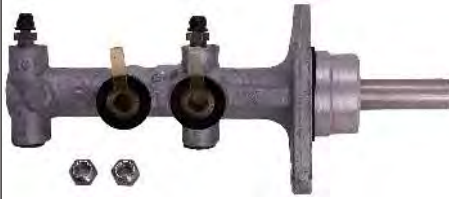

Hauptbremszylinder

Ø 20,6

2x M10x1

4x

TRW

Gewindemaß 2: 2x M12x1

L1= 25

L2= 160

OPEL, RENAULT, VAUXHALL

24.2120-1754.3

010949



Hauptbremszylinder

Ø 20,6

2x

Gewindemaß 1: M10x1

Gewindemaß 2: M12x1

L1= 23,5

L2= 107,5

DACIA, RENAULT

24.2120-1755.3

010974



Hauptbremszylinder

Ø 20,6

2x M10x1

2x

ohne Bremsflüssigkeitsbehälter

L1= 16,5

L2= 129,5

CHEVROLET, DAEWOO

24.2120-1756.3

010975



Hauptbremszylinder

Ø 20,6

2x M10x1

2x

ohne Bremsflüssigkeitsbehälter

L1= 29,5

L2= 152

MAZDA

24.2120-1757.3**010976****Hauptbremszylinder**

Ø 20,6

2x M10x1

2x

ohne Bremsflüssigkeitsbehälter

L1= 23

L2= 172

TOYOTA**24.2120-1759.3****011083****Hauptbremszylinder**

Ø 20,6

M12x1

2x

Aluguss

ohne Bremsflüssigkeitsbehälter

L1= 19

L2= 173,3

HONDA**24.2120-1760.3****011018****Hauptbremszylinder**

Ø 20,6

2x M14x1,5

2x

ohne Bremsflüssigkeitsbehälter

L1= 13,5

L2= 169,5

TOYOTA**24.2120-1761.3****011090****Hauptbremszylinder**

Ø 20,6

M12x1

2x

ohne Bremsflüssigkeitsbehälter

L1= 28

L2= 105,4

MAZDA

24.2120-1765.3

011003



Hauptbremszylinder

Ø 20,6

M10x1

2x

ohne Bremsflüssigkeitsbehälter

L1= 16

L2= 129,5

CHEVROLET, DAEWOO

24.2120-1766.3

011000



Hauptbremszylinder

Ø 20,6

M10x1

2x

ohne Bremsflüssigkeitsbehälter

L1= 33

L2= 116,5

TOYOTA

24.2120-1767.3

011004



Hauptbremszylinder

Ø 20,6

M10x1

2x

ohne Bremsflüssigkeitsbehälter

L1= 38,5

L2= 113,5

HYUNDAI

24.2120-1768.3

011041



Hauptbremszylinder

Ø 20,6

M12x1

2x

ohne Bremsflüssigkeitsbehälter

L1= 26

L2= 143

SKODA

24.2122-1588.3**011028****Hauptbremszylinder**

Ø 22,2

M10x1

4x

ATE

ohne Druckregler

L1= 27,4

L2= 124

FORD**24.2122-1703.3****010422****Hauptbremszylinder**

Ø 22,2

M10x1

4x

L1= 36,2

L2= 115,2

CITROËN, FIAT, PEUGEOT**24.2122-1704.3****010423****Hauptbremszylinder**

Ø 22,2

M10x1

4x

L1= 39

L2= 115,5

CITROËN, PEUGEOT**24.2122-1705.3****010434****Hauptbremszylinder**

Ø 22,2

M10x1

4x

L1= 36,5

L2= 118

PEUGEOT**24.2122-1707.3****010438****Hauptbremszylinder**

Ø 22,2

M10x1

4x

L1= 36,5

L2= 128

RENAULT

24.2122-1708.3

010437



Hauptbremszylinder

Ø 22,2

M10x1

2x

L1= 35

L2= 131,5

CITROËN, FIAT, PEUGEOT

24.2122-1715.3

010481



Hauptbremszylinder

Ø 22,2

M10x1

5x

L1= 19

L2= 167

CITROËN, FIAT, PEUGEOT

24.2122-1716.3

010485



Hauptbremszylinder

Ø 22,2

M10x1

4x

L1= 36

L2= 132

ALFA ROMEO, FIAT, LANCIA

24.2122-1718.3

010517



Hauptbremszylinder

Ø 22,2

M10x1

2x

L1= 36,5

L2= 117

MITSUBISHI, VOLVO

24.2122-1724.3

010561



Hauptbremszylinder

Ø 22,2

2x

Gewindemaß 1: 1x M10x1

Gewindemaß 2: 1x M12x1

L1= 23,5

L2= 122,5

OPEL, VAUXHALL

24.2122-1727.3

010586



Hauptbremszylinder

Ø 22,2

4x

BDX

Gewindemaß 1: 2x M10x1

Gewindemaß 2: 2x M12x1

L1= 34,5

L2= 115,5

NISSAN, RENAULT

24.2122-1731.3

010656



Hauptbremszylinder

Ø 22,2

M10x1

4x

L1= 36

L2= 150,2

SKODA, VW

24.2122-1733.3

010668



Hauptbremszylinder

Ø 22,2

4x

Gewindemaß 1: 2x M10x1

Gewindemaß 2: 2x M12x1

L1= 34,5

L2= 165

CITROËN, PEUGEOT

24.2122-1740.3

010711



Hauptbremszylinder

Ø 22,2

2x

DEL

Gewindemaß 1: 1x M10x1

Gewindemaß 2: 1x M12x1

L1= 27,5

L2= 118,5

OPEL, VAUXHALL

24.2122-1741.3

010695



Hauptbremszylinder

Ø 22,2

M10x1

4x

L1= 36

L2= 115

CITROËN, PEUGEOT

24.2122-1743.3

010712



Hauptbremszylinder

Ø 22,2

4x

Gewindemaß 1: 2x M10x1

Gewindemaß 2: 2x M12x1

L1= 29

L2= 117

CITROËN

24.2122-1750.3

010740



Hauptbremszylinder

Ø 22,2

M10x1

4x

L1= 29,5

L2= 120,5

FIAT

24.2122-1761.3

010822



Hauptbremszylinder

Ø 22,2

M10x1

2x

L1= 16

L2= 154,3

HYUNDAI

24.2122-1762.3

010837



Hauptbremszylinder

Ø 22,2

M10x1

2x

L1= 30

L2= 131

FIAT, LANCIA

24.2122-1764.3**010851****Hauptbremszylinder**

Ø 22,2

M12x1

2x

BOS

L1= 26,5

L2= 138

CITROËN, PEUGEOT**24.2122-1765.3****010839****Hauptbremszylinder**

Ø 22,2

M10x1

2x

L1= 16

L2= 154

HYUNDAI**24.2122-1766.3****010840****Hauptbremszylinder**

Ø 22,2

M12x1

2x

TRW

L1= 25

L2= 135

CITROËN, PEUGEOT**24.2122-1767.3****010841****Hauptbremszylinder**

Ø 22,2

M12x1

3x

TRW

ohne Drucksensor

L1= 25

L2= 135

CITROËN, PEUGEOT**24.2122-1768.3****010853****Hauptbremszylinder**

Ø 22,2

M12x1

2x

L1= 30

L2= 131

FIAT, LANCIA

24.2122-1770.3

010898



Hauptbremszylinder

Ø 22,2

M12x1

2x

TRW

L1= 45

L2= 114

MITSUBISHI, SMART

24.2122-1774.3

010987



Hauptbremszylinder

Ø 22,2

M12x1

2x

ohne Bremsflüssigkeitsbehälter

L1= 19

L2= 161

NISSAN

24.2122-1775.3

010981



Hauptbremszylinder

Ø 22,2

M10x1

4x

ohne Bremsflüssigkeitsbehälter

L1= 16,5

L2= 175,5

FORD

24.2122-1776.3

011001



Hauptbremszylinder

Ø 22,2

3x M10x1

3x

ohne Bremsflüssigkeitsbehälter

L1= 29,5

L2= 111,5

SUZUKI

24.2122-1777.3

011056



Hauptbremszylinder

Ø 22,2

2x M10x1

2x

ohne Bremsflüssigkeitsbehälter

L1= 33

L2= 138

FIAT

24.2122-1779.3

011064



Hauptbremszylinder

Ø 22,2

M10x1

2x

Aluguss

ohne Bremsflüssigkeitsbehälter

L1= 14

TOYOTA

24.2122-1981.3

011024



Hauptbremszylinder

Ø 22,2

M12x1

2x

ATE

ohne Bremsflüssigkeitsbehälter

L1= 113

L2= 66

AUDI, SEAT, SKODA, VW

24.2123-1602.3

010384



Hauptbremszylinder

Ø 23,8

M10x1

2x

TRW

L1= 32

L2= 126,5

AUDI

24.2123-1701.3

010424



Hauptbremszylinder

Ø 23,8

M10x1

4x

L1= 36,5

L2= 126,7

RENAULT

24.2123-1707.3**010492****Hauptbremszylinder**

Ø 23,8

M10x1

4x

L1= 36

L2= 117,5

CITROËN, FIAT, PEUGEOT**24.2123-1709.3****010503****Hauptbremszylinder**

Ø 23,8

M12x1

2x

L1= 32

L2= 122

AUDI, SEAT, SKODA, VW**24.2123-1710.3****010504****Hauptbremszylinder**

Ø 23,8

M10x1

4x

L1= 36

L2= 118

CITROËN, PEUGEOT**24.2123-1711.3****010518****Hauptbremszylinder**

Ø 23,8

M10x1

2x

L1= 35

L2= 165

MERCEDES-BENZ, VW**24.2123-1712.3****010519****Hauptbremszylinder**

Ø 23,8

M10x1

4x

L1= 36

L2= 120

MERCEDES-BENZ

24.2123-1713.3

010505



Hauptbremszylinder

Ø 23,8

M12x1

2x

L1= 34,5

L2= 127

CITROËN, PEUGEOT

24.2123-1714.3

010587



Hauptbremszylinder

Ø 23,8

4x

BDX

Gewindemaß 1: 2x M10x1

Gewindemaß 2: 2x M12x1

L1= 33

L2= 120,5

CITROËN, PEUGEOT

24.2123-1715.3

010520



Hauptbremszylinder

Ø 23,8

2x

BDX

Gewindemaß 1: 1x M10x1

Gewindemaß 2: 1x M12x1

L1= 33

L2= 120,5

CITROËN, PEUGEOT

24.2123-1717.3

010521



Hauptbremszylinder

Ø 23,8

M12x1

2x

L1= 39,5

L2= 121,5

AUDI, PORSCHE, VW

24.2123-1724.3**010566****Hauptbremszylinder**

Ø 23,8

3x

BDX

Gewindemaß 1: 2x M10x1

Gewindemaß 2: 1x M12x1

L1= 10

L2= 203

FORD**24.2123-1725.3****010549****Hauptbremszylinder**

Ø 23,8

4x

Gewindemaß 1: 2x M10x1

Gewindemaß 2: 2x M12x1

L1= 36,5

L2= 126,5

RENAULT**24.2123-1728.3****010558****Hauptbremszylinder**

Ø 23,8

M10x1

2x

L1= 36

L2= 128

VW**24.2123-1729.3****010567****Hauptbremszylinder**

Ø 23,8

M10x1

2x

L1= 35

L2= 150,8

MERCEDES-BENZ**24.2123-1730.3****010620****Hauptbremszylinder**

Ø 23,8

2x

Gewindemaß 1: 1x M10x1

Gewindemaß 2: 1x M12x1

L1= 39,5

L2= 120,5

AUDI, PORSCHE, VW

24.2123-1731.3**010621****Hauptbremszylinder**

Ø 23,8

M12x1

2x

L1= 32

L2= 124,5

AUDI**24.2123-1732.3****010625****Hauptbremszylinder**

Ø 23,8

M10x1

4x

ohne Bremsflüssigkeitsbehälter

L1= 36

L2= 105,5

FORD**24.2123-1733.3****010657****Hauptbremszylinder**

Ø 23,8

M10x1

2x

BOS

L1= 36,5

L2= 126,7

CITROËN, FIAT, LANCIA, PEUGEOT**24.2123-1734.3****010640****Hauptbremszylinder**

Ø 23,8

2x

TRW

Gewindemaß 1: 1x M10x1

Gewindemaß 2: 1x M12x1

L1= 39,5

L2= 119,5

CHEVROLET, OPEL, VAUXHALL

24.2123-1737.3

010654



Hauptbremszylinder

Ø 23,8

M10x1

4x

L1= 17

L2= 174

FORD

24.2123-1738.3

010658



Hauptbremszylinder

Ø 23,8

M10x1

4x

L1= 36

L2= 118,5

CITROËN, FIAT, PEUGEOT

24.2123-1739.3

010661



Hauptbremszylinder

Ø 23,8

M12x1

2x

L1= 39,5

L2= 121

CHEVROLET, OPEL, VAUXHALL

24.2123-1741.3

010681



Hauptbremszylinder

Ø 23,8

M12x1

2x

L1= 33

L2= 127

PEUGEOT

24.2123-1742.3**010671****Hauptbremszylinder**

Ø 23,8

M12x1

2x

L1= 33

L2= 121

FORD**24.2123-1746.3****010682****Hauptbremszylinder**

Ø 23,8

M10x1

2x

L1= 36,5

L2= 116,5

VOLVO**24.2123-1749.3****010713****Hauptbremszylinder**

Ø 23,8

M10x1

2x

L1= 33

L2= 120

FORD**24.2123-1751.3****010698****Hauptbremszylinder**

Ø 23,8

M10x1

4x

L1= 36

L2= 118

PEUGEOT**24.2123-1754.3****010741****Hauptbremszylinder**

Ø 23,8

M12x1

2x

L1= 67

L2= 111,5

MERCEDES-BENZ

24.2123-1755.3**010750****Hauptbremszylinder**

Ø 23,8

M10x1

2x

L1= 67

L2= 110

VW**24.2123-1759.3****010768****Hauptbremszylinder**

Ø 23,8

M12x1

2x

BOS

L1= 39

L2= 143,2

NISSAN, OPEL, RENAULT, VAUXHALL**24.2123-1760.3****010779****Hauptbremszylinder**

Ø 23,8

M12x1

2x

TRW

L1= 25

L2= 155

RENAULT**24.2123-1762.3****010823****Hauptbremszylinder**

Ø 23,8

M10x1

2x

L1= 15

L2= 161

HYUNDAI**24.2123-1763.3****010842****Hauptbremszylinder**

Ø 23,8

M10x1

2x

L1= 32,5

L2= 131

FIAT, LANCIA

24.2123-1764.3**010824****Hauptbremszylinder**

Ø 23,8

2x

TRW

Gewindemaß 1: 1x M10x1

Gewindemaß 2: 1x M12x1

L1= 29

L2= 132

OPEL, VAUXHALL**24.2123-1766.3****010825****Hauptbremszylinder**

Ø 23,8

M12x1

2x

TRW

L1= 40

L2= 121

PORSCHE**24.2123-1767.3****010844****Hauptbremszylinder**

Ø 23,8

M10x1

2x

BOS

L1= 31

L2= 131

OPEL, VAUXHALL**24.2123-1771.3****010857****Hauptbremszylinder**

Ø 23,8

2x M14x1,5

2x

BOS

ohne Bremsflüssigkeitsbehälter

L1= 37

L2= 131

TOYOTA

24.2123-1772.3

010858



Hauptbremszylinder

Ø 23,8

M12x1

2x

BOS

L1= 73

L2= 122

MERCEDES-BENZ

24.2123-1776.3

010926



Hauptbremszylinder

Ø 23,8

M12x1

2x

TRW

L1= 40

L2= 115

MERCEDES-BENZ

24.2123-1777.3

010943



Hauptbremszylinder

Ø 23,8

2x

Gewindemaß 1: 1x M10x1

Gewindemaß 2: 1x M12x1

L1= 39,5

L2= 120,5

OPEL, VAUXHALL

24.2123-1778.3

010947



Hauptbremszylinder

Ø 23,8

2x M12x1

2x

TRW

L1= 72

L2= 122

MERCEDES-BENZ

24.2123-1779.3

011078



Hauptbremszylinder

Ø 23,8

M12x1

2x

Aluguss

ohne Bremsflüssigkeitsbehälter

L1= 36

L2= 135

FORD

24.2123-1780.3

011081



Hauptbremszylinder

Ø 23,8

M12x1

2x

Aluguss

ohne Bremsflüssigkeitsbehälter

L1= 41

L2= 104

SMART

24.2125-1702.3

010482



Hauptbremszylinder

Ø 25,4

M10x1

2x

L1= 19

L2= 173,5

CITROËN, FIAT, PEUGEOT

24.2125-1703.3

010483



Hauptbremszylinder

Ø 25,4

M10x1

5x

L1= 9

L2= 168

CITROËN, FIAT, OPEL, PEUGEOT, VAUXHALL

24.2125-1704.3**010446****Hauptbremszylinder**

Ø 25,4

2x

TRW

Gewindemaß 1: 1x M10x1

Gewindemaß 2: 1x M12x1

L1= 15,5

L2= 189

OPEL, RENAULT, VAUXHALL**24.2125-1709.3****010499****Hauptbremszylinder**

Ø 25,4

M12x1

2x

L1= 38

L2= 125

FORD**24.2125-1712.3****010622****Hauptbremszylinder**

Ø 25,4

M12x1

2x

L1= 49,5

L2= 111,5

AUDI, VW**24.2125-1713.3****010623****Hauptbremszylinder**

Ø 25,4

2x

Gewindemaß 1: 1x M10x1

Gewindemaß 2: 1x M12x1

L1= 49

L2= 111

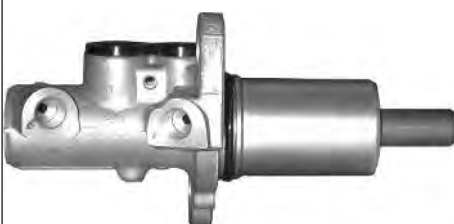
AUDI, VW**24.2125-1720.3****010688****Hauptbremszylinder**

Ø 25,4

M12x1

2x

TRW

L1= 69,5

L2= 92

AUDI, SEAT, SKODA, VW

24.2125-1721.3**010673****Hauptbremszylinder**

Ø 25,4

4x

Gewindemaß 1: 2x M10x1

Gewindemaß 2: 2x M12x1

ohne Bremsflüssigkeitsbehälter

L1= 43

L2= 110,5

FORD**24.2125-1722.3****010674****Hauptbremszylinder**

Ø 25,4

M12x1

2x

ohne Bremsflüssigkeitsbehälter

L1= 42,5

L2= 110,5

FORD**24.2125-1725.3****010717****Hauptbremszylinder**

Ø 25,4

M10x1

5x

L1= 33

L2= 147

CITROËN, FIAT, PEUGEOT**24.2125-1726.3****010718****Hauptbremszylinder**

Ø 25,4

M10x1

2x

L1= 33

L2= 147

CITROËN, FIAT, PEUGEOT**24.2125-1727.3****010723****Hauptbremszylinder**

Ø 25,4

M10x1

2x

L1= 35

L2= 165,3

MERCEDES-BENZ, VW

24.2125-1728.3

010751



Hauptbremszylinder

Ø 25,4

M12x1

2x

L1= 67

L2= 111,5

MERCEDES-BENZ

24.2125-1729.3

010752



Hauptbremszylinder

Ø 25,4

M12x1

2x

L1= 47

L2= 114

ALFA ROMEO

24.2125-1731.3

010826



Hauptbremszylinder

Ø 25,4

M12x1

2x

TRW

L1= 47,5

L2= 113

NISSAN, OPEL, RENAULT, VAUXHALL

24.2125-1732.3

010827



Hauptbremszylinder

Ø 25,4

M12x1

2x

TRW

L1= 40

L2= 122

ALFA ROMEO, CHEVROLET, FIAT, OPEL, SAAB, VAUXHALL

24.2125-1735.3

010879



Hauptbremszylinder

Ø 25,4

M10x1

2x

TRW

L1= 67

L2= 111,5

VW

24.2125-1736.3**010904****Hauptbremszylinder**

Ø 25,4

M12x1

2x

TRW

L1= 31

L2= 129

OPEL, VAUXHALL**24.2125-1737.3****010906****Hauptbremszylinder**

Ø 25,4

2x

TRW

Gewindemaß 1: M10x1

Gewindemaß 2: M12x1

L1= 31

L2= 129

OPEL, VAUXHALL**24.2125-1739.3****010948****Hauptbremszylinder**

Ø 25,4

M12x1

2x

TRW

L1= 69

L2= 90

AUDI**24.2125-1740.3****010971****Hauptbremszylinder**

Ø 25,4

2x M12x1

2x

TRW

L1= 47

L2= 113

OPEL, VAUXHALL

24.2125-1741.3**010988****Hauptbremszylinder**

Ø 25,4

M10x1

2x

ohne Bremsflüssigkeitsbehälter

L1= 15,7

L2= 152,5

NISSAN**24.2125-1742.3****010978****Hauptbremszylinder**

Ø 25,4

M12x1

2x

TRW

L1= 25,3

L2= 157

RENAULT**24.2125-1747.3****011029****Hauptbremszylinder**

Ø 25,4

M10x1

2x

Aluguss

L1= 18,5

L2= 142,4

FORD, MAZDA**24.2125-1748.3****011030****Hauptbremszylinder**

Ø 25,4

M12x1

2x

Aluguss

TRW

L1= 70,5

L2= 140,5

MERCEDES-BENZ

24.2125-1749.3

011031



Hauptbremszylinder

Ø 25,4

M12x1

2x

Aluguss

TRW

L1= 66,5

L2= 93

AUDI

24.2125-1750.3

011050



Hauptbremszylinder

Ø 25,4

M12x1

2x

Aluguss

ohne Bremsflüssigkeitsbehälter

L1= 73,5

L2= 124,5

MERCEDES-BENZ, VW

24.2126-1702.3

010950



Hauptbremszylinder

Ø 27

2x M10x1

2x

L1= 19

L2= 133

KIA

24.2126-1704.3

010990



Hauptbremszylinder

Ø 27

2x M12x1

2x

TRW

L1= 72

L2= 120

MERCEDES-BENZ, VW

24.2126-1705.3

010999



Hauptbremszylinder

Ø 27
M12x1
2x
TRW
L1= 90,5
L2= 69,3
AUDI

24.2126-3032.3

011036



Hauptbremszylinder

Ø 27
M12x1
2x
ATE
ohne Bremsflüssigkeitsbehälter
L1= 18,7
L2= 133,5
PORSCHE, VW

24.2126-3071.3

011037



Hauptbremszylinder

Ø 27
M12x1
2x
ATE
ohne Bremsflüssigkeitsbehälter
L1= 23,3
L2= 128,9
AUDI

24.2126-3131.3

011038



Hauptbremszylinder

Ø 27
M12x1
2x
ATE
ohne Bremsflüssigkeitsbehälter
L1= 37,2
L2= 139,8
VW

24.4025-1701.3

010719



Hauptbremszylinder

Ø 25,4

M12x1

2x

L1= 51

L2= 67,2

MERCEDES-BENZ

24.4120-1701.3

010846



Hauptbremszylinder

Ø 20,6

M10x1

2x

BOS

L1= 32

L2= 86,3

CITROËN, PEUGEOT, TOYOTA

24.4120-1702.3

010913



Hauptbremszylinder

Ø 20,6

M10x1

2x

TRW

ohne Bremsflüssigkeitsbehälter

L1= 6

L2= 119

FIAT

24.4120-1703.3

011015



Hauptbremszylinder

Ø 20,6

M12x1

2x

TRW

ohne Bremsflüssigkeitsbehälter

L1= 11,3

L2= 107

SEAT, SKODA, VW

24.4120-1704.3

011042

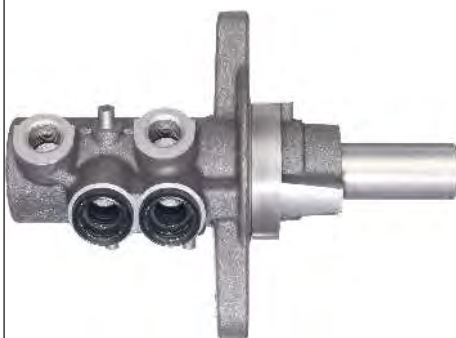

Hauptbremszylinder

Ø 20,6

M12x1

2x

Aluguss

ohne Bremsflüssigkeitsbehälter

L1= 32

L2= 85

CITROËN, PEUGEOT, TOYOTA

24.4120-1705.3

011051



Hauptbremszylinder

Ø 20,6

M12x1

2x

Aluguss

ohne Bremsflüssigkeitsbehälter

L1= 32

L2= 86

CITROËN, PEUGEOT, TOYOTA

24.4120-1706.3

011072



Hauptbremszylinder

Ø 20,6

M10x1

2x

Aluguss

ohne Bremsflüssigkeitsbehälter

L1= 5,5

L2= 110,5

FORD

24.4120-1708.3

011084



Hauptbremszylinder

Ø 20,6

M12x1

2x

Aluguss

ohne Bremsflüssigkeitsbehälter

L1= 32

L2= 85,4

TOYOTA

24.4120-1710.3

011082



Hauptbremszylinder

Ø 20,6

M12x1

2x

Aluguss

ohne Bremsflüssigkeitsbehälter

L1= 32

L2= 87,4

FORD

24.4120-1711.3

011093



Hauptbremszylinder

Ø 20,6

M10x1

2x

Aluguss

ohne Bremsflüssigkeitsbehälter

L1= 32

L2= 87,4

FORD

24.4120-1712.3

011092



Hauptbremszylinder

Ø 20,6

M10x1

2x

Aluguss

ohne Bremsflüssigkeitsbehälter

L1= 32

L2= 85,4

CITROËN, PEUGEOT, TOYOTA

24.4120-1713.3

011102



Hauptbremszylinder

Ø 20,6

M12x1

2x

Aluguss

ohne Bremsflüssigkeitsbehälter

L1= 12

L2= 96,9

HYUNDAI

24.4122-1701.3

010533



Hauptbremszylinder

Ø 22,2

M12x1

2x

TRW

L1= 10,2

L2= 109

MERCEDES-BENZ

24.4122-1703.3

010843



Hauptbremszylinder

Ø 22,2

M12x1

2x

TRW

L1= 32

L2= 112

CITROËN, PEUGEOT

24.4122-1704.3

010847



Hauptbremszylinder

Ø 22,2

M10x1

2x

TRW

L1= 6

L2= 112

CITROËN, PEUGEOT

24.4122-1705.3

010852



Hauptbremszylinder

Ø 22,2

M12x1

2x

BOS

ohne Bremsflüssigkeitsbehälter

L1= 32

L2= 80

OPEL, VAUXHALL

24.4122-1708.3

010865



Hauptbremszylinder

Ø 22,2

M10x1

2x

BOS

ohne Bremsflüssigkeitsbehälter

L1= 20

L2= 95

CITROËN

24.4122-1709.3

010871



Hauptbremszylinder

Ø 22,2

M10x1

2x

BOS

ohne Bremsflüssigkeitsbehälter

L1= 32

L2= 78

ALFA ROMEO, FIAT, OPEL, VAUXHALL

24.4122-1712.3

010899



Hauptbremszylinder

Ø 22,2

M10x1

2x

ohne Bremsflüssigkeitsbehälter

BOS

FIAT, SUZUKI

24.4122-1713.3

010900



Hauptbremszylinder

Ø 22,2

M12x1

2x

ohne Bremsflüssigkeitsbehälter

BOS

FIAT, SUZUKI

24.4122-1714.3**010914****Hauptbremszylinder**

Ø 22,2

M10x1

2x

TRW

ohne Bremsflüssigkeitsbehälter

L1= 6

L2= 119

ABARTH, FIAT**24.4122-1717.3****010993****Hauptbremszylinder**

Ø 22,2

M12x1

2x

TRW

ohne Bremsflüssigkeitsbehälter

L1= 10,8

L2= 109

MITSUBISHI**24.4122-1718.3****011019****Hauptbremszylinder**

Ø 22,2

M10x1

2x

BOS

ohne Bremsflüssigkeitsbehälter

L1= 20

L2= 91,8

OPEL, SUZUKI, VAUXHALL**24.4122-1719.3****011020****Hauptbremszylinder**

Ø 22,2

M12x1

2x

ohne Bremsflüssigkeitsbehälter

L1= 20

L2= 91,8

OPEL, SUZUKI, VAUXHALL

24.4122-1720.3

011065



Hauptbremszylinder

Ø 22,2

M12x1

2x

Aluguss

ATE

ohne Bremsflüssigkeitsbehälter

L1= 20

L2= 91,8

RENAULT

24.4122-1721.3

011079



Hauptbremszylinder

Ø 22,2

M10x1

2x

Aluguss

ATE

ohne Bremsflüssigkeitsbehälter

L1= 21

L2= 86,8

FIAT

24.4122-1722.3

011085



Hauptbremszylinder

Ø 22,2

M12x1

2x

Aluguss

ohne Bremsflüssigkeitsbehälter

L1= 27

L2= 92

BMW, MINI

24.4122-1723.3

011086



Hauptbremszylinder

Ø 22,2

M12x1

2x

Aluguss

ohne Bremsflüssigkeitsbehälter

L1= 29

L2= 102

HYUNDAI, KIA

24.4122-1724.3

011080



Hauptbremszylinder

Ø 22,2

M10x1

2x

Aluguss

ATE

ohne Bremsflüssigkeitsbehälter

L1= 29

L2= 102

HYUNDAI, KIA

24.4122-1725.3

011087



Hauptbremszylinder

Ø 22,2

M12x1

2x

Aluguss

ohne Bremsflüssigkeitsbehälter

L1= 29

L2= 102

HYUNDAI

24.4122-1732.3

011107



Hauptbremszylinder

Ø 22,2

M12x1

2x

Aluguss

ohne Bremsflüssigkeitsbehälter

L1= 29

L2= 102

HYUNDAI, KIA

24.4122-1735.3

011113



Hauptbremszylinder

Ø 22,2

M12x1

2x

Aluguss

ohne Bremsflüssigkeitsbehälter

L1= 22

L2= 86,6

CHEVROLET

24.4123-1703.3

010831



Hauptbremszylinder

Ø 23,8

M12x1

2x

TRW

L1= 55

L2= 53

MERCEDES-BENZ

24.4123-1704.3

010828



Hauptbremszylinder

Ø 23,8

M12x1

2x

TRW

L1= 6

L2= 112

CITROËN, OPEL, PEUGEOT, VAUXHALL

24.4123-1705.3

010832



Hauptbremszylinder

Ø 23,8

M10x1

2x

TRW

L1= 6

L2= 112

CITROËN, PEUGEOT

24.4123-1708.3

010859



Hauptbremszylinder

Ø 23,8

2x M10x1

2x

BOS

L1= 32

L2= 83,5

FIAT, LANCIA

24.4123-1710.3**010866****Hauptbremszylinder**

Ø 23,8

M10x1

2x

BOS

ohne Bremsflüssigkeitsbehälter

L1= 32

L2= 86,2

CHRYSLER, FIAT, LANCIA**24.4123-1712.3****010897****Hauptbremszylinder**

Ø 23,8

M12x1

2x

TRW

L1= 14

L2= 95

MINI**24.4123-1713.3****010905****Hauptbremszylinder**

Ø 23,8

4x

BOS

Gewindemaß 1: 2x M10x1

Gewindemaß 2: 2x M12x1

ohne Bremsflüssigkeitsbehälter

L1= 31,7

L2= 93,5

FORD**24.4123-1714.3****010979****Hauptbremszylinder**

Ø 23,8

2x M12x1

2x

TRW

L1= 18

L2= 100

CITROËN, PEUGEOT

24.4123-1715.3**010980****Hauptbremszylinder**

Ø 23,8

2x M12x1

2x

TRW

L1= 5,7

L2= 147

RENAULT**24.4123-1717.3****010985****Hauptbremszylinder**

Ø 23,8

M12x1

2x

TRW

ohne Bremsflüssigkeitsbehälter

L1= 5,8

L2= 111,2

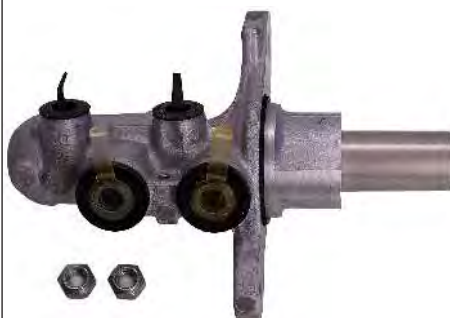
OPEL, VAUXHALL**24.4123-1718.3****011016****Hauptbremszylinder**

Ø 23,8

M12x1

2x

TRW

ohne Bremsflüssigkeitsbehälter

L1= 30,3

L2= 102,5

MERCEDES-BENZ**24.4123-1719.3****011017****Hauptbremszylinder**

Ø 23,8

M12x1

2x

TRW

ohne Bremsflüssigkeitsbehälter

L1= 5

L2= 126

AUDI, CUPRA, SEAT, SKODA, VW

24.4123-1720.3

011022



Hauptbremszylinder

Ø 23,8

M10x1

2x

BOS

ohne Bremsflüssigkeitsbehälter

L1= 32

L2= 79,9

ABARTH, ALFA ROMEO, OPEL, VAUXHALL

24.4123-1721.3

011052



Hauptbremszylinder

Ø 23,8

M12x1

2x

Aluguss

BOS

ohne Bremsflüssigkeitsbehälter

L1= 32

L2= 82

RENAULT

24.4123-1723.3

011074



Hauptbremszylinder

Ø 23,8

M12x1

2x

Aluguss

ohne Bremsflüssigkeitsbehälter

L1= 34

L2= 116

RENAULT

24.4123-1725.3

011073



Hauptbremszylinder

Ø 23,8

M12x1

2x

Aluguss

ohne Bremsflüssigkeitsbehälter

L1= 32

L2= 84

NISSAN

24.4123-1727.3

011088



Hauptbremszylinder

Ø 23,8

M12x1

2x

Aluguss

ohne Bremsflüssigkeitsbehälter

L1= 13,5

L2= 97,4

NISSAN

24.4123-1728.3

011089



Hauptbremszylinder

Ø 23,8

M12x1

2x

Aluguss

ohne Bremsflüssigkeitsbehälter

L1= 20

L2= 91

NISSAN, RENAULT

24.4123-1731.3

011094



Hauptbremszylinder

Ø 23,8

M12x1

2x

Aluguss

ohne Bremsflüssigkeitsbehälter

L1= 32

FIAT, JEEP

24.4123-1733.3

011108



Hauptbremszylinder

Ø 23,8

M12x1

2x

Aluguss

ohne Bremsflüssigkeitsbehälter

L1= 27

L2= 92

BMW, MINI

24.4125-1701.3

010867



Hauptbremszylinder

Ø 25,4

M12x1

2x

BOS

ohne Bremsflüssigkeitsbehälter

L1= 10,5

L2= 126,5

CITROËN, FIAT, PEUGEOT

24.4125-1702.3

010872



Hauptbremszylinder

Ø 25,4

M10x1

2x

BOS

ohne Bremsflüssigkeitsbehälter

L1= 10,5

L2= 126,5

CITROËN, FIAT, PEUGEOT

24.4125-1703.3

010907



Hauptbremszylinder

Ø 25,4

M12x1

2x

TRW

L1= 18

L2= 90,5

OPEL, VAUXHALL

24.4125-1704.3

010908



Hauptbremszylinder

Ø 25,4

2x

TRW

Gewindemaß 1: M10x1

Gewindemaß 2: M12x1

L1= 18

L2= 90,5

OPEL, VAUXHALL

24.4125-1708.3**011055****Hauptbremszylinder**

Ø 25,4

M12x1

2x

Aluguss

ohne Bremsflüssigkeitsbehälter

L1= 32,7

L2= 86,5

FORD**24.4126-1701.3****010868****Hauptbremszylinder**

Ø 27

M12x1

2x

BOS

ohne Bremsflüssigkeitsbehälter

L1= 10,5

L2= 126,5

CITROËN, FIAT, PEUGEOT**24.4126-1702.3****010875****Hauptbremszylinder**

Ø 27

M10x1

2x

BOS

ohne Bremsflüssigkeitsbehälter

L1= 10,5

L2= 126,5

CITROËN, FIAT, PEUGEOT**24.4150-1071.3****011046****Hauptbremszylinder**

Ø 20,6

M12x1

2x

Aluguss

ATE

ohne Bremsflüssigkeitsbehälter

L1= 25,8

L2= 86,1

RENAULT, SMART

24.4153-0222.3**011047****Hauptbremszylinder**

Ø 23,8

M12x1

2x

Aluguss

ATE

ohne Bremsflüssigkeitsbehälter

L1= 38,1

L2= 116,8

SEAT, VW**24.4153-1522.3****011048****Hauptbremszylinder**

Ø 23,8

M12x1

2x

Aluguss

ATE

ohne Bremsflüssigkeitsbehälter

L1= 18

L2= 123,3

AUDI, CUPRA, SEAT, SKODA, VW**24.4155-1236.3****011049****Hauptbremszylinder**

Ø 25,4

M12x1

2x

Aluguss

ATE

ohne Bremsflüssigkeitsbehälter

L1= 31,7

L2= 92

CITROËN, DS**24.4155-1311.3****011053****Hauptbremszylinder**

Ø 25,4

M12x1

2x

Aluguss

ATE

ohne Bremsflüssigkeitsbehälter

L1= 30,1

L2= 93,8

CITROËN, PEUGEOT

24.4156-1016.3**011068****Hauptbremszylinder**

Ø 27
 M12x1
 2x
 ATE
 L1= 19,5
 L2= 90
JAGUAR

24.4156-1076.3**011070****Hauptbremszylinder**

Ø 27
 M12x1
 2x
 ATE
 ohne Bremsflüssigkeitsbehälter
 L1= 19,5
 L2= 90
JAGUAR

24.4156-1270.3**011058****Hauptbremszylinder**

Ø 27
 M14x1
 2x
 Aluguss
 ATE
 ohne Bremsflüssigkeitsbehälter
 L1= 13,4
 L2= 101,5
LAND ROVER

24.4156-1391.3**011054****Hauptbremszylinder**

Ø 27
 M12x1
 2x
 Aluguss
 ATE
 ohne Bremsflüssigkeitsbehälter
 L1= 13,4
 L2= 101,5
VOLVO

24.9145-0001.2

399005



Hydraulikaggregat, Bremsanlage

ohne Steuergerät

empty/leer

Bremssystem: hyd.

+ ESP

empty/leer

AUDI, SEAT, SKODA, VW

24.9145-0003.2

399007



Hydraulikaggregat, Bremsanlage

für OE-Nummer: 34 51 6 863 354

ohne Steuergerät

empty/leer

Bremssystem: hyd.

+ ESP

BMW

24.9145-0004.2

399008



Hydraulikaggregat, Bremsanlage

ohne Steuergerät

empty/leer

Bremssystem: hyd.

+ ESP

FORD



24.9145-0005.2

399009



Hydraulikaggregat, Bremsanlage

ohne Steuergerät

empty/leer

Bremssystem: hyd.

+ ESP

VOLVO



DE Fahrzeugverwendungen

EN Applications of vehicles

















ES Aplicaciones















FR Applications















IT Applicazioni autoveicoli











2023

















	kw					! #		
ABARTH - 500 / 595 / 695 01/08→								
 Hauptbremszylinder								
1.4	99 - 140	08/08→				24.4122-1714.3	010914	TRW Ø 22,2 ohne Bremsflüssigkeitsbehälter
ABARTH - 500C / 595C / 695C 05/08→								
 Hauptbremszylinder								
1.4	99 - 132	05/08→				24.4122-1714.3	010914	TRW Ø 22,2 ohne Bremsflüssigkeitsbehälter
ABARTH - GRANDE PUNTO 07/07→06/10								
 Hauptbremszylinder								
1.4 1.4 ESSEESSE / SUPERSPORT	114 132	07/07→06/10 05/08→06/10				24.4123-1720.3	011022	BOS Ø 23,8 ohne Bremsflüssigkeitsbehälter
ABARTH - PUNTO 03/12→								
 Hauptbremszylinder								
1.4 1.4 SUPERSPORT	120 132	03/12→ 03/12→		für Linkslenker		24.4123-1720.3	011022	BOS Ø 23,8 ohne Bremsflüssigkeitsbehälter
ABARTH - PUNTO EVO 07/08→02/12								
 Hauptbremszylinder								
1.4	120	10/09→02/12		für Linkslenker		24.4123-1720.3	011022	BOS Ø 23,8 ohne Bremsflüssigkeitsbehälter
ALFA ROMEO - 145 (930_) 07/94→01/01								
 Hauptbremszylinder								
1.4 i.e. 16V T.S. 1.6 i.e. 16V T.S. 1.8 i.e. 16V T.S.	76 88 103	12/96→01/01 12/96→01/01 12/96→12/98		01/97→; GG		24.2122-1716.3	010485	Ø 22,2
1.6 16V T.S. 1.8 i.e. 16V 1.9 JTD 1.9 TD 2.0 16V 2.0 16V T.S.	82 106 77 66 114 110	09/97→12/00 03/98→01/01 02/99→01/01 10/94→02/99 03/98→01/01 10/95→01/01		GG		24.2122-1716.3	010485	Ø 22,2
ALFA ROMEO - 146 (930_) 12/94→10/01								
 Hauptbremszylinder								
1.4 i.e. 16V T.S. 1.6 i.e. 16V T.S. 1.8 i.e. 16V T.S.	76 88 103	11/96→01/01 11/96→10/01 11/96→01/01		01/97→; GG		24.2122-1716.3	010485	Ø 22,2
1.6 16V T.S. 1.8 i.e. 16V T.S. 1.9 JTD 1.9 TD 2.0 16V 2.0 16V T.S.	82 106 77 66 114 110	09/97→12/00 03/98→01/01 02/99→01/01 12/94→02/99 03/97→10/01 10/95→01/01		GG		24.2122-1716.3	010485	Ø 22,2
ALFA ROMEO - 155 (167_) 01/92→12/97								
 Hauptbremszylinder								
1.6 16V T.S. 1.7 T.S. 16V 1.9 TD 2.0 T.S. 16V 2.5 TD 2.5 V6	88 103 66 110 92 120	05/96→12/97 05/96→12/97 04/93→12/97 03/95→12/97 04/93→12/97 09/92→12/97		GG		24.2122-1716.3	010485	Ø 22,2
1.8 T.S. 2.0 16V Turbo Q4	77 137 - 140	02/92→12/97 01/92→12/97		05/92→; GG 11/92→; GG		24.2122-1716.3	010485	Ø 22,2
ALFA ROMEO - 159 (939_) 06/05→12/12								
 Hauptbremszylinder								
1.8 MPI 1.9 JTDM 16V 1.9 JTDM 8V 1.9 JTS 2.2 JTS 2.4 JTDM 2.4 JTDM Q4 →	103 100 - 110 85 - 88 118 136 147 - 154 154	06/05→11/11 09/05→11/11 09/05→11/11 09/05→11/11 09/05→11/11 09/05→11/11 05/07→11/11		→ 06/08; für Fahrzeuge mit elektronischer Fahrdynamikregelung		24.2125-1732.3	010827	TRW Ø 25,4







	kw			 	! #		
ALFA ROMEO - 159 (939_) 06/05→12/12							
 Hauptbremszylinder							
3.2 JTS 3.2 JTS Q4	191 191	01/08→11/11 12/05→11/11		→ 06/08; für Fahrzeuge mit elektronischer Fahrdynamikregelung		24.2125-1732.3 010827	TRW Ø 25,4
ALFA ROMEO - 159 Sportwagon (939_) 06/05→12/12							
 Hauptbremszylinder							
1.8 MPI 1.9 JTDM 16V 1.9 JTDM 8V 1.9 JTS 2.2 JTS 2.4 JTDM 2.4 JTDM Q4 3.2 JTS 3.2 JTS Q4	103 100 - 110 85 - 88 118 136 147 - 154 154 191 191	06/05→11/11 03/06→11/11 03/06→11/11 03/06→11/11 03/06→11/11 03/06→12/12 05/07→11/11 02/08→11/11 03/06→11/11		→ 06/08; für Fahrzeuge mit elektronischer Fahrdynamikregelung		24.2125-1732.3 010827	TRW Ø 25,4
ALFA ROMEO - 166 (936_) 09/98→06/07							
 Hauptbremszylinder							
2.0 T.Spark 2.0 V6 2.4 JTD 2.5 V6 24V 3.0 V6 24V 2.0 T.Spark	114 151 100 140 166 110	09/98→10/00 09/98→10/00 09/98→10/00 09/98→12/06 09/98→06/07 10/00→06/07		10/98→; für Fahrzeuge mit elektronischer Fahrdynamikregelung		24.2125-1729.3 010752	Ø 25,4
2.4 JTD 2.5 V6 24V 3.0 V6 24V 3.2 V6 24V	103 - 136 138 162 176	10/00→06/07 10/00→06/07 10/00→06/07 10/03→06/07		→ 10/00; für Fahrzeuge mit elektronischer Fahrdynamikregelung für Fahrzeuge mit elektronischer Fahrdynamikregelung		24.2125-1729.3 010752	Ø 25,4
ALFA ROMEO - BRERA (939_) 01/06→05/11							
 Hauptbremszylinder							
1.8 TBi 2.0 JTDM 2.2 JTS 2.4 JTDM 20V 3.2 JTS 3.2 JTS Q4 2.0 JTDM	147 125 136 147 - 154 191 191 120	05/09→06/10 05/09→06/10 01/06→05/11 01/06→03/11 03/08→06/10 01/06→05/11 03/08→06/10				24.2125-1732.3 010827	TRW Ø 25,4
				05/09→		24.2125-1732.3 010827	TRW Ø 25,4
ALFA ROMEO - GIULIETTA (940_) 04/10→12/20							
 Hauptbremszylinder							
1.4 BiFuel 1.4 TB 1.6 JTDM 1.8 TBi 2.0 JTDM	88 77 - 125 77 - 88 169 - 177 100 - 129	12/11→02/17 04/10→12/20 04/10→12/20 04/10→10/18 04/10→12/20				03.2123-3571.3 010962	ATE Ø 23,8
ALFA ROMEO - GIULIETTA Kasten/Schrägheck (940_) 04/11→12/20							
 Hauptbremszylinder							
1.4 1.6 JTDM 1.8 2.0 JTDM	88 - 125 77 173 103 - 129	04/11→12/20 04/11→02/16 04/11→02/16 04/11→12/20				03.2123-3571.3 010962	ATE Ø 23,8
ALFA ROMEO - GTV (916_) 09/94→10/05							
 Hauptbremszylinder							
1.8 16V 2.0 JTS 2.0 T.SPARK 16V 2.0 V6 Turbo 3.0 V6 24V 3.2 V6 24V	106 121 110 - 114 148 160 - 162 176	05/98→10/05 04/03→10/05 06/95→10/05 06/95→09/98 10/96→10/05 04/03→10/05		GG		24.2122-1716.3 010485	Ø 22,2











	kw					! #		
ALFA ROMEO - MITO (955_) 08/08→10/18								
 Hauptbremszylinder								
0.9	74	12/13→08/18					24.4122-1709.3 010871	BOS Ø 22,2 ohne Bremsflüssigkeitsbehälter
0.9 TwinAir	63 - 77	07/11→08/18						
1.4	58 - 70	08/08→08/13						
1.4 MultiAir	77	09/09→08/13						
1.3 MultiJet	59 - 70	08/08→10/18					24.4123-1720.3 011022	BOS Ø 23,8 ohne Bremsflüssigkeitsbehälter
1.4 Bifuel	88	01/09→10/18						
1.4 MultiAir	125	09/09→10/18						
1.4 TB	103	12/13→10/18						
1.4 TJet	88 - 114	08/08→08/13						
1.4 Turbo MultiAir	99 - 120	10/09→10/18						
1.6 JTDM	85 - 88	08/08→08/15						
1.4	57	03/11→10/18		05/11→			24.4122-1709.3 010871	BOS Ø 22,2 ohne Bremsflüssigkeitsbehälter
							24.4123-1720.3 011022	BOS Ø 23,8 ohne Bremsflüssigkeitsbehälter
1.4	51	05/11→10/18					24.4122-1709.3 010871	BOS Ø 22,2 ohne Bremsflüssigkeitsbehälter
							24.4123-1720.3 011022	BOS Ø 23,8 ohne Bremsflüssigkeitsbehälter
ALFA ROMEO - SPIDER (916_) 09/94→04/05								
 Hauptbremszylinder								
1.8 16V	106	05/98→04/05		GG			24.2122-1716.3 010485	Ø 22,2
2.0 JTS	121	04/03→04/05						
2.0 T.SPARK 16V	110 - 114	06/95→04/05						
2.0 V6 Turbo	148	05/98→04/05						
3.0 V6	141	06/95→04/05						
3.0 V6 24V	162	01/99→10/03						
3.2 V6 24V	176	04/03→04/05						
3.0 V6	160	09/94→04/05		10/00→; GG			24.2122-1716.3 010485	Ø 22,2
ALFA ROMEO - SPIDER (939_) 03/06→03/11								
 Hauptbremszylinder								
2.2 JTS	136	03/06→03/11		04/06→ 09/06			24.2125-1732.3 010827	TRW Ø 25,4
3.2 JTS Q4	191	03/06→03/11						
AUDI - A1 (8X1, 8XK) 05/10→10/18								
 Hauptbremszylinder								
2.0 TFSI quattro	188	03/12→11/12		10/12→; für Linkslenker			03.2125-5112.3 010966	ATE Ø 25,4
AUDI - A2 (8Z0) 02/00→08/05								
 Bremskraftverstärker								
1.2 TDI	45	03/01→08/05		8Z-2-013001→; für Linkslenker; → 07/05			03.7850-0102.4 300180	ATE Ø 9" pneumatisch
				→ 8Z-2-013000; für Linkslenker			03.7853-0202.4 300181	ATE Ø 9" pneumatisch
1.4	55	02/00→08/05		8Z-2-013001→; für Linkslenker; → 07/05			03.7850-0102.4 300180	ATE Ø 9" pneumatisch
1.4 TDI	55	02/00→08/05		06/00→; → 8Z-2-013000; für Linkslenker			03.7853-0202.4 300181	ATE Ø 9" pneumatisch
1.4 TDI	66	11/03→08/05		für Linkslenker; → 07/05			03.7850-0102.4 300180	ATE Ø 9" pneumatisch
1.6 FSI	81	05/02→08/05						
 Hauptbremszylinder								
1.2 TDI	45	03/01→08/05		8Z-3-019001→; → 07/05			03.2122-1888.3 010736	ATE Ø 22,2
1.4	55	02/00→08/05						
1.4 TDI	55	02/00→08/05						
1.6 FSI	81	05/02→08/05						
1.4 TDI	66	11/03→08/05		→ 07/05			03.2122-1888.3 010736	ATE Ø 22,2
AUDI - A3 (8L1) 09/96→09/06								
 Bremskraftverstärker								
1.6	74 - 75	09/96→05/03		09/00→; → 8L-2-037877; für Linkslenker; + ESP			03.7860-0602.4 300141	ATE Ø 10" pneumatisch
1.8	92	09/96→05/03		→ 08/00; + ESP; für Linkslenker			03.7863-0402.4 300124	ATE Ø 10" pneumatisch
1.8 T	110 - 132	12/96→05/03		8L-2-037878→; für Linkslenker; + ESP			03.7863-3502.4 300128	ATE Ø 10" pneumatisch
1.8 T quattro	132	10/98→05/03						
S3 quattro	154	03/99→04/02						
→								









	kw			 	! #		
AUDI - A3 (8L1) 09/96→09/06							
 Bremskraftverstärker							
1.8 T quattro	110	12/96→05/03		09/00→; → 8L-2-037877; für Linkslenker; + ESP	03.7860-0602.4	300141	ATE Ø 10" pneumatisch
				08/98→ 08/00; für Linkslenker; + ESP	03.7863-0402.4	300124	ATE Ø 10" pneumatisch
				8L-2-037878→; für Linkslenker; + ESP	03.7863-3502.4	300128	ATE Ø 10" pneumatisch
1.9 TDI	66 - 81	09/96→07/01		09/00→ 06/01; für Linkslenker; + ESP	03.7860-0602.4	300141	ATE Ø 10" pneumatisch
				→ 08/00; + ESP; für Linkslenker	03.7863-0402.4	300124	ATE Ø 10" pneumatisch
1.9 TDI S3 quattro	74 165	10/00→05/03 10/01→05/03		→ 8L-2-037877; für Linkslenker; + ESP	03.7860-0602.4	300141	ATE Ø 10" pneumatisch
				8L-2-037878→; für Linkslenker; + ESP	03.7863-3502.4	300128	ATE Ø 10" pneumatisch
1.9 TDI 1.9 TDI quattro	96 96	08/00→05/03 08/00→05/03		09/00→; → 8L-2-037877; für Linkslenker; + ESP	03.7860-0602.4	300141	ATE Ø 10" pneumatisch
				8L-2-037878→; für Linkslenker; + ESP	03.7863-3502.4	300128	ATE Ø 10" pneumatisch
 Hauptbremszylinder							
1.6	74 - 75	09/96→05/03		→ 08/00; für Linkslenker; + ESP	03.2123-2024.3	010597	ATE Ø 23,8
1.8	92	09/96→05/03		→ 08/00; für Rechtslenker; + ESP	03.2123-2064.3	010598	ATE Ø 23,8
1.8 T	110 - 132	12/96→05/03		09/00→; für Linkslenker; + ESP	03.2123-2715.3	010802	ATE Ø 23,8
S3 quattro	154	03/99→04/02		09/00→; für Rechtslenker; + ESP	03.2123-2774.3	010803	ATE Ø 23,8
				für Linkslenker; - ESP	24.2123-1709.3	010503	Ø 23,8
1.8 T quattro	110	12/96→05/03		08/98→ 08/00; für Rechtslenker; + ESP	03.2123-2064.3	010598	ATE Ø 23,8
				09/00→; für Linkslenker; + ESP	03.2123-2715.3	010802	ATE Ø 23,8
				09/00→; für Rechtslenker; + ESP	03.2123-2774.3	010803	ATE Ø 23,8
				08/98→; - ESP; für Linkslenker	24.2123-1709.3	010503	Ø 23,8
1.8 T quattro	132	10/98→05/03		→ 08/00; für Rechtslenker; + ESP	03.2123-2064.3	010598	ATE Ø 23,8
				09/00→; für Linkslenker; + ESP	03.2123-2715.3	010802	ATE Ø 23,8
				09/00→; für Rechtslenker; + ESP	03.2123-2774.3	010803	ATE Ø 23,8
				für Linkslenker; - ESP	24.2123-1709.3	010503	Ø 23,8
1.9 TDI	66 - 81	09/96→07/01		→ 08/00; für Linkslenker; + ESP	03.2123-2024.3	010597	ATE Ø 23,8
				→ 08/00; für Rechtslenker; + ESP	03.2123-2064.3	010598	ATE Ø 23,8
				09/00→ 06/01; für Linkslenker; + ESP	03.2123-2715.3	010802	ATE Ø 23,8
				09/00→ 06/01; für Rechtslenker; + ESP	03.2123-2774.3	010803	ATE Ø 23,8
				→ 06/01; für Linkslenker; - ESP	24.2123-1709.3	010503	Ø 23,8
1.9 TDI S3 quattro	74 165	10/00→05/03 10/01→05/03		für Linkslenker; + ESP	03.2123-2715.3	010802	ATE Ø 23,8
				für Rechtslenker; + ESP	03.2123-2774.3	010803	ATE Ø 23,8
				für Linkslenker; - ESP	24.2123-1709.3	010503	Ø 23,8
1.9 TDI 1.9 TDI quattro	96 96	08/00→05/03 08/00→05/03		09/00→; für Linkslenker; + ESP	03.2123-2715.3	010802	ATE Ø 23,8
				09/00→; für Rechtslenker; + ESP	03.2123-2774.3	010803	ATE Ø 23,8
				09/00→; für Linkslenker; - ESP	24.2123-1709.3	010503	Ø 23,8
AUDI - A3 (8P1) 05/03→12/13							
 Bremskraftverstärker							
1.2 TSI	77	04/10→08/12		für Linkslenker; +PR 1AC / 1AT	03.7863-3232.4	300307	ATE Ø 10" pneumatisch
1.4 TFSI	92	09/07→08/12					
1.6	75	05/03→08/12					
1.6 E-Power	75	01/11→08/12					
1.6 FSI	85	08/03→09/07					
1.6 TDI	66 - 77	05/09→08/12					
1.8 TFSI quattro	118	07/08→08/12					
2.0 FSI	110	05/03→06/08					
2.0 TDI	100 - 125	05/03→08/12					
2.0 TDI 16V	103	05/03→08/12					
2.0 TDI 16V quattro	103	08/04→08/12					
2.0 TDI quattro	100 - 125	05/03→08/12					
2.0 TFSI	147	09/04→08/12					
2.0 TFSI quattro	147	09/04→08/12					
1.8 T	110	08/06→08/12		01/07→; +PR 1AC / 1AT; für Linkslenker	03.7863-3232.4	300307	ATE Ø 10" pneumatisch
1.8 TFSI	118	11/06→08/12					
1.9 TDI	77	05/03→05/10		06/03→; für Linkslenker; +PR 1AC / 1AT	03.7863-3232.4	300307	ATE Ø 10" pneumatisch
3.2 V6 quattro	184	07/03→05/09		für Linkslenker	03.7863-3332.4	300308	ATE Ø 10" pneumatisch
S3 quattro	195	11/06→08/12					
S3 quattro	188	02/07→08/12		07/08→; für Linkslenker	03.7863-3332.4	300308	ATE Ø 10" pneumatisch
 Hauptbremszylinder							
1.2 TSI	77	04/10→08/12		für Linkslenker; +PR 1ZE / 1ZF / 1ZP / 1ZD / 1LJ / 1ZM	03.2122-2129.3	010799	ATE Ø 22,2
→							







	kw			 	! #		
AUDI - A3 (8P1) 05/03→12/13							
 Hauptbremszylinder							
1.2 TSI	77	04/10→08/12		8P-6A094001→; für Linkslenker; +PR 1ZE / 1ZF / 1ZP / 1ZD / 1LJ / 1ZM	03.2122-2129.3	010799	ATE Ø 22,2
				für Linkslenker; → 8P-6B009600; +PR 1ZE / 1ZF / 1ZP / 1ZD / 1LJ / 1ZM	03.2122-2129.3	010799	ATE Ø 22,2
				für Linkslenker; → 8P-6A094000; +PR 1ZE / 1ZF / 1ZP / 1ZD / 1LJ / 1ZM	03.2122-2129.3	010799	ATE Ø 22,2
				8P-6A094001→; für Linkslenker; +PR 1LK / 1ZK	03.2123-3449.3	010808	ATE Ø 23,8
				für Linkslenker; +PR 1LK / 1ZK	03.2123-3449.3	010808	ATE Ø 23,8
				für Linkslenker; → 8P-6A094000; +PR 1LK	03.2123-3449.3	010808	ATE Ø 23,8
				für Linkslenker; → 8P-6B009600; +PR 1LK	03.2123-3449.3	010808	ATE Ø 23,8
				für Rechtslenker	24.2122-1981.3	011024	ATE Ø 22,2 ohne Bremsflüssigkeitsbehälter
1.4 TFSI	92	09/07→08/12		für Linkslenker; +PR 1ZE / 1ZF / 1ZP / 1ZD / 1LJ / 1ZM	03.2122-2129.3	010799	ATE Ø 22,2
				für Linkslenker; +PR 1LK / 1ZK	03.2123-3449.3	010808	ATE Ø 23,8
				für Rechtslenker	24.2122-1981.3	011024	ATE Ø 22,2 ohne Bremsflüssigkeitsbehälter
1.6 1.6 E-Power 1.6 FSI 1.6 TDI 2.0 FSI 2.0 TDI 2.0 TDI 16V 2.0 TDI 16V quattro 2.0 TDI quattro	75	05/03→08/12		8P-6A094001→; für Linkslenker; +PR 1ZE / 1ZF / 1ZP / 1ZD / 1LJ / 1ZM	03.2122-2129.3	010799	ATE Ø 22,2
	75	01/11→08/12		8P-6A094001→; für Linkslenker; +PR 1ZE / 1ZF / 1ZP / 1ZD / 1LJ / 1ZM	03.2122-2129.3	010799	ATE Ø 22,2
	85	08/03→09/07		8P-6B009601→; für Linkslenker; +PR 1ZE / 1ZF / 1ZP / 1ZD / 1LJ / 1ZM	03.2122-2129.3	010799	ATE Ø 22,2
	66 -	05/09→08/12		für Linkslenker; → 8P-6A094000; +PR 1ZE / 1ZF / 1ZP / 1ZD / 1LJ / 1ZM	03.2122-2129.3	010799	ATE Ø 22,2
	77			für Linkslenker; → 8P-6A094000; +PR 1ZE / 1ZF / 1ZP / 1ZD / 1LJ / 1ZM	03.2122-2129.3	010799	ATE Ø 22,2
	110	05/03→06/08		für Linkslenker; → 8P-6B009600; +PR 1ZE / 1ZF / 1ZP / 1ZD / 1LJ / 1ZM	03.2122-2129.3	010799	ATE Ø 22,2
	100 -	05/03→08/12		für Linkslenker; → 8P-6A094000; +PR 1LK	03.2123-3449.3	010808	ATE Ø 23,8
	103			für Linkslenker; → 8P-6B009600; +PR 1LK	03.2123-3449.3	010808	ATE Ø 23,8
	103	05/03→08/12		für Linkslenker; → 8P-6A094000; +PR 1LK	03.2123-3449.3	010808	ATE Ø 23,8
	103	08/04→08/12		8P-6A094001→; für Linkslenker; +PR 1LK / 1ZK	03.2123-3449.3	010808	ATE Ø 23,8
	100 -	05/03→06/08		8P-6B009601→; für Linkslenker; +PR 1LK / 1ZK	03.2123-3449.3	010808	ATE Ø 23,8
	103			für Linkslenker; → 8P-6A094000; +PR 1LK	03.2123-3449.3	010808	ATE Ø 23,8
			für Linkslenker; → 8P-6B009600; +PR 1LK	03.2123-3449.3	010808	ATE Ø 23,8	
			für Rechtslenker	24.2122-1981.3	011024	ATE Ø 22,2 ohne Bremsflüssigkeitsbehälter	
1.8 T 1.8 TFSI	110	08/06→08/12		01/07→; für Linkslenker; +PR 1ZE / 1ZF / 1ZP / 1ZD / 1LJ / 1ZM	03.2122-2129.3	010799	ATE Ø 22,2
	118	11/06→08/12		01/07→; für Linkslenker; +PR 1LK / 1ZK	03.2123-3449.3	010808	ATE Ø 23,8
				01/07→; für Rechtslenker	24.2122-1981.3	011024	ATE Ø 22,2 ohne Bremsflüssigkeitsbehälter
1.8 TFSI quattro	118	07/08→08/12		für Linkslenker; +PR 1ZE / 1ZF / 1ZP / 1ZD / 1LJ / 1ZM	03.2122-2129.3	010799	ATE Ø 22,2
				für Linkslenker; +PR 1LK / 1ZK	03.2123-3449.3	010808	ATE Ø 23,8
1.9 TDI	77	05/03→05/10		06/03→; für Linkslenker; → 8P-6A094000; +PR 1ZE / 1ZF / 1ZP / 1ZD / 1LJ / 1ZM	03.2122-2129.3	010799	ATE Ø 22,2
				06/03→; für Linkslenker; → 8P-6B009600; +PR 1ZE / 1ZF / 1ZP / 1ZD / 1LJ / 1ZM	03.2122-2129.3	010799	ATE Ø 22,2
				8P-6B009601→; für Linkslenker; +PR 1ZE / 1ZF / 1ZP / 1ZD / 1LJ / 1ZM	03.2122-2129.3	010799	ATE Ø 22,2
				8P-6A094001→; für Linkslenker; +PR 1ZE / 1ZF / 1ZP / 1ZD / 1LJ / 1ZM	03.2122-2129.3	010799	ATE Ø 22,2
				06/03→; für Linkslenker; → 8P-6A094000; +PR 1LK	03.2123-3449.3	010808	ATE Ø 23,8
				06/03→; für Linkslenker; → 8P-6B009600; +PR 1LK	03.2123-3449.3	010808	ATE Ø 23,8
				8P-6B009601→; für Linkslenker; +PR 1LK / 1ZK	03.2123-3449.3	010808	ATE Ø 23,8
				8P-6A094001→; für Linkslenker; +PR 1LK / 1ZK	03.2123-3449.3	010808	ATE Ø 23,8
				06/03→; für Rechtslenker	24.2122-1981.3	011024	ATE Ø 22,2 ohne Bremsflüssigkeitsbehälter
2.0 TDI	120	06/06→06/08		8P-6A094001→; für Linkslenker; +PR 1ZE / 1ZF / 1ZP / 1ZD / 1LJ / 1ZM	03.2122-2129.3	010799	ATE Ø 22,2
				8P-6B009601→; für Linkslenker; +PR 1ZE / 1ZF / 1ZP / 1ZD / 1LJ / 1ZM	03.2122-2129.3	010799	ATE Ø 22,2
				für Linkslenker; → 8P-6B009600; +PR 1ZE / 1ZF / 1ZP / 1ZD / 1LJ / 1ZM	03.2122-2129.3	010799	ATE Ø 22,2
				für Linkslenker; → 8P-6A094000; +PR 1ZE / 1ZF / 1ZP / 1ZD / 1LJ / 1ZM	03.2122-2129.3	010799	ATE Ø 22,2











	kw			 	! #		
AUDI - A3 (8P1) 05/03→12/13							
Hauptbremszylinder							
2.0 TDI	120	06/06→06/08		8P-6A094001→; für Linkslenker; +PR 1LK / 1ZK	03.2123-3449.3	010808	ATE Ø 23,8
				für Linkslenker; → 8P-6B009600; +PR 1LK	03.2123-3449.3	010808	ATE Ø 23,8
				für Linkslenker; → 8P-6A094000; +PR 1LK	03.2123-3449.3	010808	ATE Ø 23,8
				für Rechtslenker	24.2122-1981.3	011024	ATE Ø 22,2 ohne Bremsflüssigkeitsbehälter
2.0 TDI	125	03/06→08/12		+PR 1ZE / 1ZF / 1ZP / 1ZD / 1LJ / 1ZM	03.2123-3449.3	010808	ATE Ø 23,8
2.0 TDI quattro	125	03/06→08/12		für Linkslenker; +PR 1LK / 1ZK	03.2123-3449.3	010808	ATE Ø 23,8
				für Rechtslenker	24.2122-1981.3	011024	ATE Ø 22,2 ohne Bremsflüssigkeitsbehälter
2.0 TFSI	147	09/04→08/12		8P-6B009601→; für Linkslenker; → 8P-7-103000; +PR 1ZE / 1ZF / 1ZP / 1ZD / 1LJ / 1ZM	03.2122-2129.3	010799	ATE Ø 22,2
2.0 TFSI quattro	147	09/04→08/12		8P-6A094001→; für Linkslenker; → 8P-7-103000; +PR 1ZE / 1ZF / 1ZP / 1ZD / 1LJ / 1ZM	03.2122-2129.3	010799	ATE Ø 22,2
				für Linkslenker; → 8P-6A094000; +PR 1ZE / 1ZF / 1ZP / 1ZD / 1LJ / 1ZM	03.2122-2129.3	010799	ATE Ø 22,2
				für Linkslenker; → 8P-6B009600; +PR 1ZE / 1ZF / 1ZP / 1ZD / 1LJ / 1ZM	03.2122-2129.3	010799	ATE Ø 22,2
				8P-6B009601→; für Linkslenker; → 8P-7-103000; +PR 1LK / 1ZK	03.2123-3449.3	010808	ATE Ø 23,8
				8P-7-103001→; +PR 1ZE / 1ZF / 1ZP / 1ZD / 1LJ / 1ZM	03.2123-3449.3	010808	ATE Ø 23,8
				8P-6A094001→; für Linkslenker; → 8P-7-103000; +PR 1LK / 1ZK	03.2123-3449.3	010808	ATE Ø 23,8
				für Linkslenker; → 8P-6A094000; +PR 1LK	03.2123-3449.3	010808	ATE Ø 23,8
				für Linkslenker; → 8P-6B009600; +PR 1LK	03.2123-3449.3	010808	ATE Ø 23,8
				für Rechtslenker	24.2122-1981.3	011024	ATE Ø 22,2 ohne Bremsflüssigkeitsbehälter
3.2 V6 quattro	184	07/03→05/09		für Linkslenker; - ESP	03.2122-2129.3	010799	ATE Ø 22,2
S3 quattro	195	11/06→08/12		für Linkslenker; + ESP	03.2123-3449.3	010808	ATE Ø 23,8
				für Rechtslenker; - ESP	24.2122-1981.3	011024	ATE Ø 22,2 ohne Bremsflüssigkeitsbehälter
S3 quattro	188	02/07→08/12		07/08→; für Linkslenker; - ESP	03.2122-2129.3	010799	ATE Ø 22,2
				07/08→; für Linkslenker; + ESP	03.2123-3449.3	010808	ATE Ø 23,8
				07/08→; für Rechtslenker; - ESP	24.2122-1981.3	011024	ATE Ø 22,2 ohne Bremsflüssigkeitsbehälter
Hydraulikaggregat, Bremsanlage							
1.4 TFSI	92	09/07→08/12		→ 12/08; +PR 1AT / 1AS	24.9145-0001.2	399005	
1.6	75	05/03→08/12					
1.8 TFSI quattro	118	07/08→08/12					
2.0 TDI	100 - 125	05/03→08/12					
2.0 TDI 16V	103	05/03→08/12					
2.0 TDI 16V quattro	103	08/04→08/12					
2.0 TDI quattro	125	03/06→08/12					
2.0 TFSI	147	09/04→08/12					
2.0 TFSI quattro	147	09/04→08/12					
3.2 V6 quattro	184	07/03→05/09					
S3 quattro	195	11/06→08/12					
1.6 FSI	85	08/03→09/07		+PR 1AT / 1AS	24.9145-0001.2	399005	
2.0 FSI	110	05/03→06/08					
2.0 TDI	103 - 120	06/05→06/08					
2.0 TDI quattro	100 - 103	05/03→06/08					
1.8 T	110	08/06→08/12		01/07→ 12/08; +PR 1AT / 1AS	24.9145-0001.2	399005	
1.8 TFSI	118	11/06→08/12					
1.9 TDI	77	05/03→05/10		06/03→ 12/08; +PR 1AT / 1AS	24.9145-0001.2	399005	
S3 quattro	188	02/07→08/12		07/08→ 12/08; +PR 1AT / 1AS	24.9145-0001.2	399005	
Drucksensor, Bremskraftverstärker							
1.2 TSI	77	04/10→08/12		für Linkslenker; +PR 1AS	03.0655-0101.2	370008	ATE
1.4 TFSI	92	09/07→08/12					
1.6	75	05/03→08/12					
1.6 E-Power	75	01/11→08/12					
1.6 FSI	85	08/03→09/07					
1.6 TDI	66 - 77	05/09→08/12					
→							

	kw			 	! #		
AUDI - A3 (8P1) 05/03→12/13							
Drucksensor, Bremskraftverstärker							
1.8 TFSI quattro	118	07/08→08/12		für Linkslenker; +PR 1AS		03.0655-0101.2	370008 ATE
2.0 FSI	110	05/03→06/08					
2.0 TDI	100 - 125	05/03→08/12					
2.0 TDI 16V	103	05/03→08/12					
2.0 TDI 16V quattro	103	08/04→08/12					
2.0 TDI quattro	100 - 125	05/03→08/12					
2.0 TFSI	147	09/04→08/12					
2.0 TFSI quattro	147	09/04→08/12					
1.8 T	110	08/06→08/12		01/07→; +PR 1AS; für Linkslenker		03.0655-0101.2	370008 ATE
1.8 TFSI	118	11/06→08/12					
1.9 TDI	77	05/03→05/10		06/03→; für Linkslenker; +PR 1AS		03.0655-0101.2	370008 ATE
AUDI - A3 (8V1, 8VK) 04/12→10/20							
Hauptbremszylinder							
1.0 TFSI	85	07/16→12/17		für Linkslenker		03.4153-5403.3	010994 ATE Ø 23,8
1.2 TFSI	77 - 81	02/13→08/16				24.4123-1719.3	011017 TRW Ø 23,8 ohne Bremsflüssigkeitsbehälter
1.4 TFSI	90 - 103	04/12→08/16				24.4153-1522.3	011048 ATE Ø 23,8 ohne Bremsflüssigkeitsbehälter
1.4 TFSI	110	05/14→12/17					
1.5 TFSI	110	05/17→12/17					
1.6 TDI	77 - 85	10/12→10/20					
1.8 TFSI	132	04/12→08/16					
1.8 TFSI quattro	132	08/12→08/16					
2.0 TDI	81 - 135	04/12→10/20					
2.0 TDI quattro	110 - 135	10/12→12/17					
2.0 TFSI	140	05/16→12/17					
2.0 TFSI quattro	140	05/16→12/17					
S3 quattro	206 - 228	11/12→12/17					
AUDI - A3 Cabriolet (8P7) 04/08→05/13							
Bremskraftverstärker							
1.2 TFSI	77	03/10→05/13		für Linkslenker; +PR 1ZE / 1ZF / 1LJ / 1ZA		03.7863-3232.4	300307 ATE Ø 10" pneumatisch
1.4 TFSI	92	02/11→05/13					
1.6	75	09/08→05/10					
1.6 TDI	77	05/09→05/13					
1.8 TFSI	118	04/08→05/13					
1.9 TDI	77	04/08→10/09					
2.0 TDI	100 - 103	04/08→05/13					
2.0 TFSI	147	04/08→05/13		für Linkslenker; +PR 1ZE / 1ZF / 1LJ		03.7863-3332.4	300308 ATE Ø 10" pneumatisch
Hauptbremszylinder							
1.2 TFSI	77	03/10→05/13		für Linkslenker; +PR 1ZE / 1ZF / 1LJ / 1ZA		03.2122-2129.3	010799 ATE Ø 22,2
1.4 TFSI	92	02/11→05/13					
1.6	75	09/08→05/10					
1.6 TDI	77	05/09→05/13					
1.8 TFSI	118	04/08→05/13					
1.9 TDI	77	04/08→10/09					
2.0 TDI	100 - 103	04/08→05/13					
2.0 TFSI	147	04/08→05/13		für Linkslenker; +PR 1ZE / 1ZF / 1LJ / 1ZA		03.2123-3449.3	010808 ATE Ø 23,8
AUDI - A3 Cabriolet (8V7, 8VE) 10/13→							
Hauptbremszylinder							
1.4 TFSI	85 - 103	10/13→		für Linkslenker		03.4153-5403.3	010994 ATE Ø 23,8
1.4 TFSI	110	05/14→10/20				24.4123-1719.3	011017 TRW Ø 23,8 ohne Bremsflüssigkeitsbehälter
1.5 TFSI	110	05/17→10/18					
1.6 TDI	81 - 85	02/14→10/20				24.4153-1522.3	011048 ATE Ø 23,8 ohne Bremsflüssigkeitsbehälter
1.8 TFSI	125 - 132	10/13→10/20					
1.8 TFSI quattro	132	03/14→					
2.0 TDI	100 - 135	10/13→					
2.0 TDI quattro	110 - 135	03/14→10/20					
2.0 TFSI	140	05/16→10/20					
2.0 TFSI quattro	140 - 162	05/14→10/20					
35 TFSI	110	10/18→10/20					

	kw			i 	! #		
AUDI - A3 Cabriolet (8V7, 8VE) 10/13→							
 Hauptbremszylinder							
40 TFSI 40 TFSI quattro S3 quattro	140 140 210 - 228	11/18→10/20 11/18→10/20 03/14→		für Linkslenker		03.4153-5403.3 010994 24.4123-1719.3 011017 24.4153-1522.3 011048	ATE Ø 23,8 TRW Ø 23,8 ohne Bremsflüssigkeitsbehälter ATE Ø 23,8 ohne Bremsflüssigkeitsbehälter
AUDI - A3 Limousine (8VS, 8VM) 05/13→							
 Hauptbremszylinder							
1.0 TFSI 1.2 TFSI 1.4 TFSI 1.4 TFSI 1.5 TFSI 1.6 TDI 1.6 TDI quattro 1.8 TFSI 1.8 TFSI quattro 2.0 TDI 2.0 TDI quattro 2.0 TFSI 2.0 TFSI quattro 30 TDI 30 TFSI 35 TDI 35 TFSI 40 TDI quattro 40 TFSI 40 TFSI quattro RS3 quattro S3 quattro	85 77 - 81 90 - 103 110 110 77 - 85 81 125 - 132 132 81 - 135 110 - 135 140 - 162 140 85 85 110 110 135 140 140 294 206 - 228	07/16→10/20 10/13→ 05/13→ 05/14→10/20 05/17→10/18 09/13→ 05/15→ 05/13→ 11/13→ 05/13→ 10/13→10/20 11/15→10/20 05/16→10/20 07/18→10/20 07/18→10/20 07/18→10/20 10/18→10/20 07/18→07/19 07/18→10/20 07/18→10/20 04/17→10/20 10/13→		für Linkslenker		03.4153-5403.3 010994 24.4123-1719.3 011017 24.4153-1522.3 011048	ATE Ø 23,8 TRW Ø 23,8 ohne Bremsflüssigkeitsbehälter ATE Ø 23,8 ohne Bremsflüssigkeitsbehälter
AUDI - A3 Sportback (8PA) 09/04→12/15							
 Bremskraftverstärker							
1.2 TSI 1.4 TFSI 1.6 1.6 E-Power 1.6 FSI 1.6 TDI 1.8 TFSI quattro 1.9 TDI 2.0 FSI 2.0 TDI 2.0 TDI 16V 2.0 TDI 16V quattro 2.0 TDI quattro 2.0 TFSI 2.0 TFSI quattro 1.8 TFSI 3.2 V6 quattro S3 quattro	77 92 75 75 85 66 - 77 118 77 110 100 - 125 103 103 103 - 125 147 147 118 184 188 - 195	04/10→03/13 09/07→03/13 09/04→03/13 01/11→03/13 09/04→09/07 05/09→03/13 07/08→03/13 09/04→05/10 09/04→06/08 09/04→03/13 09/04→03/13 11/05→03/13 01/06→03/13 09/04→03/13 09/04→03/13 11/06→03/13 09/04→05/09 06/08→03/13		für Linkslenker; +PR 1AC / 1AT 01/07→; +PR 1AC / 1AT; für Linkslenker für Linkslenker		03.7863-3232.4 300307 03.7863-3232.4 300307 03.7863-3332.4 300308	ATE Ø 10" pneumatisch ATE Ø 10" pneumatisch ATE Ø 10" pneumatisch
 Hauptbremszylinder							
1.2 TSI	77	04/10→03/13		für Linkslenker; +PR 1ZE / 1ZF / 1ZP / 1ZD / 1LJ / 1ZM 8P-6A094001→; für Linkslenker; +PR 1ZE / 1ZF / 1ZP / 1ZD / 1LJ / 1ZM für Linkslenker; → 8P-6B009600; +PR 1ZE / 1ZF / 1ZP / 1ZD / 1LJ / 1ZM für Linkslenker; → 8P-6A094000; +PR 1ZE / 1ZF / 1ZP / 1ZD / 1LJ / 1ZM 8P-6A094001→; für Linkslenker; +PR 1LK / 1ZK für Linkslenker; +PR 1LK / 1ZK für Linkslenker; → 8P-6A094000; +PR 1LK		03.2122-2129.3 010799 03.2122-2129.3 010799 03.2122-2129.3 010799 03.2122-2129.3 010799 03.2123-3449.3 010808 03.2123-3449.3 010808 03.2123-3449.3 010808	ATE Ø 22,2 ATE Ø 22,2 ATE Ø 22,2 ATE Ø 22,2 ATE Ø 23,8 ATE Ø 23,8 ATE Ø 23,8

	kw			 	! #		
AUDI - A3 Sportback (8PA) 09/04→12/15							
 Hauptbremszylinder							
1.2 TSI	77	04/10→03/13		für Linkslenker; → 8P-6B009600; +PR 1LK	03.2123-3449.3	010808	ATE Ø 23,8
				für Rechtslenker	24.2122-1981.3	011024	ATE Ø 22,2 ohne Bremsflüssigkeitsbehälter
1.4 TFSI	92	09/07→03/13		für Linkslenker; +PR 1ZE / 1ZF / 1ZP / 1ZD / 1LJ / 1ZM	03.2122-2129.3	010799	ATE Ø 22,2
				für Linkslenker; +PR 1LK / 1ZK	03.2123-3449.3	010808	ATE Ø 23,8
				für Rechtslenker	24.2122-1981.3	011024	ATE Ø 22,2 ohne Bremsflüssigkeitsbehälter
1.6 1.6 E-Power 1.6 FSI 1.6 TDI 1.9 TDI 2.0 FSI 2.0 TDI 2.0 TDI 16V 2.0 TDI 16V quattro 2.0 TDI quattro	75	09/04→03/13		8P-6A094001→; für Linkslenker; +PR 1ZE / 1ZF / 1ZP / 1ZD / 1LJ / 1ZM	03.2122-2129.3	010799	ATE Ø 22,2
	75	01/11→03/13					
	85	09/04→09/07		8P-6B009601→; für Linkslenker; +PR 1ZE / 1ZF / 1ZP / 1ZD / 1LJ / 1ZM	03.2122-2129.3	010799	ATE Ø 22,2
	66 - 77	05/09→03/13					
	77	09/04→05/10		für Linkslenker; → 8P-6A094000; +PR 1ZE / 1ZF / 1ZP / 1ZD / 1LJ / 1ZM	03.2122-2129.3	010799	ATE Ø 22,2
	110	09/04→06/08					
	100 - 103	09/04→03/13		für Linkslenker; → 8P-6B009600; +PR 1ZE / 1ZF / 1ZP / 1ZD / 1LJ / 1ZM	03.2122-2129.3	010799	ATE Ø 22,2
	103	09/04→03/13		8P-6A094001→; für Linkslenker; +PR 1LK / 1ZK	03.2123-3449.3	010808	ATE Ø 23,8
	103	11/05→03/13					
	103	01/06→06/08		8P-6B009601→; für Linkslenker; +PR 1LK / 1ZK	03.2123-3449.3	010808	ATE Ø 23,8
				für Linkslenker; → 8P-6A094000; +PR 1LK	03.2123-3449.3	010808	ATE Ø 23,8
				für Linkslenker; → 8P-6B009600; +PR 1LK	03.2123-3449.3	010808	ATE Ø 23,8
			für Rechtslenker	24.2122-1981.3	011024	ATE Ø 22,2 ohne Bremsflüssigkeitsbehälter	
1.8 TFSI	118	11/06→03/13		01/07→; für Linkslenker; +PR 1ZE / 1ZF / 1ZP / 1ZD / 1LJ / 1ZM	03.2122-2129.3	010799	ATE Ø 22,2
				01/07→; für Linkslenker; +PR 1LK / 1ZK	03.2123-3449.3	010808	ATE Ø 23,8
				01/07→; für Rechtslenker	24.2122-1981.3	011024	ATE Ø 22,2 ohne Bremsflüssigkeitsbehälter
1.8 TFSI quattro	118	07/08→03/13		für Linkslenker; +PR 1ZE / 1ZF / 1ZP / 1ZD / 1LJ / 1ZM	03.2122-2129.3	010799	ATE Ø 22,2
				für Linkslenker; +PR 1LK / 1ZK	03.2123-3449.3	010808	ATE Ø 23,8
2.0 TDI	104	01/10→03/13		8P-6A094001→; für Linkslenker; +PR 1ZE / 1ZF / 1ZP / 1ZD / 1LJ / 1ZM	03.2122-2129.3	010799	ATE Ø 22,2
				8P-6A094001→; für Linkslenker; +PR 1LK / 1ZK	03.2123-3449.3	010808	ATE Ø 23,8
				für Rechtslenker	24.2122-1981.3	011024	ATE Ø 22,2 ohne Bremsflüssigkeitsbehälter
2.0 TDI	120	06/06→06/08		8P-6A094001→; für Linkslenker; +PR 1ZE / 1ZF / 1ZP / 1ZD / 1LJ / 1ZM	03.2122-2129.3	010799	ATE Ø 22,2
				8P-6B009601→; für Linkslenker; +PR 1ZE / 1ZF / 1ZP / 1ZD / 1LJ / 1ZM	03.2122-2129.3	010799	ATE Ø 22,2
				für Linkslenker; → 8P-6B009600; +PR 1ZE / 1ZF / 1ZP / 1ZD / 1LJ / 1ZM	03.2122-2129.3	010799	ATE Ø 22,2
				für Linkslenker; → 8P-6A094000; +PR 1ZE / 1ZF / 1ZP / 1ZD / 1LJ / 1ZM	03.2122-2129.3	010799	ATE Ø 22,2
				8P-6A094001→; für Linkslenker; +PR 1LK / 1ZK	03.2123-3449.3	010808	ATE Ø 23,8
				für Linkslenker; → 8P-6B009600; +PR 1LK	03.2123-3449.3	010808	ATE Ø 23,8
				für Linkslenker; → 8P-6A094000; +PR 1LK	03.2123-3449.3	010808	ATE Ø 23,8
				für Rechtslenker	24.2122-1981.3	011024	ATE Ø 22,2 ohne Bremsflüssigkeitsbehälter
2.0 TDI 2.0 TDI quattro	125	03/06→03/13		+PR 1ZE / 1ZF / 1ZP / 1ZD / 1LJ / 1ZM	03.2123-3449.3	010808	ATE Ø 23,8
	125	03/06→03/13		für Linkslenker; +PR 1LK / 1ZK	03.2123-3449.3	010808	ATE Ø 23,8
				für Rechtslenker	24.2122-1981.3	011024	ATE Ø 22,2 ohne Bremsflüssigkeitsbehälter
2.0 TFSI 2.0 TFSI quattro	147	09/04→03/13		8P-6B009601→; für Linkslenker; → 8P-7-103000; +PR 1ZE / 1ZF / 1ZP / 1ZD / 1LJ / 1ZM	03.2122-2129.3	010799	ATE Ø 22,2
	147	09/04→03/13		8P-6A094001→; für Linkslenker; → 8P-7-103000; +PR 1ZE / 1ZF / 1ZP / 1ZD / 1LJ / 1ZM	03.2122-2129.3	010799	ATE Ø 22,2
				für Linkslenker; → 8P-6A094000; +PR 1ZE / 1ZF / 1ZP / 1ZD / 1LJ / 1ZM	03.2122-2129.3	010799	ATE Ø 22,2
				für Linkslenker; → 8P-6B009600; +PR 1ZE / 1ZF / 1ZP / 1ZD / 1LJ / 1ZM	03.2122-2129.3	010799	ATE Ø 22,2
				8P-6B009601→; für Linkslenker; → 8P-7-103000; +PR 1LK / 1ZK	03.2123-3449.3	010808	ATE Ø 23,8

	kw			 	! #		
AUDI - A3 Sportback (8PA) 09/04→12/15							
Hauptbremszylinder							
2.0 TFSI 2.0 TFSI quattro	147	09/04→03/13		8P-7-103001→; +PR 1ZE / 1ZF / 1ZP / 1ZD / 1LJ / 1ZM		03.2123-3449.3 010808	ATE Ø 23,8
	147	09/04→03/13		8P-6A094001→; für Linkslenker; → 8P-7-103000; +PR 1LK / 1ZK		03.2123-3449.3 010808	ATE Ø 23,8
				für Linkslenker; → 8P-6A094000; +PR 1LK		03.2123-3449.3 010808	ATE Ø 23,8
				für Linkslenker; → 8P-6B009600; +PR 1LK		03.2123-3449.3 010808	ATE Ø 23,8
				für Rechtslenker		24.2122-1981.3 011024	ATE Ø 22,2 ohne Bremsflüssigkeitsbehälter
3.2 V6 quattro S3 quattro	184	09/04→05/09		für Linkslenker; - ESP		03.2122-2129.3 010799	ATE Ø 22,2
	188 - 195	06/08→03/13		für Linkslenker; + ESP		03.2123-3449.3 010808	ATE Ø 23,8
				für Rechtslenker; - ESP		24.2122-1981.3 011024	ATE Ø 22,2 ohne Bremsflüssigkeitsbehälter
RS3 quattro	250	01/11→12/12		04/11→; für Linkslenker		03.2125-5112.3 010966	ATE Ø 25,4
Hydraulikaggregat, Bremsanlage							
1.4 TFSI 1.6 1.8 TFSI quattro 1.9 TDI 2.0 TDI 2.0 TDI 16V 2.0 TDI 16V quattro 2.0 TDI quattro 2.0 TFSI 2.0 TFSI quattro 3.2 V6 quattro S3 quattro	92	09/07→03/13		→ 12/08; +PR 1AT / 1AS		24.9145-0001.2 399005	
	75	09/04→03/13					
	118	07/08→03/13					
	77	09/04→05/10					
	100 - 125	09/04→03/13					
	103	09/04→03/13					
	103	11/05→03/13					
	125	03/06→03/13					
	147	09/04→03/13					
	147	09/04→03/13					
	184	09/04→05/09					
	188 - 195	06/08→03/13					
	85	09/04→09/07		+PR 1AT / 1AS		24.9145-0001.2 399005	
	110	09/04→06/08					
103 - 120	06/05→06/08						
103	01/06→06/08						
118	11/06→03/13		01/07→ 12/08; +PR 1AT / 1AS		24.9145-0001.2 399005		
Drucksensor, Bremskraftverstärker							
1.2 TSI 1.4 TFSI 1.6 1.6 E-Power 1.6 FSI 1.6 TDI 1.8 TFSI quattro 1.9 TDI 2.0 FSI 2.0 TDI 2.0 TDI 16V 2.0 TDI 16V quattro 2.0 TDI quattro 2.0 TFSI 2.0 TFSI quattro 1.8 TFSI	77	04/10→03/13		für Linkslenker; +PR 1AS		03.0655-0101.2 370008	ATE
	92	09/07→03/13					
	75	09/04→03/13					
	75	01/11→03/13					
	85	09/04→09/07					
	66 - 77	05/09→03/13					
	118	07/08→03/13					
	77	09/04→05/10					
	110	09/04→06/08					
	100 - 125	09/04→03/13					
	103	09/04→03/13					
	103	11/05→03/13					
	103 - 125	01/06→03/13					
	147	09/04→03/13					
	147	09/04→03/13					
	118	11/06→03/13		01/07→; +PR 1AS; für Linkslenker		03.0655-0101.2 370008	ATE
	AUDI - A3 Sportback (8VA, 8VF) 09/12→						
Hauptbremszylinder							
1.0 TFSI 1.2 TFSI 1.4 TFSI 1.4 TFSI e-tron 1.4 TFSI g-tron 1.4 TSI 1.5 TFSI 1.6 TDI 1.6 TDI quattro 1.8 TFSI 1.8 TFSI quattro 2.0 TDI →	85	07/16→10/20		für Linkslenker		03.4153-5403.3 010994	ATE Ø 23,8
	77 - 81	05/13→				24.4123-1719.3 011017	TRW Ø 23,8 ohne Bremsflüssigkeitsbehälter
	90 - 103	09/12→				24.4153-1522.3 011048	ATE Ø 23,8 ohne Bremsflüssigkeitsbehälter
	150	05/14→10/20					
	81	11/13→10/20					
	110	05/14→10/20					
	110	05/17→10/18					
	77 - 85	10/12→					
	81	05/15→08/16					
	132	09/12→					
	132	05/13→					
	81 - 135	09/12→10/20					

	kw			 	! #		
AUDI - A3 Sportback (8VA, 8VF) 09/12→							
 Hauptbremszylinder							
2.0 TDI quattro	110 - 135	02/13→10/20		für Linkslenker		03.4153-5403.3 010994	ATE Ø 23,8
2.0 TFSI	140	05/16→10/20				24.4123-1719.3 011017	TRW Ø 23,8 ohne Bremsflüssigkeitsbehälter
2.0 TFSI quattro	140	05/16→10/20				24.4153-1522.3 011048	ATE Ø 23,8 ohne Bremsflüssigkeitsbehälter
30 g-tron	96	11/18→10/20					
30 TDI	85	07/18→10/20					
30 TFSI	85	07/18→10/20					
35 TDI	110	07/18→10/20					
35 TFSI	110	10/18→10/20					
40 TDI quattro	135	07/18→10/20					
40 TFSI	140	07/18→10/20					
40 TFSI quattro	140	07/18→10/20					
RS3 quattro	270 - 294	03/15→					
S3 quattro	206 - 228	11/12→					
AUDI - A4 Allroad B8 (8KH) 04/09→05/16							
 Bremskraftverstärker							
2.0 TDI quattro	100 - 125	04/09→05/16				03.7858-4632.4 300273	ATE Ø 9 / 8" pneumatisch
2.0 TFSI quattro	155	04/09→05/16				03.7858-4632.4 300273	ATE Ø 9 / 8" pneumatisch
3.0 TDI quattro	176	04/09→01/12					
2.0 TDI quattro	110 - 140	05/13→05/16		+PR GP0 / GP1		03.7858-4632.4 300273	ATE Ø 9 / 8" pneumatisch
2.0 TFSI quattro	162 - 165	05/13→05/16					
3.0 TDI quattro	180	01/12→05/16					
2.0 TDI quattro	130	11/11→05/16		01/12→; +PR GP0 / GP1		03.7858-4632.4 300273	ATE Ø 9 / 8" pneumatisch
 Hauptbremszylinder							
2.0 TDI quattro	100 - 125	04/09→05/16				03.2125-0493.3 010940	ATE Ø 25,4
2.0 TFSI quattro	155	04/09→05/16				24.2125-1739.3 010948	TRW Ø 25,4
3.0 TDI quattro	176	04/09→01/12				03.2125-0493.3 010940	ATE Ø 25,4
2.0 TDI quattro	110 - 140	05/13→05/16		+PR GP0 / GP1			
2.0 TFSI quattro	162 - 165	05/13→05/16					
3.0 TDI quattro	180	01/12→05/16					
2.0 TDI quattro	130	11/11→05/16		01/12→; +PR GP0 / GP1			
2.0 TDI quattro	130	11/11→05/16					
AUDI - A4 B5 (8D2) 11/94→12/01							
 Hauptbremszylinder							
1.6	74	11/94→10/00		→ 01/99		24.2123-1717.3 010521	Ø 23,8
1.8	85 - 92	11/94→11/00		02/99→; - ESP; für Linkslenker		24.2125-1712.3 010622	Ø 25,4
1.8 T	132	12/97→11/00		02/99→; + ESP; für Linkslenker		24.2125-1713.3 010623	Ø 25,4
1.9 TDI	66	01/95→11/00				24.2125-1712.3 010622	Ø 25,4
2.4	120	08/97→11/00					
2.5 TDI	110	09/97→11/00					
2.6	110	01/95→11/00					
2.8	142	10/96→11/00					
1.6	75	07/00→11/00		- ESP; für Linkslenker			
1.9 TDI	85	03/00→11/00		+ ESP; für Linkslenker			
1.9 TDI quattro	85	03/00→11/00					
2.8	140	09/99→10/00				24.2123-1717.3 010521	Ø 23,8
2.8 quattro	140	09/99→10/00					
1.8 quattro	85 - 92	01/95→11/00		→ 01/99; - ESP			
1.8 T quattro	132	12/97→11/00		→ 01/99; + ESP			
1.9 TDI quattro	81	09/96→11/00		02/99→; - ESP; für Linkslenker			
2.4 quattro	120	08/97→11/00		02/99→; + ESP; für Linkslenker			
2.6 quattro	110	01/95→11/00					
1.8 T	110	01/95→11/00		05/95→ 01/99			
				02/99→; - ESP; für Linkslenker			
				02/99→; + ESP; für Linkslenker			
1.8 T quattro	110	01/95→11/00		02/95→ 01/99; - ESP		24.2123-1730.3 010620	Ø 23,8
				02/95→ 01/99; + ESP		24.2123-1730.3 010620	Ø 23,8
				02/99→; - ESP; für Linkslenker		24.2125-1712.3 010622	Ø 25,4
				02/99→; + ESP; für Linkslenker		24.2125-1713.3 010623	Ø 25,4
				02/99→; - ESP; für Linkslenker		24.2125-1712.3 010622	Ø 25,4
				02/99→; + ESP; für Linkslenker		24.2125-1713.3 010623	Ø 25,4
1.9 TDI	55	12/95→11/00		03/96→ 01/99		24.2123-1717.3 010521	Ø 23,8
				02/99→; - ESP; für Linkslenker		24.2125-1712.3 010622	Ø 25,4
				02/99→; + ESP; für Linkslenker		24.2125-1713.3 010623	Ø 25,4
→							

AUDI - A4 B5 (8D2) 11/94→12/01











Hauptbremszylinder

1.9 TDI	81	10/95→11/00		02/96→ 01/99	24.2123-1717.3 010521	Ø 23,8
				02/99→; - ESP; für Linkslenker	24.2125-1712.3 010622	Ø 25,4
				02/99→; + ESP; für Linkslenker	24.2125-1713.3 010623	Ø 25,4
2.4	121	03/97→11/00		→ 07/97	24.2123-1717.3 010521	Ø 23,8
				08/97→ 01/99	24.2123-1717.3 010521	Ø 23,8
				02/99→; - ESP; für Linkslenker	24.2125-1712.3 010622	Ø 25,4
				02/99→; + ESP; für Linkslenker	24.2125-1713.3 010623	Ø 25,4
2.4 quattro	121	03/97→11/00		08/97→ 01/99; - ESP	24.2123-1717.3 010521	Ø 23,8
				08/97→ 01/99; + ESP	24.2123-1730.3 010620	Ø 23,8
				02/99→; - ESP; für Linkslenker	24.2125-1712.3 010622	Ø 25,4
				02/99→; + ESP; für Linkslenker	24.2125-1713.3 010623	Ø 25,4
2.5 TDI quattro	110	09/97→11/00		11/97→ 01/99	24.2123-1717.3 010521	Ø 23,8
				11/97→ 01/99; + ESP	24.2123-1730.3 010620	Ø 23,8
				02/99→; - ESP; für Linkslenker	24.2125-1712.3 010622	Ø 25,4
				02/99→; + ESP; für Linkslenker	24.2125-1713.3 010623	Ø 25,4
2.8	128	09/95→07/97			24.2123-1717.3 010521	Ø 23,8
2.8 quattro	128	01/95→07/97		→ 07/96; - ESP	24.2123-1717.3 010521	Ø 23,8
				→ 07/96; + ESP	24.2123-1730.3 010620	Ø 23,8
2.8 quattro	142	10/96→08/01		→ 01/99; - ESP	24.2123-1717.3 010521	Ø 23,8
				→ 01/99; + ESP	24.2123-1730.3 010620	Ø 23,8
				02/99→ 04/01; - ESP; für Linkslenker	24.2125-1712.3 010622	Ø 25,4
				02/99→ 04/01; + ESP; für Linkslenker	24.2125-1713.3 010623	Ø 25,4
S4 quattro	195	09/97→09/01		10/97→ 01/99; - ESP	24.2123-1717.3 010521	Ø 23,8
				10/97→ 01/99; + ESP	24.2123-1730.3 010620	Ø 23,8
				02/99→ 04/01; - ESP; für Linkslenker	24.2125-1712.3 010622	Ø 25,4
				02/99→ 04/01; + ESP; für Linkslenker	24.2125-1713.3 010623	Ø 25,4

AUDI - A4 B5 Avant (8D5) 11/94→12/02

Hauptbremszylinder

1.6	74	11/94→09/01		→ 01/99	24.2123-1717.3 010521	Ø 23,8
1.8	85 - 92	07/95→09/01		02/99→ 04/01; - ESP; für Linkslenker	24.2125-1712.3 010622	Ø 25,4
				02/99→ 04/01; + ESP; für Linkslenker	24.2125-1713.3 010623	Ø 25,4
1.8 T	110 - 132	03/96→09/01				
1.9 TDI	55 - 81	02/96→09/01				
2.4	120	08/97→09/01				
2.5 TDI	110	09/97→09/01				
2.6	110	02/96→09/01				
2.8	142	10/96→09/01				
1.6	75	07/00→09/01		→ 04/01; - ESP; für Linkslenker	24.2125-1712.3 010622	Ø 25,4
				→ 04/01; + ESP; für Linkslenker	24.2125-1713.3 010623	Ø 25,4
1.9 TDI	85	03/00→09/01				
1.9 TDI quattro	85	03/00→09/01				
1.8 quattro	85 - 92	07/95→09/01		→ 01/99; - ESP	24.2123-1717.3 010521	Ø 23,8
				→ 01/99; + ESP	24.2123-1730.3 010620	Ø 23,8
1.8 T quattro	110 - 132	01/96→09/01				
1.9 TDI quattro	81	09/96→09/01		02/99→ 04/01; - ESP; für Linkslenker	24.2125-1712.3 010622	Ø 25,4
				02/99→ 04/01; + ESP; für Linkslenker	24.2125-1713.3 010623	Ø 25,4
2.4 quattro	120	08/97→09/01				
2.6 quattro	110	01/96→09/01				
2.8 quattro	142	10/96→09/01				
1.9 Hybrid	66	03/98→06/00		→ 01/99	24.2123-1717.3 010521	Ø 23,8
				02/99→; - ESP; für Linkslenker	24.2125-1712.3 010622	Ø 25,4
				02/99→; + ESP; für Linkslenker	24.2125-1713.3 010623	Ø 25,4
2.4	121	03/97→09/01		08/97→ 01/99	24.2123-1717.3 010521	Ø 23,8
				02/99→ 04/01; - ESP; für Linkslenker	24.2125-1712.3 010622	Ø 25,4
				02/99→ 04/01; + ESP; für Linkslenker	24.2125-1713.3 010623	Ø 25,4
2.4 quattro	121	03/97→09/01		08/97→ 01/99; - ESP	24.2123-1717.3 010521	Ø 23,8
				08/97→ 01/99; + ESP	24.2123-1730.3 010620	Ø 23,8
				02/99→ 04/01; - ESP; für Linkslenker	24.2125-1712.3 010622	Ø 25,4
				02/99→ 04/01; + ESP; für Linkslenker	24.2125-1713.3 010623	Ø 25,4
2.5 TDI quattro	110	09/97→09/01		11/97→ 01/99	24.2123-1717.3 010521	Ø 23,8
				11/97→ 01/99; + ESP	24.2123-1730.3 010620	Ø 23,8
				02/99→ 04/01; - ESP; für Linkslenker	24.2125-1712.3 010622	Ø 25,4
				02/99→ 04/01; + ESP; für Linkslenker	24.2125-1713.3 010623	Ø 25,4
2.8	140	03/99→09/00		- ESP; für Linkslenker	24.2125-1712.3 010622	Ø 25,4
→						

	kw			 	! #		
AUDI - A4 B5 Avant (8D5) 11/94→12/02							
 Hauptbremszylinder							
2.8 quattro	140	03/99→09/00		+ ESP; für Linkslenker		24.2125-1713.3 010623	Ø 25,4
RS4 quattro	280	05/00→09/01		06/00→ 04/01; für Linkslenker		24.2125-1713.3 010623	Ø 25,4
S4 quattro	195	09/97→09/01		10/97→ 01/99; - ESP		24.2123-1717.3 010521	Ø 23,8
				10/97→ 01/99; + ESP		24.2123-1730.3 010620	Ø 23,8
				02/99→ 04/01; - ESP; für Linkslenker		24.2125-1712.3 010622	Ø 25,4
				02/99→ 04/01; + ESP; für Linkslenker		24.2125-1713.3 010623	Ø 25,4
AUDI - A4 B6 (8E2) 11/00→12/05							
 Bremskraftverstärker							
1.6	75	11/00→12/04		8E-3-235001→		03.7858-4502.4 300202	ATE Ø 9 / 8" pneumatisch
1.8 T	110 - 140	11/00→12/04					
1.8 T quattro	110 - 140	11/00→12/04					
1.9 TDI	74 - 96	11/00→12/04					
1.9 TDI quattro	96	11/01→12/04					
2.0	96	11/00→12/04					
2.0 FSI	110	07/02→12/04					
2.4	120 - 125	09/01→12/04					
	114 - 120	08/01→12/04					
2.5 TDI quattro	132	11/00→12/04					
3.0	160 - 162	11/00→12/04					
3.0 quattro	160 - 162	11/00→12/04					
1.9 TDI	85	06/04→12/04				03.7858-4502.4 300202	ATE Ø 9 / 8" pneumatisch
 Hauptbremszylinder							
1.6	75	11/00→12/04		12/00→		03.2125-0373.3 010810	ATE Ø 25,4
1.8 T	110	11/00→07/02				24.2125-1720.3 010688	TRW Ø 25,4
1.8 T quattro	110	11/00→07/02					
1.9 TDI	96	11/00→12/04					
2.0	96	11/00→12/04					
2.5 TDI quattro	132	11/00→12/04					
3.0	162	11/00→12/04					
3.0 quattro	162	11/00→12/04					
1.8 T	120 - 140	07/01→12/04				03.2125-0373.3 010810	ATE Ø 25,4
1.8 T quattro	120 - 140	07/01→12/04				24.2125-1720.3 010688	TRW Ø 25,4
1.9 TDI	74 - 85	05/01→12/04					
1.9 TDI quattro	96	11/01→12/04					
2.0 FSI	110	07/02→12/04					
2.4	120 - 125	09/01→12/04					
	114 - 120	08/01→12/04					
3.0	160	04/01→12/04					
3.0 quattro	160	04/01→12/04					
S4 quattro	253	03/03→12/04				24.2126-1705.3 010999	TRW Ø 27
AUDI - A4 B6 Avant (8E5) 02/00→12/05							
 Bremskraftverstärker							
1.6	75	09/01→12/04		8E-3-235001→		03.7858-4502.4 300202	ATE Ø 9 / 8" pneumatisch
1.8 T	110 - 140	09/01→12/04					
1.8 T quattro	110 - 140	09/01→12/04					
1.9 TDI	74 - 96	09/01→12/04					
1.9 TDI quattro	96	11/01→12/04					
2.0	96	09/01→12/04					
2.0 FSI	110	07/02→12/04					
2.4	120 - 125	09/01→12/04					
	114 - 120	09/01→12/04					
2.5 TDI quattro	132	09/01→12/04					
3.0	160 - 162	04/01→12/04					
3.0 quattro	160 - 162	04/01→12/04					
1.9 TDI →	85	06/04→12/04				03.7858-4502.4 300202	ATE Ø 9 / 8" pneumatisch

AUDI - A4 B6 Avant (8E5) 02/00→12/05

Hauptbremszylinder

1.6	75	09/01→12/04			03.2125-0373.3	010810	ATE Ø 25,4
1.8 T	110 - 140	09/01→12/04			24.2125-1720.3	010688	TRW Ø 25,4
1.8 T quattro	110 - 140	09/01→12/04					
1.9 TDI	74 - 96	09/01→12/04					
1.9 TDI quattro	96	11/01→12/04					
2.0	96	09/01→12/04					
2.0 FSI	110	07/02→12/04					
2.4	120 - 125	09/01→12/04					
2.5 TDI	114 - 120	09/01→12/04					
2.5 TDI quattro	132	09/01→12/04					
3.0	160 - 162	04/01→12/04					
3.0 quattro	160 - 162	04/01→12/04					
S4 quattro	253	03/03→12/04			24.2126-1705.3	010999	TRW Ø 27

AUDI - A4 B6 Cabriolet (8H7) 01/02→12/09

Bremskraftverstärker

1.8 T	120 - 125	07/02→12/05		8H-3-017415→	03.7858-4502.4	300202	ATE Ø 9 / 8" pneumatisch
2.4	120 - 125	04/02→12/05					
2.5 TDI	120	08/02→12/05					
3.0	162	04/02→12/05					
1.8 T quattro	120	05/03→12/05			03.7858-4502.4	300202	ATE Ø 9 / 8" pneumatisch
2.0	96	09/04→12/05					
3.0 quattro	162	05/03→12/05					
3.0	160	04/02→12/05		8E-3-235001→	03.7858-4502.4	300202	ATE Ø 9 / 8" pneumatisch











Hauptbremszylinder













1.8 T	120 - 125	07/02→12/05		8H-7-022001→	03.2125-0373.3	010810	ATE Ø 25,4
2.4	120 - 125	04/02→12/05		8H-3-017415→ 8H-7-022000	03.2125-0373.3	010810	ATE Ø 25,4
2.5 TDI	120	08/02→12/05			24.2125-1720.3	010688	TRW Ø 25,4
3.0	162	04/02→12/05					
1.8 T quattro	120	05/03→12/05		8H-7-022001→	03.2125-0373.3	010810	ATE Ø 25,4
2.0	96	09/04→12/05		→ 8H-7-022000	03.2125-0373.3	010810	ATE Ø 25,4
3.0 quattro	162	05/03→12/05			24.2125-1720.3	010688	TRW Ø 25,4
3.0	160	04/02→12/05			03.2125-0373.3	010810	ATE Ø 25,4
					24.2125-1720.3	010688	TRW Ø 25,4
S4 quattro	253	03/04→12/05			24.2126-1705.3	010999	TRW Ø 27











AUDI - A4 B7 (8EC) 11/04→06/08













Bremskraftverstärker













1.6	75	11/04→06/08		8E-3-235001→	03.7858-4502.4	300202	ATE Ø 9 / 8" pneumatisch
1.8 T	120	11/04→06/08					
1.8 T quattro	120	11/04→06/08					
2.0	96	11/04→06/08					
2.5 TDI	120	11/04→05/06					
3.0	160	11/04→05/06					
3.0 quattro	160	11/04→07/06					
1.9 TDI	85	11/04→06/08			03.7858-4502.4	300202	ATE Ø 9 / 8" pneumatisch
2.0 TDI	120 - 125	06/06→06/08					
2.0 TDI quattro	103 - 125	01/06→06/08					
2.0 TFSI	125 - 162	11/04→06/08					
2.7 TDI	120 - 132	11/05→06/08					
3.0 TDI quattro	171	01/06→06/08					
3.2 FSI	188	01/05→06/08					
2.0 TDI	89 - 103	11/04→06/08		8E-5-400001→	03.7858-4502.4	300202	ATE Ø 9 / 8" pneumatisch
2.0 TDI 16V	103	11/04→06/08					
2.0 TFSI quattro	147 - 162	11/04→06/08					
3.0 TDI quattro	150	11/04→06/08					
3.2 FSI quattro	188	01/05→06/08					
2.0 TDI	93	11/05→11/06		06/06→	03.7858-4502.4	300202	ATE Ø 9 / 8" pneumatisch
→							







	kW			 	! #		
AUDI - A4 B7 (8EC) 11/04→06/08							
 Hauptbremszylinder							
1.6	75	11/04→06/08				03.2125-0373.3 010810	ATE Ø 25,4
1.8 T	120	11/04→06/08				24.2125-1720.3 010688	TRW Ø 25,4
1.8 T quattro	120	11/04→06/08					
1.9 TDI	85	11/04→06/08					
2.0	96	11/04→06/08					
2.0 TDI	89 - 125	11/04→06/08					
2.0 TDI 16V	103	11/04→06/08					
2.0 TDI quattro	103 - 125	01/06→06/08					
2.0 TFSI	125 - 162	06/05→06/08					
2.0 TFSI quattro	147 - 162	11/04→06/08					
2.5 TDI	120	11/04→05/06					
2.7 TDI	120 - 132	11/05→06/08					
3.0	160	11/04→05/06					
3.0 quattro	160	11/04→07/06					
3.0 TDI quattro	150 - 171	11/04→06/08					
3.2 FSI	188	01/05→06/08					
3.2 FSI quattro	188	01/05→06/08					
2.0 TDI	93	11/05→11/06		06/06→		03.2125-0373.3 010810	ATE Ø 25,4
						24.2125-1720.3 010688	TRW Ø 25,4
2.0 TFSI	147	11/04→06/08		12/04→		03.2125-0373.3 010810	ATE Ø 25,4
						24.2125-1720.3 010688	TRW Ø 25,4
RS4 quattro	309	09/05→06/08		11/05→		24.2126-1705.3 010999	TRW Ø 27
S4 quattro	253	11/04→06/08				24.2126-1705.3 010999	TRW Ø 27
AUDI - A4 B7 Avant (8ED) 11/04→06/08							
 Bremskraftverstärker							
1.6	75	11/04→06/08		8E-3-235001→		03.7858-4502.4 300202	ATE Ø 9 / 8" pneumatisch
1.8 T	120	11/04→06/08					
1.8 T quattro	120	11/04→06/08					
2.0	96	11/04→06/08					
2.5 TDI	120	11/04→05/06					
3.0	160	11/04→05/06					
3.0 quattro	160	11/04→07/06					
1.9 TDI	85	11/04→06/08				03.7858-4502.4 300202	ATE Ø 9 / 8" pneumatisch
2.0 TDI	120 - 125	06/06→06/08					
2.0 TDI quattro	103 - 125	01/06→06/08					
2.0 TFSI	125 - 162	11/04→06/08					
2.7 TDi	120	11/05→03/08					
2.7 TDI	132	01/06→06/08					
3.0 TDI quattro	171	01/06→06/08					
3.2 FSI	188	01/05→06/08					
2.0 TDI	89 - 103	11/04→06/08		8E-5-400001→		03.7858-4502.4 300202	ATE Ø 9 / 8" pneumatisch
2.0 TDI 16V	103	11/04→06/08					
2.0 TFSI quattro	147 - 162	11/04→06/08					
3.0 TDI quattro	150	11/04→06/08					
3.2 FSI quattro	188	01/05→06/08					
2.0 TDI	93	11/05→11/06		06/06→		03.7858-4502.4 300202	ATE Ø 9 / 8" pneumatisch
 Hauptbremszylinder							
1.6	75	11/04→06/08				03.2125-0373.3 010810	ATE Ø 25,4
1.8 T	120	11/04→06/08				24.2125-1720.3 010688	TRW Ø 25,4
1.8 T quattro	120	11/04→06/08					
1.9 TDI	85	11/04→06/08					
2.0	96	11/04→06/08					
2.0 TDI	89 - 125	11/04→06/08					
2.0 TDI 16V	103	11/04→06/08					
2.0 TDI quattro	103 - 125	01/06→06/08					
2.0 TFSI	125 - 162	06/05→06/08					
2.0 TFSI quattro	147 - 162	11/04→06/08					
2.5 TDI	120	11/04→05/06					
2.7 TDi	120	11/05→03/08					
2.7 TDI	132	01/06→06/08					
3.0	160	11/04→05/06					
3.0 quattro	160	11/04→07/06					
→							

	kw			 	! #		
AUDI - A4 B7 Avant (8ED) 11/04→06/08							
 Hauptbremszylinder							
3.0 TDI quattro	150 - 171	11/04→06/08				03.2125-0373.3 010810	ATE Ø 25,4
3.2 FSI	188	01/05→06/08				24.2125-1720.3 010688	TRW Ø 25,4
3.2 FSI quattro	188	01/05→06/08					
2.0 TDI	93	11/05→11/06		06/06→		03.2125-0373.3 010810	ATE Ø 25,4
						24.2125-1720.3 010688	TRW Ø 25,4
2.0 TFSI	147	11/04→06/08		12/04→		03.2125-0373.3 010810	ATE Ø 25,4
						24.2125-1720.3 010688	TRW Ø 25,4
RS4 quattro	309	09/05→06/08		11/05→		24.2126-1705.3 010999	TRW Ø 27
S4 quattro	253	11/04→06/08				24.2126-1705.3 010999	TRW Ø 27
AUDI - A4 B7 Cabriolet (8HE) 01/02→12/09							
 Bremskraftverstärker							
1.8 T	120	01/06→03/09		8E-3-235001→		03.7858-4502.4 300202	ATE Ø 9 / 8" pneumatisch
2.0 TDI	100 - 103	01/06→03/09		→ 11/08		03.7858-4502.4 300202	ATE Ø 9 / 8" pneumatisch
2.0 TFSI 16V	147	01/06→03/09					
2.7 TDI	132	06/06→03/09					
3.0 TDI quattro	150 - 171	01/06→03/09					
3.2 FSI	188	01/06→03/09					
3.2 FSI quattro	188	01/06→03/09					
 Hauptbremszylinder							
1.8 T	120	01/06→03/09				03.2125-0373.3 010810	ATE Ø 25,4
						24.2125-1720.3 010688	TRW Ø 25,4
2.0 TDI	100 - 103	01/06→03/09		→ 8H-7-022000		03.2125-0373.3 010810	ATE Ø 25,4
2.0 TFSI 16V	147	01/06→03/09		8H-7-022001→; → 11/08		03.2125-0373.3 010810	ATE Ø 25,4
2.7 TDI	132	06/06→03/09		→ 11/08		24.2125-1720.3 010688	TRW Ø 25,4
3.0 TDI quattro	150 - 171	01/06→03/09					
3.2 FSI	188	01/06→03/09					
3.2 FSI quattro	188	01/06→03/09					
RS4 quattro	309	02/06→12/08		→ 11/08		24.2126-1705.3 010999	TRW Ø 27
S4 quattro	253	11/05→03/09				24.2126-1705.3 010999	TRW Ø 27
AUDI - A4 B8 (8K2) 08/07→09/16							
 Bremskraftverstärker							
1.8 T	110	07/08→05/10				03.7858-4632.4 300273	ATE Ø 9 / 8" pneumatisch
1.8 TFSI	88 - 118	11/07→12/15					
1.8 TFSI quattro	118	09/08→03/12					
2.0 TDI	88 - 125	11/07→12/15					
2.0 TDI quattro	105 - 125	01/08→12/15					
2.0 TFSI	132 - 155	06/08→12/15					
2.0 TFSI flexible fuel	132	11/09→12/15					
2.0 TFSI flexible fuel quattro	132	11/09→12/15					
2.0 TFSI quattro	132 - 155	06/08→12/15					
2.7 TDI	120 - 140	11/07→03/12					
3.0 TDI quattro	155 - 176	11/07→03/12					
3.2 FSI	195	09/08→03/12					
3.2 FSI quattro	195	11/07→03/12					
S4 quattro	245	11/08→12/15					
 Hauptbremszylinder							
1.8 T	110	07/08→05/10				03.2125-0493.3 010940	ATE Ø 25,4
1.8 TFSI	88 - 118	11/07→12/15				24.2125-1739.3 010948	TRW Ø 25,4
1.8 TFSI quattro	118	09/08→03/12					
2.0 TDI	88 - 125	11/07→12/15					
2.0 TDI quattro	105 - 125	01/08→12/15					
2.0 TFSI	132 - 155	06/08→12/15					
2.0 TFSI flexible fuel	132	11/09→12/15					
2.0 TFSI flexible fuel quattro	132	11/09→12/15					

	kw			 	! #		
AUDI - A4 B8 (8K2) 08/07→09/16							
 Hauptbremszylinder							
2.0 TFSI quattro	132 - 155	06/08→12/15				03.2125-0493.3 010940	ATE Ø 25,4
2.7 TDI	120 - 140	11/07→03/12				24.2125-1739.3 010948	TRW Ø 25,4
3.0 TDI quattro	155 - 176	11/07→03/12					
3.2 FSI	195	09/08→03/12					
3.2 FSI quattro	195	11/07→03/12					
S4 quattro	245	11/08→12/15					
AUDI - A4 B8 Avant (8K5) 11/07→12/15							
 Bremskraftverstärker							
1.8 TFSI	88	04/08→12/15				03.7858-4632.4 300273	ATE Ø 9 / 8" pneumatisch
1.8 TFSI quattro	118	09/08→03/12					
2.0 TDI	88 - 125	04/08→12/15					
2.0 TDI quattro	105 - 125	04/08→12/15					
2.0 TFSI	132 - 155	06/08→12/15					
2.0 TFSI flexible fuel	132	11/09→12/15					
2.0 TFSI flexible fuel quattro	132	11/09→12/15					
2.0 TFSI quattro	155	06/08→12/15					
2.7 TDI	120	06/08→03/12					
3.0 TDI quattro	155 - 176	04/08→03/12					
3.2 FSI	195	09/08→03/12					
3.2 FSI quattro	195	04/08→03/12					
S4 quattro	245	11/08→12/15					
1.8 TFSI	118	11/07→03/12		04/08→		03.7858-4632.4 300273	ATE Ø 9 / 8" pneumatisch
2.7 TDI	140	04/08→03/12		06/08→		03.7858-4632.4 300273	ATE Ø 9 / 8" pneumatisch
 Hauptbremszylinder							
1.8 TFSI	88	04/08→12/15				03.2125-0493.3 010940	ATE Ø 25,4
1.8 TFSI quattro	118	09/08→03/12				24.2125-1739.3 010948	TRW Ø 25,4
2.0 TDI	88 - 125	04/08→12/15					
2.0 TDI quattro	105 - 125	04/08→12/15					
2.0 TFSI	132 - 155	06/08→12/15					
2.0 TFSI flexible fuel	132	11/09→12/15					
2.0 TFSI flexible fuel quattro	132	11/09→12/15					
2.0 TFSI quattro	155	06/08→12/15					
2.7 TDI	120	06/08→03/12					
3.0 TDI quattro	155 - 176	04/08→03/12					
3.2 FSI	195	09/08→03/12					
3.2 FSI quattro	195	04/08→03/12					
S4 quattro	245	11/08→12/15					
1.8 TFSI	118	11/07→03/12		04/08→		03.2125-0493.3 010940	ATE Ø 25,4
						24.2125-1739.3 010948	TRW Ø 25,4
2.7 TDI	140	04/08→03/12		06/08→		03.2125-0493.3 010940	ATE Ø 25,4
						24.2125-1739.3 010948	TRW Ø 25,4
AUDI - A5 (8T3) 06/07→01/17							
 Bremskraftverstärker							
1.8 TFSI	118 - 125	10/07→01/17				03.7858-4632.4 300273	ATE Ø 9 / 8" pneumatisch
2.0 TDI	125 - 130	08/08→01/17					
2.0 TDI quattro	125	08/08→03/12					
2.0 TFSI	132 - 155	06/08→11/13					
2.0 TFSI quattro	155	06/08→01/17					
2.7 TDI	120 - 140	06/07→03/12					
3.0 TDI	150	10/11→01/17					
3.0 TDI quattro	155 - 180	06/07→01/17					
3.2 FSI	195	06/07→03/12					
3.2 FSI quattro	195	06/07→03/12					
S5 quattro	245 - 260	06/07→01/17					
2.0 TDI	120	08/08→01/17		10/08→		03.7858-4632.4 300273	ATE Ø 9 / 8" pneumatisch
→							

	kw			 	! #		
AUDI - A5 (8T3) 06/07→01/17							
 Hauptbremszylinder							
1.8 TFSI	118 - 125	10/07→01/17				03.2125-0493.3 010940	ATE Ø 25,4
2.0 TDI	125 - 130	08/08→01/17				24.2125-1739.3 010948	TRW Ø 25,4
2.0 TDI quattro	125	08/08→03/12					
2.0 TFSI	132 - 155	06/08→11/13					
2.0 TFSI quattro	155	06/08→01/17					
2.7 TDI	120 - 140	06/07→03/12					
3.0 TDI	150	10/11→01/17					
3.0 TDI quattro	155 - 180	06/07→01/17					
3.2 FSI	195	06/07→03/12					
3.2 FSI quattro	195	06/07→03/12					
S5 quattro	245 - 260	06/07→01/17					
2.0 TDI	120	08/08→01/17		10/08→		03.2125-0493.3 010940	ATE Ø 25,4
						24.2125-1739.3 010948	TRW Ø 25,4
AUDI - A5 Cabriolet (8F7) 02/09→01/17							
 Bremskraftverstärker							
1.8 TFSI	118 - 125	09/09→03/16				03.7858-4632.4 300273	ATE Ø 9 / 8" pneumatisch
2.0 TDI	120 - 130	05/09→01/17					
2.0 TFSI	132	03/09→03/12					
2.0 TFSI quattro	155	03/09→01/17					
2.7 TDI	120 - 140	03/09→03/12					
3.0 TDI	150	10/11→01/17					
3.0 TDI quattro	176 - 180	03/09→01/17					
3.2 FSI	195	03/09→03/12					
3.2 FSI quattro	195	03/09→03/12					
S5 quattro	245	06/09→01/17					
2.0 TFSI	155	03/09→06/14		+PR 1LT		03.7858-4632.4 300273	ATE Ø 9 / 8" pneumatisch
 Hauptbremszylinder							
1.8 TFSI	118 - 125	09/09→03/16				03.2125-0493.3 010940	ATE Ø 25,4
2.0 TDI	120 - 130	05/09→01/17				24.2125-1739.3 010948	TRW Ø 25,4
2.0 TFSI	132	03/09→03/12					
2.0 TFSI quattro	155	03/09→01/17					
2.7 TDI	120 - 140	03/09→03/12					
3.0 TDI	150	10/11→01/17					
3.0 TDI quattro	176 - 180	03/09→01/17					
3.2 FSI	195	03/09→03/12					
3.2 FSI quattro	195	03/09→03/12					
S5 quattro	245	06/09→01/17					
2.0 TFSI	155	03/09→06/14		+PR 1LT		03.2125-0493.3 010940	ATE Ø 25,4
						24.2125-1739.3 010948	TRW Ø 25,4
AUDI - A5 Sportback (8TA) 07/07→01/17							
 Bremskraftverstärker							
1.8 TFSI	118 - 125	11/09→01/17				03.7858-4632.4 300273	ATE Ø 9 / 8" pneumatisch
2.0 TDI	100 - 130	09/09→01/17					
2.0 TDI quattro	125	09/09→03/12					
2.0 TFSI	132 - 155	09/09→06/14					
2.0 TFSI quattro	155	09/09→01/17					
2.7 TDI	120 - 140	09/09→03/12					
3.0 TDI	150	10/11→01/17					
3.0 TDI quattro	176 - 180	09/09→01/17					
3.2 FSI quattro	195	09/09→03/12					
S5 quattro	245	01/10→01/17					
 Hauptbremszylinder							
1.8 TFSI	118 - 125	11/09→01/17				03.2125-0493.3 010940	ATE Ø 25,4
→						24.2125-1739.3 010948	TRW Ø 25,4

	kW			 	! #		
AUDI - A5 Sportback (8TA) 07/07→01/17							
 Hauptbremszylinder							
2.0 TDI	100 - 130	09/09→01/17				03.2125-0493.3 010940	ATE Ø 25,4
2.0 TDI quattro	125	09/09→03/12				24.2125-1739.3 010948	TRW Ø 25,4
2.0 TFSI	132 - 155	09/09→06/14					
2.0 TFSI quattro	155	09/09→01/17					
2.7 TDI	120 - 140	09/09→03/12					
3.0 TDI	150	10/11→01/17					
3.0 TDI quattro	176 - 180	09/09→01/17					
3.2 FSI quattro	195	09/09→03/12					
S5 quattro	245	01/10→01/17					
AUDI - A6 Allroad C6 (4FH) 03/06→08/11							
 Hauptbremszylinder							
2.7 TDI quattro	120 - 140	05/06→08/11		→ 05/11		24.2126-1705.3 010999	TRW Ø 27
3.0 TDI quattro	155 - 176	05/06→08/11					
3.0 TFSI quattro	213	10/08→08/11					
2.7 TDI quattro	132	03/06→10/08				24.2126-1705.3 010999	TRW Ø 27
3.0 TDI quattro	171	05/06→10/08					
3.2 FSI quattro	188	05/06→10/08					
4.2 FSI quattro	257	05/06→12/10					
AUDI - A6 Allroad C7 (4GH, 4GJ) 01/12→09/18							
 Hauptbremszylinder							
3.0 TDI quattro	140 - 235	01/12→09/18		für Linkslenker		24.2125-1749.3 011031	TRW Ø 25,4
3.0 TFSI quattro	228 - 245	01/12→09/18					
AUDI - A6 C4 (4A2) 06/94→10/97							
 Hauptbremszylinder							
1.8	92	12/95→10/97		+ ABS		24.2123-1731.3 010621	Ø 23,8
2.8	142	12/95→10/97					
1.8 quattro	92	12/95→10/97				24.2123-1731.3 010621	Ø 23,8
2.0 16V quattro	103	06/94→10/97					
2.5 TDI quattro	103	10/95→10/97					
2.6 quattro	110	06/94→10/97					
2.8 quattro	128 - 142	06/94→10/97					
1.9 TDI	66	06/94→10/97		→ 06/95; - ABS		03.2123-0491.3 010167	Ø 23,8
2.0	74 - 85	06/94→10/97		→ 06/95; - EDS / + ABS		24.2123-1602.3 010384	TRW Ø 23,8
2.0 16V	103	06/94→10/97		07/95→; + ABS		24.2123-1731.3 010621	Ø 23,8
2.5 TDI	85 - 103	06/94→10/97		→ 06/95; + EDS / + ABS		24.2123-1731.3 010621	Ø 23,8
2.6	102 - 110	06/94→10/97					
2.8	128	06/94→10/97					
AUDI - A6 C4 Avant (4A5) 06/94→12/97							
 Hauptbremszylinder							
1.8	92	12/95→12/97		+ ABS		24.2123-1731.3 010621	Ø 23,8
2.8	142	12/95→12/97					
1.8 quattro	92	12/95→12/97				24.2123-1731.3 010621	Ø 23,8
2.0 16V quattro	103	06/94→12/97					
2.5 TDI quattro	103	07/95→12/97					
2.6 quattro	110	06/94→12/97					
2.8 quattro	128 - 142	06/94→12/97					
1.9 TDI	66	06/94→12/97		→ 06/95; - ABS		03.2123-0491.3 010167	Ø 23,8
2.0	74 - 85	06/94→12/97		→ 06/95; - EDS / + ABS		24.2123-1602.3 010384	TRW Ø 23,8
2.0 16V	103	06/94→12/97		07/95→; + ABS		24.2123-1731.3 010621	Ø 23,8
2.5 TDI	85 - 103	06/94→12/97		→ 06/95; + EDS / + ABS		24.2123-1731.3 010621	Ø 23,8
2.6	102 - 110	06/94→12/97					
2.8	128	06/94→12/97					
AUDI - A6 C5 (4B2) 01/97→12/05							
 Bremskraftverstärker							
1.8	85 - 92	05/97→01/05		4B-2-130001→		03.7858-4502.4 300202	ATE Ø 9 / 8" pneumatisch
→							

	kw			 	! #		
AUDI - A6 C5 (4B2) 01/97→12/05							
Bremskraftverstärker							
1.8 T	110 - 132	01/97→01/05		4B-2-130001→		03.7858-4502.4 300202	ATE Ø 9 / 8" pneumatisch
1.8 T quattro	110 - 132	02/97→01/05					
1.9 TDI	81 - 96	04/97→01/05					
2.0	96	08/01→01/05					
2.4	100 - 125	02/97→01/05					
2.4 quattro	115 - 125	02/97→01/05					
2.5 TDI	110 - 132	07/97→01/05					
2.5 TDI quattro	110 - 132	07/97→01/05					
2.7 quattro	187	05/01→07/04					
2.7 T	169	02/99→01/05					
2.7 T quattro	169 - 184	12/97→01/05					
2.8	132 - 142	02/97→01/05					
2.8 quattro	132 - 142	02/97→01/05					
3.0	160 - 162	06/01→01/05					
3.0 quattro	160 - 162	06/01→01/05					
3.7	191	03/99→01/05					
3.7 quattro	191	03/99→01/05					
4.2 quattro	220	11/98→01/05					
S6 quattro	250	09/99→01/05					
Hauptbremszylinder							
1.8	85 - 92	05/97→01/05		4B-2-130136→		03.2125-0373.3 010810	ATE Ø 25,4
1.8 T	132	12/97→01/05		→ 4B-X-130000; + EDS		24.2123-1717.3 010521	Ø 23,8
1.8 T quattro	132	12/97→01/05		→ 4B-X-130000; + ESP		24.2123-1730.3 010620	Ø 23,8
1.9 TDI	85	07/00→01/05		4B-X-130001→; → 05/01; für Linkslenker; + EDS		24.2125-1712.3 010622	Ø 25,4
2.4	100	07/98→01/05					
2.5 TDI	110	07/97→01/05		4B-X-130001→; → 05/01; für Linkslenker; + ESP		24.2125-1713.3 010623	Ø 25,4
2.5 TDI quattro	110 - 132	07/97→01/05					
2.8	140	07/99→01/05		06/01→		24.2125-1720.3 010688	TRW Ø 25,4
1.8 T	110	01/97→01/05		4B-2-130136→		03.2125-0373.3 010810	ATE Ø 25,4
1.8 T quattro	110	02/97→01/05		04/97→; → 4B-X-130000; + EDS		24.2123-1717.3 010521	Ø 23,8
2.4	115 - 121	02/97→01/05		04/97→; → 4B-X-130000; + ESP		24.2123-1730.3 010620	Ø 23,8
2.4 quattro	120 - 121	02/97→01/05		4B-X-130001→; → 05/01; für Linkslenker; + EDS		24.2125-1712.3 010622	Ø 25,4
2.8	142	02/97→01/05		4B-X-130001→; → 05/01; für Linkslenker; + ESP		24.2125-1713.3 010623	Ø 25,4
2.8 quattro	142	02/97→01/05					
				06/01→		24.2125-1720.3 010688	TRW Ø 25,4
1.9 TDI	81	04/97→10/00		4B-2-130136→		03.2125-0373.3 010810	ATE Ø 25,4
2.4 quattro	115	08/98→07/99		→ 4B-X-130000; + EDS		24.2123-1717.3 010521	Ø 23,8
2.8	132	10/97→05/00		→ 4B-X-130000; + ESP		24.2123-1730.3 010620	Ø 23,8
2.8 quattro	132 - 140	01/98→05/01		4B-X-130001→; für Linkslenker; + EDS		24.2125-1712.3 010622	Ø 25,4
				4B-X-130001→; für Linkslenker; + ESP		24.2125-1713.3 010623	Ø 25,4
1.9 TDI	96	08/01→01/05		4B-2-130136→		03.2125-0373.3 010810	ATE Ø 25,4
2.4	125	08/01→01/05		→ 4B-X-130000; + EDS		24.2123-1717.3 010521	Ø 23,8
2.4 quattro	125	08/01→01/05		→ 4B-X-130000; + ESP		24.2123-1730.3 010620	Ø 23,8
2.5 TDI	114	08/01→01/05					
2.7 T quattro	184	08/01→01/05				24.2125-1720.3 010688	TRW Ø 25,4
2.0	96	08/01→01/05		4B-2-130136→		03.2125-0373.3 010810	ATE Ø 25,4
2.5 TDI	120	07/02→01/05				24.2125-1720.3 010688	TRW Ø 25,4
3.0	160 - 162	06/01→01/05					
3.0 quattro	160 - 162	06/01→01/05					
3.7	191	03/99→01/05					
3.7 quattro	191	03/99→01/05					
2.5 TDI	132	02/00→01/05		4B-2-130136→		03.2125-0373.3 010810	ATE Ø 25,4
2.7 T	169	02/99→01/05		→ 05/01; für Linkslenker; + EDS		24.2125-1712.3 010622	Ø 25,4
				→ 05/01; für Linkslenker; + ESP		24.2125-1713.3 010623	Ø 25,4
				06/01→		24.2125-1720.3 010688	TRW Ø 25,4
2.7 quattro	187	05/01→07/04		4B-2-130136→		03.2125-0373.3 010810	ATE Ø 25,4
2.7 T quattro	169	12/97→01/05		→ 4B-X-130000; + EDS		24.2123-1717.3 010521	Ø 23,8
				→ 4B-X-130000; + ESP		24.2123-1730.3 010620	Ø 23,8
→							

AUDI - A6 C5 (4B2) 01/97→12/05

Hauptbremszylinder

2.7 quattro 2.7 T quattro	187	05/01→07/04		→ 05/01; für Linkslenker; + EDS	24.2125-1712.3 010622	Ø 25,4
	169	12/97→01/05		4B-X-130001→; → 05/01; für Linkslenker; + ESP	24.2125-1713.3 010623	Ø 25,4
				06/01→	24.2125-1720.3 010688	TRW Ø 25,4
4.2 quattro	220	11/98→01/05		4B-2-130136→	03.2125-0373.3 010810	ATE Ø 25,4
				→ 05/01; + EDS	24.2125-1712.3 010622	Ø 25,4
				→ 05/01; + ESP	24.2125-1713.3 010623	Ø 25,4
				06/01→	24.2125-1720.3 010688	TRW Ø 25,4
RS6 quattro	331	07/02→01/05			24.2126-1705.3 010999	TRW Ø 27
S6 quattro	250	09/99→01/05		4B-2-130136→	03.2125-0373.3 010810	ATE Ø 25,4
				→ 05/01	24.2125-1712.3 010622	Ø 25,4
					24.2125-1713.3 010623	Ø 25,4
				06/01→	24.2125-1720.3 010688	TRW Ø 25,4











AUDI - A6 C5 Avant (4B5) 11/97→01/05











Bremskraftverstärker













1.8	85 - 92	12/97→01/05		4B-2-130001→	03.7858-4502.4 300202	ATE Ø 9 / 8" pneumatisch
1.8 T	110 - 132	12/97→01/05				
1.8 T quattro	110 - 132	12/97→01/05				
1.9 TDI	81 - 96	02/98→01/05				
2.0	96	08/01→01/05				
2.4	100 - 125	12/97→01/05				
2.4 quattro	115 - 125	12/97→01/05				
2.5 TDI	110 - 132	12/97→01/05				
2.5 TDI quattro	110 - 132	12/97→01/05				
2.7 T	169	02/99→01/05				
2.7 T quattro	169 - 184	12/97→01/05				
2.8	132 - 142	12/97→01/05				
2.8 quattro	142	12/97→01/05				
3.0	160 - 162	06/01→01/05				
3.0 quattro	160 - 162	06/01→01/05				
3.7	191	03/99→01/05				
3.7 quattro	191	03/99→01/05				
4.2 quattro	220	11/98→01/05				
S6 quattro	250	09/99→01/05				











Hauptbremszylinder













1.8	85 - 92	12/97→01/05		4B-2-130136→	03.2125-0373.3 010810	ATE Ø 25,4
1.8 T	110 - 132	12/97→01/05		→ 4B-X-130000; + EDS	24.2123-1717.3 010521	Ø 23,8
				→ 4B-X-130000; + ESP	24.2123-1730.3 010620	Ø 23,8
1.8 T quattro	110 - 132	12/97→01/05		4B-X-130001→; → 05/01; für Linkslenker; + EDS	24.2125-1712.3 010622	Ø 25,4
1.9 TDI	85	07/00→01/05				
2.4	100 - 121	12/97→01/05		4B-X-130001→; → 05/01; für Linkslenker; + ESP	24.2125-1713.3 010623	Ø 25,4
2.4 quattro	120 - 121	12/97→01/05		06/01→	24.2125-1720.3 010688	TRW Ø 25,4
2.5 TDI	110	12/97→01/05				
2.5 TDI quattro	110 - 132	12/97→01/05				
2.8	140 - 142	12/97→01/05				
2.8 quattro	142	12/97→01/05				
1.9 TDI	81	02/98→04/01		4B-2-130136→	03.2125-0373.3 010810	ATE Ø 25,4
2.4 quattro 2.8	115 - 132	08/98→05/01 12/97→05/00		→ 4B-X-130000; + EDS	24.2123-1717.3 010521	Ø 23,8
				→ 4B-X-130000; + ESP	24.2123-1730.3 010620	Ø 23,8
				4B-X-130001→; für Linkslenker; + EDS	24.2125-1712.3 010622	Ø 25,4
				4B-X-130001→; für Linkslenker; + ESP	24.2125-1713.3 010623	Ø 25,4
1.9 TDI	96	08/01→01/05		4B-2-130136→	03.2125-0373.3 010810	ATE Ø 25,4
2.4	125	08/01→01/05				
2.4 quattro	125	08/01→01/05		→ 4B-X-130000; + EDS	24.2123-1717.3 010521	Ø 23,8
2.5 TDI	114	08/01→01/05		→ 4B-X-130000; + ESP	24.2123-1730.3 010620	Ø 23,8
→						













	kw			 	! #		
AUDI - A6 C5 Avant (4B5) 11/97→01/05							
 Hauptbremszylinder							
2.7 T quattro	184	08/01→01/05				24.2125-1720.3 010688	TRW Ø 25,4
2.0	96	08/01→01/05		4B-2-130136→		03.2125-0373.3 010810	ATE Ø 25,4
2.5 TDI	120	07/02→01/05					
3.0	160	06/01→01/05				24.2125-1720.3 010688	TRW Ø 25,4
	162						
3.0 quattro	160	06/01→01/05					
	162						
3.7	191	03/99→01/05					
3.7 quattro	191	03/99→01/05					
2.5 TDI	132	02/00→01/05		4B-2-130136→		03.2125-0373.3 010810	ATE Ø 25,4
2.7 T	169	02/99→01/05		→ 05/01; für Linkslenker; + EDS		24.2125-1712.3 010622	Ø 25,4
				→ 05/01; für Linkslenker; + ESP		24.2125-1713.3 010623	Ø 25,4
				06/01→		24.2125-1720.3 010688	TRW Ø 25,4
2.7 T quattro	169	12/97→01/05		4B-2-130136→		03.2125-0373.3 010810	ATE Ø 25,4
				→ 4B-X-130000; + EDS		24.2123-1717.3 010521	Ø 23,8
				→ 4B-X-130000; + ESP		24.2123-1730.3 010620	Ø 23,8
				→ 05/01; für Linkslenker; + EDS		24.2125-1712.3 010622	Ø 25,4
				4B-X-130001→; → 05/01; für Linkslenker; + ESP		24.2125-1713.3 010623	Ø 25,4
				06/01→		24.2125-1720.3 010688	TRW Ø 25,4
4.2 quattro	220	11/98→01/05		4B-2-130136→		03.2125-0373.3 010810	ATE Ø 25,4
				→ 05/01; + EDS		24.2125-1712.3 010622	Ø 25,4
				→ 05/01; + ESP		24.2125-1713.3 010623	Ø 25,4
				06/01→		24.2125-1720.3 010688	TRW Ø 25,4
RS6 plus quattro	353	04/04→01/05				24.2126-1705.3 010999	TRW Ø 27
RS6 quattro	331	07/02→01/05					
S6 quattro	250	09/99→01/05		4B-2-130136→		03.2125-0373.3 010810	ATE Ø 25,4
				→ 05/01		24.2125-1712.3 010622	Ø 25,4
						24.2125-1713.3 010623	Ø 25,4
				06/01→		24.2125-1720.3 010688	TRW Ø 25,4
AUDI - A6 C6 (4F2) 04/04→08/11							
 Hauptbremszylinder							
2.0 TDI	89 - 125	07/04→03/11				24.2126-1705.3 010999	TRW Ø 27
2.0 TFSI	125	06/05→03/11					
2.4	130	05/04→10/08					
2.4 quattro	130	01/05→10/08					
2.7 TDI	120 - 140	11/04→03/11					
2.7 TDI quattro	120 - 140	11/04→03/11					
2.8 FSI	140 - 162	11/06→03/11					
2.8 FSI quattro	140 - 162	06/07→03/11					
3.0	160	08/04→05/06					
3.0 quattro	160	05/04→05/06					
3.0 TDI quattro	155 - 176	05/04→03/11					
3.0 TFSI quattro	213 - 220	10/08→03/11					
3.2 FSI	188 - 195	05/04→03/11					
3.2 FSI quattro	183 - 188	05/04→10/08					
4.2 FSI quattro	257	06/06→03/11					
4.2 quattro	246	05/04→05/06					
RS6 quattro	426	09/08→08/10					
S6 quattro	320	03/06→03/11					
2.0 TDI	100	07/04→03/11		06/05→		24.2126-1705.3 010999	TRW Ø 27
AUDI - A6 C6 Avant (4F5) 11/04→08/11							
 Hauptbremszylinder							
2.0 TDI	89 - 125	06/05→08/11				24.2126-1705.3 010999	TRW Ø 27
2.0 TFSI	125	06/05→08/11					
2.4	130	03/05→10/08					
2.4 quattro	130	03/05→10/08					
2.7 TDI	120 - 140	03/05→08/11					
2.7 TDI quattro	120 - 140	11/04→08/11					
→							

	kw			 	! #		
AUDI - A6 C6 Avant (4F5) 11/04→08/11							
 Hauptbremszylinder							
2.8 FSI	140 - 162	11/06→08/11				24.2126-1705.3 010999	TRW Ø 27
2.8 FSI quattro	140 - 162	06/07→08/11					
3.0	160	03/05→05/06					
3.0 quattro	160	03/05→05/06					
3.0 TDI quattro	155 - 176	03/05→08/11					
3.0 TFSI quattro	213 - 220	10/08→08/11					
3.2 FSI	188	03/05→10/08					
3.2 FSI quattro	188	03/05→10/08					
4.2 FSI quattro	257	06/06→08/11					
4.2 quattro	246	03/05→05/06					
RS6 quattro	426	04/08→08/10					
S6 quattro	320	03/06→08/11					
AUDI - A6 C7 (4G2, 4GC) 11/10→09/18							
 Hauptbremszylinder							
1.8 TFSI	140	09/14→09/18		für Linkslenker		24.2125-1749.3 011031	TRW Ø 25,4
2.0 TDI	100 - 140	01/12→09/18					
2.0 TDI quattro	140	04/15→09/18					
2.0 TFSI	132 - 185	05/11→09/18					
2.0 TFSI Hybrid	180	11/11→04/15					
2.0 TFSI quattro	155 - 185	05/12→09/18					
2.8 FSI quattro	162	09/14→09/18					
3.0 TDI	155 - 160	09/14→09/18					
3.0 TDI quattro	155 - 240	09/14→09/18					
3.0 TFSI quattro	245 - 250	09/14→09/18					
S6 quattro	331	10/14→09/18					
2.0 TDI	120 - 130	03/11→09/18		04/11→; für Linkslenker		24.2125-1749.3 011031	TRW Ø 25,4
2.0 TFSI	155	03/11→05/13					
2.8 FSI	150	11/10→04/15					
2.8 FSI quattro	150	11/10→04/15					
3.0 TDI	150	11/10→09/18					
3.0 TDI quattro	150 - 180	03/11→09/18					
3.0 TFSI quattro	220 - 228	11/10→09/18					
2.0 TFSI	162	05/13→09/18		09/14→; für Linkslenker		24.2125-1749.3 011031	TRW Ø 25,4
3.0 TDI quattro	230	11/11→09/18		12/11→; für Linkslenker		24.2125-1749.3 011031	TRW Ø 25,4
S6 quattro	309	02/12→09/18		04/12→; für Linkslenker		24.2125-1749.3 011031	TRW Ø 25,4
AUDI - A6 C7 Avant (4G5, 4GD) 05/11→09/18							
 Hauptbremszylinder							
1.8 TFSI	140	09/14→09/18		für Linkslenker		24.2125-1749.3 011031	TRW Ø 25,4
2.0 TDI	100 - 140	01/12→09/18					
2.0 TDI quattro	140	04/15→09/18					
2.0 TFSI	132 - 185	06/11→09/18					
2.0 TFSI quattro	183 - 185	05/15→09/18					
2.8 FSI quattro	162	09/14→09/18					
3.0 TDI	155 - 160	09/14→09/18					
3.0 TDI quattro	155 - 240	09/14→09/18					
3.0 TFSI quattro	228 - 245	11/11→09/18					
RS6 performance quattro	445	11/15→09/18					
S6 quattro	331	10/14→09/18					
2.0 TDI	120 - 130	05/11→09/18		09/11→; für Linkslenker		24.2125-1749.3 011031	TRW Ø 25,4
2.8 FSI	150	05/11→04/15					
2.8 FSI quattro	150	05/11→04/15					
3.0 TDI	150	05/11→09/18					
3.0 TDI quattro	150 - 180	05/11→09/18					
3.0 TFSI quattro	220	05/11→05/12					
3.0 TDI quattro	230	11/11→09/18		12/11→; für Linkslenker		24.2125-1749.3 011031	TRW Ø 25,4
→							













	kw			 	! #		
AUDI - A6 C7 Avant (4G5, 4GD) 05/11→09/18							
 Hauptbremszylinder							
RS6 quattro	412	01/13→09/18		03/13→; für Linkslenker		24.2125-1749.3 011031	TRW Ø 25,4
S6 quattro	309	02/12→09/18		04/12→; für Linkslenker		24.2125-1749.3 011031	TRW Ø 25,4
AUDI - A7 Sportback (4GA, 4GF) 07/10→05/18							
 Hauptbremszylinder							
1.8 TFSI	140	04/15→05/18		für Linkslenker		24.2125-1749.3 011031	TRW Ø 25,4
2.0 TFSI	185	09/14→05/18					
2.0 TFSI quattro	183 - 185	05/15→05/18					
2.8 FSI quattro	150 - 162	10/10→05/18					
3.0 TDI	140 - 160	11/10→05/18					
3.0 TDI quattro	140 - 240	10/10→05/18					
3.0 TFSI quattro	220 - 245	10/10→05/18					
3.0 TFSI QUATTRO	250	05/16→05/18					
RS7 performance quattro	445	11/15→04/18					
RS7 quattro	412	10/13→04/18					
S7 quattro	309 - 331	02/12→05/18					
2.8 FSI	150	02/11→03/15		05/11→; für Linkslenker		24.2125-1749.3 011031	TRW Ø 25,4
AUDI - A8 D2 (4D2, 4D8) 03/94→12/05							
 Hauptbremszylinder							
2.5 TDI	110	01/97→04/00		06/97→; - ESP		24.2125-1712.3 010622	Ø 25,4
				06/97→; + ESP		24.2125-1713.3 010623	Ø 25,4
2.5 TDI	132	09/00→09/02		- ESP		24.2125-1712.3 010622	Ø 25,4
2.5 TDI quattro	110 - 132	07/97→09/02		+ ESP		24.2125-1713.3 010623	Ø 25,4
2.8	142	04/96→09/02					
2.8 quattro	142	04/96→09/02					
3.3 TDI quattro	165	06/00→09/02					
3.7	169 - 191	07/95→09/02					
3.7 quattro	191	11/98→09/02					
4.2 quattro	175 - 228	11/98→09/02					
6.0 W12 quattro	309	01/01→09/02					
S8 quattro	250 - 265	07/96→09/02					
3.7 quattro	169	07/95→11/98		10/95→; - ESP		24.2125-1712.3 010622	Ø 25,4
				10/95→; + ESP		24.2125-1713.3 010623	Ø 25,4
4.2 quattro	220	03/94→11/98		06/94→; - ESP		24.2125-1712.3 010622	Ø 25,4
				06/94→; + ESP		24.2125-1713.3 010623	Ø 25,4
AUDI - A8 D4 (4H2, 4H8, 4HC, 4HL) 11/09→01/18							
 Hauptbremszylinder							
2.0 TFSI hybrid	180	02/12→11/15		05/12→; nicht für gepanzerte Fahrzeuge		24.2125-1739.3 010948	TRW Ø 25,4
2.0 TFSI quattro	185	09/16→01/18		nicht für gepanzerte Fahrzeuge		24.2125-1739.3 010948	TRW Ø 25,4
2.5 TFSI	150	07/12→06/16					
3.0 TDI	150	09/11→09/13					
3.0 TDI quattro	155 - 193	07/10→01/18					
3.0 TFSI quattro	213 - 228	07/10→01/18					
4.0 TFSI quattro	309 - 320	03/12→12/15					
4.2 FSI quattro	273	11/09→12/12					
4.2 TDI quattro	258 - 283	11/09→01/18					
6.3 W12 quattro	368	01/11→01/18					
S8 plus quattro	445	11/15→01/18					
S8 quattro	382	04/12→01/18					
3.0 TFSI quattro	245	06/10→01/18		07/10→; nicht für gepanzerte Fahrzeuge		24.2125-1739.3 010948	TRW Ø 25,4
AUDI - ALLROAD C5 (4BH) 05/00→08/05							
 Hauptbremszylinder							
2.5 TDI quattro	120 - 132	05/00→08/05		für Linkslenker; → 07/05		24.2125-1713.3 010623	Ø 25,4
2.7 quattro	187	09/00→08/05					
2.7 T quattro	184	05/00→08/05					
4.2 V8 quattro	220	07/02→08/05					













	kw					! #		
AUDI - CABRIOLET B3 (8G7) 05/91→08/00								
 Hauptbremszylinder								
1.9 TDI	66	06/95→08/00		07/95→; → 8G-V-010000; für Rechtslenker; - ABS		03.2122-9612.3	010159	Ø 22,2
				8G-P-000001→ 8G-V-010000; für Linkslenker; - ABS		03.2123-0491.3	010167	Ø 23,8
				07/95→; für Linkslenker; + ABS		24.2123-1602.3	010384	TRW Ø 23,8
2.0 E	85	01/93→07/98		→ 8G-V-010000; für Rechtslenker; - ABS		03.2122-9612.3	010159	Ø 22,2
				8G-P-000001→ 8G-V-010000; für Linkslenker; - ABS		03.2123-0491.3	010167	Ø 23,8
2.6	110	06/93→08/00		01/94→; für Linkslenker		24.2123-1602.3	010384	TRW Ø 23,8
2.8	128	11/92→08/00		für Linkslenker		24.2123-1602.3	010384	TRW Ø 23,8
Verschlusschraube, Hauptbremszylinder								
1.9 TDI	66	06/95→08/00		8G-P-000001→ 8G-V-010000; für Linkslenker; - ABS		03.3517-0101.2	390322	
2.0 E	85	01/93→07/98						
AUDI - Q2 (GAB, GAG) 06/16→								
 Hauptbremszylinder								
1.0 TFSI	85	10/16→10/20		für Linkslenker; → 03/18		24.4123-1719.3	011017	TRW Ø 23,8 ohne Bremsflüssigkeitsbehälter
2.0 TDI	110	09/16→						
2.0 TDI quattro	110	09/16→		für Linkslenker; → 11/18		24.4153-1522.3	011048	ATE Ø 23,8 ohne Bremsflüssigkeitsbehälter
2.0 TFSI quattro	140	05/17→						
35 TDI	110	09/16→		für Linkslenker; 12/18→; +PR 1ZA / 1ZB / 1ZE / 1ZJ / 1ZK / 1ZU		24.4153-1522.3	011048	ATE Ø 23,8 ohne Bremsflüssigkeitsbehälter
1.4 TFSI	110	06/16→08/18		für Linkslenker; → 03/18		24.4123-1719.3	011017	TRW Ø 23,8 ohne Bremsflüssigkeitsbehälter
1.6 TDI	85	06/16→10/18						
2.0 TDI quattro	140	07/16→08/18		für Linkslenker		24.4153-1522.3	011048	ATE Ø 23,8 ohne Bremsflüssigkeitsbehälter
30 TDI	85	07/18→		für Linkslenker; → 11/18		24.4153-1522.3	011048	ATE Ø 23,8 ohne Bremsflüssigkeitsbehälter
30 TFSI	85	07/18→10/20						
35 TDI quattro	110	09/18→		für Linkslenker; 12/18→; +PR 1ZA / 1ZB / 1ZE / 1ZJ / 1ZK / 1ZU		24.4153-1522.3	011048	ATE Ø 23,8 ohne Bremsflüssigkeitsbehälter
35 TFSI	110	07/18→						
40 TFSI quattro	140	09/18→						
SQ2 TFSI quattro	221	08/18→						
30 TFSI	81	08/20→		für Linkslenker; +PR 1ZA / 1ZB / 1ZE / 1ZJ / 1ZK / 1ZU		24.4153-1522.3	011048	ATE Ø 23,8 ohne Bremsflüssigkeitsbehälter
AUDI - Q3 (8UB, 8UG) 06/11→03/20								
 Hauptbremszylinder								
1.4 TFSI	92	07/16→10/18		für Linkslenker		03.2123-3549.3	010809	ATE Ø 23,8
1.4 TFSI Flex	110	02/16→10/18		für Rechtslenker		24.4153-0192.3	011026	ATE Ø 23,8 ohne Bremsflüssigkeitsbehälter
1.4 TSI	110	10/13→10/18						
2.0 TDI	88 - 135	06/11→10/18						
2.0 TDI quattro	103 - 135	06/11→10/18						
2.0 TFSI	132	05/15→10/18		für Linkslenker		03.4153-0186.3	010816	ATE Ø 23,8
2.0 TFSI quattro	132 - 162	11/14→10/18		für Rechtslenker		24.4153-0192.3	011026	ATE Ø 23,8 ohne Bremsflüssigkeitsbehälter
2.0 TFSI quattro	125 - 155	06/11→10/18		für Linkslenker		03.2123-3549.3	010809	ATE Ø 23,8
				für Rechtslenker		24.4153-0192.3	011026	ATE Ø 23,8 ohne Bremsflüssigkeitsbehälter
RS 2.5 quattro	228	10/13→10/18		für Linkslenker		03.2125-5112.3	010966	ATE Ø 25,4
RS performance 2.5 quattro	270	01/15→10/18						
RS 2.5 quattro	250	05/13→10/18		03/15→; für Linkslenker		03.2125-5112.3	010966	ATE Ø 25,4
AUDI - Q5 (8RB) 11/08→12/17								
 Bremskraftverstärker								
2.0 TDI	100 - 140	11/10→05/17				03.7858-4432.4	300304	ATE Ø 9 / 8" pneumatisch
2.0 TDI quattro	100 - 140	08/09→05/17						
2.0 TFSI quattro	132 - 169	08/09→05/17						
3.0 TDI quattro	190	11/13→05/17						
SQ5 TDI quattro	230 - 250	12/12→05/17						
SQ5 TFSI quattro	260	05/13→05/17						
2.0 TDI quattro	120 - 125	11/08→05/17		→ 02/09		03.7858-4432.4	300304	ATE Ø 9 / 8" pneumatisch
2.0 TFSI quattro →	155	11/08→09/12		03/09→		03.7858-4432.4	300304	ATE Ø 9 / 8" pneumatisch











	kw			 	! #		
AUDI - Q5 (8RB) 11/08→12/17							
 Bremskraftverstärker							
3.0 TDI quattro	155 - 176	11/08→05/17		→ 02/09		03.7858-4432.4 300304	ATE Ø 9 / 8" pneumatisch
3.2 FSI quattro	199	11/08→12/12		03/09→		03.7858-4432.4 300304	ATE Ø 9 / 8" pneumatisch
2.0 TDI quattro	130	06/12→05/17		09/12→		03.7858-4432.4 300304	ATE Ø 9 / 8" pneumatisch
2.0 TFSI quattro	165	06/12→05/16					
3.0 TDI quattro	180 - 184	06/12→05/17					
3.0 TFSI quattro	200	06/12→05/17					
2.0 TFSI Hybrid quattro	180	06/11→06/16				03.7858-4632.4 300273	ATE Ø 9 / 8" pneumatisch
 Hauptbremszylinder							
2.0 TDI	100 - 140	11/10→05/17				03.2125-0493.3 010940	ATE Ø 25,4
2.0 TDI quattro	100 - 140	08/09→05/17					
2.0 TFSI quattro	132 - 162	08/09→05/17					
3.0 TDI quattro	190	11/13→05/17					
SQ5 TDI quattro	230 - 250	12/12→05/17					
SQ5 TFSI quattro	260	05/13→05/17					
2.0 TDI quattro	120 - 125	11/08→05/17		03/09→		03.2125-0493.3 010940	ATE Ø 25,4
2.0 TFSI quattro	155	11/08→09/12					
3.0 TDI quattro	155 - 176	11/08→05/17					
3.2 FSI quattro	199	11/08→12/12					
2.0 TDI quattro	130	06/12→05/17		09/12→		03.2125-0493.3 010940	ATE Ø 25,4
2.0 TFSI quattro	165	06/12→05/16					
3.0 TDI quattro	180 - 184	06/12→05/17					
3.0 TFSI quattro	200	06/12→05/17					
AUDI - Q5 Van (8RB) 11/08→12/17							
 Bremskraftverstärker							
2.0 TDI	100 - 140	11/11→05/17				03.7858-4432.4 300304	ATE Ø 9 / 8" pneumatisch
3.0 SQ5 TDI quattro	230 - 250	12/12→05/17					
3.0 TDI quattro	190	11/13→05/17					
2.0 TDI quattro	125	11/08→09/12		→ 02/09		03.7858-4432.4 300304	ATE Ø 9 / 8" pneumatisch
2.0 TFSI quattro	155	11/08→09/12		03/09→		03.7858-4432.4 300304	ATE Ø 9 / 8" pneumatisch
3.0 TDI quattro	176	11/08→04/13					
3.2 FSI quattro	199	11/08→09/12					
2.0 TDI quattro	130	07/12→06/14		09/12→		03.7858-4432.4 300304	ATE Ø 9 / 8" pneumatisch
3.0 TDI quattro	180	06/12→05/17					
 Hauptbremszylinder							
2.0 TDI	100 - 140	11/11→05/17				03.2125-0493.3 010940	ATE Ø 25,4
3.0 SQ5 TDI quattro	230 - 250	12/12→05/17					
3.0 TDI quattro	190	11/13→05/17					
2.0 TDI quattro	125	11/08→09/12		03/09→		03.2125-0493.3 010940	ATE Ø 25,4
2.0 TFSI quattro	155	11/08→09/12					
3.0 TDI quattro	176	11/08→04/13					
3.2 FSI quattro	199	11/08→09/12					
2.0 TDI quattro	130	07/12→06/14		09/12→		03.2125-0493.3 010940	ATE Ø 25,4
3.0 TDI quattro	180	06/12→05/17					
AUDI - Q7 (4LB) 03/06→01/16							
 Bremskraftverstärker							
3.0 TDI quattro	150 - 180	03/06→08/15		für Fahrzeuge ohne autom. Distanzregelung; für Linkslenker		03.7868-5802.4 300315	ATE Ø 10 / 8" pneumatisch
3.0 TFSI quattro	200 - 245	05/10→08/15		für Linkslenker; für Fahrzeuge mit autom. Distanzregelung		03.7868-5902.4 300316	ATE Ø 10 / 8" pneumatisch
3.6 FSI quattro	206	08/06→05/10					
4.2 FSI quattro	257	03/06→05/10					
4.2 quattro	231	03/06→12/10					
4.2 TDI quattro	240 - 250	03/07→08/15					
6.0 TDI quattro	368	09/08→05/14					
Pedalwegsensor, Bremspedal							
3.0 TDI quattro	150 - 180	03/06→08/15		für Fahrzeuge mit autom. Distanzregelung		03.0655-0006.2 370006	ATE
3.0 TFSI quattro	200 - 245	05/10→08/15					
→							











	kw					! #		
AUDI - Q7 (4LB) 03/06→01/16								
Pedalwegsensoren, Bremspedal								
3.6 FSI quattro	206	08/06→05/10		für Fahrzeuge mit autom. Distanzregelung		03.0655-0006.2	370006	ATE
4.2 FSI quattro	257	03/06→05/10						
4.2 quattro	231	03/06→12/10						
4.2 TDI quattro	240 - 250	03/07→08/15						
6.0 TDI quattro	368	09/08→05/14						
 Hauptbremszylinder								
3.0 TDI quattro	150 - 180	03/06→08/15		für Linkslenker		03.2126-3063.3	010812	ATE Ø 27
3.0 TFSI quattro	200 - 245	05/10→08/15		für Rechtslenker		24.2126-3071.3	011037	ATE Ø 27 ohne Bremsflüssigkeitsbehälter
3.6 FSI quattro	206	08/06→05/10						
4.2 FSI quattro	257	03/06→05/10						
4.2 quattro	231	03/06→12/10						
4.2 TDI quattro	240 - 250	03/07→08/15						
6.0 TDI quattro	368	09/08→05/14						
3.0 TDI quattro	165	06/09→05/12		für Linkslenker		03.2126-3063.3	010812	ATE Ø 27
				→ 05/10; für Rechtslenker		24.2126-3071.3	011037	ATE Ø 27 ohne Bremsflüssigkeitsbehälter
AUDI - Q7 Van (4LB) 03/06→01/16								
 Bremskraftverstärker								
3.0 TDI quattro	150 - 180	03/06→08/15		für Linkslenker; für Fahrzeuge ohne autom. Distanzregelung		03.7868-5802.4	300315	ATE Ø 10 / 8" pneumatisch
3.0 TFSI quattro	245	05/10→08/15		für Fahrzeuge mit autom. Distanzregelung; für Linkslenker		03.7868-5902.4	300316	ATE Ø 10 / 8" pneumatisch
3.6 FSI quattro	206	08/06→05/10						
4.2 FSI quattro	257	08/06→05/10						
4.2 TDI quattro	240 - 250	03/07→08/15						
6.0 TDI quattro	368	09/08→05/14						
Pedalwegsensoren, Bremspedal								
3.0 TDI quattro	150 - 180	03/06→08/15		für Fahrzeuge mit autom. Distanzregelung		03.0655-0006.2	370006	ATE
3.0 TFSI quattro	245	05/10→08/15						
3.6 FSI quattro	206	08/06→05/10						
4.2 FSI quattro	257	08/06→05/10						
4.2 TDI quattro	240 - 250	03/07→08/15						
6.0 TDI quattro	368	09/08→05/14						
 Hauptbremszylinder								
3.0 TDI quattro	150 - 180	03/06→08/15		für Linkslenker		03.2126-3063.3	010812	ATE Ø 27
3.0 TFSI quattro	245	05/10→08/15		für Rechtslenker		24.2126-3071.3	011037	ATE Ø 27 ohne Bremsflüssigkeitsbehälter
3.6 FSI quattro	206	08/06→05/10						
4.2 FSI quattro	257	08/06→05/10						
4.2 TDI quattro	240 - 250	03/07→08/15						
6.0 TDI quattro	368	09/08→05/14						
AUDI - TT (8J3) 07/06→01/15								
 Bremskraftverstärker								
1.8 TFSI	118	06/08→06/14		für Linkslenker		03.7860-4203.4	300243	ATE Ø 10" pneumatisch
2.0 TDI quattro	125	06/08→06/14						
2.0 TFSI	147 - 155	08/06→06/14						
2.0 TFSI quattro	147 - 155	06/08→06/14						
2.0 TTS quattro	195	05/08→06/14						
2.0 TTS quattro	200	05/08→06/14		für Linkslenker		03.7870-0602.4	300310	ATE Ø 11" pneumatisch
2.5 RS quattro	250	07/09→06/14						
2.5 RS quattro	265	05/11→06/14		02/12→; für Linkslenker		03.7870-0602.4	300310	ATE Ø 11" pneumatisch
3.2 V6 quattro	184	08/06→06/10		für Linkslenker; +PR 1AT		03.7870-0602.4	300310	ATE Ø 11" pneumatisch
 Hauptbremszylinder								
1.8 TFSI	118	06/08→06/14		für Linkslenker		03.2123-3549.3	010809	ATE Ø 23,8
2.0 TDI quattro	125	06/08→06/14		für Rechtslenker		24.4153-0217.3	011039	ATE Ø 23,8 ohne Bremsflüssigkeitsbehälter
2.0 TFSI	147 - 155	08/06→06/14						
2.0 TFSI quattro	147 - 155	06/08→06/14						
2.0 TTS quattro	195	05/08→06/14						
2.0 TTS quattro	200	05/08→06/14		für Linkslenker		03.2125-5112.3	010966	ATE Ø 25,4
→								























	kw					! #		
AUDI - TT (8J3) 07/06→01/15								
 Hauptbremszylinder								
2.5 RS quattro	250 - 265	07/09→06/14		für Linkslenker		03.2125-5112.3	010966	ATE Ø 25,4
3.2 V6 quattro	184	08/06→06/10						
Drucksensor, Bremskraftverstärker								
2.0 TTS quattro	200	05/08→06/14		für Rechtslenker; +PR 1AS		03.0655-0101.2	370008	ATE
2.5 RS quattro	250 - 265	07/09→06/14						
3.2 V6 quattro	184	08/06→06/10		für Linkslenker; +PR 1AS		03.0655-0101.2	370008	ATE
AUDI - TT (8N3) 10/98→12/06								
 Bremskraftverstärker								
1.8 T	110 - 140	09/02→06/06		für Linkslenker		03.7860-0602.4	300141	ATE Ø 10" pneumatisch
1.8 T quattro	140 - 180	03/05→06/06						
3.2 VR6 quattro	184	07/03→06/06						
1.8 T	132	10/98→06/06		8N-2-014301→; für Linkslenker		03.7860-0602.4	300141	ATE Ø 10" pneumatisch
1.8 T quattro	132 - 165	10/98→06/06		→ 8N-2-014300; für Linkslenker; + ESP		03.7863-0402.4	300124	ATE Ø 10" pneumatisch
 Hauptbremszylinder								
1.8 T	132	10/98→06/06		→ 8N-2-014300; für Linkslenker; + ESP		03.2123-2024.3	010597	ATE Ø 23,8
1.8 T quattro	132 - 165	10/98→06/06		→ 8N-2-014300; für Rechtslenker; + ESP		03.2123-2064.3	010598	ATE Ø 23,8
				8N-2-014301→; → 08/02; für Linkslenker		03.2123-2715.3	010802	ATE Ø 23,8
				8N-2-014301→; → 08/02; für Rechtslenker		03.2123-2774.3	010803	ATE Ø 23,8
				→ 8N-2-014300; für Linkslenker; - ESP		24.2123-1709.3	010503	Ø 23,8
AUDI - TT (FV3, FVP) 07/14→								
 Hauptbremszylinder								
1.8 TFSI	132	07/15→08/18		für Linkslenker		24.4123-1719.3	011017	TRW Ø 23,8 ohne Bremsflüssigkeitsbehälter
2.0 TDI	135	07/14→						
2.0 TDI quattro	135	01/17→						
2.0 TFSI	169	07/14→						
2.0 TFSI quattro	162 - 169	07/14→						
2.0 TTS quattro	210 - 228	11/14→						
40 TFSI	145	07/18→						
45 TFSI	180	07/18→						
45 TFSI quattro	180	07/18→						
TTS quattro	235	01/21→						
AUDI - TT Roadster (8J9) 03/07→06/14								
 Bremskraftverstärker								
1.8 TFSI	118	06/08→06/14		für Linkslenker		03.7860-4203.4	300243	ATE Ø 10" pneumatisch
2.0 TDI quattro	125	06/08→06/14						
2.0 TFSI	147 - 155	03/07→06/14						
2.0 TFSI quattro	147 - 155	06/08→06/14						
2.0 TTS quattro	195	05/08→06/14						
2.0 TTS quattro	200	05/08→06/14		für Linkslenker		03.7870-0602.4	300310	ATE Ø 11" pneumatisch
2.5 RS quattro	250 - 265	07/09→06/14						
3.2 V6 quattro	184	03/07→06/10		für Linkslenker; +PR 1AT		03.7870-0602.4	300310	ATE Ø 11" pneumatisch
 Hauptbremszylinder								
1.8 TFSI	118	06/08→06/14		für Linkslenker		03.2123-3549.3	010809	ATE Ø 23,8
2.0 TDI quattro	125	06/08→06/14						
2.0 TFSI	147	03/07→06/10		für Rechtslenker		24.4153-0217.3	011039	ATE Ø 23,8 ohne Bremsflüssigkeitsbehälter
2.0 TFSI quattro	147	06/08→06/10						
2.0 TTS quattro	195	05/08→06/14						
2.0 TTS quattro	200	05/08→06/14		für Linkslenker		03.2125-5112.3	010966	ATE Ø 25,4
2.5 RS quattro	250 - 265	07/09→06/14						
3.2 V6 quattro	184	03/07→06/10						
Drucksensor, Bremskraftverstärker								
2.0 TTS quattro	200	05/08→06/14		für Rechtslenker; +PR 1AS		03.0655-0101.2	370008	ATE
2.5 RS quattro	250 - 265	07/09→06/14						
3.2 V6 quattro	184	03/07→06/10		für Linkslenker; +PR 1AS		03.0655-0101.2	370008	ATE













	kw			 	! #		
AUDI - TT Roadster (8N9) 10/99→12/06							
 Bremskraftverstärker							
1.8 T	110 - 132	10/99→06/06		8N-2-014301→; für Linkslenker	03.7860-0602.4	300141	ATE Ø 10" pneumatisch
1.8 T quattro	132 - 165	10/99→06/06		→ 8N-2-014300; für Linkslenker; + ESP	03.7863-0402.4	300124	ATE Ø 10" pneumatisch
1.8 T	120 - 140	09/05→06/06		für Linkslenker	03.7860-0602.4	300141	ATE Ø 10" pneumatisch
1.8 T quattro	140	09/05→06/06					
3.2 VR6 quattro	184	07/03→06/06					
 Hauptbremszylinder							
1.8 T	110 - 132	10/99→06/06		→ 8N-2-014300; für Linkslenker; + ESP	03.2123-2024.3	010597	ATE Ø 23,8
1.8 T quattro	132 - 165	10/99→06/06		→ 8N-2-014300; für Rechtslenker; + ESP	03.2123-2064.3	010598	ATE Ø 23,8
				8N-2-014301→; → 08/02; für Linkslenker	03.2123-2715.3	010802	ATE Ø 23,8
				8N-2-014301→; → 08/02; für Rechtslenker	03.2123-2774.3	010803	ATE Ø 23,8
				→ 8N-2-014300; für Linkslenker; - ESP	24.2123-1709.3	010503	Ø 23,8
AUDI - TT Roadster (FV9, FVR) 11/14→							
 Hauptbremszylinder							
1.8 TFSI	132	07/15→08/18		für Linkslenker	24.4123-1719.3	011017	TRW Ø 23,8 ohne Bremsflüssigkeitsbehälter
2.0 TDI	135	11/14→					
2.0 TDI quattro	135	01/17→					
2.0 TFSI	169	11/14→					
2.0 TFSI quattro	162 - 169	11/14→					
2.0 TTS quattro	210 - 228	11/14→					
40 TFSI	145	07/18→					
45 TFSI	180	07/18→					
45 TFSI quattro	180	07/18→					
TTS quattro	235	11/20→					
BMW - 1 (E81) 09/06→09/12							
 Bremskraftverstärker							
116 d	66	01/11→12/11		für Fahrzeuge ohne Start-Stopp-Funktion	03.7848-4003.4	300235	ATE Ø 8" pneumatisch
118 i	95 - 100	09/06→12/11					
116 d	85	11/08→12/11		09/09→ 05/11; für Fahrzeuge ohne Start-Stopp-Funktion	03.7848-4003.4	300235	ATE Ø 8" pneumatisch
				03/09→ 08/09	03.7848-4003.4	300235	ATE Ø 8" pneumatisch
116 i	85	09/07→12/11			03.7848-4003.4	300235	ATE Ø 8" pneumatisch
120 d	120	03/07→12/11			03.7848-4003.4	300235	ATE Ø 8" pneumatisch
116 i	90	03/07→12/11		09/07→ 12/08	03.7848-4003.4	300235	ATE Ø 8" pneumatisch
116 i	90	11/08→12/11		09/09→ 05/11; für Fahrzeuge ohne Start-Stopp-Funktion	03.7848-4003.4	300235	ATE Ø 8" pneumatisch
				01/09→ 08/09	03.7848-4003.4	300235	ATE Ø 8" pneumatisch
118 d	100 - 105	09/06→12/11		09/09→ 05/11; für Fahrzeuge ohne Start-Stopp-Funktion	03.7848-4003.4	300235	ATE Ø 8" pneumatisch
118 i	105	09/06→12/11					
120 i	120 - 125	03/07→09/12		04/07→ 08/09	03.7848-4003.4	300235	ATE Ø 8" pneumatisch
120 d	130 - 145	03/07→12/11		09/09→ 05/11; für Fahrzeuge ohne Start-Stopp-Funktion	03.7848-4003.4	300235	ATE Ø 8" pneumatisch
				→ 08/09	03.7848-4003.4	300235	ATE Ø 8" pneumatisch
120 i	115	03/07→12/11		→ 03/07	03.7848-4003.4	300235	ATE Ø 8" pneumatisch
123 d	150	03/07→12/11		09/09→ 05/11; für Fahrzeuge ohne Start-Stopp-Funktion	03.7848-5003.4	300236	ATE Ø 8" pneumatisch
				10/07→ 08/09	03.7848-5003.4	300236	ATE Ø 8" pneumatisch
130 i	190 - 195	09/06→12/11		→ 05/11	03.7848-5003.4	300236	ATE Ø 8" pneumatisch
 Hauptbremszylinder							
116 d	66	01/11→12/11		für Linkslenker	03.2023-2407.3	010796	ATE Ø1 23,8 Ø2 22,2
116 i	85	09/07→12/11					
118 i	95 - 100	09/06→12/11					
120 d	120	03/07→12/11					
116 d	85	11/08→12/11		03/09→ 05/11; für Linkslenker	03.2023-2407.3	010796	ATE Ø1 23,8 Ø2 22,2
116 i	90	03/07→12/11		09/07→ 12/08; für Linkslenker	03.2023-2407.3	010796	ATE Ø1 23,8 Ø2 22,2
116 i	90	11/08→12/11		01/09→ 05/11; für Linkslenker	03.2023-2407.3	010796	ATE Ø1 23,8 Ø2 22,2
118 d	100 - 105	09/06→12/11		04/07→ 05/11; für Linkslenker	03.2023-2407.3	010796	ATE Ø1 23,8 Ø2 22,2
→							











	kw			 	! #		
BMW - 1 (E81) 09/06→09/12							
 Hauptbremszylinder							
118 i 120 i	105 120 - 125	09/06→12/11 03/07→09/12		04/07→ 05/11; für Linkslenker		03.2023-2407.3 010796	ATE Ø1 23,8 Ø2 22,2
120 d	130 - 145	03/07→12/11		→ 05/11; für Linkslenker		03.2023-2407.3 010796	ATE Ø1 23,8 Ø2 22,2
120 i	115	03/07→12/11		→ 03/07; für Linkslenker		03.2023-2407.3 010796	ATE Ø1 23,8 Ø2 22,2
123 d	150	03/07→12/11		10/07→ 05/11; für Linkslenker		03.2025-1904.3 010797	ATE Ø1 25,4 Ø2 22,2
130 i	190 - 195	09/06→12/11		→ 05/11; für Linkslenker		03.2025-1904.3 010797	ATE Ø1 25,4 Ø2 22,2
Hydraulikaggregat, Bremsanlage							
116 d	66	01/11→12/11				24.9145-0003.2 399007	
116 d	85	11/08→12/11		03/09→ 05/11		24.9145-0003.2 399007	
116 i	90	03/07→12/11		09/08→ 12/08		24.9145-0003.2 399007	
116 i	90	11/08→12/11		01/09→ 05/11		24.9145-0003.2 399007	
118 d	100 - 105	09/06→12/11		09/08→ 05/11		24.9145-0003.2 399007	
118 i 120 d	105 130 - 145	09/06→12/11 03/07→12/11					
120 i	120 - 125	03/07→09/12					
118 i	100	09/06→12/11		09/08→		24.9145-0003.2 399007	
123 d	150	03/07→12/11		09/08→ 05/11; für Fahrzeuge ohne Aktivlenkung		24.9145-0003.2 399007	
BMW - 1 (E87) 02/03→01/13							
 Bremskraftverstärker							
116 d	66	01/11→12/11		für Fahrzeuge ohne Start-Stopp-Funktion		03.7848-4003.4 300235	ATE Ø 8" pneumatisch
116 d 116 i 120 d	85 90 130	03/09→06/11 01/09→06/11 03/07→06/11		09/09→ 05/11; für Fahrzeuge ohne Start-Stopp-Funktion → 08/09		03.7848-4003.4 300235	ATE Ø 8" pneumatisch
116 i	85	06/04→06/11		09/04→ 08/07		03.7848-4003.4 300235	ATE Ø 8" pneumatisch
116 i	90	09/07→06/11		→ 12/08		03.7848-4003.4 300235	ATE Ø 8" pneumatisch
118 d 118 i 120 d 120 i	90 95 110 110	06/04→02/07 07/04→02/07 06/04→02/07 06/04→02/07		09/04→		03.7848-4003.4 300235	ATE Ø 8" pneumatisch
118 d 118 i 120 i	100 - 105 105 120 - 125	03/07→06/11 09/06→06/11 03/07→06/11		09/09→ 05/11; für Fahrzeuge ohne Start-Stopp-Funktion 04/07→ 08/09		03.7848-4003.4 300235	ATE Ø 8" pneumatisch
118 i 120 i	100 115	10/06→06/11 03/07→06/11		→ 03/07		03.7848-4003.4 300235	ATE Ø 8" pneumatisch
118 i	125	03/07→12/07		04/07→		03.7848-4003.4 300235	ATE Ø 8" pneumatisch
120 d	120	06/04→06/11		09/04→ 02/07		03.7848-4003.4 300235	ATE Ø 8" pneumatisch
123 d	150	03/07→06/11		09/09→ 05/11; für Fahrzeuge ohne Start-Stopp-Funktion 10/07→ 08/09		03.7848-5003.4 300236	ATE Ø 8" pneumatisch
130 i	190	03/07→06/11		→ 05/11		03.7848-5003.4 300236	ATE Ø 8" pneumatisch
130 i	195	09/05→02/07				03.7848-5003.4 300236	ATE Ø 8" pneumatisch
 Hauptbremszylinder							
116 d	66	01/11→12/11		für Linkslenker		03.2023-2407.3 010796	ATE Ø1 23,8 Ø2 22,2
116 d 116 i 120 d	85 90 130	03/09→06/11 01/09→06/11 03/07→06/11		→ 05/11; für Linkslenker		03.2023-2407.3 010796	ATE Ø1 23,8 Ø2 22,2
116 i	85	06/04→06/11		09/04→ 08/07; für Linkslenker		03.2023-2407.3 010796	ATE Ø1 23,8 Ø2 22,2
116 i	90	09/07→06/11		→ 12/08; für Linkslenker		03.2023-2407.3 010796	ATE Ø1 23,8 Ø2 22,2
118 d 118 i 120 d 120 i	90 95 110 110	06/04→02/07 07/04→02/07 06/04→02/07 06/04→02/07		09/04→; für Linkslenker		03.2023-2407.3 010796	ATE Ø1 23,8 Ø2 22,2
118 d 118 i 120 i	100 - 105 105 120 - 125	03/07→06/11 09/06→06/11 03/07→06/11		04/07→ 05/11; für Linkslenker		03.2023-2407.3 010796	ATE Ø1 23,8 Ø2 22,2
118 i 120 i	100 115	10/06→06/11 03/07→06/11		→ 03/07; für Linkslenker		03.2023-2407.3 010796	ATE Ø1 23,8 Ø2 22,2
118 i	125	03/07→12/07		04/07→; für Linkslenker		03.2023-2407.3 010796	ATE Ø1 23,8 Ø2 22,2
→							













	kw			 	! #		
BMW - 1 (E87) 02/03→01/13							
 Hauptbremszylinder							
120 d	120	06/04→06/11		09/04→ 02/07; für Linkslenker		03.2023-2407.3 010796	ATE Ø1 23,8 Ø2 22,2
123 d	150	03/07→06/11		10/07→ 05/11; für Linkslenker		03.2025-1904.3 010797	ATE Ø1 25,4 Ø2 22,2
130 i	190	03/07→06/11		→ 05/11; für Linkslenker		03.2025-1904.3 010797	ATE Ø1 25,4 Ø2 22,2
130 i	195	09/05→02/07		für Linkslenker		03.2025-1904.3 010797	ATE Ø1 25,4 Ø2 22,2
Hydraulikaggregat, Bremsanlage							
116 d	66	01/11→12/11				24.9145-0003.2 399007	
116 d	85	03/09→06/11		→ 05/11		24.9145-0003.2 399007	
116 i	90	01/09→06/11					
116 i	90	09/07→06/11		09/08→ 12/08		24.9145-0003.2 399007	
118 d	100 - 105	03/07→06/11		09/08→ 05/11		24.9145-0003.2 399007	
118 i	100 - 105	09/06→06/11					
120 d	130	03/07→06/11					
120 i	120 - 125	03/07→06/11					
123 d	150	03/07→06/11		09/08→ 05/11; für Fahrzeuge ohne Aktivlenkung		24.9145-0003.2 399007	
BMW - 1 (F20) 07/11→06/19							
 Hauptbremszylinder							
114 d	70	11/12→06/19		für Linkslenker		24.4123-1736.3 011118	Ø 23,8 ohne Bremsflüssigkeitsbehälter
116 d	85	07/11→02/15					
116 i	100	07/11→02/15					
118 d	100 - 105	07/11→06/19					
118 i	125	07/11→02/15					
120 d	120 - 147	07/11→06/19					
114 i	75	07/12→02/15		09/12→; für Linkslenker		24.4123-1736.3 011118	Ø 23,8 ohne Bremsflüssigkeitsbehälter
116 d	85	03/15→06/19		für Linkslenker; - Performance Parts		24.4123-1736.3 011118	Ø 23,8 ohne Bremsflüssigkeitsbehälter
116 i	80	03/15→06/19					
118 d	110	03/15→06/19		für Linkslenker; + Performance Parts		24.4125-1713.3 011109	Ø 25,4 ohne Bremsflüssigkeitsbehälter
118 i	100	03/15→06/19					
120 d	140 - 151	03/15→06/19					
120 d xDrive	140 - 151	03/15→06/19					
120 i	130 - 135	03/15→06/19					
118 d xDrive	105 - 110	07/13→06/19		für Fahrzeuge ohne Start-Stopp-Funktion		24.4123-1736.3 011118	Ø 23,8 ohne Bremsflüssigkeitsbehälter
120 d xDrive	135 - 147	11/12→02/15		für Fahrzeuge mit Start-Stopp-Funktion		24.4125-1713.3 011109	Ø 25,4 ohne Bremsflüssigkeitsbehälter
125 d	155 - 165	03/12→06/19		für Linkslenker		24.4125-1713.3 011109	Ø 25,4 ohne Bremsflüssigkeitsbehälter
125 i	160 - 175	03/12→06/19					
125 i Active Flex	160	11/14→11/17					
M 135 i	240	03/15→06/16					
M 140 i	250	07/16→06/19					
M 140 i xDrive	250	07/16→06/19					
M 135 i	235	07/12→02/15		09/12→; für Linkslenker		24.4125-1713.3 011109	Ø 25,4 ohne Bremsflüssigkeitsbehälter
M 135 i xDrive	235 - 240	11/12→06/16				24.4125-1713.3 011109	Ø 25,4 ohne Bremsflüssigkeitsbehälter
BMW - 1 (F21) 12/11→							
 Hauptbremszylinder							
114 d	70	06/15→		für Linkslenker		24.4123-1736.3 011118	Ø 23,8 ohne Bremsflüssigkeitsbehälter
116 d	85	12/11→					
116 i	100	12/11→					
118 d	100 - 105	12/11→					
118 i	125	07/12→					
120 d	120 - 147	01/12→					
114 d	70	07/12→		10/12→; für Linkslenker		24.4123-1736.3 011118	Ø 23,8 ohne Bremsflüssigkeitsbehälter
114 i	75	07/12→01/15		09/12→; für Linkslenker		24.4123-1736.3 011118	Ø 23,8 ohne Bremsflüssigkeitsbehälter
116 d	85	03/15→		für Linkslenker; - Performance Parts		24.4123-1736.3 011118	Ø 23,8 ohne Bremsflüssigkeitsbehälter
116 i	80	03/15→					
→							









	kw			 	! #		
BMW - 1 (F21) 12/11→							
 Hauptbremszylinder							
118 d 118 d xDrive 118 i 120 d 120 d xDrive 120 i	110 110 100 140 - 151 140 - 151 130 - 135	03/15→ 03/15→ 03/15→ 03/15→ 03/15→ 03/15→		für Linkslenker; + Performance Parts		24.4125-1713.3 011109	Ø 25,4 ohne Bremsflüssigkeitsbehälter
118 d xDrive	105	05/13→		für Fahrzeuge ohne Start-Stopp-Funktion		24.4123-1736.3 011118	Ø 23,8 ohne Bremsflüssigkeitsbehälter
				für Fahrzeuge mit Start-Stopp-Funktion		24.4125-1713.3 011109	Ø 25,4 ohne Bremsflüssigkeitsbehälter
120 d xDrive	135 - 147	01/12→		07/12→; für Fahrzeuge ohne Start-Stopp-Funktion		24.4123-1736.3 011118	Ø 23,8 ohne Bremsflüssigkeitsbehälter
				07/12→; für Fahrzeuge mit Start-Stopp-Funktion		24.4125-1713.3 011109	Ø 25,4 ohne Bremsflüssigkeitsbehälter
125 d 125 i	155 - 160 160	12/11→ 12/11→12/19		03/12→; für Linkslenker		24.4125-1713.3 011109	Ø 25,4 ohne Bremsflüssigkeitsbehälter
125 d 125 i M 135 i M 140 i M 140 i xDrive	165 165 - 175 240 250 250	03/15→ 03/13→ 03/15→ 10/15→ 09/15→		für Linkslenker		24.4125-1713.3 011109	Ø 25,4 ohne Bremsflüssigkeitsbehälter
M 135 i	235	12/11→		09/12→; für Linkslenker		24.4125-1713.3 011109	Ø 25,4 ohne Bremsflüssigkeitsbehälter
M 135 i xDrive	235	02/12→		07/12→		24.4125-1713.3 011109	Ø 25,4 ohne Bremsflüssigkeitsbehälter
M 135 i xDrive	240	03/15→				24.4125-1713.3 011109	Ø 25,4 ohne Bremsflüssigkeitsbehälter
BMW - 1 (F40) 07/19→							
 Hauptbremszylinder							
116 d 116 i 118 d 118 i	85 80 100 - 110 100 - 103	07/19→ 11/20→ 07/19→ 07/19→		für Fahrzeuge ohne M-Sportbremse		24.4122-1722.3 011085	Ø 22,2 ohne Bremsflüssigkeitsbehälter
				für Fahrzeuge mit M-Sportbremse		24.4123-1733.3 011108	Ø 23,8 ohne Bremsflüssigkeitsbehälter
120 d 120 d xDrive 120 i 128 ti	140 140 131 180 - 195	03/20→ 07/19→ 11/20→ 11/20→				24.4123-1733.3 011108	Ø 23,8 ohne Bremsflüssigkeitsbehälter
BMW - 1 (F52) 01/17→							
 Hauptbremszylinder							
118 i	100	01/17→08/19		für Fahrzeuge ohne M-Sportbremse		24.4122-1722.3 011085	Ø 22,2 ohne Bremsflüssigkeitsbehälter
				für Fahrzeuge mit M-Sportbremse		24.4123-1733.3 011108	Ø 23,8 ohne Bremsflüssigkeitsbehälter
BMW - 1 Cabriolet (E88) 12/07→12/13							
 Bremskraftverstärker							
118 d 118 i 120 d 120 i	100 - 105 100 - 105 120 - 145 115 - 120	09/08→12/13 03/08→12/13 03/08→12/13 03/08→12/13		→ 10/13; für Fahrzeuge ohne Start-Stopp-Funktion		03.7848-4003.4 300235	ATE Ø 8" pneumatisch
120 i 128 i	125 172	12/07→10/13 12/07→10/13		für Fahrzeuge ohne Start-Stopp-Funktion		03.7848-4003.4 300235	ATE Ø 8" pneumatisch
123 d	150	09/08→12/13		→ 10/13; für Fahrzeuge ohne Start-Stopp-Funktion		03.7848-5003.4 300236	ATE Ø 8" pneumatisch
125 i	160	12/07→10/13				03.7848-4003.4 300235	ATE Ø 8" pneumatisch
135 i	225	03/08→10/13				03.7845-0103.4 300268	ATE Ø 8" pneumatisch
135 i →	240	03/08→12/13		→ 10/13		03.7845-0103.4 300268	ATE Ø 8" pneumatisch











	kw			 	! #		
BMW - 1 Cabriolet (E88) 12/07→12/13							
 Hauptbremszylinder							
118 d	100 - 105	09/08→12/13		→ 10/13; für Linkslenker		03.2023-2407.3 010796	ATE Ø1 23,8 Ø2 22,2
118 i	100 - 105	03/08→12/13					
120 d	120 - 145	03/08→12/13					
120 i	115 - 120	03/08→12/13					
120 i	125	12/07→10/13		für Linkslenker		03.2023-2407.3 010796	ATE Ø1 23,8 Ø2 22,2
125 i	160	12/07→10/13					
128 i	172	12/07→10/13					
123 d	150	09/08→12/13		→ 10/13; für Linkslenker		03.2025-1904.3 010797	ATE Ø1 25,4 Ø2 22,2
135 i	240	03/08→12/13					
135 i	225	03/08→10/13		für Linkslenker		03.2025-1904.3 010797	ATE Ø1 25,4 Ø2 22,2
Hydraulikaggregat, Bremsanlage							
118 d	100 - 105	09/08→12/13		→ 10/13		24.9145-0003.2 399007	
118 i	100	09/08→12/13					
118 i	105	03/08→10/13		09/08→ 10/13		24.9145-0003.2 399007	
120 d	120 - 145	03/08→12/13		09/08→ 10/13; für Fahrzeuge ohne Aktivlenkung		24.9145-0003.2 399007	
120 i	115 - 120	03/08→12/13					
120 i	125	12/07→10/13		09/08→; für Fahrzeuge ohne Aktivlenkung		24.9145-0003.2 399007	
123 d	150	09/08→12/13		→ 10/13; für Fahrzeuge ohne Aktivlenkung		24.9145-0003.2 399007	
BMW - 1 Coupe (E82) 10/06→10/13							
 Bremskraftverstärker							
118 d	100 - 105	09/09→10/13		für Fahrzeuge ohne Start-Stopp-Funktion		03.7848-4003.4 300235	ATE Ø 8" pneumatisch
120 d	120 - 130	09/07→10/13					
120 i	115	09/09→10/13					
120 d	145	09/07→10/13		10/07→; für Fahrzeuge ohne Start-Stopp-Funktion		03.7848-4003.4 300235	ATE Ø 8" pneumatisch
120 i	125	10/07→10/13		09/09→; für Fahrzeuge ohne Start-Stopp-Funktion		03.7848-4003.4 300235	ATE Ø 8" pneumatisch
123 d	150	10/07→09/13		→ 08/09		03.7848-4003.4 300235	ATE Ø 8" pneumatisch
				09/09→; für Fahrzeuge ohne Start-Stopp-Funktion		03.7848-5003.4 300236	ATE Ø 8" pneumatisch
125 i	160	03/08→10/13				03.7848-4003.4 300235	ATE Ø 8" pneumatisch
128 i	172	10/07→10/13					
135 i	225 - 240	10/07→10/13				03.7845-0103.4 300268	ATE Ø 8" pneumatisch
 Hauptbremszylinder							
118 d	100 - 105	09/09→10/13		für Linkslenker		03.2023-2407.3 010796	ATE Ø1 23,8 Ø2 22,2
120 d	120 - 130	09/07→10/13					
120 i	115	09/09→10/13					
125 i	160	03/08→10/13					
128 i	172	10/07→10/13					
120 d	145	09/07→10/13		10/07→; für Linkslenker		03.2023-2407.3 010796	ATE Ø1 23,8 Ø2 22,2
120 i	125	10/07→10/13		09/09→; für Linkslenker		03.2023-2407.3 010796	ATE Ø1 23,8 Ø2 22,2
123 d	150	10/07→09/13		für Linkslenker		03.2025-1904.3 010797	ATE Ø1 25,4 Ø2 22,2
135 i	225 - 240	10/07→10/13					
Hydraulikaggregat, Bremsanlage							
118 d	100 - 105	09/09→10/13				24.9145-0003.2 399007	
120 d	120 - 145	09/07→10/13		09/08→; für Fahrzeuge ohne Aktivlenkung		24.9145-0003.2 399007	
123 d	150	10/07→09/13					
120 i	115	09/09→10/13		für Fahrzeuge ohne Aktivlenkung		24.9145-0003.2 399007	
120 i	125	10/07→10/13		09/09→; für Fahrzeuge ohne Aktivlenkung		24.9145-0003.2 399007	











	kw			 	! #		
BMW - 1 Van (F20) 03/15→06/19							
 Hauptbremszylinder							
118 d 118 i 120 d 120 i	110 100 140 135	03/15→06/19 07/15→06/19 03/15→06/19 07/16→06/19		für Linkslenker; - Performance Parts für Linkslenker; + Performance Parts	24.4123-1736.3 24.4125-1713.3	011118 011109	Ø 23,8 ohne Bremsflüssigkeitsbehälter Ø 25,4 ohne Bremsflüssigkeitsbehälter
M 140 i	250	07/16→06/19		für Linkslenker	24.4125-1713.3	011109	Ø 25,4 ohne Bremsflüssigkeitsbehälter
BMW - 2 Active Tourer (F45) 11/13→10/21							
 Hauptbremszylinder							
214 d	70	07/14→02/18		03/15→	24.4122-1722.3	011085	Ø 22,2 ohne Bremsflüssigkeitsbehälter
216 d 218 i 220 d xDrive 220 i	85 100 140 141	03/14→10/21 07/14→10/21 03/14→10/21 03/14→10/21		10/14→	24.4122-1722.3	011085	Ø 22,2 ohne Bremsflüssigkeitsbehälter
216 i 218 d xDrive	75 100 - 110	02/15→02/18 12/14→10/21		11/15→	24.4122-1722.3	011085	Ø 22,2 ohne Bremsflüssigkeitsbehälter
216 i 218 d 220 d 220 i	80 110 140 131	03/18→10/21 11/13→10/21 03/14→10/21 11/20→10/21			24.4122-1722.3	011085	Ø 22,2 ohne Bremsflüssigkeitsbehälter
218 d	100	11/13→10/21		09/14→	24.4122-1722.3	011085	Ø 22,2 ohne Bremsflüssigkeitsbehälter
218 i 225 xe Plug-in-Hybrid	103 162	03/18→10/21 11/20→10/21			24.4123-1733.3	011108	Ø 23,8 ohne Bremsflüssigkeitsbehälter
220 d 220 d xDrive 220 i	120 120 120	03/14→10/21 03/14→10/21 03/14→10/21		11/14→	24.4122-1722.3	011085	Ø 22,2 ohne Bremsflüssigkeitsbehälter
225 i 225 i xDrive	170 170	11/13→12/19 03/14→10/21		10/14→	24.4123-1733.3	011108	Ø 23,8 ohne Bremsflüssigkeitsbehälter
225 xe Plug-in-Hybrid	165	11/14→10/21		03/16→	24.4123-1733.3	011108	Ø 23,8 ohne Bremsflüssigkeitsbehälter
BMW - 2 Active Tourer Van (F45) 11/13→10/21							
 Hauptbremszylinder							
218 d 220 d	110 140	07/14→10/21 11/14→10/21			24.4122-1722.3	011085	Ø 22,2 ohne Bremsflüssigkeitsbehälter
218 i	103	03/18→10/21			24.4123-1733.3	011108	Ø 23,8 ohne Bremsflüssigkeitsbehälter
BMW - 2 Cabriolet (F23) 03/14→06/21							
 Hauptbremszylinder							
218 d	100 - 110	07/15→09/20		für Linkslenker; - Performance Parts	24.4123-1736.3	011118	Ø 23,8 ohne Bremsflüssigkeitsbehälter
218 i 220 i 225 i 230 i	100 135 135 185	03/15→06/21 09/15→06/21 10/17→06/21 07/16→06/21		für Linkslenker; + Performance Parts	24.4125-1713.3	011109	Ø 25,4 ohne Bremsflüssigkeitsbehälter
220 d	120 - 151	03/14→09/20		11/14→; für Linkslenker	24.4125-1713.3	011109	Ø 25,4 ohne Bremsflüssigkeitsbehälter
220 i	135	04/14→06/21		11/14→; für Linkslenker; - Performance Parts	24.4123-1736.3	011118	Ø 23,8 ohne Bremsflüssigkeitsbehälter
				11/14→; für Linkslenker; + Performance Parts	24.4125-1713.3	011109	Ø 25,4 ohne Bremsflüssigkeitsbehälter
225 d 228 i M 235 i M 235 i xDrive M 240 i M 240 i xDrive	165 180 240 240 250 250	07/15→05/19 11/14→06/16 11/14→06/16 07/15→06/16 09/15→06/21 09/15→06/21		für Linkslenker	24.4125-1713.3	011109	Ø 25,4 ohne Bremsflüssigkeitsbehälter
BMW - 2 Coupe (F22, F87) 10/12→06/21							
 Hauptbremszylinder							
218 d	100	03/14→09/20		07/15→; für Linkslenker; - Performance Parts	24.4123-1736.3	011118	Ø 23,8 ohne Bremsflüssigkeitsbehälter
				07/15→; für Linkslenker; + Performance Parts	24.4125-1713.3	011109	Ø 25,4 ohne Bremsflüssigkeitsbehälter
218 d 218 i 220 d	105 - 110 100 120	03/14→09/20 03/15→06/21 11/14→09/20		für Linkslenker; - Performance Parts für Linkslenker; + Performance Parts	24.4123-1736.3 24.4125-1713.3	011118 011109	Ø 23,8 ohne Bremsflüssigkeitsbehälter Ø 25,4 ohne Bremsflüssigkeitsbehälter











	kw			 	! #		
BMW - 2 Coupe (F22, F87) 10/12→06/21							
 Hauptbremszylinder							
220 i 225 i 230 i	135 135 185	10/13→06/21 10/17→06/21 07/16→06/21		für Linkslenker; - Performance Parts		24.4123-1736.3 011118	Ø 23,8 ohne Bremsflüssigkeitsbehälter
				für Linkslenker; + Performance Parts		24.4125-1713.3 011109	Ø 25,4 ohne Bremsflüssigkeitsbehälter
220 d	135 - 147	10/12→06/17		10/13→; für Linkslenker; - Performance Parts		24.4123-1736.3 011118	Ø 23,8 ohne Bremsflüssigkeitsbehälter
				10/13→; für Linkslenker; + Performance Parts		24.4125-1713.3 011109	Ø 25,4 ohne Bremsflüssigkeitsbehälter
220 d	140 - 151	03/14→09/20		11/14→; für Linkslenker		24.4125-1713.3 011109	Ø 25,4 ohne Bremsflüssigkeitsbehälter
220 d xDrive 225 d	120 160 - 165	03/15→09/20 01/14→05/19		für Linkslenker		24.4125-1713.3 011109	Ø 25,4 ohne Bremsflüssigkeitsbehälter
228 i M 235 i M 240 i M 240 i xDrive	180 240 250 250	07/14→06/16 10/13→06/16 09/15→06/21 09/15→06/21					
220 d xDrive	140 - 151	06/14→09/20		03/15→; für Linkslenker		24.4125-1713.3 011109	Ø 25,4 ohne Bremsflüssigkeitsbehälter
M 235 i xDrive	240	07/14→06/16				24.4125-1713.3 011109	Ø 25,4 ohne Bremsflüssigkeitsbehälter
BMW - 2 Gran Coupe (F44) 11/19→							
 Hauptbremszylinder							
216 d 218 i	85 100 - 103	03/20→ 11/19→		für Fahrzeuge ohne M-Sportbremse		24.4122-1722.3 011085	Ø 22,2 ohne Bremsflüssigkeitsbehälter
				für Fahrzeuge mit M-Sportbremse		24.4123-1733.3 011108	Ø 23,8 ohne Bremsflüssigkeitsbehälter
218 d 220 d 220 d xDrive 220 i 220 i xDrive	100 - 110 120 - 140 140 131 131	11/19→ 11/19→ 07/20→ 11/20→ 03/21→				24.4123-1733.3 011108	Ø 23,8 ohne Bremsflüssigkeitsbehälter
BMW - 2 Gran Tourer (F46) 07/14→							
 Hauptbremszylinder							
214 d 218 d 218 d xDrive	70 110 100 - 110	07/15→02/18 07/14→ 03/15→				24.4122-1722.3 011085	Ø 22,2 ohne Bremsflüssigkeitsbehälter
						24.4123-1733.3 011108	Ø 23,8 ohne Bremsflüssigkeitsbehälter
218 i	100	03/15→					
216 d	85	08/14→		03/15→		24.4122-1722.3 011085	Ø 22,2 ohne Bremsflüssigkeitsbehälter
						24.4123-1733.3 011108	Ø 23,8 ohne Bremsflüssigkeitsbehälter
216 i	75	09/14→02/18		07/15→		24.4122-1722.3 011085	Ø 22,2 ohne Bremsflüssigkeitsbehälter
						24.4123-1733.3 011108	Ø 23,8 ohne Bremsflüssigkeitsbehälter
216 i 220 d 220 d xDrive 220 i	80 140 120 - 140 120 - 141	03/18→ 09/14→ 03/15→ 03/15→				24.4123-1733.3 011108	Ø 23,8 ohne Bremsflüssigkeitsbehälter
218 d	100	07/14→		03/15→		24.4122-1722.3 011085	Ø 22,2 ohne Bremsflüssigkeitsbehälter
						24.4123-1733.3 011108	Ø 23,8 ohne Bremsflüssigkeitsbehälter
218 i	103	04/17→		nicht für Fahrzeuge mit verstärkter Bremse		24.4123-1733.3 011108	Ø 23,8 ohne Bremsflüssigkeitsbehälter
220 d	120	09/14→		07/15→		24.4123-1733.3 011108	Ø 23,8 ohne Bremsflüssigkeitsbehälter
BMW - 2 Gran Tourer Van (F46) 07/14→							
 Hauptbremszylinder							
218 d	110	07/14→				24.4122-1722.3 011085	Ø 22,2 ohne Bremsflüssigkeitsbehälter
						24.4123-1733.3 011108	Ø 23,8 ohne Bremsflüssigkeitsbehälter
→							













	kw			 	! #		
BMW - 2 Gran Tourer Van (F46) 07/14→							
 Hauptbremszylinder							
218 i	103	03/18→		nicht für Fahrzeuge mit verstärkter Bremse		24.4123-1733.3 011108	Ø 23,8 ohne Bremsflüssigkeitsbehälter
220 d	140	07/14→				24.4123-1733.3 011108	Ø 23,8 ohne Bremsflüssigkeitsbehälter
BMW - 3 (E36) 09/90→11/98							
 Bremskraftverstärker							
316 i	75	09/93→05/98		09/94→; + ABS		03.7760-3102.4 300139	ATE Ø 10" pneumatisch
318 i	85	09/93→11/98		→ 08/94; + ABS		10.6360-1903.4 300093	ATE Ø 10" pneumatisch
318 is	103	01/96→05/98		+ ABS		03.7760-3102.4 300139	ATE Ø 10" pneumatisch
318 tds	66	01/95→02/98					
320 i	110	01/91→02/98		09/94→; - ASC		03.7760-3102.4 300139	ATE Ø 10" pneumatisch
325 td	85	09/91→02/98		09/96→; + ASC		03.7760-3102.4 300139	ATE Ø 10" pneumatisch
325 tds	105	05/93→02/98		→ 08/94; - ASC		10.6360-1903.4 300093	ATE Ø 10" pneumatisch
				→ 08/96; + ASC		10.6360-1903.4 300093	ATE Ø 10" pneumatisch
323 i	125	05/95→11/98		09/96→; + ASC		03.7760-3102.4 300139	ATE Ø 10" pneumatisch
328 i	142	01/95→04/98		- ASC		03.7760-3102.4 300139	ATE Ø 10" pneumatisch
				→ 08/96; + ASC		10.6360-1903.4 300093	ATE Ø 10" pneumatisch
Pedalwegsensord, Bremspedal							
316 i	75	09/93→05/98		→ 08/94; + ABS		03.0655-0002.2 370002	ATE
318 i	85	09/93→11/98					
320 i	110	01/91→02/98		→ 08/96; + ASC		03.0655-0002.2 370002	ATE
325 td	85	09/91→02/98		→ 08/94; - ASC		03.0655-0002.2 370002	ATE
325 tds	105	05/93→02/98					
323 i	125	05/95→11/98		→ 08/96; + ASC		03.0655-0002.2 370002	ATE
328 i	142	01/95→04/98					
 Hauptbremszylinder							
316 i	75	09/93→05/98		→ 08/94; + ABS		10.6123-0239.3 010335	ATE Ø 23,8
318 i	85	09/93→11/98					
320 i	110	01/91→02/98		→ 08/96; + ASC		10.6123-0239.3 010335	ATE Ø 23,8
325 td	85	09/91→02/98		→ 08/94; - ASC		10.6123-0239.3 010335	ATE Ø 23,8
				- ABS		24.2023-1601.3 010341	TRW Ø 23,8
323 i	125	05/95→11/98		→ 08/96; + ASC		10.6123-0239.3 010335	ATE Ø 23,8
328 i	142	01/95→04/98					
325 tds	105	05/93→02/98		→ 08/96; + ASC		10.6123-0239.3 010335	ATE Ø 23,8
				→ 08/94; - ASC		10.6123-0239.3 010335	ATE Ø 23,8
BMW - 3 (E46) 12/97→05/05							
 Bremskraftverstärker							
316 i	77 - 85	12/98→02/05				03.7860-0702.4 300123	ATE Ø 10" pneumatisch
318 d	85	09/01→02/05					
318 i	87 - 105	12/97→02/05					
320 d	95 - 110	02/98→05/05					
320 i	110 - 125	03/98→02/05					
323 i	120 - 125	03/98→09/00					
325 i	141	09/00→02/05					
325 xi	141	09/00→02/05					
328 i	142	02/98→06/00					
330 d	135 - 150	10/99→02/05					
330 i	170	06/00→02/05					
330 xi	170	06/00→02/05					
330 i	168	01/01→04/05		→ 02/05		03.7860-0702.4 300123	ATE Ø 10" pneumatisch
330 xd	135	01/00→02/03		06/00→		03.7860-0702.4 300123	ATE Ø 10" pneumatisch
330 xd	150	09/02→12/04		03/03→		03.7860-0702.4 300123	ATE Ø 10" pneumatisch
 Hauptbremszylinder							
316 i	77	12/98→02/05		→ 08/01; - DSC		03.2022-2624.3 010588	Ø1 22,2 Ø2 20,6
320 i	120 - 125	09/00→02/05		02/01→; + DSC		03.2023-2256.3 010870	ATE Ø1 23,8 Ø2 22,2
325 i	141	09/00→02/05		09/01→; - DSC		03.2023-2344.3 010647	ATE Ø1 23,8 Ø2 22,2
316 i	85	02/02→02/05		+ DSC		03.2023-2256.3 010870	ATE Ø1 23,8 Ø2 22,2
318 d	85	09/01→02/05		- DSC		03.2023-2344.3 010647	ATE Ø1 23,8 Ø2 22,2
318 i	100 - 105	09/01→02/05					
→							

	kw			 	! #		
BMW - 3 (E46) 12/97→05/05							
 Hauptbremszylinder							
320 d	110	09/01→05/05		+ DSC		03.2023-2256.3 010870	ATE Ø1 23,8 Ø2 22,2
				- DSC		03.2023-2344.3 010647	ATE Ø1 23,8 Ø2 22,2
318 i	87	12/97→09/01		- DSC		03.2022-2624.3 010588	Ø1 22,2 Ø2 20,6
320 i	110	03/98→09/00					
323 i	120 - 125	03/98→09/00					
328 i	142	02/98→06/00					
320 d	95 - 100	02/98→09/01		- DSC		03.2022-2624.3 010588	Ø1 22,2 Ø2 20,6
				02/01→; + DSC		03.2023-2256.3 010870	ATE Ø1 23,8 Ø2 22,2
330 d	135	10/99→02/05		→ 08/00; + DSC		03.2023-2204.3 010644	ATE Ø1 23,8 Ø2 22,2
330 i	170	06/00→02/05		02/01→; + DSC		03.2023-2256.3 010870	ATE Ø1 23,8 Ø2 22,2
				→ 08/01; - DSC		03.2023-2304.3 010646	ATE Ø1 23,8 Ø2 22,2
				09/01→; - DSC		03.2023-2344.3 010647	ATE Ø1 23,8 Ø2 22,2
330 d	150	03/03→02/05		+ DSC		03.2023-2256.3 010870	ATE Ø1 23,8 Ø2 22,2
330 i	168	01/01→04/05		02/01→ 02/05; + DSC		03.2023-2256.3 010870	ATE Ø1 23,8 Ø2 22,2
				→ 08/01; - DSC		03.2023-2304.3 010646	ATE Ø1 23,8 Ø2 22,2
				09/01→ 02/05; - DSC		03.2023-2344.3 010647	ATE Ø1 23,8 Ø2 22,2
BMW - 3 (E90) 02/04→02/12							
 Bremskraftverstärker							
316 d	85	07/09→12/11		für Fahrzeuge ohne Start-Stopp-Funktion		03.7848-4003.4 300235	ATE Ø 8" pneumatisch
316 i	90	09/07→10/11					
318 d	100	09/07→10/11					
318 i	95 - 105	09/05→10/11					
320 i	110 - 125	12/04→10/11					
316 i	85	09/05→10/11		→ 08/07; für Fahrzeuge ohne Start-Stopp-Funktion		03.7848-4003.4 300235	ATE Ø 8" pneumatisch
320 i	115	02/07→12/11					
318 d	90	03/05→08/07		09/05→; für Fahrzeuge ohne Start-Stopp-Funktion		03.7848-4003.4 300235	ATE Ø 8" pneumatisch
318 d	105	02/07→10/11		09/07→; für Fahrzeuge ohne Start-Stopp-Funktion		03.7848-4003.4 300235	ATE Ø 8" pneumatisch
320 i	120	03/07→12/11					
320 d	110 - 115	12/04→09/07		09/05→; für Fahrzeuge ohne Start-Stopp-Funktion		03.7845-0103.4 300268	ATE Ø 8" pneumatisch
320 d	120	12/04→10/11				03.7848-5003.4 300236	ATE Ø 8" pneumatisch
320 si	127	09/05→08/06					
323 i	130 - 140	09/05→12/11					
325 d	145 - 150	09/06→10/11					
325 i	155 - 160	12/04→12/11					
325 xi	160	09/05→08/06					
328 i	172	09/06→12/11					
330 d	155 - 170	09/05→12/11					
330 i	190	12/04→10/11					
330 i xDrive	200	09/08→10/11					
330 xd	170	09/05→08/08					
330 xi	190 - 200	09/05→08/08					
320 d	130 - 135	09/07→10/11		für Fahrzeuge ohne Start-Stopp-Funktion		03.7845-0103.4 300268	ATE Ø 8" pneumatisch
320 d xDrive	120 - 135	09/08→10/11					
335 d	210	09/06→12/11					
335 i	225	09/06→12/11					
335 i xDrive	224 - 240	05/08→10/11					
335 xi	225 - 240	09/06→08/08					
325 i xDrive	155 - 160	09/08→10/11		Motorcode: N53		03.7848-5003.4 300236	ATE Ø 8" pneumatisch
325 xi	160	09/05→08/08		→ 08/07; Motorcode: N52N; für Fahrzeuge ohne Start-Stopp-Funktion		03.7845-0103.4 300268	ATE Ø 8" pneumatisch
				→ 08/07; Motorcode: N52		03.7848-5003.4 300236	ATE Ø 8" pneumatisch
				09/07→; Motorcode: N53		03.7848-5003.4 300236	ATE Ø 8" pneumatisch
325 xi	160	09/07→08/08		Motorcode: N52N; für Fahrzeuge ohne Start-Stopp-Funktion		03.7845-0103.4 300268	ATE Ø 8" pneumatisch
				Motorcode: N53		03.7848-5003.4 300236	ATE Ø 8" pneumatisch
330 d	180	09/08→10/11		→ 08/09; für Fahrzeuge ohne Start-Stopp-Funktion		03.7845-0103.4 300268	ATE Ø 8" pneumatisch
330 d xDrive	180	09/08→10/11					
330 i	200	03/07→12/11		09/09→		03.7848-5003.4 300236	ATE Ø 8" pneumatisch
→							













	kw			 	! #		
BMW - 3 (E90) 02/04→02/12							
 Bremskraftverstärker							
335 i	220 - 240	03/06→12/11		09/06→; für Fahrzeuge ohne Start-Stopp-Funktion		03.7845-0103.4 300268	ATE Ø 8" pneumatisch
335 xi	224	09/06→06/08		03/07→; für Fahrzeuge ohne Start-Stopp-Funktion		03.7845-0103.4 300268	ATE Ø 8" pneumatisch
 Hauptbremszylinder							
316 d 316 i 318 d 318 i 320 i	85 90 100 95 - 105 110 - 125	07/09→12/11 09/07→10/11 09/07→10/11 09/05→10/11 12/04→12/11		für Linkslenker		03.2023-2407.3 010796	ATE Ø1 23,8 Ø2 22,2
316 i 320 i	85 115	09/05→10/11 02/07→12/11		→ 08/07; für Linkslenker		03.2023-2407.3 010796	ATE Ø1 23,8 Ø2 22,2
318 d	90	03/05→08/07		09/05→; für Linkslenker		03.2023-2407.3 010796	ATE Ø1 23,8 Ø2 22,2
318 d	105	02/07→10/11		09/07→; für Linkslenker		03.2023-2407.3 010796	ATE Ø1 23,8 Ø2 22,2
320 d	110 - 115	12/04→09/07		09/05→; für Linkslenker		03.2025-1904.3 010797	ATE Ø1 25,4 Ø2 22,2
320 d 320 si 323 i 325 i 328 i 330 d 330 i 335 i	120 - 135 127 130 - 140 155 - 160 172 180 190 - 200 225	12/04→10/11 09/05→08/06 09/05→12/11 12/04→12/11 09/06→12/11 09/08→10/11 12/04→12/11 09/06→12/11		für Linkslenker		03.2025-1904.3 010797	ATE Ø1 25,4 Ø2 22,2
320 d xDrive 325 d 325 i xDrive 325 xi 330 d 330 d xDrive 330 i xDrive 330 xd 330 xi 335 d 335 i xDrive 335 xi	120 - 135 145 - 150 155 - 160 160 155 - 170 180 200 170 190 - 200 210 224 - 240 224 - 225	09/08→10/11 09/06→10/11 09/08→10/11 09/05→08/08 09/05→12/11 09/08→10/11 09/08→10/11 09/05→08/08 09/05→08/08 09/06→12/11 05/08→10/11 09/06→08/08				03.2025-1904.3 010797	ATE Ø1 25,4 Ø2 22,2
335 i	220 - 240	03/06→12/11		09/06→; für Linkslenker		03.2025-1904.3 010797	ATE Ø1 25,4 Ø2 22,2
335 xi	240	09/06→06/08		03/07→		03.2025-1904.3 010797	ATE Ø1 25,4 Ø2 22,2
Hydraulikaggregat, Bremsanlage							
316 d 316 i 318 d 318 i	85 90 100 - 105 100 - 105	07/09→12/11 09/07→10/11 02/07→10/11 09/07→10/11		09/08→		24.9145-0003.2 399007	
320 d 320 i	120 - 130 120 - 125	12/04→10/11 03/07→12/11		09/08→; für Fahrzeuge ohne Aktivlenkung		24.9145-0003.2 399007	
320 d	135	03/10→10/11		für Fahrzeuge ohne Aktivlenkung		24.9145-0003.2 399007	
BMW - 3 (F30, F80) 11/11→10/18							
 Hauptbremszylinder							
316 d 318 d 318 d xDrive 320 d xDrive 320 i 320 i xDrive →	85 100 - 110 110 140 125 - 135 135	03/12→10/18 03/12→10/18 07/15→02/18 07/15→10/18 03/12→10/18 07/12→10/18		für Linkslenker		24.4123-1736.3 011118	Ø 23,8 ohne Bremsflüssigkeitsbehälter











	kw			 	! #		
BMW - 3 (F30, F80) 11/11→10/18							
 Hauptbremszylinder							
316 i	100	07/12→08/16		11/12→; für Linkslenker		24.4123-1736.3 011118	Ø 23,8 ohne Bremsflüssigkeitsbehälter
318 d xDrive	105	07/13→06/15		für Linkslenker; - Performance Parts		24.4123-1736.3 011118	Ø 23,8 ohne Bremsflüssigkeitsbehälter
318 i	100	07/15→10/18		für Linkslenker; + Performance Parts		24.4125-1713.3 011109	Ø 25,4 ohne Bremsflüssigkeitsbehälter
320 d	120	11/11→10/18		02/12→; für Linkslenker		24.4123-1736.3 011118	Ø 23,8 ohne Bremsflüssigkeitsbehälter
320 d	135 - 147	11/11→03/16		02/12→; für Linkslenker		24.4125-1713.3 011109	Ø 25,4 ohne Bremsflüssigkeitsbehälter
328i	160	11/11→06/15					
328 i	180	11/11→10/18					
335 i	225 - 240	11/11→07/15					
320 d	140	07/15→10/18		für Linkslenker; für Fahrzeuge ohne M-Sportbremse		24.4125-1713.3 011109	Ø 25,4 ohne Bremsflüssigkeitsbehälter
320 d xDrive	120 - 147	08/12→10/18		für Linkslenker		24.4125-1713.3 011109	Ø 25,4 ohne Bremsflüssigkeitsbehälter
325 d	165	03/16→02/18					
328 i xDrive	180	07/12→08/16					
330 d	190	07/12→10/18					
330 d xDrive	190	03/13→10/18					
335 d xDrive	230	07/13→10/18					
335 i	250	07/13→07/15					
335 i xDrive	225 - 250	07/12→07/15					
ActiveHybrid	250	07/12→06/15					
325 d	155 - 160	03/13→02/16		04/13→; für Linkslenker		24.4125-1713.3 011109	Ø 25,4 ohne Bremsflüssigkeitsbehälter
330 d	210	07/12→10/18		09/15→; für Linkslenker		24.4125-1713.3 011109	Ø 25,4 ohne Bremsflüssigkeitsbehälter
330 d xDrive	210	03/13→10/18					
330 e	185	11/15→10/18		01/16→; für Linkslenker		24.4125-1713.3 011109	Ø 25,4 ohne Bremsflüssigkeitsbehälter
330 i	185	07/15→10/18		für Linkslenker; - Performance Parts		24.4125-1713.3 011109	Ø 25,4 ohne Bremsflüssigkeitsbehälter
330 i xDrive	185	07/15→10/18					
340 i	240 - 265	07/15→10/18					
340 i xDrive	240 - 265	07/15→10/18					
BMW - 3 Cabriolet (E36) 03/93→11/99							
 Bremskraftverstärker							
318 i	85	03/94→11/99		09/96→; + ASC		03.7760-3102.4 300139	ATE Ø 10" pneumatisch
320 i	110	12/93→11/99		09/94→; - ASC		03.7760-3102.4 300139	ATE Ø 10" pneumatisch
				→ 08/96; + ASC		10.6360-1903.4 300093	ATE Ø 10" pneumatisch
				→ 08/94; - ASC		10.6360-1903.4 300093	ATE Ø 10" pneumatisch
323 i	125	05/95→11/99		09/96→; + ASC		03.7760-3102.4 300139	ATE Ø 10" pneumatisch
328 i	142	01/95→11/99		- ASC		03.7760-3102.4 300139	ATE Ø 10" pneumatisch
				→ 08/96; + ASC		10.6360-1903.4 300093	ATE Ø 10" pneumatisch
Pedalwegsensoren, Bremspedal							
318 i	85	03/94→11/99		→ 08/94; - ASC		03.0655-0002.2 370002	ATE
320 i	110	12/93→11/99		→ 08/96; + ASC		03.0655-0002.2 370002	ATE
323 i	125	05/95→11/99		→ 08/96; + ASC		03.0655-0002.2 370002	ATE
328 i	142	01/95→11/99					
 Hauptbremszylinder							
318 i	85	03/94→11/99		→ 08/94; + ASC		10.6123-0239.3 010335	ATE Ø 23,8
320 i	110	12/93→11/99					
323 i	125	05/95→11/99		→ 08/96; + ASC		10.6123-0239.3 010335	ATE Ø 23,8
328 i	142	01/95→11/99					
BMW - 3 Cabriolet (E46) 04/00→12/07							
 Bremskraftverstärker							
318 Ci	100	12/00→08/06		09/01→		03.7860-0702.4 300123	ATE Ø 10" pneumatisch
318 Ci	105	09/01→12/07		→ 09/06		03.7860-0702.4 300123	ATE Ø 10" pneumatisch
320 Cd	110	02/05→12/07					
320 Ci	120 - 125	09/00→12/07					
330 Cd	150	08/05→12/07					
318 Ci	110	03/04→08/06				03.7860-0702.4 300123	ATE Ø 10" pneumatisch
323 Ci	120 - 125	04/00→09/00					









	kw					! #			
BMW - 3 Cabriolet (E46) 04/00→12/07									
 Bremskraftverstärker									
325 Ci	141	09/00→08/06					03.7860-0702.4	300123	ATE Ø 10" pneumatisch
330 Ci	170	06/00→08/06							
 Hauptbremszylinder									
318 Ci	100	12/00→08/06		09/01→; + DSC			03.2023-2256.3	010870	ATE Ø1 23,8 Ø2 22,2
				09/01→; - DSC			03.2023-2344.3	010647	ATE Ø1 23,8 Ø2 22,2
318 Ci	105	09/01→12/07		→ 09/06; + DSC			03.2023-2256.3	010870	ATE Ø1 23,8 Ø2 22,2
320 Ci	120	01/06→12/07		→ 09/06; - DSC			03.2023-2344.3	010647	ATE Ø1 23,8 Ø2 22,2
318 Ci	110	03/04→08/06					03.2023-2256.3	010870	ATE Ø1 23,8 Ø2 22,2
320 Cd	110	02/05→12/07		→ 09/06			03.2023-2256.3	010870	ATE Ø1 23,8 Ø2 22,2
330 Cd	150	08/05→12/07							
320 Ci	125	09/00→12/07		→ 08/01; - DSC			03.2022-2624.3	010588	Ø1 22,2 Ø2 20,6
				→ 09/06; + DSC			03.2023-2256.3	010870	ATE Ø1 23,8 Ø2 22,2
				09/01→ 09/06; - DSC			03.2023-2344.3	010647	ATE Ø1 23,8 Ø2 22,2
323 Ci	120 - 125	04/00→09/00		- DSC			03.2022-2624.3	010588	Ø1 22,2 Ø2 20,6
325 Ci	141	09/00→08/06		→ 08/01; - DSC			03.2022-2624.3	010588	Ø1 22,2 Ø2 20,6
				+ DSC			03.2023-2256.3	010870	ATE Ø1 23,8 Ø2 22,2
				09/01→; - DSC			03.2023-2344.3	010647	ATE Ø1 23,8 Ø2 22,2
330 Ci	170	06/00→08/06		→ 08/00; + DSC			03.2023-2204.3	010644	ATE Ø1 23,8 Ø2 22,2
				09/00→; + DSC			03.2023-2256.3	010870	ATE Ø1 23,8 Ø2 22,2
				→ 08/01; - DSC			03.2023-2304.3	010646	ATE Ø1 23,8 Ø2 22,2
				09/01→; - DSC			03.2023-2344.3	010647	ATE Ø1 23,8 Ø2 22,2
BMW - 3 Cabriolet (E93) 05/06→12/13									
 Bremskraftverstärker									
318 i	105	03/10→12/13		→ 11/13; für Fahrzeuge ohne Start-Stopp-Funktion			03.7848-4003.4	300235	ATE Ø 8" pneumatisch
320 d	120	01/08→12/13		→ 11/13; für Fahrzeuge ohne Start-Stopp-Funktion			03.7845-0103.4	300268	ATE Ø 8" pneumatisch
320 d	130 - 147	03/08→10/13		für Fahrzeuge ohne Start-Stopp-Funktion			03.7845-0103.4	300268	ATE Ø 8" pneumatisch
320 d	145	09/07→02/10		03/08→; für Fahrzeuge ohne Start-Stopp-Funktion			03.7845-0103.4	300268	ATE Ø 8" pneumatisch
320 i	115 - 120	09/06→10/13		03/07→ 03/08; Motorcode: N43			03.7845-0103.4	300268	ATE Ø 8" pneumatisch
				04/08→; für Fahrzeuge ohne Start-Stopp-Funktion			03.7848-4003.4	300235	ATE Ø 8" pneumatisch
				03/07→ 03/08; Motorcode: N46N			03.7848-5003.4	300236	ATE Ø 8" pneumatisch
320 i	125	03/07→10/13		→ 03/08; Motorcode: N43			03.7845-0103.4	300268	ATE Ø 8" pneumatisch
				04/08→; für Fahrzeuge ohne Start-Stopp-Funktion			03.7848-4003.4	300235	ATE Ø 8" pneumatisch
				→ 03/08; Motorcode: N46N			03.7848-5003.4	300236	ATE Ø 8" pneumatisch
323 i	140	03/07→09/11					03.7845-0103.4	300268	ATE Ø 8" pneumatisch
325 d	145 - 155	03/07→12/10		09/07→			03.7848-5003.4	300236	ATE Ø 8" pneumatisch
325 d	150	09/09→09/13		03/10→			03.7848-5003.4	300236	ATE Ø 8" pneumatisch
325 i	160	12/06→02/10		Motorcode: N52N			03.7845-0103.4	300268	ATE Ø 8" pneumatisch
				Motorcode: N53			03.7848-5003.4	300236	ATE Ø 8" pneumatisch
325 i	155	10/06→12/13		03/07→; Motorcode: N52N; → 11/13			03.7845-0103.4	300268	ATE Ø 8" pneumatisch
				03/07→; Motorcode: N53; → 11/13			03.7848-5003.4	300236	ATE Ø 8" pneumatisch
325 i	160	03/07→12/13		Motorcode: N52N; → 11/13			03.7845-0103.4	300268	ATE Ø 8" pneumatisch
				Motorcode: N53; → 11/13			03.7848-5003.4	300236	ATE Ø 8" pneumatisch
330 d	170 - 180	03/07→12/13		→ 08/09			03.7845-0103.4	300268	ATE Ø 8" pneumatisch
				09/09→ 11/13			03.7848-5003.4	300236	ATE Ø 8" pneumatisch
330 i	190	03/10→10/13					03.7848-5003.4	300236	ATE Ø 8" pneumatisch
330 i	200	03/07→10/13		→ 08/09; Motorcode: N53			03.7845-0103.4	300268	ATE Ø 8" pneumatisch
				Motorcode: N52N			03.7848-5003.4	300236	ATE Ø 8" pneumatisch
				09/09→; Motorcode: N53			03.7848-5003.4	300236	ATE Ø 8" pneumatisch
335 i	225 - 240	05/06→10/13		03/07→			03.7845-0103.4	300268	ATE Ø 8" pneumatisch
 Hauptbremszylinder									
318 i	105	03/10→12/13		→ 11/13			03.2023-2407.3	010796	ATE Ø1 23,8 Ø2 22,2
320 d	120	01/08→12/13		für Linkslenker; → 11/13			03.2025-1904.3	010797	ATE Ø1 25,4 Ø2 22,2
325 i	160	03/07→12/13							
→									













	kw			 	! #		
BMW - 3 Cabriolet (E93) 05/06→12/13							
 Hauptbremszylinder							
330 d	170 - 180	03/07→12/13		für Linkslenker; → 11/13		03.2025-1904.3 010797	ATE Ø1 25,4 Ø2 22,2
320 d	130 - 147	09/07→10/13		für Linkslenker		03.2025-1904.3 010797	ATE Ø1 25,4 Ø2 22,2
325 i	160	12/06→02/10					
330 i	190 - 200	03/07→10/13					
320 i	115 - 120	09/06→10/13		06/08→; für Linkslenker		03.2023-2407.3 010796	ATE Ø1 23,8 Ø2 22,2
				03/07→; für Linkslenker; → 05/08		03.2025-1904.3 010797	ATE Ø1 25,4 Ø2 22,2
320 i	125	03/07→10/13		06/08→; für Linkslenker		03.2023-2407.3 010796	ATE Ø1 23,8 Ø2 22,2
				für Linkslenker; → 05/08		03.2025-1904.3 010797	ATE Ø1 25,4 Ø2 22,2
325 d	145 - 155	03/07→12/10		09/07→; für Linkslenker		03.2025-1904.3 010797	ATE Ø1 25,4 Ø2 22,2
325 d	150	09/09→09/13		03/10→; für Linkslenker		03.2025-1904.3 010797	ATE Ø1 25,4 Ø2 22,2
325 i	155	10/06→12/13		03/07→; für Linkslenker; → 11/13		03.2025-1904.3 010797	ATE Ø1 25,4 Ø2 22,2
335 i	225 - 240	05/06→10/13		03/07→; für Linkslenker		03.2025-1904.3 010797	ATE Ø1 25,4 Ø2 22,2
Hydraulikaggregat, Bremsanlage							
318 i	105	03/10→12/13		→ 11/13		24.9145-0003.2 399007	
320 d	120	01/08→12/13		09/08→11/13; für Fahrzeuge ohne Aktivlenkung		24.9145-0003.2 399007	
320 d	130 - 145	09/07→02/10		09/08→; für Fahrzeuge ohne Aktivlenkung		24.9145-0003.2 399007	
320 i	115 - 125	09/06→10/13					
320 d	135 - 147	03/10→10/13		für Fahrzeuge ohne Aktivlenkung		24.9145-0003.2 399007	
BMW - 3 Compact (E36) 01/94→08/00							
 Bremskraftverstärker							
316 g	75	02/96→08/00				03.7760-3102.4 300139	ATE Ø 10" pneumatisch
316 i	77	01/99→08/00					
318 tds	66	06/95→08/00					
323 ti	120 - 125	09/97→08/00					
316 i	75	01/94→08/00		09/96→; + ABS		03.7760-3102.4 300139	ATE Ø 10" pneumatisch
				→ 08/96; + ABS		10.6360-1903.4 300093	ATE Ø 10" pneumatisch
318 ti	103	01/96→08/99		09/96→; + ASC		03.7760-3102.4 300139	ATE Ø 10" pneumatisch
				- ASC		03.7760-3102.4 300139	ATE Ø 10" pneumatisch
				→ 08/96; + ASC		10.6360-1903.4 300093	ATE Ø 10" pneumatisch
Pedalwegsensoren, Bremspedal							
316 i	75	01/94→08/00		→ 08/96; + ABS		03.0655-0002.2 370002	ATE
318 ti	103	01/96→08/99		→ 08/96; + ASC		03.0655-0002.2 370002	ATE
 Hauptbremszylinder							
316 i	75	01/94→08/00		→ 08/94; + ABS		10.6123-0239.3 010335	ATE Ø 23,8
				- ABS		24.2023-1601.3 010341	TRW Ø 23,8
BMW - 3 Compact (E46) 03/01→02/05							
 Bremskraftverstärker							
316 ti	77 - 85	06/01→02/05				03.7860-0702.4 300123	ATE Ø 10" pneumatisch
318 td	85	03/03→02/05					
320 td	100 - 110	09/01→02/05					
325 ti	141	04/01→12/04					
318 ti	100 - 105	03/01→12/04		09/01→		03.7860-0702.4 300123	ATE Ø 10" pneumatisch
 Hauptbremszylinder							
316 ti	77 - 85	06/02→02/05		+ DSC		03.2023-2256.3 010870	ATE Ø1 23,8 Ø2 22,2
320 td	100 - 110	09/01→02/05		- DSC		03.2023-2344.3 010647	ATE Ø1 23,8 Ø2 22,2
316 ti	85	06/01→02/05		→ 08/01; - DSC		03.2022-2624.3 010588	Ø1 22,2 Ø2 20,6
325 ti	141	04/01→12/04		09/01→; + DSC		03.2023-2256.3 010870	ATE Ø1 23,8 Ø2 22,2
				09/01→; - DSC		03.2023-2344.3 010647	ATE Ø1 23,8 Ø2 22,2
318 td	85	03/03→02/05		+ DSC		03.2023-2256.3 010870	ATE Ø1 23,8 Ø2 22,2
→							













	kw					! #		
BMW - 3 Compact (E46) 03/01→02/05								
 Hauptbremszylinder								
318 ti	100 - 105	03/01→12/04		09/01→; + DSC		03.2023-2256.3	010870	ATE Ø1 23,8 Ø2 22,2
				09/01→; - DSC		03.2023-2344.3	010647	ATE Ø1 23,8 Ø2 22,2
BMW - 3 Coupe (E36) 10/91→05/99								
 Bremskraftverstärker								
316 i	75	09/93→11/98		09/96→; + ASC		03.7760-3102.4	300139	ATE Ø 10" pneumatisch
320 i	110	12/91→11/98		09/94→; - ASC		03.7760-3102.4	300139	ATE Ø 10" pneumatisch
				→ 08/96; + ASC		10.6360-1903.4	300093	ATE Ø 10" pneumatisch
				→ 08/94; - ASC		10.6360-1903.4	300093	ATE Ø 10" pneumatisch
318 is	103	09/95→04/99		09/96→; + ASC		03.7760-3102.4	300139	ATE Ø 10" pneumatisch
				→ 08/96; + ASC		10.6360-1903.4	300093	ATE Ø 10" pneumatisch
323 i	125	05/95→04/99		09/96→; + ASC		03.7760-3102.4	300139	ATE Ø 10" pneumatisch
328 i	142	01/95→04/99		- ASC		03.7760-3102.4	300139	ATE Ø 10" pneumatisch
				→ 08/96; + ASC		10.6360-1903.4	300093	ATE Ø 10" pneumatisch
 Hauptbremszylinder								
316 i	75	09/93→11/98		→ 08/94; - ASC		10.6123-0239.3	010335	ATE Ø 23,8
320 i	110	12/91→11/98		→ 08/96; + ASC		10.6123-0239.3	010335	ATE Ø 23,8
318 is	103	09/95→04/99		→ 08/96; + ASC		10.6123-0239.3	010335	ATE Ø 23,8
323 i	125	05/95→04/99						
328 i	142	01/95→04/99						
BMW - 3 Coupe (E46) 12/98→07/06								
 Bremskraftverstärker								
316 Ci	77 - 85	04/00→07/06				03.7860-0702.4	300123	ATE Ø 10" pneumatisch
318 Ci	85 - 110	12/99→05/06						
320 Cd	110	11/03→07/06						
323 Ci	120 - 125	04/99→09/00						
325 Ci	141	09/00→05/06						
328 Ci	142	12/98→05/00						
330 Cd	150	03/03→07/06						
330 Ci	170	06/00→05/06						
330 xi	170	06/00→07/06						
318 Ci	100	12/00→05/06		09/01→		03.7860-0702.4	300123	ATE Ø 10" pneumatisch
320 Ci	110	02/99→08/01		08/99→ 09/00		03.7860-0702.4	300123	ATE Ø 10" pneumatisch
320 Ci	120 - 125	01/00→05/06		09/00→		03.7860-0702.4	300123	ATE Ø 10" pneumatisch
 Hauptbremszylinder								
316 Ci	77	04/00→07/06		→ 08/01; - DSC		03.2022-2624.3	010588	Ø1 22,2 Ø2 20,6
				02/01→; + DSC		03.2023-2256.3	010870	ATE Ø1 23,8 Ø2 22,2
				09/01→; - DSC		03.2023-2344.3	010647	ATE Ø1 23,8 Ø2 22,2
316 Ci	85	06/02→07/06		+ DSC		03.2023-2256.3	010870	ATE Ø1 23,8 Ø2 22,2
318 Ci	105	09/01→02/04		- DSC		03.2023-2344.3	010647	ATE Ø1 23,8 Ø2 22,2
318 Ci	85 - 87	12/99→08/01		- DSC		03.2022-2624.3	010588	Ø1 22,2 Ø2 20,6
				02/01→; + DSC		03.2023-2256.3	010870	ATE Ø1 23,8 Ø2 22,2
318 Ci	100	12/00→05/06		09/01→; + DSC		03.2023-2256.3	010870	ATE Ø1 23,8 Ø2 22,2
				09/01→; - DSC		03.2023-2344.3	010647	ATE Ø1 23,8 Ø2 22,2
318 Ci	110	03/04→05/06				03.2023-2256.3	010870	ATE Ø1 23,8 Ø2 22,2
320 Cd	110	11/03→07/06						
330 Cd	150	03/03→07/06						
320 Ci	110	02/99→08/01		08/99→ 09/00; - DSC		03.2022-2624.3	010588	Ø1 22,2 Ø2 20,6
320 Ci	120 - 125	01/00→05/06		09/00→ 08/01; - DSC		03.2022-2624.3	010588	Ø1 22,2 Ø2 20,6
				09/00→; + DSC		03.2023-2256.3	010870	ATE Ø1 23,8 Ø2 22,2
				09/01→; - DSC		03.2023-2344.3	010647	ATE Ø1 23,8 Ø2 22,2
323 Ci	120 - 125	04/99→09/00		- DSC		03.2022-2624.3	010588	Ø1 22,2 Ø2 20,6
328 Ci	142	12/98→05/00						
325 Ci	141	09/00→05/06		→ 08/01; - DSC		03.2022-2624.3	010588	Ø1 22,2 Ø2 20,6
				+ DSC		03.2023-2256.3	010870	ATE Ø1 23,8 Ø2 22,2
				09/01→; - DSC		03.2023-2344.3	010647	ATE Ø1 23,8 Ø2 22,2
330 Ci	170	06/00→05/06		→ 08/00; + DSC		03.2023-2204.3	010644	ATE Ø1 23,8 Ø2 22,2
330 xi	170	06/00→07/06		09/00→; + DSC		03.2023-2256.3	010870	ATE Ø1 23,8 Ø2 22,2
→								









	kw					! #		
BMW - 3 Coupe (E46) 12/98→07/06								
 Hauptbremszylinder								
330 Ci	170	06/00→05/06		→ 08/01; - DSC		03.2023-2304.3	010646	ATE Ø1 23,8 Ø2 22,2
330 xi	170	06/00→07/06		09/01→; - DSC		03.2023-2344.3	010647	ATE Ø1 23,8 Ø2 22,2
BMW - 3 Coupe (E92) 01/05→12/13								
 Bremskraftverstärker								
316 i	90	09/07→06/13		09/09→; für Fahrzeuge ohne Start-Stopp-Funktion		03.7848-4003.4	300235	ATE Ø 8" pneumatisch
				→ 08/09		03.7848-4003.4	300235	ATE Ø 8" pneumatisch
318 i	105	03/10→12/13		→ 06/13; für Fahrzeuge ohne Start-Stopp-Funktion		03.7848-4003.4	300235	ATE Ø 8" pneumatisch
320 d	120	03/07→06/13		09/09→; für Fahrzeuge ohne Start-Stopp-Funktion		03.7845-0103.4	300268	ATE Ø 8" pneumatisch
				→ 08/09		03.7848-5003.4	300236	ATE Ø 8" pneumatisch
320 d	130 - 145	09/06→02/10		09/09→; für Fahrzeuge ohne Start-Stopp-Funktion		03.7845-0103.4	300268	ATE Ø 8" pneumatisch
				03/07→ 08/09		03.7848-5003.4	300236	ATE Ø 8" pneumatisch
320 d	135 - 147	03/10→06/13		für Fahrzeuge ohne Start-Stopp-Funktion		03.7845-0103.4	300268	ATE Ø 8" pneumatisch
320 d xDrive	120 - 147	09/08→06/13						
320 i	115 - 125	03/07→12/13		09/09→ 06/13; für Fahrzeuge ohne Start-Stopp-Funktion		03.7848-4003.4	300235	ATE Ø 8" pneumatisch
				→ 08/09		03.7848-4003.4	300235	ATE Ø 8" pneumatisch
320 i	120	01/07→06/13		09/09→ 06/13; für Fahrzeuge ohne Start-Stopp-Funktion		03.7848-4003.4	300235	ATE Ø 8" pneumatisch
				03/07→ 08/09		03.7848-4003.4	300235	ATE Ø 8" pneumatisch
323 i	140	04/06→02/12		09/07→		03.7845-0103.4	300268	ATE Ø 8" pneumatisch
				09/06→ 08/07		03.7848-5003.4	300236	ATE Ø 8" pneumatisch
325 d	145 - 155	02/07→02/10		03/07→		03.7848-5003.4	300236	ATE Ø 8" pneumatisch
325 d	150	09/09→06/13		→ 06/13		03.7848-5003.4	300236	ATE Ø 8" pneumatisch
325 i xDrive	160	09/08→12/13						
325 i	150 - 160	09/07→10/13				03.7848-5003.4	300236	ATE Ø 8" pneumatisch
325 i xDrive	150 - 155	09/08→06/13						
325 xi	155 - 160	09/06→02/10						
328 i	172	06/06→06/13						
328 i xDrive	172	09/08→06/13						
328 xi	172	09/06→08/08						
330 d xDrive	180	02/10→06/13						
330 i	190	03/10→06/13						
330 i xDrive	200	03/10→06/13						
325 i	160	06/06→02/10		09/06→		03.7848-5003.4	300236	ATE Ø 8" pneumatisch
330 d	170	03/06→08/08		09/06→		03.7845-0103.4	300268	ATE Ø 8" pneumatisch
330 xd	170	03/06→08/08						
335 d	210	03/06→03/13						
335 i	225 - 240	06/06→06/13						
330 d	180	01/09→06/13		→ 08/09		03.7845-0103.4	300268	ATE Ø 8" pneumatisch
				09/09→ 06/13		03.7848-5003.4	300236	ATE Ø 8" pneumatisch
330 i	200	09/06→06/13		→ 08/09		03.7845-0103.4	300268	ATE Ø 8" pneumatisch
330 xd	180	03/08→02/10		09/09→		03.7848-5003.4	300236	ATE Ø 8" pneumatisch
330 xi	190 - 200	09/06→08/07				03.7845-0103.4	300268	ATE Ø 8" pneumatisch
335 i	224	03/07→06/13						
335 i xDrive	224 - 240	11/08→12/13						
330 xi	200	03/07→02/10		→ 08/09		03.7845-0103.4	300268	ATE Ø 8" pneumatisch
						03.7848-5003.4	300236	ATE Ø 8" pneumatisch
335 xi	225 - 240	03/07→02/10		09/07→		03.7845-0103.4	300268	ATE Ø 8" pneumatisch
 Hauptbremszylinder								
316 i	90	09/07→06/13		für Linkslenker		03.2023-2407.3	010796	ATE Ø1 23,8 Ø2 22,2
318 i	105	03/10→12/13		für Linkslenker; → 06/13		03.2023-2407.3	010796	ATE Ø1 23,8 Ø2 22,2
320 d	120 - 147	03/07→06/13		für Linkslenker		03.2025-1904.3	010797	ATE Ø1 25,4 Ø2 22,2
325 i	150 - 160	09/07→10/13						
330 i	190 - 200	09/06→06/13						
→								











	kW			 	! #		
BMW - 3 Coupe (E92) 01/05→12/13							
 Hauptbremszylinder							
335 i	224	03/07→06/13		für Linkslenker		03.2025-1904.3 010797	ATE Ø1 25,4 Ø2 22,2
320 d	130 - 145	09/06→02/10		03/07→; für Linkslenker		03.2025-1904.3 010797	ATE Ø1 25,4 Ø2 22,2
325 d	145 - 155	02/07→02/10					
320 d xDrive	120 - 147	09/08→06/13				03.2025-1904.3 010797	ATE Ø1 25,4 Ø2 22,2
325 i xDrive	150 - 155	09/08→06/13					
325 xi	155 - 160	09/06→02/10					
328 i	172	06/06→06/13					
328 i xDrive	172	09/08→06/13					
328 xi	172	09/06→08/08					
330 d xDrive	180	02/10→06/13					
330 i xDrive	200	03/10→06/13					
330 xd	180	03/08→02/10					
330 xi	190 - 200	09/06→02/10					
335 i xDrive	224 - 240	11/08→12/13					
320 i	115 - 125	03/07→12/13		09/07→ 06/13; für Linkslenker		03.2023-2407.3 010796	ATE Ø1 23,8 Ø2 22,2
				→ 08/07; für Linkslenker		03.2025-1904.3 010797	ATE Ø1 25,4 Ø2 22,2
320 i	120	01/07→06/13		09/07→ 06/13; für Linkslenker		03.2023-2407.3 010796	ATE Ø1 23,8 Ø2 22,2
				03/07→ 08/07; für Linkslenker		03.2025-1904.3 010797	ATE Ø1 25,4 Ø2 22,2
325 d	150	09/09→06/13		→ 06/13; für Linkslenker		03.2025-1904.3 010797	ATE Ø1 25,4 Ø2 22,2
330 d	180	01/09→06/13					
325 i	160	06/06→02/10		09/06→; für Linkslenker		03.2025-1904.3 010797	ATE Ø1 25,4 Ø2 22,2
330 d	170	03/06→08/08					
335 d	210	03/06→03/13					
335 i	225 - 240	06/06→06/13					
325 i xDrive	160	09/08→12/13		→ 06/13		03.2025-1904.3 010797	ATE Ø1 25,4 Ø2 22,2
330 xd	170	03/06→08/08		09/06→		03.2025-1904.3 010797	ATE Ø1 25,4 Ø2 22,2
335 xi	225 - 240	03/07→02/10		09/07→		03.2025-1904.3 010797	ATE Ø1 25,4 Ø2 22,2
Hydraulikaggregat, Bremsanlage							
316 i	90	09/07→06/13		09/08→		24.9145-0003.2 399007	
318 i	105	03/10→12/13		→ 06/13		24.9145-0003.2 399007	
320 d	120 - 145	09/06→06/13		09/08→; für Fahrzeuge ohne Aktivlenkung		24.9145-0003.2 399007	
320 d	135 - 147	03/10→06/13		für Fahrzeuge ohne Aktivlenkung		24.9145-0003.2 399007	
320 i	115 - 125	01/07→12/13		09/08→ 06/13; für Fahrzeuge ohne Aktivlenkung		24.9145-0003.2 399007	
BMW - 3 Gran Turismo (F34) 07/12→							
 Hauptbremszylinder							
318 d	100 - 110	03/13→		für Linkslenker; - Performance Parts		24.4123-1736.3 011118	Ø 23,8 ohne Bremsflüssigkeitsbehälter
320 d	120 - 147	03/13→		für Linkslenker; + Performance Parts		24.4125-1713.3 011109	Ø 25,4 ohne Bremsflüssigkeitsbehälter
320 i	120 - 135	03/13→					
320 i xDrive	120 - 135	07/13→					
320 d xDrive	120 - 147	07/13→		für Linkslenker		24.4125-1713.3 011109	Ø 25,4 ohne Bremsflüssigkeitsbehälter
328 i	180	03/13→06/16					
328 i xDrive	180	07/13→06/16					
330 d	190	03/14→					
330 d xDrive	190	03/14→					
335 d xDrive	230	03/14→					
335 i	225 - 250	03/13→06/16					
335 i xDrive	225 - 250	03/13→06/16					
320 i xDrive	135	11/12→06/16		03/13→; für Linkslenker; - Performance Parts		24.4123-1736.3 011118	Ø 23,8 ohne Bremsflüssigkeitsbehälter
				03/13→; für Linkslenker; + Performance Parts		24.4125-1713.3 011109	Ø 25,4 ohne Bremsflüssigkeitsbehälter
325 d	155 - 165	07/13→02/18		für Linkslenker; - Performance Parts		24.4125-1713.3 011109	Ø 25,4 ohne Bremsflüssigkeitsbehälter
330 i →	185	07/16→					











	kw					! #		
BMW - 3 Gran Turismo (F34) 07/12→								
 Hauptbremszylinder								
330 i xDrive	183 - 185	07/16→			für Linkslenker; - Performance Parts		24.4125-1713.3 011109	Ø 25,4 ohne Bremsflüssigkeitsbehälter
340 i	240 - 265	07/16→						
340 i xDrive	240 - 265	07/16→						
330 d	210	03/14→			09/15→; für Linkslenker		24.4125-1713.3 011109	Ø 25,4 ohne Bremsflüssigkeitsbehälter
330 d xDrive	210	03/14→						
BMW - 3 Touring (E36) 08/94→12/99								
 Bremskraftverstärker								
316 i	75	03/97→05/99					03.7760-3102.4 300139	ATE Ø 10" pneumatisch
318 i	85	09/95→04/99						
318 tds	66	03/95→04/99						
325 tds	105	03/95→04/99						
320 i	110	01/95→04/99			09/96→; + ASC		03.7760-3102.4 300139	ATE Ø 10" pneumatisch
323 i	125	12/95→04/99			- ASC		03.7760-3102.4 300139	ATE Ø 10" pneumatisch
328 i	142	02/95→04/99			→ 08/96; + ASC		10.6360-1903.4 300093	ATE Ø 10" pneumatisch
Pedalwegsensoren, Bremspedal								
320 i	110	01/95→04/99			→ 08/96		03.0655-0002.2 370002	ATE
323 i	125	12/95→04/99						
328 i	142	02/95→04/99						
 Hauptbremszylinder								
320 i	110	01/95→04/99			→ 08/96; + ASC		10.6123-0239.3 010335	ATE Ø 23,8
323 i	125	12/95→04/99						
328 i	142	02/95→04/99						
BMW - 3 Touring (E46) 06/99→07/05								
 Bremskraftverstärker								
316 i	85	03/02→02/05					03.7860-0702.4 300123	ATE Ø 10" pneumatisch
318 d	85	10/02→02/05						
318 i	85 - 105	10/99→07/05						
320 d	100 - 110	03/00→02/05						
320 i	110 - 125	10/99→02/05						
325 i	141	09/00→02/05						
325 xi	141	09/00→02/05						
328 i	142	06/99→05/00						
330 d	135 - 150	10/99→02/05						
330 i	170	06/00→02/05						
330 xi	170	06/00→02/05						
330 xd	135	01/00→03/03			06/00→		03.7860-0702.4 300123	ATE Ø 10" pneumatisch
330 xd	150	08/02→05/05			03/03→ 02/05		03.7860-0702.4 300123	ATE Ø 10" pneumatisch
 Hauptbremszylinder								
316 i	85	03/02→02/05			+ DSC		03.2023-2256.3 010870	ATE Ø1 23,8 Ø2 22,2
318 d	85	10/02→02/05			- DSC		03.2023-2344.3 010647	ATE Ø1 23,8 Ø2 22,2
318 i	105	09/01→07/05						
320 d	110	09/01→02/05						
318 i	85 - 87	10/99→09/01			- DSC		03.2022-2624.3 010588	Ø1 22,2 Ø2 20,6
320 d	100	03/00→09/01						
320 i	110	10/99→09/00						
328 i	142	06/99→05/00						
320 i	120 - 125	09/00→02/05			→ 08/01; - DSC		03.2022-2624.3 010588	Ø1 22,2 Ø2 20,6
					+ DSC		03.2023-2256.3 010870	ATE Ø1 23,8 Ø2 22,2
					09/01→; - DSC		03.2023-2344.3 010647	ATE Ø1 23,8 Ø2 22,2
325 i	141	09/00→02/05			→ 08/01; - DSC		03.2022-2624.3 010588	Ø1 22,2 Ø2 20,6
					02/01→; + DSC		03.2023-2256.3 010870	ATE Ø1 23,8 Ø2 22,2
					09/01→; - DSC		03.2023-2344.3 010647	ATE Ø1 23,8 Ø2 22,2
330 d	135	10/99→02/05			→ 08/00; + DSC		03.2023-2204.3 010644	ATE Ø1 23,8 Ø2 22,2
					09/00→; + DSC		03.2023-2256.3 010870	ATE Ø1 23,8 Ø2 22,2
					→ 08/01; - DSC		03.2023-2304.3 010646	ATE Ø1 23,8 Ø2 22,2
					09/01→; - DSC		03.2023-2344.3 010647	ATE Ø1 23,8 Ø2 22,2
330 d	150	03/03→02/05			+ DSC		03.2023-2256.3 010870	ATE Ø1 23,8 Ø2 22,2
330 i	170	06/00→02/05			→ 08/01; + DSC		03.2023-2204.3 010644	ATE Ø1 23,8 Ø2 22,2
					09/01→; + DSC		03.2023-2256.3 010870	ATE Ø1 23,8 Ø2 22,2
→								























	kw			 	! #		
BMW - 3 Touring (E46) 06/99→07/05							
 Hauptbremszylinder							
330 i	170	06/00→02/05		→ 08/01; - DSC		03.2023-2304.3 010646	ATE Ø1 23,8 Ø2 22,2
				09/01→; - DSC		03.2023-2344.3 010647	ATE Ø1 23,8 Ø2 22,2
BMW - 3 Touring (E91) 12/04→12/12							
 Bremskraftverstärker							
316 d	85	09/09→06/12		→ 05/12; für Fahrzeuge ohne Start-Stopp-Funktion		03.7848-4003.4 300235	ATE Ø 8" pneumatisch
316 i	90	09/08→06/12		für Fahrzeuge ohne Start-Stopp-Funktion		03.7848-4003.4 300235	ATE Ø 8" pneumatisch
318 d	90	09/05→08/07				03.7848-5003.4 300236	ATE Ø 8" pneumatisch
320 d	110 - 120	12/04→06/12					
325 xi	155 - 160	08/05→08/08					
330 d	155	06/05→05/12					
330 i	190	08/05→08/07					
330 xi	190	09/05→08/07					
318 d	100	07/07→06/12		09/07→ 05/12		03.7845-0103.4 300268	ATE Ø 8" pneumatisch
318 d	105	09/07→06/12		→ 05/12		03.7845-0103.4 300268	ATE Ø 8" pneumatisch
320 d xDrive	120	07/09→06/12					
330 i	200	03/07→06/12					
335 d	210	09/06→06/12					
318 i	95	01/06→08/07		03/07→; Motorcode: N46N		03.7845-0103.4 300268	ATE Ø 8" pneumatisch
				Motorcode: N46		03.7848-5003.4 300236	ATE Ø 8" pneumatisch
318 i	100	09/07→03/12				03.7845-0103.4 300268	ATE Ø 8" pneumatisch
320 d	135 - 147	03/10→05/12					
320 d xDrive	130 - 147	02/08→06/12					
323 i	140	09/06→07/08					
330 d xDrive	180	01/09→06/12					
335 i	225 - 240	09/06→06/12					
335 i xDrive	225 - 240	09/08→06/12					
335 xi	225 - 240	03/07→08/08					
318 i	105	05/07→05/12		09/07→		03.7845-0103.4 300268	ATE Ø 8" pneumatisch
320 d	130 - 145	02/07→12/10					
320 i	120 - 125	02/07→12/12					
320 i	110 - 115	09/05→06/12		→ 08/07; Motorcode: N46N		03.7845-0103.4 300268	ATE Ø 8" pneumatisch
				→ 08/07; Motorcode: N46		03.7848-5003.4 300236	ATE Ø 8" pneumatisch
323 i	130	04/06→06/07		09/06→		03.7845-0103.4 300268	ATE Ø 8" pneumatisch
325 d	145 - 150	09/06→06/12		→ 05/12		03.7848-5003.4 300236	ATE Ø 8" pneumatisch
325 i	160	09/07→06/12					
325 i xDrive	155 - 160	09/08→06/12					
330 i xDrive	200	09/07→06/12					
330 xd	170	09/05→06/12					
330 xi	200	09/07→06/12					
325 i	155 - 160	12/04→12/10		06/05→		03.7848-5003.4 300236	ATE Ø 8" pneumatisch
330 d	170	12/04→08/08					
325 i	155	09/07→06/12		01/12→ 05/12		03.7848-5003.4 300236	ATE Ø 8" pneumatisch
330 d	180	02/08→05/12		09/08→		03.7845-0103.4 300268	ATE Ø 8" pneumatisch
 Hauptbremszylinder							
316 d	85	09/09→06/12		für Linkslenker; → 05/12		03.2023-2407.3 010796	ATE Ø1 23,8 Ø2 22,2
316 i	90	09/08→06/12				03.2023-2407.3 010796	ATE Ø1 23,8 Ø2 22,2
318 d	90	09/05→08/07		für Linkslenker		03.2025-1904.3 010797	ATE Ø1 25,4 Ø2 22,2
318 i	95	01/06→08/07					
320 d	110 - 147	12/04→06/12					
330 d xDrive	180	01/09→06/12					
330 i	190	08/05→08/07					
335 i	225 - 240	09/06→06/12					
318 d	100	07/07→06/12		09/07→ 05/12		03.2025-1904.3 010797	ATE Ø1 25,4 Ø2 22,2
318 d	105	09/07→06/12		→ 05/12		03.2025-1904.3 010797	ATE Ø1 25,4 Ø2 22,2
320 d xDrive	120	07/09→06/12					
325 d	145 - 150	09/06→06/12					
→							











	kw			 	! #		
BMW - 3 Touring (E91) 12/04→12/12							
 Hauptbremszylinder							
325 i xDrive	155 - 160	09/08→06/12		→ 05/12		03.2025-1904.3 010797	ATE Ø1 25,4 Ø2 22,2
330 i xDrive	200	09/07→06/12					
330 xd	170	09/05→06/12					
330 xi	200	09/07→06/12					
318 i	100	09/07→03/12				03.2025-1904.3 010797	ATE Ø1 25,4 Ø2 22,2
320 d xDrive	130 - 147	02/08→06/12					
325 xi	155 - 160	08/05→08/08					
330 d	155	06/05→05/12					
330 xi	190	09/05→08/07					
335 i xDrive	225 - 240	09/08→06/12					
335 xi	225 - 240	03/07→08/08					
318 i	105	05/07→05/12		09/07→		03.2025-1904.3 010797	ATE Ø1 25,4 Ø2 22,2
320 d	130 - 145	02/07→12/10		09/07→; für Linkslenker		03.2025-1904.3 010797	ATE Ø1 25,4 Ø2 22,2
320 i	120 - 125	02/07→12/12					
320 i	110 - 115	09/05→06/12		→ 08/07; für Linkslenker		03.2025-1904.3 010797	ATE Ø1 25,4 Ø2 22,2
325 i	155 - 160	12/04→12/10		06/05→; für Linkslenker		03.2025-1904.3 010797	ATE Ø1 25,4 Ø2 22,2
325 i	155	09/07→06/12		01/12→; für Linkslenker; → 05/12		03.2025-1904.3 010797	ATE Ø1 25,4 Ø2 22,2
325 i	160	09/07→06/12		→ 05/12; für Linkslenker		03.2025-1904.3 010797	ATE Ø1 25,4 Ø2 22,2
330 i	200	03/07→06/12					
335 d	210	09/06→06/12					
330 d	170	12/04→08/08		06/05→		03.2025-1904.3 010797	ATE Ø1 25,4 Ø2 22,2
330 d	180	02/08→05/12		09/08→; für Linkslenker		03.2025-1904.3 010797	ATE Ø1 25,4 Ø2 22,2
Hydraulikaggregat, Bremsanlage							
316 d	85	09/09→06/12		→ 05/12		24.9145-0003.2 399007	
316 i	90	09/08→06/12				24.9145-0003.2 399007	
318 d	100 - 105	07/07→06/12		09/08→ 05/12		24.9145-0003.2 399007	
318 i	100 - 105	05/07→05/12		09/08→		24.9145-0003.2 399007	
320 d	130 - 145	02/07→12/10		09/08→; für Fahrzeuge ohne Aktivlenkung		24.9145-0003.2 399007	
320 i	120 - 125	02/07→12/12					
320 d	135 - 147	03/10→05/12		für Fahrzeuge ohne Aktivlenkung		24.9145-0003.2 399007	
BMW - 3 Touring (F31) 07/12→06/19							
 Hauptbremszylinder							
316 d	85	11/12→06/19		für Linkslenker; für Fahrzeuge ohne Start-Stopp-Funktion		24.4123-1736.3 011118	Ø 23,8 ohne Bremsflüssigkeitsbehälter
318 d	100 - 105	11/12→06/19					
320 d	120	07/12→06/19		für Linkslenker; für Fahrzeuge mit Start-Stopp-Funktion		24.4125-1713.3 011109	Ø 25,4 ohne Bremsflüssigkeitsbehälter
320 i	120 - 135	11/12→06/19					
320 i xDrive	120 - 135	03/13→06/19					
316 i	100	03/13→06/15		für Linkslenker		24.4123-1736.3 011118	Ø 23,8 ohne Bremsflüssigkeitsbehälter
318 d	110	07/15→06/19		für Linkslenker; - Performance Parts		24.4123-1736.3 011118	Ø 23,8 ohne Bremsflüssigkeitsbehälter
318 d xDrive	105 - 110	07/13→02/18					
318 i	100	07/15→06/19		für Linkslenker; + Performance Parts		24.4125-1713.3 011109	Ø 25,4 ohne Bremsflüssigkeitsbehälter
320 d	135 - 147	07/12→06/19		für Linkslenker		24.4125-1713.3 011109	Ø 25,4 ohne Bremsflüssigkeitsbehälter
320 d xDrive	120 - 147	03/13→06/19					
325 d	165	03/16→02/18					
328 i	180	07/12→06/15					
328 i xDrive	180	03/13→06/16					
330 d	190	07/12→06/19					
330 d xDrive	190	03/13→06/19					
335 d xDrive	230	11/13→06/19					
335 i	225 - 250	03/13→06/15					
335 i xDrive	225 - 250	03/13→06/15					
→							













	kw			 	! #		
BMW - 3 Touring (F31) 07/12→06/19							
 Hauptbremszylinder							
325 d	155 - 160	03/13→02/16		04/13→; für Linkslenker		24.4125-1713.3 011109	Ø 25,4 ohne Bremsflüssigkeitsbehälter
330 d 330 d xDrive	210 210	07/12→06/19 03/13→06/19		09/15→; für Linkslenker; - Performance Parts		24.4125-1713.3 011109	Ø 25,4 ohne Bremsflüssigkeitsbehälter
330 i 330 i xDrive 340 i	185 185 240 - 265	07/15→06/19 07/15→06/19 07/15→06/19		für Linkslenker; - Performance Parts		24.4125-1713.3 011109	Ø 25,4 ohne Bremsflüssigkeitsbehälter
BMW - 3 Touring Van (F31) 07/12→06/19							
 Hauptbremszylinder							
330 d 330 d xDrive	190 190	07/12→06/19 03/13→06/19		für Linkslenker		24.4125-1713.3 011109	Ø 25,4 ohne Bremsflüssigkeitsbehälter
330 i 340 i	185 240	07/15→06/19 07/15→06/19		- Performance Parts; für Linkslenker		24.4125-1713.3 011109	Ø 25,4 ohne Bremsflüssigkeitsbehälter
BMW - 4 Cabriolet (F33, F83) 10/13→							
 Hauptbremszylinder							
420 d	120 - 147	10/13→		für Linkslenker		24.4125-1713.3 011109	Ø 25,4 ohne Bremsflüssigkeitsbehälter
425 d	155 - 160	07/14→02/16					
428 i	180	11/13→02/17					
428 i xDrive	180	03/14→02/16					
430 d	190 - 210	07/14→					
435 d xDrive	230	07/14→					
435 i	225 - 250	11/13→02/16					
435 i xDrive	225 - 250	07/14→02/16					
420 d	140 - 151	07/15→		für Linkslenker; - Performance Parts		24.4125-1713.3 011109	Ø 25,4 ohne Bremsflüssigkeitsbehälter
425 d	165	03/16→02/18					
430 i	185	03/16→					
430 i xDrive	185	03/16→					
440 i	240 - 265	03/16→					
440 i xDrive	240 - 265	03/16→					
420 i	120 - 135	07/14→		für Linkslenker; - Performance Parts		24.4123-1736.3 011118	Ø 23,8 ohne Bremsflüssigkeitsbehälter
425 i	135	06/17→		für Linkslenker; + Performance Parts		24.4125-1713.3 011109	Ø 25,4 ohne Bremsflüssigkeitsbehälter
BMW - 4 Coupe (F32, F82) 07/13→							
 Hauptbremszylinder							
418 d	100 - 110	03/15→10/17		für Linkslenker; - Performance Parts		24.4123-1736.3 011118	Ø 23,8 ohne Bremsflüssigkeitsbehälter
418 i	100	03/16→					
420 d	120 - 147	07/13→		für Linkslenker; + Performance Parts		24.4125-1713.3 011109	Ø 25,4 ohne Bremsflüssigkeitsbehälter
420 d xDrive	120 - 147	11/13→					
420 i	120 - 135	11/13→02/17					
420 i xDrive	120 - 135	11/13→02/16					
428 i	180	07/13→02/17					
428 i xDrive	180	07/13→02/16					
435 i	225 - 250	07/13→02/16					
435 i xDrive	225 - 250	07/13→02/16					
420 i	120 - 135	03/16→		für Linkslenker; Motorcode: B48; - Performance Parts		24.4123-1736.3 011118	Ø 23,8 ohne Bremsflüssigkeitsbehälter
420 i xDrive	120 - 135	03/16→		für Linkslenker; Motorcode: B48; + Performance Parts		24.4125-1713.3 011109	Ø 25,4 ohne Bremsflüssigkeitsbehälter
425 i	135	06/17→					
425 d	155 - 160	03/14→02/16		für Linkslenker		24.4125-1713.3 011109	Ø 25,4 ohne Bremsflüssigkeitsbehälter
430 d	190 - 210	11/13→					
430 d xDrive	190 - 210	03/14→					
435 d xDrive	230	11/13→12/20					
→							











	kW			 	! #		
BMW - 4 Coupe (F32, F82) 07/13→							
 Hauptbremszylinder							
425 d 430 i 430 i xDrive 440 i 440 i xDrive	165 183 - 185 183 - 185 240 - 265 240 - 265	03/16→10/17 03/16→ 03/16→ 03/16→ 03/16→		- Performance Parts; für Linkslenker		24.4125-1713.3 011109	Ø 25,4 ohne Bremsflüssigkeitsbehälter
BMW - 4 Gran Coupe (F36) 03/14→							
 Hauptbremszylinder							
418 d 418 i 420 d	100 - 105 100 120 - 147	03/14→12/20 07/15→ 03/14→12/20		- Performance Parts + Performance Parts		24.4123-1736.3 011118 24.4125-1713.3 011109	Ø 23,8 ohne Bremsflüssigkeitsbehälter Ø 25,4 ohne Bremsflüssigkeitsbehälter
418 d 420 i 420 i xDrive 425 i	110 120 - 135 120 - 135 135	07/15→12/20 03/16→ 03/16→ 06/17→		- Performance Parts; für Linkslenker für Linkslenker; + Performance Parts		24.4123-1736.3 011118 24.4125-1713.3 011109	Ø 23,8 ohne Bremsflüssigkeitsbehälter Ø 25,4 ohne Bremsflüssigkeitsbehälter
420 d 420 d xDrive 420 i 420 i xDrive 428 i 430 d 430 d xDrive 435 d xDrive 435 i	140 120 - 147 120 - 135 180 190 - 210 190 - 210 230 225 - 250	03/15→ 03/14→ 03/14→02/17 07/14→02/16 03/14→06/16 07/14→ 07/14→ 07/14→ 03/14→02/16		für Linkslenker		24.4125-1713.3 011109	Ø 25,4 ohne Bremsflüssigkeitsbehälter
425 d 430 i 430 i xDrive 440 i 440 i xDrive	155 - 165 185 183 - 185 240 - 265 240 - 265	03/16→02/18 03/16→ 03/16→ 03/16→ 03/16→		für Linkslenker; - Performance Parts		24.4125-1713.3 011109	Ø 25,4 ohne Bremsflüssigkeitsbehälter
428 i xDrive 435 i xDrive	180 225 - 250	03/14→02/16 07/14→02/16				24.4125-1713.3 011109	Ø 25,4 ohne Bremsflüssigkeitsbehälter
BMW - 5 (E39) 09/95→07/03							
 Hauptbremszylinder							
520 d 520 i 530 d 520 i	100 100 - 125 142 110	02/00→06/03 01/96→06/03 09/98→06/03 01/96→06/03	04/00→ + DSC - DSC			24.2025-1705.3 010624 24.2025-1704.3 010619 24.2025-1705.3 010624	TRW Ø1 25,4 Ø2 20,6 Ø 25,4 TRW Ø1 25,4 Ø2 20,6
520 i	110	01/96→06/03	03/96→; + DSC 09/97→; - DSC 03/96→ 08/97; - DSC			24.2025-1704.3 010619 24.2025-1705.3 010624 24.2120-1721.3 010553	Ø 25,4 TRW Ø1 25,4 Ø2 20,6 Ø 20,6
523 i 528 i	125 142	09/95→08/00 09/95→08/00	12/95→; + DSC 09/97→; - DSC 12/95→ 08/97; - DSC			24.2025-1704.3 010619 24.2025-1705.3 010624 24.2120-1721.3 010553	Ø 25,4 TRW Ø1 25,4 Ø2 20,6 Ø 20,6
525 d	120	02/00→06/03	04/00→; + DSC 04/00→; - DSC			24.2025-1704.3 010619 24.2025-1705.3 010624	Ø 25,4 TRW Ø1 25,4 Ø2 20,6
525 i 530 i	141 170	09/00→06/03 09/00→06/03	10/00→; + DSC 10/00→; - DSC			24.2025-1704.3 010619 24.2025-1705.3 010624	Ø 25,4 TRW Ø1 25,4 Ø2 20,6
525 td	85	01/97→06/03	09/97→ 09/00 → 08/97			24.2025-1705.3 010624 24.2120-1721.3 010553	TRW Ø1 25,4 Ø2 20,6 Ø 20,6
525 tds	105	01/96→06/03	09/97→ 09/00 02/96→ 08/97			24.2025-1705.3 010624 24.2120-1721.3 010553	TRW Ø1 25,4 Ø2 20,6 Ø 20,6
530 d	135	08/98→09/00	09/98→; + DSC 09/98→; - DSC			24.2025-1704.3 010619 24.2025-1705.3 010624	Ø 25,4 TRW Ø1 25,4 Ø2 20,6
→							













	kw			 	! #		
BMW - 5 (E39) 09/95→07/03							
 Hauptbremszylinder							
535 i	173	06/96→08/98		09/97→ → 08/97		24.2025-1704.3 010619	Ø 25,4
						24.2120-1721.3 010553	Ø 20,6
535 i M5	180 294	09/98→06/03 10/98→06/03				24.2025-1704.3 010619	Ø 25,4
540 i	210	03/96→06/03		09/97→ 05/96→ 08/97		24.2025-1704.3 010619	Ø 25,4
						24.2120-1721.3 010553	Ø 20,6
BMW - 5 (E60) 12/01→03/10							
 Hauptbremszylinder							
520 d	110 - 130	09/05→12/09				24.2026-1702.3 010850	TRW Ø 27 Ø2 22,2
523 i	140	03/07→12/09					
525 d xDrive	145	09/07→12/09					
525 xi	160	04/05→12/09					
528 i	172	03/07→12/09					
530 d	170	09/05→03/07					
530 d xDrive	173	09/07→12/09					
530 i	200	03/07→12/09					
530 i xDrive	200	09/08→12/09					
530 xd	173	03/07→08/07					
530 xi	200	03/07→10/09					
535 i	225	04/06→12/09					
540 i	220 - 225	09/05→12/09					
545 i	245	07/03→08/05					
550 i	270	09/05→12/09					
M5	373	09/04→12/09					
520 i	125	07/03→03/10		→ 03/05		24.2025-1710.3 010833	TRW Ø 25,4
523 i	130	10/04→02/07		07/05→		24.2026-1702.3 010850	TRW Ø 27 Ø2 22,2
525 i	137 - 160	07/03→12/09					
530 i	190	03/05→03/07					
530 xd	170	02/05→02/07					
530 xi	190	09/04→02/07					
525 d	120 - 130	06/04→03/10		→ 03/07		24.2026-1702.3 010850	TRW Ø 27 Ø2 22,2
535 d	200	09/04→03/10					
525 d	145	01/07→03/10		03/07→ 02/10		24.2026-1702.3 010850	TRW Ø 27 Ø2 22,2
535 d	210	01/07→03/10					
525 i	141	09/03→02/05				24.2025-1710.3 010833	TRW Ø 25,4
525 i	155 - 160	07/05→03/10		→ 02/10		24.2026-1702.3 010850	TRW Ø 27 Ø2 22,2
525 i xDrive	160	09/08→03/10					
525 xd	145	11/06→08/07		03/07→		24.2026-1702.3 010850	TRW Ø 27 Ø2 22,2
530 d	173	02/07→12/09					
530 xi	200	02/07→08/08					
530 d	155 - 160	09/02→12/09		07/03→ 08/05		24.2026-1702.3 010850	TRW Ø 27 Ø2 22,2
530 i	170	12/01→02/05		07/03→		24.2025-1710.3 010833	TRW Ø 25,4
530 i	187	03/05→03/10		07/05→ 03/07		24.2026-1702.3 010850	TRW Ø 27 Ø2 22,2
BMW - 5 (F10) 01/09→10/16							
 Hauptbremszylinder							
518 d	100 - 110	07/13→10/16				24.2026-1706.3 011040	TRW Ø 27 Ø2 22,2
520 d	100 - 151	06/10→10/16					
520 d xDrive	100 - 151	01/13→10/16					
520 i	120 - 135	09/11→10/16					
525 d	150 - 160	03/10→10/16					
525 d xDrive	155 - 160	09/11→10/16					
528 i	180 - 190	03/10→10/16					
528 i xDrive	180	09/11→10/16					
530 d	190	09/11→10/16					
530 d xDrive	190	03/11→10/16					
535 d	220 - 230	09/10→10/16					
535 d xDrive	230	09/11→10/16					
535 i	240	07/13→10/16					
535 i xDrive	225 - 240	03/11→10/16					
→							













	kW			 	! #		
BMW - 5 (F10) 01/09→10/16							
 Hauptbremszylinder							
550 i	300 - 330	03/10→10/16				24.2026-1706.3 011040	TRW Ø 27 Ø2 22,2
550 i xDrive	330	07/13→10/16					
M 550 d xDrive	280	03/12→10/16					
518 d	120	10/13→10/16		07/14→		24.2026-1706.3 011040	TRW Ø 27 Ø2 22,2
520 d	155	10/13→10/16					
520 d xDrive	155	10/13→10/16					
520 d xDrive	147	01/13→06/14		02/13→		24.2026-1706.3 011040	TRW Ø 27 Ø2 22,2
523 i	150 - 155	06/09→08/11		03/10→		24.2026-1706.3 011040	TRW Ø 27 Ø2 22,2
530 d	180	01/10→08/11					
535 i	225	01/10→10/16					
530 d	210	09/10→10/16		10/15→		24.2026-1706.3 011040	TRW Ø 27 Ø2 22,2
530 d xDrive	210	03/11→10/16					
530 i	190 - 200	03/10→06/13		09/11→		24.2026-1706.3 011040	TRW Ø 27 Ø2 22,2
550 i xDrive	300	08/10→06/13		09/10→		24.2026-1706.3 011040	TRW Ø 27 Ø2 22,2
BMW - 5 Gran Turismo (F07) 01/09→02/17							
 Hauptbremszylinder							
520 d	100 - 120	07/12→02/17				24.2026-1702.3 010850	TRW Ø 27 Ø2 22,2
530 d	155 - 190	09/10→02/17					
530 d xDrive	190	07/12→02/17					
535 d	220 - 230	03/10→02/17					
535 d xDrive	230	07/12→02/17					
535 i xDrive	225	09/10→02/17					
550 i	330	07/12→02/17					
550 i xDrive	330	07/12→02/17					
520 d	135	04/11→02/17		10/11→		24.2026-1702.3 010850	TRW Ø 27 Ø2 22,2
528 i	180	07/13→02/17		08/13→		24.2026-1702.3 010850	TRW Ø 27 Ø2 22,2
530 d	180	08/09→06/12		10/09→		24.2026-1702.3 010850	TRW Ø 27 Ø2 22,2
535 i	225	01/09→02/17					
550 i	300	08/09→06/12					
530 d xDrive	180	06/10→06/12		09/10→		24.2026-1702.3 010850	TRW Ø 27 Ø2 22,2
535 d xDrive	220	03/10→06/12					
550 i xDrive	300	06/10→06/12					
BMW - 5 Touring (E39) 09/96→06/04							
 Hauptbremszylinder							
520 d	100	02/00→09/03		04/00→ 07/03		24.2025-1705.3 010624	TRW Ø1 25,4 Ø2 20,6
520 i	100	03/97→08/01		+ DSC		24.2025-1704.3 010619	Ø 25,4
523 i	120	09/98→08/00		- DSC		24.2025-1705.3 010624	TRW Ø1 25,4 Ø2 20,6
520 i	110	03/97→08/01		05/97→; + DSC		24.2025-1704.3 010619	Ø 25,4
523 i	125	03/97→08/00		09/97→; - DSC		24.2025-1705.3 010624	TRW Ø1 25,4 Ø2 20,6
528 i	142	11/96→08/00		05/97→ 08/97; - DSC		24.2120-1721.3 010553	Ø 20,6
520 i	120 - 125	09/00→12/03		→ 07/03; + DSC		24.2025-1704.3 010619	Ø 25,4
530 d	142	09/00→05/04		→ 07/03; - DSC		24.2025-1705.3 010624	TRW Ø1 25,4 Ø2 20,6
525 d	120	02/00→05/04		04/00→ 07/03; + DSC		24.2025-1704.3 010619	Ø 25,4
				04/00→ 07/03; - DSC		24.2025-1705.3 010624	TRW Ø1 25,4 Ø2 20,6
525 i	141	09/00→05/04		10/00→ 07/03; + DSC		24.2025-1704.3 010619	Ø 25,4
530 i	170	09/00→12/03		10/00→ 07/03; - DSC		24.2025-1705.3 010624	TRW Ø1 25,4 Ø2 20,6
525 tds	105	03/97→05/04		06/98→ 09/00		24.2025-1705.3 010624	TRW Ø1 25,4 Ø2 20,6
530 d	135	08/98→09/00		09/98→; + DSC		24.2025-1704.3 010619	Ø 25,4
				09/98→; - DSC		24.2025-1705.3 010624	TRW Ø1 25,4 Ø2 20,6
540 i	210	04/97→12/03		09/97→ 07/03		24.2025-1704.3 010619	Ø 25,4
				05/97→ 08/97		24.2120-1721.3 010553	Ø 20,6
BMW - 5 Touring (E61) 03/04→12/10							
 Hauptbremszylinder							
520 d	110 - 130	09/05→05/10				24.2026-1702.3 010850	TRW Ø 27 Ø2 22,2
523 i	140	03/07→01/10					
525 d	145	03/07→05/10					
525 d xDrive	145	09/08→05/10					
525 xd	145	09/07→09/08					
530 d xDrive	173	09/07→05/10					
530 i xDrive	200	09/08→05/10					
530 xd	173	03/07→08/07					
→							



















	kW			 	! #		
BMW - 5 Touring (E61) 03/04→12/10							
 Hauptbremszylinder							
530 xi	200	09/06→05/10				24.2026-1702.3 010850	TRW Ø 27 Ø2 22,2
520 d	120	04/05→05/10		07/05→		24.2026-1702.3 010850	TRW Ø 27 Ø2 22,2
530 d	170	02/05→02/07					
530 xd	170	02/05→02/07					
530 xi	190	04/05→02/07					
520 i	120 - 125	07/07→12/10		→ 05/10		24.2026-1702.3 010850	TRW Ø 27 Ø2 22,2
525 i xDrive	160	09/08→12/10					
525 xi	160	07/05→12/10					
550 i	270	07/05→12/10					
M5	373	02/07→12/10					
523 i	130	10/04→02/07		07/05→		24.2025-1710.3 010833	TRW Ø 25,4
530 i	190	09/04→02/07					
523 i	140	01/07→12/10		03/07→ 05/10		24.2026-1702.3 010850	TRW Ø 27 Ø2 22,2
530 i	200	01/07→12/10					
535 d	210	01/07→12/10					
525 d	120	03/04→03/07		12/04→		24.2026-1702.3 010850	TRW Ø 27 Ø2 22,2
525 d	130	03/04→03/07		05/04→		24.2026-1702.3 010850	TRW Ø 27 Ø2 22,2
530 d	155 - 160	03/04→05/10					
525 i	141	06/04→12/10		→ 03/05		24.2025-1710.3 010833	TRW Ø 25,4
525 i	155	03/05→05/10		→ 03/07		24.2025-1710.3 010833	TRW Ø 25,4
				03/07→		24.2026-1702.3 010850	TRW Ø 27 Ø2 22,2
525 i	160	03/05→05/10		07/05→ 03/07		24.2025-1710.3 010833	TRW Ø 25,4
				03/07→		24.2026-1702.3 010850	TRW Ø 27 Ø2 22,2
525 i	155 - 160	01/07→12/10		→ 03/07		24.2025-1710.3 010833	TRW Ø 25,4
				03/07→ 05/10		24.2026-1702.3 010850	TRW Ø 27 Ø2 22,2
530 d	173	02/07→05/10		03/07→		24.2026-1702.3 010850	TRW Ø 27 Ø2 22,2
530 i	200	09/06→03/10					
535 d	200	09/04→12/10		→ 03/07		24.2026-1702.3 010850	TRW Ø 27 Ø2 22,2
545 i	245	06/04→12/10		→ 08/05		24.2026-1702.3 010850	TRW Ø 27 Ø2 22,2
BMW - 5 Touring (F11) 11/09→02/17							
 Hauptbremszylinder							
518 d	100 - 120	07/13→02/17				24.2026-1706.3 011040	TRW Ø 27 Ø2 22,2
520 d	140 - 155	07/14→02/17					
520 d xDrive	100 - 155	07/13→02/17					
520 i	120	09/11→02/17					
525 d	150 - 160	09/10→02/17					
525 d xDrive	155 - 160	07/13→02/17					
528 i	180	09/11→02/17					
528 i xDrive	180	09/11→02/17					
530 d	190	09/11→02/17					
530 d xDrive	190	03/11→02/17					
535 d	220 - 230	09/10→02/17					
535 d xDrive	230	09/11→02/17					
535 i xDrive	225	09/11→02/17					
550 i	330	07/13→02/17					
M 550 d xDrive	280	03/12→02/17					
520 d	100 - 147	06/10→02/17		09/10→		24.2026-1706.3 011040	TRW Ø 27 Ø2 22,2
523 i	150	11/09→08/11					
528 i	190	11/09→08/11					
530 d	180	06/10→08/11					
535 i	225	06/10→02/17					
520 i	135	10/10→02/17		09/11→		24.2026-1706.3 011040	TRW Ø 27 Ø2 22,2
530 i	190 - 200	03/10→06/13					
550 i	300	09/10→06/13					
530 d	210	09/11→02/17		10/15→		24.2026-1706.3 011040	TRW Ø 27 Ø2 22,2
530 d xDrive	210	03/11→02/17					
535 i	240	07/13→02/17					
535 i xDrive	240	07/13→02/17					
BMW - 6 (E63) 09/03→12/10							
 Hauptbremszylinder							
630 i	190 - 200	09/04→08/10				24.2026-1702.3 010850	TRW Ø 27 Ø2 22,2
645 Ci	245	09/03→08/05					
650 i	270	09/05→08/10					
→							















	kw					! #		
BMW - 6 (E63) 09/03→12/10								
 Hauptbremszylinder								
M	373	09/05→07/10					24.2026-1702.3 010850	TRW Ø 27 Ø2 22,2
635 d	210	07/07→07/10		09/07→			24.2026-1702.3 010850	TRW Ø 27 Ø2 22,2
BMW - 6 Cabriolet (E64) 03/04→12/10								
 Hauptbremszylinder								
630 i	190 - 200	09/04→08/10					24.2026-1702.3 010850	TRW Ø 27 Ø2 22,2
645 Ci	245	04/04→08/05						
650 i	270	09/05→08/10						
M6	373	09/06→08/10						
635 d	210	07/07→07/10		09/07→			24.2026-1702.3 010850	TRW Ø 27 Ø2 22,2
BMW - 6 Cabriolet (F12) 12/10→06/18								
 Hauptbremszylinder								
640 d	230	09/11→06/18					24.2026-1706.3 011040	TRW Ø 27 Ø2 22,2
640 d xDrive	230	03/12→06/18						
640 i	235	09/11→06/18						
640 i xDrive	235	03/13→06/18						
650 i	298 - 330	12/10→06/18						
650 i xDrive	300	09/11→06/12						
650 i xDrive	330	07/12→06/18		09/12→			24.2026-1706.3 011040	TRW Ø 27 Ø2 22,2
BMW - 6 Coupe (F13) 07/11→10/17								
 Hauptbremszylinder								
640 d	230	09/11→10/17					24.2026-1706.3 011040	TRW Ø 27 Ø2 22,2
640 d xDrive	230	03/12→10/17						
640 i	235	07/11→10/17						
640 i xDrive	235	03/13→10/17						
650 i	298 - 300	07/11→12/12						
650 i xDrive	300	09/11→02/15						
650 i	330	07/12→10/17		09/12→			24.2026-1706.3 011040	TRW Ø 27 Ø2 22,2
650 i xDrive	330	07/12→10/17						
BMW - 6 Gran Coupe (F06) 03/12→10/18								
 Hauptbremszylinder								
640 d	230	03/12→10/18					24.2026-1706.3 011040	TRW Ø 27 Ø2 22,2
640 d xDrive	230	03/13→10/18						
640 i	235	03/12→10/18						
640 i xDrive	235	03/13→10/18						
650 i	330	07/12→10/18						
650 i xDrive	330	07/12→10/18						
BMW - 7 (E38) 03/94→11/01								
 Hauptbremszylinder								
725 tds	105	04/96→11/01		09/98→			24.2025-1704.3 010619	Ø 25,4
				09/97→ 08/98			24.2025-1705.3 010624	TRW Ø1 25,4 Ø2 20,6
				05/96→ 08/97			24.2120-1721.3 010553	Ø 20,6
iL	142	08/95→11/01		09/98→			24.2025-1704.3 010619	Ø 25,4
728 i	142	08/95→11/01		09/97→ 08/98			24.2025-1705.3 010624	TRW Ø1 25,4 Ø2 20,6
				→ 08/97			24.2120-1721.3 010553	Ø 20,6
				01/96→ 08/97			24.2120-1721.3 010553	Ø 20,6
730 d	135	08/98→04/00		09/98→; + DSC			24.2025-1704.3 010619	Ø 25,4
				09/98→; - DSC			24.2025-1705.3 010624	TRW Ø1 25,4 Ø2 20,6
730 d	142	04/00→11/01		+ DSC			24.2025-1704.3 010619	Ø 25,4
740 d	180	05/99→11/01		- DSC			24.2025-1705.3 010624	TRW Ø1 25,4 Ø2 20,6
730 i	155	10/94→11/01		09/98→			24.2025-1704.3 010619	Ø 25,4
iL	155 - 240	10/94→11/01		09/97→ 08/98			24.2025-1705.3 010624	TRW Ø1 25,4 Ø2 20,6
740 i	210	02/96→07/01		→ 08/97			24.2120-1721.3 010553	Ø 20,6
750 i	240	11/94→07/01						
iL	173	03/96→08/98		09/97→			24.2025-1705.3 010624	TRW Ø1 25,4 Ø2 20,6
735 i	173	03/96→08/98		→ 08/97			24.2120-1721.3 010553	Ø 20,6
iL	175	09/98→07/01					24.2025-1704.3 010619	Ø 25,4
735 i	175	09/98→07/01						















	kW					! #		
BMW - 7 (E65, E66, E67) 07/01→12/09								
 Hauptbremszylinder								
730 d	150 - 155	09/02→08/08					24.2026-1701.3 010746	Ø 27 Ø2 20,6
730 Ld	170	07/05→08/08						
735 i	200 - 225	11/01→12/09						
Li	200 - 270	07/01→08/08						
740 d	190	10/02→02/05						
740 i	225	03/05→08/08						
745 d	220 - 242	03/05→07/08						
745 i	245	07/01→03/05						
750 i	270	03/05→08/08						
730 d	160	06/02→02/05		09/02→			24.2026-1701.3 010746	Ø 27 Ø2 20,6
730 i	170	03/03→07/08					24.2026-1701.3 010746	Ø 27 Ø2 20,6
Li	170	03/03→07/08					24.2026-1705.3 010992	TRW Ø 27 Ø2 20,6
730 i	184 - 190	03/05→08/08		07/05→			24.2026-1701.3 010746	Ø 27 Ø2 20,6
Li	184 - 190	03/05→08/08						
760 i	320 - 327	01/03→08/08		03/03→			24.2026-1701.3 010746	Ø 27 Ø2 20,6
Li	327	01/03→08/08						
BMW - 7 (F01, F02, F03, F04) 02/08→12/15								
 Hauptbremszylinder								
730 d	155	02/08→05/15		09/08→			24.2026-1702.3 010850	TRW Ø 27 Ø2 22,2
730 d	180 - 190	09/08→05/15					24.2026-1702.3 010850	TRW Ø 27 Ø2 22,2
730 i	190	09/09→06/15						
Li	190 - 400	09/08→12/15						
740 d	225 - 230	09/09→06/15						
740 d xDrive	225 - 230	09/10→06/15						
740 i	224 - 240	09/08→12/15						
Li xDrive	235 - 330	09/09→12/15						
750 d xDrive	280	07/12→12/15						
750 i	300 - 331	09/08→06/15						
760 i	400	09/09→12/15						
730 d xDrive	155 - 190	11/11→05/15		06/12→			24.2026-1702.3 010850	TRW Ø 27 Ø2 22,2
BMW - X1 (E84) 03/09→06/15								
 Bremskraftverstärker								
sDrive 16 d	85	04/12→06/15		07/12→; für Fahrzeuge ohne Start-Stopp-Funktion			03.7845-0103.4 300268	ATE Ø 8" pneumatisch
sDrive 16 i	105	03/13→06/15		Automatikgetriebe			03.7845-0103.4 300268	ATE Ø 8" pneumatisch
sDrive 18 d	100	03/09→06/15		10/09→; für Fahrzeuge ohne Start-Stopp-Funktion			03.7845-0103.4 300268	ATE Ø 8" pneumatisch
xDrive 18 d	100	03/09→06/15						
sDrive 18 d	105	12/09→06/15		für Fahrzeuge ohne Start-Stopp-Funktion			03.7845-0103.4 300268	ATE Ø 8" pneumatisch
sDrive 18 i	100 - 110	03/10→06/15						
sDrive 20 d	120 - 135	10/09→06/15						
sDrive 20 i	135	09/11→06/15						
sDrive 28 i	180	09/12→06/15						
xDrive 18 d	105	10/09→06/15						
xDrive 20 d	120 - 135	09/09→06/15						
xDrive 20 i	135	09/11→06/15						
xDrive 25 i	160	03/10→08/11						
xDrive 28 i	180 - 194	09/09→06/15						
xDrive 28 i Flex	180	04/11→06/15						
xDrive 35 i	225	03/11→06/15						
xDrive 23 d	150	10/09→06/15		für Fahrzeuge ohne Start-Stopp-Funktion			03.7848-5003.4 300236	ATE Ø 8" pneumatisch
xDrive 25 d	160	10/09→06/15		07/12→; Automatikgetriebe			03.7845-0103.4 300268	ATE Ø 8" pneumatisch
 Hauptbremszylinder								
sDrive 16 d	85	04/12→06/15		07/12→; für Linkslenker			03.2025-1904.3 010797	ATE Ø1 25,4 Ø2 22,2
xDrive 25 d	160	10/09→06/15						
sDrive 16 i	105	03/13→06/15					03.2025-1904.3 010797	ATE Ø1 25,4 Ø2 22,2
→								















	kW			 	! #		
BMW - X1 (E84) 03/09→06/15							
 Hauptbremszylinder							
sDrive 18 d xDrive 18 d	100 100	03/09→06/15 03/09→06/15		10/09→; für Linkslenker		03.2025-1904.3 010797	ATE Ø1 25,4 Ø2 22,2
sDrive 18 d sDrive 18 i	105 100 - 110	12/09→06/15 03/10→06/15		für Linkslenker		03.2025-1904.3 010797	ATE Ø1 25,4 Ø2 22,2
sDrive 20 d	120 - 135	10/09→06/15					
sDrive 20 i	135	09/11→06/15					
sDrive 28 i	180	09/12→06/15					
xDrive 18 d	105	10/09→06/15					
xDrive 20 d	120 - 135	09/09→06/15					
xDrive 20 i	135	09/11→06/15					
xDrive 23 d	150	10/09→06/15					
xDrive 25 i	160	03/10→08/11					
xDrive 28 i	180 - 194	09/09→06/15					
xDrive 28 i Flex	180	04/11→06/15					
xDrive 35 i	225	03/11→06/15					
BMW - X1 (F48) 11/14→							
 Hauptbremszylinder							
sDrive 16 d sDrive 18 d xDrive 18 d	85 100 100 - 110	11/14→ 07/15→ 11/14→		09/15→		24.4123-1733.3 011108	Ø 23,8 ohne Bremsflüssigkeitsbehälter
xDrive 20 i xDrive 25 d xDrive 25 i	141 170 170	07/15→11/15 11/14→ 07/15→					
sDrive 18 d sDrive 18 i	110 100 - 103	07/15→ 11/15→				24.4123-1733.3 011108	Ø 23,8 ohne Bremsflüssigkeitsbehälter
sDrive 20 d	120 - 140	11/15→					
sDrive 20 i	131 - 141	07/15→					
xDrive 20 d	140	07/15→					
xDrive 20 i	131	11/20→					
xDrive 25 e Plug-in-Hybrid	162	03/20→					
xDrive 20 d	120	07/15→		11/15→		24.4123-1733.3 011108	Ø 23,8 ohne Bremsflüssigkeitsbehälter
BMW - X1 Van (F48) 07/15→							
 Hauptbremszylinder							
sDrive 18 d sDrive 18 i sDrive 20 d sDrive 20 i xDrive 20 d	110 103 140 141 140	07/15→ 07/17→ 11/15→ 07/17→ 07/15→				24.4123-1733.3 011108	Ø 23,8 ohne Bremsflüssigkeitsbehälter
BMW - X2 (F39) 11/17→							
 Hauptbremszylinder							
sDrive 16 d sDrive 18 d	85 100 - 110	11/18→ 03/18→				24.4123-1733.3 011108	Ø 23,8 ohne Bremsflüssigkeitsbehälter
sDrive 18 i	100 - 103	03/18→					
sDrive 20 d	120 - 140	11/18→					
sDrive 20 i	131 - 141	11/17→					
xDrive 18 d	100 - 110	03/18→					
xDrive 20 d	120 - 140	11/17→					
xDrive 20 i	131 - 141	03/18→					
xDrive 25 d	170	11/17→					
xDrive 25 e Plug-in-Hybrid	162	03/20→					
BMW - X3 (E83) 01/03→12/11							
 Hauptbremszylinder							
2.0 d 2.0 i 2.0 sd 2.5 i →	110 110 130 141	09/04→08/07 07/05→08/08 09/07→08/08 03/04→07/06				24.2025-1710.3 010833	TRW Ø 25,4











	kW			 	! #				
BMW - X3 (E83) 01/03→12/11									
 Hauptbremszylinder									
2.5 si	160	08/06→08/08				24.2025-1710.3 010833	TRW Ø 25,4		
2.5 si xDrive	155	08/06→08/08							
3.0 d	150 - 160	01/04→08/08							
3.0 i xDrive	170	09/03→07/06							
3.0 sd	210	09/06→08/08							
3.0 si	194 - 200	08/06→08/08							
xDrive 20 d	120 - 130	09/08→08/10							
xDrive 25 i	155 - 160	09/08→08/10							
xDrive 30 d	155 - 160	09/08→08/10							
xDrive 30 i	160 - 200	08/06→08/10							
xDrive 18 d	100 - 105	09/08→12/11		→ 08/10		24.2025-1710.3 010833	TRW Ø 25,4		
xDrive 20 i	110	09/08→08/11							
xDrive 35 d	210	09/08→08/11							
BMW - X3 (F25) 09/10→08/17									
 Hauptbremszylinder									
sDrive 18 d	100 - 110	10/12→08/17				24.4125-1709.3 011077	TRW Ø 25,4 ohne Bremsflüssigkeitsbehälter		
sDrive 20 i	125 - 135	04/14→08/17							
xDrive 20 d	120 - 140	09/10→08/17							
xDrive 20 i	135	10/11→08/17							
xDrive 28 i	180 - 190	01/11→08/17							
xDrive 30 d	155 - 210	04/11→08/17							
xDrive 35 d	230	10/11→08/17							
xDrive 35 i	225	09/10→08/17							
BMW - X4 (F26) 05/13→03/18									
 Hauptbremszylinder									
xDrive 20 d	120 - 140	04/14→03/18				24.4125-1709.3 011077	TRW Ø 25,4 ohne Bremsflüssigkeitsbehälter		
xDrive 20 i	135	04/14→03/18							
xDrive 28 i	179 - 180	04/14→03/18							
xDrive 30 d	155 - 210	04/14→03/18							
xDrive 35 d	230	04/14→03/18							
xDrive 35 i	225	04/14→03/18							
BMW - X5 (E53) 01/00→12/06									
 Hauptbremszylinder									
3.0 d	135	04/01→09/03		→ 08/01		24.2025-1704.3 010619	Ø 25,4		
3.0 i	170	04/00→10/06		09/01→					
4.4 i	210	01/00→09/03				24.2025-1707.3 010691	Ø 25,4		
3.0 d	155 - 160	10/03→09/06							
4.4 i	235	10/03→10/06							
4.6 is	255	10/01→09/03							
4.8 is	265	04/04→09/06							
BMW - Z3 Coupe (E36) 04/97→06/03									
 Bremskraftverstärker									
2.8 i	142	01/98→05/00				03.7760-3102.4 300139	ATE Ø 10" pneumatisch		
3.0 i	170	06/00→06/03		→ 12/02					
BMW - Z3 Roadster (E36) 10/95→01/03									
 Bremskraftverstärker									
1.8 i	85	10/95→10/98				03.7760-3102.4 300139	ATE Ø 10" pneumatisch		
1.9 i	103	11/95→03/99							
2.2 i	125	10/00→06/02							
2.5 i	141	10/00→08/02							
2.8 i	142	11/96→05/00							
1.9 i	85 - 87	07/98→01/03		→ 12/02		03.7760-3102.4 300139	ATE Ø 10" pneumatisch		
3.0 i	170	06/00→01/03							
2.0 i	110	04/99→01/03		→ 08/00					
→									













	kw					! #		
BMW - Z3 Roadster (E36) 10/95→01/03								
 Bremskraftverstärker								
2.2 i	120	08/00→01/03		10/00→ 12/02		03.7760-3102.4	300139	ATE Ø 10" pneumatisch
2.8 i	143	01/96→05/00		05/97→		03.7760-3102.4	300139	ATE Ø 10" pneumatisch
BMW - Z4 Coupe (E86) 03/06→01/09								
 Bremskraftverstärker								
3.0 si	195	04/06→08/08				03.7860-0702.4	300123	ATE Ø 10" pneumatisch
 Hauptbremszylinder								
3.0 si	195	04/06→08/08				03.2023-2256.3	010870	ATE Ø1 23,8 Ø2 22,2
BMW - Z4 Roadster (E85) 09/02→12/09								
 Bremskraftverstärker								
2.0 i	110	03/05→02/09		04/05→ 12/08		03.7860-0702.4	300123	ATE Ø 10" pneumatisch
2.2 i	125	10/03→10/05				03.7860-0702.4	300123	ATE Ø 10" pneumatisch
2.5 i	141	12/02→12/05						
2.5 si	160	01/06→08/08						
3.0 i	170	12/02→12/05						
3.0 si	195	01/06→08/08						
2.5 i	130	09/05→02/09		01/06→ 12/08		03.7860-0702.4	300123	ATE Ø 10" pneumatisch
2.5 si	155	09/05→02/09						
 Hauptbremszylinder								
2.0 i	110	03/05→02/09		04/05→ 12/08		03.2023-2249.3	010869	ATE Ø1 23,8 Ø2 22,2
2.2 i	125	10/03→10/05				03.2023-2249.3	010869	ATE Ø1 23,8 Ø2 22,2
2.5 i	141	12/02→12/05						
3.0 i	170	12/02→12/05						
2.5 i	130	09/05→02/09		01/06→ 12/08		03.2023-2256.3	010870	ATE Ø1 23,8 Ø2 22,2
2.5 si	155	09/05→02/09						
2.5 si	160	01/06→08/08				03.2023-2256.3	010870	ATE Ø1 23,8 Ø2 22,2
3.0 si	195	01/06→08/08						
BMW - Z4 Roadster (E89) 02/09→08/16								
 Hauptbremszylinder								
sDrive 18 i	115	04/13→08/16				03.2025-5826.3	010960	ATE Ø1 25,4 Ø2 22,2
sDrive 20 i	120 - 135	09/11→08/16						
sDrive 23 i	150	03/09→08/11						
sDrive 28 i	180	09/11→08/16						
sDrive 30 i	190 - 195	02/09→08/11						
sDrive 35 i	224 - 225	02/09→08/16						
sDrive 35 is	250	03/10→08/16						
BMW - Z8 Roadster (E52) 01/00→12/03								
 Hauptbremszylinder								
4.9	294	01/00→12/03				24.2026-1705.3	010992	TRW Ø 27 Ø2 20,6
CHEVROLET - ASTRA Schrägheck 09/98→12/11								
 Hauptbremszylinder								
2.0 DTi	74	08/02→12/11		→ 07/05; - ESP		24.2123-1734.3	010640	TRW Ø 23,8
				→ 07/05; + ESP		24.2123-1739.3	010661	Ø 23,8
 Bremskraftregler								
2.0 DTi	74	08/02→12/11		→ 07/05		03.6583-0085.3	320238	ATE lastabhängig 8/3 4x
CHEVROLET - ASTRA Stufenheck 10/98→12/11								
 Hauptbremszylinder								
2.0 DTi GLS	74	08/02→12/11		→ 07/05; - ESP		24.2123-1734.3	010640	TRW Ø 23,8
				→ 07/05; + ESP		24.2123-1739.3	010661	Ø 23,8
 Bremskraftregler								
2.0 DTi GLS	74	08/02→12/11		→ 07/05		03.6583-0085.3	320238	ATE lastabhängig 8/3 4x
CHEVROLET - AVEO Schrägheck (T300) 03/11→								
 Hauptbremszylinder								
1.2 →	51 - 63	03/11→		→ 03/12; Felgenreöße [Zoll]: 14; für Linksenker; + ABS		24.4122-1735.3	011113	Ø 22,2 ohne Bremsflüssigkeitsbehälter











	kW					! #		
CHEVROLET - AVEO Schrägheck (T300) 03/11→								
 Hauptbremszylinder								
1.3 D	55 - 70	07/11→12/15			→ 03/12; Felgenreöße [Zoll]: 14; für Linkslenker; + ABS		24.4122-1735.3 011113	Ø 22,2 ohne Bremsflüssigkeitsbehälter
1.4	74	03/11→						
1.6	85	03/11→						
CHEVROLET - AVEO Stufenheck (T300) 03/11→								
 Hauptbremszylinder								
1.2	51 - 63	03/11→			→ 03/12; Felgenreöße [Zoll]: 14; für Linkslenker; + ABS		24.4122-1735.3 011113	Ø 22,2 ohne Bremsflüssigkeitsbehälter
1.3 D	55 - 70	07/11→12/15						
1.4	74 - 103	07/11→						
1.6	85	03/11→						
CHEVROLET - CORSA Kombi 01/96→12/10								
 Hauptbremszylinder								
1.7 D	44	08/00→07/02			→ 09/00; für Linkslenker; - ABS		24.2120-0702.3 010361	nicht für Delco Ø 20,6
					→ 09/00; für Linkslenker; + ABS		24.2120-1714.3 010455	Ø 20,6
CHEVROLET - CRUZE (J300) 05/09→								
 Bremskraftverstärker								
1.4	74 - 103	09/10→			für Linkslenker		03.7858-0732.4 300272	ATE Ø 9 / 8" pneumatisch
1.6	80 - 91	05/09→						
1.7 D	96	01/12→						
1.7 TD	81	11/13→						
1.8	103 - 104	05/09→						
1.8 LPG	104	06/11→						
2.0 CDI	92 - 120	05/09→						
2.0 VCDi	122	03/12→11/18						
 Hauptbremszylinder								
1.4	74 - 103	09/10→			für Linkslenker; + ESP		03.2125-0421.3 010934	ATE Ø 25,4
1.6	80 - 91	05/09→						
1.7 D	96	01/12→						
1.7 TD	81	11/13→						
1.8	103 - 104	05/09→						
1.8 LPG	104	06/11→						
2.0 CDI	92 - 120	05/09→						
2.0 VCDi	122	03/12→11/18						
1.6	86	12/12→			für Linkslenker; für Fahrzeuge mit elektr. Dämpferregulierung		03.2125-0421.3 010934	ATE Ø 25,4
CHEVROLET - CRUZE Schrägheck (J305) 12/10→								
 Bremskraftverstärker								
1.4	74	07/13→12/15			für Linkslenker		03.7858-0732.4 300272	ATE Ø 9 / 8" pneumatisch
1.6	80 - 91	06/11→						
1.7 D	96	01/12→12/15						
1.7 TD	81	08/13→12/15						
1.8	103 - 104	06/11→						
1.8 LPG	104	06/11→12/15						
2.0 CDI	120	06/11→						
1.4	103	06/12→			08/12→; für Linkslenker		03.7858-0732.4 300272	ATE Ø 9 / 8" pneumatisch
 Hauptbremszylinder								
1.4	74	07/13→12/15			für Linkslenker; + ESP		03.2125-0421.3 010934	ATE Ø 25,4
1.6	80 - 91	06/11→						
1.7 D	96	01/12→12/15						
1.7 TD	81	08/13→12/15						
1.8	103 - 104	06/11→						
1.8 LPG	104	06/11→12/15						
2.0 CDI	120	06/11→						
1.4	103	06/12→			08/12→; für Linkslenker; + ESP		03.2125-0421.3 010934	ATE Ø 25,4

	kw			 	! #		
CHEVROLET - CRUZE Station Wagon (J308) 08/12→							
 Bremskraftverstärker							
1.4	74	08/12→		für Linkslenker		03.7858-0732.4 300272	ATE Ø 9 / 8" pneumatisch
1.6	86 - 91	08/12→12/15					
1.7 TD	81 - 96	08/12→					
1.8	104	08/12→					
2.0 TD	120	08/12→					
 Hauptbremszylinder							
1.4	74 - 103	08/12→		für Linkslenker; + ESP		03.2125-0421.3 010934	ATE Ø 25,4
1.6	86 - 91	08/12→12/15					
1.7 TD	81 - 96	08/12→					
1.8	104	08/12→					
2.0 TD	120	08/12→					
CHEVROLET - MALIBU (V300) 01/12→							
 Bremskraftverstärker							
2.0	193	01/12→12/15				03.7858-0732.4 300272	ATE Ø 9 / 8" pneumatisch
2.0 D	115 - 118	04/12→					
2.4	123 - 125	01/12→					
3.0	196	04/13→					
 Hauptbremszylinder							
2.0	193	01/12→12/15				03.2125-0421.3 010934	ATE Ø 25,4
2.0 D	115 - 118	04/12→					
2.4	123 - 125	01/12→					
3.0	196	04/13→					
CHEVROLET - MATIZ (M200, M250) 03/05→							
 Hauptbremszylinder							
0.8	37	10/10→		→ 645871; + ABS		24.2120-1755.3 010974	Ø 20,6 ohne Bremsflüssigkeitsbehälter
0.8 LPG	38	03/05→12/07					
1.0	47	03/05→12/07		645872→; + ABS		24.2120-1755.3 010974	Ø 20,6 ohne Bremsflüssigkeitsbehälter
1.0 LPG	49	03/05→03/11					
				→ 645871; - ABS		24.2120-1765.3 011003	Ø 20,6 ohne Bremsflüssigkeitsbehälter
				645872→; - ABS		24.2120-1765.3 011003	Ø 20,6 ohne Bremsflüssigkeitsbehälter
0.8	38	03/05→12/13		645872→; → 12/10; + ABS		24.2120-1755.3 010974	Ø 20,6 ohne Bremsflüssigkeitsbehälter
1.0	46 - 49	03/05→					
				→ 645871; + ABS		24.2120-1755.3 010974	Ø 20,6 ohne Bremsflüssigkeitsbehälter
				645872→; → 12/10; - ABS		24.2120-1765.3 011003	Ø 20,6 ohne Bremsflüssigkeitsbehälter
				→ 645871; - ABS		24.2120-1765.3 011003	Ø 20,6 ohne Bremsflüssigkeitsbehälter
CHEVROLET - ORLANDO (J309) 12/10→							
 Bremskraftverstärker							
1.8	104	02/11→				03.7858-0732.4 300272	ATE Ø 9 / 8" pneumatisch
1.8 LPG	104	06/11→12/15					
2.0 D	96 - 120	02/11→					
2.0 LPG	103	02/12→					
 Hauptbremszylinder							
1.8	104	02/11→		+ ESP		03.2125-0421.3 010934	ATE Ø 25,4
1.8 LPG	104	06/11→12/15					
2.0 D	96 - 120	02/11→					
2.0 LPG	103	02/12→					
CHEVROLET - SPARK 05/05→							
 Hauptbremszylinder							
0.8	37	05/05→02/10		645872→; für Linkslenker; Schaltgetriebe; + ABS		24.2120-1755.3 010974	Ø 20,6 ohne Bremsflüssigkeitsbehälter
→							

	kw			 	! #		
CHEVROLET - SPARK 05/05→							
 Hauptbremszylinder							
0.8	37	05/05→02/10		→ 645871; für Linkslenker; Schaltgetriebe; + ABS	24.2120-1755.3	010974	Ø 20,6 ohne Bremsflüssigkeitsbehälter
				645872→; für Linkslenker; Schaltgetriebe; - ABS	24.2120-1765.3	011003	Ø 20,6 ohne Bremsflüssigkeitsbehälter
				→ 645871; für Linkslenker; Schaltgetriebe; - ABS	24.2120-1765.3	011003	Ø 20,6 ohne Bremsflüssigkeitsbehälter
1.0 SX	44 - 49	05/05→		645872→; → 02/10; für Linkslenker; + ABS	24.2120-1755.3	010974	Ø 20,6 ohne Bremsflüssigkeitsbehälter
				→ 645871; für Linkslenker; + ABS	24.2120-1755.3	010974	Ø 20,6 ohne Bremsflüssigkeitsbehälter
				645872→; → 02/10; für Linkslenker; - ABS	24.2120-1765.3	011003	Ø 20,6 ohne Bremsflüssigkeitsbehälter
				→ 645871; für Linkslenker; - ABS	24.2120-1765.3	011003	Ø 20,6 ohne Bremsflüssigkeitsbehälter
CHEVROLET - SPARK Kasten/Schrägheck (M200, M250) 01/05→08/14							
 Hauptbremszylinder							
0.8	38	01/07→08/14		645872→; für Linkslenker; Schaltgetriebe; + ABS	24.2120-1755.3	010974	Ø 20,6 ohne Bremsflüssigkeitsbehälter
				→ 645871; für Linkslenker; Schaltgetriebe; + ABS	24.2120-1755.3	010974	Ø 20,6 ohne Bremsflüssigkeitsbehälter
				645872→; für Linkslenker; Schaltgetriebe; - ABS	24.2120-1765.3	011003	Ø 20,6 ohne Bremsflüssigkeitsbehälter
				→ 645871; für Linkslenker; Schaltgetriebe; - ABS	24.2120-1765.3	011003	Ø 20,6 ohne Bremsflüssigkeitsbehälter
CHEVROLET - TIGRA 08/97→09/01							
 Hauptbremszylinder							
1.6	73	09/98→12/99		- ABS	24.2120-0702.3	010361	nicht für Delco Ø 20,6
				+ ABS	24.2120-1714.3	010455	Ø 20,6
CHEVROLET - VECTRA 03/96→11/06							
 Hauptbremszylinder							
2.2 3.2	108 155	04/02→04/04 09/01→07/04		für Linkslenker; + ESP	24.2125-1732.3	010827	TRW Ø 25,4
CHRYSLER - DELTA 08/11→							
 Hauptbremszylinder							
1.4 1.4 16V 1.6 D Multijet 2.0 D Multijet	88 103 88 121	08/11→ 08/11→ 08/11→ 08/11→			24.4123-1710.3	010866	BOS Ø 23,8 ohne Bremsflüssigkeitsbehälter
CHRYSLER - VOYAGER / GRAND VOYAGER III (GS_, NS_) 01/95→03/01							
 Hauptbremszylinder							
2.0 i 2.4 AWD 2.4 i 3.0 3.3 i 3.8 i AWD	98 111 111 112 116 122 - 131	01/95→03/01 02/97→03/01 01/95→03/01 01/95→03/01 01/95→03/01 01/95→03/01		für Fahrzeuge mit STC	24.2123-1781.3	011060	Ø 23,8 ohne Bremsflüssigkeitsbehälter
2.5 TD 2.5 TDiC AWD	85 85	01/95→03/01 10/95→03/01		für Fahrzeuge ohne STC	24.2123-1781.3	011060	Ø 23,8 ohne Bremsflüssigkeitsbehälter
CHRYSLER - VOYAGER / GRAND VOYAGER IV (RG) 02/00→02/08							
 Hauptbremszylinder							
2.8 CRD	110	04/04→02/08		für Linkslenker; - ESP	24.2123-1781.3	011060	Ø 23,8 ohne Bremsflüssigkeitsbehälter
CHRYSLER - VOYAGER IV (RG, RS) 09/99→12/08							
 Hauptbremszylinder							
2.4	108	02/00→12/08		02/02→; für Linkslenker; - ESP	24.2126-1706.3	011062	Ø 26 ohne Bremsflüssigkeitsbehälter
				02/02→; für Linkslenker; + ESP	24.2126-1707.3	011061	Ø 26 ohne Bremsflüssigkeitsbehälter
2.4 3.3 →	111 128 - 131	04/03→12/07 02/00→12/08		für Linkslenker; - ESP	24.2126-1706.3	011062	Ø 26 ohne Bremsflüssigkeitsbehälter

	kw					! #		
CHRYSLER - VOYAGER IV (RG, RS) 09/99→12/08								
 Hauptbremszylinder								
3.8	160	02/00→12/08			für Linkslenker; + ESP		24.2126-1707.3 011061	Ø 26 ohne Bremsflüssigkeitsbehälter
2.5 CRD	88	08/05→12/08			für Linkslenker; - ESP		24.2123-1781.3 011060	Ø 23,8 ohne Bremsflüssigkeitsbehälter
2.5 CRD	105	02/00→12/08			10/02→; für Linkslenker; - ESP		24.2123-1781.3 011060	Ø 23,8 ohne Bremsflüssigkeitsbehälter
					→ 09/02; für Linkslenker; - ESP		24.2126-1706.3 011062	Ø 26 ohne Bremsflüssigkeitsbehälter
					→ 09/02; für Linkslenker; + ESP		24.2126-1707.3 011061	Ø 26 ohne Bremsflüssigkeitsbehälter
3.3 AWD 3.8 AWD	128 160	02/00→12/08 02/00→12/08			für Linkslenker		24.2126-1706.3 011062	Ø 26 ohne Bremsflüssigkeitsbehälter
CITROËN - AX (ZA-) 07/86→12/98								
 Hauptbremszylinder								
10	33	07/86→12/98			Orga 03826→		03.2120-2031.3 010106	ATE Ø 20,6
10	37	02/87→12/98			07/92→		03.2120-2031.3 010106	ATE Ø 20,6
11	44	09/86→12/97			10/89→		03.2120-2031.3 010106	ATE Ø 20,6
14	55	04/87→04/97			03/89→ 12/96		03.2120-2031.3 010106	ATE Ø 20,6
Electric	28	11/96→04/97					03.2120-2031.3 010106	ATE Ø 20,6
CITROËN - BERLINGO / BERLINGO FIRST Großraumlimousine (MF_, GJK_, GFK_ 07/96→12/11								
 Hauptbremszylinder								
1.1 i 1.4 i	44 55	07/96→05/08 07/96→12/11			Orga 08610→; → 03/08; - ABS		03.2123-2781.3 010631	ATE Ø 23,8
					→Orga 08609; - ABS		24.2123-1714.3 010587	BDX Ø 23,8
					→Orga 08609; für Linkslenker; + ABS		24.2123-1713.3 010505	Ø 23,8
					Orga 08610→; → 03/08; - ESP		24.2123-1715.3 010520	BDX Ø 23,8
1.4 2.0 HDi 4x4 2.0 HDi 90 electrique	53 66 66 16	11/02→10/05 11/02→10/05 12/99→10/05 01/00→10/02			- ABS		03.2123-2781.3 010631	ATE Ø 23,8
							24.2123-1714.3 010587	BDX Ø 23,8
					- ESP		24.2123-1715.3 010520	BDX Ø 23,8
1.4 bivalent 1.4 i bivalent 1.6 16V	48 55 80 -	11/02→12/11 04/03→10/08 10/00→12/11			→ 03/08; - ABS		03.2123-2781.3 010631	ATE Ø 23,8
							24.2123-1714.3 010587	BDX Ø 23,8
					→ 03/08; - ESP		24.2123-1715.3 010520	BDX Ø 23,8
1.6 HDI 75 1.6 HDI 90	55 66	07/05→12/11 07/05→05/08						
1.6 HDI 92	68	11/09→12/10			- ABS		24.2123-1714.3 010587	BDX Ø 23,8
					+ ABS / - ESP		24.2123-1715.3 010520	BDX Ø 23,8
1.8 D 1.8 i 1.9 D	43 66 50 -	07/98→10/02 05/97→10/02 07/96→10/05			Orga 08610→; - ABS		03.2123-2781.3 010631	ATE Ø 23,8
							24.2123-1714.3 010587	BDX Ø 23,8
					→Orga 08609; - ABS		24.2123-1710.3 010504	Ø 23,8
					→Orga 08609; für Linkslenker; + ABS		24.2123-1713.3 010505	Ø 23,8
1.9 D 4WD	51 51	07/98→10/05			Orga 08610→; - ESP		24.2123-1715.3 010520	BDX Ø 23,8
					Orga 08610→; - ABS		03.2123-2781.3 010631	ATE Ø 23,8
					05/97→; →Orga 08609; - ABS		24.2123-1710.3 010504	Ø 23,8
1.8 i 4WD	66	04/97→10/01			05/97→; →Orga 08609; für Linkslenker; + ABS		24.2123-1713.3 010505	Ø 23,8
					Orga 08610→; - ESP		24.2123-1715.3 010520	BDX Ø 23,8
					Orga 08610→; - ABS		03.2123-2781.3 010631	ATE Ø 23,8
							24.2123-1714.3 010587	BDX Ø 23,8
Electric	28	01/98→12/05			11/02→; - ABS		03.2123-2781.3 010631	ATE Ø 23,8
							24.2123-1714.3 010587	BDX Ø 23,8
					11/02→; - ESP		24.2123-1715.3 010520	BDX Ø 23,8
CITROËN - BERLINGO / BERLINGO FIRST Kasten/Großraumlimousine (M_) 07/96→12/11								
 Hauptbremszylinder								
1.1 i 1.4 BiFuel 1.8 D 1.9 D	44 55 43 51	07/96→03/08 07/96→10/02 07/96→10/02 07/96→12/03			Orga 08610→; - ABS		03.2123-2781.3 010631	ATE Ø 23,8
							24.2123-1714.3 010587	BDX Ø 23,8
					→Orga 08609; - ABS		24.2123-1710.3 010504	Ø 23,8
					→Orga 08609; + ABS; für Linkslenker		24.2123-1713.3 010505	Ø 23,8
1.9 D 70 4WD 2.0 HDi 90 4WD	51 66	07/98→03/06 11/00→10/05			Orga 08610→; + ABS		24.2123-1715.3 010520	BDX Ø 23,8
1.4 bivalent 1.6 HDI 75	48 55	11/02→12/11 07/05→12/11			→ 03/08; - ABS		03.2123-2781.3 010631	ATE Ø 23,8
							24.2123-1714.3 010587	BDX Ø 23,8
					→ 03/08; + ABS		24.2123-1715.3 010520	BDX Ø 23,8
→								

	kW					! #		
CITROËN - BERLINGO / BERLINGO FIRST Kasten/Großraumlimousine (M_) 07/96→12/11								
 Hauptbremszylinder								
1.4 i 1.9 D 70 2.0 HDI 90	55 51 66	07/96→12/11 04/99→12/11 12/99→12/11		Orga 08610→; → 03/08; - ABS		03.2123-2781.3 010631	ATE Ø 23,8	
				→Orga 08609; - ABS		24.2123-1714.3 010587	BDX Ø 23,8	
				→Orga 08609; + ABS; für Linkslenker		24.2123-1710.3 010504	Ø 23,8	
				Orga 08610→; → 03/08; + ABS		24.2123-1713.3 010505	Ø 23,8	
1.4 i bivalent 1.6 16V	55 80 - 81	04/03→10/05 10/00→03/08		- ABS		03.2123-2781.3 010631	ATE Ø 23,8	
				+ ABS		24.2123-1714.3 010587	BDX Ø 23,8	
						24.2123-1715.3 010520	BDX Ø 23,8	
1.6 HDI 92	68	11/09→12/10		- ABS		24.2123-1714.3 010587	BDX Ø 23,8	
				+ ABS / - ESP		24.2123-1715.3 010520	BDX Ø 23,8	
Electric	42	01/11→12/11		+ ESP		24.4123-1714.3 010979	TRW Ø 23,8	
CITROËN - BERLINGO Kasten/Großraumlimousine (B9) 04/08→								
 Hauptbremszylinder								
1.6 1.6 BlueHdI 100 1.6 BlueHdI 100 4x4 1.6 BlueHdI 120 1.6 HDi 110 1.6 HDi 115 1.6 HDi 115 4x4 1.6 HDi 75 1.6 HDi 75 4x4 1.6 HDi 90 1.6 HDi 90 16V 1.6 HDi 90 4x4 1.6 VTi 120 1.6 VTi 95 Electric	66 - 80 73 73 88 80 - 82 84 84 55 55 66 - 68 66 66 88 72 49	04/08→ 12/14→ 12/14→ 12/14→ 04/08→ 07/10→ 02/12→ 04/08→ 02/12→ 07/10→ 04/08→ 02/12→ 11/09→ 07/10→ 01/13→		+ ESP		24.4123-1714.3 010979	TRW Ø 23,8	
1.6 HDi / BlueHdI 75	55	07/10→		04/15→; + ESP		24.4123-1714.3 010979	TRW Ø 23,8	
Electric	35	01/13→		02/13→; + ESP		24.4123-1714.3 010979	TRW Ø 23,8	
PureTech 110	81	01/18→		+ ESP; →Orga 14685		24.4123-1714.3 010979	TRW Ø 23,8	
CITROËN - BERLINGO MULTISPACE (B9) 04/08→								
 Hauptbremszylinder								
1.2 PureTech 110 1.6 1.6 BlueHdI 100 1.6 BlueHdI 120 1.6 HDi 110 1.6 HDi 115 1.6 HDi 115 4x4 1.6 HDi 75 16V 1.6 HDi 90 1.6 HDi 90 4x4 1.6 VTi 120 1.6 VTi 95	81 66 - 81 73 88 80 - 82 84 84 55 66 - 68 66 88 72	02/16→ 04/08→ 12/14→ 12/14→ 04/08→ 07/10→ 02/12→ 04/08→ 04/08→ 02/12→12/14 11/09→ 07/10→		+ ESP		24.4123-1714.3 010979	TRW Ø 23,8	
1.6 HDi 75 / BlueHdI 75	55	04/08→		04/15→; + ESP		24.4123-1714.3 010979	TRW Ø 23,8	
Electric	49	09/17→		+ ESP; →Orga 14685		24.4123-1714.3 010979	TRW Ø 23,8	
CITROËN - BERLINGO Pritsche/Fahrgestell (B9) 04/08→								
 Hauptbremszylinder								
1.6 BlueHdI 100 1.6 HDi 90 1.6 HDi 90 16V 1.6 HDi 92	73 66 66 68	12/14→ 07/10→ 04/08→ 07/10→12/17		+ ESP		24.4123-1714.3 010979	TRW Ø 23,8	
CITROËN - C1 (PM_, PN_) 06/05→09/14								
 Hauptbremszylinder								
1.0	50	06/05→09/14		für Linkslenker; → 04/14; - ESP		24.4120-1701.3 010846	BOS Ø 20,6	
				für Linkslenker; → 04/14; + ESP		24.4120-1704.3 011042	Ø 20,6 ohne Bremsflüssigkeitsbehälter	
				für Rechtslenker; → 04/14; + ESP		24.4120-1705.3 011051	Ø 20,6 ohne Bremsflüssigkeitsbehälter	
1.4 HDi →	40	06/05→09/14		→ 12/08; für Linkslenker; - ESP		24.4120-1701.3 010846	BOS Ø 20,6	

	kw			 	! #		
CITROËN - C1 (PM_, PN_) 06/05→09/14							
 Hauptbremszylinder							
1.4 HDi	40	06/05→09/14		→ 12/08; für Linkslenker; + ESP		24.4120-1704.3 011042	Ø 20,6 ohne Bremsflüssigkeitsbehälter
				→ 12/08; für Rechtslenker; + ESP		24.4120-1705.3 011051	Ø 20,6 ohne Bremsflüssigkeitsbehälter
CITROËN - C1 II (PA_, PS_) 04/14→							
 Hauptbremszylinder							
1.0 VTi 68 1.0 VTi 72 1.2 VTi 82	51 53 60	04/14→ 06/18→ 04/14→		für Linkslenker; - ESP		24.4120-1712.3 011092	Ø 20,6 ohne Bremsflüssigkeitsbehälter
CITROËN - C2 (JM_) 07/03→09/17							
 Hauptbremszylinder							
1.1	44	09/03→09/12		→ 12/09; - ABS		24.2120-1741.3 010775	Ø 20,6
				10815→ 11192; für Linkslenker; - ESP		24.2122-1764.3 010851	BOS Ø 22,2
				→Orga 10800; - ESP		24.2122-1766.3 010840	TRW Ø 22,2
				→Orga 10800; + ESP		24.2122-1767.3 010841	TRW Ø 22,2 ohne Drucksensor
				→ 12/09; Orga 10801→; + ESP		24.4122-1703.3 010843	TRW Ø 22,2
				10801→ 11192; für Rechtslenker; - ESP		24.4122-1704.3 010847	TRW Ø 22,2
				10808→ 10810; für Linkslenker; - ESP		24.4122-1704.3 010847	TRW Ø 22,2
				10801→ 10807; für Linkslenker; - ESP		24.4122-1708.3 010865	BOS Ø 22,2 ohne Bremsflüssigkeitsbehälter
				10811→ 10814; für Linkslenker; - ESP		24.4122-1708.3 010865	BOS Ø 22,2 ohne Bremsflüssigkeitsbehälter
				Orga 11193→; → 12/09; für Linkslenker; - ESP		24.4122-1708.3 010865	BOS Ø 22,2 ohne Bremsflüssigkeitsbehälter
1.4 1.4 HDi	54 - 55 50 - 51	09/03→12/09 07/03→12/09		- ABS		24.2120-1741.3 010775	Ø 20,6
				10815→ 11192; für Linkslenker; - ESP		24.2122-1764.3 010851	BOS Ø 22,2
				→Orga 10800; - ESP		24.2122-1766.3 010840	TRW Ø 22,2
				→Orga 10800; + ESP		24.2122-1767.3 010841	TRW Ø 22,2 ohne Drucksensor
				Orga 10801→; + ESP		24.4122-1703.3 010843	TRW Ø 22,2
				Orga 10801→; für Rechtslenker; - ESP		24.4122-1704.3 010847	TRW Ø 22,2
				10808→ 10810; für Linkslenker; - ESP		24.4122-1704.3 010847	TRW Ø 22,2
				10801→ 10807; für Linkslenker; - ESP		24.4122-1708.3 010865	BOS Ø 22,2 ohne Bremsflüssigkeitsbehälter
				Orga 11193→; für Linkslenker; - ESP		24.4122-1708.3 010865	BOS Ø 22,2 ohne Bremsflüssigkeitsbehälter
				10811→ 10814; für Linkslenker; - ESP		24.4122-1708.3 010865	BOS Ø 22,2 ohne Bremsflüssigkeitsbehälter
1.4 16V	65	04/05→12/09		- ABS		24.2120-1741.3 010775	Ø 20,6
				10815→ 11192; für Linkslenker; - ESP		24.2122-1764.3 010851	BOS Ø 22,2
				Orga 10801→; + ESP		24.4122-1703.3 010843	TRW Ø 22,2
				Orga 10801→; für Rechtslenker; - ESP		24.4122-1704.3 010847	TRW Ø 22,2
				10808→ 10810; für Linkslenker; - ESP		24.4122-1704.3 010847	TRW Ø 22,2
				Orga 11193→; für Linkslenker; - ESP		24.4122-1708.3 010865	BOS Ø 22,2 ohne Bremsflüssigkeitsbehälter
				10801→ 10807; für Linkslenker; - ESP		24.4122-1708.3 010865	BOS Ø 22,2 ohne Bremsflüssigkeitsbehälter
				10811→ 10814; für Linkslenker; - ESP		24.4122-1708.3 010865	BOS Ø 22,2 ohne Bremsflüssigkeitsbehälter
1.6	80	07/03→10/10		→ 12/09; - ABS		24.2120-1741.3 010775	Ø 20,6
				→Orga 10800; - ESP		24.2122-1766.3 010840	TRW Ø 22,2
				→Orga 10800; + ESP		24.2122-1767.3 010841	TRW Ø 22,2 ohne Drucksensor
				→ 12/09; Orga 10801→; + ESP		24.4122-1703.3 010843	TRW Ø 22,2
				Orga 10801→; → 12/09; für Linkslenker; - ESP		24.4122-1704.3 010847	TRW Ø 22,2
1.6 HDi	80	09/05→12/09		Orga 10801→; + ESP		24.4122-1703.3 010843	TRW Ø 22,2
1.6 VTS	90	10/04→12/09		→Orga 10800; - ESP		24.2122-1766.3 010840	TRW Ø 22,2
				→Orga 10800; + ESP		24.2122-1767.3 010841	TRW Ø 22,2 ohne Drucksensor
				Orga 10801→; + ESP		24.4122-1703.3 010843	TRW Ø 22,2
CITROËN - C2 ENTERPRISE (JG_) 11/03→12/09							
 Hauptbremszylinder							
1.1 →	44	11/03→12/09		- ABS		24.2120-1741.3 010775	Ø 20,6

CITROËN - C2 ENTERPRISE (JG_) 11/03→12/09











Hauptbremszylinder















1.1	44	11/03→12/09	10815→ 11192; für Linkslenker; - ESP	24.2122-1764.3 010851	BOS Ø 22,2
			→Orga 10800; - ESP	24.2122-1766.3 010840	TRW Ø 22,2
			→Orga 10800; + ESP	24.2122-1767.3 010841	TRW Ø 22,2 ohne Drucksensor
			Orga 10801→; + ESP	24.4122-1703.3 010843	TRW Ø 22,2
			10808→ 10810; für Linkslenker; - ESP	24.4122-1704.3 010847	TRW Ø 22,2
			10801→ 11192; für Rechtslenker; - ESP	24.4122-1704.3 010847	TRW Ø 22,2
			10801→ 10807; für Linkslenker; - ESP	24.4122-1708.3 010865	BOS Ø 22,2 ohne Bremsflüssigkeitsbehälter
			10811→ 10814; für Linkslenker; - ESP	24.4122-1708.3 010865	BOS Ø 22,2 ohne Bremsflüssigkeitsbehälter
1.4 HDi	50 - 51	11/03→12/09	- ABS	24.2120-1741.3 010775	Ø 20,6
			10815→ 11192; für Linkslenker; - ESP	24.2122-1764.3 010851	BOS Ø 22,2
			→Orga 10800; - ESP	24.2122-1766.3 010840	TRW Ø 22,2
			→Orga 10800; + ESP	24.2122-1767.3 010841	TRW Ø 22,2 ohne Drucksensor
			Orga 10801→; + ESP	24.4122-1703.3 010843	TRW Ø 22,2
			Orga 10801→; für Rechtslenker; - ESP	24.4122-1704.3 010847	TRW Ø 22,2
			10808→ 10810; für Linkslenker; - ESP	24.4122-1704.3 010847	TRW Ø 22,2
			10801→ 10807; für Linkslenker; - ESP	24.4122-1708.3 010865	BOS Ø 22,2 ohne Bremsflüssigkeitsbehälter
1.4 HDi	50 - 51	11/03→12/09	Orga 11193→; für Linkslenker; - ESP	24.4122-1708.3 010865	BOS Ø 22,2 ohne Bremsflüssigkeitsbehälter
			10811→ 10814; für Linkslenker; - ESP	24.4122-1708.3 010865	BOS Ø 22,2 ohne Bremsflüssigkeitsbehälter













CITROËN - C3 I (FC_, FN_) 02/02→















Hauptbremszylinder











1.1 i 1.4 HDi 1.4 i	44 50 - 55 54	02/02→ 02/02→ 02/02→11/10	→ 08/09; - ABS	24.2120-1741.3 010775	Ø 20,6
			Orga 10815→; → 08/09; für Linkslenker; - ESP	24.2122-1764.3 010851	BOS Ø 22,2
			→Orga 10800; für Linkslenker; - ESP	24.2122-1764.3 010851	BOS Ø 22,2
			→Orga 10800; - ESP	24.2122-1766.3 010840	TRW Ø 22,2
			→Orga 10800; + ESP	24.2122-1767.3 010841	TRW Ø 22,2 ohne Drucksensor
			Orga 10801→; → 08/09; + ESP	24.4122-1703.3 010843	TRW Ø 22,2
			10808→ 10814; für Linkslenker; - ESP	24.4122-1704.3 010847	TRW Ø 22,2
			→ 08/09; für Rechtslenker; - ESP	24.4122-1704.3 010847	TRW Ø 22,2
1.1 LPG 1.4 1.4 BiFuel 1.4 i Bivalent	44 58 54 49	06/06→12/09 12/05→07/12 09/08→12/09 01/08→12/09	10801→ 10807; für Linkslenker; - ESP	24.4122-1708.3 010865	BOS Ø 22,2 ohne Bremsflüssigkeitsbehälter
			- ABS	24.2120-1741.3 010775	Ø 20,6
			Orga 10815→; für Linkslenker; - ESP	24.2122-1764.3 010851	BOS Ø 22,2
			→Orga 10800; für Linkslenker; - ESP	24.2122-1764.3 010851	BOS Ø 22,2
			→Orga 10800; - ESP	24.2122-1766.3 010840	TRW Ø 22,2
			→Orga 10800; + ESP	24.2122-1767.3 010841	TRW Ø 22,2 ohne Drucksensor
			Orga 10801→; + ESP	24.4122-1703.3 010843	TRW Ø 22,2
			10808→ 10814; für Linkslenker; - ESP	24.4122-1704.3 010847	TRW Ø 22,2
1.4 16V 1.6 16V	65 80	12/03→ 02/02→08/10	für Rechtslenker; - ESP	24.4122-1704.3 010847	TRW Ø 22,2
			10801→ 10807; für Linkslenker; - ESP	24.4122-1708.3 010865	BOS Ø 22,2 ohne Bremsflüssigkeitsbehälter
			→ 08/09; - ABS	24.2120-1741.3 010775	Ø 20,6
			→Orga 10800; für Linkslenker; - ESP	24.2122-1764.3 010851	BOS Ø 22,2
			→Orga 10800; - ESP	24.2122-1766.3 010840	TRW Ø 22,2
			→Orga 10800; + ESP	24.2122-1767.3 010841	TRW Ø 22,2 ohne Drucksensor
			Orga 10801→; → 08/09; + ESP	24.4122-1703.3 010843	TRW Ø 22,2
			→ 08/09; - ESP	24.4122-1704.3 010847	TRW Ø 22,2
1.4 16V HDi	66	02/02→	→ 08/09; - ABS	24.2120-1741.3 010775	Ø 20,6
			Orga 10815→; → 08/09; für Linkslenker; - ESP	24.2122-1764.3 010851	BOS Ø 22,2
			→Orga 10800; für Linkslenker; - ESP	24.2122-1764.3 010851	BOS Ø 22,2
			→Orga 10800; - ESP	24.2122-1766.3 010840	TRW Ø 22,2
			→Orga 10800; + ESP	24.2122-1767.3 010841	TRW Ø 22,2 ohne Drucksensor
			Orga 10801→; → 08/09; + ESP	24.4122-1703.3 010843	TRW Ø 22,2
			→ 08/09; - ESP	24.4122-1704.3 010847	TRW Ø 22,2
			→		

















	kw			 	! #		
CITROËN - C3 I (FC_, FN_) 02/02→							
 Hauptbremszylinder							
1.4 16V HDi	66	02/02→		10801→ 10807; für Linkslenker; - ESP		24.4122-1708.3 010865	BOS Ø 22,2 ohne Bremsflüssigkeitsbehälter
1.4 i Bivalent	54	02/02→		09/05→ 08/09; - ABS		24.2120-1741.3 010775	Ø 20,6
				09/05→; →Orga 10800; für Linkslenker; - ESP		24.2122-1764.3 010851	BOS Ø 22,2
				09/05→; →Orga 10800; - ESP		24.2122-1766.3 010840	TRW Ø 22,2
				09/05→; →Orga 10800; + ESP		24.2122-1767.3 010841	TRW Ø 22,2 ohne Drucksensor
				Orga 10801→; → 08/09; + ESP		24.4122-1703.3 010843	TRW Ø 22,2
				09/05→ 08/09; für Linkslenker; - ESP		24.4122-1704.3 010847	TRW Ø 22,2
1.6 16V	81	05/03→09/05		- ABS		24.2120-1741.3 010775	Ø 20,6
				→Orga 10800; für Linkslenker; - ESP		24.2122-1764.3 010851	BOS Ø 22,2
				→Orga 10800; - ESP		24.2122-1766.3 010840	TRW Ø 22,2
				→Orga 10800; + ESP		24.2122-1767.3 010841	TRW Ø 22,2 ohne Drucksensor
				Orga 10801→; + ESP		24.4122-1703.3 010843	TRW Ø 22,2
				- ESP		24.4122-1704.3 010847	TRW Ø 22,2
1.6 16V HDi	66	10/05→		→Orga 10800; für Linkslenker; - ESP		24.2122-1764.3 010851	BOS Ø 22,2
				→Orga 10800; - ESP		24.2122-1766.3 010840	TRW Ø 22,2
				→Orga 10800; + ESP		24.2122-1767.3 010841	TRW Ø 22,2 ohne Drucksensor
				Orga 10801→; → 08/09; + ESP		24.4122-1703.3 010843	TRW Ø 22,2
				→ 08/09; - ESP		24.4122-1704.3 010847	TRW Ø 22,2
1.6 16V HDi	80	09/05→		→Orga 10800; für Linkslenker; - ESP		24.2122-1764.3 010851	BOS Ø 22,2
				→Orga 10800; - ESP		24.2122-1766.3 010840	TRW Ø 22,2
				→Orga 10800; + ESP		24.2122-1767.3 010841	TRW Ø 22,2 ohne Drucksensor
				Orga 10801→; → 08/09; + ESP		24.4122-1703.3 010843	TRW Ø 22,2
				→ 08/09; - ESP		24.4122-1704.3 010847	TRW Ø 22,2
	10801→ 10807; für Linkslenker; - ESP		24.4122-1708.3 010865	BOS Ø 22,2 ohne Bremsflüssigkeitsbehälter			
CITROËN - C3 II (SC_) 09/09→							
 Hauptbremszylinder							
1.1 BiFuel	44	11/10→		Orga 13153→; + DSC		24.4122-1703.3 010843	TRW Ø 22,2
1.1 i	44	09/09→01/13		Orga 13153→; - DSC		24.4122-1704.3 010847	TRW Ø 22,2
1.4	54	11/09→09/16					
1.4 HDi 70	50	11/09→					
1.4 LPG	54	07/10→					
1.6 HDi 90	66	11/09→					
1.4 VTi	72	11/09→		Orga 13153→; + DSC		24.4123-1704.3 010828	TRW Ø 23,8
1.4 VTi 95	70	11/09→		Orga 13153→; - DSC		24.4123-1705.3 010832	TRW Ø 23,8
1.6 HDi 110	82	11/09→					
1.6 HDi 115	84	09/12→					
1.6 VTi 120	88	11/09→					
1.6 BlueHDi 100	73	07/14→		+ DSC		24.4122-1703.3 010843	TRW Ø 22,2
1.6 BlueHDi 75	55	04/15→		- DSC		24.4122-1704.3 010847	TRW Ø 22,2
1.6 HDi	68	11/09→09/16		Orga 13153→; Trommelbremse; + DSC		24.4122-1703.3 010843	TRW Ø 22,2
				Orga 13153→; Trommelbremse; - DSC		24.4122-1704.3 010847	TRW Ø 22,2
				Orga 13153→; Scheibenbremse; + DSC		24.4123-1704.3 010828	TRW Ø 23,8
				Orga 13153→; Scheibenbremse; - DSC		24.4123-1705.3 010832	TRW Ø 23,8
CITROËN - C3 II Kasten/Schrägheck (SC_) 06/10→							
 Hauptbremszylinder							
1.4 HDi	50	06/10→09/16		Orga 13153→; + DSC		24.4122-1703.3 010843	TRW Ø 22,2
				Orga 13153→; - DSC		24.4122-1704.3 010847	TRW Ø 22,2
1.6 BlueHDi	55	03/15→09/16		+ DSC		24.4122-1703.3 010843	TRW Ø 22,2
				- DSC		24.4122-1704.3 010847	TRW Ø 22,2
CITROËN - C3 III (SX) 07/16→							
 Hauptbremszylinder							
1.2 PureTech 82	61	05/18→		für Fahrzeuge mit Trommelbremse an der Hinterachse		24.4122-1703.3 010843	TRW Ø 22,2
1.2 PureTech 82 LPG	61	05/18→					
1.2 THP 110	81	07/16→		für Fahrzeuge mit Scheibenbremse an der Hinterachse		24.4123-1704.3 010828	TRW Ø 23,8
1.2 VTi 68	50	07/16→					
1.2 VTi 82	60	07/16→					
1.2 VTi 82 LPG	60	07/16→					
1.5 BlueHDi 100	75	05/18→					
→							













	kw					! #		
CITROËN - C3 III (SX) 07/16→								
 Hauptbremszylinder								
1.6 BlueHDi 100	73	07/16→			für Fahrzeuge mit Trommelbremse an der Hinterachse		24.4122-1703.3 010843	TRW Ø 22,2
1.6 BlueHDi 75	55	07/16→						
1.6 VTi	85	02/17→			für Fahrzeuge mit Scheibenbremse an der Hinterachse		24.4123-1704.3 010828	TRW Ø 23,8
CITROËN - C3 III Van (SX_, SY_) 07/16→								
 Hauptbremszylinder								
1.2 VTi	60	07/16→			für Fahrzeuge mit Trommelbremse an der Hinterachse		24.4122-1703.3 010843	TRW Ø 22,2
BlueHDi 100	73 - 75	03/19→						
BlueHDi 75	55	03/19→			für Fahrzeuge mit Scheibenbremse an der Hinterachse		24.4123-1704.3 010828	TRW Ø 23,8
PureTech 110	81	03/19→						
PureTech 82	61	03/19→						
CITROËN - C3 AIRCROSS I 08/10→								
 Hauptbremszylinder								
1.5	66	11/15→			Orga 14721→		24.4122-1704.3 010847	TRW Ø 22,2
CITROËN - C3 AIRCROSS II (2R_, 2C_) 06/17→								
 Hauptbremszylinder								
1.2 PureTech 110	81	06/17→					24.4123-1704.3 010828	TRW Ø 23,8
1.2 PureTech 130	96	07/17→						
1.2 PureTech 82	60	06/17→						
1.5 BlueHDi 100	73 - 75	08/18→						
1.5 BlueHDi 110	81	10/20→						
1.5 BlueHDi 120	88	08/18→						
1.6 BlueHDi 100	73	07/17→						
1.6 BlueHDi 115	85	06/17→						
1.6 BlueHDi 120	88	07/17→						
1.6 HDi 92	68	10/17→						
CITROËN - C3 AIRCROSS II Van (2C_, 2R_) 06/17→								
 Hauptbremszylinder								
1.5 BlueHDi 100	73	05/19→					24.4123-1704.3 010828	TRW Ø 23,8
1.5 BlueHDi 120	88	05/19→						
1.6 BlueHDi 100	73	05/19→						
PureTech 82	60 - 81	05/19→						
CITROËN - C3 PICASSO (SH_) 02/09→								
 Hauptbremszylinder								
1.2 THP 110	81	01/15→			+ ESP		24.4123-1704.3 010828	TRW Ø 23,8
1.4 VTi 95	70	02/09→			- ESP		24.4123-1705.3 010832	TRW Ø 23,8
1.4 VTi 95 LPG	70	01/12→						
1.6 BlueHDi 100	73	01/15→						
1.6 HDi	66 - 80	02/09→						
1.6 HDi 110	82	05/10→						
1.6 HDi 115	84	01/13→						
1.6 HDi 90	68	07/10→						
1.6 VTi 120	88	02/09→						
1.6 VTi	84	07/09→			10/16→; + ESP		24.4123-1704.3 010828	TRW Ø 23,8
					10/16→; - ESP		24.4123-1705.3 010832	TRW Ø 23,8
CITROËN - C3 Pluriel (HB_) 05/03→								
 Hauptbremszylinder								
1.4	54 - 55	05/03→			→ 07/10; - ABS		24.2120-1741.3 010775	Ø 20,6
1.4 HDi	50	04/04→			→Orga 10800; - ESP		24.2122-1764.3 010851	BOS Ø 22,2
					→Orga 10800; + ESP		24.2122-1766.3 010840	TRW Ø 22,2
					→Orga 10800; + ESP		24.2122-1767.3 010841	TRW Ø 22,2 ohne Drucksensor
					Orga 10801→; → 07/10; + ESP		24.4122-1703.3 010843	TRW Ø 22,2
					Orga 10801→; → 07/10; - ESP		24.4122-1704.3 010847	TRW Ø 22,2
1.6	80	05/03→			→ 07/10; - ABS		24.2120-1741.3 010775	Ø 20,6
					→Orga 10800; - ESP		24.2122-1764.3 010851	BOS Ø 22,2
					→Orga 10800; - ESP		24.2122-1766.3 010840	TRW Ø 22,2
					→Orga 10800; - ESP		24.2122-1767.3 010841	TRW Ø 22,2 ohne Drucksensor
					Orga 10801→; → 07/10; + ESP		24.4122-1703.3 010843	TRW Ø 22,2
					Orga 10801→; → 07/10; - ESP		24.4122-1704.3 010847	TRW Ø 22,2













	kw					! #		
CITROËN - C4 CACTUS 09/14→								
 Hauptbremszylinder								
1.2 PureTech 130 1.2 THP 110 1.2 VTi 75 / PureTech 75 1.2 VTi 82 1.5 BlueHDi 100 1.5 BlueHDi 120 1.6 BlueHDi 100 1.6 HDi 90	96 81 55 60 73 - 75 88 73 68	11/17→ 09/14→ 09/14→ 09/14→ 06/18→ 09/18→ 09/14→ 09/14→		für Fahrzeuge mit Trommelbremse an der Hinterachse			24.4122-1703.3 010843	TRW Ø 22,2
				für Fahrzeuge mit Scheibenbremse an der Hinterachse			24.4123-1704.3 010828	TRW Ø 23,8
CITROËN - C4 CACTUS Van (0B_, 0P_) 09/14→								
 Hauptbremszylinder								
BlueHDi 100 PureTech 110 PureTech 130 PureTech 82	73 81 96 60	05/19→ 05/19→ 05/19→ 05/19→		für Fahrzeuge mit Trommelbremse an der Hinterachse			24.4122-1703.3 010843	TRW Ø 22,2
				für Fahrzeuge mit Scheibenbremse an der Hinterachse			24.4123-1704.3 010828	TRW Ø 23,8
CITROËN - C4 GRAND PICASSO I (UA_) 10/06→12/13								
 Bremskraftverstärker								
1.6 16V 1.6 HDi 1.6 HDi 110 1.6 THP 155 1.6 VTi 120 2.0 HDi 138 2.0 HDi 150 2.0 HDi 165	103 - 110 80 82 115 88 100 110 120	07/08→08/13 10/06→06/11 09/10→08/13 09/10→08/13 07/08→08/13 10/06→12/13 07/09→08/13 09/10→08/13					03.7860-4034.4 300318	ATE Ø 10" pneumatisch
1.8 i 16V 1.8 i 16V CNG 1.8 i 16V Flex	92 86 86	10/06→12/10 03/09→12/11 06/09→01/13					03.7870-1002.4 300282	ATE Ø 11" pneumatisch
2.0 i 16V	103 - 105	10/06→12/13		→ 07/13			03.7870-1002.4 300282	ATE Ø 11" pneumatisch
 Hauptbremszylinder								
1.6 16V 1.6 HDi 1.8 i 16V 1.8 i 16V CNG 1.8 i 16V Flex	103 80 92 86 86	07/08→12/10 10/06→06/11 10/06→12/10 03/09→12/11 06/09→01/13					03.4153-0173.3 010815	ATE Ø 23,8
1.6 16V 1.6 HDi 110 1.6 VTi 120 2.0 HDi 138 2.0 HDi 150 2.0 i 16V	110 82 88 100 110 103 - 105	10/08→08/13 09/10→08/13 07/08→08/13 10/06→12/13 07/09→08/13 10/06→12/13		→ 07/13			03.4153-0173.3 010815	ATE Ø 23,8
1.6 THP 155 2.0 HDi 165	115 120	09/10→08/13 09/10→08/13		11/10→ 07/13			03.4153-0173.3 010815	ATE Ø 23,8
CITROËN - C4 GRAND PICASSO II (DA_, DE_) 06/13→								
 Hauptbremszylinder								
1.2 THP 130 1.6 BlueHDi 100 1.6 BlueHDi 120 1.6 HDi / BlueHDi 115 1.6 HDi 90 1.6 THP 150 1.6 THP 155 1.6 THP 165 1.6 VTi 120 2.0 BlueHDi 135	96 73 88 85 68 110 115 121 88 100	04/14→ 01/15→ 07/14→ 09/13→ 09/13→ 09/14→ 09/13→ 07/14→ 09/13→ 09/13→					24.4155-1311.3 011053	ATE Ø 25,4 ohne Bremsflüssigkeitsbehälter
2.0 BlueHDi 150	110	06/13→		09/13→			24.4155-1311.3 011053	ATE Ø 25,4 ohne Bremsflüssigkeitsbehälter
CITROËN - C4 PICASSO I Großraumlimousine (UD_) 10/06→12/15								
 Bremskraftverstärker								
1.6 16V 1.6 HDi 1.6 HDi 110 1.6 THP 140 1.6 THP 155 1.6 VTi 120 2.0 HDi 138 2.0 HDi 150 2.0 HDi 165	110 80 82 103 115 88 100 110 120	07/08→08/13 02/07→08/13 09/10→08/13 07/08→08/13 09/10→08/13 07/08→08/13 10/06→08/13 07/09→08/13 09/10→08/13					03.7860-4034.4 300318	ATE Ø 10" pneumatisch
→								









	kw			 	! #		
CITROËN - C4 PICASSO I Großraumlimousine (UD_) 10/06→12/15							
 Bremskraftverstärker							
1.8 Bifuel	92	01/09→10/12				03.7870-1002.4 300282	ATE Ø 11" pneumatisch
1.8 i 16V	92	02/07→12/11					
2.0 i 16V	105	05/08→05/13					
2.0 i 16V	103	09/07→08/13		→ 07/13		03.7870-1002.4 300282	ATE Ø 11" pneumatisch
 Hauptbremszylinder							
1.6 16V	110	07/08→08/13		→ 07/13		03.4153-0173.3 010815	ATE Ø 23,8
1.6 HDi	80	02/07→08/13					
1.6 THP 140	103	07/08→08/13					
1.6 VTi 120	88	07/08→08/13					
2.0 HDi 150	110	07/09→08/13					
2.0 i 16V	103	09/07→08/13					
1.6 HDi 110	82	09/10→08/13		11/10→ 07/13		03.4153-0173.3 010815	ATE Ø 23,8
1.6 THP 155	115	09/10→08/13					
2.0 HDi 165	120	09/10→08/13					
1.8 Bifuel	92	01/09→10/12				03.4153-0173.3 010815	ATE Ø 23,8
1.8 i 16V	92	02/07→12/11					
2.0 i 16V	105	05/08→05/13					
2.0 HDi 138	100	10/06→08/13		02/07→ 07/13		03.4153-0173.3 010815	ATE Ø 23,8
CITROËN - C4 PICASSO II 01/13→							
 Hauptbremszylinder							
1.2 THP 110	81	04/16→				24.4155-1311.3 011053	ATE Ø 25,4 ohne Bremsflüssigkeitsbehälter
1.2 THP 130	96	04/14→					
1.6 BlueHDi 100	73	12/14→					
1.6 BlueHDi 120	88	07/14→					
1.6 THP 150	110	09/14→					
1.6 THP 165	121	07/14→					
1.6 VTi 120	88	02/13→					
2.0 BlueHDi 135	100	09/13→					
2.0 BlueHDi 150	110	09/13→					
1.6 HDi / BlueHDi 115	85	02/13→		06/13→		24.4155-1311.3 011053	ATE Ø 25,4 ohne Bremsflüssigkeitsbehälter
1.6 HDi 90	68	02/13→					
1.6 THP 155	115	02/13→					
CITROËN - C4 PICASSO II Van (DD_) 01/13→							
 Hauptbremszylinder							
BlueHDi 150	110	09/13→				24.4155-1311.3 011053	ATE Ø 25,4 ohne Bremsflüssigkeitsbehälter
THP 155	115	02/13→					
VTi 120	88	02/13→					
e-HDi	85	02/13→		08/13→		24.4155-1311.3 011053	ATE Ø 25,4 ohne Bremsflüssigkeitsbehälter
HDi / e-HDi	68	02/13→					
CITROËN - C4 SPACETOURER (3D_) 04/18→							
 Hauptbremszylinder							
1.2 PureTech 110	81	04/18→				24.4155-1311.3 011053	ATE Ø 25,4 ohne Bremsflüssigkeitsbehälter
1.2 PureTech 130	96	04/18→					
1.5 BlueHDi 130	96	05/18→					
1.6 BlueHDi 100	73	04/18→					
1.6 BlueHDi 120	88	04/18→					
1.6 THP 165	121	04/18→					
2.0 BlueHDi 150	110	04/18→					
2.0 BlueHDi 160	120	04/18→					
CITROËN - C4 SPACETOURER Van (3D_) 04/18→							
 Hauptbremszylinder							
BlueHDi 120	88	05/19→				24.4155-1311.3 011053	ATE Ø 25,4 ohne Bremsflüssigkeitsbehälter
BlueHDi 130	96	05/19→					
PureTech 130	96	05/19→					
CITROËN - C5 III (RD_) 02/08→							
 Bremskraftverstärker							
1.6	120	03/11→		für Linkslenker		03.7860-7802.4 300280	ATE Ø 10" pneumatisch
1.6 HDi 110	80	02/08→					
1.6 THP 150	110	07/10→					
1.6 THP 155	115	04/09→					
1.6 VTi 120	88	07/10→					
1.8 16V	92	02/08→					
2.0 16V	103	02/08→					
2.0 16V BioFlex	103	02/08→12/12					
2.0 HDi	100 - 101	02/08→					
2.0 HDi 140	103	11/08→					
2.0 HDi 165	120	04/09→					
→							

	kw			 	! #		
CITROËN - C5 III (RD_) 02/08→							
 Bremskraftverstärker							
2.2 HDi	120 - 125	02/08→12/11		für Linkslenker		03.7860-7802.4 300280	ATE Ø 10" pneumatisch
2.2 HDi 200	150	07/10→					
2.7 HDi	150	02/08→					
3.0 HDi 240	177	04/09→10/14					
3.0 V6	155	02/08→					
1.6 HDi 110	82	07/10→		für Linkslenker; für Fahrzeuge ohne Start-Stopp-Funktion		03.7860-7802.4 300280	ATE Ø 10" pneumatisch
1.6 HDi 115	84	01/12→					
2.0 HDi 180	133	03/15→					
 Hauptbremszylinder							
1.6	120	03/11→		Orga 12348→		03.2123-3131.3 010977	ATE Ø 23,8
1.6 HDi 110	80 - 82	02/08→					
1.6 THP 150	110	07/10→					
1.6 THP 155	115	04/09→					
1.6 VTi 120	88	07/10→					
1.8 16V	92	02/08→					
2.0 16V	103	02/08→					
2.0 16V BioFlex	103	02/08→12/12					
2.0 HDi	100 - 101	02/08→					
2.0 HDi 140	103	11/08→					
2.0 HDi 165	120	04/09→					
2.2 HDi	120 - 125	02/08→12/11					
2.2 HDi 200	150	07/10→					
2.7 HDi	150	02/08→					
3.0 HDi 240	177	04/09→10/14					
3.0 V6	155	02/08→					
1.6 HDi 115	84	01/12→				03.2123-3131.3 010977	ATE Ø 23,8
2.0 HDi 150 / BlueHDi 150	110	04/09→02/15					
2.0 HDi 180	133	03/15→					
CITROËN - C5 III Break (RW_) 02/08→							
 Bremskraftverstärker							
1.6 HDi 110	80	02/08→		für Linkslenker		03.7860-7802.4 300280	ATE Ø 10" pneumatisch
1.6 THP 150	110	04/09→					
1.6 THP 155	115	04/09→					
1.6 VTi 120	88	07/10→					
1.8 16V	92	02/08→12/09					
2.0 16V	103	02/08→12/11					
2.0 16V BioFlex	103	02/08→					
2.0 HDi	100	02/08→					
2.0 HDi 140	103	04/09→					
2.0 HDi 150 / BlueHDi 150	110	04/09→02/15					
2.0 HDi 165	120	04/09→					
2.2 HDi	125	02/08→12/11					
2.2 HDi 165	120	02/08→					
2.2 HDi 200	150	07/10→					
2.7 HDi	150	02/08→					
3.0 HDi 240	177	04/09→10/14					
3.0 V6	155	02/08→12/10					
1.6 HDi 110	82	07/10→		für Linkslenker; für Fahrzeuge ohne Start-Stopp-Funktion		03.7860-7802.4 300280	ATE Ø 10" pneumatisch
1.6 HDi 115	84	01/12→					
2.0 HDi 180	133	03/15→					
 Hauptbremszylinder							
1.6 HDi 110	80	02/08→		01/12→		03.2123-3131.3 010977	ATE Ø 23,8
1.6 HDi 110	82	07/10→		Orga 12348→		03.2123-3131.3 010977	ATE Ø 23,8
1.6 HDi 115	84	01/12→					
1.6 THP 150	110	04/09→					
1.6 THP 155	115	04/09→					
1.6 VTi 120	88	07/10→					
1.8 16V	92	02/08→12/09					
2.0 16V	103	02/08→12/11					
2.0 16V BioFlex	103	02/08→					
2.0 HDi	100	02/08→					
2.0 HDi 140	103	04/09→					
2.0 HDi 150 / BlueHDi 150	110	04/09→02/15					
2.0 HDi 165	120	04/09→					
2.2 HDi	125	02/08→12/11					
2.2 HDi 165	120	02/08→					
2.2 HDi 200	150	07/10→					
2.7 HDi	150	02/08→					
3.0 HDi 240	177	04/09→10/14					
3.0 V6	155	02/08→12/10					
2.0 HDi 180	133	03/15→				03.2123-3131.3 010977	ATE Ø 23,8

	kw					! #		
CITROËN - C6 (TD_) 09/05→12/12								
 Bremskraftverstärker								
2.2 HDi	120 - 125	06/06→12/12		für Linkslenker; →Orga 11192		03.7860-3402.4 300217		ATE Ø 10" pneumatisch
				Orga 12047→; für Linkslenker		03.7860-8002.4 300258		ATE Ø 10" pneumatisch
2.7 HDi	150	09/05→12/11		→Orga 11073; für Linkslenker		03.7860-3402.4 300217		ATE Ø 10" pneumatisch
3.0 HDi	155	06/09→12/10		für Linkslenker		03.7860-8002.4 300258		ATE Ø 10" pneumatisch
3.0 HDi	177	04/09→12/12		07/09→; für Linkslenker		03.7860-8002.4 300258		ATE Ø 10" pneumatisch
3.0 V6	155	09/05→12/12		für Linkslenker; →Orga 11192		03.7860-3402.4 300217		ATE Ø 10" pneumatisch
 Hauptbremszylinder								
2.2 HDi	120 - 125	06/06→12/12		Orga 12348→		03.2123-3131.3 010977		ATE Ø 23,8
2.7 HDi	150	09/05→12/11						
3.0 HDi	155 - 177	04/09→12/12						
3.0 V6	155	09/05→12/12						
CITROËN - C8 (EA_, EB_) 06/02→								
 Bremskraftverstärker								
2.0 16V	103	09/05→		→Orga 10919; für Linkslenker		03.7860-2002.4 300216		ATE Ø 10" pneumatisch
2.0 HDi 135	100	03/06→		Orga 10920→; für Linkslenker; → 07/14		03.7860-4432.4 300313		ATE Ø 10" pneumatisch
2.0 HDi	79 - 81	07/02→		Orga 10528→; für Linkslenker; → 07/14		03.7860-2002.4 300216		ATE Ø 10" pneumatisch
2.2 HDi	94	07/02→						
2.0 HDi	88	07/06→		02/07→; für Linkslenker; → 07/14		03.7860-4432.4 300313		ATE Ø 10" pneumatisch
 Hauptbremszylinder								
2.0 16V	103	09/05→		→ 07/14		03.2122-2163.3 010800		ATE Ø 22,2
2.0 HDi 135	100	03/06→						
2.0 HDi	79 - 81	07/02→		Orga 10528→; → 07/14		03.2122-2163.3 010800		ATE Ø 22,2
2.2 HDi	94	07/02→						
2.0 HDi	88	07/06→		02/07→ 07/14		03.2122-2163.3 010800		ATE Ø 22,2
2.0 HDi 165	120	03/06→		→ 07/14		03.2123-3421.3 010933		ATE Ø 23,8
2.2 HDi	120	06/07→						
2.2 HDi	125	06/06→12/12				03.2123-3421.3 010933		ATE Ø 23,8
CITROËN - C8 Van (EA_, EB_) 06/02→								
 Bremskraftverstärker								
2.0	103	06/04→12/11		→Orga 10919; für Linkslenker		03.7860-2002.4 300216		ATE Ø 10" pneumatisch
				Orga 10920→; für Linkslenker		03.7860-4432.4 300313		ATE Ø 10" pneumatisch
HDi	94	11/03→07/06		Orga 10528→; für Linkslenker		03.7860-2002.4 300216		ATE Ø 10" pneumatisch
HDi 110	81	11/03→12/09						
 Hauptbremszylinder								
2.0	103	06/04→12/11				03.2122-2163.3 010800		ATE Ø 22,2
HDi	94	11/03→07/06		Orga 10528→		03.2122-2163.3 010800		ATE Ø 22,2
HDi 110	81	11/03→12/09						
CITROËN - C15 Kasten/Großraumlimousine (VD_) 10/84→10/06								
 Hauptbremszylinder								
1.0	33	10/84→12/97		→Orga 04195; für Rechtslenker		24.2119-1705.3 010460		Ø 19
 Bremskraftregler								
1.0	33	10/84→12/97				24.6512-1507.3 320023		lastabhängig 3x
1.8 D	44	07/86→12/00						
1.9 D	44 - 51	01/00→12/05						
CITROËN - C15 Kombi 04/87→08/00								
 Bremskraftregler								
1.8 D	44	04/87→08/00				24.6512-1507.3 320023		lastabhängig 3x
CITROËN - C15 Pritsche/Fahrgestell (VDPD) 11/92→10/02								
 Bremskraftregler								
1.8 D	44	11/92→05/00				24.6512-1507.3 320023		lastabhängig 3x
1.9 D	51	09/00→10/02						

	kw			 	! #		
CITROËN - C-ELYSEE (DD_) 11/12→							
 Hauptbremszylinder							
1.2 PureTech 82	61	02/18→		+ ESP; Schaltgetriebe	24.4122-1703.3	010843	TRW Ø 22,2
1.2 VTi 82	60	12/14→		+ ABS / - ESP; Schaltgetriebe	24.4122-1704.3	010847	TRW Ø 22,2
1.6 BlueHDi 100	73	11/14→					
1.2 VTi 72	53	11/12→01/17		+ ESP; Orga 13342→; Schaltgetriebe	24.4122-1703.3	010843	TRW Ø 22,2
1.6 VTi 115	85	11/12→		+ ABS / - ESP; Schaltgetriebe; Orga 13342→	24.4122-1704.3	010847	TRW Ø 22,2
1.5 BlueHDi 100	75	05/18→		+ ESP; Schaltgetriebe	24.4122-1703.3	010843	TRW Ø 22,2
				- ESP; Schaltgetriebe	24.4122-1704.3	010847	TRW Ø 22,2
1.6 HDi 92	68	11/12→		+ ESP	24.4122-1703.3	010843	TRW Ø 22,2
				+ ABS / - ESP; Orga 13342→	24.4122-1704.3	010847	TRW Ø 22,2
CITROËN - DS3 (SA_) 11/09→12/16							
 Hauptbremszylinder							
1.4 HDi 70	50	04/10→07/15		12999→ 13341	24.4123-1704.3	010828	TRW Ø 23,8
1.6 HDi 110	82	11/09→07/15					
1.6 HDi 90	68	11/09→07/15					
1.6 Racing	149 - 152	02/11→07/15					
1.6 THP 150	110	01/10→07/15					
1.6 THP 155	115	04/10→07/15					
1.6 VTi 120	88	04/10→07/15					
1.4 VTi 95	70	04/10→07/15		12999→ 13341	24.4122-1703.3	010843	TRW Ø 22,2
1.4 VTi 95 LPG	70	08/12→07/15					
1.4 VTi 98	72	11/09→07/15					
1.6 HDi 115	84	08/12→07/15		→Orga 13341	24.4123-1704.3	010828	TRW Ø 23,8
CITROËN - DS3 Cabriolet 01/13→07/15							
 Hauptbremszylinder							
1.2 THP 110	81	10/14→07/15			24.4123-1704.3	010828	TRW Ø 23,8
1.6 BlueHDi 100	73 - 75	07/14→07/15					
1.6 BlueHDi 115	85	10/13→07/15					
1.6 BlueHDi 120	88	07/14→07/15					
1.6 Racing	149 - 152	03/14→07/15					
1.6 THP 165	120 - 121	10/14→07/15					
1.6 HDi 90	68	01/13→07/15		03/13→	24.4123-1704.3	010828	TRW Ø 23,8
1.6 THP 150	110	01/13→07/15					
1.6 THP 155	115	01/13→07/15					
1.6 VTi 120	88	01/13→07/15					
CITROËN - DS5 09/11→12/16							
 Bremskraftverstärker							
1.6 BlueHDi 120	88	07/14→07/15		für Fahrzeuge mit Start-Stopp-Funktion	03.7860-3734.4	300317	ATE Ø 10" pneumatisch
1.6 HDi	85	11/13→07/15					
1.6 HDi 110	82	11/11→07/15					
1.6 THP 150	110	11/11→07/15					
1.6 THP 155	115	11/11→07/15					
1.6 THP 165	121	01/12→07/15					
1.6 THP 165 Hybrid	121	06/12→07/15					
1.6 THP 200	147	11/11→07/15					
2.0 BlueHDi 150	110	07/14→07/15					
2.0 BlueHDi 180	133	08/13→07/15					
2.0 HDi 135	100	11/11→07/15					
2.0 HDi 165	120	11/11→07/15					
1.6 HDi 115	84	06/12→07/15		08/12→; für Fahrzeuge mit Start-Stopp-Funktion	03.7860-3734.4	300317	ATE Ø 10" pneumatisch
2.0 HDi 200 Hybrid4 All-wheel Drive	147	12/11→07/15			03.7860-3734.4	300317	ATE Ø 10" pneumatisch
 Hauptbremszylinder							
1.6 BlueHDi 120	88	07/14→07/15		82 mm Radnabendurchmesser [mm]	03.4153-0173.3	010815	ATE Ø 23,8
1.6 HDi	85	11/13→07/15					
1.6 HDi 110	82	11/11→07/15		83 mm Radnabendurchmesser [mm]	24.4155-1236.3	011049	ATE Ø 25,4 ohne Bremsflüssigkeitsbehälter
1.6 THP 150	110	11/11→07/15					
1.6 THP 155	115	11/11→07/15					
1.6 THP 165	121	01/12→07/15					
1.6 THP 165 Hybrid	121	06/12→07/15					
1.6 THP 200	147	11/11→07/15					
2.0 BlueHDi 150	110	07/14→07/15					
2.0 BlueHDi 180	133	08/13→07/15					
2.0 HDi 135	100	11/11→07/15					
2.0 HDi 165	120	11/11→07/15					
2.0 HDi 200 Hybrid4 All-wheel Drive	147	12/11→07/15					
→							

	kw					! #		
CITROËN - DS5 09/11→12/16								
 Hauptbremszylinder								
1.6 HDi 115	84	06/12→07/15		08/12→; 82 mm Radnabendurchmesser [mm]		03.4153-0173.3	010815	ATE Ø 23,8
				08/12→; 83 mm Radnabendurchmesser [mm]		24.4155-1236.3	011049	ATE Ø 25,4 ohne Bremsflüssigkeitsbehälter
CITROËN - EVASION Großraumlimousine (22, U6) 03/94→07/02								
 Hauptbremszylinder								
1.8	73	05/97→07/02		→Orga 08206; - ABS		24.2122-1703.3	010422	Ø 22,2
				→Orga 08206; + ABS		24.2122-1708.3	010437	Ø 22,2
				Orga 08207→; - ABS		24.2122-1741.3	010695	Ø 22,2
1.9 TD	66	11/94→07/02		02/95→; →Orga 08206; - ABS		24.2123-1707.3	010492	Ø 23,8
				Orga 08207→; + ABS		24.2123-1733.3	010657	BOS Ø 23,8
				Orga 08207→; - ABS		24.2123-1738.3	010658	Ø 23,8
1.9 TD	68	10/95→12/98		- ABS		24.2123-1707.3	010492	Ø 23,8
2.0	89	06/94→07/02		→Orga 08206; - ABS		24.2123-1707.3	010492	Ø 23,8
2.0 16V	100	05/00→07/02		Orga 08207→; + ABS		24.2123-1733.3	010657	BOS Ø 23,8
2.0 Turbo C.T.	108	06/94→07/02		Orga 08207→; - ABS		24.2123-1738.3	010658	Ø 23,8
2.1 TD	80	05/96→07/02		Orga 08207→; - ABS		24.2123-1738.3	010658	Ø 23,8
2.0 16V	97	05/98→04/00		12/98→; →Orga 08206; - ABS		24.2123-1707.3	010492	Ø 23,8
				Orga 08207→; + ABS		24.2123-1733.3	010657	BOS Ø 23,8
				Orga 08207→; - ABS		24.2123-1738.3	010658	Ø 23,8
2.0 HDI	80 - 81	08/99→07/02		+ ABS		24.2123-1733.3	010657	BOS Ø 23,8
2.0 HDI 16V	80	09/99→07/02		- ABS		24.2123-1738.3	010658	Ø 23,8
CITROËN - GRAND C4 SPACETOURER (3A_, 3E_) 04/18→								
 Hauptbremszylinder								
1.2 PureTech 130	96	04/18→				24.4155-1311.3	011053	ATE Ø 25,4 ohne Bremsflüssigkeitsbehälter
1.5 BlueHDi 130	96	05/18→						
1.6 BlueHDi 100	73	04/18→						
1.6 BlueHDi 120	88	04/18→						
1.6 HDi 115	85	04/18→						
1.6 PureTech 180	133	04/18→						
1.6 THP 165	110 - 121	04/18→						
2.0 BlueHDi 150	110	04/18→						
2.0 BlueHDi 160	120	04/18→						
CITROËN - GRAND C4 SPACETOURER Van (3A_, 3E_) 04/18→								
 Hauptbremszylinder								
BlueHDi 130	96	05/19→				24.4155-1311.3	011053	ATE Ø 25,4 ohne Bremsflüssigkeitsbehälter
BlueHDi 160	120	05/19→						
PureTech 130	96	05/19→						
CITROËN - JUMPER Bus 04/06→								
 Hauptbremszylinder								
2.2 HDi 100	74	04/06→		Nutzlast ab [kg] 1.200 Nutzlast bis [kg] 1.400; + DSC; nicht für Facelift; Nutzlast-Code: 12Q / 14Q		24.4125-1701.3	010867	BOS Ø 25,4 ohne Bremsflüssigkeitsbehälter
2.2 HDi 110	81	07/11→						
2.2 HDi 120	88	04/06→						
2.2 HDi 130	96	07/11→		Nutzlast ab [kg] 1.200 Nutzlast bis [kg] 1.400; - DSC; nicht für Facelift; Nutzlast-Code: 12Q / 14Q		24.4125-1702.3	010872	BOS Ø 25,4 ohne Bremsflüssigkeitsbehälter
2.2 HDi 150	110	07/11→						
3.0 HDi 155	115	07/10→						
3.0 HDi 160	116	09/06→		Nutzlast ab [kg] 1.600 Nutzlast bis [kg] 2.000; + DSC; nicht für Facelift; Nutzlast-Code: 16Q / 20Q		24.4126-1701.3	010868	BOS Ø 27 ohne Bremsflüssigkeitsbehälter
3.0 HDi 180	130	07/11→		Nutzlast ab [kg] 1.600 Nutzlast bis [kg] 2.000; - DSC; nicht für Facelift; Nutzlast-Code: 16Q / 20Q		24.4126-1702.3	010875	BOS Ø 27 ohne Bremsflüssigkeitsbehälter
CITROËN - JUMPER Bus (230P) 02/94→04/02								
 Hauptbremszylinder								
1.9 D	51	01/99→04/02		→ S 15064995; Nutzlast [kg]: 1.000; für Linkslenker; - ABS		24.2122-1715.3	010481	Ø 22,2
				S 15064996→ S 16206233; Nutzlast [kg]: 1.000; + ABS		24.2125-1702.3	010482	Ø 25,4
				S 15064996→ S 16205754; Nutzlast [kg]: 1.000; für Linkslenker; - ABS		24.2125-1703.3	010483	Ø 25,4
				S 16205755→; → 03/02; Nutzlast [kg]: 1.000; - ABS		24.2125-1725.3	010717	Ø 25,4
				S 16206234→; → 03/02; Nutzlast [kg]: 1.000; + ABS		24.2125-1726.3	010718	Ø 25,4
→								

	kw			 	! #		
CITROËN - JUMPER Bus (230P) 02/94→04/02							
 Hauptbremszylinder							
1.9 TD	66	02/94→04/02		→ S 15064995; Nutzlast ab [kg] 1.000 Nutzlast bis [kg] 1.400; für Linkslenker; - ABS		24.2122-1715.3 010481	Ø 22,2
1.9 TD 4x4	68	08/96→04/02		S 15064996→ S 16206233; Nutzlast ab [kg] 1.000 Nutzlast bis [kg] 1.400; + ABS		24.2125-1702.3 010482	Ø 25,4
	68			S 15064996→ S 16205754; Nutzlast ab [kg] 1.000 Nutzlast bis [kg] 1.400; für Linkslenker; - ABS		24.2125-1703.3 010483	Ø 25,4
				S 16205755→; → 03/02; Nutzlast ab [kg] 1.000 Nutzlast bis [kg] 1.400; - ABS		24.2125-1725.3 010717	Ø 25,4
				S 16206234→; → 03/02; Nutzlast ab [kg] 1.000 Nutzlast bis [kg] 1.400; + ABS		24.2125-1726.3 010718	Ø 25,4
2.0	80	02/94→04/02		→ S 15064995; Nutzlast [kg]: 1.000; für Linkslenker; - ABS		24.2122-1715.3 010481	Ø 22,2
				S 15064996→ S 16206233; Nutzlast ab [kg] 1.000 Nutzlast bis [kg] 1.400; + ABS		24.2125-1702.3 010482	Ø 25,4
				→ S 16194399; Nutzlast [kg]: 1.800; + ABS		24.2125-1702.3 010482	Ø 25,4
				→ S 16205754; Nutzlast [kg]: 1.800; für Linkslenker; - ABS		24.2125-1703.3 010483	Ø 25,4
				S 15064996→ S 16205754; Nutzlast ab [kg] 1.000 Nutzlast bis [kg] 1.400; für Linkslenker; - ABS		24.2125-1703.3 010483	Ø 25,4
				S 16205755→; → 03/02; Nutzlast ab [kg] 1.000 Nutzlast bis [kg] 1.400; - ABS		24.2125-1725.3 010717	Ø 25,4
				S 16205353→; → 03/02; Nutzlast [kg]: 1.800; - ABS		24.2125-1725.3 010717	Ø 25,4
				S 16194400→; → 03/02; Nutzlast [kg]: 1.800; + ABS		24.2125-1726.3 010718	Ø 25,4
				S 16206234→; → 03/02; Nutzlast ab [kg] 1.000 Nutzlast bis [kg] 1.400; + ABS		24.2125-1726.3 010718	Ø 25,4
2.0 4x4	80	08/96→04/02		S 15064996→ S 16206233; Nutzlast ab [kg] 1.000 Nutzlast bis [kg] 1.400; + ABS		24.2125-1702.3 010482	Ø 25,4
				S 15064996→ S 16205754; Nutzlast ab [kg] 1.000 Nutzlast bis [kg] 1.400; für Linkslenker; - ABS		24.2125-1703.3 010483	Ø 25,4
				S 16205755→; → 03/02; Nutzlast ab [kg] 1.000 Nutzlast bis [kg] 1.400; - ABS		24.2125-1725.3 010717	Ø 25,4
				S 16206234→; → 03/02; Nutzlast ab [kg] 1.000 Nutzlast bis [kg] 1.400; + ABS		24.2125-1726.3 010718	Ø 25,4
2.5 D	63	08/94→04/02		→ S 15064995; Nutzlast [kg]: 1.400; für Linkslenker; - ABS		24.2122-1715.3 010481	Ø 22,2
2.5 TD	76	08/94→04/02		→ S 16194399; Nutzlast [kg]: 1.800; + ABS		24.2125-1702.3 010482	Ø 25,4
				S 15064996→ S 16206233; Nutzlast [kg]: 1.400; + ABS		24.2125-1702.3 010482	Ø 25,4
				→ S 16205754; Nutzlast [kg]: 1.800; für Linkslenker; - ABS		24.2125-1703.3 010483	Ø 25,4
				S 15064996→ S 16205754; Nutzlast [kg]: 1.400; für Linkslenker; - ABS		24.2125-1703.3 010483	Ø 25,4
				S 16205755→; → 03/02; Nutzlast [kg]: 1.400; - ABS		24.2125-1725.3 010717	Ø 25,4
				S 16205353→; → 03/02; Nutzlast [kg]: 1.800; - ABS		24.2125-1725.3 010717	Ø 25,4
				S 16206234→; → 03/02; Nutzlast [kg]: 1.400; + ABS		24.2125-1726.3 010718	Ø 25,4
				S 16194400→; → 03/02; Nutzlast [kg]: 1.800; + ABS		24.2125-1726.3 010718	Ø 25,4
2.5 TDi	79	12/96→11/00		→ S 16194399; Nutzlast [kg]: 1.800; + ABS		24.2125-1702.3 010482	Ø 25,4
				S 15064996→ S 16206233; Nutzlast [kg]: 1.400; + ABS		24.2125-1702.3 010482	Ø 25,4
				→ S 16205754; Nutzlast ab [kg] 1.400 Nutzlast bis [kg] 1.800; für Linkslenker; - ABS		24.2125-1703.3 010483	Ø 25,4
				S 16205353→; Nutzlast [kg]: 1.800; - ABS		24.2125-1725.3 010717	Ø 25,4
				S 16205755→; Nutzlast [kg]: 1.400; - ABS		24.2125-1725.3 010717	Ø 25,4
				S 16206234→; Nutzlast [kg]: 1.400; + ABS		24.2125-1726.3 010718	Ø 25,4
				S 16194400→; Nutzlast [kg]: 1.800; + ABS		24.2125-1726.3 010718	Ø 25,4
2.5 TDi 4x4	79	12/96→11/00		→ S 16205754; Nutzlast ab [kg] 1.400 Nutzlast bis [kg] 1.800; für Linkslenker; - ABS		24.2125-1703.3 010483	Ø 25,4
2.8 HDi 4x4	94	09/00→04/02					
→							

CITROËN - JUMPER Bus (230P) 02/94→04/02

Hauptbremszylinder

2.8 D	64	01/99→02/02	→ S 15064995; Nutzlast [kg]: 1.400; für Linkslenker; - ABS	24.2122-1715.3	010481	Ø 22,2
			→ S 16194399; Nutzlast [kg]: 1.800	24.2125-1702.3	010482	Ø 25,4
			S 15064996→ S 16206253; Nutzlast [kg]: 1.400; + ABS	24.2125-1702.3	010482	Ø 25,4
			→ S 16205352; Nutzlast [kg]: 1.800; für Linkslenker; - ABS	24.2125-1703.3	010483	Ø 25,4
			S 15064996→ S 16205754; Nutzlast [kg]: 1.400; für Linkslenker; - ABS	24.2125-1703.3	010483	Ø 25,4
			S 16205755→; Nutzlast [kg]: 1.400; - ABS	24.2125-1725.3	010717	Ø 25,4
			S 16205353→; Nutzlast [kg]: 1.800; - ABS	24.2125-1725.3	010717	Ø 25,4
			S 16194400→; Nutzlast [kg]: 1.800; + ABS	24.2125-1726.3	010718	Ø 25,4
2.8 HDi	94	09/00→04/02	S 16206254→; Nutzlast [kg]: 1.400; + ABS	24.2125-1726.3	010718	Ø 25,4
			→ S 16206233; Nutzlast [kg]: 1.400; + ABS	24.2125-1702.3	010482	Ø 25,4
			→ S 16194399; Nutzlast [kg]: 1.800; + ABS	24.2125-1702.3	010482	Ø 25,4
			→ S 16205754; Nutzlast ab [kg] 1.400 Nutzlast bis [kg] 1.800; für Linkslenker; - ABS	24.2125-1703.3	010483	Ø 25,4
			S 16205353→; → 03/02; Nutzlast [kg]: 1.800; - ABS	24.2125-1725.3	010717	Ø 25,4
			S 16205755→; → 03/02; Nutzlast [kg]: 1.400; - ABS	24.2125-1725.3	010717	Ø 25,4
			S 16194400→; → 03/02; Nutzlast [kg]: 1.800; + ABS	24.2125-1726.3	010718	Ø 25,4
			S 16206234→; → 03/02; Nutzlast [kg]: 1.400; + ABS	24.2125-1726.3	010718	Ø 25,4

Bremskraftregler

1.9 D	51	01/99→04/02	→ S 16206244; Nutzlast [kg]: 1.000; - ABS	24.6512-1701.3	320153	lastabhängig 2x
1.9 TD	66 - 68	02/94→04/02	→ S 16206244; Nutzlast ab [kg] 1.000 Nutzlast bis [kg] 1.400; - ABS	24.6512-1701.3	320153	lastabhängig 2x
1.9 TD 4x4	68	08/96→04/02				
2.0	80	02/94→04/02	→ S 16206244; Nutzlast ab [kg] 1.000 Nutzlast bis [kg] 1.800; - ABS	24.6512-1701.3	320153	lastabhängig 2x
2.0 4x4	80	08/96→04/02				
2.5 D	63	08/94→04/02	→ S 16206244; Nutzlast ab [kg] 1.400 Nutzlast bis [kg] 1.800; - ABS	24.6512-1701.3	320153	lastabhängig 2x
2.5 D 4x4	63	08/96→04/02				
2.5 TD	76	08/94→04/02				
2.5 TD 4x4	76	08/96→04/02				
2.8 D	64	01/99→02/02				
2.8 HDi	94	09/00→04/02				
2.8 HDi 4x4	94	09/00→04/02				
2.5 TDi	79	12/96→11/00	Nutzlast ab [kg] 1.400 Nutzlast bis [kg] 1.800; - ABS	24.6512-1701.3	320153	lastabhängig 2x
2.5 TDi 4x4	79	12/96→11/00				

CITROËN - JUMPER Bus (244, Z_) 04/02→

Hauptbremszylinder

2.0	81	04/02→06/06	→ 03/06; Nutzlast ab [kg] 1.000 Nutzlast bis [kg] 1.800; - ABS	24.2125-1725.3	010717	Ø 25,4
2.0 HDi	62	04/02→06/06				
2.2 HDi	74	04/02→06/06				
2.8 HDi	94	04/02→06/06				
2.0 bivalent	81	02/03→06/06	→ S 15064995; Nutzlast [kg]: 1.000; für Linkslenker; - ABS	24.2122-1715.3	010481	Ø 22,2
2.8 HDi All-wheel Drive	94	04/02→06/06	→ 03/06; - ABS	24.2125-1725.3	010717	Ø 25,4
			→ 03/06; + ABS	24.2125-1726.3	010718	Ø 25,4









Bremskraftregler









2.8 HDi All-wheel Drive	94	04/02→06/06	→ 03/06; Nutzlast ab [kg] 1.000 Nutzlast bis [kg] 1.800; - ABS	24.6512-1701.3	320153	lastabhängig 2x
-------------------------	----	-------------	----------------------------------------------------------------	----------------	--------	-----------------











CITROËN - JUMPER Kasten 04/06→

Hauptbremszylinder

2.2 HDi 100	74	04/06→12/12	Nutzlast ab [kg] 1.200 Nutzlast bis [kg] 1.400; + DSC; nicht für Facelift; Nutzlast-Code: 12Q / 14Q	24.4125-1701.3	010867	BOS Ø 25,4 ohne Bremsflüssigkeitsbehälter
2.2 HDi 110	81	07/11→				
2.2 HDi 120	88	04/06→				
2.2 HDi 130	96	07/11→				
2.2 HDi 130 4x4	96	01/12→05/16	Nutzlast ab [kg] 1.200 Nutzlast bis [kg] 1.400; - DSC; nicht für Facelift; Nutzlast-Code: 12Q / 14Q	24.4125-1702.3	010872	BOS Ø 25,4 ohne Bremsflüssigkeitsbehälter
2.2 HDi 150	110	07/11→				

	kw			 	! #		
CITROËN - JUMPER Kasten 04/06→							
 Hauptbremszylinder							
3.0 HDi 145	107	07/10→		Nutzlast ab [kg] 1.600 Nutzlast bis [kg] 2.000; + DSC; nicht für Facelift; Nutzlast-Code: 16Q / 20Q	24.4126-1701.3	010868	BOS Ø 27 ohne Bremsflüssigkeitsbehälter
3.0 HDi 155	115	07/10→					
3.0 HDi 160	116	09/06→					
3.0 HDi 180	130	07/11→		Nutzlast ab [kg] 1.600 Nutzlast bis [kg] 2.000; - DSC; nicht für Facelift; Nutzlast-Code: 16Q / 20Q	24.4126-1702.3	010875	BOS Ø 27 ohne Bremsflüssigkeitsbehälter
CITROËN - JUMPER Kasten (230L) 02/94→08/02							
 Hauptbremszylinder							
1.9 D	50 - 51	02/94→04/02		→ S 15064995; Nutzlast [kg]: 1.000; für Linkslenker; - ABS	24.2122-1715.3	010481	Ø 22,2
				S 15064996→ S 16206233; Nutzlast [kg]: 1.000; + ABS	24.2125-1702.3	010482	Ø 25,4
				S 15064996→ S 16205754; Nutzlast [kg]: 1.000; für Linkslenker; - ABS	24.2125-1703.3	010483	Ø 25,4
				S 16205755→; → 03/02; Nutzlast [kg]: 1.000; - ABS	24.2125-1725.3	010717	Ø 25,4
				S 16206234→; → 03/02; Nutzlast [kg]: 1.000; + ABS	24.2125-1726.3	010718	Ø 25,4
1.9 TD	66 - 68	03/94→04/02		→ S 15064995; Nutzlast ab [kg] 1.000 Nutzlast bis [kg] 1.400; für Linkslenker; - ABS	24.2122-1715.3	010481	Ø 22,2
				S 15064996→ S 16206233; Nutzlast ab [kg] 1.000 Nutzlast bis [kg] 1.400; + ABS	24.2125-1702.3	010482	Ø 25,4
				S 15064996→ S 16205754; Nutzlast ab [kg] 1.000 Nutzlast bis [kg] 1.400; für Linkslenker; - ABS	24.2125-1703.3	010483	Ø 25,4
				S 16205755→; → 03/02; Nutzlast ab [kg] 1.000 Nutzlast bis [kg] 1.400; - ABS	24.2125-1725.3	010717	Ø 25,4
				S 16206234→; → 03/02; Nutzlast ab [kg] 1.000 Nutzlast bis [kg] 1.400; + ABS	24.2125-1726.3	010718	Ø 25,4
2.0	80	03/94→04/02		→ S 15064995; Nutzlast ab [kg] 1.000 Nutzlast bis [kg] 1.400; für Linkslenker; - ABS	24.2122-1715.3	010481	Ø 22,2
				S 15064996→ S 16206233; Nutzlast ab [kg] 1.000 Nutzlast bis [kg] 1.400; + ABS	24.2125-1702.3	010482	Ø 25,4
				→ S 16194399; Nutzlast [kg]: 1.800; + ABS	24.2125-1702.3	010482	Ø 25,4
				→ S 16205754; Nutzlast [kg]: 1.800; für Linkslenker; - ABS	24.2125-1703.3	010483	Ø 25,4
				S 15064996→ S 16205754; Nutzlast ab [kg] 1.000 Nutzlast bis [kg] 1.400; für Linkslenker; - ABS	24.2125-1703.3	010483	Ø 25,4
				S 16205755→; → 03/02; Nutzlast ab [kg] 1.000 Nutzlast bis [kg] 1.400; - ABS	24.2125-1725.3	010717	Ø 25,4
				S 16205353→; → 03/02; Nutzlast [kg]: 1.800; - ABS	24.2125-1725.3	010717	Ø 25,4
				S 16206234→; → 03/02; Nutzlast ab [kg] 1.000 Nutzlast bis [kg] 1.400; + ABS	24.2125-1726.3	010718	Ø 25,4
2.0 4x4	80	10/96→01/02		→ S 15064995; Nutzlast ab [kg] 1.000 Nutzlast bis [kg] 1.400; für Linkslenker; - ABS	24.2122-1715.3	010481	Ø 22,2
				S 15064996→ S 16206233; Nutzlast ab [kg] 1.000 Nutzlast bis [kg] 1.400; + ABS	24.2125-1702.3	010482	Ø 25,4
				→ S 16194399; Nutzlast [kg]: 1.800; + ABS	24.2125-1702.3	010482	Ø 25,4
				→ S 16205754; Nutzlast [kg]: 1.800; für Linkslenker; - ABS	24.2125-1703.3	010483	Ø 25,4
				S 15064996→ S 16205754; Nutzlast ab [kg] 1.000 Nutzlast bis [kg] 1.400; für Linkslenker; - ABS	24.2125-1703.3	010483	Ø 25,4
				S 16205755→; Nutzlast ab [kg] 1.000 Nutzlast bis [kg] 1.400; - ABS	24.2125-1725.3	010717	Ø 25,4
				S 16205353→; Nutzlast [kg]: 1.800; - ABS	24.2125-1725.3	010717	Ø 25,4
				S 16206234→; Nutzlast ab [kg] 1.000 Nutzlast bis [kg] 1.400; + ABS	24.2125-1726.3	010718	Ø 25,4
2.0 HDI	62	11/01→04/02		→ 03/02; Nutzlast ab [kg] 1.000 Nutzlast bis [kg] 1.800; - ABS	24.2125-1725.3	010717	Ø 25,4
				→ 03/02; Nutzlast ab [kg] 1.000 Nutzlast bis [kg] 1.800; + ABS	24.2125-1726.3	010718	Ø 25,4
→							

	kw			 	! #		
CITROËN - JUMPER Kasten (230L) 02/94→08/02							
 Hauptbremszylinder							
2.5 D	63	03/94→04/02		→ S 15064995; Nutzlast [kg]: 1.400; für Linkslenker; - ABS		24.2122-1715.3 010481	Ø 22,2
2.5 D 4x4	63	03/00→04/02					
2.5 TD	76	03/94→04/02		→ S 16194399; Nutzlast [kg]: 1.800; + ABS		24.2125-1702.3 010482	Ø 25,4
				S 15064996→ S 16206233; Nutzlast [kg]: 1.400; + ABS		24.2125-1702.3 010482	Ø 25,4
				→ S 16205754; Nutzlast [kg]: 1.800; für Linkslenker; - ABS		24.2125-1703.3 010483	Ø 25,4
				S 15064996→ S 16205754; Nutzlast [kg]: 1.400; für Linkslenker; - ABS		24.2125-1703.3 010483	Ø 25,4
				S 16205353→; → 03/02; Nutzlast [kg]: 1.800; - ABS		24.2125-1725.3 010717	Ø 25,4
				S 16205755→; → 03/02; Nutzlast [kg]: 1.400; - ABS		24.2125-1725.3 010717	Ø 25,4
				S 16206234→; → 03/02; Nutzlast [kg]: 1.400; + ABS		24.2125-1726.3 010718	Ø 25,4
				S 16194400→; → 03/02; Nutzlast [kg]: 1.800; + ABS		24.2125-1726.3 010718	Ø 25,4
2.5 DT 4x4	76	10/96→08/97		→ S 15064995; Nutzlast [kg]: 1.400; für Linkslenker; - ABS		24.2122-1715.3 010481	Ø 22,2
				S 15064996→ S 16206233; Nutzlast [kg]: 1.400; + ABS		24.2125-1702.3 010482	Ø 25,4
				S 15064996→ S 16205754; Nutzlast [kg]: 1.400; für Linkslenker; - ABS		24.2125-1703.3 010483	Ø 25,4
				S 16205755→; Nutzlast [kg]: 1.400; - ABS		24.2125-1725.3 010717	Ø 25,4
				S 16206234→; Nutzlast [kg]: 1.400; + ABS		24.2125-1726.3 010718	Ø 25,4
2.5 TDi	79	12/96→11/00		→ S 16194399; Nutzlast [kg]: 1.800; + ABS		24.2125-1702.3 010482	Ø 25,4
2.5 TDi 4x4	79	03/00→11/00					
				S 15064996→ S 16206233; Nutzlast [kg]: 1.400; + ABS		24.2125-1702.3 010482	Ø 25,4
				→ S 16205754; Nutzlast ab [kg] 1.400 Nutzlast bis [kg] 1.800; für Linkslenker; - ABS		24.2125-1703.3 010483	Ø 25,4
				S 16205353→; Nutzlast [kg]: 1.800; - ABS		24.2125-1725.3 010717	Ø 25,4
				S 16205755→; Nutzlast [kg]: 1.400; - ABS		24.2125-1725.3 010717	Ø 25,4
				S 16194400→; Nutzlast [kg]: 1.800; + ABS		24.2125-1726.3 010718	Ø 25,4
				S 16206234→; Nutzlast [kg]: 1.400; + ABS		24.2125-1726.3 010718	Ø 25,4
2.8 HDi	94	09/00→04/02		→ S 16194399; Nutzlast [kg]: 1.800; + ABS		24.2125-1702.3 010482	Ø 25,4
2.8 HDi 4x4	94	09/00→04/02					
				S 15064996→ S 16206233; Nutzlast [kg]: 1.400; + ABS		24.2125-1702.3 010482	Ø 25,4
				→ S 16205754; Nutzlast ab [kg] 1.400 Nutzlast bis [kg] 1.800; für Linkslenker; - ABS		24.2125-1703.3 010483	Ø 25,4
				S 16205755→; → 03/02; Nutzlast [kg]: 1.400; - ABS		24.2125-1725.3 010717	Ø 25,4
				S 16205353→; → 03/02; Nutzlast [kg]: 1.800; - ABS		24.2125-1725.3 010717	Ø 25,4
				S 16194400→; → 03/02; Nutzlast [kg]: 1.800; + ABS		24.2125-1726.3 010718	Ø 25,4
				S 16206234→; → 03/02; Nutzlast [kg]: 1.400; + ABS		24.2125-1726.3 010718	Ø 25,4
 Bremskraftregler							
1.9 D	50-51	02/94→04/02		→ S 16206244; Nutzlast [kg]: 1.000; - ABS		24.6512-1701.3 320153	lastabhängig 2x
1.9 TD	66-68	03/94→04/02		→ S 16206244; Nutzlast ab [kg] 1.000 Nutzlast bis [kg] 1.400; - ABS		24.6512-1701.3 320153	lastabhängig 2x
2.0	80	03/94→04/02		→ S 16206244; Nutzlast ab [kg] 1.000 Nutzlast bis [kg] 1.800; - ABS		24.6512-1701.3 320153	lastabhängig 2x
2.0 4x4	80	10/96→01/02					
2.5 D	63	03/94→04/02		→ S 16206244; Nutzlast ab [kg] 1.400 Nutzlast bis [kg] 1.800; - ABS		24.6512-1701.3 320153	lastabhängig 2x
2.5 D 4x4	63	03/00→04/02					
2.5 TD	76	03/94→04/02					
2.5 TDi	79	12/96→11/00					
2.5 TDi 4x4	79	03/00→11/00					
2.8 HDi	94	09/00→04/02					
2.8 HDi 4x4	94	09/00→04/02					

	kw					! #		
CITROËN - JUMPER Kasten (244) 04/02→								
 Hauptbremszylinder								
2.0	81	04/02→06/06		→ 03/06; Nutzlast ab [kg] 1.000 Nutzlast bis [kg] 1.800; - ABS		24.2125-1725.3	010717	Ø 25,4
2.0 bivalent	81	02/03→06/06						
2.0 HDi	62	04/02→06/06		→ 03/06; Nutzlast ab [kg] 1.000 Nutzlast bis [kg] 1.800; + ABS		24.2125-1726.3	010718	Ø 25,4
2.2 HDi	74	04/02→06/06						
2.8 HDi	94	04/02→06/06						
	107							
2.8 HDi 4x4	94	04/02→06/06		→ 03/06; - ABS		24.2125-1725.3	010717	Ø 25,4
				→ 03/06; + ABS		24.2125-1726.3	010718	Ø 25,4
 Bremskraftregler								
2.8 HDi 4x4	94	04/02→06/06		→ 03/06; Nutzlast ab [kg] 1.000 Nutzlast bis [kg] 1.800; - ABS		24.6512-1701.3	320153	lastabhängig 2x
CITROËN - JUMPER Pritsche/Fahrgestell 04/06→								
 Hauptbremszylinder								
2.2 HDi 100	74	04/06→		Nutzlast ab [kg] 1.200 Nutzlast bis [kg] 1.400; + DSC; nicht für Facelift; Nutzlast-Code: 12Q / 14Q		24.4125-1701.3	010867	BOS Ø 25,4 ohne Bremsflüssigkeitsbehälter
2.2 HDi 110	81	07/11→						
2.2 HDi 120	88	04/06→						
2.2 HDi 130	96	07/11→		Nutzlast ab [kg] 1.200 Nutzlast bis [kg] 1.400; - DSC; nicht für Facelift; Nutzlast-Code: 12Q / 14Q		24.4125-1702.3	010872	BOS Ø 25,4 ohne Bremsflüssigkeitsbehälter
2.2 HDi 150	110	07/11→						
3.0 HDi 145	107	07/10→						
3.0 HDi 160	116	09/06→		Nutzlast ab [kg] 1.600 Nutzlast bis [kg] 2.000; + DSC; nicht für Facelift; Nutzlast-Code: 16Q / 20Q		24.4126-1701.3	010868	BOS Ø 27 ohne Bremsflüssigkeitsbehälter
3.0 HDi 180	130	07/11→		Nutzlast ab [kg] 1.600 Nutzlast bis [kg] 2.000; - DSC; nicht für Facelift; Nutzlast-Code: 16Q / 20Q		24.4126-1702.3	010875	BOS Ø 27 ohne Bremsflüssigkeitsbehälter
CITROËN - JUMPER Pritsche/Fahrgestell (230) 03/94→04/02								
 Hauptbremszylinder								
1.9 TD	66 - 68	03/94→04/02		→ S 15064995; Nutzlast ab [kg] 1.000 Nutzlast bis [kg] 1.400; - ABS; für Linkslenker		24.2122-1715.3	010481	Ø 22,2
				S 15064996→ S 16206233; Nutzlast ab [kg] 1.000 Nutzlast bis [kg] 1.400; + ABS		24.2125-1702.3	010482	Ø 25,4
				S 15064996→ S 16205754; Nutzlast ab [kg] 1.000 Nutzlast bis [kg] 1.400; - ABS; für Linkslenker		24.2125-1703.3	010483	Ø 25,4
				S 16205755→; → 03/02; Nutzlast ab [kg] 1.000 Nutzlast bis [kg] 1.400; - ABS		24.2125-1725.3	010717	Ø 25,4
				S 16206234→; → 03/02; Nutzlast ab [kg] 1.000 Nutzlast bis [kg] 1.400; + ABS		24.2125-1726.3	010718	Ø 25,4
2.0	80	03/94→04/02		→ S 15064995; Nutzlast ab [kg] 1.000 Nutzlast bis [kg] 1.400; - ABS; für Linkslenker		24.2122-1715.3	010481	Ø 22,2
				S 15064996→ S 16206233; Nutzlast ab [kg] 1.000 Nutzlast bis [kg] 1.400; + ABS		24.2125-1702.3	010482	Ø 25,4
				→ S 16194399; Nutzlast [kg]: 1.800; + ABS		24.2125-1702.3	010482	Ø 25,4
				→ S 16205754; Nutzlast [kg]: 1.800; - ABS; für Linkslenker		24.2125-1703.3	010483	Ø 25,4
				S 15064996→ S 16205754; Nutzlast ab [kg] 1.000 Nutzlast bis [kg] 1.400; - ABS; für Linkslenker		24.2125-1703.3	010483	Ø 25,4
				S 16205755→; → 03/02; Nutzlast ab [kg] 1.000 Nutzlast bis [kg] 1.400; - ABS		24.2125-1725.3	010717	Ø 25,4
				S 16205353→; → 03/02; Nutzlast [kg]: 1.800; - ABS		24.2125-1725.3	010717	Ø 25,4
				S 16206234→; → 03/02; Nutzlast ab [kg] 1.000 Nutzlast bis [kg] 1.400; + ABS		24.2125-1726.3	010718	Ø 25,4
				S 16194400→; → 03/02; Nutzlast [kg]: 1.800; + ABS		24.2125-1726.3	010718	Ø 25,4
2.5 D	63	03/94→04/02		→ S 15064995; Nutzlast [kg]: 1.400; - ABS; für Linkslenker		24.2122-1715.3	010481	Ø 22,2
2.5 D 4x4	63	03/00→04/02						
2.5 TD	76	03/94→04/02		→ S 16194399; Nutzlast [kg]: 1.800; + ABS		24.2125-1702.3	010482	Ø 25,4
				S 15064996→ S 16206233; Nutzlast [kg]: 1.400; + ABS		24.2125-1702.3	010482	Ø 25,4
				→ S 16205754; Nutzlast [kg]: 1.800; - ABS; für Linkslenker		24.2125-1703.3	010483	Ø 25,4
				S 15064996→ S 16205754; Nutzlast [kg]: 1.400; - ABS; für Linkslenker		24.2125-1703.3	010483	Ø 25,4
				S 16205755→; → 03/02; Nutzlast [kg]: 1.400; - ABS		24.2125-1725.3	010717	Ø 25,4



CITROËN - JUMPER Pritsche/Fahrgestell (230) 03/94 → 04/02

 **Hauptbremszylinder**

2.5 D 2.5 D 4x4 2.5 TD	63	03/94 → 04/02		S 16205353 →; → 03/02; Nutzlast [kg]: 1.800; - ABS	24.2125-1725.3	010717	Ø 25,4
	63	03/00 → 04/02					
	76	03/94 → 04/02		S 16206234 →; → 03/02; Nutzlast [kg]: 1.400; + ABS	24.2125-1726.3	010718	Ø 25,4
2.5 TDi 2.5 TDi 4x4 2.8 HDi	79	12/96 → 04/02		→ S 16206233; Nutzlast [kg]: 1.400; + ABS	24.2125-1702.3	010482	Ø 25,4
	79	03/00 → 04/02					
	94	09/00 → 04/02		→ S 16194399; Nutzlast [kg]: 1.800; + ABS	24.2125-1702.3	010482	Ø 25,4
				→ S 16205754; Nutzlast ab [kg] 1.400 Nutzlast bis [kg] 1.800; - ABS; für Linkslenker	24.2125-1703.3	010483	Ø 25,4
				S 16205353 →; → 03/02; Nutzlast [kg]: 1.800; - ABS	24.2125-1725.3	010717	Ø 25,4
				S 16205755 →; → 03/02; Nutzlast [kg]: 1.400; - ABS	24.2125-1725.3	010717	Ø 25,4
				S 16194400 →; → 03/02; Nutzlast [kg]: 1.800; + ABS	24.2125-1726.3	010718	Ø 25,4
				S 16206234 →; → 03/02; Nutzlast [kg]: 1.400; + ABS	24.2125-1726.3	010718	Ø 25,4
2.8 D	64	01/99 → 02/02		→ S 15064995; Nutzlast [kg]: 1.400; - ABS; für Linkslenker	24.2122-1715.3	010481	Ø 22,2
				→ S 16194399; Nutzlast [kg]: 1.800; + ABS	24.2125-1702.3	010482	Ø 25,4
				S 15064996 → S 16206253; Nutzlast [kg]: 1.400; + ABS	24.2125-1702.3	010482	Ø 25,4
				→ S 16205352; Nutzlast [kg]: 1.800; für Linkslenker; - ABS	24.2125-1703.3	010483	Ø 25,4
				S 15064996 → S 16205754; Nutzlast [kg]: 1.400; - ABS; für Linkslenker	24.2125-1703.3	010483	Ø 25,4
				S 16205353 →; Nutzlast [kg]: 1.800; - ABS	24.2125-1725.3	010717	Ø 25,4
				S 16205755 →; Nutzlast [kg]: 1.400; - ABS	24.2125-1725.3	010717	Ø 25,4
				S 16206254 →; Nutzlast [kg]: 1.400; + ABS	24.2125-1726.3	010718	Ø 25,4
				S 16194400 →; Nutzlast [kg]: 1.800; + ABS	24.2125-1726.3	010718	Ø 25,4

 **Bremskraftregler**

1.9 TD	66 - 68	03/94 → 04/02		→ S 16206244; Nutzlast ab [kg] 1.000 Nutzlast bis [kg] 1.400; - ABS	24.6512-1701.3	320153	lastabhängig 2x
2.0	80	03/94 → 04/02		→ S 16206244; Nutzlast ab [kg] 1.000 Nutzlast bis [kg] 1.800; - ABS	24.6512-1701.3	320153	lastabhängig 2x
2.5 D 2.5 D 4x4 2.5 TD 2.5 TDi 2.5 TDi 4x4 2.8 D 2.8 HDi	63 - 94	03/94 → 04/02 03/00 → 04/02 03/94 → 04/02 12/96 → 04/02 03/00 → 04/02 01/99 → 02/02 09/00 → 04/02		→ S 16206244; Nutzlast ab [kg] 1.400 Nutzlast bis [kg] 1.800; - ABS	24.6512-1701.3	320153	lastabhängig 2x

CITROËN - JUMPER Pritsche/Fahrgestell (244) 02/02 →

 **Hauptbremszylinder**

2.0 HDi 2.2 HDi 2.8 HDi	62	04/02 → 06/06		→ 03/06; Nutzlast ab [kg] 1.000 Nutzlast bis [kg] 1.800; - ABS	24.2125-1725.3	010717	Ø 25,4
	74	04/02 → 06/06					
2.8 HDi 4x4	94 - 107	04/02 → 06/06		→ 03/06; Nutzlast ab [kg] 1.000 Nutzlast bis [kg] 1.800; + ABS	24.2125-1726.3	010718	Ø 25,4
	94	02/02 → 06/06		04/02 → 03/06; - ABS	24.2125-1725.3	010717	Ø 25,4
				04/02 → 03/06; + ABS	24.2125-1726.3	010718	Ø 25,4













 **Bremskraftregler**













2.8 HDi 4x4	94	02/02 → 06/06		04/02 → 03/06; Nutzlast ab [kg] 1.000 Nutzlast bis [kg] 1.800; - ABS	24.6512-1701.3	320153	lastabhängig 2x
-------------	----	---------------	--	----------------------------------------------------------------------	----------------	--------	-----------------

CITROËN - JUMPY (U6U_) 06/94 → 12/06

 **Hauptbremszylinder**

1.6 1.9 D 1.9 D 70 1.9 TD	58	10/95 → 08/00		→ Orga 08206; - ABS; Nutzlast [kg]: 800	24.2122-1703.3	010422	Ø 22,2
	51	10/95 → 08/98		→ Orga 08206; + ABS; Nutzlast [kg]: 800	24.2122-1708.3	010437	Ø 22,2
	51	04/98 → 11/03		Orga 08207 →; - ABS; Nutzlast [kg]: 800	24.2122-1741.3	010695	Ø 22,2
	66 - 68	10/95 → 11/03		→ Orga 08206; - ABS; Nutzlast [kg]: 900	24.2123-1707.3	010492	Ø 23,8
→							

	kW					! #		
CITROËN - JUMPY (U6U_) 06/94→12/06								
 Hauptbremszylinder								
1.6	58	10/95→08/00		Orga 08207→; + ABS; Nutzlast [kg]: 900		24.2123-1733.3	010657	BOS Ø 23,8
1.9 D	51	10/95→08/98		Orga 08207→; - ABS; Nutzlast [kg]: 900		24.2123-1738.3	010658	Ø 23,8
1.9 D 70	51	04/98→11/03						
1.9 TD	66 - 68	10/95→11/03						
2.0	100	04/00→12/06		+ ABS		24.2123-1733.3	010657	BOS Ø 23,8
2.0 HDi 110	80	03/00→10/06		- ABS		24.2123-1738.3	010658	Ø 23,8
2.0 HDi 95	69	10/99→10/06						
2.0 i 16V	102	03/00→10/06						
CITROËN - JUMPY (VF7) 01/07→03/16								
 Hauptbremszylinder								
1.6 HDi 90 16V	66	01/07→03/16		für Linkslenker; + ESP		03.2125-0671.3	010965	ATE Ø 25,4
1.6 HDi 90 8V	66	01/07→03/16		für Linkslenker; - ESP		03.2125-0676.3	011009	ATE Ø 25,4 ohne Bremsflüssigkeitsbehälter
2.0 HDi 120	88	01/07→03/16						
2.0 HDi 125	94	07/11→03/16		für Rechtslenker; - ESP		24.2123-3396.3	011035	ATE Ø 23,8 ohne Bremsflüssigkeitsbehälter
2.0 HDi 140	100	01/07→03/16						
2.0 HDi 165	120	07/10→03/16						
2.0 HDi 95	72	07/11→03/16						
2.0 i	103	01/07→03/16						
CITROËN - JUMPY Kasten 01/07→03/16								
 Hauptbremszylinder								
1.6 HDi 90 16V	66	01/07→03/16		für Linkslenker; + ESP		03.2125-0671.3	010965	ATE Ø 25,4
1.6 HDi 90 8V	66	01/07→03/16		für Linkslenker; - ESP		03.2125-0676.3	011009	ATE Ø 25,4 ohne Bremsflüssigkeitsbehälter
2.0 HDi 120	88	01/07→03/16						
2.0 HDi 120 4x4	88	01/10→03/16		für Rechtslenker; - ESP		24.2123-3396.3	011035	ATE Ø 23,8 ohne Bremsflüssigkeitsbehälter
2.0 HDi 125	94	07/11→03/16						
2.0 HDi 125 4x4	94	07/11→03/16						
2.0 HDi 140	100	01/07→03/16						
2.0 HDi 165	120	07/10→03/16						
2.0 HDi 95	72	07/11→03/16						
2.0 i	103	01/07→03/16						
CITROËN - JUMPY Kasten (BS_, BT_, BY_, BZ_) 06/94→10/06								
 Hauptbremszylinder								
1.6 i	58	10/95→08/00		→Orga 08206; - ABS; Nutzlast [kg]: 800		24.2122-1703.3	010422	Ø 22,2
1.9 D 70	51	04/98→10/06		→Orga 08206; + ABS; Nutzlast [kg]: 800		24.2122-1708.3	010437	Ø 22,2
1.9 DT	65	10/95→08/00		Orga 08207→; - ABS; Nutzlast [kg]: 800		24.2122-1741.3	010695	Ø 22,2
1.9 TD	66	10/95→08/00						
				→Orga 08206; - ABS; Nutzlast [kg]: 900		24.2123-1707.3	010492	Ø 23,8
				Orga 08207→; + ABS; Nutzlast [kg]: 900		24.2123-1733.3	010657	BOS Ø 23,8
				Orga 08207→; - ABS; Nutzlast [kg]: 900		24.2123-1738.3	010658	Ø 23,8
2.0	100	04/00→10/06		+ ABS		24.2123-1733.3	010657	BOS Ø 23,8
2.0 HDi 110	80	01/02→10/06		- ABS		24.2123-1738.3	010658	Ø 23,8
2.0 HDi 95	69	10/99→10/06						
2.0 i 16V	102	03/00→10/06						
2.0 HDi 110	80	10/01→10/06		01/02→; + ABS		24.2123-1733.3	010657	BOS Ø 23,8
				01/02→; - ABS		24.2123-1738.3	010658	Ø 23,8
CITROËN - JUMPY Pritsche/Fahrgestell 11/06→								
 Hauptbremszylinder								
1.6 HDi 90 16V	66	06/07→03/16		für Linkslenker; + ESP		03.2125-0671.3	010965	ATE Ø 25,4
1.6 HDi 90 8V	66	06/07→03/16		für Linkslenker; - ESP		03.2125-0676.3	011009	ATE Ø 25,4 ohne Bremsflüssigkeitsbehälter
2.0 HDI	88 - 120	01/09→03/16						
2.0 HDI 100	72	07/11→03/16		für Rechtslenker; - ESP		24.2123-3396.3	011035	ATE Ø 23,8 ohne Bremsflüssigkeitsbehälter
2.0 HDi 125	94	07/11→						
2.0 i	103	11/06→03/16						
CITROËN - JUMPY Pritsche/Fahrgestell (BU_, BV_, BW_, BX_) 10/99→10/06								
 Hauptbremszylinder								
1.9 TD	51	11/00→10/06		→Orga 08206; - ABS; Nutzlast [kg]: 800		24.2122-1703.3	010422	Ø 22,2
				→Orga 08206; + ABS; Nutzlast [kg]: 800		24.2122-1708.3	010437	Ø 22,2
				Orga 08207→; - ABS; Nutzlast [kg]: 800		24.2122-1741.3	010695	Ø 22,2
				→Orga 08206; - ABS; Nutzlast [kg]: 900		24.2123-1707.3	010492	Ø 23,8
				Orga 08207→; + ABS; Nutzlast [kg]: 900		24.2123-1733.3	010657	BOS Ø 23,8
				Orga 08207→; - ABS; Nutzlast [kg]: 900		24.2123-1738.3	010658	Ø 23,8
1.9 TD	68	10/99→10/06		- ABS; Nutzlast [kg]: 800		24.2122-1741.3	010695	Ø 22,2
				+ ABS; Nutzlast [kg]: 900		24.2123-1733.3	010657	BOS Ø 23,8
				- ABS; Nutzlast [kg]: 900		24.2123-1738.3	010658	Ø 23,8
→								

	kw					! #		
CITROËN - JUMPY Pritsche/Fahrgestell (BU_, BV_, BW_, BX_) 10/99→10/06								
 Hauptbremszylinder								
2.0	100	12/03→10/06		+ ABS		24.2123-1733.3	010657	BOS Ø 23,8
2.0 HDi 110	80	12/03→10/06		- ABS		24.2123-1738.3	010658	Ø 23,8
2.0 HDi 110 16V	80	12/03→10/06						
2.0 HDi 95	69	10/99→10/06						
CITROËN - SAXO (S0, S1) 02/96→04/04								
 Hauptbremszylinder								
1.0 X	33 - 37	05/96→06/03		- ABS; Felge Lochzahl: 3		03.2120-4166.3	010452	ATE Ø 20,6
1.1 BiFuel	44	07/00→06/03				24.2120-1722.3	010544	Ø 20,6
1.1 X	40 - 44	05/96→09/03		- ABS; Felge Lochzahl: 4		24.2119-1708.3	010543	BDX Ø 19
SX	40 - 44	05/96→09/03						
1.4 VTS	55	05/96→06/03		- ABS		03.2120-4166.3	010452	ATE Ø 20,6
1.5 D	40 - 43	09/96→04/04				24.2120-1722.3	010544	Ø 20,6
1.6	66 - 88	02/96→04/04				24.2119-1708.3	010543	BDX Ø 19
VTR	65	05/96→06/03						
1.6 VTL	65	05/96→06/03						
1.6 VTS Electric	72	09/00→09/03						
	20	11/96→06/03						
1.6 VTS	87	06/96→09/03		07/96→; - ABS		03.2120-4166.3	010452	ATE Ø 20,6
						24.2120-1722.3	010544	Ø 20,6
				07/96→		24.2119-1708.3	010543	BDX Ø 19
CITROËN - SAXO Hatchback van (S3_) 10/97→06/03								
 Hauptbremszylinder								
1.0	33 - 37	10/97→06/03		- ABS; Felge Lochzahl: 3		03.2120-4166.3	010452	ATE Ø 20,6
						24.2120-1722.3	010544	Ø 20,6
				- ABS; Felge Lochzahl: 4		24.2119-1708.3	010543	BDX Ø 19
1.5 D	42 - 43	08/99→06/03		- ABS		03.2120-4166.3	010452	ATE Ø 20,6
						24.2120-1722.3	010544	Ø 20,6
						24.2119-1708.3	010543	BDX Ø 19
CITROËN - XSARA (N1) 04/97→12/05								
 Bremskraftverstärker								
1.4 HDi	50	01/03→03/05		für Linkslenker; + ABS		03.7853-0902.4	300150	ATE Ø 9" pneumatisch
1.4 i	55	04/97→03/05		→ 08/00		03.7750-9302.4	300116	ATE Ø 9" pneumatisch
1.9 D	51	07/98→03/05						
2.0 HDi 90	66	02/99→03/05		Orga 09002→; für Linkslenker; + ABS		03.7853-0902.4	300150	ATE Ø 9" pneumatisch
1.4 LPG	55	05/98→08/00				03.7750-9302.4	300116	ATE Ø 9" pneumatisch
				Orga 09002→; für Linkslenker; + ABS		03.7853-0902.4	300150	ATE Ø 9" pneumatisch
1.5 D	42	04/97→09/00		→ 08/00		03.7750-9302.4	300116	ATE Ø 9" pneumatisch
1.6 i	65	04/97→09/00						
1.8 D	43	04/97→09/00						
1.8 i	66	04/97→09/00						
1.8 i Aut.	74	04/97→09/00						
1.9 D	50	04/97→09/00						
1.9 SD	55	01/98→09/00						
1.9 TD	66	04/97→09/00						
1.6 16V	80	09/00→03/05		Orga 09002→; für Linkslenker; + ABS		03.7853-0902.4	300150	ATE Ø 9" pneumatisch
2.0 16V	100	09/00→03/05						
2.0 HDi 109	80	05/01→03/05						
1.9 D	52	04/00→04/05		→ 08/00		03.7750-9302.4	300116	ATE Ø 9" pneumatisch
				Orga 09002→; → 03/05; für Linkslenker; + ABS		03.7853-0902.4	300150	ATE Ø 9" pneumatisch
 Hauptbremszylinder								
1.4 HDi	50	01/03→03/05		+ ESP		03.2123-2761.3	010886	ATE Ø 23,8
				- ABS		03.2123-2781.3	010631	ATE Ø 23,8
1.4 i	55	04/97→03/05		→ 08/00; + ABS		03.2122-1351.3	010528	Ø 22,2
1.9 D	51	07/98→03/05				24.2122-1733.3	010668	Ø 22,2
2.0 HDi 90	66	02/99→03/05		→ 08/00; - ABS		03.2122-1356.3	010529	Ø 22,2
						24.2122-1743.3	010712	Ø 22,2
				Orga 09065→; + ESP		03.2123-2761.3	010886	ATE Ø 23,8
				Orga 09002→; - ABS		03.2123-2781.3	010631	ATE Ø 23,8
				09/00→; →Orga 09001; - ABS		24.2123-1714.3	010587	BDX Ø 23,8
				09/00→; →Orga 09001; + ABS		24.2123-1715.3	010520	BDX Ø 23,8
→								

CITROËN - XSARA (N1) 04/97→12/05

Hauptbremszylinder

1.4 LPG	55	05/98→08/00	+ ABS	03.2122-1351.3 010528	Ø 22,2
			- ABS	24.2122-1733.3 010668	Ø 22,2
			Orga 09065→; + ESP	03.2122-1356.3 010529	Ø 22,2
			Orga 09002→; - ABS	24.2122-1743.3 010712	Ø 22,2
1.5 D	42	04/97→09/00	→ 08/00; + ABS	03.2122-1351.3 010528	Ø 22,2
				24.2122-1733.3 010668	Ø 22,2
1.6 i	65	04/97→09/00			
1.8 D	43	04/97→09/00			
1.8 i	66	04/97→09/00	→ 08/00; - ABS	03.2122-1356.3 010529	Ø 22,2
1.8 i Aut.	74	04/97→09/00		24.2122-1743.3 010712	Ø 22,2
1.9 D	50	04/97→09/00			
1.9 SD	55	01/98→09/00			
1.9 TD	66	04/97→09/00			
1.6 16V	80	09/00→03/05	Orga 09065→; + ESP	03.2123-2761.3 010886	ATE Ø 23,8
			Orga 09002→; - ABS	03.2123-2781.3 010631	ATE Ø 23,8
			→Orga 09001; - ABS	24.2123-1714.3 010587	BDX Ø 23,8
			→Orga 09001; + ABS	24.2123-1715.3 010520	BDX Ø 23,8
2.0 HDi 109	80	05/01→03/05			
1.8 BiFuel	82	07/97→08/00	- ABS	24.2123-1714.3 010587	BDX Ø 23,8
			+ ABS	24.2123-1715.3 010520	BDX Ø 23,8
1.8 i 16V	81	04/97→09/00	→ 08/00; - ABS	24.2123-1714.3 010587	BDX Ø 23,8
2.0 16V	97	07/98→09/00	→ 08/00; + ABS	24.2123-1715.3 010520	BDX Ø 23,8
1.9 D	52	04/00→04/05	→ 08/00; + ABS	03.2122-1351.3 010528	Ø 22,2
				24.2122-1733.3 010668	Ø 22,2
			→ 08/00; - ABS	03.2122-1356.3 010529	Ø 22,2
				24.2122-1743.3 010712	Ø 22,2
			Orga 09065→; → 03/05; + ESP	03.2123-2761.3 010886	ATE Ø 23,8
			Orga 09002→; → 03/05; - ABS	03.2123-2781.3 010631	ATE Ø 23,8
			09/00→; →Orga 09001; - ABS	24.2123-1714.3 010587	BDX Ø 23,8
09/00→; →Orga 09001; + ABS	24.2123-1715.3 010520	BDX Ø 23,8			
2.0 16V	100	09/00→03/05	Orga 09065→; + ESP	03.2123-2761.3 010886	ATE Ø 23,8
			Orga 09002→; - ABS	03.2123-2781.3 010631	ATE Ø 23,8













CITROËN - XSARA Break (N2) 10/97→03/10











Bremskraftverstärker

1.4 HDi	50	01/03→08/05	für Linkslenker; + ABS	03.7853-0902.4 300150	ATE Ø 9" pneumatisch
1.4 i	55	10/97→08/05	→ 08/00; - ABS	03.7750-9302.4 300116	ATE Ø 9" pneumatisch
1.9 D	51	07/98→08/05			
2.0 HDi 90	66	02/99→08/05	Orga 09002→; für Linkslenker; + ABS	03.7853-0902.4 300150	ATE Ø 9" pneumatisch
1.5 D	42	10/97→09/00	→ 08/00; - ABS	03.7750-9302.4 300116	ATE Ø 9" pneumatisch
1.6 i	65	10/97→09/00			
1.8 D	43	10/97→09/00			
1.9 D	50 - 55	10/97→09/00			
1.9 TD	66	10/97→09/00			
1.6 16V	80	09/00→08/05	Orga 09002→; für Linkslenker; + ABS	03.7853-0902.4 300150	ATE Ø 9" pneumatisch
2.0 16V	100	09/00→08/05			
2.0 HDi 109	80	05/01→08/05			













Hauptbremszylinder













1.4 HDi	50	01/03→08/05	+ ESP	03.2123-2761.3 010886	ATE Ø 23,8
			- ABS	03.2123-2781.3 010631	ATE Ø 23,8
1.4 i	55	10/97→08/05	→ 08/00; - ABS	03.2122-1356.3 010529	Ø 22,2
			Orga 09065→; + ESP	03.2123-2761.3 010886	ATE Ø 23,8
			Orga 09002→; - ABS	03.2123-2781.3 010631	ATE Ø 23,8
			→Orga 09001; - ABS	24.2123-1714.3 010587	BDX Ø 23,8
			→Orga 09001; + ABS	24.2123-1715.3 010520	BDX Ø 23,8
1.5 D	42	10/97→09/00	→ 08/00; - ABS	03.2122-1356.3 010529	Ø 22,2
1.6 i	65	10/97→09/00		24.2123-1714.3 010587	BDX Ø 23,8
1.8 D	43	10/97→09/00			
1.9 D	50	10/97→09/00	→ 08/00; + ABS	24.2123-1715.3 010520	BDX Ø 23,8
1.6 16V	80	09/00→08/05	Orga 09065→; + ESP	03.2123-2761.3 010886	ATE Ø 23,8
2.0 16V	100	09/00→08/05	Orga 09002→; - ABS	03.2123-2781.3 010631	ATE Ø 23,8
2.0 HDi 109	80	05/01→08/05	→Orga 09001; - ABS	24.2123-1714.3 010587	BDX Ø 23,8
2.0 HDi 90	66	02/99→08/05	→Orga 09001; + ABS	24.2123-1715.3 010520	BDX Ø 23,8
1.8 i	66	10/97→09/00	→ 08/00; - ABS	24.2123-1714.3 010587	BDX Ø 23,8
1.8 i 16V	81	10/97→09/00	→ 08/00; + ABS	24.2123-1715.3 010520	BDX Ø 23,8











	kw					! #		
CITROËN - XSARA Break (N2) 10/97→03/10								
 Hauptbremszylinder								
1.8 i Aut.	74	10/97→09/00		→ 08/00; - ABS		24.2123-1714.3	010587	BDX Ø 23,8
1.9 D	55	01/98→09/00		→ 08/00; + ABS		24.2123-1715.3	010520	BDX Ø 23,8
1.9 TD	66	10/97→09/00						
2.0 16V	97	07/98→09/00						
1.8 LPG	81	05/98→08/00		- ABS		24.2123-1714.3	010587	BDX Ø 23,8
				+ ABS		24.2123-1715.3	010520	BDX Ø 23,8
1.9 D	51	07/98→08/05		Orga 09065→; + ESP		03.2123-2761.3	010886	ATE Ø 23,8
				Orga 09002→; - ABS		03.2123-2781.3	010631	ATE Ø 23,8
CITROËN - XSARA Coupe (N0) 01/98→04/05								
 Bremskraftverstärker								
1.4 HDi	50	01/03→03/05		für Linkslenker; + ABS		03.7853-0902.4	300150	ATE Ø 9" pneumatisch
1.4 i	55	03/98→03/05		→ 08/00		03.7750-9302.4	300116	ATE Ø 9" pneumatisch
1.9 D	51	02/99→03/05		Orga 09002→; für Linkslenker; + ABS		03.7853-0902.4	300150	ATE Ø 9" pneumatisch
2.0 HDi 90	66	02/99→03/05						
1.6 16V	80	09/00→03/05		Orga 09002→; für Linkslenker; + ABS		03.7853-0902.4	300150	ATE Ø 9" pneumatisch
2.0 16V	100	09/00→03/05						
2.0 HDi 109	80	05/01→03/05						
2.0 i 16V	120	02/98→03/05						
1.6 i	65	02/98→09/00		→ 08/00		03.7750-9302.4	300116	ATE Ø 9" pneumatisch
1.8 i	66 - 74	02/98→09/00						
1.8 i 16V	81	02/98→09/00						
1.9 D	50	02/98→09/00						
1.9 TD	66	02/98→09/00						
1.8 LPG	82	01/98→08/00		02/98→		03.7750-9302.4	300116	ATE Ø 9" pneumatisch
1.9 D	55	02/98→05/99				03.7750-9302.4	300116	ATE Ø 9" pneumatisch
 Hauptbremszylinder								
1.4 HDi	50	01/03→03/05		+ ESP		03.2123-2761.3	010886	ATE Ø 23,8
				- ABS		03.2123-2781.3	010631	ATE Ø 23,8
1.4 i	55	03/98→03/05		→ 08/00; + ABS		03.2122-1351.3	010528	Ø 22,2
1.9 D	51	02/99→03/05				24.2122-1733.3	010668	Ø 22,2
2.0 HDi 90	66	02/99→03/05		→ 08/00; - ABS		03.2122-1356.3	010529	Ø 22,2
						24.2122-1743.3	010712	Ø 22,2
				Orga 09065→; + ESP		03.2123-2761.3	010886	ATE Ø 23,8
				Orga 09002→; - ABS		03.2123-2781.3	010631	ATE Ø 23,8
				09/00→; →Orga 09001; - ABS		24.2123-1714.3	010587	BDX Ø 23,8
				09/00→; →Orga 09001; + ABS		24.2123-1715.3	010520	BDX Ø 23,8
1.6 16V	80	09/00→03/05		Orga 09065→; + ESP		03.2123-2761.3	010886	ATE Ø 23,8
2.0 16V	100	09/00→03/05		Orga 09002→; - ABS		03.2123-2781.3	010631	ATE Ø 23,8
2.0 HDi 109	80	05/01→03/05		→Orga 09001; - ABS		24.2123-1714.3	010587	BDX Ø 23,8
2.0 i 16V	120	02/98→03/05		→Orga 09001; + ABS		24.2123-1715.3	010520	BDX Ø 23,8
1.6 i	65	02/98→09/00		→ 08/00; + ABS		03.2122-1351.3	010528	Ø 22,2
1.8 i	66 - 74	02/98→09/00				24.2122-1733.3	010668	Ø 22,2
1.9 D	50	02/98→09/00		→ 08/00; - ABS		03.2122-1356.3	010529	Ø 22,2
1.9 TD	66	02/98→09/00				24.2122-1743.3	010712	Ø 22,2
1.8 i 16V	81	02/98→09/00		→ 08/00; - ABS		24.2123-1714.3	010587	BDX Ø 23,8
				→ 08/00; + ABS		24.2123-1715.3	010520	BDX Ø 23,8
1.8 LPG	82	01/98→08/00		02/98→; - ABS		24.2123-1714.3	010587	BDX Ø 23,8
				02/98→; + ABS		24.2123-1715.3	010520	BDX Ø 23,8
1.9 D	55	02/98→05/99		+ ABS		03.2122-1351.3	010528	Ø 22,2
				- ABS		24.2122-1733.3	010668	Ø 22,2
						03.2122-1356.3	010529	Ø 22,2
						24.2122-1743.3	010712	Ø 22,2
CITROËN - XSARA Kasten/Kombi 05/98→08/05								
 Bremskraftverstärker								
1.4	55	09/00→03/05		Orga 09002→; für Linkslenker; + ABS		03.7853-0902.4	300150	ATE Ø 9" pneumatisch
2.0 HDi	66	09/00→03/05						
1.8 D	43	05/98→05/99		- ABS		03.7750-9302.4	300116	ATE Ø 9" pneumatisch
1.9 D	51	06/99→08/05		→ 08/00; - ABS		03.7750-9302.4	300116	ATE Ø 9" pneumatisch
				Orga 09002→; für Linkslenker; + ABS		03.7853-0902.4	300150	ATE Ø 9" pneumatisch
 Hauptbremszylinder								
1.4	55	09/00→03/05		Orga 09065→; + ESP		03.2123-2761.3	010886	ATE Ø 23,8
→								













	kw					! #		
CITROËN - XSARA Kasten/Kombi 05/98→08/05								
 Hauptbremszylinder								
2.0 HDi	66	09/00→03/05		Orga 09002→; - ABS		03.2123-2781.3	010631	ATE Ø 23,8
				→Orga 09001; - ABS		24.2123-1714.3	010587	BDX Ø 23,8
				→Orga 09001; + ABS		24.2123-1715.3	010520	BDX Ø 23,8
1.8 D	43	05/98→05/99		- ABS		03.2122-1356.3	010529	Ø 22,2
						24.2123-1714.3	010587	BDX Ø 23,8
				+ ABS		24.2123-1715.3	010520	BDX Ø 23,8
1.9 D	51	06/99→08/05		Orga 09065→; + ESP		03.2123-2761.3	010886	ATE Ø 23,8
				Orga 09002→; - ABS		03.2123-2781.3	010631	ATE Ø 23,8
CITROËN - XSARA Kasten/Schrägheck (N3_) 05/98→03/05								
 Bremskraftverstärker								
1.4	55	05/98→10/04		→ 08/00		03.7750-9302.4	300116	ATE Ø 9" pneumatisch
1.9 D	51	06/99→03/05		Orga 09002→; für Linkslenker; + ABS		03.7853-0902.4	300150	ATE Ø 9" pneumatisch
1.4 LPG	55	06/99→08/00				03.7750-9302.4	300116	ATE Ø 9" pneumatisch
				Orga 09002→; für Linkslenker; + ABS		03.7853-0902.4	300150	ATE Ø 9" pneumatisch
1.8 D	43	05/98→05/99				03.7750-9302.4	300116	ATE Ø 9" pneumatisch
1.9 D	65	05/98→08/00						
2.0 HDi	66	09/00→03/05		Orga 09002→; für Linkslenker; + ABS		03.7853-0902.4	300150	ATE Ø 9" pneumatisch
 Hauptbremszylinder								
1.4	55	05/98→10/04		→ 08/00; + ABS		03.2122-1351.3	010528	Ø 22,2
1.9 D	51	06/99→03/05				24.2122-1733.3	010668	Ø 22,2
				→ 08/00; - ABS		03.2122-1356.3	010529	Ø 22,2
						24.2122-1743.3	010712	Ø 22,2
				Orga 09065→; + ESP		03.2123-2761.3	010886	ATE Ø 23,8
				Orga 09002→; - ABS		03.2123-2781.3	010631	ATE Ø 23,8
				09/00→; →Orga 09001; - ABS		24.2123-1714.3	010587	BDX Ø 23,8
				09/00→; →Orga 09001; + ABS		24.2123-1715.3	010520	BDX Ø 23,8
1.4 LPG	55	06/99→08/00		+ ABS		03.2122-1351.3	010528	Ø 22,2
						24.2122-1733.3	010668	Ø 22,2
				- ABS		03.2122-1356.3	010529	Ø 22,2
						24.2122-1743.3	010712	Ø 22,2
				Orga 09065→; + ESP		03.2123-2761.3	010886	ATE Ø 23,8
				Orga 09002→; - ABS		03.2123-2781.3	010631	ATE Ø 23,8
1.8 D	43	05/98→05/99		+ ABS		03.2122-1351.3	010528	Ø 22,2
1.9 D	65	05/98→08/00				24.2122-1733.3	010668	Ø 22,2
				- ABS		03.2122-1356.3	010529	Ø 22,2
						24.2122-1743.3	010712	Ø 22,2
2.0 HDi	66	09/00→03/05		Orga 09065→; + ESP		03.2123-2761.3	010886	ATE Ø 23,8
				Orga 09002→; - ABS		03.2123-2781.3	010631	ATE Ø 23,8
				→Orga 09001; - ABS		24.2123-1714.3	010587	BDX Ø 23,8
				→Orga 09001; + ABS		24.2123-1715.3	010520	BDX Ø 23,8
CITROËN - XSARA PICASSO (N68) 09/99→06/12								
 Hauptbremszylinder								
1.6	65	12/99→09/01		für DAM-Nummer ab: 0882078 →; für Linkslenker; - ABS		03.2123-2781.3	010631	ATE Ø 23,8
				06/00→; - ABS		24.2123-1714.3	010587	BDX Ø 23,8
1.6	67	06/02→08/05		Orga 08820 →; für Linkslenker; - ABS		03.2123-2781.3	010631	ATE Ø 23,8
				- ABS		24.2123-1714.3	010587	BDX Ø 23,8
1.6	70	12/99→12/10		für DAM-Nummer ab: 0882078 →; → 03/10; für Linkslenker; - ABS		03.2123-2781.3	010631	ATE Ø 23,8
				09/00→ 03/10; - ABS		24.2123-1714.3	010587	BDX Ø 23,8
1.6 16V	80	09/05→12/11		für Linkslenker; - ABS		03.2123-2781.3	010631	ATE Ø 23,8
1.6 16V LPG	80	06/04→12/10				24.2123-1714.3	010587	BDX Ø 23,8
2.0	88	02/04→10/04		- ABS				
1.6 16V	81	06/05→09/06		09/05→; für Linkslenker; - ABS		03.2123-2781.3	010631	ATE Ø 23,8
				09/05→; - ABS		24.2123-1714.3	010587	BDX Ø 23,8
1.6 Chrono	74	04/01→10/04		für DAM-Nummer ab: 0882078 →; für Linkslenker; - ABS		03.2123-2781.3	010631	ATE Ø 23,8
1.8 16V	85	02/00→08/05				24.2123-1714.3	010587	BDX Ø 23,8
				- ABS				
1.6 HDi	66	05/04→12/11		→ 03/10; für Linkslenker; - ABS		03.2123-2781.3	010631	ATE Ø 23,8
80								
2.0 16V	100	01/03→06/12		→ 03/10; - ABS		24.2123-1714.3	010587	BDX Ø 23,8
→								































	kw					! #		
CITROËN - XSARA PICASSO (N68) 09/99→06/12								
 Hauptbremszylinder								
2.0 16V	101	12/99→11/11		01/03→03/10; für Linkslenker; - ABS		03.2123-2781.3 010631	ATE Ø 23,8	
				01/03→03/10; - ABS		24.2123-1714.3 010587	BDX Ø 23,8	
2.0 HDi	66	12/99→12/11		für DAM-Nummer ab: 0882078 →; → 03/10; für Linkslenker; - ABS		03.2123-2781.3 010631	ATE Ø 23,8	
				06/00→03/10; - ABS		24.2123-1714.3 010587	BDX Ø 23,8	
CITROËN - ZX (N2) 03/91→07/99								
 Bremskraftverstärker								
1.1 1.4 1.4 i 1.6 i 1.8 D 1.8 i 1.9 1.9 D 1.9 i 1.9 TD 2.0 i	44 55 55 65 44 74 93 47 88 66 89	03/91→06/97 03/91→06/97 03/91→06/97 03/91→06/97 06/93→06/97 07/92→06/97 03/91→06/97 03/91→06/97 03/91→06/97 07/92→06/97 07/92→06/97		- ABS		03.7740-4002.4 300108	ATE Ø 8" pneumatisch	
1.4 D 1.6 1.8 1.9 DT 2.0	37 66 76 65 90	07/94→10/97 07/94→10/97 03/91→10/97 07/94→10/97 07/94→10/97		→ 06/97; - ABS		03.7740-4002.4 300108	ATE Ø 8" pneumatisch	
1.9 D	50	07/93→06/97		06/94→; - ABS		03.7740-4002.4 300108	ATE Ø 8" pneumatisch	
 Hauptbremszylinder								
1.1 1.4 1.4 i 1.6 i 1.8 D 1.8 i 1.8 i 16V 1.9 1.9 D 1.9 i 1.9 TD 2.0 i	44 55 55 65 44 74 81 93 47 88 66 89	03/91→06/97 03/91→06/97 03/91→06/97 03/91→06/97 06/93→06/97 07/92→06/97 01/96→06/97 03/91→06/97 03/91→06/97 03/91→06/97 07/92→06/97 07/92→06/97		→Orga 07125; - ABS		03.2120-2031.3 010106 24.2120-1722.3 010544	ATE Ø 20,6 Ø 20,6	
				Orga 07126→; - ABS		03.2120-4221.3 010605	ATE Ø 20,6	
				Orga 07070→; + ABS; für Linkslenker		03.2122-1331.3 010607	ATE Ø 22,2	
				→Orga 07069; + ABS		24.2122-1704.3 010423	Ø 22,2	
1.4 D 1.6 1.8	37 66 76 - 82	07/94→10/97 07/94→10/97 03/91→10/97		→Orga 07125; - ABS		03.2120-2031.3 010106 24.2120-1722.3 010544	ATE Ø 20,6 Ø 20,6	
				Orga 07126→; → 06/97; - ABS		03.2120-4221.3 010605	ATE Ø 20,6	
1.9 DT 2.0	65 90	07/94→10/97 07/94→10/97		Orga 07070→; → 06/97; + ABS; für Linkslenker		03.2122-1331.3 010607	ATE Ø 22,2	
				→Orga 07069; + ABS		24.2122-1704.3 010423	Ø 22,2	
1.9 D	50	07/93→06/97		06/94→; →Orga 07125; - ABS		03.2120-2031.3 010106 24.2120-1722.3 010544	ATE Ø 20,6 Ø 20,6	
				Orga 07126→; - ABS		03.2120-4221.3 010605	ATE Ø 20,6	
				Orga 07070→; + ABS; für Linkslenker		03.2122-1331.3 010607	ATE Ø 22,2	
				06/94→; →Orga 07069; + ABS		24.2122-1704.3 010423	Ø 22,2	
CITROËN - ZX Break (N2) 10/93→07/99								
 Hauptbremszylinder								
1.4 i 1.6 i 1.8 D 1.8 i 1.9 D	55 65 44 74 47 - 50	10/93→10/97 10/93→10/97 10/93→10/97 10/93→10/97 10/93→10/97		Orga 07070→; für Linkslenker		03.2122-1331.3 010607 24.2122-1704.3 010423	ATE Ø 22,2 Ø 22,2	
1.9 TD	66	10/93→10/97		→Orga 07069; + ABS		24.2122-1704.3 010423	Ø 22,2	
1.5 D	42	06/96→02/98		Orga 07070→; + ABS; für Linkslenker		03.2122-1331.3 010607 24.2122-1704.3 010423	ATE Ø 22,2 Ø 22,2	
				→Orga 07069; + ABS		24.2122-1704.3 010423	Ø 22,2	
1.8 i 16V	81	01/96→02/98		- ABS; für Linkslenker		03.2122-1331.3 010607 03.2122-1331.3 010607	ATE Ø 22,2 ATE Ø 22,2	
				Orga 07070→; + ABS; für Linkslenker		03.2122-1331.3 010607	ATE Ø 22,2	
				→Orga 07069; + ABS		24.2122-1704.3 010423	Ø 22,2	
CUPRA - ATECA (KH7, KHP) 09/18→								
 Hauptbremszylinder								
2.0 TSI 4Drive	221 - 257	09/18→		für Linkslenker		24.4123-1719.3 011017 24.4153-1522.3 011048	TRW Ø 23,8 ohne Bremsflüssig- keitsbehälter ATE Ø 23,8 ohne Bremsflüssig- keitsbehälter	

















	kw					! #		
DACIA - DOKKER Express Kasten/Großraumlimousine 11/12→								
 Hauptbremszylinder								
1.2 TCe 115	84	12/12→		- ESP			24.4152-0381.3 011032	ATE Ø 22,2 ohne Bremsflüssigkeitsbehälter
1.3 TCe 100	85	08/19→		+ ESP			24.4152-0391.3 011033	ATE Ø 22,2 ohne Bremsflüssigkeitsbehälter
1.3 TCe 130	75	08/19→						
1.5 Blue dCi 95	96	08/19→						
1.5 dCi	70	06/19→						
1.5 dCi 75 / Blue dCi 75	62 - 66	11/12→						
1.6	61	12/12→						
1.6 LPG	75							
	61 - 80	11/13→						
DACIA - DOKKER Großraumlimousine (KE_) 11/12→								
 Hauptbremszylinder								
1.2 TCe	85	11/12→		- ESP			24.4152-0381.3 011032	ATE Ø 22,2 ohne Bremsflüssigkeitsbehälter
1.3 TCe 100	75	08/19→		+ ESP			24.4152-0391.3 011033	ATE Ø 22,2 ohne Bremsflüssigkeitsbehälter
1.3 TCe 130	96	03/19→						
1.5 Blue dCi 95	70	12/18→						
1.5 dCi / Blue dCi 75	55	11/12→						
1.5 dCi	63 - 66	11/12→						
1.6	61	11/12→						
1.6 LPG	75							
	61 - 80	11/13→						
DACIA - DUSTER (HS_) 04/10→01/18								
 Bremskraftverstärker								
1.5 dCi	63 - 79	04/10→01/18		→ 10/13; + ABS			03.7853-4602.4 300302	ATE Ø 9" pneumatisch
1.5 dCi 4x4	66 - 81	10/10→01/18						
1.6 16V	77	04/10→01/18						
1.6 16V 4x4	77	06/10→01/18						
1.6 16V LPG	77	04/11→01/18						
1.5 dCi 4x4	80	08/13→01/18		+ ABS			03.7853-4602.4 300302	ATE Ø 9" pneumatisch
1.6 16V Hi-Flex	77	08/10→01/18		04/11→ 10/13; + ABS			03.7853-4602.4 300302	ATE Ø 9" pneumatisch
 Hauptbremszylinder								
1.2 TCe 125	92	10/13→01/18		+ ABS / - ESP			24.4152-0381.3 011032	ATE Ø 22,2 ohne Bremsflüssigkeitsbehälter
1.2 TCe 125 4x4	92	06/15→01/18		+ ABS / + ESP			24.4152-0391.3 011033	ATE Ø 22,2 ohne Bremsflüssigkeitsbehälter
1.6 SCe 115	84	06/15→01/18						
1.5 dCi	63 - 79	04/10→01/18		→ 10/13; - ESP			03.2122-2031.3 010938	ATE Ø 22,2
1.5 dCi 4x4	66 - 81	10/10→01/18		→ 10/13; + ESP			03.2122-2261.3 010964	ATE Ø 22,2
1.6 16V	77	04/10→01/18		11/13→; + ABS / - ESP			24.4152-0381.3 011032	ATE Ø 22,2 ohne Bremsflüssigkeitsbehälter
1.6 16V 4x4	77	06/10→01/18		11/13→; + ABS / + ESP			24.4152-0391.3 011033	ATE Ø 22,2 ohne Bremsflüssigkeitsbehälter
1.6 16V LPG	77	04/11→01/18						
1.5 dCi 4x4	80	08/13→01/18		+ ABS / - ESP			03.2122-2031.3 010938	ATE Ø 22,2
				+ ABS / + ESP			03.2122-2261.3 010964	ATE Ø 22,2
1.6 16V Hi-Flex	77	08/10→01/18		04/11→ 10/13; - ESP			03.2122-2031.3 010938	ATE Ø 22,2
				11/13→; + ABS / - ESP			24.4152-0381.3 011032	ATE Ø 22,2 ohne Bremsflüssigkeitsbehälter
1.6 SCe 115 4x4	84	06/15→01/18		für Linkslenker; + ABS / - ESP			24.4152-0381.3 011032	ATE Ø 22,2 ohne Bremsflüssigkeitsbehälter
				für Linkslenker; + ABS / + ESP			24.4152-0391.3 011033	ATE Ø 22,2 ohne Bremsflüssigkeitsbehälter
1.6 SCe 115 LPG	84	06/15→01/18		für Linkslenker; + ABS / - ESP			24.4152-0381.3 011032	ATE Ø 22,2 ohne Bremsflüssigkeitsbehälter
				+ ABS / + ESP			24.4152-0391.3 011033	ATE Ø 22,2 ohne Bremsflüssigkeitsbehälter
DACIA - DUSTER Kasten/SUV 04/11→								
 Bremskraftverstärker								
1.5 dCi	66	04/11→		→ 10/13; + ABS			03.7853-4602.4 300302	ATE Ø 9" pneumatisch
1.5 dCi 4x4	66	04/11→						
1.6 16V	77	04/11→						
1.6 16V 4x4	77	04/11→						
1.6 16V Hi-Flex	77	04/11→						
1.5 dCi 4x4	80	04/13→		08/13→; + ABS			03.7853-4602.4 300302	ATE Ø 9" pneumatisch
→								















	kw					! #		
DACIA - DUSTER Kasten/SUV 04/11→								
 Hauptbremszylinder								
1.2 TCe 125 4x4	92	10/13→		06/15→; + ABS / - ESP		24.4152-0381.3	011032	ATE Ø 22,2 ohne Bremsflüssigkeitsbehälter
				06/15→; + ABS / + ESP		24.4152-0391.3	011033	ATE Ø 22,2 ohne Bremsflüssigkeitsbehälter
1.5 dCi	66	04/11→		→ 10/13; - ESP		03.2122-2031.3	010938	ATE Ø 22,2
1.5 dCi 4x4	66	04/11→		→ 10/13; + ESP		03.2122-2261.3	010964	ATE Ø 22,2
1.6 16V 4x4	77	04/11→		11/13→; + ABS / - ESP		24.4152-0381.3	011032	ATE Ø 22,2 ohne Bremsflüssigkeitsbehälter
				11/13→; + ABS / + ESP		24.4152-0391.3	011033	ATE Ø 22,2 ohne Bremsflüssigkeitsbehälter
1.5 dCi 4x4	80	04/13→		08/13→; + ABS / - ESP		03.2122-2031.3	010938	ATE Ø 22,2
				08/13→; + ABS / + ESP		03.2122-2261.3	010964	ATE Ø 22,2
1.6 16V	77	04/11→		→ 10/13; - ESP		03.2122-2031.3	010938	ATE Ø 22,2
1.6 16V Hi-Flex	77	04/11→		11/13→; + ABS / - ESP		24.4152-0381.3	011032	ATE Ø 22,2 ohne Bremsflüssigkeitsbehälter
1.6 S Ce 115	84	06/15→		+ ABS / - ESP		24.4152-0381.3	011032	ATE Ø 22,2 ohne Bremsflüssigkeitsbehälter
				+ ABS / + ESP		24.4152-0391.3	011033	ATE Ø 22,2 ohne Bremsflüssigkeitsbehälter
1.6 S Ce 115 4x4	84	06/15→01/18		für Linkslenker; + ABS / - ESP		24.4152-0381.3	011032	ATE Ø 22,2 ohne Bremsflüssigkeitsbehälter
				für Linkslenker; + ABS / + ESP		24.4152-0391.3	011033	ATE Ø 22,2 ohne Bremsflüssigkeitsbehälter
DACIA - LODGY (JS_) 03/12→								
 Hauptbremszylinder								
1.2 TCe	85	03/12→		- ESP		24.4152-0381.3	011032	ATE Ø 22,2 ohne Bremsflüssigkeitsbehälter
1.3 TCe 100	75	01/19→						
1.3 TCe 130	96	01/19→		+ ESP		24.4152-0391.3	011033	ATE Ø 22,2 ohne Bremsflüssigkeitsbehälter
1.5 Blue dCi 115	85	08/18→						
1.5 Blue dCi 95	70	08/18→						
1.5 dCi	63 -	03/12→						
	81							
1.6	61	03/12→						
1.6 LPG	61 -	11/13→						
	80							
1.6 S Ce 100	75	06/15→		für Linkslenker; - ESP		24.4152-0381.3	011032	ATE Ø 22,2 ohne Bremsflüssigkeitsbehälter
				für Linkslenker; + ESP		24.4152-0391.3	011033	ATE Ø 22,2 ohne Bremsflüssigkeitsbehälter
DACIA - LOGAN (LS_) 08/04→								
 Bremskraftverstärker								
1.2 16V	55	02/06→		→ 04/13		03.7853-4602.4	300302	ATE Ø 9" pneumatisch
1.2 16V LPG	55	02/06→						
1.5 dCi	65	05/10→						
1.6 Bifuel	62	05/10→						
1.6 MPI 85	62	05/10→						
1.5 dCi	55	05/10→12/12				03.7853-4602.4	300302	ATE Ø 9" pneumatisch
1.5 dCi	63	09/07→12/11		+ ABS		03.7750-8532.4	300264	ATE Ø 9" pneumatisch
1.6	64	09/04→						
1.6 LPG	64	08/04→03/11						
1.6 16V Flexifuel	77	07/10→		01/11→ 04/13		03.7853-4602.4	300302	ATE Ø 9" pneumatisch
 Hauptbremszylinder								
1.2 16V	55	02/06→		+ ABS; → 04/13		03.2120-4611.3	010937	ATE Ø 20,6
1.2 16V LPG	55	02/06→						
1.5 dCi	65	05/10→		- ABS; → 04/13		24.2120-1762.3	011002	Ø 20,6 ohne Bremsflüssigkeitsbehälter
1.6 Bifuel	62	05/10→						
1.6 MPI 85	62	05/10→						
1.4	55	09/04→		→ 04/13; + ABS		24.2120-1754.3	010949	Ø 20,6
1.5 dCi	48	09/05→						
1.6 16V	77	02/06→		- ABS; → 04/13		24.2120-1762.3	011002	Ø 20,6 ohne Bremsflüssigkeitsbehälter
1.4 MPI LPG	55	02/06→12/12		+ ABS		24.2120-1754.3	010949	Ø 20,6
1.5 dCi	50	01/06→12/12		- ABS		24.2120-1762.3	011002	Ø 20,6 ohne Bremsflüssigkeitsbehälter
1.6	64	09/04→						
1.6 LPG	64	08/04→03/11						
1.5 dCi	55 -	09/07→12/12		+ ABS		03.2120-4611.3	010937	ATE Ø 20,6
	63			- ABS		24.2120-1762.3	011002	Ø 20,6 ohne Bremsflüssigkeitsbehälter
1.6 16V Flexifuel	77	07/10→		01/11→; + ABS; → 04/13		03.2120-4611.3	010937	ATE Ø 20,6
→								













	kw			 	! #		
DACIA - LOGAN (LS_) 08/04→							
 Hauptbremszylinder							
1.6 16V Flexifuel	77	07/10→		01/11→; - ABS; → 04/13		24.2120-1762.3 011002	Ø 20,6 ohne Bremsflüssigkeitsbehälter
DACIA - LOGAN II 10/12→							
 Hauptbremszylinder							
1.0 LPG 1.0 SCe 75 1.0 TCe 100 1.6	74 54 74 59 - 63	11/19→ 01/17→ 11/19→ 06/13→		für Linkslenker		24.4120-1771.3 011076	Ø 20,6 ohne Bremsflüssigkeitsbehälter
1.2 1.2 LPG 1.5 Blue dCi 95 1.5 dCi 1.5 dCi / Blue dCi 75 1.6 16V TCe 90 TCe 90 LPG	54 - 55 53 - 55 70 63 - 66 55 77 66 66	10/12→ 10/12→ 05/18→ 10/12→ 10/12→ 01/13→ 10/12→ 09/15→		für Linkslenker; + ABS		24.4120-1771.3 011076	Ø 20,6 ohne Bremsflüssigkeitsbehälter
DACIA - LOGAN EXPRESS (FS_) 10/07→							
 Bremskraftverstärker							
1.4 1.5 dCi 1.6 MPI 85 1.5 dCi 1.6 LPG	55 50 - 65 62 48 62	03/09→ 03/09→ 05/10→ 10/07→12/12 05/10→12/12		→ 06/13 + ABS; → 06/13 + ABS + ABS; → 01/11 + ABS; 02/11→		03.7750-8532.4 300264 03.7750-8532.4 300264 03.7750-8532.4 300264 03.7750-8532.4 300264 03.7853-4602.4 300302	ATE Ø 9" pneumatisch ATE Ø 9" pneumatisch ATE Ø 9" pneumatisch ATE Ø 9" pneumatisch ATE Ø 9" pneumatisch
 Hauptbremszylinder							
1.4 1.5 dCi 1.6 MPI 85 1.5 dCi 1.6 LPG	55 50 - 65 62 48 62	03/09→ 03/09→ 05/10→ 10/07→12/12 05/10→12/12		+ ABS; → 06/13 - ABS; → 06/13 + ABS; → 06/13 + ABS		03.2122-2031.3 010938 24.2120-1762.3 011002 03.2122-2031.3 010938 03.2122-2031.3 010938	ATE Ø 22,2 Ø 20,6 ohne Bremsflüssigkeitsbehälter ATE Ø 22,2 ATE Ø 22,2
DACIA - LOGAN MCV (KS_) 02/07→							
 Bremskraftverstärker							
1.4 1.5 dCi 1.6 1.6 16V 1.6 16V Hi-Flex 1.6 Bifuel 1.5 dCi 1.6 MPI 85	55 48 - 65 64 77 77 62 - 64 63 62	02/07→ 02/07→ 02/07→06/13 02/07→ 11/09→ 11/08→ 09/07→12/12 05/10→		→ 04/13; + ABS + ABS + ABS		03.7750-8532.4 300264 03.7750-8532.4 300264 03.7853-4602.4 300302	ATE Ø 9" pneumatisch ATE Ø 9" pneumatisch ATE Ø 9" pneumatisch
 Hauptbremszylinder							
1.4 1.5 dCi 1.6 1.6 16V 1.5 dCi 1.6 16V Hi-Flex 1.5 dCi 1.6 Bifuel 1.6 MPI 85	55 48 - 50 64 77 55 - 65 77 63 62 - 64 62	02/07→ 02/07→ 02/07→06/13 02/07→ 05/10→ 11/09→ 09/07→12/12 11/08→ 05/10→		- ABS; → 04/13 + ABS; → 04/13 - ABS; → 04/13 + ABS - ABS + ABS; → 04/13 - ABS; → 04/13 + ABS; Bosnien-Herzegowina / Kroatien / + RO / + TR		24.2120-1762.3 011002 03.2122-2031.3 010938 24.2120-1762.3 011002 03.2122-2031.3 010938 24.2120-1762.3 011002 24.2120-1754.3 010949 24.2120-1762.3 011002 03.2120-4611.3 010937	Ø 20,6 ohne Bremsflüssigkeitsbehälter ATE Ø 22,2 Ø 20,6 ohne Bremsflüssigkeitsbehälter ATE Ø 22,2 Ø 20,6 ohne Bremsflüssigkeitsbehälter Ø 20,6 ATE Ø 20,6
→							









	kw					! #		
DACIA - LOGAN MCV (KS_) 02/07→								
 Hauptbremszylinder								
1.6 MPI 85	62	05/10→		+ ABS		03.2122-2031.3	010938	ATE Ø 22,2
				- ABS; → 04/13		24.2120-1762.3	011002	Ø 20,6 ohne Bremsflüssigkeitsbehälter
DACIA - LOGAN MCV II 02/13→								
 Hauptbremszylinder								
1.0 LPG 1.0 TCe 100	74 74	11/19→ 11/19→		für Linkslenker		24.4120-1771.3	011076	Ø 20,6 ohne Bremsflüssigkeitsbehälter
1.0 SCe 75 1.2 1.2 LPG 1.5 Blue dCi 95 1.5 dCi 1.6 TCe 90 TCe 90 LPG	54 54 - 55 53 - 55 70 55 - 66 62 66 66	12/16→ 02/13→ 02/13→ 10/18→ 02/13→ 06/13→ 02/13→ 09/15→		für Linkslenker; + ABS		24.4120-1771.3	011076	Ø 20,6 ohne Bremsflüssigkeitsbehälter
DACIA - LOGAN Pick-up (US_) 03/08→								
 Bremskraftverstärker								
1.4 1.5 dCi 1.6 1.6 Bifuel 1.6 MPI 85	55 55 - 65 64 62 62	01/09→ 03/08→ 03/08→ 05/10→ 05/10→		→ 06/13		03.7750-8532.4	300264	ATE Ø 9" pneumatisch
1.5 dCi 1.6 16V 1.5 dCi	48 77 50	04/08→12/12 01/10→08/13 03/08→		+ ABS → 06/13; + ABS		03.7750-8532.4	300264	ATE Ø 9" pneumatisch ATE Ø 9" pneumatisch
 Hauptbremszylinder								
1.4	55	01/09→		+ ABS; → 06/13		03.2122-2031.3	010938	ATE Ø 22,2
				- ABS; → 06/13		24.2120-1762.3	011002	Ø 20,6 ohne Bremsflüssigkeitsbehälter
1.5 dCi 1.6 1.6 Bifuel 1.6 MPI 85	50 - 65 64 62 62	03/08→ 03/08→ 05/10→ 05/10→		+ ABS; → 06/13		03.2122-2031.3	010938	ATE Ø 22,2
1.5 dCi 1.6 16V	48 77	04/08→12/12 01/10→08/13		+ ABS		03.2122-2031.3	010938	ATE Ø 22,2
DACIA - SANDERO 06/08→								
 Bremskraftverstärker								
1.2 16V 1.2 16V LPG 1.4 1.4 MPI LPG 1.5 dCi 1.6 16V 1.6 MPI 85	55 55 55 53 48 - 65 77 62	11/08→ 11/08→ 06/08→ 01/09→ 11/08→ 07/11→ 05/10→06/13		→ 02/13; + ABS		03.7853-4602.4	300302	ATE Ø 9" pneumatisch
1.5 dCi 1.6 1.6 16V Bifuel 1.6 Hi-Flex 1.6 LPG	63 64 77 64 62 - 64	11/08→ 06/08→ 01/11→ 06/08→12/12 06/08→12/12		→ 02/13 + ABS		03.7750-8532.4 03.7853-4602.4	300264 300302	ATE Ø 9" pneumatisch ATE Ø 9" pneumatisch
1.6 LPG	60	01/11→12/12		→ 10/12; + ABS		03.7853-4602.4	300302	ATE Ø 9" pneumatisch
 Hauptbremszylinder								
1.2 16V 1.2 16V LPG 1.4 1.4 MPI LPG 1.5 dCi 1.6 16V 1.6 MPI 85	55 55 55 53 48 - 65 77 62	11/08→ 11/08→ 06/08→ 01/09→ 11/08→ 07/11→ 05/10→06/13		→ 02/13; + ABS → 02/13; - ABS		03.2120-4611.3 24.2120-1762.3	010937 011002	ATE Ø 20,6 Ø 20,6 ohne Bremsflüssigkeitsbehälter
1.5 dCi 1.6 1.6 16V Bifuel 1.6 Hi-Flex	63 64 77 64	11/08→ 06/08→ 01/11→ 06/08→12/12		→ 02/13; + ABS + ABS		03.2122-2031.3 03.2120-4611.3	010938 010937	ATE Ø 22,2 ATE Ø 20,6

	kw			 	! #		
DACIA - SANDERO 06/08→							
 Hauptbremszylinder							
1.6 LPG	62 - 64	06/08→12/12		- ABS		24.2120-1762.3 011002	Ø 20,6 ohne Bremsflüssigkeitsbehälter
1.6 LPG	60	01/11→12/12		→ 10/12; + ABS		03.2120-4611.3 010937	ATE Ø 20,6
				→ 10/12; - ABS		24.2120-1762.3 011002	Ø 20,6 ohne Bremsflüssigkeitsbehälter
DACIA - SANDERO II 10/12→							
 Hauptbremszylinder							
1.0 LPG 1.0 SCe 75 1.0 TCe 100 1.2 1.2 LPG 1.5 Blue dCi 95 1.5 dCi 1.5 dCi 75 / Blue dCi 75 1.6 TCe 90 TCe 90 LPG	74 54 74 54 - 55 55 70 63 - 66 55 63 66 66	11/19→ 12/16→ 11/19→ 10/12→ 10/12→ 08/18→ 10/12→ 10/12→ 11/12→ 10/12→ 09/15→		für Linkslenker; + ABS		24.4120-1771.3 011076	Ø 20,6 ohne Bremsflüssigkeitsbehälter
DAEWOO - MATIZ (M100, M150) 09/98→							
 Hauptbremszylinder							
0.8 1.0	38 47	09/98→ 01/03→		→ 02/05; für Linkslenker; + ABS		24.2120-1755.3 010974	Ø 20,6 ohne Bremsflüssigkeitsbehälter
				→ 02/05; für Linkslenker; - ABS		24.2120-1765.3 011003	Ø 20,6 ohne Bremsflüssigkeitsbehälter
1.0	46	04/03→12/04		für Linkslenker; + ABS		24.2120-1755.3 010974	Ø 20,6 ohne Bremsflüssigkeitsbehälter
				für Linkslenker; - ABS		24.2120-1765.3 011003	Ø 20,6 ohne Bremsflüssigkeitsbehälter
DAEWOO - MATIZ (M200, M250) 01/05→12/18							
 Hauptbremszylinder							
0.8 1.0	38 49	01/05→06/10 03/05→12/08		für Linkslenker; + ABS		24.2120-1755.3 010974	Ø 20,6 ohne Bremsflüssigkeitsbehälter
				für Linkslenker; - ABS		24.2120-1765.3 011003	Ø 20,6 ohne Bremsflüssigkeitsbehälter
DAEWOO - MATIZ (M300) 01/10→11/12							
 Hauptbremszylinder							
1.0	51	01/10→11/12		für Linkslenker; + ABS		24.2120-1755.3 010974	Ø 20,6 ohne Bremsflüssigkeitsbehälter
				für Linkslenker; - ABS		24.2120-1765.3 011003	Ø 20,6 ohne Bremsflüssigkeitsbehälter
DAEWOO - MATIZ Kasten/Schrägheck (KLA4) 08/98→08/02							
 Hauptbremszylinder							
0.8	38	08/98→08/02		für Linkslenker; + ABS		24.2120-1755.3 010974	Ø 20,6 ohne Bremsflüssigkeitsbehälter
				für Linkslenker; - ABS		24.2120-1765.3 011003	Ø 20,6 ohne Bremsflüssigkeitsbehälter
DAIHATSU - CHARADE VIII 05/11→							
 Bremskraftverstärker							
1.33 16V	73	05/11→		→ 01/13; für Linkslenker; + ESP		03.7750-7132.4 300255	ATE Ø 9" pneumatisch
				→ 01/13; für Linkslenker; - ESP		03.7853-3203.4 300241	ATE Ø 9" pneumatisch
 Hauptbremszylinder							
1.33 16V	73	05/11→		→ 01/13; für Linkslenker; - ESP		03.4152-0153.3 011006	ATE Ø 22,2 ohne Bremsflüssigkeitsbehälter
				→ 01/13; für Linkslenker; + ESP		03.4152-0158.3 011007	ATE Ø 22,2 ohne Bremsflüssigkeitsbehälter
DS - DS 5 (KF_) 01/15→12/18							
 Bremskraftverstärker							
1.6 BlueHDi 115 1.6 BlueHDi 120 →	85 88	06/15→12/18 06/15→12/18		für Fahrzeuge mit Start-Stopp-Funktion		03.7860-3734.4 300317	ATE Ø 10" pneumatisch

	kW					! #		
DS - DS 5 (KF_) 01/15→12/18								
 Bremskraftverstärker								
1.6 THP 165 1.6 THP 210 2.0 BlueHDi 135 2.0 BlueHDi 150 2.0 BlueHDi 180 2.0 Hybrid4	121 155 100 110 133 147	07/15→12/18 04/15→12/18 06/15→12/18 04/15→12/18 04/15→12/18 04/15→12/18			für Fahrzeuge mit Start-Stopp-Funktion		03.7860-3734.4 300317	ATE Ø 10" pneumatisch
 Hauptbremszylinder								
1.6 BlueHDi 115 1.6 BlueHDi 120 1.6 THP 165 1.6 THP 210 2.0 BlueHDi 135 2.0 BlueHDi 150 2.0 BlueHDi 180 2.0 Hybrid4	85 88 121 155 100 110 133 147	06/15→12/18 06/15→12/18 07/15→12/18 04/15→12/18 06/15→12/18 04/15→12/18 04/15→12/18 04/15→12/18			82 mm Radnabendurchmesser [mm] 83 mm Radnabendurchmesser [mm]		03.4153-0173.3 010815 24.4155-1236.3 011049	ATE Ø 23,8 ATE Ø 25,4 ohne Bremsflüssigkeitsbehälter
FIAT - 126 (126_) 09/72→09/00								
 Hauptbremszylinder								
650	18	07/81→09/00			→ 08/87		24.2119-0815.3 010347	Ø 19
FIAT - 500 (312_) 07/07→								
 Hauptbremszylinder								
0.9 1.3 D Multijet 1.4 1.4 Turbo	44 - 63 57 74 - 75 101	07/10→ 06/16→ 10/07→ 09/13→					24.4122-1714.3 010914	TRW Ø 22,2 ohne Bremsflüssigkeitsbehälter
0.9 Electric	77 24 - 83	10/13→ 01/10→			12/13→		24.4122-1714.3 010914	TRW Ø 22,2 ohne Bremsflüssigkeitsbehälter
1.2 1.2 LPG 1.3 D Multijet	51 51 55 - 70	07/07→ 12/10→ 10/07→					24.4120-1702.3 010913	TRW Ø 20,6 ohne Bremsflüssigkeitsbehälter
FIAT - 500 C (312_) 09/09→								
 Hauptbremszylinder								
0.9 1.3 D Multijet 1.4	44 - 77 55 - 70 74 - 75	09/09→ 09/09→ 09/09→					24.4122-1714.3 010914	TRW Ø 22,2 ohne Bremsflüssigkeitsbehälter
1.2	51	09/09→					24.4120-1702.3 010913	TRW Ø 20,6 ohne Bremsflüssigkeitsbehälter
FIAT - 500L (351_, 352_) 09/12→								
 Hauptbremszylinder								
0.9 0.9 Natural Power 1.3 D Multijet 1.4 1.4 LPG 1.6 D Multijet	77 59 - 63 62 - 70 70 88 77 - 88	09/12→ 03/13→ 09/12→ 09/12→ 02/14→ 09/12→			für Linkslenker; Schaltgetriebe, automatisch betätigt		24.4122-1734.3 011117	Ø 22,2 ohne Bremsflüssigkeitsbehälter
1.4	88 - 119	09/13→			01/14→; für Linkslenker; Schaltgetriebe, automatisch betätigt		24.4122-1734.3 011117	Ø 22,2 ohne Bremsflüssigkeitsbehälter
FIAT - BARCHETTA (183_) 03/95→05/05								
 Hauptbremszylinder								
1.8 16V	96	04/95→05/05			→ 10/04; GG		24.2122-1716.3 010485	Ø 22,2
 Bremskraftregler								
1.8 16V	96	04/95→05/05			+ ABS; → 10/04; 		24.6513-1705.3 320237	lastabhängig 2x
FIAT - BRAVA (182_) 10/95→06/03								
 Hauptbremszylinder								
1.2 16V 80 1.4 →	59 55	10/00→10/01 10/95→10/01			für Linkslenker; GG		24.2122-1716.3 010485	Ø 22,2

	kw			 	! #		
FIAT - BRAVA (182_) 10/95→06/03							
 Hauptbremszylinder							
1.4 12 V 1.6 16V	59 66 - 76	10/95→08/98 10/95→12/02		für Linkslenker; GG		24.2122-1716.3 010485	Ø 22,2
1.8 GT 16V 1.9 D 1.9 JTD 1.9 JTD 105	83 48 74 77	10/95→08/01 10/95→10/01 09/00→10/01 12/98→10/01					
1.2 16V 80	60	12/98→12/02		→ 10/01; für Linkslenker; GG		24.2122-1716.3 010485	Ø 22,2
1.9 TD 100 S 1.9 TD 75 S	74 55	03/96→10/01 03/96→10/01		06/96→; für Linkslenker; GG		24.2122-1716.3 010485	Ø 22,2
FIAT - BRAVO I (182_) 10/95→10/01							
 Hauptbremszylinder							
1.2 16V 80	59 - 60	12/98→10/01		für Linkslenker; GG		24.2122-1716.3 010485	Ø 22,2
1.4 1.6 1.6 16V 1.8 GT 1.9 D 1.9 JTD 1.9 JTD 105 2.0 HGT 20V	55 - 59 76 66 - 76 83 48 74 77 108 - 113	10/95→10/01 09/00→10/01 10/95→10/01 10/95→10/01 10/95→10/01 09/00→10/01 12/98→10/01 10/95→10/01					
1.9 TD 100 S 1.9 TD 75 S	74 55	03/96→10/01 03/96→10/01		06/96→; für Linkslenker; GG		24.2122-1716.3 010485	Ø 22,2
FIAT - BRAVO II (198_) 11/06→12/16							
 Hauptbremszylinder							
1.4 1.4 T-Jet	66 88 - 110	04/07→12/14 09/07→12/14		→ 12/07		24.2122-1777.3 011056	Ø 22,2 ohne Bremsflüssigkeitsbehälter
1.9 D Multijet	66 - 110	04/07→12/14		01/08→		24.4123-1710.3 010866	BOS Ø 23,8 ohne Bremsflüssigkeitsbehälter
1.4 16V 1.4 T-Jet 1.6 D Multijet 2.0 D Multijet	103 112 66 - 88 120 - 121	04/10→12/14 06/11→12/16 03/08→12/14 09/08→12/14				24.4123-1710.3 010866	BOS Ø 23,8 ohne Bremsflüssigkeitsbehälter
1.4 LPG	66	12/08→12/14		11/09→		24.4123-1710.3 010866	BOS Ø 23,8 ohne Bremsflüssigkeitsbehälter
1.6 D Multijet	77	09/07→12/14		03/08→		24.4123-1710.3 010866	BOS Ø 23,8 ohne Bremsflüssigkeitsbehälter
1.9 D Multijet	85	11/06→12/09		04/07→ 12/07		24.2122-1777.3 011056	Ø 22,2 ohne Bremsflüssigkeitsbehälter
				01/08→		24.4123-1710.3 010866	BOS Ø 23,8 ohne Bremsflüssigkeitsbehälter
FIAT - BRAVO Van (198_) 03/08→12/14							
 Hauptbremszylinder							
1.6 JTD Multijet	77	03/08→12/14				24.4123-1710.3 010866	BOS Ø 23,8 ohne Bremsflüssigkeitsbehälter
FIAT - CINQUECENTO (170_) 07/91→07/99							
 Hauptbremszylinder							
0.7 i	22	07/94→01/98				24.2119-0833.3 010418	Ø 19
0.9 i.e. S	29	07/91→07/99		02/92→ 05/98		24.2119-0833.3 010418	Ø 19
1.1 Sporting	40	10/94→01/98		11/94→		24.2119-0833.3 010418	Ø 19
FIAT - COUPE (175_) 11/93→08/00							
 Hauptbremszylinder							
1.8 16V	96	03/96→08/00		07/96→; GG		24.2122-1716.3 010485	Ø 22,2
FIAT - CROMA (194_) 06/05→12/11							
 Hauptbremszylinder							
1.8 16V	103	12/05→12/11		01/06→; für Linkslenker; → 11/10; für Fahrzeuge mit elektronischer Fahrdynamikregelung		24.2125-1732.3 010827	TRW Ø 25,4
→							

	kw					! #		
FIAT - CROMA (194_) 06/05→12/11								
 Hauptbremszylinder								
1.9 D Multijet	85 - 110	06/05→12/11			für Linkslenker; → 11/10; für Fahrzeuge mit elektronischer Fahrdynamikregelung		24.2125-1732.3 010827	TRW Ø 25,4
2.2 16V	108	06/05→12/10						
2.4 D Multijet	147	06/05→12/11						
1.9 D Multijet	100	12/05→10/07			für Linkslenker; für Fahrzeuge mit elektronischer Fahrdynamikregelung		24.2125-1732.3 010827	TRW Ø 25,4
FIAT - CROMA Kasten/Kombi (194_) 04/06→12/11								
 Hauptbremszylinder								
1.9 MJTD	88	04/06→12/11			für Linkslenker; → 11/10; für Fahrzeuge mit elektronischer Fahrdynamikregelung		24.2125-1732.3 010827	TRW Ø 25,4
FIAT - DOBLO Bus (263_) 11/09→								
 Hauptbremszylinder								
1.3 D Multijet	66 - 70	02/10→			für Rechtslenker; + ESP		24.4123-1731.3 011094	Ø 23,8 ohne Bremsflüssigkeitsbehälter
1.4	70 - 88	02/10→						
1.4 Natural Power	88	02/10→						
1.6 D Multijet	66 - 88	02/10→						
1.6 D Multijet	77	01/10→			02/10→; für Rechtslenker; + ESP		24.4123-1731.3 011094	Ø 23,8 ohne Bremsflüssigkeitsbehälter
2.0 D Multijet	99	01/10→						
FIAT - DOBLO Cargo (263_) 02/10→								
 Hauptbremszylinder								
1.3 D Multijet	55 - 70	02/10→			für Rechtslenker; + ESP		24.4123-1731.3 011094	Ø 23,8 ohne Bremsflüssigkeitsbehälter
1.4	70 - 88	02/10→						
1.4 Natural Power	88	06/10→						
1.6 D Multijet	66 - 88	02/10→						
2.0 D Multijet	99	02/10→						
FIAT - DOBLO Großraumlimousine (119_, 223_) 03/01→								
 Hauptbremszylinder								
1.2	48	03/01→			→ 09/05; - ABS		24.2122-1750.3 010740	Ø 22,2
1.6	68	09/02→						
1.6 16V	76	10/01→						
1.9 D	46	03/01→						
1.3 D Multijet	62	10/05→			→ 01/10; + ABS		24.4123-1710.3 010866	BOS Ø 23,8 ohne Bremsflüssigkeitsbehälter
1.9 D Multijet	88	10/05→						
1.3 JTD	55	05/05→			10/05→ 01/10; + ABS		24.4123-1710.3 010866	BOS Ø 23,8 ohne Bremsflüssigkeitsbehälter
1.3 JTD 16V	51	12/04→05/05			- ABS		24.2122-1750.3 010740	Ø 22,2
1.6 Natural Power	76	09/02→			→ 09/05; - ABS		24.2122-1750.3 010740	Ø 22,2
					→ 01/10; + ABS		24.4123-1710.3 010866	BOS Ø 23,8 ohne Bremsflüssigkeitsbehälter
1.6 Natural Power	68	11/05→07/09			+ ABS		24.4123-1710.3 010866	BOS Ø 23,8 ohne Bremsflüssigkeitsbehälter
1.9 JTD	74 - 77	10/01→			→ 09/05; - ABS		24.2122-1750.3 010740	Ø 22,2
					10/05→ 01/10; + ABS		24.4123-1710.3 010866	BOS Ø 23,8 ohne Bremsflüssigkeitsbehälter
FIAT - DOBLO Kasten/Großraumlimousine (223_) 11/00→								
 Hauptbremszylinder								
1.2	48	03/01→01/04			- ABS		24.2122-1750.3 010740	Ø 22,2
1.2 16V	59	11/01→01/06						
1.6 16V	78	11/01→08/03						
1.3 D Multijet	55	10/05→01/10			+ ABS		24.4123-1710.3 010866	BOS Ø 23,8 ohne Bremsflüssigkeitsbehälter
1.3 JTD 16V	51	05/04→12/06			→ 09/05; - ABS		24.2122-1750.3 010740	Ø 22,2
1.6 16V	76	10/01→						
1.6 Natural Power	68 - 76	09/02→						
1.9 D	46	03/01→						
1.3 JTD 16V Multijet	62	08/06→			→ 01/10; + ABS		24.4123-1710.3 010866	BOS Ø 23,8 ohne Bremsflüssigkeitsbehälter
1.9 JTD Multijet	88	12/06→						
1.9 JTD	74 - 77	10/01→			→ 09/05; - ABS		24.2122-1750.3 010740	Ø 22,2
					10/05→ 01/10; + ABS		24.4123-1710.3 010866	BOS Ø 23,8 ohne Bremsflüssigkeitsbehälter

	kw					! #		
FIAT - DOBLO Pritsche/Fahrgestell (263_) 02/10→								
 Hauptbremszylinder								
1.3 D Multijet	55 - 70	02/10→			für Rechtslenker; + ESP		24.4123-1731.3 011094	Ø 23,8 ohne Bremsflüssigkeitsbehälter
1.4	70 - 88	04/10→						
1.4 Natural Power	88	06/10→						
1.6 D Multijet	66 - 88	02/10→						
2.0 D Multijet	99	02/10→						
FIAT - DUCATO Bus (230_) 03/94→05/05								
 Hauptbremszylinder								
1.9 D	50	04/98→04/02			→ 10/01; Nutzlast [kg]: 1.000; + ABS		24.2125-1702.3 010482	Ø 25,4
1.9 D Combinato	51	06/95→04/02			→ 10/01; Nutzlast [kg]: 1.000; - ABS		24.2125-1703.3 010483	Ø 25,4
1.9 TD	66	04/98→04/02			11/01→ 03/02; Nutzlast [kg]: 1.000; - ABS		24.2125-1725.3 010717	Ø 25,4
					11/01→ 03/02; Nutzlast [kg]: 1.000; + ABS		24.2125-1726.3 010718	Ø 25,4
1.9 D	59	05/98→11/01			→ 10/01; Nutzlast [kg]: 1.000; + ABS		24.2125-1702.3 010482	Ø 25,4
					→ 10/01; Nutzlast [kg]: 1.000; - ABS		24.2125-1703.3 010483	Ø 25,4
					11/01→; Nutzlast [kg]: 1.000; - ABS		24.2125-1725.3 010717	Ø 25,4
					11/01→; Nutzlast [kg]: 1.000; + ABS		24.2125-1726.3 010718	Ø 25,4
1.9 TD Combinato	59	08/94→04/02			→ 10/94; Nutzlast [kg]: 1.000; - ABS		24.2122-1715.3 010481	Ø 22,2
1.9 TD Panorama/Combinato	60	03/94→04/02			11/94→ 10/01; Nutzlast [kg]: 1.000; + ABS		24.2125-1702.3 010482	Ø 25,4
					11/94→ 10/01; Nutzlast [kg]: 1.000; - ABS		24.2125-1703.3 010483	Ø 25,4
					11/01→ 03/02; Nutzlast [kg]: 1.000; - ABS		24.2125-1725.3 010717	Ø 25,4
					11/01→ 03/02; Nutzlast [kg]: 1.000; + ABS		24.2125-1726.3 010718	Ø 25,4
2.0 4x4	80	11/94→11/01			→ 10/01; Nutzlast ab [kg] 1.000 Nutzlast bis [kg] 1.400; + ABS		24.2125-1702.3 010482	Ø 25,4
					→ 10/01; Nutzlast [kg]: 1.800; + ABS		24.2125-1702.3 010482	Ø 25,4
					→ 10/01; Nutzlast ab [kg] 1.000 Nutzlast bis [kg] 1.400; - ABS		24.2125-1703.3 010483	Ø 25,4
					→ 10/01; Nutzlast [kg]: 1.800; - ABS		24.2125-1703.3 010483	Ø 25,4
					11/01→; Nutzlast ab [kg] 1.000 Nutzlast bis [kg] 1.400; - ABS		24.2125-1725.3 010717	Ø 25,4
					11/01→; Nutzlast [kg]: 1.800; - ABS		24.2125-1725.3 010717	Ø 25,4
					11/01→; Nutzlast [kg]: 1.800; + ABS		24.2125-1726.3 010718	Ø 25,4
					11/01→; Nutzlast ab [kg] 1.000 Nutzlast bis [kg] 1.400; + ABS		24.2125-1726.3 010718	Ø 25,4
2.0 JTD	62	10/01→04/02			→ 03/02; Nutzlast [kg]: 1.800; - ABS		24.2125-1725.3 010717	Ø 25,4
					→ 03/02; Nutzlast [kg]: 1.400; - ABS		24.2125-1725.3 010717	Ø 25,4
					→ 03/02; Nutzlast [kg]: 1.400; + ABS		24.2125-1726.3 010718	Ø 25,4
					→ 03/02; Nutzlast [kg]: 1.800; + ABS		24.2125-1726.3 010718	Ø 25,4
2.0 Panorama/Combinato	80	03/94→04/02			→ 10/94; Nutzlast ab [kg] 1.000 Nutzlast bis [kg] 1.400; - ABS		24.2122-1715.3 010481	Ø 22,2
					→ 10/01; Nutzlast [kg]: 1.800; + ABS		24.2125-1702.3 010482	Ø 25,4
					11/94→ 10/01; Nutzlast ab [kg] 1.000 Nutzlast bis [kg] 1.400; + ABS		24.2125-1702.3 010482	Ø 25,4
					→ 10/01; Nutzlast [kg]: 1.800; - ABS		24.2125-1703.3 010483	Ø 25,4
					11/94→ 10/01; Nutzlast ab [kg] 1.000 Nutzlast bis [kg] 1.400; - ABS		24.2125-1703.3 010483	Ø 25,4
					11/01→ 03/02; Nutzlast ab [kg] 1.000 Nutzlast bis [kg] 1.400; - ABS		24.2125-1725.3 010717	Ø 25,4
					11/01→ 03/02; Nutzlast [kg]: 1.800; - ABS		24.2125-1725.3 010717	Ø 25,4
					11/01→ 03/02; Nutzlast ab [kg] 1.000 Nutzlast bis [kg] 1.400; + ABS		24.2125-1726.3 010718	Ø 25,4
					11/01→ 03/02; Nutzlast [kg]: 1.800; + ABS		24.2125-1726.3 010718	Ø 25,4
2.5 D Combinato	62	08/94→04/02			→ 10/94; Nutzlast [kg]: 1.400; - ABS		24.2122-1715.3 010481	Ø 22,2
2.5 TDI Panorama/Combinato	80 - 85	03/94→04/02			11/94→ 10/01; Nutzlast [kg]: 1.400; + ABS		24.2125-1702.3 010482	Ø 25,4
					→ 10/01; Nutzlast [kg]: 1.800; + ABS		24.2125-1702.3 010482	Ø 25,4
					11/94→ 10/01; Nutzlast [kg]: 1.400; - ABS		24.2125-1703.3 010483	Ø 25,4
					→ 10/01; Nutzlast [kg]: 1.800; - ABS		24.2125-1703.3 010483	Ø 25,4
→								

FIAT - DUCATO Bus (230_) 03/94→05/05

Hauptbremszylinder

2.5 D Combinato 2.5 TDI Panorama/Combinato	62	08/94→04/02		11/01→ 03/02; Nutzlast [kg]: 1.800; - ABS	24.2125-1725.3	010717	Ø 25,4
	80 - 85	03/94→04/02		11/01→ 03/02; Nutzlast [kg]: 1.400; - ABS	24.2125-1725.3	010717	Ø 25,4
				11/01→ 03/02; Nutzlast [kg]: 1.400; + ABS	24.2125-1726.3	010718	Ø 25,4
				11/01→ 03/02; Nutzlast [kg]: 1.800; + ABS	24.2125-1726.3	010718	Ø 25,4
2.5 TD 4x4	80	11/94→04/98		Nutzlast [kg]: 1.400; + ABS	24.2125-1702.3	010482	Ø 25,4
				Nutzlast [kg]: 1.800; + ABS	24.2125-1702.3	010482	Ø 25,4
				Nutzlast [kg]: 1.800; - ABS	24.2125-1703.3	010483	Ø 25,4
				Nutzlast [kg]: 1.400; - ABS	24.2125-1703.3	010483	Ø 25,4
2.5 TDI 4x4	85	04/97→04/02		→ 10/01; Nutzlast [kg]: 1.400; + ABS	24.2125-1702.3	010482	Ø 25,4
				→ 10/01; Nutzlast [kg]: 1.400; - ABS	24.2125-1703.3	010483	Ø 25,4
				11/01→ 03/02; Nutzlast [kg]: 1.400; - ABS	24.2125-1725.3	010717	Ø 25,4
				11/01→ 03/02; Nutzlast [kg]: 1.400; + ABS	24.2125-1726.3	010718	Ø 25,4
2.8 D 2.8 JTD 2.8 JTD 4x4 2.8 TDI 2.8 TDI 4x4	64	02/98→04/02		→ 10/01; Nutzlast [kg]: 1.400; + ABS	24.2125-1702.3	010482	Ø 25,4
	94	11/00→04/02		→ 10/01; Nutzlast [kg]: 1.800; + ABS	24.2125-1702.3	010482	Ø 25,4
	94	11/00→04/02		→ 10/01; Nutzlast [kg]: 1.800; - ABS	24.2125-1703.3	010483	Ø 25,4
	90	10/97→04/02		→ 10/01; Nutzlast [kg]: 1.800; - ABS	24.2125-1703.3	010483	Ø 25,4
	90	07/99→04/02		→ 10/01; Nutzlast [kg]: 1.400; - ABS	24.2125-1703.3	010483	Ø 25,4
				11/01→ 03/02; Nutzlast [kg]: 1.800; - ABS	24.2125-1725.3	010717	Ø 25,4
				11/01→ 03/02; Nutzlast [kg]: 1.400; - ABS	24.2125-1725.3	010717	Ø 25,4
				11/01→ 03/02; Nutzlast [kg]: 1.800; + ABS	24.2125-1726.3	010718	Ø 25,4
			11/01→ 03/02; Nutzlast [kg]: 1.400; + ABS	24.2125-1726.3	010718	Ø 25,4	









Bremskraftregler









1.9 D	50 - 59	04/98→04/02		→ 10/01; Nutzlast [kg]: 1.000; - ABS	24.6512-1701.3	320153	lastabhängig 2x
1.9 D Combinato	51	06/95→04/02					
1.9 TD	66	04/98→04/02					
1.9 TD Combinato	59	08/94→04/02					
1.9 TD Panorama/Combinato	60	03/94→04/02					
2.0 4x4	80	11/94→11/01		→ 10/01; Nutzlast ab [kg] 1.000 Nutzlast bis [kg] 1.800; - ABS	24.6512-1701.3	320153	lastabhängig 2x
2.0 Panorama/Combinato	80	03/94→04/02					
2.5 D Combinato	62	08/94→04/02		→ 10/01; Nutzlast ab [kg] 1.400 Nutzlast bis [kg] 1.800; - ABS	24.6512-1701.3	320153	lastabhängig 2x
2.5 TDI 4x4	85	04/97→04/02					
2.5 TDI Panorama/Combinato	80 - 85	03/94→04/02					
2.8 D	64	02/98→04/02					
2.8 JTD	94	11/00→04/02					
2.8 JTD 4x4	94	11/00→04/02					
2.8 TDI	90	10/97→04/02					
2.8 TDI 4x4	90	07/99→04/02					
2.5 TD 4x4	80	11/94→04/98		Nutzlast ab [kg] 1.400 Nutzlast bis [kg] 1.800; - ABS	24.6512-1701.3	320153	lastabhängig 2x











FIAT - DUCATO Bus (244_) 12/01→

Hauptbremszylinder

2.0	81	12/01→07/06		Nutzlast ab [kg] 1.100 Nutzlast bis [kg] 1.800; - ABS	24.2125-1725.3	010717	Ø 25,4
2.0 4x4	81	05/02→07/06					
2.0 Bipower	81	11/02→07/06		Nutzlast ab [kg] 1.100 Nutzlast bis [kg] 1.800; + ABS	24.2125-1726.3	010718	Ø 25,4
2.0 JTD	62	12/01→07/06					
2.0 LPG	71	11/02→07/06					
2.3 JTD	81 - 93	12/01→					
2.8 JTD	107	04/04→07/06					
2.8 JTD 4x4	94	12/01→07/06					
2.8 TD	90	11/03→07/06					
2.8 TD 4x4	90	11/03→07/06					
2.8 JTD	94	12/01→		→ 07/06; Nutzlast ab [kg] 1.100 Nutzlast bis [kg] 1.800; - ABS	24.2125-1725.3	010717	Ø 25,4
				→ 07/06; Nutzlast ab [kg] 1.100 Nutzlast bis [kg] 1.800; + ABS	24.2125-1726.3	010718	Ø 25,4

	kw			 	! #		
FIAT - DUCATO Bus (250_) 07/06→							
 Hauptbremszylinder							
2 D 100 Multijet 2 3 D	74 74 82 - 96	07/06→05/11 07/06→05/11 07/06→		Nutzlast ab [kg] 1.100 Nutzlast bis [kg] 1.500; für Fahrzeuge mit elektronischer Fahrdynamikregelung		24.4125-1701.3 010867	BOS Ø 25,4 ohne Bremsflüssigkeitsbehälter
110 Multijet 2	82 - 83	10/11→		Nutzlast ab [kg] 1.100 Nutzlast bis [kg] 1.500; für Fahrzeuge ohne elektronische Fahrdynamikregelung		24.4125-1702.3 010872	BOS Ø 25,4 ohne Bremsflüssigkeitsbehälter
0 D	85 - 130	07/06→		Nutzlast ab [kg] 1.700 Nutzlast bis [kg] 2.000; für Fahrzeuge mit elektronischer Fahrdynamikregelung; Nutzlast-Code: Nutzlast leicht / Nutzlast schwer		24.4126-1701.3 010868	BOS Ø 27 ohne Bremsflüssigkeitsbehälter
115 Multijet 2 120 Multijet 2 130 Multijet 2 3 D 4x4 140 Natural Power 160 Multijet 3	85 88 96 96 100 115 - 116	06/11→ 07/06→ 01/07→ 06/11→ 04/09→ 07/06→		Nutzlast ab [kg] 1.700 Nutzlast bis [kg] 2.000; für Fahrzeuge ohne elektronische Fahrdynamikregelung; Nutzlast-Code: Nutzlast leicht / Nutzlast schwer		24.4126-1702.3 010875	BOS Ø 27 ohne Bremsflüssigkeitsbehälter
0 D 4x4 180 Multijet 3	116 130	07/06→ 06/11→					
3 D 150 Multijet 2	109 109	06/11→ 06/11→		Nutzlast ab [kg] 1.700 Nutzlast bis [kg] 2.000; für Fahrzeuge mit elektronischer Fahrdynamikregelung; Nutzlast-Code: Nutzlast leicht / Nutzlast schwer		24.4126-1701.3 010868	BOS Ø 27 ohne Bremsflüssigkeitsbehälter
				Nutzlast ab [kg] 1.700 Nutzlast bis [kg] 2.000; für Fahrzeuge ohne elektronische Fahrdynamikregelung; Nutzlast-Code: Nutzlast leicht / Nutzlast schwer		24.4126-1702.3 010875	BOS Ø 27 ohne Bremsflüssigkeitsbehälter
0 D 150 Multijet 3	107 107	04/10→ 04/10→		06/11→; Nutzlast ab [kg] 1.100 Nutzlast bis [kg] 1.500; für Fahrzeuge mit elektronischer Fahrdynamikregelung		24.4125-1701.3 010867	BOS Ø 25,4 ohne Bremsflüssigkeitsbehälter
				Nutzlast ab [kg] 1.100 Nutzlast bis [kg] 1.500; für Fahrzeuge mit elektronischer Fahrdynamikregelung		24.4125-1701.3 010867	BOS Ø 25,4 ohne Bremsflüssigkeitsbehälter
				Nutzlast ab [kg] 1.100 Nutzlast bis [kg] 1.500; für Fahrzeuge ohne elektronische Fahrdynamikregelung		24.4125-1702.3 010872	BOS Ø 25,4 ohne Bremsflüssigkeitsbehälter
				06/11→; Nutzlast ab [kg] 1.100 Nutzlast bis [kg] 1.500; für Fahrzeuge ohne elektronische Fahrdynamikregelung		24.4125-1702.3 010872	BOS Ø 25,4 ohne Bremsflüssigkeitsbehälter
				Nutzlast ab [kg] 1.700 Nutzlast bis [kg] 2.000; für Fahrzeuge mit elektronischer Fahrdynamikregelung; Nutzlast-Code: Nutzlast leicht / Nutzlast schwer		24.4126-1701.3 010868	BOS Ø 27 ohne Bremsflüssigkeitsbehälter
				Nutzlast ab [kg] 1.700 Nutzlast bis [kg] 2.000; für Fahrzeuge ohne elektronische Fahrdynamikregelung; Nutzlast-Code: Nutzlast leicht / Nutzlast schwer		24.4126-1702.3 010875	BOS Ø 27 ohne Bremsflüssigkeitsbehälter
FIAT - DUCATO Kasten (230_) 03/94→05/05							
 Hauptbremszylinder							
1.9 D 1.9 TD	50 66	04/98→04/02 04/98→04/02		→ 10/01; Nutzlast [kg]: 1.000; + ABS		24.2125-1702.3 010482	Ø 25,4
				→ 10/01; Nutzlast [kg]: 1.000; - ABS		24.2125-1703.3 010483	Ø 25,4
				11/01→ 03/02; Nutzlast [kg]: 1.000; - ABS		24.2125-1725.3 010717	Ø 25,4
				11/01→ 03/02; Nutzlast [kg]: 1.000; + ABS		24.2125-1726.3 010718	Ø 25,4
1.9 D 1.9 TD 1.9 TD CAT	51 60 59	03/94→04/02 03/94→04/02 08/94→04/02		→ 10/94; Nutzlast [kg]: 1.000; - ABS		24.2122-1715.3 010481	Ø 22,2
				11/94→ 10/01; Nutzlast [kg]: 1.000; + ABS		24.2125-1702.3 010482	Ø 25,4
				11/94→ 10/01; Nutzlast [kg]: 1.000; - ABS		24.2125-1703.3 010483	Ø 25,4
				11/01→ 03/02; Nutzlast [kg]: 1.000; - ABS		24.2125-1725.3 010717	Ø 25,4
				11/01→ 03/02; Nutzlast [kg]: 1.000; + ABS		24.2125-1726.3 010718	Ø 25,4
1.9 TD	59	05/98→11/01		→ 10/01; Nutzlast [kg]: 1.000; + ABS		24.2125-1702.3 010482	Ø 25,4
				→ 10/01; Nutzlast [kg]: 1.000; - ABS		24.2125-1703.3 010483	Ø 25,4
				11/01→; Nutzlast [kg]: 1.000; - ABS		24.2125-1725.3 010717	Ø 25,4
				11/01→; Nutzlast [kg]: 1.000; + ABS		24.2125-1726.3 010718	Ø 25,4
2.0	80	03/94→04/02		→ 10/94; Nutzlast ab [kg] 1.000 Nutzlast bis [kg] 1.400; - ABS		24.2122-1715.3 010481	Ø 22,2
				→ 10/01; Nutzlast [kg]: 1.800; + ABS		24.2125-1702.3 010482	Ø 25,4
				11/94→ 10/01; Nutzlast ab [kg] 1.000 Nutzlast bis [kg] 1.400; + ABS		24.2125-1702.3 010482	Ø 25,4
				→ 10/01; Nutzlast [kg]: 1.800; - ABS		24.2125-1703.3 010483	Ø 25,4
				11/94→ 10/01; Nutzlast ab [kg] 1.000 Nutzlast bis [kg] 1.400; - ABS		24.2125-1703.3 010483	Ø 25,4
→							

	kw			 	! #		
FIAT - DUCATO Kasten (230_) 03/94 → 05/05							
 Hauptbremszylinder							
2.0	80	03/94 → 04/02		11/01 → 03/02; Nutzlast ab [kg] 1.000 Nutzlast bis [kg] 1.400; - ABS	24.2125-1725.3	010717	Ø 25,4
				11/01 → 03/02; Nutzlast [kg]: 1.800; - ABS	24.2125-1725.3	010717	Ø 25,4
				11/01 → 03/02; Nutzlast ab [kg] 1.000 Nutzlast bis [kg] 1.400; + ABS	24.2125-1726.3	010718	Ø 25,4
				11/01 → 03/02; Nutzlast [kg]: 1.800; + ABS	24.2125-1726.3	010718	Ø 25,4
2.0 4x4	80	11/94 → 04/02		→ 10/01; Nutzlast [kg]: 1.800; + ABS	24.2125-1702.3	010482	Ø 25,4
				→ 10/01; Nutzlast ab [kg] 1.000 Nutzlast bis [kg] 1.400; + ABS	24.2125-1702.3	010482	Ø 25,4
				→ 10/01; Nutzlast ab [kg] 1.000 Nutzlast bis [kg] 1.400; - ABS	24.2125-1703.3	010483	Ø 25,4
				→ 10/01; Nutzlast [kg]: 1.800; - ABS	24.2125-1703.3	010483	Ø 25,4
				11/01 → 03/02; Nutzlast ab [kg] 1.000 Nutzlast bis [kg] 1.400; - ABS	24.2125-1725.3	010717	Ø 25,4
				11/01 → 03/02; Nutzlast [kg]: 1.800; - ABS	24.2125-1725.3	010717	Ø 25,4
				11/01 → 03/02; Nutzlast ab [kg] 1.000 Nutzlast bis [kg] 1.400; + ABS	24.2125-1726.3	010718	Ø 25,4
				11/01 → 03/02; Nutzlast [kg]: 1.800; + ABS	24.2125-1726.3	010718	Ø 25,4
2.0 JTD	62	10/01 → 04/02		→ 03/02; Nutzlast [kg]: 1.800; - ABS	24.2125-1725.3	010717	Ø 25,4
				→ 03/02; Nutzlast [kg]: 1.400; - ABS	24.2125-1725.3	010717	Ø 25,4
				→ 03/02; Nutzlast [kg]: 1.400; + ABS	24.2125-1726.3	010718	Ø 25,4
				→ 03/02; Nutzlast [kg]: 1.800; + ABS	24.2125-1726.3	010718	Ø 25,4
2.5 D 2.5 D 4x4 2.5 TDI	62	03/94 → 04/02		→ 10/94; Nutzlast [kg]: 1.400; - ABS	24.2122-1715.3	010481	Ø 22,2
	62	03/94 → 04/02		11/94 → 10/01; Nutzlast [kg]: 1.400; + ABS	24.2125-1702.3	010482	Ø 25,4
	80 - 85	03/94 → 04/02		→ 10/01; Nutzlast [kg]: 1.800; + ABS	24.2125-1702.3	010482	Ø 25,4
				11/94 → 10/01; Nutzlast [kg]: 1.400; - ABS	24.2125-1703.3	010483	Ø 25,4
				→ 10/01; Nutzlast [kg]: 1.800; - ABS	24.2125-1703.3	010483	Ø 25,4
				11/01 → 03/02; Nutzlast [kg]: 1.400; - ABS	24.2125-1725.3	010717	Ø 25,4
				11/01 → 03/02; Nutzlast [kg]: 1.800; - ABS	24.2125-1725.3	010717	Ø 25,4
				11/01 → 03/02; Nutzlast [kg]: 1.400; + ABS	24.2125-1726.3	010718	Ø 25,4
				11/01 → 03/02; Nutzlast [kg]: 1.800; + ABS	24.2125-1726.3	010718	Ø 25,4
				→ 10/94; Nutzlast [kg]: 1.400; - ABS	24.2122-1715.3	010481	Ø 22,2
				11/94 →; Nutzlast [kg]: 1.400; + ABS	24.2125-1702.3	010482	Ø 25,4
				Nutzlast [kg]: 1.800; + ABS	24.2125-1702.3	010482	Ø 25,4
			11/94 →; Nutzlast [kg]: 1.400; - ABS	24.2125-1703.3	010483	Ø 25,4	
			Nutzlast [kg]: 1.800; - ABS	24.2125-1703.3	010483	Ø 25,4	
			Nutzlast [kg]: 1.400; + ABS	24.2125-1702.3	010482	Ø 25,4	
			Nutzlast [kg]: 1.800; + ABS	24.2125-1702.3	010482	Ø 25,4	
			Nutzlast [kg]: 1.400; - ABS	24.2125-1703.3	010483	Ø 25,4	
			Nutzlast [kg]: 1.800; - ABS	24.2125-1703.3	010483	Ø 25,4	
2.5 TD 2.5 TD 4x4	80 - 85	11/94 → 04/98		→ 10/01; Nutzlast [kg]: 1.400; + ABS	24.2125-1702.3	010482	Ø 25,4
				→ 10/01; Nutzlast [kg]: 1.800; + ABS	24.2125-1702.3	010482	Ø 25,4
				→ 10/01; Nutzlast [kg]: 1.400; - ABS	24.2125-1703.3	010483	Ø 25,4
				→ 10/01; Nutzlast [kg]: 1.800; - ABS	24.2125-1703.3	010483	Ø 25,4
				11/01 → 03/02; Nutzlast [kg]: 1.400; - ABS	24.2125-1725.3	010717	Ø 25,4
				11/01 → 03/02; Nutzlast [kg]: 1.800; - ABS	24.2125-1725.3	010717	Ø 25,4
				11/01 → 03/02; Nutzlast [kg]: 1.800; + ABS	24.2125-1726.3	010718	Ø 25,4
				11/01 → 03/02; Nutzlast [kg]: 1.400; + ABS	24.2125-1726.3	010718	Ø 25,4
2.5 TDI 4x4 2.8 D 2.8 D 4x4 2.8 JTD 2.8 JTD 4x4 2.8 TDI 2.8 TDI 4x4	85	05/98 → 04/02		→ 10/01; Nutzlast [kg]: 1.400; + ABS	24.2125-1702.3	010482	Ø 25,4
	64	05/98 → 04/02		→ 10/01; Nutzlast [kg]: 1.800; + ABS	24.2125-1702.3	010482	Ø 25,4
	64	08/98 → 04/02		→ 10/01; Nutzlast [kg]: 1.800; + ABS	24.2125-1702.3	010482	Ø 25,4
	94	11/00 → 04/02		→ 10/01; Nutzlast [kg]: 1.400; - ABS	24.2125-1703.3	010483	Ø 25,4
	94	11/00 → 04/02		→ 10/01; Nutzlast [kg]: 1.800; - ABS	24.2125-1703.3	010483	Ø 25,4
	90	10/97 → 04/02		11/01 → 03/02; Nutzlast [kg]: 1.400; - ABS	24.2125-1725.3	010717	Ø 25,4
	90	06/99 → 04/02		11/01 → 03/02; Nutzlast [kg]: 1.800; - ABS	24.2125-1725.3	010717	Ø 25,4
				11/01 → 03/02; Nutzlast [kg]: 1.800; + ABS	24.2125-1726.3	010718	Ø 25,4
2.8 TD 4x4	90	05/98 → 09/01		Nutzlast ab [kg] 1.400 Nutzlast bis [kg] 1.800; + ABS	24.2125-1702.3	010482	Ø 25,4
				Nutzlast ab [kg] 1.400 Nutzlast bis [kg] 1.800; - ABS	24.2125-1703.3	010483	Ø 25,4
→							

	kW			 	! #		
FIAT - DUCATO Kasten (230_) 03/94→05/05							
 Bremskraftregler							
1.9 D	50 - 51	03/94→04/02		→ 10/01; Nutzlast [kg]: 1.000; - ABS		24.6512-1701.3 320153	lastabhängig 2x
1.9 TD	59 - 66	03/94→04/02					
1.9 TD CAT	59	08/94→04/02					
2.0	80	03/94→04/02		→ 10/01; Nutzlast ab [kg] 1.000 Nutzlast bis [kg] 1.800; - ABS		24.6512-1701.3 320153	lastabhängig 2x
2.0 4x4	80	11/94→04/02					
2.5 D	62	03/94→04/02		→ 10/01; Nutzlast ab [kg] 1.400 Nutzlast bis [kg] 1.800; - ABS		24.6512-1701.3 320153	lastabhängig 2x
2.5 D 4x4	62	03/94→04/02					
2.5 TDI	80 - 85	03/94→04/02					
2.5 TDI 4x4	85	05/98→04/02					
2.8 D	64	05/98→04/02					
2.8 D 4x4	64	08/98→04/02					
2.8 JTD	94	11/00→04/02					
2.8 JTD 4x4	94	11/00→04/02					
2.8 TDI	90	10/97→04/02					
2.8 TDI 4x4	90	06/99→04/02					
2.5 TD	80	06/94→08/98		Nutzlast ab [kg] 1.400 Nutzlast bis [kg] 1.800; - ABS		24.6512-1701.3 320153	lastabhängig 2x
2.5 TD 4x4	80 - 85	11/94→04/98					
2.8 TD 4x4	90	05/98→09/01					
FIAT - DUCATO Kasten (244_) 12/01→							
 Hauptbremszylinder							
2.0	81	12/01→07/06		Nutzlast ab [kg] 1.100 Nutzlast bis [kg] 1.800; - ABS		24.2125-1725.3 010717	Ø 25,4
2.0 Bipower	81	11/02→07/06					
2.0 JTD	62	12/01→07/06		Nutzlast ab [kg] 1.100 Nutzlast bis [kg] 1.800; + ABS		24.2125-1726.3 010718	Ø 25,4
2.0 LPG	71	11/02→07/06					
2.3 JTD	81 - 93	12/01→12/18					
2.8 JTD 4x4	94	12/01→07/06					
2.8 JTD Power	107	04/04→07/06					
2.8 TD	90	12/01→07/06					
2.8 JTD	94	12/01→12/11		→ 07/06; Nutzlast ab [kg] 1.100 Nutzlast bis [kg] 1.800; - ABS		24.2125-1725.3 010717	Ø 25,4
				→ 07/06; Nutzlast ab [kg] 1.100 Nutzlast bis [kg] 1.800; + ABS		24.2125-1726.3 010718	Ø 25,4
FIAT - DUCATO Kasten (250_) 07/06→							
 Hauptbremszylinder							
2 D	74	07/06→		Nutzlast ab [kg] 1.100 Nutzlast bis [kg] 1.500; für Fahrzeuge mit elektronischer Fahrdynamikregelung		24.4125-1701.3 010867	BOS Ø 25,4 ohne Bremsflüssigkeitsbehälter
100 Multijet 2	74	07/06→					
3 D	83 - 96	07/06→		Nutzlast ab [kg] 1.100 Nutzlast bis [kg] 1.500; für Fahrzeuge ohne elektronische Fahrdynamikregelung		24.4125-1702.3 010872	BOS Ø 25,4 ohne Bremsflüssigkeitsbehälter
110 Multijet 2	83	10/11→					
0 D	85 - 130	07/06→		Nutzlast ab [kg] 1.700 Nutzlast bis [kg] 2.000; für Fahrzeuge mit elektronischer Fahrdynamikregelung; Nutzlast-Code: Nutzlast leicht / Nutzlast schwer		24.4126-1701.3 010868	BOS Ø 27 ohne Bremsflüssigkeitsbehälter
115 Multijet 2	85	06/11→					
120 Multijet 2	88	07/06→					
3 D 4x4	88 - 96	03/10→					
130 Multijet 2	96	08/06→					
140 Natural Power	100	04/09→					
160 Multijet 3	115 - 116	07/06→					
0 D 4x4	116	07/06→					
180 Multijet 3	130	06/11→					
3 D	109	06/11→		Nutzlast ab [kg] 1.700 Nutzlast bis [kg] 2.000; für Fahrzeuge mit elektronischer Fahrdynamikregelung; Nutzlast-Code: Nutzlast leicht / Nutzlast schwer		24.4126-1701.3 010868	BOS Ø 27 ohne Bremsflüssigkeitsbehälter
150 Multijet 2	109	06/11→					
				Nutzlast ab [kg] 1.700 Nutzlast bis [kg] 2.000; für Fahrzeuge ohne elektronische Fahrdynamikregelung; Nutzlast-Code: Nutzlast leicht / Nutzlast schwer		24.4126-1702.3 010875	BOS Ø 27 ohne Bremsflüssigkeitsbehälter
0 D	107	04/10→		06/11→; Nutzlast ab [kg] 1.100 Nutzlast bis [kg] 1.500; für Fahrzeuge mit elektronischer Fahrdynamikregelung		24.4125-1701.3 010867	BOS Ø 25,4 ohne Bremsflüssigkeitsbehälter
150 Multijet 3	107	04/10→					
				Nutzlast ab [kg] 1.100 Nutzlast bis [kg] 1.500; für Fahrzeuge mit elektronischer Fahrdynamikregelung		24.4125-1701.3 010867	BOS Ø 25,4 ohne Bremsflüssigkeitsbehälter
				Nutzlast ab [kg] 1.100 Nutzlast bis [kg] 1.500; für Fahrzeuge ohne elektronische Fahrdynamikregelung		24.4125-1702.3 010872	BOS Ø 25,4 ohne Bremsflüssigkeitsbehälter
				06/11→; Nutzlast ab [kg] 1.100 Nutzlast bis [kg] 1.500; für Fahrzeuge ohne elektronische Fahrdynamikregelung		24.4125-1702.3 010872	BOS Ø 25,4 ohne Bremsflüssigkeitsbehälter
→							

FIAT - DUCATO Kasten (250_) 07/06→

Hauptbremszylinder

0 D 150 Multijet 3	107	04/10→		Nutzlast ab [kg] 1.700 Nutzlast bis [kg] 2.000; für Fahrzeuge mit elektronischer Fahrdynamikregelung; Nutzlast-Code: Nutzlast leicht / Nutzlast schwer	24.4126-1701.3	010868	BOS Ø 27 ohne Bremsflüssigkeitsbehälter
	107	04/10→		Nutzlast ab [kg] 1.700 Nutzlast bis [kg] 2.000; für Fahrzeuge ohne elektronische Fahrdynamikregelung; Nutzlast-Code: Nutzlast leicht / Nutzlast schwer	24.4126-1702.3	010875	BOS Ø 27 ohne Bremsflüssigkeitsbehälter

FIAT - DUCATO Pritsche/Fahrgestell (230_) 03/94→04/02

Hauptbremszylinder

1.9 D 1.9 TD	50	04/98→04/02		→ 10/01; Nutzlast [kg]: 1.000; + ABS	24.2125-1702.3	010482	Ø 25,4
	66	04/98→04/02		→ 10/01; Nutzlast [kg]: 1.000; - ABS	24.2125-1703.3	010483	Ø 25,4
				11/01→ 03/02; Nutzlast [kg]: 1.000; - ABS	24.2125-1725.3	010717	Ø 25,4
				11/01→ 03/02; Nutzlast [kg]: 1.000; + ABS	24.2125-1726.3	010718	Ø 25,4
1.9 D 1.9 TD 1.9 TD CAT	51	03/94→04/02		→ 10/94; Nutzlast [kg]: 1.000; - ABS	24.2122-1715.3	010481	Ø 22,2
	60	03/94→04/02		11/94→ 10/01; Nutzlast [kg]: 1.000; + ABS	24.2125-1702.3	010482	Ø 25,4
	59	08/94→04/02		11/94→ 10/01; Nutzlast [kg]: 1.000; - ABS	24.2125-1703.3	010483	Ø 25,4
				11/01→ 03/02; Nutzlast [kg]: 1.000; - ABS	24.2125-1725.3	010717	Ø 25,4
1.9 TD	59	05/98→11/01		→ 10/01; Nutzlast [kg]: 1.000; + ABS	24.2125-1702.3	010482	Ø 25,4
				→ 10/01; Nutzlast [kg]: 1.000; - ABS	24.2125-1703.3	010483	Ø 25,4
				11/01→; Nutzlast [kg]: 1.000; - ABS	24.2125-1725.3	010717	Ø 25,4
				11/01→; Nutzlast [kg]: 1.000; + ABS	24.2125-1726.3	010718	Ø 25,4
2.0	80	03/94→04/02		→ 10/94; Nutzlast ab [kg] 1.000 Nutzlast bis [kg] 1.400; - ABS	24.2122-1715.3	010481	Ø 22,2
				→ 10/01; Nutzlast [kg]: 1.800; + ABS	24.2125-1702.3	010482	Ø 25,4
				11/94→ 10/01; Nutzlast ab [kg] 1.000 Nutzlast bis [kg] 1.400; + ABS	24.2125-1702.3	010482	Ø 25,4
				→ 10/01; Nutzlast [kg]: 1.800; - ABS	24.2125-1703.3	010483	Ø 25,4
				11/94→ 10/01; Nutzlast ab [kg] 1.000 Nutzlast bis [kg] 1.400; - ABS	24.2125-1703.3	010483	Ø 25,4
				11/01→ 03/02; Nutzlast ab [kg] 1.000 Nutzlast bis [kg] 1.400; - ABS	24.2125-1725.3	010717	Ø 25,4
				11/01→ 03/02; Nutzlast [kg]: 1.800; - ABS	24.2125-1725.3	010717	Ø 25,4
				11/01→ 03/02; Nutzlast ab [kg] 1.000 Nutzlast bis [kg] 1.400; + ABS	24.2125-1726.3	010718	Ø 25,4
2.0 JTD	62	07/01→04/02		10/01→ 03/02; Nutzlast [kg]: 1.400; - ABS	24.2125-1725.3	010717	Ø 25,4
				10/01→ 03/02; Nutzlast [kg]: 1.800; - ABS	24.2125-1725.3	010717	Ø 25,4
				10/01→ 03/02; Nutzlast [kg]: 1.800; + ABS	24.2125-1726.3	010718	Ø 25,4
				10/01→ 03/02; Nutzlast [kg]: 1.400; + ABS	24.2125-1726.3	010718	Ø 25,4
2.5 D 2.5 D 4x4 2.5 TDI	62 62 80	03/94→04/02 03/94→04/02 03/94→04/02		→ 10/94; Nutzlast [kg]: 1.400; - ABS	24.2122-1715.3	010481	Ø 22,2
				11/94→ 10/01; Nutzlast [kg]: 1.400; + ABS	24.2125-1702.3	010482	Ø 25,4
				→ 10/01; Nutzlast [kg]: 1.800; + ABS	24.2125-1702.3	010482	Ø 25,4
				11/94→ 10/01; Nutzlast [kg]: 1.400; - ABS	24.2125-1703.3	010483	Ø 25,4
				→ 10/01; Nutzlast [kg]: 1.800; - ABS	24.2125-1703.3	010483	Ø 25,4
				11/01→ 03/02; Nutzlast [kg]: 1.800; - ABS	24.2125-1725.3	010717	Ø 25,4
				11/01→ 03/02; Nutzlast [kg]: 1.400; - ABS	24.2125-1725.3	010717	Ø 25,4
				11/01→ 03/02; Nutzlast [kg]: 1.400; + ABS	24.2125-1726.3	010718	Ø 25,4
2.5 TD	80 - 85	06/94→08/98		→ 10/94; Nutzlast [kg]: 1.400; - ABS	24.2122-1715.3	010481	Ø 22,2
				11/94→; Nutzlast [kg]: 1.400; + ABS	24.2125-1702.3	010482	Ø 25,4
→							

FIAT - DUCATO Pritsche/Fahrgestell (230_) 03/94→04/02

 **Hauptbremszylinder**

2.5 TD	80 - 85	06/94→08/98	Nutzlast [kg]: 1.800; + ABS	24.2125-1702.3 010482	Ø 25,4
			11/94→; Nutzlast [kg]: 1.400; - ABS	24.2125-1703.3 010483	Ø 25,4
			Nutzlast [kg]: 1.800; - ABS	24.2125-1703.3 010483	Ø 25,4
2.5 TD 4x4	85	11/94→04/98	Nutzlast [kg]: 1.400; + ABS	24.2125-1702.3 010482	Ø 25,4
			Nutzlast [kg]: 1.800; + ABS	24.2125-1702.3 010482	Ø 25,4
			Nutzlast [kg]: 1.400; - ABS	24.2125-1703.3 010483	Ø 25,4
			Nutzlast [kg]: 1.800; - ABS	24.2125-1703.3 010483	Ø 25,4
2.5 TDI 4x4 2.8 D 2.8 JTD 2.8 JTD 4x4 2.8 TDI	85	06/98→04/02 02/98→04/02 11/00→04/02 10/01→04/02 12/98→04/02	→ 10/01; Nutzlast [kg]: 1.400; + ABS	24.2125-1702.3 010482	Ø 25,4
			→ 10/01; Nutzlast [kg]: 1.800; + ABS	24.2125-1702.3 010482	Ø 25,4
			→ 10/01; Nutzlast [kg]: 1.400; - ABS	24.2125-1703.3 010483	Ø 25,4
			→ 10/01; Nutzlast [kg]: 1.800; - ABS	24.2125-1703.3 010483	Ø 25,4
			11/01→ 03/02; Nutzlast [kg]: 1.800; - ABS	24.2125-1725.3 010717	Ø 25,4
			11/01→ 03/02; Nutzlast [kg]: 1.400; - ABS	24.2125-1725.3 010717	Ø 25,4
			11/01→ 03/02; Nutzlast [kg]: 1.800; + ABS	24.2125-1726.3 010718	Ø 25,4
			11/01→ 03/02; Nutzlast [kg]: 1.400; + ABS	24.2125-1726.3 010718	Ø 25,4
2.8 iDTD 4x4	90	05/98→09/01	Nutzlast ab [kg] 1.400 Nutzlast bis [kg] 1.800; + ABS	24.2125-1702.3 010482	Ø 25,4
			Nutzlast ab [kg] 1.400 Nutzlast bis [kg] 1.800; - ABS	24.2125-1703.3 010483	Ø 25,4
2.8 TD 4x4	64	05/98→11/01	→ 09/01; Nutzlast ab [kg] 1.400 Nutzlast bis [kg] 1.800; + ABS	24.2125-1702.3 010482	Ø 25,4
			→ 09/01; Nutzlast ab [kg] 1.400 Nutzlast bis [kg] 1.800; - ABS	24.2125-1703.3 010483	Ø 25,4

 **Bremskraftregler**

1.9 D 1.9 TD 1.9 TD CAT	50 - 51 59 - 66 59	03/94→04/02 03/94→04/02 08/94→04/02	→ 10/01; Nutzlast [kg]: 1.000; - ABS	24.6512-1701.3 320153	lastabhängig 2x						
						2.0	80	03/94→04/02	→ 10/01; Nutzlast ab [kg] 1.000 Nutzlast bis [kg] 1.800; - ABS	24.6512-1701.3 320153	lastabhängig 2x
									2.5 D 2.5 D 4x4 2.5 TDI 2.5 TDI 4x4 2.8 D 2.8 JTD 2.8 JTD 4x4 2.8 TDI		
2.5 TD 2.5 TD 4x4 2.8 iDTD 4x4	80 - 85 85 90	06/94→08/98 11/94→04/98 05/98→09/01	Nutzlast ab [kg] 1.400 Nutzlast bis [kg] 1.800; - ABS	24.6512-1701.3 320153	lastabhängig 2x						
			2.8 TD 4x4			64	05/98→11/01	→ 09/01; Nutzlast ab [kg] 1.400 Nutzlast bis [kg] 1.800; - ABS		24.6512-1701.3 320153	lastabhängig 2x

FIAT - DUCATO Pritsche/Fahrgestell (244_) 12/01→

 **Hauptbremszylinder**

2.0 2.0 JTD 2.3 JTD 2.8 JTD	81 62 81 90 - 94	04/02→07/06 12/01→07/06 12/01→07/06 12/01→07/06	Nutzlast ab [kg] 1.100 Nutzlast bis [kg] 1.800; - ABS	24.2125-1725.3 010717	Ø 25,4
			Nutzlast ab [kg] 1.100 Nutzlast bis [kg] 1.800; + ABS	24.2125-1726.3 010718	Ø 25,4
2.8 JTD 4x4 2.8 JTD Power	94 107	12/01→07/06 04/04→07/06			

FIAT - DUCATO Pritsche/Fahrgestell (250_) 07/06→

 **Hauptbremszylinder**

2 D 100 Multijet 2 3 D	74 74 82 - 88	07/06→ 07/06→ 07/06→	Nutzlast ab [kg] 1.100 Nutzlast bis [kg] 1.500; für Fahrzeuge mit elektronischer Fahrdynamikregelung	24.4125-1701.3 010867	BOS Ø 25,4 ohne Bremsflüssigkeitsbehälter
			Nutzlast ab [kg] 1.100 Nutzlast bis [kg] 1.500; für Fahrzeuge ohne elektronische Fahrdynamikregelung	24.4125-1702.3 010872	BOS Ø 25,4 ohne Bremsflüssigkeitsbehälter
110 Multijet 2	82 - 83	08/06→ 07/06→	Nutzlast ab [kg] 1.700 Nutzlast bis [kg] 2.000; für Fahrzeuge mit elektronischer Fahrdynamikregelung; Nutzlast-Code: Nutzlast leicht / Nutzlast schwer	24.4126-1701.3 010868	BOS Ø 27 ohne Bremsflüssigkeitsbehälter
0 D 115 Multijet 2 120 Multijet 2 3 D 4x4 →	85 - 88 85 88 88	07/06→ 06/11→ 07/06→ 03/10→			

FIAT - DUCATO Pritsche/Fahrgestell (250_) 07/06→

Hauptbremszylinder

140 Natural Power 160 Multijet 3	100 115 - 116	04/09→ 07/06→		Nutzlast ab [kg] 1.700 Nutzlast bis [kg] 2.000; für Fahrzeuge ohne elektronische Fahrdynamikregelung; Nutzlast-Code: Nutzlast leicht / Nutzlast schwer	24.4126-1702.3	010875	BOS Ø 27 ohne Bremsflüssigkeitsbehälter
180 Multijet 3	130	06/11→					
130 Multijet 2 3 D	96 96	08/06→ 08/06→		01/07→; Nutzlast ab [kg] 1.100 Nutzlast bis [kg] 1.500; für Fahrzeuge mit elektronischer Fahrdynamikregelung	24.4125-1701.3	010867	BOS Ø 25,4 ohne Bremsflüssigkeitsbehälter
				01/07→; Nutzlast ab [kg] 1.100 Nutzlast bis [kg] 1.500; für Fahrzeuge ohne elektronische Fahrdynamikregelung	24.4125-1702.3	010872	BOS Ø 25,4 ohne Bremsflüssigkeitsbehälter
				01/07→; Nutzlast ab [kg] 1.700 Nutzlast bis [kg] 2.000; für Fahrzeuge mit elektronischer Fahrdynamikregelung; Nutzlast-Code: Nutzlast leicht / Nutzlast schwer	24.4126-1701.3	010868	BOS Ø 27 ohne Bremsflüssigkeitsbehälter
				01/07→; Nutzlast ab [kg] 1.700 Nutzlast bis [kg] 2.000; für Fahrzeuge ohne elektronische Fahrdynamikregelung; Nutzlast-Code: Nutzlast leicht / Nutzlast schwer	24.4126-1702.3	010875	BOS Ø 27 ohne Bremsflüssigkeitsbehälter
3 D 150 Multijet 2	109 109	06/11→ 06/11→		Nutzlast ab [kg] 1.700 Nutzlast bis [kg] 2.000; für Fahrzeuge mit elektronischer Fahrdynamikregelung; Nutzlast-Code: Nutzlast leicht / Nutzlast schwer	24.4126-1701.3	010868	BOS Ø 27 ohne Bremsflüssigkeitsbehälter
				Nutzlast ab [kg] 1.700 Nutzlast bis [kg] 2.000; für Fahrzeuge ohne elektronische Fahrdynamikregelung; Nutzlast-Code: Nutzlast leicht / Nutzlast schwer	24.4126-1702.3	010875	BOS Ø 27 ohne Bremsflüssigkeitsbehälter
0 D 150 Multijet 3	107 107	04/10→ 04/10→		06/11→; Nutzlast ab [kg] 1.100 Nutzlast bis [kg] 1.500; für Fahrzeuge mit elektronischer Fahrdynamikregelung	24.4125-1701.3	010867	BOS Ø 25,4 ohne Bremsflüssigkeitsbehälter
				Nutzlast ab [kg] 1.100 Nutzlast bis [kg] 1.500; für Fahrzeuge mit elektronischer Fahrdynamikregelung	24.4125-1701.3	010867	BOS Ø 25,4 ohne Bremsflüssigkeitsbehälter
				Nutzlast ab [kg] 1.100 Nutzlast bis [kg] 1.500; für Fahrzeuge ohne elektronische Fahrdynamikregelung	24.4125-1702.3	010872	BOS Ø 25,4 ohne Bremsflüssigkeitsbehälter
				06/11→; Nutzlast ab [kg] 1.100 Nutzlast bis [kg] 1.500; für Fahrzeuge ohne elektronische Fahrdynamikregelung	24.4125-1702.3	010872	BOS Ø 25,4 ohne Bremsflüssigkeitsbehälter
				Nutzlast ab [kg] 1.700 Nutzlast bis [kg] 2.000; für Fahrzeuge mit elektronischer Fahrdynamikregelung; Nutzlast-Code: Nutzlast leicht / Nutzlast schwer	24.4126-1701.3	010868	BOS Ø 27 ohne Bremsflüssigkeitsbehälter
				Nutzlast ab [kg] 1.700 Nutzlast bis [kg] 2.000; für Fahrzeuge ohne elektronische Fahrdynamikregelung; Nutzlast-Code: Nutzlast leicht / Nutzlast schwer	24.4126-1702.3	010875	BOS Ø 27 ohne Bremsflüssigkeitsbehälter

FIAT - FIORINO Kasten/Großraumlimousine (146_) 01/88→

Hauptbremszylinder

1.7 TD	46	11/96→05/00		- ABS	24.2122-1781.3	011059	Ø 22,2 ohne Bremsflüssigkeitsbehälter
60 1.7 D	44	05/88→05/00		09/88→ 08/93	24.2120-0802.3	010363	ATE Ø 20,6
				09/93→; - ABS	24.2122-1781.3	011059	Ø 22,2 ohne Bremsflüssigkeitsbehälter
65 1.7 TD 70 i.e. 1.4 75 i.e. 1.6	46 49 55	01/97→05/01 05/94→05/01 10/93→05/01		→ 03/01; - ABS	24.2122-1781.3	011059	Ø 22,2 ohne Bremsflüssigkeitsbehälter

FIAT - FIORINO Pick up (146_) 01/88→05/01

Hauptbremszylinder











1.4 1.6 1.7 TD	49 55 46	05/94→05/01 01/94→05/01 01/97→05/01		→ 03/01; - ABS	24.2122-1781.3	011059	Ø 22,2 ohne Bremsflüssigkeitsbehälter
1.7 D	42	10/93→10/99		- ABS	24.2122-1781.3	011059	Ø 22,2 ohne Bremsflüssigkeitsbehälter
1.7 D	44	05/88→10/99		09/93→; - ABS	24.2122-1781.3	011059	Ø 22,2 ohne Bremsflüssigkeitsbehälter

FIAT - GRANDE PUNTO (199_) 06/05→













Hauptbremszylinder













1.2 1.3 D Multijet	48 51 - 62	10/05→ 07/08→		→ 08/10; für Fahrzeuge mit elektronischer Fahrdynamikregelung	24.4122-1709.3	010871	BOS Ø 22,2 ohne Bremsflüssigkeitsbehälter
				09/10→ 01/11	24.4122-1709.3	010871	BOS Ø 22,2 ohne Bremsflüssigkeitsbehälter













→





















	kw			 	! #		
FIAT - GRANDE PUNTO (199_) 06/05→							
 Hauptbremszylinder							
1.4 16V	70 - 112	10/05→07/12		→ 08/10; für Fahrzeuge mit elektronischer Fahrdynamikregelung		24.4122-1709.3 010871	BOS Ø 22,2 ohne Bremsflüssigkeitsbehälter
1.4 LPG	57	12/08→					
1.4 Natural Power	57	07/08→		09/10→ 01/11		24.4122-1709.3 010871	BOS Ø 22,2 ohne Bremsflüssigkeitsbehälter
1.4 T-Jet	88	09/07→					
1.6 D Multijet	88	07/08→					
1.9 D Multijet	88	10/05→					
1.2	50 - 51	06/09→		→ 01/11		24.4122-1709.3 010871	BOS Ø 22,2 ohne Bremsflüssigkeitsbehälter
1.2 LPG	51	06/08→12/12		09/10→ 01/11		24.4122-1709.3 010871	BOS Ø 22,2 ohne Bremsflüssigkeitsbehälter
1.3 D Multijet	55	10/05→06/13		04/08→ 08/10; für Fahrzeuge mit elektronischer Fahrdynamikregelung		24.4122-1709.3 010871	BOS Ø 22,2 ohne Bremsflüssigkeitsbehälter
				09/10→ 01/11		24.4122-1709.3 010871	BOS Ø 22,2 ohne Bremsflüssigkeitsbehälter
1.3 D Multijet	56	06/09→07/14		10/09→; für Linkslenker		24.4122-1709.3 010871	BOS Ø 22,2 ohne Bremsflüssigkeitsbehälter
				→ 08/10; für Fahrzeuge mit elektronischer Fahrdynamikregelung		24.4122-1709.3 010871	BOS Ø 22,2 ohne Bremsflüssigkeitsbehälter
				09/10→ 01/11		24.4122-1709.3 010871	BOS Ø 22,2 ohne Bremsflüssigkeitsbehälter
1.3 D Multijet	66	10/05→12/10		→ 08/10; für Fahrzeuge mit elektronischer Fahrdynamikregelung		24.4122-1709.3 010871	BOS Ø 22,2 ohne Bremsflüssigkeitsbehälter
				09/10→		24.4122-1709.3 010871	BOS Ø 22,2 ohne Bremsflüssigkeitsbehälter
1.4	57	06/05→12/15		→ 08/10; für Fahrzeuge mit elektronischer Fahrdynamikregelung		24.4122-1709.3 010871	BOS Ø 22,2 ohne Bremsflüssigkeitsbehälter
1.4	55	10/05→07/07		für Fahrzeuge mit elektronischer Fahrdynamikregelung		24.4122-1709.3 010871	BOS Ø 22,2 ohne Bremsflüssigkeitsbehälter
1.4 16V	66	06/09→07/14					
1.9 D Multijet	85	06/06→12/09					
1.6	85	02/11→		für Fahrzeuge mit elektronischer Fahrdynamikregelung		24.4122-1709.3 010871	BOS Ø 22,2 ohne Bremsflüssigkeitsbehälter
						24.4122-1709.3 010871	BOS Ø 22,2 ohne Bremsflüssigkeitsbehälter
1.9 D Multijet	96	10/05→		02/06→ 08/10; für Fahrzeuge mit elektronischer Fahrdynamikregelung		24.4122-1709.3 010871	BOS Ø 22,2 ohne Bremsflüssigkeitsbehälter
				09/10→ 01/11		24.4122-1709.3 010871	BOS Ø 22,2 ohne Bremsflüssigkeitsbehälter
FIAT - GRANDE PUNTO Van (199_) 10/05→06/13							
 Hauptbremszylinder							
1.3 JTD Multijet	55	02/06→06/13		→ 08/10; für Fahrzeuge mit elektronischer Fahrdynamikregelung		24.4122-1709.3 010871	BOS Ø 22,2 ohne Bremsflüssigkeitsbehälter
1.4 LPG	57	03/09→12/12					
1.4 Natural Power	57	03/09→12/12		09/10→ 01/11		24.4122-1709.3 010871	BOS Ø 22,2 ohne Bremsflüssigkeitsbehälter
1.3 JTD Multijet	66	02/06→08/10		für Fahrzeuge mit elektronischer Fahrdynamikregelung		24.4122-1709.3 010871	BOS Ø 22,2 ohne Bremsflüssigkeitsbehälter
1.4	57	02/06→06/13		→ 08/10; für Fahrzeuge mit elektronischer Fahrdynamikregelung		24.4122-1709.3 010871	BOS Ø 22,2 ohne Bremsflüssigkeitsbehälter
FIAT - IDEA (350_) 12/03→							
 Hauptbremszylinder							
1.2 16V	59	01/04→		→ 11/06; für Fahrzeuge ohne elektronische Fahrdynamikregelung		24.2123-1763.3 010842	Ø 23,8
1.9 JTD	74	01/04→		→ 02/08		24.4123-1708.3 010859	BOS Ø 23,8
1.3 D Multijet	51	01/04→		→ 11/06; für Fahrzeuge ohne elektronische Fahrdynamikregelung		24.2123-1763.3 010842	Ø 23,8
1.4 16V	70	01/04→		12/06→ 02/08		24.4123-1708.3 010859	BOS Ø 23,8
1.3 D Multijet	66	10/05→		11/05→ 11/06; für Fahrzeuge ohne elektronische Fahrdynamikregelung		24.2123-1763.3 010842	Ø 23,8
				12/06→ 02/08		24.4123-1708.3 010859	BOS Ø 23,8
1.3 D Multijet	70	05/08→12/12		→ 09/10		24.4123-1708.3 010859	BOS Ø 23,8
1.4 LPG	57	03/09→		10/10→ 07/12		24.4123-1708.3 010859	BOS Ø 23,8
1.6 D Multijet	88	05/08→					
1.4	57	10/05→		11/05→ 11/06; für Fahrzeuge ohne elektronische Fahrdynamikregelung		24.2123-1763.3 010842	Ø 23,8
				11/05→ 02/08		24.4123-1708.3 010859	BOS Ø 23,8
1.4	66	12/03→		01/04→ 11/06; für Fahrzeuge ohne elektronische Fahrdynamikregelung		24.2123-1763.3 010842	Ø 23,8
				12/06→ 02/08		24.4123-1708.3 010859	BOS Ø 23,8
1.8	81	01/08→07/10				24.4123-1708.3 010859	BOS Ø 23,8

































	kw			 	! #		
FIAT - IDEA Van (350_) 12/03→							
 Hauptbremszylinder							
1.4 JTD Multijet	70 51 - 66	10/04→12/12 10/04→12/11		für Fahrzeuge ohne elektronische Fahrdynamikregelung; → 11/06 12/06→		24.2123-1763.3 010842	Ø 23,8
MJTD	74	10/04→12/10		für Fahrzeuge ohne elektronische Fahrdynamikregelung; → 11/06 → 12/06		24.2123-1763.3 010842	Ø 23,8
FIAT - LINEA (323_, 110_) 10/06→							
 Hauptbremszylinder							
1.3 D Multijet 1.3 JTD Multijet 1.4	66 63 57	06/07→ 10/06→ 06/07→		07/07→ 05/11; für Fahrzeuge mit elektronischer Fahrdynamikregelung		24.4122-1709.3 010871	BOS Ø 22,2 ohne Bremsflüssigkeitsbehälter
1.3 D Multijet 1.4 1.4 T-Jet	70 66 84 - 88	09/09→ 12/08→ 05/07→		→ 05/11; für Fahrzeuge mit elektronischer Fahrdynamikregelung		24.4122-1709.3 010871	BOS Ø 22,2 ohne Bremsflüssigkeitsbehälter
1.6 D Multijet 1.6	77 81	06/09→ 10/11→		für Fahrzeuge mit elektronischer Fahrdynamikregelung		24.4122-1709.3 010871	BOS Ø 22,2 ohne Bremsflüssigkeitsbehälter
FIAT - MAREA (185_) 05/96→12/07							
 Hauptbremszylinder							
1.2 16V	60	10/98→05/02		04/99→; für Linkslenker; GG		24.2122-1716.3 010485	Ø 22,2
1.4 80 12V 1.6	59 68 - 78	09/96→05/02 03/99→12/07		für Linkslenker; GG		24.2122-1716.3 010485	Ø 22,2
1.6 100 16V 1.6 100 16V Bipower 1.6 16V 1.6 SX 1.8 115 16V 1.9 JTD 105 1.9 JTD 110 1.9 TD 100 1.9 TD 75 2.0 150 20V	76 76 75 72 83 77 81 74 55 108 - 110	09/96→05/02 04/99→05/02 04/97→02/99 09/00→08/02 09/96→05/02 12/98→12/02 09/00→08/02 05/96→12/02 09/96→05/02 09/96→05/02					
2.0 155 20V 2.4 JTD 130 2.4 TD 125 1.9 JTD	113 96 91 79	04/99→01/01 04/99→05/02 09/96→04/99 01/01→12/07		→ 12/02; für Linkslenker; GG		24.2122-1716.3 010485	Ø 22,2
FIAT - MAREA Weekend (185_) 09/96→12/07							
 Hauptbremszylinder							
1.2 16V	60	10/98→05/02		04/99→; für Linkslenker; GG		24.2122-1716.3 010485	Ø 22,2
1.4 80 12V 1.6 1.6 100 16V 1.8 115 16V 1.9 JTD 105 1.9 JTD 110 1.9 TD 100 1.9 TD 75 2.0 150 20V	59 76 76 83 77 81 74 55 108 - 110	09/96→05/02 09/00→08/02 09/96→05/02 09/96→05/02 12/98→12/02 09/00→08/02 09/96→06/03 09/96→05/02 09/96→05/02					
2.4 JTD 130 2.4 TD 125 2.0 155 20V	96 91 113	04/99→05/02 09/96→04/99 04/99→02/03		→ 12/02; für Linkslenker; GG		24.2122-1716.3 010485	Ø 22,2
FIAT - PALIO (178_, 171_) 04/96→							
 Hauptbremszylinder							
1.0 1.1 1.2 1.4	45 - 56 40 50 57 - 63	04/96→10/03 07/97→10/03 06/99→10/00 10/02→		- ABS		24.2120-1770.3 011066	ATE Ø 20,6 ohne Bremsflüssigkeitsbehälter
1.2 1.7 D	44 42	07/97→08/02 04/96→09/02		10/97→; - ABS		24.2120-1770.3 011066	ATE Ø 20,6 ohne Bremsflüssigkeitsbehälter
1.2 1.5 1.7 TD	54 - 59 62 51 - 53	06/98→ 06/04→ 09/01→		→ 12/06; - ABS		24.2120-1770.3 011066	ATE Ø 20,6 ohne Bremsflüssigkeitsbehälter















	kw					! #		
FIAT - PALIO Weekend (178_, 173_, 373_, 374_, 171_) 04/96→								
 Hauptbremszylinder								
1.2	44 - 54	04/96→10/04			10/97→; - ABS		24.2120-1770.3 011066	ATE Ø 20,6 ohne Bremsflüssigkeitsbehälter
1.7 TD	51	04/96→03/01						
1.2	50 - 59	06/99→10/04			- ABS		24.2120-1770.3 011066	ATE Ø 20,6 ohne Bremsflüssigkeitsbehälter
1.4	51 - 57	07/97→						
1.5	62	02/02→			→ 12/06; - ABS		24.2120-1770.3 011066	ATE Ø 20,6 ohne Bremsflüssigkeitsbehälter
1.9 D	46	03/01→						
1.9 JTD	59	09/01→						
FIAT - PANDA / PANDA CLASSIC (169_) 09/03→								
 Hauptbremszylinder								
1.1	40	09/03→			→ 06/13; - ABS		24.2120-1744.3 010820	Ø 20,6
1.2	44 - 51	09/03→			→ 06/13; für Fahrzeuge mit elektronischer Fahrdynamikregelung		24.2120-1746.3 010835	BOS Ø 20,6
1.2 LPG	44 - 51	04/09→			→ 06/13; + ABS		24.2120-1747.3 010836	BOS Ø 20,6
1.3 D Multijet	51 - 55	09/03→						
1.4 Natural Power	57	09/10→08/13						
1.2 4x4	44	10/04→			→ 06/13; - Diff		24.4120-1702.3 010913	TRW Ø 20,6 ohne Bremsflüssigkeitsbehälter
1.2 4x4	51	04/10→08/13			10/10→ 06/13; - Diff		24.4120-1702.3 010913	TRW Ø 20,6 ohne Bremsflüssigkeitsbehälter
1.2 Natural Power	44	01/07→12/11			- ABS		24.2120-1744.3 010820	Ø 20,6
					für Fahrzeuge mit elektronischer Fahrdynamikregelung		24.2120-1746.3 010835	BOS Ø 20,6
					+ ABS		24.2120-1747.3 010836	BOS Ø 20,6
1.3 D Multijet 4x4	51	10/04→			04/06→ 08/11; - ABS		24.2120-1744.3 010820	Ø 20,6
					04/06→ 08/11; für Fahrzeuge mit elektronischer Fahrdynamikregelung		24.2120-1746.3 010835	BOS Ø 20,6
					04/06→ 08/11; + ABS		24.2120-1747.3 010836	BOS Ø 20,6
					→ 06/13		24.4122-1714.3 010914	TRW Ø 22,2 ohne Bremsflüssigkeitsbehälter
					04/06→ 08/11		24.4122-1714.3 010914	TRW Ø 22,2 ohne Bremsflüssigkeitsbehälter
1.3 JTD Multijet 4x4	55	09/10→08/13			→ 06/13		24.4122-1714.3 010914	TRW Ø 22,2 ohne Bremsflüssigkeitsbehälter
1.4	74	10/06→			11/06→ 06/13; für Fahrzeuge ohne elektronische Fahrdynamikregelung		24.2122-1762.3 010837	Ø 22,2
					11/06→ 06/13; für Fahrzeuge mit elektronischer Fahrdynamikregelung		24.2122-1768.3 010853	Ø 22,2
FIAT - PANDA (141_) 03/80→07/04								
 Hauptbremszylinder								
1000 i.e. Cat	33	10/87→08/98			→ 12/92; für Linkslenker		24.2119-0826.3 010349	Ø 19
					für Linkslenker		24.2119-0826.3 010349	Ø 19
1100	37	05/91→12/99			für Linkslenker		24.2119-0826.3 010349	Ø 19
1100	40	02/95→09/03			→ 12/02; für Linkslenker		24.2119-0826.3 010349	Ø 19
1100 4x4	40	02/95→07/04			→ 12/02; für Linkslenker		24.2120-0801.3 010362	Ø 20,6
1100 Trekking 4x4	37	10/91→07/04						
650	22	01/82→07/04			→ 12/85; 6223908→; für Linkslenker		24.2119-0826.3 010349	Ø 19
					6166304→ 6223907; für Linkslenker		24.2119-0827.3 010350	Ø 19
750	25	01/86→10/03			→ 12/97; für Linkslenker		24.2119-0826.3 010349	Ø 19
 Bremskraftregler								
1100 4x4	40	02/95→07/04			→ 12/02		24.6046-0801.3 320116	4/6 2x
1100 Trekking 4x4	37	10/91→07/04						
650	22	01/82→07/04			6166304→ 6261411		24.6046-0801.3 320116	4/6 2x
FIAT - PANDA (312_, 319_) 02/12→								
 Hauptbremszylinder								
0.9	44 - 63	02/12→					24.4122-1721.3 011079	ATE Ø 22,2 ohne Bremsflüssigkeitsbehälter
0.9 4x4	63 - 66	09/12→						
0.9 Natural Power	51 - 63	07/12→						
1.2	51	02/12→						
1.2 LPG	51	06/12→						
→								













	kW					! #		
FIAT - PANDA (312_, 319_) 02/12→								
 Hauptbremszylinder								
1.3 D Multijet	55 - 70	02/12→					24.4122-1721.3 011079	ATE Ø 22,2 ohne Bremsflüssigkeitsbehälter
1.3 D Multijet 4x4	55 - 70	06/12→						
FIAT - PANDA Kasten/Schrägheck (141_) 01/86→02/04								
 Hauptbremszylinder								
1.1 1000 i.e	40 33	09/00→02/04 08/92→02/04		→ 12/02; für Linkslenker			24.2119-0826.3 010349	Ø 19
1.1 4x4	40	09/00→02/04		→ 12/02; für Linkslenker			24.2120-0801.3 010362	Ø 20,6
 Bremskraftregler								
1.1 4x4	40	09/00→02/04		→ 12/02			24.6046-0801.3 320116	4/6 2x
FIAT - PANDA Kasten/Schrägheck (169_) 03/04→								
 Hauptbremszylinder								
1.1	40	09/04→		→ 06/13; - ABS			24.2120-1744.3 010820	Ø 20,6
1.2	44 - 51	09/04→		→ 06/13; für Fahrzeuge mit elektronischer Fahrdynamikregelung			24.2120-1746.3 010835	BOS Ø 20,6
1.2 LPG	44	04/09→		→ 06/13; + ABS			24.2120-1747.3 010836	BOS Ø 20,6
1.3 D Multijet	51	03/04→						
1.4 Natural Power	57	10/09→						
1.2 4x4	44	09/04→		10/04→ 06/13; - Diff			24.4120-1702.3 010913	TRW Ø 20,6 ohne Bremsflüssigkeitsbehälter
1.2 4x4	51	09/10→		10/10→ 06/13; - Diff			24.4120-1702.3 010913	TRW Ø 20,6 ohne Bremsflüssigkeitsbehälter
1.2 Bipower	44	09/04→12/11		- ABS			24.2120-1744.3 010820	Ø 20,6
1.2 Natural Power	44	01/07→11/09		für Fahrzeuge mit elektronischer Fahrdynamikregelung			24.2120-1746.3 010835	BOS Ø 20,6
				+ ABS			24.2120-1747.3 010836	BOS Ø 20,6
1.2 LPG	51	09/10→		11/10→ 06/13; - ABS			24.2120-1744.3 010820	Ø 20,6
				11/10→ 06/13; für Fahrzeuge mit elektronischer Fahrdynamikregelung			24.2120-1746.3 010835	BOS Ø 20,6
				11/10→ 06/13; + ABS			24.2120-1747.3 010836	BOS Ø 20,6
1.3 D Multijet	55	01/06→		06/06→ 06/13; - ABS			24.2120-1744.3 010820	Ø 20,6
				06/06→ 06/13; für Fahrzeuge mit elektronischer Fahrdynamikregelung			24.2120-1746.3 010835	BOS Ø 20,6
				06/06→ 06/13; + ABS			24.2120-1747.3 010836	BOS Ø 20,6
1.3 D Multijet 4x4	51	10/04→12/06					24.4122-1714.3 010914	TRW Ø 22,2 ohne Bremsflüssigkeitsbehälter
1.3 D Multijet 4x4	55	01/06→		→ 06/13			24.4122-1714.3 010914	TRW Ø 22,2 ohne Bremsflüssigkeitsbehälter
FIAT - PANDA VAN (312_, 519_) 02/12→								
 Hauptbremszylinder								
0.9	48 - 63	02/12→					24.4122-1721.3 011079	ATE Ø 22,2 ohne Bremsflüssigkeitsbehälter
0.9 4x4	63	09/12→						
0.9 Natural Power	59 - 63	07/12→						
1.2	51	02/12→						
1.2 LPG	51	06/12→						
1.3 D Multijet	55 - 59	02/12→						
1.3 D Multijet 4x4	55 - 59	06/12→						
FIAT - PUNTO (176_) 09/93→09/99								
 Hauptbremszylinder								
1.2 16V	63	04/97→09/99		06/97→			24.2120-1710.3 010468	Ø 20,6
1.4 GT Turbo	98	10/93→03/97		GG			24.2122-1716.3 010485	Ø 22,2
1.4 GT Turbo	96	09/96→07/99		06/97→			24.2120-1710.3 010468	Ø 20,6
				→ 05/97; GG			24.2122-1716.3 010485	Ø 22,2
1.6	65	01/94→04/97		03/94→			24.2120-1710.3 010468	Ø 20,6
1.7 D	42	04/94→09/97		01/95→ 05/97			24.2120-1710.3 010468	Ø 20,6
1.7 TD	46 - 52	01/94→09/99					24.2120-1710.3 010468	Ø 20,6
60 1.2	43	01/94→09/99						
55 1.1	40	09/93→09/99		11/93→			24.2120-1710.3 010468	Ø 20,6
60 1.2 →	44	09/93→09/99						













	kw					! #		
FIAT - PUNTO (176_) 09/93→09/99								
 Hauptbremszylinder								
75 1.2	54	10/93→09/99		11/93→			24.2120-1710.3 010468	Ø 20,6
 Bremskraftregler								
1.2 16V	63	04/97→09/99		06/97→; - ABS; 			24.6513-1705.3 320237	lastabhängig 2x
1.4 GT Turbo	96	09/96→07/99						
55 1.1	40	09/93→09/99		11/93→ 05/97; - ABS; 			24.6513-1705.3 320237	lastabhängig 2x
60 1.2	44	09/93→09/99		06/97→; 			24.6513-1705.3 320237	lastabhängig 2x
60 1.2	43	01/94→09/99		→ 05/97; - ABS; 			24.6513-1705.3 320237	lastabhängig 2x
				06/97→; 			24.6513-1705.3 320237	lastabhängig 2x
75 1.2	54	10/93→09/99		11/93→ 05/97; - ABS; 			24.6513-1705.3 320237	lastabhängig 2x
FIAT - PUNTO (188_) 09/99→07/12								
 Hauptbremszylinder								
1.2 16V 80	59	09/99→04/06		07/03→ 11/05; - ABS			24.2120-1742.3 010776	Ø 20,6
1.2 60	44	09/99→12/10		10/99→ 06/03			24.2120-1742.3 010776	Ø 20,6
				07/03→ 11/05; + ABS			24.2120-1743.3 010777	Ø 20,6
1.2 Bifuel	44	08/07→03/12		10/09→; für Linkslenker			24.4122-1709.3 010871	BOS Ø 22,2 ohne Bremsflüssigkeitsbehälter
1.2 Bipower	44	08/01→05/03					24.2120-1742.3 010776	Ø 20,6
1.2 Natural Power	38 - 44	09/03→03/12		→ 11/05; - ABS			24.2120-1742.3 010776	Ø 20,6
				→ 11/05; + ABS			24.2120-1743.3 010777	Ø 20,6
1.3 JTD 16V	51	06/03→03/12		07/03→ 11/05; für Fahrzeuge mit elektronischer Fahrdynamikregelung			24.2122-1768.3 010853	Ø 22,2
1.9 JTD	74	06/03→03/12						
1.4	70 - 71	09/03→03/12		→ 11/05; für Fahrzeuge mit elektronischer Fahrdynamikregelung			24.2122-1768.3 010853	Ø 22,2
1.4	64	08/10→03/12		für Fahrzeuge mit elektronischer Fahrdynamikregelung			24.2122-1768.3 010853	Ø 22,2
1.8 130 HGT	96	09/99→03/12		10/99→ 06/03			24.2120-1742.3 010776	Ø 20,6
				07/03→ 11/05; für Fahrzeuge mit elektronischer Fahrdynamikregelung			24.2122-1768.3 010853	Ø 22,2
1.9 DS 60	44	09/99→03/12		10/99→ 06/03			24.2120-1742.3 010776	Ø 20,6
1.9 JTD 80	59	09/99→03/12						
1.9 JTD	63	10/01→03/12		→ 06/03			24.2120-1742.3 010776	Ø 20,6
				07/03→ 11/05; für Fahrzeuge mit elektronischer Fahrdynamikregelung			24.2122-1768.3 010853	Ø 22,2
FIAT - PUNTO (199_) 01/12→								
 Hauptbremszylinder								
0.9	74 - 77	07/13→		für Linkslenker			24.4122-1709.3 010871	BOS Ø 22,2 ohne Bremsflüssigkeitsbehälter
0.9 Bifuel	63	03/12→						
0.9 Twinair Turbo	63	03/12→						
1.2	49 - 51	03/12→						
1.3 D Multijet	55 - 70	03/12→						
1.3 JTD Multijet	66	05/18→						
1.4	55 - 57	03/12→						
1.4 Bifuel	57	03/12→						
1.4 Multi Air	77	03/12→						
1.4 Natural Power	57	03/12→						
1.4 Turbo Multi Air	99	03/12→						
FIAT - PUNTO Cabriolet (176_) 04/94→06/00								
 Hauptbremszylinder								
60 1.2	43 - 44	04/94→06/00					24.2120-1710.3 010468	Ø 20,6
90 1.6	65	04/94→04/97						
85 16V 1.2	63	04/97→06/00		06/97→			24.2120-1710.3 010468	Ø 20,6
 Bremskraftregler								
60 1.2	43 - 44	04/94→06/00		→ 05/95; - ABS; 			24.6513-1705.3 320237	lastabhängig 2x
FIAT - PUNTO EVO (199_) 07/08→								
 Hauptbremszylinder								
1.2	48 - 51	10/09→		für Linkslenker			24.4122-1709.3 010871	BOS Ø 22,2 ohne Bremsflüssigkeitsbehälter
→								















	kw					! #		
FIAT - PUNTO EVO (199_) 07/08→								
 Hauptbremszylinder								
1.3 D Multijet	51 - 70	07/08→			für Linkslenker		24.4122-1709.3 010871	BOS Ø 22,2 ohne Bremsflüssigkeitsbehälter
1.4	57	10/09→02/12						
1.4 16V	77 - 99	10/09→02/12						
1.4 LPG	57	06/09→02/12						
1.4 Natural Power	57	10/09→02/12						
1.6 D Multijet	88	10/09→02/12						
1.4	55	07/09→02/12			10/09→; für Linkslenker		24.4122-1709.3 010871	BOS Ø 22,2 ohne Bremsflüssigkeitsbehälter
FIAT - PUNTO EVO Kasten/Schrägheck (199_) 03/09→02/12								
 Hauptbremszylinder								
1.3 D Multijet	55 - 70	03/09→02/12			für Linkslenker		24.4122-1709.3 010871	BOS Ø 22,2 ohne Bremsflüssigkeitsbehälter
1.4	57	03/09→02/12						
FIAT - PUNTO Kasten/Schrägheck (188_) 02/00→12/10								
 Hauptbremszylinder								
1.2 60	44	02/00→10/09			07/03→ 11/05; - ABS		24.2120-1742.3 010776	Ø 20,6
					→ 06/03		24.2120-1742.3 010776	Ø 20,6
					07/03→ 11/05; + ABS		24.2120-1743.3 010777	Ø 20,6
1.2 Natural Power	44	01/03→12/10			→ 11/05; - ABS		24.2120-1742.3 010776	Ø 20,6
					→ 11/05; + ABS		24.2120-1743.3 010777	Ø 20,6
1.3 JTD	51	06/03→10/05			07/03→; für Fahrzeuge mit elektronischer Fahrdynamikregelung		24.2122-1768.3 010853	Ø 22,2
1.9 D 60	44	02/00→10/09			→ 06/03		24.2120-1742.3 010776	Ø 20,6
1.9 JTD	63	02/00→10/09						
FIAT - PUNTO Kasten/Schrägheck (199_) 04/08→								
 Hauptbremszylinder								
0.9 Twinair Turbo	63	03/12→			für Linkslenker		24.4122-1709.3 010871	BOS Ø 22,2 ohne Bremsflüssigkeitsbehälter
1.3 D Multijet	62	03/12→						
1.4	57	03/12→						
1.4 LPG	57	03/12→						
1.3 D Multijet	55	04/08→			→ 08/10; für Fahrzeuge mit elektronischer Fahrdynamikregelung		24.4122-1709.3 010871	BOS Ø 22,2 ohne Bremsflüssigkeitsbehälter
					09/10→ 01/11		24.4122-1709.3 010871	BOS Ø 22,2 ohne Bremsflüssigkeitsbehälter
1.3 D Multijet	70	03/09→			10/09→; für Linkslenker		24.4122-1709.3 010871	BOS Ø 22,2 ohne Bremsflüssigkeitsbehälter
1.4 Natural Power	57	03/09→						
FIAT - PUNTO Van (176_) 04/96→02/00								
 Hauptbremszylinder								
1.1	40	04/96→02/00			→ 09/99		24.2120-1710.3 010468	Ø 20,6
1.7 TD	52	04/96→02/00						
1.7 D	42	04/96→02/00			→ 05/97		24.2120-1710.3 010468	Ø 20,6
1.7 TD	46	09/96→09/99					24.2120-1710.3 010468	Ø 20,6
 Bremskraftregler								
1.1	40	04/96→02/00			→ 05/97; - ABS; 		24.6513-1705.3 320237	lastabhängig 2x
					06/97→ 09/99; 		24.6513-1705.3 320237	lastabhängig 2x
FIAT - SCUDO Bus (220_) 02/96→12/06								
 Hauptbremszylinder								
1.6	58	02/96→12/06			- ABS		24.2122-1703.3 010422	Ø 22,2
1.9 D	51	02/96→12/06			+ ABS		24.2122-1708.3 010437	Ø 22,2
1.9 TD	68	02/96→12/06						
1.9 TD Eco	66	02/96→12/06						
2.0 16V	100	06/00→12/06						
2.0 JTD	69 - 80	12/99→12/06						
2.0 JTD 16V	80	05/99→12/06			12/99→; - ABS		24.2122-1703.3 010422	Ø 22,2
					12/99→; + ABS		24.2122-1708.3 010437	Ø 22,2
FIAT - SCUDO Bus (270_, 272_) 01/07→03/16								
 Hauptbremszylinder								
1.6 D Multijet	66	01/07→03/16			für Linkslenker; + ESP		03.2125-0671.3 010965	ATE Ø 25,4
2.0 D Multijet	88 - 120	01/07→03/16						
→								













	kw				! #		
FIAT - SCUDO Bus (270_, 272_) 01/07→03/16							
 Hauptbremszylinder							
2.0 D Multijet 4x4	94	04/11→03/16		für Linkslenker; - ESP		03.2125-0676.3 011009	ATE Ø 25,4 ohne Bremsflüssigkeitsbehälter
2.0 D Multijet 4x4	88 - 100	01/07→03/16		04/11→; für Linkslenker; + ESP		03.2125-0671.3 010965	ATE Ø 25,4
				04/11→; für Linkslenker; - ESP		03.2125-0676.3 011009	ATE Ø 25,4 ohne Bremsflüssigkeitsbehälter
FIAT - SCUDO Kasten (220_) 02/96→12/06							
 Hauptbremszylinder							
1.6	58	02/96→12/06		- ABS		24.2122-1703.3 010422	Ø 22,2
1.9 D	51	02/96→12/06		+ ABS		24.2122-1708.3 010437	Ø 22,2
1.9 TD	66 - 68	02/96→12/06					
2.0 JTD	80	12/02→12/06					
2.0	100	05/00→12/06		06/00→; - ABS		24.2122-1703.3 010422	Ø 22,2
				06/00→; + ABS		24.2122-1708.3 010437	Ø 22,2
2.0 JTD	69	10/99→12/06		12/99→; - ABS		24.2122-1703.3 010422	Ø 22,2
2.0 JTD 16V	80	05/99→12/06		12/99→; + ABS		24.2122-1708.3 010437	Ø 22,2
FIAT - SCUDO Kasten (270_, 272_) 01/07→03/16							
 Hauptbremszylinder							
1.6 D Multijet	66	01/07→03/16		für Linkslenker; + ESP		03.2125-0671.3 010965	ATE Ø 25,4
2.0 D Multijet	88 - 120	01/07→03/16		für Linkslenker; - ESP		03.2125-0676.3 011009	ATE Ø 25,4 ohne Bremsflüssigkeitsbehälter
2.0 D Multijet 4x4	94	05/11→03/16					
2.0 D Multijet 4x4	88 - 100	01/07→03/16		04/11→; für Linkslenker; + ESP		03.2125-0671.3 010965	ATE Ø 25,4
				04/11→; für Linkslenker; - ESP		03.2125-0676.3 011009	ATE Ø 25,4 ohne Bremsflüssigkeitsbehälter
FIAT - SCUDO Pritsche/Fahrgestell (220_) 09/96→12/06							
 Hauptbremszylinder							
1.6	58	09/96→12/06		- ABS		24.2122-1703.3 010422	Ø 22,2
1.9 D	51	04/98→12/06		+ ABS		24.2122-1708.3 010437	Ø 22,2
1.9 TD	68	09/96→12/06					
2.0 JTD	80	12/02→12/06					
2.0 JTD	69	10/99→12/06		12/99→; - ABS		24.2122-1703.3 010422	Ø 22,2
2.0 JTD 16V	80	05/99→12/06		12/99→; + ABS		24.2122-1708.3 010437	Ø 22,2
FIAT - SCUDO Pritsche/Fahrgestell (270_, 272_) 01/07→03/16							
 Hauptbremszylinder							
1.6 D Multijet	66	01/07→03/16		für Linkslenker; + ESP		03.2125-0671.3 010965	ATE Ø 25,4
2.0 D Multijet	88 - 120	01/07→03/16		für Linkslenker; - ESP		03.2125-0676.3 011009	ATE Ø 25,4 ohne Bremsflüssigkeitsbehälter
FIAT - SEDICI (189_) 06/06→10/14							
 Hauptbremszylinder							
1.6 16V	79 - 88	06/06→10/14		für Fahrzeuge ohne elektronische Fahrdynamikregelung		24.4122-1712.3 010899	BOS Ø 22,2 ohne Bremsflüssigkeitsbehälter
1.6 16V 4x4	79 - 88	06/06→10/14		für Fahrzeuge mit elektronischer Fahrdynamikregelung		24.4122-1713.3 010900	BOS Ø 22,2 ohne Bremsflüssigkeitsbehälter
1.9 D Multijet	88	06/06→10/11					
1.9 D Multijet 4x4	88	06/06→10/11					
2.0 D Multijet	99	06/06→10/14					
2.0 D Multijet 4x4	99	06/06→10/14					
FIAT - SEICENTO / 600 (187_) 11/97→01/10							
 Hauptbremszylinder							
0.9	29	11/97→12/08		04/98→ 03/08		24.2119-0833.3 010418	Ø 19
1.1	40	01/98→01/10					
Elektra	30	01/99→01/05		03/00→		24.2119-0833.3 010418	Ø 19
Elettrica	22	03/00→04/04				24.2119-0833.3 010418	Ø 19
FIAT - SEICENTO / 600 Kasten/Schrägheck (287_) 01/98→01/10							
 Hauptbremszylinder							
0.9	29	01/98→01/10		04/98→ 03/08		24.2119-0833.3 010418	Ø 19
1.1	40	01/98→01/10					













	kw					! #		
FIAT - SIENA (178_, 172_) 04/96→12/16								
 Hauptbremszylinder								
1.3	59	09/01→12/09			→ 12/06; - ABS		24.2120-1770.3 011066	ATE Ø 20,6 ohne Bremsflüssigkeitsbehälter
FIAT - STRADA Pick-up (178_, 278_) 02/98→								
 Hauptbremszylinder								
1.2	44	04/03→			→ 12/11		24.2122-1781.3 011059	Ø 22,2 ohne Bremsflüssigkeitsbehälter
1.2 Trekking	60	11/05→						
1.3 D Multijet	62	05/06→						
1.9 D	46	12/00→						
1.9 JTD	59	04/03→						
1.2	54	06/99→12/06					24.2122-1781.3 011059	Ø 22,2 ohne Bremsflüssigkeitsbehälter
1.7 TD	51	06/99→12/06						
FIAT - TIPO Kombi (356_, 357_) 03/16→								
 Hauptbremszylinder								
1.0	74	11/20→			Automatikgetriebe		24.4122-1734.3 011117	Ø 22,2 ohne Bremsflüssigkeitsbehälter
1.3 D	70	03/16→10/20						
1.4	70	03/16→10/20						
	88							
1.4 LPG	88	05/16→10/20						
1.6	81	07/16→10/20						
1.6 D	84	03/16→10/20						
	88							
1.6 Multijet	96	11/20→						
FIAT - TIPO Schrägheck (356_, 357_) 03/16→								
 Hauptbremszylinder								
1.0	74	11/20→			Automatikgetriebe		24.4122-1734.3 011117	Ø 22,2 ohne Bremsflüssigkeitsbehälter
1.3 D	70	03/16→10/20						
1.4	70	03/16→10/20						
	88							
1.4 LPG	88	05/16→10/20						
1.6 D	84	03/16→10/20						
	88							
1.6 Multijet	96	11/20→						
1.6	81	07/16→10/20					24.4122-1734.3 011117	Ø 22,2 ohne Bremsflüssigkeitsbehälter
FIAT - TIPO Stufenheck (356_, 357_) 10/15→								
 Hauptbremszylinder								
1.0	74	11/20→			Automatikgetriebe		24.4122-1734.3 011117	Ø 22,2 ohne Bremsflüssigkeitsbehälter
1.3 D	70	10/15→10/20						
1.4	70	10/15→10/20						
1.4 LPG	88	05/16→10/20						
1.6 D	84	10/15→10/20						
	88							
1.6 Multijet	96	11/20→						
1.6	81	10/15→10/20					24.4122-1734.3 011117	Ø 22,2 ohne Bremsflüssigkeitsbehälter
FIAT - ULYSSE (179_) 08/02→06/11								
 Hauptbremszylinder								
2.0	100	08/02→06/11			→ 01/11		03.2122-2163.3 010800	ATE Ø 22,2
2.0 D Multijet	88	05/06→06/11						
	100							
2.2 D Multijet	125	03/08→06/11						
2.2 JTD	120	03/08→06/11						
2.0 JTD	79	08/02→08/06					03.2122-2163.3 010800	ATE Ø 22,2
	80							
2.2 JTD	94	08/02→08/06						
FIAT - ULYSSE (220_) 06/94→08/02								
 Hauptbremszylinder								
1.8	73	05/97→08/02			→ 04/99; - ABS		24.2123-1707.3 010492	Ø 23,8
1.9 TD	66	02/95→08/02			05/99→ 07/02; + ABS		24.2123-1733.3 010657	BOS Ø 23,8
2.0	89	06/94→08/02			05/99→ 07/02; - ABS		24.2123-1738.3 010658	Ø 23,8
1.9 TD	68	05/97→12/99			→ 04/99; - ABS		24.2123-1707.3 010492	Ø 23,8
					05/99→; + ABS		24.2123-1733.3 010657	BOS Ø 23,8
					05/99→; - ABS		24.2123-1738.3 010658	Ø 23,8
2.0 16V	97	05/98→09/00			05/99→		24.2123-1733.3 010657	BOS Ø 23,8
2.1 TD	80	03/96→10/99						
2.0 16V	100	09/00→08/02			→ 07/02		24.2123-1733.3 010657	BOS Ø 23,8
→								















	kw					! #		
FIAT - ULYSSE (220_) 06/94 → 08/02								
 Hauptbremszylinder								
2.0 JTD	80	10/99 → 08/02		→ 07/02			24.2123-1733.3 010657	BOS Ø 23,8
2.0 JTD 16V	80	05/99 → 08/02						
2.0 Turbo	108	06/94 → 08/02		05/99 → 07/02			24.2123-1733.3 010657	BOS Ø 23,8
FIAT - UNO (146_) 01/83 → 12/13								
 Hauptbremszylinder								
1.0	42	05/93 → 06/01		→ 06/95			24.2120-0801.3 010362	Ø 20,6
1.7 D	43	11/94 → 08/00						
1.1	41 - 43	04/86 → 06/06					24.2120-0801.3 010362	Ø 20,6
70 S 1.4	52	10/88 → 06/06						
FORD - B-MAX (JK) 10/12 →								
 Hauptbremszylinder								
1.0 EcoBoost	74 - 103	10/12 →					24.4120-1710.3 011082	Ø 20,6 ohne Bremsflüssigkeitsbehälter
1.4	66	10/12 →						
1.4 LPG	64 - 66	08/13 →						
1.5 TDCi	55 - 70	10/12 →						
1.6 TDCi	70	10/12 →						
1.6 Ti	77	10/12 →						
FORD - B-MAX Van (JK) 08/12 →								
 Hauptbremszylinder								
1.0 EcoBoost	74 - 92	08/12 →					24.4120-1710.3 011082	Ø 20,6 ohne Bremsflüssigkeitsbehälter
1.4	66	10/12 →						
1.4 LPG	66	10/12 →						
1.5 TDCi	55 - 70	10/12 →						
1.6 TDCi	70	10/12 →						
1.6 Ti	77	10/12 →						
FORD - C-MAX (DM2) 02/07 → 09/10								
 Bremskraftverstärker								
1.6	74	02/07 → 09/10		03/07 → 04/07			03.7863-0332.4 300203	ATE Ø 10" pneumatisch
1.6 TDCi	66 - 80	02/07 → 09/10		05/07 →; für Fahrzeuge mit Bremsassistent			03.7863-3932.4 300288	ATE Ø 10" pneumatisch
1.8	90 - 92	02/07 → 09/10						
1.8 Flexifuel	92	02/07 → 09/10						
1.8 TDCi	85	02/07 → 09/10						
2.0	107	02/07 → 09/10						
2.0 TDCi	98 - 100	02/07 → 09/10						
1.6	85	04/07 → 09/10		→ 04/07			03.7863-0332.4 300203	ATE Ø 10" pneumatisch
				05/07 →; für Fahrzeuge mit Bremsassistent			03.7863-3932.4 300288	ATE Ø 10" pneumatisch
2.0 CNG	107	04/09 → 09/10		für Fahrzeuge mit Bremsassistent			03.7863-3932.4 300288	ATE Ø 10" pneumatisch
2.0 LPG	107	06/08 → 09/10						
2.0 TDCi	81	02/08 → 09/10						
 Hauptbremszylinder								
1.6	74	02/07 → 09/10		03/07 → 05/07			03.2123-3103.3 010781	ATE Ø 23,8
1.6 TDCi	66 - 80	02/07 → 09/10		06/07 → 10/08			03.2125-0483.3 010783	ATE Ø 25,4 ohne Bremsflüssigkeitsbehälter
1.8	90 - 92	02/07 → 09/10		11/08 →			03.2125-0661.3 010917	ATE Ø 25,4
1.8 Flexifuel	92	02/07 → 09/10						
1.8 TDCi	85	02/07 → 09/10						
2.0	107	02/07 → 09/10						
2.0 TDCi	98 - 100	02/07 → 09/10						
1.6	85	04/07 → 09/10		→ 05/07			03.2123-3103.3 010781	ATE Ø 23,8
				06/07 → 10/08			03.2125-0483.3 010783	ATE Ø 25,4 ohne Bremsflüssigkeitsbehälter
				11/08 →			03.2125-0661.3 010917	ATE Ø 25,4
2.0 CNG	107	04/09 → 09/10					03.2125-0661.3 010917	ATE Ø 25,4
2.0 LPG	107	06/08 → 09/10		→ 10/08			03.2125-0483.3 010783	ATE Ø 25,4 ohne Bremsflüssigkeitsbehälter
2.0 TDCi	81	02/08 → 09/10						
→				11/08 →			03.2125-0661.3 010917	ATE Ø 25,4











	kW			 	! #		
FORD - C-MAX (DM2) 02/07→09/10							
Hydraulikaggregat, Bremsanlage							
1.6 1.6 TDCi	74 66 - 80	02/07→09/10		03/07→		24.9145-0004.2	399008
1.8 1.8 Flexifuel 1.8 TDCi	90 - 92 92 85	02/07→09/10					
2.0 2.0 TDCi	107 98 - 100	02/07→09/10					
1.6 2.0 CNG 2.0 LPG 2.0 TDCi	85 107 107 81	04/07→09/10 04/09→09/10 06/08→09/10 02/08→09/10				24.9145-0004.2	399008
FORD - C-MAX II (DXA/CB7, DXA/CEU) 04/10→06/19							
 Hauptbremszylinder							
1.0 EcoBoost 1.5 EcoBoost	74 - 92 110 - 134	10/12→06/19				03.4155-5451.3	010995 ATE Ø 25,4
1.6 CNG 1.6 EcoBoost	86 110 - 134	01/13→12/14 12/10→06/19					
1.6 Flexifuel 1.6 LPG	88 86 - 88	02/11→06/19 02/12→06/19					
1.6 TDCi 1.6 Ti	70 - 85 63 - 92	12/10→06/19 12/10→06/19					
2.0 TDCi	85 - 125	04/10→06/19					
FORD - C-MAX II Van 10/10→06/19							
 Hauptbremszylinder							
1.0 EcoBoost 1.5 EcoBoost	74 - 92 110 - 134	10/12→06/19				03.4155-5451.3	010995 ATE Ø 25,4
1.6 EcoBoost	110 - 134	12/10→06/19					
1.6 TDCi	70 - 85	12/10→06/19					
1.6 Ti 2.0 TDCi	77 85 - 125	10/10→06/19 12/10→06/19					
FORD - COUGAR (EC_) 08/98→12/01							
 Hauptbremszylinder							
2.0 16V 2.5 V6 24V	96 125	08/98→12/01 08/98→12/01		09/98→		24.2125-1709.3	010499 Ø 25,4
2.5 ST 200 2.5 V6 24V	151 125	01/00→12/01 06/00→12/01				24.2125-1709.3	010499 Ø 25,4
FORD - ESCORT VI (GAL, AAL, ABL) 01/95→10/02							
 Hauptbremszylinder							
1.3 1.4 1.6 16V 1.6 16V 4x4 1.8 16V 1.8 TD	44 55 66 66 85 66	01/95→10/98		08/95→; + ABS 02/95→; - ABS		03.2123-1581.3 24.2123-1732.3	010487 010625 Ø 23,8 ohne Bremsflüssigkeitsbehälter
1.4	54	01/95→12/99		08/95→ 02/99; + ABS 02/95→ 02/99; - ABS		03.2123-1581.3 24.2123-1732.3	010487 010625 Ø 23,8 ohne Bremsflüssigkeitsbehälter
1.8 Turbo D	51	12/95→10/98		+ ABS - ABS		03.2123-1581.3 24.2123-1732.3	010487 010625 Ø 23,8 ohne Bremsflüssigkeitsbehälter
FORD - ESCORT VI Cabriolet (ALL) 03/94→08/00							
 Hauptbremszylinder							
1.4	55	02/95→08/98		08/95→; + ABS - ABS		03.2123-1581.3 24.2123-1732.3	010487 010625 Ø 23,8 ohne Bremsflüssigkeitsbehälter
→							











	kW			 	! #		
FORD - ESCORT VI Cabriolet (ALL) 03/94→08/00							
 Hauptbremszylinder							
1.6 16V XR3i	66	02/95→09/99		08/95→; + ABS		03.2123-1581.3 010487	Ø 23,8
				→ 02/99; - ABS		24.2123-1732.3 010625	Ø 23,8 ohne Bremsflüssigkeitsbehälter
1.8 16V XR3i	77	02/95→08/98		- ABS		24.2123-1732.3 010625	Ø 23,8 ohne Bremsflüssigkeitsbehälter
1.8 16V XR3i	85	10/95→08/98		+ ABS		03.2123-1581.3 010487	Ø 23,8
1.8 TD	66	09/95→08/98		- ABS		24.2123-1732.3 010625	Ø 23,8 ohne Bremsflüssigkeitsbehälter
1.8 Turbo D	51	10/96→08/99		+ ABS		03.2123-1581.3 010487	Ø 23,8
				→ 02/99; - ABS		24.2123-1732.3 010625	Ø 23,8 ohne Bremsflüssigkeitsbehälter
FORD - ESCORT VI Express (AVL) 01/95→06/01							
 Hauptbremszylinder							
1.4	54	01/95→08/00		08/95→ 02/99; + ABS		03.2123-1581.3 010487	Ø 23,8
1.8 D	44	01/95→08/00		02/95→ 02/99; - ABS		24.2123-1732.3 010625	Ø 23,8 ohne Bremsflüssigkeitsbehälter
1.8 TD	66	01/95→08/00		08/95→ 07/00; + ABS		03.2123-1581.3 010487	Ø 23,8
				02/95→ 02/99; - ABS		24.2123-1732.3 010625	Ø 23,8 ohne Bremsflüssigkeitsbehälter
1.8 Turbo D	51	12/95→06/01		→ 07/00; + ABS		03.2123-1581.3 010487	Ø 23,8
				→ 02/99; + ABS		03.2123-1581.3 010487	Ø 23,8
				→ 02/99; - ABS		24.2123-1732.3 010625	Ø 23,8 ohne Bremsflüssigkeitsbehälter
FORD - ESCORT VI Stufenheck (GAL, AFL) 01/95→08/02							
 Hauptbremszylinder							
1.3	44	01/95→02/99		08/95→; + ABS		03.2123-1581.3 010487	Ø 23,8
1.4	55	01/95→02/99		02/95→; - ABS		24.2123-1732.3 010625	Ø 23,8 ohne Bremsflüssigkeitsbehälter
1.6 i 16V	66	01/95→02/99					
1.8 16V	85	01/95→02/99					
1.8 TD	66	01/95→02/99					
1.8 Turbo D	51	12/95→02/99		+ ABS		03.2123-1581.3 010487	Ø 23,8
				- ABS		24.2123-1732.3 010625	Ø 23,8 ohne Bremsflüssigkeitsbehälter
FORD - ESCORT VI Turnier (GAL, ANL) 01/95→10/02							
 Hauptbremszylinder							
1.3	44	01/95→01/99		08/95→; + ABS		03.2123-1581.3 010487	Ø 23,8
1.4	55	01/95→02/99		02/95→; - ABS		24.2123-1732.3 010625	Ø 23,8 ohne Bremsflüssigkeitsbehälter
1.6 16V	66	01/95→02/99					
1.8 16V	85	01/95→02/99					
1.8 D	44	01/95→02/99					
1.8 TD	66	01/95→02/99					
1.8 Turbo D	51	12/95→02/99		+ ABS		03.2123-1581.3 010487	Ø 23,8
				- ABS		24.2123-1732.3 010625	Ø 23,8 ohne Bremsflüssigkeitsbehälter
FORD - ESCORT CLASSIC (AAL, ABL) 10/98→07/00							
 Hauptbremszylinder							
1.6 16V	66	10/98→07/00		+ ABS		03.2123-1581.3 010487	Ø 23,8
1.8 TD	66	10/98→07/00		→ 02/99; - ABS		24.2123-1732.3 010625	Ø 23,8 ohne Bremsflüssigkeitsbehälter
FORD - ESCORT CLASSIC Turnier (ANL) 02/99→07/00							
 Hauptbremszylinder							
1.6 16V	66	02/99→07/00		+ ABS		03.2123-1581.3 010487	Ø 23,8
1.8 TD	66	02/99→07/00		→ 02/99; - ABS		24.2123-1732.3 010625	Ø 23,8 ohne Bremsflüssigkeitsbehälter
FORD - FIESTA III (GFJ) 01/89→01/97							
 Hauptbremszylinder							
1.3 Cat	44	05/91→01/97		→ 01/94; - SCS		24.2120-1604.3 010370	Ø 20,6











	kw					! #		
FORD - FIESTA IV (JA_, JB_) 08/95→06/06								
 Bremskraftverstärker								
1.0 i 1.25 i 16V 1.3 i 1.4 i 16V 1.8 D	48 55 37 - 44 66 44	09/99→01/02 08/95→01/02 08/95→01/02		02/00→; für Linkslenker; - ABS			03.7750-2332.4 300113	ATE Ø 9" pneumatisch
1.6 16V Sport 1.8 DI	76 55	02/00→01/02 04/00→01/02		für Linkslenker; - ABS			03.7750-2332.4 300113	ATE Ø 9" pneumatisch
 Hauptbremszylinder								
1.0 i	38	04/96→09/99		- ABS			24.2122-1775.3 010981	Ø 22,2 ohne Bremsflüssigkeitsbehälter
1.0 i	48	09/99→01/02		02/00→; + ABS			03.2123-2243.3 010748	ATE Ø 23,8
				02/00→; - ABS			24.2122-1588.3 011028	ATE Ø 22,2 ohne Druckregler
				→ 01/00; - ABS			24.2122-1775.3 010981	Ø 22,2 ohne Bremsflüssigkeitsbehälter
1.25 i 16V	55	08/95→01/02		02/00→; + ABS			03.2123-2243.3 010748	ATE Ø 23,8
				02/00→; - ABS			24.2122-1588.3 011028	ATE Ø 22,2 ohne Druckregler
				01/96→ 01/00; Schaltgetriebe; - ABS			24.2122-1775.3 010981	Ø 22,2 ohne Bremsflüssigkeitsbehälter
1.3 i 1.8 D	37 - 44 44	08/95→01/02 08/95→04/00		02/00→; + ABS			03.2123-2243.3 010748	ATE Ø 23,8
				01/96→; - ABS			24.2122-1775.3 010981	Ø 22,2 ohne Bremsflüssigkeitsbehälter
1.4 i 16V	66	04/96→01/02		02/00→; + ABS			03.2123-2243.3 010748	ATE Ø 23,8
1.6 16V Sport	76	02/00→01/02		+ ABS			03.2123-2243.3 010748	ATE Ø 23,8
1.8 DI	55	04/00→01/02		+ ABS			03.2123-2243.3 010748	ATE Ø 23,8
				- ABS			24.2122-1775.3 010981	Ø 22,2 ohne Bremsflüssigkeitsbehälter
FORD - FIESTA V (JH_, JD_) 11/01→12/14								
 Bremskraftverstärker								
1.25 16V	51 - 55	05/02→06/08		für Fahrzeuge ohne Bremsassistent			03.7750-8732.4 300199	ATE Ø 9" pneumatisch
1.3 ROCAM	55	01/02→12/04		für Fahrzeuge mit Bremsassistent			03.7853-2102.4 300201	ATE Ø 9" pneumatisch
1.6	72	05/02→06/08						
1.6 TDCi	66	11/04→06/08						
1.3	44 - 51	11/01→06/08		04/02→; für Fahrzeuge ohne Bremsassistent			03.7750-8732.4 300199	ATE Ø 9" pneumatisch
				04/02→; für Fahrzeuge mit Bremsassistent			03.7853-2102.4 300201	ATE Ø 9" pneumatisch
1.4 16V	59	11/01→06/08						
1.4 TDCi	50	11/01→06/08						
1.6 16V	74	11/01→06/08						
 Hauptbremszylinder								
1.25 16V	51 - 55	05/02→06/08		für Linkslenker; - ABS			03.4153-0015.3 011005	ATE Ø 23,8 ohne Bremsflüssigkeitsbehälter
1.3 ROCAM	55	01/02→12/04		für Linkslenker; + ABS			03.4153-5287.4 010953	ATE Ø 23,8 mit Bremsflüssigkeitsbehälter
1.6	72	05/02→06/08						
1.6 TDCi	66	11/04→06/08						
1.3	44 - 51	11/01→06/08		04/02→; für Linkslenker; - ABS			03.4153-0015.3 011005	ATE Ø 23,8 ohne Bremsflüssigkeitsbehälter
				04/02→; für Linkslenker; + ABS			03.4153-5287.4 010953	ATE Ø 23,8 mit Bremsflüssigkeitsbehälter
1.4 16V	59	11/01→06/08						
1.4 TDCi	50	11/01→06/08						
1.6 16V	74	11/01→06/08						
FORD - FIESTA V Van 05/02→12/10								
 Bremskraftverstärker								
1.3	44 - 51	05/02→08/08		für Fahrzeuge ohne Bremsassistent			03.7750-8732.4 300199	ATE Ø 9" pneumatisch
				für Fahrzeuge mit Bremsassistent			03.7853-2102.4 300201	ATE Ø 9" pneumatisch
1.4	59	05/02→09/05						
1.4 TDCi	50	10/03→12/10		→ 08/08; für Fahrzeuge ohne Bremsassistent			03.7750-8732.4 300199	ATE Ø 9" pneumatisch
1.6 TDCi	66	04/07→09/09		→ 08/08; für Fahrzeuge mit Bremsassistent			03.7853-2102.4 300201	ATE Ø 9" pneumatisch
 Hauptbremszylinder								
1.3	44 - 51	05/02→08/08		für Linkslenker; - ABS			03.4153-0015.3 011005	ATE Ø 23,8 ohne Bremsflüssigkeitsbehälter
				für Linkslenker; + ABS			03.4153-5287.4 010953	ATE Ø 23,8 mit Bremsflüssigkeitsbehälter
1.4	59	05/02→09/05						
1.4 TDCi 1.6 TDCi	50 66	10/03→12/10 04/07→09/09		→ 08/08; für Linkslenker; - ABS			03.4153-0015.3 011005	ATE Ø 23,8 ohne Bremsflüssigkeitsbehälter
				→ 08/08; für Linkslenker; + ABS			03.4153-5287.4 010953	ATE Ø 23,8 mit Bremsflüssigkeitsbehälter







	kW			 	! #		
FORD - FIESTA VI (CB1, CCN) 06/08→							
 Hauptbremszylinder							
1.0	48 - 59	10/12→04/17		+ ABS		24.4120-1710.3 011082	Ø 20,6 ohne Bremsflüssigkeitsbehälter
1.0 EcoBoost	74	01/13→		- ABS		24.4120-1711.3 011093	Ø 20,6 ohne Bremsflüssigkeitsbehälter
1.0 Sport	103	05/14→04/17					
1.4	71	10/08→09/12					
1.4 TDCi	50 - 51	08/08→09/12					
1.5 TDCi	70	05/15→04/17					
1.6	62 - 90	10/10→					
1.6 TDCi	70	02/10→12/15					
1.6 Ti	99	12/10→					
1.0 EcoBoost	92	09/12→		+ ABS		24.4120-1710.3 011082	Ø 20,6 ohne Bremsflüssigkeitsbehälter
1.5 TDCi	55	09/12→04/17					
1.6 Ti	77	09/12→		10/12→; - ABS		24.4120-1711.3 011093	Ø 20,6 ohne Bremsflüssigkeitsbehälter
1.25	44 - 60	06/08→04/17		+ ABS		24.4120-1710.3 011082	Ø 20,6 ohne Bremsflüssigkeitsbehälter
1.6 TDCi	55 - 66	06/08→12/12		09/08→; - ABS		24.4120-1711.3 011093	Ø 20,6 ohne Bremsflüssigkeitsbehälter
1.6 Ti	88	06/08→09/12					
1.4 LPG	68 - 71	01/09→04/17		+ ABS		24.4120-1710.3 011082	Ø 20,6 ohne Bremsflüssigkeitsbehälter
				06/09→; - ABS		24.4120-1711.3 011093	Ø 20,6 ohne Bremsflüssigkeitsbehälter
1.6 ST	134	03/13→04/17				24.4122-1733.3 011116	Ø 22,2 ohne Bremsflüssigkeitsbehälter
1.6 ST200	147	04/16→04/17					
FORD - FIESTA VI Van 08/08→							
 Hauptbremszylinder							
1.0	48 - 59	10/12→		+ ABS		24.4120-1710.3 011082	Ø 20,6 ohne Bremsflüssigkeitsbehälter
1.0 EcoBoost	74 - 103	01/13→		- ABS		24.4120-1711.3 011093	Ø 20,6 ohne Bremsflüssigkeitsbehälter
1.25	44 - 60	08/08→					
1.4	71	10/08→12/12					
1.4 TDCi	50 - 51	01/09→					
1.5 TDCi	55 - 70	10/12→					
1.6 TDCi	66 - 70	01/09→					
1.6 Ti-VCT	88	10/08→12/12					
1.0 EcoBoost	92	09/12→		+ ABS		24.4120-1710.3 011082	Ø 20,6 ohne Bremsflüssigkeitsbehälter
				10/12→; - ABS		24.4120-1711.3 011093	Ø 20,6 ohne Bremsflüssigkeitsbehälter
1.6 ST	134	03/13→				24.4122-1733.3 011116	Ø 22,2 ohne Bremsflüssigkeitsbehälter
FORD - FIESTA Kasten/Großraumlimousine (J5_, J3_) 02/96→							
 Bremskraftverstärker							
1.3	44	02/96→08/03		02/00→ 03/02; für Linkslenker; - ABS		03.7750-2332.4 300113	ATE Ø 9" pneumatisch
1.8 D	44	02/96→04/02					
1.8 DI	55	09/00→08/03		→ 03/02; für Linkslenker; - ABS		03.7750-2332.4 300113	ATE Ø 9" pneumatisch
 Hauptbremszylinder							
1.3	44	02/96→08/03		02/00→ 03/02; - ABS		24.2122-1588.3 011028	ATE Ø 22,2 ohne Druckregler
1.8 D	44	02/96→04/02		→ 01/00; - ABS		24.2123-1737.3 010654	Ø 23,8
1.8 DI	55	09/00→08/03		→ 03/02; + ABS		03.2123-2243.3 010748	ATE Ø 23,8
				→ 03/02; - ABS		24.2122-1775.3 010981	Ø 22,2 ohne Bremsflüssigkeitsbehälter
FORD - FIESTA Kasten/Schrägheck (JV_) 05/98→08/03							
 Bremskraftverstärker							
D 1.8	44	05/98→04/02		02/00→ 03/02; für Linkslenker; - ABS		03.7750-2332.4 300113	ATE Ø 9" pneumatisch
 Hauptbremszylinder							
D 1.8	44	05/98→04/02		02/00→ 03/02; - ABS		24.2122-1588.3 011028	ATE Ø 22,2 ohne Druckregler
				→ 01/00; - ABS		24.2123-1737.3 010654	Ø 23,8
TD 1.8	55	03/00→08/03		→ 03/02; - ABS		24.2122-1588.3 011028	ATE Ø 22,2 ohne Druckregler







	kw					! #		
FORD - FIESTA Stufenheck 04/10→								
 Hauptbremszylinder								
1.4 1.6	70 62	10/10→ 09/10→		+ ABS		24.4120-1710.3	011082	Ø 20,6 ohne Bremsflüssigkeitsbehälter
1.6 Ti	81 77 - 88	04/10→		- ABS		24.4120-1711.3	011093	Ø 20,6 ohne Bremsflüssigkeitsbehälter
FORD - FIESTA Stufenheck 09/00→12/14								
 Bremskraftverstärker								
1.0 1.4 TDCi 1.6	70 50 73	09/04→12/06 05/02→11/11 05/02→11/13		für Fahrzeuge ohne Bremsassistent für Fahrzeuge mit Bremsassistent		03.7750-8732.4 03.7853-2102.4	300199 300201	ATE Ø 9" pneumatisch ATE Ø 9" pneumatisch
 Hauptbremszylinder								
1.0 1.4 TDCi 1.6	70 50 73	09/04→12/06 05/02→11/11 05/02→11/13		für Linkslenker; - ABS für Linkslenker; + ABS		03.4153-0015.3 03.4153-5287.4	011005 010953	ATE Ø 23,8 ohne Bremsflüssigkeitsbehälter ATE Ø 23,8 mit Bremsflüssigkeitsbehälter
FORD - FOCUS I (DAW, DBW) 09/98→11/09								
 Hauptbremszylinder								
1.4 16V	55	10/98→09/99		+ ABS		24.4123-1713.3	010905	BOS Ø 23,8 ohne Bremsflüssigkeitsbehälter
1.4 16V 1.6 16V 1.8 16V 1.8 DI / TDDi 1.8 TDCi 1.8 Turbo DI / TDDi 2.0 16V	55 74 85 55 85 66 96	10/98→11/04 10/98→11/04 10/98→11/04 08/99→11/04 03/01→11/04 10/98→11/04 10/98→11/04		11/01→ 09/04; + ESP → 09/04; + ABS		03.4123-0153.3 24.4123-1713.3	010659 010905	ATE Ø 23,8 BOS Ø 23,8 ohne Bremsflüssigkeitsbehälter
1.6 1.8 16V BiFuel	76 85	07/03→06/07 09/02→07/04		+ ESP + ABS		03.4123-0153.3 24.4123-1713.3	010659 010905	ATE Ø 23,8 BOS Ø 23,8 ohne Bremsflüssigkeitsbehälter
1.6 16V Flexifuel 1.8 TDCi	75 74	01/02→11/04 08/02→11/04		→ 09/04; + ESP → 09/04; + ABS		03.4123-0153.3 24.4123-1713.3	010659 010905	ATE Ø 23,8 BOS Ø 23,8 ohne Bremsflüssigkeitsbehälter
FORD - FOCUS I Kasten/Kombi (DNW) 08/98→03/05								
 Hauptbremszylinder								
1.4 1.6 1.8 1.8 TDCi 1.8 TDDi	55 74 85 85 55 - 66	04/99→03/05 04/99→03/05 04/99→03/05 08/01→03/05 08/98→03/05		11/01→ 09/04; + ESP → 09/04; + ABS		03.4123-0153.3 24.4123-1713.3	010659 010905	ATE Ø 23,8 BOS Ø 23,8 ohne Bremsflüssigkeitsbehälter
1.8 TDCi	74	08/02→03/05		→ 09/04; + ESP → 09/04; + ABS		03.4123-0153.3 24.4123-1713.3	010659 010905	ATE Ø 23,8 BOS Ø 23,8 ohne Bremsflüssigkeitsbehälter
FORD - FOCUS I Stufenheck (DFW) 02/99→11/09								
 Hauptbremszylinder								
1.4 16V 1.6 16V 1.8 16V 1.8 TDCi 1.8 Turbo DI / TDDi 2.0 16V	55 74 85 85 55 - 66 96	02/99→11/04 02/99→11/04 02/99→11/04 03/01→11/04 02/99→03/05 02/99→11/04		11/01→ 09/04; + ESP → 09/04; + ABS		03.4123-0153.3 24.4123-1713.3	010659 010905	ATE Ø 23,8 BOS Ø 23,8 ohne Bremsflüssigkeitsbehälter
1.8 TDCi	74	08/02→11/04		→ 09/04; + ESP → 09/04; + ABS		03.4123-0153.3 24.4123-1713.3	010659 010905	ATE Ø 23,8 BOS Ø 23,8 ohne Bremsflüssigkeitsbehälter
FORD - FOCUS I Turnier (DNW) 02/99→12/07								
 Hauptbremszylinder								
1.4 16V 1.6 16V 1.8 16V 1.8 DI / TDDi 1.8 TDCi 1.8 Turbo DI / TDDi 2.0 16V	55 74 85 55 85 66 96	02/99→11/04 02/99→11/04 02/99→11/04 08/99→11/04 03/01→11/04 02/99→11/04 02/99→11/04		11/01→ 09/04; + ESP → 09/04; + ABS		03.4123-0153.3 24.4123-1713.3	010659 010905	ATE Ø 23,8 BOS Ø 23,8 ohne Bremsflüssigkeitsbehälter
1.6 16V Flexifuel 1.8 TDCi →	75 74	01/02→11/04 08/02→11/04		→ 09/04; + ESP		03.4123-0153.3	010659	ATE Ø 23,8











	kw			 	! #		
FORD - FOCUS I Turnier (DNW) 02/99→12/07							
 Hauptbremszylinder							
1.6 16V Flexifuel 1.8 TDCi	75 74	01/02→11/04 08/02→11/04		→ 09/04; + ABS		24.4123-1713.3 010905	BOS Ø 23,8 ohne Bremsflüssigkeitsbehälter
1.8 BiFuel	82	02/03→01/05		+ ESP		03.4123-0153.3 010659	ATE Ø 23,8
				+ ABS		24.4123-1713.3 010905	BOS Ø 23,8 ohne Bremsflüssigkeitsbehälter
FORD - FOCUS II (DA_, HCP, DP) 07/04→09/13							
 Bremskraftverstärker							
1.4 1.6 1.6 TDCi	59 74 74 - 80	07/04→09/12 07/04→09/12 07/04→09/12		05/07→ 02/11; + ABS / für Fahrzeuge ohne Bremsassistent		03.7760-2232.4 300266	ATE Ø 10" pneumatisch
1.6 Ti 2.0 2.0 TDCi	85 107 100	07/04→09/12 07/04→09/12 07/04→09/12		10/04→ 02/11; - ABS / für Fahrzeuge ohne Bremsassistent		03.7760-2332.4 300267	ATE Ø 10" pneumatisch
				10/04→ 04/07; + ABS / für Fahrzeuge ohne Bremsassistent		03.7760-8103.4 300240	ATE Ø 10" pneumatisch
2.0 TDCi	107 100	07/04→09/12 07/04→09/12		10/04→ 04/07; + ABS / für Fahrzeuge mit Bremsassistent		03.7863-0332.4 300203	ATE Ø 10" pneumatisch
				05/07→ 02/11; + ABS / für Fahrzeuge mit Bremsassistent		03.7863-3932.4 300288	ATE Ø 10" pneumatisch
1.6 2.0 Flex	81 107	01/10→09/12 10/08→03/10		+ ABS / für Fahrzeuge ohne Bremsassistent		03.7760-2232.4 300266	ATE Ø 10" pneumatisch
				- ABS / für Fahrzeuge ohne Bremsassistent		03.7760-2332.4 300267	ATE Ø 10" pneumatisch
				+ ABS / für Fahrzeuge mit Bremsassistent		03.7863-3932.4 300288	ATE Ø 10" pneumatisch
1.6 LPG 2.0 CNG 2.0 LPG 2.0 TDCi	85 107 107 81	10/09→07/11 04/09→07/11 06/08→07/11 02/08→07/11		→ 02/11; + ABS / für Fahrzeuge ohne Bremsassistent		03.7760-2232.4 300266	ATE Ø 10" pneumatisch
				→ 02/11; - ABS / für Fahrzeuge ohne Bremsassistent		03.7760-2332.4 300267	ATE Ø 10" pneumatisch
2.0 TDCi	107 81	06/08→07/11 02/08→07/11		→ 02/11; + ABS / für Fahrzeuge mit Bremsassistent		03.7863-3932.4 300288	ATE Ø 10" pneumatisch
				05/07→ 02/11; + ABS / für Fahrzeuge ohne Bremsassistent		03.7760-2232.4 300266	ATE Ø 10" pneumatisch
1.6 TDCi 1.8 1.8 Flexifuel 1.8 TDCi	66 92 92 85	01/05→09/12 03/06→09/12 01/06→09/12 01/05→09/12		→ 02/11; - ABS / für Fahrzeuge ohne Bremsassistent		03.7760-2332.4 300267	ATE Ø 10" pneumatisch
				→ 04/07; + ABS / für Fahrzeuge ohne Bremsassistent		03.7760-8103.4 300240	ATE Ø 10" pneumatisch
				→ 04/07; + ABS / für Fahrzeuge mit Bremsassistent		03.7863-0332.4 300203	ATE Ø 10" pneumatisch
				05/07→ 02/11; + ABS / für Fahrzeuge mit Bremsassistent		03.7863-3932.4 300288	ATE Ø 10" pneumatisch
2.0	104	06/05→09/08		05/07→; + ABS / für Fahrzeuge ohne Bremsassistent		03.7760-2232.4 300266	ATE Ø 10" pneumatisch
				- ABS / für Fahrzeuge ohne Bremsassistent		03.7760-2332.4 300267	ATE Ø 10" pneumatisch
				→ 04/07; + ABS / für Fahrzeuge ohne Bremsassistent		03.7760-8103.4 300240	ATE Ø 10" pneumatisch
				→ 04/07; + ABS / für Fahrzeuge mit Bremsassistent		03.7863-0332.4 300203	ATE Ø 10" pneumatisch
				05/07→; + ABS / für Fahrzeuge mit Bremsassistent		03.7863-3932.4 300288	ATE Ø 10" pneumatisch
2.0 TDCi	98	07/04→01/08		05/07→; + ABS / für Fahrzeuge ohne Bremsassistent		03.7760-2232.4 300266	ATE Ø 10" pneumatisch
				10/04→; - ABS / für Fahrzeuge ohne Bremsassistent		03.7760-2332.4 300267	ATE Ø 10" pneumatisch
				10/04→ 04/07; + ABS / für Fahrzeuge ohne Bremsassistent		03.7760-8103.4 300240	ATE Ø 10" pneumatisch
				10/04→ 04/07; + ABS / für Fahrzeuge mit Bremsassistent		03.7863-0332.4 300203	ATE Ø 10" pneumatisch
				05/07→; + ABS / für Fahrzeuge mit Bremsassistent		03.7863-3932.4 300288	ATE Ø 10" pneumatisch
2.5 RS 2.5 RS 500	224 257	01/09→07/11 05/10→07/11		für Linkslenker; → 02/11		03.7755-3532.4 300290	ATE Ø 9 / 8" pneumatisch
 Hauptbremszylinder							
1.4 1.6 1.6 TDCi	59 74 74 - 80	07/04→09/12 07/04→09/12 07/04→09/12		10/04→ 04/07; + ABS		03.2123-3103.3 010781	ATE Ø 23,8
1.6 Ti 2.0 2.0 TDCi	85 107 100	07/04→09/12 07/04→09/12 07/04→09/12		05/07→ 10/08; + ABS		03.2125-0483.3 010783	ATE Ø 25,4 ohne Bremsflüssigkeitsbehälter
				11/08→ 02/11; + ABS		03.2125-0661.3 010917	ATE Ø 25,4
1.6	81	01/10→09/12		10/04→ 02/11; - ABS		24.2123-3041.3 011021	ATE Ø 23,8 ohne Bremsflüssigkeitsbehälter / ohne Druckregler
				+ ABS		03.2125-0661.3 010917	ATE Ø 25,4
				- ABS		24.2123-3041.3 011021	ATE Ø 23,8 ohne Bremsflüssigkeitsbehälter / ohne Druckregler
→							











	kw					! #		
FORD - FOCUS II (DA_, HCP, DP) 07/04→09/13								
 Hauptbremszylinder								
1.6 LPG 2.0 CNG	85 107	10/09→07/11 04/09→07/11		→ 02/11; + ABS → 02/11; - ABS			03.2125-0661.3 010917 24.2123-3041.3 011021	ATE Ø 25,4 ATE Ø 23,8 ohne Bremsflüssigkeitsbehälter / ohne Druckregler
1.6 TDCi 1.8 1.8 Flexifuel 1.8 TDCi 2.5 ST	66 92 92 85 166	01/05→09/12 03/06→09/12 01/06→09/12 01/05→09/12 10/05→09/12		→ 04/07; + ABS 05/07→ 10/08; + ABS 11/08→ 02/11; + ABS → 02/11; - ABS			03.2123-3103.3 010781 03.2125-0483.3 010783 03.2125-0661.3 010917 24.2123-3041.3 011021	ATE Ø 23,8 ATE Ø 25,4 ohne Bremsflüssigkeitsbehälter ATE Ø 25,4 ATE Ø 23,8 ohne Bremsflüssigkeitsbehälter / ohne Druckregler
2.0	104	06/05→09/08		→ 04/07; + ABS 05/07→; + ABS - ABS			03.2123-3103.3 010781 03.2125-0483.3 010783 24.2123-3041.3 011021	ATE Ø 23,8 ATE Ø 25,4 ohne Bremsflüssigkeitsbehälter ATE Ø 23,8 ohne Bremsflüssigkeitsbehälter / ohne Druckregler
2.0 Flex	107	10/08→03/10		+ ABS			03.2125-0661.3 010917	ATE Ø 25,4
2.0 LPG 2.0 TDCi	107 81	06/08→07/11 02/08→07/11		→ 10/08; + ABS 11/08→ 02/11; + ABS → 02/11; - ABS			03.2125-0483.3 010783 03.2125-0661.3 010917 24.2123-3041.3 011021	ATE Ø 25,4 ohne Bremsflüssigkeitsbehälter ATE Ø 25,4 ATE Ø 23,8 ohne Bremsflüssigkeitsbehälter / ohne Druckregler
2.0 TDCi	98	07/04→01/08		10/04→ 04/07; + ABS 05/07→; + ABS 10/04→; - ABS			03.2123-3103.3 010781 03.2125-0483.3 010783 24.2123-3041.3 011021	ATE Ø 23,8 ATE Ø 25,4 ohne Bremsflüssigkeitsbehälter ATE Ø 23,8 ohne Bremsflüssigkeitsbehälter / ohne Druckregler
2.5 RS 2.5 RS 500	224 257	01/09→07/11 05/10→07/11		für Linkslenker; → 02/11			03.2125-0651.3 010935	ATE Ø 25,4
Hydraulikaggregat, Bremsanlage								
1.4 1.6 1.6 TDCi 1.6 Ti 2.0 2.0 TDCi	59 74 74 - 80 85 107 100	07/04→09/12 07/04→09/12 07/04→09/12 07/04→09/12 07/04→09/12 07/04→09/12		10/04→ 02/11			24.9145-0004.2 399008	
1.6 2.0 2.0 Flex	81 104 107	01/10→09/12 06/05→09/08 10/08→03/10					24.9145-0004.2 399008	
1.6 LPG 1.6 TDCi 1.8 1.8 Flexifuel 1.8 TDCi 2.0 CNG 2.0 LPG 2.0 TDCi 2.5 ST	85 66 92 92 85 107 107 81 166	10/09→07/11 01/05→09/12 03/06→09/12 01/06→09/12 01/05→09/12 04/09→07/11 06/08→07/11 02/08→07/11 10/05→09/12		→ 02/11			24.9145-0004.2 399008	
2.0 TDCi	98	07/04→01/08		10/04→			24.9145-0004.2 399008	
FORD - FOCUS II Cabriolet 10/06→09/10								
 Bremskraftverstärker								
1.6 2.0 2.0 TDCi	74 107 100	10/06→09/10 10/06→09/10 10/06→09/10		05/07→; + ABS / für Fahrzeuge ohne Bremsassistent - ABS / für Fahrzeuge ohne Bremsassistent → 04/07; + ABS / für Fahrzeuge ohne Bremsassistent → 04/07; + ABS / für Fahrzeuge mit Bremsassistent 05/07→; + ABS / für Fahrzeuge mit Bremsassistent			03.7760-2232.4 300266 03.7760-2332.4 300267 03.7760-8103.4 300240 03.7863-0332.4 300203 03.7863-3932.4 300288	ATE Ø 10" pneumatisch ATE Ø 10" pneumatisch ATE Ø 10" pneumatisch ATE Ø 10" pneumatisch ATE Ø 10" pneumatisch
 Hauptbremszylinder								
1.6 2.0 2.0 TDCi	74 107 100	10/06→09/10 10/06→09/10 10/06→09/10		→ 04/07; + ABS 05/07→ 10/08; + ABS 11/08→; + ABS - ABS			03.2123-3103.3 010781 03.2125-0483.3 010783 03.2125-0661.3 010917 24.2123-3041.3 011021	ATE Ø 23,8 ATE Ø 25,4 ohne Bremsflüssigkeitsbehälter ATE Ø 25,4 ATE Ø 23,8 ohne Bremsflüssigkeitsbehälter / ohne Druckregler
→								













	kW					! #			
FORD - FOCUS II Cabriolet 10/06→09/10									
Hydraulikaggregat, Bremsanlage									
1.6 2.0 2.0 TDCi	74 107 100	10/06→09/10 10/06→09/10 10/06→09/10					24.9145-0004.2	399008	
FORD - FOCUS II Kasten/Kombi 07/04→07/11									
 Bremskraftverstärker									
1.4 1.6 1.6 TDCi	59 74 66 - 80	09/05→07/11 09/05→07/11 07/04→07/11		05/07→ 02/11; + ABS / für Fahrzeuge ohne Bremsassistent			03.7760-2232.4	300266	ATE Ø 10" pneumatisch
1.6 Ti-VCT 2.0 TDCi	85 100	09/05→07/11 09/05→07/11		→ 02/11; - ABS / für Fahrzeuge ohne Bremsassistent			03.7760-2332.4	300267	ATE Ø 10" pneumatisch
				→ 04/07; + ABS / für Fahrzeuge ohne Bremsassistent			03.7760-8103.4	300240	ATE Ø 10" pneumatisch
				→ 04/07; + ABS / für Fahrzeuge mit Bremsassistent			03.7863-0332.4	300203	ATE Ø 10" pneumatisch
				05/07→ 02/11; + ABS / für Fahrzeuge mit Bremsassistent			03.7863-3932.4	300288	ATE Ø 10" pneumatisch
1.8 Flexifuel	92	06/09→07/11		+ ABS / für Fahrzeuge ohne Bremsassistent			03.7760-2232.4	300266	ATE Ø 10" pneumatisch
				- ABS / für Fahrzeuge ohne Bremsassistent			03.7760-8103.4	300240	ATE Ø 10" pneumatisch
				+ ABS / für Fahrzeuge mit Bremsassistent			03.7863-0332.4	300203	ATE Ø 10" pneumatisch
							03.7863-3932.4	300288	ATE Ø 10" pneumatisch
2.0 TDCi	81	06/09→07/11		→ 02/11; + ABS / für Fahrzeuge ohne Bremsassistent			03.7760-2232.4	300266	ATE Ø 10" pneumatisch
				→ 02/11; - ABS / für Fahrzeuge ohne Bremsassistent			03.7760-2332.4	300267	ATE Ø 10" pneumatisch
				→ 02/11; + ABS / für Fahrzeuge mit Bremsassistent			03.7863-3932.4	300288	ATE Ø 10" pneumatisch
 Hauptbremszylinder									
1.4	59	09/05→07/11		+ ABS			03.2123-3103.3	010781	ATE Ø 23,8
				05/07→ 10/08; + ABS			03.2125-0483.3	010783	ATE Ø 25,4 ohne Bremsflüssigkeitsbehälter
				11/08→ 02/11; + ABS			03.2125-0661.3	010917	ATE Ø 25,4
				- ABS			24.2123-3041.3	011021	ATE Ø 23,8 ohne Bremsflüssigkeitsbehälter / ohne Druckregler
1.6	74	09/05→07/11		+ ABS			03.2123-3103.3	010781	ATE Ø 23,8
				05/07→ 10/08; + ABS			03.2125-0483.3	010783	ATE Ø 25,4 ohne Bremsflüssigkeitsbehälter
				11/08→ 02/11; + ABS			03.2125-0661.3	010917	ATE Ø 25,4
				→ 02/11; - ABS			24.2123-3041.3	011021	ATE Ø 23,8 ohne Bremsflüssigkeitsbehälter / ohne Druckregler
1.6 TDCi 1.6 Ti-VCT 2.0 TDCi	66 - 80 85 100	07/04→07/11 09/05→07/11 09/05→07/11		→ 04/07; + ABS			03.2123-3103.3	010781	ATE Ø 23,8
				05/07→ 10/08; + ABS			03.2125-0483.3	010783	ATE Ø 25,4 ohne Bremsflüssigkeitsbehälter
				11/08→ 02/11; + ABS			03.2125-0661.3	010917	ATE Ø 25,4
				→ 02/11; - ABS			24.2123-3041.3	011021	ATE Ø 23,8 ohne Bremsflüssigkeitsbehälter / ohne Druckregler
1.8 Flexifuel	92	06/09→07/11		→ 02/11; + ABS			03.2125-0661.3	010917	ATE Ø 25,4
2.0 TDCi	81	06/09→07/11		+ ABS			03.2125-0483.3	010783	ATE Ø 25,4 ohne Bremsflüssigkeitsbehälter
				→ 02/11; + ABS			03.2125-0661.3	010917	ATE Ø 25,4
				→ 02/11; - ABS			24.2123-3041.3	011021	ATE Ø 23,8 ohne Bremsflüssigkeitsbehälter / ohne Druckregler
Hydraulikaggregat, Bremsanlage									
1.4 1.6 1.8 Flexifuel	59 74 92	09/05→07/11 09/05→07/11 06/09→07/11					24.9145-0004.2	399008	
1.6 TDCi 1.6 Ti-VCT 2.0 TDCi	66 - 80 85 81 - 100	07/04→07/11 09/05→07/11 09/05→07/11		→ 02/11			24.9145-0004.2	399008	
FORD - FOCUS II Stufenheck (DB_, FCH, DH) 04/05→									
 Bremskraftverstärker									
1.4 1.6 1.6 TDCi	59 74 66 - 80	04/05→09/12 04/05→09/12 04/05→09/12		05/07→ 02/11; + ABS / für Fahrzeuge ohne Bremsassistent			03.7760-2232.4	300266	ATE Ø 10" pneumatisch
→									

	kw					! #		
FORD - FOCUS II Stufenheck (DB_, FCH, DH) 04/05→								
Bremskraftverstärker								
1.6 Ti	85	04/05→09/12		→ 02/11; - ABS / für Fahrzeuge ohne Bremsassistent		03.7760-2332.4	300267	ATE Ø 10" pneumatisch
1.8	92	03/06→09/12						
1.8 Flexifuel	92	06/06→07/11		→ 04/07; + ABS / für Fahrzeuge ohne Bremsassistent		03.7760-8103.4	300240	ATE Ø 10" pneumatisch
1.8 TDCi	85	04/05→09/12						
2.0	107	04/05→07/11		→ 04/07; + ABS / für Fahrzeuge mit Bremsassistent		03.7863-0332.4	300203	ATE Ø 10" pneumatisch
2.0 TDCi	100	04/05→09/12						
				05/07→ 02/11; + ABS / für Fahrzeuge mit Bremsassistent		03.7863-3932.4	300288	ATE Ø 10" pneumatisch
1.6	81	03/10→		+ ABS / für Fahrzeuge ohne Bremsassistent		03.7760-2232.4	300266	ATE Ø 10" pneumatisch
1.6 Flex	85	01/10→09/13						
				- ABS / für Fahrzeuge ohne Bremsassistent		03.7760-2332.4	300267	ATE Ø 10" pneumatisch
				+ ABS / für Fahrzeuge mit Bremsassistent		03.7863-3932.4	300288	ATE Ø 10" pneumatisch
1.8 Flexifuel	96	12/05→01/08		05/07→; + ABS / für Fahrzeuge ohne Bremsassistent		03.7760-2232.4	300266	ATE Ø 10" pneumatisch
				01/06→; - ABS / für Fahrzeuge ohne Bremsassistent		03.7760-2332.4	300267	ATE Ø 10" pneumatisch
				01/06→ 04/07; + ABS / für Fahrzeuge ohne Bremsassistent		03.7760-8103.4	300240	ATE Ø 10" pneumatisch
				01/06→ 04/07; + ABS / für Fahrzeuge mit Bremsassistent		03.7863-0332.4	300203	ATE Ø 10" pneumatisch
				05/07→; + ABS / für Fahrzeuge mit Bremsassistent		03.7863-3932.4	300288	ATE Ø 10" pneumatisch
2.0 TDCi	81	02/08→07/11		→ 02/11; + ABS / für Fahrzeuge ohne Bremsassistent		03.7760-2232.4	300266	ATE Ø 10" pneumatisch
				→ 02/11; - ABS / für Fahrzeuge ohne Bremsassistent		03.7760-2332.4	300267	ATE Ø 10" pneumatisch
				→ 02/11; + ABS / für Fahrzeuge mit Bremsassistent		03.7863-3932.4	300288	ATE Ø 10" pneumatisch
Hauptbremszylinder								
1.4	59	04/05→09/12		→ 04/07; + ABS		03.2123-3103.3	010781	ATE Ø 23,8
1.6	74	04/05→09/12						
1.6 TDCi	66 - 80	04/05→09/12		05/07→ 10/08; + ABS		03.2125-0483.3	010783	ATE Ø 25,4 ohne Bremsflüssigkeitsbehälter
1.6 Ti	85	04/05→09/12		11/08→ 02/11; + ABS		03.2125-0661.3	010917	ATE Ø 25,4
1.8	92	03/06→09/12		→ 02/11; - ABS		24.2123-3041.3	011021	ATE Ø 23,8 ohne Bremsflüssigkeitsbehälter / ohne Druckregler
1.8 Flexifuel	92	06/06→07/11						
1.8 TDCi	85	04/05→09/12						
2.0	107	04/05→07/11						
2.0 TDCi	100	04/05→09/12						
1.6	81	03/10→		+ ABS		03.2125-0661.3	010917	ATE Ø 25,4
1.6 Flex	85	01/10→09/13		- ABS		24.2123-3041.3	011021	ATE Ø 23,8 ohne Bremsflüssigkeitsbehälter / ohne Druckregler
1.8 Flexifuel	96	12/05→01/08		01/06→ 04/07; + ABS		03.2123-3103.3	010781	ATE Ø 23,8
				05/07→; + ABS		03.2125-0483.3	010783	ATE Ø 25,4 ohne Bremsflüssigkeitsbehälter
				01/06→; - ABS		24.2123-3041.3	011021	ATE Ø 23,8 ohne Bremsflüssigkeitsbehälter / ohne Druckregler
2.0 TDCi	81	02/08→07/11		→ 10/08; + ABS		03.2125-0483.3	010783	ATE Ø 25,4 ohne Bremsflüssigkeitsbehälter
				11/08→ 02/11; + ABS		03.2125-0661.3	010917	ATE Ø 25,4
				→ 02/11; - ABS		24.2123-3041.3	011021	ATE Ø 23,8 ohne Bremsflüssigkeitsbehälter / ohne Druckregler
Hydraulikaggregat, Bremsanlage								
1.4	59	04/05→09/12		→ 02/11		24.9145-0004.2	399008	
1.6	74	04/05→09/12						
1.6 TDCi	66 - 80	04/05→09/12						
1.6 Ti	85	04/05→09/12						
1.8	92	03/06→09/12						
1.8 Flexifuel	92	06/06→07/11						
1.8 TDCi	85	04/05→09/12						
2.0	107	04/05→07/11						
2.0 TDCi	81 - 100	04/05→09/12						
1.6	81	03/10→				24.9145-0004.2	399008	
1.6 Flex	85	01/10→09/13						
1.8 Flexifuel	96	12/05→01/08		01/06→		24.9145-0004.2	399008	

	kw					! #		
FORD - FOCUS II Turnier (DA, FFS, DS) 07/04→09/12								
Bremskraftverstärker								
1.4 1.6 1.6 TDCi	59 74 74 - 80	07/04→09/12 07/04→07/11 07/04→09/12		05/07→ 02/11; + ABS / für Fahrzeuge ohne Bremsassistent		03.7760-2232.4	300266	ATE Ø 10" pneumatisch
1.6 Ti 2.0 2.0 TDCi	85 107 100	07/04→09/12 07/04→09/12 07/04→09/12		10/04→ 02/11; - ABS / für Fahrzeuge ohne Bremsassistent		03.7760-2332.4	300267	ATE Ø 10" pneumatisch
				10/04→ 04/07; + ABS / für Fahrzeuge ohne Bremsassistent		03.7760-8103.4	300240	ATE Ø 10" pneumatisch
				10/04→ 04/07; + ABS / für Fahrzeuge mit Bremsassistent		03.7863-0332.4	300203	ATE Ø 10" pneumatisch
				05/07→ 02/11; + ABS / für Fahrzeuge mit Bremsassistent		03.7863-3932.4	300288	ATE Ø 10" pneumatisch
1.6 LPG 1.6 TDCi 2.0 LPG 2.0 TDCi	85 81 107 81	10/09→09/12 12/07→09/12 06/08→07/11 02/08→07/11		→ 02/11; + ABS / für Fahrzeuge ohne Bremsassistent		03.7760-2232.4	300266	ATE Ø 10" pneumatisch
				→ 02/11; - ABS / für Fahrzeuge ohne Bremsassistent		03.7760-2332.4	300267	ATE Ø 10" pneumatisch
				→ 02/11; + ABS / für Fahrzeuge mit Bremsassistent		03.7863-3932.4	300288	ATE Ø 10" pneumatisch
1.6 TDCi 1.8 TDCi	66 85	07/04→09/12 07/04→09/12		05/07→ 02/11; + ABS / für Fahrzeuge ohne Bremsassistent		03.7760-2232.4	300266	ATE Ø 10" pneumatisch
				01/05→ 02/11; - ABS / für Fahrzeuge ohne Bremsassistent		03.7760-2332.4	300267	ATE Ø 10" pneumatisch
				01/05→ 04/07; + ABS / für Fahrzeuge ohne Bremsassistent		03.7760-8103.4	300240	ATE Ø 10" pneumatisch
				01/05→ 04/07; + ABS / für Fahrzeuge mit Bremsassistent		03.7863-0332.4	300203	ATE Ø 10" pneumatisch
				05/07→ 02/11; + ABS / für Fahrzeuge mit Bremsassistent		03.7863-3932.4	300288	ATE Ø 10" pneumatisch
1.8 1.8 Flexifuel	92 92	03/06→09/12 01/06→09/12		05/07→ 02/11; + ABS / für Fahrzeuge ohne Bremsassistent		03.7760-2232.4	300266	ATE Ø 10" pneumatisch
				→ 02/11; - ABS / für Fahrzeuge ohne Bremsassistent		03.7760-2332.4	300267	ATE Ø 10" pneumatisch
				→ 04/07; + ABS / für Fahrzeuge ohne Bremsassistent		03.7760-8103.4	300240	ATE Ø 10" pneumatisch
				→ 04/07; + ABS / für Fahrzeuge mit Bremsassistent		03.7863-0332.4	300203	ATE Ø 10" pneumatisch
				05/07→ 02/11; + ABS / für Fahrzeuge mit Bremsassistent		03.7863-3932.4	300288	ATE Ø 10" pneumatisch
2.0 TDCi	98	07/04→01/08		05/07→; + ABS / für Fahrzeuge ohne Bremsassistent		03.7760-2232.4	300266	ATE Ø 10" pneumatisch
				10/04→; - ABS / für Fahrzeuge ohne Bremsassistent		03.7760-2332.4	300267	ATE Ø 10" pneumatisch
				10/04→ 04/07; + ABS / für Fahrzeuge ohne Bremsassistent		03.7760-8103.4	300240	ATE Ø 10" pneumatisch
				10/04→ 04/07; + ABS / für Fahrzeuge mit Bremsassistent		03.7863-0332.4	300203	ATE Ø 10" pneumatisch
				05/07→; + ABS / für Fahrzeuge mit Bremsassistent		03.7863-3932.4	300288	ATE Ø 10" pneumatisch
Hauptbremszylinder								
1.4 1.6 1.6 TDCi	59 74 74 - 80	07/04→09/12 07/04→07/11 07/04→09/12		10/04→ 04/07; + ABS		03.2123-3103.3	010781	ATE Ø 23,8
1.6 Ti 2.0 2.0 TDCi	85 107 100	07/04→09/12 07/04→09/12 07/04→09/12		05/07→ 10/08; + ABS		03.2125-0483.3	010783	ATE Ø 25,4 ohne Bremsflüssigkeitsbehälter
				11/08→ 02/11; + ABS		03.2125-0661.3	010917	ATE Ø 25,4
				10/04→ 02/11; - ABS		24.2123-3041.3	011021	ATE Ø 23,8 ohne Bremsflüssigkeitsbehälter / ohne Druckregler
1.6 LPG	85	10/09→09/12		→ 02/11; + ABS		03.2125-0661.3	010917	ATE Ø 25,4
				→ 02/11; - ABS		24.2123-3041.3	011021	ATE Ø 23,8 ohne Bremsflüssigkeitsbehälter / ohne Druckregler
1.6 TDCi 1.8 TDCi	66 85	07/04→09/12 07/04→09/12		01/05→ 04/07; + ABS		03.2123-3103.3	010781	ATE Ø 23,8
				05/07→ 10/08; + ABS		03.2125-0483.3	010783	ATE Ø 25,4 ohne Bremsflüssigkeitsbehälter
				11/08→ 02/11; + ABS		03.2125-0661.3	010917	ATE Ø 25,4
				01/05→ 02/11; - ABS		24.2123-3041.3	011021	ATE Ø 23,8 ohne Bremsflüssigkeitsbehälter / ohne Druckregler
1.6 TDCi 2.0 LPG 2.0 TDCi	81 107 81	12/07→09/12 06/08→07/11 02/08→07/11		→ 10/08; + ABS		03.2125-0483.3	010783	ATE Ø 25,4 ohne Bremsflüssigkeitsbehälter
				11/08→ 02/11; + ABS		03.2125-0661.3	010917	ATE Ø 25,4
				→ 02/11; - ABS		24.2123-3041.3	011021	ATE Ø 23,8 ohne Bremsflüssigkeitsbehälter / ohne Druckregler
1.8 1.8 Flexifuel	92 92	03/06→09/12 01/06→09/12		→ 04/07; + ABS		03.2123-3103.3	010781	ATE Ø 23,8
				05/07→ 10/08; + ABS		03.2125-0483.3	010783	ATE Ø 25,4 ohne Bremsflüssigkeitsbehälter
				11/08→ 02/11; + ABS		03.2125-0661.3	010917	ATE Ø 25,4
→								

	kW			 	! #		
FORD - FOCUS II Turnier (DA, FFS, DS) 07/04→09/12							
 Hauptbremszylinder							
1.8 1.8 Flexifuel	92 92	03/06→09/12 01/06→09/12		→ 02/11; - ABS		24.2123-3041.3 011021	ATE Ø 23,8 ohne Bremsflüssigkeitsbehälter / ohne Druckregler
2.0 TDCi	98	07/04→01/08		10/04→ 04/07; + ABS		03.2123-3103.3 010781	ATE Ø 23,8
				05/07→; + ABS		03.2125-0483.3 010783	ATE Ø 25,4 ohne Bremsflüssigkeitsbehälter
				10/04→; - ABS		24.2123-3041.3 011021	ATE Ø 23,8 ohne Bremsflüssigkeitsbehälter / ohne Druckregler
Hydraulikaggregat, Bremsanlage							
1.4 1.6 1.6 TDCi	59 74 74	07/04→09/12 07/04→07/11 07/04→09/12		10/04→ 02/11		24.9145-0004.2 399008	
1.6 Ti 2.0 2.0 TDCi	80 85 107 100	07/04→09/12 07/04→09/12 07/04→09/12					
1.6 LPG 1.6 TDCi 1.8 1.8 Flexifuel 2.0 LPG 2.0 TDCi	85 81 92 92 107 81	10/09→09/12 12/07→09/12 03/06→09/12 01/06→09/12 06/08→07/11 02/08→07/11		→ 02/11		24.9145-0004.2 399008	
1.6 TDCi 1.8 TDCi	66 85	07/04→09/12 07/04→09/12		01/05→ 02/11		24.9145-0004.2 399008	
2.0 TDCi	98	07/04→01/08		10/04→		24.9145-0004.2 399008	
FORD - FOCUS III 07/10→							
 Hauptbremszylinder							
1.0 EcoBoost 1.5 EcoBoost 1.5 TDCi 1.5 TDCi ECONetic 1.6 Flexifuel 1.6 LPG 1.6 TDCi ECONetic 1.6 Ti 2.0 ST 2.0 TDCi 2.0 TDCi ST	74 - 103 110 - 134 70 - 88 77 110 86 - 88 77 63 - 88 184 110 136	02/12→06/19 09/14→12/17 09/14→12/17 09/14→12/17 07/13→ 02/12→ 05/12→ 08/11→12/17 07/12→12/17 11/14→12/17 11/14→12/17				03.4155-5451.3 010995	ATE Ø 25,4
1.6 EcoBoost 1.6 Flexifuel 1.6 TDCi 1.6 Ti 2.0 TDCi	110 - 134 88 70 - 85 77 - 92 85 - 120	07/10→06/14 07/10→ 07/10→12/17 07/10→05/18 07/10→06/14		03/11→		03.4155-5451.3 010995	ATE Ø 25,4
2.0 2.0 Ti-GDi 2.3 RS AWD	119 125 257	09/11→12/17 08/11→ 07/15→				03.4155-5456.3 010996	ATE Ø 25,4
FORD - FOCUS III Kasten/Kombi 02/12→							
 Hauptbremszylinder							
1.0 EcoBoost 1.5 EcoBoost 1.5 TDCi 1.5 TDCi ECONetic 2.0 TDCi	74 - 92 110 - 134 70 - 88 77 110	02/12→ 09/14→ 09/14→ 09/14→ 11/14→				03.4155-5451.3 010995	ATE Ø 25,4
FORD - FOCUS III Kasten/Schrägheck 01/11→							
 Hauptbremszylinder							
1.0 EcoBoost 1.5 EcoBoost 1.5 TDCi 1.5 TDCi ECONetic →	74 - 92 110 - 134 88 77	02/12→ 09/14→ 09/14→ 09/14→				03.4155-5451.3 010995	ATE Ø 25,4

	kW			 	! #		
FORD - FOCUS III Kasten/Schrägheck 01/11→							
 Hauptbremszylinder							
1.6 EcoBoost	110 - 134	11/11→06/14				03.4155-5451.3 010995	ATE Ø 25,4
1.6 TDCi	85	02/12→					
2.0 TDCi	110	11/14→					
1.6 TDCi	70	01/11→		03/11→		03.4155-5451.3 010995	ATE Ø 25,4
1.6 Ti	77	01/11→					
2.0 TDCi	85 - 120	01/11→06/14					
FORD - FOCUS III Stufenheck 07/10→							
 Hauptbremszylinder							
1.0 EcoBoost	74 - 103	02/12→				03.4155-5451.3 010995	ATE Ø 25,4
1.5 EcoBoost	110 - 134	11/14→					
1.5 TDCi	70 - 88	11/14→					
1.5 TDCi ECONetic	77	11/14→					
1.6 Flexifuel	110	07/13→					
1.6 TDCi	77	05/12→					
1.6 Ti	63	08/11→					
2.0 TDCi	110	11/14→					
1.6 EcoBoost	110 - 134	07/10→		03/11→		03.4155-5451.3 010995	ATE Ø 25,4
1.6 Flexifuel	88	07/10→					
1.6 TDCi	70 - 85	07/10→					
1.6 Ti	77 - 92	07/10→					
2.0 TDCi	85 - 120	07/10→					
2.0 GDi	125	08/11→				03.4155-5456.3 010996	ATE Ø 25,4
FORD - FOCUS III Turnier 07/10→							
 Hauptbremszylinder							
1.0 EcoBoost	74 - 103	02/12→				03.4155-5451.3 010995	ATE Ø 25,4
1.5 EcoBoost	110 - 134	09/14→					
1.5 TDCi	70 - 88	09/14→					
1.5 TDCi ECONetic	77	09/14→					
1.6 Flexifuel	110	07/13→					
1.6 LPG	86 - 88	02/12→					
1.6 TDCi ECONetic	77	05/12→					
1.6 Ti	63 - 88	08/11→					
2.0 ST	184	07/12→					
2.0 TDCi	110	11/14→					
2.0 TDCi ST	136	11/14→					
1.6 EcoBoost	110 - 134	07/10→		03/11→		03.4155-5451.3 010995	ATE Ø 25,4
1.6 Flexifuel	88	07/10→					
1.6 TDCi	70 - 85	07/10→					
1.6 Ti	77 - 92	07/10→					
2.0 TDCi	85 - 120	07/10→					
2.0 Ti-GDi	125	07/10→		08/11→		03.4155-5456.3 010996	ATE Ø 25,4
FORD - FOCUS C-MAX (DM2) 10/03→03/07							
 Bremskraftverstärker							
1.6	74	10/03→03/07		09/06→; für Fahrzeuge ohne Bremsassistent		03.7760-2232.4 300266	ATE Ø 10" pneumatisch
1.6 TDCi	66 - 80	10/03→03/07		→ 08/06; für Fahrzeuge ohne Bremsassistent		03.7760-8103.4 300240	ATE Ø 10" pneumatisch
1.6 Ti	85	08/04→03/07		→ 08/06; für Fahrzeuge mit Bremsassistent		03.7863-0332.4 300203	ATE Ø 10" pneumatisch
1.8	88 - 92	10/03→03/07		→ 08/06; für Fahrzeuge mit Bremsassistent		03.7863-3932.4 300288	ATE Ø 10" pneumatisch
1.8 Flexifuel	92	01/06→03/07					
1.8 TDCi	85	01/05→03/07					
2.0 TDCi	98 - 100	10/03→03/07					
2.0	107	03/04→03/07		09/06→; für Fahrzeuge ohne Bremsassistent		03.7760-2232.4 300266	ATE Ø 10" pneumatisch
→				04/04→ 08/06; für Fahrzeuge ohne Bremsassistent		03.7760-8103.4 300240	ATE Ø 10" pneumatisch

	kw					! #		
FORD - FOCUS C-MAX (DM2) 10/03→03/07								
 Bremskraftverstärker								
2.0	107	03/04→03/07		04/04→08/06; für Fahrzeuge mit Bremsassistent		03.7863-0332.4	300203	ATE Ø 10" pneumatisch
				09/06→; für Fahrzeuge mit Bremsassistent		03.7863-3932.4	300288	ATE Ø 10" pneumatisch
 Hauptbremszylinder								
1.6	74	10/03→03/07				03.2123-3103.3	010781	ATE Ø 23,8
1.6 TDCi	66 - 80	10/03→03/07				03.2125-0483.3	010783	ATE Ø 25,4 ohne Bremsflüssigkeitsbehälter
1.6 Ti	85	08/04→03/07						
1.8	88 - 92	10/03→03/07						
1.8 Flexifuel	92	01/06→03/07						
1.8 TDCi	85	01/05→03/07						
2.0 TDCi	98 - 100	10/03→03/07						
2.0	107	03/04→03/07		04/04→		03.2123-3103.3	010781	ATE Ø 23,8
						03.2125-0483.3	010783	ATE Ø 25,4 ohne Bremsflüssigkeitsbehälter
Hydraulikaggregat, Bremsanlage								
1.6	74	10/03→03/07				24.9145-0004.2	399008	
1.6 TDCi	66 - 80	10/03→03/07						
1.6 Ti	85	08/04→03/07						
1.8	88 - 92	10/03→03/07						
1.8 Flexifuel	92	01/06→03/07						
1.8 TDCi	85	01/05→03/07						
2.0 TDCi	98 - 100	10/03→03/07						
2.0	107	03/04→03/07		04/04→		24.9145-0004.2	399008	
FORD - FUSION (JU_) 08/02→12/12								
 Bremskraftverstärker								
1.25	55	08/04→12/12		→ 09/12; für Fahrzeuge ohne Bremsassistent		03.7750-8732.4	300199	ATE Ø 9" pneumatisch
1.4	59	08/02→12/12						
1.4 LPG	59	01/10→12/12						
1.4 TDCi	50	08/02→12/12		→ 09/12; für Fahrzeuge mit Bremsassistent		03.7853-2102.4	300201	ATE Ø 9" pneumatisch
1.6 TDCi	66	11/04→12/12						
1.3	44	11/02→07/05		für Fahrzeuge ohne Bremsassistent		03.7750-8732.4	300199	ATE Ø 9" pneumatisch
1.6	74	08/02→11/09		für Fahrzeuge mit Bremsassistent		03.7853-2102.4	300201	ATE Ø 9" pneumatisch
 Hauptbremszylinder								
1.25	55	08/04→12/12		→ 09/12; für Linkslenker; - ABS		03.4153-0015.3	011005	ATE Ø 23,8 ohne Bremsflüssigkeitsbehälter
1.4	59	08/02→12/12						
1.4 LPG	59	01/10→12/12						
1.4 TDCi	50	08/02→12/12		→ 09/12; für Linkslenker		03.4153-5287.4	010953	ATE Ø 23,8 mit Bremsflüssigkeitsbehälter
1.6 TDCi	66	11/04→12/12						
1.3	44	11/02→07/05		für Linkslenker; - ABS		03.4153-0015.3	011005	ATE Ø 23,8 ohne Bremsflüssigkeitsbehälter
1.6	74	08/02→11/09		für Linkslenker; - ABS		03.4153-0015.3	011005	ATE Ø 23,8 ohne Bremsflüssigkeitsbehälter
				für Linkslenker		03.4153-5287.4	010953	ATE Ø 23,8 mit Bremsflüssigkeitsbehälter
FORD - GALAXY I (WGR) 03/95→05/06								
 Bremskraftverstärker								
1.9 TDI	66	03/95→05/06		09/97→03/00; für Linkslenker; + ABS		03.7755-1902.4	300138	ATE Ø 9 / 8" pneumatisch
				04/00→04/06; für Rechtslenker; - ESP		03.7755-6302.4	300221	ATE Ø 9 / 8" pneumatisch
				04/00→10/02; für Linkslenker; - ESP		03.7755-6302.4	300221	ATE Ø 9 / 8" pneumatisch
				01/96→08/97; für Linkslenker		03.7760-3002.4	300120	ATE Ø 10" pneumatisch
				04/00→10/02; für Linkslenker; + ESP		03.7858-3302.4	300122	ATE Ø 9 / 8" pneumatisch
1.9 TDI	81	08/97→04/00		10/97→03/00; für Linkslenker; + ABS		03.7755-1902.4	300138	ATE Ø 9 / 8" pneumatisch
1.9 TDI	85	04/00→05/06		→ 10/02; für Linkslenker; - ESP		03.7755-6302.4	300221	ATE Ø 9 / 8" pneumatisch
2.3 16V	103	09/01→05/06		→ 04/06; für Rechtslenker; - ESP		03.7755-6302.4	300221	ATE Ø 9 / 8" pneumatisch
2.8 V6	150	04/00→05/06		→ 10/02; für Linkslenker; + ESP		03.7858-3302.4	300122	ATE Ø 9 / 8" pneumatisch
1.9 TDI	96	02/03→05/06		→ 04/06; für Rechtslenker; - ESP		03.7755-6302.4	300221	ATE Ø 9 / 8" pneumatisch
1.9 TDI	110	05/05→05/06		für Rechtslenker; - ESP		03.7755-6302.4	300221	ATE Ø 9 / 8" pneumatisch
2.0 i	85	11/95→05/06		09/97→03/00; für Linkslenker; + ABS		03.7755-1902.4	300138	ATE Ø 9 / 8" pneumatisch
2.3 16V	107	01/97→05/06		04/00→10/02; für Linkslenker; - ESP		03.7755-6302.4	300221	ATE Ø 9 / 8" pneumatisch
→								

FORD - GALAXY I (WGR) 03/95→05/06

 **Bremskraftverstärker**

2.0 i 2.3 16V	85	11/95→05/06		04/00→ 04/06; für Rechtslenker; - ESP	03.7755-6302.4	300221	ATE Ø 9 / 8" pneumatisch
	107	01/97→05/06		→ 08/97; für Linkslenker	03.7760-3002.4	300120	ATE Ø 10" pneumatisch
2.8 i V6 2.8 i V6 4x4	128	11/95→04/00		04/00→ 10/02; für Linkslenker; + ESP	03.7858-3302.4	300122	ATE Ø 9 / 8" pneumatisch
	128	04/96→04/00		09/97→ 03/00; für Linkslenker; + ABS	03.7755-1902.4	300138	ATE Ø 9 / 8" pneumatisch
				→ 08/97; für Linkslenker	03.7760-3002.4	300120	ATE Ø 10" pneumatisch

 **Hauptbremszylinder**

1.9 TDI	66	03/95→05/06		01/96→ 08/97; + ABS	03.2123-1526.3	010477	Ø 23,8
				01/96→ 08/97; - ABS	03.2123-1548.3	010478	Ø 23,8
				09/97→ 03/00; + ABS	03.2125-0332.3	010952	Ø 25,4
				11/02→ 04/06; - ESP	03.2125-0332.3	010952	Ø 25,4
				04/00→ 10/02; - ESP	03.2125-0332.3	010952	Ø 25,4
				09/97→ 03/00; - ABS	03.2125-8404.3	010583	ATE Ø 25,4
1.9 TDI	81	08/97→04/00		04/00→ 10/02; + ESP	03.2125-9604.3	010581	Ø 25,4
				10/97→ 03/00; + ABS	03.2125-0332.3	010952	Ø 25,4
1.9 TDI 2.3 16V 2.8 V6	85 103 150	04/00→05/06 09/01→05/06 04/00→05/06		10/97→ 03/00; - ABS	03.2125-8404.3	010583	ATE Ø 25,4
				→ 10/02; - ESP	03.2125-0332.3	010952	Ø 25,4
				→ 10/02; + ESP	03.2125-9604.3	010581	Ø 25,4
1.9 TDI	96	02/03→05/06		→ 04/06; - ESP	03.2125-0332.3	010952	Ø 25,4
1.9 TDI	110	05/05→05/06		- ESP	03.2125-0332.3	010952	Ø 25,4
2.0 i 2.3 16V	85 107	11/95→05/06 01/97→05/06		→ 08/97; + ABS	03.2123-1526.3	010477	Ø 23,8
				→ 08/97; - ABS	03.2123-1548.3	010478	Ø 23,8
				09/97→ 03/00; + ABS	03.2125-0332.3	010952	Ø 25,4
				11/02→ 04/06; - ESP	03.2125-0332.3	010952	Ø 25,4
				04/00→ 10/02; - ESP	03.2125-0332.3	010952	Ø 25,4
				09/97→ 03/00; - ABS	03.2125-8404.3	010583	ATE Ø 25,4
2.8 i V6 2.8 i V6 4x4	128 128	11/95→04/00 04/96→04/00		04/00→ 10/02; + ESP	03.2125-9604.3	010581	Ø 25,4
				→ 08/97; + ABS	03.2123-1526.3	010477	Ø 23,8
				→ 08/97; - ABS	03.2123-1548.3	010478	Ø 23,8
				09/97→ 03/00; + ABS	03.2125-0332.3	010952	Ø 25,4
				09/97→ 03/00; - ABS	03.2125-8404.3	010583	ATE Ø 25,4

Verschlusschraube, Hauptbremszylinder

1.9 TDI	66	03/95→05/06		01/96→ 08/97; - ABS	03.3517-5100.1	390326		
2.0 i 2.3 16V 2.8 i V6 2.8 i V6 4x4	85 107 128 128	11/95→05/06 01/97→05/06 11/95→04/00 04/96→04/00		→ 08/97; - ABS	03.3517-5100.1	390326		

FORD - GALAXY II (WA6) 05/06→06/15

 **Bremskraftverstärker**

1.6 EcoBoost	118	11/10→06/15		02/11→	03.7755-1432.4	300300	ATE Ø 9 / 8" pneumatisch
1.6 TDCi 1.8 TDCi	85 74	02/11→06/15 05/06→06/15			03.7755-1432.4	300300	ATE Ø 9 / 8" pneumatisch
2.0 2.0 EcoBoost	107 146	05/06→06/15 03/10→06/15					
2.0 Flexifuel 2.0 TDCi	107 85	05/06→06/15 05/06→06/15					
2.2 TDCi 2.3	120 147	11/10→06/15 09/07→06/15					
2.2 TDCi	118	09/07→06/15					
2.2 TDCi	129	03/08→12/12		04/08→	03.7755-1432.4	300300	ATE Ø 9 / 8" pneumatisch















FORD - GALAXY MK I VAN (WGR) 03/95→05/06













 **Bremskraftverstärker**















2.3	103	11/02→03/06		für Rechtslenker; - ESP	03.7755-6302.4	300221	ATE Ø 9 / 8" pneumatisch
-----	-----	-------------	--	-------------------------	-----------------------	---------------	--------------------------











 **Hauptbremszylinder**

2.3	103	11/02→03/06		- ESP	03.2125-0332.3	010952	Ø 25,4
-----	-----	-------------	--	-------	-----------------------	---------------	--------













	kw					! #		
FORD - GALAXY MK II VAN (WA6) 05/06→06/15								
 Bremskraftverstärker								
2.0	107	05/06→06/15				03.7755-1432.4	300300	ATE Ø 9 / 8" pneumatisch
2.0 EcoBoost	149	03/10→06/15						
EcoBoost	118	02/11→06/15						
TDCi	85 - 147	05/06→06/15						
TDCi	85	01/07→06/15		02/11→		03.7755-1432.4	300300	ATE Ø 9 / 8" pneumatisch
FORD - GRAND C-MAX (DXA/CB7, DXA/CEU) 12/10→06/19								
 Hauptbremszylinder								
1.0 EcoBoost	74 - 92	10/12→06/19		für Linkslenker		03.4155-5456.3	010996	ATE Ø 25,4
1.5 EcoBoost	110 - 134	03/15→06/19						
1.5 TDCi	70 - 88	03/15→06/19						
1.6 EcoBoost	110 - 134	12/10→06/19						
1.6 TDCi	70 - 85	12/10→06/19						
1.6 Ti	63 - 92	12/10→06/19						
2.0 TDCi	85 - 120	12/10→06/19		für Linkslenker		03.4155-5451.3	010995	ATE Ø 25,4
						03.4155-5456.3	010996	ATE Ø 25,4
2.0 TDCi	100 - 125	02/11→06/19		für Linkslenker		03.4155-5451.3	010995	ATE Ø 25,4
FORD - GRAND C-MAX Van 12/10→06/19								
 Hauptbremszylinder								
1.0 EcoBoost	74 - 92	10/12→06/19		für Linkslenker		03.4155-5456.3	010996	ATE Ø 25,4
1.5 EcoBoost	110	03/15→06/19						
1.5 TDCi	88	03/15→06/19						
1.6 EcoBoost	110 - 134	12/10→06/19						
1.6 TDCi	70 - 85	12/10→06/19						
1.6 Ti	92	12/10→12/14						
2.0 TDCi	103 - 120	12/10→06/19		für Linkslenker		03.4155-5451.3	010995	ATE Ø 25,4
2.0 TDCi	85	02/11→06/19				03.4155-5456.3	010996	ATE Ø 25,4
2.0 TDCi	110 - 125	03/15→06/19		für Linkslenker		03.4155-5451.3	010995	ATE Ø 25,4
FORD - KA 01/08→								
 Hauptbremszylinder								
1.0	46 - 48	10/08→				24.4120-1706.3	011072	Ø 20,6 ohne Bremsflüssigkeitsbehälter
FORD - KA (RU8) 10/08→05/16								
 Hauptbremszylinder								
1.2	51	10/08→05/16				24.4120-1706.3	011072	Ø 20,6 ohne Bremsflüssigkeitsbehälter
1.3 TDCi	55	10/08→05/16						
FORD - KUGA I 02/08→11/12								
 Bremskraftverstärker								
2.0 TDCi	100	03/08→11/12		04/08→; für Linkslenker		03.7755-3532.4	300290	ATE Ø 9 / 8" pneumatisch
2.0 TDCi 4x4	100	03/08→11/12		04/08→; für Rechtslenker		03.7760-2232.4	300266	ATE Ø 10" pneumatisch
2.0 TDCi	103	03/10→11/12		für Linkslenker		03.7755-3532.4	300290	ATE Ø 9 / 8" pneumatisch
2.0 TDCi 4x4	103 - 120	03/10→11/12		für Rechtslenker		03.7760-2232.4	300266	ATE Ø 10" pneumatisch
2.5 4x4	147	02/08→11/12		für Linkslenker		03.7755-3532.4	300290	ATE Ø 9 / 8" pneumatisch
 Hauptbremszylinder								
2.0 TDCi	100	03/08→11/12		04/08→; für Rechtslenker; → 10/08		03.2125-0483.3	010783	ATE Ø 25,4 ohne Bremsflüssigkeitsbehälter
2.0 TDCi 4x4	100	03/08→11/12		11/08→; für Linkslenker		03.2125-0651.3	010935	ATE Ø 25,4
				11/08→; für Rechtslenker		03.2125-0661.3	010917	ATE Ø 25,4
2.0 TDCi	103	03/10→11/12		für Linkslenker		03.2125-0651.3	010935	ATE Ø 25,4
2.0 TDCi 4x4	103 - 120	03/10→11/12						
2.5 4x4 →	147	02/08→11/12						













	kw			 	! #		
FORD - KUGA I 02/08→11/12							
Hydraulikaggregat, Bremsanlage							
2.0 TDCi	100	03/08→11/12		04/08→		24.9145-0004.2	399008
2.0 TDCi 4x4	100	03/08→11/12					
2.0 TDCi	103	03/10→11/12				24.9145-0004.2	399008
2.0 TDCi 4x4	103 - 120	03/10→11/12					
2.5 4x4	147	02/08→11/12					
FORD - KUGA I VAN 02/08→11/12							
 Bremskraftverstärker							
2.5	147	02/08→11/12		für Linkslenker		03.7755-3532.4	300290 ATE Ø 9 / 8" pneumatisch
TDCi	103	03/10→11/12		für Linkslenker		03.7755-3532.4	300290 ATE Ø 9 / 8" pneumatisch
TDCi 4x4	103 - 120	03/10→11/12		für Rechtslenker		03.7760-2232.4	300266 ATE Ø 10" pneumatisch
 Hauptbremszylinder							
2.5	147	02/08→11/12		für Linkslenker		03.2125-0651.3	010935 ATE Ø 25,4
TDCi	103	03/10→11/12					
TDCi 4x4	103 - 120	03/10→11/12					
Hydraulikaggregat, Bremsanlage							
2.5	147	02/08→11/12				24.9145-0004.2	399008
TDCi	103	03/10→11/12					
TDCi 4x4	103 - 120	03/10→11/12					
FORD - KUGA II (DM2) 05/12→							
 Hauptbremszylinder							
1.5 EcoBoost	88 - 134	09/14→				03.4155-5456.3	010996 ATE Ø 25,4
1.5 EcoBoost 4x4	110 - 134	09/14→					
1.6 EcoBoost	110	03/13→09/14					
1.6 EcoBoost 4x4	110 - 134	10/12→04/15					
2.0 TDCi	85 - 110	03/13→					
2.0 TDCi 4x4	100 - 132	03/13→					
2.5	110 - 125	09/13→					
1.5 EcoBoost 4x4	129	08/18→06/19		für Linkslenker		03.4155-5456.3	010996 ATE Ø 25,4
1.5 EcoBoost E85	110	02/19→11/19					
2.0 EcoBoost 4x4	169	03/19→					
2.0 4x4	179	03/13→06/16		für Linkslenker; für Fahrzeuge mit Start-Stopp-Funktion		03.4155-5456.3	010996 ATE Ø 25,4
2.0 EcoBoost 4x4	178	08/17→06/18					
FORD - KUGA II VAN 05/12→							
 Hauptbremszylinder							
1.5 EcoBoost	88	06/19→		für Linkslenker		03.4155-5456.3	010996 ATE Ø 25,4
1.5 EcoBoost 4x4	129	06/19→					
1.5 EcoBoost	110	09/14→				03.4155-5456.3	010996 ATE Ø 25,4
1.5 EcoBoost 4x4	134	09/14→					
2.0 TDCi	88 - 110	09/14→					
2.0 TDCi 4x4	110 - 132	09/14→					
FORD - MONDEO II (BAP) 08/96→09/00							
 Hauptbremszylinder							
1.6 i	66	08/96→09/00		10/96→; + ABS		24.2125-1709.3	010499 Ø 25,4
1.8 i	85	08/96→09/00					
1.8 TD	66	08/96→09/00					
2.0 i	96	08/96→09/00					
2.5 24V	125	08/96→09/00					
1.6 i 16V	70	05/98→09/00		+ ABS		24.2125-1709.3	010499 Ø 25,4
2.5 24V	125	06/00→09/00					
2.5 ST 200	151	05/99→09/00					
 Bremskraftregler							
1.6 i	66	08/96→09/00		10/96→; - ABS; Scheibenbremse		03.6043-1954.3	320226 ATE 3/30 2x
1.6 i 16V	70	05/98→09/00		- ABS; Scheibenbremse		03.6043-1954.3	320226 ATE 3/30 2x
1.8 i	85	08/96→09/00		10/96→; - ABS; Scheibenbremse		03.6043-1954.3	320226 ATE 3/30 2x
2.0 i	96	08/96→09/00		10/96→; + ABS / + ASR	2	03.6043-1956.3	320202 ATE 3/40 2x
→							















	kw					! #		
FORD - MONDEO II (BAP) 08/96→09/00								
 Bremskraftregler								
1.8 TD	66	08/96→09/00		10/96→; - ABS; Scheibenbremse			03.6043-1954.3 320226	ATE 3/30 2x
				10/96→; + ABS	2	03.6043-1956.3 320202		ATE 3/40 2x
2.5 24V	125	08/96→09/00		10/96→	2	03.6043-1956.3 320202		ATE 3/40 2x
2.5 24V	125	06/00→09/00			2	03.6043-1956.3 320202		ATE 3/40 2x
2.5 ST 200	151	05/99→09/00						
FORD - MONDEO II Stufenheck (BFP) 08/96→09/00								
 Hauptbremszylinder								
1.6 i	66	08/96→09/00		10/96→; + ABS			24.2125-1709.3 010499	Ø 25,4
1.8 i	85	08/96→09/00						
1.8 TD	66	08/96→09/00						
2.0 i	96	08/96→09/00						
2.5 24V	125	08/96→09/00						
1.6 i 16V	70	05/98→09/00		+ ABS			24.2125-1709.3 010499	Ø 25,4
2.5 24V	125	06/00→09/00						
2.5 ST 200	151	05/99→09/00						
 Bremskraftregler								
1.6 i	66	08/96→09/00		10/96→; - ABS; Scheibenbremse			03.6043-1954.3 320226	ATE 3/30 2x
1.6 i 16V	70	05/98→09/00		- ABS; Scheibenbremse			03.6043-1954.3 320226	ATE 3/30 2x
1.8 i	85	08/96→09/00		10/96→; - ABS; Scheibenbremse			03.6043-1954.3 320226	ATE 3/30 2x
2.0 i	96	08/96→09/00		10/96→; + ABS / + ASR	2	03.6043-1956.3 320202		ATE 3/40 2x
1.8 TD	66	08/96→09/00		10/96→; - ABS; Scheibenbremse			03.6043-1954.3 320226	ATE 3/30 2x
				10/96→; + ABS	2	03.6043-1956.3 320202		ATE 3/40 2x
2.5 24V	125	08/96→09/00		10/96→	2	03.6043-1956.3 320202		ATE 3/40 2x
2.5 24V	125	06/00→09/00			2	03.6043-1956.3 320202		ATE 3/40 2x
2.5 ST 200	151	05/99→09/00						
FORD - MONDEO II Turnier (BNP) 08/96→09/00								
 Hauptbremszylinder								
1.6 i	66	08/96→09/00		10/96→; + ABS			24.2125-1709.3 010499	Ø 25,4
1.8 i	85	08/96→09/00						
1.8 TD	66	08/96→09/00						
2.0 i	96	08/96→09/00						
2.5 24V	125	08/96→09/00						
1.6 i 16V	70	05/98→09/00		+ ABS			24.2125-1709.3 010499	Ø 25,4
2.5 24V	125	10/99→09/00						
2.5 ST 200	151	05/99→09/00						
 Bremskraftregler								
1.6 i	66	08/96→09/00		10/96→; - ABS	2	03.6043-1953.3 320201		ATE 3/45 2x
1.6 i 16V	70	05/98→09/00		- ABS	2	03.6043-1953.3 320201		ATE 3/45 2x
1.8 i	85	08/96→09/00		10/96→; - ABS	2	03.6043-1953.3 320201		ATE 3/45 2x
2.0 i	96	08/96→09/00		10/96→; + ABS / + ASR	2	03.6043-1956.3 320202		ATE 3/40 2x
1.8 TD	66	08/96→09/00		10/96→; - ABS	2	03.6043-1953.3 320201		ATE 3/45 2x
				10/96→; + ABS	2	03.6043-1956.3 320202		ATE 3/40 2x
2.5 24V	125	08/96→09/00		10/96→	2	03.6043-1956.3 320202		ATE 3/40 2x
2.5 24V	125	10/99→09/00			2	03.6043-1956.3 320202		ATE 3/40 2x
2.5 ST 200	151	05/99→09/00						
FORD - MONDEO III (B5Y) 10/00→03/07								
 Hauptbremszylinder								
1.8 16V	81 - 92	10/00→03/07		für Fahrzeuge ohne Bremsassistent			24.2123-1779.3 011078	Ø 23,8 ohne Bremsflüssigkeitsbehälter
1.8 SCi	96	06/03→03/07						
2.0 16V	107	10/00→03/07						
2.0 16V DI / TDDi / TDCi	66	10/00→03/07						
2.0 16V TDDi / TDCi	85	10/00→03/07						
2.0 DI	92	10/00→03/07						
2.0 TDCi	96	10/01→03/07						
2.2 TDCi	110 - 114	09/04→03/07						
2.5 V6 24V	125	10/00→03/07						
3.0 V6 24V	150	09/04→03/07						
ST220	166	04/02→03/07						
FORD - MONDEO III Stufenheck (B4Y) 10/00→09/07								
 Hauptbremszylinder								
1.8 16V	81 - 92	10/00→03/07		für Fahrzeuge ohne Bremsassistent			24.2123-1779.3 011078	Ø 23,8 ohne Bremsflüssigkeitsbehälter
→								















	kw			 	! #		
FORD - MONDEO III Stufenheck (B4Y) 10/00→09/07							
 Hauptbremszylinder							
1.8 SCi 2.0 16V 2.0 16V DI / TDDi / TDCi 2.0 16V TDDi / TDCi 2.0 TDCi 2.2 TDCi 2.5 V6 2.5 V6 24V 3.0 V6 24V ST220	96 107 66 85 96 110 - 114 125 125 150 166	06/03→03/07 10/00→03/07 10/00→03/07 10/00→03/07 10/01→03/07 09/04→03/07 10/00→03/07 10/00→03/07 09/04→03/07 04/02→03/07		für Fahrzeuge ohne Bremsassistent		24.2123-1779.3 011078	Ø 23,8 ohne Bremsflüssigkeitsbehälter
2.0 DI	92	10/00→03/07		10/01→; für Fahrzeuge ohne Bremsassistent		24.2123-1779.3 011078	Ø 23,8 ohne Bremsflüssigkeitsbehälter
FORD - MONDEO III Turnier (BWY) 10/00→03/07							
 Hauptbremszylinder							
1.8 16V 1.8 SCi 2.0 16V 2.0 16V DI / TDDi / TDCi 2.0 16V TDDi / TDCi 2.0 TDCi 2.2 TDCi 2.5 V6 24V 3.0 V6 24V ST220	81 - 92 96 107 66 85 96 110 - 114 125 150 166	10/00→03/07 06/03→03/07 10/00→03/07 10/00→03/07 10/00→03/07 10/01→03/07 09/04→03/07 10/00→03/07 09/04→03/07 04/02→03/07		für Fahrzeuge ohne Bremsassistent		24.2123-1779.3 011078	Ø 23,8 ohne Bremsflüssigkeitsbehälter
FORD - MONDEO IV (BA7) 03/07→01/15							
 Bremskraftverstärker							
1.6 EcoBoost 1.6 TDCi 1.6 Ti 1.8 TDCi 2.0 EcoBoost 2.0 Flexifuel 2.0 LPG 2.0 SCTi 2.0 TDCi 2.3 1.6 Ti 1.8 TDCi 2.0 2.0 TDCi 2.5 2.2 TDCi 2.2 TDCi	118 85 88 92 176 107 107 149 85 - 120 118 81 - 92 74 107 96 - 103 162 129 147	02/11→01/15 02/11→01/15 07/10→01/15 06/07→01/15 07/10→01/15 03/09→01/15 07/09→01/15 03/10→01/15 03/07→01/15 07/07→01/15 03/07→01/15 03/07→01/15 03/07→01/15 03/07→01/15 03/07→01/15 03/08→10/10 07/10→01/15		→ 09/14 04/07→ 09/14 04/08→ 11/10→ 09/14		03.7755-1432.4 300300 03.7755-1432.4 300300 03.7755-1432.4 300300 03.7755-1432.4 300300	ATE Ø 9 / 8" pneumatisch ATE Ø 9 / 8" pneumatisch ATE Ø 9 / 8" pneumatisch ATE Ø 9 / 8" pneumatisch
FORD - MONDEO IV Stufenheck (BA7) 03/07→01/15							
 Bremskraftverstärker							
1.6 EcoBoost 1.6 TDCi 1.6 Ti 1.8 TDCi 2.0 2.0 TDCi 2.5 1.6 Ti 1.8 TDCi 2.0 Flexifuel 2.0 LPG 2.0 SCTi 2.0 TDCi 2.3 2.0 EcoBoost 2.0 TDCi 2.2 TDCi 2.2 TDCi	118 85 81 - 92 74 107 96 - 103 162 88 92 107 107 149 85 - 120 118 176 100 129 147	11/10→01/15 12/10→01/15 03/07→01/15 03/07→01/15 03/07→01/15 03/07→01/15 03/07→01/15 03/07→01/15 03/10→01/15 06/07→01/15 03/09→01/15 07/09→01/15 03/10→01/15 11/07→01/15 07/07→01/15 03/10→09/14 08/08→12/14 03/08→10/10 10/10→01/15		02/11→ 09/14 04/07→ 09/14 → 09/14 04/08→ 11/10→ 09/14		03.7755-1432.4 300300 03.7755-1432.4 300300 03.7755-1432.4 300300 03.7755-1432.4 300300 03.7755-1432.4 300300	ATE Ø 9 / 8" pneumatisch ATE Ø 9 / 8" pneumatisch ATE Ø 9 / 8" pneumatisch ATE Ø 9 / 8" pneumatisch ATE Ø 9 / 8" pneumatisch































	kw			 	! #				
FORD - MONDEO IV Turnier (BA7) 03/07→01/15									
 Bremskraftverstärker									
1.6 EcoBoost	118	02/11→01/15		→ 09/14		03.7755-1432.4 300300	ATE Ø 9 / 8" pneumatisch		
1.6 TDCi	85	02/11→01/15							
1.6 Ti	88	07/10→01/15							
2.0 EcoBoost	176	07/10→01/15							
2.0 Flexifuel	107	03/09→01/15							
2.0 LPG	107	07/09→01/15							
2.0 SCTi	149	03/10→01/15							
2.0 TDCi	85 - 120	03/07→01/15							
2.3	118	07/07→01/15							
1.6 Ti	81 - 92	03/07→12/12		04/07→		03.7755-1432.4 300300	ATE Ø 9 / 8" pneumatisch		
1.8 TDCi	74	03/07→12/12							
2.0 TDCi	96	03/07→12/12							
2.5	162	03/07→12/12							
1.8 TDCi	92	06/07→12/12							
2.0	107	03/07→01/15		04/07→ 09/14		03.7755-1432.4 300300	ATE Ø 9 / 8" pneumatisch		
2.0 TDCi	103	03/07→01/15							
2.2 TDCi	129	03/08→10/10		04/08→		03.7755-1432.4 300300	ATE Ø 9 / 8" pneumatisch		
2.2 TDCi	147	07/10→01/15		11/10→ 09/14					
FORD - MONDEO IV Van 03/07→01/15									
 Bremskraftverstärker									
1.6 EcoBoost	118	11/10→09/14				03.7755-1432.4 300300	ATE Ø 9 / 8" pneumatisch		
1.6 TDCi	85	03/13→09/14							
2.0 EcoBoost	149 - 176	03/10→09/14							
2.0 TDCi	85 - 120	11/07→09/14							
2.2 TDCi	147	03/13→09/14							
2.0	107	03/07→09/14		04/07→				03.7755-1432.4 300300	ATE Ø 9 / 8" pneumatisch
2.0 TDCi	103	03/07→09/14							
FORD - PUMA (EC_) 03/97→06/02									
 Hauptbremszylinder									
1.4 16V	66	11/97→10/00		02/00→; + ABS		03.2123-2243.3 010748	ATE Ø 23,8		
1.6 16V	76	08/00→06/02		→ 12/01; + ABS					
1.7 16V	92	03/97→06/02		02/00→ 12/01; + ABS					
FORD - RANGER (ET) 01/05→07/12									
 Hauptbremszylinder									
2.2	68	06/07→01/09				24.2125-1747.3 011029	Ø 25,4		
2.5 TDCi 4x4	105	05/06→07/12							
3.0 TDCi 4x4	115	05/06→07/12							
2.5 TDi	105	05/06→07/12		04/10→ 10/11		24.2125-1747.3 011029	Ø 25,4		
2.5 TDi 4x4	80	06/07→07/12							
3.0 TDCi	115	05/06→07/12							
FORD - S-MAX (WA6) 05/06→12/14									
 Bremskraftverstärker									
1.6 EcoBoost	118	02/11→12/14				03.7755-1432.4 300300	ATE Ø 9 / 8" pneumatisch		
1.6 TDCi	85	02/11→12/14							
1.8 TDCi	74 - 92	05/06→12/14							
2.0	107	05/06→12/14							
2.0 EcoBoost	146 - 176	03/10→12/14							
2.0 Flexifuel	107	05/06→12/14							
2.0 TDCi	85 - 120	05/06→12/14							
2.2 TDCi	147	07/10→12/14							
2.3	118	07/07→12/14							
2.5 ST	162	05/06→12/14							
2.2 TDCi	129	03/08→12/12		04/08→				03.7755-1432.4 300300	ATE Ø 9 / 8" pneumatisch
FORD - S-MAX VAN (WA6) 05/06→12/14									
 Bremskraftverstärker									
1.6	118	02/11→12/14						03.7755-1432.4 300300	ATE Ø 9 / 8" pneumatisch
2.0	107	03/10→12/14							
2.0 EcoBoost	149 - 176	03/10→12/14							
2.0 TDCi	85 - 120	01/07→12/14							













	kw					! #		
FORD - TOURNEO CONNECT / GRAND TOURNEO CONNECT V408 Großraumlimousi 09/13→								
 Hauptbremszylinder								
1.0 EcoBoost	74	11/13→			für verkürzten Radstand		03.4155-5451.3 010995	ATE Ø 25,4
1.6 EcoBoost	110	11/13→			für verlängerten Radstand		03.4155-5456.3 010996	ATE Ø 25,4
1.6 TDCi	55 - 85	09/13→						
FORD - TOURNEO COURIER B460 Großraumlimousine 02/14→								
 Hauptbremszylinder								
1.0 EcoBoost	74	02/14→			für Linkslenker; + ABS		24.4120-1710.3 011082	Ø 20,6 ohne Bremsflüssigkeitsbehälter
1.5 TDCi	55	02/14→			für Linkslenker; - ABS		24.4120-1711.3 011093	Ø 20,6 ohne Bremsflüssigkeitsbehälter
1.5 EcoBlue	74	04/18→			+ ABS		24.4120-1710.3 011082	Ø 20,6 ohne Bremsflüssigkeitsbehälter
1.5 TDCi	70	05/15→			für Linkslenker; - ABS		24.4120-1711.3 011093	Ø 20,6 ohne Bremsflüssigkeitsbehälter
1.6 TDCi	70	02/14→			für Rechtslenker; + ABS		24.4120-1710.3 011082	Ø 20,6 ohne Bremsflüssigkeitsbehälter
					für Linkslenker; - ABS		24.4120-1711.3 011093	Ø 20,6 ohne Bremsflüssigkeitsbehälter
FORD - TRANSIT Bus (E_) 06/94→07/00								
 Hauptbremszylinder								
2.0	84	08/94→03/00			→ 03/97; - ABS		24.2123-1724.3 010566	BDX Ø 23,8
2.5 DI	51 - 56	07/94→03/00			04/97→; + ABS		24.2123-1742.3 010671	Ø 23,8
2.5 TD	63 - 74	07/94→03/00			04/97→; - ABS		24.2123-1749.3 010713	Ø 23,8
2.0 CNG	84	06/94→03/00			07/94→ 03/97; - ABS		24.2123-1724.3 010566	BDX Ø 23,8
					→ 03/97; - ABS		24.2123-1724.3 010566	BDX Ø 23,8
					04/97→; + ABS		24.2123-1742.3 010671	Ø 23,8
					04/97→; - ABS		24.2123-1749.3 010713	Ø 23,8
2.5 DI	85	08/97→03/00			+ ABS		24.2123-1742.3 010671	Ø 23,8
					- ABS		24.2123-1749.3 010713	Ø 23,8
2.5 TD	55	08/94→06/00			→ 03/97; - ABS		24.2123-1724.3 010566	BDX Ø 23,8
					04/97→ 03/00; + ABS		24.2123-1742.3 010671	Ø 23,8
					04/97→ 03/00; - ABS		24.2123-1749.3 010713	Ø 23,8
FORD - TRANSIT Bus (FD_ , FB_ , FS_ , FZ_ , FC_) 04/06→12/14								
 Hauptbremszylinder								
2.2 TDCi	63	04/06→08/14			05/06→; + ABS		24.4125-1708.3 011055	Ø 25,4 ohne Bremsflüssigkeitsbehälter
2.2 TDCi	74 - 103	04/06→08/14			+ ABS		24.4125-1708.3 011055	Ø 25,4 ohne Bremsflüssigkeitsbehälter
2.2 TDCi RWD	74 - 100	09/11→12/14						
2.4 TDCi	74 - 103	04/06→08/14						
2.4 TDCi 4x4	103	11/06→08/14						
3.2 TDCi	147	02/08→08/14						
FORD - TRANSIT Bus (FD_ , FB_ , FS_ , FZ_ , FC_) 01/00→05/06								
 Hauptbremszylinder								
2.0 DI	55 - 74	08/00→05/06			- ABS		24.2125-1721.3 010673	Ø 25,4 ohne Bremsflüssigkeitsbehälter
2.0 TDCi	92	08/02→05/06			+ ABS		24.2125-1722.3 010674	Ø 25,4 ohne Bremsflüssigkeitsbehälter
2.3 16V RWD	107	08/00→05/06						
2.4 DI	66	01/00→05/06						
2.4 DI RWD	55 - 88	01/00→05/06						
2.4 TDCi	101	03/04→05/06						
2.4 TDE	85 - 92	07/01→05/06						
FORD - TRANSIT CONNECT Großraumlimousine 02/13→								
 Hauptbremszylinder								
1.6 TDCi	55 - 85	02/13→			für verkürzten Radstand		03.4155-5451.3 010995	ATE Ø 25,4
					für verlängerten Radstand		03.4155-5456.3 010996	ATE Ø 25,4













	kw					! #		
FORD - TRANSIT CONNECT V408 Kasten/Großraumlimousine 02/13→								
 Hauptbremszylinder								
1.0 EcoBoost	74	02/13→		09/13→; für verkürzten Radstand		03.4155-5451.3	010995	ATE Ø 25,4
				09/13→; für verlängerten Radstand		03.4155-5456.3	010996	ATE Ø 25,4
1.6 EcoBoost	110	11/13→		für verkürzten Radstand		03.4155-5451.3	010995	ATE Ø 25,4
1.6 TDCi	55 - 85	02/13→		für verlängerten Radstand		03.4155-5456.3	010996	ATE Ø 25,4
FORD - TRANSIT COURIER B460 Großraumlimousine 02/14→								
 Hauptbremszylinder								
1.0 EcoBoost	74	02/14→		+ ABS		24.4120-1710.3	011082	Ø 20,6 ohne Bremsflüssigkeitsbehälter
1.5 EcoBlue	74	04/18→						
1.5 TDCi	55 - 70	02/14→		für Linkslenker; - ABS		24.4120-1711.3	011093	Ø 20,6 ohne Bremsflüssigkeitsbehälter
1.6 TDCi	70	02/14→						
FORD - TRANSIT COURIER B460 Kasten/Großraumlimousine 02/14→								
 Hauptbremszylinder								
1.0 EcoBoost	74	02/14→		+ ABS		24.4120-1710.3	011082	Ø 20,6 ohne Bremsflüssigkeitsbehälter
1.5 EcoBlue	74	04/18→						
1.5 TDCi	55 - 70	02/14→		für Linkslenker; - ABS		24.4120-1711.3	011093	Ø 20,6 ohne Bremsflüssigkeitsbehälter
1.6 TDCi	70	02/14→						
FORD - TRANSIT Kasten (E_ _) 06/94→12/00								
 Hauptbremszylinder								
2.0	84	06/94→03/00		→ 03/97; - ABS		24.2123-1724.3	010566	BDX Ø 23,8
2.5 DI	51 - 56	06/94→03/00		04/97→; + ABS		24.2123-1742.3	010671	Ø 23,8
2.5 TD	63	06/94→03/00		04/97→; - ABS		24.2123-1749.3	010713	Ø 23,8
2.5 TDI	74	06/94→03/00						
2.5 DI	85	05/99→03/00		+ ABS		24.2123-1742.3	010671	Ø 23,8
2.5 TD	55	06/94→03/00		- ABS		24.2123-1749.3	010713	Ø 23,8
FORD - TRANSIT Kasten (FA_ _) 01/00→05/06								
 Hauptbremszylinder								
2.0 DI	55 - 74	08/00→05/06		- ABS		24.2125-1721.3	010673	Ø 25,4 ohne Bremsflüssigkeitsbehälter
2.0 TDCi	92	08/02→05/06						
2.3	105	03/01→03/06		+ ABS		24.2125-1722.3	010674	Ø 25,4 ohne Bremsflüssigkeitsbehälter
2.3 16V RWD	107	04/01→05/06						
2.3 BiFuel	105	03/01→03/06						
2.4 DI	66	01/00→05/06						
2.4 DI RWD	55 - 88	01/00→05/06						
2.4 TD	55	08/00→08/03						
2.4 TDCi	101	03/04→05/06						
2.4 TDE	85 - 92	07/01→05/06						
FORD - TRANSIT Kasten (FA_ _) 04/06→12/14								
 Hauptbremszylinder								
2.2 TDCi	63 - 103	04/06→08/14		+ ABS		24.4125-1708.3	011055	Ø 25,4 ohne Bremsflüssigkeitsbehälter
2.2 TDCi 4x4	92	10/11→08/14						
2.2 TDCi RWD	74 - 114	09/11→12/14						
2.3 16V CNG RWD	100	04/06→08/14						
2.3 16V LPG RWD	107	04/06→08/14						
2.3 16V RWD	107	04/06→08/14						
2.4 TDCi 4x4	103	11/06→08/14						
2.4 TDCi RWD	74 - 103	04/06→08/14						
3.2 TDCi RWD	147	09/07→08/14						
FORD - TRANSIT Pritsche/Fahrgestell (E_ _) 08/94→07/00								
 Hauptbremszylinder								
2.0	84	08/94→03/00		→ 03/97; - ABS		24.2123-1724.3	010566	BDX Ø 23,8
2.5 DI	51 - 56	08/94→03/00		04/97→; + ABS		24.2123-1742.3	010671	Ø 23,8
2.5 TD	63 - 74	08/94→03/00		04/97→; - ABS		24.2123-1749.3	010713	Ø 23,8
2.5 DI	85	05/99→03/00		+ ABS		24.2123-1742.3	010671	Ø 23,8
				- ABS		24.2123-1749.3	010713	Ø 23,8















	kW			 	! #		
FORD - TRANSIT Pritsche/Fahrgestell (FM_-, FN_-, FF_-) 04/06→12/14							
 Hauptbremszylinder							
2.2 TDCi	63 - 103	04/06→08/14		+ ABS		24.4125-1708.3 011055	Ø 25,4 ohne Bremsflüssigkeitsbehälter
2.2 TDCi 4x4	92	10/11→08/14					
2.2 TDCi RWD	74 - 114	10/11→08/14					
2.3 16V CNG RWD	100	04/06→08/14					
2.3 16V LPG RWD	107	04/06→08/14					
2.3 16V RWD	107	04/06→08/14					
2.4 TDCi 4x4	103	11/06→08/14					
2.4 TDCi RWD	74 - 103	04/06→08/14					
3.2 TDCi RWD	147	09/07→08/14					
FORD - TRANSIT Pritsche/Fahrgestell (FM_-, FN_-) 01/00→05/06							
 Hauptbremszylinder							
2.0 DI	55 - 74	08/00→05/06		- ABS		24.2125-1721.3 010673	Ø 25,4 ohne Bremsflüssigkeitsbehälter
2.0 TDCi	92	08/02→05/06					
2.3 16V	107	04/01→05/06		+ ABS		24.2125-1722.3 010674	Ø 25,4 ohne Bremsflüssigkeitsbehälter
2.3 BiFuel	105	03/01→03/06					
2.4 DI	55 - 88	01/00→05/06					
2.4 TDCi	101	03/04→05/06					
2.4 TDE	85 - 92	07/01→05/06					
FORD - TRANSIT TOURNEO Bus 08/94→12/00							
 Hauptbremszylinder							
2.0	84	11/94→12/00		09/95→ 03/97; - ABS		24.2123-1724.3 010566	BDX Ø 23,8
				04/97→ 03/00; + ABS		24.2123-1742.3 010671	Ø 23,8
				04/97→ 03/00; - ABS		24.2123-1749.3 010713	Ø 23,8
2.4 D 2.5 DI	55 - 51 - 56	08/94→06/00 11/94→12/00		→ 03/97; - ABS		24.2123-1724.3 010566	BDX Ø 23,8
				04/97→ 03/00; + ABS		24.2123-1742.3 010671	Ø 23,8
				04/97→ 03/00; - ABS		24.2123-1749.3 010713	Ø 23,8
2.5 TD	63	11/94→12/00		01/95→ 03/97; - ABS		24.2123-1724.3 010566	BDX Ø 23,8
				04/97→ 03/00; + ABS		24.2123-1742.3 010671	Ø 23,8
				04/97→ 03/00; - ABS		24.2123-1749.3 010713	Ø 23,8
2.5 TD	74	04/98→12/00		→ 03/00; + ABS		24.2123-1742.3 010671	Ø 23,8
				→ 03/00; - ABS		24.2123-1749.3 010713	Ø 23,8
FORD - TRANSIT TOURNEO Bus 07/06→08/14							
 Hauptbremszylinder							
2.2 2.2 TDCi	92 81 - 103	10/11→08/14 07/06→08/14		+ ABS		24.4125-1708.3 011055	Ø 25,4 ohne Bremsflüssigkeitsbehälter
FORD - TRANSIT TOURNEO Bus (FC_-) 06/00→03/06							
 Hauptbremszylinder							
2.0	55 - 92	06/00→03/06		- ABS		24.2125-1721.3 010673	Ø 25,4 ohne Bremsflüssigkeitsbehälter
				+ ABS		24.2125-1722.3 010674	Ø 25,4 ohne Bremsflüssigkeitsbehälter
FSO - 126P 07/72→09/00							
 Hauptbremszylinder							
650	18	07/81→09/00		→ 07/90		24.2119-0815.3 010347	Ø 19
HONDA - ACCORD VII (CL, CN) 01/03→09/12							
 Hauptbremszylinder							
2.0 2.4	110 113	01/06→03/08 09/06→05/08		für Linkslenker		24.2120-1752.3 010928	ATE Ø 20,6 mit Bremsflüssigkeitsbehälter
2.0 2.4 2.4 i 16V	114 140 115	02/03→05/08 02/03→05/08 02/03→05/08		01/06→; für Linkslenker		24.2120-1752.3 010928	ATE Ø 20,6 mit Bremsflüssigkeitsbehälter
2.0 All-wheel Drive 2.2 i-CTDi	114 103	02/03→05/08 01/04→05/08		01/06→		24.2120-1752.3 010928	ATE Ø 20,6 mit Bremsflüssigkeitsbehälter













	kw					! #		
HONDA - ACCORD VII Tourer (CM, CN) 04/03→05/08								
 Hauptbremszylinder								
2.0 2.2 i-CTDi 2.4 2.4 Vtec T	114 103 140 147	04/03→05/08 01/04→05/08 04/03→05/08 09/03→05/08		01/06→			24.2120-1752.3 010928	ATE Ø 20,6 mit Bremsflüssigkeitsbehälter
HONDA - CIVIC VI Coupe (EJ, EM1) 03/96→12/00								
 Hauptbremszylinder								
1.6 1.6 i	79 77	05/96→04/99 03/96→03/00		→ 12/98; - ABS			24.2120-1751.3 010909	Ø 20,6
HONDA - CIVIC VI Hatchback (EJ, EK) 10/95→03/01								
 Hauptbremszylinder								
1.4 i 1.4 i S 1.4 LPG	55 66 66	11/95→02/01 11/95→02/01 01/97→02/01		→ 01/01; - ABS; für Linkslenker			24.2120-1751.3 010909	Ø 20,6
HONDA - CIVIC VI Stufenheck (EJ, EK, SO) 06/95→03/01								
 Hauptbremszylinder								
1.4 1.4 i	55 66	11/95→10/98 11/95→02/01		- ABS; für Linkslenker → 01/01; - ABS; für Linkslenker			24.2120-1751.3 010909	Ø 20,6
HONDA - CIVIC VIII Hatchback (FN, FK) 09/05→								
 Hauptbremszylinder								
1.4 1.8 2.2 CTDi Type R	61 103 103 148	09/05→ 09/05→ 09/05→ 09/06→		für Linkslenker			24.2120-1759.3 011083	Ø 20,6 ohne Bremsflüssigkeitsbehälter
HYUNDAI - ATOS (MX) 01/97→								
 Hauptbremszylinder								
1.1 1.1 1.1	43 45 46	08/03→12/08 06/03→12/10 08/03→12/08		→ 08/08; + ABS → 01/07; + ABS; für Linkslenker 03/04→ 02/08; + ABS			24.2120-1767.3 011004	Ø 20,6 ohne Bremsflüssigkeitsbehälter
HYUNDAI - GETZ (TB) 06/01→01/11								
 Hauptbremszylinder								
1.1 1.6 1.1 1.4 i 1.5 CRDi 1.5 CRDi GLS 1.3 1.5 i 1.3 i 1.5 CRDi 1.5 CRDi GLS 1.6	46 77 49 71 65 81 61 - 63 73 60 60 75 78	09/02→09/05 09/02→09/05 09/05→06/09 08/05→12/10 08/05→06/09 08/05→06/09 09/03→06/09 03/03→09/05 09/02→03/04 03/03→09/05 07/04→08/05 06/05→06/09		→ 07/05; - ABS → 07/05; + ABS → 02/09; - ESP → 04/05; - ABS → 04/05; + ABS - ABS + ABS → 04/05; - ESP → 07/05; - ESP 08/05→; - ESP			24.2122-1761.3 010822 24.2122-1765.3 010839 24.2122-1765.3 010839 24.2122-1761.3 010822 24.2122-1765.3 010839 24.2122-1761.3 010822 24.2122-1765.3 010839 24.2122-1765.3 010839 24.2122-1765.3 010839 24.2122-1765.3 010839	Ø 22,2 Ø 22,2 Ø 22,2 Ø 22,2 Ø 22,2 Ø 22,2 Ø 22,2 Ø 22,2 Ø 22,2
HYUNDAI - i10 I (PA) 10/07→								
 Hauptbremszylinder								
1.2	64	12/15→		für Linkslenker			24.4120-1713.3 011102	Ø 20,6 ohne Bremsflüssigkeitsbehälter
HYUNDAI - i10 II (BA, IA) 08/13→								
 Hauptbremszylinder								
1.0 1.0 LPG 1.2	49 51 64	08/13→ 02/14→ 12/13→		12/13→; für Linkslenker für Linkslenker			24.4120-1713.3 011102	Ø 20,6 ohne Bremsflüssigkeitsbehälter Ø 20,6 ohne Bremsflüssigkeitsbehälter













	kw			 	! #		
HYUNDAI - i10 II Stufenheck 12/13→							
 Hauptbremszylinder							
1.2	64	08/15→		für Linkslenker		24.4120-1713.3 011102	Ø 20,6 ohne Bremsflüssigkeitsbehälter
HYUNDAI - i30 (GD) 06/11→							
 Hauptbremszylinder							
1.4	73 - 74	12/11→12/16		für Linkslenker; + ABS / - ESP		24.4122-1724.3 011080	ATE Ø 22,2 ohne Bremsflüssigkeitsbehälter
1.4 CRDi 1.4 LPG	66 73	12/11→12/16 01/13→		für Rechtslenker; + ABS / - ESP		24.4122-1724.3 011080	ATE Ø 22,2 ohne Bremsflüssigkeitsbehälter
1.6	88 - 96	12/11→		für Linkslenker; + ABS / + ESP		24.4122-1732.3 011107	Ø 22,2 ohne Bremsflüssigkeitsbehälter
1.6 CRDi	94 - 100	11/11→12/16					
1.6 GDI 1.6 T-GDI 1.8	99 137 110	12/11→12/16 01/15→ 01/12→					
1.6 CRDi	81	12/11→12/16		06/12→; für Linkslenker; + ABS / - ESP		24.4122-1724.3 011080	ATE Ø 22,2 ohne Bremsflüssigkeitsbehälter
				für Rechtslenker; + ABS / - ESP		24.4122-1724.3 011080	ATE Ø 22,2 ohne Bremsflüssigkeitsbehälter
				06/12→; für Linkslenker; + ABS / + ESP		24.4122-1732.3 011107	Ø 22,2 ohne Bremsflüssigkeitsbehälter
HYUNDAI - i30 Coupe 05/13→							
 Hauptbremszylinder							
1.4	73 - 74	05/13→		für Linkslenker; + ABS / - ESP		24.4122-1724.3 011080	ATE Ø 22,2 ohne Bremsflüssigkeitsbehälter
1.6 CRDi	81 - 100	12/14→		für Rechtslenker; + ABS / - ESP		24.4122-1724.3 011080	ATE Ø 22,2 ohne Bremsflüssigkeitsbehälter
1.6 GDI 1.6 T-GDI	99 137	05/13→ 01/15→		für Linkslenker; + ABS / + ESP		24.4122-1732.3 011107	Ø 22,2 ohne Bremsflüssigkeitsbehälter
1.4 CRDi	66	05/13→		für Linkslenker; - ESP		24.4122-1724.3 011080	ATE Ø 22,2 ohne Bremsflüssigkeitsbehälter
				für Rechtslenker; - ESP		24.4122-1724.3 011080	ATE Ø 22,2 ohne Bremsflüssigkeitsbehälter
				für Linkslenker; + ESP		24.4122-1732.3 011107	Ø 22,2 ohne Bremsflüssigkeitsbehälter
HYUNDAI - i30 Hatchback Van (GDE) 06/12→							
 Hauptbremszylinder							
1.4 MPI 1.6 CRDi 1.6 GDI	74 81 99	05/15→ 05/15→ 05/15→		für Linkslenker; + ABS / - ESP		24.4122-1724.3 011080	ATE Ø 22,2 ohne Bremsflüssigkeitsbehälter
				für Rechtslenker; + ABS / - ESP		24.4122-1724.3 011080	ATE Ø 22,2 ohne Bremsflüssigkeitsbehälter
				für Linkslenker; + ABS / + ESP		24.4122-1732.3 011107	Ø 22,2 ohne Bremsflüssigkeitsbehälter
HYUNDAI - i30 Kombi (GD) 06/12→							
 Hauptbremszylinder							
1.4	73 - 74	06/12→		für Linkslenker; - ESP		24.4122-1724.3 011080	ATE Ø 22,2 ohne Bremsflüssigkeitsbehälter
1.4 CRDi 1.6	66 88 - 95	06/12→ 06/12→		für Rechtslenker; - ESP		24.4122-1724.3 011080	ATE Ø 22,2 ohne Bremsflüssigkeitsbehälter
1.6 CRDi 1.6 GDI	81 - 100 99	06/12→ 06/12→		für Linkslenker; + ESP		24.4122-1732.3 011107	Ø 22,2 ohne Bremsflüssigkeitsbehälter
HYUNDAI - i30 Kombi Van (GDE, GD) 06/12→							
 Hauptbremszylinder							
1.4 MPI	74	05/15→		für Linkslenker; - ESP		24.4122-1724.3 011080	ATE Ø 22,2 ohne Bremsflüssigkeitsbehälter
				für Rechtslenker; - ESP		24.4122-1724.3 011080	ATE Ø 22,2 ohne Bremsflüssigkeitsbehälter
				für Linkslenker; + ESP		24.4122-1732.3 011107	Ø 22,2 ohne Bremsflüssigkeitsbehälter
1.6 CRDi 1.6 GDI	81 99	05/15→ 05/15→		für Linkslenker; für Fahrzeuge ohne Start-Stopp-Funktion		24.4122-1724.3 011080	ATE Ø 22,2 ohne Bremsflüssigkeitsbehälter
				für Linkslenker; für Fahrzeuge mit Start-Stopp-Funktion		24.4122-1732.3 011107	Ø 22,2 ohne Bremsflüssigkeitsbehälter













	kw			 	! #		
HYUNDAI - i40 I (VF) 03/12→05/19							
 Hauptbremszylinder							
1.6 CRDi	85 - 100	07/18→05/19		für Linkslenker		24.4123-1737.3 011119	Ø 23,8 ohne Bremsflüssigkeitsbehälter
1.6 GDI	99	03/12→05/19					
1.7 CRDi	85 - 100	03/12→05/19					
1.7 CRDi	103 - 104	10/12→05/19					
2.0 GDi	121	12/14→05/19					
2.0 GDI	130 - 131	03/12→05/19					
2.0 CVVT	110 - 130	03/12→05/19		für Linkslenker; - RU		24.4123-1737.3 011119	Ø 23,8 ohne Bremsflüssigkeitsbehälter
HYUNDAI - i40 I CW (VF) 07/11→05/19							
 Hauptbremszylinder							
1.6 CRDi	85 - 100	07/18→05/19		für Linkslenker		24.4123-1737.3 011119	Ø 23,8 ohne Bremsflüssigkeitsbehälter
1.6 GDI	99	07/11→05/19					
1.7 CRDi	85 - 104	07/11→05/19					
2.0 CVVT	121 - 130	07/11→05/19					
2.0 GDi	121	12/14→05/19					
2.0 GDI	130	07/11→05/19					
2.0 CVVT	110	10/12→05/19		für Linkslenker; - RU		24.4123-1737.3 011119	Ø 23,8 ohne Bremsflüssigkeitsbehälter
HYUNDAI - i40 I Kombi Van (VF) 07/11→05/19							
 Hauptbremszylinder							
1.7 CRDi	85	05/15→05/19		für Linkslenker		24.4123-1737.3 011119	Ø 23,8 ohne Bremsflüssigkeitsbehälter
HYUNDAI - ix20 (JC) 11/10→07/19							
 Hauptbremszylinder							
1.4	66	11/10→07/19		+ ESP		24.4122-1725.3 011087	Ø 22,2 ohne Bremsflüssigkeitsbehälter
1.4 CRDi	57 - 66	11/10→07/19					
1.4 LPG	66	11/10→07/19					
1.6	92	11/10→07/19					
1.6 CRDi	85 - 94	06/11→07/19					
1.6 LPG	92	11/10→07/19					
1.4	74	11/10→07/19		für Linkslenker; + ESP		24.4122-1725.3 011087	Ø 22,2 ohne Bremsflüssigkeitsbehälter
HYUNDAI - ix35 (LM, EL, ELH) 08/09→							
 Hauptbremszylinder							
1.6	99	11/10→		für Linkslenker; + ESP		24.4122-1723.3 011086	Ø 22,2 ohne Bremsflüssigkeitsbehälter
1.7 CRDi	85	11/10→					
2.0	113 - 122	01/10→					
2.0 4WD	113 - 120	01/10→					
2.0 CRDi	100 - 135	01/10→					
2.0 CRDi 4WD	100 - 135	01/10→					
2.0 CVVT	110	08/09→12/15					
2.0 CVVT 4WD	110 - 122	08/09→					
2.0 CVVT AWD	110	08/09→07/13					
2.0 GDi	122	08/13→					
2.0 GDi 4WD	122	08/13→12/15					
2.4 DCVVT-I 4WD	128	07/10→12/13					
2.4 4WD	129 - 130	01/10→		für Linkslenker; für Fahrzeuge mit Bremsassistent		24.4122-1723.3 011086	Ø 22,2 ohne Bremsflüssigkeitsbehälter
HYUNDAI - ix35 Van 08/09→12/15							
 Hauptbremszylinder							
CRDi	85 - 100	08/09→12/15		für Linkslenker; + ESP		24.4122-1723.3 011086	Ø 22,2 ohne Bremsflüssigkeitsbehälter
CRDi 4WD	100	08/09→12/15					
GDi	99	05/15→12/15					

















	kw					! #		
HYUNDAI - MATRIX (FC) 06/01→08/10								
 Hauptbremszylinder								
1.5 CRDi 1.6	60 66 - 76	10/01→08/10 06/01→08/10		→ 07/03; - ABS			24.2123-1762.3 010823	Ø 23,8
1.8	90	06/01→08/10		→ 07/03			24.2123-1762.3 010823	Ø 23,8
HYUNDAI - TUCSON (TL, TLE) 05/15→12/20								
 Hauptbremszylinder								
1.6 GDi	96 - 97	06/15→09/20		für Linkslenker; - ESP			24.4122-1724.3 011080	ATE Ø 22,2 ohne Bremsflüssigkeitsbehälter
1.6 T-GDi 1.6 T-GDi All-wheel Drive 1.7 CRDi	130 130 85 - 104	06/15→09/20 06/15→09/20 06/15→09/20		für Linkslenker; + ESP			24.4122-1732.3 011107	Ø 22,2 ohne Bremsflüssigkeitsbehälter
2.0	115	06/15→09/20						
2.0 CRDi 2.0 CRDi All-wheel Drive	100 100 - 136	06/15→09/20 06/15→09/20		für Linkslenker; Fahrzeugproduktionsland Tschechische Republik; - ESP			24.4122-1724.3 011080	ATE Ø 22,2 ohne Bremsflüssigkeitsbehälter
				für Linkslenker; Fahrzeugproduktionsland Tschechische Republik; + ESP			24.4122-1732.3 011107	Ø 22,2 ohne Bremsflüssigkeitsbehälter
2.0 CVVT All-wheel Drive	110	06/15→09/20		- ESP			24.4122-1724.3 011080	ATE Ø 22,2 ohne Bremsflüssigkeitsbehälter
				+ ESP			24.4122-1732.3 011107	Ø 22,2 ohne Bremsflüssigkeitsbehälter
HYUNDAI - VELOSTER (FS) 03/11→12/17								
 Hauptbremszylinder								
1.6 1.6 GDi 1.6 GDi 1.6 MPI 1.6 T-GDi	94 95 103 97 137 - 150	06/11→12/17 10/11→12/17 03/11→12/17 04/11→12/17 08/12→12/17		für Linkslenker; + ESP			24.4122-1732.3 011107	Ø 22,2 ohne Bremsflüssigkeitsbehälter
JAGUAR - S-TYPE II (X200) 10/98→12/08								
Pedalwegsensor, Bremspedal								
2.5 V6 4.2 V8 2.7 D	147 219 152	04/02→10/07 04/02→10/07 06/04→10/07		02/03→			03.0655-0007.2 370007	ATE
3.0 V6	175	01/99→10/07		05/03→			03.0655-0007.2 370007	ATE
4.2 Supercharged R 4 2 V8	298 291 291	11/01→12/08 04/02→10/07 04/02→10/07		08/03→			03.0655-0007.2 370007	ATE
 Hauptbremszylinder								
2.5 V6 2.7 D 3.0 V6 4.0 V8	147 152 175 203 - 209	04/02→10/07 06/04→10/07 01/99→10/07 01/99→12/02		M45255→ N52047; für Linkslenker; + ESP			03.4125-0032.3 010955	ATE Ø 25,4
4.2 Supercharged 4.2 V8 R 4 2 V8	298 219 291 291	11/01→12/08 04/02→10/07 04/02→10/07 04/02→10/07		N52048→; für Linkslenker; + ESP			03.4156-0051.3 011011	ATE Ø 27 ohne Bremsflüssigkeitsbehälter
JAGUAR - XF I (X250) 03/08→04/15								
 Bremskraftverstärker								
2.0 2.2 D 2.7 D 3.0 3.0 AWD 3.0 D 4.2 4.2 Kompressor 5.0	177 120 - 147 152 250 250 155 - 202 219 306 283	06/12→04/15 04/11→04/15 03/08→04/15 03/12→04/15 10/12→04/15 03/09→04/15 03/08→04/15 03/08→04/15 03/08→04/15 03/09→04/15					03.7745-6502.4 300296	ATE Ø 8" pneumatisch
 Hauptbremszylinder								
2.0 2.2 D 2.7 D 3.0	177 120 - 147 152 175 - 250	06/12→04/15 04/11→04/15 03/08→04/15 03/08→04/15		für Linkslenker			24.4156-1016.3 011068	ATE Ø 27



















	kw					! #		
JAGUAR - XF I (X250) 03/08→04/15								
 Hauptbremszylinder								
3.0 AWD 3.0 D	250 155 - 202	10/12→04/15 03/09→04/15		für Linkslenker			24.4156-1016.3 011068	ATE Ø 27
4.2 4.2 Kompressor 5.0 5.0 Kompressor 5.0 XFR-S	219 306 283 346 - 375 405	03/08→04/15 03/08→04/15 03/09→04/15 01/09→04/15 10/12→04/15						
JAGUAR - XF SPORTBRAKE (X250) 09/12→12/15								
 Bremskraftverstärker								
2.0 T 2.2 D	177 120 - 147	08/13→12/15 09/12→04/14					03.7745-6502.4 300296	ATE Ø 8" pneumatisch
 Hauptbremszylinder								
2.0 T 2.2 D 3.0 D	177 120 - 147 177 - 202	08/13→12/15 09/12→04/14 09/12→04/14		für Linkslenker			24.4156-1016.3 011068	ATE Ø 27
5.0 XFR-S	405	02/13→04/14		02/14→; für Linkslenker			24.4156-1016.3 011068	ATE Ø 27
JAGUAR - XJ (X350, X358) 03/03→03/09								
Pedalwegsensor, Bremspedal								
3.0	175 - 179	05/03→03/09		für Rechtslenker			03.0655-0007.2 370007	ATE
3.6 4.2	190 219	05/03→03/09 05/03→03/09					03.0655-0007.2 370007	ATE
R 4.2	291	03/03→03/09		05/03→			03.0655-0007.2 370007	ATE
 Hauptbremszylinder								
3.0 3.6 4.2	175 - 179 190 219	05/03→03/09 05/03→03/09 05/03→03/09		für Linkslenker			03.4125-0032.3 010955	ATE Ø 25,4
D 2.7	152	10/05→03/09		→ G49700; für Linkslenker			03.4125-0032.3 010955	ATE Ø 25,4
				H17287→; für Linkslenker			03.4156-0051.3 011011	ATE Ø 27 ohne Bremsflüssigkeitsbehälter
				G49701→ H17286; für Linkslenker			03.4156-0051.3 011011	ATE Ø 27 ohne Bremsflüssigkeitsbehälter
R 4.2	291	03/03→03/09		05/03→; für Linkslenker			03.4125-0032.3 010955	ATE Ø 25,4
JAGUAR - XJ (X351) 10/09→								
 Hauptbremszylinder								
2.0 T4 3.0 SCV6 3.0 SCV6 AWD 3.0 SDV6	177 250 250 202 - 221	05/12→ 03/12→ 10/12→ 10/09→		für Linkslenker			24.4156-1076.3 011070	ATE Ø 27 ohne Bremsflüssigkeitsbehälter
3.0 V6 5.0 SCV8 5.0 V8	175 346 - 405 283	01/11→ 10/09→ 10/09→						
JAGUAR - XK II Cabriolet (X150) 03/06→07/14								
 Hauptbremszylinder								
3.6 4.2 XK8 4.2 XKR	190 219 306 - 313	10/07→07/14 03/06→07/14 03/06→07/14		B13391→; für Linkslenker			03.4156-0051.3 011011	ATE Ø 27 ohne Bremsflüssigkeitsbehälter
5.0 V8 5.0 XKR	283 375	01/09→07/14 01/09→07/14		→ B13390; für Linkslenker			03.4156-0051.3 011011	ATE Ø 27 ohne Bremsflüssigkeitsbehälter
4.2	291	09/07→12/09		für Linkslenker			03.4156-0051.3 011011	ATE Ø 27 ohne Bremsflüssigkeitsbehälter
5.0 XKR-S	405	01/11→07/14		B13391→; für Linkslenker			03.4156-0051.3 011011	ATE Ø 27 ohne Bremsflüssigkeitsbehälter
JAGUAR - XK II Coupe (X150) 03/06→12/14								
 Hauptbremszylinder								
3.6 4.2 XK8	190 219	07/07→07/14 03/06→07/14		B13391→; für Linkslenker			03.4156-0051.3 011011	ATE Ø 27 ohne Bremsflüssigkeitsbehälter
→								



















	kw					! #		
JAGUAR - XK II Coupe (X150) 03/06→12/14								
 Hauptbremszylinder								
4.2 XKR	291 - 313	03/06→07/14			→ B13390; für Linkslenker		03.4156-0051.3 011011	ATE Ø 27 ohne Bremsflüssigkeitsbehälter
5.0 V8	283	01/09→07/14						
5.0 XKR	375 - 390	01/09→07/14						
5.0 XKR-S	405	01/11→07/14			B13391→; für Linkslenker		03.4156-0051.3 011011	ATE Ø 27 ohne Bremsflüssigkeitsbehälter
JAGUAR - XK 8 Convertible (X100) 03/96→12/06								
Pedalwegsensord, Bremspedal								
4.2	219	08/02→12/06			→ 07/05		03.0655-0007.2 370007	ATE
R 4.2	291	08/02→12/06						
JAGUAR - XK 8 Coupe (X100) 03/96→12/06								
Pedalwegsensord, Bremspedal								
4.2	219	08/02→07/05					03.0655-0007.2 370007	ATE
R 4.2	291	08/02→07/05						
JEEP - COMPASS (MP, M6, MV, M7) 01/16→								
 Hauptbremszylinder								
1.6 Multijet	96	04/21→					24.4123-1731.3 011094	Ø 23,8 ohne Bremsflüssigkeitsbehälter
JEEP - RENEGADE SUV (BU, B1, BV) 07/14→								
 Hauptbremszylinder								
1.0 T-GDi	88	08/18→			für Rechtslenker		24.4123-1731.3 011094	Ø 23,8 ohne Bremsflüssigkeitsbehälter
1.3 T-GDi	110	08/18→						
1.3 T-GDi 4x4	132	08/18→						
1.4	100 - 103	07/14→						
1.4 4x4	125	07/14→						
1.4 LPG	88	01/16→						
1.6	81	07/14→09/18						
1.6 CRD	70 - 88	07/14→						
1.6 MultiJet	96	02/20→						
2.0 CRD 4x4	88 - 125	07/14→						
JEEP - RENEGADE VAN (BU, B1) 07/14→								
 Hauptbremszylinder								
1.4	103	07/14→			für Rechtslenker		24.4123-1731.3 011094	Ø 23,8 ohne Bremsflüssigkeitsbehälter
1.4 4x4	125	07/14→						
1.6 E-torQ	81	07/14→09/18						
1.6 MultiJet	88	07/14→						
2.0 MultiJet 4x4	103 - 125	07/14→						
KIA - CEE'D (JD) 05/12→07/18								
 Hauptbremszylinder								
1.0 T-GDI	74 - 88	07/15→07/18			für Linkslenker		24.4122-1732.3 011107	Ø 22,2 ohne Bremsflüssigkeitsbehälter
1.4 MPI	74	04/15→07/18						
1.6 CRDi 136	100	07/15→07/18						
1.4 CRDi 90	66	05/12→07/18			für Linkslenker; für Fahrzeuge mit Start-Stopp-Funktion; - ESP		24.4122-1724.3 011080	ATE Ø 22,2 ohne Bremsflüssigkeitsbehälter
1.4 CVVT	66 - 73	05/12→07/18						
1.4 LPG	72	05/12→07/18			für Rechtslenker; - ESP		24.4122-1724.3 011080	ATE Ø 22,2 ohne Bremsflüssigkeitsbehälter
1.6 CRDi 110	81	05/12→07/18						
1.6 CRDi 128	94	05/12→07/18			für Linkslenker; + ESP		24.4122-1732.3 011107	Ø 22,2 ohne Bremsflüssigkeitsbehälter
1.6 GDI	99	05/12→07/18						
1.6 CVVT	95	01/13→07/18			01/14→; für Linkslenker; + ESP		24.4122-1732.3 011107	Ø 22,2 ohne Bremsflüssigkeitsbehälter
1.6 CVVT	96	11/14→07/18			für Linkslenker; + ESP		24.4122-1732.3 011107	Ø 22,2 ohne Bremsflüssigkeitsbehälter
1.6 GT	150	06/13→07/18			07/13→; für Linkslenker; für Fahrzeuge ohne Start-Stopp-Funktion		24.4122-1724.3 011080	ATE Ø 22,2 ohne Bremsflüssigkeitsbehälter
					07/13→; für Rechtslenker; - ESP		24.4122-1724.3 011080	ATE Ø 22,2 ohne Bremsflüssigkeitsbehälter
					07/13→; für Linkslenker; für Fahrzeuge mit Start-Stopp-Funktion		24.4122-1732.3 011107	Ø 22,2 ohne Bremsflüssigkeitsbehälter















	kw			 	! #		
KIA - CEE'D Combi Van (JD) 07/12→07/18							
 Hauptbremszylinder							
1.0 T-GDI	74 - 88	04/15→07/18		für Linkslenker; - ESP		24.4122-1724.3 011080	ATE Ø 22,2 ohne Bremsflüssigkeitsbehälter
1.4 CRDi 1.4 CVVT 1.6 GDi	66 73 99	04/15→07/18 04/15→07/18 04/15→07/18		für Linkslenker; + ESP		24.4122-1732.3 011107	Ø 22,2 ohne Bremsflüssigkeitsbehälter
1.6 CRDi	94	07/12→07/18		für Linkslenker; - ESP		24.4122-1724.3 011080	ATE Ø 22,2 ohne Bremsflüssigkeitsbehälter
				für Rechtslenker; - ESP		24.4122-1724.3 011080	ATE Ø 22,2 ohne Bremsflüssigkeitsbehälter
				für Linkslenker; + ESP		24.4122-1732.3 011107	Ø 22,2 ohne Bremsflüssigkeitsbehälter
KIA - CEE'D Sportwagon (JD) 09/12→07/18							
 Hauptbremszylinder							
1.0 T-GDI	74 - 88	07/15→07/18		für Linkslenker		24.4122-1732.3 011107	Ø 22,2 ohne Bremsflüssigkeitsbehälter
1.4 MPI 1.6 CRDi 136	74 100	04/15→07/18 07/15→07/18					
1.4 CRDi 90 1.4 CVVT 1.4 LPG 1.6 CRDi 110 1.6 CRDi 128 1.6 GDI	66 73 72 81 94 99	09/12→07/18 09/12→07/15 01/13→07/18 03/13→07/18 09/12→07/15 09/12→07/18		für Linkslenker; für Fahrzeuge mit Start-Stopp-Funktion; - ESP		24.4122-1724.3 011080	ATE Ø 22,2 ohne Bremsflüssigkeitsbehälter
				für Rechtslenker; - ESP		24.4122-1724.3 011080	ATE Ø 22,2 ohne Bremsflüssigkeitsbehälter
				für Linkslenker; + ESP		24.4122-1732.3 011107	Ø 22,2 ohne Bremsflüssigkeitsbehälter
1.6 CVVT	95 - 96	11/14→07/18		für Linkslenker; + ESP		24.4122-1732.3 011107	Ø 22,2 ohne Bremsflüssigkeitsbehälter
KIA - PRO CEE'D (JD) 03/13→07/18							
 Hauptbremszylinder							
1.4 CRDi 90 1.4 CVVT 1.6 CRDi 110 1.6 CRDi 128 1.6 GDI 1.6 GT	66 74 81 94 99 150	03/13→07/18 07/13→07/18 03/13→07/18 03/13→07/15 03/13→07/18 06/13→07/18		für Linkslenker; für Fahrzeuge mit Start-Stopp-Funktion; - ESP		24.4122-1724.3 011080	ATE Ø 22,2 ohne Bremsflüssigkeitsbehälter
				für Rechtslenker; - ESP		24.4122-1724.3 011080	ATE Ø 22,2 ohne Bremsflüssigkeitsbehälter
				für Linkslenker; + ESP		24.4122-1732.3 011107	Ø 22,2 ohne Bremsflüssigkeitsbehälter
1.4 CVVT	73	03/13→07/15		für Linkslenker; für Fahrzeuge mit Start-Stopp-Funktion; - ESP		24.4122-1724.3 011080	ATE Ø 22,2 ohne Bremsflüssigkeitsbehälter
				für Rechtslenker; - ESP		24.4122-1724.3 011080	ATE Ø 22,2 ohne Bremsflüssigkeitsbehälter
				für Linkslenker; für Fahrzeuge ohne Start-Stopp-Funktion; + ESP		24.4122-1732.3 011107	Ø 22,2 ohne Bremsflüssigkeitsbehälter
				für Linkslenker; für Fahrzeuge mit Start-Stopp-Funktion; + ESP		24.4122-1732.3 011107	Ø 22,2 ohne Bremsflüssigkeitsbehälter
1.4 MPI 1.6 CRDi 136	74 100	04/15→07/18 07/15→07/18		für Linkslenker		24.4122-1732.3 011107	Ø 22,2 ohne Bremsflüssigkeitsbehälter
KIA - PRO CEE'D Hatchback Van (JD) 03/12→07/18							
 Hauptbremszylinder							
1.4 CRDi 1.6 GDI	66 99	05/15→07/18 04/15→07/18		für Linkslenker; für Fahrzeuge mit Start-Stopp-Funktion; - ESP		24.4122-1724.3 011080	ATE Ø 22,2 ohne Bremsflüssigkeitsbehälter
				für Rechtslenker; - ESP		24.4122-1724.3 011080	ATE Ø 22,2 ohne Bremsflüssigkeitsbehälter
				für Linkslenker; + ESP		24.4122-1732.3 011107	Ø 22,2 ohne Bremsflüssigkeitsbehälter
1.4 CVVT 1.6 CRDi	73 94	05/12→07/18 10/12→07/18		03/13→; für Linkslenker; für Fahrzeuge mit Start-Stopp-Funktion; - ESP		24.4122-1724.3 011080	ATE Ø 22,2 ohne Bremsflüssigkeitsbehälter
				03/13→; für Rechtslenker; - ESP		24.4122-1724.3 011080	ATE Ø 22,2 ohne Bremsflüssigkeitsbehälter
				03/13→; für Linkslenker; + ESP		24.4122-1732.3 011107	Ø 22,2 ohne Bremsflüssigkeitsbehälter
KIA - SORENTO I (JC) 08/02→12/11							
 Hauptbremszylinder							
2.5 CRDi	103	08/02→03/11		→ 11/06; + ABS		24.2126-1702.3 010950	Ø 27
3.5 3.5 V6 4WD	143 143	09/02→12/06 08/02→12/11		→ 11/06; + ABS; Automatikgetriebe		24.2126-1702.3 010950	Ø 27















	kW			 	! #		
KIA - SPORTAGE III (SL) 09/09→							
 Hauptbremszylinder							
1.6 GDI 2.0 CRDi 2.0 CRDi AWD 2.0 CVVT	99 100 100 110 - 122	02/11→ 07/10→ 07/10→ 06/10→		+ ESP		24.4122-1723.3 011086	Ø 22,2 ohne Bremsflüssigkeitsbehälter
2.0 CVVT AWD	110 - 122	06/10→					
2.0 CVVT Flex 2.0 GDI	131 122 - 194	02/12→12/16 09/13→					
2.0 GDI AWD 2.4 i AWD	122 130	02/14→ 08/10→					
1.6 LPG	99	01/14→12/15		für Linkslenker; + ESP; - RU		24.4122-1723.3 011086	Ø 22,2 ohne Bremsflüssigkeitsbehälter
2.0 CVVT AWD	110 - 113	01/14→12/15		für Linkslenker; Fahrzeugproduktionsland Slowakische Republik; + ESP		24.4122-1723.3 011086	Ø 22,2 ohne Bremsflüssigkeitsbehälter
2.0 CVVT Flex AWD	131	01/12→		für Linkslenker; Fahrzeugproduktionsland Republik Korea (Südkorea)		24.4122-1723.3 011086	Ø 22,2 ohne Bremsflüssigkeitsbehälter
KIA - SPORTAGE IV (QL, QLE) 09/15→							
 Hauptbremszylinder							
1.6 CRDi	85 - 100	07/18→09/22		für Linkslenker		24.4122-1732.3 011107	Ø 22,2 ohne Bremsflüssigkeitsbehälter
1.6 CRDi AWD 1.6 CRDi Eco-Dynamics+	100 85 - 100	07/18→09/22 03/19→09/22					
1.6 CRDi Eco-Dynamics+ AWD 1.6 GDI 1.6 T-GDI 1.6 T-GDI AWD 1.7 CRDi	100 97 130 130 85 - 104	03/19→09/22 09/15→09/22 09/15→09/22 09/15→09/22 09/15→09/22					
1.6 LPG	93	07/20→09/22				24.4122-1732.3 011107	Ø 22,2 ohne Bremsflüssigkeitsbehälter
2.0 AWD 2.0 CRDi 2.0 CRDi AWD 2.0 CRDi Eco-Dynamics+ AWD	110 - 114 100 - 136 100 - 136 136	12/15→09/22 09/15→09/22 09/15→09/22 06/18→09/22		für Linkslenker; Fahrzeugproduktionsland Slowakische Republik		24.4122-1732.3 011107	Ø 22,2 ohne Bremsflüssigkeitsbehälter
KIA - SPORTAGE IV VAN (QL, QLE) 09/15→							
 Hauptbremszylinder							
1.6 CRDi Eco-Dynamics+ 1.6 CRDi Eco-Dynamics+ All-wheel Drive 1.6 T-GDI	100 100 130	03/19→ 03/19→ 05/18→		für Linkslenker		24.4122-1732.3 011107	Ø 22,2 ohne Bremsflüssigkeitsbehälter
LADA - 110 (2110) 01/95→12/12							
 Hauptbremszylinder							
1.5 1.5 16V 1.6 2.0 i Wankel 1.6	54 - 57 70 66 110 88 60	01/95→12/05 01/95→12/05 01/00→12/08 08/96→07/00 06/97→09/04 01/00→12/12				24.2120-0803.3 010415	Ø 20,6
				→ 08/07		24.2120-0803.3 010415	Ø 20,6
LADA - 111 (2111) 01/95→02/09							
 Hauptbremszylinder							
1.5 1.5 16V 1.6 1.6	57 70 60 66	01/96→12/05 01/95→08/02 09/04→02/09 09/04→12/07				24.2120-0803.3 010415	Ø 20,6
				01/05→ 12/08		24.2120-0803.3 010415	Ø 20,6
				03/06→		24.2120-0803.3 010415	Ø 20,6
LADA - 112 (2112) 01/95→12/11							
 Hauptbremszylinder							
1.5 1.5 16V 1.6 1.6	57 70 66 60	01/95→09/04 01/95→09/00 03/06→12/08 01/05→12/11				24.2120-0803.3 010415	Ø 20,6
				→ 12/08		24.2120-0803.3 010415	Ø 20,6

	kW					! #		
LADA - 1200-1600 01/70→12/05								
 Hauptbremszylinder								
1600 N/L	57	03/79→12/05		→ 06/85			24.2119-0831.3 010416	Ø 19
LADA - NOVA (2105) 05/81→04/12								
 Hauptbremszylinder								
1200 Junior/L	44	09/81→04/12		→ 12/96			24.2119-0832.3 010417	Ø 19
1300 Spezial/L	48	05/81→04/12						
1500 S	52	06/89→04/12						
1500 Special	55	03/85→04/12						
1600	56	01/88→10/01						
1700 i Classic	62	06/96→04/12						
LADA - NOVA Kombi (2104) 09/84→04/12								
 Hauptbremszylinder								
1500	49	08/94→04/12		→ 12/96			24.2119-0832.3 010417	Ø 19
1700	62	08/94→04/12						
1500	55	09/85→04/98					24.2119-0832.3 010417	Ø 19
LADA - SAMARA (2108, 2109, 2113, 2114) 09/84→12/13								
 Hauptbremszylinder								
1.5	56	04/96→12/13		→ 12/99			24.2120-0803.3 010415	Ø 20,6
1500	52	02/95→12/06						
1.5	59	08/03→12/06					24.2120-0803.3 010415	Ø 20,6
1.6	60	02/09→12/13						
1100	43	02/96→08/99						
1300	45 - 50	09/91→12/99						
LADA - SAMARA Schrägheck (2113, 2114) 03/97→12/13								
 Hauptbremszylinder								
1.5	53	08/03→12/13					24.2120-0803.3 010415	Ø 20,6
LADA - SAMARA Stufenheck (21099, 2115) 09/87→12/12								
 Hauptbremszylinder								
1100	39	07/91→08/99		→ 12/95			24.2120-0803.3 010415	Ø 20,6
1300	45 - 48	05/89→08/99						
1500	52	11/94→12/06						
LADA - TAIGA Geländewagen geschlossen (2121, 2131) 12/76→								
 Hauptbremszylinder								
1700 i	59	06/96→12/06					24.2119-0832.3 010417	Ø 19
1700 i 4x4	60	10/00→12/15						
1900 Diesel	55	01/99→12/06						
1700 i 4x4	61	05/04→					24.2120-0803.3 010415	Ø 20,6
1900 Diesel	48	01/93→08/99		03/93→			24.2119-0832.3 010417	Ø 19
LANCIA - DEDRA (835_) 01/89→07/99								
 Hauptbremszylinder								
1.6 i.e.	55	04/93→07/99		→ 10/93; für Linkslenker; - ABS			24.2120-1710.3 010468	Ø 20,6
1.8 i.e.	66	08/93→07/99						
1.8 i.e.	77	09/89→07/99		01/90→ 10/93; für Linkslenker; - ABS			24.2120-1710.3 010468	Ø 20,6
2.0 i.e.	83	09/89→07/99						
1.9 TDS	66	04/89→07/99		01/90→ 10/93; - ABS			24.2120-1710.3 010468	Ø 20,6
				01/90→ 10/93; für Linkslenker; - ABS			24.2120-1710.3 010468	Ø 20,6
2.0 i.e. Turbo	119	04/91→07/99		05/91→ 10/93; GG			24.2122-1716.3 010485	Ø 22,2
LANCIA - DELTA II (836_) 06/93→09/99								
 Hauptbremszylinder								
1.4 i.e.	51	10/94→08/99		GG			24.2122-1716.3 010485	Ø 22,2
1.6 i.e.	66	03/96→08/99						
1.6 i.e. 16V	76	01/96→08/99						
1.8 i.e.	66	07/94→08/99						
1.8 i.e. 16V	83	03/96→08/99						
1.8 i.e. 16V GT	96	03/96→08/99						
2.0 16V Turbo	142	07/96→08/99						
1.6 i.e.	55	06/93→08/99		→ 10/93			24.2119-0829.3 010351	Ø 19
				11/93→; GG			24.2122-1716.3 010485	Ø 22,2
1.8 i.e.	76	06/93→08/99		11/93→; GG			24.2122-1716.3 010485	Ø 22,2
2.0 16V	102	06/93→08/99						
2.0 16V Turbo	137	06/93→08/99						

	kw					! #		
LANCIA - DELTA III (844_) 08/08→08/14								
 Hauptbremszylinder								
1.4	88 - 110	09/08→08/14					24.4123-1710.3 010866	BOS Ø 23,8 ohne Bremsflüssigkeitsbehälter
1.4 16V	103	07/10→08/14						
1.4 Bifuel	88	07/11→08/14						
1.6 D Multijet	77 - 88	08/08→08/14						
1.8	147	01/09→08/14						
1.9 D Multijet	140	01/09→08/14						
2.0 D Multijet	120 - 121	09/08→08/14						
LANCIA - MUSA (350_) 10/04→09/12								
 Hauptbremszylinder								
1.3 D Multijet	51 - 66	10/04→09/12		→ 11/06; für Fahrzeuge ohne elektronische Fahrdynamikregelung			24.2123-1763.3 010842	Ø 23,8
1.4	57 - 70	10/04→09/12		12/06→			24.4123-1708.3 010859	BOS Ø 23,8
1.9 D Multijet	74	10/04→09/12						
1.3 D Multijet	70	03/09→09/12					24.4123-1708.3 010859	BOS Ø 23,8
1.4	66	10/07→09/12						
1.4 LPG	57	11/10→09/12						
1.6 D Multijet	85 - 88	07/08→09/12						
LANCIA - PHEDRA (179_) 09/02→11/10								
 Hauptbremszylinder								
2.0	100	09/02→11/10		→ 09/10			03.2122-2163.3 010800	ATE Ø 22,2
2.0 D Multijet	100	07/06→11/10						
2.0 JTD	79 - 88	09/02→11/10						
2.2 D Multijet	125	03/08→11/10						
2.2 JTD	94 - 120	09/02→11/10						
LANCIA - Y (840_) 11/95→09/03								
 Hauptbremszylinder								
1.1	40	11/95→09/03		05/97→ 12/98			24.2120-1710.3 010468	Ø 20,6
1.2	44	03/96→09/03		→ 07/03			24.2120-1710.3 010468	Ø 20,6
1.2 16V	59	10/00→09/03						
1.2 16V	63	04/97→09/03		05/97→ 09/00			24.2120-1710.3 010468	Ø 20,6
1.4 12V	55 - 59	03/96→09/03		→ 12/98			24.2120-1710.3 010468	Ø 20,6
 Bremskraftregler								
1.1	40	11/95→09/03		05/97→ 12/98; - ABS; 			24.6513-1705.3 320237	lastabhängig 2x
1.2	44	03/96→09/03		→ 07/03; - ABS; 			24.6513-1705.3 320237	lastabhängig 2x
1.2 16V	59	10/00→09/03						
1.2 16V	63	04/97→09/03		05/97→ 09/00; - ABS; 			24.6513-1705.3 320237	lastabhängig 2x
1.4 12V	55 - 59	03/96→09/03		→ 12/98; - ABS; 			24.6513-1705.3 320237	lastabhängig 2x
LANCIA - YPSILON (843_) 10/03→12/11								
 Hauptbremszylinder								
1.2	51 - 59	10/03→12/11		→ 06/11; für Fahrzeuge ohne elektronische Fahrdynamikregelung			24.2122-1762.3 010837	Ø 22,2
1.3 JTD	51	10/03→12/11						
1.4	57	02/06→12/11		→ 06/11; für Fahrzeuge mit elektronischer Fahrdynamikregelung			24.2122-1768.3 010853	Ø 22,2
1.4 16V	70	10/03→12/11						
1.4 LPG	57	11/10→12/11						
1.3 D Multijet	55 - 66	09/06→12/11		10/06→ 06/11; für Fahrzeuge ohne elektronische Fahrdynamikregelung			24.2122-1762.3 010837	Ø 22,2
				10/06→ 06/11; für Fahrzeuge mit elektronischer Fahrdynamikregelung			24.2122-1768.3 010853	Ø 22,2
1.3 D Multijet	77	05/07→12/11		07/07→ 06/11; für Fahrzeuge ohne elektronische Fahrdynamikregelung			24.2122-1762.3 010837	Ø 22,2
				07/07→ 06/11; für Fahrzeuge mit elektronischer Fahrdynamikregelung			24.2122-1768.3 010853	Ø 22,2
LANCIA - ZETA (22_) 05/95→10/03								
 Hauptbremszylinder								
2.0 16V	97	05/98→07/00		05/99→			24.2123-1733.3 010657	BOS Ø 23,8
2.0 Turbo	108	05/95→09/02						
2.1 TD	80	05/96→09/99						
2.0 16V	100	07/00→09/02					24.2123-1733.3 010657	BOS Ø 23,8
→								

	kw					! #		
LANCIA - ZETA (22_) 05/95→10/03								
 Hauptbremszylinder								
2.0 JTD	80	09/99→09/02				24.2123-1733.3	010657	BOS Ø 23,8
2.0 JTD 16V	81	04/01→10/03						
LAND ROVER - DISCOVERY IV (L319) 09/09→12/18								
 Hauptbremszylinder								
2.7 TD 4x4	140	09/09→12/18				24.2026-1704.3	010989	TRW Ø 27 Ø2 20,6
3.0 4x4	250	08/13→12/18						
3.0 SDV6 4x4	188	11/09→12/18						
3.0 TD 4x4	155 - 200	09/09→12/18						
4.0 4x4	160	09/09→12/18						
5.0 V8 4x4	276	09/09→12/18						
LAND ROVER - DISCOVERY IV VAN (L319) 09/09→12/17								
 Hauptbremszylinder								
3.0 TD 4x4	155 - 188	01/11→12/17				24.2026-1704.3	010989	TRW Ø 27 Ø2 20,6
LAND ROVER - FREELANDER 2 (L359) 10/06→12/15								
 Bremskraftverstärker								
2.0 Si4 4x4	177	10/11→10/14				03.7755-1232.4	300260	ATE Ø 9 / 8" pneumatisch
2.2 eD4	110	08/10→10/14						
2.2 SD4 4x4	140	08/10→10/14						
2.2 TD4 4x4	110 - 118	10/06→10/14						
3.2 4x4	171	10/06→10/14						
 Hauptbremszylinder								
2.0 Si4 4x4	177	10/11→10/14				24.4156-1270.3	011058	ATE Ø 27 ohne Bremsflüssigkeitsbehälter
2.2 eD4	110	08/10→10/14						
2.2 SD4 4x4	140	08/10→10/14						
2.2 TD4 4x4	110 - 118	10/06→10/14						
3.2 4x4	171	10/06→10/14						
LAND ROVER - FREELANDER 2 VAN (L359) 10/06→10/14								
 Bremskraftverstärker								
2.2 TD4 4x4	118	10/06→10/14				03.7755-1232.4	300260	ATE Ø 9 / 8" pneumatisch
 Hauptbremszylinder								
2.2 TD4 4x4	118	10/06→10/14				24.4156-1270.3	011058	ATE Ø 27 ohne Bremsflüssigkeitsbehälter
LAND ROVER - RANGE ROVER III (L322) 03/02→12/12								
 Hauptbremszylinder								
3.0 D 4x4	130	03/02→08/12			→ 5A999999	24.2026-1705.3	010992	TRW Ø 27 Ø2 20,6
3.6 D 4x4	200	04/06→08/12						
4.2 4x4	291	05/05→08/12						
4.4 4x4	210 - 225	03/02→08/12						
LAND ROVER - RANGE ROVER EVOQUE (L538) 06/11→12/19								
 Hauptbremszylinder								
2.0 4x4	176 - 177	06/11→12/19				24.4156-1270.3	011058	ATE Ø 27 ohne Bremsflüssigkeitsbehälter
2.0 D	110	06/15→12/19			→ FH999999	24.4156-1270.3	011058	ATE Ø 27 ohne Bremsflüssigkeitsbehälter
2.0 D 4x4	110 - 132	05/15→12/19						
2.2 D	110	06/11→12/19						
2.2 D 4x4	110 - 140	06/11→12/19						
LAND ROVER - RANGE ROVER EVOQUE Cabriolet (L538) 11/15→12/19								
 Hauptbremszylinder								
2.0 4x4	177	11/15→12/19			→ FH999999	24.4156-1270.3	011058	ATE Ø 27 ohne Bremsflüssigkeitsbehälter
2.0 D 4x4	110 - 132	11/15→12/19						
LAND ROVER - RANGE ROVER EVOQUE VAN (L538) 06/11→12/19								
 Hauptbremszylinder								
SD4 4x4	140	05/15→12/19			→ FH999999	24.4156-1270.3	011058	ATE Ø 27 ohne Bremsflüssigkeitsbehälter
TD4	110	05/15→12/19						
→								

	kw					! #		
LAND ROVER - RANGE ROVER EVOQUE VAN (L538) 06/11→12/19								
 Hauptbremszylinder								
TD4 4x4	110	05/15→12/19			→ FH999999		24.4156-1270.3 011058	ATE Ø 27 ohne Bremsflüssigkeitsbehälter
Si4 4x4	177	09/13→12/19					24.4156-1270.3 011058	ATE Ø 27 ohne Bremsflüssigkeitsbehälter
LAND ROVER - RANGE ROVER SPORT I (L320) 02/05→03/13								
 Hauptbremszylinder								
3.0 D 4x4	155 - 188	09/09→03/13			für Linkslenker		24.2026-1704.3 010989	TRW Ø 27 Ø2 20,6
5.0 4x4	276 - 375	04/09→03/13						
3.6 D 4x4	200	04/06→03/13			AA000001→; für Linkslenker		24.2026-1704.3 010989	TRW Ø 27 Ø2 20,6
MAZDA - 2 (DY) 02/03→06/07								
 Hauptbremszylinder								
1.2	55	02/03→06/07			- ABS		03.4153-0015.3 011005	ATE Ø 23,8 ohne Bremsflüssigkeitsbehälter
1.25	55	04/03→06/07						
1.3 L	67	04/03→06/07						
1.4	59	02/03→06/07			+ ABS		03.4153-5287.4 010953	ATE Ø 23,8 mit Bremsflüssigkeitsbehälter
1.4 CD	50	04/03→06/07						
1.6	74	02/03→06/07						
MAZDA - 3 (BK) 10/03→12/09								
 Hauptbremszylinder								
1.3	62	10/03→06/09			→ 03/06; für Linkslenker		03.2125-0483.3 010783	ATE Ø 25,4 ohne Bremsflüssigkeitsbehälter
1.6	77	10/03→06/09			→ 05/09; für Linkslenker		03.2125-0483.3 010783	ATE Ø 25,4 ohne Bremsflüssigkeitsbehälter
1.6 DI Turbo	80	06/04→06/09						
1.6 MZ-CD	66	06/06→12/09						
2.0	110	10/03→12/09						
2.0 MZR-CD	105	07/06→06/09						
2.0	104	10/03→06/06			für Linkslenker		03.2125-0483.3 010783	ATE Ø 25,4 ohne Bremsflüssigkeitsbehälter
2.3 MZR	115	10/03→03/09						
MAZDA - 3 (BL) 12/08→09/14								
 Hauptbremszylinder								
1.6 MZ-CD	80	12/08→05/13			06/09→; für Linkslenker		03.2125-0483.3 010783	ATE Ø 25,4 ohne Bremsflüssigkeitsbehälter
2.0 DISI	110	05/09→02/12						
2.0 MZR DISI	111	12/08→05/13						
2.2 MZR CD	110 - 136	01/09→10/13						
1.6 MZR	79	01/10→12/13			→ 11/13; für Linkslenker		03.2125-0483.3 010783	ATE Ø 25,4 ohne Bremsflüssigkeitsbehälter
2.0 MZR	108	04/09→09/14						
1.6 MZR	77	12/08→09/14			06/09→; für Linkslenker; → 11/13		03.2125-0483.3 010783	ATE Ø 25,4 ohne Bremsflüssigkeitsbehälter
2.0 MZR	110	01/09→09/14						
2.5	122	03/09→09/14						
1.6 MZR CD	85	09/10→05/13			11/10→; für Linkslenker		03.2125-0483.3 010783	ATE Ø 25,4 ohne Bremsflüssigkeitsbehälter
2.0	113	09/11→10/13			für Linkslenker		03.2125-0483.3 010783	ATE Ø 25,4 ohne Bremsflüssigkeitsbehälter
MAZDA - 3 Stufenheck (BK) 09/99→12/09								
 Hauptbremszylinder								
1.6	77	02/04→06/09			→ 05/09; für Linkslenker		03.2125-0483.3 010783	ATE Ø 25,4 ohne Bremsflüssigkeitsbehälter
1.6 DI Turbo	80	06/04→06/09						
2.0 MZR-CD	105	12/06→06/09						
2.0	104 - 110	10/03→12/09			für Linkslenker		03.2125-0483.3 010783	ATE Ø 25,4 ohne Bremsflüssigkeitsbehälter
2.3	118	03/04→03/09						
MAZDA - 3 Stufenheck (BL) 12/08→12/14								
 Hauptbremszylinder								
1.6 MZR	77	12/08→09/14			06/09→; für Linkslenker; → 11/13		03.2125-0483.3 010783	ATE Ø 25,4 ohne Bremsflüssigkeitsbehälter
2.0 MZR	110	03/09→09/14						
2.2 MZR CD	110	01/09→09/14						
1.6 MZR CD	80	12/08→05/13			06/09→; für Linkslenker		03.2125-0483.3 010783	ATE Ø 25,4 ohne Bremsflüssigkeitsbehälter
2.0 MZR DISI	111	02/09→05/13						
1.6 MZR CD	85	09/10→05/13			11/10→; für Linkslenker		03.2125-0483.3 010783	ATE Ø 25,4 ohne Bremsflüssigkeitsbehälter
2.0	113	09/11→09/14			für Linkslenker		03.2125-0483.3 010783	ATE Ø 25,4 ohne Bremsflüssigkeitsbehälter
2.2 MZR CD	136	06/09→05/13						

	kW			 	! #		
MAZDA - 6 Hatchback (GG) 08/02→12/08							
 Hauptbremszylinder							
1.8 2.0	88 104 - 108	08/02→08/07 08/02→08/07		→ 07/07; + ESP; Schaltgetriebe		24.2120-1756.3 010975	Ø 20,6 ohne Bremsflüssigkeitsbehälter
2.0 DI	89 - 105	08/02→08/07					
2.3	122	08/02→08/07					
3.0	162 - 164	01/04→12/07		+ ESP; Schaltgetriebe		24.2120-1756.3 010975	Ø 20,6 ohne Bremsflüssigkeitsbehälter
MAZDA - 6 Station Wagon (GY) 01/02→02/08							
 Hauptbremszylinder							
1.8 2.0	88 104 - 108	08/02→08/07 08/02→08/07		→ 07/07; + ESP; Schaltgetriebe		24.2120-1756.3 010975	Ø 20,6 ohne Bremsflüssigkeitsbehälter
2.0 DI	89 - 105	08/02→08/07					
2.3	122	01/02→02/08					
2.3 AWD	119	11/02→08/07					
2.0 DI	100	08/02→02/05		+ ESP; Schaltgetriebe		24.2120-1756.3 010975	Ø 20,6 ohne Bremsflüssigkeitsbehälter
MAZDA - 6 Stufenheck (GG) 06/02→12/08							
 Hauptbremszylinder							
1.8 2.0	88 104 - 108	08/02→08/07 06/02→08/07		→ 07/07; + ESP; Schaltgetriebe		24.2120-1756.3 010975	Ø 20,6 ohne Bremsflüssigkeitsbehälter
2.0 DI	89 - 105	06/02→08/07					
2.3	122	06/02→08/07					
2.3 MPS Turbo	191	12/05→08/07					
2.3	119 - 120	07/03→07/07		+ ESP; Schaltgetriebe		24.2120-1756.3 010975	Ø 20,6 ohne Bremsflüssigkeitsbehälter
MAZDA - BT-50 Pick-up (CD, UN) 08/06→12/15							
 Hauptbremszylinder							
2.5 MRZ-CD	105	08/06→06/13		für Linkslenker; + ABS		24.2125-1747.3 011029	Ø 25,4
2.5 MRZ-CD 4x4	105	12/06→12/15		+ ABS; Schaltgetriebe; → 07/12		24.2125-1747.3 011029	Ø 25,4
3.0 CDVi	115	12/06→12/15		+ ABS; Automatikgetriebe; → 07/12		24.2125-1747.3 011029	Ø 25,4
3.0 CDVi 4x4	115	10/06→12/15		12/06→; + ABS; Schaltgetriebe; → 07/12		24.2125-1747.3 011029	Ø 25,4
				12/06→; + ABS; Automatikgetriebe; → 07/12		24.2125-1747.3 011029	Ø 25,4
MAZDA - BT-50 Pritsche/Fahrgestell (CD, UN) 08/06→							
 Hauptbremszylinder							
2.5 CDVi	105	12/06→		+ ABS; Schaltgetriebe; → 07/12		24.2125-1747.3 011029	Ø 25,4
3.0 CDVi 4x4	115	12/06→		+ ABS; Automatikgetriebe; → 07/12		24.2125-1747.3 011029	Ø 25,4
MAZDA - CX-5 (KE, GH) 11/11→02/17							
 Hauptbremszylinder							
2.0	110 - 121	11/11→02/17		für Linkslenker; Schaltgetriebe		24.2120-1761.3 011090	Ø 20,6 ohne Bremsflüssigkeitsbehälter
2.0 AWD	110 - 118	11/11→02/17					
2.2 D	110 - 129	04/12→02/17					
2.2 D 4WD	129	04/12→02/17					
2.2 D AWD	110 - 129	04/12→02/17					
2.5	137 - 138	02/13→02/17					
2.5 AWD	141	02/15→02/17					
MAZDA - CX-5 (KF) 11/16→							
 Hauptbremszylinder							
2.0	110	03/18→		für Linkslenker; Schaltgetriebe		24.2120-1761.3 011090	Ø 20,6 ohne Bremsflüssigkeitsbehälter
2.0 SKYACTIV-G	120	03/18→					
2.0 SKYACTIV-G AWD	120	03/18→					
2.0	121	05/17→		für Linkslenker; Schaltgetriebe 6 Gang		24.2120-1761.3 011090	Ø 20,6 ohne Bremsflüssigkeitsbehälter
2.2 D	110	05/17→					
2.2 D AWD	110	05/17→					
2.0 AWD	118 - 121	05/17→		Schaltgetriebe 6 Gang		24.2120-1761.3 011090	Ø 20,6 ohne Bremsflüssigkeitsbehälter
→							

MERCEDES-BENZ - B-KLASSE Sports Tourer (W246, W242) 10/11→12/18

Hauptbremszylinder

B 160	75	07/15→12/18		für Linkslenker	24.4123-1718.3	011016	TRW Ø 23,8 ohne Bremsflüssigkeitsbehälter
B 160 CDI / d	66	05/13→12/18					
B 180	90	11/11→12/18					
B 180 CDI / d	80	02/13→12/18					
B 180 CDI	80	11/11→08/14					
B 200	115	11/11→12/18					
B 200 CDI / d	100	08/14→12/18					
B 200 CDI / d 4-matic	100	08/14→12/18					
B 200 CDI	100	11/11→08/14					
B 200 Natural Gas Drive / B 200 c	115	11/12→12/17					
B 220 4-matic	135	05/13→12/18					
B 220 CDI / d	120 - 130	06/13→12/18					
B 220 CDI / d 4-matic	130	08/14→12/18					
B 220 d 4-matic	125	06/18→12/18					
B 250 4-matic	155	08/14→12/18					
B 220 CDI / d	125	11/11→12/18		12/12→; für Linkslenker	24.4123-1718.3	011016	TRW Ø 23,8 ohne Bremsflüssigkeitsbehälter
B 250	155	05/12→12/18		09/12→; für Linkslenker	24.4123-1718.3	011016	TRW Ø 23,8 ohne Bremsflüssigkeitsbehälter

MERCEDES-BENZ - C-KLASSE (W202) 03/93→05/00

Bremskraftverstärker

C 180	89 - 90	03/93→05/00		A021677 / F011180→ A519673 / F619720	03.7760-2702.4	300090	ATE Ø 10" pneumatisch
C 200	100	01/94→05/00		→ A519673 / F619720	03.7760-2702.4	300090	ATE Ø 10" pneumatisch
C 200 Kompressor	132 - 141	10/95→05/00					
C 230 Kompressor	142	10/95→05/00					
C 250 Turbo-D	110	10/95→05/00					
C 200 D	55 - 65	03/93→05/00		A072908 / F060570→ A519673 / F619720	03.7760-2702.4	300090	ATE Ø 10" pneumatisch
C 220 D	55 - 70	08/93→05/00					
C 220	110	03/93→05/00		→ 08/96	03.7760-2702.4	300090	ATE Ø 10" pneumatisch
C 230	110	06/96→06/97		07/96→	03.7760-2702.4	300090	ATE Ø 10" pneumatisch
C 250 D	83	05/93→05/00		→ 08/95; A072908 / F060570→	03.7760-2702.4	300090	ATE Ø 10" pneumatisch
C 280	142	05/93→05/00		06/93→ 05/97	03.7760-2702.4	300090	ATE Ø 10" pneumatisch
C 36 AMG	206	05/94→05/00		→ 08/97	03.7760-2702.4	300090	ATE Ø 10" pneumatisch

Hauptbremszylinder

C 180	89	11/94→05/00		F011180→	03.2023-0825.3	010028	Ø1 23,8 Ø2 19
				A021677→ A136773	03.2023-0825.3	010028	Ø1 23,8 Ø2 19
				→ A021676 / F011179	24.2022-1601.3	010340	Ø1 22,2 Ø2 17,5
				A136774→	24.2023-1701.3	010514	TRW Ø1 23,8 Ø2 19
C 180	90	03/93→05/00		F011180→	03.2023-0825.3	010028	Ø1 23,8 Ø2 19
				A021677→ A136773	03.2023-0825.3	010028	Ø1 23,8 Ø2 19
				→ A021676 / F011179	24.2022-1601.3	010340	Ø1 22,2 Ø2 17,5
				A136774→ A519673	24.2023-1701.3	010514	TRW Ø1 23,8 Ø2 19
				A519674→	24.2023-1702.3	010534	TRW Ø1 23,8 Ø2 19
C 200	100	01/94→05/00		→ A136773 / F110261	03.2023-0825.3	010028	Ø1 23,8 Ø2 19
				A136774 / F110262→	24.2023-1701.3	010514	TRW Ø1 23,8 Ø2 19
C 200 CDI	75	03/98→05/00			24.2023-1702.3	010534	TRW Ø1 23,8 Ø2 19
				09/97→05/00			
C 200 D	55 - 65	03/93→05/00		A072908 / F060570→	03.2023-0825.3	010028	Ø1 23,8 Ø2 19
				→ A072907 / F060569	24.2022-1601.3	010340	Ø1 22,2 Ø2 17,5
C 200 Kompressor	132 - 141	10/95→05/00		→ A519673 / F619720	24.2023-1701.3	010514	TRW Ø1 23,8 Ø2 19
				A519674 / F619721→	24.2023-1702.3	010534	TRW Ø1 23,8 Ø2 19
C 230 Kompressor	142	10/95→05/00					
				10/95→05/00			
C 250 Turbo-D	110	10/95→05/00					
C 220	110	03/93→05/00		06/93→; → A136773 / F110261	03.2023-0825.3	010028	Ø1 23,8 Ø2 19
				→ 08/96; A136774 / F110262→	24.2023-1701.3	010514	TRW Ø1 23,8 Ø2 19
C 220 D	55 - 70	08/93→05/00		A072908 / F060570→ A136773 / F110261	03.2023-0825.3	010028	Ø1 23,8 Ø2 19
				→ A072907 / F060569	24.2022-1601.3	010340	Ø1 22,2 Ø2 17,5
				A136774 / F110262→ A519673 / F619720	24.2023-1701.3	010514	TRW Ø1 23,8 Ø2 19
				A519674 / F619721→	24.2023-1702.3	010534	TRW Ø1 23,8 Ø2 19
C 230	110	06/96→06/97		07/96→	24.2023-1701.3	010514	TRW Ø1 23,8 Ø2 19
→							

MERCEDES-BENZ - C-KLASSE (W202) 03/93→05/00

Hauptbremszylinder

C 240	125	06/97→05/00	- ESP	24.2023-1702.3	010534	TRW Ø1 23,8 Ø2 19
			+ ESP	24.2023-1704.3	010635	TRW Ø 23,8
C 250 D	83	05/93→05/00	A072908 / F060570→; → 08/95	03.2023-0825.3	010028	Ø1 23,8 Ø2 19
			06/93→; → A072907 / F060569	24.2022-1601.3	010340	Ø1 22,2 Ø2 17,5
C 280	142	05/93→05/00	06/93→; → A136773 / F110261	03.2023-0825.3	010028	Ø1 23,8 Ø2 19
			→ 05/97; A136774 / F110262→	24.2023-1701.3	010514	TRW Ø1 23,8 Ø2 19
			06/97→; - ESP	24.2023-1702.3	010534	TRW Ø1 23,8 Ø2 19
			06/97→; + ESP	24.2023-1704.3	010635	TRW Ø 23,8
C 280	145	06/97→05/00	→ A136773 / F110261	03.2023-0825.3	010028	Ø1 23,8 Ø2 19
			- ESP	24.2023-1702.3	010534	TRW Ø1 23,8 Ø2 19
			+ ESP	24.2023-1704.3	010635	TRW Ø 23,8
C 36 AMG	206	05/94→05/00	→ A136773 / F110261	03.2023-0825.3	010028	Ø1 23,8 Ø2 19
			→ 08/97; A136774 / F110262→	24.2023-1701.3	010514	TRW Ø1 23,8 Ø2 19
C 43 AMG	225	08/97→05/00	für Linkslenker; → F737081	24.2025-1703.3	010516	Ø1 25,4 Ø2 19
			für Rechtslenker	24.2025-1709.3	010693	Ø 25,4
			für Linkslenker; F737082→	24.2025-1709.3	010693	Ø 25,4











MERCEDES-BENZ - C-KLASSE (W203) 05/00→12/07











Bremskraftverstärker











C 180	95	10/00→05/02	für Linkslenker	03.7848-2002.4	300166	ATE Ø 7 / 8" pneumatisch
C 180 Kompressor	105	05/02→02/07				
C 200 CDI	75 - 90	09/00→02/07				
C 200 CGI Kompressor	125	07/03→02/07				
C 200 Kompressor	120	05/02→02/07				
C 220 CDI	100 - 105	05/00→02/07				
C 230 Kompressor	141	02/04→02/07				
C 240	125	05/00→02/07				
C 240 4-matic	125	07/02→02/07				
C 270 CDI	120 - 125	12/00→02/07				
C 30 CDI AMG	170	01/03→02/07				
C 320	160	05/00→02/07				
C 320 4-matic	160	07/02→02/07				
C 55 AMG	270	02/04→02/07				
C 200 Kompressor	120	05/00→06/02	→ 05/02; für Linkslenker	03.7848-2002.4	300166	ATE Ø 7 / 8" pneumatisch
C 220 CDI	110	04/03→02/07	02/04→; für Linkslenker	03.7848-2002.4	300166	ATE Ø 7 / 8" pneumatisch
C 230	150	01/05→02/07	06/05→; für Linkslenker	03.7848-2002.4	300166	ATE Ø 7 / 8" pneumatisch
C 280	170	01/05→02/07				
C 280 4-matic	170	01/05→02/07				
C 350	200	01/05→02/07				
C 350 4-matic	200	01/05→02/07				
C 320 CDI	165	01/05→02/07	02/05→; für Linkslenker	03.7848-2002.4	300166	ATE Ø 7 / 8" pneumatisch
C 32 AMG Kompressor	260	02/01→02/07	03/01→; für Linkslenker	03.7848-2002.4	300166	ATE Ø 7 / 8" pneumatisch







Pedalwegsensoren, Bremspedal

C 180	95	10/00→05/02		03.0655-0007.2	370007	ATE
C 180 Kompressor	105	05/02→02/07				
C 200 CDI	75 - 90	09/00→02/07				
C 200 CGI Kompressor	125	07/03→02/07				
C 200 Kompressor	120	05/02→02/07				
C 220 CDI	100 - 105	05/00→02/07				
C 230 Kompressor	141	02/04→02/07				
C 240	125	05/00→02/07				
C 240 4-matic	125	07/02→02/07				
C 270 CDI	120 - 125	12/00→02/07				
C 30 CDI AMG	170	01/03→02/07				
C 320	160	05/00→02/07				
C 320 4-matic	160	07/02→02/07				
C 55 AMG	270	02/04→02/07				
C 200 Kompressor	120	05/00→06/02	→ 05/02	03.0655-0007.2	370007	ATE
C 220 CDI	110	04/03→02/07	02/04→	03.0655-0007.2	370007	ATE
C 230	150	01/05→02/07	06/05→	03.0655-0007.2	370007	ATE
C 280	170	01/05→02/07				
C 350	200	01/05→02/07				
C 350 4-matic	200	01/05→02/07				
C 280 4-matic	170	01/05→02/07	06/05→; für Linkslenker	03.0655-0007.2	370007	ATE
C 320 CDI	165	01/05→02/07	02/05→	03.0655-0007.2	370007	ATE
→						







	kw					! #		
MERCEDES-BENZ - C-KLASSE (W203) 05/00→12/07								
Pedalwegsensoren, Bremspedal								
C 32 AMG Kompressor	260	02/01→02/07		03/01→			03.0655-0007.2 370007	ATE
 Hauptbremszylinder								
C 180	95	10/00→05/02		für Linkslenker			03.2023-1741.3 010703	ATE Ø1 23,8 Ø2 20,6
C 180 Kompressor	105	05/02→02/07						
C 200 CDI	75 - 90	09/00→02/07						
C 200 CGI Kompressor	125	07/03→02/07						
C 200 Kompressor	120	05/02→02/07						
C 220 CDI	100 - 105	05/00→02/07						
C 230 Kompressor	141	02/04→02/07						
C 240	125	05/00→02/07						
C 200 Kompressor	120	05/00→06/02		→ 05/02; für Linkslenker			03.2023-1741.3 010703	ATE Ø1 23,8 Ø2 20,6
C 220 CDI	110	04/03→02/07		02/04→; für Linkslenker			03.2023-1741.3 010703	ATE Ø1 23,8 Ø2 20,6
C 230	150	01/05→02/07		06/05→; für Linkslenker			03.2025-1741.3 010705	ATE Ø1 25,4 Ø2 20,6
C 280	170	01/05→02/07						
C 280 4-matic	170	01/05→02/07						
C 350	200	01/05→02/07						
C 350 4-matic	200	01/05→02/07						
C 240 4-matic	125	07/02→02/07		für Linkslenker			03.2025-1741.3 010705	ATE Ø1 25,4 Ø2 20,6
C 270 CDI	120 - 125	12/00→02/07						
C 30 CDI AMG	170	01/03→02/07						
C 320	160	05/00→02/07						
C 320 4-matic	160	07/02→02/07						
C 55 AMG	270	02/04→02/07						
C 320 CDI	165	01/05→02/07		02/05→; für Linkslenker			03.2025-1741.3 010705	ATE Ø1 25,4 Ø2 20,6
C 32 AMG Kompressor	260	02/01→02/07		03/01→; für Linkslenker			03.2025-1741.3 010705	ATE Ø1 25,4 Ø2 20,6
MERCEDES-BENZ - C-KLASSE (W204) 01/07→01/15								
 Bremskraftverstärker								
C 180 CDI	88	04/10→03/14		für Linkslenker; für Fahrzeuge ohne Start-Stopp-Funktion			03.7745-6302.4 300261	ATE Ø 8" pneumatisch
C 180 Kompressor	115	01/08→01/14						
C 200	137	05/11→01/14		für Linkslenker; für Fahrzeuge mit Start-Stopp-Funktion			03.7745-8902.4 300297	ATE Ø 8" pneumatisch
C 200 CDI	100	11/09→03/14						
C 220 CDI	120 - 125	10/08→01/14						
C 220 CDI 4-matic	125	02/13→01/14						
C 230 4-matic	150	07/07→01/14						
C 250 CDI	150	08/08→01/14						
C 250 CDI 4-matic	150	01/11→01/14						
C 250 CGI	150	07/09→01/14						
C 280 4-matic	170	07/07→01/14						
C 300	185	02/11→01/14						
C 300 4-matic	185	02/11→01/14						
C 300 CDI 4-matic	170	01/11→01/14						
C 320 CDI 4-matic	165	07/07→01/14						
C 350	225	01/11→01/14						
C 350 4-matic	200 - 225	07/07→01/14						
C 350 CDI	170 - 195	10/09→01/14						
C 350 CDI 4-matic	165 - 170	07/09→01/14						
C 350 CGI	215	09/08→01/14						
C 180 CGI	115	01/07→01/14		04/09→; für Linkslenker; für Fahrzeuge ohne Start-Stopp-Funktion			03.7745-6302.4 300261	ATE Ø 8" pneumatisch
C 200 CGI	135	01/07→01/14						
C 300 4-matic	170	07/07→01/14		04/09→; für Linkslenker; für Fahrzeuge mit Start-Stopp-Funktion			03.7745-8902.4 300297	ATE Ø 8" pneumatisch
C 180 Kompressor	115	01/07→01/14		03/07→; für Linkslenker; für Fahrzeuge ohne Start-Stopp-Funktion			03.7745-6302.4 300261	ATE Ø 8" pneumatisch
C 200 CDI	100	01/07→12/09						
C 220 CDI	120	01/07→11/08		03/07→; für Linkslenker; für Fahrzeuge mit Start-Stopp-Funktion			03.7745-8902.4 300297	ATE Ø 8" pneumatisch
C 230	150	01/07→01/14						
C 200 Kompressor	135	01/07→01/14		A 017628 / F 015295→; für Linkslenker; für Fahrzeuge ohne Start-Stopp-Funktion			03.7745-6302.4 300261	ATE Ø 8" pneumatisch
C 220 CDI	125	01/07→11/08						
C 280	170	01/07→01/14		A 017628 / F 015295→; für Linkslenker; für Fahrzeuge mit Start-Stopp-Funktion			03.7745-8902.4 300297	ATE Ø 8" pneumatisch
C 300	170	07/09→01/14						
C 320 CDI	165	01/07→01/14						
C 350	200	01/07→01/14						
C 350 CDI	165	07/09→01/14						
C 63 AMG	336 - 373	02/08→01/14						
C 63 AMG DR 520	383	07/10→01/14						
 Hauptbremszylinder								
C 180 CDI	88	04/10→03/14		für Linkslenker			03.2025-2521.3 010959	ATE Ø1 25,4 Ø2 22,2
C 180 Kompressor	115	01/08→01/14		für Rechtslenker			24.2025-2311.3 011023	ATE Ø1 25,4 Ø2 20,6











	kW					! #		
MERCEDES-BENZ - C-KLASSE (W204) 01/07→01/15								
 Hauptbremszylinder								
C 200	137	05/11→01/14		für Linkslenker		03.2025-2521.3	010959	ATE Ø1 25,4 Ø2 22,2
C 200 CDI	100	11/09→03/14		für Rechtslenker		24.2025-2311.3	011023	ATE Ø1 25,4 Ø2 20,6
C 220 CDI	120 - 125	10/08→01/14						
C 220 CDI 4-matic	125	02/13→01/14						
C 230 4-matic	150	07/07→01/14						
C 250 CDI 4-matic	150	01/11→01/14						
C 250 CGI	150	07/09→01/14						
C 280 4-matic	170	07/07→01/14						
C 300	170 - 185	07/09→01/14						
C 300 4-matic	185	02/11→01/14						
C 300 CDI 4-matic	170	01/11→01/14						
C 320 CDI 4-matic	165	07/07→01/14						
C 350	225	01/11→01/14						
C 350 4-matic	200 - 225	07/07→01/14						
C 350 CDI	165 - 195	07/09→01/14						
C 350 CDI 4-matic	165 - 170	07/09→01/14						
C 350 CGI	215	09/08→01/14						
C 63 AMG	336 - 373	02/08→01/14						
C 63 AMG DR 520	383	07/10→01/14						
C 180 CGI	115	01/07→01/14		04/09→; für Linkslenker		03.2025-2521.3	010959	ATE Ø1 25,4 Ø2 22,2
C 200 CGI	135	01/07→01/14		04/09→; für Rechtslenker		24.2025-2311.3	011023	ATE Ø1 25,4 Ø2 20,6
C 300 4-matic	170	07/07→01/14						
C 180 Kompressor	115	01/07→01/14		03/07→; für Linkslenker		03.2025-2521.3	010959	ATE Ø1 25,4 Ø2 22,2
C 200 CDI	100	01/07→12/09		03/07→; für Rechtslenker		24.2025-2311.3	011023	ATE Ø1 25,4 Ø2 20,6
C 200 Kompressor	135	01/07→01/14						
C 220 CDI	120 - 125	01/07→11/08						
C 230	150	01/07→01/14						
C 280	170	01/07→01/14						
C 320 CDI	165	01/07→01/14						
C 350	200	01/07→01/14						
C 250 CDI	150	08/08→01/14		10/08→; für Linkslenker		03.2025-2521.3	010959	ATE Ø1 25,4 Ø2 22,2
				10/08→; für Rechtslenker		24.2025-2311.3	011023	ATE Ø1 25,4 Ø2 20,6
MERCEDES-BENZ - C-KLASSE Coupe (C204) 01/11→								
 Bremskraftverstärker								
C 180	115	06/11→		für Linkslenker; für Fahrzeuge ohne Start-Stopp-Funktion		03.7745-6302.4	300261	ATE Ø 8" pneumatisch
C 200 CGI	135	06/11→		für Linkslenker; für Fahrzeuge mit Start-Stopp-Funktion		03.7745-8902.4	300297	ATE Ø 8" pneumatisch
C 220 CDI	120 - 125	06/11→						
C 250	150	06/11→						
C 250 CDI	150	06/11→						
C 350	225	06/11→						
C 350 4-matic	225	09/13→						
C 63 AMG	336 - 380	06/11→						
 Hauptbremszylinder								
C 180	115	06/11→		für Linkslenker		03.2025-2521.3	010959	ATE Ø1 25,4 Ø2 22,2
C 200 CGI	135	06/11→		für Rechtslenker		24.2025-2311.3	011023	ATE Ø1 25,4 Ø2 20,6
C 220 CDI	120 - 125	06/11→						
C 250	150	06/11→						
C 250 CDI	150	06/11→						
C 350	225	06/11→						
C 350 4-matic	225	09/13→						
C 63 AMG	336 - 380	06/11→						
MERCEDES-BENZ - C-KLASSE Sportcoupe (CL203) 03/01→06/11								
 Bremskraftverstärker								
C 160 Kompressor	90	05/02→05/08		04/05→; für Linkslenker		03.7848-2002.4	300166	ATE Ø 7 / 8" pneumatisch
C 180	95	03/01→05/02		für Linkslenker		03.7848-2002.4	300166	ATE Ø 7 / 8" pneumatisch
C 180 Kompressor	105	05/02→05/08						
C 200 Kompressor	120	03/01→05/08						
C 220	120	05/02→05/08						
C 220 CDI	100 - 110	03/01→05/08						
C 230 Kompressor	141 - 145	03/01→05/08						
C 30 CDI AMG	170	09/02→05/08						
C 320	160	09/02→05/08						
C 200 CDI	90	03/03→05/08		07/03→; für Linkslenker		03.7848-2002.4	300166	ATE Ø 7 / 8" pneumatisch











	kW					! #		
MERCEDES-BENZ - C-KLASSE Sportcoupe (CL203) 03/01→06/11								
 Bremskraftverstärker								
C 200 CGI Kompressor	125	03/03→05/08		07/03→;	für Linkslenker		03.7848-2002.4 300166	ATE Ø 7 / 8" pneumatisch
C 230	150	01/05→05/08		06/05→;	für Linkslenker		03.7848-2002.4 300166	ATE Ø 7 / 8" pneumatisch
C 350	200	01/05→05/08						
Pedalwegsensord, Bremspedal								
C 160 Kompressor	90	05/02→05/08		04/05→			03.0655-0007.2 370007	ATE
C 180	95	03/01→05/02					03.0655-0007.2 370007	ATE
C 180 Kompressor	105	05/02→05/08						
C 200 Kompressor	120	03/01→05/08						
C 220	120	05/02→05/08						
C 220 CDI	100 - 110	03/01→05/08						
C 230 Kompressor	141 - 145	03/01→05/08						
C 30 CDI AMG	170	09/02→05/08						
C 320	160	09/02→05/08						
C 200 CDI	90	03/03→05/08		07/03→			03.0655-0007.2 370007	ATE
C 200 CGI Kompressor	125	03/03→05/08						
C 230	150	01/05→05/08		06/05→			03.0655-0007.2 370007	ATE
C 350	200	01/05→05/08						
 Hauptbremszylinder								
C 160 Kompressor	90	05/02→05/08		04/05→;	für Linkslenker		03.2023-1741.3 010703	ATE Ø1 23,8 Ø2 20,6
C 180	95	03/01→05/02			für Linkslenker		03.2023-1741.3 010703	ATE Ø1 23,8 Ø2 20,6
C 180 Kompressor	105	05/02→05/08						
C 200 Kompressor	120	03/01→05/08						
C 220	120	05/02→05/08						
C 220 CDI	100 - 110	03/01→05/08						
C 230 Kompressor	141 - 145	03/01→05/08						
C 200 CDI	90	03/03→05/08		07/03→;	für Linkslenker		03.2023-1741.3 010703	ATE Ø1 23,8 Ø2 20,6
C 200 CGI Kompressor	125	03/03→05/08						
C 230	150	01/05→05/08		06/05→;	für Linkslenker		03.2025-1741.3 010705	ATE Ø1 25,4 Ø2 20,6
C 350	200	01/05→05/08						
C 30 CDI AMG	170	09/02→05/08			für Linkslenker		03.2025-1741.3 010705	ATE Ø1 25,4 Ø2 20,6
C 320	160	09/02→05/08						
MERCEDES-BENZ - C-KLASSE T-Model (S202) 06/96→03/01								
 Bremskraftverstärker								
C 180 T	90 - 95	06/96→03/01		→ F619720			03.7760-2702.4 300090	ATE Ø 10" pneumatisch
C 200 T	100	06/96→03/01						
C 200 T D	65	10/96→03/01						
C 200 T Kompressor	120 - 141	11/96→03/01						
C 220 T D	55 - 70	06/96→03/01						
C 230 T	110	06/96→06/98						
C 250 T Turbo-D	110	06/96→03/01						
 Hauptbremszylinder								
C 180 T	90 - 95	06/96→03/01		→ F619720			24.2023-1701.3 010514	TRW Ø1 23,8 Ø2 19
C 200 T	100	06/96→03/01		F619721→			24.2023-1702.3 010534	TRW Ø1 23,8 Ø2 19
C 200 T D	65	10/96→03/01						
C 200 T Kompressor	141	11/96→03/01						
C 220 T D	55 - 70	06/96→03/01						
C 250 T Turbo-D	110	06/96→03/01						
C 200 T CDI	75	03/98→03/01					24.2023-1702.3 010534	TRW Ø1 23,8 Ø2 19
C 220 T CDI	92	09/97→03/01						
C 230 T Kompressor	142	06/97→09/00						
C 200 T Kompressor	120	09/00→03/01		→ F619720			24.2023-1701.3 010514	TRW Ø1 23,8 Ø2 19
				F619621→			24.2023-1702.3 010534	TRW Ø1 23,8 Ø2 19
C 230 T	110	06/96→06/98		→ F619720			24.2023-1701.3 010514	TRW Ø1 23,8 Ø2 19
				→ 06/97; F619721→			24.2023-1702.3 010534	TRW Ø1 23,8 Ø2 19
C 240 T	125	06/97→03/01		- ESP			24.2023-1702.3 010534	TRW Ø1 23,8 Ø2 19
C 280 T	145	06/97→03/01		+ ESP			24.2023-1704.3 010635	TRW Ø 23,8
C 43 AMG	225	08/97→03/01		für Linkslenker; → F737081			24.2025-1703.3 010516	Ø1 25,4 Ø2 19
				für Rechtslenker			24.2025-1709.3 010693	Ø 25,4
				für Linkslenker; F737082→			24.2025-1709.3 010693	Ø 25,4











	kw			 	! #		
MERCEDES-BENZ - C-KLASSE T-Model (S203) 03/01→08/07							
Bremskraftverstärker							
C 180	95	03/01→05/02		für Linkslenker		03.7848-2002.4 300166	ATE Ø 7 / 8" pneumatisch
C 180 Kompressor	105	05/02→08/07					
C 200 CDI	75 - 90	03/01→08/07					
C 200 CGI Kompressor	125	07/03→08/07					
C 200 Kompressor	120	05/02→08/07					
C 220 CDI	100 - 110	03/01→08/07					
C 230 Kompressor	141	02/04→08/07					
C 240	125	03/01→08/07					
C 240 4-matic	125	07/02→08/07					
C 270 CDI	120 - 125	03/01→08/07					
C 30 CDI AMG	170	01/03→08/07					
C 320	160	03/01→08/07					
C 320 4-matic	160	07/02→08/07					
C 320 CDI	165	06/05→08/07					
C 32 AMG Kompressor	260	03/01→08/07					
C 55 AMG	270	02/04→08/07					
C 200 Kompressor	120	03/01→05/02		→ 04/02; für Linkslenker		03.7848-2002.4 300166	ATE Ø 7 / 8" pneumatisch
C 230	150	01/05→08/07		06/05→; für Linkslenker		03.7848-2002.4 300166	ATE Ø 7 / 8" pneumatisch
C 280	170	01/05→08/07					
C 280 4-matic	170	01/05→08/07					
C 350	200	01/05→08/07					
C 350 4-matic	200	01/05→08/07					
Pedalwegsensoren, Bremspedal							
C 180	95	03/01→05/02				03.0655-0007.2 370007	ATE
C 180 Kompressor	105	05/02→08/07					
C 200 CDI	75 - 90	03/01→08/07					
C 200 CGI Kompressor	125	07/03→08/07					
C 200 Kompressor	120	05/02→08/07					
C 220 CDI	100 - 110	03/01→08/07					
C 230 Kompressor	141	02/04→08/07					
C 240	125	03/01→08/07					
C 240 4-matic	125	07/02→08/07					
C 270 CDI	120 - 125	03/01→08/07					
C 30 CDI AMG	170	01/03→08/07					
C 320	160	03/01→08/07					
C 320 4-matic	160	07/02→08/07					
C 320 CDI	165	06/05→08/07					
C 32 AMG Kompressor	260	03/01→08/07					
C 55 AMG	270	02/04→08/07					
C 200 Kompressor	120	03/01→05/02		→ 04/02		03.0655-0007.2 370007	ATE
C 230	150	01/05→08/07		06/05→		03.0655-0007.2 370007	ATE
C 280	170	01/05→08/07					
C 350	200	01/05→08/07					
C 350 4-matic	200	01/05→08/07					
C 280 4-matic	170	01/05→08/07		06/05→; für Linkslenker		03.0655-0007.2 370007	ATE
Hauptbremszylinder							
C 180	95	03/01→05/02		für Linkslenker		03.2023-1741.3 010703	ATE Ø1 23,8 Ø2 20,6
C 180 Kompressor	105	05/02→08/07					
C 200 CDI	75 - 90	03/01→08/07					
C 200 CGI Kompressor	125	07/03→08/07					
C 200 Kompressor	120	05/02→08/07					
C 220 CDI	100 - 110	03/01→08/07					
C 230 Kompressor	141	02/04→08/07					
C 240	125	03/01→08/07					
C 200 Kompressor	120	03/01→05/02		→ 04/02; für Linkslenker		03.2023-1741.3 010703	ATE Ø1 23,8 Ø2 20,6
C 230	150	01/05→08/07		06/05→; für Linkslenker		03.2025-1741.3 010705	ATE Ø1 25,4 Ø2 20,6
C 280	170	01/05→08/07					
C 280 4-matic	170	01/05→08/07					
C 350	200	01/05→08/07					
C 350 4-matic	200	01/05→08/07					
C 240 4-matic	125	07/02→08/07		für Linkslenker		03.2025-1741.3 010705	ATE Ø1 25,4 Ø2 20,6
C 270 CDI	120 - 125	03/01→08/07					
C 30 CDI AMG	170	01/03→08/07					
C 320	160	03/01→08/07					
C 320 4-matic	160	07/02→08/07					
C 320 CDI	165	06/05→08/07					
C 32 AMG Kompressor	260	03/01→08/07					
C 55 AMG	270	02/04→08/07					

























	kw			 	! #		
MERCEDES-BENZ - C-KLASSE T-Model (S204) 08/07→08/14							
Bremskraftverstärker							
C 180	115	02/12→08/14		für Linkslenker; für Fahrzeuge ohne Start-Stopp-Funktion	03.7745-6302.4	300261	ATE Ø 8" pneumatisch
C 180 CDI	88	04/10→08/14					
C 180 CGI	115	11/09→08/14		für Linkslenker; für Fahrzeuge mit Start-Stopp-Funktion	03.7745-8902.4	300297	ATE Ø 8" pneumatisch
C 180 Kompressor	115	01/08→08/14					
C 200 CDI	100	08/10→08/14					
C 220 CDI	120 - 125	12/08→08/14					
C 220 CDI 4-matic	125	02/13→08/14					
C 250	150	02/08→12/12					
C 250 CDI 4-matic	150	04/10→08/14					
C 250 CGI	150	07/09→08/14					
C 300	170	08/07→08/14					
C 300 CDI 4-matic	170	06/11→08/14					
C 350 CDI	165 - 195	08/07→08/14					
C 350 CDI 4-matic	170	10/09→08/14					
C 350 CGI	225	06/11→08/14					
C 63 AMG	336 - 383	02/08→08/14					
C 180 Kompressor	115	08/07→08/14		09/07→; für Linkslenker; für Fahrzeuge ohne Start-Stopp-Funktion	03.7745-6302.4	300261	ATE Ø 8" pneumatisch
C 200 CDI	100	08/07→12/09					
C 200 Kompressor	135	08/07→08/14		09/07→; für Linkslenker; für Fahrzeuge mit Start-Stopp-Funktion	03.7745-8902.4	300297	ATE Ø 8" pneumatisch
C 220 CDI	125	08/07→11/08					
C 230	150	08/07→08/14					
C 280	170	08/07→08/14					
C 320 CDI	165	08/07→08/14					
C 320 CDI 4-matic	165	08/07→12/11					
C 350	200	08/07→08/14					
C 350 CDI 4-matic	165	08/07→12/11					
C 200 CGI	135	08/07→08/14		04/09→; für Linkslenker; für Fahrzeuge ohne Start-Stopp-Funktion	03.7745-6302.4	300261	ATE Ø 8" pneumatisch
C 250 CDI	150	01/09→08/14		04/09→; für Linkslenker; für Fahrzeuge mit Start-Stopp-Funktion	03.7745-8902.4	300297	ATE Ø 8" pneumatisch
C 220 CDI	120	08/07→11/08		09/07→; für Linkslenker; für Fahrzeuge ohne Start-Stopp-Funktion	03.7745-6302.4	300261	ATE Ø 8" pneumatisch
				für Linkslenker; für Fahrzeuge ohne Start-Stopp-Funktion	03.7745-6302.4	300261	ATE Ø 8" pneumatisch
				09/07→; für Linkslenker; für Fahrzeuge mit Start-Stopp-Funktion	03.7745-8902.4	300297	ATE Ø 8" pneumatisch
				für Linkslenker; für Fahrzeuge mit Start-Stopp-Funktion	03.7745-8902.4	300297	ATE Ø 8" pneumatisch
Hauptbremszylinder							
C 180	115	02/12→08/14		für Linkslenker	03.2025-2521.3	010959	ATE Ø1 25,4 Ø2 22,2
C 180 CDI	88	04/10→08/14					
C 180 CGI	115	11/09→08/14		für Rechtslenker	24.2025-2311.3	011023	ATE Ø1 25,4 Ø2 20,6
C 180 Kompressor	115	01/08→08/14					
C 200 CDI	100	08/10→08/14					
C 220 CDI	120 - 125	12/08→08/14					
C 220 CDI 4-matic	125	02/13→08/14					
C 250	150	02/08→12/12					
C 250 CDI 4-matic	150	04/10→08/14					
C 250 CGI	150	07/09→08/14					
C 300	170	08/07→08/14					
C 300 CDI 4-matic	170	06/11→08/14					
C 350 CDI	165 - 195	08/07→08/14					
C 350 CDI 4-matic	170	10/09→08/14					
C 350 CGI	225	06/11→08/14					
C 63 AMG	336 - 383	02/08→08/14					
C 180 Kompressor	115	08/07→08/14		09/07→; für Linkslenker	03.2025-2521.3	010959	ATE Ø1 25,4 Ø2 22,2
C 200 CDI	100	08/07→12/09					
C 200 Kompressor	135	08/07→08/14		09/07→; für Rechtslenker	24.2025-2311.3	011023	ATE Ø1 25,4 Ø2 20,6
C 220 CDI	125	08/07→11/08					
C 230	150	08/07→08/14					
C 280	170	08/07→08/14					
C 320 CDI	165	08/07→08/14					
C 320 CDI 4-matic	165	08/07→12/11					
C 350	200	08/07→08/14					
C 350 CDI 4-matic	165	08/07→12/11					
C 200 CGI	135	08/07→08/14		04/09→; für Linkslenker	03.2025-2521.3	010959	ATE Ø1 25,4 Ø2 22,2
C 250 CDI	150	01/09→08/14		04/09→; für Rechtslenker	24.2025-2311.3	011023	ATE Ø1 25,4 Ø2 20,6
C 220 CDI	120	08/07→11/08		09/07→; für Linkslenker	03.2025-2521.3	010959	ATE Ø1 25,4 Ø2 22,2
				für Linkslenker	03.2025-2521.3	010959	ATE Ø1 25,4 Ø2 22,2
				09/07→; für Rechtslenker	24.2025-2311.3	011023	ATE Ø1 25,4 Ø2 20,6
				für Rechtslenker	24.2025-2311.3	011023	ATE Ø1 25,4 Ø2 20,6

	kW			 	! #		
MERCEDES-BENZ - CLA Coupe (C117) 01/13→03/19							
 Hauptbremszylinder							
AMG CLA 45 4-matic CLA 180 CLA 180 CDI / d CLA 200 CLA 200 CDI / d CLA 200 CDI / d 4-matic CLA 200 CDI CLA 220 4-matic CLA 220 CDI / d CLA 220 CDI / d 4-matic CLA 220 CDI 4-matic CLA 250 CLA 250 4-matic CLA 45 AMG 4-matic	280 90 80 110 - 115 100 100 100 135 120 - 130 120 - 130 125 155 - 160 155 - 160 265	07/15→03/19 01/13→03/19 10/13→05/18 01/13→03/19 07/14→03/19 07/14→03/19 06/13→08/14 04/16→03/19 01/13→03/19 08/14→03/19 07/14→03/19 01/13→03/19 07/13→03/19 07/13→03/19	für Linkslenker			24.4123-1718.3 011016	TRW Ø 23,8 ohne Bremsflüssigkeitsbehälter
MERCEDES-BENZ - CLA Shooting Brake (X117) 01/15→03/19							
 Hauptbremszylinder							
AMG CLA 45 4-matic CLA 180 CLA 180 d CLA 200 CLA 200 CDI / d CLA 200 CDI / d 4-matic CLA 220 4-matic CLA 220 CDI / d CLA 220 CDI / d 4-matic CLA 220 d CLA 220 d 4-matic CLA 250 CLA 250 4-matic CLA 45 AMG 4-matic	280 90 80 115 100 100 135 120 - 130 120 - 130 125 125 155 160 265	07/15→03/19 01/15→03/19 07/15→05/18 01/15→03/19 01/15→03/19 01/15→03/19 04/16→03/19 01/15→03/19 01/15→03/19 07/18→03/19 07/18→03/19 01/15→03/19 01/15→03/19 01/15→07/15	für Linkslenker			24.4123-1718.3 011016	TRW Ø 23,8 ohne Bremsflüssigkeitsbehälter
MERCEDES-BENZ - CLC-KLASSE (CL203) 05/08→06/11							
 Bremskraftverstärker							
CLC 160 CLC 180 Kompressor CLC 200 CDI CLC 200 Kompressor CLC 220 CDI CLC 350 CLC 230 CLC 250	95 105 90 135 100 - 110 200 150 150	02/09→06/11 05/08→06/11 05/08→06/11 05/08→06/11 05/08→06/11 05/08→06/11 05/08→06/11 06/09→06/11	→ 10/10; für Linkslenker für Linkslenker			03.7848-2002.4 300166 03.7848-2002.4 300166	ATE Ø 7 / 8" pneumatisch ATE Ø 7 / 8" pneumatisch
Pedalwegsensord, Bremspedal							
CLC 160 CLC 180 Kompressor CLC 200 CDI CLC 200 Kompressor CLC 220 CDI CLC 350 CLC 230 CLC 250	95 105 90 135 100 - 110 200 150 150	02/09→06/11 05/08→06/11 05/08→06/11 05/08→06/11 05/08→06/11 05/08→06/11 05/08→06/11 06/09→06/11	→ 10/10			03.0655-0007.2 370007 03.0655-0007.2 370007	ATE ATE
 Hauptbremszylinder							
CLC 160 CLC 180 Kompressor CLC 200 CDI CLC 200 Kompressor CLC 220 CDI CLC 230 CLC 250 CLC 350	95 105 90 135 100 - 110 150 150 200	02/09→06/11 05/08→06/11 05/08→06/11 05/08→06/11 05/08→06/11 05/08→06/11 06/09→06/11 05/08→06/11	→ 10/10; für Linkslenker für Linkslenker → 10/10; für Linkslenker			03.2023-1741.3 010703 03.2025-1741.3 010705 03.2025-1741.3 010705	ATE Ø1 23,8 Ø2 20,6 ATE Ø1 25,4 Ø2 20,6 ATE Ø1 25,4 Ø2 20,6
MERCEDES-BENZ - CLK (C208) 06/97→12/03							
Pedalwegsensord, Bremspedal							
CLK 200 CLK 200 Kompressor →	100 141	06/97→06/02 06/97→06/00	F 129679→			03.0655-0007.2 370007	ATE









	kw					! #		
MERCEDES-BENZ - CLK (C208) 06/97→12/03								
Pedalwegsensoren, Bremspedal								
CLK 230 Kompressor	142	06/97→06/00		F 129679→		03.0655-0007.2	370007	ATE
CLK 200 Kompressor	120	06/00→06/02				03.0655-0007.2	370007	ATE
CLK 230 Kompressor	145	06/00→06/02						
 Hauptbremszylinder								
CLK 200	100	06/97→06/02		F 129679→; für Linkslenker		03.2023-2004.3	010788	ATE Ø1 23,8 Ø2 19
CLK 200 Kompressor	141	06/97→06/00		→ F 129678; - ESP		24.2023-1702.3	010534	TRW Ø1 23,8 Ø2 19
CLK 230 Kompressor	142	06/97→06/00						
CLK 200 Kompressor	120	06/00→06/02		für Linkslenker		03.2023-2004.3	010788	ATE Ø1 23,8 Ø2 19
CLK 230 Kompressor	145	06/00→06/02						
CLK 320	160	06/97→06/02		→ F 129678; - ESP		24.2023-1702.3	010534	TRW Ø1 23,8 Ø2 19
				F 129679→		24.2023-1704.3	010635	TRW Ø 23,8
				→ F 129678; + ESP		24.2023-1704.3	010635	TRW Ø 23,8
CLK 430	205	07/98→06/02				24.2025-1709.3	010693	Ø 25,4
CLK 55 AMG	255	08/99→06/02						
MERCEDES-BENZ - CLK (C209) 05/02→03/10								
 Bremskraftverstärker								
CLK 200 CGI	125	07/03→05/09		→ 04/09; für Linkslenker		03.7848-2002.4	300166	ATE Ø 7 / 8" pneumatisch
CLK 200 Kompressor	120 - 135	09/02→05/09						
CLK 240	120 - 125	06/02→05/09						
CLK 270 CDI	125	10/02→05/09						
CLK 320	160	06/02→05/09						
CLK 500	225 - 285	06/02→05/09						
CLK 55 AMG	270	09/02→05/09						
CLK 63 AMG	354 - 373	04/06→05/09						
CLK 220 CDI	100 - 110	01/05→05/09		05/05→ 04/09; für Linkslenker		03.7848-2002.4	300166	ATE Ø 7 / 8" pneumatisch
CLK 280	170	01/05→05/09						
CLK 320 CDI	165	01/05→05/09						
CLK 350	200	01/05→05/09						
CLK 270 CDI	120	02/03→06/05		für Linkslenker		03.7848-2002.4	300166	ATE Ø 7 / 8" pneumatisch
Pedalwegsensoren, Bremspedal								
CLK 200 CGI	125	07/03→05/09		→ 04/09		03.0655-0007.2	370007	ATE
CLK 200 Kompressor	120 - 135	09/02→05/09						
CLK 240	120 - 125	06/02→05/09						
CLK 270 CDI	125	10/02→05/09						
CLK 320	160	06/02→05/09						
CLK 500	225 - 285	06/02→05/09						
CLK 55 AMG	270	09/02→05/09						
CLK 63 AMG	354 - 373	04/06→05/09						
CLK 220 CDI	100 - 110	01/05→05/09		05/05→ 04/09		03.0655-0007.2	370007	ATE
CLK 280	170	01/05→05/09						
CLK 320 CDI	165	01/05→05/09						
CLK 350	200	01/05→05/09						
CLK 270 CDI	120	02/03→06/05				03.0655-0007.2	370007	ATE
 Hauptbremszylinder								
CLK 200 CGI	125	07/03→05/09		→ 04/09; für Linkslenker; für Fahrzeuge ohne Sportpaket / für Fahrzeuge ohne AMG-Sportpaket		03.2023-1741.3	010703	ATE Ø1 23,8 Ø2 20,6
CLK 200 Kompressor	120	09/02→05/09						
CLK 270 CDI	125	10/02→05/09		→ 04/09; für Linkslenker; für Fahrzeuge mit Sportpaket / für Fahrzeuge mit AMG-Sportpaket		03.2025-1741.3	010705	ATE Ø1 25,4 Ø2 20,6
CLK 200 Kompressor	135	10/06→05/09		→ 04/09; für Linkslenker; für Fahrzeuge ohne AMG-Sportpaket / für Fahrzeuge ohne Sportpaket		03.2023-1741.3	010703	ATE Ø1 23,8 Ø2 20,6
				→ 04/09; für Linkslenker; für Fahrzeuge mit Sportpaket / für Fahrzeuge mit AMG-Sportpaket		03.2025-1741.3	010705	ATE Ø1 25,4 Ø2 20,6
CLK 220 CDI	100 - 110	01/05→05/09		05/05→ 04/09; für Linkslenker		03.2025-1741.3	010705	ATE Ø1 25,4 Ø2 20,6
CLK 280	170	01/05→05/09						
CLK 320 CDI	165	01/05→05/09						
CLK 350	200	01/05→05/09						
CLK 240	120 - 125	06/02→05/09		→ 04/09; für Linkslenker		03.2025-1741.3	010705	ATE Ø1 25,4 Ø2 20,6
→								













	kW					! #		
MERCEDES-BENZ - CLK (C209) 05/02→03/10								
 Hauptbremszylinder								
CLK 320 CLK 500	160 225 - 285	06/02→05/09 06/02→05/09		→ 04/09; für Linkslenker			03.2025-1741.3 010705	ATE Ø1 25,4 Ø2 20,6
CLK 55 AMG CLK 63 AMG	270 354 - 373	09/02→05/09 04/06→05/09						
CLK 270 CDI	120	02/03→06/05		für Linkslenker; für Fahrzeuge ohne Sportpaket / für Fahrzeuge ohne AMG-Sportpaket			03.2023-1741.3 010703	ATE Ø1 23,8 Ø2 20,6
				für Linkslenker; für Fahrzeuge mit Sportpaket / für Fahrzeuge mit AMG-Sportpaket			03.2025-1741.3 010705	ATE Ø1 25,4 Ø2 20,6
MERCEDES-BENZ - CLK Cabriolet (A208) 03/98→03/02								
Pedalwegsensor, Bremspedal								
CLK 200 CLK 200 Kompressor CLK 230 Kompressor	100 141 142	03/98→03/02 03/98→06/00 03/98→06/00		T 028296→			03.0655-0007.2 370007	ATE
CLK 200 Kompressor CLK 230 Kompressor	120 145	06/00→03/02 06/00→03/02		T 028296→			03.0655-0007.2 370007	ATE
 Hauptbremszylinder								
CLK 200 CLK 200 Kompressor CLK 230 Kompressor	100 141 142	03/98→03/02 03/98→06/00 03/98→06/00		T 028296→; für Linkslenker 06/98→; → T 028295; - ESP			03.2023-2004.3 010788 24.2023-1702.3 010534	ATE Ø1 23,8 Ø2 19 TRW Ø1 23,8 Ø2 19
CLK 200 Kompressor CLK 230 Kompressor	120 145	06/00→03/02 06/00→03/02		für Linkslenker T 028296→; für Linkslenker → T 028295; - ESP			03.2023-2004.3 010788 03.2023-2004.3 010788 24.2023-1702.3 010534	ATE Ø1 23,8 Ø2 19 ATE Ø1 23,8 Ø2 19 TRW Ø1 23,8 Ø2 19
CLK 320	160	03/98→03/02		06/98→; → T 028295; - ESP T 028296→ 06/98→; → T 028295; + ESP			24.2023-1702.3 010534 24.2023-1704.3 010635 24.2023-1704.3 010635	TRW Ø1 23,8 Ø2 19 TRW Ø 23,8 TRW Ø 23,8
CLK 430	205	09/98→03/02		06/99→			24.2025-1709.3 010693	Ø 25,4
CLK 55 AMG	255	01/00→03/02					24.2025-1709.3 010693	Ø 25,4
MERCEDES-BENZ - CLK Cabriolet (A209) 06/02→03/10								
 Bremskraftverstärker								
CLK 200 CGI CLK 200 Kompressor CLK 500 CLK 63 AMG	125 135 285 354	07/03→03/10 10/06→03/10 06/06→03/10 04/06→03/10		→ 12/09; für Linkslenker			03.7848-2002.4 300166	ATE Ø 7 / 8" pneumatisch
CLK 200 Kompressor CLK 240 CLK 320 CLK 500 CLK 55 AMG	120 125 160 225 270	02/03→03/10 02/03→03/10 02/03→03/10 02/03→03/10 06/02→03/10		05/03→ 12/09; für Linkslenker			03.7848-2002.4 300166	ATE Ø 7 / 8" pneumatisch
CLK 280 CLK 320 CDI CLK 350 CLK 63 AMG	170 165 200 354	01/05→03/10 03/05→03/10 01/05→03/10 09/06→12/09		05/05→ 12/09; für Linkslenker für Linkslenker			03.7848-2002.4 300166 03.7848-2002.4 300166	ATE Ø 7 / 8" pneumatisch ATE Ø 7 / 8" pneumatisch
Pedalwegsensor, Bremspedal								
CLK 200 CGI CLK 200 Kompressor CLK 500 CLK 63 AMG	125 135 285 354	07/03→03/10 10/06→03/10 06/06→03/10 04/06→03/10		→ 12/09			03.0655-0007.2 370007	ATE
CLK 200 Kompressor CLK 240 CLK 320 CLK 500 CLK 55 AMG	120 125 160 225 270	02/03→03/10 02/03→03/10 02/03→03/10 02/03→03/10 06/02→03/10		05/03→ 12/09			03.0655-0007.2 370007	ATE
CLK 280 CLK 320 CDI CLK 350 CLK 63 AMG	170 165 200 354	01/05→03/10 03/05→03/10 01/05→03/10 09/06→12/09		05/05→ 12/09			03.0655-0007.2 370007	ATE
 Hauptbremszylinder								
CLK 200 CGI	125	07/03→03/10		→ 12/09; für Linkslenker			03.2023-1741.3 010703	ATE Ø1 23,8 Ø2 20,6
CLK 200 Kompressor CLK 500 CLK 63 AMG	135 285 354	10/06→03/10 06/06→03/10 04/06→03/10		→ 12/09; für Linkslenker			03.2025-1741.3 010705	ATE Ø1 25,4 Ø2 20,6
CLK 200 Kompressor CLK 240 CLK 320 CLK 500	120 125 160 225	02/03→03/10 02/03→03/10 02/03→03/10 02/03→03/10		05/03→ 12/09; für Linkslenker			03.2025-1741.3 010705	ATE Ø1 25,4 Ø2 20,6













	kw					! #		
MERCEDES-BENZ - CLK Cabriolet (A209) 06/02→03/10								
 Hauptbremszylinder								
CLK 55 AMG	270	06/02→03/10		05/03→ 12/09; für Linkslenker		03.2025-1741.3 010705		ATE Ø1 25,4 Ø2 20,6
CLK 280	170	01/05→03/10		05/05→ 12/09; für Linkslenker		03.2025-1741.3 010705		ATE Ø1 25,4 Ø2 20,6
CLK 320 CDI	165	03/05→03/10						
CLK 350	200	01/05→03/10						
CLK 63 AMG	354	09/06→12/09		für Linkslenker		03.2025-1741.3 010705		ATE Ø1 25,4 Ø2 20,6
MERCEDES-BENZ - CLS (C218) 01/11→12/17								
 Bremskraftverstärker								
CLS 250 CDI / BlueTEC / d	150	04/11→12/17		für Linkslenker		03.7755-8202.4 300301		ATE Ø 9 / 8" pneumatisch
CLS 350	225	01/11→08/14						
CLS 350 CDI / d	195	01/11→08/14						
CLS 350 CDI / d 4-matic	195	09/11→08/14						
CLS 350 d 4-matic	190	04/15→12/17						
CLS 500	300	02/11→12/17						
CLS 500 4-matic	300	09/11→12/17						
CLS 63 AMG	410	01/11→12/17						
CLS 63 AMG	386	01/11→12/17		03/11→; für Linkslenker		03.7755-8202.4 300301		ATE Ø 9 / 8" pneumatisch
 Hauptbremszylinder								
CLS 220 BlueTEC / d	120 - 130	05/14→12/17		für Linkslenker		03.2126-3196.3 010968		ATE Ø 27
CLS 250 BlueTEC / d 4-matic	150	05/14→12/17						
CLS 250 CDI / BlueTEC / d	150	04/11→12/17						
CLS 350	225	01/11→08/14						
CLS 350 BlueTEC / d	185 - 190	02/13→12/17						
CLS 350 BlueTEC / d 4-matic	185	02/13→12/17						
CLS 350 CDI / d	195	01/11→08/14						
CLS 350 CDI / d 4-matic	195	09/11→08/14						
CLS 350 d 4-matic	190	04/15→12/17						
CLS 400	245	05/14→12/17						
CLS 400 4-matic	245	05/14→12/17						
CLS 500	300	02/11→12/17						
CLS 500 4-matic	300	09/11→12/17						
CLS 63 AMG	410 - 430	01/11→12/17						
CLS 63 AMG 4-matic	410 - 430	02/13→12/17						
CLS 63 AMG	386	01/11→12/17		03/11→; für Linkslenker		03.2126-3196.3 010968		ATE Ø 27
MERCEDES-BENZ - CLS (C219) 10/04→02/11								
 Hauptbremszylinder								
CLS 280	170	07/08→12/10		→ 10/10; für Linkslenker		24.2125-1745.3 010998		TRW Ø 25,4
CLS 300	170	04/09→12/10						
CLS 350	200 - 215	10/04→12/10		→ 10/10; für Rechtslenker		24.2125-1748.3 011030		TRW Ø 25,4
CLS 350 CDI	165 - 200	04/09→12/10						
CLS 500	225 - 285	10/04→12/10						
CLS 55 AMG	350	01/05→12/10						
CLS 63 AMG	378	04/06→12/10						
CLS 320 CDI	155 - 165	01/05→12/10		05/05→ 10/10; für Linkslenker		24.2125-1745.3 010998		TRW Ø 25,4
				05/05→ 10/10; für Rechtslenker		24.2125-1748.3 011030		TRW Ø 25,4
CLS 55 AMG	350	09/05→12/06		für Linkslenker		24.2125-1745.3 010998		TRW Ø 25,4
				für Rechtslenker		24.2125-1748.3 011030		TRW Ø 25,4
MERCEDES-BENZ - CLS Shooting Brake (X218) 10/12→12/17								
 Bremskraftverstärker								
CLS 250 CDI / BlueTEC / d	150	10/12→12/17		→ A 26541; für Linkslenker		03.7858-1932.4 300263		ATE Ø 9 / 8" pneumatisch
CLS 350	225	10/12→08/14						
CLS 350 CDI / d	195	10/12→08/14						
CLS 350 CDI / d 4-matic	195	10/12→08/14						
 Hauptbremszylinder								
CLS 220 BlueTEC / d	120 - 130	05/14→12/17		für Linkslenker		03.2126-3196.3 010968		ATE Ø 27
CLS 250 BlueTEC / d 4-matic	150	05/14→12/17						
CLS 250 CDI / BlueTEC / d	150	10/12→12/17						











	kW					! #		
MERCEDES-BENZ - CLS Shooting Brake (X218) 10/12→12/17								
 Hauptbremszylinder								
CLS 350	225	10/12→08/14		für Linkslenker		03.2126-3196.3	010968	ATE Ø 27
CLS 350 BlueTEC / d	185 - 190	05/14→12/17						
CLS 350 BlueTEC / d 4-matic	185	05/14→12/17						
CLS 350 CDI / d	195	10/12→08/14						
CLS 350 CDI / d 4-matic	195	10/12→08/14						
CLS 350 d 4-matic	190	04/15→12/17						
CLS 400	245	05/14→12/17						
CLS 400 4-matic	245	05/14→12/17						
CLS 500	300	10/12→12/17						
CLS 500 4-matic	300	10/12→12/17						
CLS 63 AMG	386 - 430	10/12→12/17						
CLS 63 AMG 4-matic	410 - 430	02/13→12/17						
MERCEDES-BENZ - E-KLASSE (W210) 06/95→08/03								
 Bremskraftverstärker								
E 200	100	06/95→08/00		→ A394035		03.7760-4102.4	300091	ATE Ø 10" pneumatisch
E 220 D	55 - 70	06/95→03/02						
E 230	110	06/95→06/97						
E 290 Turbo-D	95	03/96→07/99						
E 300 D	100	06/95→06/97						
E 200 D	65	01/96→03/02		10/96→; → A394035		03.7760-4102.4	300091	ATE Ø 10" pneumatisch
E 250 D	83	06/95→07/99		→ A394035		03.7760-4102.4	300091	ATE Ø 10" pneumatisch
				→ A394035; für Rechtslenker		03.7760-4102.4	300091	ATE Ø 10" pneumatisch
 Hauptbremszylinder								
E 200	100	06/95→08/00		→ A394035		03.2023-1066.3	010032	Ø1 23,8 Ø2 19
E 290 Turbo-D	95	03/96→07/99		A394036→		03.2023-1812.3	010570	Ø1 23,8 Ø2 19
E 300 D	100	06/95→06/97						
E 200 CDI	75	06/98→03/02		07/98→		03.2023-1812.3	010570	Ø1 23,8 Ø2 19
E 220 CDI	92	06/98→07/99						
E 200 CDI	85	07/99→03/02				03.2023-1812.3	010570	Ø1 23,8 Ø2 19
E 220 CDI	100 - 105	07/99→03/02						
E 200 D	65	01/96→03/02		10/96→; → A394035		03.2023-1066.3	010032	Ø1 23,8 Ø2 19
				A394036→		03.2023-1812.3	010570	Ø1 23,8 Ø2 19
E 200 Kompressor	137	06/97→03/02		09/97→		24.2025-1703.3	010516	Ø1 25,4 Ø2 19
E 430	205	06/97→03/02						
E 55 AMG	260	08/97→03/02						
E 200 Kompressor	120	08/00→03/02				24.2025-1703.3	010516	Ø1 25,4 Ø2 19
E 270 CDI	120 - 125	07/99→03/02						
E 280	150	12/96→03/02						
E 280 4-matic	150	12/96→03/02						
E 300 Turbo-D	130	12/96→07/99						
E 320	165	06/97→03/02						
E 320 4-matic	165	06/97→03/02						
E 320 CDI	145	07/99→03/02						
E 430 4-matic	205	05/99→03/02						
E 220 D	55 - 70	06/95→03/02		→ A394035		03.2023-1066.3	010032	Ø1 23,8 Ø2 19
				→ 06/98; A394036→		03.2023-1812.3	010570	Ø1 23,8 Ø2 19
E 230	110	06/95→06/97		→ A394035		03.2023-1066.3	010032	Ø1 23,8 Ø2 19
E 240	125	06/97→08/00		09/97→; - ESP		03.2023-1812.3	010570	Ø1 23,8 Ø2 19
				09/97→; + ESP		24.2025-1703.3	010516	Ø1 25,4 Ø2 19
E 240	125	08/00→03/02		- ESP		03.2023-1812.3	010570	Ø1 23,8 Ø2 19
				+ ESP		24.2025-1703.3	010516	Ø1 25,4 Ø2 19
E 250 D	83	06/95→07/99		→ A394035		03.2023-1066.3	010032	Ø1 23,8 Ø2 19
				→ A394035; für Rechtslenker		03.2023-1066.3	010032	Ø1 23,8 Ø2 19
				A394036→		03.2023-1812.3	010570	Ø1 23,8 Ø2 19
				A394036→; für Rechtslenker		03.2023-1812.3	010570	Ø1 23,8 Ø2 19
E 250 Turbo-D	110	06/97→07/99		09/97→		03.2023-1812.3	010570	Ø1 23,8 Ø2 19
E 280	142	01/96→06/97		→ 09/96		24.2025-1702.3	010515	Ø1 25,4 Ø2 19
E 320	162	06/95→06/97		10/96→		24.2025-1703.3	010516	Ø1 25,4 Ø2 19
E 420	205	01/96→06/97				24.2025-1702.3	010515	Ø1 25,4 Ø2 19
E 50 AMG	255	02/96→08/97						













	kW			 	! #		
MERCEDES-BENZ - E-KLASSE (W211) 03/02→03/09							
 Hauptbremszylinder							
E 200 CDI	75 - 100	07/02→12/08		für Linkslenker		24.2125-1745.3 010998	TRW Ø 25,4
E 200 Kompressor	120 - 135	11/02→12/08		für Rechtslenker		24.2125-1748.3 011030	TRW Ø 25,4
E 200 NGT	120	03/04→12/08					
E 220 CDI	100 - 125	03/02→12/08					
E 230	150	09/07→12/08					
E 240	130	03/02→12/08					
E 240 4-matic	130	03/03→12/08					
E 270 CDI	120 - 130	03/02→12/08					
E 280 4-matic	170	01/06→12/08					
E 280 CDI	130 - 140	05/04→12/08					
E 280 CDI 4-matic	140	03/05→12/08					
E 300 BlueTEC	155	09/07→12/08					
E 320	165	03/02→12/08					
E 320 4-matic	165	03/03→12/08					
E 320 CDI	156	09/06→12/08					
E 320 CDI	150 - 165	11/02→12/08					
E 320 CDI 4-matic	165	03/05→12/08					
E 350	200	03/05→12/08					
E 350 4-matic	200	03/05→12/08					
E 350 CGI	215	09/07→12/08					
E 420 CDI	231	01/06→12/08					
E 500	225 - 285	03/02→12/08					
E 500 4-matic	225 - 285	10/03→12/08					
E 55 AMG Kompressor	350	10/02→12/08					
E 63 AMG	378	03/06→12/08					
E 280	170	03/05→12/08		05/05→; für Linkslenker		24.2125-1745.3 010998	TRW Ø 25,4
				05/05→; für Rechtslenker		24.2125-1748.3 011030	TRW Ø 25,4
E 400 CDI	191	02/03→12/08		03/03→; für Linkslenker		24.2125-1745.3 010998	TRW Ø 25,4
				03/03→; für Rechtslenker		24.2125-1748.3 011030	TRW Ø 25,4
MERCEDES-BENZ - E-KLASSE (W212) 01/09→12/16							
 Bremskraftverstärker							
E 180	115	08/13→12/15		für Linkslenker		03.7755-8202.4 300301	ATE Ø 9 / 8" pneumatisch
E 200	135	01/13→12/16					
E 200 CGI	135	08/09→12/15					
E 200 NGT	115 - 120	03/11→12/15					
E 220 BlueTEC	130	05/14→12/15					
E 220 BlueTEC 4-matic	125	01/15→12/15					
E 250	155	01/13→12/16					
E 250 CDI / BlueTEC 4-matic	150	01/11→12/15					
E 300	185	07/11→12/15					
E 300 4-matic	185	07/11→12/15					
E 350	225	09/11→12/15					
E 350 4-matic	225	09/11→12/15					
E 350 BlueTEC	185 - 190	01/13→12/15					
E 350 BlueTEC 4-matic	185 - 190	01/13→12/15					
E 350 CDI	157 - 195	09/10→12/15					
E 350 CDI 4-matic	170 - 195	09/09→12/15					
E 400	245	01/13→12/16					
E 400 4-matic	245	01/13→12/16					
E 500	300	09/11→12/15					
E 500 4-matic	300	09/11→12/15					
E 63 AMG	386 - 410	12/09→12/16					
E 63 AMG 4-matic	410	01/13→12/16					
E 200 CDI / BlueTEC	100	01/09→12/15		03/09→; für Linkslenker		03.7755-8202.4 300301	ATE Ø 9 / 8" pneumatisch
E 220 CDI	120	01/09→12/15					
E 220 CDI / BlueTEC	125	01/09→12/16					
E 250 CDI / BlueTEC	150	01/09→12/16					
E 250 CGI	150	01/09→12/15					
E 300	170	01/09→12/13					
E 350	200	01/09→12/13					
E 350 4-matic	200	01/09→08/11					
E 350 BlueTEC	155	01/09→12/15					
E 350 CDI	170	01/09→12/15					
E 350 CGI	215	01/09→08/11					
E 500	285	01/09→12/11					
→							













	kw					! #		
MERCEDES-BENZ - E-KLASSE (W212) 01/09→12/16								
 Bremskraftverstärker								
E 500 4-matic	285	01/09→12/11		03/09→; für Linkslenker		03.7755-8202.4 300301		ATE Ø 9 / 8" pneumatisch
E 250	150	05/09→12/11		für Linkslenker; +SA 800		03.7755-8202.4 300301		ATE Ø 9 / 8" pneumatisch
E 300 CDI / BlueTEC	170	03/11→12/15		04/11→; für Linkslenker		03.7755-8202.4 300301		ATE Ø 9 / 8" pneumatisch
E 63 AMG	430	02/13→12/16		04/13→; für Linkslenker		03.7755-8202.4 300301		ATE Ø 9 / 8" pneumatisch
E 63 AMG 4-matic	430	02/13→12/16						
 Hauptbremszylinder								
E 180	115	08/13→12/15		für Linkslenker		03.2126-3196.3 010968		ATE Ø 27
E 200	135	01/13→12/16				03.4156-5106.3 010997		ATE Ø 27
E 200 CGI	135	08/09→12/15						
E 200 NGT	115 - 120	03/11→12/15						
E 220 BlueTEC	130	05/14→12/15						
E 220 BlueTEC 4-matic	125	01/15→12/15						
E 250	155	01/13→12/16						
E 250 CDI / BlueTEC 4-matic	150	01/11→12/15						
E 250 CGI	150	01/09→12/15						
E 300	185	07/11→12/15						
E 300 4-matic	185	07/11→12/15						
E 350	225	09/11→12/15						
E 350 4-matic	225	09/11→12/15						
E 350 BlueTEC	185 - 190	01/13→12/15						
E 350 BlueTEC 4-matic	185 - 190	01/13→12/15						
E 350 CDI	157 - 195	09/10→12/15						
E 350 CDI 4-matic	170 - 195	09/09→12/15						
E 400	245	01/13→12/16						
E 400 4-matic	245	01/13→12/16						
E 500	300	09/11→12/15						
E 500 4-matic	300	09/11→12/15						
E 63 AMG	386 - 410	12/09→12/16						
E 63 AMG 4-matic	410	01/13→12/16						
E 200 CDI / BlueTEC	100	01/09→12/15		03/09→; für Linkslenker		03.2126-3196.3 010968		ATE Ø 27
E 220 CDI	120	01/09→12/15				03.4156-5106.3 010997		ATE Ø 27
E 220 CDI / BlueTEC	125	01/09→12/16						
E 250 CDI / BlueTEC	150	01/09→12/16						
E 300	170	01/09→12/13						
E 350	200	01/09→12/13						
E 350 4-matic	200	01/09→08/11						
E 350 BlueTEC	155	01/09→12/15						
E 350 CDI	170	01/09→12/15						
E 350 CGI	215	01/09→08/11						
E 500	285	01/09→12/11						
E 500 4-matic	285	01/09→12/11						
E 250	150	05/09→12/11		für Linkslenker; → SA Code bis: 803		03.2126-3196.3 010968		ATE Ø 27
				für Linkslenker; SA Code ab: 804 →		03.4156-5106.3 010997		ATE Ø 27
E 300 CDI / BlueTEC	170	03/11→12/15		04/11→; für Linkslenker		03.2126-3196.3 010968		ATE Ø 27
						03.4156-5106.3 010997		ATE Ø 27
E 63 AMG	430	02/13→12/16		04/13→; für Linkslenker		03.2126-3196.3 010968		ATE Ø 27
E 63 AMG 4-matic	430	02/13→12/16				03.4156-5106.3 010997		ATE Ø 27
MERCEDES-BENZ - E-KLASSE Cabriolet (A124) 05/93→03/98								
 Bremskraftverstärker								
E 200	100	06/93→03/98				03.7760-2702.4 300090		ATE Ø 10" pneumatisch
E 220	110	06/93→03/98						
E 320	162	06/93→03/98						
E 36 AMG	200	05/94→03/98						
 Hauptbremszylinder								
E 200	100	06/93→03/98		→ C 164263		03.2023-0825.3 010028		Ø1 23,8 Ø2 19
E 220	110	06/93→03/98						
E 320	162	06/93→03/98						
E 36 AMG	200	05/94→03/98						
MERCEDES-BENZ - E-KLASSE Cabriolet (A207) 01/10→12/16								
 Bremskraftverstärker								
E 200	135	03/13→12/16		für Linkslenker; für Fahrzeuge ohne Start-Stopp-Funktion		03.7745-6302.4 300261		ATE Ø 8" pneumatisch
E 220 BlueTEC	130	05/14→12/16						
E 250	155	06/13→12/16		für Linkslenker; für Fahrzeuge mit Start-Stopp-Funktion		03.7745-8902.4 300297		ATE Ø 8" pneumatisch
E 300	185	04/11→12/16						
E 320	200	07/14→12/16						
→								













	kw					! #						
MERCEDES-BENZ - E-KLASSE Cabriolet (A207) 01/10→12/16												
 Bremskraftverstärker												
E 350	200 - 225	03/10→12/14		für Linkslenker; für Fahrzeuge ohne Start-Stopp-Funktion		03.7745-6302.4	300261	ATE Ø 8" pneumatisch				
E 350 BlueTEC/ d	190	05/14→12/16		für Linkslenker; für Fahrzeuge mit Start-Stopp-Funktion		03.7745-8902.4	300297	ATE Ø 8" pneumatisch				
E 350 BlueTEC	185	06/13→12/16										
E 350 CDI	195	04/11→12/13										
E 350 CGI	215	01/10→12/14										
E 400	245	06/13→12/16										
E 500	300	09/11→12/16										
E 200 CGI	135	01/10→12/16	03/10→;	für Linkslenker; für Fahrzeuge ohne Start-Stopp-Funktion		03.7745-6302.4	300261	ATE Ø 8" pneumatisch				
E 220 CDI / BlueTEC / d	125	01/10→12/16		03/10→; für Linkslenker; für Fahrzeuge mit Start-Stopp-Funktion		03.7745-8902.4	300297	ATE Ø 8" pneumatisch				
E 220 CDI	120	02/10→12/16										
E 250 CDI / BlueTEC / d	150	01/10→12/16										
E 250 CGI	150	01/10→12/16										
E 350 CDI	170	01/10→12/11										
E 500	285	01/10→12/11										
 Hauptbremszylinder												
E 200	135	03/13→12/16		für Linkslenker		03.2025-2521.3	010959	ATE Ø1 25,4 Ø2 22,2				
E 220 BlueTEC	130	05/14→12/16		für Rechtslenker		24.2025-2311.3	011023	ATE Ø1 25,4 Ø2 20,6				
E 250	155	06/13→12/16										
E 300	185	04/11→12/16										
E 320	200	07/14→12/16										
E 350	200 - 225	03/10→12/14										
E 350 BlueTEC/ d	190	05/14→12/16										
E 350 BlueTEC	185	06/13→12/16										
E 350 CDI	195	04/11→12/13										
E 350 CGI	215	01/10→12/14										
E 400	245	06/13→12/16										
E 500	300	09/11→12/16										
E 200 CGI	135	01/10→12/16	03/10→;		für Linkslenker					03.2025-2521.3	010959	ATE Ø1 25,4 Ø2 22,2
E 220 CDI / BlueTEC / d	125	01/10→12/16			03/10→; für Rechtslenker					24.2025-2311.3	011023	ATE Ø1 25,4 Ø2 20,6
E 220 CDI	120	02/10→12/16										
E 250 CDI / BlueTEC / d	150	01/10→12/16										
E 250 CGI	150	01/10→12/16										
E 350 CDI	170	01/10→12/11										
E 500	285	01/10→12/11										
MERCEDES-BENZ - E-KLASSE Coupe (C124) 06/93→06/97												
 Bremskraftverstärker												
E 200	100	06/93→06/97				03.7760-2702.4	300090	ATE Ø 10" pneumatisch				
E 220	110	06/93→06/97										
E 320	162	06/93→06/97										
E 36 AMG	200	05/94→06/97										
 Hauptbremszylinder												
E 200	100	06/93→06/97		→ C 164263		03.2023-0825.3	010028	Ø1 23,8 Ø2 19				
E 220	110	06/93→06/97										
E 320	162	06/93→06/97										
E 36 AMG	200	05/94→06/97										
MERCEDES-BENZ - E-KLASSE Coupe (C207) 01/09→12/16												
 Bremskraftverstärker												
E 200	135	06/13→12/16		für Linkslenker; für Fahrzeuge ohne Start-Stopp-Funktion		03.7745-6302.4	300261	ATE Ø 8" pneumatisch				
E 200 CGI	135	01/10→12/16		für Linkslenker; für Fahrzeuge mit Start-Stopp-Funktion		03.7745-8902.4	300297	ATE Ø 8" pneumatisch				
E 220 BlueTEC	130	05/14→12/16										
E 220 CDI / d	125	01/10→12/16										
E 220 CDI	120	02/10→12/14										
E 250	155	06/13→12/16										
E 300	185	04/11→06/16										
E 320	200	07/14→12/16										
E 350	225	04/11→12/14										
E 350 4-matic	225	02/13→12/16										
E 350 BlueTEC / d	190	05/14→12/16										
E 350 BlueTEC	185	06/13→12/16										
E 350 CDI	195	06/11→06/13										
E 400	245	06/13→12/16										
E 500	300	09/11→12/16										
E 250 CDI / BlueTEC / d	150	01/09→12/16	05/09→;	für Linkslenker; für Fahrzeuge ohne Start-Stopp-Funktion		03.7745-6302.4	300261	ATE Ø 8" pneumatisch				
E 250 CGI	150	01/09→12/16		05/09→; für Linkslenker; für Fahrzeuge mit Start-Stopp-Funktion		03.7745-8902.4	300297	ATE Ø 8" pneumatisch				
E 350 CDI	170	01/09→06/11										
E 350 CGI	215	01/09→12/11										
E 500	285	01/09→12/16										
 Hauptbremszylinder												
E 200	135	06/13→12/16		für Linkslenker		03.2025-2521.3	010959	ATE Ø1 25,4 Ø2 22,2				
E 200 CGI	135	01/10→12/16		für Rechtslenker		24.2025-2311.3	011023	ATE Ø1 25,4 Ø2 20,6				
E 220 BlueTEC	130	05/14→12/16										
E 220 CDI / d	125	01/10→12/16										











	kw					! #		
MERCEDES-BENZ - E-KLASSE Coupe (C207) 01/09→12/16								
 Hauptbremszylinder								
E 220 CDI	120	02/10→12/14		für Linkslenker		03.2025-2521.3	010959	ATE Ø1 25,4 Ø2 22,2
E 250	155	06/13→12/16		für Rechtslenker		24.2025-2311.3	011023	ATE Ø1 25,4 Ø2 20,6
E 300	185	04/11→06/16						
E 320	200	07/14→12/16						
E 350	225	04/11→12/14						
E 350 4-matic	225	02/13→12/16						
E 350 BlueTEC / d	190	05/14→12/16						
E 350 BlueTEC	185	06/13→12/16						
E 350 CDI	195	06/11→06/13						
E 400	245	06/13→12/16						
E 500	300	09/11→12/16						
E 250 CDI / BlueTEC / d	150	01/09→12/16		05/09→; für Linkslenker		03.2025-2521.3	010959	ATE Ø1 25,4 Ø2 22,2
E 250 CGI	150	01/09→12/16		05/09→; für Rechtslenker		24.2025-2311.3	011023	ATE Ø1 25,4 Ø2 20,6
E 350 CDI	170	01/09→06/11						
E 350 CGI	215	01/09→12/11						
E 500	285	01/09→12/16						
MERCEDES-BENZ - E-KLASSE Pritsche/Fahrgestell (VF211) 03/03→07/09								
 Hauptbremszylinder								
E 220 CDI	110 - 125	10/03→07/09		für Linkslenker; +SA 807/808 / 809		24.2125-1745.3	010998	TRW Ø 25,4
E 270 CDI	120 - 130	03/03→07/09		für Rechtslenker; +SA 807/808 / 809		24.2125-1748.3	011030	TRW Ø 25,4
E 280 CDI	140	08/05→07/09						
MERCEDES-BENZ - E-KLASSE T-Model (S210) 06/96→03/03								
 Bremskraftverstärker								
E 200 T	100	06/96→08/00		→ A394035		03.7760-4102.4	300091	ATE Ø 10" pneumatisch
E 230 T	110	06/96→06/97						
E 250 T D	83	06/96→07/99		→ A394035; für Rechtslenker; Radstand [mm]: 2.833		03.7760-4102.4	300091	ATE Ø 10" pneumatisch
				→ A394035; Radstand [mm]: 2.833		03.7760-4102.4	300091	ATE Ø 10" pneumatisch
E 290 T Turbo-D	95	06/96→07/99		→ A394035; Radstand [mm]: 2.833		03.7760-4102.4	300091	ATE Ø 10" pneumatisch
 Hauptbremszylinder								
E 200 T	100	06/96→08/00		→ A394035		03.2023-1066.3	010032	Ø1 23,8 Ø2 19
E 230 T	110	06/96→06/97		A394036→		03.2023-1812.3	010570	Ø1 23,8 Ø2 19
E 200 T Kompressor	137	06/97→03/03		09/97→		24.2025-1703.3	010516	Ø1 25,4 Ø2 19
E 250 T Turbo-D	110	06/97→07/99						
E 430 T	205	06/97→03/03						
E 55 T AMG	260	08/97→03/03						
E 200 T Kompressor	120	08/00→03/03				24.2025-1703.3	010516	Ø1 25,4 Ø2 19
E 270 T CDI	120 - 125	07/99→03/03						
E 280 T 4-matic	150	12/96→03/03						
E 300 T Turbo-D	130	12/96→07/99						
E 320 T	165	12/96→03/03						
E 320 T CDI	145	07/99→03/03						
E 430 T 4-matic	205	05/99→03/03						
E 220 T CDI	100 - 105	05/99→03/03		für Linkslenker; Radstand [mm]: 2.833		03.2023-1812.3	010570	Ø1 23,8 Ø2 19
				für Linkslenker; Radstand [mm]: 3.570		24.2025-1703.3	010516	Ø1 25,4 Ø2 19
E 220 T CDI	92	06/98→07/99		07/98→; für Linkslenker; Radstand [mm]: 2.833		03.2023-1812.3	010570	Ø1 23,8 Ø2 19
				07/98→; für Linkslenker; Radstand [mm]: 3.570		24.2025-1703.3	010516	Ø1 25,4 Ø2 19
E 240 T	125	06/97→03/03		09/97→; - ESP		03.2023-1812.3	010570	Ø1 23,8 Ø2 19
				09/97→; + ESP		24.2025-1703.3	010516	Ø1 25,4 Ø2 19
E 240 T	125	08/00→03/03		- ESP		03.2023-1812.3	010570	Ø1 23,8 Ø2 19
				+ ESP		24.2025-1703.3	010516	Ø1 25,4 Ø2 19
E 250 T D	83	06/96→07/99		→ A394035; für Rechtslenker; Radstand [mm]: 2.833		03.2023-1066.3	010032	Ø1 23,8 Ø2 19
				→ A394035; Radstand [mm]: 2.833		03.2023-1066.3	010032	Ø1 23,8 Ø2 19
				→ A394035; Radstand [mm]: 3.570		24.2025-1702.3	010515	Ø1 25,4 Ø2 19
				A394036→; Radstand [mm]: 3.570		24.2025-1703.3	010516	Ø1 25,4 Ø2 19
				A394036→; für Rechtslenker; Radstand [mm]: 2.833		24.2025-1703.3	010516	Ø1 25,4 Ø2 19
				A394036→; Radstand [mm]: 2.833		24.2025-1703.3	010516	Ø1 25,4 Ø2 19
E 280 T	150	12/96→03/03		Radstand [mm]: 3.570		24.2025-1703.3	010516	Ø1 25,4 Ø2 19
E 290 T Turbo-D	95	06/96→07/99		→ A394035; Radstand [mm]: 2.833		03.2023-1066.3	010032	Ø1 23,8 Ø2 19
				→ A394035; Radstand [mm]: 3.570		24.2025-1702.3	010515	Ø1 25,4 Ø2 19
				A394036→		24.2025-1703.3	010516	Ø1 25,4 Ø2 19
E 320 T 4-matic	165	12/96→03/03		06/97→		24.2025-1703.3	010516	Ø1 25,4 Ø2 19
→								























	kW			 	! #		
MERCEDES-BENZ - E-KLASSE T-Model (S210) 06/96→03/03							
 Hauptbremszylinder							
E 420 T	205	06/96→06/97				24.2025-1702.3 010515	Ø1 25,4 Ø2 19
MERCEDES-BENZ - E-KLASSE T-Model (S211) 02/03→07/09							
 Hauptbremszylinder							
350 CGI	215	05/06→07/09		für Linkslenker		24.2125-1745.3 010998	TRW Ø 25,4
E 200 CDI	100	04/06→07/09					
E 200 Kompressor	135	04/06→07/09					
E 200 T Kompressor	120	03/03→07/09					
E 220 CDI	100	03/03→07/09					
E 220 T CDI	110 -	03/03→07/09					
	125						
E 230 T	150	05/07→07/09					
E 240 T	130	03/03→07/09					
E 240 T 4-matic	130	07/03→07/09					
E 270 T CDI	120 -	03/03→07/09					
	130						
E 280 T CDI	130 -	05/04→07/09					
	140						
E 320 T	165	03/03→07/09					
E 320 T 4-matic	165	07/03→07/09					
E 320 T CDI	150 -	03/03→07/09					
	165						
E 350 T	200	03/05→07/09					
E 350 T 4-matic	200	03/05→07/09					
E 500 T	225 -	10/03→07/09					
	285						
E 500 T 4-matic	225 -	10/03→07/09					
	285						
E 55 T AMG Kompressor	350	07/03→07/09					
E 63 AMG	378	03/06→07/09					
E 280 T	170	03/05→07/09		05/05→; für Linkslenker		24.2125-1745.3 010998	TRW Ø 25,4
E 280 T 4-matic	170	03/05→07/09					
E 280 T CDI 4-matic	140	03/05→07/09					
E 320 T CDI 4-matic	165	03/05→07/09					
MERCEDES-BENZ - E-KLASSE T-Model (S212) 08/09→12/16							
 Bremskraftverstärker							
E 200	135	11/12→12/16		03/13→; für Linkslenker		03.7755-8202.4 300301	ATE Ø 9 / 8" pneumatisch
E 250	155	11/12→12/16					
E 200 CDI / BlueTEC	100	11/09→12/16		für Linkslenker		03.7755-8202.4 300301	ATE Ø 9 / 8" pneumatisch
E 200 CGI	135	11/09→12/16					
E 220 BlueTEC	130	05/15→12/16					
E 220 BlueTEC 4-matic	125	12/14→12/16					
E 220 CDI / BlueTEC	125	11/09→12/16					
E 250 CDI / BlueTEC	150	11/09→12/16					
E 250 CDI / BlueTEC 4-matic	150	07/10→12/16					
E 250 CGI	150	11/09→12/13					
E 300	170 -	11/09→12/16					
	185						
E 300 4-matic	185	07/11→12/16					
E 300 CDI / BlueTEC	170	11/09→12/16					
E 350	225	09/11→12/14					
E 350 4-matic	200 -	11/09→12/16					
	225						
E 350 BlueTEC	155 -	11/09→12/16					
	190						
E 350 BlueTEC 4-matic	190	07/14→12/16					
E 350 CDI	170 -	11/09→12/13					
	195						
E 350 CDI 4-matic	170 -	11/09→12/13					
	195						
E 350 CGI	215	11/09→12/11					
E 400	245	01/13→12/16					
E 400 4-matic	245	01/13→12/16					
E 500	285 -	11/09→12/16					
	300						
E 500 4-matic	300	09/11→12/16					
E 63 AMG	386 -	02/11→12/16					
	410						
E 63 AMG 4-matic	410	02/11→12/16					
E 220 CDI	120	08/09→08/14		11/09→; für Linkslenker		03.7755-8202.4 300301	ATE Ø 9 / 8" pneumatisch
E 350	200	08/09→12/11					
E 63 AMG	386	08/09→12/11					
E 350 BlueTEC	185	11/12→12/16		01/13→; für Linkslenker		03.7755-8202.4 300301	ATE Ø 9 / 8" pneumatisch
E 350 BlueTEC 4-matic	185	11/12→12/16					
E 63 AMG	430	02/13→12/16		04/13→; für Linkslenker		03.7755-8202.4 300301	ATE Ø 9 / 8" pneumatisch
E 63 AMG 4-matic	430	02/13→12/16					
→							

	kW			 	! #		
MERCEDES-BENZ - E-KLASSE T-Model (S212) 08/09→12/16							
 Hauptbremszylinder							
E 200 E 250	135 155	11/12→12/16 11/12→12/16		03/13→; für Linkslenker		03.2126-3196.3 010968 03.4156-5106.3 010997	ATE Ø 27 ATE Ø 27
E 200 CDI / BlueTEC E 200 CGI E 220 BlueTEC E 220 BlueTEC 4-matic E 220 CDI / BlueTEC E 250 CDI / BlueTEC E 250 CDI / BlueTEC 4-matic E 250 CGI E 300 E 300 4-matic E 300 CDI / BlueTEC E 350 E 350 4-matic E 350 BlueTEC E 350 BlueTEC 4-matic E 350 CDI E 350 CDI 4-matic E 350 CGI E 400 E 400 4-matic E 500 E 500 4-matic E 63 AMG E 63 AMG 4-matic	100 135 130 125 125 150 150 150 170 - 185 185 170 225 200 - 225 155 - 190 190 170 - 195 170 - 195 215 245 245 285 - 300 300 386 - 410 410	11/09→12/16 11/09→12/16 05/15→12/16 12/14→12/16 11/09→12/16 11/09→12/16 07/10→12/16 11/09→12/13 11/09→12/16 07/11→12/16 11/09→12/16 09/11→12/14 11/09→12/16 11/09→12/16 07/14→12/16 11/09→12/13 11/09→12/13 11/09→12/11 01/13→12/16 01/13→12/16 11/09→12/16 09/11→12/16 02/11→12/16 02/11→12/16		für Linkslenker		03.2126-3196.3 010968 03.4156-5106.3 010997	ATE Ø 27 ATE Ø 27
E 220 CDI E 350 E 63 AMG	120 200 386	08/09→08/14 08/09→12/11 08/09→12/11		11/09→; für Linkslenker		03.2126-3196.3 010968 03.4156-5106.3 010997	ATE Ø 27 ATE Ø 27
E 350 BlueTEC E 350 BlueTEC 4-matic	185 185	11/12→12/16 11/12→12/16		01/13→; für Linkslenker		03.2126-3196.3 010968 03.4156-5106.3 010997	ATE Ø 27 ATE Ø 27
E 63 AMG E 63 AMG 4-matic	430 430	02/13→12/16 02/13→12/16		04/13→; für Linkslenker		03.2126-3196.3 010968 03.4156-5106.3 010997	ATE Ø 27 ATE Ø 27
MERCEDES-BENZ - G-KLASSE (W461) 09/89→							
 Bremskraftverstärker							
230 GE 290 GD/G 290 D G 270 CDI G 290 TD G 280 CDI G 300 CDI	92 70 115 88 135 135	06/93→07/00 06/93→07/00 01/03→ 07/97→ 04/09→ 04/10→		für Linkslenker für Rechtslenker für Linkslenker		03.6855-1402.4 300057 03.6855-1902.4 300059 03.6855-1402.4 300057	ATE Ø 9" pneumatisch ATE Ø 9" pneumatisch ATE Ø 9" pneumatisch
 Hauptbremszylinder							
230 GE 290 GD/G 290 D G 290 TD G 270 CDI	92 70 88 115	06/93→07/00 06/93→07/00 07/97→ 01/03→				03.2125-2102.3 010207 03.2125-2102.3 010207	Ø 25,4 Ø 25,4
MERCEDES-BENZ - G-KLASSE (W463) 09/89→							
 Bremskraftverstärker							
300 GE G 270 CDI G 300 TD G 320 G 36 AMG G 400 CDI G 500 G 55 AMG	128 115 130 155 - 158 200 184 218 260 - 373	06/90→08/97 10/01→07/03 08/96→07/00 09/94→08/04 01/95→07/98 12/00→07/06 04/98→ 04/99→		für Linkslenker für Rechtslenker		03.6855-1402.4 300057 03.6855-1902.4 300059	ATE Ø 9" pneumatisch ATE Ø 9" pneumatisch
 Hauptbremszylinder							
300 GE G 270 CDI G 300 TD G 320 G 36 AMG →	128 115 130 155 - 158 200	06/90→08/97 10/01→07/03 08/96→07/00 09/94→08/04 01/95→07/98		für Linkslenker; - ABS		03.2125-2102.3 010207	Ø 25,4









	kw					! #		
MERCEDES-BENZ - G-KLASSE (W463) 09/89→								
 Hauptbremszylinder								
G 400 CDI G 500 G 55 AMG	184 218 260 - 373	12/00→07/06 04/98→ 04/99→		für Linkslenker; - ABS			03.2125-2102.3 010207	Ø 25,4
G 320 CDI G 350 CDI G 500	165 155 285	09/06→ 07/11→ 05/08→		→ 12/11			24.2125-1745.3 010998	TRW Ø 25,4
MERCEDES-BENZ - G-KLASSE Cabrio (W463) 09/89→								
 Bremskraftverstärker								
300 GE 320 GE 350 G Turbo-D G 300 TD G 320 G 400 CDI G 500	125 155 100 130 158 184 218 - 285	09/89→09/97 09/94→11/97 09/91→09/97 09/96→07/00 11/97→08/04 12/00→ 04/98→		für Linkslenker für Rechtslenker			03.6855-1402.4 300057 03.6855-1902.4 300059	ATE Ø 9" pneumatisch ATE Ø 9" pneumatisch
 Hauptbremszylinder								
300 GE 320 GE 350 G Turbo-D G 300 TD G 320 G 400 CDI G 500	125 155 100 130 158 184 218 - 285	09/89→09/97 09/94→11/97 09/91→09/97 09/96→07/00 11/97→08/04 12/00→ 04/98→		für Linkslenker; - ABS			03.2125-2102.3 010207	Ø 25,4
G 320 CDI G 350 CDI	165 155	09/06→ 07/11→					24.2125-1745.3 010998	TRW Ø 25,4
MERCEDES-BENZ - GLA-KLASSE (X156) 12/13→								
 Hauptbremszylinder								
AMG GLA 45 4-matic GLA 180 GLA 180 CDI / d GLA 200 GLA 200 CDI / d GLA 200 CDI 4-matic GLA 220 4-matic GLA 220 CDI / d GLA 220 CDI / d 4-matic GLA 220 CDI GLA 220 CDI 4-matic GLA 220 d GLA 220 d 4-matic GLA 250 GLA 250 4-matic GLA 250 Flex GLA 45 AMG 4-matic	280 90 80 110 - 115 100 100 135 120 120 125 125 130 130 155 155 155 265	07/15→ 02/15→ 07/14→ 12/13→ 12/13→ 12/13→ 01/17→ 12/13→ 12/13→ 12/13→ 12/13→ 07/15→ 07/15→ 12/13→ 12/13→ 01/15→ 05/14→		für Linkslenker			24.4123-1718.3 011016	TRW Ø 23,8 ohne Bremsflüssigkeitsbehälter
MERCEDES-BENZ - GLK-KLASSE (X204) 06/08→12/15								
 Bremskraftverstärker								
200 200 CDI 250 250 4-matic 250 CDI 4-matic 300 4-matic 350 350 CDI 4-matic	135 100 - 105 155 155 150 170 - 185 200 165 - 195	08/13→06/15 07/10→06/15 08/13→06/15 08/13→06/15 09/09→06/15 07/09→12/15 04/09→06/15 07/09→06/15		für Linkslenker; für Fahrzeuge ohne Start-Stopp-Funktion für Linkslenker; für Fahrzeuge mit Start-Stopp-Funktion			03.7745-6302.4 300261 03.7745-8902.4 300297	ATE Ø 8" pneumatisch ATE Ø 8" pneumatisch
220 CDI 220 CDI 4-matic 280 4-matic 320 CDI 4-matic 350 4-matic	120 - 125 120 - 125 170 165 200 - 225	12/08→06/15 12/08→06/15 06/08→06/09 06/08→06/15 06/08→06/15		04/09→; für Linkslenker; für Fahrzeuge ohne Start-Stopp-Funktion 04/09→; für Linkslenker; für Fahrzeuge mit Start-Stopp-Funktion 09/08→; für Linkslenker; für Fahrzeuge ohne Start-Stopp-Funktion 09/08→; für Linkslenker; für Fahrzeuge mit Start-Stopp-Funktion			03.7745-6302.4 300261 03.7745-8902.4 300297 03.7745-6302.4 300261 03.7745-8902.4 300297	ATE Ø 8" pneumatisch ATE Ø 8" pneumatisch ATE Ø 8" pneumatisch ATE Ø 8" pneumatisch
 Hauptbremszylinder								
200 →	135	08/13→06/15		für Linkslenker			03.2025-2521.3 010959	ATE Ø1 25,4 Ø2 22,2













	kW					! #		
MERCEDES-BENZ - GLK-KLASSE (X204) 06/08→12/15								
 Hauptbremszylinder								
200 CDI	100 - 105	07/10→06/15		für Linkslenker		03.2025-2521.3	010959	ATE Ø1 25,4 Ø2 22,2
250	155	08/13→06/15						
250 4-matic	155	08/13→06/15						
250 CDI 4-matic	150	09/09→06/15						
300 4-matic	170 - 185	07/09→12/15						
350	200	04/09→06/15						
350 CDI 4-matic	165 - 195	07/09→06/15						
220 CDI	120 - 125	12/08→06/15		04/09→; für Linkslenker		03.2025-2521.3	010959	ATE Ø1 25,4 Ø2 22,2
220 CDI 4-matic	120 - 125	12/08→06/15						
280 4-matic	170	06/08→06/09		09/08→; für Linkslenker		03.2025-2521.3	010959	ATE Ø1 25,4 Ø2 22,2
320 CDI 4-matic	165	06/08→06/15						
350 4-matic	200 - 225	06/08→06/15						
MERCEDES-BENZ - GL-KLASSE (X164) 09/06→12/12								
Pedalwegsensor, Bremspedal								
GL 320 CDI / 350 BlueTEC 4-matic	155	12/09→08/12		→ 06/12		03.0655-0007.2	370007	ATE
GL 350 CDI 4-matic	165 - 195	05/09→08/12						
GL 450 4-matic	250	09/06→08/12						
GL 450 CDI 4-matic	225	05/09→08/12						
GL 500 4-matic	285	09/06→12/12						
GL 320 CDI 4-matic	160 - 165	09/06→12/09				03.0655-0007.2	370007	ATE
GL 420 CDI 4-matic	225	09/06→05/09						
 Hauptbremszylinder								
GL 320 CDI / 350 BlueTEC 4-matic	155	12/09→08/12		→ 06/12		03.4156-0014.3	010930	ATE Ø 27 ohne Bremsflüssigkeitsbehälter
GL 350 CDI 4-matic	165 - 195	05/09→08/12						
GL 450 4-matic	250	09/06→08/12						
GL 450 CDI 4-matic	225	05/09→08/12						
GL 500 4-matic	285	09/06→12/12						
GL 320 CDI 4-matic	160 - 165	09/06→12/09				03.4156-0014.3	010930	ATE Ø 27 ohne Bremsflüssigkeitsbehälter
GL 420 CDI 4-matic	225	09/06→05/09						
MERCEDES-BENZ - M-KLASSE (W163) 02/98→07/05								
Pedalwegsensor, Bremspedal								
ML 270 CDI	120	12/99→06/05				03.0655-0007.2	370007	ATE
ML 350	173	02/03→06/05						
ML 400 CDI	184	09/01→06/05						
ML 500	215	09/01→06/05						
ML 55 AMG	255	02/00→06/05						
ML 320	160	02/98→08/02		03/98→; + ESP		03.0655-0007.2	370007	ATE
ML 350	180	08/02→06/05		09/02→		03.0655-0007.2	370007	ATE
ML 430	200	02/98→06/05		09/98→		03.0655-0007.2	370007	ATE
 Hauptbremszylinder								
ML 230	110	02/98→06/05		03/98→		03.2125-7310.3	010743	ATE Ø 25,4
ML 320	160	02/98→08/02						
ML 270 CDI	120	12/99→06/05				03.2125-7310.3	010743	ATE Ø 25,4
ML 350	173	02/03→06/05						
ML 400 CDI	184	09/01→06/05						
ML 500	215	09/01→06/05						
ML 55 AMG	255	02/00→06/05						
ML 350	180	08/02→06/05		09/02→		03.2125-7310.3	010743	ATE Ø 25,4
ML 430	200	02/98→06/05		09/98→		03.2125-7310.3	010743	ATE Ø 25,4
MERCEDES-BENZ - M-KLASSE (W164) 02/05→12/12								
Pedalwegsensor, Bremspedal								
ML 280 CDI 4-matic	140	07/05→07/09				03.0655-0007.2	370007	ATE
ML 320 CDI 4-matic	155 - 165	07/05→07/11						
ML 350 CDI 4-matic	157	09/09→12/10						
ML 63 AMG 4-matic	375	09/06→12/11						
ML 300 4-matic	170	03/10→12/11		→ 05/11		03.0655-0007.2	370007	ATE
ML 300 CDI 4-matic	140 - 150	07/09→12/11						
ML 350 4-matic	200	02/05→12/11						
→								

	kW					! #		
MERCEDES-BENZ - M-KLASSE (W164) 02/05→12/12								
Pedalwegsensoren, Bremspedal								
ML 350 CDI 4-matic	155 - 170	07/09→12/11			→ 05/11		03.0655-0007.2 370007	ATE
ML 450 CDI 4-matic	225	09/09→12/11						
ML 500 4-matic	225 - 285	07/05→12/11						
ML 63 AMG 4-matic	375	01/06→12/11						
ML 420 CDI 4-matic	225	02/06→09/09			04/06→		03.0655-0007.2 370007	ATE
 Hauptbremszylinder								
ML 280 CDI 4-matic	140	07/05→07/09					03.4156-0014.3 010930	ATE Ø 27 ohne Bremsflüssigkeitsbehälter
ML 320 CDI 4-matic	155 - 165	07/05→07/11						
ML 350 CDI 4-matic	157	09/09→12/10						
ML 63 AMG 4-matic	375	09/06→12/11						
ML 300 4-matic	170	03/10→12/11			→ 05/11		03.4156-0014.3 010930	ATE Ø 27 ohne Bremsflüssigkeitsbehälter
ML 300 CDI 4-matic	140 - 150	07/09→12/11						
ML 350 4-matic	200	02/05→12/11						
ML 350 CDI 4-matic	155 - 170	07/09→12/11						
ML 450 CDI 4-matic	225	09/09→12/11						
ML 500 4-matic	225 - 285	07/05→12/11						
ML 63 AMG 4-matic	375	01/06→12/11						
ML 420 CDI 4-matic	225	02/06→09/09			04/06→		03.4156-0014.3 010930	ATE Ø 27 ohne Bremsflüssigkeitsbehälter
MERCEDES-BENZ - R-KLASSE (W251, V251) 08/05→10/17								
Pedalwegsensoren, Bremspedal								
R 280	170	01/07→12/14					03.0655-0007.2 370007	ATE
R 280 CDI	140	05/06→12/12						
R 280 CDI 4-matic	140	05/06→12/12						
R 300	170	07/09→12/14						
R 300 CDI	140	07/09→12/12						
R 300 CDI 4-matic	140	07/09→12/12						
R 320 CDI 4-matic	155 - 165	01/06→12/12						
R 350	200	01/07→12/12						
R 350 4-matic	200	08/05→12/12						
R 350 CDI 4-matic	165 - 195	07/09→12/14						
R 350 CGI 4-matic	225	10/11→12/14						
R 500 4-matic	225 - 285	08/05→12/14						
R 63 AMG 4-matic	375	02/06→12/10						
R 350 CDI 4-matic	155	01/06→12/14			05/09→		03.0655-0007.2 370007	ATE
 Hauptbremszylinder								
R 280	170	01/07→12/14					03.4156-0014.3 010930	ATE Ø 27 ohne Bremsflüssigkeitsbehälter
R 280 CDI	140	05/06→12/12						
R 280 CDI 4-matic	140	05/06→12/12						
R 300	170	07/09→12/14						
R 300 CDI	140	07/09→12/12						
R 300 CDI 4-matic	140	07/09→12/12						
R 320 CDI 4-matic	155 - 165	01/06→12/12						
R 350	200	01/07→12/12						
R 350 4-matic	200	08/05→12/12						
R 350 CDI 4-matic	165 - 195	07/09→12/14						
R 350 CGI 4-matic	225	10/11→12/14						
R 500 4-matic	225 - 285	08/05→12/14						
R 63 AMG 4-matic	375	02/06→12/10						
R 350 CDI 4-matic	155	01/06→12/14			05/09→		03.4156-0014.3 010930	ATE Ø 27 ohne Bremsflüssigkeitsbehälter
MERCEDES-BENZ - S-KLASSE (W140) 02/91→10/98								
 Bremskraftverstärker								
300 SE	170	03/91→10/98			A 358833→; für Linkslenker		03.7858-0102.4 300262	ATE Ø 9 / 8" pneumatisch
SEL/S320	170	03/91→10/98						
300 SE 2.8	145	01/93→10/98						
S 280	142	02/93→10/98						
S 300 Turbo-D	130	05/96→10/98						
S 350 Turbo-D	110	01/93→10/98			A 358833→; → 06/96; für Linkslenker		03.7858-0102.4 300262	ATE Ø 9 / 8" pneumatisch
 Hauptbremszylinder								
300 SE	170	03/91→10/98			07/93→; → A212244		03.2025-0211.3 010034	Ø1 25,4 Ø2 19
→								













	kw					! #		
MERCEDES-BENZ - S-KLASSE (W140) 02/91→10/98								
 Hauptbremszylinder								
SEL/S320	170	03/91→10/98		04/91→ 06/93		03.2025-0211.3 010034		Ø1 25,4 Ø2 19
				A212245→		24.2025-1702.3 010515		Ø1 25,4 Ø2 19
300 SE 2.8 S 280	145 142	01/93→10/98 02/93→10/98		07/93→; → A212244		03.2025-0211.3 010034		Ø1 25,4 Ø2 19
				→ 06/93		03.2025-0211.3 010034		Ø1 25,4 Ø2 19
				A212245→		24.2025-1702.3 010515		Ø1 25,4 Ø2 19
400 SE SEL/S420 500 SE SEL	210 210 240 240	02/91→10/98 02/91→10/98 02/91→10/98 02/91→10/98		07/93→; → A358832; für Linkslenker		03.2026-0462.3 010728		Ø1 27 Ø2 25,4
				→ 06/93; A110607→; für Linkslenker		03.2026-0462.3 010728		Ø1 27 Ø2 25,4
S 300 Turbo-D	130	05/96→10/98				24.2025-1702.3 010515		Ø1 25,4 Ø2 19
S 350 Turbo-D	110	01/93→10/98		07/93→; → A212244		03.2025-0211.3 010034		Ø1 25,4 Ø2 19
				03/93→ 06/93		03.2025-0211.3 010034		Ø1 25,4 Ø2 19
				→ 06/96; A212245→		24.2025-1702.3 010515		Ø1 25,4 Ø2 19
S 420 S 500 S 600	205 235 290	01/93→10/98 01/93→10/98 01/93→10/98		07/93→; → A358832; für Linkslenker		03.2026-0462.3 010728		Ø1 27 Ø2 25,4
MERCEDES-BENZ - S-KLASSE (W220) 09/98→08/05								
 Hauptbremszylinder								
S 280 S 320 S 430 S 500	150 165 205 220 - 225	10/98→08/05 10/98→08/05 10/98→08/05 10/98→08/05		11/98→		24.4025-1701.3 010719		Ø 25,4
S 320 CDI	145 - 150	08/99→08/05				24.4025-1701.3 010719		Ø 25,4
S 350 S 350 4-matic S 400 CDI S 430 4-matic S 500 4-matic S 55 AMG S 55 AMG Kompressor S 600	180 180 191 205 225 265 368 270 - 368	09/02→08/05 06/03→08/05 06/03→08/05 09/02→08/05 09/02→08/05 04/99→08/05 06/02→08/05 01/00→08/05						
S 63 AMG S 65 AMG	326 450	09/01→08/05 03/04→08/05						
S 400 CDI	184	06/00→08/05		08/00→		24.4025-1701.3 010719		Ø 25,4
MERCEDES-BENZ - S-KLASSE (W221) 09/05→12/13								
 Bremskraftverstärker								
S 280 S 300 S 320 CDI S 320 CDI 4-matic	170 170 173 155 - 173	08/06→12/13 08/06→12/13 12/05→06/09 10/05→12/13		→ A 265574		03.7858-1932.4 300263		ATE Ø 9 / 8" pneumatisch
S 350 4-matic S 350 CDI	200 155 - 173	02/08→12/13 06/09→12/13						
S 350 CDI 4-matic	155 - 173	01/09→07/13						
S 420 CDI S 450 CDI S 63 AMG	235 235 400 - 420	10/06→12/09 01/09→12/13 03/11→12/13						
S 320 CDI S 350 S 500	155 200 285	10/05→12/13 10/05→12/13 10/05→12/13		12/05→; → A 265574		03.7858-1932.4 300263		ATE Ø 9 / 8" pneumatisch
S 450 S 450 4-matic S 500 4-matic	250 250 285	12/05→12/13 12/05→12/13 10/05→12/13		04/06→; → A 265574		03.7858-1932.4 300263		ATE Ø 9 / 8" pneumatisch
S 63 AMG	386	10/06→12/13		01/07→; → A 265574		03.7858-1932.4 300263		ATE Ø 9 / 8" pneumatisch
Pedalwegsensor, Bremspedal								
S 250 CDI S 350 BlueTec S 350 BlueTEC 4-matic S 350 CGI S 350 CGI 4-matic S 500 CGI S 500 CGI 4-matic S 550	150 190 190 225 225 320 320 320	01/11→12/13 04/11→12/13 04/11→12/13 04/11→12/13 04/11→12/13 03/11→12/13 09/11→12/13		→ 05/13; für Fahrzeuge mit autom. Distanzregelung		03.0655-0007.2 370007		ATE
S 280 S 300 S 320 CDI 4-matic S 350 4-matic	170 170 173 200	08/06→12/13 08/06→12/13 10/06→12/13 02/08→12/13		→ A 265574		03.0655-0007.2 370007		ATE
				A 265575→; → 05/13; für Fahrzeuge mit autom. Distanzregelung		03.0655-0007.2 370007		ATE















	kw			 	! #		
MERCEDES-BENZ - S-KLASSE (W221) 09/05→12/13							
Pedalwegsensor, Bremspedal							
S 350 CDI	155 - 173	06/09→12/13		→ A 265574		03.0655-0007.2 370007	ATE
				A 265575→; → 05/13; für Fahrzeuge mit autom. Distanzregelung		03.0655-0007.2 370007	ATE
S 320 CDI	155	10/05→12/13		12/05→; → A 265574		03.0655-0007.2 370007	ATE
S 350	200	10/05→12/13		A 265575→; → 05/13; für Fahrzeuge mit autom. Distanzregelung		03.0655-0007.2 370007	ATE
S 500	285	10/05→12/13					
S 320 CDI	173	12/05→06/09		→ A 265574		03.0655-0007.2 370007	ATE
S 320 CDI 4-matic	155	10/05→12/13		A 265575→; für Fahrzeuge mit autom. Distanzregelung		03.0655-0007.2 370007	ATE
S 350 CDI 4-matic	155 - 173	01/09→07/13					
S 420 CDI	235	10/06→12/09					
S 450 CDI	235	01/09→12/13					
S 400 Hybrid	220	09/09→12/13				03.0655-0007.2 370007	ATE
S 400 Hybrid	205	01/09→12/13		06/09→ 05/13		03.0655-0007.2 370007	ATE
S 450	250	12/05→12/13		04/06→; → A 265574		03.0655-0007.2 370007	ATE
S 450 4-matic	250	12/05→12/13		A 265575→; → 05/13; für Fahrzeuge mit autom. Distanzregelung		03.0655-0007.2 370007	ATE
S 500 4-matic	285	10/05→12/13					
S 600	380	12/05→12/13		für Fahrzeuge ohne Start-Stopp-Funktion; → 05/13		03.0655-0007.2 370007	ATE
				A 060621→; für Fahrzeuge ohne Start-Stopp-Funktion; → 05/13		03.0655-0007.2 370007	ATE
				→ A 060620; für Fahrzeuge ohne Start-Stopp-Funktion		03.0655-0007.2 370007	ATE
S 63 AMG	400 - 420	03/11→12/13		→ A 265574		03.0655-0007.2 370007	ATE
				A 265575→; → 05/13; für Fahrzeuge mit autom. Distanzregelung		03.0655-0007.2 370007	ATE
				→ 05/13		03.0655-0007.2 370007	ATE
S 63 AMG	386	10/06→12/13		01/07→; → A 265574		03.0655-0007.2 370007	ATE
				A 265575→; → 05/13; für Fahrzeuge mit autom. Distanzregelung		03.0655-0007.2 370007	ATE
				01/07→ 05/13		03.0655-0007.2 370007	ATE
S 65 AMG	450	12/05→12/13		A 060621→; → 05/13		03.0655-0007.2 370007	ATE
				04/06→; → A 060620		03.0655-0007.2 370007	ATE
				04/06→ 05/13		03.0655-0007.2 370007	ATE
S 65 AMG	463	10/10→12/13		→ A 060620		03.0655-0007.2 370007	ATE
				A 060621→; → 05/13		03.0655-0007.2 370007	ATE
				→ 05/13		03.0655-0007.2 370007	ATE
 Hauptbremszylinder							
S 250 CDI	150	01/11→12/13		→ 05/13		03.4156-0073.3 010942	ATE Ø 27
S 350 BlueTec	190	04/11→12/13					
S 350 BlueTEC 4-matic	190	04/11→12/13					
S 350 CGI	225	04/11→12/13					
S 350 CGI 4-matic	225	04/11→12/13					
S 500 CGI	320	04/11→12/13					
S 500 CGI 4-matic	320	03/11→12/13					
S 550	320	09/11→12/13					
S 280	170	08/06→12/13		→ A 293047; nicht für gepanzerte Fahrzeuge		03.4055-0013.3 010793	ATE Ø 25,4
S 300	170	08/06→12/13					
S 320 CDI 4-matic	173	10/06→12/13		A 293048→; → 05/13; nicht für gepanzerte Fahrzeuge		03.4156-0073.3 010942	ATE Ø 27
S 350 4-matic	200	02/08→12/13					
S 350 CDI	155 - 173	06/09→12/13					
S 600	380	12/05→12/13					
S 63 AMG	400 - 420	03/11→12/13					
S 65 AMG	463	10/10→12/13					
S 320 CDI	155	10/05→12/13		12/05→; → A 293047; nicht für gepanzerte Fahrzeuge		03.4055-0013.3 010793	ATE Ø 25,4
S 350	200	10/05→12/13		A 293048→; → 05/13; nicht für gepanzerte Fahrzeuge		03.4156-0073.3 010942	ATE Ø 27
S 500	285	10/05→12/13					
S 320 CDI	173	12/05→06/09		→ A 293047; nicht für gepanzerte Fahrzeuge		03.4055-0013.3 010793	ATE Ø 25,4
S 320 CDI 4-matic	155	10/05→12/13					
S 350 CDI 4-matic	155 - 173	01/09→07/13		A 293048→; nicht für gepanzerte Fahrzeuge		03.4156-0073.3 010942	ATE Ø 27
S 420 CDI	235	10/06→12/09					
S 450 CDI	235	01/09→12/13					
S 400 Hybrid	220	09/09→12/13				03.4155-5141.3 010969	ATE Ø 25,4
S 400 Hybrid	205	01/09→12/13		06/09→ 05/13		03.4155-5141.3 010969	ATE Ø 25,4
S 450	250	12/05→12/13		04/06→; → A 293047; nicht für gepanzerte Fahrzeuge		03.4055-0013.3 010793	ATE Ø 25,4
S 450 4-matic	250	12/05→12/13					
S 500 4-matic	285	10/05→12/13		A 293048→; → 05/13; nicht für gepanzerte Fahrzeuge		03.4156-0073.3 010942	ATE Ø 27
S 65 AMG	450	12/05→12/13					
→							











	kw					! #		
MERCEDES-BENZ - S-KLASSE (W221) 09/05→12/13								
 Hauptbremszylinder								
S 63 AMG	386	10/06→12/13		01/07→; → A 293047; nicht für gepanzerte Fahrzeuge		03.4055-0013.3	010793	ATE Ø 25,4
				A 293048→; → 05/13; nicht für gepanzerte Fahrzeuge		03.4156-0073.3	010942	ATE Ø 27
MERCEDES-BENZ - S-KLASSE Coupe (C140) 07/92→12/99								
 Hauptbremszylinder								
500 SEC / CL 500 SEC/CL 600	235 290	10/92→12/99 09/92→02/99		06/96→; für Linkslenker		03.2026-0462.3	010728	Ø1 27 Ø2 25,4
				07/93→; → A358832; für Linkslenker		03.2026-0462.3	010728	Ø1 27 Ø2 25,4
				→ 06/93; A110607→; für Linkslenker		03.2026-0462.3	010728	Ø1 27 Ø2 25,4
SEC/CL 420	205	10/94→02/99		→ 05/96; für Linkslenker		03.2026-0462.3	010728	Ø1 27 Ø2 25,4
				06/96→; für Linkslenker		03.2026-0462.3	010728	Ø1 27 Ø2 25,4
MERCEDES-BENZ - S-KLASSE Coupe (C215) 03/99→12/06								
 Hauptbremszylinder								
CL 500 CL 55 AMG CL 55 AMG Kompressor CL 600 CL 65 AMG	225 265 368 270 - 368 450	03/99→03/06 10/99→03/06 06/02→03/06 03/99→03/06 09/03→03/06				24.4025-1701.3	010719	Ø 25,4
MERCEDES-BENZ - S-KLASSE Coupe (C216) 05/06→12/13								
 Bremskraftverstärker								
CL 500 CL 600	285 380	06/06→12/13 05/06→12/13		07/06→; → A 024306		03.7858-1932.4	300263	ATE Ø 9 / 8" pneumatisch
CL 500 CL 500 4-matic CL 63 AMG	320 320 386 - 420	02/11→12/13 02/11→12/13 09/07→12/13		→ A 024306		03.7858-1932.4	300263	ATE Ø 9 / 8" pneumatisch
CL 65 AMG	463	02/11→12/13						
CL 500 4-matic	285	02/08→12/13		03/08→; → A 024306		03.7858-1932.4	300263	ATE Ø 9 / 8" pneumatisch
CL 63 AMG CL 65 AMG	386 450	10/06→12/13 10/06→12/10		01/07→; → A 024306		03.7858-1932.4	300263	ATE Ø 9 / 8" pneumatisch
Pedalwegsensord, Bremspedal								
CL 500 CL 600	285 380	06/06→12/13 05/06→12/13		A 024307→		03.0655-0007.2	370007	ATE
				07/06→; → A 024306		03.0655-0007.2	370007	ATE
CL 500 CL 500 4-matic CL 63 AMG	320 320 386 - 420	02/11→12/13 02/11→12/13 09/07→12/13		A 024307→		03.0655-0007.2	370007	ATE
				→ A 024306		03.0655-0007.2	370007	ATE
CL 65 AMG	463	02/11→12/13						
CL 500 4-matic	285	02/08→12/13		A 024307→		03.0655-0007.2	370007	ATE
				03/08→; → A 024306		03.0655-0007.2	370007	ATE
CL 63 AMG CL 65 AMG	386 450	10/06→12/13 10/06→12/10		A 024307→		03.0655-0007.2	370007	ATE
				01/07→; → A 024306		03.0655-0007.2	370007	ATE
 Hauptbremszylinder								
CL 500 CL 600	285 380	06/06→12/13 05/06→12/13		07/06→; → A 024016		03.4055-0013.3	010793	ATE Ø 25,4
				A 024017→		03.4156-0073.3	010942	ATE Ø 27
CL 500 CL 500 4-matic CL 63 AMG	320 320 400 - 420	02/11→12/13 02/11→12/13 01/10→12/13				03.4156-0073.3	010942	ATE Ø 27
CL 500 4-matic	285	02/08→12/13		03/08→; → A 024016		03.4055-0013.3	010793	ATE Ø 25,4
				A 024017→		03.4156-0073.3	010942	ATE Ø 27
CL 63 AMG CL 65 AMG	386 450	10/06→12/13 10/06→12/10		01/07→; → A 024016		03.4055-0013.3	010793	ATE Ø 25,4
				A 024017→		03.4156-0073.3	010942	ATE Ø 27
CL 63 AMG CL 65 AMG	386 463	09/07→12/11 02/11→12/13		→ A 024016		03.4055-0013.3	010793	ATE Ø 25,4
				A 024017→		03.4156-0073.3	010942	ATE Ø 27
MERCEDES-BENZ - SL (R129) 03/89→09/04								
 Hauptbremszylinder								
280 320	142 170	08/93→10/01 09/93→10/01		→ F102744; für Linkslenker		03.2025-0211.3	010034	Ø1 25,4 Ø2 19
				F102745→ F148143; für Linkslenker		24.2025-1702.3	010515	Ø1 25,4 Ø2 19
500	235	09/92→10/01		08/93→; → F102744; - ESP; für Linkslenker		03.2025-0211.3	010034	Ø1 25,4 Ø2 19
→								



























	kw					! #		
MERCEDES-BENZ - SL (R129) 03/89→09/04								
 Hauptbremszylinder								
500	235	09/92→10/01		F102745→ F148143; - ESP; für Linkslenker		24.2025-1702.3	010515	Ø1 25,4 Ø2 19
60 AMG	280	05/97→10/01		→ F102744; - ESP; für Linkslenker		03.2025-0211.3	010034	Ø1 25,4 Ø2 19
				F102745→ F148143; - ESP; für Linkslenker		24.2025-1702.3	010515	Ø1 25,4 Ø2 19
MERCEDES-BENZ - SL (R230) 10/01→01/12								
 Bremskraftverstärker								
65 AMG Black Series	493	07/08→01/12		→ 11/11; für Linkslenker		03.7848-2002.4	300166	ATE Ø 7 / 8" pneumatisch
Pedalwegsensor, Bremspedal								
65 AMG Black Series	493	07/08→01/12		→ 11/11; für Linkslenker		03.0655-0007.2	370007	ATE
MERCEDES-BENZ - SL (R231) 12/11→								
 Hauptbremszylinder								
350	225	02/12→		03/12→		03.2126-3196.3	010968	ATE Ø 27
500	320	01/12→						
63 AMG	395 -	01/12→						
400	245 -	04/14→				03.2126-3196.3	010968	ATE Ø 27
	270							
500	335	04/15→						
63 AMG	420 -	04/14→						
	430							
65 AMG	463	05/12→						
MERCEDES-BENZ - SLC (R172) 01/16→								
 Bremskraftverstärker								
180	115	01/16→		für Linkslenker; für Fahrzeuge ohne Start-Stopp-Funktion		03.7745-1632.4	300293	ATE Ø 8 / 7" pneumatisch
200	135	01/16→						
250 d	150	01/16→10/17		für Linkslenker; für Fahrzeuge mit Start-Stopp-Funktion		03.7745-1832.4	300294	ATE Ø 8 / 7" pneumatisch
300	180	01/16→						
AMG SLC 43	270 -	01/16→						
	287							
MERCEDES-BENZ - SLK (R170) 04/96→04/04								
Pedalwegsensor, Bremspedal								
200 Kompressor	120	03/00→04/04		→ 03/04		03.0655-0007.2	370007	ATE
230 Kompressor	145	03/00→04/04						
32 AMG Kompressor	260	03/01→04/04						
320	160	03/00→04/04		04/00→ 03/04		03.0655-0007.2	370007	ATE
 Hauptbremszylinder								
200	100	09/96→03/00		→ F025730		24.2023-1701.3	010514	TRW Ø1 23,8 Ø2 19
200 Kompressor	141	10/96→03/00		F025731→		24.2023-1702.3	010534	TRW Ø1 23,8 Ø2 19
230 Kompressor	142	09/96→03/00						
200 Kompressor	120	03/00→04/04		→ 03/04; für Rechtslenker		03.2025-1741.3	010705	ATE Ø1 25,4 Ø2 20,6
230 Kompressor	145	03/00→04/04						
32 AMG Kompressor	260	03/01→04/04						
320	160	03/00→04/04		04/00→ 03/04; für Rechtslenker		03.2025-1741.3	010705	ATE Ø1 25,4 Ø2 20,6
MERCEDES-BENZ - SLK (R171) 03/04→12/11								
Pedalwegsensor, Bremspedal								
200 Kompressor	120 -	03/04→02/11		→ F 196638		03.0655-0007.2	370007	ATE
	135							
300	170	04/09→02/11		F 196639→; → 01/11		03.0655-0007.2	370007	ATE
350	200 -	06/04→02/11						
	224							
55 AMG	265 -	06/04→02/11						
	294							
280	170	01/05→02/11		F 196639→; → 01/11		03.0655-0007.2	370007	ATE
				04/05→; → F 196638		03.0655-0007.2	370007	ATE
 Hauptbremszylinder								
200 Kompressor	120 -	03/04→02/11		→ 01/11; für Linkslenker		03.2025-1741.3	010705	ATE Ø1 25,4 Ø2 20,6
	135							
300	170	04/09→02/11						
350	200 -	06/04→02/11						
	224							
55 AMG	265 -	06/04→02/11						
	294							
280	170	01/05→02/11		04/05→ 01/11; für Linkslenker		03.2025-1741.3	010705	ATE Ø1 25,4 Ø2 20,6













	kw			 	! #		
MERCEDES-BENZ - SLK (R172) 01/11→							
 Bremskraftverstärker							
200	135	02/11→		für Linkslenker; für Fahrzeuge ohne Start-Stopp-Funktion	03.7745-1632.4	300293	ATE Ø 8 / 7" pneumatisch
250	150	02/11→					
250 CDI / d	150	01/12→		für Linkslenker; für Fahrzeuge mit Start-Stopp-Funktion	03.7745-1832.4	300294	ATE Ø 8 / 7" pneumatisch
300	180	07/15→					
350	225	02/11→					
55 AMG	310	01/12→					
MERCEDES-BENZ - SPRINTER 2-t Bus (B901, B902) 01/95→05/06							
 Hauptbremszylinder							
208 CDI	60	04/00→05/06		→ A906425	24.2123-1711.3	010518	Ø 23,8
208 D	58	02/95→04/00		A906426→	24.2123-1754.3	010741	Ø 23,8
210 D	75	03/97→04/00					
211 CDI	80	04/00→05/06					
212 D	90	02/95→04/00					
213 CDI	95	04/00→05/06					
214	105	02/95→05/06					
214 NGT	95	02/95→05/06					
216 CDI	115	04/00→05/06					
MERCEDES-BENZ - SPRINTER 2-t Kasten (B901, B902) 01/95→05/06							
 Hauptbremszylinder							
208 CDI	60	04/00→05/06		→ A906425	24.2123-1711.3	010518	Ø 23,8
208 D	58 - 60	02/95→04/00		A906426→	24.2123-1754.3	010741	Ø 23,8
210 D	75	01/97→04/00					
211 CDI	80	04/00→05/06					
212 D	90	02/95→04/00					
213 CDI	95	04/00→05/06					
214	105	02/95→05/06					
214 NGT	95	02/95→05/06					
216 CDI	115	04/00→05/06					
MERCEDES-BENZ - SPRINTER 2-t Pritsche/Fahrgestell (B901, B902) 01/95→05/06							
 Hauptbremszylinder							
208 CDI	60	04/00→05/06		→ A906425	24.2123-1711.3	010518	Ø 23,8
208 D	60	09/96→04/00		A906426→	24.2123-1754.3	010741	Ø 23,8
210 D	75	01/97→04/00					
211 CDI	80	04/00→05/06					
212 D	90	02/95→04/00					
213 CDI	95	04/00→05/06					
214	105	02/95→05/06					
214 NGT	95	02/95→05/06					
216 CDI	115	04/00→05/06					
208 D	58	01/95→04/00		02/95→; → A906425	24.2123-1711.3	010518	Ø 23,8
				A906426→	24.2123-1754.3	010741	Ø 23,8
MERCEDES-BENZ - SPRINTER 3,5-t Bus (B906) 06/06→							
 Hauptbremszylinder							
309 CDI	65	04/12→			24.2126-1704.3	010990	TRW Ø 27
311 CDI	84	05/16→					
313 CDI	95	08/11→05/16					
313 CDI 4x4	95	08/11→05/16					
314 CDI	105	05/16→					
314 CDI 4x4	105	05/16→					
315 CDI	110	06/13→					
316 CDI	120	08/11→					
316 CDI 4x4	120	08/11→					
310 CDI	70	03/09→12/13		→ 09/09	24.2125-1750.3	011050	Ø 25,4 ohne Bremsflüssigkeitsbehälter
311 CDI	80	06/06→12/09					
311 CDI 4x4	80	02/08→12/09		10/09→	24.2126-1704.3	010990	TRW Ø 27
315 CDI	110	06/06→12/09					
315 CDI 4x4	110	02/08→12/09					
316	115	09/08→					
316 LGT	115	09/08→					
316 NGT	115	03/09→					
318 CDI	135	02/08→12/09					
318 CDI 4x4	135	02/08→12/09					
319 CDI / BlueTEC	140	03/09→					
319 CDI / BlueTEC 4x4	140	03/09→					
324	190	06/06→12/13					
MERCEDES-BENZ - SPRINTER 3,5-t Kasten (B906) 06/06→							
 Hauptbremszylinder							
309 CDI	65	06/06→12/09		→ 09/09	24.2125-1750.3	011050	Ø 25,4 ohne Bremsflüssigkeitsbehälter
310 CDI	70	03/09→					
311 CDI	80	06/06→12/09		10/09→	24.2126-1704.3	010990	TRW Ø 27
311 CDI 4x4	80	02/08→12/09					
→							

























	kw			 	! #		
MERCEDES-BENZ - SPRINTER 3,5-t Kasten (B906) 06/06 →							
 Hauptbremszylinder							
313 CDI	95	06/06 →		→ 09/09		24.2125-1750.3 011050	Ø 25,4 ohne Bremsflüssigkeitsbehälter
313 CDI 4x4	95	05/09 →					
315 CDI	110	06/06 → 12/09					
315 CDI 4x4	110	02/08 → 12/09		10/09 →		24.2126-1704.3 010990	TRW Ø 27
316	115	09/08 →					
316 CDI	120	03/09 →					
316 CDI 4x4	120	03/09 →					
316 LGT	115	09/08 →					
316 NGT	115	09/08 →					
318 CDI	135	06/06 → 12/09					
318 CDI 4x4	135	02/08 → 12/09					
319 CDI / BlueTEC	140	03/09 →					
319 CDI / BlueTEC 4x4	140	03/09 →					
324	190	06/06 → 12/13					
311 CDI	84	05/16 →				24.2126-1704.3 010990	TRW Ø 27
314 CDI	105	05/16 →					
314 CDI 4x4	105	05/16 →					
315 CDI	110	12/14 →					
MERCEDES-BENZ - SPRINTER 3,5-t Pritsche/Fahrgestell (B906) 06/06 →							
 Hauptbremszylinder							
309 CDI	65	06/06 → 12/09		→ 09/09		24.2125-1750.3 011050	Ø 25,4 ohne Bremsflüssigkeitsbehälter
310 CDI	70	03/09 → 05/16					
311 CDI	80	06/06 → 12/09					
311 CDI 4x4	80	02/08 → 12/09		10/09 →		24.2126-1704.3 010990	TRW Ø 27
313 CDI	95	06/06 → 05/16					
313 CDI 4x4	95	06/06 → 05/16					
315 CDI	110	06/06 → 12/09					
315 CDI 4x4	110	02/08 → 12/09					
316	115	09/08 →					
316 CDI	120	03/09 →					
316 CDI 4x4	120	03/09 →					
316 LGT	115	09/08 →					
316 NGT	115	09/08 →					
318 CDI	135	06/06 → 12/09					
318 CDI 4x4	135	02/08 → 12/09					
319 CDI / BlueTEC	140	03/09 →					
324	190	06/06 → 12/13					
311 CDI	84	05/16 →				24.2126-1704.3 010990	TRW Ø 27
314 CDI	105	05/16 →					
314 CDI 4x4	105	05/16 →					
319 CDI / BlueTEC 4x4	140	05/11 →					
MERCEDES-BENZ - SPRINTER 3-t Bus (B903) 01/95 → 05/12							
 Hauptbremszylinder							
308 CDI	60	04/00 → 05/06		→ A905511 / R400726		24.2123-1711.3 010518	Ø 23,8
308 D	58 - 60	02/95 → 04/00		A905512 / R400727 →		24.2123-1754.3 010741	Ø 23,8
310 D	75	01/97 → 12/99					
310 D 4x4	75	05/97 → 08/02					
311 CDI	80	04/00 → 05/06					
311 CDI 4x4	80	08/02 → 05/06					
312 D 2.9	90	02/95 → 04/00					
312 D 2.9 4x4	90	05/97 → 08/02					
313 CDI	95	04/00 → 05/06					
313 CDI 4x4	95	08/02 → 05/06					
314	105	02/95 → 05/06					
314 4x4	105	08/02 → 05/06					
314 NGT	95	02/95 → 05/06					
316 CDI	115	04/00 → 05/06					
316 CDI 4x4	115	08/02 → 05/06					
MERCEDES-BENZ - SPRINTER 3-t Bus (B906) 06/06 →							
 Hauptbremszylinder							
209 CDI	65	04/12 →				24.2126-1704.3 010990	TRW Ø 27
211 CDI	84	04/16 →					
214 CDI	105	04/16 →					
218 CDI	135	04/12 →					
210 CDI	70	03/09 → 12/13		→ 09/09		24.2125-1750.3 011050	Ø 25,4 ohne Bremsflüssigkeitsbehälter
211 CDI	80	06/06 → 12/09					
213 CDI	95	06/06 → 05/16					
215 CDI	110	06/06 → 12/09		10/09 →		24.2126-1704.3 010990	TRW Ø 27
216	115	09/08 →					
224	190	06/06 → 12/13					
216 CDI	120	06/06 →		03/09 → 09/09		24.2125-1750.3 011050	Ø 25,4 ohne Bremsflüssigkeitsbehälter
				10/09 →		24.2126-1704.3 010990	TRW Ø 27













	kW			 	! #		
MERCEDES-BENZ - SPRINTER 3-t Kasten (B903) 01/95→05/12							
 Hauptbremszylinder							
308 CDI	60	04/00→05/06		→ A905511 / R400726		24.2123-1711.3 010518	Ø 23,8
308 D 2.3	58 - 60	02/95→04/00		A905512 / R400727→		24.2123-1754.3 010741	Ø 23,8
310 D 2.9	75	02/95→04/00					
311 CDI	80	04/00→05/06					
311 CDI 4x4	80	08/02→05/06					
312 D 2.9	90	02/95→04/00					
312 D 2.9 4x4	90	05/97→08/02					
313 CDI	95	04/00→05/06					
313 CDI 4x4	95	08/02→05/06					
314	105	02/95→05/06					
314 4x4	105	08/02→05/06					
314 NGT	95	02/95→05/06					
316 CDI	115	04/00→05/06					
316 CDI 4x4	115	02/01→05/06					
MERCEDES-BENZ - SPRINTER 3-t Kasten (B906) 06/06→							
 Hauptbremszylinder							
209 CDI	65	06/06→12/09		→ 09/09		24.2125-1750.3 011050	Ø 25,4 ohne Bremsflüssigkeitsbehälter
210 CDI	70	03/09→					
211 CDI	80	06/06→12/09		10/09→		24.2126-1704.3 010990	TRW Ø 27
213 CDI	95	06/06→					
215 CDI	110	06/06→12/09					
216	115	09/08→					
216 CDI	120	03/09→					
218 CDI	135	06/06→12/09					
219 CDI / BlueTEC	140	03/09→					
224	190	06/06→					
211 CDI	84	04/16→				24.2126-1704.3 010990	TRW Ø 27
214 CDI	105	04/16→					
MERCEDES-BENZ - SPRINTER 3-t Pritsche/Fahrgestell (B903) 01/95→05/12							
 Hauptbremszylinder							
308 CDI	60	04/00→05/06		→ A905511 / R400726		24.2123-1711.3 010518	Ø 23,8
308 D 2.3	58 - 60	02/95→04/00		A905512 / R400727→		24.2123-1754.3 010741	Ø 23,8
310 D 2.9	75	01/97→04/00					
311 CDI	80	04/00→05/06					
311 CDI 4x4	80	04/00→05/06					
312 D 2.9	85 - 90	02/95→09/01					
313 CDI	95	04/00→05/06					
313 CDI 4x4	95	04/00→05/06					
314	105	02/95→05/06					
314 4x4	105	08/02→05/06					
314 NGT	95	02/95→05/06					
316 CDI	115	04/00→05/06					
316 CDI 4x4	115	08/02→05/06					
MERCEDES-BENZ - SPRINTER 3-t Pritsche/Fahrgestell (B906) 06/06→							
 Hauptbremszylinder							
209 CDI	65	06/06→12/09		→ 09/09		24.2125-1750.3 011050	Ø 25,4 ohne Bremsflüssigkeitsbehälter
210 CDI	70	03/09→05/16					
211 CDI	80	06/06→12/09		10/09→		24.2126-1704.3 010990	TRW Ø 27
213 CDI	95	06/06→05/16					
215 CDI	110	06/06→12/09					
216	115	09/08→05/16					
216 CDI	120	03/09→					
218 CDI	135	06/06→12/09					
219 CDI / BlueTEC	140	03/09→05/16					
224	190	06/06→12/13					
211 CDI	84	04/16→				24.2126-1704.3 010990	TRW Ø 27
214 CDI	105	04/16→					
MERCEDES-BENZ - SPRINTER 4,6-t Kasten (B906) 06/06→							
 Hauptbremszylinder							
411 CDI	80	06/09→12/18		→ 09/09		24.2125-1750.3 011050	Ø 25,4 ohne Bremsflüssigkeitsbehälter
413 CDI	95	06/06→05/16					
415 CDI	110	06/09→12/09		10/09→		24.2126-1704.3 010990	TRW Ø 27
416 CDI	120	03/09→					
418 CDI	135	06/09→05/16					
419 CDI	140	03/09→					
424	190	06/06→12/13					
411 CDI	84	04/16→				24.2126-1704.3 010990	TRW Ø 27
414 CDI	105	05/16→					
414 CDI 4x4	105	05/16→					
416 CDI 4x4	120	11/13→				24.2125-1750.3 011050	Ø 25,4 ohne Bremsflüssigkeitsbehälter
→							













	kw					! #		
MERCEDES-BENZ - SPRINTER 4,6-t Kasten (B906) 06/06→								
 Hauptbremszylinder								
416 CDI 4x4	120	11/13→					24.2126-1704.3 010990	TRW Ø 27
MERCEDES-BENZ - SPRINTER 4,6-t Pritsche/Fahrgestell (B906) 06/06→								
 Hauptbremszylinder								
411 CDI	80	06/09→12/18			→ 09/09		24.2125-1750.3 011050	Ø 25,4 ohne Bremsflüssigkeitsbehälter
413 CDI	95	03/09→						
415 CDI	110	06/06→12/09						
416 CDI	120	03/09→			10/09→		24.2126-1704.3 010990	TRW Ø 27
418 CDI	135	06/06→12/09						
419 CDI	140	03/09→						
424	190	06/06→12/13						
411 CDI	84	04/16→					24.2126-1704.3 010990	TRW Ø 27
414 CDI	105	05/16→						
415 CDI	110	01/12→						
MERCEDES-BENZ - SPRINTER 4-t Bus (B904) 02/96→05/06								
 Hauptbremszylinder								
408 CDI	60	04/00→05/06			→ A906425 / R400726		24.2125-1727.3 010723	Ø 25,4
411 CDI	80	04/00→05/06						
413 CDI	95	04/00→05/06			A906426 / R400727→		24.2125-1728.3 010751	Ø 25,4
414	105	02/96→05/06						
416 CDI	115	04/00→05/06						
MERCEDES-BENZ - SPRINTER 4-t Kasten (B904) 02/95→05/12								
 Hauptbremszylinder								
408 CDI	60	04/00→05/06			→ A906425 / R400726		24.2125-1727.3 010723	Ø 25,4
408 D	58	02/96→05/06						
410 D 4x4	75	05/97→05/06			A906426 / R400727→		24.2125-1728.3 010751	Ø 25,4
411 CDI	80	04/00→05/06						
411 CDI 4x4	80	04/00→05/06						
412 D	85 - 90	02/96→05/06						
412 D 4x4	85 - 90	05/97→05/06						
413 CDI	95	04/00→05/06						
413 CDI 4x4	95	04/00→05/06						
414	105	02/96→05/06						
414 4x4	105	05/97→05/06						
414 D 4x4	90	05/97→05/06						
414 NGT	95	02/95→05/06						
416 CDI	115	04/00→05/06						
416 CDI 4x4	115	04/00→05/06						
410 D	75	02/96→05/06			09/96→; → A906425 / R400726		24.2125-1727.3 010723	Ø 25,4
					A906426 / R400727→		24.2125-1728.3 010751	Ø 25,4
MERCEDES-BENZ - SPRINTER 4-t Pritsche/Fahrgestell (B904) 02/95→05/12								
 Hauptbremszylinder								
408 CDI	60	04/00→05/06			→ A906425 / R400726		24.2125-1727.3 010723	Ø 25,4
408 D	58	02/96→05/06						
410 D 4x4	75	05/97→05/06			A906426 / R400727→		24.2125-1728.3 010751	Ø 25,4
411 CDI	80	04/00→05/06						
411 CDI 4x4	80	04/00→05/06						
412 D	85 - 90	02/96→05/06						
412 D 4x4	85 - 90	05/97→05/06						
413 CDI	95	04/00→05/06						
413 CDI 4x4	95	04/00→05/06						
414	105	02/95→05/06						
414 4x4	105	05/97→05/06						
416 CDI	115	04/00→05/06						
416 CDI 4x4	115	04/00→05/06						
410 D	75	02/96→05/06			09/96→; → A906425 / R400726		24.2125-1727.3 010723	Ø 25,4
					A906426 / R400727→		24.2125-1728.3 010751	Ø 25,4
MERCEDES-BENZ - SPRINTER 5-t Bus (B906) 06/06→								
 Hauptbremszylinder								
513 CDI	95	03/09→			→ 09/09		24.2125-1750.3 011050	Ø 25,4 ohne Bremsflüssigkeitsbehälter
515 CDI	110	06/06→						
516 CDI	120	03/09→						
519 CDI	140	03/09→			10/09→		24.2126-1704.3 010990	TRW Ø 27













	kw			 	! #		
MERCEDES-BENZ - SPRINTER 5-t Kasten (B906) 06/06→							
 Hauptbremszylinder							
509 CDI	65	06/06→12/09		→ 09/09		24.2125-1750.3 011050	Ø 25,4 ohne Bremsflüssigkeitsbehälter
510 CDI	70	03/09→05/16					
511 CDI	80	06/06→12/09					
511 CDI 4x4	80	06/06→12/09		10/09→		24.2126-1704.3 010990	TRW Ø 27
513 CDI 4x4	95	06/06→					
515 CDI	110	06/06→12/09					
515 CDI 4x4	110	06/06→12/09					
516	115	03/09→					
516 CDI	120	03/09→					
516 CDI 4x4	120	06/06→					
516 NGT	115	03/09→					
518 CDI	135	06/06→12/09					
518 CDI 4x4	135	06/06→12/09					
519 CDI / BlueTEC	140	03/09→					
519 CDI / BlueTEC 4x4	140	03/09→					
524	190	06/06→12/13					
511 CDI	84	05/16→				24.2126-1704.3 010990	TRW Ø 27
514 CDI	105	05/16→					
514 CDI 4x4	105	05/16→					
515 CDI	110	06/11→					
513 CDI	95	06/06→		03/09→ 09/09		24.2125-1750.3 011050	Ø 25,4 ohne Bremsflüssigkeitsbehälter
				10/09→		24.2126-1704.3 010990	TRW Ø 27
MERCEDES-BENZ - SPRINTER 5-t Pritsche/Fahrgestell (B906) 06/06→							
 Hauptbremszylinder							
509 CDI	65	06/06→12/09		→ 09/09		24.2125-1750.3 011050	Ø 25,4 ohne Bremsflüssigkeitsbehälter
510 CDI	70	03/09→					
511 CDI	80	06/06→12/09					
511 CDI 4x4	80	06/06→12/09		10/09→		24.2126-1704.3 010990	TRW Ø 27
515 CDI	110	06/06→12/09					
515 CDI 4x4	110	06/06→12/09					
516	115	09/08→					
516 CDI	120	03/09→					
516 NGT	115	09/08→					
518 CDI	135	06/06→12/09					
518 CDI 4x4	135	06/06→12/09					
519 CDI / BlueTEC	140	03/09→					
519 CDI / BlueTEC 4x4	140	03/09→					
524	190	06/06→12/13					
511 CDI	84	05/16→				24.2126-1704.3 010990	TRW Ø 27
513 CDI 4x4	95	05/11→05/16					
514 CDI	105	05/16→					
514 CDI 4x4	105	05/16→					
515 CDI	110	06/11→					
516 CDI 4x4	120	05/11→					
513 CDI	95	06/06→05/16		03/09→ 09/09		24.2125-1750.3 011050	Ø 25,4 ohne Bremsflüssigkeitsbehälter
				10/09→		24.2126-1704.3 010990	TRW Ø 27
MERCEDES-BENZ - Vaneo (414) 02/02→07/05							
 Hauptbremszylinder							
1.6	60 - 75	02/02→07/05				24.4123-1703.3 010831	TRW Ø 23,8
1.7 CDI	55 - 67	02/02→07/05					
1.9	92	02/02→07/05					
MERCEDES-BENZ - VARIO Bus (B670) 08/96→							
 Hauptbremszylinder							
O 810	75	09/96→12/10				03.2128-1203.3 010922	ATE Ø 28,6
O 812	90	09/96→12/10					
O 813	95	01/06→12/13					
O 814	100	09/96→12/10					
O 815	112	09/96→12/10					
O 816 D	115	01/06→12/13					
O 818 D	130	09/06→		→ 12/13		03.2128-1203.3 010922	ATE Ø 28,6
MERCEDES-BENZ - VARIO Kasten (B667, B670, B668) 09/96→							
 Hauptbremszylinder							
512 D	90	09/96→12/10				03.2128-1203.3 010922	ATE Ø 28,6
612 D	90	09/96→12/10					
613 D	95 - 100	09/96→12/13					
614 D	95 - 100	09/96→12/13					
→							













	kW			 	! #		
MERCEDES-BENZ - VARIO Kasten (B667, B670, B668) 09/96→							
 Hauptbremszylinder							
615 D	112 - 115	09/98 → 12/13				03.2128-1203.3 010922	ATE Ø 28,6
616 D	112 - 115	09/98 → 12/13					
618 D	130	09/06 → 12/13					
812 D	90	09/96 → 12/10					
813 D	95 - 100	09/96 → 12/13					
814 D	95 - 100	09/96 → 12/13					
814 DA 4x4	95 - 100	09/96 → 12/13					
813 DA	95 - 100	09/96 → 12/13					
815 D	112 - 115	09/96 → 12/13					
816 D	112 - 115	09/96 → 12/13					
815 DA	112 - 115	09/96 → 12/13					
816 DA 4x4	112 - 115	09/96 → 12/13					
818 D	130	09/06 → 12/13					
MERCEDES-BENZ - VARIO Kipper 09/96→							
 Hauptbremszylinder							
612 D	90	09/96 → 12/10				03.2128-1203.3 010922	ATE Ø 28,6
613 D	95 - 100	09/96 → 12/13					
614 D	95 - 100	09/96 → 12/13					
812 D	90	09/96 → 12/10					
813 D	95 - 100	09/96 → 12/13					
814 D	95 - 100	09/96 → 12/13					
814 DA 4x4	95 - 100	09/96 → 12/13					
813 DA	95 - 100	09/96 → 12/13					
815 D	115	09/96 → 12/13					
816 D	115	09/96 → 12/13					
815 DA	112 - 115	09/96 → 12/13					
816 DA 4x4	112 - 115	09/96 → 12/13					
615 D	112 - 115	09/98 →		→ 12/13		03.2128-1203.3 010922	ATE Ø 28,6
616 D	112 - 115	09/98 →					
618 D	130	09/06 →					
818 D	130	09/06 →					
818 DA 4x4	130	09/06 →					
MERCEDES-BENZ - VARIO Pritsche/Fahrgestell (B670, B668, B667) 09/96→							
 Hauptbremszylinder							
512 D	90	09/96 → 12/10				03.2128-1203.3 010922	ATE Ø 28,6
612 D	90	09/96 → 12/10					
613 D	100	09/96 → 12/11					
614 D	100	09/96 → 12/11					
812 D	90	09/96 → 12/10					
813 D	95 - 100	09/96 → 12/13					
814 D	95 - 100	09/96 → 12/13					
814 DA 4x4	95 - 100	09/96 → 12/13					
813 DA	95 - 100	09/96 → 12/13					
815 D	110 - 115	09/96 → 12/13					
816 D	112 - 115	09/96 → 12/13					
815 DA	112 - 115	09/96 → 12/13					
816 DA 4x4	112 - 115	09/96 → 12/13					
615 D	112 - 115	09/98 →		→ 12/13		03.2128-1203.3 010922	ATE Ø 28,6
616 D	112 - 115	09/98 →					
→							















	kW					! #		
MERCEDES-BENZ - VARIO Pritsche/Fahrgestell (B670, B668, B667) 09/96→								
 Hauptbremszylinder								
618 D	130	09/06→			→ 12/13		03.2128-1203.3 010922	ATE Ø 28,6
818 D	130	09/06→						
818 DA 4x4	130	09/06→						
MERCEDES-BENZ - VARIO Triebkopf 09/96→								
 Hauptbremszylinder								
613 D	95	01/06→12/13					03.2128-1203.3 010922	ATE Ø 28,6
614 D	95	01/06→12/13						
615 D	115	01/06→12/13						
616 D	115	01/06→12/13						
618 D	130	09/06→12/13						
810 DT	75	09/96→06/06						
812 DT	90	09/96→06/06						
814 DT	100	09/96→06/06						
816 DT	112	09/96→06/06						
MERCEDES-BENZ - VIANO (W639) 09/03→								
 Hauptbremszylinder								
3.2	140 - 160	09/03→			→ 02/14		24.2123-1772.3 010858	BOS Ø 23,8
3.5	190	09/07→						
3.7	170	06/04→						
CDI 2.0	80	09/03→						
CDI 2.2	100 - 120	09/03→						
CDI 2.2 4-matic	100 - 120	07/10→						
CDI 3.0	150 - 165	03/06→						
3.7	165	06/04→07/07					24.2123-1772.3 010858	BOS Ø 23,8
CDI 2.0	85	08/05→						
CDI 2.0 4-matic	85	03/06→						
CDI 2.2	110	01/14→						
CDI 2.0 4-matic	80	07/05→			07/10→ 02/14		24.2123-1772.3 010858	BOS Ø 23,8
CDI 2.2 4-matic	110	07/05→						
CDI 2.2	70	09/10→			→ 3558104		24.2123-1772.3 010858	BOS Ø 23,8
					3558105→; → 02/14		24.2123-1778.3 010947	TRW Ø 23,8
MERCEDES-BENZ - VITO / MIXTO Kasten (W639) 08/03→								
 Hauptbremszylinder								
109 CDI	65 - 70	09/03→			→ 3558104		24.2123-1772.3 010858	BOS Ø 23,8
110 CDI	70	09/10→			3558105→; → 02/14		24.2123-1778.3 010947	TRW Ø 23,8
111 CDI	80 - 85	09/03→						
111 CDI 4x4	80	09/07→						
113 CDI	100	09/10→						
113 CDI 4x4	100	09/10→						
115 CDI	110	09/03→						
116 CDI	120	09/10→						
116 CDI 4x4	120	09/10→						
119	140	09/03→						
122	160	09/03→						
122 CDI	165	09/10→						
126	190	09/07→						
115 CDI 4x4	110	07/06→			09/07→; → 3558104		24.2123-1772.3 010858	BOS Ø 23,8
120 CDI	150	07/06→			3558105→; → 02/14		24.2123-1778.3 010947	TRW Ø 23,8
123	165 - 170	06/04→07/08			→ 3558104		24.2123-1772.3 010858	BOS Ø 23,8
					3558105→		24.2123-1778.3 010947	TRW Ø 23,8
MERCEDES-BENZ - VITO Bus (W638) 02/96→07/03								
 Hauptbremszylinder								
108 CDI 2.2	60	03/99→07/03			- ABS		24.2123-1712.3 010519	Ø 23,8
110 CDI 2.2	75	03/99→07/03			+ ABS		24.2123-1729.3 010567	Ø 23,8
112 CDI 2.2	90	03/99→07/03						
114 2.3	105	12/96→07/03						
108 D 2.3	58	02/96→07/03			03/96→; - ABS		24.2123-1712.3 010519	Ø 23,8
110 TD 2.3	72	02/96→07/03						
113 2.0	95	02/96→07/03			03/96→; + ABS		24.2123-1729.3 010567	Ø 23,8
MERCEDES-BENZ - VITO Bus (W639) 09/03→								
 Hauptbremszylinder								
109 CDI	65 - 70	09/03→			→ 3558104		24.2123-1772.3 010858	BOS Ø 23,8
109 CDI 4x4	70	09/07→08/14			3558105→; → 02/14		24.2123-1778.3 010947	TRW Ø 23,8















	kw					! #		
MERCEDES-BENZ - VITO Bus (W639) 09/03→								
 Hauptbremszylinder								
110 CDI	70	09/10→08/14			→ 3558104		24.2123-1772.3 010858	BOS Ø 23,8
111 CDI	80 - 85	09/03→			3558105→; → 02/14		24.2123-1778.3 010947	TRW Ø 23,8
111 CDI 4x4	80	09/07→08/14						
113 CDI	100	09/10→						
113 CDI 4x4	100	09/10→08/14						
115 CDI	110	09/03→						
115 CDI 4x4	110	09/07→08/14						
116 CDI	120	09/10→						
116 CDI 4x4	120	09/10→08/14						
119	140	09/03→						
122	160	09/03→						
122 CDI	165	09/10→						
126	190	09/07→						
120 CDI	150	07/06→			09/07→; → 3558104		24.2123-1772.3 010858	BOS Ø 23,8
					3558105→; → 02/14		24.2123-1778.3 010947	TRW Ø 23,8
123	165 - 170	06/04→07/08			→ 3558104		24.2123-1772.3 010858	BOS Ø 23,8
					3558105→		24.2123-1778.3 010947	TRW Ø 23,8
MERCEDES-BENZ - VITO Kasten (W638) 03/97→07/03								
 Hauptbremszylinder								
108 CDI 2.2	60	03/99→07/03			- ABS		24.2123-1712.3 010519	Ø 23,8
108 D 2.3	58	03/97→07/03						
110 CDI 2.2	75	03/99→07/03			+ ABS		24.2123-1729.3 010567	Ø 23,8
110 D 2.3	72	03/97→07/03						
112 CDI 2.2	90	03/99→07/03						
113 2.0	95	03/97→07/03						
114 2.3	105	03/97→07/03						
MERCEDES-BENZ - V-KLASSE (638/2) 02/96→07/03								
 Hauptbremszylinder								
V 200	95	02/97→07/03			- ABS		24.2123-1712.3 010519	Ø 23,8
V 200 CDI	75	03/99→07/03						
V 220 CDI	90	03/99→07/03			+ ABS		24.2123-1729.3 010567	Ø 23,8
V 230	105	10/96→07/03						
V 230 TD	72	09/96→07/03						
V 280	128	08/97→07/03			09/97→; - ABS		24.2123-1712.3 010519	Ø 23,8
					09/97→; + ABS		24.2123-1729.3 010567	Ø 23,8
MINI - MINI (F55) 09/13→								
 Hauptbremszylinder								
Cooper	100	09/13→			10/14→		24.4122-1722.3 011085	Ø 22,2 ohne Bremsflüssigkeitsbehälter
Cooper D	85	10/13→						
Cooper S	120 - 141	09/13→						
Cooper SD	120 - 125	09/13→						
One	75	05/14→10/17						
One D	70	02/14→						
Cooper S	131	11/20→					24.4122-1722.3 011085	Ø 22,2 ohne Bremsflüssigkeitsbehälter
One	75	11/17→						
One First	55	11/17→						
Cooper S JCW	155	09/13→			09/15→		24.4123-1733.3 011108	Ø 23,8 ohne Bremsflüssigkeitsbehälter
One First	55	06/14→10/17			03/15→		24.4122-1722.3 011085	Ø 22,2 ohne Bremsflüssigkeitsbehälter
MINI - MINI (F56) 12/13→								
 Hauptbremszylinder								
Cooper S	131	11/20→					24.4122-1722.3 011085	Ø 22,2 ohne Bremsflüssigkeitsbehälter
Cooper SE / Electric	75 - 135	11/19→						
Cooper S JCW	155	12/13→			03/15→		24.4123-1733.3 011108	Ø 23,8 ohne Bremsflüssigkeitsbehälter
John Cooper Works	170	03/15→					24.4123-1733.3 011108	Ø 23,8 ohne Bremsflüssigkeitsbehälter
John Cooper Works GP	225	03/20→						
MINI - MINI (R50, R53) 06/01→09/06								
 Bremskraftverstärker								
Cooper	85	06/01→09/06					03.7860-1402.4 300228	ATE Ø 10" pneumatisch
Cooper S	125	07/04→09/06						
John Cooper Works	160	03/06→09/06						
→								

















	kW					! #		
MINI - MINI (R50, R53) 06/01→09/06								
 Bremskraftverstärker								
One	55 - 66	06/01→09/06					03.7860-1402.4 300228	ATE Ø 10" pneumatisch
One D	55 - 65	06/03→09/06						
S Works	149	11/03→06/05						
Works	155	11/03→09/06						
Cooper S	120	03/02→09/06		07/02→			03.7860-1402.4 300228	ATE Ø 10" pneumatisch
 Hauptbremszylinder								
Cooper	85	06/01→09/06		+ DSC			03.2122-1824.3 010892	ATE Ø 22,2
Cooper S	125	07/04→09/06		- DSC				
John Cooper Works	160	03/06→09/06					03.2122-1853.3 010893	ATE Ø 22,2
One	55 - 66	06/01→09/06						
One D	55 - 65	06/03→09/06						
S Works	149	11/03→06/05						
Works	155	11/03→09/06						
Cooper S	120	03/02→09/06		07/02→; + DSC			03.2122-1824.3 010892	ATE Ø 22,2
				07/02→; - DSC			03.2122-1853.3 010893	ATE Ø 22,2
MINI - MINI (R56) 11/05→01/14								
 Hauptbremszylinder								
Cooper	85 - 90	09/06→11/13		03/10→			24.4123-1712.3 010897	TRW Ø 23,8
One D	66	06/09→07/10						
Cooper	88	10/06→02/12		11/06→			24.4123-1712.3 010897	TRW Ø 23,8
Cooper S	128	10/06→02/10						
Cooper D	80	11/06→09/10		04/07→			24.4123-1712.3 010897	TRW Ø 23,8
One	70	11/06→03/10						
Cooper D	82	06/10→11/13					24.4123-1712.3 010897	TRW Ø 23,8
Cooper S	120 - 135	03/10→11/13						
Cooper SD	100 - 105	02/11→11/13						
Cooper S John Cooper Works	147	01/12→11/13						
One	55 - 72	03/09→11/13						
One D	66	07/10→11/13						
One LPG	55	03/09→03/10						
Cooper S John Cooper Works	141	11/06→02/10		03/08→			24.4123-1712.3 010897	TRW Ø 23,8
John Cooper Works	155	11/07→11/13						
MINI - MINI Cabriolet (F57) 11/14→								
 Hauptbremszylinder								
Cooper	100	11/14→		11/15→			24.4122-1722.3 011085	Ø 22,2 ohne Bremsflüssigkeitsbehälter
Cooper D	85	12/14→						
Cooper S	120 - 141	11/14→						
Cooper S	131	11/20→					24.4122-1722.3 011085	Ø 22,2 ohne Bremsflüssigkeitsbehälter
One	75	11/17→						
Cooper SD	120 - 125	05/15→		03/16→			24.4122-1722.3 011085	Ø 22,2 ohne Bremsflüssigkeitsbehälter
One	75	06/15→10/17						
Cooper S JCW	155	11/14→		03/16→			24.4123-1733.3 011108	Ø 23,8 ohne Bremsflüssigkeitsbehälter
John Cooper Works	170	05/15→						
MINI - MINI Cabriolet (R52) 04/04→07/08								
 Bremskraftverstärker								
Cooper	85	04/04→07/08					03.7860-1402.4 300228	ATE Ø 10" pneumatisch
Cooper S	120 - 125	07/04→07/08						
John Cooper Works	155	07/04→11/07						
One	66	07/04→11/07						
 Hauptbremszylinder								
Cooper	85	04/04→07/08		+ DSC			03.2122-1824.3 010892	ATE Ø 22,2
Cooper S	120 - 125	07/04→07/08		- DSC			03.2122-1853.3 010893	ATE Ø 22,2
John Cooper Works	155	07/04→11/07						
One	66	07/04→11/07						













	kW			 	! #		
MINI - MINI Cabriolet (R57) 10/07→06/15							
 Hauptbremszylinder							
Cooper Cooper S	85 128	12/08→06/15 12/08→07/10		01/09→		24.4123-1712.3 010897	TRW Ø 23,8
Cooper Cooper S	88 - 90 141	12/08→06/15 04/08→07/10				24.4123-1712.3 010897	TRW Ø 23,8
Cooper D	82	05/09→11/13		06/10→		24.4123-1712.3 010897	TRW Ø 23,8
Cooper D	82	02/11→05/15		→ 06/14		24.4123-1712.3 010897	TRW Ø 23,8
Cooper S	120	10/07→06/15		01/09→ 06/14		24.4123-1712.3 010897	TRW Ø 23,8
Cooper S	135 - 147	02/10→06/15		03/10→ 06/14		24.4123-1712.3 010897	TRW Ø 23,8
One	72	09/09→06/15					
Cooper SD	100 - 105	06/09→05/15		02/11→ 06/14		24.4123-1712.3 010897	TRW Ø 23,8
John Cooper Works	155	08/08→05/15		03/09→ 06/14		24.4123-1712.3 010897	TRW Ø 23,8
MINI - MINI CLUBMAN (F54) 11/14→							
 Hauptbremszylinder							
Cooper Cooper D	100 100 - 110	12/14→ 12/14→		07/15→		24.4122-1722.3 011085	Ø 22,2 ohne Bremsflüssigkeitsbehälter
Cooper S	120 - 141	11/14→					
Cooper S JCW	155	11/14→06/18					
Cooper S Cooper S ALL4	131 131	11/20→ 11/20→				24.4122-1722.3 011085	Ø 22,2 ohne Bremsflüssigkeitsbehälter
Cooper S ALL4 Cooper SD ALL4	120 - 141 120 - 140	04/15→ 04/15→		01/16→		24.4122-1722.3 011085	Ø 22,2 ohne Bremsflüssigkeitsbehälter
Cooper S JCW ALL4	155	11/14→					
Cooper SD	120 - 140	02/15→		11/15→		24.4122-1722.3 011085	Ø 22,2 ohne Bremsflüssigkeitsbehälter
One One D	75 85	02/15→ 02/15→					
John Cooper Works	170	11/16→06/19				24.4123-1733.3 011108	Ø 23,8 ohne Bremsflüssigkeitsbehälter
MINI - MINI CLUBMAN (R55) 10/06→12/15							
 Hauptbremszylinder							
Cooper Cooper D	85 - 90 80 - 82	10/07→06/14 10/07→06/14				24.4123-1712.3 010897	TRW Ø 23,8
Cooper S	120 - 147	08/07→06/14					
Cooper SD	100 - 105	02/11→06/14					
Cooper S John Cooper Works	141	10/08→02/10					
One One D	72 66	03/10→06/14 03/10→06/14					
John Cooper Works	155	11/07→06/14		03/08→		24.4123-1712.3 010897	TRW Ø 23,8
MINI - MINI CLUBVAN (R55) 12/12→06/14							
 Hauptbremszylinder							
Cooper Cooper D One	90 82 72	12/12→06/14 12/12→06/14 12/12→06/14				24.4123-1712.3 010897	TRW Ø 23,8
MINI - MINI COUNTRYMAN (F60) 10/16→							
 Hauptbremszylinder							
Cooper Cooper ALL4 Cooper D	100 100 100 - 110	10/16→ 10/16→ 10/16→				24.4123-1733.3 011108	Ø 23,8 ohne Bremsflüssigkeitsbehälter
Cooper D ALL4	100 - 110	10/16→					
Cooper S	120 - 141	10/16→					
Cooper S ALL4	120 - 141	10/16→					
Cooper SD	120 - 140	10/16→					
Cooper SD ALL4	120 - 140	10/16→					
→							













	kw			 	! #		
MINI - MINI COUNTRYMAN (F60) 10/16→							
 Hauptbremszylinder							
Cooper SE ALL4	162 - 165	01/17→				24.4123-1733.3 011108	Ø 23,8 ohne Bremsflüssigkeitsbehälter
John Cooper Works ALL4 One One D	170 75 85	03/17→06/19 07/17→ 07/17→					
MINI - MINI COUNTRYMAN (R60) 08/10→10/16							
 Hauptbremszylinder							
Cooper	85 - 90	08/10→10/16		09/10→		24.4123-1712.3 010897	TRW Ø 23,8
Cooper D Cooper D ALL4 Cooper S	82 82 120 - 135	08/10→10/16 08/10→10/16 08/10→10/16					
Cooper S ALL4	120 - 135	08/10→10/16					
One One D	72 66	08/10→10/16 08/10→10/16					
Cooper ALL4	90	11/12→10/16		11/14→		24.4123-1712.3 010897	TRW Ø 23,8
Cooper D Cooper D ALL4 Cooper S Cooper S ALL4 Cooper SD	82 82 140 140 100 - 105	03/11→10/16 03/11→10/16 07/14→10/16 07/14→10/16 03/11→10/16				24.4123-1712.3 010897	TRW Ø 23,8
Cooper SD ALL4 John Cooper Works ALL4	100 - 105 160	03/11→10/16 11/12→10/16					
Cooper S	147	08/10→10/16		02/12→		24.4123-1712.3 010897	TRW Ø 23,8
MINI - MINI Coupe (R58) 12/10→05/15							
 Hauptbremszylinder							
1.6 Cooper	88	10/14→05/15				24.4123-1712.3 010897	TRW Ø 23,8
Cooper Cooper S Cooper SD Cooper S JCW John Cooper Works	85 - 90 120 - 135 100 - 105 147 155	12/10→04/15 12/10→04/15 12/10→05/15 12/10→04/15 12/10→05/15		10/11→		24.4123-1712.3 010897	TRW Ø 23,8
MINI - MINI PACEMAN (R61) 03/12→10/16							
 Hauptbremszylinder							
Cooper	88 - 90	04/12→09/16		11/12→		24.4123-1712.3 010897	TRW Ø 23,8
Cooper D Cooper D ALL4 Cooper S ALL4	82 82 120 - 140	04/12→09/16 03/12→09/16 03/12→09/16					
Cooper SD Cooper SD ALL4	105 100 - 105	03/12→09/16 04/12→09/16					
Cooper ALL4	85 - 90	11/12→09/16		07/14→		24.4123-1712.3 010897	TRW Ø 23,8
Cooper S John Cooper Works ALL4	120 - 140 160	11/12→10/16 03/13→10/16				24.4123-1712.3 010897	TRW Ø 23,8
MINI - MINI Roadster (R59) 01/11→04/15							
 Hauptbremszylinder							
Cooper	85 - 90	11/11→04/15		02/12→		24.4123-1712.3 010897	TRW Ø 23,8
Cooper S Cooper SD Cooper S JCW John Cooper Works	120 - 135 100 - 105 147 155	11/11→04/15 11/11→04/15 11/11→04/15 11/11→04/15					
MITSUBISHI - CARISMA (DA_) 07/95→06/06							
 Hauptbremszylinder							
1.6 →	66	07/95→06/06		- ABS		24.2122-1718.3 010517	Ø 22,2















	kw			 	! #		
MITSUBISHI - CARISMA (DA_) 07/95→06/06							
 Hauptbremszylinder							
1.8 1.8 MSX - 16V	85 103	07/95→07/97 07/95→07/97		- ABS		24.2122-1718.3 010517	Ø 22,2
MITSUBISHI - CARISMA Stufenheck (DA_) 09/96→06/06							
 Hauptbremszylinder							
1.6 1.8	66 85	09/96→06/06 09/96→09/97		- ABS		24.2122-1718.3 010517	Ø 22,2
MITSUBISHI - COLT VI (Z3_A, Z2_A) 10/02→12/12							
 Hauptbremszylinder							
1.1 1.1 LPG 1.3 1.3 LPG 1.5 1.5 CZT 1.3 Flexfuel 1.5 Ralliart R 1.5 DI-D	55 55 68 - 70 70 77 - 80 110 70 132 50 - 70	10/04→06/12 10/04→06/12 06/04→06/12 06/04→06/12 06/04→06/12 03/05→06/12 10/08→06/12 02/10→06/12 08/04→06/12		→ 09/08 10/08→ für Linkslenker		24.2122-1770.3 010898 24.4122-1717.3 010993 24.4122-1717.3 010993 24.2122-1770.3 010898	TRW Ø 22,2 TRW Ø 22,2 ohne Bremsflüssigkeitsbehälter TRW Ø 22,2 ohne Bremsflüssigkeitsbehälter TRW Ø 22,2
MITSUBISHI - COLT CZC VI Cabriolet (RG) 05/06→07/09							
 Hauptbremszylinder							
1.5 1.5 Turbo	80 110	05/06→07/09 05/06→07/09				24.2122-1770.3 010898	TRW Ø 22,2
MITSUBISHI - COLT Kasten/Schrägheck (Z3_V) 08/04→06/12							
 Hauptbremszylinder							
1.5 DiD	70	08/04→06/12				24.2122-1770.3 010898	TRW Ø 22,2
NISSAN - BLUEBIRD SYLPHY / SYLPHY III (B17) 07/12→							
 Hauptbremszylinder							
1.6	86	05/13→		für Linkslenker; CVT-Automatikgetriebe (Stufenlos)		24.4123-1727.3 011088	Ø 23,8 ohne Bremsflüssigkeitsbehälter
NISSAN - INTERSTAR Bus (X70) 04/02→							
 Hauptbremszylinder							
dCi 100 dCi 120	73 88	11/03→03/06 09/06→03/11		- ABS + ABS		24.2025-1708.3 010692 24.2123-1759.3 010768	Ø 25,4 BOS Ø 23,8
dCi 100 dCi 150	74 107	04/06→03/11 09/06→03/11		→ 06/10; - ABS → 06/10; + ABS		24.2025-1708.3 010692 24.2123-1759.3 010768	Ø 25,4 BOS Ø 23,8
dCi 115 dCi 80 dCi 90	84 60 66	04/02→08/06 04/02→08/06 07/02→08/06		→ 12/02; + ABS - ABS 01/03→; + ABS		24.2025-1706.3 010676 24.2025-1708.3 010692 24.2123-1759.3 010768	Ø 25,4 Ø 25,4 BOS Ø 23,8
dCi 140	100	11/03→		→ 08/06; - ABS → 08/06; + ABS		24.2025-1708.3 010692 24.2123-1759.3 010768	Ø 25,4 BOS Ø 23,8
NISSAN - INTERSTAR Kasten (X70) 04/02→							
 Hauptbremszylinder							
dCi 100 dCi 120	73 88	11/03→03/06 09/06→		- ABS + ABS		24.2025-1708.3 010692 24.2123-1759.3 010768	Ø 25,4 BOS Ø 23,8
dCi 100 dCi 150	74 107	04/06→ 09/06→		→ 06/10; - ABS → 06/10; + ABS		24.2025-1708.3 010692 24.2123-1759.3 010768	Ø 25,4 BOS Ø 23,8
dCi 115 dCi 90	84 66	04/02→ 07/02→		→ 12/02; + ABS → 08/06; - ABS 01/03→ 08/06; + ABS		24.2025-1706.3 010676 24.2025-1708.3 010692 24.2123-1759.3 010768	Ø 25,4 Ø 25,4 BOS Ø 23,8
dCi 140	100	11/03→		→ 08/06; - ABS → 08/06; + ABS		24.2025-1708.3 010692 24.2123-1759.3 010768	Ø 25,4 BOS Ø 23,8
dCi 80	60	04/02→08/06		→ 12/02; + ABS - ABS 01/03→; + ABS		24.2025-1706.3 010676 24.2025-1708.3 010692 24.2123-1759.3 010768	Ø 25,4 Ø 25,4 BOS Ø 23,8

















	kw					! #		
NISSAN - INTERSTAR Pritsche/Fahrgestell (X70) 08/03→								
 Hauptbremszylinder								
dCi 100	73	02/04→		→ 06/10; - ABS		24.2025-1708.3 010692	Ø 25,4	
				→ 06/10; + ABS		24.2123-1759.3 010768	BOS Ø 23,8	
dCi 115	84	08/03→		→ 08/06; - ABS		24.2025-1708.3 010692	Ø 25,4	
dCi 140	100	11/03→		→ 08/06; + ABS		24.2123-1759.3 010768	BOS Ø 23,8	
dCi 120	88	08/06→		- ABS		24.2025-1708.3 010692	Ø 25,4	
				+ ABS		24.2123-1759.3 010768	BOS Ø 23,8	
dCi 150	107	08/06→		09/06→ 06/10; - ABS		24.2025-1708.3 010692	Ø 25,4	
				09/06→ 06/10; + ABS		24.2123-1759.3 010768	BOS Ø 23,8	
NISSAN - KUBISTAR Kasten (X76) 08/03→								
 Hauptbremszylinder								
1.2	44	08/03→		→ 08/05; - ABS		24.2122-1727.3 010586	BDX Ø 22,2	
1.5 dCi	42 - 60	08/03→						
1.2 16V	55	04/06→		→ 10/09; - ABS		24.2122-1727.3 010586	BDX Ø 22,2	
1.4	55	08/03→10/09				24.2122-1727.3 010586	BDX Ø 22,2	
1.5 dCi	45	08/05→10/09		09/05→; - ABS		24.2122-1727.3 010586	BDX Ø 22,2	
1.5 dCi 70	50	09/05→10/09		- ABS		24.2122-1727.3 010586	BDX Ø 22,2	
1.6 16V	70	08/03→10/09						
dCi 85	62	04/06→10/09						
NISSAN - MICRA III (K12) 03/02→06/10								
 Bremskraftverstärker								
1.0 16V	48	01/03→06/10		für Linkslenker		03.7863-3002.4 300223	ATE Ø 10" pneumatisch	
1.2	66	01/07→06/10						
1.2 16V	48 - 59	01/03→06/10						
1.2 LPG	59	10/02→06/10						
1.3	60	08/04→06/10						
1.4	72	03/07→06/10						
1.4 16V	65	01/03→06/10						
1.5 dCi	48 - 63	01/03→06/10						
160 SR	81	05/05→06/10						
 Hauptbremszylinder								
1.0 16V	48	01/03→06/10		für Linkslenker; - ESP		03.2123-2863.3 010790	ATE Ø 23,8	
1.2	66	01/07→06/10						
1.2 16V	48 - 59	01/03→06/10		für Linkslenker; + ESP		03.2123-2923.3 010791	ATE Ø 23,8	
1.2 LPG	59	10/02→06/10						
1.3	60	08/04→06/10						
1.4	72	03/07→06/10						
1.4 16V	65	01/03→06/10						
1.5 dCi	48 - 63	01/03→06/10						
160 SR	81	05/05→06/10						
NISSAN - MICRA C+C III (K12) 08/05→								
 Bremskraftverstärker								
1.4 16V	65	08/05→		→ 12/10; für Linkslenker		03.7863-3002.4 300223	ATE Ø 10" pneumatisch	
1.6 160 SR	81	08/05→						
 Hauptbremszylinder								
1.4 16V	65	08/05→		→ 12/10; - ESP		03.2123-2863.3 010790	ATE Ø 23,8	
1.6 160 SR	81	08/05→		→ 12/10; + ESP		03.2123-2923.3 010791	ATE Ø 23,8	
NISSAN - NOTE (E11, NE11) 01/05→08/13								
 Bremskraftverstärker								
1.4	65	03/06→06/12		für Linkslenker		03.7863-3002.4 300223	ATE Ø 10" pneumatisch	
1.4 LPG	65	01/06→08/13						
1.5	80	03/06→12/10						
1.5 dCi	50 - 76	03/06→06/12						
1.6	81	03/06→06/12						
 Hauptbremszylinder								
1.4	65	03/06→06/12		- ESP		03.2123-2863.3 010790	ATE Ø 23,8	
1.4 LPG	65	01/06→08/13						
1.5	80	03/06→12/10		+ ESP		03.2123-2923.3 010791	ATE Ø 23,8	
1.5 dCi	50 - 76	03/06→06/12						
1.6	81	03/06→06/12						











	kW					! #		
NISSAN - NOTE VAN (E11) 01/05→08/13								
 Bremskraftverstärker								
1.5 dCi	63	01/11→09/12			für Linklenker		03.7863-3002.4 300223	ATE Ø 10" pneumatisch
 Hauptbremszylinder								
1.5 dCi	63	01/11→09/12			- ESP		03.2123-2863.3 010790	ATE Ø 23,8
					+ ESP		03.2123-2923.3 010791	ATE Ø 23,8
NISSAN - NP300 NAVARA (D40) 10/04→								
 Hauptbremszylinder								
2.5 D 4WD	98	09/08→			für Linklenker		03.2125-0161.3 010920	ATE Ø 25,4
2.5 dCi 4WD	106	01/07→						
2.5 dCi 4x4	120	02/12→12/16						
2.5 dCi	106 - 128	07/05→			→ 09/06		03.2125-0161.3 010920	ATE Ø 25,4
2.5 dCi 4WD	128	07/05→						
2.5 dCi	120	10/06→					03.2125-0161.3 010920	ATE Ø 25,4
NISSAN - NP300 NAVARA Pritsche/Fahrgestell (D40) 07/08→								
 Hauptbremszylinder								
2.5 dCi 4WD	106	08/08→			01/10→; für Linklenker		03.2125-0161.3 010920	ATE Ø 25,4
NISSAN - NP300 PICKUP (D22) 04/08→								
 Hauptbremszylinder								
2.5 dCi	98	04/08→					03.2125-0161.3 010920	ATE Ø 25,4
2.5 dCi 4x4	98	04/08→						
NISSAN - PATHFINDER III (R51) 01/05→								
 Hauptbremszylinder								
2.5 dCi	128	01/05→			für Linklenker		03.2125-0531.3 010945	ATE Ø 25,4
2.5 dCi 4WD	126 - 128	03/05→						
2.5 dCi 4WD	120	01/05→					03.2125-0531.3 010945	ATE Ø 25,4
4.0	214	01/10→08/14						
4.0 4WD	198	09/05→						
2.5 dCi 4WD	140	08/10→					03.2125-0161.3 010920	ATE Ø 25,4
NISSAN - PATHFINDER III VAN (R51_) 01/05→								
 Hauptbremszylinder								
2.5 dCi 4x4	140	03/13→08/14			für Linklenker		03.2125-0161.3 010920	ATE Ø 25,4
3.0 dCi 4x4	170	03/13→08/14						
NISSAN - PRIMASTAR Bus (X83) 03/01→								
 Hauptbremszylinder								
2.0	88	03/01→08/06			→ 01/03; - ABS		24.2120-1738.3 010759	TRW Ø 20,6
					02/03→; - ABS		24.2120-1740.3 010764	TRW Ø 20,6
					02/03→; + ABS		24.2125-1731.3 010826	TRW Ø 25,4
dCi 100	74	03/01→			→ 01/03; - ABS		24.2120-1738.3 010759	TRW Ø 20,6
dCi 80	60	03/01→			02/03→ 08/06; - ABS		24.2120-1740.3 010764	TRW Ø 20,6
					02/03→ 08/06; + ABS		24.2125-1731.3 010826	TRW Ø 25,4
dCi 115	84	09/08→			- ABS		24.2120-1740.3 010764	TRW Ø 20,6
dCi 120	84	09/06→			+ ABS		24.2125-1731.3 010826	TRW Ø 25,4
dCi 150	107	09/06→						
dCi 90	66	09/06→						
dCi 140	99	07/03→			→ 08/06; - ABS		24.2120-1740.3 010764	TRW Ø 20,6
					→ 08/06; + ABS		24.2125-1731.3 010826	TRW Ø 25,4
NISSAN - PRIMASTAR Kasten (X83) 09/02→								
 Hauptbremszylinder								
1.9 dCi 100	74	09/02→			→ 01/03; - ABS		24.2120-1738.3 010759	TRW Ø 20,6
1.9 dCi 80	60	09/02→			02/03→ 08/06; - ABS		24.2120-1740.3 010764	TRW Ø 20,6
					02/03→ 08/06; + ABS		24.2125-1731.3 010826	TRW Ø 25,4
2.0	88	02/03→			- ABS		24.2120-1740.3 010764	TRW Ø 20,6
2.0 dCi 115	84	09/06→			+ ABS		24.2125-1731.3 010826	TRW Ø 25,4
2.0 dCi 90	66	09/06→						
2.5 dCi 115	84	09/08→						
2.5 dCi 150	107	09/06→						
2.5 dCi 140	99	07/03→			→ 08/06; - ABS		24.2120-1740.3 010764	TRW Ø 20,6
					→ 08/06; + ABS		24.2125-1731.3 010826	TRW Ø 25,4













	kw					! #		
NISSAN - PRIMASTAR Pritsche/Fahrgestell (X83) 07/02→								
 Hauptbremszylinder								
1.9 dCi 100 1.9 dCi 80	74 60	07/02→08/06 07/02→08/06		→ 01/03; - ABS 02/03→; - ABS 02/03→; + ABS		24.2120-1738.3 010759 24.2120-1740.3 010764 24.2125-1731.3 010826		TRW Ø 20,6 TRW Ø 20,6 TRW Ø 25,4
2.0	88	07/02→08/06		→ 09/03; - ABS 10/03→; - ABS		24.2120-1738.3 010759 24.2125-1731.3 010826		TRW Ø 20,6 TRW Ø 25,4
2.5 dCi 140	99	07/02→08/06		- ABS + ABS		24.2120-1740.3 010764 24.2125-1731.3 010826		TRW Ø 20,6 TRW Ø 25,4
2.5 dCi 150	107	04/06→		09/06→; - ABS 09/06→; + ABS		24.2120-1740.3 010764 24.2125-1731.3 010826		TRW Ø 20,6 TRW Ø 25,4
NISSAN - PRIMERA (P12) 01/02→								
 Hauptbremszylinder								
1.6 1.8 1.8 LPG 1.9 dCi 2.0 2.2 dCi	78 - 80 85 85 85 - 88 103 102	01/02→08/08 03/02→10/08 03/02→ 08/02→10/07 03/02→10/08 04/03→04/06		06/04→		24.2122-1774.3 010987		Ø 22,2 ohne Bremsflüssigkeitsbehälter
NISSAN - PRIMERA Hatchback (P12) 01/02→								
 Hauptbremszylinder								
1.6 1.8 1.9 dCi 2.0 2.2 dCi	78 - 80 85 85 - 88 103 102	07/02→08/08 07/02→10/08 08/02→10/07 07/02→10/08 04/03→		06/04→ 06/04→ 10/07		24.2122-1774.3 010987 24.2122-1774.3 010987		Ø 22,2 ohne Bremsflüssigkeitsbehälter Ø 22,2 ohne Bremsflüssigkeitsbehälter
NISSAN - PRIMERA Kombi (WP12) 01/02→								
 Hauptbremszylinder								
1.6 Visia 1.8 1.9 dCi 1.9 dCi 2.2 dCi 2.0	80 85 85 88 102 103	01/02→04/06 03/02→05/07 08/02→10/07 04/03→ 04/03→ 03/02→		06/04→ 06/04→ 10/07 06/04→ 10/08		24.2122-1774.3 010987 24.2122-1774.3 010987 24.2122-1774.3 010987		Ø 22,2 ohne Bremsflüssigkeitsbehälter Ø 22,2 ohne Bremsflüssigkeitsbehälter Ø 22,2 ohne Bremsflüssigkeitsbehälter
NISSAN - QASHQAI / QASHQAI +2 I (J10, NJ10, JJ10E) 11/06→04/14								
 Hauptbremszylinder								
1.5 dCi 1.6 1.6 LPG 2.0 2.0 All-wheel Drive 2.0 dCi 2.0 dCi All-wheel Drive 1.6 dCi 1.6 dCi All-wheel Drive 2.0 2.0 All-wheel Drive	76 - 81 81 - 86 86 102 - 104 102 - 104 110 110 96 96 103 103	11/06→12/13 02/07→12/13 11/10→12/13 02/07→12/13 02/07→12/13 02/07→12/13 02/07→12/13 10/11→12/13 10/11→12/13 01/10→04/14 01/10→04/14		+ ESP; für Linkslenker für Linkslenker für Linkslenker; Schaltgetriebe; für Fahrzeuge mit Adaptive Cruise Control		24.4123-1725.3 011073 24.4123-1725.3 011073 24.4123-1725.3 011073		Ø 23,8 ohne Bremsflüssigkeitsbehälter Ø 23,8 ohne Bremsflüssigkeitsbehälter Ø 23,8 ohne Bremsflüssigkeitsbehälter
NISSAN - QASHQAI / QASHQAI +2 I VAN (J10, JJ10E) 12/06→04/14								
 Hauptbremszylinder								
1.5 dCi 1.6 CVTC 2.0 2.0 All-wheel Drive 2.0 dCi All-wheel Drive 1.6 dCi 1.6 dCi All-wheel Drive	81 86 104 104 110 96 96	03/13→04/14 03/13→04/14 03/13→04/14 03/13→04/14 03/13→04/14 03/13→04/14 03/13→04/14		+ ESP; für Linkslenker für Linkslenker		24.4123-1725.3 011073 24.4123-1725.3 011073		Ø 23,8 ohne Bremsflüssigkeitsbehälter Ø 23,8 ohne Bremsflüssigkeitsbehälter













	kw			 	! #		
NISSAN - QASHQAI II SUV (J11, J11_) 11/13→							
 Hauptbremszylinder							
1.2 DIG-T 1.6 dCi	85 96	11/13→ 11/13→		02/14→; Schaltgetriebe 6 Gang		24.4123-1728.3 011089	Ø 23,8 ohne Bremsflüssigkeitsbehälter
1.3 DIG-T 1.6 DIG-T 1.7 dCi	103 120 110	08/18→ 10/14→ 01/19→				24.4123-1728.3 011089	Ø 23,8 ohne Bremsflüssigkeitsbehälter
1.3 DIG-T 1.5 dCi 1.7 dCi ALL MODE 4x4-i 2.0	118 85 110 103 - 106	08/18→ 06/18→ 01/19→ 06/14→		Schaltgetriebe 6 Gang		24.4123-1728.3 011089	Ø 23,8 ohne Bremsflüssigkeitsbehälter
1.5 dCi	81	11/13→		→ 01/14; + ESP; für Linkslenker		24.4123-1725.3 011073	Ø 23,8 ohne Bremsflüssigkeitsbehälter
				02/14→		24.4123-1728.3 011089	Ø 23,8 ohne Bremsflüssigkeitsbehälter
1.6 dCi ALL MODE 4x4-i	96	11/13→		02/14→		24.4123-1728.3 011089	Ø 23,8 ohne Bremsflüssigkeitsbehälter
NISSAN - QASHQAI II VAN (J11_) 11/13→							
 Hauptbremszylinder							
1.5 dCi	81	05/15→				24.4123-1728.3 011089	Ø 23,8 ohne Bremsflüssigkeitsbehälter
1.5 dCi	85	06/18→		Schaltgetriebe 6 Gang		24.4123-1728.3 011089	Ø 23,8 ohne Bremsflüssigkeitsbehälter
NISSAN - SENTRA VII (B17) 08/12→							
 Hauptbremszylinder							
1.6 1.8	86 96	08/14→ 08/12→		für Linkslenker; CVT-Automatikgetriebe (Stufenlos)		24.4123-1727.3 011088	Ø 23,8 ohne Bremsflüssigkeitsbehälter
NISSAN - TIIDA Schrägheck (C12) 08/10→							
 Hauptbremszylinder							
1.6 1.6 CVTC 1.8	85 - 140 80 - 86 96	08/12→ 08/12→ 08/12→		für Linkslenker; CVT-Automatikgetriebe (Stufenlos)		24.4123-1727.3 011088	Ø 23,8 ohne Bremsflüssigkeitsbehälter
NISSAN - X-TRAIL I (T30) 01/01→12/13							
 Hauptbremszylinder							
2.0 2.0 4x4 2.5 4x4 2.2 DCi FWD 2.2 Di 4x4 2.5 4x4 2.5 4x4	103 - 110 103 - 206 121	07/01→01/13 06/01→01/13 09/02→01/13		→ 08/03; Schaltgetriebe; - ESP		24.2125-1741.3 010988	Ø 25,4 ohne Bremsflüssigkeitsbehälter
2.2 DCi FWD 2.2 Di 4x4 2.5 4x4 2.5 4x4	84 84 132 134	06/01→09/04 07/01→10/05 11/02→01/13 09/01→02/07		Schaltgetriebe; - ESP		24.2125-1741.3 010988	Ø 25,4 ohne Bremsflüssigkeitsbehälter
2.5 4x4	134	09/01→02/07		→ 09/03; für Linkslenker; Schaltgetriebe; - ESP		24.2125-1741.3 010988	Ø 25,4 ohne Bremsflüssigkeitsbehälter
NISSAN - X-TRAIL III (T32_, T32R, T32RR) 10/13→							
 Hauptbremszylinder							
1.6 dCi	96	04/14→		→ 10/16; für Linkslenker; Automatikgetriebe		24.4123-1728.3 011089	Ø 23,8 ohne Bremsflüssigkeitsbehälter
				für Linkslenker; Schaltgetriebe 6 Gang		24.4123-1728.3 011089	Ø 23,8 ohne Bremsflüssigkeitsbehälter
1.6 dCi ALL MODE 4x4-i	96	04/14→		→ 08/16; für Linkslenker; Fahrzeugtyp: T32R/T32RR		24.4123-1728.3 011089	Ø 23,8 ohne Bremsflüssigkeitsbehälter
1.6 DIG-T	120	06/15→				24.4123-1728.3 011089	Ø 23,8 ohne Bremsflüssigkeitsbehälter
2.0 2.0 Flexfuel 2.0 Flexfuel ALL MODE 4x4-i 2.5 ALL MODE 4x4-i 2.5 Flexfuel ALL MODE 4x4-i	104 - 108 106 106 124 126	12/13→ 09/14→ 02/14→ 10/14→ 02/14→		12/14→; für Linkslenker; Schaltgetriebe		24.4123-1728.3 011089	Ø 23,8 ohne Bremsflüssigkeitsbehälter
2.0 dCi ALL MODE 4x4-i	130	10/16→		für Linkslenker; Schaltgetriebe 6 Gang		24.4123-1728.3 011089	Ø 23,8 ohne Bremsflüssigkeitsbehälter
2.5	124	01/15→		für Linkslenker; Schaltgetriebe		24.4123-1728.3 011089	Ø 23,8 ohne Bremsflüssigkeitsbehälter













	kw					! #		
NISSAN - X-TRAIL VAN (T32) 10/13→								
 Hauptbremszylinder								
dCi	96	04/14→		→ 10/16; für Linkslenker; Automatikgetriebe		24.4123-1728.3	011089	Ø 23,8 ohne Bremsflüssigkeitsbehälter
				für Linkslenker; Schaltgetriebe 6 Gang		24.4123-1728.3	011089	Ø 23,8 ohne Bremsflüssigkeitsbehälter
dCi 4x4	96	04/14→		→ 08/16; für Linkslenker; Fahrzeugtyp: T32R/T32RR		24.4123-1728.3	011089	Ø 23,8 ohne Bremsflüssigkeitsbehälter
OPEL - ADAM (M13) 10/12→02/19								
 Hauptbremszylinder								
1.0	66 - 85	07/14→11/18		für Linkslenker; Scheibenbremse		24.4123-1722.3	011071	Ø 23,8 ohne Bremsflüssigkeitsbehälter
1.4 LPG	64	07/13→11/18						
1.4 S	110	11/14→01/19						
1.2	51	10/12→02/19		01/13→; für Linkslenker; Scheibenbremse		24.4123-1722.3	011071	Ø 23,8 ohne Bremsflüssigkeitsbehälter
1.4	64 - 74	10/12→02/19						
OPEL - AGILA (A) (H00) 09/00→12/07								
 Hauptbremszylinder								
1.0	44	08/03→12/07		+ ABS; → 07/07		24.2120-1730.3	010678	Ø 20,6
1.0 12V	43	09/00→12/07						
1.2 16V	55	09/00→12/07						
1.3 CDTI	51	08/03→12/07						
OPEL - AGILA (B) (H08) 04/08→10/14								
 Hauptbremszylinder								
1.0	48 - 50	04/08→07/14		für Linkslenker; - ESP		24.4122-1718.3	011019	BOS Ø 22,2 ohne Bremsflüssigkeitsbehälter
1.0 LPG	48	01/10→06/11						
1.2	63 - 69	04/08→10/14		für Linkslenker; + ESP		24.4122-1719.3	011020	Ø 22,2 ohne Bremsflüssigkeitsbehälter
1.2 LPG	63	04/08→10/10						
1.3 CDTI	55	04/08→04/10						
OPEL - ASTRA F (T92) 09/91→09/98								
 Hauptbremszylinder								
1.4 i	44	09/91→09/98		10/91→; - ABS		24.2120-0702.3	010361	nicht für Delco Ø 20,6
1.4 i 16V	66	02/96→09/98		- ABS; für Fahrzeuge mit verstärkter Bremse		03.2122-0264.3	010129	ATE Ø 22,2
1.4 Si	60	03/92→09/98						
1.7 D	44	07/92→09/98		- ABS; nicht für Fahrzeuge mit verstärkter Bremse		24.2120-0702.3	010361	nicht für Delco Ø 20,6
1.6 i 16V	74	08/94→09/98		- ABS		03.2122-0264.3	010129	ATE Ø 22,2
1.8 i 16V	85	11/94→09/98						
2.0 i	85	03/92→09/98						
1.7 TD	50	11/94→09/98		- ABS		24.2120-0702.3	010361	nicht für Delco Ø 20,6
1.7 TDS	60	03/92→09/98						
1.8 i	66	03/92→09/98						
 Bremskraftregler								
1.4 i	44	09/91→09/98		10/91→		03.0101-0027.2	320022	ATE Satz 3/45 2x
1.4 i 16V	66	02/96→09/98		Schaltgetriebe		03.0101-0027.2	320022	ATE Satz 3/45 2x
1.4 Si	60	03/92→09/98						
1.6	55	09/95→09/98		→ R2500000		03.0101-0027.2	320022	ATE Satz 3/45 2x
1.6 i	55	03/92→09/98						
1.6 i 16V	74	08/94→09/98				03.6583-0054.3	320146	ATE lastabhängig 8/3 4x
2.0 i 16V	100	02/95→09/98						
1.7 D	44	07/92→09/98		→ 07/93		03.0101-0026.2	320230	ATE Satz 3/40 2x
1.8 i	66	03/92→09/98		→ 07/93		03.0101-0027.2	320022	ATE Satz 3/45 2x
2.0 i	85	03/92→09/98		08/93→		03.6583-0054.3	320146	ATE lastabhängig 8/3 4x
OPEL - ASTRA F Cabriolet (T92) 03/93→03/01								
 Hauptbremszylinder								
1.4 i 16V	66	01/96→03/01		→ 09/98; - ABS; für Fahrzeuge mit verstärkter Bremse		03.2122-0264.3	010129	ATE Ø 22,2
1.4 Si	60	05/93→03/01		→ 09/98; - ABS; nicht für Fahrzeuge mit verstärkter Bremse		24.2120-0702.3	010361	nicht für Delco Ø 20,6
1.8 i 16V	85	11/94→03/01		→ 09/98; - ABS		03.2122-0264.3	010129	ATE Ø 22,2
 Bremskraftregler								
1.6 i	55	01/96→03/01		→ R2500000		03.0101-0027.2	320022	ATE Satz 3/45 2x











	kw					! #		
OPEL - ASTRA F Caravan (T92) 09/91→01/98								
 Hauptbremszylinder								
1.4 i 1.8 i	44 66	09/91→01/98 09/91→01/98		10/91→; - ABS			24.2120-0702.3 010361	nicht für Delco Ø 20,6
1.4 i 16V 1.4 Si 1.7 D	66 60 44	02/96→01/98 03/92→01/98 07/92→01/98		- ABS; für Fahrzeuge mit verstärkter Bremse			03.2122-0264.3 010129	ATE Ø 22,2
				- ABS; nicht für Fahrzeuge mit verstärkter Bremse			24.2120-0702.3 010361	nicht für Delco Ø 20,6
1.6 i 16V 1.8 i 16V	74 85	08/94→01/98 06/93→01/98		- ABS			03.2122-0264.3 010129	ATE Ø 22,2
1.7 TD 1.7 TDS	50 60	11/94→01/98 12/91→01/98		- ABS			24.2120-0702.3 010361	nicht für Delco Ø 20,6
OPEL - ASTRA F CC (T92) 09/91→02/98								
 Hauptbremszylinder								
1.4 i 1.7 TD 1.7 TDS	44 50 60	09/91→01/98 11/94→01/98 12/91→01/98		- ABS			24.2120-0702.3 010361	nicht für Delco Ø 20,6
1.4 i 16V 1.4 Si 1.7 D	66 60 44	09/96→02/98 03/92→01/98 07/92→01/98		- ABS; für Fahrzeuge mit verstärkter Bremse			03.2122-0264.3 010129	ATE Ø 22,2
				- ABS; nicht für Fahrzeuge mit verstärkter Bremse			24.2120-0702.3 010361	nicht für Delco Ø 20,6
1.6 i 16V 1.8 i 16V	74 85	08/94→01/98 09/94→01/98		- ABS			03.2122-0264.3 010129	ATE Ø 22,2
1.8 i	66	09/91→01/98		10/91→; - ABS			24.2120-0702.3 010361	nicht für Delco Ø 20,6
2.0 i	85	09/91→01/98		10/91→; - ABS			03.2122-0264.3 010129	ATE Ø 22,2
 Bremskraftregler								
1.4 i	44	09/91→01/98					03.0101-0027.2 320022	ATE Satz 3/45 2x
1.4 i 16V 1.4 Si	66 60	09/96→02/98 03/92→01/98		Schaltgetriebe			03.0101-0027.2 320022	ATE Satz 3/45 2x
1.6	55	09/95→01/98		→ R2500000			03.0101-0027.2 320022	ATE Satz 3/45 2x
1.6 i	55	09/91→01/98		10/91→; → R2500000			03.0101-0027.2 320022	ATE Satz 3/45 2x
1.6 i 16V 2.0 i 16V	74 100	08/94→01/98 02/95→01/98					03.6583-0054.3 320146	ATE lastabhängig 8/3 4x
1.7 D	44	07/92→01/98		→ 07/93			03.0101-0026.2 320230	ATE Satz 3/40 2x
1.8 i 2.0 i	66 85	09/91→01/98 09/91→01/98		10/91→ 07/93			03.0101-0027.2 320022	ATE Satz 3/45 2x
				08/93→			03.6583-0054.3 320146	ATE lastabhängig 8/3 4x
2.0 GSI 16V	110	09/91→01/98		08/92→			03.6583-0054.3 320146	ATE lastabhängig 8/3 4x
OPEL - ASTRA F CLASSIC Caravan (T92) 01/98→01/05								
 Hauptbremszylinder								
1.4 i 1.6 i	44 55	01/98→01/05 01/98→01/05					24.2120-0702.3 010361	nicht für Delco Ø 20,6
OPEL - ASTRA F CLASSIC CC (T92) 01/98→08/02								
 Hauptbremszylinder								
1.4 i 1.6 i	44 55	01/98→08/02 01/98→08/02		- ABS			24.2120-0702.3 010361	nicht für Delco Ø 20,6
 Bremskraftregler								
1.6 i 16V	74	01/98→08/02					03.6583-0054.3 320146	ATE lastabhängig 8/3 4x
OPEL - ASTRA F CLASSIC Stufenheck (T92) 01/98→08/02								
 Hauptbremszylinder								
1.4 i 1.6 i	44 55	01/98→08/02 01/98→08/02		- ABS			24.2120-0702.3 010361	nicht für Delco Ø 20,6
 Bremskraftregler								
1.6 i 16V	74	01/98→08/02					03.6583-0054.3 320146	ATE lastabhängig 8/3 4x
OPEL - ASTRA F Kasten/Kombi (T92) 10/91→01/99								
 Hauptbremszylinder								
1.6 i 16V	74	08/94→03/98		- ABS			03.2122-0264.3 010129	ATE Ø 22,2
1.7 D	44	07/92→01/99		→ 09/98; - ABS; für Fahrzeuge mit verstärkter Bremse			03.2122-0264.3 010129	ATE Ø 22,2
				→ 09/98; - ABS; nicht für Fahrzeuge mit verstärkter Bremse			24.2120-0702.3 010361	nicht für Delco Ø 20,6
1.7 TD	50	08/94→01/99		→ 09/98; - ABS			24.2120-0702.3 010361	nicht für Delco Ø 20,6

	kw			 	! #		
OPEL - ASTRA G Cabriolet (T98) 03/01→10/05							
 Hauptbremszylinder							
1.6	76	01/03→10/05		- ESP		24.2123-1734.3 010640	TRW Ø 23,8
1.6 16V	74	03/01→10/05		+ ESP		24.2123-1739.3 010661	Ø 23,8
1.8 16V	92	03/01→10/05					
2.0 16V Turbo	147	11/02→10/05					
2.0 OPC	141	03/02→10/05					
2.2 16V	108	03/01→10/05					
2.2 DTI	92	09/02→10/05		- ESP		24.2123-1734.3 010640	TRW Ø 23,8
OPEL - ASTRA G Caravan (T98) 02/98→07/04							
 Hauptbremszylinder							
1.2 16V	48	02/98→09/00		04/98→; - ESP; für Fahrzeuge mit Scheibenbremse an der Hinterachse		24.2123-1734.3 010640	TRW Ø 23,8
1.6	55	02/98→09/00					
1.6 16V	74	02/98→07/04		22000001→; - ESP; für Fahrzeuge mit Trommelbremse an der Hinterachse		24.2123-1734.3 010640	TRW Ø 23,8
				04/98→; + ESP		24.2123-1739.3 010661	Ø 23,8
1.2 16V	55	09/00→07/04		- ESP; für Fahrzeuge mit Scheibenbremse an der Hinterachse		24.2123-1734.3 010640	TRW Ø 23,8
1.4 16V	66	06/98→07/04					
1.4 LPG	66	03/98→07/04		22000001→; - ESP; für Fahrzeuge mit Trommelbremse an der Hinterachse		24.2123-1734.3 010640	TRW Ø 23,8
1.6	62 - 76	09/00→07/04					
1.6 LPG	74 - 76	03/98→07/04		+ ESP		24.2123-1739.3 010661	Ø 23,8
1.7 DTI 16V	55	02/00→07/04					
1.6 CNG	71	03/03→07/04		- ESP		24.2123-1734.3 010640	TRW Ø 23,8
1.8 16V	92	09/00→07/04		+ ESP		24.2123-1739.3 010661	Ø 23,8
2.0 DTI 16V	74	08/99→07/04					
2.0 OPC	141 - 147	09/02→07/04					
2.2 16V	108	03/01→07/04					
2.2 DTI	86 - 92	09/02→07/04					
1.7 CDTI	59	04/03→05/04		- ESP		24.2123-1734.3 010640	TRW Ø 23,8
1.7 TD	50	02/98→08/00		04/98→; - ESP; für Fahrzeuge mit Scheibenbremse an der Hinterachse		24.2123-1734.3 010640	TRW Ø 23,8
				04/98→; + ESP		24.2123-1739.3 010661	Ø 23,8
1.8 16V	85	02/98→09/00		04/98→; - ESP		24.2123-1734.3 010640	TRW Ø 23,8
2.0 16V	100	02/98→07/04					
2.0 DI	60	02/98→07/04		04/98→; + ESP		24.2123-1739.3 010661	Ø 23,8
 Bremskraftregler							
1.2 16V	48	02/98→09/00		04/98→; - ABS		03.6583-0073.3 320234	ATE lastabhängig 8/3 4x
1.6	55	02/98→09/00					
1.6 16V	74	02/98→07/04					
1.7 TD	50	02/98→08/00					
1.8 16V	85	02/98→09/00					
2.0 16V	100	02/98→07/04					
1.2 16V	55	09/00→07/04		- ABS		03.6583-0073.3 320234	ATE lastabhängig 8/3 4x
1.4 16V	66	06/98→07/04					
1.4 LPG	66	03/98→07/04					
1.6	62 - 76	09/00→07/04					
1.6 CNG	71	03/03→07/04					
1.6 LPG	74 - 76	03/98→07/04					
1.7 CDTI	59	04/03→05/04					
1.7 DTI 16V	55	02/00→07/04					
1.8 16V	92	09/00→07/04					
2.0 DI	60	02/98→07/04		04/98→; - ABS		03.6583-0074.3 320235	ATE lastabhängig 8/3 4x
2.0 DTI 16V	74	08/99→07/04		- ABS		03.6583-0074.3 320235	ATE lastabhängig 8/3 4x
OPEL - ASTRA G CC (T98) 02/98→12/09							
 Hauptbremszylinder							
1.2 16V	48	02/98→09/00		04/98→; - ESP; für Fahrzeuge mit Scheibenbremse an der Hinterachse		24.2123-1734.3 010640	TRW Ø 23,8
1.4 16V	66	02/98→01/05					
1.4 LPG	66	02/98→01/05		22000001→; - ESP; für Fahrzeuge mit Trommelbremse an der Hinterachse		24.2123-1734.3 010640	TRW Ø 23,8
1.6	55	02/98→09/00					
1.6 16V	74	02/98→01/05		04/98→; + ESP		24.2123-1739.3 010661	Ø 23,8
1.6 LPG	74	03/98→01/05					
1.2 16V	55	09/00→01/05		- ESP; für Fahrzeuge mit Scheibenbremse an der Hinterachse		24.2123-1734.3 010640	TRW Ø 23,8
1.4	66	09/07→12/09					
1.6	62 - 76	09/00→01/05		22000001→; - ESP; für Fahrzeuge mit Trommelbremse an der Hinterachse		24.2123-1734.3 010640	TRW Ø 23,8
1.6 LPG	76	11/02→06/07					
1.7 DTI 16V	55	02/00→01/05		+ ESP		24.2123-1739.3 010661	Ø 23,8
1.7 CDTI	59	04/03→01/05		- ESP		24.2123-1734.3 010640	TRW Ø 23,8
→							

	kW			 	! #		
OPEL - ASTRA G CC (T98) 02/98→12/09							
 Hauptbremszylinder							
1.7 TD	50	02/98→08/00		04/98→; - ESP; für Fahrzeuge mit Scheibenbremse an der Hinterachse		24.2123-1734.3 010640	TRW Ø 23,8
				04/98→; + ESP		24.2123-1739.3 010661	Ø 23,8
1.8	81	02/03→01/04		- ESP		24.2123-1734.3 010640	TRW Ø 23,8
1.8 16V	92	09/00→01/05					
2.0 16V OPC	118	11/99→09/02		+ ESP		24.2123-1739.3 010661	Ø 23,8
2.0 DTI 16V	74	08/99→01/05					
2.0 OPC	141 -	09/02→01/05					
	147						
2.2 DTI	86 -	09/02→01/05					
	92						
1.8 16V	85	02/98→09/00		04/98→; - ESP		24.2123-1734.3 010640	TRW Ø 23,8
2.0 16V	100	02/98→01/05		04/98→; + ESP		24.2123-1739.3 010661	Ø 23,8
2.0 DI	60	02/98→01/05					
2.2 16V	108	06/00→01/05		09/00→; - ESP		24.2123-1734.3 010640	TRW Ø 23,8
				09/00→; + ESP		24.2123-1739.3 010661	Ø 23,8
 Bremskraftregler							
1.2 16V	48	02/98→09/00		04/98→; - ABS		03.6583-0073.3 320234	ATE lastabhängig 8/3 4x
1.2 16V	55	09/00→01/05		- ABS		03.6583-0073.3 320234	ATE lastabhängig 8/3 4x
1.4 16V	66	02/98→01/05		04/98→; - ABS		03.6583-0074.3 320235	ATE lastabhängig 8/3 4x
1.4 LPG	66	02/98→01/05					
1.6	55	02/98→09/00					
1.6 16V	74	02/98→01/05					
1.6 LPG	74	03/98→01/05					
1.7 TD	50	02/98→08/00					
1.8 16V	85	02/98→09/00					
2.0 16V	100	02/98→01/05					
2.0 DI	60	02/98→01/05					
1.6	62 -	09/00→01/05		- ABS		03.6583-0074.3 320235	ATE lastabhängig 8/3 4x
	76						
1.6 LPG	76	11/02→06/07					
1.7 CDTI	59	04/03→01/05					
1.7 DTI 16V	55	02/00→01/05					
1.8	81	02/03→01/04					
1.8 16V	92	09/00→01/05					
2.0 DTI 16V	74	08/99→01/05					
OPEL - ASTRA G CLASSIC (T98) 03/04→07/09							
 Hauptbremszylinder							
1.4 16V	66	05/04→07/09		- ESP; für Fahrzeuge mit Scheibenbremse an der Hinterachse		24.2123-1734.3 010640	TRW Ø 23,8
1.6	76	03/06→06/08					
1.6 16V	74	05/04→02/06		22000001→; - ESP; für Fahrzeuge mit Trommelbremse an der Hinterachse		24.2123-1734.3 010640	TRW Ø 23,8
				+ ESP		24.2123-1739.3 010661	Ø 23,8
1.7 CDTI	59	06/04→07/09		- ESP		24.2123-1734.3 010640	TRW Ø 23,8
 Bremskraftregler							
1.4 16V	66	05/04→07/09		- ABS		03.6583-0074.3 320235	ATE lastabhängig 8/3 4x
1.6	76	03/06→06/08					
1.6 16V	74	05/04→02/06					
1.7 CDTI	59	06/04→07/09					
OPEL - ASTRA G CLASSIC Caravan (F35) 03/04→07/09							
 Hauptbremszylinder							
1.4	66	10/07→07/09		- ESP		24.2123-1734.3 010640	TRW Ø 23,8
1.4 16V	66	07/04→09/07		+ ESP		24.2123-1739.3 010661	Ø 23,8
1.6	74 -	06/04→07/09		- ESP; für Fahrzeuge mit Scheibenbremse an der Hinterachse		24.2123-1734.3 010640	TRW Ø 23,8
	76			22000001→; - ESP; für Fahrzeuge mit Trommelbremse an der Hinterachse		24.2123-1734.3 010640	TRW Ø 23,8
				+ ESP		24.2123-1739.3 010661	Ø 23,8
1.7 CDTI	59	05/04→07/09		- ESP		24.2123-1734.3 010640	TRW Ø 23,8
 Bremskraftregler							
1.4	66	10/07→07/09		- ABS		03.6583-0073.3 320234	ATE lastabhängig 8/3 4x
1.4 16V	66	07/04→09/07					
1.6	74 -	06/04→07/09					
	76						
1.7 CDTI	59	05/04→07/09					

	kw					! #		
OPEL - ASTRA G CLASSIC Stufenheck (T98) 03/04→07/09								
 Hauptbremszylinder								
1.4 16V	66	05/04→07/09		- ESP		24.2123-1734.3 010640	TRW Ø 23,8	
				+ ESP		24.2123-1739.3 010661	Ø 23,8	
1.6 16V	74	03/04→01/08		- ESP; für Fahrzeuge mit Scheibenbremse an der Hinterachse		24.2123-1734.3 010640	TRW Ø 23,8	
				22000001→; - ESP; für Fahrzeuge mit Trommelbremse an der Hinterachse		24.2123-1734.3 010640	TRW Ø 23,8	
				+ ESP		24.2123-1739.3 010661	Ø 23,8	
 Bremskraftregler								
1.4 16V	66	05/04→07/09		- ABS		03.6583-0074.3 320235	ATE lastabhängig 8/3 4x	
1.6 16V	74	03/04→01/08						
OPEL - ASTRA G Coupe (T98) 03/00→05/05								
 Hauptbremszylinder								
1.6 16V	74 - 76	03/00→05/05		- ESP; für Fahrzeuge mit Scheibenbremse an der Hinterachse		24.2123-1734.3 010640	TRW Ø 23,8	
				22000001→; - ESP; für Fahrzeuge mit Trommelbremse an der Hinterachse		24.2123-1734.3 010640	TRW Ø 23,8	
				+ ESP		24.2123-1739.3 010661	Ø 23,8	
1.8 16V	85 - 92	03/00→05/05		- ESP		24.2123-1734.3 010640	TRW Ø 23,8	
2.0 16V Turbo	140 - 147	09/00→05/05		+ ESP		24.2123-1739.3 010661	Ø 23,8	
2.2 16V	108	09/00→05/05						
2.2 DTI	92	09/02→05/05						
OPEL - ASTRA G Kasten/Kombi (F70) 09/98→04/05								
 Hauptbremszylinder								
1.2	48	09/98→08/00		- ESP; für Fahrzeuge mit Scheibenbremse an der Hinterachse		24.2123-1734.3 010640	TRW Ø 23,8	
1.4	66	09/98→04/05						
1.6	55 - 76	09/98→04/05		22000001→; - ESP; für Fahrzeuge mit Trommelbremse an der Hinterachse		24.2123-1734.3 010640	TRW Ø 23,8	
1.7 CDTi	59	07/03→11/04						
1.7 DTI 16V	55	02/00→04/05		+ ESP		24.2123-1739.3 010661	Ø 23,8	
1.7 TD	50	01/99→04/05		- ESP; für Fahrzeuge mit Scheibenbremse an der Hinterachse		24.2123-1734.3 010640	TRW Ø 23,8	
				+ ESP		24.2123-1739.3 010661	Ø 23,8	
2.0 DI	60	01/99→04/05		- ESP		24.2123-1734.3 010640	TRW Ø 23,8	
2.0 DTI	74	09/00→04/05		+ ESP		24.2123-1739.3 010661	Ø 23,8	
 Bremskraftregler								
1.2	48	09/98→08/00		- ABS		03.6583-0073.3 320234	ATE lastabhängig 8/3 4x	
1.4	66	09/98→04/05						
1.6	55 - 76	09/98→04/05						
1.7 TD	50	01/99→04/05						
2.0 DI	60	01/99→04/05		- ABS		03.6583-0074.3 320235	ATE lastabhängig 8/3 4x	
2.0 DTI	74	09/00→04/05						
OPEL - ASTRA G Stufenheck (T98) 03/98→12/09								
 Hauptbremszylinder								
1.2 16V	48 - 55	09/98→01/05		- ESP; für Fahrzeuge mit Scheibenbremse an der Hinterachse		24.2123-1734.3 010640	TRW Ø 23,8	
1.4 16V	66	09/98→01/05						
1.4 LPG	66	03/98→01/05		22000001→; - ESP; für Fahrzeuge mit Trommelbremse an der Hinterachse		24.2123-1734.3 010640	TRW Ø 23,8	
1.6	55 - 76	09/98→12/09		+ ESP		24.2123-1739.3 010661	Ø 23,8	
1.6 16V	74	09/98→01/05						
1.6 LPG	55 - 74	10/98→01/05						
1.7 DTI 16V	55	02/00→01/05						
1.4	66	09/07→12/09		- ESP		24.2123-1734.3 010640	TRW Ø 23,8	
1.8 16V	85 - 92	09/98→01/05		+ ESP		24.2123-1739.3 010661	Ø 23,8	
2.0 16V	100	09/98→01/05						
2.0 DI	60	09/98→01/05						
2.0 DTI 16V	74	08/99→01/05						
2.2 16V	108	03/01→01/05						
2.2 DTI	86 - 92	09/02→01/05						
1.7 CDTi	59	04/03→12/09		- ESP		24.2123-1734.3 010640	TRW Ø 23,8	
1.7 TD	50	09/98→08/00		- ESP; für Fahrzeuge mit Scheibenbremse an der Hinterachse		24.2123-1734.3 010640	TRW Ø 23,8	
				+ ESP		24.2123-1739.3 010661	Ø 23,8	

	kw					! #		
OPEL - ASTRA G Stufenheck (T98) 03/98→12/09								
 Bremskraftregler								
1.2 16V	48 - 55	09/98→01/05		- ABS			03.6583-0073.3 320234	ATE lastabhängig 8/3 4x
1.4	66	09/07→12/09		- ABS			03.6583-0074.3 320235	ATE lastabhängig 8/3 4x
1.4 16V	66	09/98→01/05						
1.4 LPG	66	03/98→01/05						
1.6	55 - 76	09/98→12/09						
1.6 16V	74	09/98→01/05						
1.6 LPG	55 - 74	10/98→01/05						
1.7 CDTI	59	04/03→12/09						
1.7 DTI 16V	55	02/00→01/05						
1.7 TD	50	09/98→08/00						
1.8 16V	85 - 92	09/98→01/05						
2.0 16V	100	09/98→01/05						
2.0 DI	60	09/98→01/05						
2.0 DTI 16V	74	08/99→01/05						
OPEL - ASTRA H (A04) 01/04→05/14								
 Bremskraftverstärker								
1.9 CDTI	74 - 110	09/04→10/10		für Linkslenker			03.7863-7803.4 300237	ATE Ø 10" pneumatisch
1.9 CDTI	88	06/04→10/10		09/04→; für Linkslenker			03.7863-7803.4 300237	ATE Ø 10" pneumatisch
1.9 CDTI 16V	88	04/04→10/10						
 Hauptbremszylinder								
1.2	59	08/05→10/10		für Rechtslenker; → 68999999			24.2125-1736.3 010904	TRW Ø 25,4
1.3 CDTI	66	08/05→10/10		für Linkslenker; → 68999999; + ESP			24.2125-1736.3 010904	TRW Ø 25,4
1.4	55 - 66	03/04→10/10		für Linkslenker; → 68999999; - ESP			24.2125-1737.3 010906	TRW Ø 25,4
1.4 LPG	66	08/09→10/10		72000001→; für Rechtslenker			24.4125-1703.3 010907	TRW Ø 25,4
1.6	77	03/04→10/10		72000001→; für Linkslenker; + ESP			24.4125-1703.3 010907	TRW Ø 25,4
1.6 Turbo	132	02/07→10/10		72000001→; für Linkslenker; - ESP			24.4125-1704.3 010908	TRW Ø 25,4
1.7 CDTI	59 - 74	03/04→10/10						
1.8	92 - 103	01/04→10/10						
2.0 Turbo	125 - 177	03/04→10/10						
1.6	85	12/06→05/14		01/07→; → 68999999; für Rechtslenker			24.2125-1736.3 010904	TRW Ø 25,4
				01/07→; → 68999999; für Linkslenker; + ESP			24.2125-1736.3 010904	TRW Ø 25,4
				01/07→; → 68999999; für Linkslenker; - ESP			24.2125-1737.3 010906	TRW Ø 25,4
				72000001→; → 11/10; für Rechtslenker			24.4125-1703.3 010907	TRW Ø 25,4
				72000001→; → 11/10; für Linkslenker; + ESP			24.4125-1703.3 010907	TRW Ø 25,4
				72000001→; → 11/10; für Linkslenker; - ESP			24.4125-1704.3 010908	TRW Ø 25,4
1.7 CDTI	81 - 92	02/07→05/14		04/07→; → 68999999; für Rechtslenker			24.2125-1736.3 010904	TRW Ø 25,4
				04/07→; → 68999999; für Linkslenker; + ESP			24.2125-1736.3 010904	TRW Ø 25,4
				04/07→; → 68999999; für Linkslenker; - ESP			24.2125-1737.3 010906	TRW Ø 25,4
				72000001→; → 11/10; für Rechtslenker			24.4125-1703.3 010907	TRW Ø 25,4
				72000001→; → 11/10; für Linkslenker; + ESP			24.4125-1703.3 010907	TRW Ø 25,4
				72000001→; → 11/10; für Linkslenker; - ESP			24.4125-1704.3 010908	TRW Ø 25,4
1.9 CDTI	74 - 110	09/04→10/10					03.4155-0156.3 010862	ATE Ø 25,4
1.9 CDTI	88	06/04→10/10		09/04→			03.4155-0156.3 010862	ATE Ø 25,4
1.9 CDTI 16V	88	04/04→10/10						
OPEL - ASTRA H Caravan (A04) 08/04→05/14								
 Bremskraftverstärker								
1.9 CDTI	74 - 110	09/04→10/10		für Linkslenker			03.7863-7803.4 300237	ATE Ø 10" pneumatisch
1.9 CDTI 16V	88	08/04→10/10						
 Hauptbremszylinder								
1.3 CDTI	66	08/05→10/10		72000001→; für Linkslenker; + ESP			24.2125-1703.3 010483	Ø 25,4
1.4	55 - 66	08/04→10/10		72000001→; für Linkslenker; - ESP			24.2125-1704.3 010446	TRW Ø 25,4
1.4 LPG	66	08/09→10/10		→ 62999999; für Rechtslenker			24.2125-1736.3 010904	TRW Ø 25,4
→								

	kw			 	! #		
OPEL - ASTRA H Caravan (A04) 08/04→05/14							
 Hauptbremszylinder							
1.6	77	08/04→10/10		→ 68999999; für Linkslenker; + ESP		24.2125-1736.3 010904	TRW Ø 25,4
1.6 LPG	85	08/09→10/10		→ 68999999; für Linkslenker; - ESP		24.2125-1737.3 010906	TRW Ø 25,4
1.6 Turbo	132	02/07→10/10					
1.7 CDTI	59 - 74	08/04→10/10		72000001→; für Rechtslenker		24.4125-1703.3 010907	TRW Ø 25,4
1.8	92 - 103	08/04→05/14					
2.0 Turbo	125 - 147	08/04→10/10					
1.6	85	12/06→05/14		72000001→; → 11/10; für Linkslenker; + ESP		24.2125-1703.3 010483	Ø 25,4
				72000001→; → 11/10; für Linkslenker; - ESP		24.2125-1704.3 010446	TRW Ø 25,4
				01/07→; → 62999999; für Rechtslenker		24.2125-1736.3 010904	TRW Ø 25,4
				01/07→; → 68999999; für Linkslenker; + ESP		24.2125-1736.3 010904	TRW Ø 25,4
				01/07→; → 68999999; für Linkslenker; - ESP		24.2125-1737.3 010906	TRW Ø 25,4
				72000001→; → 11/10; für Rechtslenker		24.4125-1703.3 010907	TRW Ø 25,4
1.7 CDTI	81 - 92	02/07→05/14		72000001→; → 11/10; für Linkslenker; + ESP		24.2125-1703.3 010483	Ø 25,4
				72000001→; → 11/10; für Linkslenker; - ESP		24.2125-1704.3 010446	TRW Ø 25,4
				04/07→; → 62999999; für Rechtslenker		24.2125-1736.3 010904	TRW Ø 25,4
				04/07→; → 68999999; für Linkslenker; + ESP		24.2125-1736.3 010904	TRW Ø 25,4
				04/07→; → 68999999; für Linkslenker; - ESP		24.2125-1737.3 010906	TRW Ø 25,4
				72000001→; → 11/10; für Rechtslenker		24.4125-1703.3 010907	TRW Ø 25,4
1.9 CDTI	74 - 110	09/04→10/10				03.4155-0156.3 010862	ATE Ø 25,4
1.9 CDTI 16V	88	08/04→10/10					
OPEL - ASTRA H CLASSIC Kombi (A04) 12/06→							
 Hauptbremszylinder							
1.4	66	01/09→		72000001→; für Linkslenker; + ESP		24.2125-1703.3 010483	Ø 25,4
1.7 CDTi	81	01/09→		72000001→; für Linkslenker; - ESP		24.2125-1704.3 010446	TRW Ø 25,4
1.7 CDTI	92	01/09→		→ 62999999; für Rechtslenker		24.2125-1736.3 010904	TRW Ø 25,4
1.8	103	01/12→05/14		→ 68999999; für Linkslenker; + ESP		24.2125-1736.3 010904	TRW Ø 25,4
				→ 68999999; für Linkslenker; - ESP		24.2125-1737.3 010906	TRW Ø 25,4
				72000001→; für Rechtslenker		24.4125-1703.3 010907	TRW Ø 25,4
1.6	85	12/06→05/14		72000001→; → 11/10; für Linkslenker; + ESP		24.2125-1703.3 010483	Ø 25,4
				72000001→; → 11/10; für Linkslenker; - ESP		24.2125-1704.3 010446	TRW Ø 25,4
				01/07→; → 62999999; für Rechtslenker		24.2125-1736.3 010904	TRW Ø 25,4
				01/07→; → 68999999; für Linkslenker; + ESP		24.2125-1736.3 010904	TRW Ø 25,4
				01/07→; → 68999999; für Linkslenker; - ESP		24.2125-1737.3 010906	TRW Ø 25,4
				72000001→; → 11/10; für Rechtslenker		24.4125-1703.3 010907	TRW Ø 25,4
OPEL - ASTRA H CLASSIC Schrägheck (A04) 01/09→							
 Hauptbremszylinder							
1.3 CDTI	66	01/09→		→ 68999999; für Rechtslenker		24.2125-1736.3 010904	TRW Ø 25,4
1.6	85	01/09→		→ 68999999; für Linkslenker; + ESP		24.2125-1736.3 010904	TRW Ø 25,4
1.7 CDTI	81	01/09→		→ 68999999; für Linkslenker; - ESP		24.2125-1737.3 010906	TRW Ø 25,4
				72000001→; → 11/10; für Rechtslenker		24.4125-1703.3 010907	TRW Ø 25,4
				72000001→; → 11/10; für Linkslenker; + ESP		24.4125-1703.3 010907	TRW Ø 25,4
				72000001→; → 11/10; für Linkslenker; - ESP		24.4125-1704.3 010908	TRW Ø 25,4
1.4	66	01/09→		→ 68999999; für Rechtslenker		24.2125-1736.3 010904	TRW Ø 25,4
1.7 CDTI	92	01/09→		→ 68999999; für Linkslenker; + ESP		24.2125-1736.3 010904	TRW Ø 25,4
1.8	103	02/13→		→ 68999999; für Linkslenker; - ESP		24.2125-1737.3 010906	TRW Ø 25,4
				72000001→; für Rechtslenker		24.4125-1703.3 010907	TRW Ø 25,4
				72000001→; für Linkslenker; + ESP		24.4125-1703.3 010907	TRW Ø 25,4
				72000001→; für Linkslenker; - ESP		24.4125-1704.3 010908	TRW Ø 25,4

OPEL - ASTRA H CLASSIC Stufenheck (A04) 02/07→

Hauptbremszylinder

1.6	85	01/09→05/14	→ 68999999; für Rechtslenker	24.2125-1736.3 010904	TRW Ø 25,4
			→ 68999999; für Linkslenker; + ESP	24.2125-1736.3 010904	TRW Ø 25,4
			→ 68999999; für Linkslenker; - ESP	24.2125-1737.3 010906	TRW Ø 25,4
			72000001→; → 11/10; für Rechtslenker	24.4125-1703.3 010907	TRW Ø 25,4
			72000001→; für Linkslenker; + ESP	24.4125-1703.3 010907	TRW Ø 25,4
			72000001→; für Linkslenker; - ESP	24.4125-1704.3 010908	TRW Ø 25,4
1.7 CDTi 1.7 CDTI 1.8	81 92 103	01/09→ 01/09→ 02/07→09/12	→ 68999999; für Rechtslenker	24.2125-1736.3 010904	TRW Ø 25,4
			→ 68999999; für Linkslenker; + ESP	24.2125-1736.3 010904	TRW Ø 25,4
			→ 68999999; für Linkslenker; - ESP	24.2125-1737.3 010906	TRW Ø 25,4
			72000001→; für Rechtslenker	24.4125-1703.3 010907	TRW Ø 25,4
			72000001→; für Linkslenker; + ESP	24.4125-1703.3 010907	TRW Ø 25,4
			72000001→; für Linkslenker; - ESP	24.4125-1704.3 010908	TRW Ø 25,4

OPEL - ASTRA H GTC (A04) 03/05→10/10

Bremskraftverstärker

1.9 CDTi 1.9 CDTI 1.9 CDTi 16V	110 74 - 88 88	03/05→10/10 09/05→10/10 03/05→10/10	für Linkslenker	03.7863-7803.4 300237	ATE Ø 10" pneumatisch
--------------------------------------	-------------------------	-------------------------------------------	-----------------	------------------------------	-----------------------

Hauptbremszylinder

1.3 CDTI	66	04/05→10/10	08/05→; → 68999999; für Linkslenker; + ESP	24.2125-1736.3 010904	TRW Ø 25,4
			08/05→; → 68999999; für Rechtslenker	24.2125-1736.3 010904	TRW Ø 25,4
			08/05→; → 68999999; für Linkslenker; - ESP	24.2125-1737.3 010906	TRW Ø 25,4
			72000001→; für Rechtslenker	24.4125-1703.3 010907	TRW Ø 25,4
			72000001→; für Linkslenker; + ESP	24.4125-1703.3 010907	TRW Ø 25,4
			72000001→; für Linkslenker; - ESP	24.4125-1704.3 010908	TRW Ø 25,4
1.4	55 - 66	03/05→10/10	für Rechtslenker; → 68999999	24.2125-1736.3 010904	TRW Ø 25,4
			für Linkslenker; → 68999999; + ESP	24.2125-1736.3 010904	TRW Ø 25,4
1.6 1.6 Turbo	77 132	03/05→10/10 02/07→10/10	für Linkslenker; → 68999999; - ESP	24.2125-1737.3 010906	TRW Ø 25,4
			72000001→; für Rechtslenker	24.4125-1703.3 010907	TRW Ø 25,4
1.7 CDTi 1.7 CDTI	59 92 -	03/05→10/10 03/05→10/10	72000001→; für Linkslenker; + ESP	24.4125-1703.3 010907	TRW Ø 25,4
			72000001→; für Linkslenker; - ESP	24.4125-1704.3 010908	TRW Ø 25,4
1.8	103	03/05→10/10	72000001→; für Linkslenker; - ESP	24.4125-1704.3 010908	TRW Ø 25,4
			72000001→; für Linkslenker; - ESP	24.4125-1704.3 010908	TRW Ø 25,4
2.0 Turbo	125 - 177	03/05→10/10			
1.6	85	12/06→10/10	01/07→; → 68999999; für Linkslenker; + ESP	24.2125-1736.3 010904	TRW Ø 25,4
			01/07→; → 68999999; für Rechtslenker	24.2125-1736.3 010904	TRW Ø 25,4
			01/07→; → 68999999; für Linkslenker; - ESP	24.2125-1737.3 010906	TRW Ø 25,4
			72000001→; für Rechtslenker	24.4125-1703.3 010907	TRW Ø 25,4
			72000001→; für Linkslenker; + ESP	24.4125-1703.3 010907	TRW Ø 25,4
			72000001→; für Linkslenker; - ESP	24.4125-1704.3 010908	TRW Ø 25,4
1.7 CDTI	81 - 92	02/07→10/10	04/07→; → 68999999; für Linkslenker; + ESP	24.2125-1736.3 010904	TRW Ø 25,4
			04/07→; → 68999999; für Rechtslenker	24.2125-1736.3 010904	TRW Ø 25,4
			04/07→; → 68999999; für Linkslenker; - ESP	24.2125-1737.3 010906	TRW Ø 25,4
			72000001→; für Rechtslenker	24.4125-1703.3 010907	TRW Ø 25,4
			72000001→; für Linkslenker; + ESP	24.4125-1703.3 010907	TRW Ø 25,4
			72000001→; für Linkslenker; - ESP	24.4125-1704.3 010908	TRW Ø 25,4
1.9 CDTi 1.9 CDTI 1.9 CDTi 16V	110 74 - 88 88	03/05→10/10 09/05→10/10 03/05→10/10		03.4155-0156.3 010862	ATE Ø 25,4











OPEL - ASTRA H Kasten/Kombi (L70) 02/04→12/13











Bremskraftverstärker















1.9 CDTI 1.9 CDTI 16V	74 - 110 88	09/04→12/12 08/04→10/10	für Linkslenker	03.7863-7803.4 300237	ATE Ø 10" pneumatisch
--------------------------	-------------------	----------------------------	-----------------	------------------------------	-----------------------















Hauptbremszylinder















1.3 CDTI →	66	08/05→10/10	72000001→; für Linkslenker; + ESP	24.2125-1703.3 010483	Ø 25,4
---------------	----	-------------	-----------------------------------	------------------------------	--------













	kw			 	! #		
OPEL - ASTRA H Kasten/Kombi (L70) 02/04→12/13							
 Hauptbremszylinder							
1.6 EcoTec	76 - 85	02/04→12/10		72000001→; für Linkslenker; - ESP	24.2125-1704.3	010446	TRW Ø 25,4
				→ 62999999; für Rechtslenker	24.2125-1736.3	010904	TRW Ø 25,4
				→ 68999999; für Linkslenker; + ESP	24.2125-1736.3	010904	TRW Ø 25,4
				→ 68999999; für Linkslenker; - ESP	24.2125-1737.3	010906	TRW Ø 25,4
				72000001→; für Rechtslenker	24.4125-1703.3	010907	TRW Ø 25,4
1.4 EcoTec 1.7 CDTI	66 59	12/04→12/12 12/04→07/07		für Rechtslenker; → 68999999	24.2125-1736.3	010904	TRW Ø 25,4
				→ 68999999; für Linkslenker; + ESP	24.2125-1736.3	010904	TRW Ø 25,4
				→ 68999999; für Linkslenker; - ESP	24.2125-1737.3	010906	TRW Ø 25,4
				72000001→; für Rechtslenker	24.4125-1703.3	010907	TRW Ø 25,4
				72000001→; für Linkslenker; + ESP	24.4125-1703.3	010907	TRW Ø 25,4
1.7 CDTI	74	03/04→10/10		72000001→; für Linkslenker; + ESP	24.2125-1703.3	010483	Ø 25,4
				72000001→; für Linkslenker; - ESP	24.2125-1704.3	010446	TRW Ø 25,4
				08/04→; → 62999999; für Rechtslenker	24.2125-1736.3	010904	TRW Ø 25,4
				08/04→; → 68999999; für Linkslenker; + ESP	24.2125-1736.3	010904	TRW Ø 25,4
				08/04→; → 68999999; für Linkslenker; - ESP	24.2125-1737.3	010906	TRW Ø 25,4
1.7 CDTI	81 - 92	02/07→10/10		72000001→; für Linkslenker; + ESP	24.2125-1703.3	010483	Ø 25,4
				72000001→; für Linkslenker; - ESP	24.2125-1704.3	010446	TRW Ø 25,4
				04/07→; → 62999999; für Rechtslenker	24.2125-1736.3	010904	TRW Ø 25,4
				04/07→; → 68999999; für Linkslenker; + ESP	24.2125-1736.3	010904	TRW Ø 25,4
				04/07→; → 68999999; für Linkslenker; - ESP	24.2125-1737.3	010906	TRW Ø 25,4
1.9 CDTI 1.9 CDTI 16V	74 - 110 88	09/04→12/12 08/04→10/10			03.4155-0156.3	010862	ATE Ø 25,4
OPEL - ASTRA H Stufenheck (A04) 02/07→05/14							
 Hauptbremszylinder							
1.3 CDTi 1.4 1.6 1.7 CDTi 1.8	66 66 77 74 103	02/07→10/10 02/07→06/10 02/07→06/10 02/07→10/10 02/07→09/12		→ 68999999; für Rechtslenker	24.2125-1736.3	010904	TRW Ø 25,4
				→ 68999999; für Linkslenker; + ESP	24.2125-1736.3	010904	TRW Ø 25,4
				→ 68999999; für Linkslenker; - ESP	24.2125-1737.3	010906	TRW Ø 25,4
				72000001→; für Rechtslenker	24.4125-1703.3	010907	TRW Ø 25,4
				72000001→; für Linkslenker; + ESP	24.4125-1703.3	010907	TRW Ø 25,4
1.6	85	02/07→05/14		→ 68999999; für Rechtslenker	24.2125-1736.3	010904	TRW Ø 25,4
				→ 68999999; für Linkslenker; + ESP	24.2125-1736.3	010904	TRW Ø 25,4
				→ 68999999; für Linkslenker; - ESP	24.2125-1737.3	010906	TRW Ø 25,4
				72000001→; → 11/10; für Rechtslenker	24.4125-1703.3	010907	TRW Ø 25,4
				72000001→; → 11/10; für Linkslenker; + ESP	24.4125-1703.3	010907	TRW Ø 25,4
1.7 CDTi	81	02/07→05/14		72000001→; → 11/10; für Linkslenker; - ESP	24.4125-1704.3	010908	TRW Ø 25,4
				04/07→; → 68999999; für Rechtslenker	24.2125-1736.3	010904	TRW Ø 25,4
				04/07→; → 68999999; für Linkslenker; + ESP	24.2125-1736.3	010904	TRW Ø 25,4
				04/07→; → 68999999; für Linkslenker; - ESP	24.2125-1737.3	010906	TRW Ø 25,4
				72000001→; → 11/10; für Rechtslenker	24.4125-1703.3	010907	TRW Ø 25,4
				72000001→; → 11/10; für Linkslenker; + ESP	24.4125-1703.3	010907	TRW Ø 25,4
	72000001→; → 11/10; für Linkslenker; - ESP	24.4125-1704.3	010908	TRW Ø 25,4			
OPEL - ASTRA H TwinTop (A04) 09/05→10/10							
 Bremskraftverstärker							
1.9 CDTi	110	09/05→10/10		03/06→; für Linkslenker	03.7863-7803.4	300237	ATE Ø 10" pneumatisch
 Hauptbremszylinder							
1.4 1.6 →	66 77	10/05→10/10 09/05→10/10		03/06→; → 68999999; für Linkslenker; + ESP	24.2125-1736.3	010904	TRW Ø 25,4













	kw			 	! #		
OPEL - ASTRA H TwinTop (A04) 09/05→10/10							
 Hauptbremszylinder							
1.8	92 - 103	09/05→10/10		03/06→; → 68999999; für Rechtslenker		24.2125-1736.3 010904	TRW Ø 25,4
2.0 Turbo	125 - 147	09/05→10/10		03/06→; → 68999999; für Linkslenker; - ESP		24.2125-1737.3 010906	TRW Ø 25,4
				03/06→; für Rechtslenker		24.4125-1703.3 010907	TRW Ø 25,4
				72000001→; für Linkslenker; + ESP		24.4125-1703.3 010907	TRW Ø 25,4
				72000001→; für Linkslenker; - ESP		24.4125-1704.3 010908	TRW Ø 25,4
1.6 1.6 Turbo	85 132	12/06→10/10 02/07→10/10		→ 68999999; für Rechtslenker		24.2125-1736.3 010904	TRW Ø 25,4
				→ 68999999; für Linkslenker; + ESP		24.2125-1736.3 010904	TRW Ø 25,4
				→ 68999999; für Linkslenker; - ESP		24.2125-1737.3 010906	TRW Ø 25,4
				für Rechtslenker		24.4125-1703.3 010907	TRW Ø 25,4
				72000001→; für Linkslenker; + ESP		24.4125-1703.3 010907	TRW Ø 25,4
				72000001→; für Linkslenker; - ESP		24.4125-1704.3 010908	TRW Ø 25,4
1.9 CDTi	110	09/05→10/10		03/06→; für Rechtslenker		03.4155-0156.3 010862	ATE Ø 25,4
				03/06→; für Linkslenker; + ESP		03.4155-0156.3 010862	ATE Ø 25,4
OPEL - ASTRA J (P10) 09/09→10/15							
 Bremskraftverstärker							
1.3 CDTI	70	12/09→10/15		für Linkslenker		03.7858-0732.4 300272	ATE Ø 9 / 8" pneumatisch
1.4	64 - 74	12/09→10/15					
1.4 LPG	103	01/12→10/15					
1.4 Turbo	103	12/09→10/15					
1.6	85	12/09→10/15					
1.6 CDTi	81 - 100	11/13→10/15					
1.6 SIDI	125	12/12→10/15					
1.6 Turbo	132	12/09→10/15					
1.6 Turbo 4x4	132	12/09→10/15					
1.7 CDTI	81 - 96	09/09→10/15					
2.0 BiTurbo CDTI	143	09/12→10/15					
2.0 CDTI	96 - 121	09/09→10/15					
1.4 Turbo	88	10/10→10/15		11/10→; für Linkslenker		03.7858-0732.4 300272	ATE Ø 9 / 8" pneumatisch
 Hauptbremszylinder							
1.3 CDTI	70	12/09→10/15		für Linkslenker		03.2125-0421.3 010934	ATE Ø 25,4
1.4	64 - 74	12/09→10/15					
1.4 LPG	103	01/12→10/15					
1.4 Turbo	103	12/09→10/15					
1.6	85	12/09→10/15					
1.6 CDTi	81 - 100	11/13→10/15					
1.6 SIDI	125	12/12→10/15					
1.6 Turbo	132	12/09→10/15					
1.6 Turbo 4x4	132	12/09→10/15					
1.7 CDTI	81 - 96	09/09→10/15					
2.0 BiTurbo CDTI	143	09/12→10/15					
2.0 CDTI	96 - 121	09/09→10/15					
1.4 Turbo	88	10/10→10/15		11/10→; für Linkslenker		03.2125-0421.3 010934	ATE Ø 25,4
OPEL - ASTRA J Caravan (P10) 10/10→10/15							
 Bremskraftverstärker							
1.3 CDTI	70	10/10→10/14		11/10→; für Linkslenker		03.7858-0732.4 300272	ATE Ø 9 / 8" pneumatisch
1.4	64 - 74	10/10→10/15					
1.4 Turbo	88 - 103	10/10→10/15					
1.6	85	10/10→10/15					
1.6 Turbo	132	10/10→10/15					
1.7 CDTI	74 - 96	10/10→10/15					
2.0 CDTI	118	10/10→10/15					
1.4 LPG	103	12/11→10/15		für Linkslenker		03.7858-0732.4 300272	ATE Ø 9 / 8" pneumatisch
1.6 CDTi	81 - 100	11/13→10/15					
1.6 SIDI	125	12/12→10/15					
2.0 BiTurbo CDTI	143	09/12→10/15					
2.0 CDTI	96 - 121	08/11→10/15					
→							











	kW			 	! #		
OPEL - ASTRA J Caravan (P10) 10/10→10/15							
 Hauptbremszylinder							
1.3 CDTi 1.4	70 64 - 74	10/10→10/14 10/10→10/15		11/10→; für Linkslenker		03.2125-0421.3 010934	ATE Ø 25,4
1.4 Turbo	88 - 103	10/10→10/15					
1.6	85	10/10→10/15					
1.6 Turbo	132	10/10→10/15					
1.7 CDTi	74 - 96	10/10→10/15					
2.0 CDTi	118	10/10→10/15					
1.4 LPG 1.6 CDTi	103 81 - 100	12/11→10/15 11/13→10/15		für Linkslenker		03.2125-0421.3 010934	ATE Ø 25,4
1.6 SIDI	125	12/12→10/15					
2.0 BiTurbo CDTi	143	09/12→10/15					
2.0 CDTi	96 - 121	08/11→10/15					
OPEL - ASTRA J GTC 10/11→							
 Bremskraftverstärker							
1.4	74 - 103	10/11→		für Linkslenker		03.7858-0732.4 300272	ATE Ø 9 / 8" pneumatisch
1.6	132	10/11→					
1.6 CDTi	81 - 100	07/14→					
1.6 SIDI	125 - 147	12/12→					
1.7 CDTi	81 - 96	10/11→10/15					
1.8	103	10/11→10/15					
2.0 CDTi	96 - 121	10/11→10/15					
2.0 BiTurbo CDTi	143	10/12→10/15		12/12→; für Linkslenker		03.7858-0732.4 300272	ATE Ø 9 / 8" pneumatisch
 Hauptbremszylinder							
1.4	74 - 103	10/11→		für Linkslenker		03.2125-0421.3 010934	ATE Ø 25,4
1.6	132	10/11→					
1.6 CDTi	81 - 100	07/14→					
1.6 SIDI	125 - 147	12/12→					
1.7 CDTi	81 - 96	10/11→10/15					
1.8	103	10/11→10/15					
2.0 CDTi	96 - 121	10/11→10/15					
2.0 BiTurbo CDTi	143	10/12→10/15		12/12→; für Linkslenker		03.2125-0421.3 010934	ATE Ø 25,4
OPEL - ASTRA J Kasten/Kombi (P10) 09/09→10/15							
 Bremskraftverstärker							
1.3 CDTi 1.6 CDTi	70 81	10/12→10/15 01/14→10/15		für Linkslenker		03.7858-0732.4 300272	ATE Ø 9 / 8" pneumatisch
1.7 CDTi	96	10/12→10/15					
2.0 CDTi	121	10/12→10/15					
 Hauptbremszylinder							
1.3 CDTi 1.6 CDTi	70 81	10/12→10/15 01/14→10/15		für Linkslenker		03.2125-0421.3 010934	ATE Ø 25,4
1.7 CDTi	96	10/12→10/15					
2.0 CDTi	121	10/12→10/15					
OPEL - ASTRA J Kasten/Schrägheck (P10) 09/09→10/15							
 Bremskraftverstärker							
1.3 CDTi 1.6 CDTi 1.7 CDTi	70 81 81	05/13→10/15 01/14→10/15 05/13→10/15		für Linkslenker		03.7858-0732.4 300272	ATE Ø 9 / 8" pneumatisch
 Hauptbremszylinder							
1.3 CDTi 1.6 CDTi 1.7 CDTi	70 81 81	05/13→10/15 01/14→10/15 05/13→10/15		für Linkslenker		03.2125-0421.3 010934	ATE Ø 25,4
OPEL - ASTRA J Stufenheck 06/12→							
 Bremskraftverstärker							
1.3 CDTi →	70	06/12→10/15		für Linkslenker		03.7858-0732.4 300272	ATE Ø 9 / 8" pneumatisch













	kw			 	! #		
OPEL - ASTRA J Stufenheck 06/12→							
 Bremskraftverstärker							
1.4	64 - 74	06/12→10/15		für Linkslenker		03.7858-0732.4 300272	ATE Ø 9 / 8" pneumatisch
1.4 LPG	103	07/14→					
1.4 Turbo	88 - 103	06/12→					
1.6	85	06/12→					
1.6 CDTi	81 - 100	01/14→					
1.6 SIDI	125	06/12→10/15					
1.6 Turbo	132	06/12→					
1.7 CDTi	74 - 96	06/12→10/15					
 Hauptbremszylinder							
1.3 CDTi	70	06/12→10/15		für Linkslenker		03.2125-0421.3 010934	ATE Ø 25,4
1.4	64 - 74	06/12→10/15					
1.4 LPG	103	07/14→					
1.4 Turbo	88 - 103	06/12→					
1.6	85	06/12→					
1.6 CDTi	81 - 100	01/14→					
1.6 SIDI	125	06/12→10/15					
1.6 Turbo	132	06/12→					
1.7 CDTi	74 - 96	06/12→10/15					
OPEL - CALIBRA A (C89) 08/89→07/97							
 Hauptbremszylinder							
2.0 i Turbo 4x4	150	08/91→07/97				03.2123-1121.3 010176	Ø 23,8
2.5 i V6	125	04/93→07/97		für Linkslenker		03.2123-1121.3 010176	Ø 23,8
 Bremskraftregler							
2.0 i 16V	100	02/94→07/97		P1000001→		03.0101-0038.2 320245	Satz 2x
2.0 i 16V 4x4	100	02/94→07/97					
2.0 i 4x4	85	06/90→07/97					
2.5 i V6	125	04/93→07/97		T1000001→		03.0101-0038.2 320245	Satz 2x
OPEL - CASCADA (W13) 03/13→04/19							
 Bremskraftverstärker							
1.4	88	04/13→04/18		für Linkslenker		03.7858-0732.4 300272	ATE Ø 9 / 8" pneumatisch
1.4 Turbo	103	03/13→04/18					
1.6	100 - 147	11/13→04/19					
1.6 SIDI	125	04/13→04/19					
2.0 CDTi	121 - 143	04/13→04/18					
 Hauptbremszylinder							
1.4	88	04/13→04/18		für Linkslenker		03.2125-0421.3 010934	ATE Ø 25,4
1.4 Turbo	103	03/13→04/18					
1.6	100 - 147	11/13→04/19					
1.6 SIDI	125	04/13→04/19					
2.0 CDTi	121 - 143	04/13→04/18					
OPEL - COMBO Kasten/Großraumlimousine 10/01→							
 Hauptbremszylinder							
1.3 CDTi 16V	51 - 55	08/05→		→ 33999999		24.2122-1740.3 010711	DEL Ø 22,2
1.4 16V	66	08/05→		43000001→; → 10/11; - ESP; Scheibenbremse		24.2123-1767.3 010844	BOS Ø 23,8
1.6	64	10/01→					
1.7 DI 16V	48	10/01→					
1.7 DTi 16V	55	10/01→					
1.6 CNG 16V	69 - 71	04/05→		→ 10/11; - ESP; Scheibenbremse		24.2123-1767.3 010844	BOS Ø 23,8
1.7 CDTi 16V	74	12/04→					
OPEL - COMBO Kasten/Großraumlimousine (71_) 07/94→10/01							
 Hauptbremszylinder							
1.2	33	07/94→10/01		→ 09/00; für Linkslenker; - ABS		24.2120-0702.3 010361	nicht für Delco Ø 20,6
1.4	44 - 60	07/94→10/01		→ 09/00; für Linkslenker; + ABS		24.2120-1714.3 010455	Ø 20,6
1.7 D	44	07/94→10/01					
→							













	kw					! #		
OPEL - COMBO Kasten/Großraumlimousine (71_) 07/94→10/01								
 Hauptbremszylinder								
1.4 16V	66	08/99→10/01		10/01→; → 33999999			24.2122-1740.3 010711	DEL Ø 22,2
				43000001→; - ESP; Scheibenbremse			24.2123-1767.3 010844	BOS Ø 23,8
 Bremskraftregler								
1.2	33	07/94→10/01					03.6585-0019.3 320239	ATE lastabhängig 8/5 4x
1.4	44 - 60	07/94→10/01						
1.7 D	44	07/94→10/01						
OPEL - COMBO Tour 10/01→12/11								
 Hauptbremszylinder								
1.3 CDTI 16V	51	06/04→01/11		→ 33999999			24.2122-1740.3 010711	DEL Ø 22,2
1.6	62 - 64	10/01→09/06		43000001→; - ESP; Scheibenbremse			24.2123-1767.3 010844	BOS Ø 23,8
1.7 DI 16V	48	10/01→06/04						
1.7 DTI 16V	55	10/01→06/04						
1.3 CDTI 16V	55	10/05→12/11		→ 33999999			24.2122-1740.3 010711	DEL Ø 22,2
1.4	66	10/04→12/11		43000001→; → 10/11; - ESP; Scheibenbremse			24.2123-1767.3 010844	BOS Ø 23,8
1.6 CNG	69	06/06→12/11		→ 10/11; - ESP; Scheibenbremse			24.2123-1767.3 010844	BOS Ø 23,8
1.7 CDTI 16V	74	07/04→12/11						
1.6 CNG	71	04/05→01/11		- ESP; Scheibenbremse			24.2123-1767.3 010844	BOS Ø 23,8
OPEL - CORSA B (S93) 03/93→12/02								
 Hauptbremszylinder								
1.0 i 12V	40	11/96→09/00		für Linkslenker; - ABS			24.2120-0702.3 010361	nicht für Delco Ø 20,6
1.2 i	33	03/93→09/00		für Linkslenker; + ABS			24.2120-1714.3 010455	Ø 20,6
1.4 i	40 - 44	03/93→09/00						
1.4 i 16V	63 - 66	09/94→09/00						
1.4 Si	60	03/93→09/00						
1.5 D	37	03/93→09/00						
1.5 TD	49	03/93→09/00						
1.6 i 16V	74 - 78	09/94→09/00						
1.7 D	44	02/96→09/00						
1.2 i 16V	48	03/98→09/00		04/98→; für Linkslenker; - ABS			24.2120-0702.3 010361	nicht für Delco Ø 20,6
				04/98→; für Linkslenker; + ABS			24.2120-1714.3 010455	Ø 20,6
1.6 GSI 16V	80	03/93→09/00		09/93→; für Linkslenker; - ABS			24.2120-0702.3 010361	nicht für Delco Ø 20,6
				09/93→; für Linkslenker; + ABS			24.2120-1714.3 010455	Ø 20,6
OPEL - CORSA B Kasten/Schrägheck (S93) 08/94→12/01								
 Hauptbremszylinder								
1.4 i	44	08/99→09/00		für Linkslenker; - ABS			24.2120-0702.3 010361	nicht für Delco Ø 20,6
1.7 D	44	08/99→09/00		für Linkslenker; + ABS			24.2120-1714.3 010455	Ø 20,6
OPEL - CORSA B Kombi (S93) 04/98→12/02								
 Hauptbremszylinder								
1.4 i 16V	66	01/99→12/02		→ 09/00; für Linkslenker; - ABS			24.2120-0702.3 010361	nicht für Delco Ø 20,6
1.7 D	44	01/99→12/02		→ 09/00; für Linkslenker; + ABS			24.2120-1714.3 010455	Ø 20,6
OPEL - CORSA C (X01) 09/00→12/09								
 Hauptbremszylinder								
1.0	43 - 44	09/00→12/09		→ 36999999			24.2122-1740.3 010711	DEL Ø 22,2
1.2	55	09/00→12/09						
1.2 Twinport	59	07/04→12/09						
1.3 CDTI	51	06/03→12/09						
1.7 CDTI	74	06/03→12/09						
1.7 DI	48	09/00→12/09						
1.7 DTI	55	09/00→12/09						
1.4	60	01/02→12/09		43000001→; - ESP			24.2123-1767.3 010844	BOS Ø 23,8
1.8	79	01/02→12/09						
1.4	66	09/00→12/09		43000001→; → 09/06; - ESP			24.2123-1767.3 010844	BOS Ø 23,8
1.4 Twinport	66	06/03→12/09						
1.8	92	09/00→12/09						













	kw					! #		
OPEL - CORSA C Kasten/Schrägheck (X01) 09/00→12/12								
 Hauptbremszylinder								
1.2 1.2 16V 1.3 CDTI 16V 1.7 CDTi 1.7 DI 16V 1.7 DTI 16V	59 55 51 - 59 74 48 55	07/05→06/06 09/00→07/03 07/05→06/06		→ 36999999			24.2122-1740.3 010711	DEL Ø 22,2
1.4	66	08/03→06/12		43000001→; → 09/06; - ESP			24.2123-1767.3 010844	BOS Ø 23,8
OPEL - CORSA D (S07) 07/06→08/14								
 Hauptbremszylinder								
1.0 1.2 1.3 CDTI	44 59 55 -	07/06→12/10 07/06→08/14 07/06→08/14		10/06→; für Linkslenker; + ESP			24.4122-1705.3 010852	BOS Ø 22,2 ohne Bremsflüssigkeitsbehälter
1.4 1.4 LPG	66 66 66	07/06→08/14 08/06→12/11		10/06→; für Linkslenker; - ESP			24.4122-1709.3 010871	BOS Ø 22,2 ohne Bremsflüssigkeitsbehälter
1.0 1.2 1.2 LPG	48 51 - 63 55 -	12/09→08/14 12/09→08/14 08/06→08/14		für Linkslenker; + ESP			24.4122-1705.3 010852	BOS Ø 22,2 ohne Bremsflüssigkeitsbehälter
1.3 CDTI 1.4 1.4 LPG	70 64 - 74 64	06/09→08/14 09/09→08/14 09/09→08/14		für Linkslenker; - ESP			24.4122-1709.3 010871	BOS Ø 22,2 ohne Bremsflüssigkeitsbehälter
1.4 1.6 Turbo 1.7 CDTI	88 155 96	07/12→08/14 06/11→08/14 12/09→08/14		für Linkslenker; - ESP			24.4123-1720.3 011022	BOS Ø 23,8 ohne Bremsflüssigkeitsbehälter
1.6 Turbo	110	05/07→08/14		06/07→; für Linkslenker; - ESP			24.4123-1720.3 011022	BOS Ø 23,8 ohne Bremsflüssigkeitsbehälter
1.6 Turbo	141	11/06→08/14		03/07→; für Linkslenker; - ESP			24.4123-1720.3 011022	BOS Ø 23,8 ohne Bremsflüssigkeitsbehälter
1.7 CDTI	92	08/06→12/11		10/06→; für Linkslenker; - ESP			24.4123-1720.3 011022	BOS Ø 23,8 ohne Bremsflüssigkeitsbehälter
OPEL - CORSA D Kasten/Schrägheck (S07) 07/06→08/14								
 Hauptbremszylinder								
1.0 1.3 CDTI	44 55 - 66	08/06→08/14 07/06→08/14		10/06→; für Linkslenker; + ESP			24.4122-1705.3 010852	BOS Ø 22,2 ohne Bremsflüssigkeitsbehälter
				10/06→; für Linkslenker; - ESP			24.4122-1709.3 010871	BOS Ø 22,2 ohne Bremsflüssigkeitsbehälter
1.0 1.2	48 51 - 63	01/10→08/14 08/06→08/14		für Linkslenker; + ESP			24.4122-1705.3 010852	BOS Ø 22,2 ohne Bremsflüssigkeitsbehälter
1.3 CDTI 1.4	70 74	11/09→08/14 07/12→08/14		für Linkslenker; - ESP			24.4122-1709.3 010871	BOS Ø 22,2 ohne Bremsflüssigkeitsbehälter
1.4 1.6 1.7 CDTI	88 141 96	07/12→08/14 07/12→08/14 07/12→08/14		für Linkslenker; - ESP			24.4123-1720.3 011022	BOS Ø 23,8 ohne Bremsflüssigkeitsbehälter
OPEL - CORSA E (X15) 09/14→								
 Hauptbremszylinder								
1.0 1.2 1.3 CDTI 1.4 1.4 Turbo	66 - 85 51 55 - 70 55 - 66 74	09/14→ 09/14→ 09/14→ 09/14→ 09/14→ 06/19		11/14→; für Linkslenker; Scheibenbremse			24.4123-1722.3 011071	Ø 23,8 ohne Bremsflüssigkeitsbehälter
1.4 LPG	64 - 66	03/15→		für Linkslenker; Scheibenbremse			24.4123-1722.3 011071	Ø 23,8 ohne Bremsflüssigkeitsbehälter
1.6 Turbo	152	03/15→		für Linkslenker			24.4123-1722.3 011071	Ø 23,8 ohne Bremsflüssigkeitsbehälter
OPEL - CORSA E Kasten/Schrägheck (X15) 09/14→								
 Hauptbremszylinder								
1.2 1.3 CDTI	51 55	01/15→ 01/15→		für Linkslenker; Scheibenbremse			24.4123-1722.3 011071	Ø 23,8 ohne Bremsflüssigkeitsbehälter
1.3 CDTI 1.4	70 55 - 66	09/14→ 09/14→		11/14→; für Linkslenker; Scheibenbremse			24.4123-1722.3 011071	Ø 23,8 ohne Bremsflüssigkeitsbehälter













	kW					! #		
OPEL - CROSSLAND X / CROSSLAND (P17, P2QO) 03/17→								
 Hauptbremszylinder								
1.2	60 - 96	03/17→				24.4123-1704.3	010828	TRW Ø 23,8
1.2 LPG	60	10/17→						
1.5	81	10/20→						
1.5 Turbo D	75 - 88	06/18→						
1.6 Turbo D	73 - 88	03/17→						
OPEL - CROSSLAND X Van 03/17→								
 Hauptbremszylinder								
1.2	61 - 81	07/19→				24.4123-1704.3	010828	TRW Ø 23,8
1.5	75	06/18→						
OPEL - INSIGNIA A (G09) 07/08→03/17								
 Bremskraftverstärker								
1.4	103	04/11→03/17		06/11→; für Linkslenker		03.7858-0732.4	300272	ATE Ø 9 / 8" pneumatisch
1.4 LPG	103	07/12→03/17		für Linkslenker		03.7858-0732.4	300272	ATE Ø 9 / 8" pneumatisch
1.6	85	07/08→03/17						
1.6 CDTi	88 - 100	07/15→03/17						
1.6 SIDI	125	03/13→03/17						
1.8	103	07/08→03/17						
2.0 Biturbo CDTi	140 - 143	07/08→03/17						
2.0 Biturbo CDTi 4x4	140 - 143	05/09→03/17						
2.0 CDTi	81 - 125	07/08→03/17						
2.0 CDTi 4x4	118 - 125	06/10→03/17						
2.0 E85 Turbo	162	10/10→03/17						
2.0 Turbo	162 - 184	07/08→03/17						
2.0 Turbo 4x4	162 - 184	07/08→03/17						
1.6 Turbo	132	07/08→03/17		10/08→; für Linkslenker		03.7858-0732.4	300272	ATE Ø 9 / 8" pneumatisch
2.0 CDTi	88	03/12→03/17		03/13→; für Linkslenker		03.7858-0732.4	300272	ATE Ø 9 / 8" pneumatisch
 Hauptbremszylinder								
1.4	103	04/11→03/17		06/11→; für Linkslenker		03.2125-0421.3	010934	ATE Ø 25,4
1.4 LPG	103	07/12→03/17		für Linkslenker		03.2125-0421.3	010934	ATE Ø 25,4
1.6	85	07/08→03/17						
1.6 CDTi	88 - 100	07/15→03/17						
1.6 SIDI	125	03/13→03/17						
1.8	103	07/08→03/17						
2.0 Biturbo CDTi	140 - 143	07/08→03/17						
2.0 Biturbo CDTi 4x4	140 - 143	05/09→03/17						
2.0 CDTi	81 - 125	07/08→03/17						
2.0 CDTi 4x4	118 - 125	06/10→03/17						
2.0 E85 Turbo	162	10/10→03/17						
2.0 Turbo	162 - 184	07/08→03/17						
2.0 Turbo 4x4	162 - 184	07/08→03/17						
2.8 V6 Turbo 4x4	191	07/08→03/17						
2.8 V6 Turbo OPC 4x4	239	07/09→03/17						
1.6 Turbo	132	07/08→03/17		10/08→; für Linkslenker		03.2125-0421.3	010934	ATE Ø 25,4
2.0 CDTi	88	03/12→03/17		03/13→; für Linkslenker		03.2125-0421.3	010934	ATE Ø 25,4
OPEL - INSIGNIA A Country Tourer (G09) 07/08→03/17								
 Bremskraftverstärker								
1.6 CDTi	88 - 100	07/15→03/17		für Linkslenker		03.7858-0732.4	300272	ATE Ø 9 / 8" pneumatisch
1.6 SIDI	125	07/14→03/17						
2.0 CDTi	88 - 125	07/08→03/17						
2.0 CDTi 4x4	120 - 143	09/13→03/17						
2.0 Turbo 4x4	184	09/13→03/17						











	kW			 	! #		
OPEL - INSIGNIA A Country Tourer (G09) 07/08→03/17							
 Hauptbremszylinder							
1.6 CDTi	88 - 100	07/15→03/17		für Linkslenker		03.2125-0421.3 010934	ATE Ø 25,4
1.6 SIDI	125	07/14→03/17					
2.0 CDTi	88 - 125	07/08→03/17					
2.0 CDTi 4x4	120 - 143	09/13→03/17					
2.0 Turbo 4x4	184	09/13→03/17					
OPEL - INSIGNIA A Sports Tourer (G09) 07/08→03/17							
 Bremskraftverstärker							
1.4	103	04/11→03/17		für Linkslenker		03.7858-0732.4 300272	ATE Ø 9 / 8" pneumatisch
1.4 LPG	103	09/12→03/17					
1.6	85	07/08→06/12					
1.6 CDTi	88 - 100	07/15→01/17					
1.6 SIDI	125	06/13→03/17					
1.6 Turbo	132	01/09→06/13					
1.8	103	07/08→03/17					
2.0 Biturbo CDTi	140 - 143	07/08→03/17					
2.0 Biturbo CDTi 4x4	140 - 143	07/08→03/17					
2.0 CDTi	81 - 125	07/08→12/16					
2.0 CDTi 4x4	118 - 125	06/10→12/16					
2.0 E85 Turbo	162	09/10→11/11					
2.0 Turbo	162 - 184	07/08→03/17					
2.0 Turbo 4x4	162 - 184	07/08→06/13					
2.0 CDTi	88	03/12→06/15		03/13→; für Linkslenker		03.7858-0732.4 300272	ATE Ø 9 / 8" pneumatisch
 Hauptbremszylinder							
1.4	103	04/11→03/17		für Linkslenker		03.2125-0421.3 010934	ATE Ø 25,4
1.4 LPG	103	09/12→03/17					
1.6	85	07/08→06/12					
1.6 CDTi	88 - 100	07/15→01/17					
1.6 SIDI	125	06/13→03/17					
1.6 Turbo	132	01/09→06/13					
1.8	103	07/08→03/17					
2.0 Biturbo CDTi	140 - 143	07/08→03/17					
2.0 Biturbo CDTi 4x4	140 - 143	07/08→03/17					
2.0 CDTi	81 - 125	07/08→12/16					
2.0 CDTi 4x4	118 - 125	06/10→12/16					
2.0 E85 Turbo	162	09/10→11/11					
2.0 Turbo	162 - 184	07/08→03/17					
2.0 Turbo 4x4	162 - 184	07/08→06/13					
2.8 V6 Turbo 4x4	191	10/08→06/13					
2.8 V6 Turbo OPC 4x4	239	07/09→03/17					
2.0 CDTi	88	03/12→06/15		03/13→; für Linkslenker		03.2125-0421.3 010934	ATE Ø 25,4
OPEL - INSIGNIA A Stufenheck (G09) 07/08→03/17							
 Bremskraftverstärker							
1.4	103	04/11→03/17		06/11→; für Linkslenker		03.7858-0732.4 300272	ATE Ø 9 / 8" pneumatisch
1.4 LPG	103	07/12→03/17		für Linkslenker		03.7858-0732.4 300272	ATE Ø 9 / 8" pneumatisch
1.6	85	07/08→03/17					
1.6 CDTi	88 - 100	07/15→03/17					
1.6 SIDI	125	03/13→03/17					
1.6 Turbo	132	07/08→03/17					
1.8	103	07/08→03/17					
2.0 Biturbo CDTi	140 - 143	07/08→03/17					
2.0 Biturbo CDTi 4x4	140 - 143	07/08→03/17					
2.0 CDTi	81 - 125	07/08→03/17					
2.0 CDTi 4x4	118 - 125	06/10→03/17					
→							













	kw					! #		
OPEL - INSIGNIA A Stufenheck (G09) 07/08→03/17								
 Bremskraftverstärker								
2.0 Turbo	162 - 184	07/08→03/17		für Linkslenker		03.7858-0732.4	300272	ATE Ø 9 / 8" pneumatisch
2.0 Turbo 4x4	162 - 184	07/08→03/17						
2.0 Turbo E85	162	07/08→03/17						
2.0 CDTI	88	03/12→03/17		03/13→; für Linkslenker		03.7858-0732.4	300272	ATE Ø 9 / 8" pneumatisch
 Hauptbremszylinder								
1.4	103	04/11→03/17		06/11→; für Linkslenker		03.2125-0421.3	010934	ATE Ø 25,4
1.4 LPG	103	07/12→03/17		für Linkslenker		03.2125-0421.3	010934	ATE Ø 25,4
1.6	85	07/08→03/17						
1.6 CDTi	88 - 100	07/15→03/17						
1.6 SIDI	125	03/13→03/17						
1.6 Turbo	132	07/08→03/17						
1.8	103	07/08→03/17						
2.0 Biturbo CDTI	140 - 143	07/08→03/17						
2.0 Biturbo CDTI 4x4	140 - 143	07/08→03/17						
2.0 CDTI	81 - 125	07/08→03/17						
2.0 CDTI 4x4	118 - 125	06/10→03/17						
2.0 Turbo	162 - 184	07/08→03/17						
2.0 Turbo 4x4	162 - 184	07/08→03/17						
2.0 Turbo E85	162	07/08→03/17						
2.8 V6 Turbo 4x4	191	07/08→03/17						
2.8 V6 Turbo OPC 4x4	239	07/09→03/17						
2.0 CDTI	88	03/12→03/17		03/13→; für Linkslenker		03.2125-0421.3	010934	ATE Ø 25,4
OPEL - MERIVA A Großraumlimousine (X03) 05/03→05/10								
 Hauptbremszylinder								
1.3 CDTI	51 - 55	09/03→05/10		→ 44999999; - ESP		24.2123-1764.3	010824	TRW Ø 23,8
1.4 16V Twinport	66	07/04→05/10		74237192→; + ESP		24.4123-1717.3	010985	TRW Ø 23,8 ohne Bremsflüssigkeitsbehälter
1.4 16V Twinport LPG	66	07/04→05/10						
1.6	64 - 77	05/03→05/10						
1.6 16V	74	05/03→01/06						
1.6 Turbo	132	09/05→05/10						
1.7 CDTI	74 - 92	09/03→05/10						
1.7 DTI	55	09/03→05/10						
1.8	92	05/03→05/10						
OPEL - MOVANO A Bus (X70) 07/98→								
 Hauptbremszylinder								
1.9 DTI	59	09/00→10/01		+ ABS		24.2025-1706.3	010676	Ø 25,4
2.5 D	59	07/98→09/00						
2.8 DTI	84	07/98→10/01		- ABS		24.2025-1708.3	010692	Ø 25,4
1.9 DTI	60	10/01→		→ 08/03; + ABS		24.2025-1706.3	010676	Ø 25,4
2.2 DTI	66	09/00→		→ 01/10; - ABS		24.2025-1708.3	010692	Ø 25,4
2.5 DTI	84	10/01→		09/03→; + ABS; → 08/06		24.2123-1759.3	010768	BOS Ø 23,8
3.0 DTi	100	10/03→		→ 01/10; - ABS		24.2025-1708.3	010692	Ø 25,4
				→ 08/06; + ABS		24.2123-1759.3	010768	BOS Ø 23,8
OPEL - MOVANO A Kasten (X70) 01/99→								
 Hauptbremszylinder								
1.9 DTI	59	09/00→10/01		+ ABS		24.2025-1706.3	010676	Ø 25,4
2.5 D	59	01/99→09/00						
2.8 DTI	84	01/99→10/01		- ABS		24.2025-1708.3	010692	Ø 25,4
1.9 DTI	60	10/01→		→ 08/03; + ABS		24.2025-1706.3	010676	Ø 25,4
2.2 DTI	66	09/00→		→ 01/10; - ABS		24.2025-1708.3	010692	Ø 25,4
2.5 DTI	84	10/01→		09/03→; + ABS; → 08/06		24.2123-1759.3	010768	BOS Ø 23,8
2.5 DTi	73	10/03→		→ 01/10; - ABS		24.2025-1708.3	010692	Ø 25,4
3.0 DTI	100	10/03→		→ 08/06; + ABS		24.2123-1759.3	010768	BOS Ø 23,8
OPEL - MOVANO A Pritsche/Fahrgestell (X70) 07/98→								
 Hauptbremszylinder								
2.2 DTI	66	09/00→		→ 08/03; + ABS		24.2025-1706.3	010676	Ø 25,4













	kw					! #		
OPEL - MOVANO A Pritsche/Fahrgestell (X70) 07/98→								
 Hauptbremszylinder								
2.5 DTI	84	10/01→		→ 01/10; - ABS		24.2025-1708.3	010692	Ø 25,4
				09/03→; + ABS; → 08/06		24.2123-1759.3	010768	BOS Ø 23,8
2.5 D	59	07/98→09/00		+ ABS		24.2025-1706.3	010676	Ø 25,4
2.8 DTI	84	07/98→10/01		- ABS		24.2025-1708.3	010692	Ø 25,4
2.5 DTi	73	10/03→		→ 01/10; - ABS		24.2025-1708.3	010692	Ø 25,4
3.0 DTI	100	10/03→		+ ABS; → 08/06		24.2123-1759.3	010768	BOS Ø 23,8
OPEL - OMEGA B (V94) 03/94→12/05								
 Hauptbremszylinder								
2.0	85	03/94→09/99		W1000001→; für Linkslenker; + ESP		24.2125-1740.3	010971	TRW Ø 25,4
2.0 16V	100	03/94→09/99						
2.5 TD	96	04/94→07/03						
2.0	85	03/94→12/00		W1000001→; → 09/99; für Linkslenker; + ESP		24.2125-1740.3	010971	TRW Ø 25,4
2.0 DTI 16V	74	09/97→09/00		→ 08/00; für Linkslenker; + ESP		24.2125-1740.3	010971	TRW Ø 25,4
2.2 16V	106	09/99→07/03		10/99→; für Linkslenker; + ESP		24.2125-1740.3	010971	TRW Ø 25,4
2.2 DTI 16V	81 - 88	09/00→07/03		für Linkslenker; + ESP		24.2125-1740.3	010971	TRW Ø 25,4
2.5 DTI	110	09/01→07/03						
2.5 V6	125	03/94→09/00		W1000001→; für Linkslenker; nicht für Sonderfahrzeuge; + ESP		24.2125-1740.3	010971	TRW Ø 25,4
2.6 V6	132	09/00→07/03		für Linkslenker; nicht für Sonderfahrzeuge; + ESP		24.2125-1740.3	010971	TRW Ø 25,4
3.2 V6	160	02/01→07/03						
3.0 V6	155	04/94→02/01		W1000001→; → 01/01; für Linkslenker; nicht für Sonderfahrzeuge; + ESP		24.2125-1740.3	010971	TRW Ø 25,4
OPEL - OMEGA B Caravan (V94) 03/94→07/03								
 Hauptbremszylinder								
2.0	85	03/94→09/99		W1000001→; für Linkslenker; + ESP		24.2125-1740.3	010971	TRW Ø 25,4
2.0 16V	100	03/94→09/99						
2.5 TD	96	04/94→07/01						
2.0 DTI 16V	74	09/97→09/00		→ 08/00; für Linkslenker; + ESP		24.2125-1740.3	010971	TRW Ø 25,4
2.2 16V	106	09/99→07/03		für Linkslenker; + ESP		24.2125-1740.3	010971	TRW Ø 25,4
2.2 DTI 16V	81 - 88	09/00→07/03						
2.5 DTI	110	09/01→07/03						
2.5 V6	125	03/94→09/00		W1000001→; für Linkslenker; nicht für Sonderfahrzeuge; + ESP		24.2125-1740.3	010971	TRW Ø 25,4
2.6 V6	132	09/00→07/03		für Linkslenker; nicht für Sonderfahrzeuge; + ESP		24.2125-1740.3	010971	TRW Ø 25,4
3.2 V6	160	02/01→07/03						
3.0 V6	155	04/94→02/01		W1000001→; → 01/01; für Linkslenker; nicht für Sonderfahrzeuge; + ESP		24.2125-1740.3	010971	TRW Ø 25,4
OPEL - SIGNUM CC (Z03) 05/03→12/08								
 Hauptbremszylinder								
1.8	90	05/03→07/05		für Linkslenker; + ESP		24.2125-1732.3	010827	TRW Ø 25,4
1.9 CDTI	74 - 110	04/04→02/08						
2.0 DTI	74	05/03→04/04						
2.2 DTI	92	05/03→04/04						
3.0 V6 CDTI	130	05/03→07/05						
3.2 V6	155	05/03→07/05						
1.8	103	09/05→12/08		für Linkslenker; → 05/08; + ESP		24.2125-1732.3	010827	TRW Ø 25,4
2.0 Turbo	129	05/03→12/08						
2.2 direct	114	05/03→09/08						
3.0 V6 CDTI	135	09/05→12/08						
OPEL - TIGRA (S93) 07/94→12/00								
 Hauptbremszylinder								
1.4 16V	63 - 66	07/94→12/00		für Linkslenker; - ABS		24.2120-0702.3	010361	nicht für Delco Ø 20,6
1.6 16V	74 - 78	07/94→08/98		für Linkslenker; + ABS		24.2120-1714.3	010455	Ø 20,6
OPEL - TIGRA TwinTop (X04) 06/04→12/10								
 Hauptbremszylinder								
1.3 CDTI	51	06/04→12/10		- ESP; → 08/09		24.2123-1767.3	010844	BOS Ø 23,8
1.4	66	06/04→12/10						
1.8	92	06/04→12/10						













	kw					! #		
OPEL - VECTRA B (J96) 09/95→07/04								
 Bremskraftverstärker								
2.0 i 2.0 i 16V	82 100	10/95→04/02 09/95→06/00		für Linkslenker; → W1285446		03.7745-3003.4	300157	ATE Ø 8 / 7" pneumatisch
2.5 i V6 2.6 i V6	125 125	10/95→09/00 09/00→04/02		für Linkslenker		03.7745-3003.4	300157	ATE Ø 8 / 7" pneumatisch
 Hauptbremszylinder								
1.6 i 1.6 i 16V 1.8 i 16V	55 74 85 - 92	10/95→04/02 10/95→04/02 10/95→04/02		→ V1999999; für Linkslenker		24.2122-1724.3	010561	Ø 22,2
				→ V7999999; für Linkslenker		24.2122-1724.3	010561	Ø 22,2
				→ W1999999; für Rechtslenker		24.2122-1724.3	010561	Ø 22,2
2.0 DI 16V 2.0 DTI 16V	60 74	11/96→04/02 06/97→04/02		→ V5999999; für Linkslenker		24.2122-1724.3	010561	Ø 22,2
				→ W7999999; für Rechtslenker		24.2122-1724.3	010561	Ø 22,2
				→ W5999999; für Rechtslenker		24.2122-1724.3	010561	Ø 22,2
				W7000001→ W7999999; für Linkslenker		24.2123-1777.3	010943	Ø 23,8
				W5000001→ W5999999; für Linkslenker		24.2123-1777.3	010943	Ø 23,8
				W1000001→ W1999999; für Linkslenker		24.2123-1777.3	010943	Ø 23,8
1.7 TD	60	10/95→12/98		→ 11/96		24.2122-1724.3	010561	Ø 22,2
2.0 i 2.0 i 16V 2.5 i V6	82 100 125	10/95→04/02 09/95→06/00 10/95→09/00		→ W1285446; für Linkslenker		03.2123-1622.3	010470	Ø 23,8
				→ W7154258; für Linkslenker		03.2123-1622.3	010470	Ø 23,8
				→ W5276825; für Linkslenker		03.2123-1622.3	010470	Ø 23,8
				→ W1285446; für Rechtslenker		03.2123-1722.3	010471	Ø 23,8
				→ W5276825; für Rechtslenker		03.2123-1722.3	010471	Ø 23,8
				→ W7154258; für Rechtslenker		03.2123-1722.3	010471	Ø 23,8
OPEL - VECTRA B Caravan (J96) 11/96→07/03								
 Bremskraftverstärker								
2.0 i 2.0 i 16V	82 85 - 100	11/96→02/02 11/96→07/03		für Linkslenker; → W1285446		03.7745-3003.4	300157	ATE Ø 8 / 7" pneumatisch
2.5 i V6	125	11/96→09/00		für Linkslenker		03.7745-3003.4	300157	ATE Ø 8 / 7" pneumatisch
2.6 i V6	125	09/00→07/03		→ 04/02; für Linkslenker		03.7745-3003.4	300157	ATE Ø 8 / 7" pneumatisch
 Hauptbremszylinder								
1.6 i 1.6 i 16V 1.8 i 16V	55 74 85 - 92	11/96→06/00 11/96→07/02 11/96→07/03		→ V1999999; für Linkslenker		24.2122-1724.3	010561	Ø 22,2
				→ V7999999; für Linkslenker		24.2122-1724.3	010561	Ø 22,2
				→ W1999999; für Rechtslenker		24.2122-1724.3	010561	Ø 22,2
2.0 DI 16V 2.0 DTI 16V	60 74	11/96→06/00 06/97→07/03		→ V5999999; für Linkslenker		24.2122-1724.3	010561	Ø 22,2
				→ W7999999; für Rechtslenker		24.2122-1724.3	010561	Ø 22,2
				→ W5999999; für Rechtslenker		24.2122-1724.3	010561	Ø 22,2
				W7000001→ W7999999; für Linkslenker		24.2123-1777.3	010943	Ø 23,8
				W5000001→ W5999999; für Linkslenker		24.2123-1777.3	010943	Ø 23,8
				W1000001→ W1999999; für Linkslenker		24.2123-1777.3	010943	Ø 23,8
1.7 TD	60	11/96→12/97		→ 11/96		24.2122-1724.3	010561	Ø 22,2
2.0 i 2.0 i 16V	82 85 - 100	11/96→02/02 11/96→07/03		→ W1285446; für Linkslenker		03.2123-1622.3	010470	Ø 23,8
				→ W5276825; für Linkslenker		03.2123-1622.3	010470	Ø 23,8
2.5 i V6	125	11/96→09/00		→ W7154258; für Linkslenker		03.2123-1622.3	010470	Ø 23,8
				→ W1285446; für Rechtslenker		03.2123-1722.3	010471	Ø 23,8
				→ W5276825; für Rechtslenker		03.2123-1722.3	010471	Ø 23,8
				→ W7154258; für Rechtslenker		03.2123-1722.3	010471	Ø 23,8
OPEL - VECTRA B CC (J96) 09/95→07/03								
 Bremskraftverstärker								
2.0 i 2.0 i 16V	82 85 - 100	10/95→02/02 09/95→07/03		für Linkslenker; → W1285446		03.7745-3003.4	300157	ATE Ø 8 / 7" pneumatisch
2.5 2.5 i V6	144 125	10/99→06/00 10/95→09/00		für Linkslenker		03.7745-3003.4	300157	ATE Ø 8 / 7" pneumatisch
2.6 i V6	125	09/00→07/03		→ 04/02; für Linkslenker		03.7745-3003.4	300157	ATE Ø 8 / 7" pneumatisch
 Hauptbremszylinder								
1.6 i 1.6 i 16V 1.8 FlexFuel 1.8 i 16V	55 74 85 85 - 92	10/95→07/03 10/95→07/02 01/99→09/00 10/95→07/03		→ V1999999; für Linkslenker		24.2122-1724.3	010561	Ø 22,2
				→ V7999999; für Linkslenker		24.2122-1724.3	010561	Ø 22,2
				→ W1999999; für Rechtslenker		24.2122-1724.3	010561	Ø 22,2
2.0 DI 16V	60	11/96→06/00		→ V5999999; für Linkslenker		24.2122-1724.3	010561	Ø 22,2
				→ W7999999; für Rechtslenker		24.2122-1724.3	010561	Ø 22,2











	kW					! #		
OPEL - VECTRA B CC (J96) 09/95→07/03								
 Hauptbremszylinder								
2.0 DTI 16V	74	06/97→07/03		→ W5999999; für Rechtslenker		24.2122-1724.3 010561	Ø 22,2	
				W7000001→ W7999999; für Linkslenker		24.2123-1777.3 010943	Ø 23,8	
				W5000001→ W5999999; für Linkslenker		24.2123-1777.3 010943	Ø 23,8	
				W1000001→ W1999999; für Linkslenker		24.2123-1777.3 010943	Ø 23,8	
1.7 TD	60	10/95→12/98		→ 11/96		24.2122-1724.3 010561	Ø 22,2	
2.0 i	82	10/95→02/02		→ W1285446; für Linkslenker		03.2123-1622.3 010470	Ø 23,8	
2.0 i 16V	85 - 100	09/95→07/03		→ W5276825; für Linkslenker		03.2123-1622.3 010470	Ø 23,8	
2.5	144	10/99→06/00		→ W7154258; für Linkslenker		03.2123-1622.3 010470	Ø 23,8	
2.5 i V6	125	10/95→09/00		→ W1285446; für Rechtslenker		03.2123-1722.3 010471	Ø 23,8	
				→ W5276825; für Rechtslenker		03.2123-1722.3 010471	Ø 23,8	
				→ W7154258; für Rechtslenker		03.2123-1722.3 010471	Ø 23,8	
OPEL - VECTRA C (Z02) 04/02→01/09								
 Hauptbremszylinder								
1.6	77	08/05→08/08		für Linkslenker; + ESP		24.2125-1732.3 010827	TRW Ø 25,4	
1.6 16V	74	04/02→10/05						
1.8	81 - 103	04/02→08/08						
1.8 16V	90	04/02→09/08						
1.9 CDTI	74 - 110	04/04→08/08						
2.0 16V Turbo	129	03/03→08/08						
2.0 DTI 16V	74	04/02→08/06						
2.2 DGi	114	10/03→08/08						
2.2 DTI 16V	86 - 92	04/02→12/04						
3.0 CDTi	135	08/05→08/08						
3.0 CDTI	130	02/03→07/05						
3.2 V6	155	08/02→07/06						
1.9 CDTI	88	04/04→01/09		für Linkslenker; + ESP; → 10/08		24.2125-1732.3 010827	TRW Ø 25,4	
2.2 16V	108	04/02→12/08						
OPEL - VECTRA C Caravan (Z02) 10/03→01/09								
 Hauptbremszylinder								
1.6	77	12/05→08/08		06/06→; für Linkslenker; + ESP		24.2125-1732.3 010827	TRW Ø 25,4	
1.6 16V	74	06/04→09/05		für Linkslenker; + ESP		24.2125-1732.3 010827	TRW Ø 25,4	
1.8	90 - 103	10/03→08/08						
1.9 CDTI	74 - 110	04/04→08/08						
2.0 DTI	74	10/03→08/05						
2.0 Turbo	129	10/03→08/08						
2.2 direct	114	10/03→08/08						
2.2 DTI	92	10/03→12/05						
3.0 V6 CDTI	130 - 135	10/03→08/08						
3.2 V6	155	10/03→07/05						
1.9 CDTI	88	04/04→01/09		für Linkslenker; + ESP; → 10/08		24.2125-1732.3 010827	TRW Ø 25,4	
OPEL - VECTRA C CC (Z02) 08/02→01/09								
 Hauptbremszylinder								
1.6	74 - 77	08/05→08/08		für Linkslenker; + ESP		24.2125-1732.3 010827	TRW Ø 25,4	
1.8	103	08/05→08/08						
1.8 16V	81 - 90	08/02→09/08						
1.9 CDTI	74 - 110	04/04→08/08						
2.0 16V Turbo	129	03/03→08/08						
2.0 DTI 16V	74	08/02→08/05						
2.2 16V	108	08/02→08/08						
2.2 DGi	114	10/03→08/08						
2.2 DTI 16V	86 - 92	08/02→06/08						
3.0 CDTi	135	08/05→08/08						
3.0 CDTI	130	06/03→07/05						
3.2 V6	155	08/02→07/06						
1.9 CDTI	88	04/04→01/09		für Linkslenker; + ESP; → 10/08		24.2125-1732.3 010827	TRW Ø 25,4	
OPEL - VIVARO A Bus (X83) 08/01→07/14								
 Hauptbremszylinder								
1.9 DI	60	08/01→07/06		7V600001 / 7Y000001→; + ABS		24.2120-1748.3 010894	TRW Ø 20,6	
→				7V600001 / 7Y000001→; + ASR		24.2120-1753.3 010946	TRW Ø 20,6	

	kw			 	! #		
OPEL - VIVARO A Bus (X83) 08/01→07/14							
 Hauptbremszylinder							
1.9 DI	60	08/01→07/06		4V602168→6V699999; für Rechtslenker; - ASR		24.2125-1731.3 010826	TRW Ø 25,4
1.9 DTI	74	08/01→07/14		7V600001 / 7Y000001→; → 06/14; + ABS		24.2120-1748.3 010894	TRW Ø 20,6
				7V600001 / 7Y000001→; → 06/14; + ASR		24.2120-1753.3 010946	TRW Ø 20,6
				4V602168→6V699999; für Rechtslenker; - ASR		24.2125-1731.3 010826	TRW Ø 25,4
2.0 16V 2.5 CDTI 2.5 DTI	88 84 99	08/01→07/06 08/06→03/10 04/03→03/10		7V600001 / 7Y000001→; + ABS		24.2120-1748.3 010894	TRW Ø 20,6
				7V600001 / 7Y000001→; + ASR		24.2120-1753.3 010946	TRW Ø 20,6
				4V602168→6V699999; - ASR		24.2125-1731.3 010826	TRW Ø 25,4
2.0 CDTI 2.0 ECOTEC 2.5 CDTI	66 - 84 86 107	08/06→07/14 08/06→07/14 08/06→07/14		7V600001 / 7Y000001→; → 06/14; + ABS		24.2120-1748.3 010894	TRW Ø 20,6
				7V600001 / 7Y000001→; → 06/14; + ASR		24.2120-1753.3 010946	TRW Ø 20,6
				4V602168→6V699999; - ASR		24.2125-1731.3 010826	TRW Ø 25,4
OPEL - VIVARO A Kasten (X83) 08/01→07/14							
 Hauptbremszylinder							
1.9 DI	60	08/01→07/06		7V600001 / 7Y000001→; + ABS		24.2120-1748.3 010894	TRW Ø 20,6
				7V600001 / 7Y000001→; + ASR		24.2120-1753.3 010946	TRW Ø 20,6
				4V602168→6V699999; für Rechtslenker; - ASR		24.2125-1731.3 010826	TRW Ø 25,4
1.9 DTI	74	08/01→07/14		7V600001 / 7Y000001→; → 06/14; + ABS		24.2120-1748.3 010894	TRW Ø 20,6
				7V600001 / 7Y000001→; → 06/14; + ASR		24.2120-1753.3 010946	TRW Ø 20,6
				4V602168→6V699999; für Rechtslenker; - ASR		24.2125-1731.3 010826	TRW Ø 25,4
2.0 16V 2.5 CDTI 2.5 DTI	88 84 99	08/01→07/06 08/06→03/10 04/03→03/10		7V600001 / 7Y000001→; + ABS		24.2120-1748.3 010894	TRW Ø 20,6
				7V600001 / 7Y000001→; + ASR		24.2120-1753.3 010946	TRW Ø 20,6
				4V602168→6V699999; - ASR		24.2125-1731.3 010826	TRW Ø 25,4
2.0 CDTI 2.0 ECOTEC 2.5 CDTI	66 - 84 86 107	08/06→07/14 08/06→07/14 08/06→07/14		7V600001 / 7Y000001→; → 06/14; + ABS		24.2120-1748.3 010894	TRW Ø 20,6
				7V600001 / 7Y000001→; → 06/14; + ASR		24.2120-1753.3 010946	TRW Ø 20,6
				4V602168→6V699999; - ASR		24.2125-1731.3 010826	TRW Ø 25,4
OPEL - VIVARO A Pritsche/Fahrgestell (X83) 02/01→07/14							
 Hauptbremszylinder							
1.9 Di	60	08/01→07/14		7V600001 / 7Y000001→; → 06/14; + ABS		24.2120-1748.3 010894	TRW Ø 20,6
				7V600001 / 7Y000001→; → 06/14; + ASR		24.2120-1753.3 010946	TRW Ø 20,6
				4V602168→6V699999; für Rechtslenker; - ASR		24.2125-1731.3 010826	TRW Ø 25,4
1.9 DTI	74	02/01→12/10		7V600001 / 7Y000001→; + ABS		24.2120-1748.3 010894	TRW Ø 20,6
				7V600001 / 7Y000001→; + ASR		24.2120-1753.3 010946	TRW Ø 20,6
				4V602168→6V699999; für Rechtslenker; - ASR		24.2125-1731.3 010826	TRW Ø 25,4
2.0 16V 2.5 CDTI 2.5 DTI	88 84 99	01/02→07/06 08/06→03/10 04/03→03/10		7V600001 / 7Y000001→; + ABS		24.2120-1748.3 010894	TRW Ø 20,6
				7V600001 / 7Y000001→; + ASR		24.2120-1753.3 010946	TRW Ø 20,6
				4V602168→6V699999; - ASR		24.2125-1731.3 010826	TRW Ø 25,4
2.0 CDTI 2.0 ECOTEC 2.5 CDTI	66 - 84 86 107	01/06→07/14 08/06→07/14 08/06→07/14		7V600001 / 7Y000001→; → 06/14; + ABS		24.2120-1748.3 010894	TRW Ø 20,6
				7V600001 / 7Y000001→; → 06/14; + ASR		24.2120-1753.3 010946	TRW Ø 20,6
				4V602168→6V699999; - ASR		24.2125-1731.3 010826	TRW Ø 25,4
OPEL - ZAFIRA / ZAFIRA FAMILY B (A05) 07/05→05/19							
 Bremskraftverstärker							
1.6	77 - 85	07/05→04/15		für Linkslenker; + ESP		03.7863-7803.4 300237	ATE Ø 10" pneumatisch
1.6 CNG	69	07/05→04/15					
1.6 CNG Turbo	110	04/10→04/15					
1.6 FlexFuel	85	08/08→12/12					
1.7 CDTI	81 - 92	03/07→04/15					
1.8	88 - 103	07/05→04/15					
→							







	kW					! #		
OPEL - ZAFIRA / ZAFIRA FAMILY B (A05) 07/05→05/19								
 Bremskraftverstärker								
1.8 LPG 1.9 CDTI	103 74 - 110	07/09→04/15 07/05→04/15			für Linkslenker; + ESP		03.7863-7803.4 300237	ATE Ø 10" pneumatisch
2.0	147 - 177	07/05→12/10						
2.2	110	07/05→12/12						
 Hauptbremszylinder								
1.6	77	07/05→09/12			für Linkslenker; - ESP		03.4155-0153.3 010927	ATE Ø 25,4
1.6 CNG Turbo	110	04/10→04/15			für Linkslenker; + ESP		03.4155-0156.3 010862	ATE Ø 25,4
1.8	103	07/05→04/15						
1.8 LPG	103	07/09→04/15			→ 6G999999; für Rechtslenker		24.2125-1736.3 010904	TRW Ø 25,4
2.0	147 - 177	07/05→12/10			72000001→; für Rechtslenker		24.4125-1703.3 010907	TRW Ø 25,4
1.6	85	01/08→04/15			für Linkslenker; - ESP		03.4155-0153.3 010927	ATE Ø 25,4
1.6 CNG	69	07/05→04/15			für Linkslenker; + ESP		03.4155-0156.3 010862	ATE Ø 25,4
1.6 FlexFuel	85	08/08→12/12						
1.7 CDTI	81 - 92	03/07→04/15			für Linkslenker; - ESP		03.4155-0153.3 010927	ATE Ø 25,4
1.9 CDTI	74 -	07/05→04/15			für Rechtslenker		03.4155-0156.3 010862	ATE Ø 25,4
	110				für Linkslenker; + ESP		03.4155-0156.3 010862	ATE Ø 25,4
2.2	110	07/05→12/12						
1.8	88	06/13→04/15			für Linkslenker; - ESP		03.4155-0153.3 010927	ATE Ø 25,4
					für Linkslenker; + ESP		03.4155-0156.3 010862	ATE Ø 25,4
					für Rechtslenker		24.4125-1703.3 010907	TRW Ø 25,4
OPEL - ZAFIRA A Großraumlimousine (T98) 04/99→06/05								
 Hauptbremszylinder								
1.6	76	10/03→06/05			- ESP		24.2123-1734.3 010640	TRW Ø 23,8
1.6 16V	74	04/99→06/05			+ ESP		24.2123-1739.3 010661	Ø 23,8
1.6 CNG	71	09/01→06/05						
1.6 LPG	74 - 76	04/99→06/05						
1.8 16V	85 - 92	04/99→06/05						
2.0 DTI 16V	74	09/00→06/05						
2.0 OPC	141 - 147	09/01→06/05						
2.2 16V	108	09/00→06/05						
2.2 DTI 16V	86 - 92	01/02→06/05						
2.0 DI 16V	60	07/99→06/05			10/99→; - ESP		24.2123-1734.3 010640	TRW Ø 23,8
					10/99→; + ESP		24.2123-1739.3 010661	Ø 23,8
 Bremskraftregler								
1.6	76	10/03→06/05			- ABS		03.6583-0085.3 320238	ATE lastabhängig 8/3 4x
1.6 16V	74	04/99→06/05						
1.6 CNG	71	09/01→06/05						
1.6 LPG	74 - 76	04/99→06/05						
1.8 16V	85 - 92	04/99→06/05						
2.0 DTI 16V	74	09/00→06/05						
2.0 OPC	141 - 147	09/01→06/05						
2.2 16V	108	09/00→06/05						
2.2 DTI 16V	86 - 92	01/02→06/05						
2.0 DI 16V	60	07/99→06/05			10/99→; - ABS		03.6583-0085.3 320238	ATE lastabhängig 8/3 4x
OPEL - ZAFIRA B Kasten/Großraumlimousine (A05) 07/05→04/15								
 Bremskraftverstärker								
1.6 CNG Turbo VAN	110	02/09→04/15			für Linkslenker; + ESP		03.7863-7803.4 300237	ATE Ø 10" pneumatisch
1.6 CNG VAN	69	07/05→04/15						
1.7 CDTI VAN	81 - 92	01/08→04/15						
1.8 VAN	103	07/05→04/15						
1.9 CDTI VAN	88 - 110	07/05→04/15						
2.0 VAN	147	07/05→12/10						
2.2 DGi VAN	110	07/05→12/11						
 Hauptbremszylinder								
1.6 CNG Turbo VAN	110	02/09→04/15			für Linkslenker; - ESP		03.4155-0153.3 010927	ATE Ø 25,4
1.6 CNG VAN	69	07/05→04/15			für Linkslenker; + ESP		03.4155-0156.3 010862	ATE Ø 25,4
1.8 VAN	103	07/05→04/15			→ 6G999999; für Rechtslenker		24.2125-1736.3 010904	TRW Ø 25,4
→								







	kw					! #		
OPEL - ZAFIRA B Kasten/Großraumlimousine (A05) 07/05→04/15								
 Hauptbremszylinder								
1.9 CDTi VAN	88 - 110	07/05→04/15		72000001→; für Rechtslenker		24.4125-1703.3	010907	TRW Ø 25,4
2.0 VAN	147	07/05→12/10						
2.2 DGi VAN	110	07/05→12/11						
1.7 CDTi VAN	81 - 92	01/08→04/15		für Linkslenker; - ESP		03.4155-0153.3	010927	ATE Ø 25,4
				für Rechtslenker		03.4155-0156.3	010862	ATE Ø 25,4
				für Linkslenker; + ESP		03.4155-0156.3	010862	ATE Ø 25,4
OPEL - ZAFIRA TOURER C (P12) 10/11→								
 Bremskraftverstärker								
1.4	88 - 103	10/11→		11/11→; für Linkslenker		03.7858-0732.4	300272	ATE Ø 9 / 8" pneumatisch
1.4 LPG	103	10/11→						
1.6 CNG	110	10/11→						
1.8	85 - 103	10/11→						
2.0 CDTi	81	10/11→						
1.6	100 - 125	12/12→		für Linkslenker		03.7858-0732.4	300272	ATE Ø 9 / 8" pneumatisch
1.6 CDTi	88 - 99	07/14→						
1.6 SIDI	147	07/13→						
2.0 BiTurbo CDTi	143	01/13→						
2.0 CDTi	96 - 125	10/11→						
1.6 CDTi	100	02/13→		03/13→; für Linkslenker		03.7858-0732.4	300272	ATE Ø 9 / 8" pneumatisch
 Hauptbremszylinder								
1.4	88 - 103	10/11→		11/11→; für Linkslenker		03.2125-0421.3	010934	ATE Ø 25,4
1.4 LPG	103	10/11→						
1.6 CNG	110	10/11→						
1.8	85 - 103	10/11→						
2.0 CDTi	81	10/11→						
1.6	100 - 125	12/12→		für Linkslenker		03.2125-0421.3	010934	ATE Ø 25,4
1.6 CDTi	88 - 99	07/14→						
1.6 SIDI	147	07/13→						
2.0 BiTurbo CDTi	143	01/13→						
2.0 CDTi	96 - 125	10/11→						
1.6 CDTi	100	02/13→		03/13→; für Linkslenker		03.2125-0421.3	010934	ATE Ø 25,4
OPEL - ZAFIRA TOURER C VAN (P12) 10/11→								
 Bremskraftverstärker								
2.0 CDTi	81 - 121	01/12→		für Linkslenker		03.7858-0732.4	300272	ATE Ø 9 / 8" pneumatisch
 Hauptbremszylinder								
2.0 CDTi	81 - 121	01/12→		für Linkslenker		03.2125-0421.3	010934	ATE Ø 25,4
PEUGEOT - 106 II (1A_, 1C_) 04/96→05/05								
 Hauptbremszylinder								
1.0 i	33 - 37	04/96→03/01		→Orga 08787; - ABS		03.2120-4166.3	010452	ATE Ø 20,6
1.1 BiFuel	44	04/96→03/01				24.2120-1722.3	010544	Ø 20,6
1.1 i	40	01/97→03/01		Orga 08788→; - ABS		24.2119-1708.3	010543	BDX Ø 19
1.1 i	44	05/96→07/04		→Orga 08787; - ABS		03.2120-4166.3	010452	ATE Ø 20,6
						24.2120-1722.3	010544	Ø 20,6
				Orga 08788→; → 03/04; - ABS		24.2119-1708.3	010543	BDX Ø 19
1.4 i	55	05/96→07/04		→ 03/04; - ABS		24.2119-1708.3	010543	BDX Ø 19
1.5 D	40	05/96→03/01		- ABS		24.2119-1708.3	010543	BDX Ø 19
1.5 D	42	04/98→07/04		10/00→ 03/04; - ABS		24.2119-1708.3	010543	BDX Ø 19
1.6 i	65 - 74	05/96→01/01		- ABS		03.2120-4166.3	010452	ATE Ø 20,6
1.6 S16	88	04/98→09/01				24.2120-1722.3	010544	Ø 20,6
1.6 S16	87	05/96→07/04		→ 03/04; - ABS		03.2120-4166.3	010452	ATE Ø 20,6
						24.2120-1722.3	010544	Ø 20,6
Electric	20	04/96→07/04				03.2120-4166.3	010452	ATE Ø 20,6
						24.2120-1722.3	010544	Ø 20,6











	kw					! #		
PEUGEOT - 106 Van II Kasten/Schrägheck (1S_) 04/96→03/01								
 Hauptbremszylinder								
1.0	33	04/96→03/01		05/96→; →Orga 08787; - ABS			03.2120-4166.3 010452	ATE Ø 20,6
							24.2120-1722.3 010544	Ø 20,6
				Orga 08788→; - ABS			24.2119-1708.3 010543	BDX Ø 19
1.5 D	40 - 42	05/96→03/01		- ABS			24.2119-1708.3 010543	BDX Ø 19
Electric	20	04/96→03/01					03.2120-4166.3 010452	ATE Ø 20,6
							24.2120-1722.3 010544	Ø 20,6
PEUGEOT - 107 (PM_, PN_) 06/05→05/14								
 Hauptbremszylinder								
1.0	50	06/05→05/14		für Linkslenker; - DSC			24.4120-1701.3 010846	BOS Ø 20,6
1.4 HDi	40	06/05→05/14		für Linkslenker; + DSC			24.4120-1704.3 011042	Ø 20,6 ohne Bremsflüssigkeitsbehälter
				für Rechtslenker; + DSC			24.4120-1705.3 011051	Ø 20,6 ohne Bremsflüssigkeitsbehälter
PEUGEOT - 108 05/14→								
 Hauptbremszylinder								
1.0 VTi	51	05/14→		für Linkslenker; - ESP			24.4120-1712.3 011092	Ø 20,6 ohne Bremsflüssigkeitsbehälter
1.0 VTi 72	53	05/18→						
1.2	60	05/14→						
PEUGEOT - 205 II (20A/C) 01/87→12/00								
 Hauptbremszylinder								
1.0	33	10/87→09/98		09/90→			03.2120-2031.3 010106	ATE Ø 20,6
1.8 TD	57	01/90→09/98						
1.9 Diesel	47	10/87→09/98						
1.0	37	08/92→05/97					03.2120-2031.3 010106	ATE Ø 20,6
1.8 XDT	58	08/90→05/97						
1.1	44	07/89→09/98		→ 08/90			03.2120-2031.3 010106	ATE Ø 20,6
1.4	55	07/88→09/98		09/90→			03.2120-2031.3 010106	ATE Ø 20,6
1.6	53 - 55	10/87→09/98						
1.6 Aut.	58	10/87→09/98		→ 08/90; Automatikgetriebe			03.2120-2031.3 010106	ATE Ø 20,6
				09/90→			03.2120-2031.3 010106	ATE Ø 20,6
1.6 Aut.	65	05/90→09/98		09/90→; - ABS			03.2120-2031.3 010106	ATE Ø 20,6
				→ 08/90; Automatikgetriebe			03.2120-2031.3 010106	ATE Ø 20,6
1.7 Diesel	44	07/87→09/98		03/94→			03.2120-2031.3 010106	ATE Ø 20,6
1.9 GTI	94	10/87→09/98		09/90→; - ABS			03.2120-2031.3 010106	ATE Ø 20,6
				→ 08/88; - ABS			03.2120-2031.3 010106	ATE Ø 20,6
Verschlusschraube, Hauptbremszylinder								
1.0	33	10/87→09/98		09/90→			03.3517-5100.1 390326	
1.8 TD	57	01/90→09/98						
1.9 Diesel	47	10/87→09/98						
1.0	37	08/92→05/97					03.3517-5100.1 390326	
1.8 XDT	58	08/90→05/97						
1.1	44	07/89→09/98		→ 08/90			03.3517-5100.1 390326	
1.4	55	07/88→09/98		09/90→			03.3517-5100.1 390326	
1.6	53 - 55	10/87→09/98						
1.6 Aut.	58	10/87→09/98		→ 08/90; Automatikgetriebe			03.3517-5100.1 390326	
				09/90→			03.3517-5100.1 390326	
1.6 Aut.	65	05/90→09/98		09/90→; - ABS			03.3517-5100.1 390326	
				→ 08/90; Automatikgetriebe			03.3517-5100.1 390326	
1.7 Diesel	44	07/87→09/98		03/94→			03.3517-5100.1 390326	
1.9 GTI	94	10/87→09/98		09/90→; - ABS			03.3517-5100.1 390326	
				→ 08/88; - ABS			03.3517-5100.1 390326	
Bremskraftregler								
1.9 GTI	94	10/87→09/98		→ S 1811241; - ABS			24.6043-1701.3 320150	3/15 2x
				→ S 1831920; - ABS			24.6043-1701.3 320150	3/15 2x
PEUGEOT - 205 Kasten/Schrägheck 08/90→05/97								
 Hauptbremszylinder								
1.7 Diesel	44	03/94→05/97					03.2120-2031.3 010106	ATE Ø 20,6
→								







	kw					! #			
PEUGEOT - 205 Kasten/Schrägheck 08/90→05/97									
Verschlussschraube, Hauptbremszylinder									
1.7 Diesel	44	03/94→05/97					03.3517-5100.1	390326	
PEUGEOT - 206 CC (2D) 09/00→12/08									
 Bremskraftverstärker									
1.6 1.6 16V	81	09/01→12/08		→Orga 09456; + ABS; Schaltgetriebe			03.7750-6234.4	300320	ATE Ø 9" pneumatisch
	80	09/00→12/07		Orga 09821→; → 01/07; - ABS; Schaltgetriebe			03.7750-6234.4	300320	ATE Ø 9" pneumatisch
				→Orga 09820; - ABS; Schaltgetriebe			03.7750-6234.4	300320	ATE Ø 9" pneumatisch
				Orga 09821→; → 01/07; - ABS; Automatikgetriebe			03.7750-6332.4	300226	ATE Ø 9" pneumatisch
							03.7750-6334.4	300321	ATE Ø 9" pneumatisch
				→Orga 09456; + ABS; Automatikgetriebe			03.7750-6334.4	300321	ATE Ø 9" pneumatisch
				→Orga 09820; - ABS; Automatikgetriebe			03.7750-6334.4	300321	ATE Ø 9" pneumatisch
				Orga 09741→; → 01/07; + ABS; Schaltgetriebe			03.7853-2604.4	300322	ATE Ø 9" pneumatisch
1.6 HDi 110	80	04/05→02/07		09457→ 09740; + ABS; Schaltgetriebe			03.7853-2604.4	300322	ATE Ø 9" pneumatisch
				Orga 09741→; → 01/07; Automatikgetriebe; + ABS			03.7853-2704.4	300323	ATE Ø 9" pneumatisch
1.6 HDi 110	80	04/05→02/07		→ 01/07			03.7853-2604.4	300322	ATE Ø 9" pneumatisch
							03.7853-2704.4	300323	ATE Ø 9" pneumatisch
 Hauptbremszylinder									
1.6 1.6 16V	81	09/01→12/08		→ 01/07; Schaltgetriebe; - ESP			03.2122-1351.3	010528	Ø 22,2
	80	09/00→12/07		→ 01/07; Schaltgetriebe; - ABS			03.2122-1356.3	010529	Ø 22,2
				→ 01/07; Schaltgetriebe; + ESP			03.2122-1942.3	010700	ATE Ø 22,2
				→ 01/07; Automatikgetriebe; - ABS			03.4122-0031.3	010611	ATE Ø 22,2
				→ 01/07; Automatikgetriebe; - ESP			03.4122-0041.3	010612	ATE Ø 22,2
				→ 01/07; Automatikgetriebe; + ESP			03.4122-0054.3	010813	ATE Ø 22,2
1.6 HDi 110	80	04/05→02/07		→ 01/07; - ESP			03.2122-1351.3	010528	Ø 22,2
							03.4122-0041.3	010612	ATE Ø 22,2
				→ 01/07; + ESP			03.2122-1942.3	010700	ATE Ø 22,2
2.0 S16	100	09/00→12/07		→ 01/07; - ESP			03.2122-1351.3	010528	Ø 22,2
				→ 01/07; + ESP			03.2122-1942.3	010700	ATE Ø 22,2
PEUGEOT - 206 Schrägheck (2A/C) 08/98→12/12									
 Bremskraftverstärker									
1.0 1.1 i	52	06/01→12/05		→Orga 09456; + ABS			03.7750-6234.4	300320	ATE Ø 9" pneumatisch
	44	09/98→02/07		Orga 09741→; + ABS			03.7853-2604.4	300322	ATE Ø 9" pneumatisch
				09457→ 09740; + ABS			03.7853-2604.4	300322	ATE Ø 9" pneumatisch
1.1	40	08/98→07/00		09/98→; →Orga 09456; + ABS			03.7750-6234.4	300320	ATE Ø 9" pneumatisch
				Orga 09741→; + ABS			03.7853-2604.4	300322	ATE Ø 9" pneumatisch
				09457→ 09740; + ABS			03.7853-2604.4	300322	ATE Ø 9" pneumatisch
1.4 16V	65	10/03→02/08		- ABS			03.7750-6234.4	300320	ATE Ø 9" pneumatisch
							03.7853-2604.4	300322	ATE Ø 9" pneumatisch
1.4 CNG 1.4 LPG	55	05/06→09/07		- ABS; Schaltgetriebe			03.7750-6134.4	300319	ATE Ø 9" pneumatisch
	55	05/06→09/07		- ABS; Automatikgetriebe			03.7750-6332.4	300226	ATE Ø 9" pneumatisch
				+ ABS; Schaltgetriebe			03.7750-6334.4	300321	ATE Ø 9" pneumatisch
				+ ABS; Automatikgetriebe			03.7853-2604.4	300322	ATE Ø 9" pneumatisch
1.4 Flex	60	01/06→11/09		→Orga 09820; Schaltgetriebe; - ABS			03.7750-6134.4	300319	ATE Ø 9" pneumatisch
				→Orga 09456; Schaltgetriebe; + ABS			03.7750-6234.4	300320	ATE Ø 9" pneumatisch
				Orga 09821→; Automatikgetriebe; - ABS			03.7750-6332.4	300226	ATE Ø 9" pneumatisch
				Orga 09821→; → 02/09; Automatikgetriebe; - ABS			03.7750-6334.4	300321	ATE Ø 9" pneumatisch
				→Orga 09820; Automatikgetriebe; - ABS			03.7750-6334.4	300321	ATE Ø 9" pneumatisch
				→Orga 09456; Automatikgetriebe; + ABS			03.7750-6334.4	300321	ATE Ø 9" pneumatisch
				09457→ 09740; Schaltgetriebe; + ABS			03.7853-2604.4	300322	ATE Ø 9" pneumatisch
				Orga 09741→; → 02/09; Schaltgetriebe			03.7853-2604.4	300322	ATE Ø 9" pneumatisch
				Orga 09741→; → 02/09; Automatikgetriebe			03.7853-2704.4	300323	ATE Ø 9" pneumatisch
1.4 HDi	51	09/02→02/07		→Orga 09820; - ABS			03.7750-6134.4	300319	ATE Ø 9" pneumatisch
				→Orga 09456; + ABS			03.7750-6234.4	300320	ATE Ø 9" pneumatisch
				Orga 09821→			03.7853-2604.4	300322	ATE Ø 9" pneumatisch































	kw					! #		
PEUGEOT - 206 Schrägheck (2A/C) 08/98→12/12								
Bremskraftverstärker								
1.4 HDi	51	09/02→02/07		09457→ 09740; + ABS		03.7853-2604.4	300322	ATE Ø 9" pneumatisch
1.4 HDi eco 70	50	09/01→04/09		→Orga 09820; - ABS		03.7750-6134.4	300319	ATE Ø 9" pneumatisch
				→Orga 09456; + ABS		03.7750-6234.4	300320	ATE Ø 9" pneumatisch
				Orga 09821→; → 02/09		03.7853-2604.4	300322	ATE Ø 9" pneumatisch
				09457→ 09740; + ABS		03.7853-2604.4	300322	ATE Ø 9" pneumatisch
1.4 i	55	09/98→12/12		→Orga 09820; Schaltgetriebe; - ABS		03.7750-6134.4	300319	ATE Ø 9" pneumatisch
				→Orga 09456; Schaltgetriebe; + ABS		03.7750-6234.4	300320	ATE Ø 9" pneumatisch
				Orga 09821→; → 02/09; Automatikgetriebe; - ABS		03.7750-6332.4	300226	ATE Ø 9" pneumatisch
				09457→ 09740; + ABS		03.7750-6334.4	300321	ATE Ø 9" pneumatisch
				→Orga 09456; Automatikgetriebe; + ABS		03.7750-6334.4	300321	ATE Ø 9" pneumatisch
				→Orga 09820; Automatikgetriebe; - ABS		03.7750-6334.4	300321	ATE Ø 9" pneumatisch
				Orga 09741→; → 02/09; Schaltgetriebe		03.7853-2604.4	300322	ATE Ø 9" pneumatisch
				09457→ 09740; Schaltgetriebe; + ABS		03.7853-2604.4	300322	ATE Ø 9" pneumatisch
1.6 1.6 16V 1.6 BiFuel 1.6 Flex	81 79 80 80 83	05/05→07/08 07/00→04/09 07/00→04/09 05/05→07/08		→Orga 09456; Schaltgetriebe; + ABS		03.7750-6234.4	300320	ATE Ø 9" pneumatisch
				09821→ 10996; - ABS; Schaltgetriebe		03.7750-6234.4	300320	ATE Ø 9" pneumatisch
				→Orga 09820; Schaltgetriebe; + ABS		03.7750-6234.4	300320	ATE Ø 9" pneumatisch
				09821→ 10996; Automatikgetriebe; - ABS		03.7750-6332.4	300226	ATE Ø 9" pneumatisch
				→Orga 09820; Automatikgetriebe; - ABS		03.7750-6334.4	300321	ATE Ø 9" pneumatisch
				→Orga 09456; Automatikgetriebe; + ABS		03.7750-6334.4	300321	ATE Ø 9" pneumatisch
				09741→ 10996; Schaltgetriebe		03.7853-2604.4	300322	ATE Ø 9" pneumatisch
				09457→ 09740; Schaltgetriebe; + ABS		03.7853-2604.4	300322	ATE Ø 9" pneumatisch
				09741→ 10996; Automatikgetriebe; + ABS		03.7853-2704.4	300323	ATE Ø 9" pneumatisch
			1.6 8V	66	05/99→10/03		→ 12/00; Schaltgetriebe; - ABS	
	→ 12/00; Schaltgetriebe; + ABS					03.7750-6234.4	300320	ATE Ø 9" pneumatisch
	→ 12/00; Automatikgetriebe					03.7750-6334.4	300321	ATE Ø 9" pneumatisch
1.6 HDi 110	80	05/04→02/07		+ ABS		03.7853-2604.4	300322	ATE Ø 9" pneumatisch
1.6 i	65	09/98→12/00		- ABS; Schaltgetriebe		03.7750-6134.4	300319	ATE Ø 9" pneumatisch
				Schaltgetriebe; + ABS		03.7750-6234.4	300320	ATE Ø 9" pneumatisch
				Automatikgetriebe		03.7750-6334.4	300321	ATE Ø 9" pneumatisch
1.9 D	51	09/98→11/01				03.7750-6134.4	300319	ATE Ø 9" pneumatisch
				→Orga 09456; + ABS		03.7750-6234.4	300320	ATE Ø 9" pneumatisch
				09457→ 09740; + ABS		03.7750-6334.4	300321	ATE Ø 9" pneumatisch
2.0 HDi 90	66	12/99→09/09		Orga 09457→; + ABS		03.7853-2604.4	300322	ATE Ø 9" pneumatisch
				→Orga 09820		03.7750-6234.4	300320	ATE Ø 9" pneumatisch
				→Orga 09456		03.7750-6334.4	300321	ATE Ø 9" pneumatisch
				→Orga 09456		03.7750-6234.4	300320	ATE Ø 9" pneumatisch
				→Orga 09456		03.7750-6334.4	300321	ATE Ø 9" pneumatisch
				Orga 09821→; → 02/09		03.7750-6234.4	300320	ATE Ø 9" pneumatisch
			03.7750-6332.4	300226	ATE Ø 9" pneumatisch			
			03.7750-6334.4	300321	ATE Ø 9" pneumatisch			
			09457→ 09820; + ABS		03.7853-2604.4	300322	ATE Ø 9" pneumatisch	
			Orga 09821→; → 02/09; + ABS		03.7853-2604.4	300322	ATE Ø 9" pneumatisch	
					03.7853-2704.4	300323	ATE Ø 9" pneumatisch	
Hauptbremszylinder								
1.0	52	06/01→12/05		- ABS		03.2120-4321.3	010525	ATE Ø 20,6
1.1 i	44	09/98→02/07		+ ABS		03.2122-1351.3	010528	Ø 22,2
						24.2120-1737.3	010757	Ø 20,6
1.1	40	08/98→07/00		09/98→; - ABS		03.2120-4321.3	010525	ATE Ø 20,6
				09/98→; + ABS		03.2122-1351.3	010528	Ø 22,2
				09/98→		24.2120-1737.3	010757	Ø 20,6
1.4 16V	65	10/03→02/08		- ESP		03.2122-1351.3	010528	Ø 22,2
				- ABS		03.2122-1356.3	010529	Ø 22,2
				+ ESP		03.2122-1942.3	010700	ATE Ø 22,2
1.4 CNG	55	05/06→09/07		Schaltgetriebe; - ABS		03.2120-4321.3	010525	ATE Ø 20,6
1.4 Flex	60	01/06→11/09						













	kw			 	! #		
PEUGEOT - 206 Schrägheck (2A/C) 08/98→12/12							
Hauptbremszylinder							
1.4 LPG 1.6 i	55 65	05/06→09/07 09/98→12/00	Schaltgetriebe; + ABS	03.2122-1351.3	010528	Ø 22,2	
			Automatikgetriebe; - ABS	03.4122-0031.3	010611	ATE Ø 22,2	
			Automatikgetriebe; + ABS	03.4122-0041.3	010612	ATE Ø 22,2	
			Schaltgetriebe	24.2120-1737.3	010757	Ø 20,6	
1.4 HDi	51	09/02→02/07	- ABS	03.2120-4321.3	010525	ATE Ø 20,6	
			- ESP	03.2122-1351.3	010528	Ø 22,2	
			+ ESP	03.2122-1942.3	010700	ATE Ø 22,2	
				24.2120-1737.3	010757	Ø 20,6	
1.4 HDi eco 70	50	09/01→04/09	→ 02/09; - ABS	03.2120-4321.3	010525	ATE Ø 20,6	
			→ 02/09; - ESP	03.2122-1351.3	010528	Ø 22,2	
			→ 02/09; + ESP	03.2122-1942.3	010700	ATE Ø 22,2	
			→ 02/09	24.2120-1737.3	010757	Ø 20,6	
1.4 i	55	09/98→12/12	→ 02/09; Schaltgetriebe; - ABS	03.2120-4321.3	010525	ATE Ø 20,6	
			→ 02/09; Schaltgetriebe; + ABS	03.2122-1351.3	010528	Ø 22,2	
			→ 02/09; Automatikgetriebe; - ABS	03.4122-0031.3	010611	ATE Ø 22,2	
			→ 02/09; Automatikgetriebe; + ABS	03.4122-0041.3	010612	ATE Ø 22,2	
			→ 02/09; Schaltgetriebe	24.2120-1737.3	010757	Ø 20,6	
1.6 1.6 16V 1.6 Flex	81 79 83	05/05→07/08 06/01→04/09 05/05→07/08	Schaltgetriebe; + ABS	03.2122-1351.3	010528	Ø 22,2	
			Schaltgetriebe; - ESP	03.2122-1351.3	010528	Ø 22,2	
			Schaltgetriebe; - ABS	03.2122-1356.3	010529	Ø 22,2	
			Schaltgetriebe; + ESP	03.2122-1942.3	010700	ATE Ø 22,2	
			Automatikgetriebe; - ABS	03.4122-0031.3	010611	ATE Ø 22,2	
			Automatikgetriebe; - ESP	03.4122-0041.3	010612	ATE Ø 22,2	
			Automatikgetriebe; + ESP	03.4122-0054.3	010813	ATE Ø 22,2	
1.6 16V 1.6 BiFuel	80 80	07/00→04/09 07/00→04/09	→ 02/09; Schaltgetriebe; - ESP	03.2122-1351.3	010528	Ø 22,2	
			→ 02/09; Schaltgetriebe; + ABS	03.2122-1351.3	010528	Ø 22,2	
			→ 02/09; Schaltgetriebe; - ABS	03.2122-1356.3	010529	Ø 22,2	
			→ 02/09; Schaltgetriebe; + ESP	03.2122-1942.3	010700	ATE Ø 22,2	
			→ 02/09; Automatikgetriebe; - ABS	03.4122-0031.3	010611	ATE Ø 22,2	
			→ 02/09; Automatikgetriebe; - ESP	03.4122-0041.3	010612	ATE Ø 22,2	
			→ 02/09; Automatikgetriebe; + ESP	03.4122-0054.3	010813	ATE Ø 22,2	
1.6 8V	66	05/99→10/03	→ 12/00; Schaltgetriebe; - ABS	03.2120-4321.3	010525	ATE Ø 20,6	
			→ 12/00; Schaltgetriebe; + ABS	03.2122-1351.3	010528	Ø 22,2	
			→ 12/00; Automatikgetriebe; - ABS	03.4122-0031.3	010611	ATE Ø 22,2	
			→ 12/00; Automatikgetriebe; + ABS	03.4122-0041.3	010612	ATE Ø 22,2	
			→ 12/00; Schaltgetriebe	24.2120-1737.3	010757	Ø 20,6	
1.6 HDi 110	80	05/04→02/07	- ESP	03.2122-1351.3	010528	Ø 22,2	
				03.4122-0041.3	010612	ATE Ø 22,2	
			+ ESP	03.2122-1942.3	010700	ATE Ø 22,2	
			03.4122-0054.3	010813	ATE Ø 22,2		
1.9 D	51	09/98→11/01	- ABS	03.2120-4321.3	010525	ATE Ø 20,6	
				03.4122-0031.3	010611	ATE Ø 22,2	
			+ ABS	03.2122-1351.3	010528	Ø 22,2	
				03.4122-0041.3	010612	ATE Ø 22,2	
			24.2120-1737.3	010757	Ø 20,6		
2.0 HDI 90	66	12/99→09/09	→ 02/09; - ESP	03.2122-1351.3	010528	Ø 22,2	
				03.4122-0041.3	010612	ATE Ø 22,2	
			→ 02/09; - ABS	03.2122-1356.3	010529	Ø 22,2	
				03.4122-0031.3	010611	ATE Ø 22,2	
			→ 02/09; + ESP	03.2122-1942.3	010700	ATE Ø 22,2	
			03.4122-0054.3	010813	ATE Ø 22,2		
			03.4122-0041.3	010612	ATE Ø 22,2		
2.0 RC	130	07/03→12/07		03.2122-1942.3	010700	ATE Ø 22,2	
2.0 S16	99	04/99→10/00	- ESP	03.2122-1351.3	010528	Ø 22,2	
			+ ESP	03.2122-1942.3	010700	ATE Ø 22,2	
2.0 S16	100	06/99→12/07	10/00→ 02/07; - ESP	03.2122-1351.3	010528	Ø 22,2	
			10/00→ 02/07; + ESP	03.2122-1942.3	010700	ATE Ø 22,2	







	kw			 	! #		
PEUGEOT - 206 Stufenheck 03/07→							
 Bremskraftverstärker							
1.4	55	03/07→	→ 02/09; - ABS; Schaltgetriebe	03.7750-6134.4	300319	ATE Ø 9" pneumatisch	
			→ 02/09; - ABS; Automatikgetriebe	03.7750-6332.4	300226	ATE Ø 9" pneumatisch	
			→ 02/09; - ABS; Automatikgetriebe	03.7750-6334.4	300321	ATE Ø 9" pneumatisch	
			→ 02/09; + ABS; Schaltgetriebe	03.7853-2604.4	300322	ATE Ø 9" pneumatisch	
1.4 HDi eco 70	50	09/08→	→ 02/09; + ABS; Automatikgetriebe	03.7853-2704.4	300323	ATE Ø 9" pneumatisch	
			→ 02/09	03.7853-2604.4	300322	ATE Ø 9" pneumatisch	
1.6 16V	80	03/07→	→Orga 09456; Schaltgetriebe; + ABS	03.7750-6234.4	300320	ATE Ø 9" pneumatisch	
			09821→ 10996; - ABS; Schaltgetriebe	03.7750-6234.4	300320	ATE Ø 9" pneumatisch	
			→Orga 09820; Schaltgetriebe; + ABS	03.7750-6234.4	300320	ATE Ø 9" pneumatisch	
			09821→ 10996; Automatikgetriebe; - ABS	03.7750-6332.4	300226	ATE Ø 9" pneumatisch	
			→Orga 09820; Automatikgetriebe; - ABS	03.7750-6334.4	300321	ATE Ø 9" pneumatisch	
			→Orga 09456; Automatikgetriebe; + ABS	03.7750-6334.4	300321	ATE Ø 9" pneumatisch	
			09741→ 10996; Schaltgetriebe	03.7853-2604.4	300322	ATE Ø 9" pneumatisch	
			09457→ 09740; Schaltgetriebe; + ABS	03.7853-2604.4	300322	ATE Ø 9" pneumatisch	
			09741→ 10996; Automatikgetriebe; + ABS	03.7853-2704.4	300323	ATE Ø 9" pneumatisch	
 Hauptbremszylinder							
1.4	55	03/07→	→ 02/09; Schaltgetriebe; - ABS	03.2120-4321.3	010525	ATE Ø 20,6	
			→ 02/09; Schaltgetriebe; + ABS	03.2122-1351.3	010528	Ø 22,2	
			→ 02/09; Automatikgetriebe; - ABS	03.4122-0031.3	010611	ATE Ø 22,2	
			→ 02/09; Automatikgetriebe; + ABS	03.4122-0041.3	010612	ATE Ø 22,2	
			→ 02/09; Schaltgetriebe	24.2120-1737.3	010757	Ø 20,6	
1.4 HDi eco 70	50	09/08→	→ 02/09; - ABS	03.2120-4321.3	010525	ATE Ø 20,6	
			→ 02/09; - ESP	03.2122-1351.3	010528	Ø 22,2	
			→ 02/09; + ABS	03.2122-1351.3	010528	Ø 22,2	
			→ 02/09; + ESP	03.2122-1942.3	010700	ATE Ø 22,2	
1.6 16V	80	03/07→	→ 02/09	24.2120-1737.3	010757	Ø 20,6	
			→ 02/09; Schaltgetriebe; + ABS	03.2122-1351.3	010528	Ø 22,2	
			→ 02/09; Schaltgetriebe; - ESP	03.2122-1351.3	010528	Ø 22,2	
			→ 02/09; Schaltgetriebe; - ABS	03.2122-1356.3	010529	Ø 22,2	
			→ 02/09; Schaltgetriebe; + ESP	03.2122-1942.3	010700	ATE Ø 22,2	
			→ 02/09; Automatikgetriebe; - ABS	03.4122-0031.3	010611	ATE Ø 22,2	
			→ 02/09; Automatikgetriebe; - ESP	03.4122-0041.3	010612	ATE Ø 22,2	
→ 02/09; Automatikgetriebe; + ESP	03.4122-0054.3	010813	ATE Ø 22,2				
PEUGEOT - 206 SW (2E/K) 07/02→							
 Bremskraftverstärker							
1.1	44	07/02→02/07	→Orga 09456; + ABS	03.7750-6234.4	300320	ATE Ø 9" pneumatisch	
			Orga 09741→; + ABS	03.7853-2604.4	300322	ATE Ø 9" pneumatisch	
			09457→ 09740; + ABS	03.7853-2604.4	300322	ATE Ø 9" pneumatisch	
1.4 1.4 Flex 1.4 LPG	55	07/02→02/07	→Orga 09820; Schaltgetriebe; - ABS	03.7750-6134.4	300319	ATE Ø 9" pneumatisch	
			→Orga 09456; Schaltgetriebe; + ABS	03.7750-6234.4	300320	ATE Ø 9" pneumatisch	
			Orga 09821→; - ABS; Automatikgetriebe	03.7750-6332.4	300226	ATE Ø 9" pneumatisch	
			Orga 09821→; - ABS; Automatikgetriebe	03.7750-6334.4	300321	ATE Ø 9" pneumatisch	
			→Orga 09456; + ABS; Automatikgetriebe	03.7750-6334.4	300321	ATE Ø 9" pneumatisch	
			→Orga 09820; - ABS; Automatikgetriebe	03.7750-6334.4	300321	ATE Ø 9" pneumatisch	
			09457→ 09740; Schaltgetriebe; + ABS	03.7853-2604.4	300322	ATE Ø 9" pneumatisch	
			Orga 09741→; + ABS; Schaltgetriebe	03.7853-2604.4	300322	ATE Ø 9" pneumatisch	
			Orga 09741→; + ABS; Automatikgetriebe	03.7853-2704.4	300323	ATE Ø 9" pneumatisch	
1.4 16V	65	10/03→	→ 05/07; - ABS	03.7750-6134.4	300319	ATE Ø 9" pneumatisch	
			→ 05/07; + ABS	03.7853-2604.4	300322	ATE Ø 9" pneumatisch	
1.4 HDi	50	07/02→02/07	→Orga 09820; - ABS	03.7750-6134.4	300319	ATE Ø 9" pneumatisch	
			→Orga 09456; + ABS	03.7750-6234.4	300320	ATE Ø 9" pneumatisch	
			09457→ 09820; + ABS	03.7853-2604.4	300322	ATE Ø 9" pneumatisch	
			Orga 09821→; + ABS	03.7853-2604.4	300322	ATE Ø 9" pneumatisch	
1.6 1.6 16V	81 80	05/05→07/08 07/02→	→Orga 09820; Schaltgetriebe; + ABS	03.7750-6234.4	300320	ATE Ø 9" pneumatisch	
			Orga 09821→; → 05/07; Schaltgetriebe; - ABS	03.7750-6234.4	300320	ATE Ø 9" pneumatisch	
			→Orga 09456; Schaltgetriebe; + ABS	03.7750-6234.4	300320	ATE Ø 9" pneumatisch	
→							







	kw			 	! #		
PEUGEOT - 206 SW (2E/K) 07/02→							
Bremskraftverstärker							
1.6 1.6 16V	81 80	05/05→07/08 07/02→	Orga 09821→; → 05/07; - ABS; Automatikgetriebe	03.7750-6332.4	300226	ATE Ø 9" pneumatisch	
			→Orga 09456; + ABS; Automatikgetriebe	03.7750-6334.4	300321	ATE Ø 9" pneumatisch	
			→Orga 09820; - ABS; Automatikgetriebe	03.7750-6334.4	300321	ATE Ø 9" pneumatisch	
			Orga 09741→; → 05/07; + ABS; Schaltgetriebe	03.7853-2604.4	300322	ATE Ø 9" pneumatisch	
			09457→ 09740; Schaltgetriebe; + ABS	03.7853-2604.4	300322	ATE Ø 9" pneumatisch	
			Orga 09741→; → 05/07; + ABS; Automatikgetriebe	03.7853-2704.4	300323	ATE Ø 9" pneumatisch	
1.6 Flex 1.6 LPG	81 - 83 80	05/05→07/08 07/02→02/07	→Orga 09820; Schaltgetriebe; + ABS	03.7750-6234.4	300320	ATE Ø 9" pneumatisch	
			Orga 09821→; Schaltgetriebe; - ABS	03.7750-6234.4	300320	ATE Ø 9" pneumatisch	
			→Orga 09456; Schaltgetriebe; + ABS	03.7750-6234.4	300320	ATE Ø 9" pneumatisch	
			Orga 09821→; - ABS; Automatikgetriebe	03.7750-6332.4	300226	ATE Ø 9" pneumatisch	
				03.7750-6334.4	300321	ATE Ø 9" pneumatisch	
			→Orga 09820; - ABS; Automatikgetriebe	03.7750-6334.4	300321	ATE Ø 9" pneumatisch	
			→Orga 09456; + ABS; Automatikgetriebe	03.7750-6334.4	300321	ATE Ø 9" pneumatisch	
			09457→ 09740; Schaltgetriebe; + ABS	03.7853-2604.4	300322	ATE Ø 9" pneumatisch	
1.6 HDi 110	80	05/04→	→ 05/07; + ABS	03.7853-2604.4	300322	ATE Ø 9" pneumatisch	
				03.7853-2704.4	300323	ATE Ø 9" pneumatisch	
2.0 HDi	66	07/02→02/07	→Orga 09820; - ABS	03.7750-6234.4	300320	ATE Ø 9" pneumatisch	
				03.7750-6334.4	300321	ATE Ø 9" pneumatisch	
			Orga 09821→; - ABS	03.7750-6234.4	300320	ATE Ø 9" pneumatisch	
				03.7750-6332.4	300226	ATE Ø 9" pneumatisch	
				03.7750-6334.4	300321	ATE Ø 9" pneumatisch	
			→Orga 09456; + ABS	03.7750-6234.4	300320	ATE Ø 9" pneumatisch	
	03.7750-6334.4	300321	ATE Ø 9" pneumatisch				
	09457→ 09820; + ABS	03.7853-2604.4	300322	ATE Ø 9" pneumatisch			
	Orga 09821→; + ABS	03.7853-2604.4	300322	ATE Ø 9" pneumatisch			
			03.7853-2704.4	300323	ATE Ø 9" pneumatisch		
Hauptbremszylinder							
1.1	44	07/02→02/07	- ABS	03.2120-4321.3	010525	ATE Ø 20,6	
			+ ABS	24.2120-1737.3	010757	Ø 20,6	
1.4 1.4 Flex 1.4 LPG	55 59 55	07/02→02/07 01/06→07/08 07/02→02/07	Schaltgetriebe; - ABS	03.2120-4321.3	010525	ATE Ø 20,6	
				24.2120-1737.3	010757	Ø 20,6	
			Schaltgetriebe; + ABS	03.2122-1351.3	010528	Ø 22,2	
			Automatikgetriebe; - ABS	03.4122-0031.3	010611	ATE Ø 22,2	
			Automatikgetriebe; - ESP	03.4122-0041.3	010612	ATE Ø 22,2	
			Automatikgetriebe; + ESP	03.4122-0054.3	010813	ATE Ø 22,2	
1.4 16V	65	10/03→	→ 05/07; - ESP	03.2122-1351.3	010528	Ø 22,2	
			→ 05/07; - ABS	03.2122-1356.3	010529	Ø 22,2	
			→ 05/07; + ESP	03.2122-1942.3	010700	ATE Ø 22,2	
1.4 HDi	50	07/02→02/07	- ABS	03.2120-4321.3	010525	ATE Ø 20,6	
				24.2120-1737.3	010757	Ø 20,6	
			- ESP	03.2122-1351.3	010528	Ø 22,2	
	+ ESP	03.2122-1942.3	010700	ATE Ø 22,2			
1.6 1.6 16V	81 80	05/05→07/08 07/02→	→ 05/07; Schaltgetriebe; - ESP	03.2122-1351.3	010528	Ø 22,2	
			→ 05/07; Schaltgetriebe; - ABS	03.2122-1356.3	010529	Ø 22,2	
			→ 05/07; Schaltgetriebe; + ESP	03.2122-1942.3	010700	ATE Ø 22,2	
			→ 05/07; Automatikgetriebe; - ABS	03.4122-0031.3	010611	ATE Ø 22,2	
			→ 05/07; Automatikgetriebe; - ESP	03.4122-0041.3	010612	ATE Ø 22,2	
			→ 05/07; Automatikgetriebe; + ESP	03.4122-0054.3	010813	ATE Ø 22,2	
1.6 Flex 1.6 LPG	81 - 83 80	05/05→07/08 07/02→02/07	Schaltgetriebe; - ESP	03.2122-1351.3	010528	Ø 22,2	
			Schaltgetriebe; - ABS	03.2122-1356.3	010529	Ø 22,2	
			Schaltgetriebe; + ESP	03.2122-1942.3	010700	ATE Ø 22,2	
			Automatikgetriebe; - ABS	03.4122-0031.3	010611	ATE Ø 22,2	
			Automatikgetriebe; - ESP	03.4122-0041.3	010612	ATE Ø 22,2	
			Automatikgetriebe; + ESP	03.4122-0054.3	010813	ATE Ø 22,2	
→							

	kw					! #		
PEUGEOT - 206 SW (2E/K) 07/02→								
 Hauptbremszylinder								
1.6 HDi 110	80	05/04→		→ 05/07; - ESP		03.2122-1351.3 010528	Ø 22,2	
				→ 05/07; + ESP		03.4122-0041.3 010612	ATE Ø 22,2	
						03.2122-1942.3 010700	ATE Ø 22,2	
						03.4122-0054.3 010813	ATE Ø 22,2	
2.0 16V	100	07/02→02/07		- ESP		03.2122-1351.3 010528	Ø 22,2	
				+ ESP		03.2122-1942.3 010700	ATE Ø 22,2	
2.0 HDi	66	07/02→02/07		- ESP		03.2122-1351.3 010528	Ø 22,2	
				- ABS		03.2122-1356.3 010529	Ø 22,2	
						03.4122-0031.3 010611	ATE Ø 22,2	
				+ ESP		03.2122-1942.3 010700	ATE Ø 22,2	
						03.4122-0054.3 010813	ATE Ø 22,2	
PEUGEOT - 206 Van 04/99→03/09								
 Bremskraftverstärker								
1.1	44	09/02→02/07		→Orga 09456; + ABS		03.7750-6234.4 300320	ATE Ø 9" pneumatisch	
				Orga 09741→; + ABS		03.7853-2604.4 300322	ATE Ø 9" pneumatisch	
				09457→ 09740; + ABS		03.7853-2604.4 300322	ATE Ø 9" pneumatisch	
1.4 HDi	50	09/01→03/09		→Orga 09820; - ABS		03.7750-6134.4 300319	ATE Ø 9" pneumatisch	
				→Orga 09456; + ABS		03.7750-6234.4 300320	ATE Ø 9" pneumatisch	
				Orga 09821→; → 02/09		03.7853-2604.4 300322	ATE Ø 9" pneumatisch	
				09457→ 09740; + ABS		03.7853-2604.4 300322	ATE Ø 9" pneumatisch	
1.9 D	51	04/99→05/07				03.7750-6134.4 300319	ATE Ø 9" pneumatisch	
						03.7750-6334.4 300321	ATE Ø 9" pneumatisch	
				→Orga 09456; + ABS		03.7750-6234.4 300320	ATE Ø 9" pneumatisch	
						03.7750-6334.4 300321	ATE Ø 9" pneumatisch	
				Orga 09457→; + ABS		03.7853-2604.4 300322	ATE Ø 9" pneumatisch	
 Hauptbremszylinder								
1.1	44	09/02→02/07		- ABS		03.2120-4321.3 010525	ATE Ø 20,6	
				+ ABS		03.2122-1351.3 010528	Ø 22,2	
						24.2120-1737.3 010757	Ø 20,6	
1.4 HDi	50	09/01→03/09		→ 02/09; - ABS		03.2120-4321.3 010525	ATE Ø 20,6	
				→ 02/09; - ESP		03.2122-1351.3 010528	Ø 22,2	
				→ 02/09; + ESP		03.2122-1942.3 010700	ATE Ø 22,2	
				→ 02/09		24.2120-1737.3 010757	Ø 20,6	
1.9 D	51	04/99→05/07		- ABS		03.2120-4321.3 010525	ATE Ø 20,6	
						03.4122-0031.3 010611	ATE Ø 22,2	
				+ ABS		03.2122-1351.3 010528	Ø 22,2	
						03.4122-0041.3 010612	ATE Ø 22,2	
						24.2120-1737.3 010757	Ø 20,6	
PEUGEOT - 206+ (2L_, 2M_) 01/09→08/13								
 Bremskraftverstärker								
1.1	44	01/09→06/13		→ 05/13; - ABS		03.7750-6134.4 300319	ATE Ø 9" pneumatisch	
1.1 LPG	44	04/09→06/13		→ 05/13; + ABS		03.7853-2604.4 300322	ATE Ø 9" pneumatisch	
1.4 HDi eco 70	50	01/09→06/13						
1.4 i	54 - 55	01/09→08/13						
 Hauptbremszylinder								
1.1	44	01/09→06/13		→ 05/13; - ABS		03.2120-4321.3 010525	ATE Ø 20,6	
1.1 LPG	44	04/09→06/13				24.2120-1737.3 010757	Ø 20,6	
1.4 HDi eco 70	50	01/09→06/13						
1.4 i	54 - 55	01/09→08/13		→ 05/13; + ABS		03.2122-1351.3 010528	Ø 22,2	
				→ 05/13; + ESP		03.2122-1942.3 010700	ATE Ø 22,2	
PEUGEOT - 207 (WA_, WC_) 02/06→12/15								
 Bremskraftverstärker								
2.0 HDi	66	10/08→12/12		+ ABS		03.7853-2604.4 300322	ATE Ø 9" pneumatisch	
 Hauptbremszylinder								
1.4	54 - 55	04/06→12/15		→ 06/12; + ESP		24.4122-1703.3 010843	TRW Ø 22,2	
				→ 06/12; - ESP		24.4122-1704.3 010847	TRW Ø 22,2	

	kw					! #		
PEUGEOT - 207 (WA_, WC_) 02/06→12/15								
 Hauptbremszylinder								
1.4 16V	65 - 72	02/06→10/13		→ 06/12; + ESP			24.4122-1703.3 010843	TRW Ø 22,2
1.4 Bioflex	60	08/08→12/14		→ 06/12; - ESP			24.4122-1704.3 010847	TRW Ø 22,2
1.4 HDi	50 - 52	02/06→12/15						
1.6	81	08/08→12/13						
1.6 16V	79 - 80	02/06→12/13						
1.6 Flex	83	08/08→12/13						
1.6 HDi	66	02/06→10/13						
1.4 16V	70	06/07→10/13		08/07→ 06/12; + ESP			24.4122-1703.3 010843	TRW Ø 22,2
				08/07→ 06/12; - ESP			24.4122-1704.3 010847	TRW Ø 22,2
1.4 BiFuel	54	08/07→12/13		+ ESP			24.4122-1703.3 010843	TRW Ø 22,2
				- ESP			24.4122-1704.3 010847	TRW Ø 22,2
1.6 16V RC	128	02/07→12/12		→ 06/12; + ESP			24.4123-1704.3 010828	TRW Ø 23,8
1.6 16V Turbo	110	02/06→10/13		→ 06/12; - ESP			24.4123-1705.3 010832	TRW Ø 23,8
1.6 16V VTi	88	02/07→12/12						
1.6 HDi	68 - 80	02/06→10/13						
1.6 HDi 110	82	08/09→12/12						
1.6 16V Turbo	115	10/09→12/12		01/10→ 06/12; + ESP			24.4123-1704.3 010828	TRW Ø 23,8
				01/10→ 06/12; - ESP			24.4123-1705.3 010832	TRW Ø 23,8
1.6 16V VTi	81	09/08→12/12		+ ESP			24.4123-1704.3 010828	TRW Ø 23,8
				- ESP			24.4123-1705.3 010832	TRW Ø 23,8
2.0 HDi	66	10/08→12/12		+ ABS			03.2122-1351.3 010528	Ø 22,2
PEUGEOT - 207 CC (WD_) 02/07→01/15								
 Hauptbremszylinder								
1.6 16V	88	02/07→10/13		+ ESP			24.4123-1704.3 010828	TRW Ø 23,8
1.6 16V Turbo	110 - 115	02/07→12/13		- ESP			24.4123-1705.3 010832	TRW Ø 23,8
1.6 HDi	80 - 82	02/07→01/15						
PEUGEOT - 207 Kasten/Schrägheck (WA_, WC_) 04/06→								
 Hauptbremszylinder								
1.4	54	06/07→10/08		+ ESP			24.4122-1703.3 010843	TRW Ø 22,2
				- ESP			24.4122-1704.3 010847	TRW Ø 22,2
1.4 HDi	50	04/07→		→ 06/12; + ESP			24.4122-1703.3 010843	TRW Ø 22,2
1.6 HDi	66 - 68	04/07→03/13		→ 06/12; - ESP			24.4122-1704.3 010847	TRW Ø 22,2
1.6 HDi	80	04/06→12/12		+ ESP			24.4123-1704.3 010828	TRW Ø 23,8
1.6 VTi	88	03/07→12/12		- ESP			24.4123-1705.3 010832	TRW Ø 23,8
PEUGEOT - 207 Stufenheck 12/07→12/14								
 Bremskraftverstärker								
2.0 HDi	66	12/07→12/12		+ ABS			03.7853-2604.4 300322	ATE Ø 9" pneumatisch
 Hauptbremszylinder								
1.4	54 - 55	12/07→12/12		→ 06/12; + ESP			24.4122-1703.3 010843	TRW Ø 22,2
1.4 Flex	60	11/08→12/14		→ 06/12; - ESP			24.4122-1704.3 010847	TRW Ø 22,2
1.6 Bioflex	83	01/08→12/13						
2.0 HDi	66	12/07→12/12		+ ABS			03.2122-1351.3 010528	Ø 22,2
PEUGEOT - 207 SW (WK_) 02/07→12/13								
 Bremskraftverstärker								
2.0 HDi	66	10/08→12/12		+ ABS			03.7853-2604.4 300322	ATE Ø 9" pneumatisch
 Hauptbremszylinder								
1.4	54	06/07→12/12		+ ESP			24.4122-1703.3 010843	TRW Ø 22,2
1.4 16V	72	11/09→12/12		- ESP			24.4122-1704.3 010847	TRW Ø 22,2
1.4 Flex	59	08/08→01/13						
1.4 LPG	54	08/07→12/12						
1.4 16V	70	06/07→10/13		→ 07/13; + ESP			24.4122-1703.3 010843	TRW Ø 22,2
				→ 07/13; - ESP			24.4122-1704.3 010847	TRW Ø 22,2
1.6	81	08/08→12/12		→ 06/12; + ESP			24.4122-1703.3 010843	TRW Ø 22,2
1.6 Flex	83	08/08→12/13		→ 06/12; - ESP			24.4122-1704.3 010847	TRW Ø 22,2
1.6 16V	88	06/07→10/13		→ 07/13; + ESP			24.4123-1704.3 010828	TRW Ø 23,8
→								

	kW			 	! #		
PEUGEOT - 207 SW (WK_) 02/07→12/13							
 Hauptbremszylinder							
1.6 HDi	82	08/09→10/13		→ 07/13; - ESP		24.4123-1705.3 010832	TRW Ø 23,8
1.6 16V RC	128	02/07→12/12		11/07→; + ESP		24.4123-1704.3 010828	TRW Ø 23,8
				11/07→; - ESP		24.4123-1705.3 010832	TRW Ø 23,8
1.6 16V Turbo 1.6 HDi	110 66 - 80	02/07→12/12 06/07→12/13		+ ESP		24.4123-1704.3 010828	TRW Ø 23,8
				- ESP		24.4123-1705.3 010832	TRW Ø 23,8
2.0 HDi	66	10/08→12/12		+ ABS		03.2122-1351.3 010528	Ø 22,2
PEUGEOT - 207 SW Kasten/Kombi (WK_) 08/07→12/12							
 Hauptbremszylinder							
1.6 HDi	66	08/07→12/12		+ ESP		24.4122-1703.3 010843	TRW Ø 22,2
				- ESP		24.4122-1704.3 010847	TRW Ø 22,2
1.6 HDi	80	08/07→12/12		+ ESP		24.4123-1704.3 010828	TRW Ø 23,8
				- ESP		24.4123-1705.3 010832	TRW Ø 23,8
PEUGEOT - 208 I (CA_, CC_) 03/12→03/20							
 Hauptbremszylinder							
1.0	50	03/12→12/19		Orga 13342→; Trommelbremse; + DSC		24.4122-1703.3 010843	TRW Ø 22,2
1.2 GPL	60	06/15→12/19		Orga 13342→; Trommelbremse; - DSC		24.4122-1704.3 010847	TRW Ø 22,2
1.2 THP 110	81	01/13→12/19					
1.2 VTI 82	60	03/12→12/19		Scheibenbremse; + DSC		24.4123-1704.3 010828	TRW Ø 23,8
				Scheibenbremse; - DSC		24.4123-1705.3 010832	TRW Ø 23,8
1.2 PureTech 82	61	03/18→12/19		Scheibenbremse; + DSC		24.4123-1704.3 010828	TRW Ø 23,8
				Scheibenbremse; - DSC		24.4123-1705.3 010832	TRW Ø 23,8
1.2 VTI 68 / PureTech 68	50	08/16→12/19					
1.5 BlueHDI 100	75	05/18→12/19		Scheibenbremse; - DSC		24.4123-1705.3 010832	TRW Ø 23,8
1.6 BlueHDI 100	73	01/15→12/19					
1.6 THP 165	121	03/15→12/19					
1.4 GPL	70	10/13→12/19		Trommelbremse; + DSC		24.4122-1703.3 010843	TRW Ø 22,2
				Trommelbremse; - DSC		24.4122-1704.3 010847	TRW Ø 22,2
1.4 HDi	50	03/12→12/19					
1.4 VTI	70	03/12→12/19		Scheibenbremse; + DSC		24.4123-1704.3 010828	TRW Ø 23,8
1.6	85 - 115	03/12→12/19		Scheibenbremse; + DSC		24.4123-1704.3 010828	TRW Ø 23,8
				Scheibenbremse; - DSC		24.4123-1705.3 010832	TRW Ø 23,8
1.6 BlueHDI 120	88	01/15→12/19					
1.6 e-HDi	82	07/15→12/19					
1.6 HDi	68 - 85	03/12→12/19					
1.6 HDi / BlueHDI 75	55	01/13→12/19					
1.6 GTi	147	08/12→12/19		03/13→; + DSC		24.4123-1704.3 010828	TRW Ø 23,8
				03/13→; - DSC		24.4123-1705.3 010832	TRW Ø 23,8
1.6 GTi	153	10/14→12/19		+ DSC		24.4123-1704.3 010828	TRW Ø 23,8
				- DSC		24.4123-1705.3 010832	TRW Ø 23,8
PEUGEOT - 208 Kasten/Schrägheck (CR_) 02/13→12/19							
 Hauptbremszylinder							
1.2 VTI 68 / PureTech 68	50	06/15→12/19		Scheibenbremse; + DSC		24.4123-1704.3 010828	TRW Ø 23,8
				Scheibenbremse; - DSC		24.4123-1705.3 010832	TRW Ø 23,8
1.5 BlueHDI 100	75	05/18→12/19					
1.6 Blue HDi 100	73	06/15→12/19					
1.2 VTI 82 / PureTech 82	60	06/15→12/19		Orga 13342→; Trommelbremse; + DSC		24.4122-1703.3 010843	TRW Ø 22,2
				Orga 13342→; Trommelbremse; - DSC		24.4122-1704.3 010847	TRW Ø 22,2
				Scheibenbremse; + DSC		24.4123-1704.3 010828	TRW Ø 23,8
				Scheibenbremse; - DSC		24.4123-1705.3 010832	TRW Ø 23,8
1.4 HDi 68	50	02/13→12/19		Trommelbremse; + DSC		24.4122-1703.3 010843	TRW Ø 22,2
				Trommelbremse; - DSC		24.4122-1704.3 010847	TRW Ø 22,2
1.6 BlueHDI 75	55	04/15→12/19					
1.6 HDi 92	68	03/14→12/19		Scheibenbremse; + DSC		24.4123-1704.3 010828	TRW Ø 23,8
				Scheibenbremse; - DSC		24.4123-1705.3 010832	TRW Ø 23,8
PEUGEOT - 301 11/12→							
 Hauptbremszylinder							
1.2 PureTech 82	61	02/18→		+ DSC		24.4122-1703.3 010843	TRW Ø 22,2
				- DSC		24.4122-1704.3 010847	TRW Ø 22,2
1.5 BlueHDI 100	75	05/18→		+ ESP		24.4122-1703.3 010843	TRW Ø 22,2
1.6 BlueHDI 100	73	04/14→					
1.6 HDi 90	68	11/12→					
PEUGEOT - 306 (7B, N3, N5) 04/93→10/03							
 Bremskraftverstärker							
1.1	44	06/94→05/01		→ 04/97; + ABS; für Linkslenker		03.7750-9402.4 300117	ATE Ø 9" pneumatisch
1.4 SL	55	06/94→05/01		05/97→; - ABS		03.7750-9302.4 300116	ATE Ø 9" pneumatisch
→							

	kw			 	! #		
PEUGEOT - 306 (7B, N3, N5) 04/93→10/03							
Bremskraftverstärker							
1.4 SL	55	06/94→05/01		10/94→; →Orga 08575; + ABS; für Linkslenker		03.7750-9402.4 300117	ATE Ø 9" pneumatisch
1.6	72	10/00→05/01		- ABS		03.7750-9302.4 300116	ATE Ø 9" pneumatisch
1.6 SR	65	06/94→10/00		10/94→ 04/97; für Rechtslenker; + ABS		03.7750-6334.4 300321	ATE Ø 9" pneumatisch
				05/97→; - ABS; Türenanzahl: 4		03.7750-9302.4 300116	ATE Ø 9" pneumatisch
				10/94→; →Orga 08575; + ABS; für Linkslenker		03.7750-9402.4 300117	ATE Ø 9" pneumatisch
1.8 2.0 S16	74	06/94→05/01		05/97→; - ABS; für Linkslenker		03.7750-9302.4 300116	ATE Ø 9" pneumatisch
	110	06/94→05/01		→Orga 08575; + ABS; für Linkslenker		03.7750-9402.4 300117	ATE Ø 9" pneumatisch
1.8 16V 1.8 ST 2.0 2.0 ST	81	03/97→05/01		05/97→; - ABS; für Linkslenker; Türenanzahl: 4		03.7750-9302.4 300116	ATE Ø 9" pneumatisch
	74	06/94→05/01		→Orga 08575; + ABS; für Linkslenker		03.7750-9402.4 300117	ATE Ø 9" pneumatisch
	92	11/95→06/97					
89	07/94→05/01						
1.8 16V	82	03/97→07/01		05/97→ 05/01; - ABS; für Linkslenker; Türenanzahl: 4		03.7750-9302.4 300116	ATE Ø 9" pneumatisch
				→Orga 08575; + ABS; für Linkslenker		03.7750-9402.4 300117	ATE Ø 9" pneumatisch
1.9 D 2.0 HDI 90	51	09/98→05/01		- ABS; für Linkslenker		03.7750-9302.4 300116	ATE Ø 9" pneumatisch
	66	06/99→12/01		→Orga 08575; + ABS; für Linkslenker		03.7750-9402.4 300117	ATE Ø 9" pneumatisch
1.9 D	55	03/98→05/01		- ABS; für Linkslenker		03.7750-9302.4 300116	ATE Ø 9" pneumatisch
				+ ABS; für Linkslenker		03.7750-9402.4 300117	ATE Ø 9" pneumatisch
1.9 D	68	02/94→12/97		10/94→; + ABS; für Linkslenker		03.7750-9402.4 300117	ATE Ø 9" pneumatisch
				→Orga 08575; + ABS; für Linkslenker		03.7750-9402.4 300117	ATE Ø 9" pneumatisch
1.9 SLD	47	06/94→05/01		05/97→; - ABS; für Linkslenker		03.7750-9302.4 300116	ATE Ø 9" pneumatisch
1.9 SRDT	50	06/94→05/01		10/94→; + ABS; für Linkslenker		03.7750-9402.4 300117	ATE Ø 9" pneumatisch
	66						
2.0	97	03/97→05/01		05/97→; - ABS; für Linkslenker; Türenanzahl: 4		03.7750-9302.4 300116	ATE Ø 9" pneumatisch
				05/97→; - ABS; für Linkslenker		03.7750-9302.4 300116	ATE Ø 9" pneumatisch
				→Orga 08575; + ABS; für Linkslenker		03.7750-9402.4 300117	ATE Ø 9" pneumatisch
2.0 S16	112	06/94→05/01		05/97→; - ABS; für Linkslenker		03.7750-9302.4 300116	ATE Ø 9" pneumatisch
				07/94→; →Orga 08575; + ABS; für Linkslenker		03.7750-9402.4 300117	ATE Ø 9" pneumatisch
Hauptbremszylinder							
1.1	44	06/94→05/01		→ 04/97; - ABS; Türenanzahl: 5		03.2119-3391.3 010058	ATE Ø 19
				→ 04/97; - ABS; Türenanzahl: 3		24.2119-1702.3 010435	BDX Ø 19
				→ 04/97; S 30209025→; + ABS		24.2122-1705.3 010434	Ø 22,2
1.4 SL	55	06/94→05/01		10/94→ 04/97; - ABS; nicht für Fahrschulwagen		03.2119-3391.3 010058	ATE Ø 19
				05/97→; - ABS		03.2120-4321.3 010525	ATE Ø 20,6
						24.2120-1726.3 010564	BDX Ø 20,6
				05/97→; →Orga 08575; + ABS; für Linkslenker		03.2122-1351.3 010528	Ø 22,2
				10/94→ 04/97; - ABS; für Fahrschulwagen		24.2120-1704.3 010429	BDX Ø 20,6
				→ 04/97; S 30209025→; + ABS		24.2122-1705.3 010434	Ø 22,2
1.6	72	10/00→05/01		- ABS		03.2120-4321.3 010525	ATE Ø 20,6
						24.2120-1726.3 010564	BDX Ø 20,6
				+ ABS; für Linkslenker		24.2123-1715.3 010520	BDX Ø 23,8
1.6 SR	65	06/94→10/00		10/94→ 04/97; - ABS; für Linkslenker		03.2120-1897.3 010103	ATE Ø 20,6
						24.2120-1704.3 010429	BDX Ø 20,6
				05/97→; - ABS; Türenanzahl: 4		03.2120-4321.3 010525	ATE Ø 20,6
						24.2120-1726.3 010564	BDX Ø 20,6
				05/97→; →Orga 08575; + ABS; für Linkslenker		03.2122-1351.3 010528	Ø 22,2
				→ 04/97; S 30209025→; + ABS		24.2122-1705.3 010434	Ø 22,2
1.8	74	06/94→05/01		Orga 08576→; + ABS; für Linkslenker		24.2123-1715.3 010520	BDX Ø 23,8
				- ABS; für Linkslenker		03.2120-1897.3 010103	ATE Ø 20,6
						24.2120-1704.3 010429	BDX Ø 20,6
				- ABS; für Rechtslenker		03.2120-4246.3 010614	ATE Ø 20,6
			24.2120-1722.3 010544	Ø 20,6			
			05/97→; - ABS; für Linkslenker		03.2120-4321.3 010525	ATE Ø 20,6	
					24.2120-1726.3 010564	BDX Ø 20,6	
→							

	kw			 	! #		
PEUGEOT - 306 (7B, N3, N5) 04/93→10/03							
Hauptbremszylinder							
1.8	74	06/94→05/01	05/97→; →Orga 08575; + ABS; für Linkslenker	03.2122-1351.3 010528	Ø 22,2		
			S 30209025→; + ABS	24.2122-1733.3 010668	Ø 22,2		
			Orga 08576→; + ABS; für Linkslenker	24.2123-1705.3 010434	Ø 22,2		
			Orga 08576→; + ABS; für Linkslenker	24.2123-1715.3 010520	BDX Ø 23,8		
1.8 16V 2.0	81 92	03/97→05/01 11/95→06/97	→ 04/97; - ABS; für Linkslenker; Türenanzahl: 4	03.2120-1897.3 010103	ATE Ø 20,6		
			→ 04/97; + ABS	24.2120-1704.3 010429	BDX Ø 20,6		
			05/97→; →Orga 08575; + ABS; für Linkslenker	03.2122-1351.3 010528	Ø 22,2		
			05/97→; - ABS; für Linkslenker; Türenanzahl: 4	03.2122-1356.3 010529	Ø 22,2		
			→ 04/97; + ABS	24.2122-1705.3 010434	Ø 22,2		
			Orga 08576→; + ABS; für Linkslenker	24.2123-1715.3 010520	BDX Ø 23,8		
1.8 16V	82	03/97→07/01	→ 04/97; - ABS; für Linkslenker; Türenanzahl: 4	03.2120-1897.3 010103	ATE Ø 20,6		
			→ 04/97; + ABS	24.2120-1704.3 010429	BDX Ø 20,6		
			05/97→; →Orga 08575; + ABS; für Linkslenker	03.2122-1351.3 010528	Ø 22,2		
			05/97→ 05/01; - ABS; für Linkslenker; Türenanzahl: 4	03.2122-1356.3 010529	Ø 22,2		
			→ 04/97; + ABS	24.2122-1705.3 010434	Ø 22,2		
			Orga 08576→; + ABS; für Linkslenker	24.2123-1715.3 010520	BDX Ø 23,8		
1.8 ST	74	06/94→05/01	10/94→ 04/97; - ABS; für Linkslenker	03.2120-1897.3 010103	ATE Ø 20,6		
			10/94→; - ABS; für Rechtslenker; Türenanzahl: 4	24.2120-1704.3 010429	BDX Ø 20,6		
			10/94→; - ABS; für Rechtslenker; Türenanzahl: 4	03.2120-4246.3 010614	ATE Ø 20,6		
			24.2120-1722.3 010544	Ø 20,6			
			05/97→; - ABS; für Linkslenker; Türenanzahl: 4	03.2120-4321.3 010525	ATE Ø 20,6		
			24.2120-1726.3 010564	BDX Ø 20,6			
1.9 D	51	09/98→05/01	- ABS; für Linkslenker	03.2120-4321.3 010525	ATE Ø 20,6		
			→Orga 08575; + ABS; für Linkslenker	24.2120-1726.3 010564	BDX Ø 20,6		
			- ABS; für Rechtslenker	03.2122-1351.3 010528	Ø 22,2		
			→Orga 08575; + ABS; für Rechtslenker	03.2122-1461.3 010610	ATE Ø 22,2		
			→Orga 08575; + ABS; für Rechtslenker	03.2122-1461.3 010610	ATE Ø 22,2		
			Orga 08576→; + ABS; für Linkslenker	24.2123-1715.3 010520	BDX Ø 23,8		
1.9 D	55	03/98→05/01	- ABS; für Rechtslenker	03.2120-4246.3 010614	ATE Ø 20,6		
			24.2120-1722.3 010544	Ø 20,6			
			- ABS; für Linkslenker	03.2120-4321.3 010525	ATE Ø 20,6		
			24.2120-1726.3 010564	BDX Ø 20,6			
1.9 D	68	02/94→12/97	10/94→; - ABS; für Linkslenker	03.2120-4321.3 010525	ATE Ø 20,6		
			→Orga 08575; + ABS; für Linkslenker	03.2122-1351.3 010528	Ø 22,2		
			- ABS; für Linkslenker	03.2120-1897.3 010103	ATE Ø 20,6		
			24.2120-1704.3 010429	BDX Ø 20,6			
			- ABS; für Linkslenker	03.2120-1897.3 010103	ATE Ø 20,6		
			24.2120-1704.3 010429	BDX Ø 20,6			
1.9 SLD	47 - 50	06/94→05/01	10/94→; + ABS	24.2122-1705.3 010434	Ø 22,2		
			+ ABS	24.2122-1705.3 010434	Ø 22,2		
			Orga 08576→; + ABS; für Linkslenker	24.2123-1715.3 010520	BDX Ø 23,8		
			10/94→ 04/97; - ABS; für Linkslenker	03.2120-1897.3 010103	ATE Ø 20,6		
			24.2120-1704.3 010429	BDX Ø 20,6			
			10/94→; - ABS; für Rechtslenker	03.2120-4246.3 010614	ATE Ø 20,6		
1.9 SRDT	66	06/94→05/01	10/94→; - ABS; für Rechtslenker	24.2120-1722.3 010544	Ø 20,6		
			05/97→; - ABS; für Linkslenker	03.2120-4321.3 010525	ATE Ø 20,6		
			24.2120-1726.3 010564	BDX Ø 20,6			
			05/97→; →Orga 08575; + ABS; für Linkslenker	03.2122-1351.3 010528	Ø 22,2		
			→ 04/97; S 30209025→; + ABS	24.2122-1705.3 010434	Ø 22,2		
			Orga 08576→; + ABS; für Linkslenker	24.2123-1715.3 010520	BDX Ø 23,8		
→			10/94→ 04/97; - ABS; für Linkslenker	03.2120-1897.3 010103	ATE Ø 20,6		
			24.2120-1704.3 010429	BDX Ø 20,6			
			05/97→; →Orga 08575; + ABS; für Linkslenker	03.2122-1351.3 010528	Ø 22,2		



PEUGEOT - 306 (7B, N3, N5) 04/93→10/03

 **Hauptbremszylinder**

1.9 SRDT	66	06/94→05/01	05/97→; - ABS; für Linkslenker	03.2122-1356.3	010529	Ø 22,2
			10/94→ 04/97; + ABS	24.2122-1705.3	010434	Ø 22,2
			Orga 08576→; + ABS; für Linkslenker	24.2123-1715.3	010520	BDX Ø 23,8
2.0	97	03/97→05/01	→ 04/97; - ABS; für Linkslenker	03.2120-1897.3	010103	ATE Ø 20,6
				24.2120-1704.3	010429	BDX Ø 20,6
			→ 04/97; - ABS; für Linkslenker; Türenanzahl: 4	03.2120-1897.3	010103	ATE Ø 20,6
				24.2120-1704.3	010429	BDX Ø 20,6
			05/97→; →Orga 08575; + ABS; für Linkslenker	03.2122-1351.3	010528	Ø 22,2
				24.2122-1733.3	010668	Ø 22,2
			05/97→; - ABS; für Linkslenker; Türenanzahl: 4	03.2122-1356.3	010529	Ø 22,2
				03.2122-1356.3	010529	Ø 22,2
			→ 04/97; + ABS	24.2122-1705.3	010434	Ø 22,2
2.0 HDI 90	66	06/99→12/01	- ABS; für Linkslenker	03.2122-1356.3	010529	Ø 22,2
			+ ABS; für Linkslenker	24.2123-1715.3	010520	BDX Ø 23,8
2.0 S16	110	06/94→05/01	→ 04/97; - ABS; für Linkslenker	03.2120-1897.3	010103	ATE Ø 20,6
				24.2120-1704.3	010429	BDX Ø 20,6
			05/97→; →Orga 08575; + ABS; für Linkslenker	03.2122-1351.3	010528	Ø 22,2
			05/97→; - ABS; für Linkslenker	03.2122-1356.3	010529	Ø 22,2
2.0 S16	112	06/94→05/01	→ 04/97; + ABS	24.2122-1705.3	010434	Ø 22,2
			Orga 08576→; + ABS; für Linkslenker	24.2123-1715.3	010520	BDX Ø 23,8
			07/94→ 04/97; - ABS; für Linkslenker	03.2120-1897.3	010103	ATE Ø 20,6
				24.2120-1704.3	010429	BDX Ø 20,6
2.0 ST	89	07/94→05/01	05/97→; →Orga 08575; + ABS; für Linkslenker	03.2122-1351.3	010528	Ø 22,2
				03.2122-1356.3	010529	Ø 22,2
			05/97→; - ABS; für Linkslenker	03.2122-1356.3	010529	Ø 22,2
			07/94→ 04/97; + ABS	24.2122-1705.3	010434	Ø 22,2
2.0 ST	89	07/94→05/01	Orga 08576→; + ABS; für Linkslenker	24.2123-1715.3	010520	BDX Ø 23,8
			10/94→ 04/97; - ABS; für Linkslenker; Türenanzahl: 4	03.2120-1897.3	010103	ATE Ø 20,6
				24.2120-1704.3	010429	BDX Ø 20,6
			05/97→; →Orga 08575; + ABS; für Linkslenker	03.2122-1351.3	010528	Ø 22,2
2.0 ST	89	07/94→05/01	05/97→; - ABS; für Linkslenker; Türenanzahl: 4	03.2122-1356.3	010529	Ø 22,2
				03.2122-1356.3	010529	Ø 22,2
			→ 04/97; + ABS	24.2122-1705.3	010434	Ø 22,2
			Orga 08576→; + ABS; für Linkslenker	24.2123-1715.3	010520	BDX Ø 23,8













PEUGEOT - 306 Break (7E, N3, N5) 06/94→12/02











 **Bremskraftverstärker**







1.4	55	03/97→04/02	→ 03/02; - ABS	03.7750-9302.4	300116	ATE Ø 9" pneumatisch
1.6	72	10/00→04/02				
1.6	65	03/97→10/00	- ABS	03.7750-9302.4	300116	ATE Ø 9" pneumatisch
1.8 D	44	05/97→06/00	- ABS; für Linkslenker	03.7750-9302.4	300116	ATE Ø 9" pneumatisch
1.9 D	51	05/97→05/99				
1.9 D	50 - 55	03/97→04/02	→ 03/02; - ABS; für Linkslenker	03.7750-9302.4	300116	ATE Ø 9" pneumatisch









 **Hauptbremszylinder**

1.4	55	03/97→04/02	→ 03/02; - ABS	03.2122-1356.3	010529	Ø 22,2
1.6	72	10/00→04/02	→ 03/02; + ABS; für Linkslenker	24.2123-1715.3	010520	BDX Ø 23,8
1.6	65	03/97→10/00	- ABS	03.2122-1356.3	010529	Ø 22,2
			+ ABS; für Linkslenker	24.2123-1715.3	010520	BDX Ø 23,8
1.8	74	03/97→04/02	→ 03/02; - ABS; für Linkslenker	24.2123-1714.3	010587	BDX Ø 23,8
1.8 16V	81	03/97→04/02				
2.0	97	03/97→04/02	→ 03/02; + ABS; für Linkslenker	24.2123-1715.3	010520	BDX Ø 23,8
2.0 16V	99	03/97→04/02				
2.0 HDI 90	66	06/99→04/02				
1.8 16V	82	03/97→07/01	für Linkslenker; - ABS	24.2123-1714.3	010587	BDX Ø 23,8
			+ ABS; für Linkslenker	24.2123-1715.3	010520	BDX Ø 23,8
1.8 D	44	05/97→06/00	- ABS; für Linkslenker	03.2122-1356.3	010529	Ø 22,2
1.9 D	51	05/97→05/99	+ ABS; für Linkslenker	24.2123-1715.3	010520	BDX Ø 23,8
1.9 D	50 - 55	03/97→04/02	→ 03/02; - ABS; für Linkslenker	03.2122-1356.3	010529	Ø 22,2











	kw					! #		
PEUGEOT - 306 Break (7E, N3, N5) 06/94→12/02								
 Hauptbremszylinder								
1.9 D	50 - 55	03/97→04/02		→ 03/02; + ABS; für Linkslenker			24.2123-1715.3 010520	BDX Ø 23,8
1.9 Td	52	07/95→08/00		03/97→; - ABS; für Linkslenker			03.2122-1356.3 010529	Ø 22,2
				03/97→; + ABS; für Linkslenker			24.2123-1714.3 010587	BDX Ø 23,8
1.9 TD	66	02/97→04/02		03/97→ 03/02; - ABS; für Linkslenker			03.2122-1356.3 010529	Ø 22,2
				03/97→ 03/02; + ABS; für Linkslenker			24.2123-1714.3 010587	BDX Ø 23,8
PEUGEOT - 306 Cabriolet (7D, N3, N5) 01/94→04/02								
 Bremskraftverstärker								
1.6	65	04/96→10/00		für Rechtslenker			03.7750-6334.4 300321	ATE Ø 9" pneumatisch
				→Orga 08575; für Linkslenker			03.7750-9402.4 300117	ATE Ø 9" pneumatisch
1.8 2.0 2.0 16V	74 89 - 90 97 - 99	03/94→04/02 03/94→04/02 03/97→04/02		→Orga 08575; für Linkslenker			03.7750-9402.4 300117	ATE Ø 9" pneumatisch
 Hauptbremszylinder								
1.6	65	04/96→10/00		→Orga 07737; - ABS			03.2120-4241.3 010524	ATE Ø 20,6
				→Orga 08575; + ABS; für Linkslenker			24.2120-1722.3 010544	Ø 20,6
				Orga 08576→; + ABS; für Linkslenker			24.2123-1715.3 010520	BDX Ø 23,8
1.6 1.8 16V	72 81	10/00→04/02 05/97→04/02		+ ABS; für Linkslenker			24.2123-1715.3 010520	BDX Ø 23,8
1.8	74	03/94→04/02		→Orga 08575; + ABS; für Linkslenker			03.2122-1351.3 010528	Ø 22,2
				→ 10/00; - ABS			24.2120-1722.3 010544	Ø 20,6
				Orga 08576→; → 10/00; + ABS; für Linkslenker			24.2123-1715.3 010520	BDX Ø 23,8
1.8	74	05/97→04/99		→Orga 08575; + ABS; für Linkslenker			03.2122-1351.3 010528	Ø 22,2
				- ABS			24.2120-1722.3 010544	Ø 20,6
				Orga 08576→; + ABS; für Linkslenker			24.2123-1715.3 010520	BDX Ø 23,8
2.0	89 - 90	03/94→04/02		→ 04/97; + ABS; für Linkslenker			03.2122-1351.3 010528	Ø 22,2
				→Orga 07744; - ABS			24.2122-1705.3 010434	Ø 22,2
2.0 16V	97	03/97→04/02		→Orga 08575; + ABS; für Linkslenker			03.2122-1351.3 010528	Ø 22,2
				→Orga 07744; - ABS			24.2122-1705.3 010434	Ø 22,2
				Orga 08576→; → 10/00; + ABS; für Linkslenker			24.2123-1715.3 010520	BDX Ø 23,8
2.0 16V	99	03/97→04/02		→Orga 08575; + ABS; für Linkslenker			03.2122-1351.3 010528	Ø 22,2
				→Orga 07744; - ABS			24.2122-1705.3 010434	Ø 22,2
				Orga 08576→; + ABS; für Linkslenker			24.2123-1715.3 010520	BDX Ø 23,8
PEUGEOT - 306 Kasten/Kombi (N_, 7_) 07/93→08/02								
 Bremskraftverstärker								
1.4	55	03/96→07/01		05/97→ 05/01; - ABS			03.7750-9302.4 300116	ATE Ø 9" pneumatisch
				→Orga 08575; + ABS; für Linkslenker			03.7750-9402.4 300117	ATE Ø 9" pneumatisch
1.8 D 1.9 D	44 50	05/97→06/00 05/97→05/99		- ABS; für Linkslenker			03.7750-9302.4 300116	ATE Ø 9" pneumatisch
1.9 D	51	02/99→08/02		→ 03/02; - ABS; für Linkslenker			03.7750-9302.4 300116	ATE Ø 9" pneumatisch
1.9 D	68	02/94→04/99		05/97→; - ABS; für Linkslenker			03.7750-9302.4 300116	ATE Ø 9" pneumatisch
				→Orga 08575; + ABS; für Linkslenker			03.7750-9402.4 300117	ATE Ø 9" pneumatisch
1.9 STD	51	02/94→05/99		09/98→; →Orga 08575; + ABS; für Linkslenker			03.7750-9402.4 300117	ATE Ø 9" pneumatisch
 Hauptbremszylinder								
1.4	55	03/96→07/01		→ 04/97; - ABS; nicht für Fahrschulwagen; Türenanzahl: 5			03.2119-3391.3 010058	ATE Ø 19
				→ 04/97; - ABS; nicht für Fahrschulwagen; Türenanzahl: 5			24.2119-1702.3 010435	BDX Ø 19
				05/97→ 05/01; - ABS			03.2120-4321.3 010525	ATE Ø 20,6
				05/97→; →Orga 08575; + ABS; für Linkslenker			24.2120-1726.3 010564	BDX Ø 20,6
				05/97→; →Orga 08575; + ABS; für Linkslenker			03.2122-1351.3 010528	Ø 22,2
				05/97→; →Orga 08575; + ABS; für Linkslenker			24.2122-1733.3 010668	Ø 22,2
→				→ 04/97; - ABS; für Fahrschulwagen; Türenanzahl: 3			24.2120-1704.3 010429	BDX Ø 20,6
				→ 04/97; S 30209025→; + ABS			24.2122-1705.3 010434	Ø 22,2













	kw					! #		
PEUGEOT - 306 Kasten/Kombi (N_, 7_) 07/93→08/02								
 Hauptbremszylinder								
1.4	55	03/96→07/01		Orga 08576→; → 05/01; + ABS; für Linkslenker			24.2123-1715.3 010520	BDX Ø 23,8
1.8 D	44	05/97→06/00		- ABS; für Linkslenker			03.2122-1356.3 010529	Ø 22,2
1.9 D	50	05/97→05/99		+ ABS; für Linkslenker			24.2123-1715.3 010520	BDX Ø 23,8
1.9 D	51	02/99→08/02		→ 03/02; - ABS; für Linkslenker			03.2122-1356.3 010529	Ø 22,2
				→ 03/02; + ABS; für Linkslenker			24.2123-1715.3 010520	BDX Ø 23,8
1.9 D	68	02/94→04/99		→ 04/97; - ABS; für Linkslenker			03.2120-1897.3 010103	ATE Ø 20,6
							24.2120-1704.3 010429	BDX Ø 20,6
				05/97→; →Orga 08575; + ABS; für Linkslenker			03.2122-1351.3 010528	Ø 22,2
							24.2122-1733.3 010668	Ø 22,2
				05/97→; - ABS; für Linkslenker			03.2122-1356.3 010529	Ø 22,2
				→ 04/97; + ABS			24.2122-1705.3 010434	Ø 22,2
				Orga 08576→; + ABS; für Linkslenker			24.2123-1715.3 010520	BDX Ø 23,8
1.9 STD	51	02/94→05/99		09/98→; - ABS; für Rechtslenker			03.2122-1461.3 010610	ATE Ø 22,2
				05/97→; →Orga 08575; + ABS; für Rechtslenker			03.2122-1461.3 010610	ATE Ø 22,2
2.0 HDi	66	08/98→06/00		- ABS; für Linkslenker			24.2123-1714.3 010587	BDX Ø 23,8
				+ ABS; für Linkslenker			24.2123-1715.3 010520	BDX Ø 23,8
PEUGEOT - 306 Kasten/Schrägheck 04/93→08/01								
 Bremskraftverstärker								
1.4	55	03/96→07/01		05/97→ 05/01; - ABS			03.7750-9302.4 300116	ATE Ø 9" pneumatisch
				→Orga 08575; + ABS; für Linkslenker			03.7750-9402.4 300117	ATE Ø 9" pneumatisch
1.8 D	44	04/93→05/99		05/97→; - ABS; für Linkslenker			03.7750-9302.4 300116	ATE Ø 9" pneumatisch
				+ ABS; für Linkslenker			03.7750-9402.4 300117	ATE Ø 9" pneumatisch
1.9 D	50	05/97→05/99		+ ABS; für Linkslenker			03.7750-9402.4 300117	ATE Ø 9" pneumatisch
1.9 D	51	02/99→08/01		→Orga 08575; + ABS; für Linkslenker			03.7750-9402.4 300117	ATE Ø 9" pneumatisch
 Hauptbremszylinder								
1.4	55	03/96→07/01		→ 04/97; - ABS; nicht für Fahrschulwagen; Türenanzahl: 5			03.2119-3391.3 010058	ATE Ø 19
							24.2119-1702.3 010435	BDX Ø 19
				05/97→ 05/01; - ABS			03.2120-4321.3 010525	ATE Ø 20,6
							24.2120-1726.3 010564	BDX Ø 20,6
				05/97→; →Orga 08575; + ABS; für Linkslenker			03.2122-1351.3 010528	Ø 22,2
							24.2122-1733.3 010668	Ø 22,2
				→ 04/97; - ABS; für Fahrschulwagen; Türenanzahl: 3			24.2120-1704.3 010429	BDX Ø 20,6
				→ 04/97; S 30209025→; + ABS			24.2122-1705.3 010434	Ø 22,2
				Orga 08576→; → 05/01; + ABS; für Linkslenker			24.2123-1715.3 010520	BDX Ø 23,8
1.8 D	44	04/93→05/99		→ 04/97; - ABS; für Linkslenker			03.2120-1897.3 010103	ATE Ø 20,6
							24.2120-1704.3 010429	BDX Ø 20,6
				- ABS; für Rechtslenker			03.2120-4246.3 010614	ATE Ø 20,6
							24.2120-1722.3 010544	Ø 20,6
				05/97→; - ABS; für Linkslenker			03.2120-4321.3 010525	ATE Ø 20,6
							24.2120-1726.3 010564	BDX Ø 20,6
				05/97→; →Orga 08575; + ABS; für Linkslenker			03.2122-1351.3 010528	Ø 22,2
							24.2122-1733.3 010668	Ø 22,2
				→ 04/97; S 30209025→; + ABS			24.2122-1705.3 010434	Ø 22,2
				Orga 08576→; + ABS; für Linkslenker			24.2123-1715.3 010520	BDX Ø 23,8
1.9 D	50	05/97→05/99		- ABS; für Rechtslenker			03.2120-4246.3 010614	ATE Ø 20,6
							24.2120-1722.3 010544	Ø 20,6
1.9 D	51	02/99→08/01		→ 05/01; - ABS; für Rechtslenker			03.2122-1461.3 010610	ATE Ø 22,2
				→Orga 08575; + ABS; für Rechtslenker			03.2122-1461.3 010610	ATE Ø 22,2
PEUGEOT - 306 Schrägheck (7A, 7C, N3, N5) 01/93→10/03								
 Bremskraftverstärker								
1.1	44	05/93→05/01		03/94→ 04/97; + ABS; für Linkslenker			03.7750-9402.4 300117	ATE Ø 9" pneumatisch
1.4	55	04/93→07/01		05/97→; - ABS			03.7750-9302.4 300116	ATE Ø 9" pneumatisch
				→Orga 08575; + ABS; für Linkslenker			03.7750-9402.4 300117	ATE Ø 9" pneumatisch
1.6	65	05/93→10/00		→ 04/97; + ABS; für Rechtslenker			03.7750-6334.4 300321	ATE Ø 9" pneumatisch
				05/97→; - ABS			03.7750-9302.4 300116	ATE Ø 9" pneumatisch
→								

	kw			 	! #		
PEUGEOT - 306 Schrägheck (7A, 7C, N3, N5) 01/93→10/03							
Bremskraftverstärker							
1.6	65	05/93→10/00		→Orga 08575; + ABS; für Linkslenker		03.7750-9402.4 300117	ATE Ø 9" pneumatisch
1.6	72	10/00→05/01		- ABS		03.7750-9302.4 300116	ATE Ø 9" pneumatisch
1.8	74	05/93→05/01		05/97→; - ABS; für Linkslenker		03.7750-9302.4 300116	ATE Ø 9" pneumatisch
1.8 16V	81	03/97→05/01					
1.9 Td	52	07/95→08/00		→Orga 08575; + ABS; für Linkslenker		03.7750-9402.4 300117	ATE Ø 9" pneumatisch
2.0 16V	99	03/97→06/00					
2.0 S16	110	06/94→05/01					
1.8 16V	82	03/97→10/03		05/97→ 05/01; - ABS; für Linkslenker		03.7750-9302.4 300116	ATE Ø 9" pneumatisch
				→Orga 08575; + ABS; für Linkslenker		03.7750-9402.4 300117	ATE Ø 9" pneumatisch
1.8 D	43 - 44	04/93→05/01		05/97→; - ABS; für Linkslenker		03.7750-9302.4 300116	ATE Ø 9" pneumatisch
1.9 D	47 - 50	05/93→05/01		+ ABS; für Linkslenker		03.7750-9402.4 300117	ATE Ø 9" pneumatisch
1.9 D	51	04/93→05/99		09/98→; →Orga 08575; + ABS; für Linkslenker		03.7750-9402.4 300117	ATE Ø 9" pneumatisch
1.9 D	51	09/98→05/01		- ABS; für Linkslenker		03.7750-9302.4 300116	ATE Ø 9" pneumatisch
2.0 HDI 90	66	06/99→12/02		→Orga 08575; + ABS; für Linkslenker		03.7750-9402.4 300117	ATE Ø 9" pneumatisch
1.9 D	52	01/99→08/03		→Orga 08575; + ABS; für Linkslenker		03.7750-9402.4 300117	ATE Ø 9" pneumatisch
1.9 D	55	03/98→05/01		- ABS; für Linkslenker		03.7750-9302.4 300116	ATE Ø 9" pneumatisch
				+ ABS; für Linkslenker		03.7750-9402.4 300117	ATE Ø 9" pneumatisch
1.9 D	68	01/93→12/97		10/94→; + ABS; für Linkslenker		03.7750-9402.4 300117	ATE Ø 9" pneumatisch
				10/93→; →Orga 08575; + ABS; für Linkslenker		03.7750-9402.4 300117	ATE Ø 9" pneumatisch
1.9 DT	66	05/93→05/01		05/97→; - ABS; für Linkslenker		03.7750-9302.4 300116	ATE Ø 9" pneumatisch
				10/93→; →Orga 08575; + ABS; für Linkslenker		03.7750-9402.4 300117	ATE Ø 9" pneumatisch
2.0 16V	97	03/97→05/01		05/97→; - ABS; für Linkslenker; Türenanzahl: 4		03.7750-9302.4 300116	ATE Ø 9" pneumatisch
				→Orga 08575; + ABS; für Linkslenker		03.7750-9402.4 300117	ATE Ø 9" pneumatisch
2.0 S16	112	05/93→05/01		05/97→; - ABS; für Linkslenker		03.7750-9302.4 300116	ATE Ø 9" pneumatisch
				07/94→; →Orga 08575; + ABS; für Linkslenker		03.7750-9402.4 300117	ATE Ø 9" pneumatisch
2.0 XSi	89	05/93→05/01		05/97→; - ABS; für Linkslenker		03.7750-9302.4 300116	ATE Ø 9" pneumatisch
				03/94→; →Orga 08575; + ABS; für Linkslenker		03.7750-9402.4 300117	ATE Ø 9" pneumatisch
Hauptbremszylinder							
1.1	44	05/93→05/01		03/94→ 04/97; - ABS; Türenanzahl: 5		03.2119-3391.3 010058	ATE Ø 19
				03/94→ 04/97; - ABS; Türenanzahl: 3		24.2119-1702.3 010435	BDX Ø 19
				→ 04/97; S 30209025→; + ABS		24.2122-1705.3 010434	Ø 22,2
1.4	55	04/93→07/01		→ 04/97; - ABS; nicht für Fahrschulwagen; Türenanzahl: 5		03.2119-3391.3 010058	ATE Ø 19
				05/97→; - ABS		24.2119-1702.3 010435	BDX Ø 19
				05/97→; - ABS		03.2120-4321.3 010525	ATE Ø 20,6
				05/97→; - ABS		24.2120-1726.3 010564	BDX Ø 20,6
				05/97→; →Orga 08575; + ABS; für Linkslenker		03.2122-1351.3 010528	Ø 22,2
				05/97→; →Orga 08575; + ABS; für Linkslenker		24.2122-1733.3 010668	Ø 22,2
				→ 04/97; - ABS; für Fahrschulwagen; Türenanzahl: 3		24.2120-1704.3 010429	BDX Ø 20,6
				→ 04/97; S 30209025→; + ABS		24.2122-1705.3 010434	Ø 22,2
				Orga 08576→; + ABS; für Linkslenker		24.2123-1715.3 010520	BDX Ø 23,8
1.6	65	05/93→10/00		→ 04/97; - ABS		03.2120-1897.3 010103	ATE Ø 20,6
				05/97→; - ABS		24.2120-1704.3 010429	BDX Ø 20,6
				05/97→; - ABS		03.2120-4321.3 010525	ATE Ø 20,6
				05/97→; - ABS		24.2120-1726.3 010564	BDX Ø 20,6
				05/97→; →Orga 08575; + ABS; für Linkslenker		03.2122-1351.3 010528	Ø 22,2
				05/97→; →Orga 08575; + ABS; für Linkslenker		24.2122-1733.3 010668	Ø 22,2
				→ 04/97; S 30209025→; + ABS		24.2122-1705.3 010434	Ø 22,2
				Orga 08576→; + ABS; für Linkslenker		24.2123-1715.3 010520	BDX Ø 23,8
1.6	72	10/00→05/01		- ABS		03.2120-4321.3 010525	ATE Ø 20,6
				+ ABS; für Linkslenker		24.2120-1726.3 010564	BDX Ø 20,6
				+ ABS; für Linkslenker		24.2123-1715.3 010520	BDX Ø 23,8
1.8	74	05/93→05/01		→ 04/97; - ABS; für Linkslenker		03.2120-1897.3 010103	ATE Ø 20,6
1.8 D	43 - 44	04/93→05/01				24.2120-1704.3 010429	BDX Ø 20,6
1.9 D	47 - 50	05/93→05/01		- ABS; für Rechtslenker		03.2120-4246.3 010614	ATE Ø 20,6
						24.2120-1722.3 010544	Ø 20,6

	kw			 	! #		
PEUGEOT - 306 Schrägheck (7A, 7C, N3, N5) 01/93→10/03							
 Hauptbremszylinder							
1.8 1.8 D	74 43 - 44	05/93→05/01 04/93→05/01		05/97→; - ABS; für Linkslenker		03.2120-4321.3 010525 24.2120-1726.3 010564	ATE Ø 20,6 BDX Ø 20,6
1.9 D	47 - 50	05/93→05/01		05/97→; →Orga 08575; + ABS; für Linkslenker		03.2122-1351.3 010528 24.2122-1733.3 010668	Ø 22,2 Ø 22,2
				→ 04/97; S 30209025→; + ABS		24.2122-1705.3 010434	Ø 22,2
				Orga 08576→; + ABS; für Linkslenker		24.2123-1715.3 010520	BDX Ø 23,8
1.8 16V 1.9 Td 2.0 16V 2.0 S16	81 52 99 110	03/97→05/01 07/95→08/00 03/97→06/00 06/94→05/01		→ 04/97; - ABS; für Linkslenker		03.2120-1897.3 010103 24.2120-1704.3 010429	ATE Ø 20,6 BDX Ø 20,6
				05/97→; →Orga 08575; + ABS; für Linkslenker		03.2122-1351.3 010528 24.2122-1733.3 010668	Ø 22,2 Ø 22,2
				05/97→; - ABS; für Linkslenker		03.2122-1356.3 010529	Ø 22,2
				→ 04/97; + ABS		24.2122-1705.3 010434	Ø 22,2
				Orga 08576→; + ABS; für Linkslenker		24.2123-1715.3 010520	BDX Ø 23,8
1.8 16V	82	03/97→10/03		→ 04/97; - ABS; für Linkslenker		03.2120-1897.3 010103 24.2120-1704.3 010429	ATE Ø 20,6 BDX Ø 20,6
				05/97→; →Orga 08575; + ABS; für Linkslenker		03.2122-1351.3 010528 24.2122-1733.3 010668	Ø 22,2 Ø 22,2
				05/97→ 05/01; - ABS; für Linkslenker		03.2122-1356.3 010529	Ø 22,2
				→ 04/97; + ABS		24.2122-1705.3 010434	Ø 22,2
				Orga 08576→; + ABS; für Linkslenker		24.2123-1715.3 010520	BDX Ø 23,8
1.9 D	51	04/93→05/99		09/98→; - ABS; für Rechtslenker		03.2122-1461.3 010610	ATE Ø 22,2
				05/97→; →Orga 08575; + ABS; für Rechtslenker		03.2122-1461.3 010610	ATE Ø 22,2
1.9 D	51	09/98→05/01		- ABS; für Linkslenker		03.2120-4321.3 010525 24.2120-1726.3 010564	ATE Ø 20,6 BDX Ø 20,6
				→Orga 08575; + ABS; für Linkslenker		03.2122-1351.3 010528 24.2122-1733.3 010668	Ø 22,2 Ø 22,2
				- ABS; für Rechtslenker		03.2122-1461.3 010610	ATE Ø 22,2
				→Orga 08575; + ABS; für Rechtslenker		03.2122-1461.3 010610	ATE Ø 22,2
				Orga 08576→; + ABS; für Linkslenker		24.2123-1715.3 010520	BDX Ø 23,8
1.9 D	52	01/99→08/03		→ 05/01; - ABS; für Rechtslenker		03.2122-1461.3 010610	ATE Ø 22,2
				→Orga 08575; + ABS; für Rechtslenker		03.2122-1461.3 010610	ATE Ø 22,2
1.9 D	55	03/98→05/01		- ABS; für Linkslenker		03.2120-4321.3 010525 24.2120-1726.3 010564	ATE Ø 20,6 BDX Ø 20,6
				→Orga 08575; + ABS; für Linkslenker		03.2122-1351.3 010528 24.2122-1733.3 010668	Ø 22,2 Ø 22,2
				Orga 08576→; + ABS; für Linkslenker		24.2123-1715.3 010520	BDX Ø 23,8
1.9 D	68	01/93→12/97		10/94→; - ABS; für Linkslenker		03.2120-1897.3 010103 24.2120-1704.3 010429	ATE Ø 20,6 BDX Ø 20,6
				10/93→; - ABS; für Linkslenker		03.2120-1897.3 010103 24.2120-1704.3 010429	ATE Ø 20,6 BDX Ø 20,6
				10/93→; + ABS		24.2122-1705.3 010434	Ø 22,2
				10/94→; + ABS		24.2122-1705.3 010434	Ø 22,2
				Orga 08576→; + ABS; für Linkslenker		24.2123-1715.3 010520	BDX Ø 23,8
1.9 DT	66	05/93→05/01		10/93→ 04/97; - ABS; für Linkslenker		03.2120-1897.3 010103 24.2120-1704.3 010429	ATE Ø 20,6 BDX Ø 20,6
				05/97→; →Orga 08575; + ABS; für Linkslenker		03.2122-1351.3 010528 24.2122-1733.3 010668	Ø 22,2 Ø 22,2
				05/97→; - ABS; für Linkslenker		03.2122-1356.3 010529	Ø 22,2
				10/93→ 04/97; + ABS		24.2122-1705.3 010434	Ø 22,2
				Orga 08576→; + ABS; für Linkslenker		24.2123-1715.3 010520	BDX Ø 23,8
2.0 16V	97	03/97→05/01		→ 04/97; - ABS; für Linkslenker; Türenanzahl: 4		03.2120-1897.3 010103 24.2120-1704.3 010429	ATE Ø 20,6 BDX Ø 20,6
				05/97→; →Orga 08575; + ABS; für Linkslenker		03.2122-1351.3 010528	Ø 22,2
				05/97→; - ABS; für Linkslenker; Türenanzahl: 4		03.2122-1356.3 010529	Ø 22,2
				→ 04/97		24.2122-1705.3 010434	Ø 22,2
				Orga 08576→; + ABS; für Linkslenker		24.2123-1715.3 010520	BDX Ø 23,8
2.0 HDI 90	66	06/99→12/02		→Orga 08575; + ABS; für Linkslenker		03.2122-1351.3 010528 24.2122-1733.3 010668	Ø 22,2 Ø 22,2
→							



	kw					! #		
PEUGEOT - 306 Schrägheck (7A, 7C, N3, N5) 01/93→10/03								
 Hauptbremszylinder								
2.0 HDI 90	66	06/99→12/02		- ABS; für Linkslenker	03.2122-1356.3	010529	Ø 22,2	
				Orga 08576→; + ABS; für Linkslenker	24.2123-1715.3	010520	BDX Ø 23,8	
2.0 S16	112	05/93→05/01		07/94→ 04/97; - ABS; für Linkslenker	03.2120-1897.3	010103	ATE Ø 20,6	
					24.2120-1704.3	010429	BDX Ø 20,6	
				05/97→; →Orga 08575; + ABS; für Linkslenker	03.2122-1351.3	010528	Ø 22,2	
					24.2122-1733.3	010668	Ø 22,2	
				05/97→; - ABS; für Linkslenker	03.2122-1356.3	010529	Ø 22,2	
				07/94→ 04/97; + ABS	24.2122-1705.3	010434	Ø 22,2	
2.0 S16	120	06/96→05/01		- ABS	24.2123-1714.3	010587	BDX Ø 23,8	
				+ ABS; für Linkslenker	24.2123-1715.3	010520	BDX Ø 23,8	
2.0 XSi	89	05/93→05/01		03/94→ 04/97; - ABS; für Linkslenker	03.2120-1897.3	010103	ATE Ø 20,6	
					24.2120-1704.3	010429	BDX Ø 20,6	
				05/97→; →Orga 08575; + ABS; für Linkslenker	03.2122-1351.3	010528	Ø 22,2	
					24.2122-1733.3	010668	Ø 22,2	
				05/97→; - ABS; für Linkslenker	03.2122-1356.3	010529	Ø 22,2	
				03/94→ 04/97; + ABS	24.2122-1705.3	010434	Ø 22,2	
		Orga 08576→; + ABS; für Linkslenker	24.2123-1715.3	010520	BDX Ø 23,8			
PEUGEOT - 308 II (LB_, LP_, LW_, LH_, L3_) 09/13→06/21								
 Hauptbremszylinder								
1.2 THP 110	81	11/13→06/21			24.4155-1311.3	011053	ATE Ø 25,4 ohne Bremsflüssigkeitsbehälter	
1.2 THP 130	96	11/13→06/21						
1.2 VTi 72	60	09/13→06/21						
1.5 BlueHDI 100	75	05/18→06/21						
1.5 BlueHDI 130	96	06/17→06/21						
1.6 BlueHDI 120	88	11/13→06/21						
1.6 GT 205	151	06/14→06/21						
1.6 GTi	184 - 200	06/15→06/21						
1.6 GTi PureTech 263	193	07/18→06/21						
1.6 HDi	68	09/13→06/21						
1.6 HDi / BlueHDI 115	85	09/13→06/21						
1.6 HDi 100	73	04/14→06/21						
1.6 PureTech 225	165	01/18→06/21						
1.6 THP	112 - 115	09/13→06/21						
1.6 THP 125	92	09/13→06/21						
1.6 THP 150	110	03/14→06/21						
1.6 THP 163	120	06/14→06/21						
1.6 VTi 115	85	05/15→06/21						
2.0 BlueHDI 150	110	11/13→06/21						
2.0 GT BlueHDI 180	130 - 133	06/14→06/21						
PEUGEOT - 308 Kasten/Schrägheck (LB_) 03/15→								
 Hauptbremszylinder								
1.5 BlueHDI 130	96	06/17→06/21			24.4155-1311.3	011053	ATE Ø 25,4 ohne Bremsflüssigkeitsbehälter	
1.6 BlueHDI 120	88	03/15→06/21						
1.6 e-HDi 115	85	03/15→06/21						
PEUGEOT - 308 SW II (LC_, LJ_, LR_, LX_, L4_) 03/14→06/21								
 Hauptbremszylinder								
1.2 THP 110	81	03/14→06/21		08/14→	24.4155-1311.3	011053	ATE Ø 25,4 ohne Bremsflüssigkeitsbehälter	
1.2 THP 130	96	03/14→06/21			24.4155-1311.3	011053	ATE Ø 25,4 ohne Bremsflüssigkeitsbehälter	
1.5 BlueHDI 100	75	04/18→06/21						
1.5 BlueHDI 130	96	06/17→06/21						
1.6 BlueHDI 100	73	04/14→06/21						
1.6 BlueHDI 120	88	03/14→06/21						
1.6 GT 205	151	02/15→06/21						
1.6 HDi / BlueHDI 115	85	03/14→06/21						
1.6 HDi 92	68	03/14→06/21						
1.6 PureTech 225	165	01/18→06/21						
1.6 THP 125	92	03/14→06/21						
1.6 THP 150	110	03/14→06/21						
1.6 THP 155	115	03/14→06/21						
1.6 VTi	85	03/14→06/21						
2.0 BlueHDI 150	110	03/14→06/21						
2.0 GT BlueHDI 180	130 - 132	06/17→06/21						
2.0 GT HDi 180 / BlueHDI 180	133	06/14→06/21						

	kw					! #		
PEUGEOT - 308 SW II Kasten/Kombi (LC_) 04/14→								
 Hauptbremszylinder								
1.5 BlueHDi 130 1.6 BlueHDi	96 73	06/17→06/21 04/14→06/21					24.4155-1311.3 011053	ATE Ø 25,4 ohne Bremsflüssigkeitsbehälter
PEUGEOT - 405 II (4B) 01/92→12/99								
 Hauptbremszylinder								
1.6	66	08/92→05/97		09/92→10/95; - ABS			24.2120-1701.3 010427	Ø 20,6
				09/92→10/95; + ABS			24.2122-1704.3 010423	Ø 22,2
1.9	90	01/92→11/97		09/92→12/93; + ABS			24.2122-1704.3 010423	Ø 22,2
1.9 TD	69	08/92→05/97		09/92→10/95; + ABS			24.2122-1704.3 010423	Ø 22,2
PEUGEOT - 405 II Break (4E) 08/92→10/98								
 Hauptbremszylinder								
1.9 D	52	08/92→10/98		09/92→10/95; + ABS			24.2122-1704.3 010423	Ø 22,2
PEUGEOT - 406 (8B) 08/95→01/05								
 Bremskraftverstärker								
1.6	65	11/95→05/04		Orga 08701→; → 04/04; für Linkslenker			03.7863-2804.4 300324	ATE Ø 10" pneumatisch
1.8 1.8 16V	74 81	10/96→03/99 11/95→10/00		Orga 08701→; für Linkslenker			03.7863-2804.4 300324	ATE Ø 10" pneumatisch
1.8 16V 1.8 BiFuel	85 85	10/00→05/04 09/00→05/04		für Linkslenker			03.7863-2804.4 300324	ATE Ø 10" pneumatisch
1.8 Bifuel	81	04/99→05/03		Orga 08701→; → 10/00; für Linkslenker			03.7863-2804.4 300324	ATE Ø 10" pneumatisch
2.0 2.0 HDI 110	104 80	11/96→03/99 06/98→08/01		Orga 08701→; - ESP; für Linkslenker			03.7863-2804.4 300324	ATE Ø 10" pneumatisch
				Orga 08701→; + ESP; für Linkslenker			03.7863-2804.4 300324	ATE Ø 10" pneumatisch
2.0 16V 2.0 HDI 90 2.0 Turbo 2.2 2.2 HDi	97 - 100 66 108 116 98	11/95→06/04 02/99→05/04 04/96→05/04 07/00→05/04 03/00→05/04		Orga 08701→; → 04/04; - ESP; für Linkslenker			03.7863-2804.4 300324	ATE Ø 10" pneumatisch
				Orga 08701→; → 04/04; + ESP; für Linkslenker			03.7863-2804.4 300324	ATE Ø 10" pneumatisch
2.0 16V HPI 2.0 HDi 110	103 79	05/01→05/04 08/01→05/04		→ 04/04; - ESP; für Linkslenker			03.7863-2804.4 300324	ATE Ø 10" pneumatisch
				→ 04/04; für Linkslenker; + ESP			03.7863-2804.4 300324	ATE Ø 10" pneumatisch
 Hauptbremszylinder								
1.6 1.8 1.9 D 1.9 TD	65 66 55 66 -	11/95→05/04 05/97→05/04 10/96→05/04 01/96→05/04		Orga 08701→; → 04/04			03.2123-2581.3 010613	ATE Ø 23,8
				→ 01/99; - ABS			24.2123-1710.3 010504	Ø 23,8
				→ 01/99; + ABS			24.2123-1713.3 010505	Ø 23,8
				02/99→; →Orga 08700; + ABS			24.2123-1741.3 010681	Ø 23,8
3.0 24V	68 140	10/96→05/04		02/99→; →Orga 08700; - ABS			24.2123-1751.3 010698	Ø 23,8
1.8 1.8 16V 3.0 24V	74 81 143	10/96→03/99 11/95→10/00 01/98→06/99		Orga 08701→			03.2123-2581.3 010613	ATE Ø 23,8
				→ 01/99; - ABS			24.2123-1710.3 010504	Ø 23,8
				→ 01/99; + ABS			24.2123-1713.3 010505	Ø 23,8
				02/99→; →Orga 08700; + ABS			24.2123-1741.3 010681	Ø 23,8
				02/99→; →Orga 08700; - ABS			24.2123-1751.3 010698	Ø 23,8
1.8 16V 1.8 BiFuel	85 85	10/00→05/04 09/00→05/04		- ESP			03.2123-2581.3 010613	ATE Ø 23,8
1.8 Bifuel	81	04/99→05/03		Orga 08701→; → 10/00			03.2123-2581.3 010613	ATE Ø 23,8
				→Orga 08700; + ABS			24.2123-1741.3 010681	Ø 23,8
				→Orga 08700; - ABS			24.2123-1751.3 010698	Ø 23,8
1.9 TD	69	10/95→10/97		Orga 08701→			03.2123-2581.3 010613	ATE Ø 23,8
				01/96→; - ABS			24.2123-1710.3 010504	Ø 23,8
				01/96→; + ABS			24.2123-1713.3 010505	Ø 23,8
2.0 2.0 Turbo 2.1 TD 12V	104 108 80	11/96→03/99 04/96→05/04 01/96→05/04		→ 01/99; - ABS			24.2123-1710.3 010504	Ø 23,8
				→ 01/99; + ABS			24.2123-1713.3 010505	Ø 23,8
				02/99→; →Orga 08700; + ABS			24.2123-1741.3 010681	Ø 23,8
				02/99→; →Orga 08700; - ABS			24.2123-1751.3 010698	Ø 23,8
2.0 16V	97	11/95→05/04		Orga 08701→; → 04/04; - ESP			03.2123-2581.3 010613	ATE Ø 23,8
				→ 01/99; - ABS			24.2123-1710.3 010504	Ø 23,8
				→ 01/99; + ABS			24.2123-1713.3 010505	Ø 23,8
				02/99→; →Orga 08700; + ABS			24.2123-1741.3 010681	Ø 23,8
				02/99→; →Orga 08700; - ABS			24.2123-1751.3 010698	Ø 23,8
2.0 16V	99	01/99→08/00		02/99→; + ABS			24.2123-1741.3 010681	Ø 23,8
				02/99→; - ABS			24.2123-1751.3 010698	Ø 23,8
2.0 16V	100	08/00→06/04		Orga 08701→; → 04/04; - ESP			03.2123-2581.3 010613	ATE Ø 23,8
→								

PEUGEOT - 406 (8B) 08/95→01/05

Hauptbremszylinder

2.0 HDI 90	66	02/99→05/04		→Orga 08700; + ABS	24.2123-1741.3	010681	Ø 23,8
2.2	116	07/00→05/04		→Orga 08700; - ABS	24.2123-1751.3	010698	Ø 23,8
2.2 HDi	98	03/00→05/04					
2.0 16V HPi	103	05/01→05/04		→ 04/04; - ESP	03.2123-2581.3	010613	ATE Ø 23,8
2.0 HDi 110	79	08/01→05/04					
2.0 HDi 110	80	06/98→08/01		Orga 08701→; - ESP	03.2123-2581.3	010613	ATE Ø 23,8
				02/99→; →Orga 08700; + ABS	24.2123-1741.3	010681	Ø 23,8
				02/99→; →Orga 08700; - ABS	24.2123-1751.3	010698	Ø 23,8
3.0 V6	152	03/00→05/04		Orga 08701→; → 04/04	03.2123-2581.3	010613	ATE Ø 23,8
				→Orga 08700; + ABS	24.2123-1741.3	010681	Ø 23,8
				→Orga 08700; - ABS	24.2123-1751.3	010698	Ø 23,8











PEUGEOT - 406 Break (8E/F) 10/96→10/04

Bremskraftverstärker













1.8	66	05/97→10/04		Orga 08701→; → 04/04; für Linkslenker	03.7863-2804.4	300324	ATE Ø 10" pneumatisch
1.9 D	55	10/96→10/04					
1.9 TD	66	10/96→10/04					
1.8	74	10/96→03/99		Orga 08701→; für Linkslenker	03.7863-2804.4	300324	ATE Ø 10" pneumatisch
1.8 16V	81	10/96→10/00					
1.8 16V	85	10/00→10/04		→ 04/04; für Linkslenker	03.7863-2804.4	300324	ATE Ø 10" pneumatisch
1.8 BiFuel	85	10/00→02/04		für Linkslenker	03.7863-2804.4	300324	ATE Ø 10" pneumatisch
2.0	104	11/96→03/99		Orga 08701→; - ESP; für Linkslenker	03.7863-2804.4	300324	ATE Ø 10" pneumatisch
2.0 16V	99	01/99→10/00		Orga 08701→; + ESP; für Linkslenker	03.7863-2804.4	300324	ATE Ø 10" pneumatisch
2.0 16V	97	10/96→10/04		Orga 08701→; → 04/04; - ESP; für Linkslenker	03.7863-2804.4	300324	ATE Ø 10" pneumatisch
2.0 HDI 90	66	02/99→10/04					
2.0 Turbo	108	10/96→10/04		Orga 08701→; → 04/04; + ESP; für Linkslenker	03.7863-2804.4	300324	ATE Ø 10" pneumatisch
2.2	116	07/00→10/04					
2.2 HDi	98	03/00→10/04					
2.0 16V	100	10/00→10/04		→ 04/04; - ESP; für Linkslenker	03.7863-2804.4	300324	ATE Ø 10" pneumatisch
2.0 HDi 110	79	08/01→10/04		→ 04/04; + ESP; für Linkslenker	03.7863-2804.4	300324	ATE Ø 10" pneumatisch
2.0 16V HPi	103	05/01→10/04		→ 04/04; + ESP; für Linkslenker	03.7863-2804.4	300324	ATE Ø 10" pneumatisch
2.0 HDi 110	80	02/99→04/04		Orga 08701→; → 08/01; - ESP; für Linkslenker	03.7863-2804.4	300324	ATE Ø 10" pneumatisch
				Orga 08701→; → 08/01; + ESP; für Linkslenker	03.7863-2804.4	300324	ATE Ø 10" pneumatisch















Hauptbremszylinder













1.8	66	05/97→10/04		Orga 08701→; → 04/04	03.2123-2581.3	010613	ATE Ø 23,8
1.9 D	55	10/96→10/04		→ 01/99; - ABS	24.2123-1710.3	010504	Ø 23,8
1.9 TD	66	10/96→10/04		→ 01/99; + ABS	24.2123-1713.3	010505	Ø 23,8
3.0 24V	140	10/96→10/04					
				02/99→; →Orga 08700; + ABS	24.2123-1741.3	010681	Ø 23,8
				02/99→; →Orga 08700; - ABS	24.2123-1751.3	010698	Ø 23,8
1.8	74	10/96→03/99		Orga 08701→	03.2123-2581.3	010613	ATE Ø 23,8
1.8 16V	81	10/96→10/00		→ 01/99; - ABS	24.2123-1710.3	010504	Ø 23,8
				→ 01/99; + ABS	24.2123-1713.3	010505	Ø 23,8
				02/99→; →Orga 08700; + ABS	24.2123-1741.3	010681	Ø 23,8
				02/99→; →Orga 08700; - ABS	24.2123-1751.3	010698	Ø 23,8
1.8 16V	85	10/00→10/04		→ 04/04; - ESP	03.2123-2581.3	010613	ATE Ø 23,8
2.0 16V	100	10/00→10/04					
2.0 16V HPi	103	05/01→10/04					
2.0 HDi 110	79	08/01→10/04					
1.8 BiFuel	85	10/00→02/04		- ESP	03.2123-2581.3	010613	ATE Ø 23,8
2.0	104	11/96→03/99		Orga 08701→; - ESP	03.2123-2581.3	010613	ATE Ø 23,8
				→ 01/99; - ABS	24.2123-1710.3	010504	Ø 23,8
				→ 01/99; + ABS	24.2123-1713.3	010505	Ø 23,8
				02/99→; →Orga 08700; + ABS	24.2123-1741.3	010681	Ø 23,8
				02/99→; →Orga 08700; - ABS	24.2123-1751.3	010698	Ø 23,8
2.0 16V	97	10/96→10/04		Orga 08701→; → 04/04; - ESP	03.2123-2581.3	010613	ATE Ø 23,8
2.0 Turbo	108	10/96→10/04		→ 01/99; - ABS	24.2123-1710.3	010504	Ø 23,8
2.1 TD 12V	80	10/96→10/04		→ 01/99; + ABS	24.2123-1713.3	010505	Ø 23,8
				02/99→; →Orga 08700; + ABS	24.2123-1741.3	010681	Ø 23,8
				02/99→; →Orga 08700; - ABS	24.2123-1751.3	010698	Ø 23,8
2.0 16V	99	01/99→10/00		Orga 08701→; - ESP	03.2123-2581.3	010613	ATE Ø 23,8
				→Orga 08700; + ABS	24.2123-1741.3	010681	Ø 23,8
				→Orga 08700; - ABS	24.2123-1751.3	010698	Ø 23,8
2.0 HDi 110	80	02/99→04/04		Orga 08701→; → 08/01; - ESP	03.2123-2581.3	010613	ATE Ø 23,8
→							















	kw			 	! #		
PEUGEOT - 406 Break (8E/F) 10/96→10/04							
 Hauptbremszylinder							
2.0 HDI 110	80	02/99→04/04		→Orga 08700; + ABS		24.2123-1741.3 010681	Ø 23,8
				→Orga 08700; - ABS		24.2123-1751.3 010698	Ø 23,8
2.0 HDI 90	66	02/99→10/04		Orga 08701→; → 04/04; - ESP		03.2123-2581.3 010613	ATE Ø 23,8
2.2	116	07/00→10/04					
2.2 HDi	98	03/00→10/04		→Orga 08700; + ABS		24.2123-1741.3 010681	Ø 23,8
				→Orga 08700; - ABS		24.2123-1751.3 010698	Ø 23,8
3.0 V6	152	03/00→10/04		Orga 08701→; → 04/04		03.2123-2581.3 010613	ATE Ø 23,8
				→Orga 08700; + ABS		24.2123-1741.3 010681	Ø 23,8
				→Orga 08700; - ABS		24.2123-1751.3 010698	Ø 23,8
PEUGEOT - 406 Coupe (8C) 03/97→02/05							
 Bremskraftverstärker							
2.0 16V	97	03/97→12/04		Orga 08701→; - ESP; für Linkslenker		03.7863-2804.4 300324	ATE Ø 10" pneumatisch
2.2 HDI	98	03/00→12/04		Orga 08701→; + ESP; für Linkslenker		03.7863-2804.4 300324	ATE Ø 10" pneumatisch
2.0 16V	99	04/99→09/04		Orga 08701→; → 10/00; - ESP; für Linkslenker		03.7863-2804.4 300324	ATE Ø 10" pneumatisch
				Orga 08701→; → 10/00; + ESP; für Linkslenker		03.7863-2804.4 300324	ATE Ø 10" pneumatisch
2.0 16V	100	10/00→12/04		- ESP; für Linkslenker		03.7863-2804.4 300324	ATE Ø 10" pneumatisch
2.2	116	03/02→12/04		+ ESP; für Linkslenker		03.7863-2804.4 300324	ATE Ø 10" pneumatisch
 Hauptbremszylinder							
2.0 16V	97	03/97→12/04		Orga 08701→; - ESP		03.2123-2581.3 010613	ATE Ø 23,8
				→ 01/99; - ABS		24.2123-1710.3 010504	Ø 23,8
				→ 01/99; + ABS		24.2123-1713.3 010505	Ø 23,8
				02/99→; →Orga 08700; + ABS		24.2123-1741.3 010681	Ø 23,8
				02/99→; →Orga 08700; - ABS		24.2123-1751.3 010698	Ø 23,8
2.0 16V	99	01/99→10/00		Orga 08701→; - ESP		03.2123-2581.3 010613	ATE Ø 23,8
2.2 HDI	98	03/00→12/04		→Orga 08700; + ABS		24.2123-1741.3 010681	Ø 23,8
				→Orga 08700; - ABS		24.2123-1751.3 010698	Ø 23,8
2.0 16V	99	04/99→09/04		Orga 08701→; → 10/00; - ESP		03.2123-2581.3 010613	ATE Ø 23,8
				→Orga 08700; + ABS		24.2123-1741.3 010681	Ø 23,8
				→Orga 08700; - ABS		24.2123-1751.3 010698	Ø 23,8
2.0 16V	100	10/00→12/04		- ESP		03.2123-2581.3 010613	ATE Ø 23,8
2.2	116	03/02→12/04					
3.0 24V	143	05/97→06/99		Orga 08701→		03.2123-2581.3 010613	ATE Ø 23,8
3.0 V6 24V	140	03/97→12/04		→ 01/99; - ABS		24.2123-1710.3 010504	Ø 23,8
				→ 01/99; + ABS		24.2123-1713.3 010505	Ø 23,8
				02/99→; →Orga 08700; + ABS		24.2123-1741.3 010681	Ø 23,8
				02/99→; →Orga 08700; - ABS		24.2123-1751.3 010698	Ø 23,8
3.0 V6	152	03/00→12/04		Orga 08701→		03.2123-2581.3 010613	ATE Ø 23,8
				→Orga 08700; + ABS		24.2123-1741.3 010681	Ø 23,8
				→Orga 08700; - ABS		24.2123-1751.3 010698	Ø 23,8
3.0 V6	154	03/99→06/01		Orga 08701→		03.2123-2581.3 010613	ATE Ø 23,8
				03/00→; →Orga 08700; + ABS		24.2123-1741.3 010681	Ø 23,8
				03/00→; →Orga 08700; - ABS		24.2123-1751.3 010698	Ø 23,8
PEUGEOT - 407 (6D_) 02/04→12/11							
 Bremskraftverstärker							
1.6 HDi 110	80	05/04→12/10		für Linkslenker; →Orga 11192		03.7860-3402.4 300217	ATE Ø 10" pneumatisch
1.8 16V	92	08/05→12/10					
2.0 16V	103	09/05→12/10		Orga 12047→; für Linkslenker		03.7860-8002.4 300258	ATE Ø 10" pneumatisch
	105						
2.0 Bioflex	103	09/07→02/11					
2.0 Flex	103	10/05→02/11					
2.0 HDi	93	11/04→10/07					
2.0 HDi 135	100	05/04→10/10					
2.2 HDi 170	125	03/06→12/10					
3.0	155	03/04→12/10					
1.8	85	03/04→07/05		für Linkslenker		03.7860-3402.4 300217	ATE Ø 10" pneumatisch
2.0	100	03/04→07/05					
2.0 HDi	120	06/09→12/10		für Linkslenker		03.7860-8002.4 300258	ATE Ø 10" pneumatisch
2.0 HDi	103	06/09→12/10		Orga 12047→; für Linkslenker		03.7860-8002.4 300258	ATE Ø 10" pneumatisch
2.2 HDi	120	03/06→12/10					
2.2	116	03/04→10/06		für Linkslenker; →Orga 11283		03.7860-3402.4 300217	ATE Ø 10" pneumatisch
2.2 16V	120	08/05→12/10					
→							

























	kw					! #		
PEUGEOT - 407 (6D_) 02/04→12/11								
 Bremskraftverstärker								
2.7 HDi	150	10/05→12/10			→Orga 11073; für Linkslenker		03.7860-3402.4 300217	ATE Ø 10" pneumatisch
 Hauptbremszylinder								
1.6 HDi 110	80	05/04→12/10					03.2122-2171.3 010961	ATE Ø 22,2
1.8	85	03/04→07/05						
1.8 16V	92	08/05→12/10						
2.0	100	03/04→07/05						
2.0 16V	103 - 105	09/05→12/10						
2.0 Bioflex	103	09/07→02/11						
2.0 Flex	103	10/05→02/11						
2.0 HDi	103 - 120	06/09→12/10			Orga 12348→		03.2123-3131.3 010977	ATE Ø 23,8
2.2 HDi	120	03/06→12/10						
2.2 HDi 170	125	03/06→12/10						
3.0	155	03/04→12/10						
2.0 HDi	93	11/04→10/07			→Orga 11682		03.2122-2171.3 010961	ATE Ø 22,2
2.0 HDi 135	100	05/04→10/10			Orga 12348→		03.2123-3131.3 010977	ATE Ø 23,8
PEUGEOT - 407 Coupe (6C_) 10/05→								
 Bremskraftverstärker								
2.0 HDi	100	10/05→			07/07→; →Orga 11192; für Linkslenker		03.7860-3402.4 300217	ATE Ø 10" pneumatisch
					Orga 12047→; → 12/11; für Linkslenker		03.7860-8002.4 300258	ATE Ø 10" pneumatisch
2.0 HDi	120	06/09→			→ 12/11; für Linkslenker		03.7860-8002.4 300258	ATE Ø 10" pneumatisch
3.0 HDi	177	06/09→						
2.2 16V	120	10/05→			→Orga 11283; für Linkslenker		03.7860-3402.4 300217	ATE Ø 10" pneumatisch
2.7 HDi	150	10/05→			→Orga 11073; für Linkslenker		03.7860-3402.4 300217	ATE Ø 10" pneumatisch
3.0 V6	155	10/05→			→Orga 11192; für Linkslenker		03.7860-3402.4 300217	ATE Ø 10" pneumatisch
					Orga 12047→; → 12/11; für Linkslenker		03.7860-8002.4 300258	ATE Ø 10" pneumatisch
 Hauptbremszylinder								
2.0 HDi	100 - 120	10/05→			Orga 12348→; → 12/11		03.2123-3131.3 010977	ATE Ø 23,8
2.2 16V	120	10/05→						
3.0 HDi	177	06/09→						
3.0 V6	155	10/05→						
PEUGEOT - 407 SW (6E_) 05/04→12/11								
 Bremskraftverstärker								
1.6 HDi 110	80	05/04→12/10			für Linkslenker; →Orga 11192		03.7860-3402.4 300217	ATE Ø 10" pneumatisch
1.8 16V	92	08/05→12/10						
2.0 16V	103	08/05→12/10			Orga 12047→; für Linkslenker		03.7860-8002.4 300258	ATE Ø 10" pneumatisch
2.0 Bioflex	103	01/08→12/10						
2.0 Flex	103	10/05→02/11						
2.0 HDi	93	11/04→10/07						
2.0 HDi 135	100	07/04→12/10						
2.2 HDi 170	125	03/06→12/10						
3.0	155	05/04→12/10						
1.8	85	05/04→07/05			für Linkslenker		03.7860-3402.4 300217	ATE Ø 10" pneumatisch
2.0	100	05/04→07/05						
2.0 HDi	103	08/08→12/10			Orga 12047→; für Linkslenker		03.7860-8002.4 300258	ATE Ø 10" pneumatisch
2.2 HDi	120	06/08→12/10						
2.0 HDi	120	06/09→12/10			für Linkslenker		03.7860-8002.4 300258	ATE Ø 10" pneumatisch
2.2	116	05/04→07/05			für Linkslenker; →Orga 11283		03.7860-3402.4 300217	ATE Ø 10" pneumatisch
2.2 16V	120	08/05→12/10						
2.7 HDi	150	10/05→12/10			→Orga 11073; für Linkslenker		03.7860-3402.4 300217	ATE Ø 10" pneumatisch
 Hauptbremszylinder								
1.6 HDi 110	80	05/04→12/10					03.2122-2171.3 010961	ATE Ø 22,2
1.8	85	05/04→07/05						
1.8 16V	92	08/05→12/10						
2.0	100	05/04→07/05						
2.0 16V	103	08/05→12/10						
2.0 Bioflex	103	01/08→12/10						
2.0 Flex	103	10/05→02/11						
2.0 HDi	93	11/04→10/07			→Orga 11682		03.2122-2171.3 010961	ATE Ø 22,2
2.0 HDi 135	100	07/04→12/10			Orga 12348→		03.2123-3131.3 010977	ATE Ø 23,8
2.0 HDi	103 - 120	08/08→12/10			Orga 12348→		03.2123-3131.3 010977	ATE Ø 23,8
2.2 HDi	120	06/08→12/10						
2.2 HDi 170	125	03/06→12/10						
3.0	155	05/04→12/10						









	kw					! #		
PEUGEOT - 407 SW Kasten/Kombi (6E_) 08/04→12/10								
 Bremskraftverstärker								
1.6 HDi	80	08/04→12/10		für Linkslenker; →Orga 11192		03.7860-3402.4	300217	ATE Ø 10" pneumatisch
				Orga 12047→; für Linkslenker		03.7860-8002.4	300258	ATE Ø 10" pneumatisch
2.0 HDi	103	06/09→12/10		Orga 12047→; für Linkslenker		03.7860-8002.4	300258	ATE Ø 10" pneumatisch
2.0 HDi	120	06/09→12/10		für Linkslenker		03.7860-8002.4	300258	ATE Ø 10" pneumatisch
 Hauptbremszylinder								
1.6 HDi	80	08/04→12/10				03.2122-2171.3	010961	ATE Ø 22,2
2.0 HDi	103 - 120	06/09→12/10		Orga 12348→		03.2123-3131.3	010977	ATE Ø 23,8
PEUGEOT - 508 I (8D_) 11/10→12/18								
 Bremskraftverstärker								
1.6 HDi	82 - 85	11/10→12/18		für Linkslenker; für Fahrzeuge ohne Start-Stopp-Funktion; + DSC		03.7860-7802.4	300280	ATE Ø 10" pneumatisch
1.6 THP	115	11/10→12/18		für Linkslenker; + DSC		03.7860-7802.4	300280	ATE Ø 10" pneumatisch
1.6 VTi	85 - 88	11/10→12/18						
2.0 HDi	100 - 120	11/10→12/18						
2.2 HDi	150	11/10→12/18						
 Hauptbremszylinder								
1.6 BlueHDi 120	88	03/14→12/18		+ DSC		03.2123-3131.3	010977	ATE Ø 23,8
1.6 HDi	82 - 85	11/10→12/18		- DSC		03.2123-3641.3	010963	ATE Ø 23,8
1.6 THP	110 - 121	11/10→12/18						
1.6 VTi	85 - 88	11/10→12/18						
2.0 BlueHDi 150	110	04/14→12/18						
2.0 BlueHDi 180	133	04/14→12/18						
2.0 HDi	100 - 120	11/10→12/18						
2.2 HDi	150	11/10→12/18						
2.0 HDi Hybrid4 AWC	147	11/10→12/18		06/12→; + DSC		03.2123-3131.3	010977	ATE Ø 23,8
				06/12→; - DSC		03.2123-3641.3	010963	ATE Ø 23,8
PEUGEOT - 508 SW I (8E_) 11/10→12/18								
 Bremskraftverstärker								
1.6 HDi	82 - 85	11/10→12/18		für Linkslenker; für Fahrzeuge ohne Start-Stopp-Funktion; + DSC		03.7860-7802.4	300280	ATE Ø 10" pneumatisch
1.6 THP	115	11/10→12/18		für Linkslenker; + DSC		03.7860-7802.4	300280	ATE Ø 10" pneumatisch
1.6 VTi	85 - 88	11/10→12/18						
2.0 HDi	100 - 120	11/10→12/18						
2.0 HDi RXH Hybrid4	147	11/10→12/18						
2.2 HDi	150	11/10→12/18						
 Hauptbremszylinder								
1.6	121	02/12→12/18		+ DSC		03.2123-3131.3	010977	ATE Ø 23,8
1.6 BlueHDi 120	88	03/14→12/18		- DSC		03.2123-3641.3	010963	ATE Ø 23,8
1.6 HDi	82 - 85	11/10→12/18						
1.6 THP	110 - 115	11/10→12/18						
1.6 VTi	85 - 88	11/10→12/18						
2.0 BlueHDi 150	110	04/14→12/18						
2.0 BlueHDi 180	133	04/14→12/18						
2.0 HDi	100 - 120	11/10→12/18						
2.0 HDi 180 RXH	133	10/14→12/18						
2.0 HDi RXH Hybrid4	147	11/10→12/18						
2.2 HDi	150	11/10→12/18						
PEUGEOT - 508 SW Kasten/Kombi (8E_) 11/11→								
 Bremskraftverstärker								
1.6 HDi	84	03/13→12/18		für Linkslenker; für Fahrzeuge ohne Start-Stopp-Funktion; + DSC		03.7860-7802.4	300280	ATE Ø 10" pneumatisch
2.0 HDi	103 - 120	03/13→12/18		für Linkslenker; + DSC		03.7860-7802.4	300280	ATE Ø 10" pneumatisch
2.2 HDi →	150	11/11→						

	kw					! #		
PEUGEOT - 508 SW Kasten/Kombi (8E_) 11/11→								
 Hauptbremszylinder								
1.6 HDi	84	03/13→12/18		+ DSC		03.2123-3131.3	010977	ATE Ø 23,8
2.0 HDi	103 - 120	03/13→12/18		- DSC		03.2123-3641.3	010963	ATE Ø 23,8
2.2 HDi	150	11/11→						
PEUGEOT - 605 (6B) 06/89→09/99								
 Hauptbremszylinder								
2.0	79 - 89	06/89→09/99		04/90→; - ABS		24.2122-1703.3	010422	Ø 22,2
				04/90→; + ABS		24.2122-1708.3	010437	Ø 22,2
2.0 16V	97	07/94→09/99		09/94→; →Orga 07692; - ABS		24.2122-1703.3	010422	Ø 22,2
				Orga 07693→		24.2122-1708.3	010437	Ø 22,2
				09/94→; →Orga 07692; + ABS		24.2122-1708.3	010437	Ø 22,2
2.1 TD 12V	80	08/94→09/99		- ABS		24.2122-1703.3	010422	Ø 22,2
				+ ABS		24.2122-1708.3	010437	Ø 22,2
2.1 Turbo Diesel	80	06/89→09/99		10/90→; - ABS		24.2122-1703.3	010422	Ø 22,2
				10/90→; + ABS		24.2122-1708.3	010437	Ø 22,2
3.0	123	10/89→09/99		04/90→ 08/94; - ABS		24.2122-1703.3	010422	Ø 22,2
PEUGEOT - 806 (221) 06/94→08/02								
 Hauptbremszylinder								
1.8	73	07/95→08/02		10/96→; →Orga 08206; - ABS		24.2122-1703.3	010422	Ø 22,2
				10/96→; →Orga 08206; + ABS		24.2122-1708.3	010437	Ø 22,2
				Orga 08207→; → 06/02; - ABS		24.2122-1741.3	010695	Ø 22,2
1.9 TD	66 - 68	07/95→08/02		→Orga 08206; - ABS		24.2123-1707.3	010492	Ø 23,8
2.0 16V	100	09/00→08/02		Orga 08207→; → 06/02; + ABS		24.2123-1733.3	010657	BOS Ø 23,8
				Orga 08207→; → 06/02; - ABS		24.2123-1738.3	010658	Ø 23,8
2.0	89	06/94→08/02		08/94→; →Orga 08206; - ABS		24.2123-1707.3	010492	Ø 23,8
2.0 Turbo	108	06/94→08/02		Orga 08207→; → 06/02; + ABS		24.2123-1733.3	010657	BOS Ø 23,8
				Orga 08207→; → 06/02; - ABS		24.2123-1738.3	010658	Ø 23,8
2.0 16V	97	05/98→09/00		10/98→; →Orga 08206; - ABS		24.2123-1707.3	010492	Ø 23,8
				Orga 08207→; + ABS		24.2123-1733.3	010657	BOS Ø 23,8
				Orga 08207→; - ABS		24.2123-1738.3	010658	Ø 23,8
2.0 HDi	80	08/99→08/02		→ 06/02; + ABS		24.2123-1733.3	010657	BOS Ø 23,8
2.0 HDi 16V	80	08/99→08/02		→ 06/02; - ABS		24.2123-1738.3	010658	Ø 23,8
2.1 td 12V	80	06/96→08/99		→Orga 08206; - ABS		24.2123-1707.3	010492	Ø 23,8
				Orga 08207→; + ABS		24.2123-1733.3	010657	BOS Ø 23,8
				Orga 08207→; - ABS		24.2123-1738.3	010658	Ø 23,8
PEUGEOT - 807 (EB_) 06/02→								
 Bremskraftverstärker								
2.0	100	06/02→		Orga 10528→; für Linkslenker; → 06/14		03.7860-2002.4	300216	ATE Ø 10" pneumatisch
2.0 HDi	100	06/06→						
2.2	116	06/02→						
2.0 16V	103	09/05→		Orga 10528→; für Linkslenker; →Orga 10919		03.7860-2002.4	300216	ATE Ø 10" pneumatisch
2.0 HDi	88	02/06→						
2.2 HDi	94	06/02→		Orga 10920→; für Linkslenker; → 06/14		03.7860-4432.4	300313	ATE Ø 10" pneumatisch
2.0 HDi	79	06/02→05/06		Orga 10528→; für Linkslenker; →Orga 10919		03.7860-2002.4	300216	ATE Ø 10" pneumatisch
2.2 HDi	100	04/04→05/06						
				Orga 10920→; für Linkslenker		03.7860-4432.4	300313	ATE Ø 10" pneumatisch
2.0 HDi	80	04/04→		Orga 10528→; für Linkslenker; →Orga 10919		03.7860-2002.4	300216	ATE Ø 10" pneumatisch
				Orga 10920→; → 05/06; für Linkslenker		03.7860-4432.4	300313	ATE Ø 10" pneumatisch
 Hauptbremszylinder								
2.0	100	06/02→		Orga 10528→; → 06/14		03.2122-2163.3	010800	ATE Ø 22,2
2.0 HDi	88	02/06→						
2.2	116	06/02→						
2.2 HDi	94	06/02→						
2.0 16V	103	09/05→		→ 06/14		03.2122-2163.3	010800	ATE Ø 22,2
2.0 HDi	100	06/06→						
2.0 HDi	79	06/02→05/06		Orga 10528→		03.2122-2163.3	010800	ATE Ø 22,2
2.2 HDi	100	04/04→05/06						
2.0 HDi	80	04/04→		Orga 10528→; → 05/06		03.2122-2163.3	010800	ATE Ø 22,2
2.0 HDi	120	06/09→		→ 06/14		03.2123-3421.3	010933	ATE Ø 23,8
2.2 HDi	120	06/06→		10/07→ 06/14		03.2123-3421.3	010933	ATE Ø 23,8
2.2 HDi	125	06/06→06/10		10/07→		03.2123-3421.3	010933	ATE Ø 23,8

	kw					! #		
PEUGEOT - 807 Van (EB_) 06/02→								
 Bremskraftverstärker								
2.0 HDi	79	06/02→05/06		10528→ 10919; für Linkslenker		03.7860-2002.4	300216	ATE Ø 10" pneumatisch
HDi	80 94	04/04→05/06		Orga 10920→; für Linkslenker		03.7860-4432.4	300313	ATE Ø 10" pneumatisch
 Hauptbremszylinder								
2.0 HDi	120	05/10→				03.2123-3421.3	010933	ATE Ø 23,8
2.0 HDi	79	06/02→05/06		Orga 10528→		03.2122-2163.3	010800	ATE Ø 22,2
HDi	80 94	04/04→05/06						
PEUGEOT - 1007 (KM_) 04/05→								
 Hauptbremszylinder								
1.4	54	04/05→		→Orga 11009; - DSC		24.2122-1764.3	010851	BOS Ø 22,2
1.4 16V	65	10/05→				24.2122-1766.3	010840	TRW Ø 22,2
1.4 HDi	50	04/05→						
1.6 16V	80	04/05→		→Orga 11009; + DSC		24.2122-1767.3	010841	TRW Ø 22,2 ohne Drucksensor
				Orga 11010→; → 02/11; + DSC		24.4122-1703.3	010843	TRW Ø 22,2
				Orga 11010→; → 02/11; - DSC		24.4122-1704.3	010847	TRW Ø 22,2
1.6 HDi	80	06/07→		→ 02/11; + DSC		24.4122-1703.3	010843	TRW Ø 22,2
				→ 02/11; - DSC		24.4122-1704.3	010847	TRW Ø 22,2
PEUGEOT - 2008 I (CU_) 03/13→								
 Hauptbremszylinder								
1.2 PureTech 82	61	01/18→12/19		Orga 13384→		24.4123-1704.3	010828	TRW Ø 23,8
1.2 VTi	60	03/13→12/18						
1.2 THP 110 / PureTech 110	81	01/15→				24.4123-1704.3	010828	TRW Ø 23,8
1.2 THP 130 / PureTech 130	96	01/15→						
1.4 HDi	50	06/13→						
1.5 BlueHDi 100	75	05/18→						
1.5 BlueHDi 120	88	05/18→						
1.6 BlueHDi	85	07/14→						
1.6 BlueHDi 100	73	01/15→						
1.6 BlueHDi 120	88	07/14→						
1.6 BlueHDi 75	55	01/15→						
1.6 HDi	68 - 84	03/13→						
1.6 THP 165	121	02/16→						
1.6 VTi	85 - 88	03/13→						
PEUGEOT - 2008 I Van (CU_) 03/13→								
 Hauptbremszylinder								
BlueHDi 100	75	05/18→				24.4123-1704.3	010828	TRW Ø 23,8
BlueHDi 120	88	05/18→						
PureTech 130	96	01/18→						
PEUGEOT - 3008 Großraumlimousine (0U_) 05/09→12/17								
 Bremskraftverstärker								
1.6 HDi	82	12/09→08/16		Orga 12621→; für Fahrzeuge mit Start-Stopp-Funktion		03.7860-3734.4	300317	ATE Ø 10" pneumatisch
1.6 HDi	84	03/13→08/16		für Fahrzeuge mit Start-Stopp-Funktion		03.7860-3734.4	300317	ATE Ø 10" pneumatisch
1.6 Turbo	121	05/14→08/16				03.7860-3734.4	300317	ATE Ø 10" pneumatisch
2.0 HDi Hybrid4	147	02/11→08/16						
 Hauptbremszylinder								
1.2	96	01/15→08/16				03.4153-0173.3	010815	ATE Ø 23,8
1.6 BlueHDi 120	88	05/14→08/16						
1.6 HDi	80 - 84	06/09→08/16						
1.6 HDi 115 / BlueHDi 115	85	02/13→08/16						
1.6 THP	110 - 120	06/09→08/16						
1.6 Turbo	121	05/14→08/16						
1.6 VTi	88	06/09→08/16						
2.0 HDi	100 - 120	06/09→08/16						
2.0 HDi 150 / BlueHDi 150	110	06/09→08/16						
2.0 HDi Hybrid4	147	02/11→08/16						

	kw					! #		
PEUGEOT - 3008 Van (0U_) 05/09→12/17								
 Hauptbremszylinder								
HdI	120	06/09→08/16				03.4153-0173.3	010815	ATE Ø 23,8
HdI 110	80	06/09→08/16						
HdI 150	110	06/09→08/16						
PEUGEOT - 5008 (0U_, 0E_) 06/09→03/17								
 Bremskraftverstärker								
1.6 BlueHdI 115	85	11/14→03/17		für Fahrzeuge mit Start-Stopp-Funktion		03.7860-3734.4	300317	ATE Ø 10" pneumatisch
1.6 BlueHdI 120	88	05/14→03/17						
1.6 HdI	84	03/13→03/17						
1.6 HdI	82	08/10→03/17		Orga 12656→; für Fahrzeuge mit Start-Stopp-Funktion		03.7860-3734.4	300317	ATE Ø 10" pneumatisch
 Hauptbremszylinder								
1.2	96	01/15→03/17				03.4153-0173.3	010815	ATE Ø 23,8
1.6 16V	88	09/09→03/17						
	115							
1.6 HdI	80	09/09→03/17						
	84							
2.0 HdI	120	09/09→03/17						
2.0 HdI 136 / BlueHdI 136	100	02/12→03/17						
2.0 HdI 150 / BlueHdI 150	110	06/09→03/17	09/09→			03.4153-0173.3	010815	ATE Ø 23,8
PEUGEOT - 5008 I Van (0U_) 06/09→03/17								
 Bremskraftverstärker								
HdI / e-HdI	84	03/13→03/17		für Fahrzeuge mit Start-Stopp-Funktion		03.7860-3734.4	300317	ATE Ø 10" pneumatisch
HdI	82	08/10→03/17		Orga 12656→; für Fahrzeuge mit Start-Stopp-Funktion		03.7860-3734.4	300317	ATE Ø 10" pneumatisch
 Hauptbremszylinder								
HdI / e-HdI	84	03/13→03/17				03.4153-0173.3	010815	ATE Ø 23,8
HdI	82	08/10→03/17						
HdI 136	100	02/12→03/17						
HdI 150	110	06/09→03/17						
HdI 165	120	06/09→03/17						
PEUGEOT - BOXER Bus 09/05→								
 Hauptbremszylinder								
2.2 HdI 100	74	04/06→		Nutzlast ab [kg] 1.200 Nutzlast bis [kg] 1.400; + DSC; nicht für Facelift; Nutzlast-Code: 12Q / 14Q		24.4125-1701.3	010867	BOS Ø 25,4 ohne Bremsflüssigkeitsbehälter
2.2 HdI 110	81	03/11→						
2.2 HdI 120	88	04/06→						
2.2 HdI 130	96	03/11→						
2.2 HdI 150	110	03/11→		Nutzlast ab [kg] 1.200 Nutzlast bis [kg] 1.400; - DSC; nicht für Facelift; Nutzlast-Code: 12Q / 14Q		24.4125-1702.3	010872	BOS Ø 25,4 ohne Bremsflüssigkeitsbehälter
2.8 HdI	93	09/05→09/09						
3.0 HdI 145	107	04/10→						
3.0 HdI 160	116	04/06→		Nutzlast ab [kg] 1.600 Nutzlast bis [kg] 2.000; + DSC; nicht für Facelift; Nutzlast-Code: 16Q / 20Q		24.4126-1701.3	010868	BOS Ø 27 ohne Bremsflüssigkeitsbehälter
3.0 HdI 175	130	03/11→		Nutzlast ab [kg] 1.600 Nutzlast bis [kg] 2.000; - DSC; nicht für Facelift; Nutzlast-Code: 16Q / 20Q		24.4126-1702.3	010875	BOS Ø 27 ohne Bremsflüssigkeitsbehälter
PEUGEOT - BOXER Bus (230P) 03/94→04/02								
 Hauptbremszylinder								
1.9 D	51	03/94→04/02		→ S 15064995; Nutzlast [kg]: 1.000; für Linkslenker; - ABS		24.2122-1715.3	010481	Ø 22,2
				S 15064996→ S 16206253; Nutzlast [kg]: 1.000; + ABS		24.2125-1702.3	010482	Ø 25,4
				S 15064996→ S 16205754; Nutzlast [kg]: 1.000; für Linkslenker; - ABS		24.2125-1703.3	010483	Ø 25,4
				S 16205755→; → 03/02; Nutzlast [kg]: 1.000; - ABS		24.2125-1725.3	010717	Ø 25,4
				S 16206254→; → 03/02; Nutzlast [kg]: 1.000; + ABS		24.2125-1726.3	010718	Ø 25,4
1.9 TD	66	03/94→04/02		→ S 15064995; Nutzlast ab [kg] 1.000 Nutzlast bis [kg] 1.400; - ABS; für Linkslenker		24.2122-1715.3	010481	Ø 22,2
1.9 TD 4x4	68	07/96→04/02						
	68			S 15064996→ S 16206253; Nutzlast ab [kg] 1.000 Nutzlast bis [kg] 1.400; + ABS		24.2125-1702.3	010482	Ø 25,4
				S 15064996→ S 16205754; Nutzlast ab [kg] 1.000 Nutzlast bis [kg] 1.400; für Linkslenker; - ABS		24.2125-1703.3	010483	Ø 25,4
				S 16205755→; → 03/02; Nutzlast ab [kg] 1.000 Nutzlast bis [kg] 1.400; - ABS		24.2125-1725.3	010717	Ø 25,4

	kw			 	! #		
PEUGEOT - BOXER Bus (230P) 03/94→04/02							
 Hauptbremszylinder							
1.9 TD	66	03/94→04/02		S 16206254→; → 03/02; Nutzlast ab [kg] 1.000 Nutzlast bis [kg] 1.400; + ABS		24.2125-1726.3 010718	Ø 25,4
1.9 TD 4x4	68	07/96→04/02					
2.0 i	80	03/94→04/02		→ S 15064995; Nutzlast ab [kg] 1.000 Nutzlast bis [kg] 1.400; - ABS; für Linkslenker		24.2122-1715.3 010481	Ø 22,2
2.0 i 4x4	80	08/96→04/02					
				S 15064996→ S 16206253; Nutzlast ab [kg] 1.000 Nutzlast bis [kg] 1.400; + ABS		24.2125-1702.3 010482	Ø 25,4
				→ S 16194399; Nutzlast [kg]: 1.800; + ABS		24.2125-1702.3 010482	Ø 25,4
				→ S 16205352; Nutzlast [kg]: 1.800; für Linkslenker; - ABS		24.2125-1703.3 010483	Ø 25,4
				S 15064996→ S 16205754; Nutzlast ab [kg] 1.000 Nutzlast bis [kg] 1.400; für Linkslenker; - ABS		24.2125-1703.3 010483	Ø 25,4
				S 16205755→; → 03/02; Nutzlast ab [kg] 1.000 Nutzlast bis [kg] 1.400; - ABS		24.2125-1725.3 010717	Ø 25,4
				S 16205353→; → 03/02; Nutzlast [kg]: 1.800; - ABS		24.2125-1725.3 010717	Ø 25,4
				S 16206254→; → 03/02; Nutzlast ab [kg] 1.000 Nutzlast bis [kg] 1.400; + ABS		24.2125-1726.3 010718	Ø 25,4
				S 16194400→; → 03/02; Nutzlast [kg]: 1.800; + ABS		24.2125-1726.3 010718	Ø 25,4
2.5 D	63	08/94→04/02		→ S 15064995; Nutzlast [kg]: 1.400; für Linkslenker; - ABS		24.2122-1715.3 010481	Ø 22,2
2.5 D 4x4	63	07/96→04/02					
				→ S 16194399; Nutzlast [kg]: 1.800; + ABS		24.2125-1702.3 010482	Ø 25,4
				S 15064996→ S 16206253; Nutzlast [kg]: 1.400; + ABS		24.2125-1702.3 010482	Ø 25,4
				→ S 16205352; Nutzlast [kg]: 1.800; für Linkslenker; - ABS		24.2125-1703.3 010483	Ø 25,4
				S 15064996→ S 16205754; Nutzlast [kg]: 1.400; für Linkslenker; + ABS		24.2125-1703.3 010483	Ø 25,4
				S 16205353→; → 03/02; Nutzlast [kg]: 1.800; - ABS		24.2125-1725.3 010717	Ø 25,4
				S 16205755→; → 03/02; Nutzlast [kg]: 1.400; + ABS		24.2125-1725.3 010717	Ø 25,4
				S 16206254→; → 03/02; Nutzlast [kg]: 1.400; + ABS		24.2125-1726.3 010718	Ø 25,4
				S 16194400→; → 03/02; Nutzlast [kg]: 1.800; + ABS		24.2125-1726.3 010718	Ø 25,4
2.5 DT	62	10/97→11/01		→ S 15064995; Nutzlast [kg]: 1.400; für Linkslenker; - ABS		24.2122-1715.3 010481	Ø 22,2
				→ S 16194399; Nutzlast [kg]: 1.800; + ABS		24.2125-1702.3 010482	Ø 25,4
				S 15064996→ S 16206253; Nutzlast [kg]: 1.400; + ABS		24.2125-1702.3 010482	Ø 25,4
				→ S 16205352; Nutzlast [kg]: 1.800; für Linkslenker; - ABS		24.2125-1703.3 010483	Ø 25,4
				S 15064996→ S 16205754; Nutzlast [kg]: 1.400; für Linkslenker; + ABS		24.2125-1703.3 010483	Ø 25,4
				S 16205353→; Nutzlast [kg]: 1.800; - ABS		24.2125-1725.3 010717	Ø 25,4
				S 16205755→; Nutzlast [kg]: 1.400; + ABS		24.2125-1725.3 010717	Ø 25,4
				S 16206254→; Nutzlast [kg]: 1.400; + ABS		24.2125-1726.3 010718	Ø 25,4
				S 16194400→; Nutzlast [kg]: 1.800; + ABS		24.2125-1726.3 010718	Ø 25,4
2.5 TD	76	07/94→04/02		08/94→; → S 15064995; Nutzlast [kg]: 1.400; für Linkslenker; - ABS		24.2122-1715.3 010481	Ø 22,2
				08/94→; → S 16194399; Nutzlast [kg]: 1.800; + ABS		24.2125-1702.3 010482	Ø 25,4
				S 15064996→ S 16206253; Nutzlast [kg]: 1.400; + ABS		24.2125-1702.3 010482	Ø 25,4
				08/94→; → S 16205352; Nutzlast [kg]: 1.800; für Linkslenker; - ABS		24.2125-1703.3 010483	Ø 25,4
				S 15064996→ S 16205754; Nutzlast [kg]: 1.400; für Linkslenker; - ABS		24.2125-1703.3 010483	Ø 25,4
				S 16205353→; → 03/02; Nutzlast [kg]: 1.800; - ABS		24.2125-1725.3 010717	Ø 25,4
				S 16205755→; → 03/02; Nutzlast [kg]: 1.400; - ABS		24.2125-1725.3 010717	Ø 25,4
				S 16194400→; → 03/02; Nutzlast [kg]: 1.800; + ABS		24.2125-1726.3 010718	Ø 25,4
→							

	kw			 	! #		
PEUGEOT - BOXER Bus (230P) 03/94→04/02							
 Hauptbremszylinder							
2.5 TD	76	07/94→04/02		S 16206254→; → 03/02; Nutzlast [kg]: 1.400; + ABS		24.2125-1726.3 010718	Ø 25,4
2.5 TD 4x4	76	07/96→04/02		→ S 15064995; Nutzlast [kg]: 1.400; für Linksenker; - ABS		24.2122-1715.3 010481	Ø 22,2
				→ S 16194399; Nutzlast [kg]: 1.800; + ABS		24.2125-1702.3 010482	Ø 25,4
				S 15064996→ S 16206253; Nutzlast [kg]: 1.400; + ABS		24.2125-1702.3 010482	Ø 25,4
				→ S 16205352; Nutzlast [kg]: 1.800; für Linksenker; - ABS		24.2125-1703.3 010483	Ø 25,4
				S 15064996→ S 16205754; Nutzlast [kg]: 1.400; für Linksenker; - ABS		24.2125-1703.3 010483	Ø 25,4
				S 16205755→; → 03/02; Nutzlast [kg]: 1.400; - ABS		24.2125-1725.3 010717	Ø 25,4
				S 16205353→; → 03/02; Nutzlast [kg]: 1.800; - ABS		24.2125-1725.3 010717	Ø 25,4
				S 16206254→; → 03/02; Nutzlast [kg]: 1.400; + ABS		24.2125-1726.3 010718	Ø 25,4
2.5 TDI 2.5 TDI 4x4	79	01/97→04/02		→ S 16194399; Nutzlast [kg]: 1.800; + ABS		24.2125-1702.3 010482	Ø 25,4
				→ S 16206253; Nutzlast [kg]: 1.400; + ABS		24.2125-1702.3 010482	Ø 25,4
				→ S 16205352; Nutzlast [kg]: 1.800; für Linksenker; - ABS		24.2125-1703.3 010483	Ø 25,4
				S 15064996→ S 16205754; Nutzlast [kg]: 1.400; für Linksenker; - ABS		24.2125-1703.3 010483	Ø 25,4
				S 16205755→; → 03/02; Nutzlast [kg]: 1.400; - ABS		24.2125-1725.3 010717	Ø 25,4
				S 16205353→; → 03/02; Nutzlast [kg]: 1.800; - ABS		24.2125-1725.3 010717	Ø 25,4
				S 16206254→; → 03/02; Nutzlast [kg]: 1.400; + ABS		24.2125-1726.3 010718	Ø 25,4
				S 16194400→; → 03/02; Nutzlast [kg]: 1.800; + ABS		24.2125-1726.3 010718	Ø 25,4
2.8 D	64	01/99→02/02		→ S 15064995; Nutzlast [kg]: 1.400; für Linksenker; - ABS		24.2122-1715.3 010481	Ø 22,2
				→ S 16194399; Nutzlast [kg]: 1.800; + ABS		24.2125-1702.3 010482	Ø 25,4
				S 15064995→ S 16206253; Nutzlast [kg]: 1.400; + ABS		24.2125-1702.3 010482	Ø 25,4
				→ S 16205352; Nutzlast [kg]: 1.800; für Linksenker; - ABS		24.2125-1703.3 010483	Ø 25,4
				S 15064996→ S 16205754; Nutzlast [kg]: 1.400; für Linksenker; - ABS		24.2125-1703.3 010483	Ø 25,4
				S 16205353→; Nutzlast [kg]: 1.800; - ABS		24.2125-1725.3 010717	Ø 25,4
				S 16205755→; Nutzlast [kg]: 1.400; - ABS		24.2125-1725.3 010717	Ø 25,4
				S 16206254→; Nutzlast [kg]: 1.400; + ABS		24.2125-1726.3 010718	Ø 25,4
2.8 HDI	94	11/00→04/02		→ S 16194399; Nutzlast [kg]: 1.800; + ABS		24.2125-1702.3 010482	Ø 25,4
				→ S 16206253; Nutzlast [kg]: 1.400; + ABS		24.2125-1702.3 010482	Ø 25,4
				→ S 16205352; Nutzlast [kg]: 1.800; für Linksenker; - ABS		24.2125-1703.3 010483	Ø 25,4
				→ S 16205754; Nutzlast [kg]: 1.400; für Linksenker; - ABS		24.2125-1703.3 010483	Ø 25,4
				S 16205755→; → 03/02; Nutzlast [kg]: 1.400; - ABS		24.2125-1725.3 010717	Ø 25,4
				S 16205353→; → 03/02; Nutzlast [kg]: 1.800; - ABS		24.2125-1725.3 010717	Ø 25,4
				S 16194400→; → 03/02; Nutzlast [kg]: 1.800; + ABS		24.2125-1726.3 010718	Ø 25,4
				S 16206254→; → 03/02; Nutzlast [kg]: 1.400; + ABS		24.2125-1726.3 010718	Ø 25,4
2.8 HDi 4x4	94	10/00→04/02		→ S 15064995; Nutzlast ab [kg] 1.000 Nutzlast bis [kg] 1.400; - ABS; für Linksenker		24.2122-1715.3 010481	Ø 22,2
				S 15064995→ S 16206253; Nutzlast ab [kg] 1.000 Nutzlast bis [kg] 1.400; + ABS		24.2125-1702.3 010482	Ø 25,4
→							

PEUGEOT - BOXER Bus (230P) 03/94→04/02

Hauptbremszylinder

2.8 HDi 4x4	94	10/00→04/02	→ S 16194399; Nutzlast [kg]: 1.800; + ABS	24.2125-1702.3	010482	Ø 25,4
			→ S 16205352; Nutzlast [kg]: 1.800; für Linkslenker; - ABS	24.2125-1703.3	010483	Ø 25,4
			S 15064996→ S 16205754; Nutzlast ab [kg] 1.000 Nutzlast bis [kg] 1.400; für Linkslenker; - ABS	24.2125-1703.3	010483	Ø 25,4
			S 16205755→; → 03/02; Nutzlast ab [kg] 1.000 Nutzlast bis [kg] 1.400; - ABS	24.2125-1725.3	010717	Ø 25,4
			S 16205353→; → 03/02; Nutzlast [kg]: 1.800; - ABS	24.2125-1725.3	010717	Ø 25,4
			S 16206254→; → 03/02; Nutzlast ab [kg] 1.000 Nutzlast bis [kg] 1.400; + ABS	24.2125-1726.3	010718	Ø 25,4
			S 16194400→; → 03/02; Nutzlast [kg]: 1.800; + ABS	24.2125-1726.3	010718	Ø 25,4
2.8 HDi All-wheel Drive	93	10/00→11/01	→ S 15064995; Nutzlast ab [kg] 1.000 Nutzlast bis [kg] 1.400; - ABS; für Linkslenker	24.2122-1715.3	010481	Ø 22,2
			S 15064995→ S 16206253; Nutzlast ab [kg] 1.000 Nutzlast bis [kg] 1.400; + ABS	24.2125-1702.3	010482	Ø 25,4
			→ S 16194399; Nutzlast [kg]: 1.800; + ABS	24.2125-1702.3	010482	Ø 25,4
			→ S 16205352; Nutzlast [kg]: 1.800; für Linkslenker; - ABS	24.2125-1703.3	010483	Ø 25,4
			S 15064996→ S 16205754; Nutzlast ab [kg] 1.000 Nutzlast bis [kg] 1.400; für Linkslenker; - ABS	24.2125-1703.3	010483	Ø 25,4
			S 16205755→; Nutzlast ab [kg] 1.000 Nutzlast bis [kg] 1.400; - ABS	24.2125-1725.3	010717	Ø 25,4
			S 16205353→; Nutzlast [kg]: 1.800; - ABS	24.2125-1725.3	010717	Ø 25,4
			S 16206254→; Nutzlast ab [kg] 1.000 Nutzlast bis [kg] 1.400; + ABS	24.2125-1726.3	010718	Ø 25,4
			S 16194400→; Nutzlast [kg]: 1.800; + ABS	24.2125-1726.3	010718	Ø 25,4

Bremskraftregler

1.9 D	51	03/94→04/02	→ S 16206244; Nutzlast [kg]: 1.000; - ABS	24.6512-1701.3	320153	lastabhängig 2x
1.9 TD	66	03/94→04/02	→ S 16206244; Nutzlast ab [kg] 1.000 Nutzlast bis [kg] 1.400; - ABS	24.6512-1701.3	320153	lastabhängig 2x
1.9 TD 4x4	68	07/96→04/02				
2.0 i	80	03/94→04/02	→ S 16206244; Nutzlast ab [kg] 1.000 Nutzlast bis [kg] 1.800; - ABS	24.6512-1701.3	320153	lastabhängig 2x
2.0 i 4x4	80	08/96→04/02				
2.5 TD	76	07/94→04/02	08/94→; → S 16206244; Nutzlast ab [kg] 1.400 Nutzlast bis [kg] 1.800; - ABS	24.6512-1701.3	320153	lastabhängig 2x
2.5 TD 4x4	76	07/96→04/02	→ S 16206244; Nutzlast ab [kg] 1.400 Nutzlast bis [kg] 1.800; - ABS	24.6512-1701.3	320153	lastabhängig 2x
2.5 TDI	79	01/97→04/02				
2.5 TDI 4x4	79	01/97→04/02				
2.8 D	64	01/99→02/02				
2.8 HDi	94	11/00→04/02				
2.8 HDi	93	10/00→11/01	11/00→; → S 16206244; Nutzlast ab [kg] 1.400 Nutzlast bis [kg] 1.800; - ABS	24.6512-1701.3	320153	lastabhängig 2x









PEUGEOT - BOXER Bus (244, Z_) 12/01→









Hauptbremszylinder













2.0	81	12/01→06/06	→ 03/06; Nutzlast ab [kg] 1.000 Nutzlast bis [kg] 1.800; - ABS	24.2125-1725.3	010717	Ø 25,4
	2.0 HDi	62				
2.2 HDi	74	12/01→06/06	→ 03/06; Nutzlast ab [kg] 1.000 Nutzlast bis [kg] 1.800; + ABS	24.2125-1726.3	010718	Ø 25,4
2.8 HDi 4x4	107					
2.8 HDi 4x4	94	12/01→06/06				
2.0 BiFuel	81	12/01→06/06	04/02→ 03/06; Nutzlast ab [kg] 1.000 Nutzlast bis [kg] 1.800; - ABS	24.2125-1725.3	010717	Ø 25,4
			04/02→ 03/06; Nutzlast ab [kg] 1.000 Nutzlast bis [kg] 1.800; + ABS	24.2125-1726.3	010718	Ø 25,4
2.8 HDi	90	03/02→08/05	Nutzlast ab [kg] 1.000 Nutzlast bis [kg] 1.800; - ABS	24.2125-1725.3	010717	Ø 25,4
			Nutzlast ab [kg] 1.000 Nutzlast bis [kg] 1.800; + ABS	24.2125-1726.3	010718	Ø 25,4









Bremskraftregler











2.8 HDi 4x4	94	12/01→06/06	→ 03/06; Nutzlast ab [kg] 1.000 Nutzlast bis [kg] 1.800; - ABS	24.6512-1701.3	320153	lastabhängig 2x
-------------	----	-------------	----------------------------------------------------------------	----------------	--------	-----------------













	kw					! #		
PEUGEOT - BOXER Kasten 04/06→								
 Hauptbremszylinder								
2.2 HDi 100	74	04/06→		Nutzlast ab [kg] 1.200 Nutzlast bis [kg] 1.400; + DSC; nicht für Facelift; Nutzlast-Code: 12Q / 14Q		24.4125-1701.3	010867	BOS Ø 25,4 ohne Bremsflüssigkeitsbehälter
2.2 HDi 110	81	03/11→						
2.2 HDi 120	88	04/06→						
2.2 HDi 130	96	03/11→		Nutzlast ab [kg] 1.200 Nutzlast bis [kg] 1.400; - DSC; nicht für Facelift; Nutzlast-Code: 12Q / 14Q		24.4125-1702.3	010872	BOS Ø 25,4 ohne Bremsflüssigkeitsbehälter
2.2 HDi 130 4x4	96	03/11→						
2.2 HDi 150	110	03/11→						
2.2 HDi 150 4x4	110	03/11→						
3.0 HDi	115	07/06→		Nutzlast ab [kg] 1.600 Nutzlast bis [kg] 2.000; + DSC; nicht für Facelift; Nutzlast-Code: 16Q / 20Q		24.4126-1701.3	010868	BOS Ø 27 ohne Bremsflüssigkeitsbehälter
3.0 HDi 145	107	04/10→						
3.0 HDi 160	116	04/06→						
3.0 HDi 175	130	03/11→		Nutzlast ab [kg] 1.600 Nutzlast bis [kg] 2.000; - DSC; nicht für Facelift; Nutzlast-Code: 16Q / 20Q		24.4126-1702.3	010875	BOS Ø 27 ohne Bremsflüssigkeitsbehälter
PEUGEOT - BOXER Kasten (230L) 03/94→08/05								
 Hauptbremszylinder								
1.9 D	50	07/99→04/02		→ S 16206253; Nutzlast [kg]: 1.000; + ABS		24.2125-1702.3	010482	Ø 25,4
				→ S 16205754; Nutzlast [kg]: 1.000; - ABS; für Linkslenker		24.2125-1703.3	010483	Ø 25,4
				S 16205755→; → 03/02; Nutzlast [kg]: 1.000; - ABS		24.2125-1725.3	010717	Ø 25,4
				S 16206254→; → 03/02; Nutzlast [kg]: 1.000; + ABS		24.2125-1726.3	010718	Ø 25,4
1.9 D	51	03/94→04/02		→ S 15064995; Nutzlast [kg]: 1.000; - ABS; für Linkslenker		24.2122-1715.3	010481	Ø 22,2
				S 15064996→ S 16206253; Nutzlast [kg]: 1.000; + ABS		24.2125-1702.3	010482	Ø 25,4
				S 15064996→ S 16205754; Nutzlast [kg]: 1.000; - ABS; für Linkslenker		24.2125-1703.3	010483	Ø 25,4
				S 16205755→; → 03/02; Nutzlast [kg]: 1.000; - ABS		24.2125-1725.3	010717	Ø 25,4
				S 16206254→; → 03/02; Nutzlast [kg]: 1.000; + ABS		24.2125-1726.3	010718	Ø 25,4
1.9 TD	66	07/99→04/02		→ S 16206253; Nutzlast ab [kg] 1.000 Nutzlast bis [kg] 1.400; + ABS		24.2125-1702.3	010482	Ø 25,4
				→ S 16205754; Nutzlast ab [kg] 1.000 Nutzlast bis [kg] 1.400; - ABS; für Linkslenker		24.2125-1703.3	010483	Ø 25,4
				S 16205755→; → 03/02; Nutzlast ab [kg] 1.000 Nutzlast bis [kg] 1.400; - ABS		24.2125-1725.3	010717	Ø 25,4
				S 16206254→; → 03/02; Nutzlast ab [kg] 1.000 Nutzlast bis [kg] 1.400; + ABS		24.2125-1726.3	010718	Ø 25,4
1.9 TD	68	03/94→04/02		→ S 15064995; Nutzlast ab [kg] 1.000 Nutzlast bis [kg] 1.400; - ABS; für Linkslenker		24.2122-1715.3	010481	Ø 22,2
				S 15064996→ S 16206253; Nutzlast ab [kg] 1.000 Nutzlast bis [kg] 1.400; + ABS		24.2125-1702.3	010482	Ø 25,4
				S 15064996→ S 16205754; Nutzlast ab [kg] 1.000 Nutzlast bis [kg] 1.400; - ABS; für Linkslenker		24.2125-1703.3	010483	Ø 25,4
				S 16205755→; → 03/02; Nutzlast ab [kg] 1.000 Nutzlast bis [kg] 1.400; - ABS		24.2125-1725.3	010717	Ø 25,4
				S 16206254→; → 03/02; Nutzlast ab [kg] 1.000 Nutzlast bis [kg] 1.400; + ABS		24.2125-1726.3	010718	Ø 25,4
2.0 HDI	62	08/01→04/02		→ 03/02; Nutzlast ab [kg] 1.000 Nutzlast bis [kg] 1.800; - ABS		24.2125-1725.3	010717	Ø 25,4
				→ 03/02; Nutzlast ab [kg] 1.000 Nutzlast bis [kg] 1.800; + ABS		24.2125-1726.3	010718	Ø 25,4
2.0 i	80	06/94→04/02		→ S 15064995; Nutzlast ab [kg] 1.000 Nutzlast bis [kg] 1.400; - ABS; für Linkslenker		24.2122-1715.3	010481	Ø 22,2
				S 15064996→ S 16206253; Nutzlast ab [kg] 1.000 Nutzlast bis [kg] 1.400; + ABS		24.2125-1702.3	010482	Ø 25,4
				→ S 16194399; Nutzlast [kg]: 1.800; + ABS		24.2125-1702.3	010482	Ø 25,4
				→ S 16205352; Nutzlast [kg]: 1.800; - ABS; für Linkslenker		24.2125-1703.3	010483	Ø 25,4
				S 15064996→ S 16205754; Nutzlast ab [kg] 1.000 Nutzlast bis [kg] 1.400; - ABS; für Linkslenker		24.2125-1703.3	010483	Ø 25,4
				S 16205755→; → 03/02; Nutzlast ab [kg] 1.000 Nutzlast bis [kg] 1.400; - ABS		24.2125-1725.3	010717	Ø 25,4
				S 16205353→; → 03/02; Nutzlast [kg]: 1.800; - ABS		24.2125-1725.3	010717	Ø 25,4
→								











	kw			 	! #		
PEUGEOT - BOXER Kasten (230L) 03/94→08/05							
 Hauptbremszylinder							
2.0 i	80	06/94→04/02		S 16206254→; → 03/02; Nutzlast ab [kg] 1.000 Nutzlast bis [kg] 1.400; + ABS	24.2125-1726.3	010718	Ø 25,4
				S 16194400→; → 03/02; Nutzlast [kg]: 1.800; + ABS	24.2125-1726.3	010718	Ø 25,4
2.5 D 2.5 D 4x4 2.5 TD	63	03/94→04/02		→ S 15064995; Nutzlast [kg]: 1.400; - ABS; für Linkslenker	24.2122-1715.3	010481	Ø 22,2
	63	07/99→04/02					
	76	03/94→04/02		→ S 16194399; Nutzlast [kg]: 1.800; + ABS	24.2125-1702.3	010482	Ø 25,4
				S 15064996→ S 16206253; Nutzlast [kg]: 1.400; + ABS	24.2125-1702.3	010482	Ø 25,4
				→ S 16205352; Nutzlast [kg]: 1.800; - ABS; für Linkslenker	24.2125-1703.3	010483	Ø 25,4
				S 15064996→ S 16205754; Nutzlast [kg]: 1.400; - ABS; für Linkslenker	24.2125-1703.3	010483	Ø 25,4
				S 16205755→; → 03/02; Nutzlast [kg]: 1.400; - ABS	24.2125-1725.3	010717	Ø 25,4
				S 16205353→; → 03/02; Nutzlast [kg]: 1.800; - ABS	24.2125-1725.3	010717	Ø 25,4
				S 16206254→; → 03/02; Nutzlast [kg]: 1.400; + ABS	24.2125-1726.3	010718	Ø 25,4
	S 16194400→; → 03/02; Nutzlast [kg]: 1.800; + ABS	24.2125-1726.3	010718	Ø 25,4			
2.5 DT 2.8 D	62	10/97→11/01		→ S 15064995; Nutzlast [kg]: 1.400; - ABS; für Linkslenker	24.2122-1715.3	010481	Ø 22,2
	64	01/99→02/02					
				→ S 16194399; Nutzlast [kg]: 1.800; + ABS	24.2125-1702.3	010482	Ø 25,4
				S 15064996→ S 16206253; Nutzlast [kg]: 1.400; + ABS	24.2125-1702.3	010482	Ø 25,4
				→ S 16205352; Nutzlast [kg]: 1.800; - ABS; für Linkslenker	24.2125-1703.3	010483	Ø 25,4
				S 15064996→ S 16205754; Nutzlast [kg]: 1.400; - ABS; für Linkslenker	24.2125-1703.3	010483	Ø 25,4
				S 16205755→; Nutzlast [kg]: 1.400; - ABS	24.2125-1725.3	010717	Ø 25,4
				S 16205353→; Nutzlast [kg]: 1.800; - ABS	24.2125-1725.3	010717	Ø 25,4
				S 16194400→; Nutzlast [kg]: 1.800; + ABS	24.2125-1726.3	010718	Ø 25,4
2.5 TDI 2.5 TDI 4x4 2.8 HDI	79	01/97→04/02		→ S 16206253; Nutzlast [kg]: 1.400; + ABS	24.2125-1702.3	010482	Ø 25,4
	79	07/99→04/02					
	94	11/00→04/02		→ S 16194399; Nutzlast [kg]: 1.800; + ABS	24.2125-1702.3	010482	Ø 25,4
				→ S 16205754; Nutzlast [kg]: 1.400; - ABS; für Linkslenker	24.2125-1703.3	010483	Ø 25,4
				→ S 16205352; Nutzlast [kg]: 1.800; - ABS; für Linkslenker	24.2125-1703.3	010483	Ø 25,4
				S 16205755→; → 03/02; Nutzlast [kg]: 1.400; - ABS	24.2125-1725.3	010717	Ø 25,4
				S 16205353→; → 03/02; Nutzlast [kg]: 1.800; - ABS	24.2125-1725.3	010717	Ø 25,4
				S 16194400→; → 03/02; Nutzlast [kg]: 1.800; + ABS	24.2125-1726.3	010718	Ø 25,4
				S 16206254→; → 03/02; Nutzlast [kg]: 1.400; + ABS	24.2125-1726.3	010718	Ø 25,4
 Bremskraftregler							
1.9 D	50 - 51	03/94→04/02		→ S 16206244; Nutzlast [kg]: 1.000; - ABS	24.6512-1701.3	320153	lastabhängig 2x
1.9 TD	66 - 68	03/94→04/02		→ S 16206244; Nutzlast ab [kg] 1.000 Nutzlast bis [kg] 1.400; - ABS	24.6512-1701.3	320153	lastabhängig 2x
2.0 HDI 2.0 i	62 80	08/01→04/02 06/94→04/02		→ S 16206244; Nutzlast ab [kg] 1.000 Nutzlast bis [kg] 1.800; - ABS	24.6512-1701.3	320153	lastabhängig 2x
2.5 D 2.5 D 4x4 2.5 DT 2.5 TD 2.5 TDI 2.5 TDI 4x4 2.8 D 2.8 HDI	63	03/94→04/02		→ S 16206244; Nutzlast ab [kg] 1.400 Nutzlast bis [kg] 1.800; - ABS	24.6512-1701.3	320153	lastabhängig 2x
	63	07/99→04/02					
	62	10/97→11/01					
	76	03/94→04/02					
	79	01/97→04/02					
	79	07/99→04/02					
	64	01/99→02/02					
94	11/00→04/02						
2.8 HDi	93	10/00→11/01		11/00→; → S 16206244; Nutzlast ab [kg] 1.400 Nutzlast bis [kg] 1.800; - ABS	24.6512-1701.3	320153	lastabhängig 2x













	kw					! #		
PEUGEOT - BOXER Kasten (244) 12/01→								
 Hauptbremszylinder								
2.0	81	12/01→06/06		→ 03/06; Nutzlast ab [kg] 1.000 Nutzlast bis [kg] 1.800; - ABS		24.2125-1725.3	010717	Ø 25,4
2.0 HDi	62	04/02→06/06						
2.2 HDi	74	12/01→06/06		→ 03/06; Nutzlast ab [kg] 1.000 Nutzlast bis [kg] 1.800; + ABS		24.2125-1726.3	010718	Ø 25,4
2.8 HDi	93 - 107	04/04→09/09						
2.0 BiFuel	81	12/01→06/06		04/02→ 03/06; Nutzlast ab [kg] 1.000 Nutzlast bis [kg] 1.800; - ABS		24.2125-1725.3	010717	Ø 25,4
				04/02→ 03/06; Nutzlast ab [kg] 1.000 Nutzlast bis [kg] 1.800; + ABS		24.2125-1726.3	010718	Ø 25,4
2.3 HDi	93	02/07→		Nutzlast ab [kg] 1.000 Nutzlast bis [kg] 1.800; - ABS		24.2125-1725.3	010717	Ø 25,4
2.8 HDi	90 - 94	12/01→06/06						
2.8 HDi 4x4	94	12/01→06/06		Nutzlast ab [kg] 1.000 Nutzlast bis [kg] 1.800; + ABS		24.2125-1726.3	010718	Ø 25,4
 Bremskraftregler								
2.8 HDi 4x4	94	12/01→06/06		Nutzlast ab [kg] 1.000 Nutzlast bis [kg] 1.800; - ABS		24.6512-1701.3	320153	lastabhängig 2x
PEUGEOT - BOXER Pritsche/Fahrgestell 04/06→								
 Hauptbremszylinder								
2.2 HDi 100	74	04/06→		Nutzlast ab [kg] 1.200 Nutzlast bis [kg] 1.400; + DSC; nicht für Facelift; Nutzlast-Code: 12Q / 14Q		24.4125-1701.3	010867	BOS Ø 25,4 ohne Bremsflüssigkeitsbehälter
2.2 HDi 110	81	03/11→						
2.2 HDi 120	88	04/06→		Nutzlast ab [kg] 1.200 Nutzlast bis [kg] 1.400; - DSC; nicht für Facelift; Nutzlast-Code: 12Q / 14Q		24.4125-1702.3	010872	BOS Ø 25,4 ohne Bremsflüssigkeitsbehälter
2.2 HDi 130	96	03/11→						
2.2 HDi 150	110	03/11→						
3.0 HDi	115	04/06→		Nutzlast ab [kg] 1.600 Nutzlast bis [kg] 2.000; + DSC; nicht für Facelift; Nutzlast-Code: 16Q / 20Q		24.4126-1701.3	010868	BOS Ø 27 ohne Bremsflüssigkeitsbehälter
3.0 HDi 145	107	04/10→						
3.0 HDi 160	116	04/06→						
3.0 HDi 175	130	03/11→		Nutzlast ab [kg] 1.600 Nutzlast bis [kg] 2.000; - DSC; nicht für Facelift; Nutzlast-Code: 16Q / 20Q		24.4126-1702.3	010875	BOS Ø 27 ohne Bremsflüssigkeitsbehälter
PEUGEOT - BOXER Pritsche/Fahrgestell (244) 12/01→								
 Hauptbremszylinder								
2.0 BiFuel	81	12/01→06/06		04/02→ 03/06; Nutzlast ab [kg] 1.000 Nutzlast bis [kg] 1.800; - ABS		24.2125-1725.3	010717	Ø 25,4
				04/02→ 03/06; Nutzlast ab [kg] 1.000 Nutzlast bis [kg] 1.800; + ABS		24.2125-1726.3	010718	Ø 25,4
2.0 HDi	62	12/01→06/06		→ 03/06; Nutzlast ab [kg] 1.000 Nutzlast bis [kg] 1.800; - ABS		24.2125-1725.3	010717	Ø 25,4
2.2 HDi	74	12/01→06/06						
2.8 HDi	94 - 107	12/01→06/06		→ 03/06; Nutzlast ab [kg] 1.000 Nutzlast bis [kg] 1.800; + ABS		24.2125-1726.3	010718	Ø 25,4
2.8 HDi 4x4	94	12/01→06/06						
 Bremskraftregler								
2.8 HDi 4x4	94	12/01→06/06		→ 03/06; Nutzlast ab [kg] 1.000 Nutzlast bis [kg] 1.800; - ABS		24.6512-1701.3	320153	lastabhängig 2x
PEUGEOT - BOXER Pritsche/Fahrgestell (ZCT_) 03/94→04/02								
 Hauptbremszylinder								
1.9 D	51	03/94→04/02		→ S 15064995; Nutzlast ab [kg] 1.000 Nutzlast bis [kg] 1.400; - ABS; für Linkslenker		24.2122-1715.3	010481	Ø 22,2
				S 15064996→ S 16206253; Nutzlast ab [kg] 1.000 Nutzlast bis [kg] 1.400; + ABS		24.2125-1702.3	010482	Ø 25,4
				S 15064996→ S 16205754; Nutzlast ab [kg] 1.000 Nutzlast bis [kg] 1.400; - ABS; für Linkslenker		24.2125-1703.3	010483	Ø 25,4
				S 16205755→; - ABS; Nutzlast ab [kg] 1.000 Nutzlast bis [kg] 1.400		24.2125-1725.3	010717	Ø 25,4
				S 16206254→; + ABS; Nutzlast ab [kg] 1.000 Nutzlast bis [kg] 1.400		24.2125-1726.3	010718	Ø 25,4
1.9 TD	66	06/94→04/02		12/98→; → S 16206253; Nutzlast ab [kg] 1.000 Nutzlast bis [kg] 1.400; + ABS		24.2125-1702.3	010482	Ø 25,4
				12/98→; → S 16205754; Nutzlast ab [kg] 1.000 Nutzlast bis [kg] 1.400; - ABS; für Linkslenker		24.2125-1703.3	010483	Ø 25,4
				S 16205755→; → 03/02; Nutzlast ab [kg] 1.000 Nutzlast bis [kg] 1.400; - ABS		24.2125-1725.3	010717	Ø 25,4
				S 16206254→; → 03/02; Nutzlast ab [kg] 1.000 Nutzlast bis [kg] 1.400; + ABS		24.2125-1726.3	010718	Ø 25,4
1.9 TD	68	07/94→04/02		07/96→; → S 16206253; Nutzlast ab [kg] 1.000 Nutzlast bis [kg] 1.400; + ABS		24.2125-1702.3	010482	Ø 25,4
→								















	kw			 	! #		
PEUGEOT - BOXER Pritsche/Fahrgestell (ZCT_) 03/94 → 04/02							
 Hauptbremszylinder							
1.9 TD	68	07/94 → 04/02		07/96 →; → S 16205754; Nutzlast ab [kg] 1.000 Nutzlast bis [kg] 1.400; - ABS; für Linkslenker	24.2125-1703.3	010483	Ø 25,4
				S 16205755 →; → 03/02; Nutzlast ab [kg] 1.000 Nutzlast bis [kg] 1.400; - ABS	24.2125-1725.3	010717	Ø 25,4
				S 16206254 →; → 03/02; Nutzlast ab [kg] 1.000 Nutzlast bis [kg] 1.400; + ABS	24.2125-1726.3	010718	Ø 25,4
2.0 2.0 i	81 80	12/01 → 04/02 06/94 → 04/02		→ S 15064995; Nutzlast ab [kg] 1.000 Nutzlast bis [kg] 1.400; - ABS; für Linkslenker	24.2122-1715.3	010481	Ø 22,2
				S 15064996 → S 16206253; Nutzlast ab [kg] 1.000 Nutzlast bis [kg] 1.400; + ABS	24.2125-1702.3	010482	Ø 25,4
				→ S 16194399; Nutzlast [kg]: 1.800; + ABS	24.2125-1702.3	010482	Ø 25,4
				→ S 16205352; Nutzlast [kg]: 1.800; - ABS; für Linkslenker	24.2125-1703.3	010483	Ø 25,4
				S 15064996 → S 16205754; Nutzlast ab [kg] 1.000 Nutzlast bis [kg] 1.400; - ABS; für Linkslenker	24.2125-1703.3	010483	Ø 25,4
				S 16205755 →; → 03/02; Nutzlast ab [kg] 1.000 Nutzlast bis [kg] 1.400; - ABS	24.2125-1725.3	010717	Ø 25,4
				S 16205353 →; → 03/02; Nutzlast [kg]: 1.800; - ABS	24.2125-1725.3	010717	Ø 25,4
				S 16206254 →; → 03/02; Nutzlast ab [kg] 1.000 Nutzlast bis [kg] 1.400; + ABS	24.2125-1726.3	010718	Ø 25,4
				S 16194400 →; → 03/02; Nutzlast [kg]: 1.800; + ABS	24.2125-1726.3	010718	Ø 25,4
2.5 D 2.5 D 4x4 2.5 TD	63 63 76	03/94 → 04/02 07/99 → 04/02 03/94 → 04/02		→ S 15064995; Nutzlast [kg]: 1.400; - ABS; für Linkslenker	24.2122-1715.3	010481	Ø 22,2
				→ S 16194399; Nutzlast [kg]: 1.800; + ABS	24.2125-1702.3	010482	Ø 25,4
				S 15064996 → S 16206253; Nutzlast [kg]: 1.400; + ABS	24.2125-1702.3	010482	Ø 25,4
				→ S 16205352; Nutzlast [kg]: 1.800; - ABS; für Linkslenker	24.2125-1703.3	010483	Ø 25,4
				S 15064996 → S 16205754; Nutzlast [kg]: 1.400; - ABS; für Linkslenker	24.2125-1703.3	010483	Ø 25,4
				S 16205755 →; → 03/02; Nutzlast [kg]: 1.400; - ABS	24.2125-1725.3	010717	Ø 25,4
				S 16205353 →; → 03/02; Nutzlast [kg]: 1.800; - ABS	24.2125-1725.3	010717	Ø 25,4
				S 16194400 →; → 03/02; Nutzlast [kg]: 1.800; + ABS	24.2125-1726.3	010718	Ø 25,4
				S 16206254 →; → 03/02; Nutzlast [kg]: 1.400; + ABS	24.2125-1726.3	010718	Ø 25,4
2.5 TDI 2.5 TDI 4x4 2.8 HDI	79 79 94	01/97 → 04/02 07/99 → 04/02 11/00 → 04/02		→ S 16206253; Nutzlast [kg]: 1.400; + ABS	24.2125-1702.3	010482	Ø 25,4
				→ S 16194399; Nutzlast [kg]: 1.800; + ABS	24.2125-1702.3	010482	Ø 25,4
				→ S 16205352; Nutzlast [kg]: 1.800; - ABS; für Linkslenker	24.2125-1703.3	010483	Ø 25,4
				→ S 16205754; Nutzlast [kg]: 1.400; - ABS; für Linkslenker	24.2125-1703.3	010483	Ø 25,4
				S 16205755 →; → 03/02; Nutzlast [kg]: 1.400; - ABS	24.2125-1725.3	010717	Ø 25,4
				S 16205353 →; → 03/02; Nutzlast [kg]: 1.800; - ABS	24.2125-1725.3	010717	Ø 25,4
				S 16206254 →; → 03/02; Nutzlast [kg]: 1.400; + ABS	24.2125-1726.3	010718	Ø 25,4
				S 16194400 →; → 03/02; Nutzlast [kg]: 1.800; + ABS	24.2125-1726.3	010718	Ø 25,4
2.8 D	64	01/99 → 02/02		→ S 15064995; Nutzlast [kg]: 1.400; - ABS; für Linkslenker	24.2122-1715.3	010481	Ø 22,2
				→ S 16194399; Nutzlast [kg]: 1.800; + ABS	24.2125-1702.3	010482	Ø 25,4
				S 15064995 → S 16206253; Nutzlast [kg]: 1.400; + ABS	24.2125-1702.3	010482	Ø 25,4
				→ S 16205352; Nutzlast [kg]: 1.800; - ABS; für Linkslenker	24.2125-1703.3	010483	Ø 25,4
				S 15064996 → S 16205754; Nutzlast [kg]: 1.400; - ABS; für Linkslenker	24.2125-1703.3	010483	Ø 25,4
				S 16205755 →; Nutzlast [kg]: 1.400; - ABS	24.2125-1725.3	010717	Ø 25,4
				S 16205353 →; Nutzlast [kg]: 1.800; - ABS	24.2125-1725.3	010717	Ø 25,4
→							















	kw					! #		
PEUGEOT - BOXER Pritsche/Fahrgestell (ZCT_) 03/94→04/02								
 Hauptbremszylinder								
2.8 D	64	01/99→02/02		S 16206254→; Nutzlast [kg]: 1.400; + ABS		24.2125-1726.3	010718	Ø 25,4
				S 16194400→; Nutzlast [kg]: 1.800; + ABS		24.2125-1726.3	010718	Ø 25,4
 Bremskraftregler								
1.9 D	51	03/94→04/02		→ S 16206244; Nutzlast ab [kg] 1.000 Nutzlast bis [kg] 1.400; - ABS		24.6512-1701.3	320153	lastabhängig 2x
1.9 TD	66	06/94→04/02		12/98→; → S 16206244; Nutzlast ab [kg] 1.000 Nutzlast bis [kg] 1.400; - ABS		24.6512-1701.3	320153	lastabhängig 2x
1.9 TD	68	07/94→04/02		07/96→; → S 16206244; Nutzlast ab [kg] 1.000 Nutzlast bis [kg] 1.400; - ABS		24.6512-1701.3	320153	lastabhängig 2x
2.0	81	12/01→04/02		→ S 16206244; Nutzlast ab [kg] 1.000		24.6512-1701.3	320153	lastabhängig 2x
2.0 i	80	06/94→04/02		Nutzlast bis [kg] 1.800; - ABS				
2.5 D	63	03/94→04/02		→ S 16206244; Nutzlast ab [kg] 1.400		24.6512-1701.3	320153	lastabhängig 2x
2.5 D 4x4	63	07/99→04/02		Nutzlast bis [kg] 1.800; - ABS				
2.5 TD	76	03/94→04/02						
2.5 TDI	79	01/97→04/02						
2.5 TDI 4x4	79	07/99→04/02						
2.8 D	64	01/99→02/02						
2.8 HDI	94	11/00→04/02						
2.8 HDi	93	10/00→11/01		11/00→; → S 16206244; Nutzlast ab [kg] 1.400 Nutzlast bis [kg] 1.800; - ABS		24.6512-1701.3	320153	lastabhängig 2x
PEUGEOT - EXPERT (224_) 10/95→12/06								
 Hauptbremszylinder								
1.6	58	02/96→09/00		→Orga 08206; - ABS; Nutzlast [kg]: 800		24.2122-1703.3	010422	Ø 22,2
1.8	74	10/96→09/00		→Orga 08206; + ABS; Nutzlast [kg]: 800		24.2122-1708.3	010437	Ø 22,2
1.9 D	51	02/96→12/06		Orga 08207→; - ABS; Nutzlast [kg]: 800		24.2122-1741.3	010695	Ø 22,2
1.9 TD	66	02/96→09/00		→Orga 08206; - ABS; Nutzlast [kg]: 900		24.2123-1707.3	010492	Ø 23,8
				Orga 08207→; + ABS; Nutzlast [kg]: 900		24.2123-1733.3	010657	BOS Ø 23,8
				Orga 08207→; - ABS; Nutzlast [kg]: 900		24.2123-1738.3	010658	Ø 23,8
1.9 TD	68	02/96→05/98		04/96→; →Orga 08206; - ABS; Nutzlast [kg]: 800		24.2122-1703.3	010422	Ø 22,2
				04/96→; →Orga 08206; + ABS; Nutzlast [kg]: 800		24.2122-1708.3	010437	Ø 22,2
				Orga 08207→; - ABS; Nutzlast [kg]: 800		24.2122-1741.3	010695	Ø 22,2
				04/96→; →Orga 08206; - ABS; Nutzlast [kg]: 900		24.2123-1707.3	010492	Ø 23,8
				Orga 08207→; + ABS; Nutzlast [kg]: 900		24.2123-1733.3	010657	BOS Ø 23,8
				Orga 08207→; - ABS; Nutzlast [kg]: 900		24.2123-1738.3	010658	Ø 23,8
2.0	100	07/00→12/06		+ ABS		24.2123-1733.3	010657	BOS Ø 23,8
2.0 HDi	69	10/00→10/06		- ABS		24.2123-1738.3	010658	Ø 23,8
2.0 HDI	80	07/00→12/06						
2.0 HDI 16V	80	07/00→12/06						
PEUGEOT - EXPERT Kasten (222) 07/95→03/08								
 Hauptbremszylinder								
1.6	58	02/96→09/00		→Orga 08206; - ABS; Nutzlast [kg]: 800		24.2122-1703.3	010422	Ø 22,2
1.8	74	10/96→09/00		→Orga 08206; + ABS; Nutzlast [kg]: 800		24.2122-1708.3	010437	Ø 22,2
1.9 D	51	02/96→12/98		Orga 08207→; - ABS; Nutzlast [kg]: 800		24.2122-1741.3	010695	Ø 22,2
1.9 D 70	51	12/98→12/06						
1.9 TD	66	02/96→09/00		→Orga 08206; - ABS; Nutzlast [kg]: 900		24.2123-1707.3	010492	Ø 23,8
				Orga 08207→; + ABS; Nutzlast [kg]: 900		24.2123-1733.3	010657	BOS Ø 23,8
				Orga 08207→; - ABS; Nutzlast [kg]: 900		24.2123-1738.3	010658	Ø 23,8
1.9 TD	68	02/96→05/98		04/96→; →Orga 08206; - ABS; Nutzlast [kg]: 800		24.2122-1703.3	010422	Ø 22,2
				04/96→; →Orga 08206; + ABS; Nutzlast [kg]: 800		24.2122-1708.3	010437	Ø 22,2
				Orga 08207→; - ABS; Nutzlast [kg]: 800		24.2122-1741.3	010695	Ø 22,2
				04/96→; →Orga 08206; - ABS; Nutzlast [kg]: 900		24.2123-1707.3	010492	Ø 23,8
				Orga 08207→; + ABS; Nutzlast [kg]: 900		24.2123-1733.3	010657	BOS Ø 23,8
				Orga 08207→; - ABS; Nutzlast [kg]: 900		24.2123-1738.3	010658	Ø 23,8
2.0	100	09/02→12/06		+ ABS		24.2123-1733.3	010657	BOS Ø 23,8
2.0 HDI	69 - 80	07/00→12/06		- ABS		24.2123-1738.3	010658	Ø 23,8













	kw					! #		
PEUGEOT - EXPERT Kasten (VF3A_, VF3U_, VF3X_) 01/07→								
 Hauptbremszylinder								
1.6 HDi 90 16V	66	01/07→		für Linkslenker; + ESP		03.2125-0671.3	010965	ATE Ø 25,4
1.6 HDi 90 8V	66	01/07→		für Linkslenker; - ESP		03.2125-0676.3	011009	ATE Ø 25,4 ohne Bremsflüssigkeitsbehälter
2.0 16V	103	01/07→03/16						
2.0 HDi 100	72	03/11→						
2.0 HDi 120	88	01/07→		für Rechtslenker; - ESP		24.2123-3396.3	011035	ATE Ø 23,8 ohne Bremsflüssigkeitsbehälter
2.0 HDi 120 4x4	88	01/10→						
2.0 HDi 130	94	03/11→						
2.0 HDi 130 4x4	94	01/12→03/16						
2.0 HDi 140	100	01/07→						
2.0 HDi 165	120	09/09→						
PEUGEOT - EXPERT Pritsche/Fahrgestell 01/07→								
 Hauptbremszylinder								
1.6 HDi 90 16V	66	01/07→		für Linkslenker; + ESP		03.2125-0671.3	010965	ATE Ø 25,4
1.6 HDi 90 8V	66	01/07→		für Linkslenker; - ESP		03.2125-0676.3	011009	ATE Ø 25,4 ohne Bremsflüssigkeitsbehälter
2.0 16V	103	01/07→03/16						
2.0 HDi 120	88	01/07→						
2.0 HDi 130	94	03/11→		für Rechtslenker; - ESP		24.2123-3396.3	011035	ATE Ø 23,8 ohne Bremsflüssigkeitsbehälter
2.0 HDi 140	100	01/07→						
2.0 HDi 165	120	09/09→						
PEUGEOT - EXPERT Pritsche/Fahrgestell (223) 12/95→12/06								
 Hauptbremszylinder								
1.6	58	02/96→09/00		→Orga 08206; - ABS; Nutzlast [kg]: 800		24.2122-1703.3	010422	Ø 22,2
1.9 D	51	02/96→09/01		→Orga 08206; + ABS; Nutzlast [kg]: 800		24.2122-1708.3	010437	Ø 22,2
1.9 TD	66	02/96→09/00		Orga 08207→; - ABS; Nutzlast [kg]: 800		24.2122-1741.3	010695	Ø 22,2
				→Orga 08206; - ABS; Nutzlast [kg]: 900		24.2123-1707.3	010492	Ø 23,8
				Orga 08207→; + ABS; Nutzlast [kg]: 900		24.2123-1733.3	010657	BOS Ø 23,8
				Orga 08207→; - ABS; Nutzlast [kg]: 900		24.2123-1738.3	010658	Ø 23,8
1.9 TD	68	02/96→05/98		04/96→; →Orga 08206; - ABS; Nutzlast [kg]: 800		24.2122-1703.3	010422	Ø 22,2
				04/96→; →Orga 08206; + ABS; Nutzlast [kg]: 800		24.2122-1708.3	010437	Ø 22,2
				Orga 08207→; - ABS; Nutzlast [kg]: 800		24.2122-1741.3	010695	Ø 22,2
				04/96→; →Orga 08206; - ABS; Nutzlast [kg]: 900		24.2123-1707.3	010492	Ø 23,8
				Orga 08207→; + ABS; Nutzlast [kg]: 900		24.2123-1733.3	010657	BOS Ø 23,8
				Orga 08207→; - ABS; Nutzlast [kg]: 900		24.2123-1738.3	010658	Ø 23,8
2.0 HDi	69 - 80	10/00→10/06		- ABS; Nutzlast [kg]: 800		24.2122-1741.3	010695	Ø 22,2
2.0 HDI	80	10/00→10/06		+ ABS; Nutzlast [kg]: 900		24.2123-1733.3	010657	BOS Ø 23,8
				- ABS; Nutzlast [kg]: 900		24.2123-1738.3	010658	Ø 23,8
PEUGEOT - EXPERT TEPEE (VF3X_) 01/07→								
 Hauptbremszylinder								
1.6 HDi 90 16V	66	01/07→03/16		für Linkslenker; + ESP		03.2125-0671.3	010965	ATE Ø 25,4
1.6 HDi 90 8V	66	01/07→03/16		für Linkslenker; - ESP		03.2125-0676.3	011009	ATE Ø 25,4 ohne Bremsflüssigkeitsbehälter
2.0 16V	103	01/07→03/16						
2.0 HDi 100	72	03/11→03/16						
2.0 HDi 120	88	01/07→03/16		für Rechtslenker; - ESP		24.2123-3396.3	011035	ATE Ø 23,8 ohne Bremsflüssigkeitsbehälter
2.0 HDi 120 4x4	88	01/07→03/16						
2.0 HDi 130	94	03/11→						
2.0 HDi 130 4x4	94	03/11→03/16						
2.0 HDi 140	100	01/07→						
2.0 HDi 165	120	09/09→						
PEUGEOT - PARTNER Großraumlimousine (5_, G_) 05/96→								
 Hauptbremszylinder								
1.1	44	06/96→10/02		Orga 08610→; - ABS		03.2123-2781.3	010631	ATE Ø 23,8
1.9 D	50	06/96→12/02		07/96→; →Orga 08609; - ABS		24.2123-1714.3	010587	BDX Ø 23,8
				07/96→; →Orga 08609; + ABS; für Linkslenker		24.2123-1710.3	010504	Ø 23,8
				07/96→; →Orga 08609; + ABS; für Linkslenker		24.2123-1713.3	010505	Ø 23,8
				Orga 08610→; + ABS		24.2123-1715.3	010520	BDX Ø 23,8
1.4	55	06/96→12/15		Orga 08610→; → 03/08; - ABS		03.2123-2781.3	010631	ATE Ø 23,8
				07/96→; →Orga 08609; - ABS		24.2123-1714.3	010587	BDX Ø 23,8
				07/96→; →Orga 08609; + ABS; für Linkslenker		24.2123-1710.3	010504	Ø 23,8
				07/96→; →Orga 08609; + ABS; für Linkslenker		24.2123-1713.3	010505	Ø 23,8
				Orga 08610→; → 03/08; + ABS		24.2123-1715.3	010520	BDX Ø 23,8
1.6 16V	80	07/01→03/08		- ESP / - ABS		03.2123-2781.3	010631	ATE Ø 23,8











	kW					! #		
PEUGEOT - PARTNER Großraumlimousine (5_, G_) 05/96→								
 Hauptbremszylinder								
1.6 Flexfuel 2.0 HDi 4x4	80 66	09/00→10/02 04/04→08/05		- ESP / - ABS		24.2123-1714.3	010587	BDX Ø 23,8
				- ESP / + ABS		24.2123-1715.3	010520	BDX Ø 23,8
1.6 HDi 75	55	08/05→07/08		→ 03/08; - ABS		03.2123-2781.3	010631	ATE Ø 23,8
				→ 03/08; + ABS		24.2123-1714.3	010587	BDX Ø 23,8
1.6 HDi 90	66	08/05→12/15		02/06→ 03/08; - ABS		03.2123-2781.3	010631	ATE Ø 23,8
				02/06→ 03/08; + ABS		24.2123-1715.3	010520	BDX Ø 23,8
1.6 HDi 92	68	11/09→12/10		- ABS		24.2123-1714.3	010587	BDX Ø 23,8
				+ ABS / - ESP		24.2123-1715.3	010520	BDX Ø 23,8
1.8	66	05/97→12/02		Orga 08610→; - ABS		03.2123-2781.3	010631	ATE Ø 23,8
				→Orga 08609; - ABS		24.2123-1710.3	010504	Ø 23,8
				→Orga 08609; + ABS; für Linkslenker		24.2123-1713.3	010505	Ø 23,8
				Orga 08610→; + ABS		24.2123-1715.3	010520	BDX Ø 23,8
1.9 D	51	05/96→12/98		Orga 08610→; - ABS		03.2123-2781.3	010631	ATE Ø 23,8
				12/98→; →Orga 08609; - ABS		24.2123-1710.3	010504	Ø 23,8
				12/98→; →Orga 08609; + ABS; für Linkslenker		24.2123-1713.3	010505	Ø 23,8
				Orga 08610→; + ABS		24.2123-1715.3	010520	BDX Ø 23,8
1.9 D	51	01/99→07/08		Orga 08610→; → 03/08; - ABS		03.2123-2781.3	010631	ATE Ø 23,8
				→Orga 08609; - ABS		24.2123-1710.3	010504	Ø 23,8
				→Orga 08609; + ABS; für Linkslenker		24.2123-1713.3	010505	Ø 23,8
				Orga 08610→; → 03/08; + ABS		24.2123-1715.3	010520	BDX Ø 23,8
2.0 HDi	66	02/00→07/08		→ 03/08; - ESP / - ABS		03.2123-2781.3	010631	ATE Ø 23,8
				→ 03/08; - ESP / + ABS		24.2123-1714.3	010587	BDX Ø 23,8
Electric	28	01/98→12/01		Orga 08610→; - ABS		03.2123-2781.3	010631	ATE Ø 23,8
				→Orga 08609; - ABS		24.2123-1710.3	010504	Ø 23,8
				→Orga 08609; für Linkslenker; - ABS		24.2123-1713.3	010505	Ø 23,8
				Orga 08610→; + ABS		24.2123-1715.3	010520	BDX Ø 23,8
PEUGEOT - PARTNER Kasten/Großraumlimousine 04/08→								
 Hauptbremszylinder								
1.2 THP 1.6	81 66 - 88	02/16→ 04/08→		+ ESP; →Orga 14685		24.4123-1714.3	010979	TRW Ø 23,8
1.6 BlueHDi 100 1.6 BlueHDi 120 1.6 HDi	73 88 55 -	04/15→ 04/15→ 04/08→						
1.6 HDi 16V	84 66 -	04/08→						
1.6 HDi 16V 4x4 1.6 HDi 90	68 66 68	04/08→ 04/12→ 04/10→						
1.6 HDi / BlueHDi 75	55	07/11→		01/15→; + ESP; →Orga 14685		24.4123-1714.3	010979	TRW Ø 23,8
PEUGEOT - PARTNER Kasten/Großraumlimousine (5_, G_) 06/96→								
 Hauptbremszylinder								
1.1 1.8 D 1.9 D	44 43 51	06/96→09/05 06/96→12/02 06/96→12/02		Orga 08610→; - ABS		03.2123-2781.3	010631	ATE Ø 23,8
				07/96→; →Orga 08609; - ABS		24.2123-1710.3	010504	Ø 23,8
				07/96→; →Orga 08609; + ABS; für Linkslenker		24.2123-1713.3	010505	Ø 23,8
				Orga 08610→; + ABS		24.2123-1715.3	010520	BDX Ø 23,8
1.4	48 - 54	11/02→12/10		Orga 08610→; - ABS		03.2123-2781.3	010631	ATE Ø 23,8
1.4 BiFuel	55	04/03→10/06		→Orga 08609; - ABS		24.2123-1710.3	010504	Ø 23,8
1.8 1.9 D 1.9 D 4x4	66 50 51	03/97→08/00 06/96→12/98 04/04→07/11		→Orga 08609; + ABS; für Linkslenker		24.2123-1713.3	010505	Ø 23,8
				Orga 08610→; + ABS		24.2123-1715.3	010520	BDX Ø 23,8
1.4 1.9 D →	55 51	06/96→12/15 06/96→12/15		Orga 08610→; → 03/08; - ABS		03.2123-2781.3	010631	ATE Ø 23,8

	kw					! #		
PEUGEOT - PARTNER Kasten/Großraumlimousine (5_, G_) 06/96→								
 Hauptbremszylinder								
1.4 1.9 D	55 51	06/96→12/15 06/96→12/15		Orga 08610→; → 03/08; - ABS		24.2123-1714.3	010587	BDX Ø 23,8
				07/96→; →Orga 08609; - ABS		24.2123-1710.3	010504	Ø 23,8
				07/96→; →Orga 08609; + ABS; für Linkslenker		24.2123-1713.3	010505	Ø 23,8
				Orga 08610→; → 03/08; + ABS		24.2123-1715.3	010520	BDX Ø 23,8
1.6 HDi 75 2.0 HDi 4x4	55 66	08/05→07/08 04/04→08/05		- ABS		03.2123-2781.3	010631	ATE Ø 23,8
				+ ABS		24.2123-1714.3	010587	BDX Ø 23,8
						24.2123-1715.3	010520	BDX Ø 23,8
1.6 HDi 90 2.0 HDi	66 66	08/05→12/15 04/00→07/08		→ 03/08; - ABS		03.2123-2781.3	010631	ATE Ø 23,8
						24.2123-1714.3	010587	BDX Ø 23,8
				→ 03/08; + ABS		24.2123-1715.3	010520	BDX Ø 23,8
1.6 HDi 92	68	11/09→12/10		- ABS		24.2123-1714.3	010587	BDX Ø 23,8
				+ ABS / - ESP		24.2123-1715.3	010520	BDX Ø 23,8
1.8 D	44	11/96→02/98		Orga 08610→; → 11/96; - ABS		03.2123-2781.3	010631	ATE Ø 23,8
				→Orga 08609; - ABS		24.2123-1710.3	010504	Ø 23,8
				→Orga 08609; + ABS; für Linkslenker		24.2123-1713.3	010505	Ø 23,8
				Orga 08610→; → 11/96; + ABS		24.2123-1715.3	010520	BDX Ø 23,8
Electric	25	06/96→12/02		01/98→; - ABS		03.2123-2781.3	010631	ATE Ø 23,8
						24.2123-1714.3	010587	BDX Ø 23,8
				01/98→; + ABS		24.2123-1715.3	010520	BDX Ø 23,8
PEUGEOT - PARTNER ORIGIN Großraumlimousine (G_) 07/08→12/13								
 Hauptbremszylinder								
1.4 1.6 16V 1.6 HDi 75 1.9 D	55 81 55 51	07/08→12/13 09/11→12/13 08/08→12/13 08/08→12/13		- ABS		24.2123-1714.3	010587	BDX Ø 23,8
				+ ABS		24.2123-1715.3	010520	BDX Ø 23,8
PEUGEOT - PARTNER ORIGIN Kasten/Großraumlimousine (G_) 07/08→12/15								
 Hauptbremszylinder								
1.4 1.6 1.6 HDi 75 1.6 HDi 90 1.9 D Electric	55 81 55 66 51 42	08/08→12/15 09/11→12/15 08/08→12/15 08/08→12/15 08/08→12/15 01/11→12/12		- ABS		24.2123-1714.3	010587	BDX Ø 23,8
				+ ABS		24.2123-1715.3	010520	BDX Ø 23,8
PEUGEOT - PARTNER Pritsche/Fahrgestell 01/09→								
 Hauptbremszylinder								
1.6 BlueHdi 100 1.6 HDi 1.6 HDi 16V	73 55 - 66 66	04/15→ 01/09→ 01/09→		+ ESP; →Orga 14685		24.4123-1714.3	010979	TRW Ø 23,8
PEUGEOT - PARTNER Pritsche/Fahrgestell (5_, G_) 03/97→07/08								
 Hauptbremszylinder								
1.6 HDi 75	55	02/06→07/08		- ABS		03.2123-2781.3	010631	ATE Ø 23,8
						24.2123-1714.3	010587	BDX Ø 23,8
				+ ABS		24.2123-1715.3	010520	BDX Ø 23,8
1.8	66	03/97→08/00		Orga 08610→; - ABS		03.2123-2781.3	010631	ATE Ø 23,8
						24.2123-1714.3	010587	BDX Ø 23,8
				→Orga 08609; - ABS		24.2123-1710.3	010504	Ø 23,8
				→Orga 08609; + ABS; für Linkslenker		24.2123-1713.3	010505	Ø 23,8
				Orga 08610→; + ABS		24.2123-1715.3	010520	BDX Ø 23,8
1.9 D	51	01/99→07/08		Orga 08610→; → 03/08; - ABS		03.2123-2781.3	010631	ATE Ø 23,8
						24.2123-1714.3	010587	BDX Ø 23,8
				→Orga 08609; - ABS		24.2123-1710.3	010504	Ø 23,8
				→Orga 08609; + ABS; für Linkslenker		24.2123-1713.3	010505	Ø 23,8
				Orga 08610→; → 03/08; + ABS		24.2123-1715.3	010520	BDX Ø 23,8
2.0 HDi	66	11/02→07/08		→ 03/08; - ABS		03.2123-2781.3	010631	ATE Ø 23,8
						24.2123-1714.3	010587	BDX Ø 23,8
				→ 03/08; + ABS		24.2123-1715.3	010520	BDX Ø 23,8

	kW					! #		
PEUGEOT - PARTNER TEPEE 04/08 →								
 Hauptbremszylinder								
1.2 THP	81	02/16 →			+ ESP; →Orga 14685		24.4123-1714.3 010979	TRW Ø 23,8
1.6 BlueHDi 100	73	12/14 →						
1.6 BlueHDi 100 4x4	73	04/15 →						
1.6 BlueHDi 120	88	12/14 →						
1.6 HDi	66 - 84	04/08 →						
1.6 HDi / BlueHDi 75	55	06/08 → 12/18						
1.6 HDi 16V	66	04/08 →						
1.6 HDi 75	55	06/08 →						
1.6 HDi 90	68	04/10 →						
1.6 VTi	66 - 88	04/08 →						
1.6 VTi	81	09/08 →			04/10 →; + ESP; →Orga 14685		24.4123-1714.3 010979	TRW Ø 23,8
PORSCHE - 911 (996) 08/97 → 09/05								
 Hauptbremszylinder								
3.4 Carrera	221	08/97 → 09/01					24.2123-1717.3 010521	Ø 23,8
3.6 Carrera	235	10/01 → 08/04						
3.6 Carrera S	254	02/03 → 08/05						
3.6 S	331	08/04 → 08/05						
3.4 Carrera	235	05/01 → 08/04			→ 09/01		24.2123-1717.3 010521	Ø 23,8
3.4 Carrera 4	221	08/97 → 09/01					24.2123-1730.3 010620	Ø 23,8
3.6 Carrera 4	235	10/01 → 08/04						
3.6 Carrera 4S	254	02/03 → 07/04						
3.4 Carrera 4	235	05/01 → 08/04			→ 09/01		24.2123-1730.3 010620	Ø 23,8
PORSCHE - 911 (997) 07/04 → 12/13								
 Hauptbremszylinder								
3.6 Carrera	235 - 239	07/04 → 12/08					24.2123-1766.3 010825	TRW Ø 23,8
PORSCHE - 911 Cabriolet (996) 02/98 → 08/05								
 Hauptbremszylinder								
3.4 Carrera	221	02/98 → 09/01					24.2123-1717.3 010521	Ø 23,8
3.6 Carrera	235	10/01 → 08/05						
3.6 Carrera S	254	06/02 → 08/05						
3.4 Carrera	235	05/01 → 08/05			→ 09/01		24.2123-1717.3 010521	Ø 23,8
3.4 Carrera 4	221	02/98 → 09/01					24.2123-1730.3 010620	Ø 23,8
3.6 Carrera 4	235	10/01 → 08/05						
3.6 Carrera 4S	254	06/02 → 08/05						
3.4 Carrera 4	235	05/01 → 08/05			→ 09/01		24.2123-1730.3 010620	Ø 23,8
PORSCHE - 911 Cabriolet (997) 04/05 → 12/12								
 Hauptbremszylinder								
3.6 Carrera	235 - 254	04/05 → 12/11					24.2123-1766.3 010825	TRW Ø 23,8
3.6 Carrera 4	239 - 254	04/05 → 12/12						
PORSCHE - 911 Targa (996) 12/01 → 08/05								
 Hauptbremszylinder								
3.6	235	12/01 → 08/05					24.2123-1717.3 010521	Ø 23,8
PORSCHE - BOXSTER (986) 09/96 → 12/04								
 Hauptbremszylinder								
2.5	150	09/96 → 08/99			→ 07/99		24.2123-1717.3 010521	Ø 23,8
2.7	155	06/99 → 12/02			08/99 → 12/00		24.2123-1717.3 010521	Ø 23,8
					12/01 → 06/02		24.2123-1730.3 010620	Ø 23,8
2.7	162	08/99 → 07/02			→ 12/00		24.2123-1717.3 010521	Ø 23,8
S 3.2	185	08/99 → 07/02			12/01 → 06/02		24.2123-1730.3 010620	Ø 23,8
2.7	168	07/02 → 12/04					24.2123-1730.3 010620	Ø 23,8
S 3.2	191 - 196	07/02 → 12/04						
PORSCHE - BOXSTER (987) 06/04 → 12/13								
 Hauptbremszylinder								
2.7	176	11/04 → 12/06			→ 07/06; für Fahrzeuge ohne Keramikbremse		24.2123-1766.3 010825	TRW Ø 23,8
S 3.2	206	11/04 → 12/06						
2.7	180	07/06 → 12/09			für Fahrzeuge ohne Keramikbremse		24.2123-1766.3 010825	TRW Ø 23,8
S 3.4	217	07/06 → 12/09						
→								

	kw			 	! #		
PORSCHE - BOXSTER (987) 06/04→12/13							
 Hauptbremszylinder							
2.9 S 3.4	155 - 188 228 - 235	02/09→03/12 06/09→05/12		→ 09/11; für Fahrzeuge ohne Keramikbremse		24.2123-1766.3 010825	TRW Ø 23,8
S 3.4	223	08/08→12/09		06/09→; für Fahrzeuge ohne Keramikbremse		24.2123-1766.3 010825	TRW Ø 23,8
PORSCHE - BOXSTER Spyder (987) 09/07→12/11							
 Hauptbremszylinder							
3.4 RS 60	223	09/07→12/08		08/08→; für Fahrzeuge ohne Keramikbremse		24.2123-1766.3 010825	TRW Ø 23,8
PORSCHE - CAYENNE (9PA) 09/02→12/10							
 Bremskraftverstärker							
3.0 TDI 3.6 S 4.8	176 213 283	02/09→09/10 02/07→09/10 02/07→09/10		→ 04/10; für Linkslenker		03.7868-4102.4 300250	ATE Ø 10 / 8" pneumatisch
Pedalwegsensor, Bremspedal							
3.2	177	08/03→09/07		10/03→ 12/06		03.0655-0006.2 370006	ATE
3.2 S 4.5 Turbo 4.5	184 250 331	10/03→09/07 09/02→09/07 09/02→09/07		→ 12/06		03.0655-0006.2 370006	ATE
 Hauptbremszylinder							
3.0 TDI 3.6 GTS 4.8 S 4.8 Turbo S 4.8	176 213 298 283 368 - 404	02/09→09/10 02/07→09/10 10/07→09/10 02/07→09/10 02/07→09/10		für Linkslenker; → 04/10 → 04/10; für Rechtslenker		03.2126-3014.3 010811 24.2126-3032.3 011036	ATE Ø 27 ATE Ø 27 ohne Bremsflüssigkeitsbehälter
3.2	177	08/03→09/07		10/03→ 12/06; für Linkslenker 10/03→; für Rechtslenker; → 12/06		03.2126-3014.3 010811 24.2126-3032.3 011036	ATE Ø 27 ATE Ø 27 ohne Bremsflüssigkeitsbehälter
3.2 S 4.5 Turbo 4.5	184 250 331	10/03→09/07 09/02→09/07 09/02→09/07		→ 12/06; für Linkslenker für Rechtslenker; → 12/06		03.2126-3014.3 010811 24.2126-3032.3 011036	ATE Ø 27 ATE Ø 27 ohne Bremsflüssigkeitsbehälter
Turbo 4.8 Turbo S 4.5	373 368 - 383	09/07→12/09 01/04→09/07		für Linkslenker für Rechtslenker		03.2126-3014.3 010811 24.2126-3032.3 011036	ATE Ø 27 ATE Ø 27 ohne Bremsflüssigkeitsbehälter
PORSCHE - CAYMAN (987) 11/05→12/13							
 Hauptbremszylinder							
2.7 S 3.4	180 217	07/06→12/09 11/05→12/09		für Fahrzeuge ohne Keramikbremse		24.2123-1766.3 010825	TRW Ø 23,8
2.9 R 3.4 S 3 4 Sport S 3.4	155 - 195 243 223 223 235	02/09→06/13 11/10→12/12 08/08→12/12 08/08→12/12 02/09→06/13		→ 05/12; für Fahrzeuge ohne Keramikbremse		24.2123-1766.3 010825	TRW Ø 23,8
RENAULT - 19 II Cabriolet (D53_, 853_) 04/92→06/01							
 Hauptbremszylinder							
1.8	86	01/95→06/01		→ 03/95; - ABS → 03/95; + ABS		03.2120-2031.3 010106 24.2120-1725.3 010579	ATE Ø 20,6 BDX Ø 20,6
RENAULT - AVANTIME (DE0_) 09/01→05/03							
 Hauptbremszylinder							
2.0 16V Turbo	120	11/01→05/03				03.2123-1486.3 010488	Ø 23,8
2.2 dCi 3.0 V6	110 152	05/02→05/03 09/01→05/03		- ASR + ASR		03.2123-1486.3 010488 03.2123-2621.3 010701	Ø 23,8 ATE Ø 23,8
RENAULT - CAPTUR I (J5_, H5_) 06/13→							
 Hauptbremszylinder							
0.9 TCe 90 1.2 T	66 83 - 85	06/13→ 06/13→		für Linkslenker		24.4123-1723.3 011074	Ø 23,8 ohne Bremsflüssigkeitsbehälter
1.2 TCe →	85 97	02/18→		für Rechtslenker		24.4123-1724.3 011075	TRW Ø 23,8 ohne Bremsflüssigkeitsbehälter

	kw					! #		
RENAULT - CAPTUR I (J5_, H5_) 06/13→								
 Hauptbremszylinder								
1.2 TCe 120	87 - 88	06/13→		für Linkslenker		24.4123-1723.3	011074	Ø 23,8 ohne Bremsflüssigkeitsbehälter
1.3 TCe 130	96	03/18→		für Rechtslenker		24.4123-1724.3	011075	TRW Ø 23,8 ohne Bremsflüssigkeitsbehälter
1.3 TCe 150	110	03/18→						
1.5 dCi	63	06/13→						
1.5 dCi 110	81	01/15→						
1.5 dCi 90	66	06/13→						
1.6	84	02/18→						
RENAULT - CLIO I (B/C57_, 5/357_) 05/90→08/99								
 Hauptbremszylinder								
1.1 Electric Williams	34 - 21 - 108	01/91→09/98 05/96→02/98 01/94→09/98				03.2120-2031.3	010106	ATE Ø 20,6
1.2	40 - 43	01/96→09/98		- ABS; nicht für Fahrschulwagen		03.2120-2031.3	010106	ATE Ø 20,6
1.9 D	40 - 48	01/91→09/98		+ ABS; für Linkslenker		24.2120-1725.3	010579	BDX Ø 20,6
1.2	43	05/90→09/98		10/94→; - ABS; nicht für Fahrschulwagen		03.2120-2031.3	010106	ATE Ø 20,6
				- ABS; nicht für Fahrschulwagen		03.2120-2031.3	010106	ATE Ø 20,6
				10/94→; + ABS; für Linkslenker		24.2120-1725.3	010579	BDX Ø 20,6
				+ ABS; für Linkslenker		24.2120-1725.3	010579	BDX Ø 20,6
1.4	57	05/90→02/98		01/91→; - ABS; nicht für Fahrschulwagen; für Linkslenker		03.2120-2031.3	010106	ATE Ø 20,6
				01/91→; für Rechtslenker; nicht für Ausstattungsvariante: RTi		03.2120-2031.3	010106	ATE Ø 20,6
				01/91→; + ABS; für Linkslenker		24.2120-1725.3	010579	BDX Ø 20,6
1.4	55 - 59	01/91→09/98		für Rechtslenker; nicht für Ausstattungsvariante: RTi		03.2120-2031.3	010106	ATE Ø 20,6
				- ABS; nicht für Fahrschulwagen; für Linkslenker		03.2120-2031.3	010106	ATE Ø 20,6
				+ ABS; für Linkslenker		24.2120-1725.3	010579	BDX Ø 20,6
1.8	65 - 70	01/91→09/98		- ABS; für Linkslenker		03.2120-2031.3	010106	ATE Ø 20,6
1.8 Rsi	79	08/95→09/98		+ ABS; für Linkslenker		24.2120-1725.3	010579	BDX Ø 20,6
RENAULT - CLIO I Kasten/Schrägheck (S57_) 01/91→09/98								
 Hauptbremszylinder								
1.1	34	01/91→09/98				03.2120-2031.3	010106	ATE Ø 20,6
1.2	40 - 44	01/91→09/98		- ABS; nicht für Fahrschulwagen		03.2120-2031.3	010106	ATE Ø 20,6
1.9 D	48	01/91→09/98		für Linkslenker; + ABS		24.2120-1725.3	010579	BDX Ø 20,6
1.9 RND	40	04/96→02/98						
RENAULT - CLIO II (BB_, CB_) 03/98→12/16								
 Bremskraftverstärker								
1.0	40	02/00→05/01		für Linkslenker; - ABS		03.7750-1332.4	300155	ATE Ø 9" pneumatisch
1.2	43	09/98→02/10						
1.2 LPG	43 - 44	09/98→06/09						
1.4	55	09/98→05/05						
1.5 dCi	47	06/05→12/10						
1.6	66 - 81	09/98→02/09						
1.6 16V	79	09/98→04/05						
1.6 Flex	81	05/00→12/06						
1.6 Hi-Flex	86	01/05→02/10						
1.9 D	47 - 48	09/98→05/05						
1.2 16V	55	06/01→08/16		→ 10/03; für Linkslenker; - ABS		03.7750-1332.4	300155	ATE Ø 9" pneumatisch
				→ 10/03; + ESP		03.7853-0702.4	300195	ATE Ø 9" pneumatisch
1.4 16V	70	10/99→09/04		→ 07/00; für Linkslenker; - ABS		03.7750-1332.4	300155	ATE Ø 9" pneumatisch
				→ 07/00; + ESP		03.7853-0702.4	300195	ATE Ø 9" pneumatisch
1.4 16V	72	02/00→07/08		für Linkslenker; - ABS		03.7750-1332.4	300155	ATE Ø 9" pneumatisch
1.5 dCi	42 - 74	06/01→12/12		+ ESP		03.7853-0702.4	300195	ATE Ø 9" pneumatisch
1.9 dTi	59	12/99→05/05		02/00→; für Linkslenker; - ABS		03.7750-1332.4	300155	ATE Ø 9" pneumatisch
 Hauptbremszylinder								
1.0	40	02/00→05/01		für Linkslenker; - ABS		03.2120-4381.3	010526	ATE Ø 20,6
1.2	43	09/98→02/10						
1.2 LPG	43 - 44	09/98→06/09		für Linkslenker; + ABS		03.2120-4461.3	010571	ATE Ø 20,6
→								

	kW					! #		
RENAULT - CLIO II (BB_, CB_) 03/98→12/16								
 Hauptbremszylinder								
1.4 1.4 16V 1.5 dCi	55 72 42	09/98→05/05 02/00→07/08 06/01→12/12			für Linkslenker; + ESP		03.2120-4468.3 010789	ATE Ø 20,6
1.6 1.6 16V 1.6 Flex 1.6 Hi-Flex 1.9 D	74 66 81 79 81 86 47	09/98→02/09 09/98→04/05 05/00→12/06 01/05→02/10 09/98→05/05						
1.2 16V	55	06/01→08/16			→ 10/03; für Linkslenker; - ABS	03.2120-4381.3 010526	ATE Ø 20,6	
					→ 10/03; für Linkslenker; + ABS	03.2120-4461.3 010571	ATE Ø 20,6	
					→ 10/03; für Linkslenker; + ESP	03.2120-4468.3 010789	ATE Ø 20,6	
1.4 16V	70	10/99→09/04			→ 07/00; für Linkslenker; - ABS	03.2120-4381.3 010526	ATE Ø 20,6	
					→ 07/00; für Linkslenker; + ABS	03.2120-4461.3 010571	ATE Ø 20,6	
					→ 07/00; für Linkslenker; + ESP	03.2120-4468.3 010789	ATE Ø 20,6	
1.9 dTi	59	12/99→05/05			02/00→; für Linkslenker; - ABS	03.2120-4381.3 010526	ATE Ø 20,6	
					02/00→; für Linkslenker; + ABS	03.2120-4461.3 010571	ATE Ø 20,6	
					02/00→; für Linkslenker; + ESP	03.2120-4468.3 010789	ATE Ø 20,6	
2.0 16V Sport	124 132	02/00→06/09			für Linkslenker	03.2122-1926.3 010916	ATE Ø 22,2	
 Bremskraftregler								
1.0 1.2 1.2 LPG	40 43 43	02/00→05/01 09/98→02/10 09/98→06/09			- ABS	24.6582-1721.3 320212	lastabhängig 4x	
1.4 1.4 16V 1.5 dCi	44 55 72	09/98→05/05 02/00→07/08 06/01→12/12						
1.6 1.6 16V 1.6 Flex 1.6 Hi-Flex 1.9 D	74 66 81 79 81 86 47	09/98→02/09 09/98→04/05 05/00→12/06 01/05→02/10 09/98→05/05						
1.2 16V	55	06/01→08/16			→ 12/12; - ABS	24.6582-1721.3 320212	lastabhängig 4x	
1.4 16V	70	10/99→09/04			→ 07/00; - ABS	24.6582-1721.3 320212	lastabhängig 4x	
1.9 dTi	59	12/99→05/05			02/00→; - ABS	24.6582-1721.3 320212	lastabhängig 4x	
RENAULT - CLIO II Kasten/Schrägheck (SB0/1/2_) 09/98→								
 Bremskraftverstärker								
1.2 1.9 D	44 40	03/99→10/03 03/99→05/01			- ABS	03.7750-1332.4 300155	ATE Ø 9" pneumatisch	
1.9 DTi	48 59	02/00→05/01						
1.2 1.9 D	43 47	09/98→ 09/98→			→ 12/12; - ABS	03.7750-1332.4 300155	ATE Ø 9" pneumatisch	
1.5 dCi	48 60	06/01→			für Linkslenker; → 12/12; - ABS	03.7750-1332.4 300155	ATE Ø 9" pneumatisch	
					→ 12/12; + ESP	03.7853-0702.4 300195	ATE Ø 9" pneumatisch	
1.5 dCi	59	06/01→10/04			für Linkslenker; - ABS	03.7750-1332.4 300155	ATE Ø 9" pneumatisch	
					+ ESP	03.7853-0702.4 300195	ATE Ø 9" pneumatisch	
1.5 dCi	47	06/05→12/10			für Linkslenker; - ABS	03.7750-1332.4 300155	ATE Ø 9" pneumatisch	
1.6	79	11/03→			→ 04/05; + ESP	03.7853-0702.4 300195	ATE Ø 9" pneumatisch	
 Hauptbremszylinder								
1.2 1.9 D	44 40	03/99→10/03 03/99→05/01			- ABS	03.2120-4381.3 010526	ATE Ø 20,6	
1.9 DTi	48 59	02/00→05/01			- ESP	03.2120-4461.3 010571	ATE Ø 20,6	
1.2 1.9 D	43 47	09/98→ 09/98→			+ ESP	03.2120-4468.3 010789	ATE Ø 20,6	
					→ 12/12; - ABS	03.2120-4381.3 010526	ATE Ø 20,6	
					→ 12/12; - ESP	03.2120-4461.3 010571	ATE Ø 20,6	
					→ 12/12; + ESP	03.2120-4468.3 010789	ATE Ø 20,6	
1.5 dCi	48 60	06/01→			für Linkslenker; → 12/12; - ABS	03.2120-4381.3 010526	ATE Ø 20,6	
					für Linkslenker; → 12/12; - ESP	03.2120-4461.3 010571	ATE Ø 20,6	
					für Linkslenker; → 12/12; + ESP	03.2120-4468.3 010789	ATE Ø 20,6	
1.5 dCi	59	06/01→10/04			für Linkslenker; - ABS	03.2120-4381.3 010526	ATE Ø 20,6	
					für Linkslenker; - ESP	03.2120-4461.3 010571	ATE Ø 20,6	

RENAULT - CLIO II Kasten/Schrägheck (SB0/1/2_) 09/98→

Hauptbremszylinder

1.5 dCi	59	06/01→10/04		für Linkslenker; + ESP	03.2120-4468.3	010789	ATE Ø 20,6
1.5 dCi	47	06/05→12/10		für Linkslenker; - ABS	03.2120-4381.3	010526	ATE Ø 20,6
				für Linkslenker; + ABS	03.2120-4461.3	010571	ATE Ø 20,6
				für Linkslenker; + ESP	03.2120-4468.3	010789	ATE Ø 20,6
1.6	79	11/03→		→ 04/05; - ABS	03.2120-4381.3	010526	ATE Ø 20,6
				→ 04/05; - ESP	03.2120-4461.3	010571	ATE Ø 20,6
				→ 04/05; + ESP	03.2120-4468.3	010789	ATE Ø 20,6

Bremskraftregler

1.2	43	09/98→		→ 12/12; - ABS	24.6582-1721.3	320212	lastabhängig 4x
1.5 dCi	48 - 60	06/01→					
1.9 D	47	09/98→					
1.5 dCi	47 - 59	06/01→12/10		- ABS	24.6582-1721.3	320212	lastabhängig 4x
1.9 D	40 - 48	03/99→05/01					
1.9 DTi	59	02/00→05/01					
1.6	79	11/03→		→ 04/05; - ABS	24.6582-1721.3	320212	lastabhängig 4x













RENAULT - CLIO III (BR0/1, CR0/1) 01/05→12/14















Bremskraftverstärker















1.2	57	10/05→12/12		→ 11/07; für Linkslenker; + ABS	03.7863-4502.4	300230	ATE Ø 10" pneumatisch
1.2 16V	43 - 74	06/05→12/14					
1.4 16V	72	06/05→12/12					
1.5 dCi	50 - 78	06/05→12/14					
1.6	79	09/05→12/10					
1.6 16V	82	06/05→12/14					
2.0 16V	102	09/06→12/14					
1.5 dCi	48	05/05→07/10		→ 10/06; für Linkslenker; + ABS	03.7863-4502.4	300230	ATE Ø 10" pneumatisch
1.6 16V	65	06/05→10/07		für Linkslenker; + ABS	03.7863-4502.4	300230	ATE Ø 10" pneumatisch
2.0 16V Sport	148	09/08→12/14		für Linkslenker; → 12/12	03.7860-3702.4	300305	ATE Ø 9" pneumatisch
2.0 16V Sport	145	02/06→12/12		für Linkslenker	03.7860-3702.4	300305	ATE Ø 9" pneumatisch













Hauptbremszylinder













1.2	57	10/05→12/12		- ABS	03.2123-2821.3	010944	ATE Ø 23,8
1.2 16V	43 - 58	06/05→12/14		12/07→; für Linkslenker; - ESP	03.2123-2863.3	010790	ATE Ø 23,8
				12/07→; für Linkslenker; + ESP	03.2123-2923.3	010791	ATE Ø 23,8
1.4 16V	72	06/05→12/12		12/07→; für Linkslenker; + ESP	03.2123-2923.3	010791	ATE Ø 23,8
1.5 dCi	50 - 76	06/05→12/12		→ 11/07; für Linkslenker; - ESP	03.2123-3241.3	010882	ATE Ø 23,8
				→ 11/07; für Linkslenker; + ESP	03.2123-3493.3	010792	ATE Ø 23,8
1.6	79	09/05→12/10					
1.2 16V	76	09/10→12/14		→ 12/12; - ABS	03.2123-2821.3	010944	ATE Ø 23,8
1.5 dCi	55 - 65	08/10→12/14		für Linkslenker; → 12/12; - ESP	03.2123-2863.3	010790	ATE Ø 23,8
				für Linkslenker; → 12/12; + ESP	03.2123-2923.3	010791	ATE Ø 23,8
1.6 16V GT	94	06/09→12/14		für Linkslenker; → 12/12; + ESP	03.2123-2923.3	010791	ATE Ø 23,8
1.2 16V	55 - 74	06/05→12/14		→ 12/12; - ABS	03.2123-2821.3	010944	ATE Ø 23,8
1.5 dCi	78	06/05→12/14		12/07→; für Linkslenker; → 12/12; - ESP	03.2123-2863.3	010790	ATE Ø 23,8
				12/07→; für Linkslenker; → 12/12; + ESP	03.2123-2923.3	010791	ATE Ø 23,8
2.0 16V	102	09/06→12/14		→ 11/07; für Linkslenker; - ESP	03.2123-3241.3	010882	ATE Ø 23,8
				→ 11/07; für Linkslenker; + ESP	03.2123-3493.3	010792	ATE Ø 23,8
1.2 16V Hi-Flex 1.2 Ethanol	55	07/08→12/14		- ABS	03.2123-2821.3	010944	ATE Ø 23,8
				für Linkslenker; - ESP	03.2123-2863.3	010790	ATE Ø 23,8
				für Linkslenker; + ESP	03.2123-2923.3	010791	ATE Ø 23,8
1.5 dCi	48	05/05→07/10		→ 10/06; - ABS	03.2123-2821.3	010944	ATE Ø 23,8
				→ 10/06; für Linkslenker; - ESP	03.2123-3241.3	010882	ATE Ø 23,8
				→ 10/06; für Linkslenker; + ESP	03.2123-3493.3	010792	ATE Ø 23,8
1.5 dCi	60	11/07→12/12		- ABS	03.2123-2821.3	010944	ATE Ø 23,8
				12/07→; für Linkslenker; - ESP	03.2123-2863.3	010790	ATE Ø 23,8
				12/07→; für Linkslenker; + ESP	03.2123-2923.3	010791	ATE Ø 23,8
1.6 16V	65	06/05→10/07		- ABS	03.2123-2821.3	010944	ATE Ø 23,8
				für Linkslenker; - ESP	03.2123-3241.3	010882	ATE Ø 23,8
				für Linkslenker; + ESP	03.2123-3493.3	010792	ATE Ø 23,8
2.0 16V Sport	148	09/08→12/14		→ 12/12; - ABS	03.2123-2821.3	010944	ATE Ø 23,8
				für Linkslenker; → 12/12	03.2123-3493.3	010792	ATE Ø 23,8
2.0 16V Sport	145	02/06→12/12		- ABS	03.2123-2821.3	010944	ATE Ø 23,8
				für Linkslenker	03.2123-3493.3	010792	ATE Ø 23,8

	kw			 	! #		
RENAULT - CLIO III Grandtour (KR0/1_) 11/07→							
 Bremskraftverstärker							
1.2 16V	55 - 76	11/07→12/14		für Linkslenker		03.7863-4502.4 300230	ATE Ø 10" pneumatisch
1.2 16V Hi-Flex	55 - 58	11/07→12/14					
1.4 16V	72	11/07→12/12					
1.5 dCi	48 - 78	11/07→12/12					
1.6 16V	80 - 94	11/07→12/12					
 Hauptbremszylinder							
1.2 16V	55 - 76	11/07→12/14		- ABS		03.2123-2821.3 010944	ATE Ø 23,8
1.2 16V Hi-Flex	55 - 58	11/07→12/14		- ESP		03.2123-3241.3 010882	ATE Ø 23,8
1.5 dCi	48 - 78	11/07→12/12		+ ESP		03.2123-3493.3 010792	ATE Ø 23,8
1.6 16V	80 - 82	11/07→12/12					
1.4 16V	72	11/07→12/12		- ESP		03.2123-3241.3 010882	ATE Ø 23,8
				+ ESP		03.2123-3493.3 010792	ATE Ø 23,8
1.6 16V	94	11/07→12/12		- ESP		03.2123-2863.3 010790	ATE Ø 23,8
				+ ESP		03.2123-2923.3 010791	ATE Ø 23,8
RENAULT - CLIO III Kasten/Schrägheck (SB_, SR_) 06/05→							
 Bremskraftverstärker							
1.2	55 - 74	11/05→12/14		→ 11/07; für Linkslenker; + ABS		03.7863-4502.4 300230	ATE Ø 10" pneumatisch
1.5 dCi	50 - 63	06/05→07/10					
1.2 Hi-Flex	58	11/07→12/09		für Linkslenker		03.7863-4502.4 300230	ATE Ø 10" pneumatisch
1.5 dCi	78	10/05→10/07		für Linkslenker; + ABS		03.7863-4502.4 300230	ATE Ø 10" pneumatisch
 Hauptbremszylinder							
1.2	55	11/05→12/14		→ 12/12; - ABS		03.2123-2821.3 010944	ATE Ø 23,8
				12/07→; für Linkslenker; → 12/12; - ESP		03.2123-2863.3 010790	ATE Ø 23,8
				12/07→; für Linkslenker; → 12/12; + ESP		03.2123-2923.3 010791	ATE Ø 23,8
				→ 11/07; für Linkslenker; - ESP		03.2123-3241.3 010882	ATE Ø 23,8
				→ 11/07; für Linkslenker; + ESP		03.2123-3493.3 010792	ATE Ø 23,8
1.2	74	11/07→12/11		- ABS		03.2123-2821.3 010944	ATE Ø 23,8
1.5 dCi	50 - 63	06/05→07/10		12/07→; für Linkslenker; - ESP		03.2123-2863.3 010790	ATE Ø 23,8
				12/07→; für Linkslenker; + ESP		03.2123-2923.3 010791	ATE Ø 23,8
				→ 11/07; für Linkslenker; - ESP		03.2123-3241.3 010882	ATE Ø 23,8
				→ 11/07; für Linkslenker; + ESP		03.2123-3493.3 010792	ATE Ø 23,8
1.2 Hi-Flex	58	11/07→12/09		- ABS		03.2123-2821.3 010944	ATE Ø 23,8
				- ESP		03.2123-3241.3 010882	ATE Ø 23,8
				+ ESP		03.2123-3493.3 010792	ATE Ø 23,8
1.5 dCi	55	08/10→12/14		- ABS		03.2123-2821.3 010944	ATE Ø 23,8
				für Linkslenker; - ESP		03.2123-2863.3 010790	ATE Ø 23,8
				für Linkslenker; + ESP		03.2123-2923.3 010791	ATE Ø 23,8
1.5 dCi	78	10/05→10/07		- ABS		03.2123-2821.3 010944	ATE Ø 23,8
				für Linkslenker; - ESP		03.2123-3241.3 010882	ATE Ø 23,8
				für Linkslenker; + ESP		03.2123-3493.3 010792	ATE Ø 23,8
1.5 dCi	65	08/10→12/14		→ 12/12; - ABS		03.2123-2821.3 010944	ATE Ø 23,8
				für Linkslenker; → 12/12; - ESP		03.2123-2863.3 010790	ATE Ø 23,8
				für Linkslenker; → 12/12; + ESP		03.2123-2923.3 010791	ATE Ø 23,8
RENAULT - CLIO IV (BH_) 11/12→							
 Hauptbremszylinder							
0.9 TCe 75	56	05/18→		für Linkslenker		24.4120-1771.3 011076	Ø 20,6 ohne Bremsflüssigkeitsbehälter
0.9 TCe 90	66	11/12→					
0.9 TCe 90 LPG	66	06/16→					
1.2 16V	54 - 55	11/12→					
1.2 LPG	53	01/14→					
1.2 LPG 16V	54	11/12→06/15					
1.2 TCe 120	87 - 88	03/13→		für Linkslenker		24.4123-1723.3 011074	Ø 23,8 ohne Bremsflüssigkeitsbehälter
→							

	kw					! #		
RENAULT - CLIO IV (BH_) 11/12→								
 Hauptbremszylinder								
1.2 TCe 120	87 - 88	03/13→			für Rechtslenker		24.4123-1724.3 011075	TRW Ø 23,8 ohne Bremsflüssigkeitsbehälter
1.5 dCi	62 - 63	11/12→			für Linkslenker; Schaltgetriebe		24.4120-1771.3 011076	Ø 20,6 ohne Bremsflüssigkeitsbehälter
1.5 dCi 110	81	06/16→			für Linkslenker; Automatikgetriebe		24.4123-1723.3 011074	Ø 23,8 ohne Bremsflüssigkeitsbehälter
1.5 dCi 90	66	11/12→			für Rechtslenker; Automatikgetriebe		24.4123-1724.3 011075	TRW Ø 23,8 ohne Bremsflüssigkeitsbehälter
1.5 dCi 75	55	11/12→			für Linkslenker; Schaltgetriebe		24.4120-1771.3 011076	Ø 20,6 ohne Bremsflüssigkeitsbehälter
RENAULT - CLIO IV Grandtour (KH_) 11/12→								
 Hauptbremszylinder								
0.9 TCe 75	56	08/18→			für Linkslenker		24.4123-1723.3 011074	Ø 23,8 ohne Bremsflüssigkeitsbehälter
0.9 TCe 90	66	01/13→						
1.2 16V	54	01/13→						
1.2 TCe 120	87 - 88	03/13→						
1.5 dCi 110	81	06/16→						
1.5 dCi 75	55	01/13→						
1.5 dCi 90	66	11/12→						
RENAULT - CLIO IV Kasten/Kombi (KH_) 01/13→								
 Hauptbremszylinder								
0.9 TCe 90	66	01/14→			für Linkslenker		24.4123-1723.3 011074	Ø 23,8 ohne Bremsflüssigkeitsbehälter
1.5 dCi 75	55	01/14→						
1.5 dCi 90	66	01/14→						
RENAULT - CLIO IV Kasten/Schrägheck (BH_) 01/14→								
 Hauptbremszylinder								
0.9 TCe 90	66	01/14→			für Linkslenker		24.4120-1771.3 011076	Ø 20,6 ohne Bremsflüssigkeitsbehälter
0.9 TCe 90 LPG	66	08/15→						
1.2 16V	54 - 55	01/14→						
1.2 16V LPG	53	01/14→						
1.5 dCi 75	55	01/14→			für Linkslenker; Schaltgetriebe		24.4120-1771.3 011076	Ø 20,6 ohne Bremsflüssigkeitsbehälter
1.5 dCi 90	66	01/14→			für Linkslenker; Schaltgetriebe		24.4120-1771.3 011076	Ø 20,6 ohne Bremsflüssigkeitsbehälter
					für Linkslenker; Automatikgetriebe		24.4123-1723.3 011074	Ø 23,8 ohne Bremsflüssigkeitsbehälter
					für Rechtslenker; Automatikgetriebe		24.4123-1724.3 011075	TRW Ø 23,8 ohne Bremsflüssigkeitsbehälter
RENAULT - DOKKER 12/13→								
 Hauptbremszylinder								
1.5 dCi	66	12/13→			- ESP		24.4152-0381.3 011032	ATE Ø 22,2 ohne Bremsflüssigkeitsbehälter
1.6	62	12/13→			+ ESP		24.4152-0391.3 011033	ATE Ø 22,2 ohne Bremsflüssigkeitsbehälter
RENAULT - DUSTER (HS_) 01/11→								
 Bremskraftverstärker								
1.5 dCi	63	02/12→			→ 10/13; + ABS		03.7853-4602.4 300302	ATE Ø 9" pneumatisch
1.6 16V	76	02/12→						
1.5 dCi 4x4	66	06/11→			für Linkslenker; + ABS		03.7853-4602.4 300302	ATE Ø 9" pneumatisch
1.6 16V	75 - 84	02/12→						
1.6 16V 4x4	75 - 84	06/11→						
2.0	98 - 105	10/11→						
2.0 4x4	99 - 105	10/11→						
1.5 dCi 4x4	80	09/13→01/18			+ ABS		03.7853-4602.4 300302	ATE Ø 9" pneumatisch
 Hauptbremszylinder								
1.5 dCi	63	02/12→			→ 10/13; - ESP		03.2122-2031.3 010938	ATE Ø 22,2
1.6 16V	76	02/12→			→ 10/13; + ESP		03.2122-2261.3 010964	ATE Ø 22,2
					11/13→; + ABS / - ESP		24.4152-0381.3 011032	ATE Ø 22,2 ohne Bremsflüssigkeitsbehälter
→								

	kW			 	! #		
RENAULT - DUSTER (HS_) 01/11→							
 Hauptbremszylinder							
1.5 dCi 1.6 16V	63 76	02/12→ 02/12→		11/13→; + ABS / + ESP		24.4152-0391.3 011033	ATE Ø 22,2 ohne Bremsflüssigkeitsbehälter
1.5 dCi 4x4 1.6 16V	66 75 - 84	06/11→ 02/12→		für Linkslenker; + ABS		03.2122-2031.3 010938	ATE Ø 22,2
1.6 16V 4x4 2.0 2.0 4x4	84 75 - 84 98 - 105	06/11→ 10/11→ 10/11→		für Linkslenker; + ESP		03.2122-2261.3 010964	ATE Ø 22,2
1.5 dCi 4x4	80	09/13→01/18		+ ABS / - ESP		03.2122-2031.3 010938	ATE Ø 22,2
				+ ABS / + ESP		03.2122-2261.3 010964	ATE Ø 22,2
RENAULT - ESPACE III (JEO_) 11/96→10/02							
 Hauptbremszylinder							
1.9 dTi 2.0	72 84 - 102	02/99→10/02 11/96→10/02		+ ABS		03.2123-1486.3 010488	Ø 23,8
2.0 16V	103	10/98→10/02		- ABS		03.2123-1546.3 010536	ATE Ø 23,8
2.2 12V TD 2.2 D	83 84	11/96→10/00 11/97→01/00		+ ABS		03.2123-1486.3 010488	Ø 23,8
3.0 3.0 V6 24V	123 140	11/96→10/98 10/98→10/02		- ABS		03.2123-1741.3 010537	ATE Ø 23,8
2.2 dCi	95	10/00→10/02				03.2123-1486.3 010488	Ø 23,8
2.2 dCi	85	07/00→10/02				03.2123-1741.3 010537	ATE Ø 23,8
RENAULT - ESPACE IV (JK0/1_) 11/02→							
 Bremskraftverstärker							
1.9 dCi 2.0 2.0 dCi 2.0 Turbo 2.2 dCi 3.0 dCi 3.5 V6	85 - 88 98 - 125 96 - 127 120 102 - 110 120 - 133 177	11/02→ 11/02→ 01/06→ 11/02→ 11/02→ 11/02→ 11/02→		für Linkslenker		03.7868-1602.4 300220	ATE Ø 10 / 8" pneumatisch
 Hauptbremszylinder							
1.9 dCi 2.0 2.0 Turbo 2.2 dCi 3.0 dCi 3.5 V6	85 - 88 98 - 100 120 110 130 177	11/02→ 11/02→12/15 11/02→ 11/02→08/06 11/02→08/06 11/02→		→ 12/04; + ESP		03.4125-0014.3 010794	ATE Ø 25,4
				- ESP		03.4125-0021.3 010888	ATE Ø 25,4
				01/05→; + ESP		03.4155-0043.3 010795	ATE Ø 25,4
2.0 2.0 dCi	125 96 - 127	04/05→ 01/06→		- ESP		03.4125-0021.3 010888	ATE Ø 25,4
2.2 dCi 3.0 dCi	102 120 - 133	02/06→ 09/05→		+ ESP		03.4155-0043.3 010795	ATE Ø 25,4
RENAULT - EXPRESS Kasten/Großraumlimousine 07/95→03/98							
 Hauptbremszylinder							
1.9 D	47	07/95→03/98				03.2120-2031.3 010106	ATE Ø 20,6
RENAULT - EXPRESS Pick-up 07/95→10/99							
 Hauptbremszylinder							
1.9 D	40	07/95→10/97		09/95→		03.2120-2031.3 010106	ATE Ø 20,6
1.9 D	47	07/95→10/99		→ 03/98		03.2120-2031.3 010106	ATE Ø 20,6
RENAULT - GRAND SCÉNIC II (JM0/1_) 04/04→06/09							
 Hauptbremszylinder							
1.5 dCi 1.6 →	74 76 77 - 83	04/04→11/08 04/04→11/08				24.2123-1760.3 010779 24.4123-1721.3 011052	TRW Ø 23,8 BOS Ø 23,8 ohne Bremsflüssigkeitsbehälter

	kw			 	! #		
RENAULT - GRAND SCÉNIC II (JM0/1_) 04/04→06/09							
 Hauptbremszylinder							
1.9 dCi	81 - 88	04/04→01/09				24.2123-1760.3 010779	TRW Ø 23,8
2.0 dCi	110	09/05→11/08				24.4123-1721.3 011052	BOS Ø 23,8 ohne Bremsflüssigkeitsbehälter
1.5 dCi	78	05/05→01/09		06/06→		24.2123-1760.3 010779 24.4123-1721.3 011052	TRW Ø 23,8 BOS Ø 23,8 ohne Bremsflüssigkeitsbehälter
1.6 Flex	82	06/06→06/09		→ 03/09		24.2123-1760.3 010779 24.4123-1721.3 011052	TRW Ø 23,8 BOS Ø 23,8 ohne Bremsflüssigkeitsbehälter
1.9 dCi	96	04/04→02/08		05/05→		24.2123-1760.3 010779 24.4123-1721.3 011052	TRW Ø 23,8 BOS Ø 23,8 ohne Bremsflüssigkeitsbehälter
2.0	99 - 120	04/04→06/09		→ 03/09		24.2123-1760.3 010779 24.4123-1721.3 011052	TRW Ø 23,8 BOS Ø 23,8 ohne Bremsflüssigkeitsbehälter
RENAULT - GRAND SCÉNIC III (JZ0/1_) 02/09→							
 Hauptbremszylinder							
1.2 TCe	85 - 96	04/12→				24.4123-1715.3 010980	TRW Ø 23,8
1.4 16V	96	02/09→					
1.5 dCi	63 - 81	02/09→					
1.6 16V	81	02/09→					
1.6 16V Bifuel	79 - 81	02/09→					
1.6 dCi	96	04/11→					
1.6 E85	81	02/09→					
1.9 dCi	96	02/09→					
2.0 16V	103	02/09→					
2.0 dCi	110 - 118	02/09→					
1.2 TCe	97	01/13→		03/13→		24.4123-1715.3 010980	TRW Ø 23,8
RENAULT - KADJAR (HA_, HL_) 06/15→							
 Hauptbremszylinder							
1.2 TCe 130	96	06/15→		für Linkslenker		24.4123-1728.3 011089	Ø 23,8 ohne Bremsflüssigkeitsbehälter
1.3 TCe 140	103	08/18→					
1.3 TCe 160	116 - 117	08/18→					
1.5 BLUE dCi 115	85	08/18→					
1.5 dCi 110	81	06/15→					
1.6 dCi 130	96	06/15→					
1.6 dCi 130 4x4	96	06/15→					
1.6 TCe 165	120	11/16→					
1.7 Blue dCi 150	110	08/18→					
1.7 Blue dCi 150 4WD	110	08/18→					
RENAULT - KANGOO / GRAND KANGOO II (KW0/1_) 02/08→							
 Hauptbremszylinder							
1.2 TCe 115	84	07/13→		+ ABS; → 12/14		24.4122-1720.3 011065	ATE Ø 22,2 ohne Bremsflüssigkeitsbehälter
1.5 dCi	78	02/08→					
1.5 dCi 105	76	02/08→					
1.5 dCi 110	80 - 81	09/10→					
1.5 dCi 70	50	02/08→					
1.5 dCi 75	55	11/12→					
1.5 dCi 85	63	02/08→					
1.5 dCi 90	66	06/08→					
1.6	64	02/08→					
1.6 16V	78	02/08→					
1.6 16V FLEX	78	02/08→					
1.6 16V LPG	78	12/08→					
RENAULT - KANGOO (KC0/1_) 08/97→							
 Hauptbremszylinder							
1.0	50	01/02→01/07		für Linkslenker		24.2122-1727.3 010586	BDX Ø 22,2
1.0 RN	43	01/02→01/07					
1.2	43	08/97→		03/98→ 12/07; - ABS		24.2122-1727.3 010586	BDX Ø 22,2
1.4	55	08/97→					
D 55 1.9	40	08/97→					
1.2 16V	55	06/01→		→ 12/07; - ABS		24.2122-1727.3 010586	BDX Ø 22,2
1.5 dCi	45 - 60	12/01→					
→							

	kw					! #		
RENAULT - KANGOO (KC0/1_) 08/97→								
 Hauptbremszylinder								
1.6 16V	70	06/01→			→ 12/07; - ABS		24.2122-1727.3 010586	BDX Ø 22,2
1.6 16V 4x4	70	10/01→						
1.9 dCi 4x4	59	10/01→						
	62							
1.9 dTi	59	02/00→						
1.9 RXED	48	09/99→06/01			- ABS		24.2122-1727.3 010586	BDX Ø 22,2
D 65 1.9	47	08/97→06/01			03/98→; - ABS		24.2122-1727.3 010586	BDX Ø 22,2
RENAULT - KANGOO BE BOP (KW0/1_) 02/09→								
 Hauptbremszylinder								
1.5 dCi	66 - 80	02/09→			→ 12/10; + ABS		24.4122-1720.3 011065	ATE Ø 22,2 ohne Bremsflüssigkeitsbehälter
1.5 dCi 75	55	09/10→						
1.6	78	02/09→12/12						
RENAULT - KANGOO Express (FC0/1_) 08/97→								
 Hauptbremszylinder								
1.0	43	01/02→01/07			für Linkslenker		24.2122-1727.3 010586	BDX Ø 22,2
1.0	50	01/02→01/07			07/03→; - ABS		24.2122-1727.3 010586	BDX Ø 22,2
1.2	43	08/97→			03/98→ 12/07; - ABS		24.2122-1727.3 010586	BDX Ø 22,2
1.4	55	08/97→06/08						
D 55 1.9	40	08/97→						
D 65 1.9	47	08/97→						
1.2	44	07/98→07/01			- ABS		24.2122-1727.3 010586	BDX Ø 22,2
1.2 BiFuel	43	07/98→07/01						
1.6	66	09/99→06/01						
1.9 D	48	09/99→06/03						
1.2 16V	55	10/01→			→ 12/07; - ABS		24.2122-1727.3 010586	BDX Ø 22,2
1.5 dCi	42 - 62	12/01→						
1.6 16V	70	10/01→						
1.6 16V 4x4	70	10/01→						
1.6 16V bivalent	60	06/05→						
1.6 Flex	72	03/07→12/18						
1.9 dCi	62	07/03→						
1.9 dCi 4x4	59 - 62	10/01→						
1.9 dTi	59	02/00→						
RENAULT - KANGOO Express (FW0/1_) 02/08→								
 Hauptbremszylinder								
1.2 TCe 115	84	07/13→			+ ABS; → 12/14		24.4122-1720.3 011065	ATE Ø 22,2 ohne Bremsflüssigkeitsbehälter
1.5 dCi 105	76	02/08→						
1.5 dCi 110	80 - 81	09/10→						
1.5 dCi 70	50	02/08→						
1.5 dCi 75	55	09/10→						
1.5 dCi 85	63	02/08→						
1.5 dCi 90	66	06/09→						
1.6	64	02/08→						
1.6 16V	78	02/08→						
1.6 16V FLEX	78	02/08→						
1.6 16V LPG	78	02/08→						
Z.E.	44	10/11→						
RENAULT - KAPTUR (H5_) 03/16→								
 Hauptbremszylinder								
1.6	84	03/16→					24.4152-0391.3 011033	ATE Ø 22,2 ohne Bremsflüssigkeitsbehälter
2.0 4WD	105	03/16→						
RENAULT - KOLEOS II (HC_) 04/16→								
 Hauptbremszylinder								
1.6 dCi 130	96	04/16→			für Linkslenker		24.4123-1728.3 011089	Ø 23,8 ohne Bremsflüssigkeitsbehälter
1.7 BLUE dCi 150	110	06/19→						
2.0 BLUE DCI 185	135	01/20→						
2.0 BLUE DCI 185 4WD	135	01/20→						
2.0 BLUE dCi 190 4WD	140	06/19→						
2.0 dCi 175	130	04/16→						
2.0 dCi 175 4WD	130	04/16→						
2.0 TCe	107	04/16→						
2.5 Sce	126	04/16→						
2.5 Sce 4WD	126	04/16→						

RENAULT - LAGUNA I (B56_, 556_) 11/93→08/02

Hauptbremszylinder











1.6 16V	79	11/97→03/01	02/99→ 02/01	24.2123-1701.3	010424	Ø 23,8
1.8 16V	88	04/98→03/01	→ 01/99	24.2123-1725.3	010549	Ø 23,8
1.9 dTi	72	10/97→03/01				
3.0 24V	140	03/97→03/01				
1.8	69 - 70	06/95→02/01	- ABS	03.2122-1001.3	010562	Ø 22,2
			→ 01/97; + ABS	10.6123-0312.3	010457	ATE Ø 23,8
			02/97→; + ABS	24.2123-1725.3	010549	Ø 23,8
1.8	66 - 69	11/93→03/01	→ 02/01; - ABS	03.2122-1001.3	010562	Ø 22,2
			→ 01/97; + ABS	10.6123-0312.3	010457	ATE Ø 23,8
			02/97→ 02/01; + ABS	24.2123-1725.3	010549	Ø 23,8
2.2 D	61	11/93→03/01				
			02/97→ 02/01; + ABS	24.2123-1725.3	010549	Ø 23,8
1.8	66	08/95→03/01	02/99→ 02/01; + ABS	24.2123-1701.3	010424	Ø 23,8
			02/97→ 02/01; + ABS	24.2123-1725.3	010549	Ø 23,8
1.9 dCi	79	09/99→03/01	→ 02/01	24.2123-1701.3	010424	Ø 23,8
2.0	80	03/99→03/01				
2.0 16V	103	09/99→03/01				
2.0	84	06/95→02/01	→ 01/97; + ABS	10.6123-0312.3	010457	ATE Ø 23,8
			02/97→ 02/01; + ABS	24.2123-1725.3	010549	Ø 23,8
2.0 16V	102	06/95→03/01	→ 02/01; + ABS	10.6123-0312.3	010457	ATE Ø 23,8
			02/99→ 02/01; + ABS	24.2123-1701.3	010424	Ø 23,8
			02/97→ 01/99; + ABS	24.2123-1725.3	010549	Ø 23,8
			→ 02/01; - ABS	24.2123-1725.3	010549	Ø 23,8
2.2 dT	83	03/96→03/01	→ 01/97; + ABS	10.6123-0312.3	010457	ATE Ø 23,8
			02/99→ 02/01; + ABS	24.2123-1701.3	010424	Ø 23,8
			02/97→ 01/99; + ABS	24.2123-1725.3	010549	Ø 23,8
			→ 02/01; - ABS	24.2123-1725.3	010549	Ø 23,8
3.0	123	11/93→03/01	→ 01/97; + ABS	10.6123-0312.3	010457	ATE Ø 23,8
			02/97→ 02/01	24.2123-1725.3	010549	Ø 23,8







RENAULT - LAGUNA I Grandtour (K56_) 09/95→08/02











Hauptbremszylinder

















1.6 16V	79	11/97→03/01	02/99→ 02/01	24.2123-1701.3	010424	Ø 23,8
1.8 16V	88	04/98→03/01	→ 01/99	24.2123-1725.3	010549	Ø 23,8
1.9 dTi	72	10/97→03/01				
3.0 24V	140	03/97→03/01				
1.8	66	09/95→03/01	→ 01/97; + ABS	10.6123-0312.3	010457	ATE Ø 23,8
			02/99→ 02/01; + ABS	24.2123-1701.3	010424	Ø 23,8
			02/97→ 01/99; + ABS	24.2123-1725.3	010549	Ø 23,8
			02/97→ 02/01; + ABS	24.2123-1725.3	010549	Ø 23,8
			→ 02/01; - ABS	24.2123-1725.3	010549	Ø 23,8
1.8	69	09/95→03/01	→ 01/97; + ABS	10.6123-0312.3	010457	ATE Ø 23,8
			02/97→ 02/01; + ABS	24.2123-1725.3	010549	Ø 23,8
2.2 D	61	09/95→03/01	→ 02/01; - ABS	24.2123-1725.3	010549	Ø 23,8
1.9 dCi	79	09/99→03/01	→ 02/01	24.2123-1701.3	010424	Ø 23,8
2.0	84	10/98→01/01	+ ABS	10.6123-0312.3	010457	ATE Ø 23,8
			- ABS	24.2123-1725.3	010549	Ø 23,8
2.0	83	09/95→03/01	→ 02/01; + ABS	10.6123-0312.3	010457	ATE Ø 23,8
			11/95→ 01/97; + ABS	10.6123-0312.3	010457	ATE Ø 23,8
			→ 01/97; + ABS	10.6123-0312.3	010457	ATE Ø 23,8
			02/99→ 02/01; + ABS	24.2123-1701.3	010424	Ø 23,8
			11/95→ 02/01; - ABS	24.2123-1725.3	010549	Ø 23,8
			02/97→ 01/99; + ABS	24.2123-1725.3	010549	Ø 23,8
			02/97→ 02/01; + ABS	24.2123-1725.3	010549	Ø 23,8
			→ 02/01	24.2123-1725.3	010549	Ø 23,8
			→ 02/01; - ABS	24.2123-1725.3	010549	Ø 23,8
2.0 16V	102	09/95→03/01	→ 02/01; + ABS	10.6123-0312.3	010457	ATE Ø 23,8
			→ 01/97; + ABS	10.6123-0312.3	010457	ATE Ø 23,8
			02/99→ 02/01; + ABS	24.2123-1701.3	010424	Ø 23,8
			09/99→ 02/01	24.2123-1701.3	010424	Ø 23,8
			02/97→ 01/99	24.2123-1725.3	010549	Ø 23,8
2.2 dT	83	03/96→03/01	→ 02/01; - ABS	24.2123-1725.3	010549	Ø 23,8
			→ 01/97; + ABS	10.6123-0312.3	010457	ATE Ø 23,8
			02/99→ 02/01; + ABS	24.2123-1701.3	010424	Ø 23,8













→

	kw					! #		
RENAULT - LAGUNA I Grandtour (K56_) 09/95→08/02								
 Hauptbremszylinder								
2.2 dT	83	03/96→03/01		02/97→ 01/99; + ABS			24.2123-1725.3 010549	Ø 23,8
				→ 02/01; - ABS			24.2123-1725.3 010549	Ø 23,8
3.0	123	02/96→03/01		03/96→ 01/97; + ABS			10.6123-0312.3 010457	ATE Ø 23,8
				→ 02/01; + ABS			10.6123-0312.3 010457	ATE Ø 23,8
				02/97→ 02/01			24.2123-1725.3 010549	Ø 23,8
RENAULT - LAGUNA II (BG0/1_) 03/01→12/07								
 Bremskraftverstärker								
1.6 1.6 16V 1.6 LPG 1.8 16V	76 79 79 86 - 89	03/01→05/05 03/01→05/05 03/01→05/05 03/01→05/05		06/01→; für Linkslenker			03.7873-1202.4 300197	ATE Ø 11" pneumatisch
1.6 16V 1.9 dCi 2.0 16V 2.0 dCi 2.2 dCi	82 79 - 96 99 - 150 127 102	02/05→08/07 03/01→12/07 08/02→12/07 01/06→08/07 05/05→08/07		→ 06/07; für Linkslenker			03.7873-1202.4 300197	ATE Ø 11" pneumatisch
1.8 16V 1.9 dCi 2.0 16V IDE 3.0 V6 24V	85 - 88 88 103 152	03/01→12/07 03/01→09/07 04/01→09/07 03/01→08/07		06/01→ 06/07; für Linkslenker			03.7873-1202.4 300197	ATE Ø 11" pneumatisch
1.9 dCi 1.9 dCi 2.0 16V 2.0 16V Turbo 2.0 dCi 2.2 dCi	68 - 74 77 98 120 110 85 - 110	10/01→05/05 06/01→05/05 08/02→12/06 01/03→03/05 08/05→08/06 10/01→08/06		für Linkslenker			03.7873-1202.4 300197	ATE Ø 11" pneumatisch
Pedalwegsensord, Bremspedal								
1.6 1.6 16V 1.6 LPG 1.8 16V	76 79 79 86 - 89	03/01→05/05 03/01→05/05 03/01→05/05 03/01→05/05		→ 05/01; für Linkslenker			03.0655-0007.2 370007	ATE
				für Rechtslenker			03.0655-0007.2 370007	ATE
1.6 16V 1.9 dCi 2.0 16V 2.0 dCi 2.2 dCi	82 79 - 96 99 - 150 127 102	02/05→08/07 03/01→12/07 08/02→12/07 01/06→08/07 05/05→08/07		→ 06/07; für Rechtslenker			03.0655-0007.2 370007	ATE
1.8 16V 1.9 dCi 2.0 16V IDE 3.0 V6 24V	85 - 88 88 103 152	03/01→12/07 03/01→09/07 04/01→09/07 03/01→08/07		→ 05/01; für Linkslenker			03.0655-0007.2 370007	ATE
				→ 06/07; für Rechtslenker			03.0655-0007.2 370007	ATE
1.9 dCi 1.9 dCi 2.0 16V 2.0 16V Turbo 2.0 dCi 2.2 dCi	68 - 74 77 98 120 110 85 - 110	10/01→05/05 06/01→05/05 08/02→12/06 01/03→03/05 08/05→08/06 10/01→08/06		für Rechtslenker			03.0655-0007.2 370007	ATE
2.9 V6 24V	155	03/01→08/07					03.0655-0007.2 370007	ATE
 Hauptbremszylinder								
1.6 1.6 16V 1.6 LPG 1.8 16V	76 79 79 86 - 89	03/01→05/05 03/01→05/05 03/01→05/05 03/01→05/05		→ 03/05			03.4123-0081.3 010585	ATE Ø 23,8
1.9 dCi 1.9 dCi 2.0 16V 2.2 dCi	68 - 74 77 98 85 - 110	10/01→05/05 06/01→05/05 08/02→12/06 10/01→08/06		04/05→			03.4153-0063.3 010773	ATE Ø 23,8
1.6 16V 1.9 dCi 2.0 dCi →	82 85 - 96 127	02/05→08/07 05/05→12/07 01/06→08/07		→ 06/07			03.4153-0063.3 010773	ATE Ø 23,8

	kw					! #		
RENAULT - LAGUNA II (BG0/1_) 03/01→12/07								
Hauptbremszylinder								
2.2 dCi	102	05/05→08/07		→ 06/07			03.4153-0063.3 010773	ATE Ø 23,8
1.8 16V	85 - 88	03/01→12/07		→ 03/05			03.4123-0081.3 010585	ATE Ø 23,8
1.9 dCi	79 - 88	03/01→09/07		04/05→ 06/07			03.4153-0063.3 010773	ATE Ø 23,8
2.0 16V	99 - 150	08/02→12/07						
2.0 16V IDE	103	04/01→09/07						
3.0 V6 24V	152	03/01→08/07						
2.0 16V Turbo	120	01/03→03/05					03.4153-0063.3 010773	ATE Ø 23,8
2.0 dCi	110	08/05→08/06						
2.9 V6 24V	155	03/01→08/07					03.4123-0081.3 010585	ATE Ø 23,8
Verschlusschraube, Hauptbremszylinder								
1.6	76	03/01→05/05		→ 03/05; - ESP			03.3517-0300.1 390323	
1.6 16V	79	03/01→05/05						
1.6 LPG	79	03/01→05/05						
1.8 16V	85 - 89	03/01→12/07						
1.9 dCi	68 - 88	03/01→09/07						
1.9 dCi	77	06/01→05/05						
2.0 16V	98 - 150	08/02→12/07						
2.0 16V IDE	103	04/01→09/07						
2.2 dCi	85 - 110	10/01→08/06						
3.0 V6 24V	152	03/01→08/07						
2.9 V6 24V	155	03/01→08/07		- ESP			03.3517-0300.1 390323	
RENAULT - LAGUNA II Grandtour (KG0/1_) 03/01→12/07								
Bremskraftverstärker								
1.6	76	03/01→10/05		06/01→; für Linkslenker			03.7873-1202.4 300197	ATE Ø 11" pneumatisch
1.8 16V	85 - 89	03/01→05/05						
3.0 V6 24V	152	03/01→12/07						
1.6 16V	82	02/05→08/07		→ 06/07; für Linkslenker			03.7873-1202.4 300197	ATE Ø 11" pneumatisch
1.6 Bifuel	79	06/05→12/07						
1.9 dCi	79 - 96	03/01→12/07						
2.0 16V	98 - 150	08/02→12/07						
2.0 dCi	127	01/06→12/07						
2.2 dCi	102	05/05→12/07						
1.6 16V	79	03/01→12/07		06/01→ 06/07; für Linkslenker			03.7873-1202.4 300197	ATE Ø 11" pneumatisch
1.9 dCi	88	03/01→09/07						
2.0 16V IDE	103	04/01→09/07						
1.9 dCi	66	08/03→09/07		03/04→ 06/07; für Linkslenker			03.7873-1202.4 300197	ATE Ø 11" pneumatisch
1.9 dCi	68 - 74	10/01→05/05		für Linkslenker			03.7873-1202.4 300197	ATE Ø 11" pneumatisch
1.9 dCi	77	06/01→05/05						
2.0 16V Turbo	120	01/03→08/05						
2.0 dCi	110	08/05→08/06						
2.2 dCi	85 - 110	10/01→08/06						
2.9 V6 24V	155	10/03→12/07						
Pedalwegsensor, Bremspedal								
1.6	76	03/01→10/05		→ 05/01; für Linkslenker			03.0655-0007.2 370007	ATE
1.8 16V	85 - 89	03/01→05/05		für Rechtslenker			03.0655-0007.2 370007	ATE
3.0 V6 24V	152	03/01→12/07						
1.6 16V	82	02/05→08/07		→ 06/07; für Rechtslenker			03.0655-0007.2 370007	ATE
1.6 Bifuel	79	06/05→12/07						
1.9 dCi	79 - 96	03/01→12/07						
2.0 16V	98 - 150	08/02→12/07						
2.0 dCi	127	01/06→12/07						
2.2 dCi	102	05/05→12/07						
1.6 16V	79	03/01→12/07		→ 05/01; für Linkslenker			03.0655-0007.2 370007	ATE
2.0 16V IDE	103	04/01→09/07		→ 06/07; für Rechtslenker			03.0655-0007.2 370007	ATE
1.9 dCi	66	08/03→09/07		03/04→ 06/07; für Rechtslenker			03.0655-0007.2 370007	ATE
1.9 dCi	68 - 74	10/01→05/05		für Rechtslenker			03.0655-0007.2 370007	ATE
1.9 dCi	77	06/01→05/05						
2.0 16V Turbo	120	01/03→08/05						
2.0 dCi	110	08/05→08/06						
→								

	kW					! #		
RENAULT - LAGUNA II Grandtour (KG0/1_) 03/01→12/07								
Pedalwegsensord, Bremspedal								
2.2 dCi	85 - 110	10/01→08/06		für Rechtslenker			03.0655-0007.2 370007	ATE
2.9 V6 24V	155	10/03→12/07						
1.9 dCi	88	03/01→09/07		→ 05/01; für Linkslenker			03.0655-0007.2 370007	ATE
				06/01→ 06/07; für Rechtslenker			03.0655-0007.2 370007	ATE
 Hauptbremszylinder								
1.6	76	03/01→10/05		→ 03/05			03.4123-0081.3 010585	ATE Ø 23,8
1.8 16V	85 - 89	03/01→05/05		04/05→			03.4153-0063.3 010773	ATE Ø 23,8
1.9 dCi	68 - 74	10/01→05/05						
1.9 dCi	77	06/01→05/05						
2.2 dCi	85 - 110	10/01→08/06						
2.9 V6 24V	155	10/03→12/07						
3.0 V6 24V	152	03/01→12/07						
1.6 16V	79 - 82	03/01→12/07		→ 03/05			03.4123-0081.3 010585	ATE Ø 23,8
1.9 dCi	79 - 88	03/01→12/07		04/05→ 06/07			03.4153-0063.3 010773	ATE Ø 23,8
2.0 16V	98 - 99	08/02→12/07						
2.0 16V IDE	103	04/01→09/07						
1.6 Bifuel	79	06/05→12/07		→ 06/07			03.4153-0063.3 010773	ATE Ø 23,8
1.9 dCi	85 - 96	05/05→12/07						
2.0 16V	125 - 150	01/05→09/07						
2.0 dCi	127	01/06→12/07						
2.2 dCi	102	05/05→12/07						
1.9 dCi	66	08/03→09/07		03/04→ 03/05			03.4123-0081.3 010585	ATE Ø 23,8
				04/05→ 06/07			03.4153-0063.3 010773	ATE Ø 23,8
1.9 dCi	81	01/05→12/07		→ 03/05			03.4123-0081.3 010585	ATE Ø 23,8
				→ 06/07			03.4153-0063.3 010773	ATE Ø 23,8
2.0 16V Turbo	120	01/03→08/05					03.4153-0063.3 010773	ATE Ø 23,8
2.0 dCi	110	08/05→08/06						
Verschlusschraube, Hauptbremszylinder								
1.6	76	03/01→10/05		→ 03/05; - ESP			03.3517-0300.1 390323	
1.6 16V	79 - 82	03/01→12/07						
1.8 16V	85 - 89	03/01→05/05						
1.9 dCi	68 - 88	03/01→12/07						
1.9 dCi	77	06/01→05/05						
2.0 16V	98 - 99	08/02→12/07						
2.0 16V IDE	103	04/01→09/07						
2.2 dCi	85 - 110	10/01→08/06						
2.9 V6 24V	155	10/03→12/07						
3.0 V6 24V	152	03/01→12/07						
1.9 dCi	66	08/03→09/07		03/04→ 03/05; - ESP			03.3517-0300.1 390323	
RENAULT - LODGY (JS_) 07/13→								
 Hauptbremszylinder								
1.5 dCi	62	01/15→		- ESP			24.4152-0381.3 011032	ATE Ø 22,2 ohne Bremsflüssigkeitsbehälter
1.6	59	07/13→		+ ESP			24.4152-0391.3 011033	ATE Ø 22,2 ohne Bremsflüssigkeitsbehälter
RENAULT - LOGAN/STEPWAY II (L8_) 09/12→								
 Hauptbremszylinder								
1.2	55	11/13→		für Linkslenker; + ABS			24.4120-1771.3 011076	Ø 20,6 ohne Bremsflüssigkeitsbehälter
1.2 16V LPG	53	11/13→						
1.5 dCi	62 - 66	12/13→						
1.6	59 - 83	11/13→						
RENAULT - LOGAN I (LS_) 09/04→								
 Bremskraftverstärker								
1.4	55	09/04→		→ 10/09; + ABS			03.7750-8532.4 300264	ATE Ø 9" pneumatisch
→								

	kw					! #		
RENAULT - LOGAN I (LS_) 09/04→								
 Bremskraftverstärker								
1.4 LPG	53	02/08→10/13		11/09→; + ABS		03.7853-4602.4	300302	ATE Ø 9" pneumatisch
1.5 dCi	48	04/06→10/13		→ 04/13; + ABS		03.7853-4602.4	300302	ATE Ø 9" pneumatisch
1.5 dCi	50 - 63	04/07→		→ 10/09; + ABS		03.7750-8532.4	300264	ATE Ø 9" pneumatisch
1.6	64 - 77	09/04→		11/09→ 04/13; + ABS		03.7853-4602.4	300302	ATE Ø 9" pneumatisch
 Hauptbremszylinder								
1.4	55	09/04→		+ ABS		24.2120-1754.3	010949	Ø 20,6
1.4 LPG	53	02/08→10/13		- ABS		24.2120-1762.3	011002	Ø 20,6 ohne Bremsflüssigkeitsbehälter
1.5 dCi	48 - 63	04/06→		+ ABS; → 04/13		24.2120-1754.3	010949	Ø 20,6
1.6	64 - 77	09/04→		- ABS; → 04/13		24.2120-1762.3	011002	Ø 20,6 ohne Bremsflüssigkeitsbehälter
RENAULT - LOGAN I Kombi (KS_) 04/07→								
 Bremskraftverstärker								
1.4	55	10/07→		→ 10/09; + ABS		03.7750-8532.4	300264	ATE Ø 9" pneumatisch
1.5 dCi	50 - 63	04/07→		11/09→ 04/13; + ABS		03.7853-4602.4	300302	ATE Ø 9" pneumatisch
1.6	64 - 77	04/07→						
1.5 dCi	66	06/11→06/15		→ 04/13; + ABS		03.7853-4602.4	300302	ATE Ø 9" pneumatisch
 Hauptbremszylinder								
1.4	55	10/07→		+ ABS; → 04/13		24.2120-1754.3	010949	Ø 20,6
1.5 dCi	50 - 66	04/07→		- ABS; → 04/13		24.2120-1762.3	011002	Ø 20,6 ohne Bremsflüssigkeitsbehälter
1.6	64 - 77	04/07→						
RENAULT - LOGAN II Kombi (K8_) 11/13→								
 Hauptbremszylinder								
1.2 16V	54	12/13→		für Linkslenker; + ABS		24.4120-1771.3	011076	Ø 20,6 ohne Bremsflüssigkeitsbehälter
1.2 16V LPG	53	12/13→						
1.5 dCi	62 - 66	12/13→						
1.6	59 - 78	12/13→						
RENAULT - LOGAN EXPRESS (US_) 04/07→								
 Bremskraftverstärker								
1.5 dCi	50	04/07→		→ 04/13; + ABS		03.7750-8532.4	300264	ATE Ø 9" pneumatisch
1.6	64	04/07→						
 Hauptbremszylinder								
1.5 dCi	50	04/07→		09/07→ 04/13; + ABS		03.2122-2031.3	010938	ATE Ø 22,2
1.6	64	04/07→						
RENAULT - MASTER I Bus (T_) 08/80→07/98								
 Hauptbremszylinder								
28-35 2.0	58	10/86→07/98		→ 08/94		24.2125-1704.3	010446	TRW Ø 25,4
28-35 2.1 D	44	08/80→07/98						
28-35 2.5 D	55	08/89→07/98				24.2125-1704.3	010446	TRW Ø 25,4
30 2.2	67	08/80→07/98						
35 2	69	08/89→07/98						
5 TD	69	08/89→07/98						
RENAULT - MASTER I Kasten (T_) 07/80→07/98								
 Hauptbremszylinder								
28-35 2	55 - 72	08/89→07/98				24.2125-1704.3	010446	TRW Ø 25,4
5 D	55	08/89→07/98						
5 TD	69 - 72	08/89→07/98						
28-35 2.0	58	10/86→07/98						
28-35 2.1 D	44	08/80→07/98						
30 2.2	67	08/80→07/98						
35 2	69	08/89→07/98						

	kw					! #		
RENAULT - MASTER I Pritsche/Fahrgestell (P_) 07/80→07/98								
 Hauptbremszylinder								
28-35 2.0	58	10/86→07/98					24.2125-1704.3 010446	TRW Ø 25,4
28-35 2.5 D	52	09/80→07/98		08/89→			24.2125-1704.3 010446	TRW Ø 25,4
RENAULT - MASTER II Bus (JD) 03/98→								
 Hauptbremszylinder								
1.9 dCi 80	60	11/01→		→ 10/03; + ABS			24.2025-1706.3 010676	Ø 25,4
1.9 dTI	59	09/00→		11/03→ 08/06; - ABS			24.2025-1708.3 010692	Ø 25,4
2.2 dCi 90	66	09/00→		→ 10/03; - ABS			24.2025-1708.3 010692	Ø 25,4
2.5 dCi 120	84	10/01→		11/03→ 08/06; + ABS			24.2123-1759.3 010768	BOS Ø 23,8
2.5 D	59	07/98→01/01		+ ABS			24.2025-1706.3 010676	Ø 25,4
2.8 dTI	84	07/98→10/01		- ABS			24.2025-1708.3 010692	Ø 25,4
2.5 dCi	74 - 107	08/06→		- ABS; → 12/10			24.2025-1708.3 010692	Ø 25,4
2.5 dCi 100	73	10/03→		→ 08/06; - ABS			24.2025-1708.3 010692	Ø 25,4
3.0 dCi 140	100	10/03→		→ 08/06; + ABS			24.2123-1759.3 010768	BOS Ø 23,8
RENAULT - MASTER II Kasten (FD) 07/98→								
 Hauptbremszylinder								
1.9 dCi 80	60	11/01→		→ 10/03; + ABS			24.2025-1706.3 010676	Ø 25,4
1.9 dTI	59	09/00→		11/03→ 08/06; - ABS			24.2025-1708.3 010692	Ø 25,4
2.2 dCi 90	66	09/00→		→ 10/03; - ABS			24.2025-1708.3 010692	Ø 25,4
2.5 dCi 120	84	10/01→		11/03→ 08/06; + ABS			24.2123-1759.3 010768	BOS Ø 23,8
2.5 D	59	07/98→01/01		+ ABS			24.2025-1706.3 010676	Ø 25,4
2.8 D	63	01/02→09/04		- ABS			24.2025-1708.3 010692	Ø 25,4
2.8 dTI	84	07/98→10/01		- ABS			24.2025-1708.3 010692	Ø 25,4
2.5 dCi	74	08/06→01/10		- ABS			24.2025-1708.3 010692	Ø 25,4
2.5 dCi	85	10/04→02/12		- ABS			24.2025-1708.3 010692	Ø 25,4
				+ ABS			24.2123-1759.3 010768	BOS Ø 23,8
2.5 dCi	88 - 107	08/06→		- ABS; → 12/10			24.2025-1708.3 010692	Ø 25,4
2.5 dCi 100	73	10/03→		→ 08/06; - ABS			24.2025-1708.3 010692	Ø 25,4
3.0 dCi 140	100	10/03→10/06		→ 08/06; + ABS			24.2123-1759.3 010768	BOS Ø 23,8
RENAULT - MASTER II Pritsche/Fahrgestell (ED/HD/UD) 07/98→								
 Hauptbremszylinder								
2.2 dCi 90	66	09/00→		→ 10/03; + ABS			24.2025-1706.3 010676	Ø 25,4
2.5 dCi 120	84	10/01→		11/03→ 08/06; - ABS			24.2025-1708.3 010692	Ø 25,4
				→ 10/03; - ABS			24.2025-1708.3 010692	Ø 25,4
				11/03→ 08/06; + ABS			24.2123-1759.3 010768	BOS Ø 23,8
2.5 D	59	07/98→01/01		+ ABS			24.2025-1706.3 010676	Ø 25,4
2.8 dTI	84	07/98→10/01		- ABS			24.2025-1708.3 010692	Ø 25,4
2.5 dCi	74 - 107	08/06→		- ABS; → 12/10			24.2025-1708.3 010692	Ø 25,4
2.5 dCi 100	73	10/03→		→ 08/06; - ABS			24.2025-1708.3 010692	Ø 25,4
3.0 dCi 140	100	10/03→		→ 08/06; + ABS			24.2123-1759.3 010768	BOS Ø 23,8
RENAULT - MASTER III Bus (JV) 02/11→								
 Bremskraftverstärker								
2.3 dCi 100 FWD	74	02/11→					03.7868-5202.4 300309	ATE Ø 10 / 8" pneumatisch
2.3 dCi 110 FWD	81	09/14→						
2.3 dCi 125 FWD	92	02/11→						
2.3 dCi 135 FWD	100	07/14→						
2.3 dCi 145 FWD	107	02/11→						
2.3 dCi 165 FWD	120	07/14→						
2.3 dCi 170 FWD	125	07/15→						
2.3 dCi 180 FWD	132	01/20→						
2.3 dCi 150 FWD	110	10/12→		01/13→			03.7868-5202.4 300309	ATE Ø 10 / 8" pneumatisch
 Hauptbremszylinder								
2.3 dCi 100 FWD	74	02/11→					03.2126-3121.3 010967	ATE Ø 27
2.3 dCi 110 FWD	81	09/14→						
2.3 dCi 125 FWD	92	02/11→						
2.3 dCi 135 FWD	100	07/14→						
2.3 dCi 145 FWD	107	02/11→						
2.3 dCi 165 FWD	120	07/14→						
2.3 dCi 170 FWD	125	07/15→						
2.3 dCi 180 FWD	132	01/20→						
2.3 dCi 150 FWD	110	10/12→		01/13→			03.2126-3121.3 010967	ATE Ø 27



RENAULT - MASTER III Kasten (FV) 02/10→

	Bremskraftverstärker							
2.3 dCi 100 FWD	74	02/10→				03.7868-5202.4	300309	ATE Ø 10 / 8" pneumatisch
2.3 dCi 100 RWD	74	02/10→						
2.3 dCi 110 FWD	81	09/14→						
2.3 dCi 125 FWD	92	02/10→						
2.3 dCi 125 RWD	92	02/10→						
2.3 dCi 130 FWD	96	06/16→						
2.3 dCi 130 RWD	96	03/12→						
2.3 dCi 135 FWD	100	07/14→						
2.3 dCi 135 RWD	100	07/14→						
2.3 dCi 145 FWD	107	02/10→						
2.3 dCi 145 RWD	107	02/10→						
2.3 dCi 150 FWD	110	03/13→						
2.3 dCi 150 RWD	110	03/13→						
2.3 dCi 165 FWD	120	07/14→						
2.3 dCi 165 RWD	120	07/14→						
2.3 dCi 170 FWD	125	07/15→						
2.3 dCi 180 FWD	132	07/19→						
Z.E.	57	03/18→						

	Hauptbremszylinder						
--	---------------------------	--	--	--	--	--	--

2.3 dCi 100 FWD	74	02/10→				03.2126-3121.3	010967	ATE Ø 27
2.3 dCi 100 RWD	74	02/10→						
2.3 dCi 110 FWD	81	09/14→						
2.3 dCi 125 FWD	92	02/10→						
2.3 dCi 125 RWD	92	02/10→						
2.3 dCi 130 FWD	96	06/16→						
2.3 dCi 130 RWD	96	03/12→						
2.3 dCi 135 FWD	100	07/14→						
2.3 dCi 135 RWD	100	07/14→						
2.3 dCi 145 FWD	107	02/10→						
2.3 dCi 145 RWD	107	02/10→						
2.3 dCi 150 FWD	110	03/13→						
2.3 dCi 150 RWD	110	03/13→						
2.3 dCi 165 FWD	120	07/14→						
2.3 dCi 165 RWD	120	07/14→						
2.3 dCi 170 FWD	125	07/15→						
2.3 dCi 180 FWD	132	07/19→						
Z.E.	57	03/18→						







RENAULT - MASTER III Pritsche/Fahrgestell (EV, HV, UV) 02/10→

	Bremskraftverstärker						
--	-----------------------------	--	--	--	--	--	--









2.3 dCi 100 FWD	74	02/10→				03.7868-5202.4	300309	ATE Ø 10 / 8" pneumatisch
2.3 dCi 100 RWD	74	02/10→						
2.3 dCi 110 FWD	81	09/14→						
2.3 dCi 125 FWD	92	02/10→						
2.3 dCi 125 RWD	92	02/10→						
2.3 dCi 130 FWD	96	03/12→						
2.3 dCi 130 RWD	96	07/16→						
2.3 dCi 135 FWD	100	07/14→						
2.3 dCi 135 RWD	100	07/14→						
2.3 dCi 145 FWD	107	02/10→						
2.3 dCi 145 RWD	107	02/10→						
2.3 dCi 150 FWD	110	03/13→						
2.3 dCi 150 RWD	110	03/13→						
2.3 dCi 165 FWD	120	07/14→						
2.3 dCi 165 RWD	120	07/14→						
2.3 dCi 170 FWD	125	06/16→						
2.3 dCi 180 FWD	132	07/19→						
Z.E.	57	03/18→						











	Hauptbremszylinder						
--	---------------------------	--	--	--	--	--	--

2.3 dCi 100 FWD	74	02/10→				03.2126-3121.3	010967	ATE Ø 27
2.3 dCi 100 RWD	74	02/10→						
2.3 dCi 110 FWD	81	09/14→						
2.3 dCi 125 FWD	92	02/10→						
2.3 dCi 125 RWD	92	02/10→						
2.3 dCi 130 FWD	96	03/12→						
2.3 dCi 130 RWD	96	07/16→						
2.3 dCi 135 FWD	100	07/14→						
2.3 dCi 135 RWD	100	07/14→						
2.3 dCi 145 FWD	107	02/10→						
2.3 dCi 145 RWD	107	02/10→						
2.3 dCi 150 FWD	110	03/13→						
2.3 dCi 150 RWD	110	03/13→						
2.3 dCi 165 FWD	120	07/14→						
2.3 dCi 165 RWD	120	07/14→						
2.3 dCi 170 FWD	125	06/16→						
2.3 dCi 180 FWD	132	07/19→						
Z.E.	57	03/18→						







	kw			 	! #		
RENAULT - MEGANE I (BA0/1_) 08/95→12/04							
Bremskraftverstärker							
1.4 16V	70	03/99→08/03		→ 12/02; + ABS; für Linkslenker	03.7760-5502.4 300151	ATE Ø 10" pneumatisch	
				→ 12/02; - ABS	03.7863-2002.4 300126	ATE Ø 10" pneumatisch	
1.4 e	55	01/96→08/03		03/99→ 12/02; + ABS; für Linkslenker	03.7760-5502.4 300151	ATE Ø 10" pneumatisch	
				03/99→ 12/02; - ABS	03.7760-5602.4 300121	ATE Ø 10" pneumatisch	
1.6 16V	81	11/01→12/04		→ 12/02; + ABS; für Linkslenker; für Fahrzeuge ohne verstärktes Fahrwerk	03.7760-5102.4 300140	ATE Ø 10" pneumatisch	
				→ 12/02; + ABS; für Linkslenker	03.7760-5502.4 300151	ATE Ø 10" pneumatisch	
				→ 12/02; + ABS; für Linkslenker; für Fahrzeuge mit verstärktem Fahrwerk	03.7863-2002.4 300126	ATE Ø 10" pneumatisch	
				→ 12/02; - ABS; für Fahrzeuge mit verstärktem Fahrwerk	03.7760-5502.4 300151	ATE Ø 10" pneumatisch	
				→ 12/02; - ABS	03.7760-5602.4 300121	ATE Ø 10" pneumatisch	
1.6 16V 1.6 LPG	79 80	03/99→08/02 10/00→08/02		+ ABS; für Linkslenker; für Fahrzeuge ohne verstärktes Fahrwerk	03.7760-5102.4 300140	ATE Ø 10" pneumatisch	
				+ ABS; für Linkslenker	03.7760-5502.4 300151	ATE Ø 10" pneumatisch	
				+ ABS; für Linkslenker; für Fahrzeuge mit verstärktem Fahrwerk	03.7863-2002.4 300126	ATE Ø 10" pneumatisch	
				- ABS	03.7760-5502.4 300151	ATE Ø 10" pneumatisch	
				- ABS; für Fahrzeuge mit verstärktem Fahrwerk	03.7760-5602.4 300121	ATE Ø 10" pneumatisch	
1.8 16V	85	01/01→08/03		→ 12/02; für Linkslenker	03.7760-5602.4 300121	ATE Ø 10" pneumatisch	
1.9 dCi	75	02/01→08/03		→ 12/02; + ABS; für Linkslenker	03.7863-2002.4 300126	ATE Ø 10" pneumatisch	
				→ 12/02; - ABS	03.7863-2002.4 300126	ATE Ø 10" pneumatisch	
				→ 12/02; - ABS	03.7760-5602.4 300121	ATE Ø 10" pneumatisch	
1.9 D Eco	47	01/96→08/03		06/98→ 12/02; + ABS; für Linkslenker	03.7760-5502.4 300151	ATE Ø 10" pneumatisch	
				06/98→ 12/02; - ABS	03.7760-5602.4 300121	ATE Ø 10" pneumatisch	
1.9 dTi	72	03/97→02/01		03/99→; für Linkslenker	03.7760-5102.4 300140	ATE Ø 10" pneumatisch	
1.9 dTi	59	02/01→08/03		→ 12/02; + ABS; für Linkslenker	03.7760-5602.4 300121	ATE Ø 10" pneumatisch	
				→ 12/02; + ABS; für Linkslenker	03.7863-2002.4 300126	ATE Ø 10" pneumatisch	
Hauptbremszylinder							
1.4 16V	70	03/99→08/03		→ 12/02; für Rechtslenker	03.2120-4441.3 010510	ATE Ø 20,6	
				→ 12/02; - ABS	03.2122-1541.3 010511	Ø 22,2	
1.4 e	55	01/96→08/03		→ 12/02; - ABS	03.2120-2031.3 010106	ATE Ø 20,6	
				06/98→ 02/99; - ABS	03.2120-2031.3 010106	ATE Ø 20,6	
				06/98→ 02/99; + ABS	03.2120-4441.3 010510	ATE Ø 20,6	
				03/99→ 12/02; - ABS	03.2122-1541.3 010511	Ø 22,2	
				→ 12/02; + ABS; für Linkslenker	24.2120-1723.3 010545	BDX Ø 20,6	
				→ 12/02; + ABS; für Rechtslenker	24.2120-1725.3 010579	BDX Ø 20,6	
1.4 Eco 1.6 i	52 55	01/96→03/99 01/96→03/99		- ABS	03.2120-2031.3 010106	ATE Ø 20,6	
				+ ABS	24.2120-1723.3 010545	BDX Ø 20,6	
1.6 16V	81	11/01→12/04		→ 12/02; - ABS	03.2122-1541.3 010511	Ø 22,2	
				→ 12/02; - ABS; für Fahrzeuge mit verstärktem Fahrwerk	03.2122-1541.3 010511	Ø 22,2	
				→ 12/02; + ABS; für Linkslenker; für Fahrzeuge ohne verstärktes Fahrwerk	03.2123-2146.3 010572	Ø 23,8	
				→ 12/02; + ABS; für Linkslenker	03.2123-2146.3 010572	Ø 23,8	
1.6 16V 1.6 LPG	79 80	03/99→08/02 10/00→08/02		- ABS	03.2122-1541.3 010511	Ø 22,2	
				- ABS; für Fahrzeuge mit verstärktem Fahrwerk	03.2122-1541.3 010511	Ø 22,2	
				+ ABS; für Linkslenker; für Fahrzeuge ohne verstärktes Fahrwerk	03.2123-2146.3 010572	Ø 23,8	
				+ ABS; für Linkslenker	03.2123-2146.3 010572	Ø 23,8	
1.6 e	66	01/96→03/99		- ABS	03.2120-2031.3 010106	ATE Ø 20,6	
				+ ABS	24.2120-1723.3 010545	BDX Ø 20,6	
				+ ABS; für Linkslenker	24.2120-1723.3 010545	BDX Ø 20,6	
				+ ABS; für Rechtslenker	24.2120-1725.3 010579	BDX Ø 20,6	
1.6 LPG	66	08/95→03/99		01/96→; - ABS	03.2120-2031.3 010106	ATE Ø 20,6	
				01/96→; + ABS	24.2120-1723.3 010545	BDX Ø 20,6	
				01/96→; + ABS; für Linkslenker	24.2120-1723.3 010545	BDX Ø 20,6	
				01/96→; + ABS; für Rechtslenker	24.2120-1725.3 010579	BDX Ø 20,6	
1.8 16V	85	01/01→08/03		→ 12/02; für Linkslenker	03.2123-2146.3 010572	Ø 23,8	
→							

























	kw			 	! #		
RENAULT - MEGANE I (BA0/1_) 08/95→12/04							
 Hauptbremszylinder							
1.9 D	69	04/96→02/01		09/96→; - ABS	03.2120-2031.3	010106	ATE Ø 20,6
				09/96→; + ABS	24.2120-1723.3	010545	BDX Ø 20,6
1.9 DCi	77	03/99→08/03		→ 12/02; + ABS; für Linkslenker	03.2123-2146.3	010572	Ø 23,8
1.9 dTi	59	02/01→08/03					
1.9 dCi	75	02/01→08/03		→ 12/02; - ABS	03.2122-1541.3	010511	Ø 22,2
				→ 12/02; + ABS; für Linkslenker	03.2123-2146.3	010572	Ø 23,8
1.9 D Eco	47	01/96→08/03		→ 12/02; - ABS; für Rechtslenker	03.2120-2031.3	010106	ATE Ø 20,6
				→ 12/02; - ABS	03.2120-2031.3	010106	ATE Ø 20,6
				→ 12/02; - ABS; für Linkslenker; nicht für Fahrschulwagen	03.2120-2031.3	010106	ATE Ø 20,6
				→ 12/02; + ABS; für Linkslenker	03.2120-4441.3	010510	ATE Ø 20,6
					24.2120-1723.3	010545	BDX Ø 20,6
				→ 12/02; + ABS; für Linkslenker; nicht für Fahrschulwagen	03.2120-4441.3	010510	ATE Ø 20,6
					24.2120-1723.3	010545	BDX Ø 20,6
				06/98→ 12/02; für Rechtslenker	03.2120-4441.3	010510	ATE Ø 20,6
				06/98→ 12/02; - ABS	03.2122-1541.3	010511	Ø 22,2
1.9 dT	76	08/98→10/99		- ABS	03.2120-2031.3	010106	ATE Ø 20,6
				+ ABS	03.2122-1541.3	010511	Ø 22,2
				+ ABS; für Linkslenker	03.2120-4441.3	010510	ATE Ø 20,6
1.9 dT	66	01/96→08/03		+ ABS; für Linkslenker	24.2120-1723.3	010545	BDX Ø 20,6
				+ ABS; für Rechtslenker	24.2120-1725.3	010579	BDX Ø 20,6
				→ 12/02; - ABS	03.2120-2031.3	010106	ATE Ø 20,6
				03/96→ 12/02; - ABS	03.2122-1541.3	010511	Ø 22,2
				→ 12/02; - ABS	03.2120-2031.3	010106	ATE Ø 20,6
1.9 dTi	72	03/97→02/01		→ 12/02; + ABS; für Linkslenker	03.2120-4441.3	010510	ATE Ø 20,6
				→ 12/02; + ABS	24.2120-1723.3	010545	BDX Ø 20,6
				→ 12/02; + ABS	03.2120-4441.3	010510	ATE Ø 20,6
				→ 12/02; + ABS; für Rechtslenker	24.2120-1725.3	010579	BDX Ø 20,6
				- ABS	03.2120-2031.3	010106	ATE Ø 20,6
					03.2122-1541.3	010511	Ø 22,2
1.9 TDI	69	09/96→08/03		→ 02/99; + ABS	03.2120-4441.3	010510	ATE Ø 20,6
				→ 02/99; + ABS; für Linkslenker	24.2120-1723.3	010545	BDX Ø 20,6
				+ ABS; für Linkslenker	03.2120-4441.3	010510	ATE Ø 20,6
					24.2120-1723.3	010545	BDX Ø 20,6
				03/99→; + ABS; für Linkslenker	03.2123-2146.3	010572	Ø 23,8
				03/99→; + ABS	03.2123-2146.3	010572	Ø 23,8
				+ ABS; für Rechtslenker	24.2120-1725.3	010579	BDX Ø 20,6
				→ 02/99; + ABS; für Rechtslenker	24.2120-1725.3	010579	BDX Ø 20,6
2.0 16V	108	07/96→08/03		→ 12/02; - ABS	03.2120-2031.3	010106	ATE Ø 20,6
				→ 12/02; + ABS	24.2120-1723.3	010545	BDX Ø 20,6
2.0 i	80	03/99→08/03		→ 12/02	24.2123-1701.3	010424	Ø 23,8
2.0 i	84	01/96→08/03		→ 12/02	03.2120-2031.3	010106	ATE Ø 20,6
				→ 12/02; - ABS	03.2120-2031.3	010106	ATE Ø 20,6
				→ 12/02; + ABS; für Linkslenker	03.2122-1541.3	010511	Ø 22,2
				→ 12/02; + ABS; für Linkslenker	03.2120-4441.3	010510	ATE Ø 20,6
		24.2120-1723.3	010545	BDX Ø 20,6			
		→ 12/02; + ABS; für Rechtslenker	24.2120-1725.3	010579	BDX Ø 20,6		
RENAULT - MEGANE I Cabriolet (EA0/1_) 10/96→08/03							
 Bremskraftverstärker							
1.4 16V	70	03/99→08/03		+ ABS; für Linkslenker	03.7760-5502.4	300151	ATE Ø 10" pneumatisch
				- ABS	03.7760-5602.4	300121	ATE Ø 10" pneumatisch
				10/00→; + ABS; für Linkslenker	03.7863-2002.4	300126	ATE Ø 10" pneumatisch
1.6 16V	79	03/99→07/03		+ ABS; für Linkslenker	03.7760-5102.4	300140	ATE Ø 10" pneumatisch
→							











	kw					! #		
RENAULT - MEGANE I Cabriolet (EA0/1_) 10/96→08/03								
 Bremskraftverstärker								
1.6 16V	79	03/99→07/03		10/00→; - ABS		03.7760-5602.4 300121	ATE Ø 10" pneumatisch	
				10/00→; + ABS; für Linkslenker		03.7863-2002.4 300126	ATE Ø 10" pneumatisch	
2.0 16V	102	01/02→08/03		für Linkslenker		03.7760-5102.4 300140	ATE Ø 10" pneumatisch	
2.0 16V IDE	103	11/99→08/03		für Linkslenker		03.7760-5102.4 300140	ATE Ø 10" pneumatisch	
				10/00→; - ABS		03.7760-5602.4 300121	ATE Ø 10" pneumatisch	
				10/00→; + ABS; für Linkslenker		03.7863-2002.4 300126	ATE Ø 10" pneumatisch	
 Hauptbremszylinder								
1.4 16V	70	03/99→08/03		- ABS		03.2122-1541.3 010511	Ø 22,2	
				10/00→; + ABS; für Linkslenker		03.2123-2146.3 010572	Ø 23,8	
1.6 16V	79	03/99→07/03		10/00→; - ABS		03.2122-1541.3 010511	Ø 22,2	
				10/00→; + ABS; für Linkslenker		03.2123-2146.3 010572	Ø 23,8	
				+ ABS; für Linkslenker		03.2123-2146.3 010572	Ø 23,8	
1.6 e	66	10/96→03/99		- ABS; für Linkslenker		03.2120-2031.3 010106	ATE Ø 20,6	
2.0	84	04/97→08/03		+ ABS; für Linkslenker		03.2120-4441.3 010510	ATE Ø 20,6	
2.0 i	80	03/99→08/03		+ ABS; für Linkslenker		24.2120-1723.3 010545	BDX Ø 20,6	
				+ ABS; für Rechtslenker		24.2120-1725.3 010579	BDX Ø 20,6	
2.0 16V	102	01/02→08/03		für Linkslenker		03.2123-2146.3 010572	Ø 23,8	
2.0 16V	108	10/96→11/99				24.2123-1701.3 010424	Ø 23,8	
2.0 16V IDE	103	11/99→08/03		10/00→; - ABS		03.2122-1541.3 010511	Ø 22,2	
				für Linkslenker		03.2123-2146.3 010572	Ø 23,8	
				10/00→; + ABS; für Linkslenker		03.2123-2146.3 010572	Ø 23,8	
RENAULT - MEGANE I Classic (LA0/1_) 09/96→08/08								
 Bremskraftverstärker								
1.4	55	09/96→08/03		09/98→ 12/02; + ABS		03.7760-5502.4 300151	ATE Ø 10" pneumatisch	
				04/98→ 12/02; + ABS		03.7760-5602.4 300121	ATE Ø 10" pneumatisch	
1.4 16V	70	03/99→08/03		→ 12/02; + ABS; für Linkslenker		03.7760-5502.4 300151	ATE Ø 10" pneumatisch	
						03.7863-2002.4 300126	ATE Ø 10" pneumatisch	
				→ 12/02; - ABS		03.7760-5602.4 300121	ATE Ø 10" pneumatisch	
1.6	64	02/00→09/00		+ ABS		03.7760-5502.4 300151	ATE Ø 10" pneumatisch	
				- ABS		03.7760-5602.4 300121	ATE Ø 10" pneumatisch	
1.6 16V	81	09/99→12/01		+ ABS; für Linkslenker; für Fahrzeuge ohne verstärktes Fahrwerk		03.7760-5102.4 300140	ATE Ø 10" pneumatisch	
				+ ABS		03.7760-5502.4 300151	ATE Ø 10" pneumatisch	
				+ ABS; für Linkslenker; für Fahrzeuge mit verstärktem Fahrwerk		03.7760-5502.4 300151	ATE Ø 10" pneumatisch	
				- ABS		03.7760-5602.4 300121	ATE Ø 10" pneumatisch	
				- ABS; für Fahrzeuge mit verstärktem Fahrwerk		03.7760-5602.4 300121	ATE Ø 10" pneumatisch	
1.6 16V	79	03/99→07/03		→ 12/02; + ABS; für Linkslenker; für Fahrzeuge ohne verstärktes Fahrwerk		03.7760-5102.4 300140	ATE Ø 10" pneumatisch	
				09/99→ 12/02; + ABS		03.7760-5502.4 300151	ATE Ø 10" pneumatisch	
				→ 12/02; + ABS; für Linkslenker; für Fahrzeuge mit verstärktem Fahrwerk		03.7760-5502.4 300151	ATE Ø 10" pneumatisch	
				→ 12/02; - ABS; für Fahrzeuge mit verstärktem Fahrwerk		03.7760-5602.4 300121	ATE Ø 10" pneumatisch	
				09/99→ 12/02; - ABS		03.7760-5602.4 300121	ATE Ø 10" pneumatisch	
1.6 e	66	09/96→03/99		+ ABS; für Linkslenker		03.7760-5502.4 300151	ATE Ø 10" pneumatisch	
				- ABS; für Linkslenker; für Fahrzeuge mit verstärktem Fahrwerk		03.7760-5602.4 300121	ATE Ø 10" pneumatisch	
1.8 16V	85	01/01→08/03		→ 12/02; + ABS; für Linkslenker		03.7863-2002.4 300126	ATE Ø 10" pneumatisch	
1.9 D	47	09/96→08/03		09/98→ 12/02; + ABS; für Linkslenker		03.7760-5502.4 300151	ATE Ø 10" pneumatisch	
				09/98→ 12/02; - ABS		03.7760-5602.4 300121	ATE Ø 10" pneumatisch	
1.9 dCi	75	02/01→08/03		→ 12/02; + ABS; für Linkslenker		03.7760-5102.4 300140	ATE Ø 10" pneumatisch	
						03.7863-2002.4 300126	ATE Ø 10" pneumatisch	
1.9 dTi	72	03/97→02/01		03/99→; für Linkslenker		03.7760-5102.4 300140	ATE Ø 10" pneumatisch	
				03/99→; + ABS; für Linkslenker		03.7760-5502.4 300151	ATE Ø 10" pneumatisch	
				- ABS		03.7760-5602.4 300121	ATE Ø 10" pneumatisch	
				+ ABS; für Linkslenker		03.7863-2002.4 300126	ATE Ø 10" pneumatisch	
1.9 TDI	69	09/96→08/03		→ 12/02; + ABS		03.7760-5502.4 300151	ATE Ø 10" pneumatisch	
				→ 12/02; - ABS		03.7760-5602.4 300121	ATE Ø 10" pneumatisch	
2.0 i	84	09/96→08/03		09/98→ 12/02; + ABS; für Linkslenker		03.7760-5502.4 300151	ATE Ø 10" pneumatisch	
→								



























	kw					! #		
RENAULT - MEGANE I Classic (LA0/1) 09/96→08/08								
Bremskraftverstärker								
2.0 i	84	09/96→08/03		→ 12/02; - ABS; für Linkslenker		03.7760-5602.4	300121	ATE Ø 10" pneumatisch
2.0 RT	103	03/01→08/03		→ 02/03; - ABS		03.7760-5602.4	300121	ATE Ø 10" pneumatisch
				→ 02/03; + ABS; für Linkslenker		03.7863-2002.4	300126	ATE Ø 10" pneumatisch
Hauptbremszylinder								
1.4	55	09/96→08/03		→ 12/02; - ABS		03.2120-2031.3	010106	ATE Ø 20,6
				→ 03/99; + ABS		03.2120-4441.3	010510	ATE Ø 20,6
				04/98→ 12/02; - ABS		03.2122-1541.3	010511	Ø 22,2
				09/98→ 02/99; + ABS		24.2120-1723.3	010545	BDX Ø 20,6
				→ 12/02; + ABS		24.2120-1723.3	010545	BDX Ø 20,6
1.4 16V	70	03/99→08/03		→ 12/02; + ABS; für Rechtslenker		03.2120-4441.3	010510	ATE Ø 20,6
				→ 12/02; - ABS		03.2122-1541.3	010511	Ø 22,2
1.6	64	02/00→09/00		- ABS		03.2122-1541.3	010511	Ø 22,2
1.6 16V	81	09/99→12/01		- ABS		03.2122-1541.3	010511	Ø 22,2
				- ABS; für Fahrzeuge mit verstärktem Fahrwerk		03.2122-1541.3	010511	Ø 22,2
				+ ABS; für Linkslenker; für Fahrzeuge ohne verstärktes Fahrwerk		03.2123-2146.3	010572	Ø 23,8
1.6 16V	79	03/99→07/03		09/99→ 12/02; - ABS		03.2122-1541.3	010511	Ø 22,2
				→ 12/02; - ABS; für Fahrzeuge mit verstärktem Fahrwerk		03.2122-1541.3	010511	Ø 22,2
				→ 12/02; + ABS; für Linkslenker; für Fahrzeuge ohne verstärktes Fahrwerk		03.2123-2146.3	010572	Ø 23,8
1.6 e	66	09/96→03/99		- ABS		03.2120-2031.3	010106	ATE Ø 20,6
				+ ABS; für Linkslenker		03.2120-4441.3	010510	ATE Ø 20,6
				+ ABS; für Rechtslenker		24.2120-1723.3	010545	BDX Ø 20,6
1.6 i	55	09/96→03/99		- ABS		03.2120-2031.3	010106	ATE Ø 20,6
				+ ABS		03.2120-4441.3	010510	ATE Ø 20,6
						24.2120-1723.3	010545	BDX Ø 20,6
1.8 16V	85	01/01→08/03		→ 12/02; + ABS; für Linkslenker		03.2123-2146.3	010572	Ø 23,8
1.9 D	47	09/96→08/03		→ 12/02; - ABS		03.2120-2031.3	010106	ATE Ø 20,6
				→ 12/02; + ABS		03.2120-4441.3	010510	ATE Ø 20,6
						24.2120-1723.3	010545	BDX Ø 20,6
				→ 12/02; + ABS; für Linkslenker		03.2120-4441.3	010510	ATE Ø 20,6
						24.2120-1723.3	010545	BDX Ø 20,6
1.9 dCi	75	02/01→08/03		09/98→ 12/02; - ABS		03.2122-1541.3	010511	Ø 22,2
				→ 12/02; + ABS; für Rechtslenker		24.2120-1725.3	010579	BDX Ø 20,6
				→ 12/02; - ABS		03.2122-1541.3	010511	Ø 22,2
1.9 dT	76	08/98→10/99		→ 12/02; + ABS; für Linkslenker		03.2123-2146.3	010572	Ø 23,8
				- ABS		03.2120-2031.3	010106	ATE Ø 20,6
				+ ABS		03.2120-4441.3	010510	ATE Ø 20,6
						24.2120-1723.3	010545	BDX Ø 20,6
				+ ABS; für Linkslenker		03.2120-4441.3	010510	ATE Ø 20,6
1.9 dT	66	09/96→08/03				24.2120-1723.3	010545	BDX Ø 20,6
				+ ABS; für Rechtslenker		24.2120-1725.3	010579	BDX Ø 20,6
				→ 12/02; - ABS		03.2120-2031.3	010106	ATE Ø 20,6
				→ 12/02; + ABS		03.2120-4441.3	010510	ATE Ø 20,6
						24.2120-1723.3	010545	BDX Ø 20,6
1.9 dTi	72	03/97→02/01		→ 12/02; + ABS; für Linkslenker		03.2120-4441.3	010510	ATE Ø 20,6
						24.2120-1723.3	010545	BDX Ø 20,6
				+ ABS; für Rechtslenker		24.2120-1725.3	010579	BDX Ø 20,6
				→ 12/02; + ABS; für Rechtslenker		24.2120-1725.3	010579	BDX Ø 20,6
				- ABS		03.2120-2031.3	010106	ATE Ø 20,6
				+ ABS; für Linkslenker		03.2120-4441.3	010510	ATE Ø 20,6
						03.2123-2146.3	010572	Ø 23,8
	03/99→; - ABS; für Linkslenker		03.2122-1541.3	010511	Ø 22,2			
	+ ABS; für Linkslenker; für Fahrzeuge ohne verstärktes Fahrwerk		03.2123-2146.3	010572	Ø 23,8			
	+ ABS; für Rechtslenker		24.2120-1725.3	010579	BDX Ø 20,6			
	→ 02/99; + ABS; für Rechtslenker		24.2120-1725.3	010579	BDX Ø 20,6			
1.9 TDI	69	09/96→08/03		→ 12/02; - ABS		03.2122-1541.3	010511	Ø 22,2
2.0 i	84	09/96→08/03		→ 12/02; - ABS		03.2120-2031.3	010106	ATE Ø 20,6
→								











	kw					! #		
RENAULT - MEGANE I Classic (LA0/1_) 09/96→08/08								
 Hauptbremszylinder								
2.0 i	84	09/96→08/03		→ 12/02	03.2120-2031.3	010106	ATE Ø 20,6	
				→ 12/02; + ABS; für Linkslenker	03.2120-4441.3	010510	ATE Ø 20,6	
				24.2120-1723.3	010545	BDX Ø 20,6		
				03/99→ 12/02; - ABS; für Linkslenker	03.2122-1541.3	010511	Ø 22,2	
2.0 RT	103	03/01→08/03		→ 12/02; + ABS; für Rechtslenker	24.2120-1725.3	010579	BDX Ø 20,6	
				→ 02/03; - ABS	03.2122-1541.3	010511	Ø 22,2	
2.0 RT	112	10/96→02/99		→ 02/03; + ABS; für Linkslenker	03.2123-2146.3	010572	Ø 23,8	
				+ ABS; für Linkslenker	03.2120-2031.3	010106	ATE Ø 20,6	
					03.2120-4441.3	010510	ATE Ø 20,6	
RENAULT - MEGANE I Coach (DA0/1_) 03/96→08/03								
 Bremskraftverstärker								
1.4 16V	70	03/99→07/03		→ 02/03; + ABS; für Linkslenker	03.7760-5502.4	300151	ATE Ø 10" pneumatisch	
				→ 02/03; - ABS	03.7760-5602.4	300121	ATE Ø 10" pneumatisch	
				10/00→ 02/03; + ABS; für Linkslenker	03.7863-2002.4	300126	ATE Ø 10" pneumatisch	
1.6 16V	79	03/99→07/03		→ 02/03; + ABS; für Linkslenker	03.7760-5102.4	300140	ATE Ø 10" pneumatisch	
				10/00→ 02/03; - ABS	03.7760-5602.4	300121	ATE Ø 10" pneumatisch	
				10/00→ 02/03; + ABS; für Linkslenker	03.7863-2002.4	300126	ATE Ø 10" pneumatisch	
1.9 dCi	75	02/01→08/03		→ 02/03; + ABS; für Linkslenker	03.7760-5102.4	300140	ATE Ø 10" pneumatisch	
					03.7863-2002.4	300126	ATE Ø 10" pneumatisch	
1.9 dTi	72	03/97→02/01		03/99→; für Linkslenker	03.7760-5102.4	300140	ATE Ø 10" pneumatisch	
2.0 16V	108	03/96→11/99						
2.0 16V	102	01/02→08/03		→ 02/03; für Linkslenker	03.7760-5102.4	300140	ATE Ø 10" pneumatisch	
				→ 02/03; - ABS	03.7760-5602.4	300121	ATE Ø 10" pneumatisch	
				→ 02/03; + ABS; für Linkslenker	03.7863-2002.4	300126	ATE Ø 10" pneumatisch	
2.0 16V IDE	103	11/99→08/03		→ 02/03; für Linkslenker	03.7760-5102.4	300140	ATE Ø 10" pneumatisch	
				10/00→ 02/03; - ABS	03.7760-5602.4	300121	ATE Ø 10" pneumatisch	
				10/00→ 02/03; + ABS; für Linkslenker	03.7863-2002.4	300126	ATE Ø 10" pneumatisch	
 Hauptbremszylinder								
1.4 16V	70	03/99→07/03		→ 02/03; für Rechtslenker	03.2120-4441.3	010510	ATE Ø 20,6	
				→ 02/03; - ABS	03.2122-1541.3	010511	Ø 22,2	
				10/00→ 02/03; + ABS; für Linkslenker	03.2123-2146.3	010572	Ø 23,8	
1.6 16V	79	03/99→07/03		10/00→ 02/03; - ABS	03.2122-1541.3	010511	Ø 22,2	
				10/00→ 02/03; + ABS; für Linkslenker	03.2123-2146.3	010572	Ø 23,8	
				→ 02/03; + ABS; für Linkslenker	03.2123-2146.3	010572	Ø 23,8	
1.6 e	66	03/96→03/99		- ABS; für Linkslenker	03.2120-2031.3	010106	ATE Ø 20,6	
				+ ABS	03.2120-4441.3	010510	ATE Ø 20,6	
				+ ABS; für Linkslenker	24.2120-1723.3	010545	BDX Ø 20,6	
				+ ABS; für Rechtslenker	24.2120-1725.3	010579	BDX Ø 20,6	
1.9 dCi	75	02/01→08/03		→ 02/03; - ABS	03.2122-1541.3	010511	Ø 22,2	
			102	01/02→08/03		→ 02/03; + ABS; für Linkslenker	03.2123-2146.3	010572
1.9 dTi	72	03/97→02/01		05/97→; - ABS	03.2120-2031.3	010106	ATE Ø 20,6	
				05/97→ 02/99; + ABS	03.2120-4441.3	010510	ATE Ø 20,6	
				24.2120-1723.3	010545	BDX Ø 20,6		
2.0 16V	108	03/96→11/99		03/99→; + ABS	03.2123-2146.3	010572	Ø 23,8	
				→ 02/99	24.2123-1701.3	010424	Ø 23,8	
2.0 16V IDE	103	11/99→08/03		10/00→ 02/03; - ABS	03.2122-1541.3	010511	Ø 22,2	
				→ 02/03; für Linkslenker	03.2123-2146.3	010572	Ø 23,8	
				10/00→ 02/03; + ABS; für Linkslenker	03.2123-2146.3	010572	Ø 23,8	
2.0 i	80 - 84	03/96→08/03		→ 02/03; - ABS; für Linkslenker	03.2120-2031.3	010106	ATE Ø 20,6	
				→ 02/03; + ABS	03.2120-4441.3	010510	ATE Ø 20,6	
				→ 02/03; + ABS; für Linkslenker	24.2120-1723.3	010545	BDX Ø 20,6	
				→ 02/03; + ABS; für Rechtslenker	24.2120-1725.3	010579	BDX Ø 20,6	
RENAULT - MEGANE I Grandtour (KA0/1_) 03/99→08/03								
 Bremskraftverstärker								
1.4 16V	70	03/99→08/03		+ ABS; für Fahrzeuge mit verstärktem Fahrwerk	03.7760-5502.4	300151	ATE Ø 10" pneumatisch	
				- ABS	03.7760-5602.4	300121	ATE Ø 10" pneumatisch	
→								











	kw					! #		
RENAULT - MEGANE I Grandtour (KA0/1_) 03/99→08/03								
 Bremskraftverstärker								
1.4 16V	70	03/99→08/03			+ ABS; für Linkslenker		03.7863-2002.4 300126	ATE Ø 10" pneumatisch
1.4 e	55	03/99→08/03			+ ABS; für Fahrzeuge mit verstärktem Fahrwerk		03.7760-5502.4 300151	ATE Ø 10" pneumatisch
1.6 e	66	03/99→08/03						
1.9 D	47	04/99→08/03			- ABS		03.7760-5602.4 300121	ATE Ø 10" pneumatisch
1.6 16V	79	03/99→08/03			+ ABS; für Linkslenker; für Fahrzeuge ohne verstärktes Fahrwerk		03.7760-5102.4 300140	ATE Ø 10" pneumatisch
					- ABS		03.7760-5602.4 300121	ATE Ø 10" pneumatisch
					+ ABS; für Linkslenker		03.7863-2002.4 300126	ATE Ø 10" pneumatisch
1.6 Bifuel	80	03/99→09/00			- ABS		03.7760-5602.4 300121	ATE Ø 10" pneumatisch
1.8 16V	85	01/01→08/03			+ ABS; für Linkslenker		03.7863-2002.4 300126	ATE Ø 10" pneumatisch
1.9 dCi	75	02/01→08/03			+ ABS; für Linkslenker; für Fahrzeuge ohne verstärktes Fahrwerk		03.7760-5102.4 300140	ATE Ø 10" pneumatisch
					+ ABS; für Linkslenker		03.7863-2002.4 300126	ATE Ø 10" pneumatisch
1.9 dTi	72	03/99→02/01			+ ABS; für Linkslenker; für Fahrzeuge ohne verstärktes Fahrwerk		03.7760-5102.4 300140	ATE Ø 10" pneumatisch
					- ABS		03.7760-5602.4 300121	ATE Ø 10" pneumatisch
1.9 dTi	59	02/01→08/03			- ABS		03.7760-5602.4 300121	ATE Ø 10" pneumatisch
					+ ABS; für Linkslenker		03.7863-2002.4 300126	ATE Ø 10" pneumatisch
 Hauptbremszylinder								
1.4 16V	70	03/99→08/03			- ABS		03.2122-1541.3 010511	Ø 22,2
1.4 e	55	03/99→08/03						
1.6 e	66	03/99→08/03						
1.9 D	47	04/99→08/03						
1.6 16V	79	03/99→08/03			- ABS		03.2123-1551.3 010512	Ø 23,8
1.6 Bifuel	80	03/99→09/00						
1.9 dCi	75	02/01→08/03			+ ABS		03.2123-2146.3 010572	Ø 23,8
1.9 dTi	72	03/99→02/01						
1.8 16V	85	01/01→08/03			+ ABS		03.2123-2146.3 010572	Ø 23,8
							03.2123-2621.3 010701	ATE Ø 23,8
1.9 dTi	59	02/01→08/03			- ABS		03.2123-2146.3 010572	Ø 23,8
					+ ABS		03.2123-2621.3 010701	ATE Ø 23,8
RENAULT - MEGANE I Hatchback Van (SA0/1_) 08/95→07/03								
 Bremskraftverstärker								
1.9	47	08/95→09/00			06/98→; + ABS; für Linkslenker		03.7760-5502.4 300151	ATE Ø 10" pneumatisch
					06/98→; - ABS		03.7760-5602.4 300121	ATE Ø 10" pneumatisch
1.9 dCi	59	10/00→07/03			+ ABS; für Linkslenker		03.7863-2002.4 300126	ATE Ø 10" pneumatisch
 Hauptbremszylinder								
1.9	47	08/95→09/00			- ABS; für Rechtslenker		03.2120-2031.3 010106	ATE Ø 20,6
					- ABS		03.2120-2031.3 010106	ATE Ø 20,6
					- ABS; für Linkslenker; nicht für Fahrschulwagen		03.2120-2031.3 010106	ATE Ø 20,6
					06/98→; für Rechtslenker		03.2120-4441.3 010510	ATE Ø 20,6
					+ ABS; für Linkslenker; nicht für Fahrschulwagen		03.2120-4441.3 010510	ATE Ø 20,6
							24.2120-1723.3 010545	BDX Ø 20,6
					+ ABS; für Linkslenker		03.2120-4441.3 010510	ATE Ø 20,6
							24.2120-1723.3 010545	BDX Ø 20,6
					06/98→; - ABS		03.2122-1541.3 010511	Ø 22,2
1.9 dCi	59	10/00→07/03			+ ABS; für Rechtslenker		24.2120-1725.3 010579	BDX Ø 20,6
					→ 03/99; + ABS; für Rechtslenker		24.2120-1725.3 010579	BDX Ø 20,6
					+ ABS; für Linkslenker		03.2123-2146.3 010572	Ø 23,8
RENAULT - Megane I Kombi van (KA_) 02/00→07/03								
 Bremskraftverstärker								
1.4	70	04/01→07/03			+ ABS; für Fahrzeuge mit verstärktem Fahrwerk		03.7760-5502.4 300151	ATE Ø 10" pneumatisch
					- ABS		03.7760-5602.4 300121	ATE Ø 10" pneumatisch
					+ ABS; für Linkslenker		03.7863-2002.4 300126	ATE Ø 10" pneumatisch
1.6 1.6 BiFuel	79 79 80	04/01→07/03 04/01→07/03			+ ABS; für Linkslenker; für Fahrzeuge ohne verstärktes Fahrwerk		03.7760-5102.4 300140	ATE Ø 10" pneumatisch
					- ABS		03.7760-5602.4 300121	ATE Ø 10" pneumatisch
					+ ABS; für Linkslenker		03.7863-2002.4 300126	ATE Ø 10" pneumatisch
1.8	85	04/01→07/03			+ ABS; für Linkslenker		03.7863-2002.4 300126	ATE Ø 10" pneumatisch
→								















	kw					! #		
RENAULT - Megane I Kombi van (KA_) 02/00→07/03								
 Bremskraftverstärker								
1.9 D	47	02/00→09/00		+ ABS; für Fahrzeuge mit verstärktem Fahrwerk		03.7760-5502.4	300151	ATE Ø 10" pneumatisch
				- ABS		03.7760-5602.4	300121	ATE Ø 10" pneumatisch
1.9 dCi	75 - 77	04/01→07/03		+ ABS; für Linkslenker; für Fahrzeuge ohne verstärktes Fahrwerk		03.7760-5102.4	300140	ATE Ø 10" pneumatisch
				+ ABS; für Linkslenker		03.7863-2002.4	300126	ATE Ø 10" pneumatisch
1.9 DTI	59	04/01→07/03		- ABS		03.7760-5602.4	300121	ATE Ø 10" pneumatisch
				+ ABS; für Linkslenker		03.7863-2002.4	300126	ATE Ø 10" pneumatisch
 Hauptbremszylinder								
1.4	70	04/01→07/03		- ABS		03.2122-1541.3	010511	Ø 22,2
1.9 D	47	02/00→09/00						
1.6	79	04/01→07/03		- ABS		03.2123-1551.3	010512	Ø 23,8
1.6 BiFuel	79 - 80	04/01→07/03		+ ABS		03.2123-2146.3	010572	Ø 23,8
1.9 dCi	75 - 77	04/01→07/03						
1.8	85	04/01→07/03		+ ABS		03.2123-2146.3	010572	Ø 23,8
						03.2123-2621.3	010701	ATE Ø 23,8
1.9 DTI	59	04/01→07/03		- ABS		03.2123-2146.3	010572	Ø 23,8
				+ ABS		03.2123-2621.3	010701	ATE Ø 23,8
RENAULT - MEGANE II (BM0/1_, CM0/1_) 07/01→10/12								
 Hauptbremszylinder								
1.4 16V	60 - 72	11/02→02/08				24.2123-1760.3	010779	TRW Ø 23,8
1.5 dCi	63 - 78	10/03→06/08				24.4123-1721.3	011052	BOS Ø 23,8 ohne Bremsflüssigkeitsbehälter
1.6	77 - 79	06/05→01/11						
1.6 16V	82 - 83	11/02→06/08						
1.6 Flex-Fuel	77	01/07→02/08						
1.9 dCi	88	11/02→02/08						
2.0	169	08/06→02/08						
2.0 16V	99	11/02→02/08						
2.0 16V Turbo	120	05/04→02/08						
2.0 dCi	110 - 127	09/05→02/08						
1.5 dCi	60	09/02→02/08		11/02→		24.2123-1760.3	010779	TRW Ø 23,8
						24.4123-1721.3	011052	BOS Ø 23,8 ohne Bremsflüssigkeitsbehälter
1.5 dCi	76	01/07→03/09		→ 11/08		24.2123-1760.3	010779	TRW Ø 23,8
1.9 dCi	96	05/05→12/09				24.4123-1721.3	011052	BOS Ø 23,8 ohne Bremsflüssigkeitsbehälter
2.0 Renault Sport	165	05/04→10/09						
1.6 Bifuel	77	06/05→02/08		01/07→		24.2123-1760.3	010779	TRW Ø 23,8
						24.4123-1721.3	011052	BOS Ø 23,8 ohne Bremsflüssigkeitsbehälter
1.9 dCi	66	11/02→12/05				24.4123-1721.3	011052	BOS Ø 23,8 ohne Bremsflüssigkeitsbehälter
1.9 dCi	68 - 85	11/02→02/08		01/06→		24.2123-1760.3	010779	TRW Ø 23,8
						24.4123-1721.3	011052	BOS Ø 23,8 ohne Bremsflüssigkeitsbehälter
RENAULT - MEGANE II Coupé-Cabriolet (EM0/1_) 09/03→03/10								
 Hauptbremszylinder								
1.5 dCi	76	01/07→06/09				24.2123-1760.3	010779	TRW Ø 23,8
1.6	77 - 83	09/03→03/09				24.4123-1721.3	011052	BOS Ø 23,8 ohne Bremsflüssigkeitsbehälter
1.9 dCi	81 - 96	09/03→03/09						
2.0	102	09/03→02/07						
2.0 16V Turbo	120	05/04→03/09						
2.0 dCi	110	09/05→03/09						
1.5 dCi	78	03/06→01/09		→ 06/08		24.2123-1760.3	010779	TRW Ø 23,8
						24.4123-1721.3	011052	BOS Ø 23,8 ohne Bremsflüssigkeitsbehälter
1.6 16V	82	01/06→06/08		01/07→		24.2123-1760.3	010779	TRW Ø 23,8
						24.4123-1721.3	011052	BOS Ø 23,8 ohne Bremsflüssigkeitsbehälter
1.9 dCi	85	09/03→03/09		01/06→		24.2123-1760.3	010779	TRW Ø 23,8
→								













	kw					! #		
RENAULT - MEGANE II Coupé-Cabriolet (EM0/1_) 09/03→03/10								
 Hauptbremszylinder								
1.9 dCi	85	09/03→03/09		01/06→			24.4123-1721.3 011052	BOS Ø 23,8 ohne Bremsflüssigkeitsbehälter
2.0	99	09/03→12/09		→ 03/07			24.2123-1760.3 010779 24.4123-1721.3 011052	TRW Ø 23,8 BOS Ø 23,8 ohne Bremsflüssigkeitsbehälter
RENAULT - MEGANE II Hatchback Van (KM0/2_) 08/03→07/09								
 Hauptbremszylinder								
1.5 dCi	60 - 78	08/03→03/09					24.2123-1760.3 010779 24.4123-1721.3 011052	TRW Ø 23,8 BOS Ø 23,8 ohne Bremsflüssigkeitsbehälter
RENAULT - MEGANE II Kasten/Kombi (KM_) 08/03→07/09								
 Hauptbremszylinder								
1.5 dCi	60 - 78	08/03→07/09					24.2123-1760.3 010779 24.4123-1721.3 011052	TRW Ø 23,8 BOS Ø 23,8 ohne Bremsflüssigkeitsbehälter
1.6	82	10/03→01/08						
1.9 dCi	96	02/06→10/06						
RENAULT - MEGANE II Kombi (KM0/1_) 08/03→08/12								
 Hauptbremszylinder								
1.4	72	08/03→07/09		09/03→ 12/08			24.2123-1760.3 010779 24.4123-1721.3 011052	TRW Ø 23,8 BOS Ø 23,8 ohne Bremsflüssigkeitsbehälter
1.6	83	08/03→07/09						
1.9 dCi	88	08/03→07/09						
2.0	99	08/03→07/09						
1.5 dCi	63 - 78	02/04→07/09					24.2123-1760.3 010779 24.4123-1721.3 011052	TRW Ø 23,8 BOS Ø 23,8 ohne Bremsflüssigkeitsbehälter
1.6 16V	75 - 77	05/05→07/09						
1.6 LPG 16V	82	01/06→08/09						
1.9 dCi	66 - 68	03/04→02/07						
2.0	102	12/06→01/11						
1.5 dCi	60	08/03→05/06		09/03→			24.2123-1760.3 010779 24.4123-1721.3 011052	TRW Ø 23,8 BOS Ø 23,8 ohne Bremsflüssigkeitsbehälter
1.5 dCi	76	01/07→07/09		→ 12/08			24.2123-1760.3 010779 24.4123-1721.3 011052	TRW Ø 23,8 BOS Ø 23,8 ohne Bremsflüssigkeitsbehälter
1.6 16V Hi-Flex	77	02/08→07/09						
1.9 dCi	81 - 85	05/05→07/09						
2.0 dCi	110	09/05→07/09						
1.6 16V	81	05/06→10/11		→ 07/09			24.2123-1760.3 010779 24.4123-1721.3 011052	TRW Ø 23,8 BOS Ø 23,8 ohne Bremsflüssigkeitsbehälter
1.6 16V	82	01/06→08/09		01/07→ 12/08			24.2123-1760.3 010779 24.4123-1721.3 011052	TRW Ø 23,8 BOS Ø 23,8 ohne Bremsflüssigkeitsbehälter
1.9 dCi	96	05/05→07/09		→ 02/07			24.2123-1760.3 010779 24.4123-1721.3 011052	TRW Ø 23,8 BOS Ø 23,8 ohne Bremsflüssigkeitsbehälter
RENAULT - MEGANE II Stufenheck (LM0/1_) 08/03→								
 Hauptbremszylinder								
1.4	60	09/03→		→ 08/06			24.2123-1760.3 010779 24.4123-1721.3 011052	TRW Ø 23,8 BOS Ø 23,8 ohne Bremsflüssigkeitsbehälter
1.4	72	09/03→		→ 12/08			24.2123-1760.3 010779 24.4123-1721.3 011052	TRW Ø 23,8 BOS Ø 23,8 ohne Bremsflüssigkeitsbehälter
1.5 dCi	78	05/05→12/10						
1.6	77 - 83	09/03→						
1.6 Hi-Flex	85	03/06→						
1.9 dCi	81 - 96	09/03→						
2.0 dCi	110	09/05→						
1.5 dCi	74	02/04→12/10		→ 03/06; für Fahrzeuge ohne Sportfahrwerk			24.2123-1760.3 010779 24.2125-1742.3 010978	TRW Ø 23,8 TRW Ø 25,4
				→ 03/06; für Fahrzeuge mit Sportfahrwerk			24.4123-1721.3 011052	BOS Ø 23,8 ohne Bremsflüssigkeitsbehälter
				→ 03/06				
1.5 dCi →	60	08/03→12/10		09/03→ 12/08			24.2123-1760.3 010779	TRW Ø 23,8















	kW					! #		
RENAULT - MEGANE II Stufenheck (LM0/1_) 08/03→								
 Hauptbremszylinder								
1.5 dCi	60	08/03→12/10		09/03→ 12/08			24.4123-1721.3 011052	BOS Ø 23,8 ohne Bremsflüssigkeitsbehälter
1.5 dCi	76	10/03→12/10		01/07→; für Fahrzeuge ohne Sportfahrwerk; → 12/08			24.2123-1760.3 010779	TRW Ø 23,8
				01/07→; für Fahrzeuge mit Sportfahrwerk; → 12/08			24.2125-1742.3 010978	TRW Ø 25,4
				01/07→ 12/08			24.4123-1721.3 011052	BOS Ø 23,8 ohne Bremsflüssigkeitsbehälter
1.5 dCi 1.9 dCi 2.0	63 68 99	05/05→12/10 03/04→ 09/03→		für Fahrzeuge ohne Sportfahrwerk; → 12/08			24.2123-1760.3 010779	TRW Ø 23,8
				für Fahrzeuge mit Sportfahrwerk; → 12/08			24.2125-1742.3 010978	TRW Ø 25,4
				→ 12/08			24.4123-1721.3 011052	BOS Ø 23,8 ohne Bremsflüssigkeitsbehälter
1.6 2.0	81 101	09/03→11/08 04/06→11/10					24.2123-1760.3 010779	TRW Ø 23,8
							24.4123-1721.3 011052	BOS Ø 23,8 ohne Bremsflüssigkeitsbehälter
1.6 16V	82	01/06→		01/07→ 12/08			24.2123-1760.3 010779	TRW Ø 23,8
							24.4123-1721.3 011052	BOS Ø 23,8 ohne Bremsflüssigkeitsbehälter
1.9 dCi	66	09/03→12/05		für Fahrzeuge ohne Sportfahrwerk			24.2123-1760.3 010779	TRW Ø 23,8
				für Fahrzeuge mit Sportfahrwerk			24.2125-1742.3 010978	TRW Ø 25,4
							24.4123-1721.3 011052	BOS Ø 23,8 ohne Bremsflüssigkeitsbehälter
RENAULT - MEGANE III Combi Van (KZ0/1) 01/09→08/15								
 Hauptbremszylinder								
1.5 dCi	63 - 81	01/09→08/15					24.4123-1715.3 010980	TRW Ø 23,8
RENAULT - MEGANE III Coupe (DZ0/1_) 11/08→								
 Hauptbremszylinder								
1.2 TCe	85 - 97	03/12→08/15					24.4123-1715.3 010980	TRW Ø 23,8
1.4 TCe	96	04/09→						
1.5 dCi	63 - 81	11/08→						
1.6 16V	74 - 81	11/08→						
1.6 16V Bifuel	81	11/08→						
1.6 dCi	96	04/11→08/15						
1.9 dCi	96	11/08→08/15						
2.0 CVT	103	05/09→						
2.0 dCi	110 - 120	04/09→						
2.0 TCe	132 - 184	11/08→						
RENAULT - MEGANE III Grandtour (KZ0/1) 11/08→								
 Hauptbremszylinder								
1.2 TCe	85 - 97	03/12→					24.4123-1715.3 010980	TRW Ø 23,8
1.4 TCe	96	05/09→						
1.5 dCi	63 - 81	02/09→						
1.6 16V	74 - 81	05/09→						
1.6 BiFuel	81	11/08→						
1.6 dCi	96	04/11→						
1.9 dCi	96	05/09→						
2.0 CVT	103	05/09→						
2.0 dCi	110 - 120	04/09→						
2.0 TCe	140 - 162	09/12→						
2.0 TCe	132	11/08→		05/09→			24.4123-1715.3 010980	TRW Ø 23,8
RENAULT - MEGANE III Hatchback Van (BZ_) 11/08→08/15								
 Hauptbremszylinder								
1.5 dCi	66 - 81	11/08→08/15					24.4123-1715.3 010980	TRW Ø 23,8













	kw					! #		
RENAULT - MEGANE III Schrägheck (BZ0/1_, B3_) 11/08→								
 Hauptbremszylinder								
1.2 TCe	85	03/12→					24.4123-1715.3 010980	TRW Ø 23,8
1.4 TCe	96	04/09→						
1.5 dCi	63 - 81	11/08→						
1.6	86	01/14→						
1.6 16V	74 - 85	11/08→						
1.6 16V BiFuel	81	05/09→08/15						
1.6 16V Hi-Flex	81	11/08→08/15						
1.6 dCi	96	04/11→08/15						
1.9 dCi	96	11/08→						
2.0	105	01/11→						
2.0 CVT	103	02/09→						
2.0 dCi	110 - 120	04/09→						
2.0 TCe	132	11/08→08/15						
RENAULT - MEGANE CC (EZ0/1_) 06/10→								
 Hauptbremszylinder								
1.2 TCe	85	09/12→08/15					24.4123-1715.3 010980	TRW Ø 23,8
1.4 TCe	96	06/10→						
1.5 dCi	78 - 81	06/10→						
1.6 16V	81	06/10→						
1.6 16V Hi-Flex	81	06/10→						
1.6 dCi	96	04/11→						
1.9 dCi	96	06/10→						
2.0 CVT	103	06/10→						
2.0 dCi	118	06/10→						
2.0 TCe	132	06/10→						
1.2 TCe	97	01/13→		04/13→			24.4123-1715.3 010980	TRW Ø 23,8
RENAULT - MEGANE Scenic (JA0/1_) 10/96→12/01								
 Bremskraftverstärker								
1.4 i	55	01/97→09/99		10/98→			03.7760-5102.4 300140	ATE Ø 10" pneumatisch
1.6 i	55	01/97→09/99						
1.6 16V	79	04/98→10/99		10/98→ 09/99; für Linkslenker			03.7760-5102.4 300140	ATE Ø 10" pneumatisch
1.6 e	66	10/96→10/99						
2.0 RXE 4x4	84	05/97→10/99						
1.9 D	47	03/97→09/99		10/98→; für Linkslenker			03.7760-5102.4 300140	ATE Ø 10" pneumatisch
1.9 dTi	72	04/97→09/99		10/98→			03.7760-5102.4 300140	ATE Ø 10" pneumatisch
2.0 i	80	01/99→09/99		für Linkslenker			03.7760-5102.4 300140	ATE Ø 10" pneumatisch
2.0 i	84	01/97→09/99		10/98→; für Linkslenker			03.7760-5102.4 300140	ATE Ø 10" pneumatisch
 Hauptbremszylinder								
1.4 i	55	01/97→09/99		→ 09/98; - ABS			03.2120-2031.3 010106	ATE Ø 20,6
1.6 i	55	01/97→09/99		10/98→; - ABS			03.2123-1551.3 010512	Ø 23,8
				10/98→; + ABS			03.2123-2146.3 010572	Ø 23,8
				→ 09/98; + ABS			24.2120-1723.3 010545	BDX Ø 20,6
1.6 16V	79	04/98→10/99		10/98→ 09/99; für Linkslenker; - ABS			03.2123-1551.3 010512	Ø 23,8
2.0 RXE 4x4	84	05/97→10/99		10/98→ 09/99; für Linkslenker; + ABS			03.2123-2146.3 010572	Ø 23,8
1.6 e	66	10/96→10/99		11/96→ 09/98; - ABS; Schaltgetriebe			03.2120-2031.3 010106	ATE Ø 20,6
				10/98→ 09/99; für Linkslenker; - ABS			03.2123-1551.3 010512	Ø 23,8
				10/98→ 09/99; für Linkslenker; + ABS			03.2123-2146.3 010572	Ø 23,8
				11/96→ 09/98; + ABS; für Linkslenker; Schaltgetriebe			24.2120-1723.3 010545	BDX Ø 20,6
				11/96→ 09/98; + ABS; für Rechtslenker; Schaltgetriebe			24.2120-1725.3 010579	BDX Ø 20,6
1.9 D	47	03/97→09/99		10/98→; - ABS			03.2123-1551.3 010512	Ø 23,8
1.9 dTi	72	04/97→09/99		10/98→; - ABS; für Linkslenker			03.2123-1551.3 010512	Ø 23,8
				10/98→; + ABS			03.2123-2146.3 010572	Ø 23,8
				10/98→; + ABS; für Linkslenker			03.2123-2146.3 010572	Ø 23,8
2.0 i	80	01/99→09/99		- ABS; für Linkslenker			03.2123-1551.3 010512	Ø 23,8
				+ ABS; für Linkslenker			03.2123-2146.3 010572	Ø 23,8
2.0 i	84	01/97→09/99		10/98→; - ABS; für Linkslenker			03.2123-1551.3 010512	Ø 23,8
				10/98→; + ABS; für Linkslenker			03.2123-2146.3 010572	Ø 23,8

	kw					! #		
RENAULT - MODUS / GRAND MODUS (F/JP0_) 09/04 →								
 Bremskraftverstärker								
1.2	48 - 58	12/04 →		für Linkslenker; → 06/13; + ABS		03.7863-4502.4	300230	ATE Ø 10" pneumatisch
1.2 16V	74	05/07 →						
1.2	55	12/04 →		für Linkslenker; → 06/13; + ABS		03.7863-4502.4	300230	ATE Ø 10" pneumatisch
				→ 01/05; für Linkslenker		03.7863-6002.4	300249	ATE Ø 10" pneumatisch
1.4	72	12/04 →		02/05 →; für Linkslenker; → 10/07; + ABS		03.7863-4502.4	300230	ATE Ø 10" pneumatisch
				→ 01/05; für Linkslenker		03.7863-6002.4	300249	ATE Ø 10" pneumatisch
1.5 dCi	50 - 63	09/04 →		02/05 →; für Linkslenker; → 06/13; + ABS		03.7863-4502.4	300230	ATE Ø 10" pneumatisch
1.6	65 - 82	12/04 →		→ 01/05; für Linkslenker		03.7863-6002.4	300249	ATE Ø 10" pneumatisch
1.5 dCi	48	12/04 →		02/05 →; für Linkslenker; → 06/13; + ABS		03.7863-4502.4	300230	ATE Ø 10" pneumatisch
1.5 dCi	76	05/07 →		→ 10/07; für Linkslenker; + ABS		03.7863-4502.4	300230	ATE Ø 10" pneumatisch
 Hauptbremszylinder								
1.2	48 - 76	12/04 →		für Linkslenker; → 06/13; - ESP		03.2123-3241.3	010882	ATE Ø 23,8
1.5 dCi 75	55	10/10 →		für Linkslenker; → 06/13; + ESP		03.2123-3493.3	010792	ATE Ø 23,8
1.5 dCi 90	65	10/10 →						
1.2	55	12/04 →		für Linkslenker; → 06/13; - ABS		03.2123-2821.3	010944	ATE Ø 23,8
1.4	72	12/04 →		für Linkslenker; → 01/05; + ABS / - ESP		03.2123-2863.3	010790	ATE Ø 23,8
1.5 dCi	50 - 63	12/04 →		für Linkslenker; → 01/05; + ESP		03.2123-2923.3	010791	ATE Ø 23,8
				02/05 →; für Linkslenker; → 06/13; - ESP		03.2123-3241.3	010882	ATE Ø 23,8
				02/05 →; für Linkslenker; → 06/13; + ESP		03.2123-3493.3	010792	ATE Ø 23,8
1.2 16V	74	05/07 →		für Linkslenker; → 06/13; - ABS		03.2123-2821.3	010944	ATE Ø 23,8
1.5 dCi	76	05/07 →		für Linkslenker; → 06/13; - ESP		03.2123-3241.3	010882	ATE Ø 23,8
				für Linkslenker; → 06/13; + ESP		03.2123-3493.3	010792	ATE Ø 23,8
1.2 16V Hi-Flex	55	10/08 →		für Linkslenker; → 06/13; - ABS		03.2123-2821.3	010944	ATE Ø 23,8
1.2 GPL	55	05/08 → 12/12		für Linkslenker; - ABS		03.2123-2821.3	010944	ATE Ø 23,8
1.5 dCi	60	09/04 →		09/05 →; für Linkslenker; → 06/13; - ABS		03.2123-2821.3	010944	ATE Ø 23,8
				für Linkslenker; → 01/05; + ABS / - ESP		03.2123-2863.3	010790	ATE Ø 23,8
				für Linkslenker; → 01/05; + ESP		03.2123-2923.3	010791	ATE Ø 23,8
				02/05 →; für Linkslenker; → 06/13; - ESP		03.2123-3241.3	010882	ATE Ø 23,8
				02/05 →; für Linkslenker; → 06/13; + ESP		03.2123-3493.3	010792	ATE Ø 23,8
1.5 dCi	48	12/04 →		02/05 →; für Linkslenker; → 06/13; - ESP		03.2123-3241.3	010882	ATE Ø 23,8
				02/05 →; für Linkslenker; → 06/13; + ESP		03.2123-3493.3	010792	ATE Ø 23,8
1.5 dCi	78	05/05 →		05/07 →; für Linkslenker; → 06/13; - ESP		03.2123-3241.3	010882	ATE Ø 23,8
				05/07 →; für Linkslenker; → 06/13; + ESP		03.2123-3493.3	010792	ATE Ø 23,8
1.6	65 - 82	12/04 →		für Linkslenker; → 06/13; - ABS		03.2123-2821.3	010944	ATE Ø 23,8
				für Linkslenker; → 01/05; + ABS / - ESP		03.2123-2863.3	010790	ATE Ø 23,8
				für Linkslenker; → 01/05; + ESP		03.2123-2923.3	010791	ATE Ø 23,8
				für Linkslenker; → 06/13; - ESP		03.2123-3241.3	010882	ATE Ø 23,8
				für Linkslenker; → 06/13; + ESP		03.2123-3493.3	010792	ATE Ø 23,8
RENAULT - RAPID 09/94 → 03/98								
 Hauptbremszylinder								
1.9 D	47	09/94 → 03/98		07/95 →		03.2120-2031.3	010106	ATE Ø 20,6
RENAULT - RAPID Kasten/Großraumlimousine (F40_, G40_) 07/85 → 11/01								
 Hauptbremszylinder								
1.2	40	09/91 → 03/98		10/92 →; für Linkslenker		03.2120-2031.3	010106	ATE Ø 20,6
						03.2120-2031.3	010106	ATE Ø 20,6
1.4	43 - 59	09/91 → 08/97		für Linkslenker		03.2120-2031.3	010106	ATE Ø 20,6
1.9 D	40	09/94 → 03/98						
1.4	58	01/94 → 03/98		für Linkslenker		03.2120-2031.3	010106	ATE Ø 20,6
						03.2120-2031.3	010106	ATE Ø 20,6
				09/94 →		03.2120-2031.3	010106	ATE Ø 20,6
1.4	55	09/91 → 03/98		für Linkslenker		03.2120-2031.3	010106	ATE Ø 20,6
						03.2120-2031.3	010106	ATE Ø 20,6
1.4 Cat	43	08/88 → 03/98		09/91 →		03.2120-2031.3	010106	ATE Ø 20,6
1.6 D	40	03/86 → 08/98						
1.9 D	47	09/91 → 03/98				03.2120-2031.3	010106	ATE Ø 20,6
				09/95 →		03.2120-2031.3	010106	ATE Ø 20,6
→								















	kw					! #		
RENAULT - RAPID Kasten/Großraumlimousine (F40_, G40_) 07/85→11/01								
 Hauptbremszylinder								
Electric	21	01/94→11/98					03.2120-2031.3 010106	ATE Ø 20,6
 Bremskraftregler								
1.4 Cat	43	08/88→03/98		→ 08/91			03.6583-0006.3 320100	ATE lastabhängig 8/3 4x
1.6 D	40	03/86→08/98						
RENAULT - SAFRANE II (B54_) 07/96→12/00								
 Hauptbremszylinder								
2.0 16V	100	07/96→12/00		08/96→; für Rechtslenker			24.2122-1707.3 010438	Ø 22,2
				08/96→; für Linkslenker			24.2123-1701.3 010424	Ø 23,8
2.2 dT	83	07/96→12/00		08/96→			24.2123-1701.3 010424	Ø 23,8
2.5 20V	121	07/96→12/00						
2.9 24V	140	03/99→12/00					24.2123-1701.3 010424	Ø 23,8
3.0 V6	123	07/96→12/00		→ 07/96			24.2123-1701.3 010424	Ø 23,8
				10/96→			24.2123-1701.3 010424	Ø 23,8
RENAULT - SANDERO/STEPWAY I (BS_) 11/07→								
 Bremskraftverstärker								
1.4	55	02/09→		+ ABS			03.7853-4602.4 300302	ATE Ø 9" pneumatisch
1.4 LPG	53	02/09→						
1.6	62 -	12/07→						
	82							
1.6 Flex	82	08/08→						
 Hauptbremszylinder								
1.4	55	02/09→		+ ABS			03.2120-4611.3 010937	ATE Ø 20,6
1.4 LPG	53	02/09→						
1.6	62 -	12/07→		- ABS			24.2120-1762.3 011002	Ø 20,6 ohne Bremsflüssigkeitsbehälter
	82							
1.6 Flex	82	08/08→						
RENAULT - SANDERO/STEPWAY II (B8_) 11/13→								
 Hauptbremszylinder								
1.2 16V	54 -	12/13→		für Linkslenker; + ABS			24.4120-1771.3 011076	Ø 20,6 ohne Bremsflüssigkeitsbehälter
	55							
1.2 16V LPG	53	12/13→						
1.5 dCi	62	12/13→						
1.6	59 -	11/13→						
	83							
1.6 16V	75	04/14→						
1.6 Flex	78	09/14→						
TCe 90	66	09/15→						
RENAULT - SCÉNIC I Großraumlimousine (JA0/1_, FA0_) 08/99→07/10								
 Bremskraftverstärker								
1.4 16V	70	09/99→08/03		- ABS; → 06/03; für Linkslenker			03.7760-5102.4 300140	ATE Ø 10" pneumatisch
1.6	75 -	09/99→09/03		→ 06/03; + ABS; für Linkslenker			03.7863-2002.4 300126	ATE Ø 10" pneumatisch
	79							
1.6 BiFuel	75	03/01→08/03						
1.8 16V	85	01/01→08/03						
1.9 dCi	75	09/99→08/03						
1.9 dCi RX4	74 -	11/00→08/03						
	75							
2.0 16V	103	09/99→08/03						
2.0 16V RX4	102	06/00→08/03						
1.6 BiFuel	79	09/99→04/01		- ABS; für Linkslenker			03.7760-5102.4 300140	ATE Ø 10" pneumatisch
1.8 4x4	85	07/00→04/01		+ ABS; für Linkslenker			03.7863-2002.4 300126	ATE Ø 10" pneumatisch
1.9 D	47	09/99→03/01		+ ABS; für Linkslenker			03.7863-2002.4 300126	ATE Ø 10" pneumatisch
1.9 dTi	72	09/99→08/03		- ABS; → 06/03; für Linkslenker			03.7760-5102.4 300140	ATE Ø 10" pneumatisch
2.0 16V	102	07/00→08/03						
1.9 dTi	59	02/01→08/03		→ 06/03; + ABS; für Linkslenker			03.7863-2002.4 300126	ATE Ø 10" pneumatisch
 Hauptbremszylinder								
1.4 16V	70	09/99→08/03		→ 06/03; - ABS; für Linkslenker			03.2123-1551.3 010512	Ø 23,8
1.6	75 -	09/99→09/03		→ 06/03; + ABS / - ESP; für Linkslenker			03.2123-2146.3 010572	Ø 23,8
	79							
1.6 BiFuel	75	03/01→08/03		→ 06/03; + ABS / + ESP; für Linkslenker			03.2123-2621.3 010701	ATE Ø 23,8
1.8 16V	85	01/01→08/03						
1.9 dCi	75	09/99→08/03						
1.9 dCi RX4	74 -	11/00→08/03						
	75							
2.0 16V	102 -	09/99→08/03						
→	103							















	kW					! #		
RENAULT - SCÉNIC I Großraumlimousine (JA0/1_ , FA0_) 08/99→07/10								
 Hauptbremszylinder								
2.0 16V RX4	102	06/00→08/03			→ 06/03; - ABS; für Linkslenker		03.2123-1551.3 010512	Ø 23,8
					→ 06/03; + ABS / - ESP; für Linkslenker		03.2123-2146.3 010572	Ø 23,8
					→ 06/03; + ABS / + ESP; für Linkslenker		03.2123-2621.3 010701	ATE Ø 23,8
1.6 BiFuel 1.8 4x4	79 85	09/99→04/01 07/00→04/01			für Linkslenker; - ABS		03.2123-1551.3 010512	Ø 23,8
					+ ABS / - ESP; für Linkslenker		03.2123-2146.3 010572	Ø 23,8
					+ ABS / + ESP; für Linkslenker		03.2123-2621.3 010701	ATE Ø 23,8
1.9 D	47	09/99→03/01			+ ABS / - ESP; für Linkslenker		03.2123-2146.3 010572	Ø 23,8
					+ ABS / + ESP; für Linkslenker		03.2123-2621.3 010701	ATE Ø 23,8
1.9 dTi	72	09/99→08/03			→ 06/03; - ABS; für Linkslenker		03.2123-1551.3 010512	Ø 23,8
					→ 06/03; + ABS; für Linkslenker		03.2123-2146.3 010572	Ø 23,8
1.9 dTi	59	02/01→08/03			→ 06/03; + ABS / - ESP; für Linkslenker		03.2123-2146.3 010572	Ø 23,8
					→ 06/03; + ABS / + ESP; für Linkslenker		03.2123-2621.3 010701	ATE Ø 23,8
RENAULT - SCÉNIC II (JM0/1_) 06/03→07/10								
 Hauptbremszylinder								
1.4	72	06/03→11/08					24.2123-1760.3 010779	TRW Ø 23,8
1.5 dCi	60 - 78	06/03→11/08					24.4123-1721.3 011052	BOS Ø 23,8 ohne Bremsflüssigkeitsbehälter
1.6	77 - 83	06/03→11/08						
1.6 BiFuel	83	08/03→05/06						
1.6 Hi-Flex	81	03/05→07/10						
1.9 D	85	06/06→11/08						
1.9 dCi	72 - 96	06/03→11/08						
1.9 dCi 130	97	10/05→12/09						
2.0 16V Turbo	120	05/04→11/08						
2.0 dCi	110	09/05→11/08						
1.6 16V	82	10/05→11/08		01/07→			24.2123-1760.3 010779 24.4123-1721.3 011052	TRW Ø 23,8 BOS Ø 23,8 ohne Bremsflüssigkeitsbehälter
2.0	99 - 101	06/03→06/09		→ 03/09			24.2123-1760.3 010779 24.4123-1721.3 011052	TRW Ø 23,8 BOS Ø 23,8 ohne Bremsflüssigkeitsbehälter
RENAULT - SCÉNIC III (JZ0/1_) 12/08→								
 Hauptbremszylinder								
1.2 TCe	85 - 96	04/12→					24.4123-1715.3 010980	TRW Ø 23,8
1.4 16V	96	02/09→						
1.5 dCi	63 - 81	04/09→						
1.6 16V	81	02/09→						
1.6 16V Bifuel	79	04/12→12/13						
1.6 dCi	96	04/11→						
1.9 dCi	96	02/09→						
2.0 16V	101	12/08→						
2.0 dCi	118	04/09→						
1.2 TCe	97	01/13→		03/13→			24.4123-1715.3 010980	TRW Ø 23,8
1.5 dCi	78	02/09→		04/09→			24.4123-1715.3 010980	TRW Ø 23,8
2.0 16V	103	02/09→						
2.0 dCi	110	02/09→						
1.6 16V Bifuel	81	02/09→		06/09→			24.4123-1715.3 010980	TRW Ø 23,8
1.6 E85	81	02/09→						
RENAULT - SCÉNIC III VAN (JZ0/1_) 12/08→								
 Hauptbremszylinder								
1.4 TCe	96	01/13→					24.4123-1715.3 010980	TRW Ø 23,8
1.5 dCi	70 - 81	04/09→						
1.6 dCi	96	01/13→						
1.6 VVT	81	01/13→						
1.9 dCi	96	01/13→						
RENAULT - THALIA I (LB_) 02/98→								
 Bremskraftverstärker								
1.2 16V	55	04/02→					03.7750-1332.4 300155	ATE Ø 9" pneumatisch
1.4	55	08/00→						
1.4 16V	72	08/00→						
1.5 dCi	47 - 62	06/01→						
1.6	82	01/04→12/08						













	kw					! #		
RENAULT - THALIA I (LB_) 02/98→								
 Bremskraftverstärker								
1.6 16V	79	07/00→02/09				03.7750-1332.4	300155	ATE Ø 9" pneumatisch
1.6 Authentique Hi-Flex	86	11/04→02/09						
1.9 D	48	02/98→05/01						
1.6	66	03/98→		04/02→		03.7750-1332.4	300155	ATE Ø 9" pneumatisch
 Hauptbremszylinder								
1.2 16V	55	04/02→		- ABS		03.2120-2031.3	010106	ATE Ø 20,6
1.4	55	08/00→		+ ABS		03.2120-4461.3	010571	ATE Ø 20,6
1.4 16V	72	08/00→						
1.5 dCi	47 - 62	06/01→						
1.4	72	05/00→02/09		- ABS		03.2120-2031.3	010106	ATE Ø 20,6
1.6	82	01/04→12/08		- ABS; 04/08→		03.2120-2031.3	010106	ATE Ø 20,6
1.6 Authentique Hi-Flex	86	11/04→02/09		+ ABS		03.2120-4461.3	010571	ATE Ø 20,6
 Bremskraftregler								
1.2 16V	55	04/02→				24.6582-1721.3	320212	lastabhängig 4x
1.4	55	08/00→						
1.4 16V	72	08/00→						
1.5 dCi	47 - 62	06/01→						
1.6 16V	79	07/00→02/09						
1.9 D	48	02/98→05/01						
1.6	66	03/98→		04/02→		24.6582-1721.3	320212	lastabhängig 4x
RENAULT - THALIA II (LU_) 09/08→								
 Hauptbremszylinder								
1.2 16V	55	09/08→06/14		- ABS		03.2120-2031.3	010106	ATE Ø 20,6
1.2 LPG	55	01/10→12/13						
1.4	55	09/08→06/14						
1.5 dCi	47 - 66	09/08→						
1.4	72	01/09→12/11		für Linkslenker; + ABS		03.2120-4461.3	010571	ATE Ø 20,6
1.6 16V	77 - 79	09/08→		+ ABS		03.2120-4461.3	010571	ATE Ø 20,6
 Bremskraftregler								
1.6 16V	77 - 79	09/08→				24.6582-1721.3	320212	lastabhängig 4x
RENAULT - THALIA III (L8_) 12/13→								
 Hauptbremszylinder								
0.9 TCe	66	06/14→		für Linkslenker; + ABS		24.4120-1771.3	011076	Ø 20,6 ohne Bremsflüssigkeitsbehälter
1.2 16V	55	12/13→						
1.2 LPG	55	03/14→						
1.5 dCi	55 - 70	12/13→						
1.0 SCe	54	01/17→11/19		für Linkslenker		24.4120-1771.3	011076	Ø 20,6 ohne Bremsflüssigkeitsbehälter
RENAULT - TRAFIC II Bus (JL) 03/01→								
 Hauptbremszylinder								
1.9 dCi	59	04/01→07/03		für Linkslenker; - ESP		24.2120-1738.3	010759	TRW Ø 20,6
				für Rechtslenker; - ESP		24.2125-1731.3	010826	TRW Ø 25,4
1.9 dCi	75	01/12→12/18		für Linkslenker; - ESP		24.2120-1740.3	010764	TRW Ø 20,6
				für Rechtslenker; - ESP		24.2125-1731.3	010826	TRW Ø 25,4
1.9 dCi 100	74	03/01→10/06		→ 09/03; für Linkslenker; - ESP		24.2120-1738.3	010759	TRW Ø 20,6
				10/03→; für Linkslenker; - ESP		24.2120-1740.3	010764	TRW Ø 20,6
				10/03→; für Rechtslenker; - ESP		24.2125-1731.3	010826	TRW Ø 25,4
1.9 dCi 80	60	03/01→10/06		→ 09/03; für Linkslenker; - ESP		24.2120-1738.3	010759	TRW Ø 20,6
				10/03→; für Linkslenker; - ESP		24.2120-1740.3	010764	TRW Ø 20,6
				für Rechtslenker; - ESP		24.2125-1731.3	010826	TRW Ø 25,4
2.0	88	03/01→		→ 08/14; - ESP		24.2125-1731.3	010826	TRW Ø 25,4
2.0 16V	86	08/06→		für Linkslenker; → 08/14; - ESP		24.2120-1740.3	010764	TRW Ø 20,6
				für Rechtslenker; → 08/14; - ESP		24.2125-1731.3	010826	TRW Ø 25,4
2.0 dCi 115	84	08/06→		10/06→ 08/14; + ABS / - ESP		24.2120-1748.3	010894	TRW Ø 20,6
2.5 dCi 145	107	08/06→		10/06→ 08/14; + ABS / + ESP		24.2120-1753.3	010946	TRW Ø 20,6
2.0 dCi 90	66	08/06→		10/06→ 08/14; - ESP		24.2125-1731.3	010826	TRW Ø 25,4
2.5 dCi 115	84	02/08→		→ 08/14; + ABS / - ESP		24.2120-1748.3	010894	TRW Ø 20,6
→								













	kw					! #		
RENAULT - TRAFIC II Bus (JL) 03/01→								
 Hauptbremszylinder								
2.5 dCi 115	84	02/08→			→ 08/14; + ABS / + ESP		24.2120-1753.3 010946	TRW Ø 20,6
2.5 dCi 135	99	05/03→10/06			- ESP		24.2125-1731.3 010826	TRW Ø 25,4
RENAULT - TRAFIC II Kasten (FL) 03/01→								
 Hauptbremszylinder								
1.9 dCi	59	04/01→07/03			für Linkslenker; - ESP		24.2120-1738.3 010759	TRW Ø 20,6
					für Rechtslenker; - ESP		24.2125-1731.3 010826	TRW Ø 25,4
1.9 dCi	75	03/01→			→ 09/03; für Linkslenker; - ESP		24.2120-1738.3 010759	TRW Ø 20,6
					10/03→ 08/14; für Linkslenker; - ESP		24.2120-1740.3 010764	TRW Ø 20,6
					für Rechtslenker; → 08/14; - ESP		24.2125-1731.3 010826	TRW Ø 25,4
1.9 dCi 100	74	03/01→10/06			→ 09/03; für Linkslenker; - ESP		24.2120-1738.3 010759	TRW Ø 20,6
					10/03→; für Linkslenker; - ESP		24.2120-1740.3 010764	TRW Ø 20,6
					10/03→; für Rechtslenker; - ESP		24.2125-1731.3 010826	TRW Ø 25,4
1.9 dCi 80	60	03/01→10/06			→ 09/03; für Linkslenker; - ESP		24.2120-1738.3 010759	TRW Ø 20,6
					10/03→; für Linkslenker; - ESP		24.2120-1740.3 010764	TRW Ø 20,6
					für Rechtslenker; - ESP		24.2125-1731.3 010826	TRW Ø 25,4
2.0	88	03/01→			→ 08/14; - ESP		24.2125-1731.3 010826	TRW Ø 25,4
2.5 dCi	84	08/07→						
2.0 16V	86	08/06→			für Linkslenker; → 08/14; - ESP		24.2120-1740.3 010764	TRW Ø 20,6
					für Rechtslenker; → 08/14; - ESP		24.2125-1731.3 010826	TRW Ø 25,4
2.0 dCi 115	84	08/06→			10/06→ 08/14; + ABS / - ESP		24.2120-1748.3 010894	TRW Ø 20,6
2.5 dCi 145	107	08/06→			10/06→ 08/14; + ABS / + ESP		24.2120-1753.3 010946	TRW Ø 20,6
2.0 dCi 90	66	08/06→			10/06→ 08/14; - ESP		24.2125-1731.3 010826	TRW Ø 25,4
2.5 dCi 135	99	05/03→10/06			- ESP		24.2125-1731.3 010826	TRW Ø 25,4
RENAULT - TRAFIC II Pritsche/Fahrgestell (EL) 03/01→								
 Hauptbremszylinder								
1.9 dCi	59	09/01→07/03			für Linkslenker; - ESP		24.2120-1738.3 010759	TRW Ø 20,6
					für Rechtslenker; - ESP		24.2125-1731.3 010826	TRW Ø 25,4
1.9 dCi 100	74	03/01→10/06			→ 09/03; für Linkslenker; - ESP		24.2120-1738.3 010759	TRW Ø 20,6
					10/03→; für Linkslenker; - ESP		24.2120-1740.3 010764	TRW Ø 20,6
					10/03→; für Rechtslenker; - ESP		24.2125-1731.3 010826	TRW Ø 25,4
1.9 dCi 80	60	03/01→10/06			→ 09/03; für Linkslenker; - ESP		24.2120-1738.3 010759	TRW Ø 20,6
					10/03→; für Linkslenker; - ESP		24.2120-1740.3 010764	TRW Ø 20,6
					für Rechtslenker; - ESP		24.2125-1731.3 010826	TRW Ø 25,4
2.0	88	03/01→10/06			- ESP		24.2125-1731.3 010826	TRW Ø 25,4
2.0 16V	86	08/06→			für Linkslenker; → 08/14; - ESP		24.2120-1740.3 010764	TRW Ø 20,6
					für Rechtslenker; → 08/14; - ESP		24.2125-1731.3 010826	TRW Ø 25,4
2.0 dCi 115	84	08/06→			10/06→ 08/14; + ABS / - ESP		24.2120-1748.3 010894	TRW Ø 20,6
2.5 dCi 145	107	08/06→			10/06→ 08/14; + ABS / + ESP		24.2120-1753.3 010946	TRW Ø 20,6
2.0 dCi 90	66	08/06→			10/06→ 08/14; - ESP		24.2125-1731.3 010826	TRW Ø 25,4
2.5 dCi	84	08/07→			→ 08/14; - ESP		24.2125-1731.3 010826	TRW Ø 25,4
2.5 dCi 135	99	03/01→10/06			05/03→; - ESP		24.2125-1731.3 010826	TRW Ø 25,4
RENAULT - TRAFIC Bus (T_, P_, V_) 03/89→03/01								
 Hauptbremszylinder								
2.1 D	47	06/94→10/97					03.2125-3801.3 010215	Ø 25,4
2.2	74	06/94→10/97			- ABS; für Rechtslenker		03.2125-3801.3 010215	Ø 25,4
2.5 D	55	05/89→03/01					03.2125-3801.3 010215	Ø 25,4
2.5 D 4x4	55	08/89→03/01			11/97→; + ABS		24.2025-1706.3 010676	Ø 25,4
					11/97→; - ABS		24.2025-1708.3 010692	Ø 25,4
RENAULT - TRAFIC Kasten (T_, P_, V_) 03/89→10/02								
 Hauptbremszylinder								
2.1 D	47	06/94→10/97					03.2125-3801.3 010215	Ø 25,4
2.2	74	06/94→10/97			- ABS; für Rechtslenker		03.2125-3801.3 010215	Ø 25,4
2.2 4x4	74	06/94→10/97						
2.5 D	55	05/89→03/01			→ 10/97		03.2125-3801.3 010215	Ø 25,4
2.5 D 4x4	55	05/89→03/01			11/97→; + ABS		24.2025-1706.3 010676	Ø 25,4
					11/97→; - ABS		24.2025-1708.3 010692	Ø 25,4























	kw					! #		
RENAULT - TRAFIC Pritsche/Fahrgestell (T_, P_, V_) 03/89→03/01								
 Hauptbremszylinder								
2.0 RWD	59	05/89→10/97					03.2125-3801.3 010215	Ø 25,4
2.1 D	47	09/94→04/98		→ 10/97			03.2125-3801.3 010215	Ø 25,4
2.1 D RWD	47	06/94→10/97		→ 0005150			03.2120-1142.3 010085	Ø 20,6
							03.2125-3801.3 010215	Ø 25,4
RENAULT - TWINGO I (C06_) 03/93→10/12								
 Hauptbremszylinder								
1.2	40 - 43	05/96→06/07		- ABS			24.2120-1706.3 010262	Ø 20,6
1.2 16V	44 - 55	01/01→06/07		+ ABS			24.2120-1723.3 010545	BDX Ø 20,6
1.2 LPG	43	09/00→06/07						
1.2 LPG	44	10/03→06/07		08/04→; - ABS			24.2120-1706.3 010262	Ø 20,6
				08/04→; + ABS			24.2120-1723.3 010545	BDX Ø 20,6
RENAULT - TWINGO I Kasten/Schrägheck (S06_) 03/93→06/12								
 Hauptbremszylinder								
1.2	43 - 55	05/96→06/12		- ABS			24.2120-1706.3 010262	Ø 20,6
				+ ABS			24.2120-1723.3 010545	BDX Ø 20,6
RENAULT - TWINGO II (CNO_) 03/07→								
 Bremskraftverstärker								
1.2	43	03/07→09/14		→ 07/14; für Linkslenker; + ESP			03.7750-7332.4 300298	ATE Ø 9" pneumatisch
1.2 16V	55 - 56	03/07→		→ 07/14; für Linkslenker; - ESP			03.7853-3902.4 300270	ATE Ø 9" pneumatisch
1.2 TCe 100	75	02/11→						
1.2 Turbo	74	03/07→09/14						
1.5 dCi	47 - 62	03/07→09/14						
1.5 dCi 75	55	10/10→						
1.5 dCi 90	63	10/10→						
1.6 RS	98	05/08→09/14		für Linkslenker; → 07/14			03.7750-8832.4 300299	ATE Ø 9" pneumatisch
 Hauptbremszylinder								
1.2	43	03/07→09/14		→ 07/14; für Linkslenker; - ESP			03.2120-4581.3 010915	ATE Ø 20,6
1.2 16V	55 - 56	03/07→		→ 07/14; für Linkslenker; + ESP			03.2120-4641.3 010932	ATE Ø 20,6
1.2 TCe 100	75	02/11→						
1.2 Turbo	74	03/07→09/14						
1.5 dCi	47 - 62	03/07→09/14						
1.5 dCi 75	55	10/10→						
1.5 dCi 90	63	10/10→						
1.6 RS	98	05/08→09/14		für Linkslenker; → 07/14			03.2123-2751.3 011014	ATE Ø 23,8
RENAULT - TWINGO II Kasten/Schrägheck (CNO_) 09/10→09/14								
 Bremskraftverstärker								
1.2	55	09/10→09/14		für Linkslenker; + ESP			03.7750-7332.4 300298	ATE Ø 9" pneumatisch
1.5 dCi	55	10/10→09/14		für Linkslenker; - ESP			03.7853-3902.4 300270	ATE Ø 9" pneumatisch
 Hauptbremszylinder								
1.2	55	09/10→09/14		für Linkslenker; - ESP			03.2120-4581.3 010915	ATE Ø 20,6
1.5 dCi	55	10/10→09/14		für Linkslenker; + ESP			03.2120-4641.3 010932	ATE Ø 20,6
RENAULT - TWINGO III (BCM_, BCA_) 09/14→								
 Hauptbremszylinder								
0.9 TCe 110	80	11/16→					24.4150-1071.3 011046	ATE Ø 20,6 ohne Bremsflüssigkeitsbehälter
0.9 TCe 90	66	09/14→						
0.9 TCe 90 LPG	66	08/18→						
0.9 TCe 95	68	03/19→						
1.0 SCe 65	48	03/19→						
1.0 SCe 70	51 - 52	09/14→						
1.0 SCe 75	54	03/19→						
Z.E:	60	05/20→						

	kw			 	! #		
RENAULT - VEL SATIS (BJ0_) 06/02→							
 Bremskraftverstärker							
2.0 16 V Turbo 2.0 16V Turbo 2.0 Turbo 2.2 dCi 3.0 dCi 3.5 3.5 V6	125 120 108 83 - 110 130 170 177	04/04→ 06/02→08/09 04/05→ 06/02→ 06/02→06/06 10/04→ 06/02→		→ 10/05; für Linkslenker; für Fahrzeuge ohne autom. Distanzregelung		03.7858-2802.4 300303	ATE Ø 9 / 8" pneumatisch
Pedalwegsensord, Bremspedal							
2.0 16 V Turbo 2.0 16V Turbo 2.0 Turbo 2.2 dCi 3.0 dCi 3.5 3.5 V6	125 120 108 83 - 110 130 170 177	04/04→ 06/02→08/09 04/05→ 06/02→ 06/02→06/06 10/04→ 06/02→		→ 10/05; für Fahrzeuge mit autom. Distanzregelung		03.0655-0005.2 370005	ATE
 Hauptbremszylinder							
2.0 16 V Turbo 2.2 dCi 3.5 V6	125 83 - 102 177	04/04→ 04/04→ 06/02→		→ 03/05 04/05→ 12/09		03.4125-0014.3 010794 03.4155-0043.3 010795	ATE Ø 25,4 ATE Ø 25,4
2.0 16V Turbo 2.2 dCi 3.0 dCi	120 110 130	06/02→08/09 06/02→08/09 06/02→06/06		→ 03/05 04/05→		03.4125-0014.3 010794 03.4155-0043.3 010795	ATE Ø 25,4 ATE Ø 25,4
2.0 dCi 2.0 Turbo 3.0 dCi 3.5	110 - 127 108 133 170	08/05→ 04/05→ 06/06→08/09 10/04→		→ 12/09 → 03/05 → 12/09		03.4155-0043.3 010795 03.4155-0043.3 010795 03.4125-0014.3 010794 03.4155-0043.3 010795	ATE Ø 25,4 ATE Ø 25,4 ATE Ø 25,4 ATE Ø 25,4
RENAULT - WIND (E4M_) 07/10→							
 Bremskraftverstärker							
1.2 1.2 TCe 100 1.6	74 75 98	07/10→ 02/11→ 07/10→		für Linkslenker; → 09/13		03.7750-8832.4 300299	ATE Ø 9" pneumatisch
 Hauptbremszylinder							
1.2 1.2 TCe 100 1.6	74 75 98	07/10→ 02/11→ 07/10→		für Linkslenker; → 09/13		03.2123-2751.3 011014	ATE Ø 23,8
SAAB - 9-3 (YS3D) 02/98→08/03							
 Bremskraftverstärker							
2.0 i 2.0 SE Turbo 2.0 Turbo 2.2 TiD 2.3 i 2.0 Turbo	96 147 113 - 151 92 110 110	02/98→09/02 02/98→09/02 02/98→09/02 11/00→09/02 02/98→09/02 03/99→09/02		01/01→; für Linkslenker für Linkslenker		03.7750-2932.4 300175 03.7750-2932.4 300175	ATE Ø 9" pneumatisch ATE Ø 9" pneumatisch
 Hauptbremszylinder							
2.0 i 2.0 SE Turbo 2.0 Turbo 2.2 TiD 2.3 i 2.0 Turbo 2.2 TiD	96 147 113 - 151 92 110 85	02/98→09/02 02/98→09/02 02/98→09/02 11/00→09/02 02/98→09/02 03/99→09/02 02/98→11/00		→ 12/00; für Linkslenker 01/01→ für Linkslenker		03.2123-1121.3 010176 03.2123-1626.3 010727 03.2123-1626.3 010727 03.2123-1121.3 010176	Ø 23,8 ATE Ø 23,8 ATE Ø 23,8 Ø 23,8
SAAB - 9-3 (YS3F, E79, D79, D75) 09/02→02/15							
 Hauptbremszylinder							
1 8t 8t BioPower 1.9 TiD 1.9 TTiD →	110 110 110 88 - 110 96 - 132	09/02→02/15 09/02→02/15 01/07→02/15 09/04→02/15 12/07→02/15		für Linkslenker; → 06/12		24.2125-1732.3 010827	TRW Ø 25,4















	kW					! #		
SAAB - 9-3 (YS3F, E79, D79, D75) 09/02→02/15								
 Hauptbremszylinder								
2.0 t	120 - 177	09/02→02/15			für Linkslenker; → 06/12		24.2125-1732.3 010827	TRW Ø 25,4
2.0 t BioPower	129 - 154	09/02→02/15						
2.0 t Bio Power	120 - 162	01/07→02/15						
2.0 t BioPower XWD	120 - 162	01/08→02/15						
2.0 Turbo Performance	185	04/04→02/15						
2.0 Turbo XWD	154	01/08→02/15						
2.0 t XWD	120 - 177	01/07→02/15						
2.2 TiD	92	09/02→02/15						
1.8 i	90	01/04→02/15			03/04→; für Linkslenker; → 06/12		24.2125-1732.3 010827	TRW Ø 25,4
2.0 T16	143	06/06→02/15			für Linkslenker		24.2125-1732.3 010827	TRW Ø 25,4
2.8 Turbo V6	184	03/05→02/15			→ 12/05; für Linkslenker		24.2125-1732.3 010827	TRW Ø 25,4
SAAB - 9-3 Cabriolet (YS3D) 02/98→08/03								
 Bremskraftverstärker								
2.0 i	96	02/98→08/03			09/00→ 07/03; für Linkslenker		03.7750-2932.4 300175	ATE Ø 9" pneumatisch
2.0 Turbo	113 - 151	02/98→08/03						
2.3 i	110	02/98→08/03						
2.3 Turbo	165	10/99→08/03						
2.0 SE Turbo	147	02/98→08/03			01/01→ 07/03; für Linkslenker		03.7750-2932.4 300175	ATE Ø 9" pneumatisch
2.0 Turbo	110	01/01→08/03			→ 07/03; für Linkslenker		03.7750-2932.4 300175	ATE Ø 9" pneumatisch
2.3	169	09/99→01/02			09/00→; für Linkslenker		03.7750-2932.4 300175	ATE Ø 9" pneumatisch
 Hauptbremszylinder								
2.0 i	96	02/98→08/03			→ 08/00; für Linkslenker		03.2123-1121.3 010176	Ø 23,8
2.0 Turbo	113 - 151	02/98→08/03			09/00→ 07/03		03.2123-1626.3 010727	ATE Ø 23,8
2.3 i	110	02/98→08/03						
2.3 Turbo	165	10/99→08/03						
2.0 SE Turbo	147	02/98→08/03			→ 08/00; für Linkslenker		03.2123-1121.3 010176	Ø 23,8
					01/01→ 07/03		03.2123-1626.3 010727	ATE Ø 23,8
2.0 Turbo	110	01/01→08/03			→ 07/03		03.2123-1626.3 010727	ATE Ø 23,8
2.3	169	09/99→01/02			10/99→ 08/00; für Linkslenker		03.2123-1121.3 010176	Ø 23,8
					09/00→		03.2123-1626.3 010727	ATE Ø 23,8
SAAB - 9-3 Cabriolet (YS3F) 08/03→02/15								
 Hauptbremszylinder								
1	110	08/03→02/15			→ 06/12; für Linkslenker		24.2125-1732.3 010827	TRW Ø 25,4
8t	110	08/03→02/15						
8t BioPower	110	01/07→02/15						
1.8 i	90	01/04→02/15						
1.9 TiD	88 - 110	09/04→02/15						
1.9 TTiD	96 - 132	12/07→02/15						
2.0 t	120 - 162	08/03→02/15						
2.0 t BioPower	120 - 162	01/11→02/15						
2.0 Turbo Performance	185	04/04→02/15						
2.0	130 - 143	09/04→09/07			für Linkslenker		24.2125-1732.3 010827	TRW Ø 25,4
2.0 t BioPower	129	01/07→02/15			→ 06/12; für Linkslenker		24.2125-1732.3 010827	TRW Ø 25,4
					07/07→ 06/12; für Linkslenker		24.2125-1732.3 010827	TRW Ø 25,4
2.0 t BioPower	147	06/07→02/15			07/07→ 06/12; für Linkslenker		24.2125-1732.3 010827	TRW Ø 25,4
2.0 T BioPower	145	06/07→02/15						
SAAB - 9-3 Kombi (E50) 03/05→02/15								
 Hauptbremszylinder								
1.8 i	90	03/05→02/15			→ 06/12; für Linkslenker		24.2125-1732.3 010827	TRW Ø 25,4
1.8 t	110	03/05→02/15						
1.8t 2.0	110	03/05→02/15						
1.9 TiD	88 - 110	03/05→02/15						
1.9 TTiD	96 - 132	12/07→02/15						
2.0 t	110 - 177	03/05→02/15						
2.0 T16	143	04/06→02/15						
→								







	kW					! #		
SAAB - 9-3 Kombi (E50) 03/05→02/15								
 Hauptbremszylinder								
2.0 t BioPower	110 - 162	01/07→02/15		→ 06/12; für Linkslenker			24.2125-1732.3 010827	TRW Ø 25,4
2.0 t Bio Power	147	02/09→02/15						
2.0 t BioPower XWD	120 - 162	01/07→02/15						
2.0 t Bio Power XWD	154	06/08→02/15						
2.0 t XWD	120 - 177	01/07→02/15						
2.0 t XWD	154	06/08→02/15		07/08→ 06/12; für Linkslenker			24.2125-1732.3 010827	TRW Ø 25,4
SAAB - 9-3X (YS3) 02/09→02/15								
 Hauptbremszylinder								
1.9 TTiD AWD	132	02/09→12/12		03/09→ 06/12; für Linkslenker			24.2125-1732.3 010827	TRW Ø 25,4
2.0 t BioPower XWD	154	02/09→12/12						
2.0 t XWD	154	02/09→02/15						
2.0 T16 XWD	162	01/11→02/15		→ 06/12; für Linkslenker			24.2125-1732.3 010827	TRW Ø 25,4
2.0 t BioPower XWD	162	01/11→12/12						
SAAB - 9-5 (YS3E) 09/97→12/09								
 Bremskraftverstärker								
1.9 TiD	110	01/06→12/09		für Linkslenker			03.7745-3902.4 300129	ATE Ø 8 / 7" pneumatisch
2.0 t BioPower	110	01/05→12/09						
2.2 TiD	88	03/02→12/09						
2.3 t BioPower	136 - 152	11/06→12/09						
2.3 Turbo	134 - 191	07/03→12/09						
2.0 t	110 - 136	09/97→12/09		→ 12/01; für Linkslenker			03.7745-3003.4 300157	ATE Ø 8 / 7" pneumatisch
2.3 t	125 - 136	09/97→12/09		01/02→; für Linkslenker			03.7745-3902.4 300129	ATE Ø 8 / 7" pneumatisch
2.3 Turbo	184	09/01→12/09						
3.0 TiD	130	07/01→08/05						
3.0 V6t	147	01/98→08/05						
2.0 t Biopower	132	09/05→12/09		06/06→; für Linkslenker			03.7745-3902.4 300129	ATE Ø 8 / 7" pneumatisch
2.0 Turbo SE	141	10/98→07/00		für Linkslenker			03.7745-3003.4 300157	ATE Ø 8 / 7" pneumatisch
2.3 Turbo	169	10/99→09/01						
2.3 Turbo	224	06/03→08/05		→ 03/04; für Linkslenker			03.7745-3902.4 300129	ATE Ø 8 / 7" pneumatisch
 Hauptbremszylinder								
1.9 TiD	110	01/06→12/09		für Linkslenker			03.2125-9911.3 010883	ATE Ø 25,4
2.3 t BioPower	136 - 152	11/06→12/09						
2.3 Turbo	134 - 188	04/08→12/09						
2.0 t	110 - 136	09/97→12/09		01/06→; für Linkslenker			03.2125-9911.3 010883	ATE Ø 25,4
2.0 t BioPower	110	01/05→12/09						
2.2 TiD	88	03/02→12/09						
2.3 t	136	01/01→12/09						
2.3 Turbo	162 - 191	09/01→12/09						
2.0 t Biopower	132	09/05→12/09		06/06→; für Linkslenker			03.2125-9911.3 010883	ATE Ø 25,4
SAAB - 9-5 (YS3G) 01/10→01/12								
 Bremskraftverstärker								
1.6 Turbo	132	05/10→01/12		für Linkslenker			03.7858-0732.4 300272	ATE Ø 9 / 8" pneumatisch
2.0 t BioPower	162	05/10→01/12						
2.0 t BioPower XWD	162	05/10→01/12						
2.0 TiD	118	05/10→01/12						
2.0 TTiD	140	05/10→01/12						
2.0 TTiD XWD	140	05/10→01/12						
2.0 Turbo	162	05/10→01/12						
2.0 Turbo XWD	162	05/10→01/12						
2.8 Turbo V6 XWD	221	05/10→01/12						
 Hauptbremszylinder								
1.6 Turbo	132	05/10→01/12		für Linkslenker			03.2125-0421.3 010934	ATE Ø 25,4
2.0 t BioPower	162	05/10→01/12						
2.0 t BioPower XWD	162	05/10→01/12						
2.0 TiD	118	05/10→01/12						
2.0 TTiD	140	05/10→01/12						
2.0 TTiD XWD	140	05/10→01/12						
2.0 Turbo	162	05/10→01/12						
2.0 Turbo XWD	162	05/10→01/12						
2.8 Turbo V6 XWD	221	05/10→01/12						









	kw					! #		
SAAB - 9-5 Kombi (YS3E) 10/98→12/09								
 Bremskraftverstärker								
1.9 TiD	110 - 129	01/06→12/09		für Linkslenker			03.7745-3902.4 300129	ATE Ø 8 / 7" pneumatisch
2.0 t BioPower	110	01/06→12/09						
2.2 TiD	88	03/02→12/09						
2.3 t BioPower	136 - 152	11/06→12/09						
2.3 Turbo	162 - 224	06/03→12/09						
2.0 t	110	10/98→12/09		→ 12/01; für Linkslenker			03.7745-3003.4 300157	ATE Ø 8 / 7" pneumatisch
2.3 t	125 - 136	10/98→12/09		01/02→; für Linkslenker			03.7745-3902.4 300129	ATE Ø 8 / 7" pneumatisch
3.0 TiD	130	07/01→08/05						
3.0 V6t	147	10/98→08/05						
2.0 t	136 - 141	10/98→07/01		für Linkslenker			03.7745-3003.4 300157	ATE Ø 8 / 7" pneumatisch
2.3 Turbo	169	10/99→09/01						
2.0 t Biopower	132	09/05→12/09		06/06→; für Linkslenker			03.7745-3902.4 300129	ATE Ø 8 / 7" pneumatisch
2.3 t BioPower	154	11/06→12/09		01/07→; für Linkslenker			03.7745-3902.4 300129	ATE Ø 8 / 7" pneumatisch
2.3 Turbo	184	09/01→12/09		01/02→; für Linkslenker			03.7745-3902.4 300129	ATE Ø 8 / 7" pneumatisch
 Hauptbremszylinder								
1.9 TiD	110 - 129	01/06→12/09		für Linkslenker			03.2125-9911.3 010883	ATE Ø 25,4
2.0 t BioPower	110	01/06→12/09						
2.3 t BioPower	136 - 152	11/06→12/09						
2.3 Turbo	191	01/06→12/09						
2.0 t	110	10/98→12/09		01/06→; für Linkslenker			03.2125-9911.3 010883	ATE Ø 25,4
2.2 TiD	88	03/02→12/09						
2.3 t	125 - 136	10/98→12/09						
2.3 Turbo	162 - 184	09/01→12/09						
2.0 t Biopower	132	09/05→12/09		06/06→; für Linkslenker			03.2125-9911.3 010883	ATE Ø 25,4
2.3 t BioPower	154	11/06→12/09		01/07→; für Linkslenker			03.2125-9911.3 010883	ATE Ø 25,4
SAAB - 900 II 07/93→04/99								
 Hauptbremszylinder								
2.0 -16 Turbo	136	07/93→02/98		09/93→; für Linkslenker			03.2123-1121.3 010176	Ø 23,8
2.3 -16	110	07/93→02/98		09/93→; → T2024503; für Rechtslenker			03.2123-1121.3 010176	Ø 23,8
				09/93→; → T7003723; für Rechtslenker			03.2123-1121.3 010176	Ø 23,8
2.0 i	96	08/94→02/98		für Linkslenker			03.2123-1121.3 010176	Ø 23,8
				→ T2024503; für Rechtslenker			03.2123-1121.3 010176	Ø 23,8
				→ T7003723; für Rechtslenker			03.2123-1121.3 010176	Ø 23,8
2.5 -24 V6	125	07/93→02/98		09/93→; für Linkslenker			03.2123-1121.3 010176	Ø 23,8
SAAB - 900 II Cabriolet 09/93→04/99								
 Hauptbremszylinder								
2.0 -16 Turbo	136	12/93→02/98		für Linkslenker			03.2123-1121.3 010176	Ø 23,8
2.0 i	96	12/93→02/98		→ T2024503; für Rechtslenker			03.2123-1121.3 010176	Ø 23,8
2.3 -16	110	12/93→02/98		→ T7003723; für Rechtslenker			03.2123-1121.3 010176	Ø 23,8
2.5 -24 V6	125	12/93→02/98		für Linkslenker			03.2123-1121.3 010176	Ø 23,8
SAAB - 900 II Coupe 12/93→04/99								
 Hauptbremszylinder								
2.0 -16 Turbo	136	12/93→02/98		für Linkslenker			03.2123-1121.3 010176	Ø 23,8
2.0 i	96	08/94→02/98		→ T2024503; für Rechtslenker			03.2123-1121.3 010176	Ø 23,8
2.3 -16	110	12/93→02/98		→ T7003723; für Rechtslenker			03.2123-1121.3 010176	Ø 23,8
2.5 -24 V6	125	12/93→02/98		für Linkslenker			03.2123-1121.3 010176	Ø 23,8
SEAT - ALHAMBRA (7V8, 7V9) 04/96→03/10								
 Bremskraftverstärker								
1.8 T 20V	110	10/97→03/10		7M-W-507042→; → 05/00; für Linkslenker; + ABS			03.7755-1902.4 300138	ATE Ø 9 / 8" pneumatisch
				06/00→; → 7M-3-515799; für Linkslenker; - ESP			03.7755-6302.4 300221	ATE Ø 9 / 8" pneumatisch
				06/00→; für Rechtslenker; - ESP			03.7755-6302.4 300221	ATE Ø 9 / 8" pneumatisch
				7M-3-515800→; für Linkslenker; - ESP			03.7755-6302.4 300221	ATE Ø 9 / 8" pneumatisch
→								







	kw			 	! #			
SEAT - ALHAMBRA (7V8, 7V9) 04/96→03/10								
Bremskraftverstärker								
1.8 T 20V	110	10/97→03/10		05/98→; → 7M-W-507041; für Linkslenker; + ABS	03.7760-3002.4	300120	ATE Ø 10" pneumatisch	
				05/98→ 05/00; für Rechtslenker; + ABS	03.7760-3002.4	300120	ATE Ø 10" pneumatisch	
				06/00→; → 7M-3-515799; für Linkslenker; + ESP	03.7858-3302.4	300122	ATE Ø 9 / 8" pneumatisch	
				7M-3-515800→; für Linkslenker; + ESP	03.7858-9502.4	300205	ATE Ø 9 / 8" pneumatisch	
1.9 TDI 2.0 i	66	04/96→03/10		7M-W-507042→; → 05/00; für Linkslenker; + ABS	03.7755-1902.4	300138	ATE Ø 9 / 8" pneumatisch	
				06/00→; → 7M-3-515799; für Linkslenker; - ESP	03.7755-6302.4	300221	ATE Ø 9 / 8" pneumatisch	
	85	04/96→03/10		06/00→; für Rechtslenker; - ESP	03.7755-6302.4	300221	ATE Ø 9 / 8" pneumatisch	
				7M-3-515800→; für Linkslenker; - ESP	03.7755-6302.4	300221	ATE Ø 9 / 8" pneumatisch	
				→ 05/00; für Rechtslenker; + ABS	03.7760-3002.4	300120	ATE Ø 10" pneumatisch	
				→ 7M-W-507041; für Linkslenker; + ABS	03.7760-3002.4	300120	ATE Ø 10" pneumatisch	
				06/00→; → 7M-3-515799; für Linkslenker; + ESP	03.7858-3302.4	300122	ATE Ø 9 / 8" pneumatisch	
				7M-3-515800→; für Linkslenker; + ESP	03.7858-9502.4	300205	ATE Ø 9 / 8" pneumatisch	
1.9 TDI	81	08/96→06/00		7M-W-507042→; → 05/00; für Linkslenker; + ABS	03.7755-1902.4	300138	ATE Ø 9 / 8" pneumatisch	
				10/97→ 05/00; für Rechtslenker; + ABS	03.7760-3002.4	300120	ATE Ø 10" pneumatisch	
				10/97→; → 7M-W-507041; für Linkslenker; + ABS	03.7760-3002.4	300120	ATE Ø 10" pneumatisch	
1.9 TDI 2.8 V6	85 - 96	06/00→03/10		7M-3-515800→; für Linkslenker; - ESP	03.7755-6302.4	300221	ATE Ø 9 / 8" pneumatisch	
				für Rechtslenker; - ESP	03.7755-6302.4	300221	ATE Ø 9 / 8" pneumatisch	
	150	06/00→03/10		→ 7M-3-515799; für Linkslenker; - ESP	03.7755-6302.4	300221	ATE Ø 9 / 8" pneumatisch	
				→ 7M-3-515799; für Linkslenker; + ESP	03.7858-3302.4	300122	ATE Ø 9 / 8" pneumatisch	
1.9 TDI 2.0 TDI	110 103	05/05→05/07 11/05→03/10		- ESP	03.7755-6302.4	300221	ATE Ø 9 / 8" pneumatisch	
				für Linkslenker; + ESP	03.7858-9502.4	300205	ATE Ø 9 / 8" pneumatisch	
1.9 TDI 4motion 2.8 V6 4motion	85 150	06/00→03/10 06/00→03/10		02/01→; → 7M-3-515799; für Linkslenker; - ESP	03.7755-6302.4	300221	ATE Ø 9 / 8" pneumatisch	
				02/01→; für Rechtslenker; - ESP	03.7755-6302.4	300221	ATE Ø 9 / 8" pneumatisch	
	150	06/00→03/10		7M-3-515800→; für Linkslenker; - ESP	03.7755-6302.4	300221	ATE Ø 9 / 8" pneumatisch	
				02/01→; → 7M-3-515799; für Linkslenker; + ESP	03.7858-3302.4	300122	ATE Ø 9 / 8" pneumatisch	
				7M-3-515800→; für Linkslenker; + ESP	03.7858-9502.4	300205	ATE Ø 9 / 8" pneumatisch	
Pedalwegsensord, Bremspedal								
1.8 T 20V 1.9 TDI 1.9 TDI 4motion 2.0 i 2.8 V6 2.8 V6 4motion	110 66 - 96	10/97→03/10 04/96→03/10		7M-3-515800→; für Linkslenker; + ESP	03.0655-0006.2	370006	ATE	
	85 85 150 150	06/00→03/10 04/96→03/10 06/00→03/10 06/00→03/10						
1.9 TDI 2.0 TDI	110 103	05/05→05/07 11/05→03/10		für Linkslenker; + ESP	03.0655-0006.2	370006	ATE	
Hauptbremszylinder								
1.8 T 20V	110	10/97→03/10		05/98→; → 7M-W-507041; + ABS	03.2123-1526.3	010477	Ø 23,8	
				05/98→; → 7M-W-507041; - ABS	03.2123-1548.3	010478	Ø 23,8	
				06/00→; → 7M-3-515799; - ESP	03.2125-0332.3	010952	Ø 25,4	
				7M-W-507042→; → 05/00; + ABS	03.2125-0332.3	010952	Ø 25,4	
				7M-3-515800→; - ESP	03.2125-0332.3	010952	Ø 25,4	
				7M-W-507042→; → 05/00; - ABS	03.2125-8404.3	010583	ATE Ø 25,4	
				06/00→; → 7M-3-515799; + ESP	03.2125-9604.3	010581	Ø 25,4	
1.9 TDI 2.0 i	66 85	04/96→03/10 04/96→03/10		→ 7M-W-507041; + ABS	03.2123-1526.3	010477	Ø 23,8	
				→ 7M-W-507041; - ABS	03.2123-1548.3	010478	Ø 23,8	
	85	04/96→03/10		06/00→; → 7M-3-515799; - ESP	03.2125-0332.3	010952	Ø 25,4	
				7M-W-507042→; → 05/00; + ABS	03.2125-0332.3	010952	Ø 25,4	
				7M-3-515800→; - ESP	03.2125-0332.3	010952	Ø 25,4	
				7M-W-507042→; → 05/00; - ABS	03.2125-8404.3	010583	ATE Ø 25,4	
				06/00→; → 7M-3-515799; + ESP	03.2125-9604.3	010581	Ø 25,4	
1.9 TDI	81	08/96→06/00		10/97→; → 7M-W-507041; + ABS	03.2123-1526.3	010477	Ø 23,8	
				10/97→; → 7M-W-507041; - ABS	03.2123-1548.3	010478	Ø 23,8	
				7M-W-507042→; → 05/00; + ABS	03.2125-0332.3	010952	Ø 25,4	
→								





















	kw					! #		
SEAT - ALHAMBRA (7V8, 7V9) 04/96→03/10								
 Hauptbremszylinder								
1.9 TDI	81	08/96→06/00			7M-W-507042→; → 05/00; - ABS		03.2125-8404.3 010583	ATE Ø 25,4
1.9 TDI	85	06/00→03/10			→ 7M-3-515799; - ESP		03.2125-0332.3 010952	Ø 25,4
2.8 V6	96 150	06/00→03/10			7M-3-515800→; - ESP		03.2125-0332.3 010952	Ø 25,4
					→ 7M-3-515799; + ESP		03.2125-9604.3 010581	Ø 25,4
1.9 TDI	110	05/05→05/07			- ESP		03.2125-0332.3 010952	Ø 25,4
2.0 TDI	103	11/05→03/10						
1.9 TDI 4motion	85	06/00→03/10			02/01→; → 7M-3-515799; - ESP		03.2125-0332.3 010952	Ø 25,4
2.8 V6 4motion	150	06/00→03/10			7M-3-515800→; - ESP		03.2125-0332.3 010952	Ø 25,4
					02/01→; → 7M-3-515799; + ESP		03.2125-9604.3 010581	Ø 25,4
Verschlusschraube, Hauptbremszylinder								
1.8 T 20V	110	10/97→03/10			05/98→; → 7M-W-507041; - ABS		03.3517-5100.1 390326	
1.9 TDI	66	04/96→03/10			→ 7M-W-507041; - ABS		03.3517-5100.1 390326	
2.0 i	85	04/96→03/10						
1.9 TDI	81	08/96→06/00			10/97→; → 7M-W-507041; - ABS		03.3517-5100.1 390326	
SEAT - ALHAMBRA (710, 711) 06/10→								
 Bremskraftverstärker								
1.4 TSI	110	06/10→04/15			für Linkslenker		03.7873-4502.4 300284	ATE Ø 11" pneumatisch
1.8 TSI	118	11/12→04/15						
2.0 TDI	85	06/10→						
	130							
2.0 TDI 4Drive	103	05/11→04/15						
2.0 TSI	147	11/10→05/12						
 Hauptbremszylinder								
1.4 TSI	110	06/10→			für Linkslenker		03.4153-0186.3 010816	ATE Ø 23,8
1.8 TSI	118	11/12→04/15						
2.0 TDI	85	06/10→			für Rechtslenker		24.4153-0222.3 011047	ATE Ø 23,8 ohne Bremsflüssigkeitsbehälter
	135							
2.0 TDi 4Drive	130	11/18→						
2.0 TDI 4Drive	103	05/11→						
	135							
2.0 TSI	147	11/10→						
	162							
SEAT - ALHAMBRA VAN (7V8, 7V9) 03/96→03/10								
 Bremskraftverstärker								
1.9 TDI	96	11/02→11/08			7M-3-515800→; für Linkslenker; - ESP		03.7755-6302.4 300221	ATE Ø 9 / 8" pneumatisch
1.9 TDI 4motion	85	06/02→05/08			für Rechtslenker; - ESP		03.7755-6302.4 300221	ATE Ø 9 / 8" pneumatisch
					→ 7M-3-515799; für Linkslenker; - ESP		03.7755-6302.4 300221	ATE Ø 9 / 8" pneumatisch
					→ 7M-3-515799; für Linkslenker; + ESP		03.7858-3302.4 300122	ATE Ø 9 / 8" pneumatisch
					7M-3-515800→; für Linkslenker; + ESP		03.7858-9502.4 300205	ATE Ø 9 / 8" pneumatisch
Pedalwegsensor, Bremspedal								
1.9 TDI	96	11/02→11/08			7M-3-515800→; für Linkslenker; + ESP		03.0655-0006.2 370006	ATE
1.9 TDI 4motion	85	06/02→05/08						
 Hauptbremszylinder								
1.9 TDI	96	11/02→11/08			→ 7M-3-515799; - ESP		03.2125-0332.3 010952	Ø 25,4
1.9 TDI 4motion	85	06/02→05/08			7M-3-515800→; - ESP		03.2125-0332.3 010952	Ø 25,4
					→ 7M-3-515799; + ESP		03.2125-9604.3 010581	Ø 25,4
SEAT - ALHAMBRA VAN (711) 06/10→								
 Hauptbremszylinder								
TDI	110	05/15→			für Linkslenker		03.4153-0186.3 010816	ATE Ø 23,8
	135							
TDI 4Drive	110	05/15→			für Rechtslenker		24.4153-0222.3 011047	ATE Ø 23,8 ohne Bremsflüssigkeitsbehälter
TSi	110	05/15→						
SEAT - ALTEA (5P1) 03/04→								
 Bremskraftverstärker								
1.2 TSI	77	04/10→			05/10→; für Linkslenker		03.7863-3232.4 300307	ATE Ø 10" pneumatisch
1.4 16V	63	05/06→					03.7863-3332.4 300308	ATE Ø 10" pneumatisch
1.4 TSI	92	11/07→						
1.6	75	03/04→			→ 04/10; +PR 1AC / 1AT; für Linkslenker		03.7863-3232.4 300307	ATE Ø 10" pneumatisch
1.6 LPG	75	09/09→						
1.6 TDI	77	10/09→						
1.8 TFSI	118	01/07→						
→								













	kw			 	! #		
SEAT - ALTEA (5P1) 03/04 →							
Bremskraftverstärker							
1.9 TDI	66 - 77	04/04 →		05/10 →; für Linkslenker	03.7863-3232.4	300307	ATE Ø 10" pneumatisch
2.0 TDI	103 - 125	11/05 →		→ 04/10; +PR 1AC / 1AT; für Linkslenker	03.7863-3332.4	300308	ATE Ø 10" pneumatisch
2.0 TDI 16V	103	03/04 →			03.7863-3232.4	300307	ATE Ø 10" pneumatisch
1.6 Multifuel	75	11/10 →	05/11	für Linkslenker	03.7863-3232.4	300307	ATE Ø 10" pneumatisch
1.6 TDI	66	11/10 →			03.7863-3332.4	300308	ATE Ø 10" pneumatisch
2.0 FSI	110	05/04 →	03/09	+PR 1AC / 1AT; für Linkslenker	03.7863-3232.4	300307	ATE Ø 10" pneumatisch
2.0 TDI	100	03/04 →	05/09				
2.0 TFSI	147	04/06 →	05/09				
2.0 TDI 16V 4WD	103	10/10 →		für Linkslenker	03.7863-3232.4	300307	ATE Ø 10" pneumatisch
					03.7863-3332.4	300308	ATE Ø 10" pneumatisch
				+PR 1AC / 1AT; für Linkslenker	03.7863-3232.4	300307	ATE Ø 10" pneumatisch
Hauptbremszylinder							
1.2 TSI	77	04/10 →		→ 04/10; für Linkslenker	03.2122-2129.3	010799	ATE Ø 22,2
1.4 TSI	92	11/07 →		05/10 →; +PR 1AC / 1AT / 1AS; für Linkslenker	03.2122-2129.3	010799	ATE Ø 22,2
1.6	75	03/04 →					
1.6 LPG	75	09/09 →					
1.6 TDI	77	10/09 →		05/10 →; +PR 1AC / 1AT / 1LJ; für Linkslenker	03.2123-3449.3	010808	ATE Ø 23,8
1.8 TFSI	118	01/07 →					
1.9 TDI	66 - 77	04/04 →		→ 04/10; für Rechtslenker	24.2122-1981.3	011024	ATE Ø 22,2 ohne Bremsflüssigkeitsbehälter
2.0 TDI	103 - 125	11/05 →			24.4152-0132.3	011025	ATE Ø 22,2 ohne Bremsflüssigkeitsbehälter
2.0 TDI 16V	103	03/04 →		05/10 →; +PR 1AC / 1AT / 1AS / 1ZD / 1LJ / 1LV; für Rechtslenker	24.4152-0132.3	011025	ATE Ø 22,2 ohne Bremsflüssigkeitsbehälter
				05/10 →; für Rechtslenker	24.4153-0202.3	011027	ATE Ø 23,8 ohne Bremsflüssigkeitsbehälter
1.4 16V	63	05/06 →		→ 04/10; für Linkslenker	03.2122-2129.3	010799	ATE Ø 22,2
				05/10 →; +PR 1AC / 1AT / 1AS; für Linkslenker	03.2122-2129.3	010799	ATE Ø 22,2
				05/10 →; +PR 1AC / 1AT / 1LJ; für Linkslenker	03.2123-3449.3	010808	ATE Ø 23,8
				→ 04/10; für Rechtslenker	24.2122-1981.3	011024	ATE Ø 22,2 ohne Bremsflüssigkeitsbehälter
					24.4152-0132.3	011025	ATE Ø 22,2 ohne Bremsflüssigkeitsbehälter
				05/10 →; +PR 1LJ / 1LV / 1AC / 1AT / 1AS / 1ZD; für Rechtslenker	24.4152-0132.3	011025	ATE Ø 22,2 ohne Bremsflüssigkeitsbehälter
				05/10 →; für Rechtslenker	24.4153-0202.3	011027	ATE Ø 23,8 ohne Bremsflüssigkeitsbehälter
1.6 Multifuel	75	11/10 →	05/11	für Linkslenker; +PR 1AC / 1AT / 1AS	03.2122-2129.3	010799	ATE Ø 22,2
1.6 TDI	66	11/10 →		für Linkslenker; +PR 1AC / 1AT / 1LJ	03.2123-3449.3	010808	ATE Ø 23,8
				für Rechtslenker; +PR 1AC / 1AT / 1AS / 1ZD / 1LJ / 1LV	24.4152-0132.3	011025	ATE Ø 22,2 ohne Bremsflüssigkeitsbehälter
				für Rechtslenker	24.4153-0202.3	011027	ATE Ø 23,8 ohne Bremsflüssigkeitsbehälter
2.0 FSI	110	05/04 →	03/09	für Linkslenker	03.2122-2129.3	010799	ATE Ø 22,2
				für Rechtslenker	24.2122-1981.3	011024	ATE Ø 22,2 ohne Bremsflüssigkeitsbehälter
					24.4152-0132.3	011025	ATE Ø 22,2 ohne Bremsflüssigkeitsbehälter
2.0 TDI	100	03/04 →	05/09	für Linkslenker	03.2122-2129.3	010799	ATE Ø 22,2
2.0 TFSI	147	04/06 →	05/09	für Rechtslenker	24.2122-1981.3	011024	ATE Ø 22,2 ohne Bremsflüssigkeitsbehälter
					24.4153-0202.3	011027	ATE Ø 23,8 ohne Bremsflüssigkeitsbehälter
				für Rechtslenker; +PR 1AC / 1AT / 1AS / 1ZD / 1LJ / 1LV	24.4152-0132.3	011025	ATE Ø 22,2 ohne Bremsflüssigkeitsbehälter
2.0 TDI 16V 4WD	103	10/10 →		für Linkslenker	03.2122-2129.3	010799	ATE Ø 22,2
				für Linkslenker; +PR 1AC / 1AT / 1AS	03.2122-2129.3	010799	ATE Ø 22,2
				für Linkslenker; +PR 1AC / 1AT / 1LJ	03.2123-3449.3	010808	ATE Ø 23,8
				für Rechtslenker	24.2122-1981.3	011024	ATE Ø 22,2 ohne Bremsflüssigkeitsbehälter
					24.4152-0132.3	011025	ATE Ø 22,2 ohne Bremsflüssigkeitsbehälter
					24.4153-0202.3	011027	ATE Ø 23,8 ohne Bremsflüssigkeitsbehälter
				für Rechtslenker; +PR 1AC / 1AT / 1AS / 1ZD / 1LJ / 1LV	24.4152-0132.3	011025	ATE Ø 22,2 ohne Bremsflüssigkeitsbehälter











	kw			 	! #			
SEAT - ALTEA (5P1) 03/04 →								
Hydraulikaggregat, Bremsanlage								
1.2 TSI	77	04/10 →		+PR 1AT / 1AS		24.9145-0001.2	399005	
1.4 16V	63	05/06 →						
1.4 TSI	92	11/07 →						
1.6	75	03/04 →						
1.6 LPG	75	09/09 →						
1.6 TDI	66 -	10/09 →						
	77							
1.8 TFSI	118	01/07 →						
1.9 TDI	66 -	04/04 →						
	77							
2.0 FSI	110	05/04 → 03/09						
2.0 TDI	100 -	03/04 →						
	125							
2.0 TDI 16V	103	03/04 →						
2.0 TDI 16V 4WD	103	10/10 →						
2.0 TFSI	147	04/06 → 05/09						
Drucksensor, Bremskraftverstärker								
1.2 TSI	77	04/10 →		→ 04/10; +PR 1AS; für Linkslenker		03.0655-0101.2	370008	ATE
1.4 16V	63	05/06 →						
1.4 TSI	92	11/07 →						
1.6	75	03/04 →						
1.6 LPG	75	09/09 →						
1.6 TDI	77	10/09 →						
1.8 TFSI	118	01/07 →						
1.9 TDI	66 -	04/04 →						
	77							
2.0 TDI	103 -	11/05 →						
	125							
2.0 TDI 16V	103	03/04 →						
2.0 FSI	110	05/04 → 03/09		+PR 1AS; für Linkslenker		03.0655-0101.2	370008	ATE
2.0 TDI	100	03/04 → 05/09						
2.0 TDI 16V 4WD	103	10/10 →						
2.0 TFSI	147	04/06 → 05/09						
SEAT - ALTEA XL (5P5, 5P8) 10/06 →								
 Bremskraftverstärker								
1.2 TSI	77	04/10 →		05/10 →; für Linkslenker		03.7863-3232.4	300307	ATE Ø 10" pneumatisch
1.4 TSI	92	11/07 →				03.7863-3332.4	300308	ATE Ø 10" pneumatisch
1.6	75	10/06 →						
1.6 LPG	75	09/09 →		→ 04/10; +PR 1AC / 1AT; für Linkslenker		03.7863-3232.4	300307	ATE Ø 10" pneumatisch
1.6 Multifuel	75	10/06 → 11/10						
1.6 TDI	77	10/09 →						
1.8 TFSI	118	01/07 →						
1.9 TDI	66 -	10/06 → 12/10						
	77							
1.9 TDI 4x4	77	06/09 → 12/10						
2.0 TDI	103	10/06 →						
2.0 TDI 16V	103	10/06 →						
2.0 TDI 4x4	103	06/07 →						
1.4 16V	63	10/06 →		05/10 →; für Linkslenker		03.7863-3232.4	300307	ATE Ø 10" pneumatisch
						03.7863-3332.4	300308	ATE Ø 10" pneumatisch
				05/08 →; +PR 1AC / 1AT; → 04/10; für Linkslenker		03.7863-3232.4	300307	ATE Ø 10" pneumatisch
1.6 TDI	66	11/10 →		für Linkslenker		03.7863-3232.4	300307	ATE Ø 10" pneumatisch
2.0 TDI 16V 4x4	103	10/10 →				03.7863-3332.4	300308	ATE Ø 10" pneumatisch
2.0 TFSI	155	05/09 →						
2.0 TFSI 4x4	155	05/09 →						
2.0 FSI	110	10/06 → 03/09		+PR 1AC / 1AT; für Linkslenker		03.7863-3232.4	300307	ATE Ø 10" pneumatisch
2.0 TDI	100 -	11/06 → 12/13						
	125							
2.0 TDI 4x4	125	06/07 → 06/13						
2.0 TFSI	147	10/06 → 05/09						
2.0 TFSI 4x4	147	06/07 → 05/09						
 Hauptbremszylinder								
1.2 TSI	77	04/10 →		→ 04/10; für Linkslenker		03.2122-2129.3	010799	ATE Ø 22,2
1.4 TSI	92	11/07 →				03.2122-2129.3	010799	ATE Ø 22,2
1.6	75	10/06 →		05/10 →; für Linkslenker; +PR 1AC / 1AT / 1AS				
1.6 LPG	75	09/09 →						
1.6 Multifuel	75	10/06 → 11/10		05/10 →; +PR 1AC / 1AT / 1LJ; für Linkslenker		03.2123-3449.3	010808	ATE Ø 23,8
1.6 TDI	77	10/09 →						
1.8 TFSI	118	01/07 →		→ 04/10; für Rechtslenker		24.2122-1981.3	011024	ATE Ø 22,2 ohne Bremsflüssigkeitsbehälter
1.9 TDI	66 -	10/06 → 12/10				24.4152-0132.3	011025	ATE Ø 22,2 ohne Bremsflüssigkeitsbehälter
	77							
2.0 TDI	103	10/06 →						
2.0 TDI 16V	103	10/06 →						
2.0 TDI 4x4	103	06/07 →		05/10 →; für Rechtslenker; +PR 1AC / 1AT / 1AS / 1ZD / 1LJ / 1LV		24.4152-0132.3	011025	ATE Ø 22,2 ohne Bremsflüssigkeitsbehälter
2.0 TFSI	155	05/09 →						
2.0 TFSI 4x4	155	05/09 →						
→								











	kw			 	! #		
SEAT - ALTEA XL (5P5, 5P8) 10/06→							
Hauptbremszylinder							
1.2 TSI 1.4 TSI 1.6 1.6 LPG 1.6 Multifuel 1.6 TDI 1.8 TFSI 1.9 TDI 2.0 TDI 2.0 TDI 16V 2.0 TDI 4x4 2.0 TFSI 2.0 TFSI 4x4	77 92 75 75 75 77 118 66 - 77 103 103 103 155 155	04/10→ 11/07→ 10/06→ 09/09→ 10/06→11/10 10/09→ 01/07→ 10/06→12/10 10/06→ 10/06→ 06/07→ 05/09→ 05/09→		05/10→; für Rechtslenker		24.4153-0202.3 011027	ATE Ø 23,8 ohne Bremsflüssigkeitsbehälter
1.4 16V	63	10/06→		05/10→; für Linkslenker; +PR 1AC / 1AT / 1AS		03.2122-2129.3 010799	ATE Ø 22,2
				05/08→ 04/10; für Linkslenker		03.2122-2129.3 010799	ATE Ø 22,2
				05/10→; +PR 1AC / 1AT / 1LJ; für Linkslenker		03.2123-3449.3 010808	ATE Ø 23,8
				05/08→ 04/10; für Rechtslenker		24.2122-1981.3 011024	ATE Ø 22,2 ohne Bremsflüssigkeitsbehälter
						24.4152-0132.3 011025	ATE Ø 22,2 ohne Bremsflüssigkeitsbehälter
				05/10→; für Rechtslenker; +PR 1AC / 1AT / 1AS / 1ZD / 1LJ / 1LV		24.4152-0132.3 011025	ATE Ø 22,2 ohne Bremsflüssigkeitsbehälter
			05/10→; für Rechtslenker		24.4153-0202.3 011027	ATE Ø 23,8 ohne Bremsflüssigkeitsbehälter	
1.6 TDI 2.0 TDI 16V 4x4	66 103	11/10→ 10/10→		für Linkslenker; +PR 1AC / 1AT / 1AS		03.2122-2129.3 010799	ATE Ø 22,2
				für Linkslenker; +PR 1AC / 1AT / 1LJ		03.2123-3449.3 010808	ATE Ø 23,8
				+PR 1AC / 1AT / 1AS / 1ZD / 1LJ / 1LV; für Rechtslenker		24.4152-0132.3 011025	ATE Ø 22,2 ohne Bremsflüssigkeitsbehälter
				für Rechtslenker		24.4153-0202.3 011027	ATE Ø 23,8 ohne Bremsflüssigkeitsbehälter
1.9 TDI 4x4	77	06/09→12/10		→ 04/10; für Linkslenker		03.2122-2129.3 010799	ATE Ø 22,2
				05/10→; für Linkslenker; +PR 1AC / 1AT / 1AS		03.2122-2129.3 010799	ATE Ø 22,2
				→ 04/10; für Rechtslenker		24.2122-1981.3 011024	ATE Ø 22,2 ohne Bremsflüssigkeitsbehälter
						24.4152-0132.3 011025	ATE Ø 22,2 ohne Bremsflüssigkeitsbehälter
				05/10→; für Rechtslenker; +PR 1AC / 1AT / 1AS / 1ZD / 1LJ / 1LV		24.4152-0132.3 011025	ATE Ø 22,2 ohne Bremsflüssigkeitsbehälter
			05/10→; für Rechtslenker		24.4153-0202.3 011027	ATE Ø 23,8 ohne Bremsflüssigkeitsbehälter	
2.0 FSI 2.0 TDI 2.0 TFSI 4x4	110 100 147	10/06→03/09 11/06→03/09 06/07→05/09		für Linkslenker		03.2122-2129.3 010799	ATE Ø 22,2
				für Rechtslenker		24.2122-1981.3 011024	ATE Ø 22,2 ohne Bremsflüssigkeitsbehälter
						24.4153-0202.3 011027	ATE Ø 23,8 ohne Bremsflüssigkeitsbehälter
			+PR 1AC / 1AT / 1AS / 1ZD / 1LJ / 1LV; für Rechtslenker		24.4152-0132.3 011025	ATE Ø 22,2 ohne Bremsflüssigkeitsbehälter	
2.0 TDI 2.0 TDI 4x4	125 125	06/07→12/13 06/07→06/13		für Linkslenker		03.2122-2129.3 010799	ATE Ø 22,2
				für Rechtslenker		24.2122-1981.3 011024	ATE Ø 22,2 ohne Bremsflüssigkeitsbehälter
						24.4152-0132.3 011025	ATE Ø 22,2 ohne Bremsflüssigkeitsbehälter
2.0 TFSI	147	10/06→05/09		für Linkslenker		03.2122-2129.3 010799	ATE Ø 22,2
				für Rechtslenker		24.2122-1981.3 011024	ATE Ø 22,2 ohne Bremsflüssigkeitsbehälter
				+PR 1AC / 1AT / 1AS / 1ZD / 1LJ / 1LV; für Rechtslenker		24.4152-0132.3 011025	ATE Ø 22,2 ohne Bremsflüssigkeitsbehälter
Drucksensor, Bremskraftverstärker							
1.2 TSI 1.4 TSI 1.6 1.6 LPG 1.6 Multifuel 1.6 TDI 1.8 TFSI 1.9 TDI 1.9 TDI 4x4 →	77 92 75 75 75 77 118 66 - 77 77	04/10→ 11/07→ 10/06→ 09/09→ 10/06→11/10 10/09→ 01/07→ 10/06→12/10 06/09→12/10		→ 04/10; für Linkslenker; +PR 1AS		03.0655-0101.2 370008	ATE













	kw			 	! #		
SEAT - ALTEA XL (5P5, 5P8) 10/06→							
Drucksensor, Bremskraftverstärker							
2.0 TDI	103	10/06→		→ 04/10; für Linkslenker; +PR 1AS		03.0655-0101.2 370008	ATE
2.0 TDI 16V	103	10/06→					
2.0 TDI 4x4	103	06/07→					
1.4 16V	63	10/06→		05/08→; +PR 1AS; → 04/10; für Linkslenker		03.0655-0101.2 370008	ATE
2.0 FSI	110	10/06→03/09		+PR 1AS; für Linkslenker		03.0655-0101.2 370008	ATE
2.0 TDI	100 - 125	11/06→12/13					
2.0 TDI 4x4	125	06/07→06/13					
2.0 TFSI	147 - 155	10/06→					
2.0 TFSI 4x4	147 - 155	06/07→					
SEAT - AROSA (6H1) 05/97→06/04							
Hauptbremszylinder							
1.0	37	05/97→06/04		für Linkslenker; - ABS		03.2120-3943.3 010532	ATE Ø 20,6
1.4	44	05/97→06/04		für Linkslenker; + ABS		03.2122-1344.3 010593	ATE Ø 22,2
1.4 16V	74	01/00→06/04					
1.4 TDI	55	01/00→06/04					
1.7 SDI	44	08/97→06/04		11/97→; für Linkslenker; - ABS		03.2120-3943.3 010532	ATE Ø 20,6
				11/97→; für Linkslenker; + ABS		03.2122-1344.3 010593	ATE Ø 22,2
SEAT - ATECA (KH7, KHP) 04/16→							
Hauptbremszylinder							
1.4 TSI 4Drive	110	06/16→		für Linkslenker		24.4123-1719.3 011017	TRW Ø 23,8 ohne Bremsflüssigkeitsbehälter
1.5 TSI 4Drive	110	07/18→					
2.0 TDI 4Drive	140	06/16→				24.4153-1522.3 011048	ATE Ø 23,8 ohne Bremsflüssigkeitsbehälter
2.0 TSI 4Drive	140	05/17→					
2.0 TDI 4Drive	110	04/16→		06/16→; für Linkslenker		24.4123-1719.3 011017	TRW Ø 23,8 ohne Bremsflüssigkeitsbehälter
				für Linkslenker		24.4153-1522.3 011048	ATE Ø 23,8 ohne Bremsflüssigkeitsbehälter
SEAT - CORDOBA (6K1, 6K2) 02/93→12/02							
Bremskraftverstärker							
1.0	51	06/01→08/02		für Linkslenker; - ABS		03.7750-6302.4 300161	ATE Ø 9" pneumatisch
				+ ABS; für Linkslenker; +PR 1KB		10.6350-3902.4 300213	ATE Ø 9" pneumatisch
				+ ABS; für Linkslenker; +PR 1KK / 1KM / 1KQ		10.6350-4002.4 300285	ATE Ø 9" pneumatisch
1.0 i	37	09/96→10/02		06/99→ 09/02; für Linkslenker; - ABS		03.7750-6302.4 300161	ATE Ø 9" pneumatisch
1.4 i	44	06/94→10/02					
1.4 i 16V	74	09/96→10/02		06/99→ 09/02; für Linkslenker; + ABS; +PR 1KB		10.6350-3902.4 300213	ATE Ø 9" pneumatisch
1.6 i	55 - 74	02/93→10/02					
1.9 TDI	66 - 81	08/96→10/02		06/99→ 09/02; für Linkslenker; + ABS; +PR 1KK / 1KM / 1KQ		10.6350-4002.4 300285	ATE Ø 9" pneumatisch
1.4 16V	55	05/00→10/02		→ 09/02; für Linkslenker; - ABS		03.7750-6302.4 300161	ATE Ø 9" pneumatisch
1.8 T 20V Cupra	115	07/00→10/02					
1.9 SDI	50	06/99→10/02		→ 09/02; für Linkslenker; + ABS; +PR 1KB		10.6350-3902.4 300213	ATE Ø 9" pneumatisch
				→ 09/02; für Linkslenker; + ABS; +PR 1KK / 1KM / 1KQ		10.6350-4002.4 300285	ATE Ø 9" pneumatisch
Hauptbremszylinder							
1.0	51	06/01→08/02		für Linkslenker; - ABS		03.2122-1042.3 010137	Ø 22,2
				für Linkslenker; + ABS		03.2123-1424.3 010637	ATE Ø 23,8
1.0 i	37	09/96→10/02		06/99→ 09/02; für Linkslenker; - ABS		03.2122-1042.3 010137	Ø 22,2
				06/99→ 09/02; für Linkslenker; + ABS		03.2123-1424.3 010637	ATE Ø 23,8
1.4	40	12/97→04/99		- ABS		03.2120-3943.3 010532	ATE Ø 20,6
1.4 16V	55	05/00→10/02		→ 09/02; für Linkslenker; - ABS		03.2122-1042.3 010137	Ø 22,2
1.8 T 20V Cupra	115	07/00→10/02					
1.9 SDI	50	06/99→10/02		→ 09/02; für Linkslenker; + ABS		03.2123-1424.3 010637	ATE Ø 23,8
1.4 i	44	06/94→10/02		→ 05/99; - ABS		03.2120-3943.3 010532	ATE Ø 20,6
1.4 i 16V	74	09/96→10/02		06/99→ 09/02; für Linkslenker; - ABS		03.2122-1042.3 010137	Ø 22,2
1.6 i	74	07/96→10/02		06/99→ 09/02; für Linkslenker; + ABS		03.2123-1424.3 010637	ATE Ø 23,8
1.6 i	55	02/93→10/02		11/93→ 05/99; - ABS		03.2120-3943.3 010532	ATE Ø 20,6
				06/99→ 09/02; für Linkslenker; - ABS		03.2122-1042.3 010137	Ø 22,2
				06/99→ 09/02; für Linkslenker; + ABS		03.2123-1424.3 010637	ATE Ø 23,8
1.6 i	55	05/94→06/99		→ 05/99; - ABS		03.2120-3943.3 010532	ATE Ø 20,6
1.9 SDI	47	08/96→06/99					
→							











	kw					! #		
SEAT - CORDOBA (6K1, 6K2) 02/93→12/02								
 Hauptbremszylinder								
1.8 i	66	02/93→09/02		11/93→05/99; - ABS		03.2120-3943.3 010532	ATE Ø 20,6	
1.9 TDI	66 - 81	08/96→10/02		06/99→09/02; für Linkslenker; - ABS		03.2122-1042.3 010137	Ø 22,2	
				→ 05/99; - ABS		03.2122-1042.3 010137	Ø 22,2	
				06/99→09/02; für Linkslenker; + ABS		03.2123-1424.3 010637	ATE Ø 23,8	
2.0 i	85	02/93→06/99		11/93→05/99; - ABS		03.2122-1042.3 010137	Ø 22,2	
				11/93→05/99; für Linkslenker; + ABS		10.6123-0674.3 010639	ATE Ø 23,8	
Verschlusschraube, Hauptbremszylinder								
1.4	40	12/97→04/99		- ABS		03.3517-0101.2 390322		
1.4 i	44	06/94→10/02		→ 05/99; - ABS		03.3517-0101.2 390322		
1.4 i 16V	74	09/96→10/02						
1.6 i	55 - 74	05/94→10/02						
1.9 SDI	47	08/96→06/99						
1.9 TDI	66 - 81	08/96→10/02						
1.6 i	55	02/93→10/02		11/93→05/99; - ABS		03.3517-0101.2 390322		
1.8 i	66	02/93→09/02						
2.0 i	85	02/93→06/99						
SEAT - CORDOBA (6L2) 09/02→11/09								
 Bremskraftverstärker								
1.2	47	10/02→06/06		für Linkslenker		03.7750-6302.4 300161	ATE Ø 9" pneumatisch	
1.4 TDI	55	10/02→12/05						
1.2 12V	51	05/06→11/09		→ 06/09; für Linkslenker		03.7750-6302.4 300161	ATE Ø 9" pneumatisch	
1.4 16V	63 - 74	10/02→11/09						
1.4 TDI	51 - 59	05/05→11/09						
1.6	74	04/03→11/09						
1.6 16V	77	11/06→11/09						
1.9 TDI	96	10/02→11/09						
1.4 16V	55	09/02→12/07		10/02→; für Linkslenker		03.7750-6302.4 300161	ATE Ø 9" pneumatisch	
1.9 SDI	47	09/02→11/09		10/02→06/09; für Linkslenker		03.7750-6302.4 300161	ATE Ø 9" pneumatisch	
1.9 TDI	74	09/02→11/09						
2.0	85	09/02→11/09						
 Hauptbremszylinder								
1.2	47	10/02→06/06		+ ABS		24.2120-1734.3 010702	Ø 20,6	
1.4 TDI	55	10/02→12/05		- ABS		24.2120-1736.3 010732	Ø 20,6	
1.2 12V	51	05/06→11/09		→ 06/09; + ABS		24.2120-1734.3 010702	Ø 20,6	
1.4 16V	63 - 74	10/02→11/09		→ 06/09; - ABS		24.2120-1736.3 010732	Ø 20,6	
1.4 TDI	51 - 59	05/05→11/09						
1.6	74	04/03→11/09						
1.6 16V	77	11/06→11/09						
1.9 TDI	96	10/02→11/09						
1.4 16V	55	09/02→12/07		10/02→; + ABS		24.2120-1734.3 010702	Ø 20,6	
				10/02→; - ABS		24.2120-1736.3 010732	Ø 20,6	
1.9 SDI	47	09/02→11/09		10/02→06/09; + ABS		24.2120-1734.3 010702	Ø 20,6	
1.9 TDI	74	09/02→11/09						
2.0	85	09/02→11/09		10/02→06/09; - ABS		24.2120-1736.3 010732	Ø 20,6	
 Bremskraftregler								
1.2	47	10/02→06/06		- ABS		03.6583-0216.3 320247	ATE lastabhängig 8/3 4x	
1.4 TDI	55	10/02→12/05						
1.2 12V	51	05/06→11/09		→ 06/09; - ABS		03.6583-0216.3 320247	ATE lastabhängig 8/3 4x	
1.4 16V	63 - 74	10/02→11/09						
1.4 TDI	51 - 59	05/05→11/09						
1.6	74	04/03→11/09						
1.6 16V	77	11/06→11/09						
1.9 TDI	96	10/02→11/09						
1.4 16V	55	09/02→12/07		10/02→; - ABS		03.6583-0216.3 320247	ATE lastabhängig 8/3 4x	
1.9 SDI	47	09/02→11/09		10/02→06/09; - ABS		03.6583-0216.3 320247	ATE lastabhängig 8/3 4x	
1.9 TDI	74	09/02→11/09						
2.0	85	09/02→11/09						
SEAT - CORDOBA Vario (6K5) 07/96→12/02								
 Bremskraftverstärker								
1.4	74	02/00→07/00		für Linkslenker; - ABS		03.7750-6302.4 300161	ATE Ø 9" pneumatisch	
→								

	kw					! #		
SEAT - CORDOBA Vario (6K5) 07/96→12/02								
 Bremskraftverstärker								
1.4	74	02/00→07/00		für Linkslenker; + ABS; +PR 1KB		10.6350-3902.4	300213	ATE Ø 9" pneumatisch
				für Linkslenker; + ABS; +PR 1KK / 1KM / 1KQ		10.6350-4002.4	300285	ATE Ø 9" pneumatisch
1.4 16V	55	06/99→12/02		→ 09/02; für Linkslenker; - ABS		03.7750-6302.4	300161	ATE Ø 9" pneumatisch
1.9 SDI	50	06/99→12/02		→ 09/02; für Linkslenker; + ABS; +PR 1KB		10.6350-3902.4	300213	ATE Ø 9" pneumatisch
				→ 09/02; für Linkslenker; + ABS; +PR 1KK / 1KM / 1KQ		10.6350-4002.4	300285	ATE Ø 9" pneumatisch
1.4 i	44	09/96→12/02		06/99→ 09/02; für Linkslenker; - ABS		03.7750-6302.4	300161	ATE Ø 9" pneumatisch
1.6 i	55 - 74	09/96→12/02		06/99→ 09/02; für Linkslenker; + ABS; +PR 1KB		10.6350-3902.4	300213	ATE Ø 9" pneumatisch
1.9 TDI	66 - 81	08/96→12/02		06/99→ 09/02; für Linkslenker; + ABS; +PR 1KK / 1KM / 1KQ		10.6350-4002.4	300285	ATE Ø 9" pneumatisch
 Hauptbremszylinder								
1.4	74	02/00→07/00		- ABS		03.2120-3943.3	010532	ATE Ø 20,6
				für Linkslenker; - ABS		03.2122-1042.3	010137	Ø 22,2
				für Linkslenker; + ABS		03.2123-1424.3	010637	ATE Ø 23,8
1.4 16V	55	06/99→12/02		→ 09/02; für Linkslenker; - ABS		03.2122-1042.3	010137	Ø 22,2
1.9 SDI	50	06/99→12/02		→ 09/02; für Linkslenker; + ABS		03.2123-1424.3	010637	ATE Ø 23,8
1.4 i	44	09/96→12/02		→ 05/99; - ABS		03.2120-3943.3	010532	ATE Ø 20,6
1.6 i	55 - 74	09/96→12/02		06/99→ 09/02; für Linkslenker; - ABS		03.2122-1042.3	010137	Ø 22,2
				06/99→ 09/02; für Linkslenker; + ABS		03.2123-1424.3	010637	ATE Ø 23,8
1.6 i	55	05/97→06/99		→ 05/99; - ABS		03.2120-3943.3	010532	ATE Ø 20,6
1.9 SDI	47	09/96→06/99						
1.9 TDI	66 - 81	08/96→12/02		06/99→ 09/02; für Linkslenker; - ABS		03.2122-1042.3	010137	Ø 22,2
				→ 05/99; - ABS		03.2122-1042.3	010137	Ø 22,2
				06/99→ 09/02; für Linkslenker; + ABS		03.2123-1424.3	010637	ATE Ø 23,8
Verschlusschraube, Hauptbremszylinder								
1.4	74	02/00→07/00		- ABS		03.3517-0101.2	390322	
1.4 i	44	09/96→12/02		→ 05/99; - ABS		03.3517-0101.2	390322	
1.6 i	55 - 74	09/96→12/02						
1.9 SDI	47	09/96→06/99						
1.9 TDI	66 - 81	08/96→12/02						
SEAT - CORDOBA VARIO Kasten/Kombi (6K5) 08/00→12/02								
 Bremskraftverstärker								
1.9 TDI	81	08/00→12/02		→ 09/02; für Linkslenker; - ABS		03.7750-6302.4	300161	ATE Ø 9" pneumatisch
				→ 09/02; für Linkslenker; + ABS; +PR 1KB		10.6350-3902.4	300213	ATE Ø 9" pneumatisch
				→ 09/02; für Linkslenker; + ABS; +PR 1KK / 1KM / 1KQ		10.6350-4002.4	300285	ATE Ø 9" pneumatisch
 Hauptbremszylinder								
1.9 TDI	81	08/00→12/02		→ 09/02; für Linkslenker; - ABS		03.2122-1042.3	010137	Ø 22,2
				→ 09/02; für Linkslenker; + ABS		03.2123-1424.3	010637	ATE Ø 23,8
SEAT - EXEO (3R2) 12/08→05/13								
 Bremskraftverstärker								
1.6	75	03/09→09/10		04/09→		03.7858-4502.4	300202	ATE Ø 9 / 8" pneumatisch
1.8 T	110	12/08→05/10						
2.0 TDI	88 - 125	12/08→05/13						
2.0 TFSI	147	03/09→05/13						
1.8 TSI	88 - 118	05/10→05/13				03.7858-4502.4	300202	ATE Ø 9 / 8" pneumatisch
2.0 TFSI	155	05/10→05/13						
 Hauptbremszylinder								
1.6	75	03/09→09/10		04/09→		03.2125-0373.3	010810	ATE Ø 25,4
1.8 T	110	12/08→05/10				24.2125-1720.3	010688	TRW Ø 25,4
2.0 TDI	88 - 125	12/08→05/13						
2.0 TFSI	147	03/09→05/13						
1.8 TSI	88 - 118	05/10→05/13				03.2125-0373.3	010810	ATE Ø 25,4
2.0 TFSI	155	05/10→05/13				24.2125-1720.3	010688	TRW Ø 25,4

	kw					! #		
SEAT - EXEO ST (3R5) 05/09→05/13								
 Bremskraftverstärker								
1.6 1.8 T 1.8 TSI 2.0 TDI 2.0 TFSI	75 110 88 - 118 88 - 125 147 - 155	06/09→09/10 06/09→05/10 05/10→05/13 05/09→05/13 06/09→05/13				03.7858-4502.4	300202	ATE Ø 9 / 8" pneumatisch
 Hauptbremszylinder								
1.6 1.8 T 1.8 TSI 2.0 TDI 2.0 TFSI	75 110 88 - 118 88 - 125 147 - 155	06/09→09/10 06/09→05/10 05/10→05/13 05/09→05/13 06/09→05/13				03.2125-0373.3 24.2125-1720.3	010810 010688	ATE Ø 25,4 TRW Ø 25,4
SEAT - IBIZA II (6K1) 03/93→05/02								
 Bremskraftverstärker								
1.0 16V 1.4 16V 1.8 T 20V Cupra 1.8 T 20V Cupra R 1.9 SDI	51 55 115 132 50	10/99→02/02 05/00→02/02 07/00→02/02 07/00→02/02 08/99→02/02		→ 01/02; für Linkslenker; - ABS → 01/02; für Linkslenker; +PR 0G1 / 0G3 / 1KB; Schaltgetriebe → 01/02; für Linkslenker; +PR 0G4; Schaltgetriebe		03.7750-6302.4 10.6350-3902.4 10.6350-4002.4	300161 300213 300285	ATE Ø 9" pneumatisch ATE Ø 9" pneumatisch ATE Ø 9" pneumatisch
				→ 01/02; für Linkslenker; +PR 1KM / 1KK / 1KQ / 1ZK / 1KB; Automatikgetriebe		10.6350-4002.4	300285	ATE Ø 9" pneumatisch
1.0 i 1.4 i 1.4 i 16V 1.9 TDI	37 44 74 66 - 81	09/96→02/02 09/93→02/02 06/97→02/02 08/96→02/02		08/99→ 01/02; für Linkslenker; - ABS 08/99→ 01/02; für Linkslenker; +PR 0G1 / 0G3 / 1KB; Schaltgetriebe 6K-TR069487→; → 07/99; für Linkslenker 08/99→ 01/02; für Linkslenker; +PR 1KM / 1KK / 1KQ / 1ZK / 1KB; Automatikgetriebe 08/99→ 01/02; für Linkslenker; +PR 0G4; Schaltgetriebe 6K-TR069487→; → 07/99; für Linkslenker; + ABS		03.7750-6302.4 10.6350-3902.4 10.6350-3902.4 10.6350-4002.4 10.6350-4002.4 10.6350-4002.4	300161 300213 300213 300285 300285 300285	ATE Ø 9" pneumatisch ATE Ø 9" pneumatisch ATE Ø 9" pneumatisch ATE Ø 9" pneumatisch ATE Ø 9" pneumatisch ATE Ø 9" pneumatisch
1.3 i 2.0 i 16V	40 110	03/93→08/99 08/96→08/99		6K-TR069487→; → 07/99; für Linkslenker 6K-TR069487→; → 07/99; für Linkslenker; + ABS		10.6350-3902.4 10.6350-4002.4	300213 300285	ATE Ø 9" pneumatisch ATE Ø 9" pneumatisch
1.4	40	12/97→04/99		6K-TR069487→; für Linkslenker 6K-TR069487→; für Linkslenker; + ABS		10.6350-3902.4 10.6350-4002.4	300213 300285	ATE Ø 9" pneumatisch ATE Ø 9" pneumatisch
1.6 i	55 - 74	03/93→02/02		08/99→ 01/02; für Linkslenker; - ABS → 07/99; für Linkslenker; - ABS 08/99→ 01/02; für Linkslenker; +PR 0G1 / 0G3 / 1KB; Schaltgetriebe 6K-TR069487→; → 07/99; für Linkslenker 08/99→ 01/02; für Linkslenker; +PR 0G4; Schaltgetriebe 08/99→ 01/02; für Linkslenker; +PR 1KM / 1KK / 1KQ / 1ZK / 1KB; Automatikgetriebe 6K-TR069487→; → 07/99; für Linkslenker; + ABS		03.7750-6302.4 03.7750-6302.4 10.6350-3902.4 10.6350-3902.4 10.6350-4002.4 10.6350-4002.4 10.6350-4002.4	300161 300161 300213 300213 300285 300285 300285	ATE Ø 9" pneumatisch ATE Ø 9" pneumatisch ATE Ø 9" pneumatisch ATE Ø 9" pneumatisch ATE Ø 9" pneumatisch ATE Ø 9" pneumatisch ATE Ø 9" pneumatisch
1.6 i 1.9 D	55 47	09/94→06/99 04/93→06/99		für Linkslenker; - ABS 6K-TR069487→; für Linkslenker 6K-TR069487→; für Linkslenker; + ABS		03.7750-6302.4 10.6350-3902.4 10.6350-4002.4	300161 300213 300285	ATE Ø 9" pneumatisch ATE Ø 9" pneumatisch ATE Ø 9" pneumatisch
1.8 i 1.9 SDI 2.0 i	66 47 85	03/93→08/99 08/96→08/99 03/93→08/99		→ 07/99; für Linkslenker; - ABS 6K-TR069487→; → 07/99; für Linkslenker 6K-TR069487→; → 07/99; für Linkslenker; + ABS		03.7750-6302.4 10.6350-3902.4 10.6350-4002.4	300161 300213 300285	ATE Ø 9" pneumatisch ATE Ø 9" pneumatisch ATE Ø 9" pneumatisch
 Hauptbremszylinder								
1.0 16V 1.4 16V 1.8 T 20V Cupra →	51 55 115	10/99→02/02 05/00→02/02 07/00→02/02		→ 01/02; für Linkslenker; - ABS → 01/02; für Linkslenker; + ABS		03.2122-1042.3 03.2123-1424.3	010137 010637	Ø 22,2 ATE Ø 23,8

	kw			 	! #		
SEAT - IBIZA II (6K1) 03/93→05/02							
 Hauptbremszylinder							
1.8 T 20V Cupra R 1.9 SDI	132 50	07/00→02/02 08/99→02/02		→ 01/02; für Linkslenker; - ABS → 01/02; für Linkslenker; + ABS		03.2122-1042.3 010137 03.2123-1424.3 010637	Ø 22,2 ATE Ø 23,8
1.0 i 1.4 i 1.6 i	37 44 55 - 74	09/96→02/02 09/93→02/02 03/93→02/02		→ 07/99; - ABS 08/99→ 01/02; für Linkslenker; - ABS 08/99→ 01/02; für Linkslenker; + ABS		03.2120-3943.3 010532 03.2122-1042.3 010137 03.2123-1424.3 010637	ATE Ø 20,6 Ø 22,2 ATE Ø 23,8
1.3 i 1.8 i 1.9 SDI	40 66 47	03/93→08/99 03/93→08/99 08/96→08/99		→ 07/99; - ABS		03.2120-3943.3 010532	ATE Ø 20,6
1.4 1.6 i 1.9 D	40 55 47	12/97→04/99 09/94→06/99 04/93→06/99		- ABS		03.2120-3943.3 010532	ATE Ø 20,6
1.4 i 16V	74	06/97→02/02		08/99→ 01/02; für Linkslenker; - ABS 08/99→ 01/02; für Linkslenker; + ABS		03.2122-1042.3 010137 03.2123-1424.3 010637	Ø 22,2 ATE Ø 23,8
1.9 TDI	66	08/96→02/02		08/99→ 01/02; für Linkslenker; - ABS → 07/99; - ABS 08/99→ 01/02; für Linkslenker; + ABS		03.2122-1042.3 010137 03.2122-1042.3 010137 03.2123-1424.3 010637	Ø 22,2 Ø 22,2 ATE Ø 23,8
1.9 TDI	81	02/97→02/02		03/97→ 07/99; - ABS 08/99→ 01/02; für Linkslenker; - ABS 08/99→ 01/02; für Linkslenker; + ABS		03.2122-1042.3 010137 03.2122-1042.3 010137 03.2123-1424.3 010637	Ø 22,2 Ø 22,2 ATE Ø 23,8
2.0 i	85	03/93→08/99		→ 07/99; - ABS → 07/99; für Linkslenker; + ABS		03.2122-1042.3 010137 10.6123-0674.3 010639	Ø 22,2 ATE Ø 23,8
Verschlusschraube, Hauptbremszylinder							
1.0 i 1.3 i 1.4 i 1.6 i	37 40 44 55 - 74	09/96→02/02 03/93→08/99 09/93→02/02 03/93→02/02		→ 07/99; - ABS		03.3517-0101.2 390322	
1.8 i 1.9 SDI 1.9 TDI 2.0 i	66 47 66 85	03/93→08/99 08/96→08/99 08/96→02/02 03/93→08/99					
1.4 1.6 i 1.9 D	40 55 47	12/97→04/99 09/94→06/99 04/93→06/99		- ABS		03.3517-0101.2 390322	
1.9 TDI	81	02/97→02/02		03/97→ 07/99; - ABS		03.3517-0101.2 390322	
SEAT - IBIZA III (6L1) 02/02→11/09							
 Hauptbremszylinder							
1.2 1.2 12V 1.4 16V	44 - 47 51 55 - 74	02/02→05/08 05/06→11/09 02/02→11/09		+ ABS - ABS		24.2120-1734.3 010702 24.2120-1736.3 010732	Ø 20,6 Ø 20,6
1.4 TDI	51 - 59	05/02→11/09					
1.6 1.6 16V	74 77	02/03→11/09 11/06→11/09					
1.8 T Cupra R 1.8 T FR	132 110	01/04→02/08 12/03→05/08					
1.9 SDI 1.9 TDI	47 74 - 96	02/02→12/05 02/02→11/09					
1.9 TDI Cupra R 1.9 TDI Joya Racer 2.0	118 112 85	03/04→02/08 07/03→06/04 04/02→11/09					
 Bremskraftregler							
1.2 1.2 12V 1.4 16V	44 - 47 51 55 - 74	02/02→05/08 05/06→11/09 02/02→11/09		- ABS		03.6583-0216.3 320247	ATE lastabhängig 8/3 4x
1.4 TDI	51 - 59	05/02→11/09					
1.6 1.6 16V	74 77	02/03→11/09 11/06→11/09					
1.8 T Cupra R 1.8 T FR	132 110	01/04→02/08 12/03→05/08					
1.9 SDI 1.9 TDI	47 74 - 96	02/02→12/05 02/02→11/09					
1.9 TDI Cupra R 1.9 TDI Joya Racer 2.0	118 112 85	03/04→02/08 07/03→06/04 04/02→11/09					

	kW			 	! #		
SEAT - IBIZA IV (6J5, 6P1) 03/08→12/17							
 Bremskraftregler							
1.0 1.0 TSI	55 70 - 81	05/15→06/17 05/15→06/17		- ABS		03.6583-0216.3 320247	ATE lastabhängig 8/3 4x
1.2 1.2 TDI 1.2 TSI	44 55 63 - 81	07/09→05/11 06/10→05/15 09/10→06/17					
1.4 TDI	55 - 77	07/08→06/17					
1.6 1.6 LPG 1.9 TDI	81 60 66	07/15→06/17 05/11→05/15 07/08→06/10					
1.2 1.2 LPG 1.4 1.4 LPG 1.6 1.9 TDI	51 51 63 63 77 77	03/08→05/15 03/08→05/11 03/08→05/15 03/08→05/11 05/08→03/12 03/08→06/10		07/08→; - ABS		03.6583-0216.3 320247	ATE lastabhängig 8/3 4x
SEAT - IBIZA IV Kasten/Schrägheck (6J1) 04/08→05/15							
 Bremskraftregler							
1.2 1.2 TDI	51 55	04/08→05/15 05/10→05/15		- ABS		03.6583-0216.3 320247	ATE lastabhängig 8/3 4x
SEAT - IBIZA IV SC (6J1, 6P5) 06/08→12/18							
 Bremskraftregler							
1.0 1.0 TSI	55 70 - 81	05/15→12/16 05/15→12/16		- ABS		03.6583-0216.3 320247	ATE lastabhängig 8/3 4x
1.2 1.2 TDI 1.2 TSI	44 - 51 55	07/08→05/15 05/10→05/15					
1.4 1.4 LPG 1.4 TDI	63 - 81 63	09/10→12/16 07/08→05/15 07/08→05/11					
1.6 1.6 LPG 1.9 TDI	55 - 77 77 81 60 66 - 77	07/08→12/16 07/08→12/16 05/11→05/15 06/08→06/10					
SEAT - IBIZA IV ST (6J8, 6P8) 03/10→07/16							
 Bremskraftregler							
1.0 1.0 TSI	55 70 - 81	05/15→07/16 05/15→07/16		- ABS		03.6583-0216.3 320247	ATE lastabhängig 8/3 4x
1.2 1.2 TDI 1.2 TSI	44 - 51 55	05/10→05/15 04/10→05/15					
1.4 1.4 TDI	63 - 77 77	09/10→07/16 03/10→05/15 05/15→07/16					
1.6	85	02/12→05/15					
SEAT - IBIZA V (KJ1, KJG) 01/17→							
 Hauptbremszylinder							
1.0 1.0 MPi 1.0 TGI 1.0 TSI	48 - 55 59 66	01/17→ 07/18→ 11/17→		für Linkslenker; +PR 1ZE / 1ZQ		24.4123-1719.3 011017	TRW Ø 23,8 ohne Bremsflüssigkeitsbehälter
1.5 TSI 1.6 1.6 TDI	70 - 85 110 81 59 - 85	01/17→ 07/17→ 05/17→ 09/17→					
SEAT - INCA (6K9) 11/95→11/03							
 Bremskraftverstärker							
1.4 16V 1.4 i 1.6 i →	55 44 55	04/00→06/03 11/95→06/03 11/95→09/00		für Linkslenker; - ABS für Linkslenker; + ABS		03.7750-6302.4 300161 10.6350-4002.4 300285	ATE Ø 9" pneumatisch ATE Ø 9" pneumatisch

	kw			 	! #		
SEAT - INCA (6K9) 11/95→11/03							
 Bremskraftverstärker							
1.7 D	42	09/96→06/03		für Linkslenker; - ABS	03.7750-6302.4	300161	ATE Ø 9" pneumatisch
1.9 D	47	11/95→06/03		für Linkslenker; + ABS	10.6350-4002.4	300285	ATE Ø 9" pneumatisch
1.9 SDI	47	11/95→06/03					
1.9 TDI	66	09/96→06/03					
 Hauptbremszylinder							
1.4 16V	55	04/00→06/03		- ABS	03.2122-1042.3	010137	Ø 22,2
				+ ABS	03.2123-1424.3	010637	ATE Ø 23,8
					03.2123-1484.3	010595	ATE Ø 23,8
1.4 i	44	11/95→06/03		für Linkslenker; - ABS	03.2122-1042.3	010137	Ø 22,2
1.6 i	55	11/95→09/00					
1.7 D	42	09/96→06/03		→ 9K-X-006000; für Rechtslenker; - ABS	03.2122-1042.3	010137	Ø 22,2
1.9 D	47	11/95→06/03		für Linkslenker; + ABS	03.2123-1424.3	010637	ATE Ø 23,8
1.9 SDI	47	11/95→06/03		für Rechtslenker; + ABS	03.2123-1484.3	010595	ATE Ø 23,8
1.9 TDI	66	09/96→06/03					
Verschlusschraube, Hauptbremszylinder							
1.4 16V	55	04/00→06/03		- ABS	03.3517-0101.2	390322	
1.4 i	44	11/95→06/03		für Linkslenker; - ABS	03.3517-0101.2	390322	
1.6 i	55	11/95→09/00					
1.7 D	42	09/96→06/03		→ 9K-X-006000; für Rechtslenker; - ABS	03.3517-0101.2	390322	
1.9 D	47	11/95→06/03					
1.9 SDI	47	11/95→06/03					
1.9 TDI	66	09/96→06/03					
SEAT - LEON (1M1) 11/99→06/06							
 Bremskraftverstärker							
1.4 16V	55	11/99→06/06		1M-1R023639→; → 07/05; für Linkslenker; + ESP	03.7860-0602.4	300141	ATE Ø 10" pneumatisch
1.6	74	11/99→06/06					
1.6 16 V	77	09/00→06/06		1M-1B018342→; → 07/05; für Linkslenker; + ESP	03.7860-0602.4	300141	ATE Ø 10" pneumatisch
1.8 20V	92	11/99→06/06					
1.8 20V T	132	11/99→06/06		→ 1M-1R023638; für Linkslenker; + ESP	03.7863-0402.4	300124	ATE Ø 10" pneumatisch
1.8 20V T 4	132	11/99→06/06					
1.8 T Cupra R	165	07/03→06/06		→ 1M-1B018341; für Linkslenker; + ESP	03.7863-0402.4	300124	ATE Ø 10" pneumatisch
1.9 SDI	50	11/99→06/06					
1.9 TDI	66	11/99→06/06					
	96						
1.9 TDI Syncro	110	05/02→06/06					
2.8 Cupra 4	150	02/01→06/06					
1.6	75	10/05→06/06		→ 1M-1B018341; für Linkslenker; + ESP	03.7863-0402.4	300124	ATE Ø 10" pneumatisch
				→ 1M-1R023638; für Linkslenker; + ESP	03.7863-0402.4	300124	ATE Ø 10" pneumatisch
1.8 T Cupra R	154	02/02→06/06		1M-1B018342→; → 07/05; für Linkslenker; + ESP	03.7860-0602.4	300141	ATE Ø 10" pneumatisch
				1M-1R023639→; → 07/05; für Linkslenker; + ESP	03.7860-0602.4	300141	ATE Ø 10" pneumatisch
				05/02→; → 1M-1B018341; + ESP; für Linkslenker	03.7863-0402.4	300124	ATE Ø 10" pneumatisch
				05/02→; → 1M-1R023638; + ESP; für Linkslenker	03.7863-0402.4	300124	ATE Ø 10" pneumatisch
1.9 TDI	74	10/05→06/06		1M-1B018342→; für Linkslenker; + ESP	03.7860-0602.4	300141	ATE Ø 10" pneumatisch
2.8	150	05/02→06/04		1M-1R023639→; für Linkslenker; + ESP	03.7860-0602.4	300141	ATE Ø 10" pneumatisch
				→ 1M-1B018341; für Linkslenker; + ESP	03.7863-0402.4	300124	ATE Ø 10" pneumatisch
				→ 1M-1R023638; für Linkslenker; + ESP	03.7863-0402.4	300124	ATE Ø 10" pneumatisch
1.9 TDI	110	09/00→06/06		1M-1B018342→; → 07/05; für Linkslenker; + ESP	03.7860-0602.4	300141	ATE Ø 10" pneumatisch
				1M-1R023639→; → 07/05; für Linkslenker; + ESP	03.7860-0602.4	300141	ATE Ø 10" pneumatisch
				02/01→; → 1M-1B018341; für Linkslenker; + ESP	03.7863-0402.4	300124	ATE Ø 10" pneumatisch
				02/01→; → 1M-1R023638; für Linkslenker; + ESP	03.7863-0402.4	300124	ATE Ø 10" pneumatisch
 Hauptbremszylinder							
1.4 16V	55	11/99→06/06		→ 08/00; für Linkslenker; + ESP	03.2123-2024.3	010597	ATE Ø 23,8
1.6	74	11/99→06/06		→ 08/00; für Rechtslenker; + ESP	03.2123-2064.3	010598	ATE Ø 23,8
1.8 20V	92	11/99→06/06					
1.8 20V T	132	11/99→06/06		09/00→ 07/05; für Linkslenker; + ESP	03.2123-2715.3	010802	ATE Ø 23,8
1.9 SDI	50	11/99→06/06		09/00→ 07/05; für Rechtslenker; + ESP	03.2123-2774.3	010803	ATE Ø 23,8
1.9 TDI	66	11/99→06/06		→ 07/05; für Linkslenker; - ESP	24.2123-1709.3	010503	Ø 23,8
1.6 16 V	77	09/00→06/06		→ 07/05; für Linkslenker; + ESP	03.2123-2715.3	010802	ATE Ø 23,8
1.8 T Cupra R	165	07/03→06/06		→ 07/05; + ESP; für Rechtslenker	03.2123-2774.3	010803	ATE Ø 23,8
1.9 TDI	96	05/03→06/06					
1.9 TDI Syncro	110	05/02→06/06		→ 07/05; für Linkslenker; - ESP	24.2123-1709.3	010503	Ø 23,8
2.8 Cupra 4	150	02/01→06/06					
→							

SEAT - LEON (1M1) 11/99→06/06

Hauptbremszylinder

1.8 20V T 4	132	11/99→06/06	→ 08/00; für Linkslenker; + ESP	03.2123-2024.3 010597	ATE Ø 23,8
			→ 08/00; für Rechtslenker; + ESP	03.2123-2064.3 010598	ATE Ø 23,8
			→ 07/05; für Linkslenker; + ESP	03.2123-2715.3 010802	ATE Ø 23,8
			→ 07/05; + ESP; für Rechtslenker	03.2123-2774.3 010803	ATE Ø 23,8
			→ 07/05; für Linkslenker; - ESP	24.2123-1709.3 010503	Ø 23,8
1.8 T Cupra R	154	02/02→06/06	05/02→ 07/05; für Linkslenker; + ESP	03.2123-2715.3 010802	ATE Ø 23,8
			05/02→ 07/05; + ESP; für Rechtslenker	03.2123-2774.3 010803	ATE Ø 23,8
			05/02→ 07/05; für Linkslenker; - ESP	24.2123-1709.3 010503	Ø 23,8
1.9 TDI 2.8	74 150	10/05→06/06 05/02→06/04	für Linkslenker; + ESP	03.2123-2715.3 010802	ATE Ø 23,8
			für Rechtslenker; + ESP	03.2123-2774.3 010803	ATE Ø 23,8
			für Linkslenker; - ESP	24.2123-1709.3 010503	Ø 23,8
1.9 TDI	81	11/99→06/06	→ 08/00; für Linkslenker; + ESP	03.2123-2024.3 010597	ATE Ø 23,8
			→ 08/00; für Rechtslenker; + ESP	03.2123-2064.3 010598	ATE Ø 23,8
			→ 07/05; für Linkslenker; + ESP	03.2123-2715.3 010802	ATE Ø 23,8
			09/00→ 07/05; für Rechtslenker; + ESP	03.2123-2774.3 010803	ATE Ø 23,8
			→ 07/05; für Linkslenker; - ESP	24.2123-1709.3 010503	Ø 23,8
1.9 TDI	110	09/00→06/06	02/01→ 07/05; + ESP; für Linkslenker	03.2123-2715.3 010802	ATE Ø 23,8
			02/01→ 07/05; für Rechtslenker; + ESP	03.2123-2774.3 010803	ATE Ø 23,8
			02/01→ 07/05; für Linkslenker; - ESP	24.2123-1709.3 010503	Ø 23,8









Bremskraftregler









1.4 16V	55	11/99→06/06	→ 07/05	03.6583-0179.3 320228	ATE lastabhängig 8/3 4x
1.6	74	11/99→06/06			
1.6 16 V	77	09/00→06/06			
1.8 20V	92	11/99→06/06			
1.8 20V T	132	11/99→06/06			
1.8 20V T 4	132	11/99→06/06			
1.8 T Cupra R	165	07/03→06/06			
1.9 SDI	50	11/99→06/06			
1.9 TDI	66 - 96	11/99→06/06			
1.9 TDI Syncro	110	05/02→06/06			
2.8 Cupra 4	150	02/01→06/06			
1.8 T Cupra R	154	02/02→06/06			
1.9 TDI	74	10/05→06/06			
2.8	150	05/02→06/04			
1.9 TDI	110	09/00→06/06			
1.8 T Cupra R	154	02/02→06/06	05/02→ 07/05	03.6583-0179.3 320228	ATE lastabhängig 8/3 4x
1.9 TDI	74	10/05→06/06		03.6583-0179.3 320228	ATE lastabhängig 8/3 4x
2.8	150	05/02→06/04		03.6583-0179.3 320228	ATE lastabhängig 8/3 4x
1.9 TDI	110	09/00→06/06	02/01→ 07/05	03.6583-0179.3 320228	ATE lastabhängig 8/3 4x

SEAT - LEON (1P1) 05/05→12/13

Bremskraftverstärker

1.2 TSI	77	02/10→12/12	→ 05/10; +PR 1AC / 1AT; für Linkslenker; für Kolben-Ø [mm]: 22,2	03.7863-3232.4 300307	ATE Ø 10" pneumatisch			
1.4 16V	63	06/06→12/12						
1.4 TSI	92	11/07→12/12						
1.6 LPG	75	12/09→12/12						
1.6 TDI	77	02/10→12/12						
1.8 TSI	118	06/07→12/12						
2.0 Cupra R	195	09/09→12/12						
2.0 TDI	125	05/06→12/12						
2.0 TFSI	155	06/09→12/12						
1.6 2.0 TDI 16V	75 103	07/05→12/12 07/05→12/12				06/10→; +PR 1AC / 1AT; → 10/12; für Linkslenker; für Kolben-Ø [mm]: 22,2	03.7863-3232.4 300307	ATE Ø 10" pneumatisch
						08/05→ 05/10; +PR 1AC / 1AT; für Linkslenker; für Kolben-Ø [mm]: 22,2	03.7863-3232.4 300307	ATE Ø 10" pneumatisch
						06/10→; +PR 1AC / 1AT; → 10/12; für Linkslenker; für Kolben-Ø [mm]: 23,81	03.7863-3332.4 300308	ATE Ø 10" pneumatisch
						08/05→ 05/10; +PR 1AC / 1AT; für Linkslenker; für Kolben-Ø [mm]: 23,81	03.7863-3332.4 300308	ATE Ø 10" pneumatisch
1.6 MultiFuel 1.6 TDI	75 66	07/05→08/13 11/10→12/12				für Linkslenker; → 10/12; +PR 1AC / 1AT; für Kolben-Ø [mm]: 22,2	03.7863-3232.4 300307	ATE Ø 10" pneumatisch
						für Linkslenker; → 10/12; +PR 1AC / 1AT; für Kolben-Ø [mm]: 23,81	03.7863-3332.4 300308	ATE Ø 10" pneumatisch
1.9 TDI 2.0 TDI 2.0 TFSI	66 103 177	06/07→12/10 10/05→10/10 11/06→05/11				→ 05/10; +PR 1AC / 1AT; für Linkslenker; für Kolben-Ø [mm]: 22,2	03.7863-3232.4 300307	ATE Ø 10" pneumatisch
						06/10→; +PR 1AC / 1AT; für Linkslenker; für Kolben-Ø [mm]: 22,2	03.7863-3232.4 300307	ATE Ø 10" pneumatisch
						→ 05/10; +PR 1AC / 1AT; für Linkslenker; für Kolben-Ø [mm]: 23,81	03.7863-3332.4 300308	ATE Ø 10" pneumatisch
						06/10→; +PR 1AC / 1AT; für Linkslenker; für Kolben-Ø [mm]: 23,81	03.7863-3332.4 300308	ATE Ø 10" pneumatisch
1.9 TDI	77	07/05→12/10				06/10→; +PR 1AC / 1AT; für Linkslenker; für Kolben-Ø [mm]: 22,2	03.7863-3232.4 300307	ATE Ø 10" pneumatisch

	kw			 	! #		
SEAT - LEON (1P1) 05/05→12/13							
 Bremskraftverstärker							
1.9 TDI	77	07/05→12/10		08/05→ 05/10; +PR 1AC / 1AT; für Linkslenker; für Kolben-Ø [mm]: 22,2		03.7863-3232.4 300307	ATE Ø 10" pneumatisch
				06/10→; +PR 1AC / 1AT; für Linkslenker; für Kolben-Ø [mm]: 23,81		03.7863-3332.4 300308	ATE Ø 10" pneumatisch
				08/05→ 05/10; +PR 1AC / 1AT; für Linkslenker; für Kolben-Ø [mm]: 23,81		03.7863-3332.4 300308	ATE Ø 10" pneumatisch
2.0 FSI	110	07/05→05/10		08/05→; +PR 1AC / 1AT; für Linkslenker; für Kolben-Ø [mm]: 22,2		03.7863-3232.4 300307	ATE Ø 10" pneumatisch
2.0 TDI	100	07/05→05/10		08/05→; +PR 1AC / 1AT; für Linkslenker; für Kolben-Ø [mm]: 23,81		03.7863-3332.4 300308	ATE Ø 10" pneumatisch
2.0 TFSI	147	05/05→03/09		08/05→; +PR 1AC / 1AT; für Linkslenker; für Kolben-Ø [mm]: 23,81		03.7863-3332.4 300308	ATE Ø 10" pneumatisch
2.0 TFSI	136	09/05→05/06		+PR 1AC / 1AT; für Linkslenker; für Kolben-Ø [mm]: 22,2		03.7863-3232.4 300307	ATE Ø 10" pneumatisch
				+PR 1AC / 1AT; für Linkslenker; für Kolben-Ø [mm]: 23,81		03.7863-3332.4 300308	ATE Ø 10" pneumatisch
 Hauptbremszylinder							
1.2 TSI	77	02/10→12/12		06/10→; +PR 1ZE / 1ZF; → 10/12; für Linkslenker		03.2122-2129.3 010799	ATE Ø 22,2
1.4 16V	63	06/06→12/12					
1.4 TSI	92	11/07→12/12		F1P-6-027023→; → 05/10; für Linkslenker; +PR 1AC / 1AT / 1AS		03.2122-2129.3 010799	ATE Ø 22,2
1.6 LPG	75	12/09→12/12					
1.6 TDI	77	02/10→12/12		F1P-6-027023→; für Linkslenker; → 05/10; +PR 1AC / 1AT / 1LJ / 1ZA		03.2123-3449.3 010808	ATE Ø 23,8
1.8 TSI	118	06/07→12/12					
2.0 Cupra R	195	09/09→12/12		06/10→; für Linkslenker; → 10/12; +PR 1LB / 1ZA / 1ZB		03.2123-3449.3 010808	ATE Ø 23,8
2.0 TDI	125	05/06→12/12					
2.0 TFSI	155	06/09→12/12		→ 05/10; für Rechtslenker		24.2122-1981.3 011024	ATE Ø 22,2 ohne Bremsflüssigkeitsbehälter
						24.4152-0132.3 011025	ATE Ø 22,2 ohne Bremsflüssigkeitsbehälter
						24.4153-0202.3 011027	ATE Ø 23,8 ohne Bremsflüssigkeitsbehälter
				06/10→; +PR 1ZE / 1ZF; → 10/12; für Rechtslenker		24.4152-0132.3 011025	ATE Ø 22,2 ohne Bremsflüssigkeitsbehälter
				F1P-6-027023→; → 05/10; für Rechtslenker; +PR 1AC / 1AT / 1AS		24.4152-0132.3 011025	ATE Ø 22,2 ohne Bremsflüssigkeitsbehälter
				F1P-6-027023→; → 05/10; für Rechtslenker; +PR 1AC / 1AT / 1LJ / 1ZA		24.4153-0202.3 011027	ATE Ø 23,8 ohne Bremsflüssigkeitsbehälter
				06/10→; +PR 1LB / 1ZA / 1ZB; → 10/12; für Rechtslenker		24.4153-0202.3 011027	ATE Ø 23,8 ohne Bremsflüssigkeitsbehälter
1.6	75	07/05→12/12		F1P-6-027023→; → 05/10; für Linkslenker; +PR 1AC / 1AT / 1AS		03.2122-2129.3 010799	ATE Ø 22,2
2.0 TDI 16V	103	07/05→12/12		06/10→; +PR 1ZE / 1ZF; → 10/12; für Linkslenker		03.2122-2129.3 010799	ATE Ø 22,2
				06/10→; für Linkslenker; → 10/12; +PR 1LB / 1ZA / 1ZB		03.2123-3449.3 010808	ATE Ø 23,8
				F1P-6-027023→; für Linkslenker; → 05/10; +PR 1AC / 1AT / 1LJ / 1ZA		03.2123-3449.3 010808	ATE Ø 23,8
				08/05→ 05/10; für Rechtslenker		24.2122-1981.3 011024	ATE Ø 22,2 ohne Bremsflüssigkeitsbehälter
						24.4152-0132.3 011025	ATE Ø 22,2 ohne Bremsflüssigkeitsbehälter
						24.4153-0202.3 011027	ATE Ø 23,8 ohne Bremsflüssigkeitsbehälter
				06/10→; +PR 1ZE / 1ZF; → 10/12; für Rechtslenker		24.4152-0132.3 011025	ATE Ø 22,2 ohne Bremsflüssigkeitsbehälter
				F1P-6-027023→; → 05/10; für Rechtslenker; +PR 1AC / 1AT / 1AS		24.4152-0132.3 011025	ATE Ø 22,2 ohne Bremsflüssigkeitsbehälter
				06/10→; +PR 1LB / 1ZA / 1ZB; → 10/12; für Rechtslenker		24.4153-0202.3 011027	ATE Ø 23,8 ohne Bremsflüssigkeitsbehälter
				F1P-6-027023→; → 05/10; für Rechtslenker; +PR 1AC / 1AT / 1LJ / 1ZA		24.4153-0202.3 011027	ATE Ø 23,8 ohne Bremsflüssigkeitsbehälter
1.6 MultiFuel	75	07/05→08/13		für Linkslenker; → 10/12; +PR 1ZE / 1ZF		03.2122-2129.3 010799	ATE Ø 22,2
				für Linkslenker; → 10/12; +PR 1LB / 1ZA / 1ZB		03.2123-3449.3 010808	ATE Ø 23,8
				für Rechtslenker; +PR 1AC / 1AT / 1AS		24.4152-0132.3 011025	ATE Ø 22,2 ohne Bremsflüssigkeitsbehälter
				+PR 1ZE / 1ZF; für Rechtslenker		24.4152-0132.3 011025	ATE Ø 22,2 ohne Bremsflüssigkeitsbehälter
				+PR 1LB / 1ZA / 1ZB; für Rechtslenker		24.4153-0202.3 011027	ATE Ø 23,8 ohne Bremsflüssigkeitsbehälter
				für Rechtslenker; +PR 1AC / 1AT / 1LJ / 1ZA		24.4153-0202.3 011027	ATE Ø 23,8 ohne Bremsflüssigkeitsbehälter
1.6 TDI	66	11/10→12/12		für Linkslenker; → 10/12; +PR 1ZE / 1ZF		03.2122-2129.3 010799	ATE Ø 22,2
→							

	kw			 	! #					
SEAT - LEON (1P1) 05/05→12/13										
 Hauptbremszylinder										
1.6 TDI	66	11/10→12/12		für Linkslenker; → 10/12; +PR 1LB / 1ZA / 1ZB	03.2123-3449.3	010808	ATE Ø 23,8			
				für Rechtslenker; → 10/12; +PR 1ZE / 1ZF	24.4152-0132.3	011025	ATE Ø 22,2 ohne Bremsflüssigkeitsbehälter			
				für Rechtslenker; → 10/12; +PR 1LB / 1ZA / 1ZB	24.4153-0202.3	011027	ATE Ø 23,8 ohne Bremsflüssigkeitsbehälter			
1.9 TDI 2.0 TDI 2.0 TFSI	66 103 177	06/07→12/10 10/05→10/10 11/06→05/11		06/10→; +PR 1ZE / 1ZF; für Linkslenker	03.2122-2129.3	010799	ATE Ø 22,2			
				F1P-6-027023→; → 05/10; für Linkslenker; +PR 1AC / 1AT / 1AS	03.2122-2129.3	010799	ATE Ø 22,2			
				F1P-6-027023→; für Linkslenker; → 05/10; +PR 1AC / 1AT / 1LJ / 1ZA	03.2123-3449.3	010808	ATE Ø 23,8			
				06/10→; +PR 1LB / 1ZA / 1ZB; für Linkslenker	03.2123-3449.3	010808	ATE Ø 23,8			
				→ 05/10; für Rechtslenker	24.2122-1981.3	011024	ATE Ø 22,2 ohne Bremsflüssigkeitsbehälter			
					24.4152-0132.3	011025	ATE Ø 22,2 ohne Bremsflüssigkeitsbehälter			
					24.4153-0202.3	011027	ATE Ø 23,8 ohne Bremsflüssigkeitsbehälter			
				06/10→; +PR 1ZE / 1ZF; für Rechtslenker	24.4152-0132.3	011025	ATE Ø 22,2 ohne Bremsflüssigkeitsbehälter			
				F1P-6-027023→; → 05/10; für Rechtslenker; +PR 1AC / 1AT / 1AS	24.4152-0132.3	011025	ATE Ø 22,2 ohne Bremsflüssigkeitsbehälter			
				F1P-6-027023→; → 05/10; für Rechtslenker; +PR 1AC / 1AT / 1LJ / 1ZA	24.4153-0202.3	011027	ATE Ø 23,8 ohne Bremsflüssigkeitsbehälter			
1.9 TDI	77	07/05→12/10		F1P-6-027023→; → 05/10; für Linkslenker; +PR 1AC / 1AT / 1AS	03.2122-2129.3	010799	ATE Ø 22,2			
				06/10→; +PR 1ZE / 1ZF; für Linkslenker	03.2122-2129.3	010799	ATE Ø 22,2			
				06/10→; +PR 1LB / 1ZA / 1ZB; für Linkslenker	03.2123-3449.3	010808	ATE Ø 23,8			
				F1P-6-027023→; für Linkslenker; → 05/10; +PR 1AC / 1AT / 1LJ / 1ZA	03.2123-3449.3	010808	ATE Ø 23,8			
				08/05→ 05/10; für Rechtslenker	24.2122-1981.3	011024	ATE Ø 22,2 ohne Bremsflüssigkeitsbehälter			
					24.4152-0132.3	011025	ATE Ø 22,2 ohne Bremsflüssigkeitsbehälter			
					24.4153-0202.3	011027	ATE Ø 23,8 ohne Bremsflüssigkeitsbehälter			
				06/10→; +PR 1ZE / 1ZF; für Rechtslenker	24.4152-0132.3	011025	ATE Ø 22,2 ohne Bremsflüssigkeitsbehälter			
				F1P-6-027023→; → 05/10; für Rechtslenker; +PR 1AC / 1AT / 1AS	24.4152-0132.3	011025	ATE Ø 22,2 ohne Bremsflüssigkeitsbehälter			
				06/10→; +PR 1LB / 1ZA / 1ZB; für Rechtslenker	24.4153-0202.3	011027	ATE Ø 23,8 ohne Bremsflüssigkeitsbehälter			
2.0 FSI 2.0 TDI 2.0 TFSI	110 100 147	07/05→05/10 07/05→05/10 05/05→03/09		F1P-6-027023→; für Linkslenker; +PR 1AC / 1AT / 1AS	03.2122-2129.3	010799	ATE Ø 22,2			
				F1P-6-027023→; für Linkslenker; +PR 1AC / 1AT / 1LJ / 1ZA	03.2123-3449.3	010808	ATE Ø 23,8			
				08/05→; für Rechtslenker	24.2122-1981.3	011024	ATE Ø 22,2 ohne Bremsflüssigkeitsbehälter			
				F1P-6-027023→; für Rechtslenker; +PR 1AC / 1AT / 1AS	24.4152-0132.3	011025	ATE Ø 22,2 ohne Bremsflüssigkeitsbehälter			
				+PR 1ZE / 1ZF; für Rechtslenker	24.4152-0132.3	011025	ATE Ø 22,2 ohne Bremsflüssigkeitsbehälter			
				+PR 1LB / 1ZA / 1ZB; für Rechtslenker	24.4153-0202.3	011027	ATE Ø 23,8 ohne Bremsflüssigkeitsbehälter			
				F1P-6-027023→; für Rechtslenker; +PR 1AC / 1AT / 1LJ / 1ZA	24.4153-0202.3	011027	ATE Ø 23,8 ohne Bremsflüssigkeitsbehälter			
			2.0 TFSI	136	09/05→05/06		F1P-6-027023→; für Linkslenker; +PR 1AC / 1AT / 1AS	03.2122-2129.3	010799	ATE Ø 22,2
							F1P-6-027023→; für Linkslenker; +PR 1AC / 1AT / 1LJ / 1ZA	03.2123-3449.3	010808	ATE Ø 23,8
							für Rechtslenker	24.2122-1981.3	011024	ATE Ø 22,2 ohne Bremsflüssigkeitsbehälter
	F1P-6-027023→; für Rechtslenker; +PR 1AC / 1AT / 1AS	24.4152-0132.3				011025	ATE Ø 22,2 ohne Bremsflüssigkeitsbehälter			



SEAT - LEON (1P1) 05/05→12/13

Hauptbremszylinder

2.0 TFSI	136	09/05→05/06		+PR 1ZE / 1ZF; für Rechtslenker	24.4152-0132.3	011025	ATE Ø 22,2 ohne Bremsflüssigkeitsbehälter
				+PR 1LB / 1ZA / 1ZB; für Rechtslenker	24.4153-0202.3	011027	ATE Ø 23,8 ohne Bremsflüssigkeitsbehälter
				F1P-6-027023→; für Rechtslenker; +PR 1AC / 1AT / 1LJ / 1ZA	24.4153-0202.3	011027	ATE Ø 23,8 ohne Bremsflüssigkeitsbehälter

Hydraulikaggregat, Bremsanlage

1.2 TSI 1.4 16V 1.4 TSI 1.6 LPG 1.6 MultiFuel 1.6 TDI	77 63 92 75 75 66 -	02/10→12/12 06/06→12/12 11/07→12/12 12/09→12/12 07/05→08/13 02/10→12/12		→ 10/12; +PR 1AT / 1AS											
								77							
								118							
								195							
								125							
								155							
								1.6	75	07/05→12/12		08/05→ 10/12; +PR 1AT / 1AS	24.9145-0001.2	399005	
								2.0 TDI 16V	103	07/05→12/12					
								1.9 TDI	66	06/07→12/10		+PR 1AT / 1AS	24.9145-0001.2	399005	
								2.0 TDI	103	10/05→10/10					
2.0 TFSI	136 -	09/05→05/11													
	177														
1.9 TDI	77	07/05→12/10		08/05→; +PR 1AT / 1AS	24.9145-0001.2	399005									
2.0 FSI	110	07/05→05/10													
2.0 TDI	100	07/05→05/10													
2.0 TFSI	147	05/05→03/09													









Drucksensor, Bremskraftverstärker











1.2 TSI 1.4 16V 1.4 TSI 1.6 LPG 1.6 MultiFuel 1.6 TDI	77 63 92 75 75 66 -	02/10→12/12 06/06→12/12 11/07→12/12 12/09→12/12 07/05→08/13 02/10→12/12		+PR 1AS; → 10/12											
								77							
								118							
								195							
								125							
								155							
								1.6	75	07/05→12/12		08/05→; +PR 1AS; → 10/12	03.0655-0101.2	370008	ATE
								2.0 TDI 16V	103	07/05→12/12					
								1.9 TDI	66	06/07→12/10		+PR 1AS	03.0655-0101.2	370008	ATE
								2.0 TDI	103	10/05→10/10					
2.0 TFSI	136 -	09/05→05/11													
	177														
1.9 TDI	77	07/05→12/10		08/05→; +PR 1AS	03.0655-0101.2	370008	ATE								
2.0 FSI	110	07/05→05/10													
2.0 TDI	100	07/05→05/10													
2.0 TFSI	147	05/05→03/09													









SEAT - LEON (5F1) 09/12→05/21













Hauptbremszylinder











1.0 TSi 1.5 TGi 1.5 TSI	63 96 96 -	09/18→08/20 10/18→08/20 09/18→08/20		für Linkslenker				
								110
								140
2.0 TSI	140	09/18→08/20						
				für Linkslenker; +PR 1ZA / 1ZE	24.4123-1719.3	011017	TRW Ø 23,8 ohne Bremsflüssigkeitsbehälter	
					24.4153-1522.3	011048	ATE Ø 23,8 ohne Bremsflüssigkeitsbehälter	
					24.4153-1522.3	011048	ATE Ø 23,8 ohne Bremsflüssigkeitsbehälter	
1.0 TSI	85	05/15→08/20		für Linkslenker	03.4153-5403.3	010994	ATE Ø 23,8	
1.2 TSI	81	04/14→08/20			24.4123-1719.3	011017	TRW Ø 23,8 ohne Bremsflüssigkeitsbehälter	
1.4 TSI	92 -	05/14→08/20						
	110							
2.0 Cupra	213	10/15→08/20			24.4153-1522.3	011048	ATE Ø 23,8 ohne Bremsflüssigkeitsbehälter	
				11/16→; für Linkslenker; +PR 1ZA / 1ZE	24.4123-1719.3	011017	TRW Ø 23,8 ohne Bremsflüssigkeitsbehälter	
				für Linkslenker; +PR 1ZA / 1ZE	24.4153-1522.3	011048	ATE Ø 23,8 ohne Bremsflüssigkeitsbehälter	
1.2 TSI	63 -	12/12→08/20		für Linkslenker	03.4153-5403.3	010994	ATE Ø 23,8	
1.4 TSI	77				24.4123-1719.3	011017	TRW Ø 23,8 ohne Bremsflüssigkeitsbehälter	
	103	09/12→08/20						

	kw			 	! #		
SEAT - LEON (5F1) 09/12→05/21							
 Hauptbremszylinder							
1.6 TDI	66 - 81	09/12→08/20		11/16→; für Linkslenker; +PR 1ZA / 1ZE		24.4123-1719.3 011017	TRW Ø 23,8 ohne Bremsflüssigkeitsbehälter
1.8 TSI	132	02/13→08/18		02/14→; für Linkslenker		24.4153-1522.3 011048	ATE Ø 23,8 ohne Bremsflüssigkeitsbehälter
2.0 Cupra	195 - 206	10/13→08/20					
2.0 TDI	81 - 135	09/12→08/20		02/14→; für Linkslenker; +PR 1ZA / 1ZE		24.4153-1522.3 011048	ATE Ø 23,8 ohne Bremsflüssigkeitsbehälter
1.4 TGI	81	02/13→08/18		10/13→; für Linkslenker		03.4153-5403.3 010994 24.4123-1719.3 011017	ATE Ø 23,8 TRW Ø 23,8 ohne Bremsflüssigkeitsbehälter
				11/16→; für Linkslenker; +PR 1ZA / 1ZE		24.4123-1719.3 011017	TRW Ø 23,8 ohne Bremsflüssigkeitsbehälter
				02/14→; für Linkslenker		24.4153-1522.3 011048	ATE Ø 23,8 ohne Bremsflüssigkeitsbehälter
				02/14→; für Linkslenker; +PR 1ZA / 1ZE		24.4153-1522.3 011048	ATE Ø 23,8 ohne Bremsflüssigkeitsbehälter
1.4 TSI	90	11/12→10/16		für Linkslenker		03.4153-5403.3 010994 24.4123-1719.3 011017	ATE Ø 23,8 TRW Ø 23,8 ohne Bremsflüssigkeitsbehälter
				für Linkslenker; +PR 1ZA / 1ZE		24.4123-1719.3 011017	TRW Ø 23,8 ohne Bremsflüssigkeitsbehälter
				02/14→; für Linkslenker		24.4153-1522.3 011048	ATE Ø 23,8 ohne Bremsflüssigkeitsbehälter
				02/14→; für Linkslenker; +PR 1ZA / 1ZE		24.4153-1522.3 011048	ATE Ø 23,8 ohne Bremsflüssigkeitsbehälter
1.6 TDI	85	11/16→08/20		01/17→; für Linkslenker		03.4153-5403.3 010994 24.4123-1719.3 011017	ATE Ø 23,8 TRW Ø 23,8 ohne Bremsflüssigkeitsbehälter
				01/17→; für Linkslenker; +PR 1ZA / 1ZE		24.4123-1719.3 011017	TRW Ø 23,8 ohne Bremsflüssigkeitsbehälter
				für Linkslenker; +PR 1ZA / 1ZE		24.4153-1522.3 011048	ATE Ø 23,8 ohne Bremsflüssigkeitsbehälter
				für Linkslenker		24.4153-1522.3 011048	ATE Ø 23,8 ohne Bremsflüssigkeitsbehälter
2.0 Cupra	221	01/17→08/18		für Linkslenker; +PR 1ZA / 1ZE		24.4123-1719.3 011017	TRW Ø 23,8 ohne Bremsflüssigkeitsbehälter
2.0 Cupra R	228	11/17→08/18				24.4153-1522.3 011048	ATE Ø 23,8 ohne Bremsflüssigkeitsbehälter
SEAT - LEON Kasten/Schrägheck (5F1) 09/12→08/20							
 Hauptbremszylinder							
1.0 TSI	85	05/15→08/20		für Linkslenker		03.4153-5403.3 010994	ATE Ø 23,8
1.2 TSI	81	04/14→08/18				24.4123-1719.3 011017	TRW Ø 23,8 ohne Bremsflüssigkeitsbehälter
1.4 TSI	110	05/14→08/20				24.4153-1522.3 011048	ATE Ø 23,8 ohne Bremsflüssigkeitsbehälter
				11/16→; für Linkslenker; +PR 1ZA / 1ZE		24.4123-1719.3 011017	TRW Ø 23,8 ohne Bremsflüssigkeitsbehälter
				für Linkslenker; +PR 1ZA / 1ZE		24.4153-1522.3 011048	ATE Ø 23,8 ohne Bremsflüssigkeitsbehälter
1.2 TSI	63	01/13→08/18		für Linkslenker		03.4153-5403.3 010994	ATE Ø 23,8
						24.4123-1719.3 011017	TRW Ø 23,8 ohne Bremsflüssigkeitsbehälter
				11/16→; für Linkslenker; +PR 1ZA / 1ZE		24.4123-1719.3 011017	TRW Ø 23,8 ohne Bremsflüssigkeitsbehälter
				02/14→; für Linkslenker		24.4153-1522.3 011048	ATE Ø 23,8 ohne Bremsflüssigkeitsbehälter
1.8 TFSI	132	02/13→08/18				24.4153-1522.3 011048	ATE Ø 23,8 ohne Bremsflüssigkeitsbehälter
2.0 TDI	110 - 135	10/12→08/18		02/14→; für Linkslenker; +PR 1ZA / 1ZE		24.4153-1522.3 011048	ATE Ø 23,8 ohne Bremsflüssigkeitsbehälter
1.4 TSI	90 - 103	09/12→10/16		für Linkslenker		03.4153-5403.3 010994	ATE Ø 23,8
				für Linkslenker; +PR 1ZA / 1ZE		24.4123-1719.3 011017	TRW Ø 23,8 ohne Bremsflüssigkeitsbehälter
				02/14→; für Linkslenker		24.4153-1522.3 011048	ATE Ø 23,8 ohne Bremsflüssigkeitsbehälter
				02/14→; für Linkslenker; +PR 1ZA / 1ZE		24.4153-1522.3 011048	ATE Ø 23,8 ohne Bremsflüssigkeitsbehälter
1.6 TDI	66 - 81	09/12→10/16					
				01/17→; für Linkslenker		03.4153-5403.3 010994 24.4123-1719.3 011017	ATE Ø 23,8 TRW Ø 23,8 ohne Bremsflüssigkeitsbehälter
1.6 TDI	85	11/16→08/20					
→							













	kw			 	! #		
SEAT - LEON Kasten/Schrägheck (5F1) 09/12→08/20							
 Hauptbremszylinder							
1.6 TDI	85	11/16→08/20		01/17→; für Linkslenker; +PR 1ZA / 1ZE	24.4123-1719.3	011017	TRW Ø 23,8 ohne Bremsflüssigkeitsbehälter
				für Linkslenker; +PR 1ZA / 1ZE	24.4153-1522.3	011048	ATE Ø 23,8 ohne Bremsflüssigkeitsbehälter
				für Linkslenker	24.4153-1522.3	011048	ATE Ø 23,8 ohne Bremsflüssigkeitsbehälter
2.0 Cupra	213	09/15→10/16		für Linkslenker	03.4153-5403.3	010994	ATE Ø 23,8
				für Linkslenker; +PR 1ZA / 1ZE	24.4153-1522.3	011048	ATE Ø 23,8 ohne Bremsflüssigkeitsbehälter
				für Linkslenker; +PR 1ZA / 1ZE	24.4123-1719.3	011017	TRW Ø 23,8 ohne Bremsflüssigkeitsbehälter
2.0 Cupra	221	01/17→08/18		für Linkslenker	03.4153-5403.3	010994	ATE Ø 23,8
				für Linkslenker; +PR 1ZA / 1ZE	24.4123-1719.3	011017	TRW Ø 23,8 ohne Bremsflüssigkeitsbehälter
				für Linkslenker; +PR 1ZA / 1ZE	24.4153-1522.3	011048	ATE Ø 23,8 ohne Bremsflüssigkeitsbehälter
SEAT - LEON SC (5F5) 01/13→12/18							
 Hauptbremszylinder							
1.0 TSI	85	05/15→08/18		für Linkslenker	03.4153-5403.3	010994	ATE Ø 23,8
1.2 TSI	81	05/14→08/18			24.4123-1719.3	011017	TRW Ø 23,8 ohne Bremsflüssigkeitsbehälter
1.4 TSI	92 - 110	05/14→08/18			24.4153-1522.3	011048	ATE Ø 23,8 ohne Bremsflüssigkeitsbehälter
2.0 Cupra	213	10/15→11/16			24.4123-1719.3	011017	TRW Ø 23,8 ohne Bremsflüssigkeitsbehälter
				11/16→; für Linkslenker; +PR 1ZA / 1ZE	24.4123-1719.3	011017	TRW Ø 23,8 ohne Bremsflüssigkeitsbehälter
				für Linkslenker; +PR 1ZA / 1ZE	24.4153-1522.3	011048	ATE Ø 23,8 ohne Bremsflüssigkeitsbehälter
1.2 TSI	63	01/13→08/18		für Linkslenker	03.4153-5403.3	010994	ATE Ø 23,8
1.4 TSI	103	02/13→11/16			24.4123-1719.3	011017	TRW Ø 23,8 ohne Bremsflüssigkeitsbehälter
1.6 TDI	66 - 81	02/13→08/18			24.4123-1719.3	011017	TRW Ø 23,8 ohne Bremsflüssigkeitsbehälter
1.8 TSI	132	02/13→08/18		11/16→; für Linkslenker; +PR 1ZA / 1ZE	24.4123-1719.3	011017	TRW Ø 23,8 ohne Bremsflüssigkeitsbehälter
2.0 Cupra	195 - 206	10/13→11/16			24.4153-1522.3	011048	ATE Ø 23,8 ohne Bremsflüssigkeitsbehälter
2.0 TDI	81 - 135	02/13→08/18		02/14→; für Linkslenker	24.4153-1522.3	011048	ATE Ø 23,8 ohne Bremsflüssigkeitsbehälter
				02/14→; für Linkslenker; +PR 1ZA / 1ZE	24.4153-1522.3	011048	ATE Ø 23,8 ohne Bremsflüssigkeitsbehälter
1.2 TSI	77	02/13→04/14		für Linkslenker	03.4153-5403.3	010994	ATE Ø 23,8
1.4 TSI	90	02/13→06/15			24.4123-1719.3	011017	TRW Ø 23,8 ohne Bremsflüssigkeitsbehälter
				02/14→; für Linkslenker	24.4153-1522.3	011048	ATE Ø 23,8 ohne Bremsflüssigkeitsbehälter
				02/14→; für Linkslenker; +PR 1ZA / 1ZE	24.4153-1522.3	011048	ATE Ø 23,8 ohne Bremsflüssigkeitsbehälter
1.6 TDI	85	11/16→08/18		01/17→; für Linkslenker	03.4153-5403.3	010994	ATE Ø 23,8
				01/17→; für Linkslenker; +PR 1ZA / 1ZE	24.4123-1719.3	011017	TRW Ø 23,8 ohne Bremsflüssigkeitsbehälter
				für Linkslenker; +PR 1ZA / 1ZE	24.4153-1522.3	011048	ATE Ø 23,8 ohne Bremsflüssigkeitsbehälter
				für Linkslenker	24.4153-1522.3	011048	ATE Ø 23,8 ohne Bremsflüssigkeitsbehälter
2.0 Cupra	221	01/17→08/18		für Linkslenker; +PR 1ZA / 1ZE	24.4123-1719.3	011017	TRW Ø 23,8 ohne Bremsflüssigkeitsbehälter
					24.4153-1522.3	011048	ATE Ø 23,8 ohne Bremsflüssigkeitsbehälter
SEAT - LEON ST (5F8) 09/12→08/20							
 Hauptbremszylinder							
1.0 Tsi	63	09/18→08/20		für Linkslenker	03.4153-5403.3	010994	ATE Ø 23,8
1.5 TGi	96	10/18→08/20					
→							













	kw			 	! #		
SEAT - LEON ST (5F8) 09/12→08/20							
 Hauptbremszylinder							
1.5 TSI 2.0 Cupra 2.0 Cupra 4Drive	96 - 110	09/18→08/20		für Linkslenker		24.4123-1719.3 011017	TRW Ø 23,8 ohne Bremsflüssigkeitsbehälter
	213	10/15→08/20				24.4153-1522.3 011048	ATE Ø 23,8 ohne Bremsflüssigkeitsbehälter
	221	11/16→08/20					
				für Linkslenker; +PR 1ZA / 1ZE		24.4123-1719.3 011017	TRW Ø 23,8 ohne Bremsflüssigkeitsbehälter
						24.4153-1522.3 011048	ATE Ø 23,8 ohne Bremsflüssigkeitsbehälter
1.0 TSI 1.2 TSI 1.4 TSI 1.6 TDI 4Drive 1.8 TSI 4Drive 2.0 TDI 4Drive	85	05/15→08/20		für Linkslenker		03.4153-5403.3 010994	ATE Ø 23,8
	81	05/14→08/20				24.4123-1719.3 011017	TRW Ø 23,8 ohne Bremsflüssigkeitsbehälter
	92 - 110	05/14→08/20					
	77 - 81	04/14→08/20				24.4153-1522.3 011048	ATE Ø 23,8 ohne Bremsflüssigkeitsbehälter
	132	11/14→08/18		11/16→; für Linkslenker; +PR 1ZA / 1ZE		24.4123-1719.3 011017	TRW Ø 23,8 ohne Bremsflüssigkeitsbehälter
	110 - 135	04/14→08/20				24.4153-1522.3 011048	ATE Ø 23,8 ohne Bremsflüssigkeitsbehälter
1.2 TSI 1.4 TGI 1.4 TSI 1.6 TDI 1.8 TSI 2.0 Cupra 2.0 TDI	63 - 77	08/13→08/20		für Linkslenker		03.4153-5403.3 010994	ATE Ø 23,8
	81	10/13→08/18				24.4123-1719.3 011017	TRW Ø 23,8 ohne Bremsflüssigkeitsbehälter
	103	10/13→08/20					
	66 - 81	09/13→08/20		11/16→; für Linkslenker; +PR 1ZA / 1ZE		24.4123-1719.3 011017	TRW Ø 23,8 ohne Bremsflüssigkeitsbehälter
	132	10/13→08/18		02/14→; für Linkslenker		24.4153-1522.3 011048	ATE Ø 23,8 ohne Bremsflüssigkeitsbehälter
	195 - 206	10/13→08/20					
	81 - 135	02/13→08/20		02/14→; für Linkslenker; +PR 1ZA / 1ZE		24.4153-1522.3 011048	ATE Ø 23,8 ohne Bremsflüssigkeitsbehälter
1.4 TSI	90	09/12→06/15		für Linkslenker		03.4153-5403.3 010994	ATE Ø 23,8
						24.4123-1719.3 011017	TRW Ø 23,8 ohne Bremsflüssigkeitsbehälter
				für Linkslenker; +PR 1ZA / 1ZE		24.4123-1719.3 011017	TRW Ø 23,8 ohne Bremsflüssigkeitsbehälter
				02/14→; für Linkslenker		24.4153-1522.3 011048	ATE Ø 23,8 ohne Bremsflüssigkeitsbehälter
			02/14→; für Linkslenker; +PR 1ZA / 1ZE		24.4153-1522.3 011048	ATE Ø 23,8 ohne Bremsflüssigkeitsbehälter	
1.6 TDI	85	11/16→08/20		01/17→; für Linkslenker		03.4153-5403.3 010994	ATE Ø 23,8
						24.4123-1719.3 011017	TRW Ø 23,8 ohne Bremsflüssigkeitsbehälter
				01/17→; für Linkslenker; +PR 1ZA / 1ZE		24.4123-1719.3 011017	TRW Ø 23,8 ohne Bremsflüssigkeitsbehälter
				für Linkslenker; +PR 1ZA / 1ZE		24.4153-1522.3 011048	ATE Ø 23,8 ohne Bremsflüssigkeitsbehälter
			für Linkslenker		24.4153-1522.3 011048	ATE Ø 23,8 ohne Bremsflüssigkeitsbehälter	
1.6 TDI 4Drive 2.0 TSI 2.0 TSI 4Drive	85	07/18→08/20		für Linkslenker		03.4153-5403.3 010994	ATE Ø 23,8
	140	07/18→08/20				24.4123-1719.3 011017	TRW Ø 23,8 ohne Bremsflüssigkeitsbehälter
	140	09/18→08/20		für Linkslenker; +PR 1ZA / 1ZE		24.4153-1522.3 011048	ATE Ø 23,8 ohne Bremsflüssigkeitsbehälter
2.0 Cupra	221	11/16→08/18		für Linkslenker; +PR 1ZA / 1ZE		24.4123-1719.3 011017	TRW Ø 23,8 ohne Bremsflüssigkeitsbehälter
						24.4153-1522.3 011048	ATE Ø 23,8 ohne Bremsflüssigkeitsbehälter
SEAT - LEON ST Kasten/Kombi (5F8) 01/13→08/20							
 Hauptbremszylinder							
1.0 TSI 1.2 TSI 1.4 TSI 2.0 TDI 4Drive	85	05/15→08/20		für Linkslenker		03.4153-5403.3 010994	ATE Ø 23,8
	81	05/14→08/18				24.4123-1719.3 011017	TRW Ø 23,8 ohne Bremsflüssigkeitsbehälter
	110	05/14→08/20					
	110 - 135	09/14→08/18				24.4153-1522.3 011048	ATE Ø 23,8 ohne Bremsflüssigkeitsbehälter
			11/16→; für Linkslenker; +PR 1ZA / 1ZE		24.4123-1719.3 011017	TRW Ø 23,8 ohne Bremsflüssigkeitsbehälter	
			für Linkslenker; +PR 1ZA / 1ZE		24.4153-1522.3 011048	ATE Ø 23,8 ohne Bremsflüssigkeitsbehälter	
1.2 TSI 1.6 TDI 1.8 TFSI 2.0 Cupra →	63	01/13→08/18		für Linkslenker		03.4153-5403.3 010994	ATE Ø 23,8
	81	09/13→08/20				24.4123-1719.3 011017	TRW Ø 23,8 ohne Bremsflüssigkeitsbehälter
	132	10/13→08/18					
	206	10/13→08/20					











	kw					! #		
SEAT - LEON ST Kasten/Kombi (5F8) 01/13→08/20								
 Hauptbremszylinder								
2.0 TDI	110 - 135	04/13→08/18		11/16→; für Linkslenker; +PR 1ZA / 1ZE			24.4123-1719.3 011017	TRW Ø 23,8 ohne Bremsflüssigkeitsbehälter
				02/14→; für Linkslenker			24.4153-1522.3 011048	ATE Ø 23,8 ohne Bremsflüssigkeitsbehälter
				02/14→; für Linkslenker; +PR 1ZA / 1ZE			24.4153-1522.3 011048	ATE Ø 23,8 ohne Bremsflüssigkeitsbehälter
1.6 TDI	85	11/16→08/20		01/17→; für Linkslenker			03.4153-5403.3 010994 24.4123-1719.3 011017	ATE Ø 23,8 TRW Ø 23,8 ohne Bremsflüssigkeitsbehälter
				01/17→; für Linkslenker; +PR 1ZA / 1ZE			24.4123-1719.3 011017	TRW Ø 23,8 ohne Bremsflüssigkeitsbehälter
				für Linkslenker; +PR 1ZA / 1ZE			24.4153-1522.3 011048	ATE Ø 23,8 ohne Bremsflüssigkeitsbehälter
				für Linkslenker			24.4153-1522.3 011048	ATE Ø 23,8 ohne Bremsflüssigkeitsbehälter
2.0 Cupra	221	11/16→08/18		für Linkslenker; +PR 1ZA / 1ZE		24.4123-1719.3 011017 24.4153-1522.3 011048	TRW Ø 23,8 ohne Bremsflüssigkeitsbehälter ATE Ø 23,8 ohne Bremsflüssigkeitsbehälter	
2.0 Cupra 4Drive	221	11/16→08/18		für Linkslenker			03.4153-5403.3 010994 24.4123-1719.3 011017 24.4153-1522.3 011048	ATE Ø 23,8 TRW Ø 23,8 ohne Bremsflüssigkeitsbehälter ATE Ø 23,8 ohne Bremsflüssigkeitsbehälter
				für Linkslenker; +PR 1ZA / 1ZE			24.4123-1719.3 011017 24.4153-1522.3 011048	TRW Ø 23,8 ohne Bremsflüssigkeitsbehälter ATE Ø 23,8 ohne Bremsflüssigkeitsbehälter
SEAT - MARBELLA (28A) 08/86→05/99								
 Hauptbremszylinder								
0.9 0.9 Cat	32 30	07/97→10/98 11/96→10/98					24.2119-0826.3 010349	Ø 19
SEAT - MARBELLA Kasten/Schrägheck (028A) 11/86→05/99								
 Hauptbremszylinder								
0.9	30	05/95→05/99					24.2119-0826.3 010349	Ø 19
SEAT - Mii (KF1, KE1) 10/11→								
 Hauptbremszylinder								
1.0	44 - 55	10/11→07/19		05/12→			24.4120-1703.3 011015	TRW Ø 20,6 ohne Bremsflüssigkeitsbehälter
1.0 EcoFuel	50	10/12→07/19					24.4120-1703.3 011015	TRW Ø 20,6 ohne Bremsflüssigkeitsbehälter
SEAT - TOLEDO I (1L2) 01/91→10/99								
 Hauptbremszylinder								
1.6 i	54	05/91→03/99		09/91→; → 1L-ZD101450			03.2120-2031.3 010106	ATE Ø 20,6
				1L-ZD101451→ 1L-ZD315000			03.2120-3943.3 010532	ATE Ø 20,6
				→ 09/98; 1L-ZD315001→			03.2122-1042.3 010137	Ø 22,2
1.6 i	55 - 74	01/93→03/99		→ 1L-ZD101450			03.2120-2031.3 010106	ATE Ø 20,6
				1L-ZD101451→ 1L-ZD315000			03.2120-3943.3 010532	ATE Ø 20,6
				→ 09/98; 1L-ZD315001→			03.2122-1042.3 010137	Ø 22,2
1.8 16V	92 - 98	05/91→03/99		09/91→ 03/94; für Linkslenker			10.6123-0674.3 010639	ATE Ø 23,8
1.9 D	47	12/95→03/99		→ 1L-ZD315000			03.2120-3943.3 010532	ATE Ø 20,6
				→ 09/98; 1L-ZD315001→			03.2122-1042.3 010137	Ø 22,2
1.9 D	50	05/91→03/99		09/91→; → 1L-ZD315000			03.2120-3943.3 010532	ATE Ø 20,6
				→ 09/98; 1L-ZD315001→			03.2122-1042.3 010137	Ø 22,2
1.9 TD	55	05/91→03/99		09/91→; → 1L-ZD315000; - ABS			03.2120-3943.3 010532	ATE Ø 20,6
				→ 09/98; 1L-ZD315001→; - ABS			03.2122-1042.3 010137	Ø 22,2
				→ 09/98; für Linkslenker; + ABS			10.6123-0674.3 010639	ATE Ø 23,8
2.0 i	85	05/91→03/99		09/91→ 09/98; für Linkslenker			10.6123-0674.3 010639	ATE Ø 23,8
2.0 i 16V →	110	11/93→03/99		03/94→ 09/98; für Linkslenker			10.6123-0674.3 010639	ATE Ø 23,8











	kw			 	! #		
SEAT - TOLEDO I (1L2) 01/91→10/99							
Verschlusschraube, Hauptbremszylinder							
1.6 i	54	05/91→03/99		09/91→; → 1L-ZD101450		03.3517-0101.2 390322	
				→ 09/98; 1L-ZD315001→		03.3517-0101.2 390322	
				1L-ZD101451→ 1L-ZD315000		03.3517-0101.2 390322	
1.6 i	55 - 74	01/93→03/99		→ 1L-ZD101450		03.3517-0101.2 390322	
				→ 09/98; 1L-ZD315001→		03.3517-0101.2 390322	
				1L-ZD101451→ 1L-ZD315000		03.3517-0101.2 390322	
1.9 D	47	12/95→03/99		→ 1L-ZD315000		03.3517-0101.2 390322	
				→ 09/98; 1L-ZD315001→		03.3517-0101.2 390322	
1.9 D	50	05/91→03/99		→ 09/98; 1L-ZD315001→		03.3517-0101.2 390322	
				09/91→; → 1L-ZD315000		03.3517-0101.2 390322	
1.9 TD	55	05/91→03/99		→ 09/98; 1L-ZD315001→; - ABS		03.3517-0101.2 390322	
				09/91→; → 1L-ZD315000; - ABS		03.3517-0101.2 390322	
1.9 TDI	66 - 81	08/95→03/99		→ 09/98; - ABS		03.3517-0101.2 390322	
SEAT - TOLEDO II (1M2) 10/98→05/06							
 Bremskraftverstärker							
1.4 16V	55	01/00→05/02		1M-1R023639→; für Linkslenker; + ESP		03.7860-0602.4 300141	ATE Ø 10" pneumatisch
1.6	74	10/98→07/04		1M-1B018342→; für Linkslenker; + ESP		03.7860-0602.4 300141	ATE Ø 10" pneumatisch
1.8 20V	92	10/98→07/04		→ 1M-1R023638; für Linkslenker; + ESP		03.7863-0402.4 300124	ATE Ø 10" pneumatisch
1.9 TDI	66 - 110	10/98→05/06		→ 1M-1B018341; für Linkslenker; + ESP		03.7863-0402.4 300124	ATE Ø 10" pneumatisch
1.9 TDI 4Drive	110	10/00→10/05					
2.3 V5	110	10/98→11/00					
2.3 V5 20V	125	09/00→11/03					
1.6 16V	77	06/00→05/06		1M-1R023639→; → 09/04; für Linkslenker; + ESP		03.7860-0602.4 300141	ATE Ø 10" pneumatisch
1.9 TDI	96	05/03→05/06		1M-1B018342→; → 09/04; für Linkslenker; + ESP		03.7860-0602.4 300141	ATE Ø 10" pneumatisch
				→ 1M-1R023638; für Linkslenker; + ESP		03.7863-0402.4 300124	ATE Ø 10" pneumatisch
				→ 1M-1B018341; für Linkslenker; + ESP		03.7863-0402.4 300124	ATE Ø 10" pneumatisch
1.8 20VT	132	09/00→07/04		1M-1R023639→; für Linkslenker; + ESP		03.7860-0602.4 300141	ATE Ø 10" pneumatisch
				1M-1B018342→; für Linkslenker; + ESP		03.7860-0602.4 300141	ATE Ø 10" pneumatisch
				05/01→; → 1M-1R023638; für Linkslenker; + ESP		03.7863-0402.4 300124	ATE Ø 10" pneumatisch
				05/01→; → 1M-1B018341; für Linkslenker; + ESP		03.7863-0402.4 300124	ATE Ø 10" pneumatisch
 Hauptbremszylinder							
1.4 16V	55	01/00→05/02		→ 08/00; für Linkslenker; + ESP		03.2123-2024.3 010597	ATE Ø 23,8
1.6	74	10/98→07/04		→ 08/00; für Rechtslenker; + ESP		03.2123-2064.3 010598	ATE Ø 23,8
1.8 20V	92	10/98→07/04		09/00→; für Linkslenker; + ESP		03.2123-2715.3 010802	ATE Ø 23,8
1.9 TDI	66 - 81	10/98→07/04		09/00→; für Rechtslenker; + ESP		03.2123-2774.3 010803	ATE Ø 23,8
2.3 V5	110	10/98→11/00		für Linkslenker; - ESP		24.2123-1709.3 010503	Ø 23,8
1.6 16V	77	06/00→05/06		→ 08/00; für Linkslenker; + ESP		03.2123-2024.3 010597	ATE Ø 23,8
				→ 08/00; für Rechtslenker; + ESP		03.2123-2064.3 010598	ATE Ø 23,8
				09/00→ 09/04; für Linkslenker; + ESP		03.2123-2715.3 010802	ATE Ø 23,8
				09/00→ 09/04; für Rechtslenker; + ESP		03.2123-2774.3 010803	ATE Ø 23,8
				→ 09/04; für Linkslenker; - ESP		24.2123-1709.3 010503	Ø 23,8
1.8 20VT	132	09/00→07/04		05/01→; + ESP; für Linkslenker		03.2123-2715.3 010802	ATE Ø 23,8
				05/01→; für Rechtslenker; + ESP		03.2123-2774.3 010803	ATE Ø 23,8
1.9 TDI	74 - 110	10/00→05/06		für Linkslenker; + ESP		03.2123-2715.3 010802	ATE Ø 23,8
1.9 TDI 4Drive	110	10/00→10/05		+ ESP; für Rechtslenker		03.2123-2774.3 010803	ATE Ø 23,8
2.3 V5 20V	125	09/00→11/03		für Linkslenker; - ESP		24.2123-1709.3 010503	Ø 23,8
1.9 TDI	96	05/03→05/06		→ 09/04; für Linkslenker; + ESP		03.2123-2715.3 010802	ATE Ø 23,8
				→ 09/04; + ESP; für Rechtslenker		03.2123-2774.3 010803	ATE Ø 23,8
				→ 09/04; für Linkslenker; - ESP		24.2123-1709.3 010503	Ø 23,8
 Bremskraftregler							
1.4 16V	55	01/00→05/02		- ABS		03.6583-0179.3 320228	ATE lastabhängig 8/3 4x
1.6	74	10/98→07/04					
1.8 20V	92	10/98→07/04					
1.9 TDI	66 - 110	10/98→05/06					
1.9 TDI 4Drive	110	10/00→10/05					
2.3 V5	110	10/98→11/00					
2.3 V5 20V	125	09/00→11/03					
→							































	kw					! #		
SEAT - TOLEDO II (1M2) 10/98→05/06								
 Bremskraftregler								
1.6 16V 1.9 TDI	77 96	06/00→05/06 05/03→05/06		→ 09/04; - ABS			03.6583-0179.3 320228	ATE lastabhängig 8/3 4x
SEAT - TOLEDO III (5P2) 04/04→05/09								
 Bremskraftverstärker								
1.4 16V 1.4 TSI 1.6 1.8 TFSI 1.9 TDI 2.0 FSI 2.0 TDI 2.0 TFSI 2.0 TDI 2.0 TDI 16V	63 92 75 118 77 110 103 - 125 147 100 103	05/06→05/09 11/07→05/09 10/04→05/09 01/07→05/09 10/04→05/09 10/04→05/09 11/05→05/09 11/05→05/09 09/04→05/09 04/04→05/09		→ 03/09; für Linkslenker; +PR 1AC / 1AT 10/04→ 03/09; für Linkslenker; +PR 1AC / 1AT			03.7863-3232.4 300307 03.7863-3232.4 300307	ATE Ø 10" pneumatisch ATE Ø 10" pneumatisch
 Hauptbremszylinder								
1.4 16V 1.4 TSI 1.6 1.8 TFSI 1.9 TDI 2.0 FSI 2.0 TDI 2.0 TFSI 2.0 TDI 2.0 TDI 16V	63 92 75 118 77 110 103 - 125 147 100 103	05/06→05/09 11/07→05/09 10/04→05/09 01/07→05/09 10/04→05/09 10/04→05/09 11/05→05/09 11/05→05/09 09/04→05/09 04/04→05/09		→ 03/09; für Linkslenker → 03/09; für Rechtslenker 10/04→ 03/09; für Linkslenker 10/04→ 03/09; für Rechtslenker			03.2122-2129.3 010799 24.2122-1981.3 011024 03.2122-2129.3 010799 24.2122-1981.3 011024	ATE Ø 22,2 ATE Ø 22,2 ohne Bremsflüssigkeitsbehälter ATE Ø 22,2 ATE Ø 22,2 ohne Bremsflüssigkeitsbehälter
Hydraulikaggregat, Bremsanlage								
1.4 16V 1.4 TSI 1.6 1.8 TFSI 1.9 TDI 2.0 FSI 2.0 TDI 2.0 TFSI 2.0 TDI 2.0 TDI 16V	63 92 75 118 77 110 103 - 125 147 100 103	05/06→05/09 11/07→05/09 10/04→05/09 01/07→05/09 10/04→05/09 10/04→05/09 11/05→05/09 11/05→05/09 09/04→05/09 04/04→05/09	➡	→ 03/09; +PR 1AT / 1AS 10/04→ 03/09; +PR 1AT / 1AS			24.9145-0001.2 399005 24.9145-0001.2 399005	
Drucksensor, Bremskraftverstärker								
1.4 16V 1.4 TSI 1.6 1.8 TFSI 1.9 TDI 2.0 FSI 2.0 TDI 2.0 TFSI 2.0 TDI 2.0 TDI 16V	63 92 75 118 77 110 103 - 125 147 100 103	05/06→05/09 11/07→05/09 10/04→05/09 01/07→05/09 10/04→05/09 10/04→05/09 11/05→05/09 11/05→05/09 09/04→05/09 04/04→05/09		→ 03/09; für Linkslenker; +PR 1AS 10/04→ 03/09; für Linkslenker; +PR 1AS			03.0655-0101.2 370008 03.0655-0101.2 370008	ATE ATE
SKODA - CITIGO (NF1) 10/11→08/19								
 Hauptbremszylinder								
1.0 1.0 CNG	44 - 55 50	10/11→08/19 11/12→08/19		05/12→			24.4120-1703.3 011015 24.4120-1703.3 011015	TRW Ø 20,6 ohne Bremsflüssigkeitsbehälter TRW Ø 20,6 ohne Bremsflüssigkeitsbehälter
SKODA - FABIA I (6Y2) 08/99→03/08								
 Hauptbremszylinder								
1.0 1.4 1.2 1.2 1.4 16V 1.4 TDI →	37 50 40 47 55 - 74 51 - 59	12/99→08/02 08/99→05/03 07/01→04/07 01/03→03/08 12/99→03/08 04/03→03/08		02/00→; + ABS 02/00→; - ABS 08/02→; + ABS 08/02→; - ABS → 12/07; + ABS → 12/07; - ABS			24.2120-1734.3 010702 24.2120-1736.3 010732 24.2120-1734.3 010702 24.2120-1736.3 010732 24.2120-1734.3 010702 24.2120-1736.3 010732	Ø 20,6 Ø 20,6 Ø 20,6 Ø 20,6 Ø 20,6 Ø 20,6











	kw					! #		
SKODA - FABIA I (6Y2) 08/99→03/08								
 Hauptbremszylinder								
1.9 SDI 2.0	47 85	12/99→03/08 12/99→03/08		→ 12/07; + ABS → 12/07; - ABS		24.2120-1734.3 010702 24.2120-1736.3 010732		Ø 20,6 Ø 20,6
1.4	44 - 59	08/00→10/06		+ ABS - ABS		24.2120-1734.3 010702 24.2120-1736.3 010732		Ø 20,6 Ø 20,6
1.9 TDI	74	01/00→03/08		02/00→ 12/07; + ABS 02/00→ 12/07; - ABS		24.2120-1734.3 010702 24.2120-1736.3 010732		Ø 20,6 Ø 20,6
1.9 TDI RS	96	06/03→03/08		09/03→ 12/07; + ABS 09/03→ 12/07; - ABS		24.2120-1734.3 010702 24.2120-1736.3 010732		Ø 20,6 Ø 20,6
 Bremskraftregler								
1.4	44 - 59	08/00→10/06		+PR 1AL; - ABS; Schrägheck		03.6583-0216.3 320247		ATE lastabhängig 8/3 4x
1.4	50	08/99→05/03		02/00→; +PR 1AL; - ABS; Schrägheck		03.6583-0216.3 320247		ATE lastabhängig 8/3 4x
1.4 16V 1.4 TDI 1.9 SDI 2.0	55 - 74 51 - 59 47 85	12/99→03/08 04/03→03/08 12/99→03/08 12/99→03/08		→ 12/07; +PR 1AL; - ABS; Schrägheck		03.6583-0216.3 320247		ATE lastabhängig 8/3 4x
1.9 TDI	74	01/00→03/08		02/00→ 12/07; +PR 1AL; - ABS; Schrägheck		03.6583-0216.3 320247		ATE lastabhängig 8/3 4x
1.9 TDI RS	96	06/03→03/08		09/03→ 12/07; +PR 1AL; - ABS; Schrägheck		03.6583-0216.3 320247		ATE lastabhängig 8/3 4x
SKODA - FABIA I Combi (6Y5) 04/00→12/07								
 Hauptbremszylinder								
1.2	40	07/01→12/07		08/02→; + ABS 08/02→; - ABS		24.2120-1734.3 010702 24.2120-1736.3 010732		Ø 20,6 Ø 20,6
1.2 1.4	47 44 - 50	01/03→12/07 04/00→05/03		+ ABS - ABS		24.2120-1734.3 010702 24.2120-1736.3 010732		Ø 20,6 Ø 20,6
1.4 16V 1.4 TDI 1.9 SDI 1.9 TDI 2.0	55 - 74 51 - 59 47 74 85	04/00→12/07 04/03→12/07 04/00→12/07 04/00→12/07 04/00→12/07						
 Bremskraftregler								
1.4 1.4 16V 1.4 TDI 1.9 SDI 1.9 TDI 2.0	44 - 50 55 - 74 51 - 59 47 74 85	04/00→05/03 04/00→12/07 04/03→12/07 04/00→12/07 04/00→12/07 04/00→12/07		+PR 1AL; - ABS; Schrägheck		03.6583-0216.3 320247		ATE lastabhängig 8/3 4x
SKODA - FABIA I Praktik (6Y5) 01/00→12/07								
 Hauptbremszylinder								
1.2	40	07/01→12/07		08/02→; + ABS 08/02→; - ABS		24.2120-1734.3 010702 24.2120-1736.3 010732		Ø 20,6 Ø 20,6
1.2 1.4	47 44 - 55	01/03→12/07 04/00→12/07		+ ABS - ABS		24.2120-1734.3 010702 24.2120-1736.3 010732		Ø 20,6 Ø 20,6
1.4 TDI 1.9 SDI 1.9 TDI	51 - 55 47 74	08/04→12/07 07/01→12/07 01/00→12/07						
1.9 TDI	74	01/00→12/07		02/00→; + ABS 02/00→; - ABS		24.2120-1734.3 010702 24.2120-1736.3 010732		Ø 20,6 Ø 20,6
 Bremskraftregler								
1.4 1.4 TDI 1.9 SDI 1.9 TDI	44 - 55 51 - 55 47 74	04/00→12/07 08/04→12/07 07/01→12/07 01/00→12/07		+PR 1AL; - ABS; Schrägheck		03.6583-0216.3 320247		ATE lastabhängig 8/3 4x
1.9 TDI	74	01/00→12/07		02/00→; +PR 1AL; - ABS; Schrägheck		03.6583-0216.3 320247		ATE lastabhängig 8/3 4x







	kw			 	! #		
SKODA - FABIA I Stufenheck (6Y3) 10/99→12/07							
 Hauptbremszylinder							
1.2	40	07/01→12/07		08/02→; + ABS		24.2120-1734.3 010702	Ø 20,6
				08/02→; - ABS		24.2120-1736.3 010732	Ø 20,6
1.2	47	01/03→12/07		+ ABS		24.2120-1734.3 010702	Ø 20,6
1.4	44 - 50	04/00→05/03		- ABS		24.2120-1736.3 010732	Ø 20,6
1.4 16V	55 - 74	10/99→12/07					
1.4 TDI	51 - 59	04/03→12/07					
2.0	85	12/99→12/07					
1.9 SDI	47	11/99→12/07		12/99→; + ABS		24.2120-1734.3 010702	Ø 20,6
				12/99→; - ABS		24.2120-1736.3 010732	Ø 20,6
1.9 TDI	74	01/00→12/07		02/00→; + ABS		24.2120-1734.3 010702	Ø 20,6
				02/00→; - ABS		24.2120-1736.3 010732	Ø 20,6
 Bremskraftregler							
1.4	44 - 50	04/00→05/03		+PR 1AL; - ABS; Schrägheck		03.6583-0216.3 320247	ATE lastabhängig 8/3 4x
1.4 16V	55 - 74	10/99→12/07					
1.4 TDI	51 - 59	04/03→12/07					
2.0	85	12/99→12/07					
1.9 SDI	47	11/99→12/07		12/99→; +PR 1AL; - ABS; Schrägheck		03.6583-0216.3 320247	ATE lastabhängig 8/3 4x
1.9 TDI	74	01/00→12/07		02/00→; +PR 1AL; - ABS; Schrägheck		03.6583-0216.3 320247	ATE lastabhängig 8/3 4x
SKODA - FABIA II (542) 12/06→12/14							
 Hauptbremszylinder							
1.2	44	12/06→12/14		03/07→ 06/14; +PR 1AC / 1AR / 1LB / 1LM; für Linkslenker; + ABS		24.2119-1712.3 010912	Ø 19 ohne Bremsflüssigkeitsbehälter
				03/07→ 06/14; +PR 1LN / 1LQ / 1LR; für Linkslenker; + ABS		24.2120-1734.3 010702	Ø 20,6
				03/07→ 06/14; +PR 1AL / 1LQ / 1LN / 1LR; für Linkslenker; - ABS		24.2120-1736.3 010732	Ø 20,6
1.2	51	01/07→12/14		03/07→ 06/14; +PR 1AC / 1AR / 1LB / 1LM; für Linkslenker; + ABS		24.2119-1712.3 010912	Ø 19 ohne Bremsflüssigkeitsbehälter
1.4	63	01/07→12/14					
1.4 LPG	63	01/07→11/14		03/07→ 06/14; +PR 1AC / 1AR / 1AT / 1LN / 1LQ / 1LR; für Linkslenker; + ABS		24.2120-1734.3 010702	Ø 20,6
				03/07→ 06/14; +PR 1AL / 1LQ / 1LN / 1LR; für Linkslenker; - ABS		24.2120-1736.3 010732	Ø 20,6
1.2 12V	44	11/11→12/14		→ 06/14; +PR 1AC / 1AR / 1LB / 1LM; für Linkslenker; + ABS		24.2119-1712.3 010912	Ø 19 ohne Bremsflüssigkeitsbehälter
				→ 06/14; +PR 1LN / 1LQ / 1LR; für Linkslenker; + ABS		24.2120-1734.3 010702	Ø 20,6
				→ 06/14; +PR 1AL / 1LQ / 1LN / 1LR; für Linkslenker; - ABS		24.2120-1736.3 010732	Ø 20,6
1.2 12V	55	10/10→12/14		+PR 1AC / 1AR / 1LB / 1LM; für Linkslenker; + ABS		24.2119-1712.3 010912	Ø 19 ohne Bremsflüssigkeitsbehälter
1.2 LPG	44	03/09→11/11		+PR 1AC / 1AR / 1AT / 1LN / 1LQ / 1LR; für Linkslenker; + ABS		24.2120-1734.3 010702	Ø 20,6
				+PR 1AL / 1LQ / 1LN / 1LR; für Linkslenker; - ABS		24.2120-1736.3 010732	Ø 20,6
1.2 LPG	51	07/07→11/14		→ 06/14; +PR 1AC / 1AR / 1LB / 1LM; für Linkslenker; + ABS		24.2119-1712.3 010912	Ø 19 ohne Bremsflüssigkeitsbehälter
1.2 TSI	63 - 77	03/10→12/14					
1.4 TSI RS	132	05/10→12/14		→ 06/14; +PR 1AC / 1AR / 1AT / 1LN / 1LQ / 1LR; für Linkslenker; + ABS		24.2120-1734.3 010702	Ø 20,6
1.6	77	04/07→12/14		→ 06/14; +PR 1AL / 1LQ / 1LN / 1LR; für Linkslenker; - ABS		24.2120-1736.3 010732	Ø 20,6
1.2 TDI	55	05/10→12/14		→ 06/14; +PR 1AC / 1AR / 1LB / 1LM; für Linkslenker; + ABS		24.2119-1712.3 010912	Ø 19 ohne Bremsflüssigkeitsbehälter
1.6 TDI	55 - 77	03/10→12/14		→ 06/14; +PR 1AC / 1AR / 1AT / 1LN / 1LQ / 1LR; für Linkslenker; + ABS		24.2120-1734.3 010702	Ø 20,6
				→ 06/14; +PR 1AL / 1LQ / 1LN / 1LR; für Linkslenker; - ABS		24.2120-1736.3 010732	Ø 20,6
				→ 06/14; +PR 1AC / 1AR / 1AT / 1LN / 1LQ / 1LR; für Rechtslenker; + ABS; für Fahrzeuge mit Rußpartikelfilter		24.2120-1768.3 011041	Ø 20,6 ohne Bremsflüssigkeitsbehälter
1.4 TDI	51 - 59	01/07→03/10		03/07→; +PR 1AC / 1AR / 1LB / 1LM; für Linkslenker; + ABS		24.2119-1712.3 010912	Ø 19 ohne Bremsflüssigkeitsbehälter
				03/07→; +PR 1AC / 1AR / 1AT / 1LN / 1LQ / 1LR; für Linkslenker; + ABS		24.2120-1734.3 010702	Ø 20,6
				03/07→; +PR 1AL / 1LQ / 1LN / 1LR; für Linkslenker; - ABS		24.2120-1736.3 010732	Ø 20,6













	kw			 	! #		
SKODA - FABIA II (542) 12/06→12/14							
 Hauptbremszylinder							
1.4 TDI	51 - 59	01/07→03/10		03/07→; +PR 1AC / 1AR / 1AT / 1LN / 1LQ / 1LR; für Rechtslenker; + ABS; für Fahrzeuge mit Rußpartikelfilter	24.2120-1768.3	011041	Ø 20,6 ohne Bremsflüssigkeitsbehälter
1.9 TDI	77	04/07→03/10		+PR 1AC / 1AR / 1LB / 1LM; für Linkslenker; + ABS	24.2119-1712.3	010912	Ø 19 ohne Bremsflüssigkeitsbehälter
				+PR 1AC / 1AR / 1AT / 1LN / 1LQ / 1LR; für Linkslenker; + ABS	24.2120-1734.3	010702	Ø 20,6
				+PR 1AL / 1LQ / 1LN / 1LR; für Linkslenker; - ABS	24.2120-1736.3	010732	Ø 20,6
				für Rechtslenker; +PR 1AC / 1AR / 1AT / 1LN / 1LQ / 1LR; + ABS; für Fahrzeuge mit Rußpartikelfilter	24.2120-1768.3	011041	Ø 20,6 ohne Bremsflüssigkeitsbehälter
 Bremskraftregler							
1.2	44 - 51	12/06→12/14		03/07→ 06/14; - ABS	03.6583-0216.3	320247	ATE lastabhängig 8/3 4x
1.4	63	01/07→12/14					
1.4 LPG	63	01/07→11/14					
1.2 12V	44	11/11→12/14		→ 06/14; - ABS	03.6583-0216.3	320247	ATE lastabhängig 8/3 4x
1.2 LPG	51	07/07→11/14					
1.2 TDI	55	05/10→12/14					
1.2 TSI	63 - 77	03/10→12/14					
1.6	77	04/07→12/14					
1.6 TDI	55 - 77	03/10→12/14					
1.2 12V	55	10/10→12/14		- ABS	03.6583-0216.3	320247	ATE lastabhängig 8/3 4x
1.2 LPG	44	03/09→11/11					
1.9 TDI	77	04/07→03/10					
1.4 TDI	51 - 59	01/07→03/10		03/07→; - ABS	03.6583-0216.3	320247	ATE lastabhängig 8/3 4x
SKODA - FABIA II Combi (545) 10/07→12/14							
 Hauptbremszylinder							
1.2	44	10/07→11/14		→ 06/14; +PR 1AC / 1AR / 1LB / 1LM; für Linkslenker; + ABS	24.2119-1712.3	010912	Ø 19 ohne Bremsflüssigkeitsbehälter
1.2 12V	44	11/11→12/14		→ 06/14; +PR 1LN / 1LQ / 1LR; für Linkslenker; + ABS	24.2120-1734.3	010702	Ø 20,6
				→ 06/14; +PR 1AL / 1LQ / 1LN / 1LR; für Linkslenker; - ABS	24.2120-1736.3	010732	Ø 20,6
1.2	51	10/07→12/14		→ 06/14; +PR 1AC / 1AR / 1LB / 1LM; für Linkslenker; + ABS	24.2119-1712.3	010912	Ø 19 ohne Bremsflüssigkeitsbehälter
1.2 LPG	51	10/07→11/14					
1.2 TSI	63 - 77	03/10→12/14		→ 06/14; +PR 1AC / 1AR / 1AT / 1LN / 1LQ / 1LR; für Linkslenker; + ABS	24.2120-1734.3	010702	Ø 20,6
1.4	63	10/07→12/14					
1.4 LPG	63	10/07→11/14		→ 06/14; +PR 1AL / 1LQ / 1LN / 1LR; für Linkslenker; - ABS	24.2120-1736.3	010732	Ø 20,6
1.4 TSI RS	132	05/10→12/14					
1.6	77	10/07→12/14					
1.2 LPG	44	03/09→11/11		+PR 1AC / 1AR / 1LB / 1LM; für Linkslenker; + ABS	24.2119-1712.3	010912	Ø 19 ohne Bremsflüssigkeitsbehälter
				+PR 1AC / 1AR / 1AT / 1LN / 1LQ / 1LR; für Linkslenker; + ABS	24.2120-1734.3	010702	Ø 20,6
				+PR 1AL / 1LQ / 1LN / 1LR; für Linkslenker; - ABS	24.2120-1736.3	010732	Ø 20,6
1.2 TDI	55	05/10→12/14		→ 06/14; +PR 1AC / 1AR / 1LB / 1LM; für Linkslenker; + ABS	24.2119-1712.3	010912	Ø 19 ohne Bremsflüssigkeitsbehälter
1.6 TDI	55 - 77	03/10→12/14		→ 06/14; +PR 1AC / 1AR / 1AT / 1LN / 1LQ / 1LR; für Linkslenker; + ABS	24.2120-1734.3	010702	Ø 20,6
				→ 06/14; +PR 1AL / 1LQ / 1LN / 1LR; für Linkslenker; - ABS	24.2120-1736.3	010732	Ø 20,6
				→ 06/14; +PR 1AC / 1AR / 1AT / 1LN / 1LQ / 1LR; für Rechtslenker; + ABS; für Fahrzeuge mit Rußpartikelfilter	24.2120-1768.3	011041	Ø 20,6 ohne Bremsflüssigkeitsbehälter
1.4 TDI	51 - 59	10/07→03/10		+PR 1AC / 1AR / 1LB / 1LM; für Linkslenker; + ABS	24.2119-1712.3	010912	Ø 19 ohne Bremsflüssigkeitsbehälter
1.9 TDI	77	10/07→03/10		+PR 1AC / 1AR / 1AT / 1LN / 1LQ / 1LR; für Linkslenker; + ABS	24.2120-1734.3	010702	Ø 20,6
				+PR 1AL / 1LQ / 1LN / 1LR; für Linkslenker; - ABS	24.2120-1736.3	010732	Ø 20,6
				+PR 1AC / 1AR / 1AT / 1LN / 1LQ / 1LR; für Rechtslenker; + ABS; für Fahrzeuge mit Rußpartikelfilter	24.2120-1768.3	011041	Ø 20,6 ohne Bremsflüssigkeitsbehälter
 Bremskraftregler							
1.2	44 - 51	10/07→12/14		→ 06/14; - ABS	03.6583-0216.3	320247	ATE lastabhängig 8/3 4x
→							











	kw			 	! #		
SKODA - FABIA II Combi (545) 10/07→12/14							
 Bremskraftregler							
1.2 12V	44	11/11→12/14		→ 06/14; - ABS		03.6583-0216.3 320247	ATE lastabhängig 8/3 4x
1.2 LPG	51	10/07→11/14					
1.2 TDI	55	05/10→12/14					
1.2 TSI	63 - 77	03/10→12/14					
1.4	63	10/07→12/14					
1.4 LPG	63	10/07→11/14					
1.6	77	10/07→12/14					
1.6 TDI	55 - 77	03/10→12/14					
1.2 LPG	44	03/09→11/11		- ABS		03.6583-0216.3 320247	ATE lastabhängig 8/3 4x
1.4 TDI	51 - 59	10/07→03/10					
1.9 TDI	77	10/07→03/10					
SKODA - FELICIA I (6U1) 10/94→03/98							
 Hauptbremszylinder							
1.3	40 - 50	10/94→03/98		→ 02/98; + ABS		03.2123-1428.3 010476	Ø 23,8
1.6	55	08/95→03/98		→ 02/98; - ABS		24.2122-1731.3 010656	Ø 22,2
1.9 D	47	10/95→03/98		10/96→ 02/98; + ABS		03.2123-1428.3 010476	Ø 23,8
				10/96→ 02/98; - ABS		24.2122-1731.3 010656	Ø 22,2
 Bremskraftregler							
1.3	40 - 50	10/94→03/98		→ 02/98		03.6584-0107.3 320110	ATE lastabhängig 8/4 4x
1.6	55	08/95→03/98					
1.9 D	47	10/95→03/98		10/96→ 02/98		03.6583-0167.3 320140	ATE lastabhängig 8/3 4x
SKODA - FELICIA I Kombi (6U5) 07/95→03/98							
 Hauptbremszylinder							
1.3	40 - 50	08/95→03/98		→ 02/98; + ABS		03.2123-1428.3 010476	Ø 23,8
1.6	55	08/95→03/98		→ 02/98; - ABS		24.2122-1731.3 010656	Ø 22,2
1.9 D	47	10/95→03/98		10/96→ 02/98; + ABS		03.2123-1428.3 010476	Ø 23,8
				10/96→ 02/98; - ABS		24.2122-1731.3 010656	Ø 22,2
 Bremskraftregler							
1.3	40 - 50	08/95→03/98		→ 02/98		03.6584-0107.3 320110	ATE lastabhängig 8/4 4x
1.6	55	08/95→03/98					
1.9 D	47	10/95→03/98		10/96→ 02/98		03.6583-0167.3 320140	ATE lastabhängig 8/3 4x
SKODA - FELICIA I Pick-up (6UF, 6U7) 10/95→04/02							
 Hauptbremszylinder							
1.3	40	06/97→04/02		→ 12/00; - ABS / + ABS		03.2123-1428.3 010476	Ø 23,8
				→ 12/00; - ABS		24.2122-1731.3 010656	Ø 22,2
1.3	43	10/95→04/02		06/97→ 12/00; - ABS / + ABS		03.2123-1428.3 010476	Ø 23,8
				06/97→ 12/00; - ABS		24.2122-1731.3 010656	Ø 22,2
1.3	50	06/97→04/02		→ 12/00; + ABS		03.2123-1428.3 010476	Ø 23,8
1.9 D	47	06/97→04/02		→ 12/00		24.2122-1731.3 010656	Ø 22,2
1.6	55	06/97→04/02		→ 12/99; + ABS		03.2123-1428.3 010476	Ø 23,8
				→ 12/99		24.2122-1731.3 010656	Ø 22,2
 Bremskraftregler							
1.3	40 - 50	06/97→04/02		→ 12/00		03.6584-0107.3 320110	ATE lastabhängig 8/4 4x
1.3	43	10/95→04/02		06/97→ 12/00		03.6584-0107.3 320110	ATE lastabhängig 8/4 4x
1.6	55	06/97→04/02		→ 12/99		03.6584-0107.3 320110	ATE lastabhängig 8/4 4x
1.9 D	47	06/97→04/02		→ 12/00		03.6583-0167.3 320140	ATE lastabhängig 8/3 4x
SKODA - FELICIA II (6U1) 01/98→06/01							
 Hauptbremszylinder							
1.3	40 - 50	01/98→06/01		03/98→		03.2123-1428.3 010476	Ø 23,8
1.6	55	01/98→06/01					
1.9 D	47	01/98→06/01					







	kw					! #		
SKODA - FELICIA II Kombi (6U5) 07/95→06/01								
 Hauptbremszylinder								
1.3 1.6 1.9 D	50 55 47	08/96→06/01 01/98→06/01 01/98→06/01		03/98→			03.2123-1428.3 010476	Ø 23,8
SKODA - FELICIA Cube Van (6U5) 11/95→12/01								
 Hauptbremszylinder								
1.3 1.6 1.9 D	43 - 50 55 47	11/95→11/00 06/98→12/01 03/97→12/01		03/98→			03.2123-1428.3 010476	Ø 23,8
SKODA - KAROQ (NU7, ND7) 07/17→								
 Hauptbremszylinder								
1.0 TSI 1.4 TSI 1.4 TSI 4x4 1.5 TSI 1.5 TSI 4x4 1.6 SRE 1.6 TDI 2.0 TDI 2.0 TDI 4x4 2.0 TSI 4x4	81 - 85 110 110 110 110 81 85 85 - 110 110 - 140 140	07/17→ 07/17→ 09/19→ 07/17→ 07/17→ 07/17→ 07/17→ 07/17→ 07/17→ 04/19→		für Linkslenker			24.4123-1719.3 011017 24.4153-1522.3 011048	TRW Ø 23,8 ohne Bremsflüssigkeitsbehälter ATE Ø 23,8 ohne Bremsflüssigkeitsbehälter
SKODA - KODIAQ (NS7, NV7, NS6) 10/16→								
 Hauptbremszylinder								
1.4 TSI 1.4 TSI 4x4 1.5 TSI 1.5 TSI 4x4 2.0 RS 4x4 2.0 RS Bi-TDI 4x4 2.0 TDI 2.0 TDI 4x4 2.0 TSI 4x4	92 - 110 110 110 180 176 110 110 - 147 132 - 140	10/16→ 10/16→ 07/18→ 07/18→ 06/21→ 11/18→ 10/16→ 10/16→ 10/16→ 10/16→ 10/16→		für Linkslenker; +PR 1ZA			24.4123-1719.3 011017	TRW Ø 23,8 ohne Bremsflüssigkeitsbehälter
SKODA - OCTAVIA I (1U2) 09/96→12/10								
 Bremskraftverstärker								
1.4 1.4 16V 1.6 1.6 1.9 TDI 1.6 1.9 SDI 1.9 TDI 2.0 1.8 1.8 T 1.8 T 4x4 RS 1.8 T 1.9 TDI 1.9 TDI	44 55 75 55 66 74 50 81 85 92 110 110 132 74 96	04/99→03/01 09/00→12/10 11/00→12/10 09/96→09/04 09/96→03/10 02/97→12/07 06/97→12/03 08/97→01/06 04/99→05/07 09/96→07/00 08/97→12/10 05/01→05/06 05/01→01/06 10/05→12/10 09/02→09/04		→ 07/00; für Linkslenker; + ESP 05/01→ 06/10; +PR 1AC / 1AH / 1AJ / 1AT; für Linkslenker 10/96→ 07/00; für Linkslenker; + ESP 05/01→; +PR 1AC / 1AH / 1AJ / 1AT; für Linkslenker → 07/00; für Linkslenker; + ESP 05/01→; +PR 1AC / 1AH / 1AJ / 1AT; für Linkslenker 10/96→; für Linkslenker; + ESP 03/98→ 07/00; für Linkslenker; + ESP 05/01→ 06/10; +PR 1AC / 1AH / 1AJ / 1AT; für Linkslenker +PR 1AC / 1AH / 1AJ / 1AT; für Linkslenker → 06/10; +PR 1AC / 1AH / 1AJ / 1AT; für Linkslenker 01/03→; +PR 1AC / 1AH / 1AJ / 1AT; für Linkslenker			03.7863-0402.4 300124 03.7863-3502.4 300128 03.7863-0402.4 300124 03.7863-3502.4 300128 03.7863-0402.4 300124 03.7863-3502.4 300128 03.7863-0402.4 300124 03.7863-3502.4 300128 03.7863-0402.4 300124 03.7863-3502.4 300128 03.7863-3502.4 300128 03.7863-3502.4 300128 03.7863-3502.4 300128 03.7863-3502.4 300128	ATE Ø 10" pneumatisch ATE Ø 10" pneumatisch ATE Ø 10" pneumatisch ATE Ø 10" pneumatisch ATE Ø 10" pneumatisch ATE Ø 10" pneumatisch ATE Ø 10" pneumatisch ATE Ø 10" pneumatisch ATE Ø 10" pneumatisch ATE Ø 10" pneumatisch ATE Ø 10" pneumatisch ATE Ø 10" pneumatisch ATE Ø 10" pneumatisch ATE Ø 10" pneumatisch ATE Ø 10" pneumatisch
 Hauptbremszylinder								
1.4 1.6 1.9 SDI 1.9 TDI 2.0	44 74 50 81 85	04/99→03/01 02/97→12/07 06/97→12/03 08/97→01/06 04/99→05/07		→ 07/00; für Linkslenker; + ESP → 07/00; für Rechtslenker; + ESP 08/00→; für Linkslenker; +PR 1AT 08/00→; für Rechtslenker; +PR 1AT 08/00→; für Linkslenker; +PR 1AC / 1AH / 1AJ 08/00→; für Linkslenker; +PR 1AM			03.2123-2024.3 010597 03.2123-2064.3 010598 03.2123-2715.3 010802 03.2123-2774.3 010803 03.2123-2973.3 010951 24.2123-1709.3 010503	ATE Ø 23,8 ATE Ø 23,8 ATE Ø 23,8 ATE Ø 23,8 ATE Ø 23,8 Ø 23,8

	kw					! #		
SKODA - OCTAVIA I (1U2) 09/96→12/10								
 Hauptbremszylinder								
1.4 1.6 1.9 SDI 1.9 TDI 2.0	44 74 50 81 85	04/99→03/01 02/97→12/07 06/97→12/03 08/97→01/06 04/99→05/07		→ 07/00; für Linkslenker; - ESP			24.2123-1709.3 010503	Ø 23,8
1.4 16V 1.6 1.9 TDI	55 75 74	09/00→12/10 11/00→12/10 10/05→12/10		→ 06/10; für Linkslenker; +PR 1AT		03.2123-2715.3 010802	ATE Ø 23,8	
				→ 06/10; für Rechtslenker; +PR 1AT		03.2123-2774.3 010803	ATE Ø 23,8	
				→ 06/10; für Linkslenker; +PR 1AC / 1AH / 1AJ		03.2123-2973.3 010951	ATE Ø 23,8	
				→ 06/10; für Linkslenker; +PR 1AM		24.2123-1709.3 010503	Ø 23,8	
1.6 1.9 TDI	55 66	09/96→09/04 09/96→03/10		10/96→ 07/00; für Linkslenker; + ESP		03.2123-2024.3 010597	ATE Ø 23,8	
				10/96→ 07/00; für Rechtslenker; + ESP		03.2123-2064.3 010598	ATE Ø 23,8	
				08/00→; für Linkslenker; +PR 1AT		03.2123-2715.3 010802	ATE Ø 23,8	
				08/00→; für Rechtslenker; +PR 1AT		03.2123-2774.3 010803	ATE Ø 23,8	
				08/00→; für Linkslenker; +PR 1AC / 1AH / 1AJ		03.2123-2973.3 010951	ATE Ø 23,8	
				08/00→; für Linkslenker; +PR 1AM		24.2123-1709.3 010503	Ø 23,8	
				10/96→ 07/00; für Linkslenker; - ESP		24.2123-1709.3 010503	Ø 23,8	
1.8	92	09/96→07/00		10/96→; für Linkslenker; + ESP		03.2123-2024.3 010597	ATE Ø 23,8	
				10/96→; für Rechtslenker; + ESP		03.2123-2064.3 010598	ATE Ø 23,8	
				10/96→; für Linkslenker; - ESP		24.2123-1709.3 010503	Ø 23,8	
1.8 T	110	08/97→12/10		03/98→ 07/00; für Linkslenker; + ESP		03.2123-2024.3 010597	ATE Ø 23,8	
				03/98→ 07/00; für Rechtslenker; + ESP		03.2123-2064.3 010598	ATE Ø 23,8	
				08/00→ 06/10; für Linkslenker; +PR 1AT		03.2123-2715.3 010802	ATE Ø 23,8	
				08/00→ 06/10; für Rechtslenker; +PR 1AT		03.2123-2774.3 010803	ATE Ø 23,8	
				08/00→ 06/10; für Linkslenker; +PR 1AC / 1AH / 1AJ		03.2123-2973.3 010951	ATE Ø 23,8	
				08/00→ 06/10; für Linkslenker; +PR 1AM		24.2123-1709.3 010503	Ø 23,8	
				03/98→ 07/00; für Linkslenker; - ESP		24.2123-1709.3 010503	Ø 23,8	
1.8 T 4x4 RS 1.8 T	110 132	05/01→05/06 05/01→01/06		für Linkslenker; +PR 1AT		03.2123-2715.3 010802	ATE Ø 23,8	
				für Rechtslenker; +PR 1AT		03.2123-2774.3 010803	ATE Ø 23,8	
				für Linkslenker; +PR 1AC / 1AH / 1AJ		03.2123-2973.3 010951	ATE Ø 23,8	
				für Linkslenker; +PR 1AM		24.2123-1709.3 010503	Ø 23,8	
1.9 TDI	96	09/02→09/04		01/03→; für Linkslenker; +PR 1AT		03.2123-2715.3 010802	ATE Ø 23,8	
				01/03→; für Rechtslenker; +PR 1AT		03.2123-2774.3 010803	ATE Ø 23,8	
				01/03→; für Linkslenker; +PR 1AC / 1AH / 1AJ		03.2123-2973.3 010951	ATE Ø 23,8	
				01/03→; für Linkslenker; +PR 1AM		24.2123-1709.3 010503	Ø 23,8	
 Bremskraftregler								
1.4 1.6 1.9 SDI	44 74 50	04/99→03/01 02/97→12/07 06/97→12/03		Scheibenbremse		03.6583-0179.3 320228	ATE lastabhängig 8/3 4x	
				Trommelbremse		03.6584-0107.3 320110	ATE lastabhängig 8/4 4x	
1.4 16V 1.6	55 75	09/00→12/10 11/00→12/10		→ 06/10; Scheibenbremse		03.6583-0179.3 320228	ATE lastabhängig 8/3 4x	
				→ 06/10; Trommelbremse		03.6584-0107.3 320110	ATE lastabhängig 8/4 4x	
1.6 1.9 TDI	55 66	09/96→09/04 09/96→03/10		10/96→; Scheibenbremse		03.6583-0179.3 320228	ATE lastabhängig 8/3 4x	
				10/96→; Trommelbremse		03.6584-0107.3 320110	ATE lastabhängig 8/4 4x	
1.8	92	09/96→07/00		10/96→; Scheibenbremse		03.6583-0179.3 320228	ATE lastabhängig 8/3 4x	
1.8 T	110	08/97→12/10		03/98→ 06/10; Scheibenbremse		03.6583-0179.3 320228	ATE lastabhängig 8/3 4x	
1.8 T 4x4 1.9 TDI 2.0 RS 1.8 T	110 81 85 132	05/01→05/06 08/97→01/06 04/99→05/07 05/01→01/06		Scheibenbremse		03.6583-0179.3 320228	ATE lastabhängig 8/3 4x	
1.9 TDI	74	10/05→12/10		→ 06/10; Scheibenbremse		03.6583-0179.3 320228	ATE lastabhängig 8/3 4x	
1.9 TDI	96	09/02→09/04		01/03→; Scheibenbremse		03.6583-0179.3 320228	ATE lastabhängig 8/3 4x	
SKODA - OCTAVIA I Combi (1U5) 07/98→12/10								
 Bremskraftverstärker								
1.4 16V 1.6 1.9 TDI	55 75 74	08/00→12/10 09/00→12/10 08/00→12/10		05/01→ 06/10; +PR 1AC / 1AH / 1AJ / 1AT; für Linkslenker		03.7863-3502.4 300128	ATE Ø 10" pneumatisch	
1.6	55 - 74	07/98→12/07		→ 07/00; für Linkslenker; + ESP		03.7863-0402.4 300124	ATE Ø 10" pneumatisch	
1.9 SDI 1.9 TDI	50 66 - 81	07/98→12/03 07/98→03/10		05/01→; +PR 1AC / 1AH / 1AJ / 1AT; für Linkslenker		03.7863-3502.4 300128	ATE Ø 10" pneumatisch	
1.9 TDI 4x4 →	66	11/99→02/06						

	kw			 	! #		
SKODA - OCTAVIA I Combi (1U5) 07/98→12/10							
Bremskraftverstärker							
2.0	85	04/99→05/07		→ 07/00; für Linkslenker; + ESP	03.7863-0402.4	300124	ATE Ø 10" pneumatisch
				05/01→; +PR 1AC / 1AH / 1AJ / 1AT; für Linkslenker	03.7863-3502.4	300128	ATE Ø 10" pneumatisch
1.8 20V	92	07/98→07/00		für Linkslenker; + ESP	03.7863-0402.4	300124	ATE Ø 10" pneumatisch
1.8 T	110	07/98→12/10		→ 07/00; für Linkslenker; + ESP	03.7863-0402.4	300124	ATE Ø 10" pneumatisch
2.0 4x4	88	01/00→12/10		05/01→ 06/10; +PR 1AC / 1AH / 1AJ / 1AT; für Linkslenker	03.7863-3502.4	300128	ATE Ø 10" pneumatisch
1.8 T 4x4	110	05/01→05/06		+PR 1AC / 1AH / 1AJ / 1AT; für Linkslenker	03.7863-3502.4	300128	ATE Ø 10" pneumatisch
RS 1.8 T	132	08/02→01/06					
1.9 TDI	96	09/02→09/04		01/03→; +PR 1AC / 1AH / 1AJ / 1AT; für Linkslenker	03.7863-3502.4	300128	ATE Ø 10" pneumatisch
1.9 TDI 4x4	74	09/00→01/06		05/01→; +PR 1AC / 1AH / 1AJ / 1AT; für Linkslenker	03.7863-3502.4	300128	ATE Ø 10" pneumatisch
2.0 4x4	85	08/00→09/04					
Hauptbremszylinder							
1.4 16V	55	08/00→12/10		→ 06/10; für Linkslenker; +PR 1AT	03.2123-2715.3	010802	ATE Ø 23,8
1.6	75	09/00→12/10		→ 06/10; für Rechtslenker; +PR 1AT	03.2123-2774.3	010803	ATE Ø 23,8
1.9 TDI	74	08/00→12/10		→ 06/10; für Linkslenker; +PR 1AC / 1AH / 1AJ	03.2123-2973.3	010951	ATE Ø 23,8
				→ 06/10; für Linkslenker; +PR 1AM	24.2123-1709.3	010503	Ø 23,8
1.6	55 - 74	07/98→12/07		→ 07/00; für Linkslenker; + ESP	03.2123-2024.3	010597	ATE Ø 23,8
1.9 SDI	50	07/98→12/03		→ 07/00; für Rechtslenker; + ESP	03.2123-2064.3	010598	ATE Ø 23,8
1.9 TDI	66 - 81	07/98→03/10		08/00→; für Linkslenker; +PR 1AT	03.2123-2715.3	010802	ATE Ø 23,8
1.9 TDI 4x4	66	11/99→02/06		08/00→; für Rechtslenker; +PR 1AT	03.2123-2774.3	010803	ATE Ø 23,8
2.0	85	04/99→05/07		08/00→; für Linkslenker; +PR 1AC / 1AH / 1AJ	03.2123-2973.3	010951	ATE Ø 23,8
				08/00→; für Linkslenker; +PR 1AM	24.2123-1709.3	010503	Ø 23,8
				→ 07/00; für Linkslenker; - ESP	24.2123-1709.3	010503	Ø 23,8
1.8 20V	92	07/98→07/00		für Linkslenker; + ESP	03.2123-2024.3	010597	ATE Ø 23,8
				für Rechtslenker; + ESP	03.2123-2064.3	010598	ATE Ø 23,8
				für Linkslenker; - ESP	24.2123-1709.3	010503	Ø 23,8
1.8 T	110	07/98→12/10		→ 07/00; für Linkslenker; + ESP	03.2123-2024.3	010597	ATE Ø 23,8
2.0 4x4	88	01/00→12/10		→ 07/00; für Rechtslenker; + ESP	03.2123-2064.3	010598	ATE Ø 23,8
				08/00→ 06/10; für Linkslenker; +PR 1AT	03.2123-2715.3	010802	ATE Ø 23,8
				08/00→ 06/10; für Rechtslenker; +PR 1AT	03.2123-2774.3	010803	ATE Ø 23,8
				08/00→ 06/10; für Linkslenker; +PR 1AC / 1AH / 1AJ	03.2123-2973.3	010951	ATE Ø 23,8
				08/00→ 06/10; für Linkslenker; +PR 1AM	24.2123-1709.3	010503	Ø 23,8
				→ 07/00; für Linkslenker; - ESP	24.2123-1709.3	010503	Ø 23,8
1.8 T 4x4	110	05/01→05/06		für Linkslenker; +PR 1AT	03.2123-2715.3	010802	ATE Ø 23,8
1.9 TDI 4x4	74	09/00→01/06		für Rechtslenker; +PR 1AT	03.2123-2774.3	010803	ATE Ø 23,8
RS 1.8 T	132	08/02→01/06		für Linkslenker; +PR 1AC / 1AH / 1AJ	03.2123-2973.3	010951	ATE Ø 23,8
				für Linkslenker; +PR 1AM	24.2123-1709.3	010503	Ø 23,8
1.9 TDI	96	09/02→09/04		01/03→; für Linkslenker; +PR 1AT	03.2123-2715.3	010802	ATE Ø 23,8
				01/03→; für Rechtslenker; +PR 1AT	03.2123-2774.3	010803	ATE Ø 23,8
				01/03→; für Linkslenker; +PR 1AC / 1AH / 1AJ	03.2123-2973.3	010951	ATE Ø 23,8
				01/03→; für Linkslenker; +PR 1AM	24.2123-1709.3	010503	Ø 23,8
2.0 4x4	85	08/00→09/04		05/01→; für Linkslenker; +PR 1AT	03.2123-2715.3	010802	ATE Ø 23,8
				05/01→; für Rechtslenker; +PR 1AT	03.2123-2774.3	010803	ATE Ø 23,8
				05/01→; für Linkslenker; +PR 1AC / 1AH / 1AJ	03.2123-2973.3	010951	ATE Ø 23,8
				05/01→; für Linkslenker; +PR 1AM	24.2123-1709.3	010503	Ø 23,8
Bremskraftregler							
1.4 16V	55	08/00→12/10		→ 06/10; Scheibenbremse	03.6583-0179.3	320228	ATE lastabhängig 8/3 4x
1.6	75	09/00→12/10		→ 06/10; Trommelbremse	03.6584-0107.3	320110	ATE lastabhängig 8/4 4x
1.6	55 - 74	07/98→12/07		Scheibenbremse	03.6583-0179.3	320228	ATE lastabhängig 8/3 4x
1.9 SDI	50	07/98→12/03		Trommelbremse	03.6584-0107.3	320110	ATE lastabhängig 8/4 4x
1.9 TDI	66	07/98→03/10					
1.8 20V	92	07/98→07/00		Scheibenbremse	03.6583-0179.3	320228	ATE lastabhängig 8/3 4x
1.8 T 4x4	110	05/01→05/06					
1.9 TDI	81	07/98→01/06					
1.9 TDI 4x4	66 - 74	11/99→02/06					

	kw					! #		
SKODA - OCTAVIA I Combi (1U5) 07/98→12/10								
 Bremskraftregler								
2.0 RS 1.8 T	85 132	04/99→05/07 08/02→01/06		Scheibenbremse			03.6583-0179.3 320228	ATE lastabhängig 8/3 4x
1.8 T 1.9 TDI 2.0 4x4	110 74 88	07/98→12/10 08/00→12/10 01/00→12/10		→ 06/10; Scheibenbremse			03.6583-0179.3 320228	ATE lastabhängig 8/3 4x
1.9 TDI 2.0 4x4	96 85	09/02→09/04 08/00→09/04		01/03→; Scheibenbremse 05/01→; Scheibenbremse			03.6583-0179.3 320228	ATE lastabhängig 8/3 4x
SKODA - OCTAVIA I Kasten/Kombi (1U5) 08/00→03/10								
 Bremskraftverstärker								
1.9 D 1.9 TDI	50 66	08/00→12/03 08/00→03/10		für Linkslenker; + ESP 05/01→; +PR 1AC / 1AH / 1AJ / 1AT; für Linkslenker			03.7863-0402.4 300124 03.7863-3502.4 300128	ATE Ø 10" pneumatisch ATE Ø 10" pneumatisch
 Hauptbremszylinder								
1.9 D 1.9 TDI	50 66	08/00→12/03 08/00→03/10		für Linkslenker; + ESP für Rechtslenker; + ESP für Linkslenker; +PR 1AT für Rechtslenker; +PR 1AT für Linkslenker; +PR 1AC / 1AH / 1AJ für Linkslenker; - ESP für Linkslenker; +PR 1AM			03.2123-2024.3 010597 03.2123-2064.3 010598 03.2123-2715.3 010802 03.2123-2774.3 010803 03.2123-2973.3 010951 24.2123-1709.3 010503 24.2123-1709.3 010503	ATE Ø 23,8 ATE Ø 23,8 ATE Ø 23,8 ATE Ø 23,8 ATE Ø 23,8 Ø 23,8 Ø 23,8
 Bremskraftregler								
1.9 D 1.9 TDI	50 66	08/00→12/03 08/00→03/10		Scheibenbremse Trommelbremse			03.6583-0179.3 320228 03.6584-0107.3 320110	ATE lastabhängig 8/3 4x ATE lastabhängig 8/4 4x
SKODA - OCTAVIA II (1Z3) 02/04→06/13								
 Bremskraftverstärker								
1.2 TSI 1.4 1.4 TSI 1.6 1.6 TDI 1.8 TSI 2.0 TDI 2.0 TFSI	77 59 90 75 77 112 - 118 81 147	02/10→06/13 06/04→04/13 11/08→06/13 06/04→06/13 06/09→04/13 06/07→06/13 03/10→06/13 10/05→02/13		→ 01/13; für Linkslenker; +PR 1AC / 1AT			03.7863-3232.4 300307	ATE Ø 10" pneumatisch
1.4 1.6 FSI 2.0 TDI	55 85 100	05/04→05/06 02/04→10/08 02/04→05/10		06/04→; für Linkslenker; +PR 1AC / 1AT			03.7863-3232.4 300307	ATE Ø 10" pneumatisch
1.6 LPG 1.6 MultiFuel	75 75	08/09→11/12 01/08→06/13		09/09→; für Linkslenker; +PR 1AC / 1AT 09/09→ 01/13; für Linkslenker; +PR 1AC / 1AT			03.7863-3232.4 300307 03.7863-3232.4 300307	ATE Ø 10" pneumatisch ATE Ø 10" pneumatisch
1.9 TDI 2.0 FSI 2.0 TDI 2.0 TDI RS	77 110 103 125	06/04→12/10 11/04→10/08 11/05→05/10 04/06→02/13		für Linkslenker; +PR 1AC / 1AT			03.7863-3232.4 300307	ATE Ø 10" pneumatisch
2.0 TDI 16V	103	02/04→04/13		06/04→ 01/13; für Linkslenker; +PR 1AC / 1AT			03.7863-3232.4 300307	ATE Ø 10" pneumatisch
 Hauptbremszylinder								
1.2 TSI 1.4 1.4 TSI 1.6 1.6 TDI 1.8 TSI 2.0 TDI 2.0 TFSI	77 59 90 75 77 112 - 118 81 147	02/10→06/13 06/04→04/13 11/08→06/13 06/04→06/13 06/09→04/13 06/07→06/13 03/10→06/13 10/05→02/13		→ 01/13; für Linkslenker → 01/13; für Rechtslenker			03.2122-2129.3 010799 24.2122-1981.3 011024	ATE Ø 22,2 ATE Ø 22,2 ohne Bremsflüssigkeitsbehälter
1.4 1.6 FSI 2.0 TDI	55 85 100	05/04→05/06 02/04→10/08 02/04→05/10		06/04→; für Linkslenker 06/04→; für Rechtslenker			03.2122-2129.3 010799 24.2122-1981.3 011024	ATE Ø 22,2 ATE Ø 22,2 ohne Bremsflüssigkeitsbehälter
1.6 LPG 1.6 MultiFuel	75 75	08/09→11/12 01/08→06/13		09/09→; für Linkslenker 09/09→ 01/13; für Linkslenker 09/09→; für Rechtslenker 09/09→ 01/13; für Rechtslenker			03.2122-2129.3 010799 24.2122-1981.3 011024 03.2122-2129.3 010799 24.2122-1981.3 011024	ATE Ø 22,2 ATE Ø 22,2 ohne Bremsflüssigkeitsbehälter ATE Ø 22,2 ATE Ø 22,2 ohne Bremsflüssigkeitsbehälter
1.9 TDI →	77	06/04→12/10		für Linkslenker			03.2122-2129.3 010799	ATE Ø 22,2

	kw					! #		
SKODA - OCTAVIA II (1Z3) 02/04→06/13								
 Hauptbremszylinder								
2.0 FSI	110	11/04→10/08			für Rechtslenker		24.2122-1981.3 011024	ATE Ø 22,2 ohne Bremsflüssigkeitsbehälter
2.0 TDI	103	11/05→05/10						
2.0 TDI RS	125	04/06→02/13						
2.0 TDI 16V	103	02/04→04/13			06/04→ 01/13; für Linkslenker		03.2122-2129.3 010799	ATE Ø 22,2
					06/04→ 01/13; für Rechtslenker		24.2122-1981.3 011024	ATE Ø 22,2 ohne Bremsflüssigkeitsbehälter
Hydraulikaggregat, Bremsanlage								
1.4	55	05/04→05/06			06/04→; +PR 1AT		24.9145-0001.2 399005	
1.6 FSI	85	02/04→10/08						
1.4	59	06/04→04/13			→ 12/08; +PR 1AT		24.9145-0001.2 399005	
1.4 TSI	90	11/08→06/13						
1.6	75	06/04→06/13						
1.8 TSI	118	06/07→04/13						
1.9 TDI	77	06/04→12/10						
2.0 TDI	103	11/05→05/10						
2.0 TDI RS	125	04/06→02/13						
2.0 TFSI	147	10/05→02/13						
2.0 FSI	110	11/04→10/08			+PR 1AT		24.9145-0001.2 399005	
2.0 TDI	100	02/04→05/10			06/04→ 12/08; +PR 1AT		24.9145-0001.2 399005	
2.0 TDI 16V	103	02/04→04/13						
Drucksensor, Bremskraftverstärker								
1.2 TSI	77	02/10→06/13			→ 01/13; für Linkslenker; +PR 1AS		03.0655-0101.2 370008	ATE
1.4	59	06/04→04/13						
1.4 TSI	90	11/08→06/13						
1.6	75	06/04→06/13						
1.6 TDI	77	06/09→04/13						
1.8 TSI	112 - 118	06/07→06/13						
2.0 TDI	81	03/10→06/13						
2.0 TFSI	147	10/05→02/13						
1.4	55	05/04→05/06			06/04→; für Linkslenker; +PR 1AS		03.0655-0101.2 370008	ATE
1.6 FSI	85	02/04→10/08						
2.0 TDI	100	02/04→05/10						
1.6 LPG	75	08/09→11/12			09/09→; für Linkslenker; +PR 1AS		03.0655-0101.2 370008	ATE
1.6 MultiFuel	75	01/08→06/13			09/09→ 01/13; für Linkslenker; +PR 1AS		03.0655-0101.2 370008	ATE
1.9 TDI	77	06/04→12/10			für Linkslenker; +PR 1AS		03.0655-0101.2 370008	ATE
2.0 FSI	110	11/04→10/08						
2.0 TDI	103	11/05→05/10						
2.0 TDI RS	125	04/06→02/13						
2.0 TDI 16V	103	02/04→04/13			06/04→ 01/13; für Linkslenker; +PR 1AS		03.0655-0101.2 370008	ATE
SKODA - OCTAVIA II Combi (1Z5) 02/04→06/13								
 Bremskraftverstärker								
1.2 TSI	77	02/10→04/13			→ 01/13; für Linkslenker; +PR 1AC / 1AT		03.7863-3232.4 300307	ATE Ø 10" pneumatisch
1.4	59	05/06→06/13						
1.4 TSI	90	11/08→06/13						
1.6	75	09/04→06/13						
1.6 TDI	77	06/09→04/13						
1.6 TDI 4x4	77	06/09→02/13						
1.8 TSI	112 - 118	06/07→06/13						
1.8 TSI 4x4	112 - 118	11/08→02/13						
2.0 TDI	81	03/10→06/13						
2.0 TDI 16V 4x4	103	05/10→02/13						
2.0 TDI 4x4	81	05/11→02/13						
2.0 TFSI	147	10/05→02/13						
1.4	55	05/04→05/06			06/04→; für Linkslenker; +PR 1AC / 1AT		03.7863-3232.4 300307	ATE Ø 10" pneumatisch
1.6 FSI	85	02/04→10/08						
2.0 TDI 16V	100	02/04→05/10						
1.6 LPG	75	08/09→11/12			09/09→; für Linkslenker; +PR 1AC / 1AT		03.7863-3232.4 300307	ATE Ø 10" pneumatisch
1.6 MultiFuel	75	01/08→06/13			09/09→ 01/13; für Linkslenker; +PR 1AC / 1AT		03.7863-3232.4 300307	ATE Ø 10" pneumatisch
1.9 TDI	77	09/04→12/10			für Linkslenker; +PR 1AC / 1AT		03.7863-3232.4 300307	ATE Ø 10" pneumatisch
1.9 TDI 4x4	77	11/04→12/10						
2.0 FSI	110	11/04→10/08						
2.0 FSI 4x4	110	11/04→04/09						
2.0 TDI	103	11/05→05/10						
2.0 TDI 4x4	103	07/06→05/10						
2.0 TDI RS	125	04/06→02/13						
2.0 TDI 16V	103	02/04→05/13			06/04→ 01/13; für Linkslenker; +PR 1AC / 1AT		03.7863-3232.4 300307	ATE Ø 10" pneumatisch
 Hauptbremszylinder								
1.2 TSI	77	02/10→04/13			→ 01/13; für Linkslenker		03.2122-2129.3 010799	ATE Ø 22,2
→								

	kw			 	! #		
SKODA - OCTAVIA II Combi (1Z5) 02/04→06/13							
Hauptbremszylinder							
1.4 1.4 TSI 1.6 1.6 TDI 1.6 TDI 4x4 1.8 TSI 1.8 TSI 4x4 2.0 TDI 2.0 TDI 16V 4x4 2.0 TDI 4x4 2.0 TFSI	59 90 75 77 77 112 - 118 112 - 118 81 103 81 147	05/06→06/13 11/08→06/13 09/04→06/13 06/09→04/13 06/09→02/13 06/07→06/13 11/08→02/13 03/10→06/13 05/10→02/13 05/11→02/13 10/05→02/13		→ 01/13; für Rechtslenker		24.2122-1981.3 011024	ATE Ø 22,2 ohne Bremsflüssigkeitsbehälter
1.4 1.6 FSI 2.0 TDI 16V	55 85 100	05/04→05/06 02/04→10/08 02/04→05/10		06/04→; für Linkslenker 06/04→; für Rechtslenker		03.2122-2129.3 010799 24.2122-1981.3 011024	ATE Ø 22,2 ATE Ø 22,2 ohne Bremsflüssigkeitsbehälter
1.6 LPG	75	08/09→11/12		09/09→; für Linkslenker 09/09→; für Rechtslenker		03.2122-2129.3 010799 24.2122-1981.3 011024	ATE Ø 22,2 ATE Ø 22,2 ohne Bremsflüssigkeitsbehälter
1.6 MultiFuel	75	01/08→06/13		09/09→ 01/13; für Linkslenker 09/09→ 01/13; für Rechtslenker		03.2122-2129.3 010799 24.2122-1981.3 011024	ATE Ø 22,2 ATE Ø 22,2 ohne Bremsflüssigkeitsbehälter
1.9 TDI 1.9 TDI 4x4 2.0 FSI 2.0 FSI 4x4 2.0 TDI 2.0 TDI 4x4 2.0 TDI RS	77 77 110 110 103 103 125	09/04→12/10 11/04→12/10 11/04→10/08 11/04→04/09 11/05→05/10 07/06→05/10 04/06→02/13		für Linkslenker für Rechtslenker		03.2122-2129.3 010799 24.2122-1981.3 011024	ATE Ø 22,2 ATE Ø 22,2 ohne Bremsflüssigkeitsbehälter
2.0 TDI 16V	103	02/04→05/13		06/04→ 01/13; für Linkslenker 06/04→ 01/13; für Rechtslenker		03.2122-2129.3 010799 24.2122-1981.3 011024	ATE Ø 22,2 ATE Ø 22,2 ohne Bremsflüssigkeitsbehälter
Hydraulikaggregat, Bremsanlage							
1.4 1.6 FSI	55 85	05/04→05/06 02/04→10/08		06/04→; +PR 1AT		24.9145-0001.2 399005	
1.4 1.4 TSI 1.6 1.8 TSI 1.8 TSI 4x4 1.9 TDI 1.9 TDI 4x4 2.0 TDI 2.0 TDI 4x4 2.0 TDI RS 2.0 TFSI	59 90 75 118 118 77 77 103 103 125 147	05/06→06/13 11/08→06/13 09/04→06/13 06/07→04/13 11/08→02/13 09/04→12/10 11/04→12/10 11/05→05/10 07/06→05/10 04/06→02/13 10/05→02/13		→ 12/08; +PR 1AT		24.9145-0001.2 399005	
2.0 FSI 2.0 FSI 4x4	110 110	11/04→10/08 11/04→04/09		+PR 1AT		24.9145-0001.2 399005	
2.0 TDI 16V	100 - 103	02/04→05/13		06/04→ 12/08; +PR 1AT		24.9145-0001.2 399005	
Drucksensor, Bremskraftverstärker							
1.2 TSI 1.4 1.4 TSI 1.6 1.6 TDI 1.6 TDI 4x4 1.8 TSI 1.8 TSI 4x4 2.0 TDI 2.0 TDI 16V 4x4 2.0 TDI 4x4 2.0 TFSI	77 59 90 75 77 77 112 - 118 112 - 118 81 103 81 147	02/10→04/13 05/06→06/13 11/08→06/13 09/04→06/13 06/09→04/13 06/09→02/13 06/07→06/13 11/08→02/13 03/10→06/13 05/10→02/13 05/11→02/13 10/05→02/13		→ 01/13; für Linkslenker; +PR 1AS		03.0655-0101.2 370008	ATE
1.4 1.6 FSI 2.0 TDI 16V	55 85 100	05/04→05/06 02/04→10/08 02/04→05/10		06/04→; für Linkslenker; +PR 1AS		03.0655-0101.2 370008	ATE
1.6 LPG	75	08/09→11/12		09/09→; für Linkslenker; +PR 1AS		03.0655-0101.2 370008	ATE
1.6 MultiFuel	75	01/08→06/13		09/09→ 01/13; für Linkslenker; +PR 1AS		03.0655-0101.2 370008	ATE
1.9 TDI 1.9 TDI 4x4 2.0 FSI 2.0 FSI 4x4 2.0 TDI 2.0 TDI 4x4 →	77 77 110 110 103 103	09/04→12/10 11/04→12/10 11/04→10/08 11/04→04/09 11/05→05/10 07/06→05/10		für Linkslenker; +PR 1AS		03.0655-0101.2 370008	ATE

SKODA - OCTAVIA II Combi (1Z5) 02/04→06/13

Drucksensor, Bremskraftverstärker

2.0 TDI RS	125	04/06→02/13	für Linkslenker; +PR 1AS	03.0655-0101.2	370008	ATE
2.0 TDI 16V	103	02/04→05/13	06/04→ 01/13; für Linkslenker; +PR 1AS	03.0655-0101.2	370008	ATE

SKODA - OCTAVIA III (5E3, NL3, NR3) 11/12→03/21













Hauptbremszylinder













1.0 TSI	85	05/16→10/20	für Linkslenker; +PR 1ZA / 1ZB / 1ZE / 1ZF	03.4153-5403.3	010994	ATE Ø 23,8
1.2 TSI	81	05/15→02/17		24.4123-1719.3	011017	TRW Ø 23,8 ohne Bremsflüssigkeitsbehälter
1.5 TSI	110	02/17→10/20				
1.6	81	01/14→10/20				
1.6 TDI	85	02/17→10/20		24.4153-1522.3	011048	ATE Ø 23,8 ohne Bremsflüssigkeitsbehälter
1.6 TDI 4x4	77 -	05/13→10/20				
	85					
1.8 TSI 4x4	132	05/14→10/20				
2.0 TDI 4x4	110	05/13→10/20				
2.0 TSI	140	02/17→10/20				
2.0 TSI 4x4	140	02/19→10/20				
2.0 TSI RS	169 -	05/15→10/20				
	180					
1.2 TSI	63 -	11/12→02/17	02/13→; für Linkslenker; +PR 1ZA / 1ZB / 1ZE / 1ZF	03.4153-5403.3	010994	ATE Ø 23,8
	77			24.4123-1719.3	011017	TRW Ø 23,8 ohne Bremsflüssigkeitsbehälter
1.6 TDI	66 -	11/12→10/20				
2.0 TDI	77		01/14→; für Linkslenker; +PR 1ZA / 1ZB / 1ZE / 1ZF	24.4153-1522.3	011048	ATE Ø 23,8 ohne Bremsflüssigkeitsbehälter
2.0 TDI	110	11/12→10/20				
1.4 TSI	103	11/12→02/17	für Linkslenker; +PR 1ZA / 1ZB / 1ZE / 1ZF	03.4153-5403.3	010994	ATE Ø 23,8
1.4 TSI G-TEC	81	11/13→02/17		24.4123-1719.3	011017	TRW Ø 23,8 ohne Bremsflüssigkeitsbehälter
1.6 TDI	81	05/13→02/17				
1.8 TSI	132	11/12→10/20				
2.0 TDI	105	11/12→02/17		01/14→; für Linkslenker; +PR 1ZA / 1ZB / 1ZE / 1ZF	24.4153-1522.3	011048
2.0 TDI RS	135	05/13→10/20				
2.0 TSI RS	162	05/13→02/17				
1.4 TSI	110	08/14→10/20	05/15→; für Linkslenker; +PR 1ZA / 1ZB / 1ZE / 1ZF	03.4153-5403.3	010994	ATE Ø 23,8
				24.4123-1719.3	011017	TRW Ø 23,8 ohne Bremsflüssigkeitsbehälter
			für Linkslenker; +PR 1ZA / 1ZB / 1ZE / 1ZF	24.4153-1522.3	011048	ATE Ø 23,8 ohne Bremsflüssigkeitsbehälter
2.0 TDI / TDI RS 4x4	135	05/13→10/20	für Linkslenker; +PR 1ZA / 1ZB / 1ZE / 1ZF	03.4153-5403.3	010994	ATE Ø 23,8
				24.4123-1719.3	011017	TRW Ø 23,8 ohne Bremsflüssigkeitsbehälter
			09/14→; +PR 1ZA / 1ZB / 1ZE / 1ZF; für Linkslenker	24.4153-1522.3	011048	ATE Ø 23,8 ohne Bremsflüssigkeitsbehälter

SKODA - OCTAVIA III Combi (5E5, 5E6) 11/12→10/20













Hauptbremszylinder















1.0 TSI	85	05/16→10/20	für Linkslenker; +PR 1ZA / 1ZB / 1ZE / 1ZF	03.4153-5403.3	010994	ATE Ø 23,8
1.2 TSI	81	05/15→02/17		24.4123-1719.3	011017	TRW Ø 23,8 ohne Bremsflüssigkeitsbehälter
1.5 TSI	110	02/17→10/20				
1.5 TSI G-TEC	96	01/19→10/20				
1.6	81	01/14→02/17		24.4153-1522.3	011048	ATE Ø 23,8 ohne Bremsflüssigkeitsbehälter
1.6 TDI	85	02/17→10/20				
1.6 TDI 4x4	81 -	05/15→10/20				
	85					
2.0 TDI / TDI RS 4x4	135	05/13→10/20				
2.0 TSI	140	02/17→10/20				
2.0 TSI 4x4	140	02/19→10/20				
2.0 TSI RS	169 -	05/15→10/20				
	180					
1.2 TSI	63 -	11/12→02/17	02/13→; für Linkslenker; +PR 1ZA / 1ZB / 1ZE / 1ZF	03.4153-5403.3	010994	ATE Ø 23,8
	77			24.4123-1719.3	011017	TRW Ø 23,8 ohne Bremsflüssigkeitsbehälter
1.6 TDI	66 -	11/12→10/20				
2.0 TDI	77		01/14→; für Linkslenker; +PR 1ZA / 1ZB / 1ZE / 1ZF	24.4153-1522.3	011048	ATE Ø 23,8 ohne Bremsflüssigkeitsbehälter
2.0 TDI	110	11/12→10/20				
1.4 TSI	103	11/12→02/17	für Linkslenker; +PR 1ZA / 1ZB / 1ZE / 1ZF	03.4153-5403.3	010994	ATE Ø 23,8
1.4 TSI G-TEC	81	11/12→02/17		24.4123-1719.3	011017	TRW Ø 23,8 ohne Bremsflüssigkeitsbehälter
1.6 TDI	81	05/13→02/17				
1.6 TDI 4x4	77	11/12→05/15				
1.8 TSI	132	11/12→10/20		01/14→; für Linkslenker; +PR 1ZA / 1ZB / 1ZE / 1ZF	24.4153-1522.3	011048
1.8 TSI 4x4	132	11/12→02/17				
2.0 TDI	105	11/12→02/17				
2.0 TDI 4x4	110	11/12→10/20				
2.0 TDI RS	135	05/13→10/20				
1.4 TSI	110	08/14→10/20	05/15→; für Linkslenker; +PR 1ZA / 1ZB / 1ZE / 1ZF	03.4153-5403.3	010994	ATE Ø 23,8
				24.4123-1719.3	011017	TRW Ø 23,8 ohne Bremsflüssigkeitsbehälter
			für Linkslenker; +PR 1ZA / 1ZB / 1ZE / 1ZF	24.4153-1522.3	011048	ATE Ø 23,8 ohne Bremsflüssigkeitsbehälter















	kW					! #		
SKODA - OCTAVIA III Combi (5E5, 5E6) 11/12→10/20								
 Hauptbremszylinder								
2.0 TSI RS	162	11/12→02/17		05/13→; +PR 1ZA / 1ZB / 1ZE / 1ZF; für Linkslenker		03.4153-5403.3 010994 24.4123-1719.3 011017	ATE Ø 23,8 TRW Ø 23,8 ohne Bremsflüssigkeitsbehälter	
				01/14→; für Linkslenker; +PR 1ZA / 1ZB / 1ZE / 1ZF		24.4153-1522.3 011048	ATE Ø 23,8 ohne Bremsflüssigkeitsbehälter	
SKODA - ROOMSTER (5J7) 03/06→05/15								
 Hauptbremszylinder								
1.2	47	05/06→01/07		07/06→; für Linkslenker; + ABS		24.2120-1734.3 010702	Ø 20,6	
				07/06→; für Linkslenker; - ABS		24.2120-1736.3 010732	Ø 20,6	
				07/06→; für Rechtslenker		24.2120-1768.3 011041	Ø 20,6 ohne Bremsflüssigkeitsbehälter	
1.2	51	01/07→05/15		→ 12/10; für Linkslenker; + ABS		24.2120-1734.3 010702	Ø 20,6	
1.2 LPG	51	03/09→05/15		→ 12/10; für Linkslenker; - ABS		24.2120-1736.3 010732	Ø 20,6	
1.2 TDI	55	03/10→05/15		→ 12/10; für Rechtslenker		24.2120-1768.3 011041	Ø 20,6 ohne Bremsflüssigkeitsbehälter	
1.2 TSI	63 - 77	03/10→05/15						
1.4	63	09/06→05/15						
1.4 LPG	63	03/10→05/15						
1.6	77	09/06→05/15						
1.6 TDI	66 - 77	03/10→05/15						
1.4 TDI	51 - 59	07/06→03/10		für Linkslenker; + ABS		24.2120-1734.3 010702	Ø 20,6	
1.6 LPG	77	06/06→07/10		für Linkslenker; - ABS		24.2120-1736.3 010732	Ø 20,6	
1.9 TDI	77	09/06→03/10		für Rechtslenker		24.2120-1768.3 011041	Ø 20,6 ohne Bremsflüssigkeitsbehälter	
 Bremskraftregler								
1.2	47	05/06→01/07		07/06→; - ABS		03.6584-0107.3 320110	ATE lastabhängig 8/4 4x	
1.2	51	01/07→05/15		→ 04/15; - ABS		03.6584-0107.3 320110	ATE lastabhängig 8/4 4x	
1.2 LPG	51	03/09→05/15						
1.2 TDI	55	03/10→05/15						
1.2 TSI	63 - 77	03/10→05/15						
1.4	63	09/06→05/15						
1.4 LPG	63	03/10→05/15						
1.6	77	09/06→05/15						
1.6 TDI	66 - 77	03/10→05/15						
1.4 TDI	51 - 59	07/06→03/10		- ABS		03.6584-0107.3 320110	ATE lastabhängig 8/4 4x	
1.6 LPG	77	06/06→07/10						
1.9 TDI	77	09/06→03/10						
SKODA - ROOMSTER Praktik (5J) 03/07→05/15								
 Hauptbremszylinder								
1.2	51	03/07→05/15		für Linkslenker; → 12/10; + ABS		24.2120-1734.3 010702	Ø 20,6	
1.2 TDI	55	03/10→05/15		für Linkslenker; → 12/10; - ABS		24.2120-1736.3 010732	Ø 20,6	
1.2 TSI	63	03/10→05/15		für Rechtslenker; → 12/10		24.2120-1768.3 011041	Ø 20,6 ohne Bremsflüssigkeitsbehälter	
1.4	63	03/07→05/15						
1.6 TDI	66	03/10→05/15						
1.4 TDI	51 - 59	03/07→03/10		für Linkslenker; + ABS		24.2120-1734.3 010702	Ø 20,6	
				für Linkslenker; - ABS		24.2120-1736.3 010732	Ø 20,6	
				für Rechtslenker		24.2120-1768.3 011041	Ø 20,6 ohne Bremsflüssigkeitsbehälter	
 Bremskraftregler								
1.2	51	03/07→05/15		→ 04/15; - ABS		03.6584-0107.3 320110	ATE lastabhängig 8/4 4x	
1.2 TDI	55	03/10→05/15						
1.2 TSI	63	03/10→05/15						
1.4	63	03/07→05/15						
1.6 TDI	66	03/10→05/15						
1.4 TDI	51 - 59	03/07→03/10		- ABS		03.6584-0107.3 320110	ATE lastabhängig 8/4 4x	
SKODA - SUPERB I (3U4) 12/01→03/08								
 Hauptbremszylinder								
1.8 T	110	12/01→03/08		→ 02/08		03.2125-0373.3 010810	ATE Ø 25,4	
2.0	85	12/01→03/08				24.2125-1720.3 010688	TRW Ø 25,4	
1.9 TDI	74 - 77	08/02→05/07				03.2125-0373.3 010810	ATE Ø 25,4	
2.0 TDI	91	02/06→03/08				24.2125-1720.3 010688	TRW Ø 25,4	
2.5 TDI	114	12/01→08/03						
→								















	kW			 	! #		
SKODA - SUPERB I (3U4) 12/01→03/08							
 Hauptbremszylinder							
1.9 TDI	85 - 96	12/01→03/08		→ 12/07		03.2125-0373.3 010810	ATE Ø 25,4
2.0 TDI	103	10/05→03/08				24.2125-1720.3 010688	TRW Ø 25,4
2.5 TDI	120	06/03→03/08					
2.8 V6	140 - 142	12/01→03/08					
SKODA - SUPERB II (3T4) 03/08→05/15							
 Bremskraftverstärker							
1.4 TSI	92	07/08→05/15		08/08→ 02/15; für Linkslenker		03.7863-3332.4 300308	ATE Ø 10" pneumatisch
1.8 TSI	118	03/08→05/15					
2.0 TDI	125	07/08→05/15					
1.6 TDI	77	09/10→05/15		→ 02/15; für Linkslenker		03.7863-3332.4 300308	ATE Ø 10" pneumatisch
1.8 TSI	112	03/09→05/15					
1.8 TSI 4x4	112 - 118	11/08→05/15					
2.0 TDI 16V	103	01/09→05/15					
2.0 TDI 16V 4x4	103	11/10→05/15					
2.0 TFSI	147	05/10→05/15					
3.6 FSI 4x4	191	11/08→05/15					
1.9 TDI	77	03/08→11/10		08/08→; für Linkslenker		03.7863-3332.4 300308	ATE Ø 10" pneumatisch
2.0 TDI	103	03/08→05/10					
2.0 TDI 4x4	125	09/08→05/15		10/08→ 02/15; für Linkslenker		03.7863-3332.4 300308	ATE Ø 10" pneumatisch
 Hauptbremszylinder							
1.4 TSI	92	07/08→05/15		08/08→ 02/15; für Linkslenker		03.2123-3449.3 010808	ATE Ø 23,8
1.8 TSI	118	03/08→05/15		08/08→ 02/15; für Rechtslenker		24.4153-0202.3 011027	ATE Ø 23,8 ohne Bremsflüssigkeitsbehälter
2.0 TDI	125	07/08→05/15					
1.6 TDI	77	09/10→05/15		→ 02/15; für Linkslenker		03.2123-3449.3 010808	ATE Ø 23,8
1.8 TSI	112	03/09→05/15					
1.8 TSI 4x4	112 - 118	11/08→05/15		→ 02/15; für Rechtslenker		24.4153-0202.3 011027	ATE Ø 23,8 ohne Bremsflüssigkeitsbehälter
2.0 TDI 16V	103	01/09→05/15					
2.0 TDI 16V 4x4	103	11/10→05/15					
2.0 TFSI	147	05/10→05/15					
3.6 FSI 4x4	191	11/08→05/15					
1.9 TDI	77	03/08→11/10		08/08→; für Linkslenker		03.2123-3449.3 010808	ATE Ø 23,8
2.0 TDI	103	03/08→05/10		08/08→; für Rechtslenker		24.4153-0202.3 011027	ATE Ø 23,8 ohne Bremsflüssigkeitsbehälter
2.0 TDI 4x4	125	09/08→05/15		10/08→ 02/15; für Linkslenker		03.2123-3449.3 010808	ATE Ø 23,8
				10/08→ 02/15; für Rechtslenker		24.4153-0202.3 011027	ATE Ø 23,8 ohne Bremsflüssigkeitsbehälter
SKODA - SUPERB II Kombi (3T5) 10/09→05/15							
 Bremskraftverstärker							
1.4 TSI	92	10/09→05/15		11/09→ 02/15; für Linkslenker		03.7863-3332.4 300308	ATE Ø 10" pneumatisch
1.8 TSI	112 - 118	10/09→05/15					
1.8 TSI 4x4	112 - 118	10/09→05/15					
2.0 TDI	125	10/09→05/15					
2.0 TDI 16V	103	10/09→05/15					
2.0 TDI 4x4	125	10/09→05/15					
3.6 V6 4x4	191	10/09→05/15					
1.6 TDI	77	09/10→05/15		→ 02/15; für Linkslenker		03.7863-3332.4 300308	ATE Ø 10" pneumatisch
2.0 TDI 16V 4x4	103	11/10→05/15					
2.0 TFSI	147	05/10→05/15					
1.9 TDI	77	10/09→11/10		für Linkslenker		03.7863-3332.4 300308	ATE Ø 10" pneumatisch
2.0 TDI	103	10/09→03/10		11/09→; für Linkslenker		03.7863-3332.4 300308	ATE Ø 10" pneumatisch
 Hauptbremszylinder							
1.4 TSI	92	10/09→05/15		11/09→ 02/15; für Linkslenker		03.2123-3449.3 010808	ATE Ø 23,8
1.8 TSI	112 - 118	10/09→05/15		11/09→ 02/15; für Rechtslenker		24.4153-0202.3 011027	ATE Ø 23,8 ohne Bremsflüssigkeitsbehälter
1.8 TSI 4x4	112 - 118	10/09→05/15					
2.0 TDI	125	10/09→05/15					
2.0 TDI 16V	103	10/09→05/15					
2.0 TDI 4x4	125	10/09→05/15					
3.6 V6 4x4	191	10/09→05/15					
1.6 TDI	77	09/10→05/15		→ 02/15; für Linkslenker		03.2123-3449.3 010808	ATE Ø 23,8
2.0 TDI 16V 4x4	103	11/10→05/15					
2.0 TFSI	147	05/10→05/15		→ 02/15; für Rechtslenker		24.4153-0202.3 011027	ATE Ø 23,8 ohne Bremsflüssigkeitsbehälter
1.9 TDI	77	10/09→11/10		für Linkslenker		03.2123-3449.3 010808	ATE Ø 23,8
→							































	kw			 	! #		
SKODA - SUPERB II Kombi (3T5) 10/09→05/15							
 Hauptbremszylinder							
1.9 TDI	77	10/09→11/10		für Rechtslenker		24.4153-0202.3 011027	ATE Ø 23,8 ohne Bremsflüssigkeitsbehälter
2.0 TDI	103	10/09→03/10		11/09→; für Linkslenker		03.2123-3449.3 010808	ATE Ø 23,8
				11/09→; für Rechtslenker		24.4153-0202.3 011027	ATE Ø 23,8 ohne Bremsflüssigkeitsbehälter
SKODA - SUPERB III (3V3) 03/15→							
 Hauptbremszylinder							
1.4 TSI	92 - 110	03/15→		für Linkslenker		24.4123-1719.3 011017	TRW Ø 23,8 ohne Bremsflüssigkeitsbehälter
1.4 TSI 4x4	110	03/15→				24.4153-1522.3 011048	ATE Ø 23,8 ohne Bremsflüssigkeitsbehälter
1.5 TSI	110	02/17→					
1.6 TDI	88	03/15→					
1.8 TSI	132	03/15→					
2.0 TDI	110 - 147	03/15→					
	110 - 147	03/15→					
2.0 TDI 4x4	110 - 147	03/15→					
2.0 TSI	162	03/15→					
2.0 TSI 4x4	200 - 206	03/15→					
2.0 TDI	90	07/20→		für Linkslenker		24.4153-1522.3 011048	ATE Ø 23,8 ohne Bremsflüssigkeitsbehälter
2.0 TSI	140	07/19→					
SKODA - SUPERB III Kombi (3V5) 03/15→							
 Hauptbremszylinder							
1.4 TSI	92 - 110	03/15→		für Linkslenker		24.4123-1719.3 011017	TRW Ø 23,8 ohne Bremsflüssigkeitsbehälter
1.4 TSI 4x4	110	03/15→				24.4153-1522.3 011048	ATE Ø 23,8 ohne Bremsflüssigkeitsbehälter
1.5 TSi	110	02/17→					
1.6 TDI	88	03/15→					
1.8 TSI	132	03/15→					
2.0 TDI	110 - 147	03/15→					
	110 - 147	03/15→					
2.0 TDI 4x4	110 - 147	03/15→					
2.0 TSI	162	03/15→					
2.0 TSI 4x4	200 - 206	03/15→					
2.0 TDI	90	07/20→		für Linkslenker		24.4153-1522.3 011048	ATE Ø 23,8 ohne Bremsflüssigkeitsbehälter
2.0 TSI	140	07/19→					
SKODA - YETI (5L) 05/09→12/17							
 Bremskraftverstärker							
1.2 TSI	77 - 81	09/09→12/17		für Linkslenker; +PR 1AC / 1AS / 1AT / 1ZE / 1ZF		03.7863-3232.4 300307	ATE Ø 10" pneumatisch
1.4 TSI	90 - 92	06/10→12/17		+PR 1AT / 1ZA / 1ZE / 1LK; für Linkslenker		03.7863-3332.4 300308	ATE Ø 10" pneumatisch
1.4 TSI 4x4	110	05/15→12/17					
1.6	81	04/14→12/17					
1.6 TDI	77	11/10→05/15					
1.8 TSI 4x4	112 - 118	05/09→12/17					
2.0 TDI	81 - 110	11/09→12/17					
2.0 TDI 4x4	81 - 125	05/09→12/17					
 Hauptbremszylinder							
1.2 TSI	77 - 81	09/09→12/17		für Linkslenker; +PR 1ZE / 1ZF		03.2122-2129.3 010799	ATE Ø 22,2
1.4 TSI	90 - 92	06/10→12/17		für Linkslenker; +PR 1ZA		03.2123-3449.3 010808	ATE Ø 23,8
	110	05/15→12/17		für Rechtslenker; +PR 1ZE / 1ZF		24.4152-0132.3 011025	ATE Ø 22,2 ohne Bremsflüssigkeitsbehälter
1.4 TSI 4x4	81	04/14→12/17				24.4153-0202.3 011027	ATE Ø 23,8 ohne Bremsflüssigkeitsbehälter
1.6	77	11/10→05/15		für Rechtslenker; +PR 1ZA			
1.6 TDI	112 - 118	05/09→12/17					
1.8 TSI 4x4	81 - 110	11/09→12/17					
2.0 TDI	81 - 125	05/09→12/17					
2.0 TDI 4x4	81 - 125	05/09→12/17					















	kw					! #		
SMART - CITY-COUPÉ (450) 07/98→01/04								
 Hauptbremszylinder								
0.6	33 - 52	07/98→01/04		01/03→; für Linkslenker			24.2119-1711.3 010911	Ø 19 ohne Bremsflüssigkeitsbehälter
0.8 CDI	30	11/99→01/04		→ 12/02; für Linkslenker; zusätzlich benötigter Artikel (Artikel-Nummer): Q0014462V001000000			24.2119-1711.3 010911	Ø 19 ohne Bremsflüssigkeitsbehälter
0.7	37 - 55	01/03→01/04		für Linkslenker			24.2119-1711.3 010911	Ø 19 ohne Bremsflüssigkeitsbehälter
SMART - CROSSBLADE (450) 06/02→12/03								
 Hauptbremszylinder								
0.6	52	06/02→12/03		01/03→; für Linkslenker			24.2119-1711.3 010911	Ø 19 ohne Bremsflüssigkeitsbehälter
				→ 12/02; für Linkslenker; zusätzlich benötigter Artikel (Artikel-Nummer): Q0014462V001000000			24.2119-1711.3 010911	Ø 19 ohne Bremsflüssigkeitsbehälter
SMART - FORFOUR (454) 01/04→06/06								
 Hauptbremszylinder								
1.1	55	01/04→06/06		03/04→; für Linkslenker			24.2122-1770.3 010898	TRW Ø 22,2
1.3	70	01/04→06/06						
1.5	80	01/04→06/06						
1.1	47	02/05→06/06		für Linkslenker			24.2122-1770.3 010898	TRW Ø 22,2
1.5 BRABUS	130	05/05→06/06						
1.5 CDI	50 - 70	09/04→06/06						
1.5	90	01/04→06/06		11/04→; für Linkslenker			24.2122-1770.3 010898	TRW Ø 22,2
SMART - FORFOUR Schrägheck (453) 07/14→								
 Hauptbremszylinder								
0.9	66	11/14→		Schaltgetriebe			24.4150-1071.3 011046	ATE Ø 20,6 ohne Bremsflüssigkeitsbehälter
0.9 Brabus electric drive / EQ electric drive	80	07/16→					24.4150-1071.3 011046	ATE Ø 20,6 ohne Bremsflüssigkeitsbehälter
	41	05/17→						
	60	05/17→						
1.0	45	11/14→		01/15→; Schaltgetriebe			24.4150-1071.3 011046	ATE Ø 20,6 ohne Bremsflüssigkeitsbehälter
1.0	52	07/14→		11/14→; Schaltgetriebe			24.4150-1071.3 011046	ATE Ø 20,6 ohne Bremsflüssigkeitsbehälter
SMART - FORTWO Cabrio (450) 01/04→01/07								
 Hauptbremszylinder								
0.6	45	01/04→12/06		für Linkslenker			24.2119-1711.3 010911	Ø 19 ohne Bremsflüssigkeitsbehälter
0.6 Brabus	55	01/04→12/06						
0.7	45 - 55	01/04→01/07						
0.8 CDI	30	01/04→01/07						
SMART - FORTWO Cabrio (451) 01/07→								
 Hauptbremszylinder								
1.0	52	01/07→		K014181→; für Linkslenker			24.2123-1780.3 011081	Ø 23,8 ohne Bremsflüssigkeitsbehälter
SMART - FORTWO Cabriolet (453) 09/15→								
 Hauptbremszylinder								
0.9	66	09/15→					24.4150-1071.3 011046	ATE Ø 20,6 ohne Bremsflüssigkeitsbehälter
0.9 Brabus	80	07/16→						
1.0 electric drive / EQ electric drive	52	09/15→						
	41	05/17→						
	60	05/17→						
SMART - FORTWO Coupe (450) 01/04→02/07								
 Hauptbremszylinder								
0.6	45	01/04→02/07		→ J182805; für Linkslenker			24.2119-1711.3 010911	Ø 19 ohne Bremsflüssigkeitsbehälter
0.7	45	01/04→01/07						
0.8 CDI	30	01/04→01/07						
0.8 D	33	09/04→12/06						
0.7	34 - 55	01/04→02/07		für Linkslenker			24.2119-1711.3 010911	Ø 19 ohne Bremsflüssigkeitsbehälter
0.7	40	01/04→01/07		→ J182808; für Linkslenker			24.2119-1711.3 010911	Ø 19 ohne Bremsflüssigkeitsbehälter













	kw					! #		
SMART - FORTWO Coupe (451) 01/07→								
 Hauptbremszylinder								
1.0	45 - 52	01/07→			K014181→; für Linkslenker		24.2123-1780.3 011081	Ø 23,8 ohne Bremsflüssigkeitsbehälter
SMART - FORTWO Coupe (453) 07/14→								
 Hauptbremszylinder								
0.9	66	09/14→			11/14→		24.4150-1071.3 011046	ATE Ø 20,6 ohne Bremsflüssigkeitsbehälter
1.0	52	07/14→						
0.9 Brabus electric drive / EQ electric drive	80 / 41 / 60	07/16→ / 05/17→ / 05/17→					24.4150-1071.3 011046	ATE Ø 20,6 ohne Bremsflüssigkeitsbehälter
1.0	45	11/14→			01/15→		24.4150-1071.3 011046	ATE Ø 20,6 ohne Bremsflüssigkeitsbehälter
SUBARU - JUSTY III (G3X) 09/03→								
 Hauptbremszylinder								
1.3 AWD	69	09/03→			→ 08/07		24.2120-1730.3 010678	Ø 20,6
1.5 AWD	73	09/03→						
1.3 CDTi	51	12/03→08/07			für Linkslenker		24.2120-1730.3 010678	Ø 20,6
SUZUKI - IGNIS II (MH) 08/03→								
 Hauptbremszylinder								
1.3	69	09/03→			→ 12/12; + ABS		24.2120-1730.3 010678	Ø 20,6
1.3 4x4	69	09/03→						
1.3 DDiS	51	09/03→						
1.5	73	09/03→						
1.5 4x4	73	09/03→						
SUZUKI - JIMNY Geländewagen geschlossen (SN) 07/98→								
 Hauptbremszylinder								
1.3	63	08/04→			- ABS		24.2122-1776.3 011001	Ø 22,2 ohne Bremsflüssigkeitsbehälter
1.3 16V	59 - 60	09/98→						
1.3 16V 4WD	59 - 60	09/98→						
1.3 16V 4x4	63	08/05→						
1.3 4WD	62	05/14→						
1.3 4x4	63	09/98→08/00						
1.5 DDiS 4WD	48	12/03→						
1.5 DDiS 4x4	63	08/05→						
SUZUKI - JIMNY Geländewagen offen (SN) 01/98→								
 Hauptbremszylinder								
1.3	63	08/04→			- ABS		24.2122-1776.3 011001	Ø 22,2 ohne Bremsflüssigkeitsbehälter
1.3 4WD	63	03/13→						
SUZUKI - SPLASH (EX) 01/08→								
 Hauptbremszylinder								
1.0	48 - 50	01/08→			für Linkslenker; - ESP		24.4122-1718.3 011019	BOS Ø 22,2 ohne Bremsflüssigkeitsbehälter
1.2	63	01/08→			für Linkslenker; + ESP		24.4122-1719.3 011020	Ø 22,2 ohne Bremsflüssigkeitsbehälter
1.2 LPG	63	04/08→12/14						
1.2 VVT	66 - 69	09/10→						
1.3 CDTI	55	01/08→						
SUZUKI - SWIFT III (MZ, EZ) 02/05→								
 Hauptbremszylinder								
1.2	66	04/08→12/10			für Linkslenker; - ESP		24.4122-1718.3 011019	BOS Ø 22,2 ohne Bremsflüssigkeitsbehälter
1.3	67	02/05→06/15						
1.3 4x4	66 - 68	02/05→			für Linkslenker; + ESP		24.4122-1719.3 011020	Ø 22,2 ohne Bremsflüssigkeitsbehälter
1.3 DDiS	51 - 55	08/05→						
1.5	75	02/05→						
1.5 4x4	74	02/05→						
1.6	92	05/06→						
1.3	68	02/05→			→ 09/10; für Linkslenker; - ESP		24.4122-1718.3 011019	BOS Ø 22,2 ohne Bremsflüssigkeitsbehälter
					→ 09/10; für Linkslenker; + ESP		24.4122-1719.3 011020	Ø 22,2 ohne Bremsflüssigkeitsbehälter
1.3 LPG	68	09/08→12/10			- ESP		24.4122-1718.3 011019	BOS Ø 22,2 ohne Bremsflüssigkeitsbehälter
→								















	kw					! #		
SUZUKI - SWIFT III (MZ, EZ) 02/05→								
 Hauptbremszylinder								
1.3 LPG	68	09/08→12/10			+ ESP		24.4122-1719.3 011020	Ø 22,2 ohne Bremsflüssigkeitsbehälter
SUZUKI - SX4 (EY, GY) 06/06→								
 Hauptbremszylinder								
1.5	73	06/06→07/10			- ESP; Fahrzeugproduktionsland Ungarn		24.4122-1712.3 010899	BOS Ø 22,2 ohne Bremsflüssigkeitsbehälter
1.5 VVT	82	07/10→						
1.5 VVTi	81	07/07→12/15			+ ESP; Fahrzeugproduktionsland Ungarn		24.4122-1713.3 010900	BOS Ø 22,2 ohne Bremsflüssigkeitsbehälter
1.6 LPG	79	06/06→12/12						
1.6 VVT	79 - 88	06/06→						
1.6 VVT 4x4	79 - 88	06/06→						
1.5 VVT 4x4	82	07/10→			- ESP		24.4122-1712.3 010899	BOS Ø 22,2 ohne Bremsflüssigkeitsbehälter
1.6 DDiS	66	04/07→						
1.9 DDiS	88	06/06→			+ ESP		24.4122-1713.3 010900	BOS Ø 22,2 ohne Bremsflüssigkeitsbehälter
1.9 DDiS 4x4	88	06/06→						
2.0 16V 4x4	112	01/10→						
2.0 DDiS	99	07/09→						
2.0 DDiS 4x4	99	07/09→						
SUZUKI - SX4 Stufenheck (GY, RW) 10/07→								
 Hauptbremszylinder								
1.6	79 - 88	10/07→			- ESP; Fahrzeugproduktionsland Ungarn		24.4122-1712.3 010899	BOS Ø 22,2 ohne Bremsflüssigkeitsbehälter
1.6 AWD	79	10/07→12/11			+ ESP; Fahrzeugproduktionsland Ungarn		24.4122-1713.3 010900	BOS Ø 22,2 ohne Bremsflüssigkeitsbehälter
SUZUKI - WAGON R Schrägheck 03/02→12/12								
 Hauptbremszylinder								
1.0	39 - 44	07/03→08/05					24.2120-1730.3 010678	Ø 20,6
1.2	59	06/04→08/05						
1.3	65	09/03→12/10			+ ABS		24.2120-1730.3 010678	Ø 20,6
SUZUKI - WAGON R+ Schrägheck (MM) 05/00→								
 Hauptbremszylinder								
1.0 XT Plus	74	08/00→07/01					24.2120-1730.3 010678	Ø 20,6
1.2	59	01/05→12/08						
1.3	56	05/00→12/04			+ ABS		24.2120-1730.3 010678	Ø 20,6
1.3	69	09/03→			→ 04/08; + ABS		24.2120-1730.3 010678	Ø 20,6
1.3 4WD	69	09/03→						
1.3 DDiS	51	09/03→						
1.3 4WD	56	10/01→			→ 12/04; + ABS		24.2120-1730.3 010678	Ø 20,6
TOYOTA - AVENSIS (_T22_) 09/97→02/03								
 Bremskraftverstärker								
1.8 i	81	09/97→10/00			→ 09/00; für Linkslenker		03.7745-4402.4 300295	ATE Ø 8 / 7" pneumatisch
1.8 VVT-i	95	10/00→02/03			für Linkslenker		03.7745-4402.4 300295	ATE Ø 8 / 7" pneumatisch
2.0 VVT-i	110	10/00→02/03			08/01→; für Linkslenker		03.7745-4402.4 300295	ATE Ø 8 / 7" pneumatisch
 Hauptbremszylinder								
1.6 i	74	09/97→10/00			→ 09/00		03.2123-2221.3 010861	ATE Ø 23,8
1.8 i	81	09/97→10/00						
2.0 i	94	09/97→10/00						
1.6 i	81	10/97→06/00					03.2123-2221.3 010861	ATE Ø 23,8
1.6 VVT-i	81	10/00→02/03						
1.8 VVT-i	95	10/00→02/03						
2.0 D	61	10/97→05/98						
2.0 D-4D	81 - 85	10/99→02/03						
2.0 TD	66	09/97→02/03						
2.0 VVT-i	110	10/00→02/03						
TOYOTA - AVENSIS (_T25_) 03/03→11/08								
 Hauptbremszylinder								
1.6 VVT-i	81	04/03→11/08			+ ESP		24.2123-1771.3 010857	BOS Ø 23,8 ohne Bremsflüssigkeitsbehälter
1.8 VVT-i	95	03/03→10/08						
2.0 D-4D	85 - 93	04/03→11/08						
2.0 VVTi	114	03/03→10/08						
2.0 VVT-i	108	03/03→11/08						













	kw					! #		
TOYOTA - AVENSIS (_T25_) 03/03→11/08								
 Hauptbremszylinder								
2.2 D-4D 2.2 D-CAT 2.4 VVT-i	110 130 120 125	10/05→11/08 07/05→11/08 09/03→11/08		+ ESP			24.2123-1771.3 010857	BOS Ø 23,8 ohne Bremsflüssigkeitsbehälter
TOYOTA - AVENSIS Kombi (_T22_) 09/97→02/03								
 Bremskraftverstärker								
1.8 i	81	09/97→10/00		→ 09/00; für Linkslenker			03.7745-4402.4 300295	ATE Ø 8 / 7" pneumatisch
1.8 VVT-i	95	10/00→02/03		für Linkslenker			03.7745-4402.4 300295	ATE Ø 8 / 7" pneumatisch
2.0 VVT-i	110	10/00→02/03		08/01→; für Linkslenker			03.7745-4402.4 300295	ATE Ø 8 / 7" pneumatisch
 Hauptbremszylinder								
1.6 i	74 - 81	09/97→10/00		→ 09/00			03.2123-2221.3 010861	ATE Ø 23,8
1.8 i	81	09/97→10/00						
2.0 i	94	09/97→10/00						
1.6 VVT-i	81	07/00→02/03		10/00→			03.2123-2221.3 010861	ATE Ø 23,8
1.8 VVT-i	95	10/00→02/03					03.2123-2221.3 010861	ATE Ø 23,8
2.0 D	61 - 85	10/97→02/03						
2.0 D-4D	81	10/99→02/03						
2.0 TD	66	09/97→02/03						
2.0 VVT-i	110	10/00→02/03						
TOYOTA - AVENSIS Kombi (_T25_) 04/03→11/08								
 Hauptbremszylinder								
1.6 VVT-i	81	04/03→11/08		+ ESP			24.2123-1771.3 010857	BOS Ø 23,8 ohne Bremsflüssigkeitsbehälter
2.0 D-4D	85 - 93	04/03→11/08						
2.0 VVT-i	108 - 114	04/03→11/08						
2.2 D-4D	110	10/05→11/08						
2.2 D-CAT	130	07/05→11/08						
2.4 VVT-i	120 - 125	09/03→11/08						
1.8 VVT-i	95	04/03→11/08		+ ESP; 02/04→			24.2123-1771.3 010857	BOS Ø 23,8 ohne Bremsflüssigkeitsbehälter
TOYOTA - AVENSIS Liftback (_T22_) 09/97→02/03								
 Bremskraftverstärker								
1.8 i	81	09/97→10/00		→ 09/00; für Linkslenker			03.7745-4402.4 300295	ATE Ø 8 / 7" pneumatisch
1.8 VVT-i	95	10/00→02/03		für Linkslenker			03.7745-4402.4 300295	ATE Ø 8 / 7" pneumatisch
2.0 VVT-i	110	10/00→02/03		08/01→; für Linkslenker			03.7745-4402.4 300295	ATE Ø 8 / 7" pneumatisch
 Hauptbremszylinder								
1.6 i	74 - 81	09/97→10/00		→ 09/00			03.2123-2221.3 010861	ATE Ø 23,8
1.8 i	81	09/97→10/00						
2.0 i	94	09/97→10/00						
1.6 VVT-i	81	10/00→02/03					03.2123-2221.3 010861	ATE Ø 23,8
1.8 VVT-i	95	10/00→02/03						
2.0 D	85	09/02→02/03						
2.0 D-4D	81	10/99→02/03						
2.0 TD	66	09/97→02/03						
2.0 VVT-i	110	10/00→02/03						
TOYOTA - AVENSIS Stufenheck (_T25_) 01/03→11/08								
 Hauptbremszylinder								
1.6 VVT-i	81	04/03→11/08		+ ESP			24.2123-1771.3 010857	BOS Ø 23,8 ohne Bremsflüssigkeitsbehälter
2.0 D-4D	85 - 93	04/03→11/08						
2.0 VVTi	114	01/03→11/08						
2.0 VVT-i	108	04/03→11/08						
2.2 D-4D	110	10/05→11/08						
2.2 D-CAT	130	07/05→11/08						
2.4 VVT-i	120 - 125	09/03→11/08						
1.8 VVT-i	95	04/03→11/08		+ ESP; 02/04→			24.2123-1771.3 010857	BOS Ø 23,8 ohne Bremsflüssigkeitsbehälter
TOYOTA - AYGO (_B1_) 02/05→05/14								
 Hauptbremszylinder								
1.0 →	50	07/05→05/14		- ESP; für Linkslenker			24.4120-1701.3 010846	BOS Ø 20,6













	kw			 	! #		
TOYOTA - AYGO (_B1_) 02/05→05/14							
 Hauptbremszylinder							
1.0 GPL 1.4 D-4D	50 40	07/05→05/14 07/05→08/10		+ ESP; für Linkslenker		24.4120-1704.3 011042	Ø 20,6 ohne Bremsflüssigkeitsbehälter
				+ ESP; für Rechtslenker		24.4120-1705.3 011051	Ø 20,6 ohne Bremsflüssigkeitsbehälter
TOYOTA - AYGO (_B4_) 05/14→							
 Hauptbremszylinder							
1.0	51	05/14→		+ ESP		24.4120-1708.3 011084	Ø 20,6 ohne Bremsflüssigkeitsbehälter
				- ESP		24.4120-1712.3 011092	Ø 20,6 ohne Bremsflüssigkeitsbehälter
1.0 VVTi	53	03/18→		für Linkslenker; + ESP		24.4120-1708.3 011084	Ø 20,6 ohne Bremsflüssigkeitsbehälter
				für Linkslenker; - ESP		24.4120-1712.3 011092	Ø 20,6 ohne Bremsflüssigkeitsbehälter
1.2	60	05/14→		für Linkslenker		24.4120-1708.3 011084	Ø 20,6 ohne Bremsflüssigkeitsbehälter
TOYOTA - AYGO Kasten/Schrägheck (_B1_) 07/05→05/14							
 Hauptbremszylinder							
1.0 VVTi	50	07/05→05/14		- ESP; für Linkslenker		24.4120-1701.3 010846	BOS Ø 20,6
				+ ESP; für Linkslenker		24.4120-1704.3 011042	Ø 20,6 ohne Bremsflüssigkeitsbehälter
				+ ESP; für Rechtslenker		24.4120-1705.3 011051	Ø 20,6 ohne Bremsflüssigkeitsbehälter
TOYOTA - COROLLA (_E10_) 06/91→11/99							
 Hauptbremszylinder							
1.3 12V 1.6 2.0 D	53 85 53	07/92→04/97 05/92→04/97 07/92→04/97		→ 05/95; + ABS		24.2122-1779.3 011064	Ø 22,2 ohne Bremsflüssigkeitsbehälter
TOYOTA - COROLLA (_E11_) 05/95→06/02							
 Hauptbremszylinder							
1.3 1.4	63 63	05/97→09/99 05/97→09/99		für Linkslenker		03.2122-1691.3 010918	ATE Ø 22,2
1.4 16V	71	02/00→11/01		für Linkslenker; + ABS		03.2122-1691.3 010918	ATE Ø 22,2
1.6 16V 1.8	81 85 - 93	10/99→12/01 04/97→06/02				03.2122-1691.3 010918	ATE Ø 22,2
1.9 D 2.0 D-4D	51 66	02/00→11/01 09/00→11/01					
TOYOTA - COROLLA (_E12_) 01/01→12/07							
 Hauptbremszylinder							
1.4 D	66	07/04→02/07		→ 10/06; - ESP		24.2120-1749.3 010903	TRW Ø 20,6
				→ 10/06; + ESP		24.2120-1760.3 011018	Ø 20,6 ohne Bremsflüssigkeitsbehälter
1.4 VVT-i 1.6 VVT-i 2.0 D-4D	71 81 85	11/01→02/07 01/02→12/06 05/03→02/07		06/04→ 10/06; - ESP		24.2120-1749.3 010903	TRW Ø 20,6
				→ 05/04; - ESP		24.2120-1749.3 010903	TRW Ø 20,6
				06/04→ 10/06; + ESP		24.2120-1760.3 011018	Ø 20,6 ohne Bremsflüssigkeitsbehälter
				→ 05/04; + ESP		24.2120-1760.3 011018	Ø 20,6 ohne Bremsflüssigkeitsbehälter
1.8 4WD 1.8 VVTi	100 100	01/01→02/07 01/01→12/07		→ 01/02		03.2122-1691.3 010918	ATE Ø 22,2
1.8 VVTL-i TS	160 - 165	02/05→02/07		→ 10/06; + ESP		24.2120-1760.3 011018	Ø 20,6 ohne Bremsflüssigkeitsbehälter
1.8 VVTL-i TS	141	11/01→02/07		→ 05/04; + ESP		24.2120-1760.3 011018	Ø 20,6 ohne Bremsflüssigkeitsbehälter
2.0 D-4D	66 - 81	01/02→12/06		→ 05/04; - ESP		24.2120-1749.3 010903	TRW Ø 20,6
				→ 05/04; + ESP		24.2120-1760.3 011018	Ø 20,6 ohne Bremsflüssigkeitsbehälter
TOYOTA - COROLLA Compact (_E10_) 05/92→12/99							
 Hauptbremszylinder							
1.6 i 1.6 Si 2.0 D	78 84 53	09/94→11/99 07/92→04/97 07/92→04/97		→ 05/95; + ABS		24.2122-1779.3 011064	Ø 22,2 ohne Bremsflüssigkeitsbehälter











	kw					! #		
TOYOTA - COROLLA Compact (_E11_) 04/97→01/02								
 Hauptbremszylinder								
1.4	63	05/97→09/99			für Linkslenker		03.2122-1691.3 010918	ATE Ø 22,2
1.4	71	10/99→01/02			für Linkslenker; + ABS		03.2122-1691.3 010918	ATE Ø 22,2
1.6	81	10/99→10/01					03.2122-1691.3 010918	ATE Ø 22,2
1.9 D	51	02/00→01/02						
2.0 D-4D	66	09/00→01/02						
TOYOTA - COROLLA Kasten/Kombi (_E11_) 09/00→10/01								
 Hauptbremszylinder								
2.0 D4d	66	09/00→10/01					03.2122-1691.3 010918	ATE Ø 22,2
TOYOTA - COROLLA Kombi (_E10_) 09/91→04/98								
 Hauptbremszylinder								
1.6 Si	84	07/92→04/97			→ 05/95; + ABS		24.2122-1779.3 011064	Ø 22,2 ohne Bremsflüssigkeitsbehälter
1.8	81	09/92→04/97						
2.0 D	53	07/92→04/97						
TOYOTA - COROLLA Kombi (_E11_) 04/97→10/01								
 Hauptbremszylinder								
1.4	63	04/97→02/00			05/97→ 09/99; für Linkslenker		03.2122-1691.3 010918	ATE Ø 22,2
1.4 16V	71	02/00→10/01			für Linkslenker; + ABS		03.2122-1691.3 010918	ATE Ø 22,2
1.6 16V	81	02/00→10/01					03.2122-1691.3 010918	ATE Ø 22,2
1.9 D	51	02/00→10/01						
2.0 D-4D	66	09/00→10/01						
1.8 4WD	81	04/97→10/01			05/97→		03.2122-1691.3 010918	ATE Ø 22,2
TOYOTA - COROLLA Kombi (_E12_) 03/01→12/08								
 Hauptbremszylinder								
1.3	65	09/02→08/07			06/04→; - ESP		24.2120-1749.3 010903	TRW Ø 20,6
1.4 VVT-i	71	01/02→02/07			→ 05/04; - ESP		24.2120-1749.3 010903	TRW Ø 20,6
1.5	81	03/01→09/06			06/04→; + ESP		24.2120-1760.3 011018	Ø 20,6 ohne Bremsflüssigkeitsbehälter
					→ 05/04; + ESP		24.2120-1760.3 011018	Ø 20,6 ohne Bremsflüssigkeitsbehälter
1.4 D4-D	66	06/04→10/07			→ 10/06; - ESP		24.2120-1749.3 010903	TRW Ø 20,6
					→ 10/06; + ESP		24.2120-1760.3 011018	Ø 20,6 ohne Bremsflüssigkeitsbehälter
1.6 VVT-i	81	01/02→08/07			06/04→ 10/06; - ESP		24.2120-1749.3 010903	TRW Ø 20,6
2.0 D-4D	85	04/04→02/07			→ 05/04; - ESP		24.2120-1749.3 010903	TRW Ø 20,6
					06/04→ 10/06; + ESP		24.2120-1760.3 011018	Ø 20,6 ohne Bremsflüssigkeitsbehälter
					→ 05/04; + ESP		24.2120-1760.3 011018	Ø 20,6 ohne Bremsflüssigkeitsbehälter
1.8	100	12/01→12/07			→ 10/06; + ESP		24.2120-1760.3 011018	Ø 20,6 ohne Bremsflüssigkeitsbehälter
2.0 D-4D	66	01/02→02/07			→ 05/04; - ESP		24.2120-1749.3 010903	TRW Ø 20,6
					→ 05/04; + ESP		24.2120-1760.3 011018	Ø 20,6 ohne Bremsflüssigkeitsbehälter
TOYOTA - COROLLA LEVIN Coupe (_E10_) 06/91→08/97								
 Hauptbremszylinder								
1.6 GT	85	06/91→08/97			05/92→ 05/95; + ABS		24.2122-1779.3 011064	Ø 22,2 ohne Bremsflüssigkeitsbehälter
TOYOTA - COROLLA Liftback (_E10_) 05/92→12/99								
 Hauptbremszylinder								
1.3 XLI	65	07/92→04/97			→ 05/95; + ABS		24.2122-1779.3 011064	Ø 22,2 ohne Bremsflüssigkeitsbehälter
1.6 GLI	84	07/92→04/97						
2.0 D	53	07/92→04/97						
TOYOTA - COROLLA Liftback (_E11_) 04/97→01/02								
 Hauptbremszylinder								
1.4	63	05/97→09/99			für Linkslenker		03.2122-1691.3 010918	ATE Ø 22,2
1.4	71	10/99→01/02			für Linkslenker; + ABS		03.2122-1691.3 010918	ATE Ø 22,2
1.6	81	02/00→01/02					03.2122-1691.3 010918	ATE Ø 22,2
1.9 D	51	02/00→01/02						
2.0 D-4D	66	09/00→01/02						

	kw					! #		
TOYOTA - COROLLA Stufenheck (_E12_) 08/00→12/08								
 Hauptbremszylinder								
1.3 1.4 D-4D 1.8	65 66 92 - 100	08/00→05/04 06/04→10/06 11/01→10/06		- ESP + ESP			24.2120-1749.3 010903 24.2120-1760.3 011018	TRW Ø 20,6 Ø 20,6 ohne Bremsflüssigkeitsbehälter
1.4 VVT-i 1.5	71 80	10/01→10/06 11/01→07/07		06/04→; - ESP → 05/04; - ESP 06/04→; + ESP → 05/04; + ESP			24.2120-1749.3 010903 24.2120-1749.3 010903 24.2120-1760.3 011018 24.2120-1760.3 011018	TRW Ø 20,6 TRW Ø 20,6 Ø 20,6 ohne Bremsflüssigkeitsbehälter Ø 20,6 ohne Bremsflüssigkeitsbehälter
1.6 VVT-i	81	10/01→03/08		01/02→ 05/04; - ESP 06/04→ 10/06; - ESP 06/04→ 10/06; + ESP 01/02→ 05/04; + ESP			24.2120-1749.3 010903 24.2120-1749.3 010903 24.2120-1760.3 011018 24.2120-1760.3 011018	TRW Ø 20,6 TRW Ø 20,6 Ø 20,6 ohne Bremsflüssigkeitsbehälter Ø 20,6 ohne Bremsflüssigkeitsbehälter
1.8	96	03/01→07/05		01/02→ 05/04; - ESP 01/02→ 05/04; + ESP			24.2120-1749.3 010903 24.2120-1760.3 011018	TRW Ø 20,6 Ø 20,6 ohne Bremsflüssigkeitsbehälter
2.0 D-4D	66	01/02→12/06		05/03→ 05/04; - ESP → 05/04; - ESP 05/03→ 05/04; + ESP → 05/04; + ESP			24.2120-1749.3 010903 24.2120-1749.3 010903 24.2120-1760.3 011018 24.2120-1760.3 011018	TRW Ø 20,6 TRW Ø 20,6 Ø 20,6 ohne Bremsflüssigkeitsbehälter Ø 20,6 ohne Bremsflüssigkeitsbehälter
2.0 D-4D	85	06/04→07/07		→ 10/06; - ESP → 10/06; + ESP			24.2120-1749.3 010903 24.2120-1760.3 011018	TRW Ø 20,6 Ø 20,6 ohne Bremsflüssigkeitsbehälter
TOYOTA - COROLLA Verso (_E12_) 07/01→05/07								
 Hauptbremszylinder								
1.6 VVT-i 2.0 D-4D	81 66	08/01→05/04 01/02→05/04					24.2120-1749.3 010903	TRW Ø 20,6
TOYOTA - COROLLA Verso (ZER_, ZZE12_, R1_) 03/04→04/09								
 Hauptbremszylinder								
1.3 VVTi 1.6 1.8 2.0 D-4D	64 81 95 85	03/04→03/09 04/04→03/09 04/04→03/09 04/04→03/09		09/05→; + ESP 05/04→ 08/05; + ESP			24.2123-1771.3 010857 24.2123-1771.3 010857	BOS Ø 23,8 ohne Bremsflüssigkeitsbehälter BOS Ø 23,8 ohne Bremsflüssigkeitsbehälter
2.2 D-4D	100 - 130	10/05→03/09		+ ESP			24.2123-1771.3 010857	BOS Ø 23,8 ohne Bremsflüssigkeitsbehälter
TOYOTA - RAV 4 II (_A2_) 05/00→11/05								
 Hauptbremszylinder								
1.8	92	08/00→11/05		02/01→ 07/03; Schaltgetriebe 02/01→ 07/03; Automatikgetriebe			24.2120-1757.3 010976 24.2120-1757.3 010976	Ø 20,6 ohne Bremsflüssigkeitsbehälter Ø 20,6 ohne Bremsflüssigkeitsbehälter
2.0 2.0 4WD	110 110	09/00→12/03 05/00→11/05		→ 07/03; Schaltgetriebe → 07/03; Automatikgetriebe			24.2120-1757.3 010976 24.2120-1757.3 010976	Ø 20,6 ohne Bremsflüssigkeitsbehälter Ø 20,6 ohne Bremsflüssigkeitsbehälter
2.0 D 4WD	85	05/01→11/05		09/01→ 07/03; Schaltgetriebe 09/01→ 07/03; Automatikgetriebe			24.2120-1757.3 010976 24.2120-1757.3 010976	Ø 20,6 ohne Bremsflüssigkeitsbehälter Ø 20,6 ohne Bremsflüssigkeitsbehälter
TOYOTA - YARIS / VIOS Stufenheck (_P9_) 08/05→12/13								
 Bremskraftverstärker								
1.5	80	08/07→12/13		für Linkslenker; + ESP für Linkslenker; - ESP			03.7750-7132.4 300255 03.7853-3203.4 300241	ATE Ø 9" pneumatisch ATE Ø 9" pneumatisch
 Hauptbremszylinder								
1.5 →	80	08/07→12/13		+ ESP			03.4152-0058.3 010885	ATE Ø 22,2 ohne Bremsflüssigkeitsbehälter







	kw					! #		
TOYOTA - YARIS / VIOS Stufenheck (_P9_) 08/05→12/13								
 Hauptbremszylinder								
1.5	80	08/07→12/13		+ ESP			03.4152-0158.3 011007	ATE Ø 22,2 ohne Bremsflüssigkeitsbehälter
				- ESP			03.4152-0153.3 011006	ATE Ø 22,2 ohne Bremsflüssigkeitsbehälter
TOYOTA - YARIS (_P1_) 01/99→12/05								
 Hauptbremszylinder								
1.0	48	03/03→09/05		04/03→ 08/05; Fahrzeugproduktionsland Frankreich			24.2120-1766.3 011000	Ø 20,6 ohne Bremsflüssigkeitsbehälter
1.3	64	04/02→09/05		→ 08/05; Fahrzeugproduktionsland Frankreich			24.2120-1766.3 011000	Ø 20,6 ohne Bremsflüssigkeitsbehälter
1.4 D-4D	55	10/01→09/05		12/01→ 08/05; Fahrzeugproduktionsland Frankreich			24.2120-1766.3 011000	Ø 20,6 ohne Bremsflüssigkeitsbehälter
TOYOTA - YARIS (_P9_) 01/05→12/14								
 Bremskraftverstärker								
1.0 GPL 1.0 VVT-i	51 51 - 52	01/06→12/11 08/05→12/11		für Linkslenker; Fahrzeugproduktionsland Frankreich; + ESP			03.7750-7132.4 300255	ATE Ø 9" pneumatisch
				für Linkslenker; Fahrzeugproduktionsland Frankreich; - ESP			03.7853-3203.4 300241	ATE Ø 9" pneumatisch
1.33 VVT-i	73 - 74	11/08→12/11		für Linkslenker; + ESP			03.7750-7132.4 300255	ATE Ø 9" pneumatisch
1.3 4WD 1.3 VVT-i	64 63 - 64	08/07→11/10 08/05→12/12		für Linkslenker; - ESP			03.7853-3203.4 300241	ATE Ø 9" pneumatisch
1.5	80	11/05→12/14						
1.4 D-4D	66	08/05→12/12		für Linkslenker; + ESP			03.7750-7132.4 300255	ATE Ø 9" pneumatisch
				für Linkslenker			03.7853-3402.4 300256	ATE Ø 9" pneumatisch
 Hauptbremszylinder								
1.0 GPL 1.0 VVT-i	51 51 - 52	01/06→12/11 08/05→12/11		Fahrzeugproduktionsland Frankreich; + ESP			03.4152-0058.3 010885	ATE Ø 22,2 ohne Bremsflüssigkeitsbehälter
				Fahrzeugproduktionsland Frankreich; - ESP			03.4152-0153.3 011006	ATE Ø 22,2 ohne Bremsflüssigkeitsbehälter
1.33 VVT-i	73 - 74	11/08→12/11		+ ESP			03.4152-0058.3 010885	ATE Ø 22,2 ohne Bremsflüssigkeitsbehälter
1.3 4WD 1.3 VVT-i	64 64	08/07→11/10 08/05→11/10					03.4152-0158.3 011007	ATE Ø 22,2 ohne Bremsflüssigkeitsbehälter
1.4 D-4D	66	08/05→12/12						
1.5	80	11/05→12/14		- ESP			03.4152-0153.3 011006	ATE Ø 22,2 ohne Bremsflüssigkeitsbehälter
1.3 VVT-i	63	11/05→12/12		+ ESP			03.4152-0058.3 010885	ATE Ø 22,2 ohne Bremsflüssigkeitsbehälter
				01/06→ 08/11; - ESP			03.4152-0153.3 011006	ATE Ø 22,2 ohne Bremsflüssigkeitsbehälter
				01/06→ 08/11; + ESP			03.4152-0158.3 011007	ATE Ø 22,2 ohne Bremsflüssigkeitsbehälter
VAUXHALL - ADAM (M13) 10/12→04/19								
 Hauptbremszylinder								
1.0 1.4 S	85 110	07/14→11/18 11/14→01/19		für Linkslenker; Scheibenbremse			24.4123-1722.3 011071	Ø 23,8 ohne Bremsflüssigkeitsbehälter
1.2 1.4	51 64 - 74	10/12→04/19 10/12→02/19		01/13→; für Linkslenker; Scheibenbremse			24.4123-1722.3 011071	Ø 23,8 ohne Bremsflüssigkeitsbehälter
VAUXHALL - AGILA Mk I (A) (H00) 02/00→03/08								
 Hauptbremszylinder								
1.0 12V 1.2 16V Twinport	43 59	09/00→08/05 07/04→11/06		+ ABS			24.2120-1730.3 010678	Ø 20,6
1.0 12V	44	02/00→11/06		09/00→; + ABS			24.2120-1730.3 010678	Ø 20,6
1.2 16V	55	09/00→03/08		+ ABS; → 07/07			24.2120-1730.3 010678	Ø 20,6
VAUXHALL - AGILA Mk II (B) (H08) 01/08→11/14								
 Hauptbremszylinder								
1.0 12V 1.0 i →	48 50	01/08→11/14 08/11→11/14		für Linkslenker; - ESP			24.4122-1718.3 011019	BOS Ø 22,2 ohne Bremsflüssigkeitsbehälter

	kw					! #		
VAUXHALL - AGILA Mk II (B) (H08) 01/08→11/14								
 Hauptbremszylinder								
1.2 i 16V	63	01/08→11/14			für Linkslenker; + ESP		24.4122-1719.3 011020	Ø 22,2 ohne Bremsflüssigkeitsbehälter
1.3 CDTI	69 55	01/08→11/14						
VAUXHALL - ASTRA Mk III (F) Cabriolet (T92) 09/91→03/01								
 Bremskraftregler								
1.6 i	55	01/96→03/01			→ R2500000		03.0101-0027.2 320022	ATE Satz 3/45 2x
VAUXHALL - ASTRA Mk III (F) CC (T92) 09/91→02/98								
 Hauptbremszylinder								
1.4 i	44	09/91→02/98			10/91→; - ABS		24.2120-0702.3 010361	nicht für Delco Ø 20,6
1.4 S	55	09/91→02/98						
1.8 i	66	09/91→02/98						
1.4 i	60	03/92→02/98			- ABS; für Fahrzeuge mit verstärkter Bremse		03.2122-0264.3 010129	ATE Ø 22,2
1.7 D	42	12/91→02/98			- ABS; nicht für Fahrzeuge mit verstärkter Bremse		24.2120-0702.3 010361	nicht für Delco Ø 20,6
1.6 i	74	03/92→02/98			- ABS		03.2122-0264.3 010129	ATE Ø 22,2
1.6 i 16V	74	01/94→02/98						
1.8 i 16V	92	09/94→02/98						
1.7 TD	50 - 60	12/91→02/98			- ABS		24.2120-0702.3 010361	nicht für Delco Ø 20,6
2.0 i	85	09/91→02/98			10/91→; - ABS		03.2122-0264.3 010129	ATE Ø 22,2
 Bremskraftregler								
1.4 i	44	09/91→02/98			10/91→		03.0101-0027.2 320022	ATE Satz 3/45 2x
1.4 S	55	09/91→02/98						
1.4 i	60	03/92→02/98			Schaltgetriebe		03.0101-0027.2 320022	ATE Satz 3/45 2x
1.6 i	55	09/91→02/98			10/91→; → R2500000		03.0101-0027.2 320022	ATE Satz 3/45 2x
1.6 i	74	03/92→02/98			→ 07/93		03.0101-0026.2 320230	ATE Satz 3/40 2x
					08/93→		03.6583-0054.3 320146	ATE lastabhängig 8/3 4x
1.6 i 16V	74	01/94→02/98					03.6583-0054.3 320146	ATE lastabhängig 8/3 4x
1.8 i 16V	85 - 92	09/94→02/98						
1.7 D	42	12/91→02/98			→ 07/93		03.0101-0026.2 320230	ATE Satz 3/40 2x
1.8 i	66	09/91→02/98			10/91→ 07/93		03.0101-0027.2 320022	ATE Satz 3/45 2x
2.0 i	85	09/91→02/98			08/93→		03.6583-0054.3 320146	ATE lastabhängig 8/3 4x
2.0 i 16V	110	09/91→02/98			08/92→		03.6583-0054.3 320146	ATE lastabhängig 8/3 4x
VAUXHALL - ASTRA Mk III (F) Kombi (T92) 03/91→12/98								
 Hauptbremszylinder								
1.4 i	44	09/91→02/98			10/91→; - ABS		24.2120-0702.3 010361	nicht für Delco Ø 20,6
1.8 i	66	09/91→02/98						
1.4 i	60	03/91→02/98			10/91→; - ABS; für Fahrzeuge mit verstärkter Bremse		03.2122-0264.3 010129	ATE Ø 22,2
					10/91→; - ABS; nicht für Fahrzeuge mit verstärkter Bremse		24.2120-0702.3 010361	nicht für Delco Ø 20,6
1.6 i	52	07/94→02/98			- ABS		24.2120-0702.3 010361	nicht für Delco Ø 20,6
1.7 TD	50 - 60	12/91→02/98						
1.6 i 16V	74	01/94→02/98			- ABS		03.2122-0264.3 010129	ATE Ø 22,2
1.7 D	42	12/91→02/98			- ABS; für Fahrzeuge mit verstärkter Bremse		03.2122-0264.3 010129	ATE Ø 22,2
					- ABS; nicht für Fahrzeuge mit verstärkter Bremse		24.2120-0702.3 010361	nicht für Delco Ø 20,6
2.0 i	85	09/91→02/98			10/91→; - ABS		03.2122-0264.3 010129	ATE Ø 22,2
VAUXHALL - ASTRA Mk III (F) Stufenheck (T92) 09/91→09/98								
 Hauptbremszylinder								
1.6 i 16V	74	08/94→09/98			- ABS		03.2122-0264.3 010129	ATE Ø 22,2
1.8 i 16V	82	09/95→02/98						
2.0 i	85	03/92→09/98						
1.7 D	44	07/92→09/98			- ABS; für Fahrzeuge mit verstärkter Bremse		03.2122-0264.3 010129	ATE Ø 22,2
					- ABS; nicht für Fahrzeuge mit verstärkter Bremse		24.2120-0702.3 010361	nicht für Delco Ø 20,6
1.7 TD	50 - 60	12/91→09/98			- ABS		24.2120-0702.3 010361	nicht für Delco Ø 20,6
1.8 i →	66	03/92→09/98						











	kw					! #		
VAUXHALL - ASTRA Mk III (F) Stufenheck (T92) 09/91→09/98								
 Bremskraftregler								
1.6 i	55	03/92→09/98			→ R2500000		03.0101-0027.2 320022	ATE Satz 3/45 2x
1.6 i 16V	74	08/94→09/98					03.6583-0054.3 320146	ATE lastabhängig 8/3 4x
2.0 i 16V	100	02/95→09/98						
1.7 D	44	07/92→09/98			→ 07/93		03.0101-0026.2 320230	ATE Satz 3/40 2x
1.8 i	66	03/92→09/98			→ 07/93		03.0101-0027.2 320022	ATE Satz 3/45 2x
2.0 i	85	03/92→09/98			08/93→		03.6583-0054.3 320146	ATE lastabhängig 8/3 4x
VAUXHALL - ASTRA Mk IV (G) Cabriolet (T98) 03/01→10/05								
 Hauptbremszylinder								
1.6 16V	74 - 76	03/01→10/05			- ESP		24.2123-1734.3 010640	TRW Ø 23,8
					+ ESP		24.2123-1739.3 010661	Ø 23,8
1.8 16V	92	03/01→10/05						
2.0	147	09/02→10/05						
2.0 Turbo	141	03/02→10/05						
2.2 16V	108	03/01→10/05						
VAUXHALL - ASTRA Mk IV (G) CC (T98) 02/98→05/05								
 Hauptbremszylinder								
1.4 16V	66	02/98→05/05			04/98→; - ESP; für Fahrzeuge mit Scheibenbremse an der Hinterachse		24.2123-1734.3 010640	TRW Ø 23,8
1.6	55	02/98→09/00						
1.6 16V	74	02/98→05/05			22000001→; - ESP; für Fahrzeuge mit Trommelbremse an der Hinterachse		24.2123-1734.3 010640	TRW Ø 23,8
1.6 Dualfuel	55	02/98→12/00						
					04/98→; + ESP		24.2123-1739.3 010661	Ø 23,8
1.4 16V Dualfuel	66	09/99→06/03			- ESP; für Fahrzeuge mit Scheibenbremse an der Hinterachse		24.2123-1734.3 010640	TRW Ø 23,8
1.6	62	09/00→05/05						
1.6 Dualfuel	62 - 74	09/99→05/05			22000001→; - ESP; für Fahrzeuge mit Trommelbremse an der Hinterachse		24.2123-1734.3 010640	TRW Ø 23,8
1.7 DTI 16V	55	02/00→05/05						
					+ ESP		24.2123-1739.3 010661	Ø 23,8
1.6	76	12/02→05/05			- ESP		24.2123-1734.3 010640	TRW Ø 23,8
1.8 16V	92	09/00→05/05						
1.8 16V Dualfuel	87 - 92	07/02→05/05			+ ESP		24.2123-1739.3 010661	Ø 23,8
2.0	147	08/02→05/05						
2.0 DTI 16V	74	08/99→05/05						
2.0 SRI Turbo	141	11/01→05/05						
2.2 16V	108	03/01→05/05						
1.7 CDTI 16V	59	04/03→05/05			- ESP		24.2123-1734.3 010640	TRW Ø 23,8
1.7 TD	50	02/98→08/00			04/98→; - ESP; für Fahrzeuge mit Scheibenbremse an der Hinterachse		24.2123-1734.3 010640	TRW Ø 23,8
					04/98→; + ESP		24.2123-1739.3 010661	Ø 23,8
1.8 16V	85	02/98→09/00			04/98→; - ESP		24.2123-1734.3 010640	TRW Ø 23,8
2.0 16V	100	02/98→05/05						
2.0 DI	60	02/98→05/05			04/98→; + ESP		24.2123-1739.3 010661	Ø 23,8
 Bremskraftregler								
1.4 16V	66	02/98→05/05			04/98→; - ABS		03.6583-0074.3 320235	ATE lastabhängig 8/3 4x
1.6	55	02/98→09/00						
1.6 16V	74	02/98→05/05						
1.6 Dualfuel	55	02/98→12/00						
1.7 TD	50	02/98→08/00						
1.8 16V	85	02/98→09/00						
2.0 16V	100	02/98→05/05						
2.0 DI	60	02/98→05/05						
1.4 16V Dualfuel	66	09/99→06/03			- ABS		03.6583-0074.3 320235	ATE lastabhängig 8/3 4x
1.6	62	09/00→05/05						
1.6 Dualfuel	63 - 74	09/99→05/05						
1.7 CDTI 16V	59	04/03→05/05						
1.7 DTI 16V	55	02/00→05/05						
1.8 16V	92	09/00→05/05						
1.8 16V Dualfuel	87 - 92	07/02→05/05						
2.0 DTI 16V	74	08/99→05/05						
VAUXHALL - ASTRA Mk IV (G) Coupe (T98) 03/00→08/05								
 Hauptbremszylinder								
1.6 16V	76	03/00→08/05			- ESP; für Fahrzeuge mit Scheibenbremse an der Hinterachse		24.2123-1734.3 010640	TRW Ø 23,8
					22000001→; - ESP; für Fahrzeuge mit Trommelbremse an der Hinterachse		24.2123-1734.3 010640	TRW Ø 23,8
					+ ESP		24.2123-1739.3 010661	Ø 23,8
1.8 16V	85 - 92	03/00→08/05			- ESP		24.2123-1734.3 010640	TRW Ø 23,8
→					+ ESP		24.2123-1739.3 010661	Ø 23,8

	kw					! #		
VAUXHALL - ASTRA Mk IV (G) Coupe (T98) 03/00→08/05								
 Hauptbremszylinder								
1.8 16V Dualfuel	87 - 92	07/02→08/05		- ESP		24.2123-1734.3	010640	TRW Ø 23,8
2.0 16V Turbo	140	09/00→08/05		+ ESP		24.2123-1739.3	010661	Ø 23,8
2.2 16V	108	03/00→08/05		09/00→; - ESP		24.2123-1734.3	010640	TRW Ø 23,8
				09/00→; + ESP		24.2123-1739.3	010661	Ø 23,8
VAUXHALL - ASTRA Mk IV (G) Kombi (T98) 02/98→05/05								
 Hauptbremszylinder								
1.4 16V	66	02/98→05/05		04/98→; - ESP; für Fahrzeuge mit Scheibenbremse an der Hinterachse		24.2123-1734.3	010640	TRW Ø 23,8
1.6	55 - 62	03/98→04/04						
1.6 16V	74	03/98→04/04		22000001→; - ESP; für Fahrzeuge mit Trommelbremse an der Hinterachse		24.2123-1734.3	010640	TRW Ø 23,8
1.6 Dualfuel	63	03/98→04/04		04/98→; + ESP		24.2123-1739.3	010661	Ø 23,8
1.4 16V Dualfuel	66	09/99→06/03		- ESP; für Fahrzeuge mit Scheibenbremse an der Hinterachse		24.2123-1734.3	010640	TRW Ø 23,8
1.6	76	12/02→05/05						
1.6 Dualfuel	55 - 74	02/98→05/05		22000001→; - ESP; für Fahrzeuge mit Trommelbremse an der Hinterachse		24.2123-1734.3	010640	TRW Ø 23,8
1.7 DTI 16V	55	02/00→05/05		+ ESP		24.2123-1739.3	010661	Ø 23,8
1.7 CDTI 16V	59	04/03→05/05		- ESP		24.2123-1734.3	010640	TRW Ø 23,8
1.7 TD	50	02/98→08/00		04/98→; - ESP; für Fahrzeuge mit Scheibenbremse an der Hinterachse		24.2123-1734.3	010640	TRW Ø 23,8
				04/98→; + ESP		24.2123-1739.3	010661	Ø 23,8
1.8 16V	85	02/98→08/00		04/98→; - ESP		24.2123-1734.3	010640	TRW Ø 23,8
2.0 DI	60	03/98→04/04		04/98→; + ESP		24.2123-1739.3	010661	Ø 23,8
1.8 16V	92	09/00→05/05		- ESP		24.2123-1734.3	010640	TRW Ø 23,8
1.8 16V Dualfuel	87 - 92	07/02→05/05		+ ESP		24.2123-1739.3	010661	Ø 23,8
2.2 16V	108	03/01→05/05						
2.0 DTI 16V	74	03/98→04/04		08/99→; - ESP		24.2123-1734.3	010640	TRW Ø 23,8
				08/99→; + ESP		24.2123-1739.3	010661	Ø 23,8
 Bremskraftregler								
1.4 16V	66	02/98→05/05		04/98→; - ABS		03.6583-0073.3	320234	ATE lastabhängig 8/3 4x
1.6	55 - 62	03/98→04/04						
1.6 16V	74	03/98→04/04						
1.6 Dualfuel	63	03/98→04/04						
1.7 TD	50	02/98→08/00						
1.8 16V	85	02/98→08/00						
1.4 16V Dualfuel	66	09/99→06/03		- ABS		03.6583-0073.3	320234	ATE lastabhängig 8/3 4x
1.6	76	12/02→05/05						
1.6 Dualfuel	55 - 74	02/98→08/04						
1.7 CDTI 16V	59	04/03→05/05						
1.7 DTI 16V	55	02/00→05/05						
1.8 16V	92	09/00→05/05						
1.8 16V Dualfuel	87 - 92	07/02→05/05						
2.0 DI	60	03/98→04/04		04/98→; - ABS		03.6583-0074.3	320235	ATE lastabhängig 8/3 4x
2.0 DTI 16V	74	03/98→04/04		08/99→; - ABS		03.6583-0074.3	320235	ATE lastabhängig 8/3 4x
VAUXHALL - ASTRA Mk IV (G) Stufenheck (T98) 02/98→05/05								
 Hauptbremszylinder								
1.4 16V	66	09/98→05/05		- ESP; für Fahrzeuge mit Scheibenbremse an der Hinterachse		24.2123-1734.3	010640	TRW Ø 23,8
1.6	55 - 62	09/98→05/05						
1.6 16V	74	09/98→05/05		22000001→; - ESP; für Fahrzeuge mit Trommelbremse an der Hinterachse		24.2123-1734.3	010640	TRW Ø 23,8
1.6 Dualfuel	55 - 74	02/98→05/05		+ ESP		24.2123-1739.3	010661	Ø 23,8
1.7 DTI 16V	55	02/00→05/05						
1.7 CDTI 16V	59	04/03→05/05		- ESP		24.2123-1734.3	010640	TRW Ø 23,8
1.7 TD	50	09/98→08/00		- ESP; für Fahrzeuge mit Scheibenbremse an der Hinterachse		24.2123-1734.3	010640	TRW Ø 23,8
				+ ESP		24.2123-1739.3	010661	Ø 23,8
1.8 16V	85 - 92	02/98→07/04		04/98→; - ESP		24.2123-1734.3	010640	TRW Ø 23,8
1.8 16V Dualfuel	87	02/98→07/04		04/98→; + ESP		24.2123-1739.3	010661	Ø 23,8
2.0 DI	60	02/98→07/04						
1.8 16V Dualfuel	92	07/02→12/03		- ESP		24.2123-1734.3	010640	TRW Ø 23,8
2.0 16V	100	09/98→05/05		+ ESP		24.2123-1739.3	010661	Ø 23,8
2.0 DTI 16V	74	02/98→07/04		08/99→; - ESP		24.2123-1734.3	010640	TRW Ø 23,8
				08/99→; + ESP		24.2123-1739.3	010661	Ø 23,8



























	kw					! #		
VAUXHALL - ASTRA Mk IV (G) Stufenheck (T98) 02/98→05/05								
Bremskraftregler								
1.4 16V 1.6	66 55 - 62	09/98→05/05 09/98→05/05		- ABS			03.6583-0074.3 320235	ATE lastabhängig 8/3 4x
1.6 16V 1.6 Dualfuel	74 55 - 74	09/98→05/05 02/98→05/05						
1.7 CDTI 16V 1.7 DTI 16V 1.7 TD	59 55 50	04/03→05/05 02/00→05/05 09/98→08/00						
1.8 16V Dualfuel 2.0 16V	92 100	07/02→12/03 09/98→05/05						
1.8 16V 1.8 16V Dualfuel 2.0 DI 2.0 DTI 16V	85 - 92 87 60 74	02/98→07/04 02/98→07/04 02/98→07/04 02/98→07/04		04/98→; - ABS 08/99→; - ABS			03.6583-0074.3 320235	ATE lastabhängig 8/3 4x
VAUXHALL - ASTRA Mk V (H) (A04) 01/04→03/11								
Bremskraftverstärker								
1.9 CDTI 1.9 CDTI 16V	88 - 110 88	01/04→05/09 01/04→05/09		09/04→; für Linkslenker			03.7863-7803.4 300237	ATE Ø 10" pneumatisch
Hauptbremszylinder								
1.3 CDTI	66	01/04→05/09		08/05→; → 68999999; für Linkslenker; + ESP			24.2125-1736.3 010904	TRW Ø 25,4
				08/05→; → 68999999; für Rechtslenker			24.2125-1736.3 010904	TRW Ø 25,4
				08/05→; → 68999999; für Linkslenker; - ESP			24.2125-1737.3 010906	TRW Ø 25,4
				72000001→; für Rechtslenker			24.4125-1703.3 010907	TRW Ø 25,4
				72000001→; für Linkslenker; + ESP			24.4125-1703.3 010907	TRW Ø 25,4
				72000001→; für Linkslenker; - ESP			24.4125-1704.3 010908	TRW Ø 25,4
1.4 1.6 1.7 CDTI	66 77 59 - 74	01/04→05/09 01/04→05/09 01/04→05/09		für Rechtslenker; → 68999999			24.2125-1736.3 010904	TRW Ø 25,4
				für Linkslenker; → 68999999; + ESP			24.2125-1736.3 010904	TRW Ø 25,4
				für Linkslenker; → 68999999; - ESP			24.2125-1737.3 010906	TRW Ø 25,4
1.8 2.0 Turbo	92 125	01/04→05/09 01/04→05/09		72000001→; für Rechtslenker			24.4125-1703.3 010907	TRW Ø 25,4
				72000001→; für Linkslenker; + ESP			24.4125-1703.3 010907	TRW Ø 25,4
				72000001→; für Linkslenker; - ESP			24.4125-1704.3 010908	TRW Ø 25,4
1.6 1.6 Turbo	85 132	01/04→05/09 09/06→09/09		01/07→; → 68999999; für Linkslenker; + ESP			24.2125-1736.3 010904	TRW Ø 25,4
				01/07→; → 68999999; für Rechtslenker			24.2125-1736.3 010904	TRW Ø 25,4
				01/07→; → 68999999; für Linkslenker; - ESP			24.2125-1737.3 010906	TRW Ø 25,4
				72000001→; für Rechtslenker			24.4125-1703.3 010907	TRW Ø 25,4
				72000001→; für Linkslenker; + ESP			24.4125-1703.3 010907	TRW Ø 25,4
				72000001→; für Linkslenker; - ESP			24.4125-1704.3 010908	TRW Ø 25,4
1.7 CDTi	81	01/04→03/11		04/07→; → 68999999; für Linkslenker; + ESP			24.2125-1736.3 010904	TRW Ø 25,4
				04/07→; → 68999999; für Rechtslenker			24.2125-1736.3 010904	TRW Ø 25,4
				04/07→; → 68999999; für Linkslenker; - ESP			24.2125-1737.3 010906	TRW Ø 25,4
				72000001→; für Rechtslenker			24.4125-1703.3 010907	TRW Ø 25,4
				72000001→; für Linkslenker; + ESP			24.4125-1703.3 010907	TRW Ø 25,4
				72000001→; für Linkslenker; - ESP			24.4125-1704.3 010908	TRW Ø 25,4
1.8	103	01/04→05/09		01/06→; → 68999999; für Linkslenker; + ESP			24.2125-1736.3 010904	TRW Ø 25,4
				01/06→; → 68999999; für Rechtslenker			24.2125-1736.3 010904	TRW Ø 25,4
				01/06→; → 68999999; für Linkslenker; - ESP			24.2125-1737.3 010906	TRW Ø 25,4
				72000001→; für Rechtslenker			24.4125-1703.3 010907	TRW Ø 25,4
				72000001→; für Linkslenker; + ESP			24.4125-1703.3 010907	TRW Ø 25,4
				72000001→; für Linkslenker; - ESP			24.4125-1704.3 010908	TRW Ø 25,4
1.9 CDTI 1.9 CDTI 16V 2.0 Turbo	88 - 110 88 147	01/04→05/09 01/04→05/09 01/04→05/09		09/04→			03.4155-0156.3 010862	ATE Ø 25,4
				09/04→; für Linkslenker; → 68999999; + ESP			24.2125-1736.3 010904	TRW Ø 25,4
				09/04→; für Rechtslenker; → 68999999			24.2125-1736.3 010904	TRW Ø 25,4
				09/04→; für Linkslenker; → 68999999; - ESP			24.2125-1737.3 010906	TRW Ø 25,4

































	kw					! #		
VAUXHALL - ASTRA Mk V (H) (A04) 01/04→03/11								
 Hauptbremszylinder								
2.0 Turbo	147	01/04→05/09		72000001→; für Rechtslenker	24.4125-1703.3	010907	TRW Ø 25,4	
				72000001→; für Linkslenker; + ESP	24.4125-1703.3	010907	TRW Ø 25,4	
				72000001→; für Linkslenker; - ESP	24.4125-1704.3	010908	TRW Ø 25,4	
2.0 Turbo	177	01/04→05/09		03/05→; → 68999999; für Linkslenker; + ESP	24.2125-1736.3	010904	TRW Ø 25,4	
				03/05→; → 68999999; für Rechtslenker	24.2125-1736.3	010904	TRW Ø 25,4	
				03/05→; → 68999999; für Linkslenker; - ESP	24.2125-1737.3	010906	TRW Ø 25,4	
				72000001→; für Rechtslenker	24.4125-1703.3	010907	TRW Ø 25,4	
				72000001→; für Linkslenker; + ESP	24.4125-1703.3	010907	TRW Ø 25,4	
				72000001→; für Linkslenker; - ESP	24.4125-1704.3	010908	TRW Ø 25,4	
VAUXHALL - ASTRA Mk V (H) Kombi (A04) 08/04→10/12								
 Bremskraftverstärker								
1.9 CDTi	88	08/04→03/09		für Linkslenker	03.7863-7803.4	300237	ATE Ø 10" pneumatisch	
1.9 CDTi 16V	88	08/04→03/09						
1.9 CDTi	110	08/04→03/09		09/04→; für Linkslenker	03.7863-7803.4	300237	ATE Ø 10" pneumatisch	
 Hauptbremszylinder								
1.3 CDTi	66	08/04→03/09		72000001→; für Linkslenker; + ESP	24.2125-1703.3	010483	Ø 25,4	
				72000001→; für Linkslenker; - ESP	24.2125-1704.3	010446	TRW Ø 25,4	
				08/05→; → 62999999; für Rechtslenker	24.2125-1736.3	010904	TRW Ø 25,4	
				08/05→; → 68999999; für Linkslenker; + ESP	24.2125-1736.3	010904	TRW Ø 25,4	
				08/05→; → 68999999; für Linkslenker; - ESP	24.2125-1737.3	010906	TRW Ø 25,4	
				72000001→; für Rechtslenker	24.4125-1703.3	010907	TRW Ø 25,4	
1.4 1.6 1.7 CDTi 1.7 CDTi 1.8	66 77 74 59 92 - 103 125	08/04→03/09 08/04→03/09 08/04→03/09 08/04→05/09 10/04→10/10		72000001→; für Linkslenker; + ESP	24.2125-1703.3	010483	Ø 25,4	
				72000001→; für Linkslenker; - ESP	24.2125-1704.3	010446	TRW Ø 25,4	
				→ 62999999; für Rechtslenker	24.2125-1736.3	010904	TRW Ø 25,4	
				→ 68999999; für Linkslenker; + ESP	24.2125-1736.3	010904	TRW Ø 25,4	
				→ 68999999; für Linkslenker; - ESP	24.2125-1737.3	010906	TRW Ø 25,4	
				72000001→; für Rechtslenker	24.4125-1703.3	010907	TRW Ø 25,4	
2.0 Turbo	125	08/04→10/10		72000001→; für Rechtslenker	24.4125-1703.3	010907	TRW Ø 25,4	
1.6	85 - 132	08/04→03/11		72000001→; für Linkslenker; + ESP	24.2125-1703.3	010483	Ø 25,4	
				72000001→; für Linkslenker; - ESP	24.2125-1704.3	010446	TRW Ø 25,4	
				01/07→; → 62999999; für Rechtslenker	24.2125-1736.3	010904	TRW Ø 25,4	
				01/07→; → 68999999; für Linkslenker; + ESP	24.2125-1736.3	010904	TRW Ø 25,4	
				01/07→; → 68999999; für Linkslenker; - ESP	24.2125-1737.3	010906	TRW Ø 25,4	
				72000001→; für Rechtslenker	24.4125-1703.3	010907	TRW Ø 25,4	
1.7 CDTi	81	08/04→10/12		72000001→; → 11/10; für Linkslenker; + ESP	24.2125-1703.3	010483	Ø 25,4	
				72000001→; → 11/10; für Linkslenker; - ESP	24.2125-1704.3	010446	TRW Ø 25,4	
				04/07→; → 62999999; für Rechtslenker	24.2125-1736.3	010904	TRW Ø 25,4	
				04/07→; → 68999999; für Linkslenker; + ESP	24.2125-1736.3	010904	TRW Ø 25,4	
				04/07→; → 68999999; für Linkslenker; - ESP	24.2125-1737.3	010906	TRW Ø 25,4	
				72000001→; → 11/10; für Rechtslenker	24.4125-1703.3	010907	TRW Ø 25,4	
1.9 CDTi 1.9 CDTi 16V	88 88	08/04→03/09 08/04→03/09			03.4155-0156.3	010862	ATE Ø 25,4	
1.9 CDTi	110	08/04→03/09		09/04→	03.4155-0156.3	010862	ATE Ø 25,4	
2.0 Turbo	147	08/04→10/10		72000001→; für Linkslenker; + ESP	24.2125-1703.3	010483	Ø 25,4	
				72000001→; für Linkslenker; - ESP	24.2125-1704.3	010446	TRW Ø 25,4	
				09/04→; → 62999999; für Rechtslenker	24.2125-1736.3	010904	TRW Ø 25,4	
				09/04→; → 68999999; für Linkslenker; + ESP	24.2125-1736.3	010904	TRW Ø 25,4	
				09/04→; → 68999999; für Linkslenker; - ESP	24.2125-1737.3	010906	TRW Ø 25,4	
				72000001→; für Rechtslenker	24.4125-1703.3	010907	TRW Ø 25,4	
VAUXHALL - ASTRA Mk V (H) Sport Hatch (A04) 02/05→11/10								
 Bremskraftverstärker								
1.9 CDTi	74	08/05→11/10		09/05→; für Linkslenker	03.7863-7803.4	300237	ATE Ø 10" pneumatisch	
→								



























	kw			 	! #		
VAUXHALL - ASTRA Mk V (H) Sport Hatch (A04) 02/05→11/10							
 Bremskraftverstärker							
1.9 CDTi	88 - 110	02/05→11/10		für Linkslenker		03.7863-7803.4 300237	ATE Ø 10" pneumatisch
 Hauptbremszylinder							
1.3 CDTi	66	04/05→11/10		08/05→; → 68999999; für Linkslenker; + ESP		24.2125-1736.3 010904	TRW Ø 25,4
				08/05→; → 68999999; für Rechtslenker		24.2125-1736.3 010904	TRW Ø 25,4
				08/05→; → 68999999; für Linkslenker; - ESP		24.2125-1737.3 010906	TRW Ø 25,4
				72000001→; für Rechtslenker		24.4125-1703.3 010907	TRW Ø 25,4
				72000001→; für Linkslenker; + ESP		24.4125-1703.3 010907	TRW Ø 25,4
				72000001→; für Linkslenker; - ESP		24.4125-1704.3 010908	TRW Ø 25,4
1.4 i 16V	66	03/05→11/10		für Rechtslenker; → 68999999		24.2125-1736.3 010904	TRW Ø 25,4
1.6	77	02/05→11/10		für Linkslenker; → 68999999; + ESP		24.2125-1736.3 010904	TRW Ø 25,4
1.7 CDTi	74	02/05→11/10		für Linkslenker; → 68999999; - ESP		24.2125-1737.3 010906	TRW Ø 25,4
1.8	92	02/05→11/10		für Linkslenker; → 68999999; - ESP		24.2125-1737.3 010906	TRW Ø 25,4
1.8 i 16V	103	03/07→11/10		72000001→; für Rechtslenker		24.4125-1703.3 010907	TRW Ø 25,4
2.0 Turbo	125	02/05→11/10		72000001→; für Linkslenker; + ESP		24.4125-1703.3 010907	TRW Ø 25,4
2.0 VXR	176	02/09→11/10		72000001→; für Linkslenker; - ESP		24.4125-1704.3 010908	TRW Ø 25,4
1.6 1.6 i 16V	132 85	10/06→11/10 12/06→11/10		01/07→; → 68999999; für Linkslenker; + ESP		24.2125-1736.3 010904	TRW Ø 25,4
				01/07→; → 68999999; für Rechtslenker		24.2125-1736.3 010904	TRW Ø 25,4
				01/07→; → 68999999; für Linkslenker; - ESP		24.2125-1737.3 010906	TRW Ø 25,4
				72000001→; für Rechtslenker		24.4125-1703.3 010907	TRW Ø 25,4
				72000001→; für Linkslenker; + ESP		24.4125-1703.3 010907	TRW Ø 25,4
	72000001→; für Linkslenker; - ESP		24.4125-1704.3 010908	TRW Ø 25,4			
1.7 CDTi	81	02/07→11/09		04/07→; → 68999999; für Linkslenker; + ESP		24.2125-1736.3 010904	TRW Ø 25,4
				04/07→; → 68999999; für Rechtslenker		24.2125-1736.3 010904	TRW Ø 25,4
				04/07→; → 68999999; für Linkslenker; - ESP		24.2125-1737.3 010906	TRW Ø 25,4
				72000001→; für Rechtslenker		24.4125-1703.3 010907	TRW Ø 25,4
				72000001→; für Linkslenker; + ESP		24.4125-1703.3 010907	TRW Ø 25,4
	72000001→; für Linkslenker; - ESP		24.4125-1704.3 010908	TRW Ø 25,4			
1.9 CDTi	74	08/05→11/10		09/05→		03.4155-0156.3 010862	ATE Ø 25,4
1.9 CDTi	88 - 110	02/05→11/10				03.4155-0156.3 010862	ATE Ø 25,4
VAUXHALL - ASTRA Mk V (H) TwinTop (A04) 09/05→08/11							
 Bremskraftverstärker							
1.9 CDTi	110	01/06→11/10		03/06→; für Linkslenker		03.7863-7803.4 300237	ATE Ø 10" pneumatisch
 Hauptbremszylinder							
1.6 2.0 2.0 Turbo	77 125 147	09/05→11/10 02/06→11/10 01/06→11/10		03/06→; → 68999999; für Linkslenker; + ESP		24.2125-1736.3 010904	TRW Ø 25,4
				03/06→; → 68999999; für Rechtslenker		24.2125-1736.3 010904	TRW Ø 25,4
				03/06→; → 68999999; für Linkslenker; - ESP		24.2125-1737.3 010906	TRW Ø 25,4
				03/06→; für Rechtslenker		24.4125-1703.3 010907	TRW Ø 25,4
				72000001→; für Linkslenker; + ESP		24.4125-1703.3 010907	TRW Ø 25,4
				72000001→; für Linkslenker; - ESP		24.4125-1704.3 010908	TRW Ø 25,4
1.6 i 16V	85	10/06→08/11		12/06→; → 68999999; für Linkslenker; + ESP		24.2125-1736.3 010904	TRW Ø 25,4
				12/06→; → 68999999; für Rechtslenker		24.2125-1736.3 010904	TRW Ø 25,4
				12/06→; → 68999999; für Linkslenker; - ESP		24.2125-1737.3 010906	TRW Ø 25,4
				12/06→; für Rechtslenker		24.4125-1703.3 010907	TRW Ø 25,4
				72000001→; für Linkslenker; + ESP		24.4125-1703.3 010907	TRW Ø 25,4
				72000001→; für Linkslenker; - ESP		24.4125-1704.3 010908	TRW Ø 25,4
1.8	103	05/08→11/10		→ 68999999; für Rechtslenker		24.2125-1736.3 010904	TRW Ø 25,4
				→ 68999999; für Linkslenker; + ESP		24.2125-1736.3 010904	TRW Ø 25,4
				→ 68999999; für Linkslenker; - ESP		24.2125-1737.3 010906	TRW Ø 25,4
				für Rechtslenker		24.4125-1703.3 010907	TRW Ø 25,4
				72000001→; für Linkslenker; + ESP		24.4125-1703.3 010907	TRW Ø 25,4
				72000001→; für Linkslenker; - ESP		24.4125-1704.3 010908	TRW Ø 25,4
→							













	kw			 	! #		
VAUXHALL - ASTRA Mk V (H) TwinTop (A04) 09/05→08/11							
 Hauptbremszylinder							
1.9 CDTi	110	01/06→11/10		03/06→; für Rechtslenker		03.4155-0156.3 010862	ATE Ø 25,4
				03/06→; für Linkslenker; + ESP		03.4155-0156.3 010862	ATE Ø 25,4
VAUXHALL - ASTRA Mk VI (J) (P10) 12/09→10/15							
 Bremskraftverstärker							
1.3 CDTI	70	12/09→10/15		für Linkslenker		03.7858-0732.4 300272	ATE Ø 9 / 8" pneumatisch
1.4	64 - 74	12/09→10/15					
1.4 Turbo	88 - 103	12/09→10/15					
1.6	85	12/09→10/15					
1.6 Turbo	132	12/09→10/15					
1.7 CDTi	81 - 96	12/09→10/15					
1.7 CDTI	74	10/10→10/15					
2.0 BiTurbo CDTI	143	12/12→10/15					
2.0 CDTi	118 - 121	12/09→10/15					
1.6 CDTi	81	11/13→10/15		02/14→; für Linkslenker		03.7858-0732.4 300272	ATE Ø 9 / 8" pneumatisch
1.6 CDTi	100	11/13→10/15		01/14→; für Linkslenker		03.7858-0732.4 300272	ATE Ø 9 / 8" pneumatisch
 Hauptbremszylinder							
1.3 CDTI	70	12/09→10/15		für Linkslenker		03.2125-0421.3 010934	ATE Ø 25,4
1.4	64 - 74	12/09→10/15					
1.4 Turbo	88 - 103	12/09→10/15					
1.6	85	12/09→10/15					
1.6 Turbo	132	12/09→10/15					
1.7 CDTi	81 - 96	12/09→10/15					
1.7 CDTI	74	10/10→10/15					
2.0 BiTurbo CDTI	143	12/12→10/15					
2.0 CDTi	118 - 121	12/09→10/15					
1.6 CDTi	81	11/13→10/15		02/14→; für Linkslenker		03.2125-0421.3 010934	ATE Ø 25,4
1.6 CDTi	100	11/13→10/15		01/14→; für Linkslenker		03.2125-0421.3 010934	ATE Ø 25,4
VAUXHALL - ASTRA Mk VI (J) GTC (P10) 10/11→10/15							
 Bremskraftverstärker							
1.4	74 - 103	10/11→10/15		für Linkslenker		03.7858-0732.4 300272	ATE Ø 9 / 8" pneumatisch
1.6	132	10/11→10/15					
1.6 CDTi	81 - 100	07/14→10/15					
1.6 SIDI	125 - 147	09/13→10/15					
1.7 CDTi	81 - 96	10/11→10/15					
2.0 BiTurbo CDTI	143	12/12→10/15					
2.0 CDTi	121	10/11→10/15					
 Hauptbremszylinder							
1.4	74 - 103	10/11→10/15		für Linkslenker		03.2125-0421.3 010934	ATE Ø 25,4
1.6	132	10/11→10/15					
1.6 CDTi	81 - 100	07/14→10/15					
1.6 SIDI	125 - 147	09/13→10/15					
1.7 CDTi	81 - 96	10/11→10/15					
2.0 BiTurbo CDTI	143	12/12→10/15					
2.0 CDTi	121	10/11→10/15					
VAUXHALL - ASTRA Mk VI (J) Kombi (P10) 10/10→10/15							
 Bremskraftverstärker							
1.3 CDTi	70	10/10→10/15		11/10→; für Linkslenker		03.7858-0732.4 300272	ATE Ø 9 / 8" pneumatisch
1.4	64 - 74	10/10→10/15					
1.4 Turbo	103	10/10→10/15					
1.6	85	10/10→10/15					
1.6 Turbo	132	10/10→10/15					
1.7 CDTi	81 - 92	10/10→10/15					
2.0 CDTi	118	10/10→06/11					
→							











	kw					! #		
VAUXHALL - ASTRA Mk VI (J) Kombi (P10) 10/10→10/15								
 Bremskraftverstärker								
1.6 CDTi	81	01/14→10/15		02/14→; für Linkslenker		03.7858-0732.4	300272	ATE Ø 9 / 8" pneumatisch
1.6 CDTi	100	01/14→10/15		für Linkslenker		03.7858-0732.4	300272	ATE Ø 9 / 8" pneumatisch
1.7 CDTi	96	06/11→10/15						
2.0 BiTurbo CDTI	143	12/12→10/15						
2.0 CDTi	121	08/11→10/15						
 Hauptbremszylinder								
1.3 CDTi	70	10/10→10/15		11/10→; für Linkslenker		03.2125-0421.3	010934	ATE Ø 25,4
1.4	64 - 74	10/10→10/15						
1.4 Turbo	103	10/10→10/15						
1.6	85	10/10→10/15						
1.6 Turbo	132	10/10→10/15						
1.7 CDTi	81 - 92	10/10→10/15						
2.0 CDTi	118	10/10→06/11						
1.6 CDTi	81	01/14→10/15		02/14→; für Linkslenker		03.2125-0421.3	010934	ATE Ø 25,4
1.6 CDTi	100	01/14→10/15		für Linkslenker		03.2125-0421.3	010934	ATE Ø 25,4
1.7 CDTi	96	06/11→10/15						
2.0 BiTurbo CDTI	143	12/12→10/15						
2.0 CDTi	121	08/11→10/15						
VAUXHALL - ASTRA Mk VI (J) Stufenheck (P10) 06/12→10/15								
 Bremskraftverstärker								
1.3 CDTI	70	06/12→10/15		für Linkslenker		03.7858-0732.4	300272	ATE Ø 9 / 8" pneumatisch
1.4	74	06/12→10/15						
1.4 Turbo	103	06/12→10/15						
1.6	85	06/12→10/15						
1.6 Turbo	132	06/12→10/15						
1.7 CDTI	81 - 96	06/12→10/15						
 Hauptbremszylinder								
1.3 CDTI	70	06/12→10/15		für Linkslenker		03.2125-0421.3	010934	ATE Ø 25,4
1.4	74	06/12→10/15						
1.4 Turbo	103	06/12→10/15						
1.6	85	06/12→10/15						
1.6 Turbo	132	06/12→10/15						
1.7 CDTI	81 - 96	06/12→10/15						
VAUXHALL - ASTRVAN Mk III (F) Kasten/Kombi (T92) 01/91→08/98								
 Hauptbremszylinder								
1.6 i	55	10/91→08/98		- ABS		03.2122-0264.3	010129	ATE Ø 22,2
1.7 TD	50	09/94→08/98		- ABS		24.2120-0702.3	010361	nicht für Delco Ø 20,6
VAUXHALL - ASTRVAN Mk IV (G) Kasten/Kombi (T98) 01/93→08/06								
 Hauptbremszylinder								
1.4 16V	66	09/00→05/05		- ESP; für Fahrzeuge mit Scheibenbremse an der Hinterachse		24.2123-1734.3	010640	TRW Ø 23,8
1.6 Dualfuel	55 - 74	02/98→08/05						
1.6 Dualfuel 16V	77	10/04→12/05		22000001→; - ESP; für Fahrzeuge mit Trommelbremse an der Hinterachse		24.2123-1734.3	010640	TRW Ø 23,8
1.6 i	55 - 62	08/98→08/06		+ ESP		24.2123-1739.3	010661	Ø 23,8
1.7 DTI 16V	55	04/01→08/06						
1.7 CDTI	59	07/03→08/06		- ESP		24.2123-1734.3	010640	TRW Ø 23,8
1.7 TD	50	08/98→08/06		- ESP; für Fahrzeuge mit Scheibenbremse an der Hinterachse		24.2123-1734.3	010640	TRW Ø 23,8
				+ ESP		24.2123-1739.3	010661	Ø 23,8
2.0 DI	60	08/98→08/06		- ESP		24.2123-1734.3	010640	TRW Ø 23,8
2.0 DTI	74	04/04→08/06		+ ESP		24.2123-1739.3	010661	Ø 23,8
 Bremskraftregler								
1.4 16V	66	09/00→05/05		- ABS		03.6583-0073.3	320234	ATE lastabhängig 8/3 4x
1.6 Dualfuel	55 - 74	02/98→08/05						
1.6 Dualfuel 16V	77	10/04→12/05						
1.7 CDTI	59	07/03→08/06						
1.7 TD	50	08/98→08/06						
2.0 DI	60	08/98→08/06		- ABS		03.6583-0074.3	320235	ATE lastabhängig 8/3 4x
2.0 DTI	74	04/04→08/06						

	kw					! #		
VAUXHALL - ASTRAVAN Mk V (H) Kasten/Kombi (A04) 03/05→								
 Bremskraftverstärker								
1.9 CDTi	88 - 110	03/05→11/11			→ 11/10; für Linkslenker		03.7863-7803.4 300237	ATE Ø 10" pneumatisch
 Hauptbremszylinder								
1.3 CDTi	66	08/05→			72000001→; → 11/10; für Linkslenker; + ESP		24.2125-1703.3 010483	Ø 25,4
1.4 i	66	03/05→						
1.6	76	03/05→			72000001→; → 11/10; für Linkslenker; - ESP		24.2125-1704.3 010446	TRW Ø 25,4
1.7 CDTi	74	03/05→11/11						
					→ 62999999; für Rechtslenker		24.2125-1736.3 010904	TRW Ø 25,4
					→ 68999999; für Linkslenker; + ESP		24.2125-1736.3 010904	TRW Ø 25,4
					→ 68999999; für Linkslenker; - ESP		24.2125-1737.3 010906	TRW Ø 25,4
					72000001→; → 11/10; für Rechtslenker		24.4125-1703.3 010907	TRW Ø 25,4
1.7 CDTi	59	03/05→07/06			72000001→; für Linkslenker; + ESP		24.2125-1703.3 010483	Ø 25,4
					72000001→; für Linkslenker; - ESP		24.2125-1704.3 010446	TRW Ø 25,4
					→ 62999999; für Rechtslenker		24.2125-1736.3 010904	TRW Ø 25,4
					→ 68999999; für Linkslenker; + ESP		24.2125-1736.3 010904	TRW Ø 25,4
					→ 68999999; für Linkslenker; - ESP		24.2125-1737.3 010906	TRW Ø 25,4
					72000001→; für Rechtslenker		24.4125-1703.3 010907	TRW Ø 25,4
1.7 CDTi	81 - 92	06/11→			→ 62999999; für Rechtslenker		24.2125-1736.3 010904	TRW Ø 25,4
					→ 68999999; für Linkslenker; + ESP		24.2125-1736.3 010904	TRW Ø 25,4
					→ 68999999; für Linkslenker; - ESP		24.2125-1737.3 010906	TRW Ø 25,4
1.9 CDTi	88 - 110	03/05→11/11			→ 11/10		03.4155-0156.3 010862	ATE Ø 25,4
VAUXHALL - CALIBRA (C89) 06/90→07/97								
 Hauptbremszylinder								
2.0 i Turbo 4x4	150	03/92→07/97					03.2123-1121.3 010176	Ø 23,8
2.5 i V6	125	04/93→07/97			für Linkslenker		03.2123-1121.3 010176	Ø 23,8
 Bremskraftregler								
2.0 i	85	06/90→07/97			P1000001→		03.0101-0038.2 320245	Satz 2x
2.0 i 16V	100	06/90→07/97						
2.0 i 16V 4x4	100	02/94→07/97						
2.0 i 4x4	85	06/90→07/97						
2.5 i V6	125	04/93→07/97			T1000001→		03.0101-0038.2 320245	Satz 2x
VAUXHALL - CASCADA Cabriolet (W13) 02/13→								
 Bremskraftverstärker								
1.4	103	02/13→			für Linkslenker		03.7858-0732.4 300272	ATE Ø 9 / 8" pneumatisch
1.6	125 - 147	02/13→						
2.0 CDTi	121 - 143	02/13→						
 Hauptbremszylinder								
1.4	103	02/13→			für Linkslenker		03.2125-0421.3 010934	ATE Ø 25,4
1.6	125 - 147	02/13→						
2.0 CDTi	121 - 143	02/13→						
VAUXHALL - COMBO Mk I (B) (S93) 07/94→10/01								
 Hauptbremszylinder								
1.4	44	07/94→10/01			→ 09/00; für Linkslenker; - ABS		24.2120-0702.3 010361	nicht für Delco Ø 20,6
1.4 16V	66	08/99→10/01						
1.7 D	44	07/94→10/01			→ 09/00; für Linkslenker; + ABS		24.2120-1714.3 010455	Ø 20,6
 Bremskraftregler								
1.4	44	07/94→10/01					03.6585-0019.3 320239	ATE lastabhängig 8/5 4x
1.4 16V	66	08/99→10/01						
1.7 D	44	07/94→10/01						
VAUXHALL - COMBO Mk II (C) Kasten/Großraumlimousine (F25) 09/01→02/12								
 Hauptbremszylinder								
1.3 CDTi 16V	51 - 55	09/04→02/12			→ 33999999		24.2122-1740.3 010711	DEL Ø 22,2
1.4 i 16V	66	01/04→11/11			43000001→; → 10/11; - ESP; Scheibenbremse		24.2123-1767.3 010844	BOS Ø 23,8
1.6	64	10/01→11/11						
1.7 DTi 16V	55	10/01→11/11						
→								











	kw				! #		
VAUXHALL - COMBO Mk II (C) Kasten/Großraumlimousine (F25) 09/01→02/12							
 Hauptbremszylinder							
1.4 16V	66	10/01→05/07		→ 33999999		24.2122-1740.3 010711	DEL Ø 22,2
				43000001→; - ESP; Scheibenbremse		24.2123-1767.3 010844	BOS Ø 23,8
1.6	62	09/01→10/04		10/01→; → 33999999		24.2122-1740.3 010711	DEL Ø 22,2
				43000001→; - ESP; Scheibenbremse		24.2123-1767.3 010844	BOS Ø 23,8
1.6 CNG 16V	69 - 71	04/05→02/12		→ 10/11; - ESP; Scheibenbremse		24.2123-1767.3 010844	BOS Ø 23,8
1.7 CDTI 16V	74	12/04→11/11					
1.7 DI 16V	48	09/01→11/11		10/01→; → 33999999		24.2122-1740.3 010711	DEL Ø 22,2
				43000001→; → 10/11; - ESP; Scheibenbremse		24.2123-1767.3 010844	BOS Ø 23,8
VAUXHALL - COMBO TOUR Mk II (C) (F25) 09/01→02/12							
 Hauptbremszylinder							
1.3 CDTI 16V	51	09/04→09/06		→ 33999999		24.2122-1740.3 010711	DEL Ø 22,2
1.4	66	10/04→09/10					
1.6	64	10/01→06/04		43000001→; - ESP; Scheibenbremse		24.2123-1767.3 010844	BOS Ø 23,8
1.3 CDTI 16V	55	07/06→02/12		→ 33999999		24.2122-1740.3 010711	DEL Ø 22,2
1.7 DTI 16V	55	10/01→02/12		43000001→; → 10/11; - ESP; Scheibenbremse		24.2123-1767.3 010844	BOS Ø 23,8
1.6 CNG	69	06/06→09/10		- ESP; Scheibenbremse		24.2123-1767.3 010844	BOS Ø 23,8
1.7 CDTI 16V	74	12/04→09/10					
1.6 CNG	71	04/05→02/12		→ 10/11; - ESP; Scheibenbremse		24.2123-1767.3 010844	BOS Ø 23,8
1.7 DI 16V	48	09/01→06/04		10/01→; → 33999999		24.2122-1740.3 010711	DEL Ø 22,2
				43000001→; - ESP; Scheibenbremse		24.2123-1767.3 010844	BOS Ø 23,8
VAUXHALL - CORSA Mk I (B) (S93) 12/92→09/00							
 Hauptbremszylinder							
1.0 i 12V	40	11/96→09/00		für Linkslenker; - ABS		24.2120-0702.3 010361	nicht für Delco Ø 20,6
1.4 i	44	03/93→09/00					
1.4 i 16V	66	09/94→09/00		für Linkslenker; + ABS		24.2120-1714.3 010455	Ø 20,6
1.4 i S	60	03/93→09/00					
1.6 i 16V	78	09/94→09/00					
1.7 D	44	02/96→09/00					
1.2 i	33	03/93→09/00		für Linkslenker; - ABS		24.2120-0702.3 010361	nicht für Delco Ø 20,6
				04/98→; für Linkslenker; - ABS		24.2120-0702.3 010361	nicht für Delco Ø 20,6
				für Linkslenker; + ABS		24.2120-1714.3 010455	Ø 20,6
				04/98→; für Linkslenker; + ABS		24.2120-1714.3 010455	Ø 20,6
1.2 i 16V	48	03/98→09/00		04/98→; für Linkslenker; - ABS		24.2120-0702.3 010361	nicht für Delco Ø 20,6
				04/98→; für Linkslenker; + ABS		24.2120-1714.3 010455	Ø 20,6
1.6 GSI 16V	80	03/93→09/00		09/93→; für Linkslenker; - ABS		24.2120-0702.3 010361	nicht für Delco Ø 20,6
				09/93→; für Linkslenker; + ABS		24.2120-1714.3 010455	Ø 20,6
VAUXHALL - CORSA Mk II (C) (X01) 08/00→04/07							
 Hauptbremszylinder							
1.0 12V	43 - 44	09/00→10/06		→ 36999999		24.2122-1740.3 010711	DEL Ø 22,2
1.2 16V	55	09/00→10/06					
1.2 16V Dualfuel	55	08/01→10/06					
1.2 Twinport	59	07/04→10/06					
1.3 CDTI 16V	51	10/03→04/07					
1.4 16V	66	09/00→10/06		43000001→; → 09/06; - ESP		24.2123-1767.3 010844	BOS Ø 23,8
1.4 Twinport	66	06/03→10/06					
1.7 CDTI 16V	74	08/00→09/06		06/03→; → 36999999		24.2122-1740.3 010711	DEL Ø 22,2
1.7 DI 16V	48	08/00→09/06		09/00→; → 36999999		24.2122-1740.3 010711	DEL Ø 22,2
1.7 DTI 16V	55	08/00→09/06					
1.8 16V	92	08/00→09/06		43000001→; - ESP		24.2123-1767.3 010844	BOS Ø 23,8
VAUXHALL - CORSA Mk III (D) (S07) 07/06→08/14							
 Hauptbremszylinder							
1.0	44	08/06→08/14		für Linkslenker; + ESP		24.4122-1705.3 010852	BOS Ø 22,2 ohne Bremsflüssigkeitsbehälter
1.0 i 12V	48	01/10→08/14					
1.2	51 - 59	08/06→08/14		für Linkslenker; - ESP		24.4122-1709.3 010871	BOS Ø 22,2 ohne Bremsflüssigkeitsbehälter
1.2 LPG	59 - 63	09/09→08/14					
1.3 CDTI	70	07/10→08/14					
1.4	74	01/10→08/14					
1.2 i 16V	63	12/09→08/14		06/10→; für Linkslenker; + ESP		24.4122-1705.3 010852	BOS Ø 22,2 ohne Bremsflüssigkeitsbehälter
→							

	kw					! #		
VAUXHALL - CORSA Mk III (D) (S07) 07/06→08/14								
 Hauptbremszylinder								
1.2 i 16V	63	12/09→08/14		06/10→; für Linkslenker; - ESP		24.4122-1709.3	010871	BOS Ø 22,2 ohne Bremsflüssigkeitsbehälter
1.3 CDTi	55 - 66	08/06→08/14		10/06→; für Linkslenker; + ESP		24.4122-1705.3	010852	BOS Ø 22,2 ohne Bremsflüssigkeitsbehälter
1.4 1.4 LPG	66	08/06→08/14 07/06→08/14		10/06→; für Linkslenker; - ESP		24.4122-1709.3	010871	BOS Ø 22,2 ohne Bremsflüssigkeitsbehälter
1.4 1.6 VXR	88 141 - 155	08/12→08/14 11/06→08/14		für Linkslenker; - ESP		24.4123-1720.3	011022	BOS Ø 23,8 ohne Bremsflüssigkeitsbehälter
1.7 CDTi 1.6 SRi	92 110	11/06→08/14 05/07→08/14		06/07→; für Linkslenker; - ESP		24.4123-1720.3	011022	BOS Ø 23,8 ohne Bremsflüssigkeitsbehälter
1.7 CDTi	96	03/07→08/14		06/10→; für Linkslenker; - ESP		24.4123-1720.3	011022	BOS Ø 23,8 ohne Bremsflüssigkeitsbehälter
VAUXHALL - CORSA Mk IV (E) (X15) 08/14→								
 Hauptbremszylinder								
1.0 1.2 1.3 CDTi 1.4	66 - 85 51 55 - 70 55 - 74	08/14→ 08/14→ 08/14→ 08/14→		11/14→; für Linkslenker; Scheibenbremse		24.4123-1722.3	011071	Ø 23,8 ohne Bremsflüssigkeitsbehälter
1.6 VXR	151	04/15→		für Linkslenker		24.4123-1722.3	011071	Ø 23,8 ohne Bremsflüssigkeitsbehälter
VAUXHALL - CORSAVAN Mk I (B) Kasten/Schrägheck (S93) 01/94→09/00								
 Hauptbremszylinder								
1.4 i 1.7 D	44 44	01/94→09/00 01/94→09/00		für Linkslenker; - ABS für Linkslenker; + ABS		24.2120-0702.3 24.2120-1714.3	010361 010455	nicht für Delco Ø 20,6 Ø 20,6
VAUXHALL - CORSAVAN Mk II (C) Kasten/Schrägheck (X01) 09/00→11/06								
 Hauptbremszylinder								
1.2 16V 1.2 16V Dualfuel 1.3 CDTi 16V 1.7 DI 16V 1.7 DTi 16V	55 55 52 48 55	09/00→06/06 08/01→06/06 04/04→06/06 09/00→06/06 09/00→06/06		→ 36999999		24.2122-1740.3	010711	DEL Ø 22,2
1.2 16V 1.2 16V Dualfuel	59 59	07/04→11/06 07/04→12/05		für Linkslenker; + ESP für Linkslenker; - ESP		24.4122-1705.3 24.4122-1709.3	010852 010871	BOS Ø 22,2 ohne Bremsflüssigkeitsbehälter BOS Ø 22,2 ohne Bremsflüssigkeitsbehälter
1.4	66	11/03→06/06		43000001→; - ESP		24.2123-1767.3	010844	BOS Ø 23,8
VAUXHALL - CORSAVAN Mk III (D) Kasten/Schrägheck (S07) 07/06→								
 Hauptbremszylinder								
1.2 1.3 CDTi	51 70	01/10→ 07/06→		06/10→; für Linkslenker; + ESP 06/10→; für Linkslenker; - ESP		24.4122-1705.3 24.4122-1709.3	010852 010871	BOS Ø 22,2 ohne Bremsflüssigkeitsbehälter BOS Ø 22,2 ohne Bremsflüssigkeitsbehälter
1.2	59	07/09→		für Linkslenker; + ESP für Linkslenker; - ESP		24.4122-1705.3 24.4122-1709.3	010852 010871	BOS Ø 22,2 ohne Bremsflüssigkeitsbehälter BOS Ø 22,2 ohne Bremsflüssigkeitsbehälter
1.3 CDTi	55 - 66	07/06→		10/06→; für Linkslenker; + ESP 10/06→; für Linkslenker; - ESP		24.4122-1705.3 24.4122-1709.3	010852 010871	BOS Ø 22,2 ohne Bremsflüssigkeitsbehälter BOS Ø 22,2 ohne Bremsflüssigkeitsbehälter
VAUXHALL - CORSAVAN Mk IV (E) Kasten/Schrägheck (X15) 10/14→								
 Hauptbremszylinder								
1.2 1.3 CDTi	51 55 - 70	10/14→ 10/14→		11/14→; für Linkslenker; Scheibenbremse		24.4123-1722.3	011071	Ø 23,8 ohne Bremsflüssigkeitsbehälter
VAUXHALL - CROSSLAND X / CROSSLAND (P17) 03/17→								
 Hauptbremszylinder								
1.2 →	61 - 96	03/17→				24.4123-1704.3	010828	TRW Ø 23,8

	kw			 	! #		
VAUXHALL - CROSSLAND X / CROSSLAND (P17) 03/17→							
 Hauptbremszylinder							
1.5 Turbo D)) 1.5 Turbo D 1.6 Turbo D	81 75 - 88 73 - 88	10/20→ 06/18→ 03/17→				24.4123-1704.3 010828	TRW Ø 23,8
VAUXHALL - INSIGNIA Mk I (A) Country Tourer (G09) 07/08→05/17							
 Bremskraftverstärker							
1.6 Turbo 2.0 Biturbo CDTI 4x4 2.0 CDTI 2.0 CDTI 4x4	125 143 120 - 125 125	07/13→05/17 09/13→05/17 07/13→05/17 11/14→05/17		für Linkslenker		03.7858-0732.4 300272	ATE Ø 9 / 8" pneumatisch
 Hauptbremszylinder							
1.6 Turbo 2.0 Biturbo CDTI 4x4 2.0 CDTI 2.0 CDTI 4x4	125 143 120 - 125 125	07/13→05/17 09/13→05/17 07/13→05/17 11/14→05/17		für Linkslenker		03.2125-0421.3 010934	ATE Ø 25,4
VAUXHALL - INSIGNIA Mk I (A) Schrägheck (G09) 07/08→05/17							
 Bremskraftverstärker							
1.4 1.4 LPG 1.6 1.6 CDTI 1.6 Turbo 1.8 2.0 Biturbo CDTI 2.0 Biturbo CDTI 4x4 2.0 CDTI 2.0 CDTI 4x4 2.0 Turbo 2.0 Turbo 4x4 2.0 CDTI 2.0 CDTI 4x4	103 103 85 100 125 - 132 103 143 143 81 - 140 125 - 140 162 - 184 162 88 118	04/11→05/17 07/12→05/17 07/08→07/12 07/15→05/17 01/09→05/17 07/08→05/17 03/12→05/17 03/12→05/17 07/08→05/17 05/09→05/17 07/08→05/17 07/08→05/17 03/12→03/16 07/08→05/17		06/11→; für Linkslenker für Linkslenker 03/13→; für Linkslenker 06/10→; für Linkslenker		03.7858-0732.4 300272 03.7858-0732.4 300272 03.7858-0732.4 300272 03.7858-0732.4 300272	ATE Ø 9 / 8" pneumatisch ATE Ø 9 / 8" pneumatisch ATE Ø 9 / 8" pneumatisch ATE Ø 9 / 8" pneumatisch
 Hauptbremszylinder							
1.4 1.4 LPG 1.6 1.6 CDTI 1.6 Turbo 1.8 2.0 Biturbo CDTI 2.0 Biturbo CDTI 4x4 2.0 CDTI 2.0 CDTI 4x4 2.0 Turbo 2.0 Turbo 4x4 2.8 V6 Turbo 4x4 2.8 VXR 2.0 CDTI 2.0 CDTI 4x4	103 103 85 100 125 - 132 103 143 143 81 - 140 125 - 140 162 - 184 162 191 239 88 118	04/11→05/17 07/12→05/17 07/08→07/12 07/15→05/17 01/09→05/17 07/08→05/17 03/12→05/17 03/12→05/17 07/08→05/17 05/09→05/17 07/08→05/17 07/08→05/17 07/08→05/17 07/09→05/17 03/12→03/16 07/08→05/17		06/11→; für Linkslenker für Linkslenker 03/13→; für Linkslenker 06/10→; für Linkslenker		03.2125-0421.3 010934 03.2125-0421.3 010934 03.2125-0421.3 010934 03.2125-0421.3 010934	ATE Ø 25,4 ATE Ø 25,4 ATE Ø 25,4 ATE Ø 25,4
VAUXHALL - INSIGNIA Mk I (A) Sports Tourer (G09) 07/08→05/17							
 Bremskraftverstärker							
1.4 1.4 LPG 1.6 1.6 CDTI 1.6 Turbo 1.8 2.0 Biturbo CDTI 2.0 Biturbo CDTI 4x4 →	103 103 85 100 125 - 132 103 143 143	04/11→05/17 07/12→05/17 07/08→07/12 07/15→05/17 01/09→05/17 07/08→05/17 03/12→05/17 03/12→05/17		06/11→; für Linkslenker für Linkslenker →		03.7858-0732.4 300272 03.7858-0732.4 300272 →	ATE Ø 9 / 8" pneumatisch ATE Ø 9 / 8" pneumatisch →

	kw					! #		
VAUXHALL - INSIGNIA Mk I (A) Sports Tourer (G09) 07/08→05/17								
 Bremskraftverstärker								
2.0 CDTI	81 - 140	07/08→05/17		für Linkslenker		03.7858-0732.4	300272	ATE Ø 9 / 8" pneumatisch
2.0 CDTI 4x4	125 - 140	05/09→05/17						
2.0 Turbo	162 - 184	07/08→05/17						
2.0 Turbo 4x4	162	07/08→05/17						
2.0 CDTI	88	03/12→03/16		03/13→; für Linkslenker		03.7858-0732.4	300272	ATE Ø 9 / 8" pneumatisch
2.0 CDTI 4x4	118	07/08→05/17		06/10→; für Linkslenker		03.7858-0732.4	300272	ATE Ø 9 / 8" pneumatisch
 Hauptbremszylinder								
1.4	103	04/11→05/17		06/11→; für Linkslenker		03.2125-0421.3	010934	ATE Ø 25,4
1.4 LPG	103	07/12→05/17		für Linkslenker		03.2125-0421.3	010934	ATE Ø 25,4
1.6	85	07/08→07/12						
1.6 CDTI	100	07/15→05/17						
1.6 Turbo	125 - 132	01/09→05/17						
1.8	103	07/08→05/17						
2.0 Biturbo CDTI	143	03/12→05/17						
2.0 Biturbo CDTI 4x4	143	03/12→05/17						
2.0 CDTI	81 - 140	07/08→05/17						
2.0 CDTI 4x4	125 - 140	05/09→05/17						
2.0 Turbo	162 - 184	07/08→05/17						
2.0 Turbo 4x4	162	07/08→05/17						
2.8 V6 Turbo	191	08/08→05/17						
2.8 VXR	239	07/09→05/17						
2.0 CDTI	88	03/12→03/16		03/13→; für Linkslenker		03.2125-0421.3	010934	ATE Ø 25,4
2.0 CDTI 4x4	118	07/08→05/17		06/10→; für Linkslenker		03.2125-0421.3	010934	ATE Ø 25,4
VAUXHALL - INSIGNIA Mk I (A) Stufenheck (G09) 07/08→05/17								
 Bremskraftverstärker								
1.4	103	04/11→05/17		06/11→; für Linkslenker		03.7858-0732.4	300272	ATE Ø 9 / 8" pneumatisch
1.4 LPG	103	07/12→05/17		für Linkslenker		03.7858-0732.4	300272	ATE Ø 9 / 8" pneumatisch
1.6	85	07/08→07/12						
1.6 CDTI	100	07/15→05/17						
1.6 Turbo	132	01/09→05/17						
1.8	103	07/08→05/17						
2.0 Biturbo CDTI	143	03/12→05/17						
2.0 Biturbo CDTI 4x4	143	03/12→05/17						
2.0 CDTI	96 - 140	07/08→05/17						
2.0 CDTI 4x4	125 - 140	05/09→05/17						
2.0 Turbo	162	07/08→05/17						
2.0 Turbo 4x4	162 - 184	07/08→05/17						
2.0 CDTI 4x4	118	07/08→05/17		06/10→; für Linkslenker		03.7858-0732.4	300272	ATE Ø 9 / 8" pneumatisch
2.0 Turbo	184	09/11→05/17		04/14→; für Linkslenker		03.7858-0732.4	300272	ATE Ø 9 / 8" pneumatisch
 Hauptbremszylinder								
1.4	103	04/11→05/17		06/11→; für Linkslenker		03.2125-0421.3	010934	ATE Ø 25,4
1.4 LPG	103	07/12→05/17		für Linkslenker		03.2125-0421.3	010934	ATE Ø 25,4
1.6	85	07/08→07/12						
1.6 CDTI	100	07/15→05/17						
1.6 Turbo	132	01/09→05/17						
1.8	103	07/08→05/17						
2.0 Biturbo CDTI	143	03/12→05/17						
2.0 Biturbo CDTI 4x4	143	03/12→05/17						
2.0 CDTI	96 - 140	07/08→05/17						
2.0 CDTI 4x4	125 - 140	05/09→05/17						
2.0 Turbo	162	07/08→05/17						
2.0 Turbo 4x4	162 - 184	07/08→05/17						
2.8 V6 Turbo 4x4	191	07/08→05/17						
2.8 VXR	239	07/09→05/17						
2.0 CDTI 4x4	118	07/08→05/17		06/10→; für Linkslenker		03.2125-0421.3	010934	ATE Ø 25,4
2.0 Turbo	184	09/11→05/17		04/14→; für Linkslenker		03.2125-0421.3	010934	ATE Ø 25,4

	kw					! #		
VAUXHALL - MERIVA A (X03) 01/03→06/10								
 Hauptbremszylinder								
1.3 CDTi	51	04/05→06/10		→ 44999999; - ESP		24.2123-1764.3	010824	TRW Ø 23,8
1.6 Turbo	132	05/06→06/10		74237192→; → 05/10; + ESP		24.4123-1717.3	010985	TRW Ø 23,8 ohne Bremsflüssigkeitsbehälter
1.7 DTi	55	06/03→06/10						
1.8 i 16V	92	05/03→06/10						
1.3 CDTi	55	01/03→10/09		09/03→; → 44999999; - ESP		24.2123-1764.3	010824	TRW Ø 23,8
				74237192→; + ESP		24.4123-1717.3	010985	TRW Ø 23,8 ohne Bremsflüssigkeitsbehälter
1.4 16V Twinport	66	01/03→06/10		07/04→; → 44999999; - ESP		24.2123-1764.3	010824	TRW Ø 23,8
				74237192→; → 05/10; + ESP		24.4123-1717.3	010985	TRW Ø 23,8 ohne Bremsflüssigkeitsbehälter
1.6 i	64	01/03→06/10		05/03→; → 44999999; - ESP		24.2123-1764.3	010824	TRW Ø 23,8
				74237192→; → 05/10; + ESP		24.4123-1717.3	010985	TRW Ø 23,8 ohne Bremsflüssigkeitsbehälter
1.6 i 16V	74	01/03→09/05		05/03→; → 44999999; - ESP		24.2123-1764.3	010824	TRW Ø 23,8
				74237192→; + ESP		24.4123-1717.3	010985	TRW Ø 23,8 ohne Bremsflüssigkeitsbehälter
1.6 i 16V Twinport	77	05/03→06/10		01/06→; → 44999999; - ESP		24.2123-1764.3	010824	TRW Ø 23,8
				74237192→; → 05/10; + ESP		24.4123-1717.3	010985	TRW Ø 23,8 ohne Bremsflüssigkeitsbehälter
1.7 CDTi	74	09/03→08/05		→ 44999999; - ESP		24.2123-1764.3	010824	TRW Ø 23,8
				74237192→; + ESP		24.4123-1717.3	010985	TRW Ø 23,8 ohne Bremsflüssigkeitsbehälter
VAUXHALL - MOVANO Mk I (A) Chassis/Cab (X70) 10/98→12/10								
 Hauptbremszylinder								
2.2 DTi	66	09/00→05/10		→ 08/03; + ABS		24.2025-1706.3	010676	Ø 25,4
				→ 01/10; - ABS		24.2025-1708.3	010692	Ø 25,4
				09/03→; + ABS; → 08/06		24.2123-1759.3	010768	BOS Ø 23,8
2.5 CDTi	73	11/03→12/06		- ABS		24.2025-1708.3	010692	Ø 25,4
				+ ABS		24.2123-1759.3	010768	BOS Ø 23,8
2.5 D	59	10/98→08/02		→ 09/00; + ABS		24.2025-1706.3	010676	Ø 25,4
				→ 09/00; - ABS		24.2025-1708.3	010692	Ø 25,4
2.5 DTi	84	01/01→12/06		→ 08/03; + ABS		24.2025-1706.3	010676	Ø 25,4
				- ABS		24.2025-1708.3	010692	Ø 25,4
				09/03→; + ABS; → 08/06		24.2123-1759.3	010768	BOS Ø 23,8
2.8 DTi	84	10/98→10/01		+ ABS		24.2025-1706.3	010676	Ø 25,4
				- ABS		24.2025-1708.3	010692	Ø 25,4
3.0 DTi	100	10/03→05/10		→ 01/10; - ABS		24.2025-1708.3	010692	Ø 25,4
				→ 08/06; + ABS		24.2123-1759.3	010768	BOS Ø 23,8
VAUXHALL - MOVANO Mk I (A) Combi (X70) 10/98→05/10								
 Hauptbremszylinder								
1.9 DTi	60	10/01→05/10		→ 08/03; + ABS		24.2025-1706.3	010676	Ø 25,4
2.2 DTi	66	09/00→05/10		→ 01/10; - ABS		24.2025-1708.3	010692	Ø 25,4
				09/03→; + ABS; → 08/06		24.2123-1759.3	010768	BOS Ø 23,8
2.5 D	59	10/98→09/00		+ ABS		24.2025-1706.3	010676	Ø 25,4
2.8 DTi	84	10/98→10/01		- ABS		24.2025-1708.3	010692	Ø 25,4
2.5 DTi	84	10/01→08/09		→ 08/03; + ABS		24.2025-1706.3	010676	Ø 25,4
				- ABS		24.2025-1708.3	010692	Ø 25,4
				09/03→; + ABS; → 08/06		24.2123-1759.3	010768	BOS Ø 23,8
3.0 DTi	100	10/03→05/10		→ 01/10; - ABS		24.2025-1708.3	010692	Ø 25,4
				→ 08/06; + ABS		24.2123-1759.3	010768	BOS Ø 23,8
VAUXHALL - MOVANO Mk I (A) Van (X70) 10/98→12/10								
 Hauptbremszylinder								
1.9 DTi	60	10/01→05/10		→ 08/03; + ABS		24.2025-1706.3	010676	Ø 25,4
2.2 DTi	66	09/00→05/10		→ 01/10; - ABS		24.2025-1708.3	010692	Ø 25,4
2.5 DTi	84	10/01→05/10		09/03→; + ABS; → 08/06		24.2123-1759.3	010768	BOS Ø 23,8
2.5	73	11/03→12/06		- ABS		24.2025-1708.3	010692	Ø 25,4
				+ ABS		24.2123-1759.3	010768	BOS Ø 23,8
2.5 D	59	10/98→09/00		+ ABS		24.2025-1706.3	010676	Ø 25,4
2.8 TDI	84	10/98→10/01		- ABS		24.2025-1708.3	010692	Ø 25,4
3.0 DTi	100	10/03→05/10		→ 01/10; - ABS		24.2025-1708.3	010692	Ø 25,4
→								

	kw					! #		
VAUXHALL - MOVANO Mk I (A) Van (X70) 10/98→12/10								
 Hauptbremszylinder								
3.0 DTi	100	10/03→05/10		→ 08/06; + ABS			24.2123-1759.3 010768	BOS Ø 23,8
VAUXHALL - OMEGA (B) Kombi (V94) 12/93→06/03								
 Hauptbremszylinder								
2.0	85	03/94→09/99		W1000001→; für Linkslenker; + ESP			24.2125-1740.3 010971	TRW Ø 25,4
2.0 Dualfuel	100	01/99→07/01						
2.5 TD	96	04/94→07/01						
2.0 16V	100	03/94→07/01		W1000001→; → 09/99; für Linkslenker; + ESP			24.2125-1740.3 010971	TRW Ø 25,4
2.0 DTI 16V	74	01/98→09/00		→ 08/00; für Linkslenker; + ESP			24.2125-1740.3 010971	TRW Ø 25,4
2.2 16V	106	02/94→06/03		10/99→; für Linkslenker; + ESP			24.2125-1740.3 010971	TRW Ø 25,4
2.2 DTI 16V	88	08/00→06/03		09/00→; für Linkslenker; + ESP			24.2125-1740.3 010971	TRW Ø 25,4
2.5 V6	125	03/94→09/00		W1000001→; für Linkslenker; nicht für Sonderfahrzeuge; + ESP			24.2125-1740.3 010971	TRW Ø 25,4
3.0 V6	155	07/94→07/00						
2.6 V6	132	08/00→06/03		09/00→; für Linkslenker; nicht für Sonderfahrzeuge; + ESP			24.2125-1740.3 010971	TRW Ø 25,4
3.2 V6	160	02/01→06/03		für Linkslenker; nicht für Sonderfahrzeuge; + ESP			24.2125-1740.3 010971	TRW Ø 25,4
VAUXHALL - OMEGA (B) Stufenheck (V94) 12/93→07/03								
 Hauptbremszylinder								
2.0	85	03/94→09/99		W1000001→; für Linkslenker; + ESP			24.2125-1740.3 010971	TRW Ø 25,4
2.0 Dualfuel	100	05/98→07/01						
2.5 TD	96	04/94→07/01						
2.0 16V	100	03/94→07/01		W1000001→; → 09/99; für Linkslenker; + ESP			24.2125-1740.3 010971	TRW Ø 25,4
2.0 DTI 16V	74	01/98→09/00		→ 08/00; für Linkslenker; + ESP			24.2125-1740.3 010971	TRW Ø 25,4
2.2 16V	106	01/94→06/03		10/99→; für Linkslenker; + ESP			24.2125-1740.3 010971	TRW Ø 25,4
2.2 DTI 16V	88	08/00→07/03		09/00→; für Linkslenker; + ESP			24.2125-1740.3 010971	TRW Ø 25,4
2.5 V6	125	03/94→09/00		W1000001→; für Linkslenker; nicht für Sonderfahrzeuge; + ESP			24.2125-1740.3 010971	TRW Ø 25,4
3.0 V6	155	04/94→07/00						
2.6 V6	132	08/00→07/03		09/00→; für Linkslenker; nicht für Sonderfahrzeuge; + ESP			24.2125-1740.3 010971	TRW Ø 25,4
3.2 V6	160	02/01→07/03		für Linkslenker; nicht für Sonderfahrzeuge; + ESP			24.2125-1740.3 010971	TRW Ø 25,4
VAUXHALL - SIGNUM (Z03) 03/03→10/08								
 Hauptbremszylinder								
1.8	90	06/03→07/05		für Linkslenker; + ESP			24.2125-1732.3 010827	TRW Ø 25,4
1.9 CDTi	88	04/04→03/08						
1.9 CDTi 16V	110	04/04→03/08						
2.0 DTI	74	05/03→04/04						
2.2 DTI	92	05/03→05/08						
2.2 i	114	05/03→05/08						
3.0 CDTi	130	05/03→05/08						
3.2 V6	155	05/03→05/08						
1.8	103	08/05→05/08		09/05→; für Linkslenker; + ESP			24.2125-1732.3 010827	TRW Ø 25,4
2.0 i Turbo	129	03/03→10/08		05/03→; für Linkslenker; → 05/08; + ESP			24.2125-1732.3 010827	TRW Ø 25,4
3.0 V6 CDTi	135	07/05→06/08		09/05→ 05/08; für Linkslenker; + ESP			24.2125-1732.3 010827	TRW Ø 25,4
VAUXHALL - TIGRA Mk I (S93) 07/94→12/00								
 Hauptbremszylinder								
1.4 16V	66	07/94→12/00		für Linkslenker; - ABS			24.2120-0702.3 010361	nicht für Delco Ø 20,6
				für Linkslenker; + ABS			24.2120-1714.3 010455	Ø 20,6
1.6 16V	78	07/94→12/00		→ 08/98; für Linkslenker; - ABS			24.2120-0702.3 010361	nicht für Delco Ø 20,6
				→ 08/98; für Linkslenker; + ABS			24.2120-1714.3 010455	Ø 20,6
VAUXHALL - TIGRA TwinTop (X04) 06/04→08/09								
 Hauptbremszylinder								
1.3 CDTi	51	06/04→08/09		- ESP			24.2123-1767.3 010844	BOS Ø 23,8
1.4	66	06/04→08/09						
1.8	92	06/04→08/09						
VAUXHALL - VECTRA (B) CC (J96) 08/95→07/03								
 Bremskraftverstärker								
2.0 Dualfuel	100	08/98→01/01		für Linkslenker; → W1285446			03.7745-3003.4 300157	ATE Ø 8 / 7" pneumatisch
2.0 i 16V	100	10/95→01/01						
2.5 i GSi	143	03/98→07/00		für Linkslenker			03.7745-3003.4 300157	ATE Ø 8 / 7" pneumatisch
2.5 i V6	125	09/95→08/00						
→								

VAUXHALL - VECTRA (B) CC (J96) 08/95→07/03

Bremskraftverstärker

2.6 i V6	125	09/00→07/03	→ 04/02; für Linkslenker	03.7745-3003.4	300157	ATE Ø 8 / 7" pneumatisch
----------	-----	-------------	--------------------------	-----------------------	---------------	--------------------------

Hauptbremszylinder

1.6 i 1.6 i 16V	55 74	08/95→10/01 08/95→10/01	09/95→; → V1999999; für Linkslenker	24.2122-1724.3	010561	Ø 22,2
			09/95→; → V7999999; für Linkslenker	24.2122-1724.3	010561	Ø 22,2
			09/95→; → W1999999; für Rechtslenker	24.2122-1724.3	010561	Ø 22,2
			09/95→; → V5999999; für Linkslenker	24.2122-1724.3	010561	Ø 22,2
			09/95→; → W7999999; für Rechtslenker	24.2122-1724.3	010561	Ø 22,2
			09/95→; → W5999999; für Rechtslenker	24.2122-1724.3	010561	Ø 22,2
			W7000001→ W7999999; für Linkslenker	24.2123-1777.3	010943	Ø 23,8
			W5000001→ W5999999; für Linkslenker	24.2123-1777.3	010943	Ø 23,8
1.8 Dualfuel 1.8 i 16V 2.0 DTi 16V	92 85 - 92 74	09/00→07/03 09/95→07/03 06/97→10/01	→ V1999999; für Linkslenker	24.2122-1724.3	010561	Ø 22,2
			→ V7999999; für Linkslenker	24.2122-1724.3	010561	Ø 22,2
			→ W1999999; für Rechtslenker	24.2122-1724.3	010561	Ø 22,2
			→ V5999999; für Linkslenker	24.2122-1724.3	010561	Ø 22,2
			→ W7999999; für Rechtslenker	24.2122-1724.3	010561	Ø 22,2
			→ W5999999; für Rechtslenker	24.2122-1724.3	010561	Ø 22,2
			W7000001→ W7999999; für Linkslenker	24.2123-1777.3	010943	Ø 23,8
			W5000001→ W5999999; für Linkslenker	24.2123-1777.3	010943	Ø 23,8
2.0 Di 16V	60	08/95→10/01	11/96→; → V1999999; für Linkslenker	24.2122-1724.3	010561	Ø 22,2
			11/96→; → W5999999; für Rechtslenker	24.2122-1724.3	010561	Ø 22,2
			11/96→; → V7999999; für Linkslenker	24.2122-1724.3	010561	Ø 22,2
			11/96→; → V5999999; für Linkslenker	24.2122-1724.3	010561	Ø 22,2
			11/96→; → W7999999; für Rechtslenker	24.2122-1724.3	010561	Ø 22,2
			11/96→; → W1999999; für Rechtslenker	24.2122-1724.3	010561	Ø 22,2
			W7000001→ W7999999; für Linkslenker	24.2123-1777.3	010943	Ø 23,8
			W5000001→ W5999999; für Linkslenker	24.2123-1777.3	010943	Ø 23,8
2.0 Dualfuel 2.0 i 16V 2.5 i GSi 2.5 i V6	100 100 143 125	08/98→01/01 10/95→01/01 03/98→07/00 09/95→08/00	→ W5276825; für Linkslenker	03.2123-1622.3	010470	Ø 23,8
			→ W7154258; für Linkslenker	03.2123-1622.3	010470	Ø 23,8
			→ W1285446; für Linkslenker	03.2123-1622.3	010470	Ø 23,8
			→ W1285446; für Rechtslenker	03.2123-1722.3	010471	Ø 23,8
			→ W5276825; für Rechtslenker	03.2123-1722.3	010471	Ø 23,8
			→ W7154258; für Rechtslenker	03.2123-1722.3	010471	Ø 23,8

VAUXHALL - VECTRA (B) Kombi (J96) 08/95→03/02









Bremskraftverstärker

2.0 Dualfuel 2.0 i 16V	100 100	10/98→01/01 10/95→01/01	für Linkslenker; → W1285446	03.7745-3003.4	300157	ATE Ø 8 / 7" pneumatisch
2.5 i GSi 2.5 i V6 2.6 i V6	143 125 125	05/98→09/99 11/96→08/00 09/00→03/02	für Linkslenker	03.7745-3003.4	300157	ATE Ø 8 / 7" pneumatisch













Hauptbremszylinder













1.8 Dualfuel 1.8 i 16V	92 85 - 92	09/00→03/02 09/96→03/02	→ V1999999; für Linkslenker	24.2122-1724.3	010561	Ø 22,2
			→ V7999999; für Linkslenker	24.2122-1724.3	010561	Ø 22,2
			→ W1999999; für Rechtslenker	24.2122-1724.3	010561	Ø 22,2
			→ V5999999; für Linkslenker	24.2122-1724.3	010561	Ø 22,2
			→ W7999999; für Rechtslenker	24.2122-1724.3	010561	Ø 22,2
			→ W5999999; für Rechtslenker	24.2122-1724.3	010561	Ø 22,2
			W7000001→ W7999999; für Linkslenker	24.2123-1777.3	010943	Ø 23,8
			W5000001→ W5999999; für Linkslenker	24.2123-1777.3	010943	Ø 23,8
2.0 DI 16V	60	08/95→10/01	11/96→; → V7999999; für Linkslenker	24.2122-1724.3	010561	Ø 22,2
			11/96→; → W7999999; für Rechtslenker	24.2122-1724.3	010561	Ø 22,2
			11/96→; → V5999999; für Linkslenker	24.2122-1724.3	010561	Ø 22,2
			11/96→; → V1999999; für Linkslenker	24.2122-1724.3	010561	Ø 22,2
			11/96→; → W5999999; für Rechtslenker	24.2122-1724.3	010561	Ø 22,2
			11/96→; → W1999999; für Rechtslenker	24.2122-1724.3	010561	Ø 22,2
			W7000001→ W7999999; für Linkslenker	24.2123-1777.3	010943	Ø 23,8















→











	kw				! #		
VAUXHALL - VECTRA (B) Kombi (J96) 08/95→03/02							
 Hauptbremszylinder							
2.0 DI 16V	60	08/95→10/01		W5000001→ W5999999; für Linkslenker	24.2123-1777.3	010943	Ø 23,8
				W1000001→ W1999999; für Linkslenker	24.2123-1777.3	010943	Ø 23,8
2.0 DTI 16V	74	08/95→10/01		06/97→; → W1999999; für Rechtslenker	24.2122-1724.3	010561	Ø 22,2
				06/97→; → V7999999; für Linkslenker	24.2122-1724.3	010561	Ø 22,2
				06/97→; → V5999999; für Linkslenker	24.2122-1724.3	010561	Ø 22,2
				06/97→; → V1999999; für Linkslenker	24.2122-1724.3	010561	Ø 22,2
				06/97→; → W7999999; für Rechtslenker	24.2122-1724.3	010561	Ø 22,2
				06/97→; → W5999999; für Rechtslenker	24.2122-1724.3	010561	Ø 22,2
				W7000001→ W7999999; für Linkslenker	24.2123-1777.3	010943	Ø 23,8
				W5000001→ W5999999; für Linkslenker	24.2123-1777.3	010943	Ø 23,8
				W1000001→ W1999999; für Linkslenker	24.2123-1777.3	010943	Ø 23,8
2.0 Dualfuel 2.0 i 16V 2.5 i GSi 2.5 i V6	100	10/98→01/01		→ W1285446; für Linkslenker	03.2123-1622.3	010470	Ø 23,8
	100	10/95→01/01		→ W5276825; für Linkslenker	03.2123-1622.3	010470	Ø 23,8
	143	05/98→09/99		→ W7154258; für Linkslenker	03.2123-1622.3	010470	Ø 23,8
	125	11/96→08/00		→ W1285446; für Rechtslenker	03.2123-1722.3	010471	Ø 23,8
	125	11/96→08/00		→ W5276825; für Rechtslenker	03.2123-1722.3	010471	Ø 23,8
				→ W7154258; für Rechtslenker	03.2123-1722.3	010471	Ø 23,8
VAUXHALL - VECTRA (B) Stufenheck (J96) 08/95→03/02							
 Bremskraftverstärker							
2.0 Dualfuel 2.0 i 16V	100	05/98→01/01		für Linkslenker; → W1285446	03.7745-3003.4	300157	ATE Ø 8 / 7" pneumatisch
	100	10/95→01/01					
2.5 i GSi 2.5 i V6 2.6 i V6	143	03/98→07/00		für Linkslenker	03.7745-3003.4	300157	ATE Ø 8 / 7" pneumatisch
	125	09/95→08/00					
	125	09/00→03/02					
 Hauptbremszylinder							
1.6 i 1.6 i 16V	55	08/95→10/01		09/95→; → V1999999; für Linkslenker	24.2122-1724.3	010561	Ø 22,2
	74	08/95→10/01		09/95→; → W5999999; für Rechtslenker	24.2122-1724.3	010561	Ø 22,2
				09/95→; → V5999999; für Linkslenker	24.2122-1724.3	010561	Ø 22,2
				09/95→; → W7999999; für Rechtslenker	24.2122-1724.3	010561	Ø 22,2
				09/95→; → V7999999; für Linkslenker	24.2122-1724.3	010561	Ø 22,2
				09/95→; → W1999999; für Rechtslenker	24.2122-1724.3	010561	Ø 22,2
				W7000001→ W7999999; für Linkslenker	24.2123-1777.3	010943	Ø 23,8
				W5000001→ W5999999; für Linkslenker	24.2123-1777.3	010943	Ø 23,8
				W1000001→ W1999999; für Linkslenker	24.2123-1777.3	010943	Ø 23,8
1.8 Dualfuel 1.8 i 16V	92	09/00→03/02		→ V1999999; für Linkslenker	24.2122-1724.3	010561	Ø 22,2
	85 - 92	10/95→03/02		→ V7999999; für Linkslenker	24.2122-1724.3	010561	Ø 22,2
				→ W1999999; für Rechtslenker	24.2122-1724.3	010561	Ø 22,2
				→ V5999999; für Linkslenker	24.2122-1724.3	010561	Ø 22,2
				→ W7999999; für Rechtslenker	24.2122-1724.3	010561	Ø 22,2
				→ W5999999; für Rechtslenker	24.2122-1724.3	010561	Ø 22,2
				W7000001→ W7999999; für Linkslenker	24.2123-1777.3	010943	Ø 23,8
	W5000001→ W5999999; für Linkslenker	24.2123-1777.3	010943	Ø 23,8			
	W1000001→ W1999999; für Linkslenker	24.2123-1777.3	010943	Ø 23,8			
2.0 DI 16V	60	08/95→10/01		11/96→; → W7999999; für Rechtslenker	24.2122-1724.3	010561	Ø 22,2
				11/96→; → V7999999; für Linkslenker	24.2122-1724.3	010561	Ø 22,2
				11/96→; → V1999999; für Linkslenker	24.2122-1724.3	010561	Ø 22,2
				11/96→; → W5999999; für Rechtslenker	24.2122-1724.3	010561	Ø 22,2
				11/96→; → V5999999; für Linkslenker	24.2122-1724.3	010561	Ø 22,2
				11/96→; → W1999999; für Rechtslenker	24.2122-1724.3	010561	Ø 22,2
				W7000001→ W7999999; für Linkslenker	24.2123-1777.3	010943	Ø 23,8
				W5000001→ W5999999; für Linkslenker	24.2123-1777.3	010943	Ø 23,8
				W1000001→ W1999999; für Linkslenker	24.2123-1777.3	010943	Ø 23,8
2.0 DTI 16V	74	08/95→10/01		06/97→; → V1999999; für Linkslenker	24.2122-1724.3	010561	Ø 22,2
				06/97→; → V7999999; für Linkslenker	24.2122-1724.3	010561	Ø 22,2
				06/97→; → W1999999; für Rechtslenker	24.2122-1724.3	010561	Ø 22,2
				06/97→; → V5999999; für Linkslenker	24.2122-1724.3	010561	Ø 22,2
				06/97→; → W7999999; für Rechtslenker	24.2122-1724.3	010561	Ø 22,2
				06/97→; → W5999999; für Rechtslenker	24.2122-1724.3	010561	Ø 22,2
				W7000001→ W7999999; für Linkslenker	24.2123-1777.3	010943	Ø 23,8
→							

























	kw					! #		
VAUXHALL - VECTRA (B) Stufenheck (J96) 08/95→03/02								
 Hauptbremszylinder								
2.0 DTI 16V	74	08/95→10/01		W5000001→ W5999999; für Linkslenker		24.2123-1777.3 010943		Ø 23,8
				W1000001→ W1999999; für Linkslenker		24.2123-1777.3 010943		Ø 23,8
2.0 Dualfuel	100	05/98→01/01		→ W1285446; für Linkslenker		03.2123-1622.3 010470		Ø 23,8
2.0 i 16V	100	10/95→01/01		→ W5276825; für Linkslenker		03.2123-1622.3 010470		Ø 23,8
2.5 i GSi	143	03/98→07/00		→ W7154258; für Linkslenker		03.2123-1622.3 010470		Ø 23,8
2.5 i V6	125	09/95→08/00		→ W1285446; für Rechtslenker		03.2123-1722.3 010471		Ø 23,8
				→ W5276825; für Rechtslenker		03.2123-1722.3 010471		Ø 23,8
				→ W7154258; für Rechtslenker		03.2123-1722.3 010471		Ø 23,8
VAUXHALL - VECTRA Mk II (C) (Z02) 01/00→10/08								
 Hauptbremszylinder								
1.8	103	01/06→07/08		für Linkslenker; + ESP		24.2125-1732.3 010827		TRW Ø 25,4
1.8 16V	90	04/02→07/08						
1.8 16V Dualfuel	90	04/02→07/08						
1.9 CDTI 16V	110	04/04→08/08						
2.0 DTI 16V	74	04/02→10/08						
2.2 DTI 16V	92	04/02→10/08						
3.0 CDTi	135	08/05→07/08						
3.0 V6 CDTI	130	06/03→08/05						
3.2 V6	155	06/03→07/08						
1.9 CDTI	88	04/02→09/08		04/04→; für Linkslenker; + ESP		24.2125-1732.3 010827		TRW Ø 25,4
2.0 16V Turbo	129	01/00→10/08		03/03→; für Linkslenker; + ESP		24.2125-1732.3 010827		TRW Ø 25,4
2.2 16V	108	01/02→10/08		04/02→; für Linkslenker; + ESP		24.2125-1732.3 010827		TRW Ø 25,4
2.2 direct	114	01/02→10/08		10/03→; für Linkslenker; + ESP		24.2125-1732.3 010827		TRW Ø 25,4
VAUXHALL - VECTRA Mk II (C) CC (Z02) 08/02→05/09								
 Hauptbremszylinder								
1.8	103	01/06→07/08		für Linkslenker; + ESP		24.2125-1732.3 010827		TRW Ø 25,4
1.8 16V	90	08/02→07/08						
1.8 16V Dualfuel	90	08/02→07/08						
1.9 CDTI 16V	110	04/04→07/08						
2.0 16V Turbo	129	03/03→07/08						
2.0 DTI 16V	74	08/02→07/08						
2.2 16V	108	08/02→07/08						
2.2 direct	114	10/03→08/05						
2.2 DTI 16V	92	08/02→07/08						
3.0 CDTi	135	08/05→07/08						
3.0 V6 CDTI	130	06/03→08/05						
3.2 V6	155	08/02→07/08						
1.9 CDTI	88	08/02→07/08		04/04→; für Linkslenker; + ESP		24.2125-1732.3 010827		TRW Ø 25,4
VAUXHALL - VECTRA Mk II (C) Kombi (Z02) 10/03→05/09								
 Hauptbremszylinder								
1.8	103	01/06→07/08		für Linkslenker; + ESP		24.2125-1732.3 010827		TRW Ø 25,4
1.8 16V	90	10/03→08/05						
1.9 CDTI	88	04/04→07/08						
2.0 16V Turbo	129	10/03→07/08						
2.0 DTI 16V	74	10/03→07/08						
2.2 direct	114	10/03→07/08						
2.2 DTI 16V	92	10/03→07/08						
3.0 CDTi	135	08/05→07/08						
3.0 V6 CDTI	130	10/03→08/05						
3.2 V6	155	10/03→08/05						
1.9 CDTI 16V	110	04/04→05/09		für Linkslenker; + ESP; → 10/08		24.2125-1732.3 010827		TRW Ø 25,4
VAUXHALL - VIVARO A Bus (X83) 08/01→07/14								
 Hauptbremszylinder								
1.9 DI	59	08/01→12/06		7V600001 / 7Y000001→; + ABS		24.2120-1748.3 010894		TRW Ø 20,6
1.9 DTI	74	08/01→12/06		7V600001 / 7Y000001→; + ASR		24.2120-1753.3 010946		TRW Ø 20,6
				4V602168→ 6V699999; für Rechtslenker; - ASR		24.2125-1731.3 010826		TRW Ø 25,4
2.0 16V	88	08/01→12/06		7V600001 / 7Y000001→; + ABS		24.2120-1748.3 010894		TRW Ø 20,6
				7V600001 / 7Y000001→; + ASR		24.2120-1753.3 010946		TRW Ø 20,6
				4V602168→ 6V699999; - ASR		24.2125-1731.3 010826		TRW Ø 25,4
2.0 CDTI	66 - 84	01/06→07/14		7V600001 / 7Y000001→; → 06/14; + ABS		24.2120-1748.3 010894		TRW Ø 20,6
2.0 ECOTEC	86	08/06→07/14		7V600001 / 7Y000001→; → 06/14; + ASR		24.2120-1753.3 010946		TRW Ø 20,6
2.5 CDTI	84 - 107	01/06→07/14						
2.5 DTI	99	07/03→07/14		4V602168→ 6V699999; - ASR		24.2125-1731.3 010826		TRW Ø 25,4









	kw					! #		
VAUXHALL - VIVARO A Kasten (X83) 08/01→07/14								
 Hauptbremszylinder								
1.9 DI 1.9 DTI	59 74	08/01→12/06 08/01→12/06		7V600001 / 7Y000001→; + ABS		24.2120-1748.3	010894	TRW Ø 20,6
				7V600001 / 7Y000001→; + ASR		24.2120-1753.3	010946	TRW Ø 20,6
				4V602168→ 6V699999; für Rechtslenker; - ASR		24.2125-1731.3	010826	TRW Ø 25,4
2.0 16V 2.5 CDTI	88 84	08/01→12/06 08/06→08/08		7V600001 / 7Y000001→; + ABS		24.2120-1748.3	010894	TRW Ø 20,6
				7V600001 / 7Y000001→; + ASR		24.2120-1753.3	010946	TRW Ø 20,6
				4V602168→ 6V699999; - ASR		24.2125-1731.3	010826	TRW Ø 25,4
2.0 CDTI 2.0 ECOTEC 2.5 CDTI 2.5 DTI	66 - 84 86 107 99	01/06→07/14 08/06→07/14 08/06→07/14 07/03→07/14		7V600001 / 7Y000001→; → 06/14; + ABS		24.2120-1748.3	010894	TRW Ø 20,6
				7V600001 / 7Y000001→; → 06/14; + ASR		24.2120-1753.3	010946	TRW Ø 20,6
				4V602168→ 6V699999; - ASR		24.2125-1731.3	010826	TRW Ø 25,4
VAUXHALL - VIVARO A Pritsche/Fahrgestell (X83) 04/03→07/14								
 Hauptbremszylinder								
2.0 16V 2.0 CDTI	88 66 - 84	04/03→07/14 01/06→07/14		7V600001 / 7Y000001→; → 06/14; + ABS		24.2120-1748.3	010894	TRW Ø 20,6
2.0 ECOTEC 2.5 CDTI	86 84 - 107	08/06→07/14 08/06→07/14		7V600001 / 7Y000001→; → 06/14; + ASR		24.2120-1753.3	010946	TRW Ø 20,6
				4V602168→ 6V699999; - ASR		24.2125-1731.3	010826	TRW Ø 25,4
2.5 CDTI	99	04/03→07/06		7V600001 / 7Y000001→; + ABS		24.2120-1748.3	010894	TRW Ø 20,6
				7V600001 / 7Y000001→; + ASR		24.2120-1753.3	010946	TRW Ø 20,6
				4V602168→ 6V699999; - ASR		24.2125-1731.3	010826	TRW Ø 25,4
VAUXHALL - ZAFIRA A (T98) 11/98→08/05								
 Hauptbremszylinder								
1.6 16V 1.8 16V 1.8 Dualfuel 2.0 DI 16V	74 92 92 60	04/99→08/05 09/00→08/05 09/00→08/05 10/99→08/05		- ESP; → 06/05		24.2123-1734.3	010640	TRW Ø 23,8
				+ ESP; → 06/05		24.2123-1739.3	010661	Ø 23,8
1.6 CNG 1.8 16V 2.0 2.0 GSI Turbo	71 85 147 141	09/01→06/05 05/99→08/00 06/02→06/05 09/01→06/05		- ESP		24.2123-1734.3	010640	TRW Ø 23,8
				+ ESP		24.2123-1739.3	010661	Ø 23,8
1.6 Dualfuel	74	11/98→08/05		04/99→; - ESP; → 06/05		24.2123-1734.3	010640	TRW Ø 23,8
				04/99→; + ESP; → 06/05		24.2123-1739.3	010661	Ø 23,8
2.0 DTI 16V	74	04/99→08/05		06/00→; - ESP; → 06/05		24.2123-1734.3	010640	TRW Ø 23,8
				06/00→; + ESP; → 06/05		24.2123-1739.3	010661	Ø 23,8
2.2 16V	108	11/98→08/04		09/00→; - ESP		24.2123-1734.3	010640	TRW Ø 23,8
				09/00→; + ESP		24.2123-1739.3	010661	Ø 23,8
 Bremskraftregler								
1.6 16V 1.8 16V 1.8 Dualfuel 2.0 DI 16V	74 92 92 60	04/99→08/05 09/00→08/05 09/00→08/05 10/99→08/05		- ABS; → 06/05		03.6583-0085.3	320238	ATE lastabhängig 8/3 4x
1.6 CNG 1.8 16V 2.0 2.0 GSI Turbo	71 85 147 141	09/01→06/05 05/99→08/00 06/02→06/05 09/01→06/05		- ABS		03.6583-0085.3	320238	ATE lastabhängig 8/3 4x
1.6 Dualfuel	74	11/98→08/05		04/99→; - ABS; → 06/05		03.6583-0085.3	320238	ATE lastabhängig 8/3 4x
2.0 DTI 16V	74	04/99→08/05		06/00→; - ABS; → 06/05		03.6583-0085.3	320238	ATE lastabhängig 8/3 4x
2.2 16V	108	11/98→08/04		09/00→; - ABS		03.6583-0085.3	320238	ATE lastabhängig 8/3 4x
VAUXHALL - ZAFIRA Mk II (B) (A05) 04/05→11/14								
 Bremskraftverstärker								
1.6 1.7 CDTI 1.9 CDTI 2.0 2.2 1.8	77 - 85 81 - 92 88 - 110 147 - 176 110 88	07/05→11/14 01/08→11/14 07/05→11/14 07/05→11/14 07/05→11/14 04/13→11/14		für Linkslenker; + ESP		03.7863-7803.4	300237	ATE Ø 10" pneumatisch
1.8 →	103	04/05→11/14		06/13→; für Linkslenker; + ESP		03.7863-7803.4	300237	ATE Ø 10" pneumatisch
				07/05→; für Linkslenker; + ESP		03.7863-7803.4	300237	ATE Ø 10" pneumatisch







	kw					! #		
VAUXHALL - ZAFIRA Mk II (B) (A05) 04/05→11/14								
 Hauptbremszylinder								
1.6 2.0	77 147 - 176	07/05→11/14 07/05→11/14		für Linkslenker; - ESP		03.4155-0153.3 010927	ATE Ø 25,4	
				für Linkslenker; + ESP		03.4155-0156.3 010862	ATE Ø 25,4	
				→ 6G999999; für Rechtslenker		24.2125-1736.3 010904	TRW Ø 25,4	
				72000001→; für Rechtslenker		24.4125-1703.3 010907	TRW Ø 25,4	
1.6	85	12/07→11/14		für Linkslenker; - ESP		03.4155-0153.3 010927	ATE Ø 25,4	
				für Linkslenker; + ESP		03.4155-0156.3 010862	ATE Ø 25,4	
1.7 CDTi	81 - 92	01/08→11/14		für Linkslenker; - ESP		03.4155-0153.3 010927	ATE Ø 25,4	
1.9 CDTi	88 -	07/05→11/14		für Rechtslenker		03.4155-0156.3 010862	ATE Ø 25,4	
2.2	110 110	07/05→11/14		für Linkslenker; + ESP		03.4155-0156.3 010862	ATE Ø 25,4	
1.8	88	04/13→11/14		06/13→; für Linkslenker; - ESP		03.4155-0153.3 010927	ATE Ø 25,4	
				06/13→; für Linkslenker; + ESP		03.4155-0156.3 010862	ATE Ø 25,4	
				06/13→; für Rechtslenker		24.4125-1703.3 010907	TRW Ø 25,4	
1.8	103	04/05→11/14		07/05→; für Linkslenker; - ESP		03.4155-0153.3 010927	ATE Ø 25,4	
				07/05→; für Linkslenker; + ESP		03.4155-0156.3 010862	ATE Ø 25,4	
				07/05→; → 6G999999; für Rechtslenker		24.2125-1736.3 010904	TRW Ø 25,4	
				72000001→; für Rechtslenker		24.4125-1703.3 010907	TRW Ø 25,4	
VAUXHALL - ZAFIRA Mk III (P12) 10/11→08/18								
 Bremskraftverstärker								
1.4	88 - 103	10/11→08/18		11/11→; für Linkslenker		03.7858-0732.4 300272	ATE Ø 9 / 8" pneumatisch	
1.6 CNG	110	10/11→08/18						
1.8	85 - 103	10/11→08/18						
2.0 CDTi	81 - 121	10/11→08/18						
1.6 CDTi	99 - 100	03/13→08/18		für Linkslenker		03.7858-0732.4 300272	ATE Ø 9 / 8" pneumatisch	
1.6 SIDI	147	07/13→08/18						
2.0 BiTurbo CDTi	143	11/12→08/18						
2.0 CDTi	125	01/15→08/18						
 Hauptbremszylinder								
1.4	88 - 103	10/11→08/18		11/11→; für Linkslenker		03.2125-0421.3 010934	ATE Ø 25,4	
1.6 CNG	110	10/11→08/18						
1.8	85 - 103	10/11→08/18						
2.0 CDTi	81 - 121	10/11→08/18						
1.6 CDTi	99 - 100	03/13→08/18		für Linkslenker		03.2125-0421.3 010934	ATE Ø 25,4	
1.6 SIDI	147	07/13→08/18						
2.0 BiTurbo CDTi	143	11/12→08/18						
2.0 CDTi	125	01/15→08/18						
VOLVO - 850 (854) 06/91→10/97								
 Bremskraftverstärker								
2.3 Turbo R	179	09/94→10/97		09/95→ 12/96; für Linkslenker		03.7760-3602.4 300176	ATE Ø 10" pneumatisch	
Pedalwegsensor, Bremspedal								
2.3 Turbo R	179	09/94→10/97		08/95→ 08/95		03.0655-0003.2 370003	ATE	
 Hauptbremszylinder								
2.3 Turbo R	179	09/94→10/97		09/95→ 12/96; - ASR		03.2023-1084.3 010591	ATE Ø1 23,8 Ø2 20,6	
VOLVO - 850 Kombi (855) 04/92→10/97								
 Bremskraftverstärker								
2.0 Turbo	132	09/93→10/97		09/95→ 12/95; für Linkslenker		03.7760-3602.4 300176	ATE Ø 10" pneumatisch	
2.3 Turbo R	177	06/95→10/97		09/95→ 12/96; für Linkslenker		03.7760-3602.4 300176	ATE Ø 10" pneumatisch	
Pedalwegsensor, Bremspedal								
2.0 Turbo	132	09/93→10/97		→ 08/95		03.0655-0003.2 370003	ATE	
2.3 Turbo R	177	06/95→10/97		08/95→ 08/95		03.0655-0003.2 370003	ATE	
 Hauptbremszylinder								
2.0 Turbo	132	09/93→10/97		09/95→ 12/96; - ASR		03.2023-1084.3 010591	ATE Ø1 23,8 Ø2 20,6	
2.3 Turbo R	177	06/95→10/97						

	kw					! #		
VOLVO - 940 II (944) 08/94 → 12/98								
 Hauptbremszylinder								
2.0 Turbo 2.3 2.3 ti 2.3 Turbo 2.4 TD Interc.	114 96 99 121 90	04/96 → 10/98 08/94 → 10/98 01/95 → 10/98 08/94 → 10/98 08/94 → 10/98					03.2023-0875.3 010890	ATE Ø1 23,8 Ø2 20,6 ohne Bremsflüssigkeitsbehälter
2.3 Turbo	126	01/95 → 12/98		→ 10/98			03.2023-0875.3 010890	ATE Ø1 23,8 Ø2 20,6 ohne Bremsflüssigkeitsbehälter
VOLVO - 940 II Kombi (945) 09/90 → 10/98								
 Hauptbremszylinder								
2.0 Turbo 2.3 2.3 ti 2.3 Turbo 2.4 TD Interc.	114 96 99 121 - 126 90	04/96 → 10/98 08/94 → 10/98 01/95 → 10/98 08/94 → 10/98 08/94 → 10/98					03.2023-0875.3 010890	ATE Ø1 23,8 Ø2 20,6 ohne Bremsflüssigkeitsbehälter
VOLVO - C30 (533) 09/06 → 12/13								
 Bremskraftverstärker								
1.6 1.6 D 1.8 2.0 2.0 D 2.0 FlexFuel 2.4 i D5 Electric T5	74 80 92 107 100 107 125 120 - 132 82 - 89 162 - 184	10/06 → 12/12 10/06 → 12/12 10/06 → 12/12 10/06 → 12/12 10/06 → 12/12 01/10 → 12/12 10/06 → 12/12 10/06 → 12/12 12/10 → 12/12 10/06 → 12/13		für Linkslenker			03.7863-4832.4 300289	ATE Ø 10" pneumatisch
1.8 FlexFuel	92	01/07 → 12/12		04/07 →; für Linkslenker			03.7863-4832.4 300289	ATE Ø 10" pneumatisch
Pedalwegsensord, Bremspedal								
1.6 1.6 D 1.8 2.0 2.0 D 2.0 FlexFuel 2.4 i D5 T5	74 80 92 107 100 107 125 120 - 132 162 - 184	10/06 → 12/12 10/06 → 12/12 10/06 → 12/12 10/06 → 12/12 10/06 → 12/12 01/10 → 12/12 10/06 → 12/12 10/06 → 12/12 10/06 → 12/13					03.0655-0007.2 370007	ATE
1.8 FlexFuel	92	01/07 → 12/12		04/07 →			03.0655-0007.2 370007	ATE
Electric	82 - 89	12/10 → 12/12		für Linkslenker			03.0655-0007.2 370007	ATE
 Hauptbremszylinder								
1.6 1.6 D 1.8 2.0 2.0 D 2.0 FlexFuel 2.4 i D5 Electric T5	74 80 92 107 100 107 125 120 - 132 82 - 89 162 - 184	10/06 → 12/12 10/06 → 12/12 10/06 → 12/12 10/06 → 12/12 10/06 → 12/12 01/10 → 12/12 10/06 → 12/12 10/06 → 12/12 12/10 → 12/12 10/06 → 12/13		für Linkslenker			03.2123-3593.3 010919	ATE Ø 23,8
1.8 FlexFuel	92	01/07 → 12/12		04/07 →; für Linkslenker			03.2123-3593.3 010919	ATE Ø 23,8
D2 D3 D4	84 110 130	10/10 → 12/12 10/10 → 12/12 10/10 → 12/12		für Linkslenker			03.2123-3624.3 010956	ATE Ø 23,8
Hydraulikaggregat, Bremsanlage								
1.6 1.6 D 1.8 2.0 2.0 D 2.0 FlexFuel 2.4 i D2 →	74 80 92 107 100 107 125 84	10/06 → 12/12 10/06 → 12/12 10/06 → 12/12 10/06 → 12/12 10/06 → 12/12 01/10 → 12/12 10/06 → 12/12 10/10 → 12/12		für Rechtslenker; Getriebetyp: B6; Schaltgetriebe; + DSTC			24.9145-0005.2 399009	
				für Rechtslenker; Getriebetyp: AW55-50/51SN; Automatikgetriebe; + DSTC			24.9145-0005.2 399009	
				für Linkslenker; Getriebetyp: M66; Schaltgetriebe; + DSTC			24.9145-0005.2 399009	









	kW			 	! #		
VOLVO - C30 (533) 09/06→12/13							
Hydraulikaggregat, Bremsanlage							
D5	120 - 132	10/06→12/12		für Rechtslenker; Getriebetyp: B6; Schaltgetriebe; + DSTC		24.9145-0005.2	399009
T5	162 - 184	10/06→12/13		für Rechtslenker; Getriebetyp: AW55-50/51SN; Automatikgetriebe; + DSTC		24.9145-0005.2	399009
				für Linkslenker; Getriebetyp: M66; Schaltgetriebe; + DSTC		24.9145-0005.2	399009
1.8 FlexFuel	92	01/07→12/12		04/07→; für Rechtslenker; Getriebetyp: AW55-50/51SN; Automatikgetriebe; + DSTC		24.9145-0005.2	399009
				04/07→; für Rechtslenker; Getriebetyp: B6; Schaltgetriebe; + DSTC		24.9145-0005.2	399009
				04/07→; für Linkslenker; Getriebetyp: M66; Schaltgetriebe; + DSTC		24.9145-0005.2	399009
D3 D4	110 130	10/10→12/12		für Rechtslenker; Getriebetyp: AW55-50/51SN; Automatikgetriebe; + DSTC		24.9145-0005.2	399009
		10/10→12/12		→ 203925; für Rechtslenker; Getriebetyp: B6; Schaltgetriebe; + DSTC		24.9145-0005.2	399009
Electric	82 - 89	12/10→12/12		+ DSTC		24.9145-0005.2	399009
VOLVO - C70 I Cabriolet (873) 03/98→10/05							
 Bremskraftverstärker							
2.0	132	03/98→10/05		→ 12/98; für Linkslenker		03.7760-3602.4	300176
2.0 T	166	03/98→10/05					
2.4	125	06/98→10/05					
2.4 T	142	03/98→10/05					
T5	176	03/98→10/05					
Pedalwegsensor, Bremspedal							
2.0	132	03/98→10/05		01/99→		03.0655-0004.2	370004
2.0 T	166	03/98→10/05					
2.4	125	06/98→10/05					
2.4 T	142	03/98→10/05					
T5	176	03/98→10/05					
2.0 T	120	03/00→10/05				03.0655-0004.2	370004
2.4 T	147	07/02→10/05					
T5	180	07/02→10/05					
 Hauptbremszylinder							
2.0	132	03/98→10/05		→ 12/98; - ASR		03.2023-1084.3	010591
2.0 T	166	03/98→10/05					
2.4	125	06/98→10/05		01/99→		03.2123-2164.3	010599
2.4 T	142	03/98→10/05					
T5	176	03/98→10/05					
2.0 T	120	03/00→10/05				03.2123-2164.3	010599
2.4 T	147	07/02→10/05					
T5	180	07/02→10/05					
VOLVO - C70 I Coupe (872) 03/97→09/02							
 Bremskraftverstärker							
2.0	132	03/97→09/02		→ 12/98; für Linkslenker		03.7760-3602.4	300176
2.0 T	166	03/97→09/02					
2.4 T	142	03/97→09/02					
T-5	176	03/97→09/02					
Pedalwegsensor, Bremspedal							
2.0	132	03/97→09/02		01/99→		03.0655-0004.2	370004
2.0 T	166	03/97→09/02					
2.4 T	142	03/97→09/02					
T-5	176	03/97→09/02					
2.0 T	120	03/00→09/02				03.0655-0004.2	370004
2.4	121	03/99→09/02					
2.4	125	05/99→09/02		11/99→		03.0655-0004.2	370004
 Hauptbremszylinder							
2.0	132	03/97→09/02		→ 12/98; für Linkslenker; - ASR		03.2023-1084.3	010591
2.0 T	166	03/97→09/02					
2.4 T	142	03/97→09/02		01/99→		03.2123-2164.3	010599
T-5	176	03/97→09/02					
2.0 T	120	03/00→09/02				03.2123-2164.3	010599
2.4	121	03/99→09/02					
2.4	125	05/99→09/02		11/99→		03.2123-2164.3	010599









	kw			 	! #		
VOLVO - C70 II Cabriolet (542) 03/06→12/13							
 Bremskraftverstärker							
2.0 D	100	01/08→10/09		06/08→; für Linkslenker		03.7863-4832.4 300289	ATE Ø 10" pneumatisch
2.4	103	03/06→10/09		für Linkslenker		03.7863-4832.4 300289	ATE Ø 10" pneumatisch
2.4 D	120	03/07→06/13					
2.4 i	125	03/06→10/09					
D5	132	03/06→06/13					
T5	162 - 169	03/06→06/13					
Pedalwegsensord, Bremspedal							
2.0 D	100	01/08→10/09		06/08→; für Linkslenker		03.0655-0007.2 370007	ATE
				50576→; für Rechtslenker		03.0655-0007.2 370007	ATE
				06/08→; → 50575; für Rechtslenker		03.0655-0007.2 370007	ATE
2.4	103	03/06→10/09				03.0655-0007.2 370007	ATE
2.4 D	120	03/07→06/13					
2.4 i	125	03/06→10/09					
D5	132	03/06→06/13					
T5	162 - 169	03/06→06/13					
 Hauptbremszylinder							
2.0 D	100	01/08→10/09		06/08→; für Linkslenker		03.2123-3593.3 010919	ATE Ø 23,8
2.4	103	03/06→10/09		für Linkslenker		03.2123-3593.3 010919	ATE Ø 23,8
2.4 D	120	03/07→06/13					
2.4 i	125	03/06→10/09					
D5	132	03/06→06/13					
T5	162 - 169	03/06→06/13					
D3	110	10/10→06/13		für Linkslenker		03.2123-3624.3 010956	ATE Ø 23,8
D4	130	10/10→06/13					
Hydraulikaggregat, Bremsanlage							
2.0 D	100	01/08→10/09		06/08→; → 112003; + DSTC		24.9145-0005.2 399009	
				112004→; + DSTC; Ausstattungs-Code: GZ01		24.9145-0005.2 399009	
2.4	103	03/06→10/09		→ 112003; + DSTC		24.9145-0005.2 399009	
2.4 D	120	03/07→06/13					
2.4 i	125	03/06→10/09		112004→; + DSTC; Ausstattungs-Code: GZ01		24.9145-0005.2 399009	
D5	132	03/06→06/13					
T5	162 - 169	03/06→06/13					
D3	110	10/10→06/13		→ 112003; + DSTC		24.9145-0005.2 399009	
D4	130	10/10→06/13					
VOLVO - S40 I (644) 07/95→12/04							
 Hauptbremszylinder							
1.6	77	09/95→08/99		→ 08/97		24.2122-1718.3 010517	Ø 22,2
1.8	85	07/95→08/99		09/97→		24.2123-1746.3 010682	Ø 23,8
1.9 T4	147	05/97→07/00					
1.9 TD	66	07/95→08/99					
2.0	100 - 103	07/95→12/03					
1.6	80	03/99→12/03				24.2123-1746.3 010682	Ø 23,8
1.8	90	03/99→12/03					
1.8 i	90 - 92	03/98→12/03					
1.9 DI	70 - 85	03/99→12/03					
2.0 D	100	12/02→06/04					
2.0 T	120 - 121	07/00→12/03					
2.0 T4	147	07/00→12/03					
2.0 T	118	10/97→12/03		→ 07/00		24.2123-1746.3 010682	Ø 23,8
VOLVO - S40 II (544) 12/03→12/12							
 Bremskraftverstärker							
1.6	74	01/05→12/12		→ 05/12; für Linkslenker		03.7863-4832.4 300289	ATE Ø 10" pneumatisch
1.6 D	81	01/05→12/12					
2.0	107	10/06→12/12					
2.0 F	107	10/09→12/12					
T5	169	03/07→12/12					
1.8	92	04/04→12/10		für Linkslenker		03.7863-4832.4 300289	ATE Ø 10" pneumatisch
2.0 CDI	98	07/05→12/06					
2.0 D	100	01/04→12/10					
2.4	103 - 125	01/04→12/12					
2.4 CDI	120	03/07→12/10					
→							









	kw				! #		
VOLVO - S40 II (544) 12/03→12/12							
 Bremskraftverstärker							
D4 D5 T5 T5 AWD	96 132 162 162 - 169	07/05→12/06 03/06→12/10 01/04→12/07 04/04→12/10		für Linkslenker		03.7863-4832.4 300289	ATE Ø 10" pneumatisch
1.8 FlexFuel	92	01/06→12/10		04/07→; für Linkslenker		03.7863-4832.4 300289	ATE Ø 10" pneumatisch
Pedalwegsensord, Bremspedal							
1.6 1.6 D 2.0 2.0 F T5	74 81 107 107 169	01/05→12/12 01/05→12/12 10/06→12/12 10/09→12/12 03/07→12/12		→ 05/12		03.0655-0007.2 370007	ATE
1.8 2.0 CDI 2.0 D 2.4 2.4 CDI D4 D5 T5 T5 AWD	92 98 100 103 - 125 120 96 132 162 162 - 169	04/04→12/10 07/05→12/06 01/04→12/10 01/04→12/12 03/07→12/10 07/05→12/06 03/06→12/10 01/04→12/07 04/04→12/10				03.0655-0007.2 370007	ATE
1.8 FlexFuel	92	01/06→12/10		04/07→		03.0655-0007.2 370007	ATE
 Hauptbremszylinder							
1.6 1.6 D 2.0 2.0 F T5	74 81 107 107 169	01/05→12/12 01/05→12/12 10/06→12/12 10/09→12/12 03/07→12/12		→ 05/12; für Linkslenker		03.2123-3593.3 010919	ATE Ø 23,8
1.8 2.0 CDI 2.0 D 2.4 2.4 CDI D4 D5 T5 T5 AWD	92 98 100 103 - 125 120 96 132 162 162 - 169	04/04→12/10 07/05→12/06 01/04→12/10 01/04→12/12 03/07→12/10 07/05→12/06 03/06→12/10 01/04→12/07 04/04→12/10		für Linkslenker		03.2123-3593.3 010919	ATE Ø 23,8
1.8 FlexFuel	92	01/06→12/10		04/07→; für Linkslenker		03.2123-3593.3 010919	ATE Ø 23,8
D2 D3 D4	84 110 130	10/10→12/12 10/10→12/12 10/10→12/12		→ 05/12; für Linkslenker		03.2123-3624.3 010956	ATE Ø 23,8
Hydraulikaggregat, Bremsanlage							
1.6 1.6 D 2.0 2.0 F T5	74 81 107 107 169	01/05→12/12 01/05→12/12 10/06→12/12 10/09→12/12 03/07→12/12		→ 05/12; + DSTC		24.9145-0005.2 399009	
1.8 2.0 CDI 2.0 D 2.4 2.4 CDI D4 D5 T5	92 98 100 103 - 125 120 96 132 162	04/04→12/10 07/05→12/06 01/04→12/10 01/04→12/12 03/07→12/10 07/05→12/06 03/06→12/10 01/04→12/07		+ DSTC		24.9145-0005.2 399009	
1.8 FlexFuel	92	01/06→12/10		04/07→; + DSTC		24.9145-0005.2 399009	
VOLVO - S60 I (384) 07/00→04/10							
 Bremskraftverstärker							
2.0 T	132	07/00→04/10		09/01→ 12/01		03.7755-3402.4 300189	ATE Ø 9 / 8" pneumatisch
				01/02→ 01/09; - DSTC		03.7755-4702.4 300224	ATE Ø 9 / 8" pneumatisch
				01/02→ 01/09; + DSTC		03.7858-3532.4 300233	ATE Ø 9 / 8" pneumatisch
2.4 2.4 T	103 147	07/00→04/10 07/00→04/10		11/00→ 12/01		03.7755-3402.4 300189	ATE Ø 9 / 8" pneumatisch
				01/02→ 01/09; - DSTC		03.7755-4702.4 300224	ATE Ø 9 / 8" pneumatisch
				01/02→ 01/09; + DSTC		03.7858-3532.4 300233	ATE Ø 9 / 8" pneumatisch
2.4	125	11/00→04/10		→ 12/01		03.7755-3402.4 300189	ATE Ø 9 / 8" pneumatisch
				01/02→ 01/09; - DSTC		03.7755-4702.4 300224	ATE Ø 9 / 8" pneumatisch
				01/02→ 01/09; + DSTC		03.7858-3532.4 300233	ATE Ø 9 / 8" pneumatisch
→							











	kw			 	! #		
VOLVO - S60 I (384) 07/00→04/10							
Bremskraftverstärker							
2.4	132	01/05→10/06		- DSTC		03.7755-4702.4 300224	ATE Ø 9 / 8" pneumatisch
2.4 CDI	85	10/03→12/05		+ DSTC		03.7858-3532.4 300233	ATE Ø 9 / 8" pneumatisch
2.4 D	90	05/05→12/06					
2.4 Bifuel	103	07/01→04/10		06/02→ 01/09; - DSTC		03.7755-4702.4 300224	ATE Ø 9 / 8" pneumatisch
				06/02→ 01/09; + DSTC		03.7858-3532.4 300233	ATE Ø 9 / 8" pneumatisch
2.4 D	93	03/05→04/10		09/05→ 01/09; - DSTC		03.7755-4702.4 300224	ATE Ø 9 / 8" pneumatisch
D5	136	03/05→04/10		09/05→ 01/09; + DSTC		03.7858-3532.4 300233	ATE Ø 9 / 8" pneumatisch
2.4 D	96	05/01→04/10		01/02→ 01/09; - DSTC		03.7755-4702.4 300224	ATE Ø 9 / 8" pneumatisch
				01/02→ 01/09; + DSTC		03.7858-3532.4 300233	ATE Ø 9 / 8" pneumatisch
2.4 D	120	07/05→12/09		→ 01/09; - DSTC		03.7755-4702.4 300224	ATE Ø 9 / 8" pneumatisch
T5	191	04/04→04/10		→ 01/09; + DSTC		03.7858-3532.4 300233	ATE Ø 9 / 8" pneumatisch
2.4 T AWD	147	06/01→04/10		11/01→ 12/01		03.7755-3402.4 300189	ATE Ø 9 / 8" pneumatisch
				01/02→ 01/09; - DSTC		03.7755-4702.4 300224	ATE Ø 9 / 8" pneumatisch
				01/02→ 01/09; + DSTC		03.7858-3532.4 300233	ATE Ø 9 / 8" pneumatisch
2.5 T	154	01/03→04/10		02/04→ 01/09; - DSTC		03.7755-4702.4 300224	ATE Ø 9 / 8" pneumatisch
				02/04→ 01/09; + DSTC		03.7858-3532.4 300233	ATE Ø 9 / 8" pneumatisch
2.5 T AWD	154	07/02→04/10		04/04→ 01/09; - DSTC		03.7755-4702.4 300224	ATE Ø 9 / 8" pneumatisch
				04/04→ 01/09; + DSTC		03.7858-3532.4 300233	ATE Ø 9 / 8" pneumatisch
D5	120	01/01→04/10		07/01→ 12/01		03.7755-3402.4 300189	ATE Ø 9 / 8" pneumatisch
				01/02→ 01/09; - DSTC		03.7755-4702.4 300224	ATE Ø 9 / 8" pneumatisch
				01/02→ 01/09; + DSTC		03.7858-3532.4 300233	ATE Ø 9 / 8" pneumatisch
5 T AWD R 2	221	01/03→04/10		03/03→ 01/09; - DSTC		03.7755-4702.4 300224	ATE Ø 9 / 8" pneumatisch
	221	01/03→04/10		03/03→ 01/09; + DSTC		03.7858-3532.4 300233	ATE Ø 9 / 8" pneumatisch
T5	184	07/00→04/10		08/00→ 12/01		03.7755-3402.4 300189	ATE Ø 9 / 8" pneumatisch
				01/02→ 04/04; - DSTC		03.7755-4702.4 300224	ATE Ø 9 / 8" pneumatisch
				01/02→ 04/04; + DSTC		03.7858-3532.4 300233	ATE Ø 9 / 8" pneumatisch
T5	195	07/00→09/02		→ 12/01		03.7755-3402.4 300189	ATE Ø 9 / 8" pneumatisch
				- DSTC		03.7755-4702.4 300224	ATE Ø 9 / 8" pneumatisch
				+ DSTC		03.7858-3532.4 300233	ATE Ø 9 / 8" pneumatisch
Pedalwegsensor, Bremspedal							
2.0 T	132	07/00→04/10		09/01→ 12/01		03.0655-0004.2 370004	ATE
				01/05→ 01/09		03.0655-0005.2 370005	ATE
				01/02→ 01/09		03.0655-0005.2 370005	ATE
2.4	103	07/00→04/10		11/00→ 12/01		03.0655-0004.2 370004	ATE
2.4 T	147	07/00→04/10		01/05→ 01/09		03.0655-0005.2 370005	ATE
				01/02→ 01/09		03.0655-0005.2 370005	ATE
2.4	125	11/00→04/10		→ 12/01		03.0655-0004.2 370004	ATE
				01/05→ 01/09		03.0655-0005.2 370005	ATE
				01/02→ 01/09		03.0655-0005.2 370005	ATE
2.4	132	01/05→10/06				03.0655-0005.2 370005	ATE
2.4 CDI	85	10/03→12/05					
2.4 D	90	05/05→12/06					
2.4 Bifuel	103	07/01→04/10		06/02→ 01/09		03.0655-0005.2 370005	ATE
				01/05→ 01/09		03.0655-0005.2 370005	ATE
2.4 D	93	03/05→04/10		09/05→ 01/09		03.0655-0005.2 370005	ATE
D5	136	03/05→04/10					
2.4 D	96	05/01→04/10		01/05→ 01/09		03.0655-0005.2 370005	ATE
				01/02→ 01/09		03.0655-0005.2 370005	ATE
2.4 D	120	07/05→12/09		→ 01/09		03.0655-0005.2 370005	ATE
2.4 T AWD	147	06/01→04/10		11/01→ 12/01		03.0655-0004.2 370004	ATE
				01/05→ 01/09		03.0655-0005.2 370005	ATE
				01/02→ 01/09		03.0655-0005.2 370005	ATE
2.5 T	154	01/03→04/10		01/05→ 01/09		03.0655-0005.2 370005	ATE
				02/04→ 01/09		03.0655-0005.2 370005	ATE
2.5 T AWD	154	07/02→04/10		01/05→ 01/09		03.0655-0005.2 370005	ATE
				04/04→ 01/09		03.0655-0005.2 370005	ATE
D5	120	01/01→04/10		07/01→ 12/01		03.0655-0004.2 370004	ATE
				01/05→ 01/09		03.0655-0005.2 370005	ATE
				01/02→ 01/09		03.0655-0005.2 370005	ATE
5 T AWD R 2	221	01/03→04/10		01/05→ 01/09		03.0655-0005.2 370005	ATE
	221	01/03→04/10		03/03→ 01/09		03.0655-0005.2 370005	ATE
→							











	kw			 	! #		
VOLVO - S60 I (384) 07/00→04/10							
Pedalwegsensord, Bremspedal							
T5	184	07/00→04/10		08/00→ 12/01		03.0655-0004.2 370004	ATE
				01/02→ 04/04		03.0655-0005.2 370005	ATE
T5	195	07/00→09/02		→ 12/01		03.0655-0004.2 370004	ATE
						03.0655-0005.2 370005	ATE
T5	191	04/04→04/10		→ 01/09		03.0655-0005.2 370005	ATE
				01/05→ 01/09		03.0655-0005.2 370005	ATE
 Hauptbremszylinder							
2.0 T	132	07/00→04/10		09/01→; → 8535; - DSTC		03.2125-7637.3 010707	ATE Ø 25,4
				09/01→; → 11551; für Rechtslenker; + DSTC		03.2125-7637.3 010707	ATE Ø 25,4
				8536→; → 01/09; für Rechtslenker; - DSTC		03.2125-7638.3 010738	ATE Ø 25,4
				11552→; → 01/09; für Rechtslenker; + DSTC		03.2125-7638.3 010738	ATE Ø 25,4
				09/01→; → 9499; für Linkslenker; + DSTC		03.2125-7708.3 010739	ATE Ø 25,4
				9500→; → 01/09; für Linkslenker; + DSTC		03.2125-7713.3 010819	ATE Ø 25,4
				8536→; → 01/09; für Linkslenker; - DSTC		03.2125-7743.3 010921	ATE Ø 25,4
2.4 2.4 T	103 147	07/00→04/10 07/00→04/10		11/00→; → 8535; - DSTC		03.2125-7637.3 010707	ATE Ø 25,4
				11/00→; → 11551; für Rechtslenker; + DSTC		03.2125-7637.3 010707	ATE Ø 25,4
				8536→; → 01/09; für Rechtslenker; - DSTC		03.2125-7638.3 010738	ATE Ø 25,4
				11552→; → 01/09; für Rechtslenker; + DSTC		03.2125-7638.3 010738	ATE Ø 25,4
				11/00→; → 9499; für Linkslenker; + DSTC		03.2125-7708.3 010739	ATE Ø 25,4
				9500→; → 01/09; für Linkslenker; + DSTC		03.2125-7713.3 010819	ATE Ø 25,4
				8536→; → 01/09; für Linkslenker; - DSTC		03.2125-7743.3 010921	ATE Ø 25,4
2.4 2.4 D	125 120	11/00→04/10 07/05→12/09		→ 8535; - DSTC		03.2125-7637.3 010707	ATE Ø 25,4
				→ 11551; für Rechtslenker; + DSTC		03.2125-7637.3 010707	ATE Ø 25,4
				8536→; → 01/09; für Rechtslenker; - DSTC		03.2125-7638.3 010738	ATE Ø 25,4
				11552→; → 01/09; für Rechtslenker; + DSTC		03.2125-7638.3 010738	ATE Ø 25,4
				→ 9499; für Linkslenker; + DSTC		03.2125-7708.3 010739	ATE Ø 25,4
				9500→; → 01/09; für Linkslenker; + DSTC		03.2125-7713.3 010819	ATE Ø 25,4
				8536→; → 01/09; für Linkslenker; - DSTC		03.2125-7743.3 010921	ATE Ø 25,4
2.4 2.4 CDI 2.4 D	132 85 90	01/05→10/06 10/03→12/05 05/05→12/06		für Linkslenker; + DSTC		03.2125-7713.3 010819	ATE Ø 25,4
				für Linkslenker; - DSTC		03.2125-7743.3 010921	ATE Ø 25,4
2.4 Bifuel	103	07/01→04/10		06/02→; → 11551; für Rechtslenker; + DSTC		03.2125-7637.3 010707	ATE Ø 25,4
				06/02→ 01/09; für Rechtslenker; - DSTC		03.2125-7638.3 010738	ATE Ø 25,4
				11552→; → 01/09; für Rechtslenker; + DSTC		03.2125-7638.3 010738	ATE Ø 25,4
				06/02→; → 9499; für Linkslenker; + DSTC		03.2125-7708.3 010739	ATE Ø 25,4
				9500→; → 01/09; für Linkslenker; + DSTC		03.2125-7713.3 010819	ATE Ø 25,4
				06/02→ 01/09; für Linkslenker; - DSTC		03.2125-7743.3 010921	ATE Ø 25,4
2.4 D D5	93 136	03/05→04/10 03/05→04/10		09/05→; für Rechtslenker; → 01/09; - DSTC		03.2125-7638.3 010738	ATE Ø 25,4
				09/05→ 01/09; für Rechtslenker; + DSTC		03.2125-7638.3 010738	ATE Ø 25,4
				09/05→ 01/09; für Linkslenker; + DSTC		03.2125-7713.3 010819	ATE Ø 25,4
				09/05→ 01/09; für Linkslenker; - DSTC		03.2125-7743.3 010921	ATE Ø 25,4
2.4 D	96	05/01→04/10		12/01→; → 8535; - DSTC		03.2125-7637.3 010707	ATE Ø 25,4
				12/01→; → 11551; für Rechtslenker; + DSTC		03.2125-7637.3 010707	ATE Ø 25,4
				8536→; → 01/09; für Rechtslenker; - DSTC		03.2125-7638.3 010738	ATE Ø 25,4
				11552→; → 01/09; für Rechtslenker; + DSTC		03.2125-7638.3 010738	ATE Ø 25,4
→							









	kw			 	! #		
VOLVO - S60 I (384) 07/00→04/10							
 Hauptbremszylinder							
2.4 D	96	05/01→04/10	12/01→; → 9499; für Linkslenker; + DSTC	03.2125-7708.3	010739	ATE Ø 25,4	
			9500→; → 01/09; für Linkslenker; + DSTC	03.2125-7713.3	010819	ATE Ø 25,4	
			8536→; → 01/09; für Linkslenker; - DSTC	03.2125-7743.3	010921	ATE Ø 25,4	
2.4 T AWD	147	06/01→04/10	11/01→; → 8535; - DSTC	03.2125-7637.3	010707	ATE Ø 25,4	
			11/01→; → 11551; für Rechtslenker; + DSTC	03.2125-7637.3	010707	ATE Ø 25,4	
			8536→; → 01/09; für Rechtslenker; - DSTC	03.2125-7638.3	010738	ATE Ø 25,4	
			11552→; → 01/09; für Rechtslenker; + DSTC	03.2125-7638.3	010738	ATE Ø 25,4	
			11/01→; → 9499; für Linkslenker; + DSTC	03.2125-7708.3	010739	ATE Ø 25,4	
			9500→; → 01/09; für Linkslenker; + DSTC	03.2125-7713.3	010819	ATE Ø 25,4	
			8536→; → 01/09; für Linkslenker; - DSTC	03.2125-7743.3	010921	ATE Ø 25,4	
2.5 T	154	01/03→04/10	02/04→; → 11551; für Rechtslenker; + DSTC	03.2125-7637.3	010707	ATE Ø 25,4	
			02/04→ 01/09; für Rechtslenker; - DSTC	03.2125-7638.3	010738	ATE Ø 25,4	
			11552→; → 01/09; für Rechtslenker; + DSTC	03.2125-7638.3	010738	ATE Ø 25,4	
			02/04→; → 9499; für Linkslenker; + DSTC	03.2125-7708.3	010739	ATE Ø 25,4	
			9500→; → 01/09; für Linkslenker; + DSTC	03.2125-7713.3	010819	ATE Ø 25,4	
2.5 T AWD	154	07/02→04/10	02/04→ 01/09; für Linkslenker; - DSTC	03.2125-7743.3	010921	ATE Ø 25,4	
			04/04→; → 11551; für Rechtslenker; + DSTC	03.2125-7637.3	010707	ATE Ø 25,4	
			04/04→ 01/09; für Rechtslenker; - DSTC	03.2125-7638.3	010738	ATE Ø 25,4	
			11552→; → 01/09; für Rechtslenker; + DSTC	03.2125-7638.3	010738	ATE Ø 25,4	
			04/04→; → 9499; für Linkslenker; + DSTC	03.2125-7708.3	010739	ATE Ø 25,4	
D5	120	01/01→04/10	9500→; → 01/09; für Linkslenker; + DSTC	03.2125-7713.3	010819	ATE Ø 25,4	
			04/04→ 01/09; für Linkslenker; - DSTC	03.2125-7743.3	010921	ATE Ø 25,4	
			07/01→; → 8535; - DSTC	03.2125-7637.3	010707	ATE Ø 25,4	
			07/01→; → 11551; für Rechtslenker; + DSTC	03.2125-7637.3	010707	ATE Ø 25,4	
			8536→; → 01/09; für Rechtslenker; - DSTC	03.2125-7638.3	010738	ATE Ø 25,4	
			11552→; → 01/09; für Rechtslenker; + DSTC	03.2125-7638.3	010738	ATE Ø 25,4	
			07/01→; → 9499; für Linkslenker; + DSTC	03.2125-7708.3	010739	ATE Ø 25,4	
5 T AWD R 2	221 221	01/03→04/10 01/03→04/10	9500→; → 01/09; für Linkslenker; + DSTC	03.2125-7713.3	010819	ATE Ø 25,4	
			03/03→ 01/09; für Rechtslenker; - DSTC	03.2125-7638.3	010738	ATE Ø 25,4	
			11552→; → 01/09; für Rechtslenker; + DSTC	03.2125-7638.3	010738	ATE Ø 25,4	
			03/03→; → 9499; für Linkslenker; + DSTC	03.2125-7708.3	010739	ATE Ø 25,4	
			03/03→ 01/09; für Linkslenker; - DSTC	03.2125-7743.3	010921	ATE Ø 25,4	
			08/00→; → 8535; - DSTC	03.2125-7637.3	010707	ATE Ø 25,4	
T5	184	07/00→04/10	9500→; → 01/09; für Linkslenker; + DSTC	03.2125-7713.3	010819	ATE Ø 25,4	
			08/00→; → 11551; für Rechtslenker; + DSTC	03.2125-7637.3	010707	ATE Ø 25,4	
			11552→; → 04/04; für Rechtslenker; + DSTC	03.2125-7638.3	010738	ATE Ø 25,4	
			8536→; → 04/04; für Rechtslenker; - DSTC	03.2125-7638.3	010738	ATE Ø 25,4	
			08/00→; → 9499; für Linkslenker; + DSTC	03.2125-7708.3	010739	ATE Ø 25,4	
			03/03→ 01/09; für Linkslenker; - DSTC	03.2125-7743.3	010921	ATE Ø 25,4	

	kw			 	! #									
VOLVO - S60 I (384) 07/00→04/10														
 Hauptbremszylinder														
T5	184	07/00→04/10		8536→; → 04/04; für Linkslenker; - DSTC		03.2125-7743.3 010921	ATE Ø 25,4							
T5	195	07/00→09/02		→ 8535; - DSTC		03.2125-7637.3 010707	ATE Ø 25,4							
				→ 11551; für Rechtslenker; + DSTC		03.2125-7637.3 010707	ATE Ø 25,4							
				8536→; für Rechtslenker; - DSTC		03.2125-7638.3 010738	ATE Ø 25,4							
				11552→; für Rechtslenker; + DSTC		03.2125-7638.3 010738	ATE Ø 25,4							
				→ 9499; für Linkslenker; + DSTC		03.2125-7708.3 010739	ATE Ø 25,4							
				9500→; für Linkslenker; + DSTC		03.2125-7713.3 010819	ATE Ø 25,4							
T5	191	04/04→04/10		8536→; für Linkslenker; - DSTC		03.2125-7743.3 010921	ATE Ø 25,4							
				→ 11551; für Rechtslenker; + DSTC		03.2125-7637.3 010707	ATE Ø 25,4							
				→ 01/09; für Rechtslenker; - DSTC		03.2125-7638.3 010738	ATE Ø 25,4							
				11552→; → 01/09; für Rechtslenker; + DSTC		03.2125-7638.3 010738	ATE Ø 25,4							
				→ 9499; für Linkslenker; + DSTC		03.2125-7708.3 010739	ATE Ø 25,4							
	9500→; → 01/09; für Linkslenker; + DSTC		03.2125-7713.3 010819	ATE Ø 25,4										
			→ 01/09; für Linkslenker; - DSTC		03.2125-7743.3 010921	ATE Ø 25,4								
VOLVO - S60 II (134) 04/10→12/19														
 Bremskraftverstärker														
2.0 Polestar AWD	270	06/15→05/18		für Fahrzeuge ohne Kollisionswarner		03.7755-9703.4 300239	ATE Ø 9 / 8" pneumatisch							
2.5 T	183	01/13→01/16												
D2	88	03/15→05/18												
D3	110	03/15→05/18												
D4	133 - 140	09/13→05/18												
D4 AWD	140	03/15→05/18												
D4 Drive-E Polestar	147	03/15→05/18												
D5	165	03/15→05/18												
D5 Drive-E Polestar	171	03/15→05/18												
T5	186	09/11→12/15												
T5 AWD	187	08/15→12/18												
2.0 T	132	05/12→12/15			12/13→; für Fahrzeuge ohne Kollisionswarner				03.7755-9703.4 300239	ATE Ø 9 / 8" pneumatisch				
Pedalwegsensoren, Bremspedal														
2.0 T	132	05/12→12/15		12/13→; für Fahrzeuge mit Kollisionswarner		03.0655-0007.2 370007	ATE							
2.0 T 2.5 T D2 D3 D4 D4 AWD D4 Drive-E Polestar D5 D5 AWD D5 Drive-E Polestar DRIVE / D2 T2 T3 T4 T4F T5 T5 AWD T5 DRIVE T6 T6 AWD	149 183 88 100 - 120 133 - 140 140 147 151 - 169 151 - 169 171 84 90 110 - 112 132 132 177 - 186 180 - 187 180 225 224 - 242	04/10→12/11 01/13→01/16 03/15→05/18 04/10→05/18 09/13→05/18 03/15→05/18 03/15→05/18 04/10→05/18 04/10→12/15 03/15→05/18 01/11→12/15 10/15→05/18 04/10→05/18 04/10→12/15 04/11→12/15 04/10→12/18 09/12→12/18 09/14→12/15 09/13→12/18 04/10→12/18		für Fahrzeuge mit Kollisionswarner		03.0655-0007.2 370007	ATE							
								D4	120	04/10→12/14	05/12→; für Fahrzeuge mit Kollisionswarner		03.0655-0007.2 370007	ATE
								D5	158	04/11→12/15	06/11→; für Fahrzeuge mit Kollisionswarner		03.0655-0007.2 370007	ATE
								D5 AWD	158	04/11→12/15				
								T4	140	03/15→05/18	05/15→; für Fahrzeuge mit Kollisionswarner		03.0655-0007.2 370007	ATE
								→						















	kw					! #		
VOLVO - S60 II (134) 04/10→12/19								
 Hauptbremszylinder								
2.0 Polestar AWD	270	06/15→05/18			für Rechtslenker		24.4156-1391.3 011054	ATE Ø 27 ohne Bremsflüssigkeitsbehälter
2.0 T	132	05/12→12/15			12/13→		24.4156-1391.3 011054	ATE Ø 27 ohne Bremsflüssigkeitsbehälter
D5	165	03/15→05/18					24.4156-1391.3 011054	ATE Ø 27 ohne Bremsflüssigkeitsbehälter
D5 Drive-E Polestar	171	03/15→05/18						
T2	90	10/15→05/18						
T5	186	09/11→12/15						
T5 AWD	186	09/12→12/15						
T6 AWD	225	09/15→12/18						
VOLVO - S60 II Cross Country (134) 03/15→12/18								
 Bremskraftverstärker								
D4	140	03/15→05/18			für Fahrzeuge ohne Kollisionswarner		03.7755-9703.4 300239	ATE Ø 9 / 8" pneumatisch
D4 Polestar AWD	162	03/15→07/18						
T5 AWD	183	03/15→12/18						
D4 AWD	140	03/15→05/18			für Fahrzeuge ohne Kollisionswarner; Ausstattungs-Code: RC01		03.7755-0132.4 300265	ATE Ø 9 / 8" pneumatisch
D4 Drive-E Polestar	147	03/15→05/18						
T5 AWD	187	03/15→12/18			für Fahrzeuge ohne Kollisionswarner; Ausstattungs-Code: RC02		03.7755-9703.4 300239	ATE Ø 9 / 8" pneumatisch
Pedalwegsensor, Bremspedal								
D4 Polestar AWD	162	03/15→07/18			für Fahrzeuge mit Kollisionswarner		03.0655-0007.2 370007	ATE
T5 AWD	183	03/15→12/18						
T5 Drive-E Polestar AWD	186	06/16→05/18						
VOLVO - S70 (874) 11/96→11/00								
 Bremskraftverstärker								
2.0	93 - 132	01/97→11/00			für Linkslenker		03.7760-3602.4 300176	ATE Ø 10" pneumatisch
2.0 Turbo	155 - 166	01/97→11/00						
2.3	195	04/99→09/00						
2.3 Turbo	184	01/97→11/00						
2.4	103 - 125	01/97→11/00						
2.4 AWD	103 - 121	11/96→09/00						
2.4 Bifuel	103 - 106	10/98→11/00						
2.4 Blu-Fuel	103	07/97→09/00						
2.4 T5 AWD	142	11/96→04/99						
2.4 Turbo	142	01/97→11/00						
2.5 TDI	103	01/97→11/00						
2.5 TDi AWD	103	10/99→09/00						
T5	176	01/97→11/00						
2.3	177	11/96→11/00			01/97→; für Linkslenker		03.7760-3602.4 300176	ATE Ø 10" pneumatisch
2.4 AWD	125	04/99→09/00			→ 05/99; für Linkslenker		03.7760-3602.4 300176	ATE Ø 10" pneumatisch
 Hauptbremszylinder								
2.0	93 - 132	01/97→11/00			→ 12/98; - ASR		03.2023-1084.3 010591	ATE Ø1 23,8 Ø2 20,6
2.0 Turbo	155 - 166	01/97→11/00			01/99→		03.2123-2164.3 010599	ATE Ø 23,8
2.3 Turbo	184	01/97→11/00						
2.4	106 - 125	01/97→11/00						
2.4 AWD	106 - 121	11/96→05/99						
2.4 Bifuel	106	10/98→11/00						
2.4 T5 AWD	142	11/96→04/99						
2.4 Turbo	142	01/97→11/00						
2.5 TDI	103	01/97→11/00						
T5	176	01/97→11/00						
2.3	177	11/96→11/00			01/97→ 12/98; - ASR		03.2023-1084.3 010591	ATE Ø1 23,8 Ø2 20,6
					01/99→		03.2123-2164.3 010599	ATE Ø 23,8
2.3	195	04/99→09/00						
2.4	103	08/99→11/00						
2.4 AWD	103	04/99→09/00						
2.4 Bifuel	103	07/99→11/00						
2.4 Blu-Fuel	103	07/97→09/00						
2.5 TDi AWD	103	10/99→09/00						
2.4 AWD	125	04/99→09/00			→ 05/99		03.2123-2164.3 010599	ATE Ø 23,8













	kw			 	! #		
VOLVO - S80 I (184) 05/98→02/08							
 Bremskraftverstärker							
2.0	120	06/98→07/06		→ 12/01; - DSTC		03.7755-3402.4 300189	ATE Ø 9 / 8" pneumatisch
2.0 T	132 - 166	06/98→07/06		01/02→ 02/06; - DSTC		03.7755-4702.4 300224	ATE Ø 9 / 8" pneumatisch
2.4	103 - 125	01/99→07/06		01/02→ 02/06; + DSTC		03.7858-3532.4 300233	ATE Ø 9 / 8" pneumatisch
2.4 Bifuel	103	09/01→07/06					
2.4 D	96	10/01→07/06					
2.4 T	147	06/00→07/06					
2.5 TDI	103	01/99→07/06					
2.9	147 - 150	05/98→07/06					
3.0	144	06/01→07/06					
D5	120	08/01→07/06					
T6	200	06/01→07/06					
2.3 R	195	04/00→08/05		→ 12/01; - DSTC		03.7755-3402.4 300189	ATE Ø 9 / 8" pneumatisch
				01/02→; - DSTC		03.7755-4702.4 300224	ATE Ø 9 / 8" pneumatisch
				01/02→; + DSTC		03.7858-3532.4 300233	ATE Ø 9 / 8" pneumatisch
2.5 T	154	03/03→07/06		07/03→ 02/06; - DSTC		03.7755-4702.4 300224	ATE Ø 9 / 8" pneumatisch
				07/03→ 02/06; + DSTC		03.7858-3532.4 300233	ATE Ø 9 / 8" pneumatisch
2.5 T AWD	154	07/03→07/06		→ 02/06; - DSTC		03.7755-4702.4 300224	ATE Ø 9 / 8" pneumatisch
				→ 02/06; + DSTC		03.7858-3532.4 300233	ATE Ø 9 / 8" pneumatisch
T5 AWD	147	04/00→09/03		06/00→ 12/01; - DSTC		03.7755-3402.4 300189	ATE Ø 9 / 8" pneumatisch
				01/02→; - DSTC		03.7755-4702.4 300224	ATE Ø 9 / 8" pneumatisch
				01/02→; + DSTC		03.7858-3532.4 300233	ATE Ø 9 / 8" pneumatisch
T6	200	05/98→12/01		- DSTC		03.7755-3402.4 300189	ATE Ø 9 / 8" pneumatisch
Pedalwegsensoren, Bremspedal							
2.0	120	06/98→07/06		→ 12/01		03.0655-0004.2 370004	ATE
2.0 T	132 - 166	06/98→07/06		01/02→ 02/06		03.0655-0005.2 370005	ATE
2.4	103 - 125	01/99→07/06					
2.4 Bifuel	103	09/01→07/06					
2.4 D	96	10/01→07/06					
2.4 T	147	06/00→07/06					
2.5 TDI	103	01/99→07/06					
2.9	147 - 150	05/98→07/06					
3.0	144	06/01→07/06					
D5	120	08/01→07/06					
T6	200	06/01→07/06					
2.3 R	195	04/00→08/05		→ 12/01		03.0655-0004.2 370004	ATE
				01/02→		03.0655-0005.2 370005	ATE
2.5 T	154	03/03→07/06		07/03→ 02/06		03.0655-0005.2 370005	ATE
2.5 T AWD	154	07/03→07/06		→ 02/06		03.0655-0005.2 370005	ATE
T5 AWD	147	04/00→09/03		06/00→ 12/01		03.0655-0004.2 370004	ATE
				01/02→		03.0655-0005.2 370005	ATE
T6	200	05/98→12/01				03.0655-0004.2 370004	ATE
 Hauptbremszylinder							
2.0	120	06/98→07/06		→ 174095; - DSTC		03.2125-7637.3 010707	ATE Ø 25,4
2.0 T	166	06/98→07/06					
2.4	103 - 125	01/99→07/06		→ 02/06; 174096→; für Rechtslenker		03.2125-7638.3 010738	ATE Ø 25,4
				→ 174095; + DSTC		03.2125-7708.3 010739	ATE Ø 25,4
2.5 TDI	103	01/99→07/06		→ 02/06; 174096→; für Linkslenker; + DSTC		03.2125-7713.3 010819	ATE Ø 25,4
2.9	147 - 150	05/98→07/06		→ 02/06; 174096→; für Linkslenker; - DSTC		03.2125-7743.3 010921	ATE Ø 25,4
2.0 T	132	12/99→07/06		→ 02/06; für Rechtslenker		03.2125-7638.3 010738	ATE Ø 25,4
2.4 Bifuel	103	09/01→07/06					
2.4 D	96	10/01→07/06		→ 02/06; für Linkslenker; + DSTC		03.2125-7713.3 010819	ATE Ø 25,4
2.4 T	147	06/00→07/06		→ 02/06; für Linkslenker; - DSTC		03.2125-7743.3 010921	ATE Ø 25,4
2.5 T AWD	154	07/03→07/06					
3.0	144	06/01→07/06					
D5	120	08/01→07/06					
T6	200	06/01→07/06					
2.3 R	195	04/00→08/05		→ 174095; - DSTC		03.2125-7637.3 010707	ATE Ø 25,4
T6	200	05/98→12/01		174096→; für Rechtslenker		03.2125-7638.3 010738	ATE Ø 25,4
				→ 174095; + DSTC		03.2125-7708.3 010739	ATE Ø 25,4
				174096→; für Linkslenker; + DSTC		03.2125-7713.3 010819	ATE Ø 25,4
				174096→; für Linkslenker; - DSTC		03.2125-7743.3 010921	ATE Ø 25,4
2.5 T	154	03/03→07/06		07/03→ 02/06; für Rechtslenker		03.2125-7638.3 010738	ATE Ø 25,4
→							









	kw			 	! #		
VOLVO - S80 I (184) 05/98→02/08							
 Hauptbremszylinder							
2.5 T	154	03/03→07/06		07/03→ 02/06; für Linkslenker; + DSTC	03.2125-7713.3 010819	ATE Ø 25,4	
				07/03→ 02/06; für Linkslenker; - DSTC	03.2125-7743.3 010921	ATE Ø 25,4	
T5 AWD	147	04/00→09/03		06/00→; für Rechtslenker	03.2125-7638.3 010738	ATE Ø 25,4	
				06/00→; für Linkslenker; + DSTC	03.2125-7713.3 010819	ATE Ø 25,4	
				06/00→; für Linkslenker; - DSTC	03.2125-7743.3 010921	ATE Ø 25,4	
VOLVO - S80 II (124) 03/06→12/16							
 Bremskraftverstärker							
1.6 D DRIVE	80	01/10→12/11		für Linkslenker; für Fahrzeuge ohne Kollisionswarner	03.7755-9703.4 300239	ATE Ø 9 / 8" pneumatisch	
1.6 DRIVE	84	06/11→01/14					
D2	85	01/14→12/16		für Linkslenker; → 151000; für Fahrzeuge mit Kollisionswarner	03.7858-5032.4 300275	ATE Ø 9 / 8" pneumatisch	
D3 / D4	120	01/10→12/16					
2.0	107	01/08→09/12		für Linkslenker; für Fahrzeuge ohne Kollisionswarner	03.7755-9703.4 300239	ATE Ø 9 / 8" pneumatisch	
2.0 FlexFuel	107	01/08→12/11					
2.0 T	149	01/10→05/11					
2.0 TDi	100	02/08→03/11		für Linkslenker; für Fahrzeuge mit Kollisionswarner	03.7858-4832.4 300274	ATE Ø 9 / 8" pneumatisch	
2.4 D	120 - 129	03/06→03/11					
2.5 T	147	03/06→12/11					
2.5 T FlexFuel	147	05/08→12/11					
3.2	175 - 179	03/06→12/14					
3.2 AWD	175 - 179	01/07→12/12					
3.2 Flexifuel AWD	177	01/09→03/10					
D5	136 - 151	03/06→12/11					
D5 AWD	136 - 151	01/07→12/11					
T6 AWD	210	01/07→12/10					
2.0 Drive- E	180	12/14→12/16		für Linkslenker; für Fahrzeuge ohne Kollisionswarner	03.7755-9703.4 300239	ATE Ø 9 / 8" pneumatisch	
				für Linkslenker; für Fahrzeuge mit Kollisionswarner	03.7858-5032.4 300275	ATE Ø 9 / 8" pneumatisch	
2.5 T	170	01/10→12/12		für Fahrzeuge ohne Kollisionswarner	03.7755-9703.4 300239	ATE Ø 9 / 8" pneumatisch	
2.5 T FlexFuel	170	01/10→12/11					
D3	100	05/12→05/14		→ 151000; für Fahrzeuge mit Kollisionswarner	03.7858-5032.4 300275	ATE Ø 9 / 8" pneumatisch	
D5	158	06/11→04/15					
D5 AWD	158	06/11→04/15					
T4	132	10/10→04/14					
T4F	132	05/11→01/14					
T6 AWD	224	10/10→12/16					
2.5 T	183 - 187	01/12→12/16		für Fahrzeuge ohne Kollisionswarner	03.7755-9703.4 300239	ATE Ø 9 / 8" pneumatisch	
D4	133	09/13→12/16					
T5	162 - 180	10/10→12/16		für Linkslenker; für Fahrzeuge ohne Kollisionswarner	03.7755-9703.4 300239	ATE Ø 9 / 8" pneumatisch	
				für Rechtslenker; für Fahrzeuge mit Kollisionswarner	03.7858-4832.4 300274	ATE Ø 9 / 8" pneumatisch	
				für Linkslenker; für Fahrzeuge mit Kollisionswarner	03.7858-5032.4 300275	ATE Ø 9 / 8" pneumatisch	
Pedalwegsensord, Bremspedal							
1.6 D DRIVE	80	01/10→12/11		für Rechtslenker	03.0655-0007.2 370007	ATE	
1.6 DRIVE	84	06/11→01/14					
D2	85	01/14→12/16		für Linkslenker; → 151000	03.0655-0007.2 370007	ATE	
D3 / D4	120	01/10→12/16		151001→; für Linkslenker; für Fahrzeuge mit Kollisionswarner	03.0655-0007.2 370007	ATE	
2.0	107	01/08→09/12		für Rechtslenker	03.0655-0007.2 370007	ATE	
2.0 FlexFuel	107	01/08→12/11					
2.0 T	149	01/10→05/11		für Linkslenker; für Fahrzeuge mit Kollisionswarner	03.0655-0007.2 370007	ATE	
2.0 TDi	100	02/08→03/11					
2.4 D	120 - 129	03/06→03/11					
2.5 T	147	03/06→12/11					
2.5 T FlexFuel	147	05/08→12/11					
3.2	175 - 179	03/06→12/14					
3.2 AWD	175 - 179	01/07→12/12					
3.2 Flexifuel AWD	177	01/09→03/10					
D5	136 - 151	03/06→12/11					
D5 AWD	136 - 151	01/07→12/11					
T6 AWD	210	01/07→12/10					
2.0 Drive- E	180	12/14→12/16		für Linkslenker; für Fahrzeuge mit Kollisionswarner	03.0655-0007.2 370007	ATE	
→							













	kw					! #		
VOLVO - S80 II (124) 03/06→12/16								
Pedalwegsensord, Bremspedal								
2.5 T	170	01/10→12/12			→ 151000		03.0655-0007.2 370007	ATE
2.5 T FlexFuel	170	01/10→12/11			151001→; für Fahrzeuge mit Kollisionswarner		03.0655-0007.2 370007	ATE
D3	100	05/12→05/14						
D5	158	06/11→04/15						
D5 AWD	158	06/11→04/15						
T4	132	10/10→04/14						
T4F	132	05/11→01/14						
T6 AWD	224	10/10→12/16						
2.5 T	183 - 187	01/12→12/16			für Fahrzeuge mit Kollisionswarner		03.0655-0007.2 370007	ATE
D4	133	09/13→12/16						
T5	162 - 180	10/10→12/16						
 Hauptbremszylinder								
T5	162	01/14→12/16					24.4156-1391.3 011054	ATE Ø 27 ohne Bremsflüssigkeitsbehälter
VOLVO - S90 I (964) 11/96→12/98								
 Hauptbremszylinder								
2.5	125 - 132	11/96→10/98					03.2023-0875.3 010890	ATE Ø1 23,8 Ø2 20,6 ohne Bremsflüssigkeitsbehälter
2.9	132 - 150	01/97→05/98						
VOLVO - V40 Cross Country (526) 09/13→12/15								
 Hauptbremszylinder								
1.6 D2/ DRIVe	84	09/13→12/15			für Fahrzeuge ohne Kollisionswarner		03.2125-5016.3 011010	ATE Ø 25,4
VOLVO - V40 Cross Country (526) 10/12→08/19								
 Hauptbremszylinder								
D3	110	04/15→08/19			Ausstattungs-Code: KI01		03.2125-5016.3 011010	ATE Ø 25,4
T3	112	04/15→08/19			für Fahrzeuge ohne Kollisionswarner		03.2125-5016.3 011010	ATE Ø 25,4
T4	140	08/15→08/19						
T4 GTDi	132	10/12→12/16					03.2125-5016.3 011010	ATE Ø 25,4
VOLVO - V40 Kasten/Schrägheck (525) 09/13→12/15								
 Hauptbremszylinder								
1.6 D2/ DRIVe	84	09/13→12/15			für Fahrzeuge ohne Kollisionswarner		03.2125-5016.3 011010	ATE Ø 25,4
2.0 D3	110	09/13→12/15						
2.0 D4	130	09/13→12/14						
VOLVO - V40 Kombi (645) 07/95→06/04								
 Hauptbremszylinder								
1.6	77	12/95→08/99			→ 08/97		24.2122-1718.3 010517	Ø 22,2
1.8	85	07/95→08/99			09/97→		24.2123-1746.3 010682	Ø 23,8
1.9 TD	66	07/95→08/99						
2.0	100 - 103	07/95→06/04						
1.6	80	03/99→06/04					24.2123-1746.3 010682	Ø 23,8
1.8	90	03/99→06/04						
1.8 Bi-Fuel	88	11/99→08/03						
1.8 Blu-Fuel	85	06/01→08/03						
1.8 i	90 - 92	03/98→06/04						
1.8 LPG	90	03/99→06/04						
1.9	127	09/03→06/04						
1.9 DI	70 - 85	03/99→06/04						
2.0 T	118 - 120	10/97→06/04						
1.9 T4	147	05/97→07/00			→ 08/97; + ABS			
					09/97→		24.2123-1746.3 010682	Ø 23,8
2.0 T	121	07/99→06/04			07/00→ 06/01		24.2123-1746.3 010682	Ø 23,8
2.0 T4	147	07/00→06/04			→ 04/04		24.2123-1746.3 010682	Ø 23,8
VOLVO - V40 Schrägheck (525) 03/12→08/19								
 Hauptbremszylinder								
D2	84	03/12→12/16			09/12→; für Fahrzeuge ohne Kollisionswarner		03.2125-5016.3 011010	ATE Ø 25,4
D3	110	03/12→03/15						
D4	130	03/12→12/14						
T3 GTDi	110	03/12→12/16						
T4 GTDi	132	03/12→12/16						
→								













	kw			 	! #		
VOLVO - V40 Schrägheck (525) 03/12→08/19							
 Hauptbremszylinder							
D3 T4	110 132 - 147	04/15→08/19 07/13→12/15		für Fahrzeuge ohne Kollisionswarner		03.2125-5016.3 011010	ATE Ø 25,4
VOLVO - V50 (545) 12/03→12/12							
 Bremskraftverstärker							
1.6 1.6 D 2.0 2.0 FlexFuel T5	74 80 107 107 169	01/05→12/12 03/05→12/12 10/06→12/12 01/10→12/12 03/07→12/12		→ 05/12; für Linkslenker		03.7863-4832.4 300289	ATE Ø 10" pneumatisch
1.6 D 1.8 1.8 BiFuel 1.8 FlexFuel 2.0 CDI 2.0 D 2.0 D4 2.4 2.4 AWD 2.4 Tdi D5 T5 T5 AWD	81 92 93 92 98 100 96 103 - 125 125 120 132 162 162 - 169	01/05→12/11 04/04→12/10 01/09→09/10 01/05→12/10 12/03→12/06 04/04→12/10 07/05→12/06 04/04→12/10 08/06→12/09 05/07→12/10 03/06→12/10 04/04→12/07 04/04→12/10		für Linkslenker		03.7863-4832.4 300289	ATE Ø 10" pneumatisch
Pedalwegsensord, Bremspedal							
1.6 1.6 D 2.0 2.0 FlexFuel T5	74 80 107 107 169	01/05→12/12 03/05→12/12 10/06→12/12 01/10→12/12 03/07→12/12		→ 05/12		03.0655-0007.2 370007	ATE
1.6 D 1.8 1.8 BiFuel 1.8 FlexFuel 2.0 CDI 2.0 D 2.0 D4 2.4 2.4 AWD 2.4 Tdi D5 T5 T5 AWD	81 92 93 92 98 100 96 103 - 125 125 120 132 162 162 - 169	01/05→12/11 04/04→12/10 01/09→09/10 01/05→12/10 12/03→12/06 04/04→12/10 07/05→12/06 04/04→12/10 08/06→12/09 05/07→12/10 03/06→12/10 04/04→12/07 04/04→12/10				03.0655-0007.2 370007	ATE
 Hauptbremszylinder							
1.6 1.6 D 2.0 2.0 FlexFuel T5	74 80 107 107 169	01/05→12/12 03/05→12/12 10/06→12/12 01/10→12/12 03/07→12/12		→ 05/12; für Linkslenker		03.2123-3593.3 010919	ATE Ø 23,8
1.6 D 1.8 1.8 BiFuel 1.8 FlexFuel 2.0 CDI 2.0 D 2.0 D4 2.4 2.4 AWD 2.4 Tdi D5 T5 T5 AWD	81 92 93 92 98 100 96 103 - 125 125 120 132 162 162 - 169	01/05→12/11 04/04→12/10 01/09→09/10 01/05→12/10 12/03→12/06 04/04→12/10 07/05→12/06 04/04→12/10 08/06→12/09 05/07→12/10 03/06→12/10 04/04→12/07 04/04→12/10		für Linkslenker		03.2123-3593.3 010919	ATE Ø 23,8
D2 D3 D4	84 110 130	01/10→12/12 10/10→12/12 10/10→12/12		→ 05/12; für Linkslenker		03.2123-3624.3 010956	ATE Ø 23,8
Hydraulikaggregat, Bremsanlage							
1.6 1.6 D 2.0 2.0 FlexFuel	74 80 107 107	01/05→12/12 03/05→12/12 10/06→12/12 01/10→12/12		→ 05/12; + DSTC; Getriebetyp: MPS6		24.9145-0005.2 399009	
D2 D3	84 110	01/10→12/12 10/10→12/12		→ 520022; für Linkslenker; + DSTC; nicht für Getriebetyp: MPS6		24.9145-0005.2 399009	
D3 →	110	10/10→12/12		520023→; → 05/12; für Linkslenker; + DSTC; nicht für Getriebetyp: MPS6		24.9145-0005.2 399009	









	kw			 	! #		
VOLVO - V50 (545) 12/03→12/12							
Hydraulikaggregat, Bremsanlage							
D4 T5	130 169	10/10→12/12 03/07→12/12		→ 05/12; + DSTC; Getriebetyp: MPS6		24.9145-0005.2	399009
				→ 520022; für Linkslenker; + DSTC; nicht für Getriebetyp: MPS6		24.9145-0005.2	399009
				520023→; → 05/12; für Linkslenker; + DSTC; nicht für Getriebetyp: MPS6		24.9145-0005.2	399009
1.6 D 1.8 1.8 BiFuel 1.8 FlexFuel	81 92 93 92	01/05→12/11 04/04→12/10 01/09→09/10 01/05→12/10		→ 520022; für Linkslenker; + DSTC; nicht für Getriebetyp: MPS6		24.9145-0005.2	399009
2.0 CDI 2.0 D 2.0 D4 2.4	98 100 96 103 -	12/03→12/06 04/04→12/10 07/05→12/06 04/04→12/10		+ DSTC; Getriebetyp: MPS6		24.9145-0005.2	399009
2.4 AWD 2.4 Tdi D5 T5 T5 AWD	125 120 132 162 162 -	08/06→12/09 05/07→12/10 03/06→12/10 04/04→12/07 04/04→12/10		520023→; für Linkslenker; + DSTC; nicht für Getriebetyp: MPS6		24.9145-0005.2	399009
	169						
VOLVO - V60 I (155) 07/10→12/18							
 Bremskraftverstärker							
2.0 BiFuel 2.0 Polestar AWD 2.0 T D2 D3 D4	157 270 132 88 110 133 -	03/14→12/15 06/15→05/18 01/14→07/18 03/15→05/18 03/15→05/18 10/13→05/18		für Fahrzeuge ohne Kollisionswarner		03.7755-9703.4	300239
D4 AWD D5 D6 Hybrid AWD T5 T6 T6 AWD	133 - 140 165 206 162 224 242	10/13→05/18 140 03/15→05/18 03/15→05/18 01/14→12/17 07/14→04/15 04/14→12/15					
3.0 T AWD	258	04/14→05/18		05/14→; für Fahrzeuge ohne Kollisionswarner		03.7755-9703.4	300239
D4 AWD	120	05/12→12/15		12/12→; für Fahrzeuge ohne Kollisionswarner		03.7755-9703.4	300239
T5	157	10/13→05/18		04/14→; für Fahrzeuge ohne Kollisionswarner		03.7755-9703.4	300239
T5 AWD	180 - 187	07/14→05/18		für Fahrzeuge ohne Kollisionswarner; Ausstattungs-Code: RC01		03.7755-0132.4	300265
				für Fahrzeuge ohne Kollisionswarner; Ausstattungs-Code: RC02		03.7755-9703.4	300239
Pedalwegsensoren, Bremspedal							
1.6 DRiVe D5 D5 AWD	84 158 158	02/11→12/15 04/11→12/15 04/11→12/15		06/11→; für Fahrzeuge mit Kollisionswarner		03.0655-0007.2	370007
2.0 T D3 / D4 D5 D5 AWD T3 T4 T5 T6 AWD	149 120 151 151 110 132 177 224	07/10→12/12 07/10→12/14 07/10→12/11 07/10→12/11 09/10→12/15 09/10→12/15 09/10→12/14 07/10→12/15		11/10→; für Fahrzeuge mit Kollisionswarner		03.0655-0007.2	370007
D2 D3 D4 D4 AWD D5 D5 AWD D5 Hybrid AWD D6 Hybrid AWD T3 T4F T5 T6 T6 AWD	88 110 133 - 140 133 - 140 165 - 169 169 169 206 112 132 176 - 180 224 - 225 225 -	03/15→05/18 03/15→05/18 10/13→05/18 10/13→05/18 140 04/14→05/18 169 04/14→12/15 03/15→05/18 03/15→05/18 03/15→05/18 04/11→12/15 08/12→12/18 180 10/13→12/18 225 10/13→12/18		für Fahrzeuge mit Kollisionswarner		03.0655-0007.2	370007
→							







	kw			 	! #		
VOLVO - V60 I (155) 07/10→12/18							
Pedalwegsensoren, Bremspedal							
D3	100	05/12→12/15		10/12→; für Fahrzeuge mit Kollisionswarner		03.0655-0007.2 370007	ATE
D4 AWD	120	05/12→12/15		12/12→; für Fahrzeuge mit Kollisionswarner		03.0655-0007.2 370007	ATE
D6 Hybrid AWD	206	06/12→12/15		11/12→; für Fahrzeuge mit Kollisionswarner		03.0655-0007.2 370007	ATE
T2	90	10/15→03/17		01/16→; für Fahrzeuge mit Kollisionswarner		03.0655-0007.2 370007	ATE
T4	140	03/15→05/18		05/15→; für Fahrzeuge mit Kollisionswarner		03.0655-0007.2 370007	ATE
T5	157	10/13→05/18		04/14→; für Fahrzeuge mit Kollisionswarner		03.0655-0007.2 370007	ATE
 Hauptbremszylinder							
2.0 BiFuel	157	03/14→12/15				24.4156-1391.3 011054	ATE Ø 27 ohne Bremsflüssigkeitsbehälter
2.0 T	132	01/14→07/18					
D2	88	03/15→05/18					
D5 Hybrid AWD	169	03/15→05/18					
D6 Hybrid AWD	206	03/15→05/18					
T5	162	01/14→12/17					
2.0 Polestar AWD	270	06/15→05/18		für Rechtslenker		24.4156-1391.3 011054	ATE Ø 27 ohne Bremsflüssigkeitsbehälter
T2	90	10/15→03/17		01/16→		24.4156-1391.3 011054	ATE Ø 27 ohne Bremsflüssigkeitsbehälter
VOLVO - V60 I Cross Country (157) 09/10→12/18							
 Bremskraftverstärker							
D3	110	03/15→05/18		für Fahrzeuge ohne Kollisionswarner; Ausstattungs-Code: RC01		03.7755-0132.4 300265	ATE Ø 9 / 8" pneumatisch
D4	140	03/15→05/18					
D4 AWD	140	03/15→05/18					
T5	180	03/15→05/18		für Fahrzeuge ohne Kollisionswarner; Ausstattungs-Code: RC02		03.7755-9703.4 300239	ATE Ø 9 / 8" pneumatisch
T5 AWD	180 - 187	03/15→05/18					
T5 Drive-E Polestar	186	03/15→07/18					
T5 Drive-E Polestar AWD	186	03/15→07/18					
D4 Polestar AWD	147 - 162	03/15→05/18		für Fahrzeuge ohne Kollisionswarner		03.7755-9703.4 300239	ATE Ø 9 / 8" pneumatisch
Pedalwegsensoren, Bremspedal							
D4 Drive-E Polestar	147	03/15→05/18		05/15→; für Fahrzeuge mit Kollisionswarner		03.0655-0007.2 370007	ATE
D4 Polestar AWD	147 - 162	03/15→05/18		für Fahrzeuge mit Kollisionswarner		03.0655-0007.2 370007	ATE
VOLVO - V60 I Kasten/Kombi (155) 09/13→12/15							
 Bremskraftverstärker							
2.4 D4 AWD	133	09/13→12/15		für Fahrzeuge ohne Kollisionswarner		03.7755-9703.4 300239	ATE Ø 9 / 8" pneumatisch
Pedalwegsensoren, Bremspedal							
1.6 DRIVE	84	09/13→12/15		für Fahrzeuge mit Kollisionswarner		03.0655-0007.2 370007	ATE
2.0 D3	100	09/13→12/15					
2.0 D4	120	09/13→12/15					
2.4 D4 AWD	133	09/13→12/15					
2.4 D5	158	09/13→12/15					
VOLVO - V70 I (875, 876) 12/95→12/00							
 Bremskraftverstärker							
2.0	93 - 132	12/95→03/00		01/97→; für Linkslenker		03.7760-3602.4 300176	ATE Ø 10" pneumatisch
2.0 Turbo	155	12/95→03/00					
2.3 Turbo	184	12/95→03/00					
2.4	106	12/95→03/00					
2.5 TDi AWD	103	11/96→02/00					
2.0	120	01/97→12/00		→ 03/00; für Linkslenker		03.7760-3602.4 300176	ATE Ø 10" pneumatisch
2.3 T-5 AWD	176	01/97→12/00					
2.4 Bifuel	103	08/99→12/00					
2.4 Turbo AWD	195	03/99→12/00					
2.0 Turbo	166	11/96→12/00		01/97→ 03/00; für Linkslenker		03.7760-3602.4 300176	ATE Ø 10" pneumatisch
2.0 Turbo AWD	166	11/96→12/00					
2.3	177	11/96→11/00					
2.3 T-5	176	11/96→12/00					
2.4	125	12/95→05/00					
2.4 Turbo	142	04/96→12/00					
2.4 Turbo AWD	142	04/96→12/00					
2.5 TDI	103	12/95→12/00					
→							



















	kw			 	! #		
VOLVO - V70 I (875, 876) 12/95→12/00							
 Bremskraftverstärker							
2.3 AWD	177	04/97→09/98		für Linkslenker		03.7760-3602.4 300176	ATE Ø 10" pneumatisch
2.3 T AWD	184	04/97→03/00					
2.4	121	06/98→12/99					
2.4	103	03/99→12/00		08/99→ 03/00; für Linkslenker		03.7760-3602.4 300176	ATE Ø 10" pneumatisch
2.4 AWD	121	06/98→12/99		10/98→ 05/99; für Linkslenker		03.7760-3602.4 300176	ATE Ø 10" pneumatisch
2.4 Bifuel	106	05/98→12/99		10/98→ 08/99; für Linkslenker		03.7760-3602.4 300176	ATE Ø 10" pneumatisch
 Hauptbremszylinder							
2.0	93 - 132	12/95→03/00		01/97→ 12/98; - ASR		03.2023-1084.3 010591	ATE Ø1 23,8 Ø2 20,6
2.0 Turbo	155	12/95→03/00		01/99→		03.2123-2164.3 010599	ATE Ø 23,8
2.3 Turbo	184	12/95→03/00					
2.4	106	12/95→03/00					
2.5 TDi AWD	103	11/96→02/00					
2.0	120	01/97→12/00		→ 12/98; - ASR		03.2023-1084.3 010591	ATE Ø1 23,8 Ø2 20,6
2.3 T-5 AWD	176	01/97→12/00		01/99→ 03/00		03.2123-2164.3 010599	ATE Ø 23,8
2.0 Turbo	166	11/96→12/00		01/97→ 12/98; - ASR		03.2023-1084.3 010591	ATE Ø1 23,8 Ø2 20,6
2.0 Turbo AWD	166	11/96→12/00		01/99→ 03/00		03.2123-2164.3 010599	ATE Ø 23,8
2.3	177	11/96→11/00					
2.3 T-5	176	11/96→12/00					
2.4	125	12/95→05/00					
2.4 Turbo	142	04/96→12/00					
2.4 Turbo AWD	142	04/96→12/00					
2.5 TDI	103	12/95→12/00					
2.3 AWD	177	04/97→09/98		- ASR		03.2023-1084.3 010591	ATE Ø1 23,8 Ø2 20,6
2.3 AWD	195	12/98→02/00		01/99→ 05/99		03.2123-2164.3 010599	ATE Ø 23,8
2.3 T AWD	184	04/97→03/00		→ 12/98; - ASR		03.2023-1084.3 010591	ATE Ø1 23,8 Ø2 20,6
2.4	121	06/98→12/99		01/99→		03.2123-2164.3 010599	ATE Ø 23,8
2.4	103	03/99→12/00		08/99→ 03/00		03.2123-2164.3 010599	ATE Ø 23,8
2.4 AWD	121	06/98→12/99		10/98→ 05/99; - ASR		03.2023-1084.3 010591	ATE Ø1 23,8 Ø2 20,6
				01/99→ 05/99		03.2123-2164.3 010599	ATE Ø 23,8
2.4 Bifuel	103	08/99→12/00		→ 03/00		03.2123-2164.3 010599	ATE Ø 23,8
2.4 Turbo AWD	195	03/99→12/00					
2.4 Bifuel	106	05/98→12/99		10/98→ 12/98; - ASR		03.2023-1084.3 010591	ATE Ø1 23,8 Ø2 20,6
				01/99→ 08/99		03.2123-2164.3 010599	ATE Ø 23,8
VOLVO - V70 II (285) 11/99→12/08							
 Bremskraftverstärker							
2.0 T	132	11/99→08/07		07/01→ 12/01; - DSTC		03.7755-3402.4 300189	ATE Ø 9 / 8" pneumatisch
				01/02→ 07/07; - DSTC		03.7755-4702.4 300224	ATE Ø 9 / 8" pneumatisch
				01/02→ 07/07; + DSTC		03.7858-3532.4 300233	ATE Ø 9 / 8" pneumatisch
2.3	195	10/00→09/04		→ 12/01; - DSTC		03.7755-3402.4 300189	ATE Ø 9 / 8" pneumatisch
				- DSTC		03.7755-4702.4 300224	ATE Ø 9 / 8" pneumatisch
				+ DSTC		03.7858-3532.4 300233	ATE Ø 9 / 8" pneumatisch
2.4	103 - 125	03/00→08/07		→ 12/01; - DSTC		03.7755-3402.4 300189	ATE Ø 9 / 8" pneumatisch
2.4 Bifuel	103	09/01→08/07		01/02→ 07/07; - DSTC		03.7755-4702.4 300224	ATE Ø 9 / 8" pneumatisch
				01/02→ 07/07; + DSTC		03.7858-3532.4 300233	ATE Ø 9 / 8" pneumatisch
2.4 CDI	90	07/05→12/08		- DSTC		03.7755-4702.4 300224	ATE Ø 9 / 8" pneumatisch
2.5 AWD	155	09/02→12/04		+ DSTC		03.7858-3532.4 300233	ATE Ø 9 / 8" pneumatisch
2.4 D	93	04/05→12/08		05/05→ 07/07; - DSTC		03.7755-4702.4 300224	ATE Ø 9 / 8" pneumatisch
				05/05→ 07/07; + DSTC		03.7858-3532.4 300233	ATE Ø 9 / 8" pneumatisch
2.4 D	96	07/01→08/07		12/01→ 12/01; - DSTC		03.7755-3402.4 300189	ATE Ø 9 / 8" pneumatisch
				01/02→ 07/07; - DSTC		03.7755-4702.4 300224	ATE Ø 9 / 8" pneumatisch
				01/02→ 07/07; + DSTC		03.7858-3532.4 300233	ATE Ø 9 / 8" pneumatisch
2.4 T	147	11/99→08/03		03/00→ 12/01; - DSTC		03.7755-3402.4 300189	ATE Ø 9 / 8" pneumatisch
T5	184	11/99→12/04		01/02→; - DSTC		03.7755-4702.4 300224	ATE Ø 9 / 8" pneumatisch
				01/02→; + DSTC		03.7858-3532.4 300233	ATE Ø 9 / 8" pneumatisch
2.4 T AWD	147	09/01→08/02		→ 12/01; - DSTC		03.7755-3402.4 300189	ATE Ø 9 / 8" pneumatisch
				01/02→; - DSTC		03.7755-4702.4 300224	ATE Ø 9 / 8" pneumatisch
				01/02→; + DSTC		03.7858-3532.4 300233	ATE Ø 9 / 8" pneumatisch
2.5 T	154	07/01→08/07		04/04→ 07/07; - DSTC		03.7755-4702.4 300224	ATE Ø 9 / 8" pneumatisch
				04/04→ 07/07; + DSTC		03.7858-3532.4 300233	ATE Ø 9 / 8" pneumatisch
2.5 T AWD	154	07/02→08/07		09/02→ 07/07; - DSTC		03.7755-4702.4 300224	ATE Ø 9 / 8" pneumatisch
				09/02→ 07/07; + DSTC		03.7858-3532.4 300233	ATE Ø 9 / 8" pneumatisch
2.5 TDI	103	11/99→08/07		03/00→ 12/01; - DSTC		03.7755-3402.4 300189	ATE Ø 9 / 8" pneumatisch
→							























	kw			 	! #		
VOLVO - V70 II (285) 11/99→12/08							
 Bremskraftverstärker							
2.5 TDI	103	11/99→08/07		01/02→ 07/07; - DSTC		03.7755-4702.4 300224	ATE Ø 9 / 8" pneumatisch
				01/02→ 07/07; + DSTC		03.7858-3532.4 300233	ATE Ø 9 / 8" pneumatisch
D5	120	01/01→12/08		08/01→ 12/01; - DSTC		03.7755-3402.4 300189	ATE Ø 9 / 8" pneumatisch
				01/02→ 07/07; - DSTC		03.7755-4702.4 300224	ATE Ø 9 / 8" pneumatisch
				01/02→ 07/07; + DSTC		03.7858-3532.4 300233	ATE Ø 9 / 8" pneumatisch
D5	136	04/05→12/08		12/05→ 07/07; - DSTC		03.7755-4702.4 300224	ATE Ø 9 / 8" pneumatisch
D5 AWD	136	05/05→08/07		12/05→ 07/07; + DSTC		03.7858-3532.4 300233	ATE Ø 9 / 8" pneumatisch
D5 AWD	120	07/02→08/07		03/03→ 07/07; - DSTC		03.7755-4702.4 300224	ATE Ø 9 / 8" pneumatisch
				03/03→ 07/07; + DSTC		03.7858-3532.4 300233	ATE Ø 9 / 8" pneumatisch
5 T AWD	221	03/03→08/07		→ 07/07; - DSTC		03.7755-4702.4 300224	ATE Ø 9 / 8" pneumatisch
R 2	221	03/03→08/07					
T5	191	04/04→08/07		→ 07/07; + DSTC		03.7858-3532.4 300233	ATE Ø 9 / 8" pneumatisch
Pedalwegsensoren, Bremspedal							
2.0 T	132	11/99→08/07		07/01→ 12/01		03.0655-0004.2 370004	ATE
				01/02→ 07/07		03.0655-0005.2 370005	ATE
				01/05→ 07/07		03.0655-0005.2 370005	ATE
2.3	195	10/00→09/04		→ 12/01		03.0655-0004.2 370004	ATE
						03.0655-0005.2 370005	ATE
2.4	103 - 125	03/00→08/07		→ 12/01		03.0655-0004.2 370004	ATE
2.4 Bifuel	103	09/01→08/07		01/02→ 07/07		03.0655-0005.2 370005	ATE
				01/05→ 07/07		03.0655-0005.2 370005	ATE
2.4 CDI	90	07/05→12/08				03.0655-0005.2 370005	ATE
2.5 AWD	155	09/02→12/04					
2.4 D	93	04/05→12/08		05/05→ 07/07		03.0655-0005.2 370005	ATE
2.4 D	96	07/01→08/07		12/01→ 12/01		03.0655-0004.2 370004	ATE
				01/02→ 07/07		03.0655-0005.2 370005	ATE
				01/05→ 07/07		03.0655-0005.2 370005	ATE
2.4 T	147	11/99→08/03		03/00→ 12/01		03.0655-0004.2 370004	ATE
T5	184	11/99→12/04		01/02→		03.0655-0005.2 370005	ATE
2.4 T AWD	147	09/01→08/02		→ 12/01		03.0655-0004.2 370004	ATE
				01/02→		03.0655-0005.2 370005	ATE
2.5 T	154	07/01→08/07		01/05→ 07/07		03.0655-0005.2 370005	ATE
				04/04→ 07/07		03.0655-0005.2 370005	ATE
2.5 T AWD	154	07/02→08/07		01/05→ 07/07		03.0655-0005.2 370005	ATE
				09/02→ 07/07		03.0655-0005.2 370005	ATE
2.5 TDI	103	11/99→08/07		03/00→ 12/01		03.0655-0004.2 370004	ATE
				01/02→ 07/07		03.0655-0005.2 370005	ATE
				01/05→ 07/07		03.0655-0005.2 370005	ATE
D5	120	01/01→12/08		08/01→ 12/01		03.0655-0004.2 370004	ATE
				01/02→ 07/07		03.0655-0005.2 370005	ATE
				01/05→ 07/07		03.0655-0005.2 370005	ATE
D5	136	04/05→12/08		12/05→ 07/07		03.0655-0005.2 370005	ATE
D5 AWD	136	05/05→08/07					
D5 AWD	120	07/02→08/07		01/05→ 07/07		03.0655-0005.2 370005	ATE
				03/03→ 07/07		03.0655-0005.2 370005	ATE
5 T AWD	221	03/03→08/07		→ 07/07		03.0655-0005.2 370005	ATE
R 2	221	03/03→08/07					
T5	191	04/04→08/07		01/05→ 07/07		03.0655-0005.2 370005	ATE
 Hauptbremszylinder							
2.0 T	132	11/99→08/07		07/01→; → 68132; - DSTC		03.2125-7637.3 010707	ATE Ø 25,4
				07/01→; → 67770; für Rechtslenker; + DSTC		03.2125-7637.3 010707	ATE Ø 25,4
				68133→; → 07/07; für Rechtslenker; - DSTC		03.2125-7638.3 010738	ATE Ø 25,4
				67771→; → 07/07; für Rechtslenker; + DSTC		03.2125-7638.3 010738	ATE Ø 25,4
				07/01→; → 70377; für Linkslenker; + DSTC		03.2125-7708.3 010739	ATE Ø 25,4
				70378→; → 07/07; für Linkslenker; + DSTC		03.2125-7713.3 010819	ATE Ø 25,4
				68133→; → 07/07; für Linkslenker; - DSTC		03.2125-7743.3 010921	ATE Ø 25,4
2.3	195	10/00→09/04		→ 68132; - DSTC		03.2125-7637.3 010707	ATE Ø 25,4
2.4 CDI	90	07/05→12/08					
→							











	kw			 	! #		
VOLVO - V70 II (285) 11/99→12/08							
Hauptbremszylinder							
2.4 T AWD	147	09/01→08/02	→ 67770; für Rechtslenker; + DSTC	03.2125-7637.3	010707	ATE Ø 25,4	
			67771→; für Rechtslenker; + DSTC	03.2125-7638.3	010738	ATE Ø 25,4	
			68133→; für Rechtslenker; - DSTC	03.2125-7638.3	010738	ATE Ø 25,4	
			→ 70377; für Linkslenker; + DSTC	03.2125-7708.3	010739	ATE Ø 25,4	
			70378→; für Linkslenker; + DSTC	03.2125-7713.3	010819	ATE Ø 25,4	
			68133→; für Linkslenker; - DSTC	03.2125-7743.3	010921	ATE Ø 25,4	
2.4 2.4 Bifuel	103 - 125 103	03/00→08/07 09/01→08/07	→ 68132; - DSTC	03.2125-7637.3	010707	ATE Ø 25,4	
			→ 67770; für Rechtslenker; + DSTC	03.2125-7637.3	010707	ATE Ø 25,4	
			68133→; → 07/07; für Rechtslenker; - DSTC	03.2125-7638.3	010738	ATE Ø 25,4	
			67771→; → 07/07; für Rechtslenker; + DSTC	03.2125-7638.3	010738	ATE Ø 25,4	
			→ 70377; für Linkslenker; + DSTC	03.2125-7708.3	010739	ATE Ø 25,4	
			70378→; → 07/07; für Linkslenker; + DSTC	03.2125-7713.3	010819	ATE Ø 25,4	
			68133→; → 07/07; für Linkslenker; - DSTC	03.2125-7743.3	010921	ATE Ø 25,4	
2.4 D	93	04/05→12/08	05/05→ 07/07; für Rechtslenker	03.2125-7638.3	010738	ATE Ø 25,4	
			05/05→ 07/07; für Linkslenker; + DSTC	03.2125-7713.3	010819	ATE Ø 25,4	
			05/05→ 07/07; für Linkslenker; - DSTC	03.2125-7743.3	010921	ATE Ø 25,4	
2.4 D	96	07/01→08/07	12/01→; → 68132; - DSTC	03.2125-7637.3	010707	ATE Ø 25,4	
			12/01→; → 67770; für Rechtslenker; + DSTC	03.2125-7637.3	010707	ATE Ø 25,4	
			68133→; → 07/07; für Rechtslenker; - DSTC	03.2125-7638.3	010738	ATE Ø 25,4	
			67771→; → 07/07; für Rechtslenker; + DSTC	03.2125-7638.3	010738	ATE Ø 25,4	
			12/01→; → 70377; für Linkslenker; + DSTC	03.2125-7708.3	010739	ATE Ø 25,4	
			70378→; → 07/07; für Linkslenker; + DSTC	03.2125-7713.3	010819	ATE Ø 25,4	
			68133→; → 07/07; für Linkslenker; - DSTC	03.2125-7743.3	010921	ATE Ø 25,4	
2.4 T T5	147 184	11/99→08/03 11/99→12/04	03/00→; → 67770; für Rechtslenker; + DSTC	03.2125-7637.3	010707	ATE Ø 25,4	
			03/00→; → 68132; - DSTC	03.2125-7637.3	010707	ATE Ø 25,4	
			67771→; für Rechtslenker; + DSTC	03.2125-7638.3	010738	ATE Ø 25,4	
			68133→; für Rechtslenker; - DSTC	03.2125-7638.3	010738	ATE Ø 25,4	
			03/00→; → 70377; für Linkslenker; + DSTC	03.2125-7708.3	010739	ATE Ø 25,4	
			70378→; für Linkslenker; + DSTC	03.2125-7713.3	010819	ATE Ø 25,4	
			68133→; für Linkslenker; - DSTC	03.2125-7743.3	010921	ATE Ø 25,4	
2.5 AWD	155	09/02→12/04	für Rechtslenker	03.2125-7638.3	010738	ATE Ø 25,4	
			für Linkslenker; + DSTC	03.2125-7713.3	010819	ATE Ø 25,4	
			für Linkslenker; - DSTC	03.2125-7743.3	010921	ATE Ø 25,4	
2.5 T	154	07/01→08/07	04/04→ 07/07; für Rechtslenker	03.2125-7638.3	010738	ATE Ø 25,4	
			04/04→ 07/07; für Linkslenker; + DSTC	03.2125-7713.3	010819	ATE Ø 25,4	
			04/04→ 07/07; für Linkslenker; - DSTC	03.2125-7743.3	010921	ATE Ø 25,4	
2.5 T AWD	154	07/02→08/07	09/02→ 07/07; für Rechtslenker	03.2125-7638.3	010738	ATE Ø 25,4	
			09/02→ 07/07; für Linkslenker; + DSTC	03.2125-7713.3	010819	ATE Ø 25,4	
			09/02→ 07/07; für Linkslenker; - DSTC	03.2125-7743.3	010921	ATE Ø 25,4	
2.5 TDI	103	11/99→08/07	03/00→; → 68132; - DSTC	03.2125-7637.3	010707	ATE Ø 25,4	
			03/00→; → 67770; für Rechtslenker; + DSTC	03.2125-7637.3	010707	ATE Ø 25,4	
			68133→; → 07/07; für Rechtslenker; - DSTC	03.2125-7638.3	010738	ATE Ø 25,4	
			67771→; → 07/07; für Rechtslenker; + DSTC	03.2125-7638.3	010738	ATE Ø 25,4	
			03/00→; → 70377; für Linkslenker; + DSTC	03.2125-7708.3	010739	ATE Ø 25,4	
			70378→; → 07/07; für Linkslenker; + DSTC	03.2125-7713.3	010819	ATE Ø 25,4	
D5 →	120	01/01→12/08	08/01→; → 68132; - DSTC	03.2125-7637.3	010707	ATE Ø 25,4	
			08/01→; → 67770; für Rechtslenker; + DSTC	03.2125-7637.3	010707	ATE Ø 25,4	













	kw			 	! #		
VOLVO - V70 II (285) 11/99→12/08							
 Hauptbremszylinder							
D5	120	01/01→12/08		68133→; → 07/07; für Rechtslenker; - DSTC		03.2125-7638.3 010738	ATE Ø 25,4
				67771→; → 07/07; für Rechtslenker; + DSTC		03.2125-7638.3 010738	ATE Ø 25,4
				08/01→; → 70377; für Linkslenker; + DSTC		03.2125-7708.3 010739	ATE Ø 25,4
				70378→; → 07/07; für Linkslenker; + DSTC		03.2125-7713.3 010819	ATE Ø 25,4
				68133→; → 07/07; für Linkslenker; - DSTC		03.2125-7743.3 010921	ATE Ø 25,4
D5	136	04/05→12/08		12/05→ 07/07; für Rechtslenker		03.2125-7638.3 010738	ATE Ø 25,4
D5 AWD	136	05/05→08/07		12/05→ 07/07; für Linkslenker; + DSTC		03.2125-7713.3 010819	ATE Ø 25,4
				12/05→ 07/07; für Linkslenker; - DSTC		03.2125-7743.3 010921	ATE Ø 25,4
D5 AWD	120	07/02→08/07		03/03→ 07/07; für Rechtslenker; + DSTC		03.2125-7638.3 010738	ATE Ø 25,4
				68133→; → 07/07; für Rechtslenker; - DSTC		03.2125-7638.3 010738	ATE Ø 25,4
				03/03→ 07/07; für Linkslenker; + DSTC		03.2125-7713.3 010819	ATE Ø 25,4
				03/03→ 07/07; für Linkslenker; - DSTC		03.2125-7743.3 010921	ATE Ø 25,4
5 T AWD	221	03/03→08/07		→ 07/07; für Rechtslenker; + DSTC		03.2125-7638.3 010738	ATE Ø 25,4
R 2	221	03/03→08/07		→ 07/07; für Linkslenker; + DSTC		03.2125-7713.3 010819	ATE Ø 25,4
				→ 07/07; für Linkslenker; - DSTC		03.2125-7743.3 010921	ATE Ø 25,4
T5	191	04/04→08/07		→ 07/07; für Rechtslenker		03.2125-7638.3 010738	ATE Ø 25,4
				→ 07/07; für Linkslenker; + DSTC		03.2125-7713.3 010819	ATE Ø 25,4
				→ 07/07; für Linkslenker; - DSTC		03.2125-7743.3 010921	ATE Ø 25,4
VOLVO - V70 III (135) 04/07→04/16							
 Bremskraftverstärker							
1.6 D	80	07/09→12/11		01/10→; für Linkslenker; für Fahrzeuge ohne Kollisionswarner		03.7755-9703.4 300239	ATE Ø 9 / 8" pneumatisch
2.0 T	149	09/09→12/11		01/10→; für Rechtslenker; für Fahrzeuge mit Kollisionswarner		03.7858-4832.4 300274	ATE Ø 9 / 8" pneumatisch
1.6 DRIVE / D2	84	04/11→12/15		für Linkslenker; für Fahrzeuge ohne Kollisionswarner		03.7755-9703.4 300239	ATE Ø 9 / 8" pneumatisch
2.0 D	107	10/07→12/11		für Rechtslenker; für Fahrzeuge mit Kollisionswarner		03.7858-4832.4 300274	ATE Ø 9 / 8" pneumatisch
2.0 FlexiFuel	100	10/07→12/15					
T5	107	01/08→12/11					
	177	01/10→12/14					
2.0 BiFuel	157	03/13→12/15		→ 213000; für Fahrzeuge ohne Kollisionswarner		03.7755-9703.4 300239	ATE Ø 9 / 8" pneumatisch
2.5 T	147	08/07→12/09					
2.5 T FlexiFuel	147	05/08→12/09		→ 213000; für Fahrzeuge mit Kollisionswarner		03.7858-5032.4 300275	ATE Ø 9 / 8" pneumatisch
3.2	175 -	08/07→12/14					
	179						
3.2 AWD	179	04/10→12/15					
D3	100	10/07→12/15					
D3 / D4	120	03/10→12/15					
D5	158 -	03/11→04/16					
	169						
D5 AWD	151 -	12/09→04/16					
	169						
T4	132	10/10→12/15					
T4F	132	01/11→12/15					
T6 AWD	210 -	08/07→04/16					
	242						
2.4 D	120	04/07→12/10		08/07→; → 213000; für Fahrzeuge ohne Kollisionswarner		03.7755-9703.4 300239	ATE Ø 9 / 8" pneumatisch
3.2 AWD	175	04/07→12/10					
D5	136	04/07→12/09		08/07→; → 213000; für Fahrzeuge mit Kollisionswarner		03.7858-5032.4 300275	ATE Ø 9 / 8" pneumatisch
2.4 D	129	04/09→12/10		10/09→; → 213000; für Fahrzeuge ohne Kollisionswarner		03.7755-9703.4 300239	ATE Ø 9 / 8" pneumatisch
2.5 T	170	04/09→12/12					
2.5 T FlexiFuel	170	04/09→12/11		10/09→; → 213000; für Fahrzeuge mit Kollisionswarner		03.7858-5032.4 300275	ATE Ø 9 / 8" pneumatisch
D4	133	10/13→04/16		für Fahrzeuge ohne Kollisionswarner		03.7755-9703.4 300239	ATE Ø 9 / 8" pneumatisch
D4 AWD	133	10/13→04/16					
D5	151	10/08→12/11		12/09→; → 213000; für Fahrzeuge ohne Kollisionswarner		03.7755-9703.4 300239	ATE Ø 9 / 8" pneumatisch
				12/09→; → 213000; für Fahrzeuge mit Kollisionswarner		03.7858-5032.4 300275	ATE Ø 9 / 8" pneumatisch
D5 AWD	136	04/07→12/09		10/07→; → 213000; für Fahrzeuge ohne Kollisionswarner		03.7755-9703.4 300239	ATE Ø 9 / 8" pneumatisch
				10/07→; → 213000; für Fahrzeuge mit Kollisionswarner		03.7858-5032.4 300275	ATE Ø 9 / 8" pneumatisch
D5 AWD	158	04/11→12/15		06/11→; → 213000; für Fahrzeuge ohne Kollisionswarner		03.7755-9703.4 300239	ATE Ø 9 / 8" pneumatisch
→							

	kw					! #		
VOLVO - V70 III (135) 04/07→04/16								
Bremskraftverstärker								
D5 AWD	158	04/11→12/15		06/11→; → 213000; für Fahrzeuge mit Kollisionswarner		03.7858-5032.4	300275	ATE Ø 9 / 8" pneumatisch
T5	180	10/13→04/16		für Fahrzeuge ohne Kollisionswarner		03.7755-9703.4	300239	ATE Ø 9 / 8" pneumatisch
				für Fahrzeuge mit Kollisionswarner		03.7858-5032.4	300275	ATE Ø 9 / 8" pneumatisch
Pedalwegsensord, Bremspedal								
1.6 D	80	07/09→12/11		01/10→; für Fahrzeuge mit Kollisionswarner		03.0655-0007.2	370007	ATE
2.0 T	149	09/09→12/11						
1.6 DRiVe / D2	84	04/11→12/15		für Fahrzeuge mit Kollisionswarner		03.0655-0007.2	370007	ATE
2.0	107	10/07→12/11						
2.0 D	100	10/07→12/15						
2.0 FlexiFuel	107	01/08→12/11						
D4	133	10/13→04/16						
D4 AWD	120 - 133	10/07→04/16						
T5	177 - 180	01/10→04/16						
2.0 BiFuel	157	03/13→12/15		für Fahrzeuge mit Kollisionswarner		03.0655-0007.2	370007	ATE
				→ 213000; für Fahrzeuge mit Kollisionswarner		03.0655-0007.2	370007	ATE
2.0 GDI	157	04/12→12/15		03/13→; für Fahrzeuge mit Kollisionswarner		03.0655-0007.2	370007	ATE
2.4 D	120	04/07→12/10		08/07→; → 213000; für Fahrzeuge mit Kollisionswarner		03.0655-0007.2	370007	ATE
3.2 AWD	175	04/07→12/10						
D5	136	04/07→12/09		213001→; für Fahrzeuge mit Kollisionswarner		03.0655-0007.2	370007	ATE
2.4 D	129	04/09→12/10		10/09→; → 213000; für Fahrzeuge mit Kollisionswarner		03.0655-0007.2	370007	ATE
2.5 T	170	04/09→12/12						
2.5 T FlexiFuel	170	04/09→12/11		213001→; für Fahrzeuge mit Kollisionswarner		03.0655-0007.2	370007	ATE
2.5 T	147	08/07→12/09		→ 213000; für Fahrzeuge mit Kollisionswarner		03.0655-0007.2	370007	ATE
2.5 T FlexiFuel	147	05/08→12/09						
3.2	175 - 179	08/07→12/14		213001→; für Fahrzeuge mit Kollisionswarner		03.0655-0007.2	370007	ATE
3.2 AWD	179	04/10→12/15						
D3	100	10/07→12/15						
D3 / D4	120	03/10→12/15						
D5	158 - 169	03/11→04/16						
D5 AWD	151 - 169	12/09→04/16						
T4	132	10/10→12/15						
T4F	132	01/11→12/15						
T6 AWD	210 - 242	08/07→04/16						
D5	151	10/08→12/11		12/09→; → 213000; für Fahrzeuge mit Kollisionswarner		03.0655-0007.2	370007	ATE
				213001→; für Fahrzeuge mit Kollisionswarner		03.0655-0007.2	370007	ATE
D5 AWD	136	04/07→12/09		10/07→; → 213000; für Fahrzeuge mit Kollisionswarner		03.0655-0007.2	370007	ATE
				213001→; für Fahrzeuge mit Kollisionswarner		03.0655-0007.2	370007	ATE
D5 AWD	158	04/11→12/15		06/11→; → 213000; für Fahrzeuge mit Kollisionswarner		03.0655-0007.2	370007	ATE
				213001→; für Fahrzeuge mit Kollisionswarner		03.0655-0007.2	370007	ATE
Hauptbremszylinder								
D5	169	03/11→04/16				24.4156-1391.3	011054	ATE Ø 27 ohne Bremsflüssigkeitsbehälter
D5 AWD	169	03/11→04/16						
T6 AWD	224 - 242	01/10→04/16						
VOLVO - V70 III Kasten/Kombi (135) 09/13→12/15								
Bremskraftverstärker								
2.0 D3 DRiVe	100	09/13→12/15		→ 213000; für Fahrzeuge ohne Kollisionswarner		03.7755-9703.4	300239	ATE Ø 9 / 8" pneumatisch
2.4 D5	158	09/13→12/15						
				→ 213000; für Fahrzeuge mit Kollisionswarner		03.7858-5032.4	300275	ATE Ø 9 / 8" pneumatisch
Pedalwegsensord, Bremspedal								
2.0 D3 DRiVe	100	09/13→12/15		→ 213000; für Fahrzeuge mit Kollisionswarner		03.0655-0007.2	370007	ATE
2.4 D5	158	09/13→12/15						
				213001→; für Fahrzeuge mit Kollisionswarner		03.0655-0007.2	370007	ATE
2.4 D4 AWD	120	09/13→12/15		für Fahrzeuge mit Kollisionswarner		03.0655-0007.2	370007	ATE











	kW					! #		
VOLVO - V90 I Kombi (965) 11/96→12/98								
 Hauptbremszylinder								
2.5	125 - 132	11/96→10/98					03.2023-0875.3 010890	ATE Ø1 23,8 Ø2 20,6 ohne Bremsflüssigkeitsbehälter
2.9	132 - 150	01/97→12/98						
VOLVO - XC60 I SUV (156) 05/08→12/17								
 Bremskraftverstärker								
2.4 D	129	04/09→12/10		für Fahrzeuge ohne Kollisionswarner			03.7755-0132.4 300265	ATE Ø 9 / 8" pneumatisch
3.2 AWD	175	07/09→12/10		für Fahrzeuge mit Kollisionswarner			03.7858-5132.4 300276	ATE Ø 9 / 8" pneumatisch
D3 / D4	120	03/10→12/14						
D5	158	06/11→02/17						
D5 AWD	151	07/09→06/11						
2.4 D / D3 / D4 AWD	120	05/08→02/17		09/08→; für Fahrzeuge ohne Kollisionswarner			03.7755-0132.4 300265	ATE Ø 9 / 8" pneumatisch
D5 AWD	136	05/08→12/09						
T6 AWD	210	05/08→12/10		09/08→; für Fahrzeuge mit Kollisionswarner			03.7858-5132.4 300276	ATE Ø 9 / 8" pneumatisch
3.2	171 - 179	09/11→12/14		→ 236999; für Fahrzeuge ohne Kollisionswarner			03.7755-0132.4 300265	ATE Ø 9 / 8" pneumatisch
3.2 AWD	179	03/10→12/15		→ 236999; für Fahrzeuge mit Kollisionswarner			03.7858-5132.4 300276	ATE Ø 9 / 8" pneumatisch
D5 AWD	169	04/14→12/15						
T6 AWD	224	03/10→02/17						
D3	110	03/15→04/17		für Fahrzeuge ohne Kollisionswarner			03.7755-0132.4 300265	ATE Ø 9 / 8" pneumatisch
D4	133 - 140	10/13→02/17						
D4 AWD	133 - 140	10/13→02/17		→ 236999; für Fahrzeuge ohne Kollisionswarner			03.7755-0132.4 300265	ATE Ø 9 / 8" pneumatisch
D5 AWD	162	03/15→02/17		237000→; für Fahrzeuge ohne Kollisionswarner			03.7755-0132.4 300265	ATE Ø 9 / 8" pneumatisch
T6 AWD	242	04/14→12/15		→ 236999; für Fahrzeuge mit Kollisionswarner			03.7858-5132.4 300276	ATE Ø 9 / 8" pneumatisch
D5 AWD	158	04/11→12/15		06/11→; → 236999; für Fahrzeuge ohne Kollisionswarner			03.7755-0132.4 300265	ATE Ø 9 / 8" pneumatisch
				06/11→; → 236999; für Fahrzeuge mit Kollisionswarner			03.7858-5132.4 300276	ATE Ø 9 / 8" pneumatisch
T5	180	10/13→02/17		für Fahrzeuge ohne Kollisionswarner			03.7755-9703.4 300239	ATE Ø 9 / 8" pneumatisch
T5 AWD	180	10/15→02/17						
T6	225	10/13→02/17						
T6 AWD	225	10/13→12/17						
Pedalwegsensoren, Bremspedal								
2.0 T	149	12/09→12/12		03/10→; für Fahrzeuge mit Kollisionswarner			03.0655-0007.2 370007	ATE
2.4 D	129	04/09→12/10		für Fahrzeuge mit Kollisionswarner			03.0655-0007.2 370007	ATE
3.2 AWD	175	07/09→12/10						
D3	110	03/15→04/17						
D3 / D4	120	03/10→12/14						
D4	133 - 140	10/13→02/17						
D5	158	06/11→02/17						
D5 AWD	151	07/09→06/11						
T5	177 - 180	09/10→02/17						
T5 AWD	180 - 187	04/14→02/17						
T6	225	10/13→02/17						
T6 AWD	225	10/13→12/17						
2.4 D / D3 / D4 AWD	120	05/08→02/17		09/08→; für Fahrzeuge mit Kollisionswarner			03.0655-0007.2 370007	ATE
D5 AWD	136	05/08→12/09						
T6 AWD	210	05/08→12/10						
3.2	171 - 179	09/11→12/14		→ 236999; für Fahrzeuge mit Kollisionswarner			03.0655-0007.2 370007	ATE
3.2 AWD	179	03/10→12/15		237000→; für Fahrzeuge mit Kollisionswarner			03.0655-0007.2 370007	ATE
D4 AWD	133 - 140	10/13→02/17						
D5 AWD	162 - 169	04/14→02/17						
T6 AWD	224 - 242	03/10→02/17						
D5 AWD	158	04/11→12/15		06/11→; → 236999; für Fahrzeuge mit Kollisionswarner			03.0655-0007.2 370007	ATE
				237000→; für Fahrzeuge mit Kollisionswarner			03.0655-0007.2 370007	ATE
VOLVO - XC60 I VAN (156) 05/08→12/17								
 Bremskraftverstärker								
D4	120	09/13→02/17		für Fahrzeuge ohne Kollisionswarner			03.7755-0132.4 300265	ATE Ø 9 / 8" pneumatisch
D4 AWD	120	09/13→02/17		für Fahrzeuge mit Kollisionswarner			03.7858-5132.4 300276	ATE Ø 9 / 8" pneumatisch
D5 AWD	158	09/13→02/17						
→								









	kw			 	! #		
VOLVO - XC60 I VAN (156) 05/08→12/17							
Pedalwegsensor, Bremspedal							
D4	120	09/13→02/17		für Fahrzeuge mit Kollisionswarner		03.0655-0007.2 370007	ATE
D4 AWD	120	09/13→02/17					
D5 AWD	158	09/13→02/17					
VOLVO - XC70 I Cross Country (295) 10/97→10/07							
 Bremskraftverstärker							
2.4 T XC AWD	142 - 147	11/97→09/02		→ 12/01; - DSTC		03.7755-3402.4 300189	ATE Ø 9 / 8" pneumatisch
				01/02→; - DSTC		03.7755-4702.4 300224	ATE Ø 9 / 8" pneumatisch
				+ DSTC		03.7858-3532.4 300233	ATE Ø 9 / 8" pneumatisch
2.5 T XC AWD	154	09/02→08/07		→ 07/07; - DSTC		03.7755-4702.4 300224	ATE Ø 9 / 8" pneumatisch
D5 AWD	136	12/05→08/07					
D5 XC AWD	120	09/02→08/07		→ 07/07; + DSTC		03.7858-3532.4 300233	ATE Ø 9 / 8" pneumatisch
Pedalwegsensor, Bremspedal							
2.4 T XC AWD	142 - 147	11/97→09/02		→ 12/01		03.0655-0004.2 370004	ATE
						03.0655-0005.2 370005	ATE
				01/02→		03.0655-0005.2 370005	ATE
2.5 T XC AWD	154	09/02→08/07		→ 07/07		03.0655-0005.2 370005	ATE
D5 AWD	136	12/05→08/07					
D5 XC AWD	120	09/02→08/07					
 Hauptbremszylinder							
2.4 T XC AWD	142 - 147	11/97→09/02		11001→; für Rechtslenker; - DSTC		03.2125-7637.3 010707	ATE Ø 25,4
				→ 11000; für Linkslenker; - DSTC		03.2125-7637.3 010707	ATE Ø 25,4
				→ 69018; für Rechtslenker; + DSTC		03.2125-7637.3 010707	ATE Ø 25,4
				69019→; für Rechtslenker; + DSTC		03.2125-7638.3 010738	ATE Ø 25,4
				→ 11000; für Rechtslenker; - DSTC		03.2125-7638.3 010738	ATE Ø 25,4
				→ 66913; für Linkslenker; + DSTC		03.2125-7708.3 010739	ATE Ø 25,4
				66914→; für Linkslenker; + DSTC		03.2125-7713.3 010819	ATE Ø 25,4
				11001→; für Linkslenker; - DSTC		03.2125-7743.3 010921	ATE Ø 25,4
2.5 T XC AWD	154	09/02→08/07		→ 07/07; für Rechtslenker; - DSTC		03.2125-7637.3 010707	ATE Ø 25,4
D5 XC AWD	120	09/02→08/07		→ 07/07; für Rechtslenker; + DSTC		03.2125-7638.3 010738	ATE Ø 25,4
				→ 07/07; für Linkslenker; + DSTC		03.2125-7713.3 010819	ATE Ø 25,4
				→ 07/07; für Linkslenker; - DSTC		03.2125-7743.3 010921	ATE Ø 25,4
D5 AWD	136	12/05→08/07		→ 07/07; für Rechtslenker; - DSTC		03.2125-7637.3 010707	ATE Ø 25,4
				→ 07/07; für Linkslenker; + DSTC		03.2125-7713.3 010819	ATE Ø 25,4
				→ 07/07; für Linkslenker; - DSTC		03.2125-7743.3 010921	ATE Ø 25,4
VOLVO - XC70 II (136) 04/07→12/16							
 Bremskraftverstärker							
2.4 D	129	06/09→12/10		01/10→; für Fahrzeuge ohne Kollisionswarner		03.7755-0132.4 300265	ATE Ø 9 / 8" pneumatisch
						03.7755-9703.4 300239	ATE Ø 9 / 8" pneumatisch
				01/10→; für Fahrzeuge mit Kollisionswarner		03.7858-5032.4 300275	ATE Ø 9 / 8" pneumatisch
						03.7858-5132.4 300276	ATE Ø 9 / 8" pneumatisch
2.4 D / D4 AWD	120	08/07→04/16		für Fahrzeuge ohne Kollisionswarner		03.7755-0132.4 300265	ATE Ø 9 / 8" pneumatisch
3.2 AWD	175 - 179	08/07→12/14				03.7755-9703.4 300239	ATE Ø 9 / 8" pneumatisch
D3	120	04/10→12/15		für Fahrzeuge mit Kollisionswarner		03.7858-5032.4 300275	ATE Ø 9 / 8" pneumatisch
D5 AWD	158 - 169	04/11→04/16				03.7858-5132.4 300276	ATE Ø 9 / 8" pneumatisch
T5	180	10/13→12/16					
T6 AWD	210 - 224	01/08→12/16					
T6 Polestar AWD	242	11/13→12/16					
D4	133	10/13→04/16		für Fahrzeuge ohne Kollisionswarner		03.7755-9703.4 300239	ATE Ø 9 / 8" pneumatisch
D4 AWD	133	10/13→04/16					
T5 AWD	187	08/15→12/16					
T6 AWD	183	03/15→12/16					
D5 AWD	136	04/07→12/09		08/07→; für Fahrzeuge ohne Kollisionswarner		03.7755-0132.4 300265	ATE Ø 9 / 8" pneumatisch
						03.7755-9703.4 300239	ATE Ø 9 / 8" pneumatisch
				08/07→; für Fahrzeuge mit Kollisionswarner		03.7858-5032.4 300275	ATE Ø 9 / 8" pneumatisch
						03.7858-5132.4 300276	ATE Ø 9 / 8" pneumatisch
D5 AWD	151	04/09→12/11		12/09→; für Fahrzeuge ohne Kollisionswarner		03.7755-0132.4 300265	ATE Ø 9 / 8" pneumatisch
						03.7755-9703.4 300239	ATE Ø 9 / 8" pneumatisch
				12/09→; für Fahrzeuge mit Kollisionswarner		03.7858-5032.4 300275	ATE Ø 9 / 8" pneumatisch
						03.7858-5132.4 300276	ATE Ø 9 / 8" pneumatisch
→							











	kW			 	! #		
VOLVO - XC70 II (136) 04/07→12/16							
Pedalwegsensord, Bremspedal							
2.4 D	129	06/09→12/10		01/10→; für Fahrzeuge mit Kollisionswarner		03.0655-0007.2 370007	ATE
2.4 D / D4 AWD 3.2 AWD D3 D5 AWD T5 T6 AWD T6 Polestar AWD	120 175 - 179 120 158 - 169 180 210 - 224 242	08/07→04/16 08/07→12/14 04/10→12/15 04/11→04/16 10/13→12/16 01/08→12/16 11/13→12/16		für Fahrzeuge mit Kollisionswarner		03.0655-0007.2 370007	ATE
D5 AWD	136	04/07→12/09		08/07→; für Fahrzeuge mit Kollisionswarner		03.0655-0007.2 370007	ATE
D5 AWD	151	04/09→12/11		12/09→; für Fahrzeuge mit Kollisionswarner		03.0655-0007.2 370007	ATE
VOLVO - XC70 II VAN (136) 04/07→12/16							
 Bremskraftverstärker							
2.0 D4 2.4 D4 AWD 2.4 D5 AWD	120 120 158	09/13→12/16 09/13→04/16 09/13→12/16		für Fahrzeuge ohne Kollisionswarner		03.7755-0132.4 300265 03.7755-9703.4 300239	ATE Ø 9 / 8" pneumatisch
				für Fahrzeuge mit Kollisionswarner		03.7858-5032.4 300275 03.7858-5132.4 300276	ATE Ø 9 / 8" pneumatisch
Pedalwegsensord, Bremspedal							
2.0 D4 2.4 D4 AWD 2.4 D5 AWD	120 120 158	09/13→12/16 09/13→04/16 09/13→12/16		für Fahrzeuge mit Kollisionswarner		03.0655-0007.2 370007	ATE
VOLVO - XC90 I (275) 06/02→01/15							
 Bremskraftverstärker							
2.5 2.5 AWD 2.5 T AWD D3 / D5 D5 AWD T6 AWD V8 AWD	153 153 154 120 120 - 136 200 232 - 235	01/03→12/06 06/02→12/14 10/02→09/14 04/09→12/14 10/02→12/10 10/02→12/06 09/04→12/10		für Linkslenker; Felgengröße [Zoll]: 18		03.7858-3032.4 300257 03.7858-3632.4 300234	ATE Ø 9 / 8" pneumatisch
3.2 3.2 AWD D5 AWD	175 - 179 179 147 - 155	09/11→09/14 04/10→09/14 01/11→12/14		für Linkslenker		03.7858-3632.4 300234	ATE Ø 9 / 8" pneumatisch
3.2 AWD	175	03/06→12/10		05/06→; für Linkslenker; Felgengröße [Zoll]: 18		03.7858-3032.4 300257	ATE Ø 9 / 8" pneumatisch
				05/06→; für Linkslenker		03.7858-3632.4 300234	ATE Ø 9 / 8" pneumatisch
Pedalwegsensord, Bremspedal							
2.5 2.5 AWD 2.5 T AWD 3.2 3.2 AWD D3 / D5 D5 AWD T6 AWD V8 AWD	153 153 154 175 - 179 179 120 120 - 155 200 232 - 235	01/03→12/06 06/02→12/14 10/02→09/14 09/11→09/14 04/10→09/14 04/09→12/14 10/02→12/14 10/02→12/06 09/04→12/10				03.0655-0005.2 370005	ATE
3.2 AWD D5 AWD	175 136	03/06→12/10 04/05→12/10		05/06→		03.0655-0005.2 370005	ATE
 Hauptbremszylinder							
2.5 2.5 AWD 2.5 T AWD D3 / D5 D5 AWD	153 153 154 120 120 - 155	01/03→12/06 06/02→12/14 10/02→09/14 04/09→12/14 10/02→12/14		für Rechtslenker		03.2125-7638.3 010738	ATE Ø 25,4
				für Linkslenker		03.2125-7713.3 010819	ATE Ø 25,4
3.2 3.2 AWD T6 AWD →	175 - 179 179 200	09/11→09/14 04/10→09/14 10/02→12/06		für Linkslenker		03.2125-7713.3 010819	ATE Ø 25,4













	kw			 	! #		
VOLVO - XC90 I (275) 06/02→01/15							
 Hauptbremszylinder							
V8 AWD	232 - 235	09/04→12/10		für Linkslenker		03.2125-7713.3 010819	ATE Ø 25,4
3.2 AWD	175	03/06→12/10		05/06→; für Linkslenker		03.2125-7713.3 010819	ATE Ø 25,4
D5 AWD	136	04/05→12/10		05/06→; für Rechtslenker		03.2125-7638.3 010738	ATE Ø 25,4
				05/06→; für Linkslenker		03.2125-7713.3 010819	ATE Ø 25,4
VOLVO - XC90 I VAN (275) 06/02→01/15							
 Bremskraftverstärker							
2.4 D4	120	09/13→12/14		für Linkslenker; Felgenreöße [Zoll]: 18		03.7858-3032.4 300257	ATE Ø 9 / 8" pneumatisch
				für Linkslenker		03.7858-3632.4 300234	ATE Ø 9 / 8" pneumatisch
2.4 D5 AWD	147	09/13→12/14		für Linkslenker		03.7858-3632.4 300234	ATE Ø 9 / 8" pneumatisch
Pedalwegsensoren, Bremspedal							
2.4 D4	120	09/13→12/14				03.0655-0005.2 370005	ATE
2.4 D5 AWD	147	09/13→12/14					
 Hauptbremszylinder							
2.4 D4	120	09/13→12/14		für Rechtslenker		03.2125-7638.3 010738	ATE Ø 25,4
2.4 D5 AWD	147	09/13→12/14		für Linkslenker		03.2125-7713.3 010819	ATE Ø 25,4
VW - AMAROK (2HA, 2HB, S1B, S6B, S7A, S7B) 09/10→							
 Hauptbremszylinder							
2.0 BiTDI	120 - 132	09/10→				03.2126-5132.3 011012	ATE Ø 27
2.0 BiTDI 4motion	120 - 132	09/10→				24.2126-3131.3 011038	ATE Ø 27 ohne Bremsflüssigkeitsbehälter
2.0 TDI	90 - 103	09/10→					
2.0 TDI 4motion	90 - 103	09/10→					
2.0 TSI	118	12/10→10/16					
3.0 TDI	120	06/16→					
3.0 TDI 4motion	150 - 190	06/16→					
3.0 TDI 4motion	120 - 165	06/16→		09/16→		03.2126-5132.3 011012	ATE Ø 27
						24.2126-3131.3 011038	ATE Ø 27 ohne Bremsflüssigkeitsbehälter
VW - AMAROK Pritsche/Fahrgestell (S1B, S6B, S7B) 09/11→							
 Hauptbremszylinder							
2.0 BiTDI	132	09/11→07/19		11/11→		03.2126-5132.3 011012	ATE Ø 27
						24.2126-3131.3 011038	ATE Ø 27 ohne Bremsflüssigkeitsbehälter
2.0 BiTDI 4motion	132	09/11→07/19		11/11→		03.2126-5132.3 011012	ATE Ø 27
						24.2126-3131.3 011038	ATE Ø 27 ohne Bremsflüssigkeitsbehälter
2.0 TDI	90 - 103	09/11→10/16		07/12→		03.2126-5132.3 011012	ATE Ø 27
						24.2126-3131.3 011038	ATE Ø 27 ohne Bremsflüssigkeitsbehälter
2.0 TDI 4motion	103	09/11→10/16		06/12→		03.2126-5132.3 011012	ATE Ø 27
						24.2126-3131.3 011038	ATE Ø 27 ohne Bremsflüssigkeitsbehälter
3.0 TDI 4motion	150 - 190	06/16→				03.2126-5132.3 011012	ATE Ø 27
						24.2126-3131.3 011038	ATE Ø 27 ohne Bremsflüssigkeitsbehälter
VW - ARTEON (3H7, 3H8) 03/17→							
 Hauptbremszylinder							
1.5 TSI	110	11/17→07/19		für Linkslenker; Herstellereinschränkung ATE		24.4153-1522.3 011048	ATE Ø 23,8 ohne Bremsflüssigkeitsbehälter
2.0 TDI	110 - 147	03/17→					
2.0 TDI 4motion	140 - 176	03/17→					
2.0 TSI	140	05/17→					
2.0 TSI 4motion	200 - 206	04/17→					

	kw			 	! #		
VW - ARTEON SHOOTING BRAKE (3H9) 06/20→							
 Hauptbremszylinder							
1.5 TSi 2.0 TDI 2.0 TDI 4motion 2.0 TSi 2.0 TSi 4motion 2.0 TSi 4motion	110 110 - 147 140 - 147 140 200 206	08/20→ 09/20→ 09/20→ 09/20→ 06/20→ 06/20→		für Linkslenker; Herstellereinschränkung ATE		24.4153-1522.3 011048	ATE Ø 23,8 ohne Bremsflüssigkeitsbehälter
VW - BEETLE (5C1, 5C2) 04/11→07/19							
 Hauptbremszylinder							
1.2 TSi 1.2 TSi 16V 1.6 TDI	77 77 77	07/11→07/19 12/14→07/19 10/11→07/16		für Rechtslenker		24.4152-0132.3 011025	ATE Ø 22,2 ohne Bremsflüssigkeitsbehälter
1.4 TSi 2.0 TSi	110 130 - 162	12/14→07/19 12/14→07/19		für Rechtslenker		24.4153-0202.3 011027	ATE Ø 23,8 ohne Bremsflüssigkeitsbehälter
1.4 TSi	118	10/11→07/16		für Rechtslenker; +PR 1ZP		24.4152-0132.3 011025	ATE Ø 22,2 ohne Bremsflüssigkeitsbehälter
				für Rechtslenker; +PR 1ZA		24.4153-0202.3 011027	ATE Ø 23,8 ohne Bremsflüssigkeitsbehälter
2.0 TDI	81	06/14→09/18		12/14→; für Rechtslenker		24.4153-0202.3 011027	ATE Ø 23,8 ohne Bremsflüssigkeitsbehälter
2.0 TDI	103	04/11→07/16		für Rechtslenker; +PR 1ZP		24.4152-0132.3 011025	ATE Ø 22,2 ohne Bremsflüssigkeitsbehälter
2.0 TDI	110	07/14→09/18		09/14→; +PR 1ZP; für Rechtslenker		24.4152-0132.3 011025	ATE Ø 22,2 ohne Bremsflüssigkeitsbehälter
2.0 TFSI	147	04/11→07/16		für Rechtslenker; +PR 1LV		24.4152-0132.3 011025	ATE Ø 22,2 ohne Bremsflüssigkeitsbehälter
				für Rechtslenker; +PR 1ZA / 1ZB		24.4153-0202.3 011027	ATE Ø 23,8 ohne Bremsflüssigkeitsbehälter
2.0 TSi	155	12/12→07/19		05/13→; für Rechtslenker; +PR 1LV		24.4152-0132.3 011025	ATE Ø 22,2 ohne Bremsflüssigkeitsbehälter
				05/13→; für Rechtslenker; +PR 1ZA / 1ZB		24.4153-0202.3 011027	ATE Ø 23,8 ohne Bremsflüssigkeitsbehälter
VW - BEETLE Cabriolet (5C7, 5C8) 12/11→07/19							
 Hauptbremszylinder							
1.2 TSi 1.6 TDI	77 77	12/11→07/19 12/11→07/16		11/12→; für Rechtslenker		24.4152-0132.3 011025	ATE Ø 22,2 ohne Bremsflüssigkeitsbehälter
1.2 TSi 16V	77	12/14→07/19		für Rechtslenker		24.4152-0132.3 011025	ATE Ø 22,2 ohne Bremsflüssigkeitsbehälter
1.4 TSi 2.0 TSi	110 162	12/14→09/18 12/14→09/18		für Rechtslenker		24.4153-0202.3 011027	ATE Ø 23,8 ohne Bremsflüssigkeitsbehälter
1.4 TSi	118	12/11→07/16		11/12→; für Rechtslenker; +PR 1ZP		24.4152-0132.3 011025	ATE Ø 22,2 ohne Bremsflüssigkeitsbehälter
				11/12→; +PR 1ZA; für Rechtslenker		24.4153-0202.3 011027	ATE Ø 23,8 ohne Bremsflüssigkeitsbehälter
2.0 TDI	81	06/14→09/18		12/14→; für Rechtslenker		24.4153-0202.3 011027	ATE Ø 23,8 ohne Bremsflüssigkeitsbehälter
2.0 TDI	103	04/12→07/16		11/12→; für Rechtslenker; +PR 1ZP		24.4152-0132.3 011025	ATE Ø 22,2 ohne Bremsflüssigkeitsbehälter
				11/12→; +PR 1ZE; für Rechtslenker		24.4153-0202.3 011027	ATE Ø 23,8 ohne Bremsflüssigkeitsbehälter
2.0 TDI	110	09/14→09/18		für Rechtslenker; +PR 1ZP		24.4152-0132.3 011025	ATE Ø 22,2 ohne Bremsflüssigkeitsbehälter
				für Rechtslenker; +PR 1ZE		24.4153-0202.3 011027	ATE Ø 23,8 ohne Bremsflüssigkeitsbehälter
2.0 TFSI	147	12/11→07/16		11/12→; für Rechtslenker; +PR 1LV		24.4152-0132.3 011025	ATE Ø 22,2 ohne Bremsflüssigkeitsbehälter
				11/12→; +PR 1ZA / 1ZB; für Rechtslenker		24.4153-0202.3 011027	ATE Ø 23,8 ohne Bremsflüssigkeitsbehälter
2.0 TSi	155	12/12→07/19		05/13→; für Rechtslenker; +PR 1LV		24.4152-0132.3 011025	ATE Ø 22,2 ohne Bremsflüssigkeitsbehälter
				05/13→; für Rechtslenker; +PR 1ZA / 1ZB		24.4153-0202.3 011027	ATE Ø 23,8 ohne Bremsflüssigkeitsbehälter
2.5	125	12/11→07/16		12/12→; für Rechtslenker		24.4152-0132.3 011025 24.4153-0202.3 011027	ATE Ø 22,2 ohne Bremsflüssigkeitsbehälter ATE Ø 23,8 ohne Bremsflüssigkeitsbehälter

	kw					! #		
VW - BORA (9M2) 01/05→12/14								
 Bremskraftverstärker								
2.0	85	01/05→12/14		→ 1J-2-373846; für Linkslenker; + ESP		03.7860-0602.4	300141	ATE Ø 10" pneumatisch
				für Linkslenker; + ESP		03.7863-0402.4	300124	ATE Ø 10" pneumatisch
				1J-2-373847→; für Linkslenker; + ESP		03.7863-3502.4	300128	ATE Ø 10" pneumatisch
 Hauptbremszylinder								
2.0	85	01/05→12/14		für Linkslenker; + ESP		03.2123-2024.3	010597	ATE Ø 23,8
						03.2123-2715.3	010802	ATE Ø 23,8
				für Rechtslenker; + ESP		03.2123-2064.3	010598	ATE Ø 23,8
						03.2123-2774.3	010803	ATE Ø 23,8
				für Linkslenker; - ESP		24.2123-1709.3	010503	Ø 23,8
VW - BORA I (1J2) 10/98→12/13								
 Bremskraftverstärker								
1.4 16V	55	03/00→05/05		09/00→; → 1J-2-373846; für Linkslenker; + ESP		03.7860-0602.4	300141	ATE Ø 10" pneumatisch
1.6	74 - 75	10/98→05/05		→ 08/00; für Linkslenker; + ESP		03.7863-0402.4	300124	ATE Ø 10" pneumatisch
1.6 16V	77	05/00→05/05		1J-2-373847→; für Linkslenker; + ESP; → 12/04		03.7863-3502.4	300128	ATE Ø 10" pneumatisch
1.8	92	10/98→05/05						
1.8 4motion	92	02/99→05/05						
1.9 SDI	50	10/98→05/05						
2.0	85	10/98→12/13						
1.6	78	06/02→10/04		→ 1J-2-373846; für Linkslenker; + ESP		03.7860-0602.4	300141	ATE Ø 10" pneumatisch
				für Linkslenker; + ESP		03.7863-0402.4	300124	ATE Ø 10" pneumatisch
				1J-2-373847→; für Linkslenker; + ESP		03.7863-3502.4	300128	ATE Ø 10" pneumatisch
1.6 FSI	81	01/02→05/05		→ 1J-2-373846; für Linkslenker; + ESP		03.7860-0602.4	300141	ATE Ø 10" pneumatisch
1.9 TDI	74	09/00→05/05		1J-2-373847→; für Linkslenker; + ESP; → 12/04		03.7863-3502.4	300128	ATE Ø 10" pneumatisch
1.9 TDI 4motion	74	09/00→05/05						
2.0 4motion	85	04/00→05/05						
2.3 V5	125	10/00→05/05						
2.3 V5 4motion	125	10/00→05/05						
1.8 T	110	05/00→05/05		09/00→; → 1J-2-373846; für Linkslenker; + ESP		03.7860-0602.4	300141	ATE Ø 10" pneumatisch
				1J-2-373847→; für Linkslenker; + ESP; → 12/04		03.7863-3502.4	300128	ATE Ø 10" pneumatisch
1.8 T	132	03/02→05/05		05/02→; für Linkslenker; + ESP; → 12/04		03.7863-3502.4	300128	ATE Ø 10" pneumatisch
1.9 TDI	66	10/98→05/05		09/00→ 06/01; für Linkslenker; + ESP		03.7860-0602.4	300141	ATE Ø 10" pneumatisch
				→ 08/00; für Linkslenker; + ESP		03.7863-0402.4	300124	ATE Ø 10" pneumatisch
1.9 TDI	81	10/98→06/01		09/00→; für Linkslenker; + ESP		03.7860-0602.4	300141	ATE Ø 10" pneumatisch
1.9 TDI 4motion	85	02/99→06/01		→ 08/00; für Linkslenker; + ESP		03.7863-0402.4	300124	ATE Ø 10" pneumatisch
1.9 TDI	85	12/98→01/02		09/00→ 06/01; für Linkslenker; + ESP		03.7860-0602.4	300141	ATE Ø 10" pneumatisch
1.9 TDI 4motion	66	11/98→04/02		02/99→ 08/00; für Linkslenker; + ESP		03.7863-0402.4	300124	ATE Ø 10" pneumatisch
1.9 TDI	96	11/00→05/05		04/01→; → 1J-2-373846; für Linkslenker; + ESP		03.7860-0602.4	300141	ATE Ø 10" pneumatisch
1.9 TDI 4motion	96	11/00→05/05		1J-2-373847→; für Linkslenker; + ESP; → 12/04		03.7863-3502.4	300128	ATE Ø 10" pneumatisch
1.9 TDI	110	05/00→05/05		10/00→; → 1J-2-373846; für Linkslenker; + ESP		03.7860-0602.4	300141	ATE Ø 10" pneumatisch
1.9 TDI 4motion	110	05/00→05/05		1J-2-373847→; für Linkslenker; + ESP; → 12/04		03.7863-3502.4	300128	ATE Ø 10" pneumatisch
2.3 V5	110	10/98→10/00		09/00→; → 1J-2-373846; für Linkslenker; + ESP		03.7860-0602.4	300141	ATE Ø 10" pneumatisch
				→ 08/00; für Linkslenker; + ESP		03.7863-0402.4	300124	ATE Ø 10" pneumatisch
				1J-2-373847→; für Linkslenker; + ESP		03.7863-3502.4	300128	ATE Ø 10" pneumatisch
2.3 V5 4motion	110	12/98→10/00		09/00→; → 1J-2-373846; für Linkslenker; + ESP		03.7860-0602.4	300141	ATE Ø 10" pneumatisch
				02/99→ 08/00; für Linkslenker; + ESP		03.7863-0402.4	300124	ATE Ø 10" pneumatisch
				1J-2-373847→; für Linkslenker; + ESP		03.7863-3502.4	300128	ATE Ø 10" pneumatisch
2.8 V6 4motion	150	03/99→05/05		09/00→; → 1J-2-373846; für Linkslenker; + ESP		03.7860-0602.4	300141	ATE Ø 10" pneumatisch
				05/99→ 08/00; für Linkslenker; + ESP		03.7863-0402.4	300124	ATE Ø 10" pneumatisch
				1J-2-373847→; für Linkslenker; + ESP; → 12/04		03.7863-3502.4	300128	ATE Ø 10" pneumatisch
 Hauptbremszylinder								
1.4 16V	55	03/00→05/05		→ 08/00; für Linkslenker; + ESP		03.2123-2024.3	010597	ATE Ø 23,8
1.6	74 - 75	10/98→05/05		→ 08/00; für Rechtslenker; + ESP		03.2123-2064.3	010598	ATE Ø 23,8
1.6 16V	77	05/00→05/05		09/00→; für Linkslenker; + ESP; → 12/04		03.2123-2715.3	010802	ATE Ø 23,8
1.8	92	10/98→05/05		09/00→; für Rechtslenker; + ESP; → 12/04		03.2123-2774.3	010803	ATE Ø 23,8
1.8 4motion	92	02/99→05/05						

	kw			 	! #		
VW - BORA I (1J2) 10/98→12/13							
 Hauptbremszylinder							
1.9 SDI 2.0	50 85	10/98→05/05 10/98→12/13		für Linkslenker; - ESP; → 12/04		24.2123-1709.3 010503	Ø 23,8
1.6	78	06/02→10/04		für Linkslenker; + ESP		03.2123-2024.3 010597	ATE Ø 23,8
				für Rechtslenker; + ESP		03.2123-2715.3 010802	ATE Ø 23,8
				für Rechtslenker; + ESP		03.2123-2064.3 010598	ATE Ø 23,8
				für Linkslenker; - ESP		03.2123-2774.3 010803	ATE Ø 23,8
1.6 FSI 1.9 TDI 1.9 TDI 4motion 2.0 4motion 2.3 V5 2.3 V5 4motion	81	01/02→05/05		für Linkslenker; + ESP; → 12/04		03.2123-2715.3 010802	ATE Ø 23,8
	74	09/00→05/05		für Rechtslenker; + ESP; → 12/04		03.2123-2774.3 010803	ATE Ø 23,8
	74	09/00→05/05		für Linkslenker; - ESP; → 12/04		24.2123-1709.3 010503	Ø 23,8
	85	04/00→05/05		für Linkslenker; - ESP; → 12/04		24.2123-1709.3 010503	Ø 23,8
	125	10/00→05/05		für Linkslenker; - ESP; → 12/04		24.2123-1709.3 010503	Ø 23,8
1.8 T	110	05/00→05/05		09/00→; für Linkslenker; + ESP; → 12/04		03.2123-2715.3 010802	ATE Ø 23,8
				09/00→; für Rechtslenker; + ESP; → 12/04		03.2123-2774.3 010803	ATE Ø 23,8
				09/00→; für Linkslenker; - ESP; → 12/04		24.2123-1709.3 010503	Ø 23,8
1.8 T	132	03/02→05/05		05/02→; für Linkslenker; + ESP; → 12/04		03.2123-2715.3 010802	ATE Ø 23,8
				05/02→; für Rechtslenker; + ESP; → 12/04		03.2123-2774.3 010803	ATE Ø 23,8
				05/02→; für Linkslenker; - ESP; → 12/04		24.2123-1709.3 010503	Ø 23,8
1.9 TDI	66	10/98→05/05		→ 08/00; für Linkslenker; + ESP		03.2123-2024.3 010597	ATE Ø 23,8
				→ 08/00; für Rechtslenker; + ESP		03.2123-2064.3 010598	ATE Ø 23,8
				09/00→ 06/01; für Linkslenker; + ESP		03.2123-2715.3 010802	ATE Ø 23,8
				09/00→ 06/01; für Rechtslenker; + ESP		03.2123-2774.3 010803	ATE Ø 23,8
				→ 06/01; für Linkslenker; - ESP		24.2123-1709.3 010503	Ø 23,8
1.9 TDI 1.9 TDI 4motion 2.3 V5	81	10/98→06/01		→ 08/00; für Linkslenker; + ESP		03.2123-2024.3 010597	ATE Ø 23,8
	85	02/99→06/01		→ 08/00; für Rechtslenker; + ESP		03.2123-2064.3 010598	ATE Ø 23,8
	110	10/98→10/00		09/00→; für Linkslenker; + ESP		03.2123-2715.3 010802	ATE Ø 23,8
				09/00→; für Rechtslenker; + ESP		03.2123-2774.3 010803	ATE Ø 23,8
				für Linkslenker; - ESP		24.2123-1709.3 010503	Ø 23,8
1.9 TDI 1.9 TDI 4motion	85	12/98→01/02		02/99→ 08/00; für Linkslenker; + ESP		03.2123-2024.3 010597	ATE Ø 23,8
	66	11/98→04/02		02/99→ 08/00; für Rechtslenker; + ESP		03.2123-2064.3 010598	ATE Ø 23,8
				09/00→ 06/01; für Linkslenker; + ESP		03.2123-2715.3 010802	ATE Ø 23,8
				09/00→ 06/01; für Rechtslenker; + ESP		03.2123-2774.3 010803	ATE Ø 23,8
				02/99→ 06/01; für Linkslenker; - ESP		24.2123-1709.3 010503	Ø 23,8
1.9 TDI 1.9 TDI 4motion	96	11/00→05/05		04/01→; für Linkslenker; + ESP; → 12/04		03.2123-2715.3 010802	ATE Ø 23,8
	96	11/00→05/05		04/01→; für Rechtslenker; + ESP; → 12/04		03.2123-2774.3 010803	ATE Ø 23,8
				04/01→; für Linkslenker; - ESP; → 12/04		24.2123-1709.3 010503	Ø 23,8
1.9 TDI 1.9 TDI 4motion	110	05/00→05/05		10/00→; für Linkslenker; + ESP; → 12/04		03.2123-2715.3 010802	ATE Ø 23,8
	110	05/00→05/05		10/00→; für Rechtslenker; + ESP; → 12/04		03.2123-2774.3 010803	ATE Ø 23,8
				10/00→; für Linkslenker; - ESP; → 12/04		24.2123-1709.3 010503	Ø 23,8
2.3 V5 4motion	110	12/98→10/00		02/99→ 08/00; für Linkslenker; + ESP		03.2123-2024.3 010597	ATE Ø 23,8
				02/99→ 08/00; für Rechtslenker; + ESP		03.2123-2064.3 010598	ATE Ø 23,8
				09/00→; für Linkslenker; + ESP		03.2123-2715.3 010802	ATE Ø 23,8
				09/00→; für Rechtslenker; + ESP		03.2123-2774.3 010803	ATE Ø 23,8
				02/99→; für Linkslenker; - ESP		24.2123-1709.3 010503	Ø 23,8
2.8 V6 4motion	150	03/99→05/05		05/99→ 08/00; + ESP; für Linkslenker		03.2123-2024.3 010597	ATE Ø 23,8
				05/99→ 08/00; + ESP; für Rechtslenker		03.2123-2064.3 010598	ATE Ø 23,8
				09/00→; für Linkslenker; + ESP; → 12/04		03.2123-2715.3 010802	ATE Ø 23,8
				09/00→; für Rechtslenker; + ESP; → 12/04		03.2123-2774.3 010803	ATE Ø 23,8
				05/99→; für Linkslenker; - ESP; → 12/04		24.2123-1709.3 010503	Ø 23,8
VW - BORA Variant (1J6) 05/99→05/05							
 Bremskraftverstärker							
1.4 16V 1.6 FSI 1.9 TDI	55 81 74 - 110	09/01→05/05 01/02→05/05 09/00→05/05		→ 1J-2-373846; für Linkslenker; + ESP		03.7860-0602.4 300141	ATE Ø 10" pneumatisch
1.9 TDI 4motion 2.0 4motion 2.3 V5 2.3 V5 4motion →	74 - 110	09/00→05/05		1J-2-373847→; für Linkslenker; + ESP; → 12/04		03.7863-3502.4 300128	ATE Ø 10" pneumatisch
	74 - 110	09/00→05/05					
	85	04/00→05/05					
	125	10/00→05/05					
	125	10/00→05/05					

	kw			 	! #		
VW - BORA Variant (1J6) 05/99→05/05							
 Bremskraftverstärker							
1.6	74 - 75	05/99→05/05		09/00→; → 1J-2-373846; für Linkslenker; + ESP		03.7860-0602.4 300141	ATE Ø 10" pneumatisch
1.6 16V	77	02/00→05/05		→ 08/00; für Linkslenker; + ESP		03.7863-0402.4 300124	ATE Ø 10" pneumatisch
1.8 4motion	92	05/99→05/05		1J-2-373847→; für Linkslenker; + ESP;		03.7863-3502.4 300128	ATE Ø 10" pneumatisch
2.0	85	05/99→05/05		→ 12/04			
2.8 V6 4motion	150	05/99→05/05					
1.8 T	110	05/00→05/05		09/00→; → 1J-2-373846; für Linkslenker; + ESP		03.7860-0602.4 300141	ATE Ø 10" pneumatisch
				1J-2-373847→; für Linkslenker; + ESP;		03.7863-3502.4 300128	ATE Ø 10" pneumatisch
				→ 12/04			
1.8 T	132	05/02→05/05		für Linkslenker; + ESP; → 12/04		03.7863-3502.4 300128	ATE Ø 10" pneumatisch
1.9 TDI	81 - 85	05/99→06/01		09/00→; für Linkslenker; + ESP		03.7860-0602.4 300141	ATE Ø 10" pneumatisch
1.9 TDI 4motion	85	05/99→06/01		→ 08/00; für Linkslenker; + ESP		03.7863-0402.4 300124	ATE Ø 10" pneumatisch
1.9 TDI	96	11/00→05/05		04/01→; → 1J-2-373846; für Linkslenker; + ESP		03.7860-0602.4 300141	ATE Ø 10" pneumatisch
1.9 TDI 4motion	96	11/00→05/05		1J-2-373847→; für Linkslenker; + ESP;		03.7863-3502.4 300128	ATE Ø 10" pneumatisch
				→ 12/04			
2.0 4motion	88	12/99→05/03		04/00→; → 1J-2-373846; für Linkslenker; + ESP		03.7860-0602.4 300141	ATE Ø 10" pneumatisch
				1J-2-373847→; für Linkslenker; + ESP		03.7863-3502.4 300128	ATE Ø 10" pneumatisch
2.3 V5	110	05/99→10/00		09/00→; → 1J-2-373846; für Linkslenker; + ESP		03.7860-0602.4 300141	ATE Ø 10" pneumatisch
2.3 V5 4motion	110	05/99→10/00		→ 08/00; für Linkslenker; + ESP		03.7863-0402.4 300124	ATE Ø 10" pneumatisch
				1J-2-373847→; für Linkslenker; + ESP		03.7863-3502.4 300128	ATE Ø 10" pneumatisch
 Hauptbremszylinder							
1.4 16V	55	09/01→05/05		für Linkslenker; + ESP; → 12/04		03.2123-2715.3 010802	ATE Ø 23,8
1.6 FSI	81	01/02→05/05		für Rechtslenker; + ESP; → 12/04		03.2123-2774.3 010803	ATE Ø 23,8
1.8 T	132	05/02→05/05		für Linkslenker; - ESP; → 12/04		24.2123-1709.3 010503	Ø 23,8
1.9 TDI	74 - 110	09/00→05/05					
1.9 TDI 4motion	74 - 110	09/00→05/05					
2.0 4motion	85	04/00→05/05					
2.3 V5	125	10/00→05/05					
2.3 V5 4motion	125	10/00→05/05					
1.6	74 - 75	05/99→05/05		→ 08/00; für Linkslenker; + ESP		03.2123-2024.3 010597	ATE Ø 23,8
1.6 16V	77	02/00→05/05		→ 08/00; für Rechtslenker; + ESP		03.2123-2064.3 010598	ATE Ø 23,8
1.8 4motion	92	05/99→05/05		09/00→; für Linkslenker; + ESP; → 12/04		03.2123-2715.3 010802	ATE Ø 23,8
2.0	85	05/99→05/05		09/00→; für Rechtslenker; + ESP; → 12/04		03.2123-2774.3 010803	ATE Ø 23,8
2.8 V6 4motion	150	05/99→05/05		für Linkslenker; - ESP; → 12/04		24.2123-1709.3 010503	Ø 23,8
1.8 T	110	05/00→05/05		09/00→; für Linkslenker; + ESP; → 12/04		03.2123-2715.3 010802	ATE Ø 23,8
				09/00→; für Rechtslenker; + ESP; → 12/04		03.2123-2774.3 010803	ATE Ø 23,8
				09/00→; für Linkslenker; - ESP; → 12/04		24.2123-1709.3 010503	Ø 23,8
1.9 TDI	81 - 85	05/99→06/01		→ 08/00; für Linkslenker; + ESP		03.2123-2024.3 010597	ATE Ø 23,8
1.9 TDI 4motion	85	05/99→06/01		→ 08/00; für Rechtslenker; + ESP		03.2123-2064.3 010598	ATE Ø 23,8
2.3 V5	110	05/99→10/00		09/00→; für Linkslenker; + ESP		03.2123-2715.3 010802	ATE Ø 23,8
2.3 V5 4motion	110	05/99→10/00		09/00→; für Rechtslenker; + ESP		03.2123-2774.3 010803	ATE Ø 23,8
				für Linkslenker; - ESP		24.2123-1709.3 010503	Ø 23,8
1.9 TDI	96	11/00→05/05		04/01→; für Linkslenker; + ESP; → 12/04		03.2123-2715.3 010802	ATE Ø 23,8
1.9 TDI 4motion	96	11/00→05/05		04/01→; für Rechtslenker; + ESP; → 12/04		03.2123-2774.3 010803	ATE Ø 23,8
				04/01→; für Linkslenker; - ESP; → 12/04		24.2123-1709.3 010503	Ø 23,8
2.0 4motion	88	12/99→05/03		04/00→; für Linkslenker; + ESP		03.2123-2715.3 010802	ATE Ø 23,8
				04/00→; für Rechtslenker; + ESP		03.2123-2774.3 010803	ATE Ø 23,8
				04/00→; für Linkslenker; - ESP		24.2123-1709.3 010503	Ø 23,8
VW - CADDY II Großraumlimousine (9K9B) 11/95→12/04							
 Bremskraftverstärker							
1.4	44	11/95→06/03		für Linkslenker; - ABS		03.7750-6302.4 300161	ATE Ø 9" pneumatisch
1.4 16V	55	08/00→01/04		→ 9K-1-538270; für Linkslenker		10.6350-3902.4 300213	ATE Ø 9" pneumatisch
1.6	55	11/95→09/00					
1.7 SDI	42	07/96→09/00		9K-1-538271→; für Linkslenker		10.6350-4002.4 300285	ATE Ø 9" pneumatisch
1.9 D	47	11/95→01/04					
1.9 SDI	47	11/95→01/04					
1.9 TDI	66	10/96→01/04					
→							

	kw					! #		
VW - CADDY II Großraumlimousine (9K9B) 11/95→12/04								
 Hauptbremszylinder								
1.4	44	11/95→06/03		für Linkslenker; - ABS		03.2122-1042.3	010137	Ø 22,2
1.4 16V	55	08/00→01/04		→ 9K-X-514000; für Rechtslenker; - ABS		03.2122-1042.3	010137	Ø 22,2
1.6	55	11/95→09/00						
1.9 D	47	11/95→01/04		für Linkslenker; + ABS		03.2123-1424.3	010637	ATE Ø 23,8
1.9 SDI	47	11/95→01/04		für Rechtslenker; + ABS		03.2123-1484.3	010595	ATE Ø 23,8
1.9 TDI	66	10/96→01/04						
1.7 SDI	42	07/96→09/00		für Linkslenker; - ABS		03.2122-1042.3	010137	Ø 22,2
				→ 9K-X-514000; für Rechtslenker; - ABS		03.2122-1042.3	010137	Ø 22,2
				für Linkslenker; + ABS		03.2123-1424.3	010637	ATE Ø 23,8
Verschlusschraube, Hauptbremszylinder								
1.4	44	11/95→06/03		für Linkslenker; - ABS		03.3517-0101.2	390322	
1.4 16V	55	08/00→01/04		→ 9K-X-514000; für Rechtslenker; - ABS		03.3517-0101.2	390322	
1.6	55	11/95→09/00						
1.7 SDI	42	07/96→09/00						
1.9 D	47	11/95→01/04						
1.9 SDI	47	11/95→01/04						
1.9 TDI	66	10/96→01/04						
VW - CADDY II Kasten/Großraumlimousine (9K9A) 11/95→01/04								
 Bremskraftverstärker								
1.4	55	08/00→01/04		für Linkslenker; - ABS		03.7750-6302.4	300161	ATE Ø 9" pneumatisch
1.7 SDI	42	07/96→09/00		→ 9K-1-538270; für Linkslenker		10.6350-3902.4	300213	ATE Ø 9" pneumatisch
1.9 D	47	11/95→01/04						
1.9 SDI	47	11/95→01/04		9K-1-538271→; für Linkslenker		10.6350-4002.4	300285	ATE Ø 9" pneumatisch
1.9 TDI	66	09/96→01/04						
60 1.4	44	11/95→01/04						
75 1.6	55	11/95→09/00						
 Hauptbremszylinder								
1.4	55	08/00→01/04		für Linkslenker; - ABS		03.2122-1042.3	010137	Ø 22,2
1.9 D	47	11/95→01/04		→ 9K-X-514000; für Rechtslenker; - ABS		03.2122-1042.3	010137	Ø 22,2
1.9 SDI	47	11/95→01/04						
1.9 TDI	66	09/96→01/04		für Linkslenker; + ABS		03.2123-1424.3	010637	ATE Ø 23,8
60 1.4	44	11/95→01/04		für Rechtslenker; + ABS		03.2123-1484.3	010595	ATE Ø 23,8
75 1.6	55	11/95→09/00						
1.7 SDI	42	07/96→09/00		für Linkslenker; - ABS		03.2122-1042.3	010137	Ø 22,2
				→ 9K-X-514000; für Rechtslenker; - ABS		03.2122-1042.3	010137	Ø 22,2
				für Linkslenker; + ABS		03.2123-1424.3	010637	ATE Ø 23,8
Verschlusschraube, Hauptbremszylinder								
1.4	55	08/00→01/04		für Linkslenker; - ABS		03.3517-0101.2	390322	
1.7 SDI	42	07/96→09/00		→ 9K-X-514000; für Rechtslenker; - ABS		03.3517-0101.2	390322	
1.9 D	47	11/95→01/04						
1.9 SDI	47	11/95→01/04						
1.9 TDI	66	09/96→01/04						
60 1.4	44	11/95→01/04						
75 1.6	55	11/95→09/00						
VW - CADDY II Pick-up (9U7) 06/96→12/00								
 Hauptbremszylinder								
1.6	55	06/96→12/00		10/97→; + ABS		03.2123-1428.3	010476	Ø 23,8
1.9 D	47	06/96→12/00		10/97→; - ABS		24.2122-1731.3	010656	Ø 22,2
 Bremskraftregler								
1.6	55	06/96→12/00		10/97→		03.6583-0167.3	320140	ATE lastabhängig 8/3 4x
1.9 D	47	06/96→12/00				03.6584-0107.3	320110	ATE lastabhängig 8/4 4x
VW - CADDY III Großraumlimousine (2KB, 2KJ, 2CB, 2CJ) 03/04→05/15								
 Bremskraftverstärker								
1.2 TSI	63	09/10→05/15		für Linkslenker		03.7873-4302.4	300312	ATE Ø 11" pneumatisch
77								
1.4	55	03/04→08/10						
59								
1.6	75	04/04→05/15						
1.6 BiFuel	75	05/11→05/15						
1.6 TDI	55	08/10→05/15						
75								
1.9 D	48	10/05→06/09						
1.9 TDI	55	04/04→08/10						
77								
1.9 TDI 4motion	77	05/08→08/10						
2.0 EcoFuel	80	04/06→05/15						
2.0 SDI	51	03/04→08/10						
→								

VW - CADDY III Großraumlimousine (2KB, 2KJ, 2CB, 2CJ) 03/04→05/15

 **Bremskraftverstärker**

2.0 TDI	103 - 125	09/07→05/15		für Linkslenker	03.7873-4302.4	300312	ATE Ø 11" pneumatisch
2.0 TDI 16V	103	11/10→05/15					
2.0 TDI 16V 4motion	103	11/10→05/15					
2.0 TDI	81	08/10→05/15		10/10→; für Linkslenker	03.7873-4302.4	300312	ATE Ø 11" pneumatisch
2.0 TDI 4motion	81	08/10→05/15					

 **Hauptbremszylinder**

1.2 TSI	63 - 77	09/10→05/15		für Linkslenker	03.2122-2129.3	010799	ATE Ø 22,2
1.6 TDI	55 - 75	08/10→05/15		für Rechtslenker	24.4152-0132.3	011025	ATE Ø 22,2 ohne Bremsflüssigkeitsbehälter
2.0 TDI	125	05/12→05/15					
2.0 TDI 16V 4motion	103	11/10→05/15					
1.4	55 - 59	03/04→08/10		für Linkslenker	03.2122-2129.3	010799	ATE Ø 22,2
1.6	75	04/04→05/15		für Rechtslenker; → 2K-6-150 000	24.2122-1981.3	011024	ATE Ø 22,2 ohne Bremsflüssigkeitsbehälter
1.6 BiFuel	75	05/11→05/15					
1.9 D	48	10/05→06/09		2K-7-000 001→; für Rechtslenker	24.4152-0132.3	011025	ATE Ø 22,2 ohne Bremsflüssigkeitsbehälter
1.9 TDI	55 - 77	04/04→08/10					
1.9 TDI 4motion	77	05/08→08/10					
2.0 EcoFuel	80	04/06→05/15					
2.0 SDI	51	03/04→08/10					
2.0 TDI	103	09/07→08/10					
2.0 TDI 16V	103	11/10→05/15					
2.0 TDI	81	08/10→05/15		10/10→; für Linkslenker	03.2122-2129.3	010799	ATE Ø 22,2
2.0 TDI 4motion	81	08/10→05/15		10/10→; für Rechtslenker	24.4152-0132.3	011025	ATE Ø 22,2 ohne Bremsflüssigkeitsbehälter

Hydraulikaggregat, Bremsanlage

1.2 TSI	63 - 77	09/10→05/15		→ 12/10; +PR 1AT	24.9145-0001.2	399005	
1.6	75	04/04→05/15					
1.6 TDI	55 - 75	08/10→05/15					
2.0 EcoFuel	80	04/06→05/15					
2.0 TDI 16V	103	11/10→05/15					
2.0 TDI 16V 4motion	103	11/10→05/15					
1.4	55 - 59	03/04→08/10		+PR 1AT	24.9145-0001.2	399005	
1.9 D	48	10/05→06/09					
1.9 TDI	55 - 77	04/04→08/10					
1.9 TDI 4motion	77	05/08→08/10					
2.0 SDI	51	03/04→08/10					
2.0 TDI	103	09/07→08/10					
2.0 TDI	81	08/10→05/15		10/10→ 12/10; +PR 1AT	24.9145-0001.2	399005	
2.0 TDI 4motion	81	08/10→05/15					











VW - CADDY III Kasten/Großraumlimousine (2KA, 2KH, 2CA, 2CH) 03/04→05/15













 **Bremskraftverstärker**













1.2 TSI	63 - 77	09/10→05/15		für Linkslenker	03.7873-4302.4	300312	ATE Ø 11" pneumatisch
1.4	55 - 59	03/04→08/10					
1.6	75	04/04→05/15					
1.6 BiFuel	75	05/11→05/15					
1.6 TDI	55 - 75	08/10→05/15					
1.9 TDI	55 - 77	04/04→08/10					
1.9 TDI 4motion	77	11/08→08/10					
2.0 EcoFuel	80	04/06→05/15					
2.0 SDI	51	03/04→08/10					
2.0 TDI	62 - 125	09/07→05/15					
2.0 TDI 16V	103	11/10→05/15					
2.0 TDI 16V 4motion	103	11/10→05/15					
2.0 TDI 4motion	62	12/10→05/15					
2.0 TDI	81	08/10→05/15		10/10→; für Linkslenker	03.7873-4302.4	300312	ATE Ø 11" pneumatisch
2.0 TDI 4motion	81	08/10→05/15					













 **Hauptbremszylinder**







1.2 TSI	63 - 77	09/10→05/15		für Linkslenker	03.2122-2129.3	010799	ATE Ø 22,2
1.6 TDI	55 - 75	08/10→05/15		für Rechtslenker	24.4152-0132.3	011025	ATE Ø 22,2 ohne Bremsflüssigkeitsbehälter
2.0 TDI	125	05/12→05/15					
→							

	kW					! #		
VW - CADDY III Kasten/Großraumlimousine (2KA, 2KH, 2CA, 2CH) 03/04→05/15								
 Hauptbremszylinder								
2.0 TDI 4motion	62	12/10→05/15		für Linkslenker		03.2122-2129.3	010799	ATE Ø 22,2
				für Rechtslenker		24.4152-0132.3	011025	ATE Ø 22,2 ohne Bremsflüssigkeitsbehälter
1.4	55 - 59	03/04→08/10		für Linkslenker		03.2122-2129.3	010799	ATE Ø 22,2
1.6	75	04/04→05/15		für Rechtslenker; → 2K-6-150 000		24.2122-1981.3	011024	ATE Ø 22,2 ohne Bremsflüssigkeitsbehälter
1.6 BiFuel	75	05/11→05/15						
1.9 TDI	55 - 77	04/04→08/10		2K-7-000 001→; für Rechtslenker		24.4152-0132.3	011025	ATE Ø 22,2 ohne Bremsflüssigkeitsbehälter
1.9 TDI 4motion	77	11/08→08/10						
2.0 EcoFuel	80	04/06→05/15						
2.0 SDI	51	03/04→08/10						
2.0 TDI	62 - 103	09/07→05/15						
2.0 TDI 16V	103	11/10→05/15						
2.0 TDI 16V 4motion	103	11/10→05/15						
2.0 TDI	81	08/10→05/15		10/10→; für Linkslenker		03.2122-2129.3	010799	ATE Ø 22,2
2.0 TDI 4motion	81	08/10→05/15		10/10→; für Rechtslenker		24.4152-0132.3	011025	ATE Ø 22,2 ohne Bremsflüssigkeitsbehälter
Hydraulikaggregat, Bremsanlage								
1.2 TSI	63 - 77	09/10→05/15		→ 12/10; +PR 1AT		24.9145-0001.2	399005	
1.6	75	04/04→05/15						
1.6 TDI	55 - 75	08/10→05/15						
2.0 EcoFuel	80	04/06→05/15						
2.0 TDI	62	11/10→05/15						
2.0 TDI 16V	103	11/10→05/15						
2.0 TDI 16V 4motion	103	11/10→05/15						
2.0 TDI 4motion	62	12/10→05/15						
1.4	55 - 59	03/04→08/10		+PR 1AT		24.9145-0001.2	399005	
1.9 TDI	55 - 77	04/04→08/10						
1.9 TDI 4motion	77	11/08→08/10						
2.0 SDI	51	03/04→08/10						
2.0 TDI	103	09/07→08/10						
2.0 TDI	81	08/10→05/15		10/10→ 12/10; +PR 1AT		24.9145-0001.2	399005	
2.0 TDI 4motion	81	08/10→05/15						
VW - CADDY IV Großraumlimousine (SAB, SAJ) 05/15→								
 Hauptbremszylinder								
1.0 TSI	62 - 75	11/15→09/20		für Linkslenker		03.2123-3449.3	010808	ATE Ø 23,8
1.2 TSI	62	06/15→09/20		für Rechtslenker		24.4153-0202.3	011027	ATE Ø 23,8 ohne Bremsflüssigkeitsbehälter
1.4 TGI CNG	81	06/15→09/20						
1.4 TSI	92 - 96	05/15→09/20						
1.6	81	11/15→09/20						
1.6 TDI	55 - 75	05/15→09/20						
2.0 TDI	55 - 110	05/15→09/20						
2.0 TDI 4motion	81 - 110	05/15→09/20						
ABT e-Caddy	83	04/20→						
VW - CADDY IV Kasten/Großraumlimousine (SAA, SAH) 05/15→								
 Hauptbremszylinder								
1.0 TSI	75	11/15→09/20		für Linkslenker		03.2123-3449.3	010808	ATE Ø 23,8
1.2 TSI	62	06/15→09/20		für Rechtslenker		24.4153-0202.3	011027	ATE Ø 23,8 ohne Bremsflüssigkeitsbehälter
1.4 TGI CNG	81	06/15→09/20						
1.4 TSI	92 - 96	05/15→09/20						
1.6	81	11/15→09/20						
1.6 TDI	55 - 75	05/15→09/20						
2.0 TDI	55 - 110	05/15→09/20						
2.0 TDI 4motion	55 - 110	05/15→09/20						
ABT e-Caddy	83	04/20→						
VW - CADDY ALLTRACK Großraumlimousine (SAB) 05/15→								
 Hauptbremszylinder								
1.0 TSI	62 - 75	11/15→		für Linkslenker		03.2123-3449.3	010808	ATE Ø 23,8
→								











	kw					! #		
VW - CADDY ALLTRACK Großraumlimousine (SAB) 05/15→								
 Hauptbremszylinder								
1.2 TSI 1.4 TGI CNG 1.4 TSI 1.6 TDI 2.0 TDI 2.0 TDI 4motion	62 81 92 - 96 55 - 75 55 - 110 81 - 110	06/15→ 06/15→ 05/15→ 05/15→ 05/15→ 05/15→		für Rechtslenker		24.4153-0202.3	011027	ATE Ø 23,8 ohne Bremsflüssigkeitsbehälter
VW - CADDY ALLTRACK Kasten/Großraumlimousine (SAA) 05/15→								
 Hauptbremszylinder								
1.0 TSI 1.2 TSI 1.4 TGI CNG 1.4 TSI 1.6 SRE 1.6 TDI 2.0 TDI 2.0 TDI 4motion	75 62 81 92 - 96 81 55 - 75 55 - 110 81 - 110	11/15→ 06/15→ 06/15→ 05/15→ 05/15→ 11/15→09/20 05/15→ 05/15→ 05/15→ 05/15→ 05/15→		für Linkslenker für Rechtslenker		03.2123-3449.3	010808	ATE Ø 23,8
						24.4153-0202.3	011027	ATE Ø 23,8 ohne Bremsflüssigkeitsbehälter
VW - CADDY Kasten/Großraumlimousine (6K9, 9E7, 9E9) 09/02→12/09								
 Bremskraftverstärker								
1.9 D	47	02/98→06/09		für Linkslenker		03.7873-4302.4	300312	ATE Ø 11" pneumatisch
 Hauptbremszylinder								
1.9 D	47	02/98→06/09		für Linkslenker		03.2122-2129.3	010799	ATE Ø 22,2
				für Rechtslenker; → 2K-6-150 000		24.2122-1981.3	011024	ATE Ø 22,2 ohne Bremsflüssigkeitsbehälter
				2K-7-000 001→; für Rechtslenker		24.4152-0132.3	011025	ATE Ø 22,2 ohne Bremsflüssigkeitsbehälter
Hydraulikaggregat, Bremsanlage								
1.9 D	47	02/98→06/09		+PR 1AT		24.9145-0001.2	399005	
VW - CALIFORNIA T5 Camper (7EC, 7EF, 7EG, 7HF) 04/03→08/15								
 Bremskraftverstärker								
1.9 TDI 2.0 TDI 2.0 TDI 4motion 2.5 TDi 2.5 TDI 2.5 TDI 4motion	63 - 77 62 - 132 103 - 132 120 96 - 128 96 - 128	05/07→11/09 09/09→08/15 10/09→08/15 05/07→11/09 05/07→11/09 05/07→11/09		+PR 1AJ / 1AE / 1AC / 1AR; → 7H-A-050000 +PR 1AK; → 7H-A-050000		03.7765-1002.4	300246	ATE Ø 10 / 9" pneumatisch
						03.7868-3702.4	300208	ATE Ø 10 / 8" pneumatisch
Pedalwegsensor, Bremspedal								
1.9 TDI 2.0 TDI 2.0 TDI 4motion 2.5 TDi 2.5 TDI 2.5 TDI 4motion	63 - 77 62 - 132 103 - 132 120 96 - 128 96 - 128	05/07→11/09 09/09→08/15 10/09→08/15 05/07→11/09 05/07→11/09 05/07→11/09		+PR 1AT; → 7H-A-050000		03.0655-0006.2	370006	ATE
 Hauptbremszylinder								
1.9 TDI	63 - 77	05/07→11/09		→ 7H-A-050000		03.2126-3014.3	010811	ATE Ø 27
				7H-6-000001→ 7H-6-200000; für Rechtslenker; +PR 1AT		03.2126-3014.3	010811	ATE Ø 27
				7H-A-200001→		03.2126-3144.3	010941	ATE Ø 27
2.0 TDI 2.0 TDI 4motion	62 - 132 100 - 132	09/09→08/15 10/09→08/15		→ 7H-A-050000 7H-A-200001→		03.2126-3014.3	010811	ATE Ø 27
						03.2126-3144.3	010941	ATE Ø 27















	kW					! #		
VW - CALIFORNIA T5 Camper (7EC, 7EF, 7EG, 7HF) 04/03→08/15								
 Hauptbremszylinder								
2.5 TDi	120	05/07→11/09		→ 7H-A-050000		03.2126-3014.3	010811	ATE Ø 27
2.5 TDI	96 - 128	05/07→11/09		7H-A-200001→		03.2126-3144.3	010941	ATE Ø 27
2.5 TDI 4motion	96 - 128	05/07→11/09						
2.0 TDI	84	05/11→08/15				03.2126-3144.3	010941	ATE Ø 27
2.0 TSI	110 - 150	05/11→08/15						
2.0 TSI 4motion	150	07/11→08/15						
VW - CC B7 (358) 11/11→12/16								
 Bremskraftverstärker								
1.4 TSI	110 - 118	11/11→12/16		+PR 1ZG; für Linkslenker		03.7873-4402.4	300292	ATE Ø 11" pneumatisch
1.4 TSI MultiFuel	118	11/11→12/16		+PR 1LA / 1LB / 1ZM; für Linkslenker		03.7873-4502.4	300284	ATE Ø 11" pneumatisch
1.8 TSI	112 - 118	11/11→12/16						
2.0 TDI	100 - 135	11/11→12/16						
2.0 TDI 4motion	103 - 130	11/11→12/16						
2.0 TFSI	147	11/11→12/16						
2.0 TSI	155	11/11→12/16						
3.6 FSI 4motion	220	11/11→12/16						
 Hauptbremszylinder								
1.4 TSI	110 - 118	11/11→12/16		für Linkslenker; +PR 1ZG		03.4152-0116.3	010814	ATE Ø 22,2
1.4 TSI MultiFuel	118	11/11→12/16		für Linkslenker; +PR 1LA / 1LB / 1ZM		03.4153-0186.3	010816	ATE Ø 23,8
1.8 TSI	112 - 118	11/11→12/16		für Rechtslenker; +PR 1LA / 1LB / 1ZM		24.4153-0192.3	011026	ATE Ø 23,8 ohne Bremsflüssigkeitsbehälter
2.0 TDI	100 - 135	11/11→12/16						
2.0 TDI 4motion	103 - 130	11/11→12/16						
2.0 TFSI	147	11/11→12/16						
2.0 TSI	155	11/11→12/16						
3.6 FSI 4motion	220	11/11→12/16						
Drucksensor, Bremskraftverstärker								
3.6 FSI 4motion	220	11/11→12/16		+PR 1ZG; für Rechtslenker		03.0655-0101.2	370008	ATE
VW - CRAFTER 30-35 Bus (2E_) 04/06→12/16								
 Hauptbremszylinder								
2.0 TDI	80 - 100	05/11→12/16		07/11→		24.2126-1704.3	010990	TRW Ø 27
2.0 TDI	84 - 120	07/11→12/16				24.2126-1704.3	010990	TRW Ø 27
2.0 TDI 4motion	120	11/11→12/16						
2.5 TDI	65 - 120	04/06→05/13		→ 06/11; +PR 0WC / 0WL / 5EV / 5EX		24.2125-1750.3	011050	Ø 25,4 ohne Bremsflüssigkeitsbehälter
				07/11→		24.2126-1704.3	010990	TRW Ø 27
VW - CRAFTER 30-50 Kasten (2E_) 04/06→12/16								
 Hauptbremszylinder								
2.0 TDI	80 - 100	05/11→12/16		07/11→		24.2126-1704.3	010990	TRW Ø 27
2.0 TDI	84 - 120	07/11→12/16				24.2126-1704.3	010990	TRW Ø 27
2.0 TDI 4motion	120	07/11→12/16						
2.5 TDI	65 - 120	04/06→05/13		→ 06/11; +PR 0WC / 0WL / 5EV / 5EX		24.2125-1750.3	011050	Ø 25,4 ohne Bremsflüssigkeitsbehälter
				07/11→		24.2126-1704.3	010990	TRW Ø 27
VW - CRAFTER 30-50 Pritsche/Fahrgestell (2F_) 04/06→12/16								
 Hauptbremszylinder								
2.0 TDI	80 - 100	05/11→12/16		07/11→		24.2126-1704.3	010990	TRW Ø 27
2.0 TDI	84 - 120	07/11→12/16				24.2126-1704.3	010990	TRW Ø 27
2.0 TDI 4motion	120	11/11→12/16						
2.5 TDI	65 - 120	04/06→05/13		→ 06/11; +PR 0WC / 0WL / 5EV / 5EX		24.2125-1750.3	011050	Ø 25,4 ohne Bremsflüssigkeitsbehälter
				07/11→		24.2126-1704.3	010990	TRW Ø 27

	kw					! #		
VW - EOS (1F7, 1F8) 03/06→08/15								
 Bremskraftverstärker								
1.4 TSI	90 - 118	11/07→08/15		für Linkslenker		03.7863-3332.4	300308	ATE Ø 10" pneumatisch
1.6 FSI	85	06/06→05/08						
2.0 TDI	100 - 103	06/06→08/15						
2.0 TDI 16V	103	05/08→08/15						
2.0 FSI	110	03/06→05/08		05/06→; für Linkslenker; +PR 1ZD		03.7863-3232.4	300307	ATE Ø 10" pneumatisch
2.0 TFSI	147	03/06→08/15		05/06→; für Linkslenker; +PR 1ZA / 1ZE / 1LJ		03.7863-3332.4	300308	ATE Ø 10" pneumatisch
2.0 TSI	155	11/09→08/15		für Linkslenker; +PR 1ZD		03.7863-3232.4	300307	ATE Ø 10" pneumatisch
3.2 V6	184	06/06→05/09		für Linkslenker; +PR 1ZA / 1ZE / 1LJ		03.7863-3332.4	300308	ATE Ø 10" pneumatisch
3.6 V6	191	05/09→11/10		für Linkslenker; +PR 1ZD		03.7863-3232.4	300307	ATE Ø 10" pneumatisch
				+PR 1LK; für Linkslenker		03.7863-3332.4	300308	ATE Ø 10" pneumatisch
 Hauptbremszylinder								
1.4 TSI	90 - 118	11/07→08/15		für Linkslenker; +PR 1AT / 1ZD		03.2122-2129.3	010799	ATE Ø 22,2
1.6 FSI	85	06/06→05/08		für Linkslenker; +PR 1ZA / 1ZE / 1LJ / 1LK		03.2123-3449.3	010808	ATE Ø 23,8
2.0 TDI	100 - 103	06/06→08/15		für Rechtslenker; +PR 1ZD		24.4152-0132.3	011025	ATE Ø 22,2 ohne Bremsflüssigkeitsbehälter
2.0 TDI 16V	103	05/08→08/15						
2.0 TSI	155	11/09→08/15		für Rechtslenker; +PR 1ZA / 1ZE / 1LJ		24.4153-0202.3	011027	ATE Ø 23,8 ohne Bremsflüssigkeitsbehälter
3.2 V6	184	06/06→05/09						
3.6 V6	191	05/09→11/10						
2.0 FSI	110	03/06→05/08		05/06→; für Linkslenker; +PR 1AT / 1ZD		03.2122-2129.3	010799	ATE Ø 22,2
2.0 TFSI	147	03/06→08/15		05/06→; für Linkslenker; +PR 1ZA / 1ZE / 1LJ / 1LK		03.2123-3449.3	010808	ATE Ø 23,8
				05/06→; für Rechtslenker; +PR 1ZD		24.4152-0132.3	011025	ATE Ø 22,2 ohne Bremsflüssigkeitsbehälter
				05/06→; für Rechtslenker; +PR 1ZA / 1ZE / 1LJ		24.4153-0202.3	011027	ATE Ø 23,8 ohne Bremsflüssigkeitsbehälter
Hydraulikaggregat, Bremsanlage								
1.4 TSI	90 - 118	11/07→08/15		→ 12/08		24.9145-0001.2	399005	
2.0 TDI 16V	103	05/08→08/15						
3.2 V6	184	06/06→05/09						
1.6 FSI	85	06/06→05/08				24.9145-0001.2	399005	
2.0 TDI	103	06/06→05/08						
2.0 FSI	110	03/06→05/08		05/06→		24.9145-0001.2	399005	
2.0 TFSI	147	03/06→08/15		05/06→ 12/08		24.9145-0001.2	399005	
VW - FOX Schrägheck (5Z1, 5Z3, 5Z4) 08/03→10/15								
 Hauptbremszylinder								
1.2	40	04/05→07/11		+PR 1ZN; - ABS		24.2119-1712.3	010912	Ø 19 ohne Bremsflüssigkeitsbehälter
1.4	55	04/05→12/09						
1.4 TDI	51	04/05→12/09		+PR 1ZF / 1AC / 1AT; + ABS		24.2120-1734.3	010702	Ø 20,6
				+PR 1ZN; + ABS		24.2120-1734.3	010702	Ø 20,6
1.2	44	09/10→12/11		→ 08/11; +PR 1ZN; - ABS		24.2119-1712.3	010912	Ø 19 ohne Bremsflüssigkeitsbehälter
1.6	74	10/03→08/14						
1.6 Total Flex	74	10/03→08/14		→ 08/11; +PR 1ZF / 1AC / 1AT; + ABS		24.2120-1734.3	010702	Ø 20,6
				→ 08/11; +PR 1ZN; + ABS		24.2120-1734.3	010702	Ø 20,6
VW - FOX Van (5Z1) 09/10→12/11								
 Hauptbremszylinder								
1.2	44	09/10→12/11		→ 08/11; +PR 1ZN; - ABS		24.2119-1712.3	010912	Ø 19 ohne Bremsflüssigkeitsbehälter
				→ 08/11; +PR 1ZF / 1AC / 1AT; + ABS		24.2120-1734.3	010702	Ø 20,6
				→ 08/11; +PR 1ZN; + ABS		24.2120-1734.3	010702	Ø 20,6
VW - GOLF III (1H1) 10/89→07/98								
 Bremskraftverstärker								
1.4	40	11/91→08/97		für Linkslenker; - ABS		03.7750-5502.4	300081	ATE Ø 9" pneumatisch
1.6	55 - 74	09/92→08/97		1H-S-088705→; für Linkslenker; + ABS		10.6360-2002.4	300143	ATE Ø 10" pneumatisch
1.8	55 - 66	11/91→08/97						
1.8 Syncro	66	01/93→08/97						
1.9 TD	55	11/91→08/97						
GTD	55	11/91→08/97						
2.0 GTI 16V	110	08/92→08/97						
→								

	kw			 	! #		
VW - GOLF III (1H1) 10/89→07/98							
Bremskraftverstärker							
2.8 VR6	128	01/92→08/97		für Linkslenker; - ABS	03.7750-5502.4	300081	ATE Ø 9" pneumatisch
				1H-S-088705→; für Linkslenker; + ABS	10.6360-2002.4	300143	ATE Ø 10" pneumatisch
1.4	44	10/91→08/97		11/91→; für Linkslenker; - ABS	03.7750-5502.4	300081	ATE Ø 9" pneumatisch
				1H-S-088705→; für Linkslenker; + ABS	10.6360-2002.4	300143	ATE Ø 10" pneumatisch
1.9 D	47	11/91→08/97		für Linkslenker; - ABS	03.7750-5502.4	300081	ATE Ø 9" pneumatisch
				08/93→ 07/95; für Linkslenker; - ABS	03.7750-5502.4	300081	ATE Ø 9" pneumatisch
				1H-S-088705→; für Linkslenker; + ABS	10.6360-2002.4	300143	ATE Ø 10" pneumatisch
				1H-S-088705→; → 07/95; für Linkslenker; + ABS	10.6360-2002.4	300143	ATE Ø 10" pneumatisch
1.9 SDI	47	07/95→08/97		für Linkslenker; - ABS	03.7750-5502.4	300081	ATE Ø 9" pneumatisch
1.9 TDI	81	04/96→08/97		für Linkslenker; + ABS	10.6360-2002.4	300143	ATE Ø 10" pneumatisch
1.9 TDI Syncro	66	08/95→08/97					
2.0	85	11/91→08/97					
2.0 Syncro	85	08/95→08/97					
1.9 TDI	66	08/93→08/97		10/93→; für Linkslenker; - ABS	03.7750-5502.4	300081	ATE Ø 9" pneumatisch
				1H-S-088705→; für Linkslenker; + ABS	10.6360-2002.4	300143	ATE Ø 10" pneumatisch
2.0 GL	79	08/95→09/97		→ 08/97; für Linkslenker; - ABS	03.7750-5502.4	300081	ATE Ø 9" pneumatisch
2.8 VR6	120	08/95→09/97		1H-S-088705→; → 08/97; für Linkslenker; + ABS	10.6360-2002.4	300143	ATE Ø 10" pneumatisch
2.9 VR6 Syncro	140	10/94→08/97		1H-S-088705→; für Linkslenker; + ABS	10.6360-2002.4	300143	ATE Ø 10" pneumatisch
Hauptbremszylinder							
1.4	40	11/91→08/97		- ABS	03.2120-3943.3	010532	ATE Ø 20,6
1.6	55	09/92→08/97		1H-S-088705→; für Linkslenker; + ABS	03.2122-1144.3	010636	ATE Ø 22,2
1.9 TD	55	11/91→08/97					
GTD	55	11/91→08/97					
1.4	44	10/91→08/97		11/91→; - ABS	03.2120-3943.3	010532	ATE Ø 20,6
				1H-S-088705→; für Linkslenker; + ABS	03.2122-1144.3	010636	ATE Ø 22,2
1.6	74	07/95→08/97		- ABS	03.2122-1042.3	010137	Ø 22,2
2.0 GTI 16V	110	08/92→08/97		1H-S-088705→; für Linkslenker; + ABS	03.2123-1424.3	010637	ATE Ø 23,8
				1H-S-088705→; für Rechtslenker; + ABS	03.2123-1484.3	010595	ATE Ø 23,8
				→ 1H-S-088704; für Linkslenker; + ABS	10.6123-0674.3	010639	ATE Ø 23,8
1.8	55-66	11/91→08/97		- ABS; nicht für Ausstattungsvariante: GT	03.2120-3943.3	010532	ATE Ø 20,6
				- ABS	03.2122-1042.3	010137	Ø 22,2
				1H-S-088705→; für Linkslenker; + ABS; nicht für Ausstattungsvariante: GT	03.2122-1144.3	010636	ATE Ø 22,2
				1H-S-088705→; für Linkslenker; + ABS	03.2123-1424.3	010637	ATE Ø 23,8
				1H-S-088705→; für Rechtslenker; + ABS	03.2123-1484.3	010595	ATE Ø 23,8
				→ 1H-S-088704; für Linkslenker; + ABS	10.6123-0674.3	010639	ATE Ø 23,8
1.8 Syncro	66	01/93→08/97		- ABS	03.2122-1042.3	010137	Ø 22,2
				1H-S-088705→; für Linkslenker; + ABS	03.2123-1424.3	010637	ATE Ø 23,8
1.9 D	47	11/91→08/97		- ABS	03.2120-3943.3	010532	ATE Ø 20,6
				08/93→ 07/95; - ABS	03.2120-3943.3	010532	ATE Ø 20,6
				1H-S-088705→; für Linkslenker; + ABS	03.2122-1144.3	010636	ATE Ø 22,2
				1H-S-088705→; → 07/95; für Linkslenker; + ABS	03.2122-1144.3	010636	ATE Ø 22,2
1.9 SDI	47	07/95→08/97		- ABS	03.2120-3943.3	010532	ATE Ø 20,6
				+ ABS	03.2122-1144.3	010636	ATE Ø 22,2
1.9 TDI	66	08/93→08/97		10/93→; - ABS	03.2122-1042.3	010137	Ø 22,2
				1H-S-088705→; für Linkslenker; + ABS	03.2123-1424.3	010637	ATE Ø 23,8
				1H-S-088705→; für Rechtslenker; + ABS	03.2123-1484.3	010595	ATE Ø 23,8
				10/93→; → 1H-S-088704; für Linkslenker; + ABS	10.6123-0674.3	010639	ATE Ø 23,8
1.9 TDI	81	04/96→08/97		- ABS	03.2122-1042.3	010137	Ø 22,2
				für Linkslenker; + ABS	03.2123-1424.3	010637	ATE Ø 23,8
				für Rechtslenker; + ABS	03.2123-1484.3	010595	ATE Ø 23,8
1.9 TDI Syncro	66	08/95→08/97		- ABS	03.2122-1042.3	010137	Ø 22,2
2.0 Syncro	85	08/95→08/97		für Linkslenker; + ABS	03.2123-1424.3	010637	ATE Ø 23,8
2.0	85	11/91→08/97		- ABS	03.2122-1042.3	010137	Ø 22,2
2.0 GL	79	08/95→09/97		→ 08/97; - ABS	03.2122-1042.3	010137	Ø 22,2
				1H-S-088705→; → 08/97; für Linkslenker; + ABS	03.2123-1424.3	010637	ATE Ø 23,8
				1H-S-088705→; → 08/97; für Rechtslenker; + ABS	03.2123-1484.3	010595	ATE Ø 23,8
				→ 1H-S-088704; für Linkslenker; + ABS	10.6123-0674.3	010639	ATE Ø 23,8
→							



	kw					! #		
VW - GOLF III (1H1) 10/89→07/98								
 Hauptbremszylinder								
2.8 VR6	120	08/95→09/97		1H-S-088705→; → 08/97; für Linkslenker; + ABS		03.2123-1424.3	010637	ATE Ø 23,8
				1H-S-088705→; → 08/97; für Rechtslenker; + ABS		03.2123-1484.3	010595	ATE Ø 23,8
				→ 1H-S-088704; für Linkslenker; + ABS		10.6123-0674.3	010639	ATE Ø 23,8
2.8 VR6	128	01/92→08/97		1H-S-088705→; für Linkslenker; + ABS		03.2123-1424.3	010637	ATE Ø 23,8
				1H-S-088705→; für Rechtslenker; + ABS		03.2123-1484.3	010595	ATE Ø 23,8
				→ 1H-S-088704; für Linkslenker; + ABS		10.6123-0674.3	010639	ATE Ø 23,8
2.9 VR6 Syncro	140	10/94→08/97		1H-S-088705→; für Linkslenker; + ABS		03.2123-1424.3	010637	ATE Ø 23,8
				→ 1H-S-088704; für Linkslenker; + ABS		10.6123-0674.3	010639	ATE Ø 23,8
Citystromer	20	11/94→08/97		+ ABS; für Linkslenker		03.2122-1144.3	010636	ATE Ø 22,2
Verschlusschraube, Hauptbremszylinder								
1.4	40	11/91→08/97		- ABS		03.3517-0101.2	390322	
1.6	55 - 74	09/92→08/97						
1.8 Syncro	66	01/93→08/97						
1.9 SDI	47	07/95→08/97						
1.9 TD	55	11/91→08/97						
GTD	55	11/91→08/97						
1.9 TDI	81	04/96→08/97						
1.9 TDI Syncro	66	08/95→08/97						
2.0	85	11/91→08/97						
2.0 GTI 16V	110	08/92→08/97						
2.0 Syncro	85	08/95→08/97						
1.4	44	10/91→08/97		11/91→; - ABS		03.3517-0101.2	390322	
1.8	55 - 66	11/91→08/97		- ABS; nicht für Ausstattungsvariante: GT		03.3517-0101.2	390322	
				- ABS		03.3517-0101.2	390322	
1.9 D	47	11/91→08/97		08/93→ 07/95; - ABS		03.3517-0101.2	390322	
				- ABS		03.3517-0101.2	390322	
1.9 TDI	66	08/93→08/97		10/93→; - ABS		03.3517-0101.2	390322	
2.0 GL	79	08/95→09/97		→ 08/97; - ABS		03.3517-0101.2	390322	
 Bremskraftregler								
1.4	40 - 44	10/91→08/97		1H-V-040001→		03.6584-0107.3	320110	ATE lastabhängig 8/4 4x
1.6	55 - 74	09/92→08/97		nicht für Ausstattungsvariante: GT		03.6584-0107.3	320110	ATE lastabhängig 8/4 4x
1.8	55 - 66	11/91→08/97						
1.9 D	47	11/91→08/97				03.6584-0107.3	320110	ATE lastabhängig 8/4 4x
				08/93→ 07/95		03.6584-0107.3	320110	ATE lastabhängig 8/4 4x
1.9 SDI	47	07/95→08/97				03.6584-0107.3	320110	ATE lastabhängig 8/4 4x
1.9 TD	55	11/91→08/97						
GTD	55	11/91→08/97						
1.9 TDI	66	08/93→08/97		10/93→		03.6584-0107.3	320110	ATE lastabhängig 8/4 4x
VW - GOLF III Cabriolet (1E7) 07/93→05/98								
 Bremskraftverstärker								
1.6	74	10/94→02/98		für Linkslenker; - ABS		03.7750-5502.4	300081	ATE Ø 9" pneumatisch
1.9 TDI	66	08/95→05/98		1E-S-021847→; für Linkslenker; + ABS		10.6360-2002.4	300143	ATE Ø 10" pneumatisch
1.8	55 - 66	07/93→05/98		09/93→; für Linkslenker; - ABS		03.7750-5502.4	300081	ATE Ø 9" pneumatisch
2.0	85	07/93→05/98		1E-S-021847→; für Linkslenker; + ABS		10.6360-2002.4	300143	ATE Ø 10" pneumatisch
1.9 TDI	81	07/96→05/98		09/96→; für Linkslenker; - ABS		03.7750-5502.4	300081	ATE Ø 9" pneumatisch
				09/96→; für Linkslenker; + ABS		10.6360-2002.4	300143	ATE Ø 10" pneumatisch
 Hauptbremszylinder								
1.6	74	10/94→02/98		- ABS		03.2122-1042.3	010137	Ø 22,2
1.9 TDI	66	08/95→05/98		1E-S-021847→; für Linkslenker; + ABS		03.2123-1424.3	010637	ATE Ø 23,8
				1E-S-021847→; für Rechtslenker; + ABS		03.2123-1484.3	010595	ATE Ø 23,8
				→ 1E-S-021846; für Linkslenker; + ABS		10.6123-0674.3	010639	ATE Ø 23,8
1.8	55 - 66	07/93→05/98		09/93→; - ABS		03.2122-1042.3	010137	Ø 22,2
2.0	85	07/93→05/98		1E-S-021847→; für Linkslenker; + ABS		03.2123-1424.3	010637	ATE Ø 23,8
				1E-S-021847→; für Rechtslenker; + ABS		03.2123-1484.3	010595	ATE Ø 23,8
				09/93→; → 1E-S-021846; für Linkslenker; + ABS		10.6123-0674.3	010639	ATE Ø 23,8
1.9 TDI	81	07/96→05/98		09/96→; - ABS		03.2122-1042.3	010137	Ø 22,2
→								

	kw					! #		
VW - GOLF III Cabriolet (1E7) 07/93→05/98								
 Hauptbremszylinder								
1.9 TDI	81	07/96→05/98		09/96→; für Linkslenker; + ABS		03.2123-1424.3	010637	ATE Ø 23,8
				09/96→; für Rechtslenker; + ABS		03.2123-1484.3	010595	ATE Ø 23,8
Verschlusschraube, Hauptbremszylinder								
1.6	74	10/94→02/98		- ABS		03.3517-0101.2	390322	
1.9 TDI	66	08/95→05/98						
1.8	55 - 66	07/93→05/98		09/93→; - ABS		03.3517-0101.2	390322	
2.0	85	07/93→05/98						
1.9 TDI	81	07/96→05/98		09/96→; - ABS		03.3517-0101.2	390322	
 Bremskraftregler								
1.6	74	10/94→02/98				03.6584-0107.3	320110	ATE lastabhängig 8/4 4x
1.9 TDI	66	08/95→05/98						
1.8	55 - 66	07/93→05/98		09/93→		03.6584-0107.3	320110	ATE lastabhängig 8/4 4x
2.0	85	07/93→05/98						
VW - GOLF III Van (1H1) 08/91→12/97								
 Bremskraftverstärker								
1.8	66	08/91→12/97		11/91→ 08/97; für Linkslenker; - ABS		03.7750-5502.4	300081	ATE Ø 9" pneumatisch
				1H-S-088705→; → 08/97; für Linkslenker; + ABS		10.6360-2002.4	300143	ATE Ø 10" pneumatisch
 Hauptbremszylinder								
1.8	66	08/91→12/97		11/91→ 08/97; - ABS; nicht für Ausstattungsvariante: GT		03.2120-3943.3	010532	ATE Ø 20,6
				1H-S-088705→; → 08/97; für Linkslenker; + ABS; nicht für Ausstattungsvariante: GT		03.2122-1144.3	010636	ATE Ø 22,2
Verschlusschraube, Hauptbremszylinder								
1.8	66	08/91→12/97		11/91→ 08/97; - ABS; nicht für Ausstattungsvariante: GT		03.3517-0101.2	390322	
 Bremskraftregler								
1.8	66	08/91→12/97		11/91→ 08/97; nicht für Ausstattungsvariante: GT		03.6584-0107.3	320110	ATE lastabhängig 8/4 4x
VW - GOLF III Variant (1H5) 07/93→04/99								
 Bremskraftverstärker								
1.4	40 - 44	07/93→04/99		für Linkslenker; - ABS		03.7750-5502.4	300081	ATE Ø 9" pneumatisch
1.6	74	07/94→04/99		1H-SW385335→; für Linkslenker; + ABS		10.6360-2002.4	300143	ATE Ø 10" pneumatisch
1.8	55 - 66	07/93→04/99						
1.8 Syncro	66	10/94→04/99						
1.9 D	47	07/93→04/99						
1.9 TD	55	07/93→04/99						
1.9 TDI	66	03/94→04/99						
1.9 TDI Syncro	66	07/95→04/99						
2.0	85	07/93→04/99						
2.0 Syncro	85	08/95→04/99						
1.9 SDI	47	07/95→04/99		für Linkslenker; - ABS		03.7750-5502.4	300081	ATE Ø 9" pneumatisch
1.9 TDI	81	04/96→04/99		für Linkslenker; + ABS		10.6360-2002.4	300143	ATE Ø 10" pneumatisch
2.9 VR6 Syncro	140	10/94→04/99		1H-SW385335→; für Linkslenker; + ABS		10.6360-2002.4	300143	ATE Ø 10" pneumatisch
 Hauptbremszylinder								
1.4	40 - 44	07/93→04/99		- ABS		03.2120-3943.3	010532	ATE Ø 20,6
				1H-SW385335→; für Linkslenker; + ABS		03.2122-1144.3	010636	ATE Ø 22,2
1.6	74	07/94→04/99		- ABS		03.2122-1042.3	010137	Ø 22,2
1.8	55 - 66	07/93→04/99		1H-SW385335→; für Linkslenker; + ABS		03.2123-1424.3	010637	ATE Ø 23,8
1.9 TDI	66	03/94→04/99		1H-SW385335→; für Rechtslenker; + ABS		03.2123-1484.3	010595	ATE Ø 23,8
2.0	85	07/93→04/99		→ 1H-SW385334; für Linkslenker; + ABS		10.6123-0674.3	010639	ATE Ø 23,8
1.8 Syncro	66	10/94→04/99		- ABS		03.2122-1042.3	010137	Ø 22,2
1.9 TDI Syncro	66	07/95→04/99						
2.0 Syncro	85	08/95→04/99		1H-SW385335→; für Linkslenker; + ABS		03.2123-1424.3	010637	ATE Ø 23,8
1.9 D	47	07/93→04/99		- ABS		03.2122-1042.3	010137	Ø 22,2
1.9 TD	55	07/93→04/99		1H-SW385335→; für Linkslenker; + ABS		03.2122-1144.3	010636	ATE Ø 22,2
1.9 SDI	47	07/95→04/99		- ABS		03.2122-1042.3	010137	Ø 22,2
→								

VW - GOLF III Variant (1H5) 07/93→04/99

Hauptbremszylinder

1.9 SDI	47	07/95→04/99		für Linkslenker; + ABS		03.2122-1144.3 010636	ATE Ø 22,2
1.9 TDI	81	04/96→04/99		- ABS		03.2122-1042.3 010137	Ø 22,2
				für Linkslenker; + ABS		03.2123-1424.3 010637	ATE Ø 23,8
				für Rechtslenker; + ABS		03.2123-1484.3 010595	ATE Ø 23,8
2.9 VR6 Syncro	140	10/94→04/99		1H-SW385335→; für Linkslenker; + ABS		03.2123-1424.3 010637	ATE Ø 23,8
				07/95→; → 1H-SW385334; für Linkslenker; + ABS		10.6123-0674.3 010639	ATE Ø 23,8

Verschlusschraube, Hauptbremszylinder

1.4	40 - 44	07/93→04/99		- ABS	2	03.3517-0101.2 390322	
1.6	74	07/94→04/99		- ABS		03.3517-0101.2 390322	
1.8	55 - 66	07/93→04/99					
1.8 Syncro	66	10/94→04/99					
1.9 D	47	07/93→04/99					
1.9 SDI	47	07/95→04/99					
1.9 TD	55	07/93→04/99					
1.9 TDI	66 - 81	03/94→04/99					
1.9 TDI Syncro	66	07/95→04/99					
2.0	85	07/93→04/99					
2.0 Syncro	85	08/95→04/99					







Bremskraftregler











1.4	40 - 44	07/93→04/99				03.6584-0107.3 320110	ATE lastabhängig 8/4 4x
1.6	74	07/94→04/99					
1.8	55 - 66	07/93→04/99					
1.9 D	47	07/93→04/99					
1.9 SDI	47	07/95→04/99					
1.9 TD	55	07/93→04/99					
1.9 TDI	66 - 81	03/94→04/99					
2.0	85	07/93→04/99					













VW - GOLF IV (1J1) 08/97→04/08

Bremskraftverstärker

1.4 16V	55	10/97→05/04		09/00→ 10/01; für Linkslenker; +PR 1AT		03.7860-0602.4 300141	ATE Ø 10" pneumatisch
1.6	75	08/00→06/05		→ 08/00; für Linkslenker; +PR 1AT		03.7863-0402.4 300124	ATE Ø 10" pneumatisch
1.6 16V	77	02/00→06/05		11/01→ 10/03; für Linkslenker; +PR 1AT		03.7863-3502.4 300128	ATE Ø 10" pneumatisch
1.6	74	08/97→05/04		09/00→ 10/01; für Linkslenker; +PR 1AT		03.7860-0602.4 300141	ATE Ø 10" pneumatisch
1.8	92	08/97→06/05		10/97→ 08/00; für Linkslenker; +PR 1AT		03.7863-0402.4 300124	ATE Ø 10" pneumatisch
1.9 SDI	50	08/97→06/05					
1.9 TDI	81	08/97→05/04		11/01→ 10/03; für Linkslenker; +PR 1AT		03.7863-3502.4 300128	ATE Ø 10" pneumatisch
1.6	74	02/01→03/07		für Linkslenker; +PR 1AT		03.7863-3502.4 300128	ATE Ø 10" pneumatisch
2.0 BiFuel	85	05/02→05/03					
1.6 FSI	81	01/02→06/05		→ 10/03; für Linkslenker; +PR 1AT		03.7863-3502.4 300128	ATE Ø 10" pneumatisch
3.2 R32 4motion	177	09/02→06/05					
1.8 4motion	92	05/98→06/05		09/00→ 10/01; für Linkslenker; +PR 1AT		03.7860-0602.4 300141	ATE Ø 10" pneumatisch
				07/98→ 08/00; für Linkslenker; +PR 1AT		03.7863-0402.4 300124	ATE Ø 10" pneumatisch
				11/01→ 10/03; für Linkslenker; +PR 1AT		03.7863-3502.4 300128	ATE Ø 10" pneumatisch
1.8 T	110	08/97→06/05		09/00→; für Linkslenker; +PR 1AT		03.7860-0602.4 300141	ATE Ø 10" pneumatisch
2.3 V5	110	08/97→10/00		10/97→ 08/00; für Linkslenker; +PR 1AT		03.7863-0402.4 300124	ATE Ø 10" pneumatisch
1.8 T GTI	132	08/01→06/05		→ 10/01; für Linkslenker; +PR 1AT		03.7860-0602.4 300141	ATE Ø 10" pneumatisch
2.0 4motion	85	10/00→06/05		11/01→ 10/03; für Linkslenker; +PR 1AT		03.7863-3502.4 300128	ATE Ø 10" pneumatisch
1.9 TDI	66	10/97→05/04		09/00→ 06/01; für Linkslenker; +PR 1AT		03.7860-0602.4 300141	ATE Ø 10" pneumatisch
1.9 TDI 4motion	66	07/98→04/02		→ 08/00; für Linkslenker; +PR 1AT		03.7863-0402.4 300124	ATE Ø 10" pneumatisch
1.9 TDI	74	09/00→06/05		→ 10/01; für Linkslenker; +PR 1AT		03.7860-0602.4 300141	ATE Ø 10" pneumatisch
1.9 TDI 4motion	74	09/00→06/05		11/01→; für Linkslenker; +PR 1AT		03.7863-3502.4 300128	ATE Ø 10" pneumatisch
1.9 TDI	85	12/98→06/01		09/00→; für Linkslenker; +PR 1AT		03.7860-0602.4 300141	ATE Ø 10" pneumatisch
				05/99→ 08/00; für Linkslenker; +PR 1AT		03.7863-0402.4 300124	ATE Ø 10" pneumatisch
1.9 TDI	96	11/00→06/05		04/01→ 10/01; für Linkslenker; +PR 1AT		03.7860-0602.4 300141	ATE Ø 10" pneumatisch
1.9 TDI 4motion	96	11/00→06/05		11/01→ 10/03; für Linkslenker; +PR 1AT		03.7863-3502.4 300128	ATE Ø 10" pneumatisch
1.9 TDI	110	05/00→06/05		09/00→ 10/01; für Linkslenker; +PR 1AT		03.7860-0602.4 300141	ATE Ø 10" pneumatisch
1.9 TDI 4motion	110	02/00→06/05		11/01→ 10/03; für Linkslenker; +PR 1AT		03.7863-3502.4 300128	ATE Ø 10" pneumatisch
1.9 TDI 4motion	85	09/99→06/01		09/00→; für Linkslenker; +PR 1AT		03.7860-0602.4 300141	ATE Ø 10" pneumatisch
				11/99→ 08/00; für Linkslenker; +PR 1AT		03.7863-0402.4 300124	ATE Ø 10" pneumatisch
2.0	85	07/98→05/04		09/00→ 10/01; für Linkslenker; +PR 1AT		03.7860-0602.4 300141	ATE Ø 10" pneumatisch
→							

	kw			 	! #		
VW - GOLF IV (1J1) 08/97→04/08							
Bremskraftverstärker							
2.0	85	07/98→05/04		08/98→ 08/00; für Linkslenker; +PR 1AT	03.7863-0402.4	300124	ATE Ø 10" pneumatisch
				11/01→ 10/03; für Linkslenker; +PR 1AT	03.7863-3502.4	300128	ATE Ø 10" pneumatisch
2.3 V5	125	10/00→06/05		→ 10/03; für Linkslenker; +PR 1AT	03.7860-0602.4	300141	ATE Ø 10" pneumatisch
2.3 V5 4motion	125	10/00→06/05		11/01→ 10/03; für Linkslenker; +PR 1AT	03.7863-3502.4	300128	ATE Ø 10" pneumatisch
2.3 V5 4motion	110	12/98→10/00		09/00→; für Linkslenker; +PR 1AT	03.7860-0602.4	300141	ATE Ø 10" pneumatisch
				→ 08/00; für Linkslenker; +PR 1AT	03.7863-0402.4	300124	ATE Ø 10" pneumatisch
2.8 VR6	147	03/02→06/05		für Linkslenker; +PR 1AT	03.7860-0602.4	300141	ATE Ø 10" pneumatisch
					03.7863-3502.4	300128	ATE Ø 10" pneumatisch
2.8 VR6 4motion	150	03/99→06/05		09/00→ 10/03; für Linkslenker; +PR 1AT	03.7860-0602.4	300141	ATE Ø 10" pneumatisch
				→ 08/00; für Linkslenker; +PR 1AT	03.7863-0402.4	300124	ATE Ø 10" pneumatisch
				11/01→ 10/03; für Linkslenker; +PR 1AT	03.7863-3502.4	300128	ATE Ø 10" pneumatisch
Hauptbremszylinder							
1.4 16V	55	10/97→05/04		→ 08/00; für Linkslenker; +PR 1AT	03.2123-2024.3	010597	ATE Ø 23,8
1.6	75	08/00→06/05		→ 08/00; für Rechtslenker; +PR 1AT	03.2123-2064.3	010598	ATE Ø 23,8
1.6 16V	77	02/00→06/05		09/00→ 10/03; für Linkslenker; +PR 1AT	03.2123-2715.3	010802	ATE Ø 23,8
2.8 VR6 4motion	150	03/99→06/05		09/00→ 10/03; für Rechtslenker; +PR 1AT	03.2123-2774.3	010803	ATE Ø 23,8
				→ 10/03; für Linkslenker; +PR 1AM / 1AC / 1AH / 1AJ	24.2123-1709.3	010503	Ø 23,8
1.6	74	08/97→05/04		10/97→ 08/00; für Linkslenker; +PR 1AT	03.2123-2024.3	010597	ATE Ø 23,8
1.8	92	08/97→06/05		10/97→ 08/00; für Rechtslenker; +PR 1AT	03.2123-2064.3	010598	ATE Ø 23,8
1.9 SDI	50	08/97→06/05		09/00→ 10/03; für Linkslenker; +PR 1AT	03.2123-2715.3	010802	ATE Ø 23,8
1.9 TDI	81	08/97→05/04		09/00→ 10/03; für Rechtslenker; +PR 1AT	03.2123-2774.3	010803	ATE Ø 23,8
				10/97→ 10/03; für Linkslenker; +PR 1AM / 1AC / 1AH / 1AJ	24.2123-1709.3	010503	Ø 23,8
1.6	74	02/01→03/07		für Linkslenker; +PR 1AT	03.2123-2715.3	010802	ATE Ø 23,8
1.9 TDI	74	09/00→06/05		für Rechtslenker; +PR 1AT	03.2123-2774.3	010803	ATE Ø 23,8
1.9 TDI 4motion	74	09/00→06/05		für Linkslenker; +PR 1AM / 1AC / 1AH / 1AJ	24.2123-1709.3	010503	Ø 23,8
2.0 BiFuel	85	05/02→05/03					
2.8 VR6	147	03/02→06/05					
1.6 FSI	81	01/02→06/05		→ 10/03; für Linkslenker; +PR 1AT	03.2123-2715.3	010802	ATE Ø 23,8
1.8 T GTI	132	08/01→06/05		→ 10/03; für Rechtslenker; +PR 1AT	03.2123-2774.3	010803	ATE Ø 23,8
2.0 4motion	85	10/00→06/05		→ 10/03; für Linkslenker; +PR 1AM / 1AC / 1AH / 1AJ	24.2123-1709.3	010503	Ø 23,8
2.3 V5	125	10/00→06/05					
2.3 V5 4motion	125	10/00→06/05					
3.2 R32 4motion	177	09/02→06/05					
1.8 4motion	92	05/98→06/05		07/98→ 08/00; für Linkslenker; +PR 1AT	03.2123-2024.3	010597	ATE Ø 23,8
				07/98→ 08/00; für Rechtslenker; +PR 1AT	03.2123-2064.3	010598	ATE Ø 23,8
				09/00→ 10/03; für Linkslenker; +PR 1AT	03.2123-2715.3	010802	ATE Ø 23,8
				09/00→ 10/03; für Rechtslenker; +PR 1AT	03.2123-2774.3	010803	ATE Ø 23,8
				07/98→ 10/03; für Linkslenker; +PR 1AM / 1AC / 1AH / 1AJ	24.2123-1709.3	010503	Ø 23,8
1.8 T	110	08/97→06/05		10/97→ 08/00; für Linkslenker; +PR 1AT	03.2123-2024.3	010597	ATE Ø 23,8
2.3 V5	110	08/97→10/00		10/97→ 08/00; für Rechtslenker; +PR 1AT	03.2123-2064.3	010598	ATE Ø 23,8
				09/00→; für Linkslenker; +PR 1AT	03.2123-2715.3	010802	ATE Ø 23,8
				09/00→; für Rechtslenker; +PR 1AT	03.2123-2774.3	010803	ATE Ø 23,8
				10/97→; für Linkslenker; +PR 1AM / 1AC / 1AH / 1AJ	24.2123-1709.3	010503	Ø 23,8
1.9 TDI	66	10/97→05/04		→ 08/00; für Linkslenker; +PR 1AT	03.2123-2024.3	010597	ATE Ø 23,8
				→ 08/00; für Rechtslenker; +PR 1AT	03.2123-2064.3	010598	ATE Ø 23,8
				09/00→ 04/02; für Linkslenker; +PR 1AT	03.2123-2715.3	010802	ATE Ø 23,8
				09/00→ 06/01; für Rechtslenker; +PR 1AT	03.2123-2774.3	010803	ATE Ø 23,8
				→ 06/01; für Linkslenker; +PR 1AM / 1AC / 1AH / 1AJ	24.2123-1709.3	010503	Ø 23,8
1.9 TDI	85	12/98→06/01		05/99→ 08/00; für Linkslenker; +PR 1AT	03.2123-2024.3	010597	ATE Ø 23,8
				05/99→ 08/00; für Rechtslenker; +PR 1AT	03.2123-2064.3	010598	ATE Ø 23,8
				09/00→; für Linkslenker; +PR 1AT	03.2123-2715.3	010802	ATE Ø 23,8
				09/00→; für Rechtslenker; +PR 1AT	03.2123-2774.3	010803	ATE Ø 23,8
				05/99→; für Linkslenker; +PR 1AM / 1AC / 1AH / 1AJ	24.2123-1709.3	010503	Ø 23,8
1.9 TDI	96	11/00→06/05		04/01→ 10/03; für Linkslenker; +PR 1AT	03.2123-2715.3	010802	ATE Ø 23,8
→							

	kw					! #		
VW - GOLF IV (1J1) 08/97→04/08								
 Hauptbremszylinder								
1.9 TDI 4motion	96	11/00→06/05		04/01→ 10/03; für Rechtslenker; +PR 1AT	03.2123-2774.3	010803	ATE Ø 23,8	
				04/01→ 10/03; für Linkslenker; +PR 1AM / 1AC / 1AH / 1AJ	24.2123-1709.3	010503	Ø 23,8	
1.9 TDI 1.9 TDI 4motion	110	05/00→06/05		09/00→ 10/03; für Linkslenker; +PR 1AT	03.2123-2715.3	010802	ATE Ø 23,8	
	110	02/00→06/05		09/00→ 10/03; für Rechtslenker; +PR 1AT	03.2123-2774.3	010803	ATE Ø 23,8	
1.9 TDI 4motion	66	07/98→04/02		→ 08/00; für Linkslenker; +PR 1AT	03.2123-2024.3	010597	ATE Ø 23,8	
				→ 08/00; für Rechtslenker; +PR 1AT	03.2123-2064.3	010598	ATE Ø 23,8	
				09/00→ 06/01; für Linkslenker; +PR 1AT	03.2123-2715.3	010802	ATE Ø 23,8	
				09/00→ 06/01; für Rechtslenker; +PR 1AT	03.2123-2774.3	010803	ATE Ø 23,8	
				→ 06/01; für Linkslenker; +PR 1AM / 1AC / 1AH / 1AJ	24.2123-1709.3	010503	Ø 23,8	
1.9 TDI 4motion	85	09/99→06/01		11/99→ 08/00; für Linkslenker; +PR 1AT	03.2123-2024.3	010597	ATE Ø 23,8	
				11/99→ 08/00; für Rechtslenker; +PR 1AT	03.2123-2064.3	010598	ATE Ø 23,8	
				09/00→; für Linkslenker; +PR 1AT	03.2123-2715.3	010802	ATE Ø 23,8	
				09/00→; für Rechtslenker; +PR 1AT	03.2123-2774.3	010803	ATE Ø 23,8	
				11/99→; für Linkslenker; +PR 1AM / 1AC / 1AH / 1AJ	24.2123-1709.3	010503	Ø 23,8	
2.0	85	07/98→05/04		08/98→ 08/00; für Linkslenker; +PR 1AT	03.2123-2024.3	010597	ATE Ø 23,8	
				08/98→ 08/00; für Rechtslenker; +PR 1AT	03.2123-2064.3	010598	ATE Ø 23,8	
				09/00→ 10/03; für Linkslenker; +PR 1AT	03.2123-2715.3	010802	ATE Ø 23,8	
				09/00→ 10/03; für Rechtslenker; +PR 1AT	03.2123-2774.3	010803	ATE Ø 23,8	
				08/98→ 10/03; für Linkslenker; +PR 1AM / 1AC / 1AH / 1AJ	24.2123-1709.3	010503	Ø 23,8	
2.3 V5 4motion	110	12/98→10/00		→ 08/00; für Linkslenker; +PR 1AT	03.2123-2024.3	010597	ATE Ø 23,8	
				→ 08/00; für Rechtslenker; +PR 1AT	03.2123-2064.3	010598	ATE Ø 23,8	
				09/00→; für Linkslenker; +PR 1AT	03.2123-2715.3	010802	ATE Ø 23,8	
				09/00→; für Rechtslenker; +PR 1AT	03.2123-2774.3	010803	ATE Ø 23,8	
				für Linkslenker; +PR 1AM / 1AC / 1AH / 1AJ	24.2123-1709.3	010503	Ø 23,8	
VW - GOLF IV (9B3) 03/06→								
 Bremskraftverstärker								
1.6 1.6 Total Flex	74	03/07→12/10		1K-9-400001→; → 11/10; +PR 1ZK; für Linkslenker	03.7860-8802.4	300291	ATE Ø 10" pneumatisch	
	74 - 77	03/07→06/14		+PR 1ZD / 1ZF / 1ZP / 1LV; für Linkslenker	03.7863-3232.4	300307	ATE Ø 10" pneumatisch	
1.8 GTI 2.0	132	01/07→12/10		1K-9-400001→; → 11/10; +PR 1ZA / 1ZB / 1ZE / 1LJ; für Linkslenker	03.7863-3332.4	300308	ATE Ø 10" pneumatisch	
	85	01/07→12/10		→ 1K-9-200000; +PR 1LJ / 1LL / 1LM; für Linkslenker	03.7863-3332.4	300308	ATE Ø 10" pneumatisch	
1.8 GTI	142	04/07→12/09		1K-9-400001→; +PR 1ZK; für Linkslenker	03.7860-8802.4	300291	ATE Ø 10" pneumatisch	
				+PR 1ZD / 1ZF / 1ZP / 1LV; für Linkslenker	03.7863-3232.4	300307	ATE Ø 10" pneumatisch	
				1K-9-400001→; +PR 1ZA / 1ZB / 1ZE / 1LJ; für Linkslenker	03.7863-3332.4	300308	ATE Ø 10" pneumatisch	
				→ 1K-9-200000; +PR 1LJ / 1LL / 1LM; für Linkslenker	03.7863-3332.4	300308	ATE Ø 10" pneumatisch	
 Hauptbremszylinder								
1.6 1.6 Total Flex	74	03/07→12/10		+PR 1ZD / 1ZF / 1ZP / 1LV; für Linkslenker	03.2122-2129.3	010799	ATE Ø 22,2	
	74 - 77	03/07→06/14		+PR 1ZA / 1ZB / 1ZE / 1LJ; für Linkslenker	03.2123-3449.3	010808	ATE Ø 23,8	
1.8 GTI 2.0	132 - 142	01/07→12/10		+PR 1ZD / 1ZF / 1ZP / 1LV; für Rechtslenker	24.4152-0132.3	011025	ATE Ø 22,2 ohne Bremsflüssigkeitsbehälter	
	85	01/07→12/10		+PR 1ZA / 1ZB / 1ZE / 1LJ; für Rechtslenker	24.4153-0202.3	011027	ATE Ø 23,8 ohne Bremsflüssigkeitsbehälter	
VW - GOLF IV Cabriolet (1E7) 06/98→12/02								
 Bremskraftverstärker								
1.6 →	74	06/98→06/02		für Linkslenker; - ABS; → 02/02	03.7750-5502.4	300081	ATE Ø 9" pneumatisch	

	kw					! #		
VW - GOLF IV Cabriolet (1E7) 06/98→12/02								
 Bremskraftverstärker								
1.8	55 - 66	06/98→06/02		1E-S-021847→; für Linkslenker; + ABS; → 02/02		10.6360-2002.4	300143	ATE Ø 10" pneumatisch
1.9 TDI	66	06/98→06/02						
2.0	85	06/98→06/02						
1.9 TDI	81	06/98→06/02		für Linkslenker; - ABS; → 02/02		03.7750-5502.4	300081	ATE Ø 9" pneumatisch
				für Linkslenker; + ABS; → 02/02		10.6360-2002.4	300143	ATE Ø 10" pneumatisch
 Hauptbremszylinder								
1.6	74	06/98→06/02		- ABS; → 02/02		03.2122-1042.3	010137	Ø 22,2
1.8	55 - 66	06/98→06/02		1E-S-021847→; für Linkslenker; + ABS; → 02/02		03.2123-1424.3	010637	ATE Ø 23,8
1.9 TDI	66	06/98→06/02						
2.0	85	06/98→06/02		1E-S-021847→; für Rechtslenker; + ABS; → 02/02		03.2123-1484.3	010595	ATE Ø 23,8
				→ 1E-S-021846; für Linkslenker; + ABS		10.6123-0674.3	010639	ATE Ø 23,8
1.9 TDI	81	06/98→06/02		- ABS; → 02/02		03.2122-1042.3	010137	Ø 22,2
				für Linkslenker; + ABS; → 02/02		03.2123-1424.3	010637	ATE Ø 23,8
				für Rechtslenker; + ABS; → 02/02		03.2123-1484.3	010595	ATE Ø 23,8
Verschlusschraube, Hauptbremszylinder								
1.6	74	06/98→06/02		- ABS; → 02/02		03.3517-0101.2	390322	
1.8	55 - 66	06/98→06/02						
1.9 TDI	66 - 81	06/98→06/02						
2.0	85	06/98→06/02						
 Bremskraftregler								
1.6	74	06/98→06/02		→ 02/02		03.6584-0107.3	320110	ATE lastabhängig 8/4 4x
1.8	55 - 66	06/98→06/02						
1.9 TDI	66	06/98→06/02						
2.0	85	06/98→06/02						
VW - GOLF IV Van (1J1) 10/97→05/04								
 Bremskraftverstärker								
1.9 TDI	66	05/00→09/02		09/00→ 06/01; für Linkslenker; +PR 1AT		03.7860-0602.4	300141	ATE Ø 10" pneumatisch
				→ 08/00; für Linkslenker; +PR 1AT		03.7863-0402.4	300124	ATE Ø 10" pneumatisch
1.9 TDI	96	04/01→05/04		→ 06/01; für Linkslenker; +PR 1AT		03.7860-0602.4	300141	ATE Ø 10" pneumatisch
				→ 10/01; für Linkslenker; +PR 1AT		03.7860-0602.4	300141	ATE Ø 10" pneumatisch
				11/01→ 10/03; für Linkslenker; +PR 1AT		03.7863-3502.4	300128	ATE Ø 10" pneumatisch
1.9 TDI 4motion	85	01/00→04/01		für Linkslenker; +PR 1AT; 09/00→		03.7860-0602.4	300141	ATE Ø 10" pneumatisch
				→ 08/00; für Linkslenker; +PR 1AT		03.7863-0402.4	300124	ATE Ø 10" pneumatisch
 Hauptbremszylinder								
1.9 TDI	66	05/00→09/02		→ 08/00; für Linkslenker; +PR 1AT		03.2123-2024.3	010597	ATE Ø 23,8
				→ 08/00; für Rechtslenker; +PR 1AT		03.2123-2064.3	010598	ATE Ø 23,8
				09/00→ 04/02; für Linkslenker; +PR 1AT		03.2123-2715.3	010802	ATE Ø 23,8
				09/00→ 06/01; für Rechtslenker; +PR 1AT		03.2123-2774.3	010803	ATE Ø 23,8
				→ 06/01; für Linkslenker; +PR 1AM / 1AC / 1AH / 1AJ		24.2123-1709.3	010503	Ø 23,8
1.9 TDI	96	04/01→05/04		→ 10/03; für Linkslenker; +PR 1AT		03.2123-2715.3	010802	ATE Ø 23,8
				→ 04/02; für Linkslenker; +PR 1AT		03.2123-2715.3	010802	ATE Ø 23,8
				→ 10/03; für Rechtslenker; +PR 1AT		03.2123-2774.3	010803	ATE Ø 23,8
				→ 06/01; für Rechtslenker; +PR 1AT		03.2123-2774.3	010803	ATE Ø 23,8
				→ 10/03; für Linkslenker; +PR 1AM / 1AC / 1AH / 1AJ		24.2123-1709.3	010503	Ø 23,8
				→ 06/01; für Linkslenker; +PR 1AM / 1AC / 1AH / 1AJ		24.2123-1709.3	010503	Ø 23,8
1.9 TDI 4motion	85	01/00→04/01		→ 08/00; für Linkslenker; +PR 1AT		03.2123-2024.3	010597	ATE Ø 23,8
				→ 08/00; für Rechtslenker; +PR 1AT		03.2123-2064.3	010598	ATE Ø 23,8
				09/00→; für Linkslenker; +PR 1AT		03.2123-2715.3	010802	ATE Ø 23,8
				09/00→; für Rechtslenker; +PR 1AT		03.2123-2774.3	010803	ATE Ø 23,8
				für Linkslenker; +PR 1AM / 1AC / 1AH / 1AJ		24.2123-1709.3	010503	Ø 23,8

VW - GOLF IV Variant (1J5) 05/99→06/06

Bremskraftverstärker

1.4 16V 1.6	55 74 - 75	05/99→06/06 05/99→06/06		09/00→; für Linkslenker; +PR 1AT; → 10/01	03.7860-0602.4	300141	ATE Ø 10" pneumatisch
1.6 16V	77	02/00→06/06		→ 08/00; für Linkslenker; +PR 1AT	03.7863-0402.4	300124	ATE Ø 10" pneumatisch
1.8 4motion	92	05/99→06/06		11/01→; für Linkslenker; +PR 1AT	03.7863-3502.4	300128	ATE Ø 10" pneumatisch
1.8 T	110	05/00→06/06					
1.9 SDI	50	05/99→06/06					
1.9 TDI	66	05/99→05/06					
1.9 TDI 4motion	66	05/99→04/02					
2.0	85	05/99→06/06					
2.3 V5	110	05/99→06/06					
2.3 V5 4motion	110	05/99→06/06					
2.8 V6 4motion	150	05/99→06/06					
1.6 FSI	81	01/02→06/06		für Linkslenker; +PR 1AT	03.7863-3502.4	300128	ATE Ø 10" pneumatisch
1.9 TDI 4motion	110	05/02→06/05					
2.0 Bi-Fuel	85	02/02→06/06					
1.9 TDI	74 - 110	09/00→06/06		für Linkslenker; +PR 1AT; → 10/01	03.7860-0602.4	300141	ATE Ø 10" pneumatisch
1.9 TDI 4motion	74	09/00→06/06		11/01→; für Linkslenker; +PR 1AT	03.7863-3502.4	300128	ATE Ø 10" pneumatisch
2.0 4motion	85	10/00→06/06					
2.3 V5	125	10/00→06/06					
2.3 V5 4motion	125	10/00→06/06					
1.9 TDI	81 - 85	05/99→06/01		09/00→; für Linkslenker; +PR 1AT	03.7860-0602.4	300141	ATE Ø 10" pneumatisch
1.9 TDI 4motion	85	12/99→04/01		→ 08/00; für Linkslenker; +PR 1AT	03.7863-0402.4	300124	ATE Ø 10" pneumatisch
1.9 TDI	96	11/00→06/06		04/01→; für Linkslenker; +PR 1AT; →	03.7860-0602.4	300141	ATE Ø 10" pneumatisch
1.9 TDI 4motion	96	11/00→06/06		10/01			
				11/01→; für Linkslenker; +PR 1AT	03.7863-3502.4	300128	ATE Ø 10" pneumatisch
2.0 4motion	88	12/99→06/06		09/00→; für Linkslenker; +PR 1AT; →	03.7860-0602.4	300141	ATE Ø 10" pneumatisch
				10/01			
				04/00→ 08/00; für Linkslenker; +PR 1AT	03.7863-0402.4	300124	ATE Ø 10" pneumatisch
				11/01→; für Linkslenker; +PR 1AT	03.7863-3502.4	300128	ATE Ø 10" pneumatisch







Hauptbremszylinder









1.4 16V 1.6	55 74 - 75	05/99→06/06 05/99→06/06		→ 08/00; für Linkslenker; +PR 1AT	03.2123-2024.3	010597	ATE Ø 23,8
1.6 16V	77	02/00→06/06		→ 08/00; für Rechtslenker; +PR 1AT	03.2123-2064.3	010598	ATE Ø 23,8
1.8 4motion	92	05/99→06/06		09/00→; für Linkslenker; +PR 1AT	03.2123-2715.3	010802	ATE Ø 23,8
1.8 T	110	05/00→06/06		09/00→; für Rechtslenker; +PR 1AT	03.2123-2774.3	010803	ATE Ø 23,8
1.9 SDI	50	05/99→06/06		für Linkslenker; +PR 1AM / 1AC / 1AH /	24.2123-1709.3	010503	Ø 23,8
1.9 TDI	66 - 85	05/99→05/06		1AJ			
1.9 TDI 4motion	66 - 85	05/99→04/02					
2.0	85	05/99→06/06					
2.3 V5	110	05/99→06/06					
2.3 V5 4motion	110	05/99→06/06					
2.8 V6 4motion	150	05/99→06/06					
1.6 FSI	81	01/02→06/06		für Linkslenker; +PR 1AT	03.2123-2715.3	010802	ATE Ø 23,8
1.9 TDI	74 - 110	09/00→06/06		für Rechtslenker; +PR 1AT	03.2123-2774.3	010803	ATE Ø 23,8
1.9 TDI 4motion	74 - 110	09/00→06/06		für Linkslenker; +PR 1AM / 1AC / 1AH /	24.2123-1709.3	010503	Ø 23,8
2.0 4motion	85	10/00→06/06		1AJ			
2.0 Bi-Fuel	85	02/02→06/06					
2.3 V5	125	10/00→06/06					
2.3 V5 4motion	125	10/00→06/06					
1.9 TDI	96	11/00→06/06		04/01→; für Linkslenker; +PR 1AT	03.2123-2715.3	010802	ATE Ø 23,8
1.9 TDI 4motion	96	11/00→06/06		04/01→; für Rechtslenker; +PR 1AT	03.2123-2774.3	010803	ATE Ø 23,8
				04/01→; für Linkslenker; +PR 1AM /	24.2123-1709.3	010503	Ø 23,8
				1AC / 1AH / 1AJ			
2.0 4motion	88	12/99→06/06		04/00→ 08/00; +PR 1AT; für Linkslenker	03.2123-2024.3	010597	ATE Ø 23,8
				04/00→ 08/00; +PR 1AT; für Rechts-	03.2123-2064.3	010598	ATE Ø 23,8
				lenker			
				09/00→; für Linkslenker; +PR 1AT	03.2123-2715.3	010802	ATE Ø 23,8
				09/00→; für Rechtslenker; +PR 1AT	03.2123-2774.3	010803	ATE Ø 23,8
				04/00→; für Linkslenker; +PR 1AM /	24.2123-1709.3	010503	Ø 23,8
				1AC / 1AH / 1AJ			











VW - GOLF V (1K1) 10/03→07/10













Bremskraftverstärker











1.4 16V 1.4 FSI 1.6 FSI 2.0	55 66 85 85	10/03→05/06 10/03→07/06 10/03→07/08 01/05→11/08		für Linkslenker; +PR 1AC / 1AT	03.7863-3232.4	300307	ATE Ø 10" pneumatisch
1.4 16V →	59	05/06→11/08		+PR 1AC / 1AT; für Linkslenker; → 09/08	03.7863-3232.4	300307	ATE Ø 10" pneumatisch









	kw			 	! #		
VW - GOLF V (1K1) 10/03→07/10							
Bremskraftverstärker							
1.4 TSI	90 - 125	11/05→11/08		+PR 1AC / 1AT; für Linkslenker; → 09/08		03.7863-3232.4 300307	ATE Ø 10" pneumatisch
1.6	75	01/04→11/08					
1.6 MultiFuel	75	10/07→11/08					
1.9 TDI	66 - 77	10/03→11/08					
1.9 TDI 4motion	77	08/04→11/08					
2.0 FSI	110	01/04→11/08					
2.0 FSI 4motion	110	08/04→11/08					
2.0 SDI	55	01/04→11/08					
2.0 TDI	100 - 125	10/03→11/08					
2.0 TDI 16V	103	10/03→11/08					
2.0 TDI 16V 4motion	103	08/04→11/08					
2.0 TDI 4motion	103	01/07→11/08					
2.5	125	05/07→11/08					
2.0 GTI	147 - 169	10/04→02/09		für Linkslenker; → 09/08; +PR 1AC / 1AT		03.7863-3332.4 300308	ATE Ø 10" pneumatisch
3.2 R32 4motion	184	11/05→11/08					
Hauptbremszylinder							
1.4 16V	55	10/03→05/06		für Linkslenker; → 1K-6W078889		03.2122-2129.3 010799	ATE Ø 22,2
1.4 FSI	66	10/03→07/06		1K-6W078890→; für Linkslenker		03.2122-2129.3 010799	ATE Ø 22,2
1.6 FSI	85	10/03→07/08		für Rechtslenker; +PR 1AC / 1AT		24.2122-1981.3 011024	ATE Ø 22,2 ohne Bremsflüssigkeitsbehälter
				für Rechtslenker; +PR 1AS		24.4152-0132.3 011025	ATE Ø 22,2 ohne Bremsflüssigkeitsbehälter
1.4 16V	59	05/06→11/08		1K-6W078890→; für Linkslenker; → 09/08		03.2122-2129.3 010799	ATE Ø 22,2
1.4 TSI	103 - 125	11/05→11/08		für Linkslenker; → 1K-6W078889		03.2122-2129.3 010799	ATE Ø 22,2
1.6	75	01/04→11/08		→ 09/08; für Rechtslenker; +PR 1AC / 1AT		24.2122-1981.3 011024	ATE Ø 22,2 ohne Bremsflüssigkeitsbehälter
1.6 MultiFuel	75	10/07→11/08		→ 09/08; für Rechtslenker; +PR 1AS		24.4152-0132.3 011025	ATE Ø 22,2 ohne Bremsflüssigkeitsbehälter
1.9 TDI	66 - 77	10/03→11/08					
1.9 TDI 4motion	77	08/04→11/08					
2.0	85	01/05→11/08					
2.0 FSI	110	01/04→11/08					
2.0 FSI 4motion	110	08/04→11/08					
2.0 SDI	55	01/04→11/08					
2.0 TDI	100 - 125	10/03→11/08					
2.0 TDI 16V	103	10/03→11/08					
2.0 TDI 16V 4motion	103	08/04→11/08					
2.0 TDI 4motion	103	01/07→11/08					
1.4 TSI	90	05/07→11/08		→ 09/08; für Linkslenker		03.2122-2129.3 010799	ATE Ø 22,2
2.5	125	05/07→11/08		→ 09/08; für Rechtslenker; +PR 1AC / 1AT		24.2122-1981.3 011024	ATE Ø 22,2 ohne Bremsflüssigkeitsbehälter
				→ 09/08; für Rechtslenker; +PR 1AS		24.4152-0132.3 011025	ATE Ø 22,2 ohne Bremsflüssigkeitsbehälter
2.0 GTI	147 - 169	10/04→02/09		1K-6W078890→; für Linkslenker; → 09/08		03.2123-3449.3 010808	ATE Ø 23,8
				für Linkslenker; → 1K-6W078889		03.2123-3449.3 010808	ATE Ø 23,8
				→ 09/08; für Rechtslenker; +PR 1AC / 1AT		24.2122-1981.3 011024	ATE Ø 22,2 ohne Bremsflüssigkeitsbehälter
				→ 09/08; für Rechtslenker; +PR 1AS		24.4152-0132.3 011025	ATE Ø 22,2 ohne Bremsflüssigkeitsbehälter
				1K-6W078890→; für Rechtslenker; → 09/08		24.4153-0202.3 011027	ATE Ø 23,8 ohne Bremsflüssigkeitsbehälter
3.2 R32 4motion	184	11/05→11/08		1K-6W078890→; für Linkslenker; → 09/08		03.2123-3449.3 010808	ATE Ø 23,8
				für Linkslenker; → 1K-6W078889		03.2123-3449.3 010808	ATE Ø 23,8
				1K-6W078890→; für Rechtslenker; → 09/08		24.4153-0202.3 011027	ATE Ø 23,8 ohne Bremsflüssigkeitsbehälter
Hydraulikaggregat, Bremsanlage							
1.4 16V	55	10/03→05/06		+PR 1AT / 1AS		24.9145-0001.2 399005	
1.4 FSI	66	10/03→07/06					
1.6 FSI	85	10/03→07/08					
1.4 16V	59	05/06→11/08		→ 09/08; +PR 1AT / 1AS		24.9145-0001.2 399005	
1.4 TSI	90 - 125	11/05→11/08					
1.6	75	01/04→11/08					
1.6 MultiFuel	75	10/07→11/08					
1.9 TDI	66 - 77	10/03→11/08					
1.9 TDI 4motion	77	08/04→11/08					
2.0	85	01/05→11/08					
→							













	kW			 	! #		
VW - GOLF V (1K1) 10/03→07/10							
Hydraulikaggregat, Bremsanlage							
2.0 FSI	110	01/04→11/08		→ 09/08; +PR 1AT / 1AS		24.9145-0001.2	399005
2.0 FSI 4motion	110	08/04→11/08					
2.0 GTI	147 - 169	10/04→02/09					
2.0 SDI	55	01/04→11/08					
2.0 TDI	100 - 125	10/03→11/08					
2.0 TDI 16V	103	10/03→11/08					
2.0 TDI 16V 4motion	103	08/04→11/08					
2.0 TDI 4motion	103	01/07→11/08					
2.5	125	05/07→11/08					
3.2 R32 4motion	184	11/05→11/08					
Drucksensor, Bremskraftverstärker							
1.4 16V	55	10/03→05/06		für Linkslenker; +PR 1AS		03.0655-0101.2	370008
1.4 FSI	66	10/03→07/06					ATE
1.6 FSI	85	10/03→07/08					
1.4 16V	59	05/06→11/08		+PR 1AS; für Linkslenker; → 09/08		03.0655-0101.2	370008
1.4 TSI	90 - 125	11/05→11/08					ATE
1.6	75	01/04→11/08					
1.6 MultiFuel	75	10/07→11/08					
1.9 TDI	66 - 77	10/03→11/08					
1.9 TDI 4motion	77	08/04→11/08					
2.0	85	01/05→11/08					
2.0 FSI	110	01/04→11/08					
2.0 FSI 4motion	110	08/04→11/08					
2.0 SDI	55	01/04→11/08					
2.0 TDI	100 - 125	10/03→11/08					
2.0 TDI 16V	103	10/03→11/08					
2.0 TDI 16V 4motion	103	08/04→11/08					
2.0 TDI 4motion	103	01/07→11/08					
2.5	125	05/07→11/08					
VW - GOLF V Variant (1K5) 01/07→07/09							
 Bremskraftverstärker							
1.4	59	06/07→07/09		→ 06/09; für Linkslenker; +PR 1AC / 1AT		03.7863-3232.4	300307
1.4 TSI	90 - 103	06/07→07/09					ATE Ø 10" pneumatisch
1.6	75	06/07→07/09					
1.6 MultiFuel	75	11/07→07/09					
1.9 TDI	77	06/07→07/09					
1.9 TDI 4motion	77	01/08→07/09					
2.0 TDI	96 - 103	06/07→07/09					
2.0 TDI 16V	103	06/07→07/09					
1.4 TSI	118 - 125	06/07→07/09		→ 06/09; für Linkslenker; +PR 1AC / 1AT		03.7863-3332.4	300308
2.0 TFSI	147	06/07→07/09					ATE Ø 10" pneumatisch
 Hauptbremszylinder							
1.4	59	06/07→07/09		→ 06/09; für Linkslenker		03.2122-2129.3	010799
				→ 06/09; für Rechtslenker		24.4152-0132.3	011025
1.4 TSI	90 - 103	06/07→07/09		→ 06/09; für Linkslenker; +PR 1AS		03.2122-2129.3	010799
1.6	75	06/07→07/09		→ 06/09; für Rechtslenker		24.4152-0132.3	011025
1.6 MultiFuel	75	11/07→07/09					ATE Ø 22,2 ohne Bremsflüssigkeitsbehälter
1.4 TSI	118	07/08→07/09		→ 06/09; für Linkslenker		03.2122-2129.3	010799
				→ 06/09; +PR 1LJ / 1LL; für Linkslenker		03.2123-3449.3	010808
				→ 06/09; für Rechtslenker		24.4152-0132.3	011025
				→ 06/09; +PR 1LJ / 1LL; für Rechtslenker		24.4153-0202.3	011027
							ATE Ø 22,2 ohne Bremsflüssigkeitsbehälter
1.4 TSI	125	06/07→07/09		→ 06/09; für Linkslenker; +PR 1AS		03.2122-2129.3	010799
				→ 06/09; +PR 1LJ / 1LL; für Linkslenker		03.2123-3449.3	010808
				→ 06/09; für Rechtslenker		24.4152-0132.3	011025
				→ 06/09; +PR 1LJ / 1LL; für Rechtslenker		24.4153-0202.3	011027
							ATE Ø 22,2 ohne Bremsflüssigkeitsbehälter
1.9 TDI	77	06/07→07/09		→ 06/09; für Linkslenker; +PR 1AC / 1AT		03.2122-2129.3	010799
1.9 TDI 4motion	77	01/08→07/09					
2.0 TDI	96 - 103	06/07→07/09		→ 06/09; für Rechtslenker		24.4152-0132.3	011025
2.0 TDI 16V	103	06/07→07/09					ATE Ø 22,2 ohne Bremsflüssigkeitsbehälter
→							







	kw					! #		
VW - GOLF V Variant (1K5) 01/07→07/09								
 Hauptbremszylinder								
2.0 TFSI	147	06/07→07/09		→ 06/09; für Linkslenker; +PR 1AC / 1AT		03.2122-2129.3	010799	ATE Ø 22,2
				→ 06/09; +PR 1LJ / 1LL; für Linkslenker		03.2123-3449.3	010808	ATE Ø 23,8
				→ 06/09; für Rechtslenker		24.4152-0132.3	011025	ATE Ø 22,2 ohne Bremsflüssigkeitsbehälter
				→ 06/09; +PR 1LJ / 1LL; für Rechtslenker		24.4153-0202.3	011027	ATE Ø 23,8 ohne Bremsflüssigkeitsbehälter
Hydraulikaggregat, Bremsanlage								
1.4	59	06/07→07/09		→ 06/09; +PR 1AT / 1AS		24.9145-0001.2	399005	
1.4 TSI	90 - 125	06/07→07/09						
1.6	75	06/07→07/09						
1.6 MultiFuel	75	11/07→07/09						
1.9 TDI	77	06/07→07/09						
1.9 TDI 4motion	77	01/08→07/09						
2.0 TDI	96 - 103	06/07→07/09						
2.0 TDI 16V	103	06/07→07/09						
2.0 TFSI	147	06/07→07/09						
Drucksensor, Bremskraftverstärker								
1.4 TSI	90 - 118	06/07→07/09		→ 06/09; für Linkslenker; +PR 1AS		03.0655-0101.2	370008	ATE
2.0 TDI	96 - 103	06/07→07/09						
2.0 TDI 16V	103	06/07→07/09						
1.4 TSI	103 - 125	06/07→07/09		→ 06/09; für Rechtslenker; +PR 1AS		03.0655-0101.2	370008	ATE
1.6	75	06/07→07/09		→ 06/09; +PR 1AS		03.0655-0101.2	370008	ATE
1.6 MultiFuel	75	11/07→07/09						
VW - GOLF VI (5K1) 10/08→12/14								
 Bremskraftverstärker								
1.2 TSI	63	05/10→11/12		1K-9-400001→; → 11/10; für Linkslenker; +PR 1ZK		03.7860-8802.4	300291	ATE Ø 10" pneumatisch
1.4	59	10/08→11/12						
1.4 TSI	90 - 118	10/08→11/12		für Linkslenker; +PR 1ZD / 1ZF / 1ZP / 1LV		03.7863-3232.4	300307	ATE Ø 10" pneumatisch
1.6	75	10/08→11/12						
1.6 BiFuel	75	03/09→11/12		1K-9-400001→; → 11/10; für Linkslenker; +PR 1ZA / 1ZB / 1ZE / 1LJ		03.7863-3332.4	300308	ATE Ø 10" pneumatisch
1.6 MultiFuel	75	10/08→11/12						
1.6 TDI	66 - 77	02/09→11/12		→ 1K-9-200000; +PR 1LJ / 1LL / 1LM; für Linkslenker		03.7863-3332.4	300308	ATE Ø 10" pneumatisch
2.0 GTi	147 - 155	04/09→11/13						
2.0 R 4motion	188 - 199	11/09→11/13						
2.0 TDI	81 - 125	10/08→05/13						
2.0 TDI 4motion	103	05/09→11/12						
2.5	125	07/09→05/13						
1.2 TSI	77	11/08→11/12		1K-9-400001→; → 11/10; für Linkslenker; +PR 1ZK		03.7860-8802.4	300291	ATE Ø 10" pneumatisch
				05/09→; für Linkslenker; +PR 1ZD / 1ZF / 1ZP / 1LV		03.7863-3232.4	300307	ATE Ø 10" pneumatisch
				05/09→; → 1K-9-200000; für Linkslenker; +PR 1LJ / 1LL / 1LM		03.7863-3332.4	300308	ATE Ø 10" pneumatisch
				1K-9-400001→; → 11/10; für Linkslenker; +PR 1ZA / 1ZB / 1ZE / 1LJ		03.7863-3332.4	300308	ATE Ø 10" pneumatisch
1.8 TSI	118	06/09→01/11		1K-9-400001→; → 11/10; für Linkslenker; +PR 1ZK		03.7860-8802.4	300291	ATE Ø 10" pneumatisch
				für Linkslenker; +PR 1ZD / 1ZF / 1ZP / 1LV		03.7863-3232.4	300307	ATE Ø 10" pneumatisch
				→ 1K-9-200000; für Linkslenker		03.7863-3332.4	300308	ATE Ø 10" pneumatisch
				1K-9-400001→; → 11/10; für Linkslenker; +PR 1ZA / 1ZB / 1ZE / 1LJ		03.7863-3332.4	300308	ATE Ø 10" pneumatisch
2.0 GTi	173	05/11→11/12		für Linkslenker; +PR 1ZD / 1ZF / 1ZP / 1LV		03.7863-3232.4	300307	ATE Ø 10" pneumatisch
2.0 TFSI 4motion	191	09/11→11/13		→ 1K-9-200000; +PR 1LJ / 1LL / 1LM; für Linkslenker		03.7863-3332.4	300308	ATE Ø 10" pneumatisch
 Hauptbremszylinder								
1.2 TSI	63	05/10→11/12		für Linkslenker; +PR 1ZD / 1ZF / 1ZP / 1LV		03.2122-2129.3	010799	ATE Ø 22,2
1.4	59	10/08→11/12						
1.4 TSI	90 - 118	10/08→11/12		+PR 1ZA / 1ZB / 1ZE / 1LJ; für Linkslenker		03.2123-3449.3	010808	ATE Ø 23,8
1.6	75	10/08→11/12						
1.6 BiFuel	75	03/09→11/12						

	kW					! #		
VW - GOLF VI (5K1) 10/08→12/14								
 Hauptbremszylinder								
1.6 MultiFuel 1.6 TDI	75 66 - 77	10/08→11/12 02/09→11/12		für Rechtslenker; +PR 1ZD / 1ZF / 1ZP / 1LV		24.4152-0132.3	011025	ATE Ø 22,2 ohne Bremsflüssigkeitsbehälter
1.8 TSI 2.0 GTI	118 147 - 173	06/09→01/11 04/09→11/13		für Rechtslenker; +PR 1ZA / 1ZB / 1ZE / 1LJ		24.4153-0202.3	011027	ATE Ø 23,8 ohne Bremsflüssigkeitsbehälter
2.0 R 4motion 2.0 TDI	188 - 199 81 - 125	11/09→11/13 10/08→05/13						
2.0 TDI 4motion 2.0 TFSI 4motion 2.5	103 191 125	05/09→11/12 09/11→11/13 07/09→05/13						
1.2 TSI	77	11/08→11/12		05/09→; für Linkslenker; +PR 1ZD / 1ZF / 1ZP / 1LV		03.2122-2129.3	010799	ATE Ø 22,2
				05/09→; für Linkslenker; +PR 1ZA / 1ZB / 1ZE / 1LJ		03.2123-3449.3	010808	ATE Ø 23,8
				05/09→; für Rechtslenker; +PR 1ZD / 1ZF / 1ZP / 1LV		24.4152-0132.3	011025	ATE Ø 22,2 ohne Bremsflüssigkeitsbehälter
				05/09→; für Rechtslenker; +PR 1ZA / 1ZB / 1ZE / 1LJ		24.4153-0202.3	011027	ATE Ø 23,8 ohne Bremsflüssigkeitsbehälter
VW - GOLF VI Cabriolet (517) 03/11→05/16								
 Bremskraftverstärker								
1.2 TSI 1.4 TSI 1.6 TDI	77 118 77	03/11→05/16 03/11→05/16 03/11→05/16		06/11→; für Linkslenker; +PR 1ZK		03.7860-8802.4	300291	ATE Ø 10" pneumatisch
				06/11→; für Linkslenker; +PR 1ZD / 1ZP / 1LV		03.7863-3232.4	300307	ATE Ø 10" pneumatisch
				06/11→; für Linkslenker; +PR 1ZA / 1ZB / 1ZE		03.7863-3332.4	300308	ATE Ø 10" pneumatisch
1.2 TSI 16V 1.4 TSI	77 90 - 110	11/13→05/16 11/11→05/16		für Linkslenker; +PR 1ZK		03.7860-8802.4	300291	ATE Ø 10" pneumatisch
				für Linkslenker; +PR 1ZD / 1ZP / 1LV		03.7863-3232.4	300307	ATE Ø 10" pneumatisch
2.0 GTI 2.0 R 2.0 TDI	155 195 81 - 110	05/12→05/16 01/13→05/16 11/11→05/16		für Linkslenker; +PR 1ZA / 1ZB / 1ZE		03.7863-3332.4	300308	ATE Ø 10" pneumatisch
2.0 TSI	162	11/13→05/16						
 Hauptbremszylinder								
1.2 TSI 1.4 TSI 1.6 TDI	77 118 77	03/11→05/16 03/11→05/16 03/11→05/16		06/11→; für Linkslenker; +PR 1ZD / 1ZP / 1LV		03.2122-2129.3	010799	ATE Ø 22,2
				06/11→; für Linkslenker; +PR 1ZA / 1ZB / 1ZE / 1ZK		03.2123-3449.3	010808	ATE Ø 23,8
				06/11→; für Rechtslenker; +PR 1ZD / 1ZP		24.4152-0132.3	011025	ATE Ø 22,2 ohne Bremsflüssigkeitsbehälter
				06/11→; für Rechtslenker; +PR 1ZA / 1ZB / 1ZE / 1ZK		24.4153-0202.3	011027	ATE Ø 23,8 ohne Bremsflüssigkeitsbehälter
1.2 TSI 16V 1.4 TSI	77 90 - 110	11/13→05/16 11/11→05/16		für Linkslenker; +PR 1ZD / 1ZP / 1LV		03.2122-2129.3	010799	ATE Ø 22,2
				für Linkslenker; +PR 1ZA / 1ZB / 1ZE / 1ZK		03.2123-3449.3	010808	ATE Ø 23,8
2.0 GTI 2.0 R 2.0 TDI	155 195 81 - 110	05/12→05/16 01/13→05/16 11/11→05/16		für Rechtslenker; +PR 1ZD / 1ZP		24.4152-0132.3	011025	ATE Ø 22,2 ohne Bremsflüssigkeitsbehälter
2.0 TSI	162	11/13→05/16		für Rechtslenker; +PR 1ZA / 1ZB / 1ZE / 1ZK		24.4153-0202.3	011027	ATE Ø 23,8 ohne Bremsflüssigkeitsbehälter
VW - GOLF VI Van (5K1_) 10/08→11/12								
 Bremskraftverstärker								
1.2 TSi 1.2 TSi BlueMotion 1.4 TSi	63 77 118	05/10→11/12 05/09→11/12 10/08→11/12		1K-9-400001→; → 11/10; für Linkslenker; +PR 1ZK		03.7860-8802.4	300291	ATE Ø 10" pneumatisch
1.6 TDi 1.6 TDi BlueMotion 2.0 GTI 2.0 TDi	66 77 155 103 - 125	02/09→11/12 05/09→11/12 02/09→11/12 09/09→11/12		für Linkslenker; +PR 1ZD / 1ZF / 1ZP / 1LV		03.7863-3232.4	300307	ATE Ø 10" pneumatisch
				1K-9-400001→; → 11/10; für Linkslenker; +PR 1ZA / 1ZB / 1ZE / 1LJ		03.7863-3332.4	300308	ATE Ø 10" pneumatisch
				→ 1K-9-200000; für Linkslenker; +PR 1LJ / 1LL / 1LM		03.7863-3332.4	300308	ATE Ø 10" pneumatisch
2.0 TSi R 4motion TSi	199 90	11/09→11/12 10/08→11/12						
 Hauptbremszylinder								
1.2 TSi 1.2 TSi BlueMotion 1.4 TSi	63 77 118	05/10→11/12 05/09→11/12 10/08→11/12		für Linkslenker; +PR 1ZD / 1ZF / 1ZP / 1LV		03.2122-2129.3	010799	ATE Ø 22,2
1.6 TDi 1.6 TDi BlueMotion 2.0 GTI	66 77 155	02/09→11/12 05/09→11/12 02/09→11/12		für Linkslenker; +PR 1ZA / 1ZB / 1ZE / 1LJ		03.2123-3449.3	010808	ATE Ø 23,8
				für Rechtslenker; +PR 1ZD / 1ZF / 1ZP / 1LV		24.4152-0132.3	011025	ATE Ø 22,2 ohne Bremsflüssigkeitsbehälter







	kw			 	! #		
VW - GOLF VI Van (5K1_) 10/08→11/12							
 Hauptbremszylinder							
2.0 TDi	103 - 125	09/09→11/12		für Rechtslenker; +PR 1ZA / 1ZB / 1ZE / 1LJ	24.4153-0202.3	011027	ATE Ø 23,8 ohne Bremsflüssigkeitsbehälter
2.0 TSi R 4motion	199	11/09→11/12					
TSi	90	10/08→11/12					
VW - GOLF VI Variant (AJ5) 07/09→07/14							
 Bremskraftverstärker							
1.2 TSI	63	07/10→07/13		für Linkslenker; +PR 1AC / 1AT / 1ZD / 1ZP	03.7863-3232.4	300307	ATE Ø 10" pneumatisch
1.6 MultiFuel	75	07/10→07/13					
1.6 TDI	66	12/09→07/13					
2.0 TDI	81	01/10→07/13					
1.2 TSI	77	07/09→07/13		12/09→; für Linkslenker; +PR 1ZD / 1ZP	03.7863-3232.4	300307	ATE Ø 10" pneumatisch
1.4	59	07/09→07/13					
1.4 TSI	90 - 118	07/09→07/13		+PR 1AC / 1AT; → 11/09; für Linkslenker	03.7863-3332.4	300308	ATE Ø 10" pneumatisch
1.6	75	07/09→07/13					
1.6 BiFuel	75	07/09→12/10					
1.6 TDI	77	07/09→07/13					
1.6 TDI 4motion	77	07/09→07/13					
2.0 TDI	100 - 103	07/09→07/13					
2.0 TFSI	147	07/09→07/13					
 Hauptbremszylinder							
1.2 TSI	63	07/10→07/13		für Linkslenker; +PR 1ZD / 1ZP	03.2122-2129.3	010799	ATE Ø 22,2
1.6 MultiFuel	75	07/10→07/13		+PR 1ZD / 1ZP; für Rechtslenker	24.4152-0132.3	011025	ATE Ø 22,2 ohne Bremsflüssigkeitsbehälter
				+PR 1LJ / 1ZA / 1ZE; für Rechtslenker	24.4153-0202.3	011027	ATE Ø 23,8 ohne Bremsflüssigkeitsbehälter
1.2 TSI	77	07/09→07/13		12/09→; für Linkslenker; +PR 1ZD / 1ZP	03.2122-2129.3	010799	ATE Ø 22,2
1.4	59	07/09→07/13					
1.4 TSI	90 - 118	07/09→07/13		→ 11/09; für Linkslenker; +PR 1AC / 1AT	03.2122-2129.3	010799	ATE Ø 22,2
				→ 11/09; +PR 1LJ / 1LL	03.2123-3449.3	010808	ATE Ø 23,8
1.6	75	07/09→07/13		→ 11/09; für Rechtslenker	24.4152-0132.3	011025	ATE Ø 22,2 ohne Bremsflüssigkeitsbehälter
1.6 BiFuel	75	07/09→12/10					
1.6 TDI	77	07/09→07/13					
1.6 TDI 4motion	77	07/09→07/13		12/09→; +PR 1ZD / 1ZP; für Rechtslenker	24.4152-0132.3	011025	ATE Ø 22,2 ohne Bremsflüssigkeitsbehälter
2.0 TDI	100 - 103	07/09→07/13					
				→ 11/09; +PR 1LJ / 1LL; für Rechtslenker	24.4153-0202.3	011027	ATE Ø 23,8 ohne Bremsflüssigkeitsbehälter
2.0 TFSI	147	07/09→07/13		12/09→; +PR 1LJ / 1ZA / 1ZE; für Rechtslenker	24.4153-0202.3	011027	ATE Ø 23,8 ohne Bremsflüssigkeitsbehälter
1.6 TDI	66	12/09→07/13		für Linkslenker; +PR 1ZD / 1ZP	03.2122-2129.3	010799	ATE Ø 22,2
				+PR 1LJ / 1LL; für Linkslenker	03.2123-3449.3	010808	ATE Ø 23,8
				+PR 1ZD / 1ZP; für Rechtslenker	24.4152-0132.3	011025	ATE Ø 22,2 ohne Bremsflüssigkeitsbehälter
				+PR 1LJ / 1ZA / 1ZE; für Rechtslenker	24.4153-0202.3	011027	ATE Ø 23,8 ohne Bremsflüssigkeitsbehälter
2.0 TDI	81	01/10→07/13		für Linkslenker; +PR 1AC / 1AT / 1ZD / 1ZP	03.2122-2129.3	010799	ATE Ø 22,2
				+PR 1ZD / 1ZP; für Rechtslenker	24.4152-0132.3	011025	ATE Ø 22,2 ohne Bremsflüssigkeitsbehälter
				+PR 1LJ / 1ZA / 1ZE / 1LL; für Rechtslenker	24.4153-0202.3	011027	ATE Ø 23,8 ohne Bremsflüssigkeitsbehälter
VW - GOLF VII (5G1, BQ1, BE1, BE2) 08/12→03/21							
 Hauptbremszylinder							
1.0 TSI	63 - 85	05/15→08/20		für Linkslenker; +PR 1ZA / 1ZD / 1ZE / 1ZF / 1ZP	03.4153-5403.3	010994	ATE Ø 23,8
1.2 TSI	77 - 81	11/12→03/17			24.4123-1719.3	011017	TRW Ø 23,8 ohne Bremsflüssigkeitsbehälter
1.4 TSI	92 - 110	05/14→03/21					
1.4 TSI MultiFuel	90 - 92	11/12→07/18					
1.5 TGI	96	11/18→08/20					
1.5 TSI	96 - 110	04/17→08/20					
1.6	81	05/14→07/17					
1.6 TDI	66 - 85	04/13→08/20					
1.6 TDI 4motion	77 - 81	11/12→03/17					
2.0 GTD	135	04/13→08/20					
2.0 GTI	155 - 180	04/13→08/20					
→							

	kw				! #		
VW - GOLF VII (5G1, BQ1, BE1, BE2) 08/12→03/21							
 Hauptbremszylinder							
2.0 GTI Clubsport	195	02/16→03/17		für Linkslenker; +PR 1ZA / 1ZD / 1ZE / 1ZF / 1ZP		03.4153-5403.3 010994	ATE Ø 23,8
2.0 GTI Clubsport S	228	09/16→03/17				24.4123-1719.3 011017	TRW Ø 23,8 ohne Bremsflüssigkeitsbehälter
2.0 GTI TCR	213	11/18→08/20					
2.0 R 360S 4motion	265	09/16→03/17					
2.0 R 4motion	206 - 228	11/13→08/20					
2.0 TDI	81 - 110	08/12→08/20					
2.0 TDI 4motion	110	11/12→08/20					
1.2 TSI	63	08/12→03/17		11/12→; für Linkslenker; +PR 1ZA / 1ZD / 1ZE / 1ZF / 1ZP		03.4153-5403.3 010994	ATE Ø 23,8
1.4 TSI	103	08/12→07/17				24.4123-1719.3 011017	TRW Ø 23,8 ohne Bremsflüssigkeitsbehälter
1.6 TDI	77	08/12→03/17					
1.4 TGI CNG	81	06/13→07/18		08/13→; für Linkslenker; +PR 1ZA / 1ZD / 1ZE / 1ZF / 1ZP		03.4153-5403.3 010994	ATE Ø 23,8
						24.4123-1719.3 011017	TRW Ø 23,8 ohne Bremsflüssigkeitsbehälter
1.4 TSI	90	11/12→03/17		06/13→; für Linkslenker; +PR 1ZA / 1ZD / 1ZE / 1ZF / 1ZP		03.4153-5403.3 010994	ATE Ø 23,8
1.6 TDI	81	01/13→03/17				24.4123-1719.3 011017	TRW Ø 23,8 ohne Bremsflüssigkeitsbehälter
VW - GOLF VII Van (5G1) 08/12→03/17							
 Hauptbremszylinder							
1.2 TSi BlueMotion	63	08/12→03/17		11/12→; für Linkslenker; +PR 1ZA / 1ZD / 1ZE / 1ZF / 1ZP		03.4153-5403.3 010994	ATE Ø 23,8
1.4 TSi BlueMotion	103	08/12→03/17				24.4123-1719.3 011017	TRW Ø 23,8 ohne Bremsflüssigkeitsbehälter
1.6 TDi BlueMotion	77	08/12→03/17					
1.2 TSi BlueMotion	77	11/12→03/17		für Linkslenker; +PR 1ZA / 1ZD / 1ZE / 1ZF / 1ZP		03.4153-5403.3 010994	ATE Ø 23,8
1.4 TSi BlueMotion	90	05/13→03/17				24.4123-1719.3 011017	TRW Ø 23,8 ohne Bremsflüssigkeitsbehälter
1.6 TDi BlueMotion	66 - 81	04/13→03/17					
2.0 GTD	135	04/13→03/17					
2.0 GTi	162 - 169	04/13→03/17					
2.0 TDi BlueMotion	110	05/13→05/14					
2.0 TDi BlueMotion 4motion	110	05/13→05/14					
VW - GOLF VII Variant (BA5, BV5) 04/13→							
 Hauptbremszylinder							
1.0 TSI	63 - 85	05/15→08/20		für Linkslenker; +PR 1ZA / 1ZD / 1ZE / 1ZF / 1ZP		03.4153-5403.3 010994	ATE Ø 23,8
1.2 TSI	81	04/14→03/17				24.4123-1719.3 011017	TRW Ø 23,8 ohne Bremsflüssigkeitsbehälter
1.4 TSI	92 - 110	05/14→				24.4153-1522.3 011048	ATE Ø 23,8 ohne Bremsflüssigkeitsbehälter
1.4 TSI MultiFuel	92	05/14→03/17					
1.5 TSI	96 - 110	04/17→08/20					
1.6	81	05/14→07/17					
1.6 TDI	85	11/16→08/20					
1.8 TSI 4motion	132	11/16→08/20					
2.0 GTD	135	01/15→07/19					
2.0 R 360S 4motion	265	09/16→03/17					
2.0 R 4motion	206 - 228	03/15→08/20					
1.2 TSI	63 - 77	04/13→08/20		07/13→; für Linkslenker; +PR 1ZA / 1ZD / 1ZE / 1ZF / 1ZP		03.4153-5403.3 010994	ATE Ø 23,8
1.4 TSI	90 - 103	05/13→08/20				24.4123-1719.3 011017	TRW Ø 23,8 ohne Bremsflüssigkeitsbehälter
1.6 TDI	66 - 81	05/13→07/18		12/13→; für Linkslenker; +PR 1ZA / 1ZD / 1ZE / 1ZF / 1ZP		24.4153-1522.3 011048	ATE Ø 23,8 ohne Bremsflüssigkeitsbehälter
1.6 TDI 4motion	77 - 81	05/13→03/17					
2.0 TDI	81 - 110	04/13→					
2.0 TDI 4motion	110	04/13→08/20					
1.4 TGI CNG	81	09/13→07/18		für Linkslenker; +PR 1ZA / 1ZD / 1ZE / 1ZF / 1ZP		03.4153-5403.3 010994	ATE Ø 23,8
1.4 TSI MultiFuel	90	04/13→03/17				24.4123-1719.3 011017	TRW Ø 23,8 ohne Bremsflüssigkeitsbehälter
				12/13→; für Linkslenker; +PR 1ZA / 1ZD / 1ZE / 1ZF / 1ZP		24.4153-1522.3 011048	ATE Ø 23,8 ohne Bremsflüssigkeitsbehälter
1.5 TGI	96	12/18→08/20		für Linkslenker; +PR 1ZA / 1ZD / 1ZE / 1ZF / 1ZP		03.4153-5403.3 010994	ATE Ø 23,8
						24.4123-1719.3 011017	TRW Ø 23,8 ohne Bremsflüssigkeitsbehälter

	kw			 	! #		
VW - GOLF ALLTRACK VII Variant (BA5, BV5) 12/14→							
 Hauptbremszylinder							
1.6 TDI 4motion 1.8 TSI 4motion 2.0 TDI 4motion	81 132 110 - 135	12/14→03/17 12/14→08/20 12/14→08/20		+PR 1ZA / 1ZD / 1ZE / 1ZF / 1ZP +PR 1ZA / 1ZD / 1ZE / 1ZF / 1ZP; für Linkslenker	24.4123-1719.3 24.4153-1522.3	011017 011048	TRW Ø 23,8 ohne Bremsflüssigkeitsbehälter ATE Ø 23,8 ohne Bremsflüssigkeitsbehälter
VW - GOLF Kasten/Schrägheck (1K1) 07/03→							
 Bremskraftverstärker							
TDI	77	11/03→02/06		für Linkslenker; +PR 1AC / 1AT	03.7863-3232.4	300307	ATE Ø 10" pneumatisch
 Hauptbremszylinder							
TDI	77	11/03→02/06		für Linkslenker; → 1K-6W078889 1K-6W078890→; für Linkslenker für Rechtslenker; +PR 1AC / 1AT für Rechtslenker; +PR 1AS	03.2122-2129.3 03.2122-2129.3 24.2122-1981.3 24.4152-0132.3	010799 010799 011024 011025	ATE Ø 22,2 ATE Ø 22,2 ATE Ø 22,2 ohne Bremsflüssigkeitsbehälter ATE Ø 22,2 ohne Bremsflüssigkeitsbehälter
Hydraulikaggregat, Bremsanlage							
TDI	77	11/03→02/06		+PR 1AT / 1AS	24.9145-0001.2	399005	
Drucksensor, Bremskraftverstärker							
TDI	77	11/03→02/06		für Linkslenker; +PR 1AS	03.0655-0101.2	370008	ATE
VW - GOLF PLUS V (5M1, 521) 12/04→12/13							
 Bremskraftverstärker							
1.2 TSI 1.6 BiFuel 1.6 TDI 2.0 TDI	63 - 77 75 66 - 77 81	11/09→12/13 05/09→12/13 02/09→12/13 01/09→12/13		1K-9-900001→; für Linkslenker; → 11/10; +PR 1ZK 12/10→; für Linkslenker; +PR 1ZF / 1AC 1K-9-900001→; für Linkslenker; → 11/10; +PR 1ZD / 1ZF / 1ZP / 1LV 12/10→; für Linkslenker; +PR 1ZA / 1ZE / 1AS / 1AT 1K-9-900001→; für Linkslenker; → 11/10; +PR 1ZA / 1ZB / 1ZE	03.7860-8802.4 03.7863-3232.4 03.7863-3232.4 03.7863-3332.4 03.7863-3332.4	300291 300307 300307 300308 300308	ATE Ø 10" pneumatisch ATE Ø 10" pneumatisch ATE Ø 10" pneumatisch ATE Ø 10" pneumatisch ATE Ø 10" pneumatisch
1.4 16V 1.4 FSI 1.4 TSI 1.6 FSI 1.9 TDI 2.0 FSI 2.0 TDI	55 - 66 66 103 85 66 - 77 110 96	01/05→11/06 07/05→11/06 05/06→06/08 12/04→05/08 01/05→01/09 05/05→06/08 05/05→05/07		1K-9-900001→; für Linkslenker; +PR 1ZK 1K-9-900001→; für Linkslenker; +PR 1ZD / 1ZF / 1ZP / 1LV für Linkslenker; +PR 1AC / 1AT; → 1K-9-899999 1K-9-900001→; für Linkslenker; +PR 1ZA / 1ZB / 1ZE	03.7860-8802.4 03.7863-3232.4 03.7863-3232.4 03.7863-3232.4	300291 300307 300307 300308	ATE Ø 10" pneumatisch ATE Ø 10" pneumatisch ATE Ø 10" pneumatisch ATE Ø 10" pneumatisch
1.4 16V 1.4 TSI 1.6 1.6 MultiFuel 2.0 TDI 2.0 TDI 16V	59 - 90 118 75 75 100 - 103 103	05/06→12/13 06/07→12/13 05/05→12/13 11/07→12/13 05/05→12/13 01/05→12/13		1K-9-900001→; für Linkslenker; → 11/10; +PR 1ZK 12/10→; für Linkslenker; +PR 1ZF / 1AC 1K-9-900001→; für Linkslenker; → 11/10; +PR 1ZD / 1ZF / 1ZP / 1LV für Linkslenker; +PR 1AC / 1AT; → 1K-9-899999 12/10→; für Linkslenker; +PR 1ZA / 1ZE / 1AS / 1AT 1K-9-900001→; für Linkslenker; → 11/10; +PR 1ZA / 1ZB / 1ZE	03.7860-8802.4 03.7863-3232.4 03.7863-3232.4 03.7863-3232.4 03.7863-3332.4 03.7863-3332.4	300291 300307 300307 300307 300308 300308	ATE Ø 10" pneumatisch ATE Ø 10" pneumatisch ATE Ø 10" pneumatisch ATE Ø 10" pneumatisch ATE Ø 10" pneumatisch ATE Ø 10" pneumatisch
1.4 TSI	125	05/06→06/08		1K-9-900001→; für Linkslenker; +PR 1ZK 1K-9-900001→; für Linkslenker; +PR 1ZD / 1ZF / 1ZP / 1LV +PR 1AC / 1AT; für Linkslenker; → 1K-6-565000 1K-9-900001→; für Linkslenker; +PR 1ZA / 1ZB / 1ZE 1K-6-565001→ 1K-9-899999; für Linkslenker; +PR 1AC / 1AT	03.7860-8802.4 03.7863-3232.4 03.7863-3232.4 03.7863-3332.4 03.7863-3332.4	300291 300307 300307 300308 300308	ATE Ø 10" pneumatisch ATE Ø 10" pneumatisch ATE Ø 10" pneumatisch ATE Ø 10" pneumatisch ATE Ø 10" pneumatisch
 Hauptbremszylinder							
1.2 TSI 1.6 BiFuel 1.6 TDI 2.0 TDI	63 - 77 75 66 - 77 81	11/09→12/13 05/09→12/13 02/09→12/13 01/09→12/13		1K-C-500001→; für Linkslenker; +PR 1ZF / 1AC 1K-9-900001→; für Linkslenker; → 1K-C-500000; +PR 1ZF 1K-C-500001→; für Linkslenker; +PR 1ZA / 1ZE / 1AS / 1AT	03.2122-2129.3 03.2122-2129.3 03.2123-3449.3	010799 010799 010808	ATE Ø 22,2 ATE Ø 22,2 ATE Ø 23,8

	kw			 	! #		
VW - GOLF PLUS V (5M1, 521) 12/04→12/13							
Hauptbremszylinder							
1.2 TSI	63 - 77	11/09→12/13		1K-9-900001→; für Linkslenker; → 1K-C-500000; +PR 1ZE / 1LJ / 1ZA	03.2123-3449.3	010808	ATE Ø 23,8
1.6 BiFuel 1.6 TDI	75 66 - 77	05/09→12/13 02/09→12/13		1K-9-900001→; für Rechtslenker; → 1K-C-500000; +PR 1ZF	24.4152-0132.3	011025	ATE Ø 22,2 ohne Bremsflüssigkeitsbehälter
2.0 TDI	81	01/09→12/13		1K-C-500001→; für Rechtslenker; +PR 1ZF / 1AC	24.4152-0132.3	011025	ATE Ø 22,2 ohne Bremsflüssigkeitsbehälter
				1K-C-500001→; für Rechtslenker; +PR 1ZA / 1ZE / 1AS / 1AT	24.4153-0202.3	011027	ATE Ø 23,8 ohne Bremsflüssigkeitsbehälter
				1K-9-900001→; für Rechtslenker; → 1K-C-500000; +PR 1ZE / 1LJ / 1ZA	24.4153-0202.3	011027	ATE Ø 23,8 ohne Bremsflüssigkeitsbehälter
1.4 16V	55 - 59	01/05→12/13		1K-C-500001→; für Linkslenker; +PR 1ZF / 1AC	03.2122-2129.3	010799	ATE Ø 22,2
1.4 FSI	66	07/05→11/06		für Linkslenker; → 1K-6-565000	03.2122-2129.3	010799	ATE Ø 22,2
1.4 TSI	103	05/06→06/08					
1.6	75	05/05→12/13		1K-9-900001→; für Linkslenker; → 1K-C-500000; +PR 1ZF	03.2122-2129.3	010799	ATE Ø 22,2
1.6 MultiFuel	75	11/07→12/13					
1.9 TDI	66 - 77	01/05→01/09		1K-6-565001→; für Linkslenker; → 1K-8-500000; +PR 1AC / 1AT / 1AS	03.2122-2129.3	010799	ATE Ø 22,2
2.0 FSI	110	05/05→06/08		1K-8-500001→; für Linkslenker; → 1K-9-899999; +PR 1LK / 1ZA / 1ZC / 1ZD / 1ZE / 1ZF / 1ZM / 1ZP	03.2122-2129.3	010799	ATE Ø 22,2
2.0 TDI	96 - 103	05/05→12/13					
2.0 TDI 16V	103	01/05→12/13		1K-C-500001→; für Linkslenker; +PR 1ZA / 1ZE / 1AS / 1AT	03.2123-3449.3	010808	ATE Ø 23,8
				1K-8-500001→; für Linkslenker; → 1K-9-899999; +PR 1LJ	03.2123-3449.3	010808	ATE Ø 23,8
				1K-6-565001→; für Linkslenker; → 1K-8-500000; +PR 1LJ	03.2123-3449.3	010808	ATE Ø 23,8
				1K-9-900001→; für Linkslenker; → 1K-C-500000; +PR 1ZE / 1LJ / 1ZA	03.2123-3449.3	010808	ATE Ø 23,8
				für Rechtslenker; → 1K-6-565000	24.2122-1981.3	011024	ATE Ø 22,2 ohne Bremsflüssigkeitsbehälter
				1K-C-500001→; für Rechtslenker; +PR 1ZF / 1AC	24.4152-0132.3	011025	ATE Ø 22,2 ohne Bremsflüssigkeitsbehälter
				1K-6-565001→; für Rechtslenker; → 1K-8-500000; +PR 1AC / 1AT / 1AS	24.4152-0132.3	011025	ATE Ø 22,2 ohne Bremsflüssigkeitsbehälter
				1K-9-900001→; für Rechtslenker; → 1K-C-500000; +PR 1ZF	24.4152-0132.3	011025	ATE Ø 22,2 ohne Bremsflüssigkeitsbehälter
				1K-8-500001→; für Rechtslenker; → 1K-9-899999; +PR 1LK / 1ZA / 1ZC / 1ZD / 1ZE / 1ZF / 1ZM / 1ZP	24.4152-0132.3	011025	ATE Ø 22,2 ohne Bremsflüssigkeitsbehälter
				1K-8-500001→; für Rechtslenker; → 1K-9-899999; +PR 1LJ	24.4153-0202.3	011027	ATE Ø 23,8 ohne Bremsflüssigkeitsbehälter
				1K-9-900001→; für Rechtslenker; → 1K-C-500000; +PR 1ZE / 1LJ / 1ZA	24.4153-0202.3	011027	ATE Ø 23,8 ohne Bremsflüssigkeitsbehälter
				1K-C-500001→; für Rechtslenker; +PR 1ZA / 1ZE / 1AS / 1AT	24.4153-0202.3	011027	ATE Ø 23,8 ohne Bremsflüssigkeitsbehälter
			1.4 TSI	90	06/07→12/13		1K-6-565001→; für Linkslenker; → 1K-8-500000; +PR 1AC / 1AT / 1AS
	1K-C-500001→; für Linkslenker; +PR 1ZF / 1AC	03.2122-2129.3				010799	ATE Ø 22,2
	1K-8-500001→; für Linkslenker; → 1K-9-899999; +PR 1LK / 1ZA / 1ZC / 1ZD / 1ZE / 1ZF / 1ZM / 1ZP	03.2122-2129.3				010799	ATE Ø 22,2
	1K-9-900001→; für Linkslenker; → 1K-C-500000; +PR 1ZF	03.2122-2129.3				010799	ATE Ø 22,2
	1K-C-500001→; für Linkslenker; +PR 1ZA / 1ZE / 1AS / 1AT	03.2123-3449.3				010808	ATE Ø 23,8
	1K-9-900001→; für Linkslenker; → 1K-C-500000; +PR 1ZE / 1LJ / 1ZA	03.2123-3449.3				010808	ATE Ø 23,8
	1K-8-500001→; für Linkslenker; → 1K-9-899999; +PR 1LJ	03.2123-3449.3				010808	ATE Ø 23,8
	1K-6-565001→; für Linkslenker; → 1K-8-500000; +PR 1LJ	03.2123-3449.3				010808	ATE Ø 23,8
	1K-C-500001→; für Rechtslenker; +PR 1ZF / 1AC	24.4152-0132.3				011025	ATE Ø 22,2 ohne Bremsflüssigkeitsbehälter
	1K-6-565001→; für Rechtslenker; → 1K-8-500000; +PR 1AC / 1AT / 1AS	24.4152-0132.3				011025	ATE Ø 22,2 ohne Bremsflüssigkeitsbehälter
	1K-9-900001→; für Rechtslenker; → 1K-C-500000; +PR 1ZF	24.4152-0132.3				011025	ATE Ø 22,2 ohne Bremsflüssigkeitsbehälter
	1K-8-500001→; für Rechtslenker; → 1K-9-899999; +PR 1LK / 1ZA / 1ZC / 1ZD / 1ZE / 1ZF / 1ZM / 1ZP	24.4152-0132.3				011025	ATE Ø 22,2 ohne Bremsflüssigkeitsbehälter
	1K-C-500001→; für Rechtslenker; +PR 1ZA / 1ZE / 1AS / 1AT	24.4153-0202.3				011027	ATE Ø 23,8 ohne Bremsflüssigkeitsbehälter

→

	kw			 	! #		
VW - GOLF PLUS V (5M1, 521) 12/04→12/13							
Hauptbremszylinder							
1.4 TSI	90	06/07→12/13		1K-8-500001→; für Rechtslenker; → 1K-9-899999; +PR 1LJ	24.4153-0202.3	011027	ATE Ø 23,8 ohne Bremsflüssigkeitsbehälter
				1K-9-900001→; für Rechtslenker; → 1K-C-500000; +PR 1ZE / 1LJ / 1ZA	24.4153-0202.3	011027	ATE Ø 23,8 ohne Bremsflüssigkeitsbehälter
1.4 TSI	118	06/08→12/13		1K-C-500001→; für Linkslenker; +PR 1ZF / 1AC	03.2122-2129.3	010799	ATE Ø 22,2
				1K-9-900001→; für Linkslenker; → 1K-C-500000; +PR 1ZF	03.2122-2129.3	010799	ATE Ø 22,2
				1K-8-500001→; für Linkslenker; → 1K-9-899999; +PR 1LK / 1ZA / 1ZC / 1ZD / 1ZE / 1ZF / 1ZM / 1ZP	03.2122-2129.3	010799	ATE Ø 22,2
				1K-C-500001→; für Linkslenker; +PR 1ZA / 1ZE / 1AS / 1AT	03.2123-3449.3	010808	ATE Ø 23,8
				1K-8-500001→; für Linkslenker; → 1K-9-899999; +PR 1LJ	03.2123-3449.3	010808	ATE Ø 23,8
				1K-9-900001→; für Linkslenker; → 1K-C-500000; +PR 1ZE / 1LJ / 1ZA	03.2123-3449.3	010808	ATE Ø 23,8
				1K-C-500001→; für Rechtslenker; +PR 1ZF / 1AC	24.4152-0132.3	011025	ATE Ø 22,2 ohne Bremsflüssigkeitsbehälter
				1K-8-500001→; für Rechtslenker; → 1K-9-899999; +PR 1LK / 1ZA / 1ZC / 1ZD / 1ZE / 1ZF / 1ZM / 1ZP	24.4152-0132.3	011025	ATE Ø 22,2 ohne Bremsflüssigkeitsbehälter
				1K-9-900001→; für Rechtslenker; → 1K-C-500000; +PR 1ZF	24.4152-0132.3	011025	ATE Ø 22,2 ohne Bremsflüssigkeitsbehälter
				1K-C-500001→; für Rechtslenker; +PR 1ZA / 1ZE / 1AS / 1AT	24.4153-0202.3	011027	ATE Ø 23,8 ohne Bremsflüssigkeitsbehälter
				1K-9-900001→; für Rechtslenker; → 1K-C-500000; +PR 1ZE / 1LJ / 1ZA	24.4153-0202.3	011027	ATE Ø 23,8 ohne Bremsflüssigkeitsbehälter
				1K-8-500001→; für Rechtslenker; → 1K-9-899999; +PR 1LJ	24.4153-0202.3	011027	ATE Ø 23,8 ohne Bremsflüssigkeitsbehälter
			1.4 TSI	125	05/06→06/08		1K-6-565001→; für Linkslenker; → 1K-8-500000; +PR 1AC / 1AT / 1AS
	für Linkslenker; → 1K-6-565000	03.2122-2129.3				010799	ATE Ø 22,2
	1K-9-900001→; für Linkslenker; → 1K-C-500000; +PR 1ZF	03.2122-2129.3				010799	ATE Ø 22,2
	1K-C-500001→; für Linkslenker; +PR 1ZF / 1AC	03.2122-2129.3				010799	ATE Ø 22,2
	1K-8-500001→; für Linkslenker; → 1K-9-899999; +PR 1LK / 1ZA / 1ZC / 1ZD / 1ZE / 1ZF / 1ZM / 1ZP	03.2122-2129.3				010799	ATE Ø 22,2
	1K-C-500001→; für Linkslenker; +PR 1ZA / 1ZE / 1AS / 1AT	03.2123-3449.3				010808	ATE Ø 23,8
	1K-9-900001→; für Linkslenker; → 1K-C-500000; +PR 1ZE / 1LJ / 1ZA	03.2123-3449.3				010808	ATE Ø 23,8
	1K-8-500001→; für Linkslenker; → 1K-9-899999; +PR 1LJ	03.2123-3449.3				010808	ATE Ø 23,8
	1K-6-565001→; für Linkslenker; → 1K-8-500000; +PR 1LJ	03.2123-3449.3				010808	ATE Ø 23,8
	→ 1K-7-550000; für Rechtslenker	24.2122-1981.3				011024	ATE Ø 22,2 ohne Bremsflüssigkeitsbehälter
	1K-C-500001→; für Rechtslenker; +PR 1ZF / 1AC	24.4152-0132.3				011025	ATE Ø 22,2 ohne Bremsflüssigkeitsbehälter
	1K-8-500001→; für Rechtslenker; → 1K-9-899999; +PR 1LK / 1ZA / 1ZC / 1ZD / 1ZE / 1ZF / 1ZM / 1ZP	24.4152-0132.3				011025	ATE Ø 22,2 ohne Bremsflüssigkeitsbehälter
	1K-9-900001→; für Rechtslenker; → 1K-C-500000; +PR 1ZF	24.4152-0132.3				011025	ATE Ø 22,2 ohne Bremsflüssigkeitsbehälter
	1K-7-550001→; für Rechtslenker; → 1K-8-500000; +PR 1AC / 1AT / 1AS / 1LJ	24.4153-0202.3				011027	ATE Ø 23,8 ohne Bremsflüssigkeitsbehälter
	1K-9-900001→; für Rechtslenker; → 1K-C-500000; +PR 1ZE / 1LJ / 1ZA	24.4153-0202.3				011027	ATE Ø 23,8 ohne Bremsflüssigkeitsbehälter
	1K-8-500001→; für Rechtslenker; → 1K-9-899999; +PR 1LJ	24.4153-0202.3				011027	ATE Ø 23,8 ohne Bremsflüssigkeitsbehälter
	1K-C-500001→; für Rechtslenker; +PR 1ZA / 1ZE / 1AS / 1AT	24.4153-0202.3				011027	ATE Ø 23,8 ohne Bremsflüssigkeitsbehälter
1.6 FSI	85	12/04→05/08					1K-C-500001→; für Linkslenker; +PR 1ZF / 1AC
				für Linkslenker; → 1K-6-565000	03.2122-2129.3	010799	ATE Ø 22,2
				1K-9-900001→; für Linkslenker; → 1K-C-500000; +PR 1ZF	03.2122-2129.3	010799	ATE Ø 22,2
				1K-8-500001→; für Linkslenker; → 1K-9-899999; +PR 1LK / 1ZA / 1ZC / 1ZD / 1ZE / 1ZF / 1ZM / 1ZP	03.2122-2129.3	010799	ATE Ø 22,2

VW - GOLF PLUS V (5M1, 521) 12/04→12/13

Hauptbremszylinder

1.6 FSI	85	12/04→05/08		1K-6-565001→; für Linkslenker; → 1K-8-500000; +PR 1AC / 1AT / 1AS	03.2122-2129.3	010799	ATE Ø 22,2
				1K-C-500001→; für Linkslenker; +PR 1ZA / 1ZE / 1AS / 1AT	03.2123-3449.3	010808	ATE Ø 23,8
				1K-6-565001→; für Linkslenker; → 1K-8-500000; +PR 1LJ	03.2123-3449.3	010808	ATE Ø 23,8
				1K-8-500001→; für Linkslenker; → 1K-9-899999; +PR 1LJ	03.2123-3449.3	010808	ATE Ø 23,8
				1K-9-900001→; für Linkslenker; → 1K- C-500000; +PR 1ZE / 1LJ / 1ZA	03.2123-3449.3	010808	ATE Ø 23,8
				01/05→; für Rechtslenker; → 1K-6-565000	24.2122-1981.3	011024	ATE Ø 22,2 ohne Bremsflüssig- keitsbehälter
				1K-C-500001→; für Rechtslenker; +PR 1ZF / 1AC	24.4152-0132.3	011025	ATE Ø 22,2 ohne Bremsflüssig- keitsbehälter
				1K-6-565001→; für Rechtslenker; → 1K-8-500000; +PR 1AC / 1AT / 1AS	24.4152-0132.3	011025	ATE Ø 22,2 ohne Bremsflüssig- keitsbehälter
				1K-9-900001→; für Rechtslenker; → 1K- C-500000; +PR 1ZF	24.4152-0132.3	011025	ATE Ø 22,2 ohne Bremsflüssig- keitsbehälter
				1K-8-500001→; für Rechtslenker; → 1K-9-899999; +PR 1LK / 1ZA / 1ZC / 1ZD / 1ZE / 1ZF / 1ZM / 1ZP	24.4152-0132.3	011025	ATE Ø 22,2 ohne Bremsflüssig- keitsbehälter
				1K-9-900001→; für Rechtslenker; → 1K- C-500000; +PR 1ZE / 1LJ / 1ZA	24.4153-0202.3	011027	ATE Ø 23,8 ohne Bremsflüssig- keitsbehälter
				1K-C-500001→; für Rechtslenker; +PR 1ZA / 1ZE / 1AS / 1AT	24.4153-0202.3	011027	ATE Ø 23,8 ohne Bremsflüssig- keitsbehälter
	1K-8-500001→; für Rechtslenker; → 1K-9-899999; +PR 1LJ	24.4153-0202.3	011027	ATE Ø 23,8 ohne Bremsflüssig- keitsbehälter			

Hydraulikaggregat, Bremsanlage

1.4 16V	55	01/05→11/06		+PR 1AT / 1AS	24.9145-0001.2	399005	
1.4 FSI	66	07/05→11/06					
1.4 TSI	103 -	05/06→06/08					
	125						
1.6 FSI	85	12/04→05/08					
1.9 TDI	66	05/05→12/08					
2.0 FSI	110	05/05→06/08					
2.0 TDI	96	05/05→05/07					
1.4 16V	59	05/06→12/13		→ 12/08; +PR 1AT / 1AS	24.9145-0001.2	399005	
1.4 TSI	90 -	06/07→12/13					
	118						
1.6	75	05/05→12/13					
1.6 MultiFuel	75	11/07→12/13					
1.9 TDI	77	01/05→01/09					
2.0 TDI	100 -	05/05→12/13					
	103						
2.0 TDI 16V	103	01/05→12/13					









Drucksensor, Bremskraftverstärker

1.4 16V	55 -	01/05→12/13		1K-6-565001→; für Rechtslenker; → 1K-9-899999; +PR 1AS	03.0655-0101.2	370008	ATE
1.4 FSI	59						
1.4 TSI	66	07/05→11/06					
	90 -	05/06→12/13					
	118						
1.6	75	05/05→12/13					
1.6 FSI	85	12/04→05/08					
1.6 MultiFuel	75	11/07→12/13					
1.9 TDI	66 -	01/05→01/09					
	77						
2.0 FSI	110	05/05→06/08					
2.0 TDI	96 -	05/05→12/13					
	103						
2.0 TDI 16V	103	01/05→12/13					
1.4 TSI	125	05/06→06/08		1K-6-565001→ 1K-9-899999; für Rechts- lenker; +PR 1AC / 1AT / 1AS	03.0655-0101.2	370008	ATE
				+PR 1AS; für Linkslenker; → 1K-6-565000	03.0655-0101.2	370008	ATE









VW - GOLF PLUS Van (521) 01/09→08/14













Bremskraftverstärker











1.2 Tsi 1.6 Tdi →	77 66 - 77	11/09→08/14 02/09→08/14		1K-9-900001→; für Linkslenker; → 11/10; +PR 1ZK	03.7860-8802.4	300291	ATE Ø 10" pneumatisch
				12/10→; für Linkslenker; +PR 1ZF / 1AC	03.7863-3232.4	300307	ATE Ø 10" pneumatisch
				1K-9-900001→; für Linkslenker; → 11/10; +PR 1ZD / 1ZF / 1ZP / 1LV	03.7863-3232.4	300307	ATE Ø 10" pneumatisch
				12/10→; für Linkslenker; +PR 1ZA / 1ZE / 1AS / 1AT	03.7863-3332.4	300308	ATE Ø 10" pneumatisch













	kw			 	! #		
VW - GOLF PLUS Van (521) 01/09→08/14							
 Bremskraftverstärker							
1.2 TSi 1.6 TDi	77 66 - 77	11/09→08/14 02/09→08/14		1K-9-900001→; für Linkslenker; → 11/10; +PR 1ZA / 1ZB / 1ZE	03.7863-3332.4	300308	ATE Ø 10" pneumatisch
1.4 TSi 2.0 TDi	90 - 118 103	01/09→08/14 11/09→08/14		1K-9-900001→; für Linkslenker; → 11/10; +PR 1ZK	03.7860-8802.4	300291	ATE Ø 10" pneumatisch
				12/10→; für Linkslenker; +PR 1ZF / 1AC	03.7863-3232.4	300307	ATE Ø 10" pneumatisch
				1K-9-900001→; für Linkslenker; → 11/10; +PR 1ZD / 1ZF / 1ZP / 1LV	03.7863-3232.4	300307	ATE Ø 10" pneumatisch
				+PR 1AC / 1AT; für Linkslenker; → 1K-9-899999	03.7863-3232.4	300307	ATE Ø 10" pneumatisch
				12/10→; für Linkslenker; +PR 1ZA / 1ZE / 1AS / 1AT	03.7863-3332.4	300308	ATE Ø 10" pneumatisch
				1K-9-900001→; für Linkslenker; → 11/10; +PR 1ZA / 1ZB / 1ZE	03.7863-3332.4	300308	ATE Ø 10" pneumatisch
 Hauptbremszylinder							
1.2 TSi 1.6 TDi	77 66 - 77	11/09→08/14 02/09→08/14		1K-C-500001→; für Linkslenker; +PR 1ZF / 1AC	03.2122-2129.3	010799	ATE Ø 22,2
				1K-9-900001→; für Linkslenker; → 1K- C-500000; +PR 1ZF	03.2122-2129.3	010799	ATE Ø 22,2
				1K-C-500001→; für Linkslenker; +PR 1ZA / 1ZE / 1AS / 1AT	03.2123-3449.3	010808	ATE Ø 23,8
				1K-9-900001→; für Linkslenker; → 1K- C-500000; +PR 1ZE / 1LJ / 1ZA	03.2123-3449.3	010808	ATE Ø 23,8
				1K-9-900001→; für Rechtslenker; → 1K- C-500000; +PR 1ZF	24.4152-0132.3	011025	ATE Ø 22,2 ohne Bremsflüssig- keitsbehälter
				1K-C-500001→; für Rechtslenker; +PR 1ZF / 1AC	24.4152-0132.3	011025	ATE Ø 22,2 ohne Bremsflüssig- keitsbehälter
				1K-C-500001→; für Rechtslenker; +PR 1ZA / 1ZE / 1AS / 1AT	24.4153-0202.3	011027	ATE Ø 23,8 ohne Bremsflüssig- keitsbehälter
				1K-9-900001→; für Rechtslenker; → 1K- C-500000; +PR 1ZE / 1LJ / 1ZA	24.4153-0202.3	011027	ATE Ø 23,8 ohne Bremsflüssig- keitsbehälter
1.4 TSi	90	01/09→08/14		1K-9-900001→; für Linkslenker; → 1K- C-500000; +PR 1ZF	03.2122-2129.3	010799	ATE Ø 22,2
				1K-C-500001→; für Linkslenker; +PR 1ZF / 1AC	03.2122-2129.3	010799	ATE Ø 22,2
				1K-6-565001→; für Linkslenker; → 1K-8-500000; +PR 1AC / 1AT / 1AS	03.2122-2129.3	010799	ATE Ø 22,2
				1K-8-500001→; für Linkslenker; → 1K-9-899999; +PR 1LK / 1ZA / 1ZC / 1ZD / 1ZE / 1ZF / 1ZM / 1ZP	03.2122-2129.3	010799	ATE Ø 22,2
				1K-C-500001→; für Linkslenker; +PR 1ZA / 1ZE / 1AS / 1AT	03.2123-3449.3	010808	ATE Ø 23,8
				1K-6-565001→; für Linkslenker; → 1K-8-500000; +PR 1LJ	03.2123-3449.3	010808	ATE Ø 23,8
				1K-9-900001→; für Linkslenker; → 1K- C-500000; +PR 1ZE / 1LJ / 1ZA	03.2123-3449.3	010808	ATE Ø 23,8
				1K-8-500001→; für Linkslenker; → 1K-9-899999; +PR 1LJ	03.2123-3449.3	010808	ATE Ø 23,8
				1K-C-500001→; für Rechtslenker; +PR 1ZF / 1AC	24.4152-0132.3	011025	ATE Ø 22,2 ohne Bremsflüssig- keitsbehälter
				1K-6-565001→; für Rechtslenker; → 1K-8-500000; +PR 1AC / 1AT / 1AS	24.4152-0132.3	011025	ATE Ø 22,2 ohne Bremsflüssig- keitsbehälter
				1K-9-900001→; für Rechtslenker; → 1K- C-500000; +PR 1ZF	24.4152-0132.3	011025	ATE Ø 22,2 ohne Bremsflüssig- keitsbehälter
				1K-8-500001→; für Rechtslenker; → 1K-9-899999; +PR 1LK / 1ZA / 1ZC / 1ZD / 1ZE / 1ZF / 1ZM / 1ZP	24.4152-0132.3	011025	ATE Ø 22,2 ohne Bremsflüssig- keitsbehälter
				1K-C-500001→; für Rechtslenker; +PR 1ZA / 1ZE / 1AS / 1AT	24.4153-0202.3	011027	ATE Ø 23,8 ohne Bremsflüssig- keitsbehälter
				1K-8-500001→; für Rechtslenker; → 1K-9-899999; +PR 1LJ	24.4153-0202.3	011027	ATE Ø 23,8 ohne Bremsflüssig- keitsbehälter
				1K-9-900001→; für Rechtslenker; → 1K- C-500000; +PR 1ZE / 1LJ / 1ZA	24.4153-0202.3	011027	ATE Ø 23,8 ohne Bremsflüssig- keitsbehälter
1.4 TSi	118	01/09→09/12		1K-C-500001→; für Linkslenker; +PR 1ZF / 1AC	03.2122-2129.3	010799	ATE Ø 22,2
				1K-9-900001→; für Linkslenker; → 1K- C-500000; +PR 1ZF	03.2122-2129.3	010799	ATE Ø 22,2
				1K-8-500001→; für Linkslenker; → 1K-9-899999; +PR 1LK / 1ZA / 1ZC / 1ZD / 1ZE / 1ZF / 1ZM / 1ZP	03.2122-2129.3	010799	ATE Ø 22,2
				1K-C-500001→; für Linkslenker; +PR 1ZA / 1ZE / 1AS / 1AT	03.2123-3449.3	010808	ATE Ø 23,8
→							

























	kw					! #		
VW - GOLF PLUS Van (521) 01/09→08/14								
 Hauptbremszylinder								
1.4 TSi	118	01/09→09/12		1K-9-900001→; für Linkslenker; → 1K-C-500000; +PR 1ZE / 1LJ / 1ZA	03.2123-3449.3	010808	ATE Ø 23,8	
				1K-8-500001→; für Linkslenker; → 1K-9-899999; +PR 1LJ	03.2123-3449.3	010808	ATE Ø 23,8	
				1K-C-500001→; für Rechtslenker; +PR 1ZF / 1AC	24.4152-0132.3	011025	ATE Ø 22,2 ohne Bremsflüssigkeitsbehälter	
				1K-8-500001→; für Rechtslenker; → 1K-9-899999; +PR 1LK / 1ZA / 1ZC / 1ZD / 1ZE / 1ZF / 1ZM / 1ZP	24.4152-0132.3	011025	ATE Ø 22,2 ohne Bremsflüssigkeitsbehälter	
				1K-9-900001→; für Rechtslenker; → 1K-C-500000; +PR 1ZF	24.4152-0132.3	011025	ATE Ø 22,2 ohne Bremsflüssigkeitsbehälter	
				1K-C-500001→; für Rechtslenker; +PR 1ZA / 1ZE / 1AS / 1AT	24.4153-0202.3	011027	ATE Ø 23,8 ohne Bremsflüssigkeitsbehälter	
				1K-9-900001→; für Rechtslenker; → 1K-C-500000; +PR 1ZE / 1LJ / 1ZA	24.4153-0202.3	011027	ATE Ø 23,8 ohne Bremsflüssigkeitsbehälter	
2.0 TDi	103	11/09→08/14		1K-C-500001→; für Linkslenker; +PR 1ZF / 1AC	03.2122-2129.3	010799	ATE Ø 22,2	
				für Linkslenker; → 1K-6-565000	03.2122-2129.3	010799	ATE Ø 22,2	
				1K-6-565001→; für Linkslenker; → 1K-8-500000; +PR 1AC / 1AT / 1AS	03.2122-2129.3	010799	ATE Ø 22,2	
				1K-9-900001→; für Linkslenker; → 1K-C-500000; +PR 1ZF	03.2122-2129.3	010799	ATE Ø 22,2	
				1K-8-500001→; für Linkslenker; → 1K-9-899999; +PR 1LK / 1ZA / 1ZC / 1ZD / 1ZE / 1ZF / 1ZM / 1ZP	03.2122-2129.3	010799	ATE Ø 22,2	
				1K-C-500001→; für Linkslenker; +PR 1ZA / 1ZE / 1AS / 1AT	03.2123-3449.3	010808	ATE Ø 23,8	
				1K-9-900001→; für Linkslenker; → 1K-C-500000; +PR 1ZE / 1LJ / 1ZA	03.2123-3449.3	010808	ATE Ø 23,8	
				1K-8-500001→; für Linkslenker; → 1K-9-899999; +PR 1LJ	03.2123-3449.3	010808	ATE Ø 23,8	
				1K-6-565001→; für Linkslenker; → 1K-8-500000; +PR 1LJ	03.2123-3449.3	010808	ATE Ø 23,8	
				für Rechtslenker; → 1K-6-565000	24.2122-1981.3	011024	ATE Ø 22,2 ohne Bremsflüssigkeitsbehälter	
				1K-C-500001→; für Rechtslenker; +PR 1ZF / 1AC	24.4152-0132.3	011025	ATE Ø 22,2 ohne Bremsflüssigkeitsbehälter	
				1K-6-565001→; für Rechtslenker; → 1K-8-500000; +PR 1AC / 1AT / 1AS	24.4152-0132.3	011025	ATE Ø 22,2 ohne Bremsflüssigkeitsbehälter	
				1K-9-900001→; für Rechtslenker; → 1K-C-500000; +PR 1ZF	24.4152-0132.3	011025	ATE Ø 22,2 ohne Bremsflüssigkeitsbehälter	
				1K-8-500001→; für Rechtslenker; → 1K-9-899999; +PR 1LK / 1ZA / 1ZC / 1ZD / 1ZE / 1ZF / 1ZM / 1ZP	24.4152-0132.3	011025	ATE Ø 22,2 ohne Bremsflüssigkeitsbehälter	
				1K-9-900001→; für Rechtslenker; → 1K-C-500000; +PR 1ZE / 1LJ / 1ZA	24.4153-0202.3	011027	ATE Ø 23,8 ohne Bremsflüssigkeitsbehälter	
	1K-8-500001→; für Rechtslenker; → 1K-9-899999; +PR 1LJ	24.4153-0202.3	011027	ATE Ø 23,8 ohne Bremsflüssigkeitsbehälter				
	1K-C-500001→; für Rechtslenker; +PR 1ZA / 1ZE / 1AS / 1AT	24.4153-0202.3	011027	ATE Ø 23,8 ohne Bremsflüssigkeitsbehälter				
Hydraulikaggregat, Bremsanlage								
1.4 TSi	90 - 118	01/09→08/14		+PR 1AT / 1AS	24.9145-0001.2	399005		
2.0 TDi	103	11/09→08/14						
Drucksensor, Bremskraftverstärker								
1.4 TSi	90 - 118	01/09→08/14		1K-6-565001→; für Rechtslenker; → 1K-9-899999; +PR 1AS	03.0655-0101.2	370008	ATE	
2.0 TDi	103	11/09→08/14		für Linkslenker; → 1K-9-899999; +PR 1AS	03.0655-0101.2	370008	ATE	
VW - GOLF SPORTSVAN VII (AM1, AN1) 02/14→08/20								
 Hauptbremszylinder								
1.0 TSI	63 - 85	05/15→08/20		für Linkslenker	24.4123-1719.3	011017	TRW Ø 23,8 ohne Bremsflüssigkeitsbehälter	
1.2 TSI	63 - 81	04/14→11/17			24.4153-1522.3	011048	ATE Ø 23,8 ohne Bremsflüssigkeitsbehälter	
1.4 TSI	92	04/14→08/20						
1.4 TSI MultiFuel	92	04/14→11/17						
1.5 TSI	96 - 110	05/17→08/20						
→								

	kw					! #		
VW - GOLF SPORTSVAN VII (AM1, AN1) 02/14→08/20								
 Hauptbremszylinder								
1.6 1.6 TDI	81 66 - 85	05/14→11/16 02/14→08/20		für Linkslenker		24.4123-1719.3	011017	TRW Ø 23,8 ohne Bremsflüssigkeitsbehälter
2.0 TDI	81	05/14→11/17				24.4153-1522.3	011048	ATE Ø 23,8 ohne Bremsflüssigkeitsbehälter
1.4 TSI 1.6 TDI 2.0 TDI	110 81 110	02/14→07/18 02/14→11/16 02/14→08/20		05/14→; für Linkslenker		24.4123-1719.3	011017	TRW Ø 23,8 ohne Bremsflüssigkeitsbehälter
				für Linkslenker		24.4153-1522.3	011048	ATE Ø 23,8 ohne Bremsflüssigkeitsbehälter
VW - GOLF VAN IV Variant (1J5) 05/99→06/06								
 Bremskraftverstärker								
1.4 1.6 1.9 SDI 1.9 TDI	55 77 50 81	05/00→06/06 05/00→06/06 05/99→05/06 05/99→05/06		09/00→ 10/01; für Linkslenker; +PR 1AT		03.7860-0602.4	300141	ATE Ø 10" pneumatisch
				→ 08/00; für Linkslenker; +PR 1AT		03.7863-0402.4	300124	ATE Ø 10" pneumatisch
				11/01→ 10/03; für Linkslenker; +PR 1AT		03.7863-3502.4	300128	ATE Ø 10" pneumatisch
1.9 TDI	66	05/99→05/06		09/00→ 10/01; für Linkslenker; +PR 1AT		03.7860-0602.4	300141	ATE Ø 10" pneumatisch
				→ 08/00; für Linkslenker; +PR 1AT		03.7863-0402.4	300124	ATE Ø 10" pneumatisch
				11/01→; für Linkslenker; +PR 1AT		03.7863-3502.4	300128	ATE Ø 10" pneumatisch
1.9 TDI	74	02/00→06/06		→ 10/01; für Linkslenker; +PR 1AT		03.7860-0602.4	300141	ATE Ø 10" pneumatisch
				11/01→; für Linkslenker; +PR 1AT		03.7863-3502.4	300128	ATE Ø 10" pneumatisch
1.9 TDI	85	05/99→04/02		09/00→; für Linkslenker; +PR 1AT		03.7860-0602.4	300141	ATE Ø 10" pneumatisch
				→ 08/00; für Linkslenker; +PR 1AT		03.7863-0402.4	300124	ATE Ø 10" pneumatisch
1.9 TDI	96	04/01→05/06		→ 10/01; für Linkslenker; +PR 1AT		03.7860-0602.4	300141	ATE Ø 10" pneumatisch
				11/01→ 10/03; für Linkslenker; +PR 1AT		03.7863-3502.4	300128	ATE Ø 10" pneumatisch
 Hauptbremszylinder								
1.4 1.6 1.9 SDI 1.9 TDI	55 77 50 81	05/00→06/06 05/00→06/06 05/99→05/06 05/99→05/06		→ 08/00; für Linkslenker; +PR 1AT		03.2123-2024.3	010597	ATE Ø 23,8
				→ 08/00; für Rechtslenker; +PR 1AT		03.2123-2064.3	010598	ATE Ø 23,8
				09/00→ 10/03; für Linkslenker; +PR 1AT		03.2123-2715.3	010802	ATE Ø 23,8
				09/00→ 10/03; für Rechtslenker; +PR 1AT		03.2123-2774.3	010803	ATE Ø 23,8
				→ 10/03; für Linkslenker; +PR 1AM / 1AC / 1AH / 1AJ		24.2123-1709.3	010503	Ø 23,8
1.9 TDI	66 - 85	05/99→05/06		→ 08/00; für Linkslenker; +PR 1AT		03.2123-2024.3	010597	ATE Ø 23,8
				→ 08/00; für Rechtslenker; +PR 1AT		03.2123-2064.3	010598	ATE Ø 23,8
				09/00→; für Linkslenker; +PR 1AT		03.2123-2715.3	010802	ATE Ø 23,8
				09/00→; für Rechtslenker; +PR 1AT		03.2123-2774.3	010803	ATE Ø 23,8
				für Linkslenker; +PR 1AM / 1AC / 1AH / 1AJ		24.2123-1709.3	010503	Ø 23,8
1.9 TDI	74	02/00→06/06		für Linkslenker; +PR 1AT		03.2123-2715.3	010802	ATE Ø 23,8
				für Rechtslenker; +PR 1AT		03.2123-2774.3	010803	ATE Ø 23,8
				für Linkslenker; +PR 1AM / 1AC / 1AH / 1AJ		24.2123-1709.3	010503	Ø 23,8
1.9 TDI	96	04/01→05/06		→ 10/03; für Linkslenker; +PR 1AT		03.2123-2715.3	010802	ATE Ø 23,8
				→ 10/03; für Rechtslenker; +PR 1AT		03.2123-2774.3	010803	ATE Ø 23,8
				→ 10/03; für Linkslenker; +PR 1AM / 1AC / 1AH / 1AJ		24.2123-1709.3	010503	Ø 23,8
VW - GOLF VAN VI Variant (AJ5) 07/09→05/14								
 Bremskraftverstärker								
1.2 TSi 1.4 TSi 1.6 TDi BlueMotion 2.0 TDi	77 118 77 103	09/09→05/14 07/09→10/12 07/09→05/14 07/09→05/14		1K-9-400001→; → 11/10; für Linkslenker; +PR 1ZK		03.7860-8802.4	300291	ATE Ø 10" pneumatisch
				12/09→; für Linkslenker; +PR 1ZD / 1ZP		03.7863-3232.4	300307	ATE Ø 10" pneumatisch
				+PR 1AC / 1AT; → 11/09; für Linkslenker		03.7863-3332.4	300308	ATE Ø 10" pneumatisch
1.4 TSi	90	07/09→05/14		12/09→; für Linkslenker; +PR 1ZD / 1ZP		03.7863-3232.4	300307	ATE Ø 10" pneumatisch
				+PR 1AC / 1AT; → 11/09; für Linkslenker		03.7863-3332.4	300308	ATE Ø 10" pneumatisch
1.6 TDi	66	12/09→10/12		1K-9-400001→; → 11/10; für Linkslenker; +PR 1ZK		03.7860-8802.4	300291	ATE Ø 10" pneumatisch
				für Linkslenker; +PR 1ZD / 1ZP		03.7863-3232.4	300307	ATE Ø 10" pneumatisch
				+PR 1AC / 1AT; für Linkslenker		03.7863-3332.4	300308	ATE Ø 10" pneumatisch
 Hauptbremszylinder								
1.2 TSi 1.4 TSi	77 90 - 118	09/09→05/14 07/09→05/14		12/09→; für Linkslenker; +PR 1ZD / 1ZP		03.2122-2129.3	010799	ATE Ø 22,2
				→ 11/09; für Linkslenker; +PR 1AC / 1AT		03.2122-2129.3	010799	ATE Ø 22,2
1.6 TDi BlueMotion 2.0 TDi →	77 103	07/09→05/14 07/09→05/14		→ 11/09; +PR 1LJ / 1LL		03.2123-3449.3	010808	ATE Ø 23,8

	kw			 	! #		
VW - GOLF VAN VI Variant (AJ5) 07/09→05/14							
 Hauptbremszylinder							
1.2 TSi 1.4 TSi	77 90 - 118	09/09→05/14 07/09→05/14		→ 11/09; für Rechtslenker		24.4152-0132.3 011025	ATE Ø 22,2 ohne Bremsflüssigkeitsbehälter
1.6 TDi BlueMotion 2.0 TDi	77 103	07/09→05/14 07/09→05/14		12/09→; +PR 1ZD / 1ZP; für Rechtslenker		24.4152-0132.3 011025	ATE Ø 22,2 ohne Bremsflüssigkeitsbehälter
				→ 11/09; +PR 1LJ / 1LL; für Rechtslenker		24.4153-0202.3 011027	ATE Ø 23,8 ohne Bremsflüssigkeitsbehälter
				12/09→; +PR 1LJ / 1ZA / 1ZE; für Rechtslenker		24.4153-0202.3 011027	ATE Ø 23,8 ohne Bremsflüssigkeitsbehälter
1.6 TDi	66	12/09→10/12		für Linkslenker; +PR 1ZD / 1ZP / 1AC / 1AT		03.2122-2129.3 010799	ATE Ø 22,2
				+PR 1ZD / 1ZP; für Rechtslenker		24.4152-0132.3 011025	ATE Ø 22,2 ohne Bremsflüssigkeitsbehälter
				+PR 1LJ / 1ZA / 1ZE; für Rechtslenker		24.4153-0202.3 011027	ATE Ø 23,8 ohne Bremsflüssigkeitsbehälter
VW - GOLF VAN VII Variant (BA5) 04/13→03/17							
 Hauptbremszylinder							
1.2 TSi BlueMotion 1.4 TSi BlueMotion	63 - 77 90 - 103	04/13→03/17 05/13→03/17		für Linkslenker; +PR 1ZA / 1ZD / 1ZE / 1ZF / 1ZP		03.4153-5403.3 010994 24.4123-1719.3 011017	ATE Ø 23,8 TRW Ø 23,8 ohne Bremsflüssigkeitsbehälter
1.6 TDi BlueMotion 1.6 TDi BlueMotion 4motion 2.0 TDi BlueMotion 2.0 TDi BlueMotion 4motion	66 - 81 77 110 110	05/13→03/17 05/13→03/17 04/13→03/17 04/13→03/17					
VW - JETTA III (1K2) 09/04→12/13							
 Hauptbremszylinder							
1.4 TSI 1.6 1.6 FSI 1.6 MultiFuel 1.6 TDI 1.9 TDI 2.0 FSI 2.0 TDI 2.0 TDI 16V 2.0 TFSI 2.5	90 - 125 75 85 75 66 - 77 74 - 77 110 100 - 125 103 147 125	07/06→10/10 09/04→10/10 09/05→10/10 01/08→10/10 06/09→10/10 08/05→10/10 08/05→10/10 09/05→10/10 08/05→10/10 10/05→10/10 07/08→10/10		für Linkslenker; +PR 1AS für Rechtslenker		03.2122-2129.3 010799 24.2122-1981.3 011024	ATE Ø 22,2 ATE Ø 22,2 ohne Bremsflüssigkeitsbehälter
2.5	110	01/06→10/10		07/08→; für Linkslenker; +PR 1AS		03.2122-2129.3 010799	ATE Ø 22,2
				07/08→; für Rechtslenker		24.2122-1981.3 011024	ATE Ø 22,2 ohne Bremsflüssigkeitsbehälter
Hydraulikaggregat, Bremsanlage							
1.4 TSI 1.6 1.6 FSI 1.6 MultiFuel 1.6 TDI 1.9 TDI 2.0 FSI 2.0 TDI 2.0 TDI 16V 2.0 TFSI 2.5	90 - 125 75 85 75 66 - 77 74 - 77 110 100 - 125 103 147 125	07/06→10/10 09/04→10/10 09/05→10/10 01/08→10/10 06/09→10/10 08/05→10/10 08/05→10/10 09/05→10/10 08/05→10/10 10/05→10/10 07/08→10/10		+PR 1AT / 1AS		24.9145-0001.2 399005	
2.5	110	01/06→10/10		07/08→; +PR 1AT / 1AS		24.9145-0001.2 399005	
Drucksensor, Bremskraftverstärker							
1.4 TSI 1.6 1.6 FSI 1.6 MultiFuel 1.6 TDI →	90 - 125 75 85 75 66 - 77	07/06→10/10 09/04→10/10 09/05→10/10 01/08→10/10 06/09→10/10		für Linkslenker; +PR 1AS		03.0655-0101.2 370008	ATE

	kw					! #		
VW - JETTA III (1K2) 09/04→12/13								
Drucksensor, Bremskraftverstärker								
1.9 TDI	74 - 77	08/05→10/10			für Linkslenker; +PR 1AS		03.0655-0101.2 370008	ATE
2.0 FSI	110	08/05→10/10						
2.0 TDI	100 - 125	09/05→10/10						
2.0 TDI 16V	103	08/05→10/10						
2.0 TFSI	147	10/05→10/10						
2.5	125	07/08→10/10						
2.5	110	01/06→10/10			07/08→; für Linkslenker; +PR 1AS		03.0655-0101.2 370008	ATE
VW - JETTA IV (162, 163, AV3, AV2) 01/08→								
 Bremskraftverstärker								
2.0 TFSI	147	12/10→			04/11→; für Linkslenker; - ESP		03.7863-3332.4 300308	ATE Ø 10" pneumatisch
2.5	125	04/10→						
2.0 TSI	155	12/12→12/17			für Linkslenker; - ESP		03.7863-3332.4 300308	ATE Ø 10" pneumatisch
 Hauptbremszylinder								
1.2 TSI	77	10/10→12/17			04/11→; für Rechtslenker; +PR 1AT / 1AS		24.4152-0132.3 011025	ATE Ø 22,2 ohne Bremsflüssigkeitsbehälter
1.6 TDI	77	04/10→07/15						
2.0 TDI	103	02/11→			04/11→; für Rechtslenker; +PR 1AC		24.4153-0202.3 011027	ATE Ø 23,8 ohne Bremsflüssigkeitsbehälter
2.0 TFSI	147	12/10→						
2.5	125	04/10→						
1.2 TSI 16V	77	08/14→12/17			für Rechtslenker; +PR 1AT / 1AS		24.4152-0132.3 011025	ATE Ø 22,2 ohne Bremsflüssigkeitsbehälter
1.4 TSI	90 - 118	04/11→						
1.4 TSI Hybrid	125	04/11→			für Rechtslenker; +PR 1AC		24.4153-0202.3 011027	ATE Ø 23,8 ohne Bremsflüssigkeitsbehälter
1.6	63 - 81	12/11→						
1.6 MPI	66	09/15→04/18						
1.8 TSI	125	07/14→						
2.0	85	06/10→12/17						
2.0 TDI	81 - 110	10/10→						
2.0 TSI	155	12/12→12/17						
VW - JETTA VII Stufenheck (BU3, BU4) 12/17→								
 Hauptbremszylinder								
1.4 TSI	110	12/17→			für Rechtslenker; +PR 1AT / 1AS		24.4152-0132.3 011025	ATE Ø 22,2 ohne Bremsflüssigkeitsbehälter
					für Rechtslenker; +PR 1AC		24.4153-0202.3 011027	ATE Ø 23,8 ohne Bremsflüssigkeitsbehälter
VW - LOAD UP (121, 122, BL1, BL2) 12/14→								
 Hauptbremszylinder								
1.0	44	12/14→11/19			für Linkslenker		24.4120-1703.3 011015	TRW Ø 20,6 ohne Bremsflüssigkeitsbehälter
1.0 BlueMotion	55	05/16→11/19						
1.0 EcoFuel	50	12/14→08/20						
1.0 TSi BlueMotion	66	05/16→09/18						
VW - LT 28-35 II Bus (2DB, 2DE, 2DK) 04/96→07/06								
 Hauptbremszylinder								
2.3	105	05/96→07/06			→ 2D-X-012290; + ABS		24.2123-1711.3 010518	Ø 23,8
2.5 SDI	55	07/96→07/06			→ 2D-2-011024; + ABS		24.2123-1711.3 010518	Ø 23,8
2.5 TDI	75	05/96→08/99			→ 2D-2-011024; - ABS		24.2123-1728.3 010558	Ø 23,8
					2D-2-011025→		24.2123-1755.3 010750	Ø 23,8
					2D-X-012291→ 2D-2-011024; + ABS		24.2125-1727.3 010723	Ø 25,4
					2D-2-011025→; + ABS		24.2125-1735.3 010879	TRW Ø 25,4
2.5 TDI	61 - 80	05/99→07/06			→ 2D-2-011024; + ABS		24.2123-1711.3 010518	Ø 23,8
2.8 TDI	96 - 116	01/99→06/06			→ 2D-2-011024; - ABS		24.2123-1728.3 010558	Ø 23,8
					2D-2-011025→		24.2123-1755.3 010750	Ø 23,8
VW - LT 28-46 II Kasten (2DA, 2DD, 2DH) 04/96→07/06								
 Hauptbremszylinder								
2.3	105	05/96→07/06			→ 2D-2-011024; + ABS		24.2123-1711.3 010518	Ø 23,8
2.5 SDI	55	09/96→07/06			→ 2D-X-012290; + ABS		24.2123-1711.3 010518	Ø 23,8
2.5 TDI	61 - 80	05/96→07/06			→ 2D-2-011024; - ABS		24.2123-1728.3 010558	Ø 23,8
2.8 TDI	92 - 116	07/97→07/06			2D-2-011025→		24.2123-1755.3 010750	Ø 23,8
					2D-X-012291→ 2D-2-011024; + ABS		24.2125-1727.3 010723	Ø 25,4
					2D-2-011025→; + ABS		24.2125-1735.3 010879	TRW Ø 25,4

	kw					! #		
VW - LT 28-46 II Pritsche/Fahrgestell (2DC, 2DF, 2DG, 2DL, 2DM) 04/96→07/06								
 Hauptbremszylinder								
2.3	105	06/96→07/06		→ 2D-2-011024; + ABS		24.2123-1711.3	010518	Ø 23,8
2.5 SDI	55	09/96→07/06		→ 2D-X-012290; + ABS		24.2123-1711.3	010518	Ø 23,8
2.5 TDI	61 - 80	06/96→07/06		→ 2D-2-011024; - ABS		24.2123-1728.3	010558	Ø 23,8
2.8 TDI	92 - 116	07/97→07/06		2D-2-011025→		24.2123-1755.3	010750	Ø 23,8
				2D-X-012291→ 2D-2-011024; + ABS		24.2125-1727.3	010723	Ø 25,4
				2D-2-011025→; + ABS		24.2125-1735.3	010879	TRW Ø 25,4
VW - LUPO I (6X1, 6E1) 09/98→07/05								
 Bremskraftverstärker								
1.4 16V	74	08/99→07/05		für Linkslenker; + ESP; +PR 1AT / 1LX / 1ZE		03.7853-0102.4	300252	ATE Ø 9" pneumatisch
1.4 FSI	77	02/01→07/05						
1.6 GTI	92	09/00→07/05						
 Hauptbremszylinder								
1.0	37	09/98→07/05		- ABS		03.2120-3943.3	010532	ATE Ø 20,6
1.2 TDI 3L	45	07/99→07/05		für Linkslenker; + ABS / - ESP		03.2122-1344.3	010593	ATE Ø 22,2
1.4	44	10/00→07/05						
1.4 TDI	55	01/99→07/05						
1.7 SDI	44	09/98→07/05						
1.4 16V	55	09/98→07/05		10/98→; - ABS		03.2120-3943.3	010532	ATE Ø 20,6
				10/98→; für Linkslenker; + ABS / - ESP		03.2122-1344.3	010593	ATE Ø 22,2
1.4 16V	74	08/99→07/05		für Linkslenker; + ABS / - ESP		03.2123-1824.3	010596	ATE Ø 23,8
1.4 FSI	77	02/01→07/05						
1.6 GTI	92	09/00→07/05						
VW - MULTIVAN T5 (7HM, 7HN, 7HF, 7EF, 7EM, 7EN) 04/03→08/15								
 Bremskraftverstärker								
1.9 TDI	62 - 77	04/03→11/09		+PR 1AJ / 1AE / 1AC / 1AR; → 7H-A-050000		03.7765-1002.4	300246	ATE Ø 10 / 9" pneumatisch
2.0	85	11/03→08/15						
2.0 BiTDI	132	09/09→08/15		+PR 1AK; → 7H-A-050000		03.7868-3702.4	300208	ATE Ø 10 / 8" pneumatisch
2.0 BiTDI 4motion	132	09/09→08/15						
2.0 TDI	62 - 103	09/09→08/15						
2.0 TDI 4motion	103	09/09→08/15						
2.5 TDI	96 - 128	04/03→11/09						
2.5 TDI 4motion	96 - 128	07/04→11/09						
VR6 3.2	173	02/04→12/09						
VR6 3.2 4motion	173	07/04→12/09						
Pedalwegsensor, Bremspedal								
1.9 TDI	62 - 77	04/03→11/09		+PR 1AT; → 7H-A-050000		03.0655-0006.2	370006	ATE
2.0	85	11/03→08/15						
2.0 BiTDI	132	09/09→08/15						
2.0 BiTDI 4motion	132	09/09→08/15						
2.0 TDI	62 - 103	09/09→08/15						
2.0 TDI 4motion	103	09/09→08/15						
2.5 TDI	96 - 128	04/03→11/09						
2.5 TDI 4motion	96 - 128	07/04→11/09						
VR6 3.2	173	02/04→12/09						
VR6 3.2 4motion	173	07/04→12/09						
 Hauptbremszylinder								
1.9 TDI	62 - 77	04/03→11/09		→ 7H-A-050000		03.2126-3014.3	010811	ATE Ø 27
2.0	85	11/03→08/15						
VR6 3.2	173	02/04→12/09		7H-6-000001→ 7H-6-200000; für Rechtslenker; +PR 1AT		03.2126-3014.3	010811	ATE Ø 27
				7H-A-200001→		03.2126-3144.3	010941	ATE Ø 27
2.0 BiTDI	132	09/09→08/15		→ 7H-A-050000		03.2126-3014.3	010811	ATE Ø 27
2.0 BiTDI 4motion	132	09/09→08/15						
2.0 TDI	62 - 103	09/09→08/15		7H-A-200001→		03.2126-3144.3	010941	ATE Ø 27
2.0 TDI 4motion	100 - 103	09/09→08/15						
2.5 TDI	96 - 128	04/03→11/09						
2.5 TDI 4motion	96 - 128	07/04→11/09						
VR6 3.2 4motion	173	07/04→12/09						
2.0 TDI	84	05/11→08/15				03.2126-3144.3	010941	ATE Ø 27
→								

	kw					! #		
VW - MULTIVAN T5 (7HM, 7HN, 7HF, 7EF, 7EM, 7EN) 04/03→08/15								
 Hauptbremszylinder								
2.0 TSI	110	05/11→08/15				03.2126-3144.3	010941	ATE Ø 27
2.0 TSI 4motion	150	07/11→08/15						
VW - NEW BEETLE (9C1, 1C1) 01/98→11/10								
 Bremskraftverstärker								
1.4	55	11/01→09/10		→ 9C-2-620000; für Linkslenker; + ESP		03.7860-0602.4	300141	ATE Ø 10" pneumatisch
				9C-2-620001→; für Linkslenker; + ESP; → 05/10		03.7863-3502.4	300128	ATE Ø 10" pneumatisch
1.6	74	10/99→09/00		9C-Y-613783→ 9C-2-620000; für Linkslenker; + ESP		03.7860-0602.4	300141	ATE Ø 10" pneumatisch
				11/99→; → 9C-Y-613782; für Linkslenker; + ESP		03.7863-0402.4	300124	ATE Ø 10" pneumatisch
				9C-2-620001→; für Linkslenker; + ESP		03.7863-3502.4	300128	ATE Ø 10" pneumatisch
1.6	75	06/00→09/10		9C-Y-613783→ 9C-2-620000; für Linkslenker; + ESP		03.7860-0602.4	300141	ATE Ø 10" pneumatisch
1.8 T	110	10/99→09/10						
1.9 TDI	74	02/01→09/10		→ 9C-Y-613782; für Linkslenker; + ESP		03.7863-0402.4	300124	ATE Ø 10" pneumatisch
2.0	85	01/98→09/10		9C-2-620001→; für Linkslenker; + ESP; → 05/10		03.7863-3502.4	300128	ATE Ø 10" pneumatisch
2.5	110	07/05→09/10						
1.8 T	132	11/01→06/05		→ 9C-2-620000; für Linkslenker; + ESP		03.7860-0602.4	300141	ATE Ø 10" pneumatisch
				9C-2-620001→; für Linkslenker; + ESP		03.7863-3502.4	300128	ATE Ø 10" pneumatisch
1.9 TDI	66	01/98→06/04		9C-Y-613783→; → 02/01; für Linkslenker; + ESP		03.7860-0602.4	300141	ATE Ø 10" pneumatisch
				→ 9C-Y-613782; für Linkslenker; + ESP		03.7863-0402.4	300124	ATE Ø 10" pneumatisch
1.9 TDI	77	07/05→09/10		für Linkslenker; + ESP; → 05/10		03.7863-3502.4	300128	ATE Ø 10" pneumatisch
2.3 V5	125	10/00→09/10		9C-Y-613783→ 9C-2-620000; für Linkslenker; + ESP		03.7860-0602.4	300141	ATE Ø 10" pneumatisch
				→ 9C-Y-613782; für Linkslenker; + ESP		03.7863-0402.4	300124	ATE Ø 10" pneumatisch
				9C-2-620001→; für Linkslenker; + ESP; → 05/05		03.7863-3502.4	300128	ATE Ø 10" pneumatisch
3.2 RSI 4motion	165	04/00→05/01		9C-Y-613783→ 9C-2-620000; für Linkslenker; + ESP		03.7860-0602.4	300141	ATE Ø 10" pneumatisch
				→ 9C-Y-613782; für Linkslenker; + ESP		03.7863-0402.4	300124	ATE Ø 10" pneumatisch
				9C-2-620001→; für Linkslenker; + ESP		03.7863-3502.4	300128	ATE Ø 10" pneumatisch
 Hauptbremszylinder								
1.4	55	11/01→09/10		für Linkslenker; + ESP; → 05/10		03.2123-2715.3	010802	ATE Ø 23,8
				9C-7-557429→; für Rechtslenker; + ESP; → 05/10		03.2123-2774.3	010803	ATE Ø 23,8
				für Rechtslenker; + ESP; → 9C-7-557428		03.2123-2774.3	010803	ATE Ø 23,8
				für Linkslenker; - ESP; → 06/05		24.2123-1709.3	010503	Ø 23,8
1.6	74	10/99→09/00		11/99→; → 9C-Y-613782; für Linkslenker; + ESP		03.2123-2024.3	010597	ATE Ø 23,8
				11/99→; → 9C-Y-613782; für Rechtslenker; + ESP		03.2123-2064.3	010598	ATE Ø 23,8
				9C-Y-613783→; für Linkslenker; + ESP		03.2123-2715.3	010802	ATE Ø 23,8
				9C-Y-613783→; für Rechtslenker; + ESP; → 9C-7-557428		03.2123-2774.3	010803	ATE Ø 23,8
				9C-7-557429→; für Rechtslenker; + ESP		03.2123-2774.3	010803	ATE Ø 23,8
				11/99→; für Linkslenker; - ESP		24.2123-1709.3	010503	Ø 23,8
1.6	75	06/00→09/10		→ 9C-Y-613782; für Linkslenker; + ESP		03.2123-2024.3	010597	ATE Ø 23,8
1.8 T	110	10/99→09/10		→ 9C-Y-613782; für Rechtslenker; + ESP		03.2123-2064.3	010598	ATE Ø 23,8
1.9 TDI	74	02/01→09/10						
2.0	85	01/98→09/10		9C-Y-613783→; für Linkslenker; + ESP; → 05/10		03.2123-2715.3	010802	ATE Ø 23,8
				9C-Y-613783→; für Rechtslenker; + ESP; → 9C-7-557428		03.2123-2774.3	010803	ATE Ø 23,8
				9C-7-557429→; für Rechtslenker; + ESP; → 05/10		03.2123-2774.3	010803	ATE Ø 23,8
				für Linkslenker; - ESP; → 06/05		24.2123-1709.3	010503	Ø 23,8
1.8 T	132	11/01→06/05		für Linkslenker; + ESP		03.2123-2715.3	010802	ATE Ø 23,8
				für Rechtslenker; + ESP		03.2123-2774.3	010803	ATE Ø 23,8
				für Linkslenker; - ESP		24.2123-1709.3	010503	Ø 23,8
1.9 TDI	66	01/98→06/04		→ 9C-Y-613782; für Linkslenker; + ESP		03.2123-2024.3	010597	ATE Ø 23,8
				→ 9C-Y-613782; für Rechtslenker; + ESP		03.2123-2064.3	010598	ATE Ø 23,8
				9C-Y-613783→; → 02/01; für Linkslenker; + ESP		03.2123-2715.3	010802	ATE Ø 23,8
→								



VW - NEW BEETLE (9C1, 1C1) 01/98→11/10

Hauptbremszylinder

1.9 TDI	66	01/98→06/04	9C-Y-613783→; → 02/01; für Rechtslenker; + ESP	03.2123-2774.3	010803	ATE Ø 23,8
			→ 02/01; für Linkslenker; - ESP	24.2123-1709.3	010503	Ø 23,8
1.9 TDI	77	07/05→09/10	für Linkslenker; + ESP; → 05/10	03.2123-2715.3	010802	ATE Ø 23,8
			9C-7-557429→; für Rechtslenker; + ESP; → 05/10	03.2123-2774.3	010803	ATE Ø 23,8
			für Rechtslenker; + ESP; → 9C-7-557428	03.2123-2774.3	010803	ATE Ø 23,8
2.3 V5	125	10/00→09/10	→ 9C-Y-613782; für Linkslenker; + ESP	03.2123-2024.3	010597	ATE Ø 23,8
			→ 9C-Y-613782; für Rechtslenker; + ESP	03.2123-2064.3	010598	ATE Ø 23,8
			9C-Y-613783→; für Linkslenker; + ESP; → 12/05	03.2123-2715.3	010802	ATE Ø 23,8
			9C-Y-613783→; für Rechtslenker; + ESP; → 12/05	03.2123-2774.3	010803	ATE Ø 23,8
			für Linkslenker; - ESP; → 05/05	24.2123-1709.3	010503	Ø 23,8
2.5	110	07/05→09/10	→ 9C-Y-613782; für Linkslenker; + ESP	03.2123-2024.3	010597	ATE Ø 23,8
			→ 9C-Y-613782; für Rechtslenker; + ESP	03.2123-2064.3	010598	ATE Ø 23,8
			9C-Y-613783→; für Linkslenker; + ESP; → 05/10	03.2123-2715.3	010802	ATE Ø 23,8
			9C-Y-613783→; für Rechtslenker; + ESP; → 9C-7-557428	03.2123-2774.3	010803	ATE Ø 23,8
			9C-7-557429→; für Rechtslenker; + ESP; → 05/10	03.2123-2774.3	010803	ATE Ø 23,8
			für Linkslenker; - ESP	24.2123-1709.3	010503	Ø 23,8
3.2 RSI 4motion	165	04/00→05/01	→ 9C-Y-613782; für Linkslenker; + ESP	03.2123-2024.3	010597	ATE Ø 23,8
			→ 9C-Y-613782; für Rechtslenker; + ESP	03.2123-2064.3	010598	ATE Ø 23,8
			9C-Y-613783→; für Linkslenker; + ESP	03.2123-2715.3	010802	ATE Ø 23,8
			9C-Y-613783→; für Rechtslenker; + ESP	03.2123-2774.3	010803	ATE Ø 23,8
			für Linkslenker; - ESP	24.2123-1709.3	010503	Ø 23,8

Bremskraftregler

1.4	55	11/01→09/10	- ABS; → 06/05	03.6583-0179.3	320228	ATE lastabhängig 8/3 4x
1.6	75	06/00→09/10				
1.8 T	110	10/99→09/10				
1.9 TDI	74	02/01→09/10				
2.0	85	01/98→09/10				
1.6	74	10/99→09/00	11/99→; - ABS	03.6583-0179.3	320228	ATE lastabhängig 8/3 4x
1.8 T	132	11/01→06/05	- ABS	03.6583-0179.3	320228	ATE lastabhängig 8/3 4x
2.5	110	07/05→09/10				
3.2 RSI 4motion	165	04/00→05/01				
1.9 TDI	66	01/98→06/04	→ 02/01; - ABS	03.6583-0179.3	320228	ATE lastabhängig 8/3 4x
2.3 V5	125	10/00→09/10	- ABS; → 05/05	03.6583-0179.3	320228	ATE lastabhängig 8/3 4x













VW - NEW BEETLE Cabriolet (1Y7) 09/02→12/11

Bremskraftverstärker

1.4	55	01/03→09/10	für Linkslenker; + ESP; → 05/10	03.7863-3502.4	300128	ATE Ø 10" pneumatisch
1.6	75	01/03→09/10				
1.9 TDI	77	07/05→09/10				
2.5	110	07/05→09/10				
1.8 T	110	01/03→09/10	12/03→; für Linkslenker; + ESP; → 05/10	03.7863-3502.4	300128	ATE Ø 10" pneumatisch
1.9 TDI	74	06/03→09/10	07/03→; für Linkslenker; + ESP; → 05/10	03.7863-3502.4	300128	ATE Ø 10" pneumatisch
2.0	85	09/02→10/10	01/03→; für Linkslenker; + ESP; → 05/10	03.7863-3502.4	300128	ATE Ø 10" pneumatisch

Hauptbremszylinder

1.4	55	01/03→09/10	für Linkslenker; + ESP; → 05/10	03.2123-2715.3	010802	ATE Ø 23,8
			1Y-7-413421→; für Rechtslenker; + ESP; → 05/10	03.2123-2774.3	010803	ATE Ø 23,8
1.6	75	01/03→09/10	für Rechtslenker; + ESP; → 1Y-7-413420	03.2123-2774.3	010803	ATE Ø 23,8
			für Linkslenker; - ESP; → 06/05	24.2123-1709.3	010503	Ø 23,8
1.8 T	110	01/03→09/10	12/03→; für Linkslenker; + ESP; → 05/10	03.2123-2715.3	010802	ATE Ø 23,8
			1Y-7-413421→; für Rechtslenker; + ESP; → 05/10	03.2123-2774.3	010803	ATE Ø 23,8
			12/03→; für Rechtslenker; + ESP; → 1Y-7-413420	03.2123-2774.3	010803	ATE Ø 23,8
			12/03→; für Linkslenker; - ESP; → 06/05	24.2123-1709.3	010503	Ø 23,8
1.9 TDI	74	06/03→09/10	07/03→; für Linkslenker; + ESP; → 05/10	03.2123-2715.3	010802	ATE Ø 23,8
→						

	kw					! #		
VW - NEW BEETLE Cabriolet (1Y7) 09/02→12/11								
 Hauptbremszylinder								
1.9 TDI	74	06/03→09/10		1Y-7-413421→; für Rechtslenker; + ESP; → 05/10	03.2123-2774.3	010803	ATE Ø 23,8	
				07/03→; für Rechtslenker; + ESP; → 1Y-7-413420	03.2123-2774.3	010803	ATE Ø 23,8	
				07/03→; für Linkslenker; - ESP; → 06/05	24.2123-1709.3	010503	Ø 23,8	
1.9 TDI 2.5	77 110	07/05→09/10 07/05→09/10		für Linkslenker; + ESP; → 05/10	03.2123-2715.3	010802	ATE Ø 23,8	
				1Y-7-413421→; für Rechtslenker; + ESP; → 05/10	03.2123-2774.3	010803	ATE Ø 23,8	
2.0	85	09/02→10/10		für Rechtslenker; + ESP; → 1Y-7-413420	03.2123-2774.3	010803	ATE Ø 23,8	
				01/03→; für Linkslenker; + ESP; → 05/10	03.2123-2715.3	010802	ATE Ø 23,8	
				1Y-7-413421→; für Rechtslenker; + ESP; → 05/10	03.2123-2774.3	010803	ATE Ø 23,8	
				01/03→; für Rechtslenker; + ESP; → 1Y-7-413420	03.2123-2774.3	010803	ATE Ø 23,8	
				01/03→; für Linkslenker; - ESP; → 06/05	24.2123-1709.3	010503	Ø 23,8	
VW - PASSAT ALLTRACK B7 (365) 01/12→12/14								
 Bremskraftverstärker								
1.8 TSI	112 - 118	01/12→12/14		+PR 1ZG; für Linkslenker	03.7873-4402.4	300292	ATE Ø 11" pneumatisch	
2.0 TDI 2.0 TDI 4motion	103 103 - 130	01/12→12/14 01/12→12/14		+PR 1LA / 1LB / 1ZM; für Linkslenker	03.7873-4502.4	300284	ATE Ø 11" pneumatisch	
2.0 TSI 4motion	155	01/12→12/14						
 Hauptbremszylinder								
1.8 TSI	112 - 118	01/12→12/14		+PR 1ZG; für Linkslenker	03.4152-0116.3	010814	ATE Ø 22,2	
2.0 TDI	103	01/12→12/14		+PR 1LA / 1LB / 1ZM; für Linkslenker	03.4153-0186.3	010816	ATE Ø 23,8	
2.0 TDI 4motion	103 - 130	01/12→12/14		+PR 1LA / 1LB / 1ZM; für Rechtslenker	24.4153-0192.3	011026	ATE Ø 23,8 ohne Bremsflüssigkeitsbehälter	
2.0 TSI 4motion	155	01/12→12/14						
VW - PASSAT ALLTRACK B8 Variant (3G5, CB5) 05/15→								
 Hauptbremszylinder								
1.4 TSI 4motion	110	05/15→		für Linkslenker; +PR 1ZA / 1ZD	24.4123-1719.3	011017	TRW Ø 23,8 ohne Bremsflüssigkeitsbehälter	
2.0 TDI 4motion	110 - 176	05/15→						
2.0 TSI 4motion	162 - 206	07/15→			24.4153-1522.3	011048	ATE Ø 23,8 ohne Bremsflüssigkeitsbehälter	
VW - PASSAT B3/B4 Variant (3A5, 35I) 02/88→06/97								
 Bremskraftverstärker								
1.8	55	08/90→05/97		10/93→ 12/96; für Linkslenker; - ABS	03.7750-4302.4	300076	ATE Ø 9" pneumatisch	
1.9 TD	55	03/91→05/97		→ 10/93; für Linkslenker; - ABS	03.7750-4302.4	300076	ATE Ø 9" pneumatisch	
2.8 VR6	128	06/91→05/97		10/93→ 12/95; für Rechtslenker; - ABS	03.7750-4902.4	300079	ATE Ø 9" pneumatisch	
				→ 10/93; für Rechtslenker; - ABS	03.7750-4902.4	300079	ATE Ø 9" pneumatisch	
1.8	66	02/88→05/97		10/93→ 12/96; für Linkslenker; - ABS	03.7750-4302.4	300076	ATE Ø 9" pneumatisch	
				04/88→ 10/93; für Linkslenker; - ABS	03.7750-4302.4	300076	ATE Ø 9" pneumatisch	
				10/93→ 12/95; für Rechtslenker; - ABS	03.7750-4902.4	300079	ATE Ø 9" pneumatisch	
				04/88→ 10/93; für Rechtslenker; - ABS	03.7750-4902.4	300079	ATE Ø 9" pneumatisch	
1.9 TDI	66	10/93→05/97		→ 12/96; für Linkslenker; - ABS	03.7750-4302.4	300076	ATE Ø 9" pneumatisch	
2.0 16V	110	01/94→05/97		→ 12/95; für Rechtslenker; - ABS	03.7750-4902.4	300079	ATE Ø 9" pneumatisch	
1.9 TDI	81	03/96→05/97		→ 12/96; für Linkslenker; - ABS	03.7750-4302.4	300076	ATE Ø 9" pneumatisch	
2.0	85	02/90→05/97		03/90→ 10/93; für Linkslenker; - ABS	03.7750-4302.4	300076	ATE Ø 9" pneumatisch	
				10/93→ 12/96; für Linkslenker; - ABS	03.7750-4302.4	300076	ATE Ø 9" pneumatisch	
				03/90→ 10/93; für Rechtslenker; - ABS	03.7750-4902.4	300079	ATE Ø 9" pneumatisch	
				10/93→ 12/95; für Rechtslenker; - ABS	03.7750-4902.4	300079	ATE Ø 9" pneumatisch	
 Hauptbremszylinder								
1.8	55	08/90→05/97		→ 07/91; - ABS	03.2120-3943.3	010532	ATE Ø 20,6	
1.9 TD	55	03/91→05/97		08/91→ 10/93; - ABS	03.2122-1042.3	010137	Ø 22,2	
				10/93→ 12/96; - ABS	03.2122-1042.3	010137	Ø 22,2	
				3A-T-000001→; → 12/96; für Linkslenker; + ABS	03.2123-1424.3	010637	ATE Ø 23,8	
				3A-T-000001→; → 12/96; für Rechtslenker; + ABS	03.2123-1484.3	010595	ATE Ø 23,8	
→								

VW - PASSAT B3/B4 Variant (3A5, 35I) 02/88→06/97

Hauptbremszylinder

1.8 1.9 TD	55 55	08/90→05/97 03/91→05/97		10/93→; → 3A-S-300000; für Linkslenker; + ABS	10.6123-0674.3 010639	ATE Ø 23,8
1.8	66	02/88→05/97		10/93→ 12/96; - ABS	03.2122-1042.3 010137	Ø 22,2
				04/88→ 10/93; - ABS	03.2122-1042.3 010137	Ø 22,2
				3A-T-000001→; → 12/96; für Linkslenker; + ABS	03.2123-1424.3 010637	ATE Ø 23,8
				3A-T-000001→; → 12/96; für Rechtslenker; + ABS	03.2123-1484.3 010595	ATE Ø 23,8
				10/93→; → 3A-S-300000; für Linkslenker; + ABS	10.6123-0674.3 010639	ATE Ø 23,8
1.9 TDI 2.0 16V	66 - 81 110	10/93→05/97		→ 12/96; - ABS	03.2122-1042.3 010137	Ø 22,2
				3A-T-000001→; → 12/96; für Linkslenker; + ABS	03.2123-1424.3 010637	ATE Ø 23,8
		01/94→05/97		3A-T-000001→; → 12/96; für Rechtslenker; + ABS	03.2123-1484.3 010595	ATE Ø 23,8
				→ 3A-S-300000; für Linkslenker; + ABS	10.6123-0674.3 010639	ATE Ø 23,8
2.0	85	02/90→05/97		03/90→ 07/91; - ABS	03.2120-3943.3 010532	ATE Ø 20,6
				10/93→ 12/96; - ABS	03.2122-1042.3 010137	Ø 22,2
				08/91→ 10/93; - ABS	03.2122-1042.3 010137	Ø 22,2
				3A-T-000001→; → 12/96; für Linkslenker; + ABS	03.2123-1424.3 010637	ATE Ø 23,8
				3A-T-000001→; → 12/96; für Rechtslenker; + ABS	03.2123-1484.3 010595	ATE Ø 23,8
				10/93→; → 3A-S-300000; für Linkslenker; + ABS	10.6123-0674.3 010639	ATE Ø 23,8
2.8 VR6	128	06/91→05/97		10/93→ 12/96; - ABS	03.2122-1042.3 010137	Ø 22,2
				3A-T-000001→; → 12/96; für Linkslenker; + ABS	03.2123-1424.3 010637	ATE Ø 23,8
				3A-T-000001→; → 12/96; für Rechtslenker; + ABS	03.2123-1484.3 010595	ATE Ø 23,8
				10/93→; → 3A-S-300000; für Linkslenker; + ABS	10.6123-0674.3 010639	ATE Ø 23,8
2.9 VR6 Syncro	135	01/94→05/97		3A-T-000001→; → 12/96; für Linkslenker; + ABS	03.2123-1424.3 010637	ATE Ø 23,8
				10/94→; → 3A-S-300000; für Linkslenker; + ABS	10.6123-0674.3 010639	ATE Ø 23,8









Verschlusschraube, Hauptbremszylinder

1.8 1.9 TD	55 55	08/90→05/97 03/91→05/97		10/93→ 12/96; - ABS	03.3517-0101.2 390322	
				08/91→ 10/93; - ABS	03.3517-0101.2 390322	
				→ 07/91; - ABS	03.3517-0101.2 390322	
1.8	66	02/88→05/97		10/93→ 12/96; - ABS	03.3517-0101.2 390322	
				04/88→ 10/93; - ABS	03.3517-0101.2 390322	
1.9 TDI	66 - 81	10/93→05/97		→ 12/96; - ABS	03.3517-0101.2 390322	
2.0 16V	110	01/94→05/97				
2.0	85	02/90→05/97		10/93→ 12/96; - ABS	03.3517-0101.2 390322	
				08/91→ 10/93; - ABS	03.3517-0101.2 390322	
				03/90→ 07/91; - ABS	03.3517-0101.2 390322	
2.8 VR6	128	06/91→05/97		10/93→ 12/96; - ABS	03.3517-0101.2 390322	









VW - PASSAT B5.5 (3B3) 10/00→12/05











Hauptbremszylinder













1.6	75	11/00→05/05		05/02→	03.2125-0373.3 010810	ATE Ø 25,4
1.8 T	125	02/01→11/05		→ 3B-X-800000; - ESP	24.2123-1717.3 010521	Ø 23,8
1.8 T 20V	110	11/00→05/05		→ 3B-X-800000; + ESP	24.2123-1730.3 010620	Ø 23,8
2.3 V5	125	11/00→05/05		→ 3B-X-800000; + ESP	24.2123-1730.3 010620	Ø 23,8
2.3 V5 4motion	125	11/00→05/05		3B-Y-000001→ 3B-1-400000; für Linkslenker; - ESP	24.2125-1712.3 010622	Ø 25,4
2.5 TDI	110	11/00→05/05		3B-Y-000001→ 3B-1-400000; für Linkslenker; - ESP	24.2125-1712.3 010622	Ø 25,4
2.5 TDI 4motion	110	11/00→05/05		3B-Y-000001→ 3B-1-400000; für Linkslenker; + ESP	24.2125-1713.3 010623	Ø 25,4
2.8 4motion	140 - 142	10/00→05/05		3B-2-000001→	24.2125-1720.3 010688	TRW Ø 25,4
1.8 T 4motion	125	11/03→05/05		→ 3B-X-800000; - ESP	24.2123-1717.3 010521	Ø 23,8
				→ 3B-X-800000; + ESP	24.2123-1730.3 010620	Ø 23,8
1.9 TDI	74 - 96	11/00→05/05		05/02→	03.2125-0373.3 010810	ATE Ø 25,4
1.9 TDI 4motion	96	11/00→05/05		→ 3B-1-400000; für Linkslenker; - ESP	24.2125-1712.3 010622	Ø 25,4
2.0	85	11/00→05/05		→ 3B-1-400000; für Linkslenker; + ESP	24.2125-1713.3 010623	Ø 25,4
2.0 4motion	85	11/00→05/05		3B-2-000001→	24.2125-1720.3 010688	TRW Ø 25,4
2.0 →	96	11/01→05/05		05/02→	03.2125-0373.3 010810	ATE Ø 25,4













	kw			 	! #		
VW - PASSAT B5.5 (3B3) 10/00→12/05							
 Hauptbremszylinder							
2.0	96	11/01→05/05		05/02→		24.2125-1720.3 010688	TRW Ø 25,4
2.0 TDI	100	12/03→05/05				03.2125-0373.3 010810	ATE Ø 25,4
						24.2125-1720.3 010688	TRW Ø 25,4
2.5 TDI 2.5 TDI 4motion 2.8	120 132 140 - 142	05/03→05/05 01/03→05/05 10/00→05/05				03.2125-0373.3 010810	ATE Ø 25,4
					→ 3B-X-800000; - ESP	24.2123-1717.3 010521	Ø 23,8
					→ 3B-X-800000; + ESP	24.2123-1730.3 010620	Ø 23,8
					3B-Y-000001→ 3B-1-400000; für Linkslenker; - ESP	24.2125-1712.3 010622	Ø 25,4
					3B-Y-000001→ 3B-1-400000; für Linkslenker; + ESP	24.2125-1713.3 010623	Ø 25,4
4.0 W8 4motion	202	09/01→09/04		05/02→		03.2125-0373.3 010810	ATE Ø 25,4
						24.2125-1720.3 010688	TRW Ø 25,4
VW - PASSAT B5.5 Variant (3B6) 09/00→08/05							
 Hauptbremszylinder							
1.6 1.8 T 20V	75 110	11/00→05/05		05/02→		03.2125-0373.3 010810	ATE Ø 25,4
					→ 3B-X-800000; - ESP	24.2123-1717.3 010521	Ø 23,8
2.3 VR5	125	11/00→05/05				24.2123-1730.3 010620	Ø 23,8
2.3 VR5 4motion	125	11/00→05/05				24.2123-1730.3 010620	Ø 23,8
2.5 TDI	110	11/00→05/05				24.2125-1712.3 010622	Ø 25,4
2.5 TDI 4motion	110	11/00→05/05				24.2125-1712.3 010622	Ø 25,4
2.8 4motion	140 - 142	10/00→05/05				24.2125-1713.3 010623	Ø 25,4
					3B-Y-000001→ 3B-1-400000; für Linkslenker; + ESP	24.2125-1713.3 010623	Ø 25,4
1.8 4motion	125	11/03→05/05				03.2125-0373.3 010810	ATE Ø 25,4
					→ 3B-1-400000; für Linkslenker; - ESP	24.2125-1712.3 010622	Ø 25,4
					→ 3B-1-400000; für Linkslenker; + ESP	24.2125-1713.3 010623	Ø 25,4
1.8 T	125	05/02→08/05		05/02→		03.2125-0373.3 010810	ATE Ø 25,4
					→ 06/05	03.2125-0373.3 010810	ATE Ø 25,4
					→ 3B-X-800000; - ESP	24.2123-1717.3 010521	Ø 23,8
					→ 3B-X-800000; + ESP	24.2123-1730.3 010620	Ø 23,8
					3B-Y-000001→ 3B-1-400000; für Linkslenker; - ESP	24.2125-1712.3 010622	Ø 25,4
3B-Y-000001→ 3B-1-400000; für Linkslenker; + ESP	24.2125-1713.3 010623	Ø 25,4					
3B-2-000001→; → 06/05	24.2125-1720.3 010688	TRW Ø 25,4					
1.9 TDI	74	11/00→05/05		05/02→		03.2125-0373.3 010810	ATE Ø 25,4
1.9 TDI 4motion	96	11/00→05/05				24.2125-1712.3 010622	Ø 25,4
					→ 3B-1-400000; für Linkslenker; - ESP	24.2125-1712.3 010622	Ø 25,4
2.0	85	11/00→05/05				24.2125-1713.3 010623	Ø 25,4
2.0 4motion	85	11/00→05/05				24.2125-1720.3 010688	TRW Ø 25,4
2.0	96	11/01→05/05		05/02→		03.2125-0373.3 010810	ATE Ø 25,4
2.0 TDI	100	12/03→05/05				24.2125-1720.3 010688	TRW Ø 25,4
						03.2125-0373.3 010810	ATE Ø 25,4
						24.2125-1720.3 010688	TRW Ø 25,4
2.5 TDI 2.5 TDI 4motion	120 132	05/03→05/05 01/03→05/05				03.2125-0373.3 010810	ATE Ø 25,4
					→ 3B-X-800000; - ESP	24.2123-1717.3 010521	Ø 23,8
					→ 3B-X-800000; + ESP	24.2123-1730.3 010620	Ø 23,8
					3B-Y-000001→ 3B-1-400000; für Linkslenker; - ESP	24.2125-1712.3 010622	Ø 25,4
					3B-Y-000001→ 3B-1-400000; für Linkslenker; + ESP	24.2125-1713.3 010623	Ø 25,4
3B-2-000001→	24.2125-1720.3 010688	TRW Ø 25,4					
2.8	142	10/00→08/05		05/02→ 06/05		03.2125-0373.3 010810	ATE Ø 25,4
					→ 3B-X-800000; - ESP	24.2123-1717.3 010521	Ø 23,8
					→ 3B-X-800000; + ESP	24.2123-1730.3 010620	Ø 23,8
					3B-Y-000001→ 3B-1-400000; für Linkslenker; - ESP	24.2125-1712.3 010622	Ø 25,4
					3B-Y-000001→ 3B-1-400000; für Linkslenker; + ESP	24.2125-1713.3 010623	Ø 25,4
3B-2-000001→; → 06/05	24.2125-1720.3 010688	TRW Ø 25,4					
4.0 W8 4motion	202	09/01→09/04		05/02→		03.2125-0373.3 010810	ATE Ø 25,4
						24.2125-1720.3 010688	TRW Ø 25,4

























	kw					! #		
VW - PASSAT B5 (3B2) 08/96→12/01								
 Hauptbremszylinder								
1.6	74	10/96→11/00		→ 3B-X-800000; - ESP		24.2123-1717.3 010521	Ø 23,8	
1.8 T	110	10/96→11/00		→ 3B-X-800000; + ESP		24.2123-1730.3 010620	Ø 23,8	
1.9 TDI	81 - 85	10/96→11/00		3B-Y-000001→ 3B-1-400000; für Linkslenker; - ESP		24.2125-1712.3 010622	Ø 25,4	
1.9 TDI 4motion	85	08/99→11/00		3B-Y-000001→ 3B-1-400000; für Linkslenker; + ESP		24.2125-1713.3 010623	Ø 25,4	
2.3 VR5	110	10/96→11/00		3B-2-000001→		24.2125-1720.3 010688	TRW Ø 25,4	
2.3 VR5 Syncro/4motion	81	06/97→08/00		→ 3B-X-800000; - ESP		24.2123-1717.3 010521	Ø 23,8	
2.5 TDI Syncro/4motion	110	10/97→11/00		→ 3B-X-800000; + ESP		24.2123-1730.3 010620	Ø 23,8	
2.8 V6	132 - 142	08/96→11/00		3B-Y-000001→; → 09/00; für Linkslenker; - ESP		24.2125-1712.3 010622	Ø 25,4	
2.8 V6 4motion	140	09/99→11/00		3B-Y-000001→; → 09/00; für Linkslenker; + ESP		24.2125-1713.3 010623	Ø 25,4	
2.8 V6 Syncro/4motion	142	10/96→11/00		→ 3B-X-800000; - ESP		24.2123-1717.3 010521	Ø 23,8	
1.8	85 - 92	10/96→11/00		→ 3B-X-800000; + ESP		24.2123-1730.3 010620	Ø 23,8	
1.9 TDI	66	10/96→11/00		3B-Y-000001→; → 09/00; für Linkslenker; - ESP		24.2125-1712.3 010622	Ø 25,4	
				3B-Y-000001→; → 09/00; für Linkslenker; + ESP		24.2125-1713.3 010623	Ø 25,4	
1.8 Syncro/4motion	92	12/96→08/00		→ 3B-X-800000; - ESP		24.2123-1717.3 010521	Ø 23,8	
				→ 3B-X-800000; + ESP		24.2123-1730.3 010620	Ø 23,8	
				3B-Y-000001→; für Linkslenker; - ESP		24.2125-1712.3 010622	Ø 25,4	
				3B-Y-000001→; für Linkslenker; + ESP		24.2125-1713.3 010623	Ø 25,4	
1.9 TDI	74	02/00→11/00		10/00→; → 3B-1-400000; für Linkslenker; - ESP		24.2125-1712.3 010622	Ø 25,4	
2.0	88	04/00→11/00		10/00→; → 3B-1-400000; für Linkslenker; + ESP		24.2125-1713.3 010623	Ø 25,4	
2.0 4motion	88	04/00→11/00		3B-2-000001→		24.2125-1720.3 010688	TRW Ø 25,4	
2.5 TDI	110	07/98→11/00		08/98→; → 3B-X-800000; - ESP		24.2123-1717.3 010521	Ø 23,8	
				08/98→; → 3B-X-800000; + ESP		24.2123-1730.3 010620	Ø 23,8	
				3B-Y-000001→ 3B-1-400000; für Linkslenker; - ESP		24.2125-1712.3 010622	Ø 25,4	
				3B-Y-000001→ 3B-1-400000; für Linkslenker; + ESP		24.2125-1713.3 010623	Ø 25,4	
				3B-2-000001→		24.2125-1720.3 010688	TRW Ø 25,4	
VW - PASSAT B5 Variant (3B5) 05/97→12/01								
 Hauptbremszylinder								
1.6	74	06/97→11/00		→ 3B-X-800000; - ESP		24.2123-1717.3 010521	Ø 23,8	
1.8 T	110	05/97→11/00		→ 3B-X-800000; + ESP		24.2123-1730.3 010620	Ø 23,8	
1.9 TDI	81 - 85	06/97→11/00		3B-Y-000001→ 3B-1-400000; für Linkslenker; - ESP		24.2125-1712.3 010622	Ø 25,4	
1.9 TDI 4motion	85	08/99→11/00		3B-Y-000001→ 3B-1-400000; für Linkslenker; + ESP		24.2125-1713.3 010623	Ø 25,4	
2.3 VR5	110	06/97→11/00		3B-2-000001→		24.2125-1720.3 010688	TRW Ø 25,4	
2.3 VR5 Syncro/4motion	110	10/97→11/00		→ 3B-X-800000; - ESP		24.2123-1717.3 010521	Ø 23,8	
2.5 TDI Syncro/4motion	110	12/98→11/00		→ 3B-X-800000; + ESP		24.2123-1730.3 010620	Ø 23,8	
2.8 V6	132 - 142	06/97→11/00		3B-Y-000001→; → 09/00; für Linkslenker; - ESP		24.2125-1712.3 010622	Ø 25,4	
2.8 V6 4motion	140	09/99→11/00		3B-Y-000001→; → 09/00; für Linkslenker; + ESP		24.2125-1713.3 010623	Ø 25,4	
2.8 V6 Syncro/4motion	142	06/97→11/00		→ 3B-X-800000; - ESP		24.2123-1717.3 010521	Ø 23,8	
1.8	85 - 92	06/97→11/00		→ 3B-X-800000; + ESP		24.2123-1730.3 010620	Ø 23,8	
1.8 Syncro/4motion	92	06/97→11/00		3B-Y-000001→; → 09/00; für Linkslenker; - ESP		24.2125-1712.3 010622	Ø 25,4	
1.9 TDI	66	06/97→11/00		3B-Y-000001→; → 09/00; für Linkslenker; + ESP		24.2125-1713.3 010623	Ø 25,4	
1.9 TDI	74	02/00→11/00		10/00→; → 3B-1-400000; für Linkslenker; - ESP		24.2125-1712.3 010622	Ø 25,4	
2.0	88	04/00→11/00		10/00→; → 3B-1-400000; für Linkslenker; + ESP		24.2125-1713.3 010623	Ø 25,4	
2.0 4motion	88	04/00→11/00		3B-2-000001→		24.2125-1720.3 010688	TRW Ø 25,4	
2.5 TDI	110	07/98→11/00		08/98→; → 3B-X-800000; - ESP		24.2123-1717.3 010521	Ø 23,8	
				08/98→; → 3B-X-800000; + ESP		24.2123-1730.3 010620	Ø 23,8	
				3B-Y-000001→ 3B-1-400000; für Linkslenker; - ESP		24.2125-1712.3 010622	Ø 25,4	
				3B-Y-000001→ 3B-1-400000; für Linkslenker; + ESP		24.2125-1713.3 010623	Ø 25,4	
				3B-2-000001→		24.2125-1720.3 010688	TRW Ø 25,4	











	kw					! #		
VW - PASSAT B6 (3C2) 03/05→12/10								
 Bremskraftverstärker								
1.4 TSI	90	05/07→07/10		10/07→; für Linkslenker; - ESP		03.7873-4402.4	300292	ATE Ø 11" pneumatisch
1.8 TSI	118	05/07→07/10						
1.4 TSI EcoFuel	110	01/09→07/10		für Linkslenker; - ESP		03.7873-4402.4	300292	ATE Ø 11" pneumatisch
1.6	75	05/05→07/10						
1.6 FSI	85	03/05→06/08						
1.6 TDI	77	08/09→07/10						
1.8 TSI	112	11/09→07/10						
1.9 TDI	77	03/05→07/10						
2.0 BlueTDI	105	01/09→11/10						
2.0 FSI	110 - 125	03/05→07/10						
2.0 FSI 4motion	110	09/05→07/10						
2.0 TDI	81 - 125	03/05→11/10						
2.0 TDI 16V	103	03/05→07/10						
2.0 TDI 16V 4motion	103	03/05→08/10						
2.0 TDI 4motion	103 - 125	03/05→07/10						
2.0 TFSI	147	07/05→07/10						
3.2 FSI 4motion	184	11/05→07/10						
3.6 R36 4motion	220	04/07→07/10		für Linkslenker		03.7873-4502.4	300284	ATE Ø 11" pneumatisch
 Hauptbremszylinder								
1.4 TSI	90	05/07→07/10		10/07→; +PR 1ZG; für Linkslenker		03.4152-0116.3	010814	ATE Ø 22,2
1.8 TSI	118	05/07→07/10		10/07→; für Linkslenker; +PR 1LJ / 1LK / 1LH / 1LM		03.4153-0186.3	010816	ATE Ø 23,8
				10/07→; für Rechtslenker; +PR 1LJ / 1LK / 1LH / 1LM		24.4153-0192.3	011026	ATE Ø 23,8 ohne Bremsflüssigkeitsbehälter
1.4 TSI EcoFuel	110	01/09→07/10		für Linkslenker; +PR 1ZG		03.4152-0116.3	010814	ATE Ø 22,2
1.6	75	05/05→07/10						
1.6 FSI	85	03/05→06/08		für Linkslenker; +PR 1LJ / 1LK / 1LH / 1LM		03.4153-0186.3	010816	ATE Ø 23,8
1.6 TDI	77	08/09→07/10						
1.8 TSI	112	11/09→07/10		für Rechtslenker; +PR 1LJ / 1LK / 1LH / 1LM		24.4153-0192.3	011026	ATE Ø 23,8 ohne Bremsflüssigkeitsbehälter
1.9 TDI	77	03/05→07/10						
2.0 BlueTDI	105	01/09→11/10						
2.0 FSI	110 - 125	03/05→07/10						
2.0 FSI 4motion	110	09/05→07/10						
2.0 TDI	81 - 125	03/05→11/10						
2.0 TDI 16V	103	03/05→07/10						
2.0 TDI 16V 4motion	103	03/05→08/10						
2.0 TDI 4motion	103 - 125	03/05→07/10						
2.0 TFSI	147	07/05→07/10						
3.2 FSI 4motion	184	11/05→07/10						
3.6 R36 4motion	220	04/07→07/10						
VW - PASSAT B6 Variant (3C5) 08/05→11/11								
 Bremskraftverstärker								
1.4 TSI	90	05/07→11/10		10/07→; +PR 1LJ; für Linkslenker		03.7873-4502.4	300284	ATE Ø 11" pneumatisch
1.4 TSI EcoFuel	110	01/09→11/10		+PR 1LJ; für Linkslenker		03.7873-4502.4	300284	ATE Ø 11" pneumatisch
1.6	75	08/05→11/10		+PR 1ZG; für Linkslenker		03.7873-4402.4	300292	ATE Ø 11" pneumatisch
1.6 FSI	85	08/05→06/08						
1.6 TDI	77	08/09→11/10		+PR 1LJ; für Linkslenker		03.7873-4502.4	300284	ATE Ø 11" pneumatisch
1.8 TSI	112	11/09→11/10						
1.9 TDI	77	08/05→11/10						
2.0 BlueTDI	105	01/09→11/10						
2.0 FSI	110	08/05→11/10						
2.0 FSI 4motion	110	09/05→11/10						
2.0 TDI	81 - 125	08/05→11/10						
2.0 TDI 16V	103	08/05→11/10						
2.0 TDI 4motion	125	05/09→11/10						
2.0 TFSI	147	08/05→11/10						
3.2 FSI 4motion	184	11/05→11/10						
1.8 TSI	118	05/07→10/11		10/07→; +PR 1ZG; für Linkslenker		03.7873-4402.4	300292	ATE Ø 11" pneumatisch
				10/07→; +PR 1LJ; für Linkslenker		03.7873-4502.4	300284	ATE Ø 11" pneumatisch
2.0 TDI 16V 4motion	103	08/05→11/10		09/05→; +PR 1ZG; für Linkslenker		03.7873-4402.4	300292	ATE Ø 11" pneumatisch
2.0 TDI 4motion	103	08/05→05/09		09/05→; +PR 1LJ; für Linkslenker		03.7873-4502.4	300284	ATE Ø 11" pneumatisch
3.6 R36 4motion	220	04/07→11/10		für Linkslenker		03.7873-4502.4	300284	ATE Ø 11" pneumatisch
 Hauptbremszylinder								
1.4 TSI	90	05/07→11/10		10/07→; +PR 1ZG; für Linkslenker		03.4152-0116.3	010814	ATE Ø 22,2
1.8 TSI	118	05/07→10/11		10/07→; für Linkslenker; +PR 1LJ / 1LK / 1LH / 1LM		03.4153-0186.3	010816	ATE Ø 23,8
→								











	kw			 	! #		
VW - PASSAT B6 Variant (3C5) 08/05→11/11							
 Hauptbremszylinder							
1.4 TSI 1.8 TSI	90 118	05/07→11/10 05/07→10/11		10/07→; +PR 1LJ / 1LK; für Rechtslenker		24.4153-0192.3 011026	ATE Ø 23,8 ohne Bremsflüssigkeitsbehälter
1.4 TSI EcoFuel 1.6 1.6 FSI 1.6 TDI 1.8 TSI 1.9 TDI 2.0 BlueTDI 2.0 FSI 2.0 FSI 4motion 2.0 TDI	110 75 85 77 112 77 105 110 110 81 - 125	01/09→11/10 08/05→11/10 08/05→06/08 08/09→11/10 11/09→11/10 08/05→11/10 01/09→11/10 08/05→11/10 09/05→11/10 08/05→11/10		+PR 1ZG; für Linkslenker +PR 1LJ / 1LK / 1LH / 1LM; für Linkslenker +PR 1LJ / 1LK; für Rechtslenker		03.4152-0116.3 010814 03.4153-0186.3 010816 24.4153-0192.3 011026	ATE Ø 22,2 ATE Ø 23,8 ATE Ø 23,8 ohne Bremsflüssigkeitsbehälter
2.0 TDI 16V 2.0 TDI 4motion 2.0 TFSI 3.2 FSI 4motion 3.6 R36 4motion	103 103 147 184 220	08/05→11/10 08/05→05/09		09/05→; +PR 1ZG; für Linkslenker 09/05→; +PR 1LJ / 1LK / 1LH / 1LM; für Linkslenker 09/05→; +PR 1LJ / 1LK; für Rechtslenker		03.4152-0116.3 010814 03.4153-0186.3 010816 24.4153-0192.3 011026	ATE Ø 22,2 ATE Ø 23,8 ATE Ø 23,8 ohne Bremsflüssigkeitsbehälter
VW - PASSAT B7 (362) 08/10→12/15							
 Bremskraftverstärker							
1.4 TSI 1.4 TSI EcoFuel 1.4 TSI MultiFuel 1.6 TDI 1.8 TSI 2.0 TDI 2.0 TDI 4motion 2.0 TSI 3.6 FSI 4motion 2.0 TDI 4motion	90 - 118 110 118 77 112 - 118 100 - 130 103 - 130 155 220 125	08/10→12/14 08/10→12/14 11/10→12/14 08/10→12/14 08/10→12/14 08/10→12/14 11/10→12/14 01/11→12/14 08/10→01/13		→ 10/14; +PR 1ZG; für Linkslenker → 10/14; +PR 1LA / 1LB / 1ZM; für Linkslenker +PR 1ZG; für Linkslenker +PR 1LA / 1LB / 1ZM; für Linkslenker		03.7873-4402.4 300292 03.7873-4502.4 300284 03.7873-4402.4 300292 03.7873-4502.4 300284	ATE Ø 11" pneumatisch ATE Ø 11" pneumatisch ATE Ø 11" pneumatisch ATE Ø 11" pneumatisch
 Hauptbremszylinder							
1.4 TSI 1.4 TSI EcoFuel 1.4 TSI MultiFuel 1.6 TDI 1.8 TSI 2.0 TDI 2.0 TDI 4motion 2.0 TSI 3.6 FSI 4motion 2.0 TDI 4motion	90 - 118 110 118 77 112 - 118 100 - 130 103 - 130 155 220 125	08/10→12/14 08/10→12/14 11/10→12/14 08/10→12/14 08/10→12/14 08/10→12/14 11/10→12/14 01/11→12/14 08/10→01/13		→ 10/14; +PR 1ZG; für Linkslenker → 10/14; +PR 1LA / 1LB / 1ZM; für Linkslenker → 10/14; +PR 1LA / 1LB / 1ZM; für Rechtslenker +PR 1ZG; für Linkslenker +PR 1LA / 1LB / 1ZM; für Linkslenker +PR 1LA / 1LB / 1ZM; für Rechtslenker		03.4152-0116.3 010814 03.4153-0186.3 010816 24.4153-0192.3 011026 03.4152-0116.3 010814 03.4153-0186.3 010816 24.4153-0192.3 011026	ATE Ø 22,2 ATE Ø 23,8 ATE Ø 23,8 ohne Bremsflüssigkeitsbehälter ATE Ø 22,2 ATE Ø 23,8 ATE Ø 23,8 ohne Bremsflüssigkeitsbehälter
VW - PASSAT B7 (A32, A33) 01/11→							
 Bremskraftverstärker							
2.0 TDI 2.5 2.0 TDI	103 125 110	04/11→06/15 01/11→ 06/14→		→ 10/14; +PR 1ZG; für Linkslenker → 10/14; +PR 1LA / 1LB / 1ZM; für Linkslenker +PR 1ZG; für Linkslenker +PR 1LA / 1LB / 1ZM; für Linkslenker		03.7873-4402.4 300292 03.7873-4502.4 300284 03.7873-4402.4 300292 03.7873-4502.4 300284	ATE Ø 11" pneumatisch ATE Ø 11" pneumatisch ATE Ø 11" pneumatisch ATE Ø 11" pneumatisch
 Hauptbremszylinder							
2.0 TDI 2.5 →	103 125	04/11→06/15 01/11→		→ 10/14; +PR 1ZG; für Linkslenker → 10/14; +PR 1LA / 1LB / 1ZM; für Linkslenker		03.4152-0116.3 010814 03.4153-0186.3 010816	ATE Ø 22,2 ATE Ø 23,8

	kw					! #		
VW - PASSAT B7 (A32, A33) 01/11→								
 Hauptbremszylinder								
2.0 TDI 2.5	103 125	04/11→06/15 01/11→		→ 10/14; +PR 1LA / 1LB / 1ZM; für Rechtslenker		24.4153-0192.3	011026	ATE Ø 23,8 ohne Bremsflüssigkeitsbehälter
2.0 TDI	110	06/14→		+PR 1ZG; für Linkslenker		03.4152-0116.3	010814	ATE Ø 22,2
				+PR 1LA / 1LB / 1ZM; für Linkslenker		03.4153-0186.3	010816	ATE Ø 23,8
				+PR 1LA / 1LB / 1ZM; für Rechtslenker		24.4153-0192.3	011026	ATE Ø 23,8 ohne Bremsflüssigkeitsbehälter
VW - PASSAT B7 Kasten/Kombi (365) 08/10→12/14								
 Bremskraftverstärker								
1.4 TSi BlueMotion 1.6 TDi BlueMotion 1.8 TFSi 2.0 TDi BlueMotion 2.0 TFSi 3.6 FSi 4motion	90 77 118 103 155 220	08/10→12/14 08/10→12/14 08/10→12/14 08/10→12/14 11/10→12/14 01/11→12/14		→ 10/14; +PR 1ZG; für Linkslenker		03.7873-4402.4	300292	ATE Ø 11" pneumatisch
2.0 TDi BlueMotion	125	08/10→12/14		→ 10/14; +PR 1LA / 1LB / 1ZM; für Linkslenker		03.7873-4502.4	300284	ATE Ø 11" pneumatisch
				+PR 1ZG; für Linkslenker		03.7873-4402.4	300292	ATE Ø 11" pneumatisch
				+PR 1LA / 1LB / 1ZM; für Linkslenker		03.7873-4502.4	300284	ATE Ø 11" pneumatisch
 Hauptbremszylinder								
1.4 TSi BlueMotion 1.6 TDi BlueMotion 1.8 TFSi 2.0 TDi BlueMotion 2.0 TFSi 3.6 FSi 4motion	90 77 118 103 155 220	08/10→12/14 08/10→12/14 08/10→12/14 08/10→12/14 11/10→12/14 01/11→12/14		→ 10/14; +PR 1ZG; für Linkslenker		03.4152-0116.3	010814	ATE Ø 22,2
2.0 TDi BlueMotion	125	08/10→12/14		→ 10/14; +PR 1LA / 1LB / 1ZM; für Linkslenker		03.4153-0186.3	010816	ATE Ø 23,8
				→ 10/14; +PR 1LA / 1LB / 1ZM; für Rechtslenker		24.4153-0192.3	011026	ATE Ø 23,8 ohne Bremsflüssigkeitsbehälter
				+PR 1ZG; für Linkslenker		03.4152-0116.3	010814	ATE Ø 22,2
				+PR 1LA / 1LB / 1ZM; für Linkslenker		03.4153-0186.3	010816	ATE Ø 23,8
				+PR 1LA / 1LB / 1ZM; für Rechtslenker		24.4153-0192.3	011026	ATE Ø 23,8 ohne Bremsflüssigkeitsbehälter
VW - PASSAT B7 Variant (365) 08/10→12/15								
 Bremskraftverstärker								
1.4 TSi 1.4 TSi EcoFuel 1.4 TSi MultiFuel 1.6 TDI 1.8 TSi 2.0 TDI 2.0 TDI 4motion 2.0 TSi 3.6 FSi 4motion	90 - 118 110 118 77 112 - 118 100 - 130 103 - 130 155 220	08/10→12/14 08/10→12/14 11/10→12/14 08/10→12/14 08/10→12/14 08/10→12/14 08/10→12/14 11/10→12/15 01/11→12/14		→ 10/14; +PR 1ZG; für Linkslenker		03.7873-4402.4	300292	ATE Ø 11" pneumatisch
2.0 TDI 4motion	125	08/10→01/13		→ 10/14; +PR 1LA / 1LB / 1ZM; für Linkslenker		03.7873-4502.4	300284	ATE Ø 11" pneumatisch
				+PR 1ZG; für Linkslenker		03.7873-4402.4	300292	ATE Ø 11" pneumatisch
				+PR 1LA / 1LB / 1ZM; für Linkslenker		03.7873-4502.4	300284	ATE Ø 11" pneumatisch
 Hauptbremszylinder								
1.4 TSi 1.4 TSi EcoFuel 1.4 TSi MultiFuel 1.6 TDI 1.8 TSi 2.0 TDI 2.0 TDI 4motion 2.0 TSi 3.6 FSi 4motion	90 - 118 110 118 77 112 - 118 100 - 130 103 - 130 155 220	08/10→12/14 08/10→12/14 11/10→12/14 08/10→12/14 08/10→12/14 08/10→12/14 08/10→12/14 11/10→12/15 01/11→12/14		→ 10/14; +PR 1ZG; für Linkslenker		03.4152-0116.3	010814	ATE Ø 22,2
2.0 TDI 4motion	125	08/10→01/13		→ 10/14; +PR 1LA / 1LB / 1ZM; für Linkslenker		03.4153-0186.3	010816	ATE Ø 23,8
				→ 10/14; +PR 1LA / 1LB / 1ZM; für Rechtslenker		24.4153-0192.3	011026	ATE Ø 23,8 ohne Bremsflüssigkeitsbehälter
				+PR 1ZG; für Linkslenker		03.4152-0116.3	010814	ATE Ø 22,2
				+PR 1LA / 1LB / 1ZM; für Linkslenker		03.4153-0186.3	010816	ATE Ø 23,8
				+PR 1LA / 1LB / 1ZM; für Rechtslenker		24.4153-0192.3	011026	ATE Ø 23,8 ohne Bremsflüssigkeitsbehälter
VW - PASSAT B8 (3G2, CB2) 08/14→								
 Hauptbremszylinder								
1.4 GTE Hybrid 1.4 TSi	160 92 - 110	06/15→11/18 11/14→		für Linkslenker; +PR 1ZA / 1ZD		24.4123-1719.3	011017	TRW Ø 23,8 ohne Bremsflüssigkeitsbehälter
1.4 TSi 4motion	110	02/15→				24.4153-1522.3	011048	ATE Ø 23,8 ohne Bremsflüssigkeitsbehälter













	kw					! #		
VW - PASSAT B8 (3G2, CB2) 08/14→								
 Hauptbremszylinder								
1.5 TSI 1.8 TSI 2.0 TDI	110 132 81 -	08/18→ 02/15→ 11/14→		für Linkslenker; +PR 1ZA / 1ZD		24.4123-1719.3	011017	TRW Ø 23,8 ohne Bremsflüssigkeitsbehälter
2.0 TDI 4motion	147 140 -	11/14→ 11/14→				24.4153-1522.3	011048	ATE Ø 23,8 ohne Bremsflüssigkeitsbehälter
2.0 TSI 2.0 TSI 4motion	147 140 - 162 200 - 206	02/15→ 02/15→ 05/15→						
1.6 TDI 2.0 TDI 4motion	88 110 - 176	08/14→ 08/14→		für Linkslenker; +PR 1ZA / 1ZD		24.4123-1719.3	011017	TRW Ø 23,8 ohne Bremsflüssigkeitsbehälter
				11/14→; für Linkslenker; +PR 1ZA / 1ZD		24.4153-1522.3	011048	ATE Ø 23,8 ohne Bremsflüssigkeitsbehälter
VW - PASSAT B8 Variant (3G5, CB5) 08/14→								
 Hauptbremszylinder								
1.4 GTE Hybrid 1.4 TSI	160 92 - 110	06/15→ 11/14→		für Linkslenker; +PR 1ZA / 1ZD		24.4123-1719.3	011017	TRW Ø 23,8 ohne Bremsflüssigkeitsbehälter
1.4 TSI 4motion 1.5 TSI 1.8 TSI 2.0 TDI	110 110 132 81 - 147	02/15→ 08/18→ 02/15→ 11/14→				24.4153-1522.3	011048	ATE Ø 23,8 ohne Bremsflüssigkeitsbehälter
2.0 TDI 4motion 2.0 TSI 2.0 TSI 4motion	140 - 147 140 200 - 206	11/14→ 11/14→ 11/18→ 05/15→						
1.6 TDI 2.0 TDI 4motion	88 110 - 176	08/14→ 08/14→		für Linkslenker; +PR 1ZA / 1ZD		24.4123-1719.3	011017	TRW Ø 23,8 ohne Bremsflüssigkeitsbehälter
2.0 TSI	162	08/14→		11/14→; für Linkslenker; +PR 1ZA / 1ZD		24.4153-1522.3	011048	ATE Ø 23,8 ohne Bremsflüssigkeitsbehälter
VW - PASSAT CC B6 (357) 02/08→01/12								
 Bremskraftverstärker								
1.4 TSI MultiFuel 2.0 TSI	118 155	01/11→01/12 11/10→01/12		→ 09/11; für Linkslenker; +PR 1ZG		03.7873-4402.4	300292	ATE Ø 11" pneumatisch
				→ 09/11; +PR 1LA / 1LB / 1ZM; für Linkslenker		03.7873-4502.4	300284	ATE Ø 11" pneumatisch
1.8 TSI	112	11/08→05/10		für Linkslenker; +PR 1AT / 1ZG		03.7873-4402.4	300292	ATE Ø 11" pneumatisch
				+PR 1AT / 1LH / 1LK / 1ZM; für Linkslenker		03.7873-4502.4	300284	ATE Ø 11" pneumatisch
1.8 TSI 2.0 TDI	118 103 - 125	06/08→01/12 06/08→01/12		→ 05/10; +PR 1AT / 1ZG; für Linkslenker		03.7873-4402.4	300292	ATE Ø 11" pneumatisch
2.0 TDI 4motion 2.0 TFSI	103 - 125 147	08/09→01/12 06/08→01/12		06/10→ 09/11; für Linkslenker; +PR 1ZG		03.7873-4402.4	300292	ATE Ø 11" pneumatisch
				→ 10/10; +PR 1AT / 1LH / 1LK / 1ZM; für Linkslenker		03.7873-4502.4	300284	ATE Ø 11" pneumatisch
				11/10→ 09/11; für Linkslenker; +PR 1LA / 1LB / 1ZM		03.7873-4502.4	300284	ATE Ø 11" pneumatisch
2.0 BlueTDI 2.0 TDI	105 100 - 120	05/09→11/10 05/08→05/11		06/10→; +PR 1ZG; für Linkslenker		03.7873-4402.4	300292	ATE Ø 11" pneumatisch
				→ 05/10; +PR 1AT / 1ZG; für Linkslenker		03.7873-4402.4	300292	ATE Ø 11" pneumatisch
				11/10→; +PR 1LA / 1LB / 1ZM; für Linkslenker		03.7873-4502.4	300284	ATE Ø 11" pneumatisch
				→ 10/10; +PR 1AT / 1LH / 1LK / 1ZM; für Linkslenker		03.7873-4502.4	300284	ATE Ø 11" pneumatisch
3.6 FSI 4motion	206	06/08→01/12		→ 10/10; +PR 1AT / 1LH / 1LK / 1ZM; für Linkslenker		03.7873-4502.4	300284	ATE Ø 11" pneumatisch
				11/10→ 09/11; für Linkslenker; +PR 1LA / 1LB / 1ZM		03.7873-4502.4	300284	ATE Ø 11" pneumatisch
3.6 FSI 4motion	220	02/08→12/11		+PR 1AT / 1LH / 1LK / 1ZM; für Linkslenker		03.7873-4502.4	300284	ATE Ø 11" pneumatisch
 Hauptbremszylinder								
1.4 TSI MultiFuel 2.0 TDI 4motion	118 103 - 125	01/11→01/12 08/09→01/12		→ 09/11; +PR 1ZG; für Linkslenker		03.4152-0116.3	010814	ATE Ø 22,2
				→ 09/11; für Linkslenker; +PR 1LH / 1LK / 1ZM		03.4153-0186.3	010816	ATE Ø 23,8
				→ 09/11; für Rechtslenker; +PR 1LH / 1LK / 1ZM		24.4153-0192.3	011026	ATE Ø 23,8 ohne Bremsflüssigkeitsbehälter
1.8 TSI 2.0 BlueTDI 2.0 TDI	112 105 100 - 120	11/08→05/10 05/09→11/10 05/08→05/11		+PR 1ZG; für Linkslenker		03.4152-0116.3	010814	ATE Ø 22,2
				+PR 1LH / 1LK; für Linkslenker		03.4153-0186.3	010816	ATE Ø 23,8
3.6 FSI 4motion	220	02/08→12/11		+PR 1LH / 1LK; für Rechtslenker		24.4153-0192.3	011026	ATE Ø 23,8 ohne Bremsflüssigkeitsbehälter
→								















	kw					! #		
VW - PASSAT CC B6 (357) 02/08→01/12								
 Hauptbremszylinder								
1.8 TSI	118	06/08→01/12		→ 09/11; +PR 1ZG; für Linkslenker		03.4152-0116.3	010814	ATE Ø 22,2
2.0 TDI	103 - 125	06/08→01/12		→ 09/11; +PR 1LH / 1LK; für Linkslenker		03.4153-0186.3	010816	ATE Ø 23,8
2.0 TFSI	147	06/08→01/12		→ 09/11; +PR 1LH / 1LK; für Rechtslenker		24.4153-0192.3	011026	ATE Ø 23,8 ohne Bremsflüssigkeitsbehälter
2.0 TSI	155	11/10→01/12						
3.6 FSI 4motion	206	06/08→01/12						
VW - POLO (6N2) 10/99→10/01								
 Bremskraftverstärker								
1.0	37	10/99→09/01		für Linkslenker; + ESP; +PR 1AT / 1LX / 1ZE / 1ZJ / 1ZK		03.7853-0102.4	300252	ATE Ø 9" pneumatisch
1.4 16V	55	10/99→09/01						
1.4 TDI	55	10/99→09/01						
1.6 16V GTI	92	10/99→09/01						
1.7 SDI	44	10/99→09/01						
1.4	40 - 44	10/99→09/01			→ 6N-T-300000; für Linkslenker; + ABS			
1.4 16V	74	10/99→09/01		für Linkslenker; + ESP; +PR 1AT / 1LX / 1ZE / 1ZJ / 1ZK		03.7853-0102.4	300252	ATE Ø 9" pneumatisch
1.9 D	47	10/99→09/01						
1.9 SDI	47	10/99→09/01						
 Hauptbremszylinder								
1.0	37	10/99→09/01		für Linkslenker; - ABS		03.2120-3943.3	010532	ATE Ø 20,6
1.7 SDI	44	10/99→09/01		+ ABS		03.2122-1344.3	010593	ATE Ø 22,2
1.4	40	10/99→09/01		für Linkslenker; - ABS		03.2120-3943.3	010532	ATE Ø 20,6
1.4 16V	55	10/99→09/01						
1.4	44	10/99→09/01						
1.9 D	47	10/99→09/01			für Linkslenker; - ABS			
1.9 SDI	47	10/99→09/01		6N-V-000001→; + ABS		03.2122-1344.3	010593	ATE Ø 22,2
1.4 16V	74	10/99→09/01		→ 6N-T-300000; + ABS		03.2123-1484.3	010595	ATE Ø 23,8
				6N-V-000001→; + ABS		03.2123-1824.3	010596	ATE Ø 23,8
1.4 TDI	55	10/99→09/01		+ ABS		03.2123-1824.3	010596	ATE Ø 23,8
1.6 16V GTI	92	10/99→09/01						
Verschlusschraube, Hauptbremszylinder								
1.0	37	10/99→09/01		für Linkslenker; - ABS		03.3517-0101.2	390322	
1.4	40 - 44	10/99→09/01						
1.4 16V	55	10/99→09/01						
1.7 SDI	44	10/99→09/01						
1.9 D	47	10/99→09/01						
1.9 SDI	47	10/99→09/01						
 Bremskraftregler								
1.4 16V	55	10/99→09/01		+ ABS		03.6583-0179.3	320228	ATE lastabhängig 8/3 4x
1.4 TDI	55	10/99→09/01						
1.4 16V	74	10/99→09/01						
					ausschließlich für Rennsportzwecke			
						03.6583-0179.3	320228	ATE lastabhängig 8/3 4x
1.6 16V GTI	92	10/99→09/01				03.6583-0179.3	320228	ATE lastabhängig 8/3 4x
VW - POLO (9N_, 9A_) 10/01→10/14								
 Hauptbremszylinder								
1.2	40	01/02→05/07		9N-5-500001→; + ABS		24.2119-1712.3	010912	Ø 19 ohne Bremsflüssigkeitsbehälter
				9N-5-500001→; - ABS		24.2120-1734.3	010702	Ø 20,6
				- ABS; für Fahrzeuge mit Servolenkung; → 9N-5-180000		24.2120-1736.3	010732	Ø 20,6
1.2	44	05/07→11/09		→ 05/09; + ABS		24.2119-1712.3	010912	Ø 19 ohne Bremsflüssigkeitsbehälter
1.2 12V	51	05/07→11/09						
1.8 GTI	110	09/05→11/09						
				→ 05/09; - ABS		24.2120-1736.3	010732	Ø 20,6
1.2 12V	47	10/01→07/07		11/01→; + ABS		24.2119-1712.3	010912	Ø 19 ohne Bremsflüssigkeitsbehälter
				11/01→; - ABS		24.2120-1734.3	010702	Ø 20,6
						24.2120-1736.3	010732	Ø 20,6
1.4	61	08/02→11/09		9N-5-500001→; → 05/09; + ABS		24.2119-1712.3	010912	Ø 19 ohne Bremsflüssigkeitsbehälter
				05/06→; → 9N-5-180000; + ABS		24.2120-1734.3	010702	Ø 20,6
				9N-5-500001→; → 05/09; - ABS		24.2120-1736.3	010732	Ø 20,6
				05/06→; → 9N-5-180000; - ABS		24.2120-1736.3	010732	Ø 20,6
→								







	kw			 	! #		
VW - POLO (9N_, 9A_) 10/01→10/14							
 Hauptbremszylinder							
1.4 16V	55 - 74	10/01→05/08		9N-5-500001→; + ABS		24.2119-1712.3 010912	Ø 19 ohne Bremsflüssigkeitsbehälter
1.4 TDI	55	10/01→06/05				24.2120-1734.3 010702	Ø 20,6
				11/01→; + ABS; → 9N-5-180000		24.2120-1734.3 010702	Ø 20,6
				11/01→; - ABS; → 9N-5-180000		24.2120-1736.3 010732	Ø 20,6
				9N-5-500001→; - ABS		24.2120-1736.3 010732	Ø 20,6
1.4 16V	59	05/06→11/09		9N-5-500001→; → 05/09; + ABS		24.2119-1712.3 010912	Ø 19 ohne Bremsflüssigkeitsbehälter
1.4 BiFuel	60	05/06→11/09				24.2120-1734.3 010702	Ø 20,6
1.4 TDI	51 - 59	04/05→11/09				24.2120-1734.3 010702	Ø 20,6
1.6 16V	77	05/06→11/09		→ 9N-5-180000; + ABS		24.2120-1734.3 010702	Ø 20,6
1.9 TDI	96	11/03→11/09		9N-5-500001→; → 05/09; - ABS		24.2120-1736.3 010732	Ø 20,6
				→ 9N-5-180000; - ABS		24.2120-1736.3 010732	Ø 20,6
1.4 FSI	63	02/02→07/06		9N-5-500001→; + ABS		24.2119-1712.3 010912	Ø 19 ohne Bremsflüssigkeitsbehälter
1.6	74	08/02→05/05				24.2120-1734.3 010702	Ø 20,6
1.6 Flex	74	06/08→04/09				24.2120-1734.3 010702	Ø 20,6
				→ 9N-5-180000; + ABS		24.2120-1734.3 010702	Ø 20,6
				→ 9N-5-180000; - ABS		24.2120-1736.3 010732	Ø 20,6
				9N-5-500001→; - ABS		24.2120-1736.3 010732	Ø 20,6
1.8 GTI Cup Edition	132	05/06→11/09		06/06→ 05/09; + ABS		24.2119-1712.3 010912	Ø 19 ohne Bremsflüssigkeitsbehälter
						24.2120-1734.3 010702	Ø 20,6
				06/06→ 05/09; - ABS		24.2120-1736.3 010732	Ø 20,6
1.9 SDI	47	10/01→11/09		9N-5-500001→; → 05/09; + ABS		24.2119-1712.3 010912	Ø 19 ohne Bremsflüssigkeitsbehälter
1.9 TDI	74	10/01→11/09				24.2120-1734.3 010702	Ø 20,6
				11/01→; + ABS; → 9N-5-180000		24.2120-1734.3 010702	Ø 20,6
				9N-5-500001→; → 05/09; - ABS		24.2120-1736.3 010732	Ø 20,6
				11/01→; - ABS; → 9N-5-180000		24.2120-1736.3 010732	Ø 20,6
 Bremskraftregler							
1.2	40	01/02→05/07		- ABS		03.6583-0216.3 320247	ATE lastabhängig 8/3 4x
VW - POLO III (6N1) 10/94→10/99							
 Bremskraftverstärker							
1.7 SDI	42	04/97→10/99		05/97→; für Linkslenker; + ESP; +PR 1AT / 1LX / 1ZE / 1ZJ / 1ZK		03.7853-0102.4 300252	ATE Ø 9" pneumatisch
100 1.4 16V	74	04/96→10/99		→ 6N-T-300000; für Linkslenker; + ABS		03.7750-6002.4 300134	ATE Ø 9" pneumatisch
55 1.3	40	10/94→04/97				03.7853-0102.4 300252	ATE Ø 9" pneumatisch
55 1.4	40	08/95→10/99		für Linkslenker; + ESP; +PR 1AT / 1LX / 1ZE / 1ZJ / 1ZK		03.7853-0102.4 300252	ATE Ø 9" pneumatisch
60 1.4	44	07/95→10/99					
64 1.9 D	47	10/94→10/99					
64 1.9 SDI	47	07/96→10/99					
75 1.6 4motion	55	08/95→10/99					
120 1.6 16V GTI	88	09/98→10/99		für Linkslenker; + ESP; +PR 1AT / 1LX / 1ZE / 1ZJ / 1ZK		03.7853-0102.4 300252	ATE Ø 9" pneumatisch
50 1.0	37	09/96→10/99					
60 1.7 SDI	44	08/97→10/99					
75 1.6	55	10/94→10/99		→ 6N-T-300000; für Linkslenker; + ABS		03.7750-6002.4 300134	ATE Ø 9" pneumatisch
				→ 09/99; für Linkslenker; + ESP; +PR 1AT / 1LX / 1ZE / 1ZJ / 1ZK		03.7853-0102.4 300252	ATE Ø 9" pneumatisch
 Hauptbremszylinder							
1.7 SDI	42	04/97→10/99		05/97→; für Linkslenker; - ABS		03.2120-3943.3 010532	ATE Ø 20,6
				05/97→; + ABS		03.2122-1344.3 010593	ATE Ø 22,2
100 1.4 16V	74	04/96→10/99		→ 6N-T-300000; + ABS		03.2123-1484.3 010595	ATE Ø 23,8
				6N-V-000001→; + ABS		03.2123-1824.3 010596	ATE Ø 23,8
120 1.6 16V GTI	88	09/98→10/99		+ ABS		03.2123-1824.3 010596	ATE Ø 23,8
50 1.0	37	09/96→10/99		für Linkslenker; - ABS		03.2120-3943.3 010532	ATE Ø 20,6
60 1.7 SDI	44	08/97→10/99		+ ABS		03.2122-1344.3 010593	ATE Ø 22,2
55 1.3	40	10/94→04/97		für Linkslenker; - ABS		03.2120-3943.3 010532	ATE Ø 20,6
60 1.4	44	07/95→10/99					
64 1.9 D	47	10/94→10/99		6N-V-000001→; + ABS		03.2122-1344.3 010593	ATE Ø 22,2
64 1.9 SDI	47	07/96→10/99					
75 1.6 4motion	55	08/95→10/99					
55 1.4	40	08/95→10/99		für Linkslenker; - ABS		03.2120-3943.3 010532	ATE Ø 20,6
75 1.6	55	10/94→10/99		→ 09/99; für Linkslenker; - ABS		03.2120-3943.3 010532	ATE Ø 20,6
				6N-V-000001→; → 09/99; + ABS		03.2122-1344.3 010593	ATE Ø 22,2
→							









	kw			 	! #		
VW - POLO III (6N1) 10/94→10/99							
Verschlusschraube, Hauptbremszylinder							
1.7 SDI	42	04/97→10/99		05/97→; für Linkslenker; - ABS		03.3517-0101.2	390322
50 1.0	37	09/96→10/99		für Linkslenker; - ABS		03.3517-0101.2	390322
55 1.3	40	10/94→04/97					
55 1.4	40	08/95→10/99					
60 1.4	44	07/95→10/99					
60 1.7 SDI	44	08/97→10/99					
64 1.9 D	47	10/94→10/99					
64 1.9 SDI	47	07/96→10/99					
75 1.6 4motion	55	08/95→10/99					
75 1.6	55	10/94→10/99		→ 09/99; für Linkslenker; - ABS		03.3517-0101.2	390322
 Bremskraftregler							
100 1.4 16V	74	04/96→10/99		ausschließlich für Rennsportzwecke		03.6583-0167.3	320140 ATE lastabhängig 8/3 4x
						03.6583-0179.3	320228 ATE lastabhängig 8/3 4x
120 1.6 16V GTI	88	09/98→10/99				03.6583-0179.3	320228 ATE lastabhängig 8/3 4x
VW - POLO III CLASSIC (6V2) 01/95→11/09							
 Bremskraftverstärker							
1.6	74	11/02→07/06		für Linkslenker; - ABS		03.7750-6302.4	300161 ATE Ø 9" pneumatisch
1.9 TDI	67	01/97→08/99		für Linkslenker; + ABS; +PR 1KB		10.6350-3902.4	300213 ATE Ø 9" pneumatisch
2.0	85	08/99→09/01					
90 1.9 TDI	66	09/96→09/01		für Linkslenker; + ABS; +PR 1KK / 1KM / 1KQ		10.6350-4002.4	300285 ATE Ø 9" pneumatisch
1.9 SDI	48	06/96→09/01		für Linkslenker; + ABS; +PR 1KB		10.6350-3902.4	300213 ATE Ø 9" pneumatisch
54 1.4	40	01/98→08/99					
57 1.7 SDI	42	07/97→09/01		für Linkslenker; + ABS; +PR 1KK / 1KM / 1KQ		10.6350-4002.4	300285 ATE Ø 9" pneumatisch
60 1.4	44	12/95→09/01					
64 1.9 SDI	47	12/95→08/99					
75 1.4 16V	55	10/99→09/01					
75 1.6	55	11/95→09/01					
100 1.6	74	12/95→09/01		für Linkslenker; - ABS		03.7750-6302.4	300161 ATE Ø 9" pneumatisch
				05/96→; für Linkslenker; + ABS; +PR 1KB		10.6350-3902.4	300213 ATE Ø 9" pneumatisch
				05/96→; für Linkslenker; + ABS; +PR 1KK / 1KM / 1KQ		10.6350-4002.4	300285 ATE Ø 9" pneumatisch
110 1.9 TDI	81	06/98→01/02		für Linkslenker; - ABS; → 09/01		03.7750-6302.4	300161 ATE Ø 9" pneumatisch
				für Linkslenker; + ABS; → 09/01; +PR 1KB		10.6350-3902.4	300213 ATE Ø 9" pneumatisch
				für Linkslenker; + ABS; → 09/01; +PR 1KK / 1KM / 1KQ		10.6350-4002.4	300285 ATE Ø 9" pneumatisch
68 1.9 SDI	50	08/99→01/02		für Linkslenker; + ABS; → 09/01; +PR 1KB		10.6350-3902.4	300213 ATE Ø 9" pneumatisch
				für Linkslenker; + ABS; → 09/01; +PR 1KK / 1KM / 1KQ		10.6350-4002.4	300285 ATE Ø 9" pneumatisch
90 1.8	66	01/97→09/01		03/98→; für Linkslenker; - ABS		03.7750-6302.4	300161 ATE Ø 9" pneumatisch
				03/98→; für Linkslenker; + ABS; +PR 1KB		10.6350-3902.4	300213 ATE Ø 9" pneumatisch
				03/98→; für Linkslenker; + ABS; +PR 1KK / 1KM / 1KQ		10.6350-4002.4	300285 ATE Ø 9" pneumatisch
 Hauptbremszylinder							
1.6	74	11/02→07/06		für Linkslenker; - ABS		03.2122-1042.3	010137 Ø 22,2
1.9 TDI	67	01/97→08/99		→ 6K-X-523000; für Rechtslenker; - ABS		03.2122-1042.3	010137 Ø 22,2
90 1.9 TDI	66	09/96→09/01		für Linkslenker; + ABS		03.2122-1144.3	010636 ATE Ø 22,2
1.9 SDI	48	06/96→09/01		für Linkslenker; - ABS		03.2120-3943.3	010532 ATE Ø 20,6
54 1.4	40	01/98→08/99					
60 1.4	44	12/95→09/01		→ 6K-X-523000; für Rechtslenker; - ABS		03.2120-3943.3	010532 ATE Ø 20,6
64 1.9 SDI	47	12/95→08/99		für Linkslenker; + ABS		03.2122-1144.3	010636 ATE Ø 22,2
75 1.4 16V	55	10/99→09/01					
100 1.6	74	12/95→09/01		für Linkslenker; - ABS		03.2122-1042.3	010137 Ø 22,2
				→ 6K-X-523000; für Rechtslenker; - ABS		03.2122-1042.3	010137 Ø 22,2
				05/96→; für Linkslenker; + ABS		03.2122-1144.3	010636 ATE Ø 22,2
110 1.9 TDI	81	06/98→01/02		für Linkslenker; - ABS; → 09/01		03.2122-1042.3	010137 Ø 22,2
				→ 6K-X-523000; für Rechtslenker; - ABS		03.2122-1042.3	010137 Ø 22,2
				für Linkslenker; + ABS; → 09/01		03.2122-1144.3	010636 ATE Ø 22,2
2.0	85	08/99→09/01		für Linkslenker; + ABS		03.2122-1144.3	010636 ATE Ø 22,2
57 1.7 SDI	42	07/97→09/01		für Linkslenker; - ABS		03.2120-3943.3	010532 ATE Ø 20,6
				11/97→; → 6K-X-523000; für Rechtslenker; - ABS		03.2120-3943.3	010532 ATE Ø 20,6
				für Linkslenker; + ABS		03.2122-1144.3	010636 ATE Ø 22,2
68 1.9 SDI	50	08/99→01/02		für Linkslenker; - ABS; → 09/01		03.2120-3943.3	010532 ATE Ø 20,6
→							





















	kw					! #		
VW - POLO III CLASSIC (6V2) 01/95→11/09								
 Hauptbremszylinder								
68 1.9 SDI	50	08/99→01/02		→ 6K-X-523000; für Rechtslenker; - ABS		03.2120-3943.3	010532	ATE Ø 20,6
				für Linkslenker; + ABS; → 09/01		03.2122-1144.3	010636	ATE Ø 22,2
75 1.6	55	11/95→09/01		6K-V-022629→ 6K-X-523000; für Rechtslenker; - ABS		03.2120-3943.3	010532	ATE Ø 20,6
				6K-V-022629→; für Linkslenker; - ABS		03.2120-3943.3	010532	ATE Ø 20,6
				→ 6K-V-022628; - ABS		03.2122-1042.3	010137	Ø 22,2
				für Linkslenker; + ABS		03.2122-1144.3	010636	ATE Ø 22,2
90 1.8	66	01/97→09/01		03/98→; für Linkslenker; + ABS		03.2122-1144.3	010636	ATE Ø 22,2
 Bremskraftregler								
1.9 TDI	67	01/97→08/99				03.6583-0179.3	320228	ATE lastabhängig 8/3 4x
90 1.9 TDI	66	09/96→09/01						
110 1.9 TDI	81	06/98→01/02		→ 09/01		03.6583-0179.3	320228	ATE lastabhängig 8/3 4x
VW - POLO IV Stufenheck (9A4, 9A2, 9N2, 9A6) 09/02→								
 Hauptbremszylinder								
1.0	58	02/03→10/03		9N-5-500001→; + ABS		24.2119-1712.3	010912	Ø 19 ohne Bremsflüssigkeitsbehälter
1.4	74	11/03→06/05						
1.4 TDI	55	07/03→06/05				24.2120-1734.3	010702	Ø 20,6
				+ ABS; → 9N-5-180000		24.2120-1734.3	010702	Ø 20,6
				- ABS; → 9N-5-180000		24.2120-1736.3	010732	Ø 20,6
				9N-5-500001→; - ABS		24.2120-1736.3	010732	Ø 20,6
1.4	55 - 61	11/02→04/12		9N-5-500001→; → 05/09; + ABS		24.2119-1712.3	010912	Ø 19 ohne Bremsflüssigkeitsbehälter
1.6 Flex	77	05/08→10/14				24.2120-1734.3	010702	Ø 20,6
1.9 SDI	47	09/02→04/12		+ ABS; → 9N-5-180000		24.2120-1734.3	010702	Ø 20,6
1.9 TDi	74	09/02→						
2.0 Flex	88	10/08→12/14		9N-5-500001→; → 05/09; - ABS		24.2120-1736.3	010732	Ø 20,6
				- ABS; → 9N-5-180000		24.2120-1736.3	010732	Ø 20,6
1.6	74	09/02→		9N-5-500001→; → 05/09; + ABS		24.2119-1712.3	010912	Ø 19 ohne Bremsflüssigkeitsbehälter
						24.2120-1734.3	010702	Ø 20,6
				05/06→; → 9N-5-180000; + ABS		24.2120-1734.3	010702	Ø 20,6
				9N-5-500001→; → 05/09; - ABS		24.2120-1736.3	010732	Ø 20,6
				05/06→; → 9N-5-180000; - ABS		24.2120-1736.3	010732	Ø 20,6
1.6 Flex	76	12/04→10/14		9N-5-500001→; + ABS		24.2119-1712.3	010912	Ø 19 ohne Bremsflüssigkeitsbehälter
1.6 Total Flex	74	10/04→06/06				24.2120-1734.3	010702	Ø 20,6
				05/06→; → 9N-5-180000; + ABS		24.2120-1734.3	010702	Ø 20,6
				05/06→; → 9N-5-180000; - ABS		24.2120-1736.3	010732	Ø 20,6
				9N-5-500001→; - ABS		24.2120-1736.3	010732	Ø 20,6
VW - POLO IV Stufenheck (9N4) 09/02→12/10								
 Hauptbremszylinder								
1.4 TDi	55	01/03→12/07		9N-5-500001→; + ABS		24.2119-1712.3	010912	Ø 19 ohne Bremsflüssigkeitsbehälter
						24.2120-1734.3	010702	Ø 20,6
				+ ABS; → 9N-5-180000		24.2120-1734.3	010702	Ø 20,6
				- ABS; → 9N-5-180000		24.2120-1736.3	010732	Ø 20,6
				9N-5-500001→; - ABS		24.2120-1736.3	010732	Ø 20,6
1.9 TDI	74	07/03→12/10		9N-5-500001→; → 05/09; + ABS		24.2119-1712.3	010912	Ø 19 ohne Bremsflüssigkeitsbehälter
						24.2120-1734.3	010702	Ø 20,6
				+ ABS; → 9N-5-180000		24.2120-1734.3	010702	Ø 20,6
				9N-5-500001→; → 05/09; - ABS		24.2120-1736.3	010732	Ø 20,6
				- ABS; → 9N-5-180000		24.2120-1736.3	010732	Ø 20,6
VW - POLO Van Kasten/Kombi (6V5) 05/96→09/01								
 Bremskraftverstärker								
1.4	44 - 55	08/97→09/01		für Linkslenker; +PR 1KB; + ABS		10.6350-3902.4	300213	ATE Ø 9" pneumatisch
1.6	55	09/97→12/98		für Linkslenker; - ABS		03.7750-6302.4	300161	ATE Ø 9" pneumatisch
				für Linkslenker; + ABS		10.6350-3902.4	300213	ATE Ø 9" pneumatisch
1.7 SDI	44	08/97→12/99		für Linkslenker; - ABS		03.7750-6302.4	300161	ATE Ø 9" pneumatisch
				für Linkslenker; +PR 1KB; + ABS		10.6350-3902.4	300213	ATE Ø 9" pneumatisch













	kw					! #		
VW - POLO Van Kasten/Kombi (6V5) 05/96→09/01								
 Hauptbremszylinder								
1.4	44 - 55	08/97→09/01		- ABS		03.2122-1042.3	010137	Ø 22,2
1.6	55	09/97→12/98		für Linkslenker; + ABS		03.2122-1144.3	010636	ATE Ø 22,2
1.7 SDI	44	08/97→12/99						
1.9 SDI	50	10/99→09/01		9N-5-500001→; + ABS		24.2119-1712.3	010912	Ø 19 ohne Bremsflüssigkeitsbehälter
				+ ABS; → 9N-5-180000		24.2120-1734.3	010702	Ø 20,6
				- ABS; → 9N-5-180000		24.2120-1736.3	010732	Ø 20,6
				9N-5-500001→; - ABS		24.2120-1736.3	010732	Ø 20,6
VW - POLO Van Kasten/Schrägheck (6N1) 09/94→12/99								
 Bremskraftverstärker								
1.0	33	10/94→12/99		→ 6N-T-300000; für Linkslenker; + ABS		03.7750-6002.4	300134	ATE Ø 9" pneumatisch
				→ 09/96; für Linkslenker; + ESP; +PR 1AT / 1LX / 1ZE / 1ZJ / 1ZK		03.7853-0102.4	300252	ATE Ø 9" pneumatisch
 Hauptbremszylinder								
1.0	33	10/94→12/99		→ 09/96; für Linkslenker; - ABS		03.2120-3943.3	010532	ATE Ø 20,6
				6N-V-000001→; → 09/96; + ABS		03.2122-1344.3	010593	ATE Ø 22,2
Verschlusschraube, Hauptbremszylinder								
1.0	33	10/94→12/99		→ 09/96; für Linkslenker; - ABS		03.3517-0101.2	390322	
VW - POLO Variant (6V5) 04/97→09/01								
 Bremskraftverstärker								
1.4	40 - 44	05/97→09/01		für Linkslenker; +PR 1KB; + ABS		10.6350-3902.4	300213	ATE Ø 9" pneumatisch
1.4 16V	55	10/99→09/01						
1.6	55 - 74	05/97→09/01		für Linkslenker; - ABS		03.7750-6302.4	300161	ATE Ø 9" pneumatisch
				für Linkslenker; + ABS		10.6350-3902.4	300213	ATE Ø 9" pneumatisch
1.7 SDI	42	08/97→09/01		für Linkslenker; - ABS		03.7750-6302.4	300161	ATE Ø 9" pneumatisch
1.8	66	05/97→09/01						
1.9 SDI	47 - 50	06/97→09/01		für Linkslenker; +PR 1KB; + ABS		10.6350-3902.4	300213	ATE Ø 9" pneumatisch
1.9 TDI	66 - 81	05/97→09/01						
 Hauptbremszylinder								
1.4	40 - 44	05/97→09/01		- ABS		03.2122-1042.3	010137	Ø 22,2
1.4 16V	55	10/99→09/01		für Linkslenker; + ABS		03.2122-1144.3	010636	ATE Ø 22,2
1.6	55 - 74	05/97→09/01						
1.7 SDI	42	08/97→09/01						
1.8	66	05/97→09/01						
1.9 SDI	47 - 50	06/97→09/01						
1.9 TDI	66 - 81	05/97→09/01						
 Bremskraftregler								
1.8	66	05/97→09/01				03.6583-0179.3	320228	ATE lastabhängig 8/3 4x
1.9 TDI	66 - 81	05/97→09/01						
VW - SCIROCCO III (137, 138) 05/08→11/17								
 Bremskraftverstärker								
1.4 TSI	90	08/08→11/17		09/08→; für Linkslenker; +PR 1ZK		03.7860-8802.4	300291	ATE Ø 10" pneumatisch
				09/08→; für Linkslenker; +PR 1ZD / 1ZP		03.7863-3232.4	300307	ATE Ø 10" pneumatisch
				09/08→; für Linkslenker; +PR 1ZA / 1ZE / 1LJ		03.7863-3332.4	300308	ATE Ø 10" pneumatisch
1.4 TSI	92 - 110	11/13→11/17		+PR 1ZK; für Linkslenker		03.7860-8802.4	300291	ATE Ø 10" pneumatisch
2.0 R	188 - 195	11/09→11/17		für Linkslenker; +PR 1ZD / 1ZP		03.7863-3232.4	300307	ATE Ø 10" pneumatisch
2.0 TDI	100 - 135	05/09→11/17						
2.0 TSI	132 - 162	11/09→11/17		für Linkslenker; +PR 1ZA / 1ZE / 1LJ		03.7863-3332.4	300308	ATE Ø 10" pneumatisch
1.4 TSI	118	05/08→11/17		08/08→; +PR 1ZK; für Linkslenker		03.7860-8802.4	300291	ATE Ø 10" pneumatisch
2.0 TFSI	147	05/08→11/09		08/08→; +PR 1ZD / 1ZP; für Linkslenker		03.7863-3232.4	300307	ATE Ø 10" pneumatisch
→								













	kw			 	! #		
VW - SCIROCCO III (137, 138) 05/08→11/17							
Bremskraftverstärker							
1.4 TSI 2.0 TFSI	118 147	05/08→11/17 05/08→11/09		08/08→; +PR 1ZA / 1ZE / 1LJ; für Linkslenker	03.7863-3332.4	300308	ATE Ø 10" pneumatisch
2.0 R	206	05/14→11/17		08/14→; für Linkslenker; +PR 1ZK	03.7860-8802.4	300291	ATE Ø 10" pneumatisch
				08/14→; für Linkslenker; +PR 1ZD / 1ZP	03.7863-3232.4	300307	ATE Ø 10" pneumatisch
				08/14→; für Linkslenker; +PR 1ZA / 1ZE / 1LJ	03.7863-3332.4	300308	ATE Ø 10" pneumatisch
2.0 TDI	103	08/08→11/17		10/08→; +PR 1ZK; für Linkslenker	03.7860-8802.4	300291	ATE Ø 10" pneumatisch
				10/08→; +PR 1ZD / 1ZP; für Linkslenker	03.7863-3232.4	300307	ATE Ø 10" pneumatisch
				10/08→; +PR 1ZA / 1ZE / 1LJ; für Linkslenker	03.7863-3332.4	300308	ATE Ø 10" pneumatisch
Hauptbremszylinder							
1.4 TSI	90	08/08→11/17		09/08→; +PR 1ZD / 1ZP; für Linkslenker	03.2122-2129.3	010799	ATE Ø 22,2
				09/08→; +PR 1ZA / 1ZE / 1LJ / 1ZK; für Linkslenker	03.2123-3449.3	010808	ATE Ø 23,8
				09/08→; +PR 1ZD / 1ZP; für Rechtslenker	24.4152-0132.3	011025	ATE Ø 22,2 ohne Bremsflüssigkeitsbehälter
				09/08→; +PR 1ZA / 1ZE / 1LJ / 1ZK; für Rechtslenker	24.4153-0202.3	011027	ATE Ø 23,8 ohne Bremsflüssigkeitsbehälter
1.4 TSI 2.0 R	92 - 110 188 - 195	11/13→11/17 11/09→11/17		für Linkslenker; +PR 1ZD / 1ZP	03.2122-2129.3	010799	ATE Ø 22,2
				für Linkslenker; +PR 1ZA / 1ZE / 1LJ / 1ZK	03.2123-3449.3	010808	ATE Ø 23,8
2.0 TDI	100 - 135	05/09→11/17		für Rechtslenker; +PR 1ZD / 1ZP	24.4152-0132.3	011025	ATE Ø 22,2 ohne Bremsflüssigkeitsbehälter
2.0 TSI	132 - 162	11/09→11/17		für Rechtslenker; +PR 1ZA / 1ZE / 1LJ / 1ZK	24.4153-0202.3	011027	ATE Ø 23,8 ohne Bremsflüssigkeitsbehälter
1.4 TSI 2.0 TFSI	118 147	05/08→11/17 05/08→11/09		08/08→; +PR 1ZD / 1ZP; für Linkslenker	03.2122-2129.3	010799	ATE Ø 22,2
				08/08→; +PR 1ZA / 1ZE / 1LJ / 1ZK; für Linkslenker	03.2123-3449.3	010808	ATE Ø 23,8
				08/08→; +PR 1ZD / 1ZP; für Rechtslenker	24.4152-0132.3	011025	ATE Ø 22,2 ohne Bremsflüssigkeitsbehälter
				08/08→; +PR 1ZA / 1ZE / 1LJ / 1ZK; für Rechtslenker	24.4153-0202.3	011027	ATE Ø 23,8 ohne Bremsflüssigkeitsbehälter
2.0 R	206	05/14→11/17		08/14→; für Linkslenker; +PR 1ZD / 1ZP	03.2122-2129.3	010799	ATE Ø 22,2
				08/14→; für Linkslenker; +PR 1ZA / 1ZE / 1LJ / 1ZK	03.2123-3449.3	010808	ATE Ø 23,8
				08/14→; für Rechtslenker; +PR 1ZD / 1ZP	24.4152-0132.3	011025	ATE Ø 22,2 ohne Bremsflüssigkeitsbehälter
				08/14→; für Rechtslenker; +PR 1ZA / 1ZE / 1LJ / 1ZK	24.4153-0202.3	011027	ATE Ø 23,8 ohne Bremsflüssigkeitsbehälter
2.0 TDI	103	08/08→11/17		10/08→; +PR 1ZD / 1ZP; für Linkslenker	03.2122-2129.3	010799	ATE Ø 22,2
				10/08→; +PR 1ZA / 1ZE / 1LJ / 1ZK; für Linkslenker	03.2123-3449.3	010808	ATE Ø 23,8
				10/08→; +PR 1ZD / 1ZP; für Rechtslenker	24.4152-0132.3	011025	ATE Ø 22,2 ohne Bremsflüssigkeitsbehälter
				10/08→; +PR 1ZA / 1ZE / 1LJ / 1ZK; für Rechtslenker	24.4153-0202.3	011027	ATE Ø 23,8 ohne Bremsflüssigkeitsbehälter
Drucksensor, Bremskraftverstärker							
1.4 TSI	90	08/08→11/17		09/08→; +PR 1ZD / 1ZP	03.0655-0101.2	370008	ATE
				09/08→; +PR 1ZK	03.0655-0101.2	370008	ATE
				09/08→; für Linkslenker; +PR 1ZA / 1ZE / 1LJ	03.0655-0101.2	370008	ATE
				09/08→; für Rechtslenker; +PR 1ZA / 1ZB / 1ZE / 1LJ	03.0655-0101.2	370008	ATE
1.4 TSI 2.0 R	92 - 110 188 - 195	11/13→11/17 11/09→11/17		+PR 1ZD / 1ZP	03.0655-0101.2	370008	ATE
				+PR 1ZK	03.0655-0101.2	370008	ATE
2.0 TDI	100 - 135	05/09→11/17		für Linkslenker; +PR 1ZA / 1ZE / 1LJ	03.0655-0101.2	370008	ATE
2.0 TSI	132 - 162	11/09→11/17		für Rechtslenker; +PR 1ZA / 1ZB / 1ZE / 1LJ	03.0655-0101.2	370008	ATE
1.4 TSI 2.0 TFSI	118 147	05/08→11/17 05/08→11/09		08/08→; +PR 1ZD / 1ZP	03.0655-0101.2	370008	ATE
				08/08→; +PR 1ZK	03.0655-0101.2	370008	ATE
				08/08→; +PR 1ZA / 1ZE / 1LJ; für Linkslenker	03.0655-0101.2	370008	ATE
				08/08→; +PR 1ZA / 1ZB / 1ZE / 1LJ; für Rechtslenker	03.0655-0101.2	370008	ATE
2.0 R →	206	05/14→11/17		08/14→; +PR 1ZD / 1ZP	03.0655-0101.2	370008	ATE











	kw			 	! #		
VW - SCIROCCO III (137, 138) 05/08→11/17							
Drucksensor, Bremskraftverstärker							
2.0 R	206	05/14→11/17		08/14→; +PR 1ZK	03.0655-0101.2	370008	ATE
				08/14→; für Linkslenker; +PR 1ZA / 1ZE / 1LJ	03.0655-0101.2	370008	ATE
				08/14→; für Rechtslenker; +PR 1ZA / 1ZB / 1ZE / 1LJ	03.0655-0101.2	370008	ATE
2.0 TDI	103	08/08→11/17		10/08→; +PR 1ZD / 1ZP	03.0655-0101.2	370008	ATE
				10/08→; +PR 1ZK	03.0655-0101.2	370008	ATE
				10/08→; +PR 1ZA / 1ZE / 1LJ; für Linkslenker	03.0655-0101.2	370008	ATE
				10/08→; +PR 1ZA / 1ZB / 1ZE / 1LJ; für Rechtslenker	03.0655-0101.2	370008	ATE
VW - SCIROCCO Van (137) 06/08→05/14							
 Bremskraftverstärker							
1.4 TSi	90	08/08→05/14		09/08→; für Linkslenker; +PR 1ZK	03.7860-8802.4	300291	ATE Ø 10" pneumatisch
				09/08→; für Linkslenker; +PR 1ZD / 1ZP	03.7863-3232.4	300307	ATE Ø 10" pneumatisch
				09/08→; für Linkslenker; +PR 1ZA / 1ZE / 1LJ	03.7863-3332.4	300308	ATE Ø 10" pneumatisch
1.4 TSi	118	06/08→05/14		08/08→; +PR 1ZK; für Linkslenker	03.7860-8802.4	300291	ATE Ø 10" pneumatisch
				08/08→; +PR 1ZD / 1ZP; für Linkslenker	03.7863-3232.4	300307	ATE Ø 10" pneumatisch
				08/08→; +PR 1ZA / 1ZE / 1LJ; für Linkslenker	03.7863-3332.4	300308	ATE Ø 10" pneumatisch
2.0 TDi	103	08/08→05/14		10/08→; +PR 1ZK; für Linkslenker	03.7860-8802.4	300291	ATE Ø 10" pneumatisch
				10/08→; +PR 1ZD / 1ZP; für Linkslenker	03.7863-3232.4	300307	ATE Ø 10" pneumatisch
				10/08→; +PR 1ZA / 1ZE / 1LJ; für Linkslenker	03.7863-3332.4	300308	ATE Ø 10" pneumatisch
2.0 TDi 2.0 TFSi	125 155	05/09→05/14 11/09→05/14		für Linkslenker; +PR 1ZK	03.7860-8802.4	300291	ATE Ø 10" pneumatisch
				für Linkslenker; +PR 1ZD / 1ZP	03.7863-3232.4	300307	ATE Ø 10" pneumatisch
				für Linkslenker; +PR 1ZA / 1ZE / 1LJ	03.7863-3332.4	300308	ATE Ø 10" pneumatisch
 Hauptbremszylinder							
1.4 TSi	90	08/08→05/14		09/08→; +PR 1ZD / 1ZP; für Linkslenker	03.2122-2129.3	010799	ATE Ø 22,2
				09/08→; +PR 1ZA / 1ZE / 1LJ / 1ZK; für Linkslenker	03.2123-3449.3	010808	ATE Ø 23,8
				09/08→; +PR 1ZD / 1ZP; für Rechtslenker	24.4152-0132.3	011025	ATE Ø 22,2 ohne Bremsflüssigkeitsbehälter
				09/08→; +PR 1ZA / 1ZE / 1LJ / 1ZK; für Rechtslenker	24.4153-0202.3	011027	ATE Ø 23,8 ohne Bremsflüssigkeitsbehälter
1.4 TSi	118	06/08→05/14		08/08→; +PR 1ZD / 1ZP; für Linkslenker	03.2122-2129.3	010799	ATE Ø 22,2
				08/08→; +PR 1ZA / 1ZE / 1LJ / 1ZK; für Linkslenker	03.2123-3449.3	010808	ATE Ø 23,8
				08/08→; +PR 1ZD / 1ZP; für Rechtslenker	24.4152-0132.3	011025	ATE Ø 22,2 ohne Bremsflüssigkeitsbehälter
				08/08→; +PR 1ZA / 1ZE / 1LJ / 1ZK; für Rechtslenker	24.4153-0202.3	011027	ATE Ø 23,8 ohne Bremsflüssigkeitsbehälter
2.0 TDi	103	08/08→05/14		10/08→; +PR 1ZD / 1ZP; für Linkslenker	03.2122-2129.3	010799	ATE Ø 22,2
				10/08→; +PR 1ZA / 1ZE / 1LJ / 1ZK; für Linkslenker	03.2123-3449.3	010808	ATE Ø 23,8
				10/08→; +PR 1ZD / 1ZP; für Rechtslenker	24.4152-0132.3	011025	ATE Ø 22,2 ohne Bremsflüssigkeitsbehälter
				10/08→; +PR 1ZA / 1ZE / 1LJ / 1ZK; für Rechtslenker	24.4153-0202.3	011027	ATE Ø 23,8 ohne Bremsflüssigkeitsbehälter
2.0 TDi 2.0 TFSi	125 155	05/09→05/14 11/09→05/14		für Linkslenker; +PR 1ZD / 1ZP	03.2122-2129.3	010799	ATE Ø 22,2
				für Linkslenker; +PR 1ZA / 1ZE / 1LJ / 1ZK	03.2123-3449.3	010808	ATE Ø 23,8
				für Rechtslenker; +PR 1ZD / 1ZP	24.4152-0132.3	011025	ATE Ø 22,2 ohne Bremsflüssigkeitsbehälter
				für Rechtslenker; +PR 1ZA / 1ZE / 1LJ / 1ZK	24.4153-0202.3	011027	ATE Ø 23,8 ohne Bremsflüssigkeitsbehälter
Drucksensor, Bremskraftverstärker							
1.4 TSi	90	08/08→05/14		09/08→; +PR 1ZD / 1ZP	03.0655-0101.2	370008	ATE
				09/08→; +PR 1ZK	03.0655-0101.2	370008	ATE
				09/08→; für Linkslenker; +PR 1ZA / 1ZE / 1LJ	03.0655-0101.2	370008	ATE
				09/08→; für Rechtslenker; +PR 1ZA / 1ZB / 1ZE / 1LJ	03.0655-0101.2	370008	ATE
1.4 TSi →	118	06/08→05/14		08/08→; +PR 1ZD / 1ZP	03.0655-0101.2	370008	ATE









	kw			 	! #		
VW - SCIROCCO Van (137) 06/08→05/14							
Drucksensor, Bremskraftverstärker							
1.4 TSi	118	06/08→05/14		08/08→; +PR 1ZK		03.0655-0101.2 370008	ATE
				08/08→; +PR 1ZA / 1ZE / 1LJ; für Linkslenker		03.0655-0101.2 370008	ATE
				08/08→; +PR 1ZA / 1ZB / 1ZE / 1LJ; für Rechtslenker		03.0655-0101.2 370008	ATE
2.0 TDi	103	08/08→05/14		10/08→; +PR 1ZD / 1ZP		03.0655-0101.2 370008	ATE
				10/08→; +PR 1ZK		03.0655-0101.2 370008	ATE
				10/08→; +PR 1ZA / 1ZE / 1LJ; für Linkslenker		03.0655-0101.2 370008	ATE
				10/08→; +PR 1ZA / 1ZB / 1ZE / 1LJ; für Rechtslenker		03.0655-0101.2 370008	ATE
2.0 TDi	125	05/09→05/14		+PR 1ZD / 1ZP		03.0655-0101.2 370008	ATE
2.0 TFSi	155	11/09→05/14		+PR 1ZK		03.0655-0101.2 370008	ATE
				für Linkslenker; +PR 1ZA / 1ZE / 1LJ		03.0655-0101.2 370008	ATE
				für Rechtslenker; +PR 1ZA / 1ZB / 1ZE / 1LJ		03.0655-0101.2 370008	ATE
VW - SHARAN (7M8, 7M9, 7M6) 05/95→03/10							
 Bremskraftverstärker							
1.8 T 20V	110	09/97→03/10		7M-W-020919→; → 04/00; für Linkslenker		03.7755-1902.4 300138	ATE Ø 9 / 8" pneumatisch
1.9 TDI	66	09/95→03/10					
2.0	85	09/95→03/10		05/02→; - ESP; für Linkslenker		03.7755-6302.4 300221	ATE Ø 9 / 8" pneumatisch
				05/00→ 04/02; +PR 1AT		03.7755-6302.4 300221	ATE Ø 9 / 8" pneumatisch
				→ 7M-W-020918; für Rechtslenker		03.7760-3002.4 300120	ATE Ø 10" pneumatisch
				→ 7M-W-060000; für Linkslenker		03.7760-3002.4 300120	ATE Ø 10" pneumatisch
				05/00→; für Linkslenker; + ESP; → 7M-3-029999		03.7858-3302.4 300122	ATE Ø 9 / 8" pneumatisch
				7M-3-030000→; + ESP; für Linkslenker		03.7858-9502.4 300205	ATE Ø 9 / 8" pneumatisch
1.9 TDI	81	09/96→04/00		7M-W-020919→; für Linkslenker		03.7755-1902.4 300138	ATE Ø 9 / 8" pneumatisch
2.8 VR6	128	09/95→04/00		→ 7M-W-060000; für Linkslenker		03.7760-3002.4 300120	ATE Ø 10" pneumatisch
2.8 VR6 Syncro	128	11/96→04/00		→ 7M-W-020918; für Rechtslenker		03.7760-3002.4 300120	ATE Ø 10" pneumatisch
1.9 TDI	85	04/00→03/10		05/02→; - ESP; für Linkslenker		03.7755-6302.4 300221	ATE Ø 9 / 8" pneumatisch
1.9 TDI 4motion	85	03/00→03/10		05/00→ 04/02; +PR 1AT		03.7755-6302.4 300221	ATE Ø 9 / 8" pneumatisch
				05/00→; für Linkslenker; + ESP; → 7M-3-029999		03.7858-3302.4 300122	ATE Ø 9 / 8" pneumatisch
				7M-3-030000→; + ESP; für Linkslenker		03.7858-9502.4 300205	ATE Ø 9 / 8" pneumatisch
1.9 TDI	96 - 110	11/02→03/10		- ESP; für Linkslenker		03.7755-6302.4 300221	ATE Ø 9 / 8" pneumatisch
2.0 TDI	100 - 103	11/05→03/10		+ ESP; für Linkslenker		03.7858-9502.4 300205	ATE Ø 9 / 8" pneumatisch
2.0 16V	110	09/95→02/00		7M-W-020919→; für Linkslenker		03.7755-1902.4 300138	ATE Ø 9 / 8" pneumatisch
				→ 7M-W-020918; für Rechtslenker		03.7760-3002.4 300120	ATE Ø 10" pneumatisch
				→ 7M-W-060000; für Linkslenker		03.7760-3002.4 300120	ATE Ø 10" pneumatisch
				7M-3-030000→; + ESP; für Linkslenker		03.7858-9502.4 300205	ATE Ø 9 / 8" pneumatisch
2.0 LPG	85	04/06→03/10		- ESP; für Linkslenker		03.7755-6302.4 300221	ATE Ø 9 / 8" pneumatisch
				→ 7M-W-020918; für Rechtslenker		03.7760-3002.4 300120	ATE Ø 10" pneumatisch
				→ 7M-W-060000; für Linkslenker		03.7760-3002.4 300120	ATE Ø 10" pneumatisch
				für Linkslenker; + ESP; → 7M-3-029999		03.7858-3302.4 300122	ATE Ø 9 / 8" pneumatisch
				7M-3-030000→; + ESP; für Linkslenker		03.7858-9502.4 300205	ATE Ø 9 / 8" pneumatisch
2.8 V6 24V	150	04/00→03/10		05/02→; - ESP; für Linkslenker		03.7755-6302.4 300221	ATE Ø 9 / 8" pneumatisch
2.8 V6 24V 4motion	150	04/00→03/10		→ 04/02; +PR 1AT		03.7755-6302.4 300221	ATE Ø 9 / 8" pneumatisch
				für Linkslenker; + ESP; → 7M-3-029999		03.7858-3302.4 300122	ATE Ø 9 / 8" pneumatisch
				7M-3-030000→; + ESP; für Linkslenker		03.7858-9502.4 300205	ATE Ø 9 / 8" pneumatisch
Pedalwegsensor, Bremspedal							
1.8 T 20V	110	09/97→03/10		7M-3-030364→; für Rechtslenker; + ESP		03.0655-0006.2 370006	ATE
1.9 TDI	66 - 85	09/95→03/10		7M-3-030000→; + ESP; für Linkslenker		03.0655-0006.2 370006	ATE
1.9 TDI 4motion	85	03/00→03/10					
2.0	85	09/95→03/10					
2.0 16V	110	09/95→02/00					
2.0 LPG	85	04/06→03/10					
2.8 V6 24V	150	04/00→03/10					
2.8 V6 24V 4motion	150	04/00→03/10					
1.9 TDI	96 - 110	11/02→03/10		+ ESP; für Linkslenker		03.0655-0006.2 370006	ATE
2.0 TDI	100 - 103	11/05→03/10					
→							











	kw					! #		
VW - SHARAN (7M8, 7M9, 7M6) 05/95→03/10								
 Hauptbremszylinder								
1.8 T 20V	110	09/97→03/10		→ 7M-W-020918; + ABS		03.2123-1526.3	010477	Ø 23,8
				→ 7M-W-020918; - ABS		03.2123-1548.3	010478	Ø 23,8
				05/02→; - ESP; für Rechtslenker		03.2125-0332.3	010952	Ø 25,4
				7M-W-020919→; - ESP; → 04/02		03.2125-0332.3	010952	Ø 25,4
				7M-W-020919→; → 04/00; - ABS		03.2125-8404.3	010583	ATE Ø 25,4
				05/00→; + ESP; → 7M-3-029999		03.2125-9604.3	010581	Ø 25,4
1.9 TDI 2.0	66	09/95→03/10		→ 7M-W-020918; + ABS		03.2123-1526.3	010477	Ø 23,8
	85	09/95→03/10		→ 7M-W-020918; - ABS		03.2123-1548.3	010478	Ø 23,8
				05/02→; - ESP; für Rechtslenker; → 05/05		03.2125-0332.3	010952	Ø 25,4
				7M-W-020919→; - ESP; → 04/02		03.2125-0332.3	010952	Ø 25,4
				7M-W-020919→; → 04/00; - ABS		03.2125-8404.3	010583	ATE Ø 25,4
				05/00→; + ESP; → 7M-3-029999		03.2125-9604.3	010581	Ø 25,4
1.9 TDI 2.0 16V 2.8 VR6 2.8 VR6 Syncro	81	09/96→04/00		→ 7M-W-020918; + ABS		03.2123-1526.3	010477	Ø 23,8
	110	09/95→02/00		→ 7M-W-020918; - ABS		03.2123-1548.3	010478	Ø 23,8
	128	09/95→04/00		7M-W-020919→; - ESP		03.2125-0332.3	010952	Ø 25,4
	128	11/96→04/00		7M-W-020919→; - ABS		03.2125-8404.3	010583	ATE Ø 25,4
1.9 TDI 1.9 TDI 4motion	85	04/00→03/10		05/02→; - ESP; für Rechtslenker; → 05/05		03.2125-0332.3	010952	Ø 25,4
	85	03/00→03/10		05/00→; + ESP; → 7M-3-029999		03.2125-9604.3	010581	Ø 25,4
				- ESP; für Rechtslenker; → 05/05		03.2125-0332.3	010952	Ø 25,4
1.9 TDI	96	11/02→03/10		- ESP; für Rechtslenker; → 05/05		03.2125-0332.3	010952	Ø 25,4
2.0 LPG	85	04/06→03/10		→ 7M-W-020918; + ABS		03.2123-1526.3	010477	Ø 23,8
				→ 7M-W-020918; - ABS		03.2123-1548.3	010478	Ø 23,8
				+ ESP; → 7M-3-029999		03.2125-9604.3	010581	Ø 25,4
2.8 V6 24V 2.8 V6 24V 4motion	150 150	04/00→03/10 04/00→03/10		+ ESP; → 7M-3-029999		03.2125-9604.3	010581	Ø 25,4
Verschlusschraube, Hauptbremszylinder								
1.8 T 20V 1.9 TDI 2.0 2.0 16V 2.0 LPG 2.8 VR6 2.8 VR6 Syncro	110 66 - 81 85 110 85 128 128	09/97→03/10 09/95→03/10 09/95→03/10 09/95→02/00 04/06→03/10 09/95→04/00 11/96→04/00		→ 7M-W-020918		03.3517-5100.1	390326	
VW - SHARAN (7N1, 7N2) 05/10→								
 Bremskraftverstärker								
1.4 TSI 2.0 TDI	110 100 - 103	05/10→ 05/10→		07/10→; für Linkslenker		03.7873-4502.4	300284	ATE Ø 11" pneumatisch
2.0 TDI 2.0 TDI 4motion 2.0 TFSI	85 - 130 103 - 147	08/10→ 05/11→11/15 12/10→11/15		für Linkslenker		03.7873-4502.4	300284	ATE Ø 11" pneumatisch
 Hauptbremszylinder								
1.4 TSI 2.0 TDI	110 100 - 103	05/10→ 05/10→		07/10→; für Linkslenker		03.4153-0186.3	010816	ATE Ø 23,8
				07/10→; für Rechtslenker		24.4153-0222.3	011047	ATE Ø 23,8 ohne Bremsflüssigkeitsbehälter
1.4 TSI 2.0 TDI 2.0 TDI 4motion 2.0 TFSI 2.0 TSI	110 85 - 135 103 - 135 147 162	05/15→ 08/10→ 05/11→ 12/10→11/15 05/15→		für Linkslenker		03.4153-0186.3	010816	ATE Ø 23,8
				für Rechtslenker		24.4153-0222.3	011047	ATE Ø 23,8 ohne Bremsflüssigkeitsbehälter
VW - SHARAN VAN (7M_) 05/95→03/10								
 Bremskraftverstärker								
1.9 TDI	96	11/02→05/03		- ESP; für Linkslenker		03.7755-6302.4	300221	ATE Ø 9 / 8" pneumatisch
				+ ESP; für Linkslenker		03.7858-9502.4	300205	ATE Ø 9 / 8" pneumatisch
2.8 VR6	150	08/01→05/03		7M-W-020919→; für Linkslenker		03.7755-1902.4	300138	ATE Ø 9 / 8" pneumatisch
				→ 7M-W-060000; für Linkslenker		03.7760-3002.4	300120	ATE Ø 10" pneumatisch
→				→ 7M-W-020918; für Rechtslenker		03.7760-3002.4	300120	ATE Ø 10" pneumatisch











	kw					! #		
VW - SHARAN VAN (7M_) 05/95→03/10								
Pedalwegsensor, Bremspedal								
1.9 TDI	96	11/02→05/03		+ ESP; für Linkslenker			03.0655-0006.2 370006	ATE
 Hauptbremszylinder								
1.9 TDI	96	11/02→05/03		- ESP; für Rechtslenker			03.2125-0332.3 010952	Ø 25,4
2.8 VR6	150	08/01→05/03		→ 7M-W-020918; + ABS			03.2123-1526.3 010477	Ø 23,8
				→ 7M-W-020918; - ABS			03.2123-1548.3 010478	Ø 23,8
				7M-W-020919→; - ESP			03.2125-0332.3 010952	Ø 25,4
				7M-W-020919→; - ABS			03.2125-8404.3 010583	ATE Ø 25,4
Verschlusschraube, Hauptbremszylinder								
2.8 VR6	150	08/01→05/03		→ 7M-W-020918			03.3517-5100.1 390326	
VW - SHARAN VAN (7N1, 7N2) 05/10→								
 Bremskraftverstärker								
1.4 TSI	110	05/10→11/15		07/10→; für Linkslenker			03.7873-4502.4 300284	ATE Ø 11" pneumatisch
2.0 TDI	100 - 103	05/10→11/15						
2.0 TDI	85 - 125	08/10→11/15		für Linkslenker			03.7873-4502.4 300284	ATE Ø 11" pneumatisch
2.0 TSI	147	12/10→11/15						
 Hauptbremszylinder								
1.4 TSI	110	05/10→11/15		07/10→; für Linkslenker			03.4153-0186.3 010816	ATE Ø 23,8
2.0 TDI	100 - 103	05/10→11/15		07/10→; für Rechtslenker			24.4153-0222.3 011047	ATE Ø 23,8 ohne Bremsflüssigkeitsbehälter
2.0 TDI	85 - 125	08/10→11/15		für Linkslenker			03.4153-0186.3 010816	ATE Ø 23,8
2.0 TSI	147	12/10→11/15		für Rechtslenker			24.4153-0222.3 011047	ATE Ø 23,8 ohne Bremsflüssigkeitsbehälter
VW - TIGUAN (5N_) 09/07→07/18								
 Bremskraftverstärker								
1.4 TSI	90 - 118	05/08→07/18		für Linkslenker			03.7873-4502.4 300284	ATE Ø 11" pneumatisch
1.4 TSI 4motion	110 - 118	09/07→07/18						
2.0 TDI	81 - 110	03/08→07/18						
2.0 TDI 4motion	100 - 135	11/07→07/18						
2.0 TFSI	147	11/07→07/18						
2.0 TFSI 4motion	125	09/07→07/18						
2.0 TSI 4motion	132 - 155	05/11→07/18						
2.0 TDI 4motion	103	09/07→07/18		11/07→; für Linkslenker			03.7873-4502.4 300284	ATE Ø 11" pneumatisch
2.0 TDI 4motion	125	09/07→07/18		01/08→; für Linkslenker			03.7873-4502.4 300284	ATE Ø 11" pneumatisch
2.0 TFSI 4motion	147	09/07→07/18		02/08→; für Linkslenker			03.7873-4502.4 300284	ATE Ø 11" pneumatisch
 Hauptbremszylinder								
1.4 TSI	90 - 118	05/08→07/18		für Linkslenker			03.4153-0186.3 010816	ATE Ø 23,8
1.4 TSI 4motion	110 - 118	09/07→07/18		für Rechtslenker			24.4153-0192.3 011026	ATE Ø 23,8 ohne Bremsflüssigkeitsbehälter
2.0 TDI	81 - 110	03/08→07/18						
2.0 TDI 4motion	100 - 135	11/07→07/18						
2.0 TFSI	147	11/07→07/18						
2.0 TFSI 4motion	125	09/07→07/18						
2.0 TSI 4motion	132 - 155	05/11→07/18						
2.0 TDI 4motion	103	09/07→07/18		11/07→; für Linkslenker			03.4153-0186.3 010816	ATE Ø 23,8
				11/07→; für Rechtslenker			24.4153-0192.3 011026	ATE Ø 23,8 ohne Bremsflüssigkeitsbehälter
2.0 TDI 4motion	125	09/07→07/18		01/08→; für Linkslenker			03.4153-0186.3 010816	ATE Ø 23,8
				01/08→; für Rechtslenker			24.4153-0192.3 011026	ATE Ø 23,8 ohne Bremsflüssigkeitsbehälter
2.0 TFSI 4motion	147	09/07→07/18		02/08→; für Linkslenker			03.4153-0186.3 010816	ATE Ø 23,8
				02/08→; für Rechtslenker			24.4153-0192.3 011026	ATE Ø 23,8 ohne Bremsflüssigkeitsbehälter









	kw					! #		
VW - TIGUAN (AD1, AX1) 01/16→								
 Hauptbremszylinder								
1.4 TSI	92 - 110	01/16→07/18		für Linkslenker; +PR 1ZA / 1ZD		24.4123-1719.3	011017	TRW Ø 23,8 ohne Bremsflüssigkeitsbehälter
1.4 TSI 4motion	110	05/16→07/18						
1.5 TSI	96 - 110	07/18→						
1.6 TDI	85	05/16→06/20						
2.0 TDI	81 - 90	05/16→						
2.0 TDI 4motion	130 - 176	04/16→						
2.0 TSI 4motion	132 - 180	01/16→						
2.0 TSI R 4motion	235	11/20→						
2.0 TDI	110	01/16→07/20		02/16→; für Linkslenker; +PR 1ZA / 1ZD		24.4123-1719.3	011017	TRW Ø 23,8 ohne Bremsflüssigkeitsbehälter
2.0 TDI 4motion	110	01/16→07/20						
VW - TIGUAN Kasten/SUV (AD1) 07/15→								
 Hauptbremszylinder								
TDI BlueMotion	140	01/16→07/20		für Linkslenker; +PR 1ZA / 1ZD		24.4123-1719.3	011017	TRW Ø 23,8 ohne Bremsflüssigkeitsbehälter
VW - TIGUAN VAN (5N_) 09/07→07/18								
 Bremskraftverstärker								
1.4 TSI	90 - 118	05/08→07/18		für Linkslenker		03.7873-4502.4	300284	ATE Ø 11" pneumatisch
1.4 TSI 4motion	118	09/12→07/18						
2.0 TDI	81 - 103	11/09→07/18						
2.0 TDI 4motion	103 - 130	11/07→07/18						
2.0 TSI 4motion	125 - 155	11/09→07/18						
 Hauptbremszylinder								
1.4 TSI	90 - 118	05/08→07/18		für Linkslenker		03.4153-0186.3	010816	ATE Ø 23,8
1.4 TSI 4motion	118	09/12→07/18		für Rechtslenker		24.4153-0192.3	011026	ATE Ø 23,8 ohne Bremsflüssigkeitsbehälter
2.0 TDI	81 - 103	11/09→07/18						
2.0 TDI 4motion	103 - 130	11/07→07/18						
2.0 TSI 4motion	125 - 155	11/09→07/18						
VW - TOUAREG (7LA, 7L6, 7L7) 10/02→01/13								
 Bremskraftverstärker								
2.5 R5 TDI	120 - 128	01/03→05/10		12/06→; für Linkslenker; → 03/10; +PR 1LB / 1LE / 1LF		03.7868-3702.4	300208	ATE Ø 10 / 8" pneumatisch
3.0 TDI	155	04/06→05/10						
3.0 V6 TDI	165	11/04→05/10						
3.6 V6 FSI	206	10/05→05/10						
4.2 V8 FSI	257	06/06→05/10						
5.0 V10 TDI	230	10/02→05/10						
3.0 V6 TDI	176	11/07→05/10		→ 03/10; für Linkslenker; +PR 1LB / 1LE / 1LF		03.7868-3702.4	300208	ATE Ø 10 / 8" pneumatisch
5.0 R50 TDI	257	08/07→05/10		01/08→ 03/10; für Linkslenker; +PR 1LB / 1LE / 1LF		03.7868-3702.4	300208	ATE Ø 10 / 8" pneumatisch
Pedalwegsensor, Bremspedal								
2.5 R5 TDI	120 - 128	01/03→05/10		→ 11/06		03.0655-0006.2	370006	ATE
3.0 TDI	155	04/06→05/10						
3.0 V6 TDI	165	11/04→05/10						
6.0 W12	331	08/04→05/10						
3.2 V6	162	10/02→11/06		11/02→ 12/05		03.0655-0006.2	370006	ATE
3.2 V6	177	11/04→11/06		→ 12/05		03.0655-0006.2	370006	ATE
3.6 V6 FSI	206	10/05→05/10		01/06→ 11/06		03.0655-0006.2	370006	ATE
4.2 V8	228	12/02→11/06				03.0655-0006.2	370006	ATE
5.0 V10 TDI	230	10/02→05/10		11/02→ 11/06		03.0655-0006.2	370006	ATE
 Hauptbremszylinder								
2.5 R5 TDI	120 - 128	01/03→05/10		für Linkslenker; → 03/10		03.2126-3014.3	010811	ATE Ø 27
3.0 TDI	155	04/06→05/10		für Rechtslenker; → 11/06		24.2126-3032.3	011036	ATE Ø 27 ohne Bremsflüssigkeitsbehälter
3.0 V6 TDI	165	11/04→05/10						
→								







	kw					! #		
VW - TOUAREG (7LA, 7L6, 7L7) 10/02→01/13								
 Hauptbremszylinder								
3.0 V6 TDI	176	11/07→05/10		für Linkslenker		03.2126-3014.3	010811	ATE Ø 27
4.2 V8	228	12/02→11/06		für Rechtslenker		24.2126-3032.3	011036	ATE Ø 27 ohne Bremsflüssigkeitsbehälter
3.2 V6	162	10/02→11/06		11/02→; für Linkslenker; → 12/05		03.2126-3014.3	010811	ATE Ø 27
				11/02→; für Rechtslenker		24.2126-3032.3	011036	ATE Ø 27 ohne Bremsflüssigkeitsbehälter
3.2 V6	177	11/04→11/06		für Linkslenker; → 12/05		03.2126-3014.3	010811	ATE Ø 27
				für Rechtslenker		24.2126-3032.3	011036	ATE Ø 27 ohne Bremsflüssigkeitsbehälter
3.6 V6 FSI	206	10/05→05/10		01/06→ 03/10; für Linkslenker		03.2126-3014.3	010811	ATE Ø 27
				01/06→ 11/06; für Rechtslenker		24.2126-3032.3	011036	ATE Ø 27 ohne Bremsflüssigkeitsbehälter
4.2 V8 FSI	257	06/06→05/10		12/06→ 03/10; für Linkslenker		03.2126-3014.3	010811	ATE Ø 27
5.0 R50 TDI	257	08/07→05/10		01/08→ 03/10; für Linkslenker		03.2126-3014.3	010811	ATE Ø 27
5.0 V10 TDI	230	10/02→05/10		11/02→; für Linkslenker; → 03/10		03.2126-3014.3	010811	ATE Ø 27
				11/02→; für Rechtslenker; → 11/06		24.2126-3032.3	011036	ATE Ø 27 ohne Bremsflüssigkeitsbehälter
6.0 W12	331	08/04→05/10		für Linkslenker; → 11/06		03.2126-3014.3	010811	ATE Ø 27
				für Rechtslenker; → 11/06		24.2126-3032.3	011036	ATE Ø 27 ohne Bremsflüssigkeitsbehälter
VW - TOURAN (1T1, 1T2) 02/03→05/10								
 Bremskraftverstärker								
1.4 TSI	103	02/06→05/10		09/06→; +PR 1AT; für Linkslenker		03.7873-4302.4	300312	ATE Ø 11" pneumatisch
1.4 TSI	125	11/06→05/10		für Linkslenker; +PR 1AT		03.7873-4302.4	300312	ATE Ø 11" pneumatisch
1.4 TSI EcoFuel	110	05/09→05/10						
1.6	75	07/03→05/10						
1.6 BiFuel	75	11/06→05/10						
1.6 FSI	85	02/03→01/07						
1.9 TDI	66 - 77	02/03→05/10						
2.0 EcoFuel	80	02/06→05/09						
2.0 FSI	110	10/03→01/07						
2.0 TDI	103	12/05→05/10						
2.0 TDI 16V	103	08/03→05/10						
2.0 TDI	100	02/03→05/10		08/03→; für Linkslenker; +PR 1AT		03.7873-4302.4	300312	ATE Ø 11" pneumatisch
2.0 TDI	125	12/05→05/10		02/06→; +PR 1AT; für Linkslenker		03.7873-4302.4	300312	ATE Ø 11" pneumatisch
 Hauptbremszylinder								
1.4 TSI	103	02/06→05/10		09/06→; +PR 1ZE / 1ZP; für Linkslenker		03.2122-2129.3	010799	ATE Ø 22,2
				1T-6-100 001→; für Rechtslenker		24.4152-0132.3	011025	ATE Ø 22,2 ohne Bremsflüssigkeitsbehälter
1.4 TSI	125	11/06→05/10		für Linkslenker; +PR 1ZE / 1ZP		03.2122-2129.3	010799	ATE Ø 22,2
1.6	75	07/03→05/10						
1.6 BiFuel	75	11/06→05/10		→ 1T-6-100 000; für Rechtslenker; +PR 1ZE / 1ZP		24.2122-1981.3	011024	ATE Ø 22,2 ohne Bremsflüssigkeitsbehälter
1.9 TDI	66 - 77	02/03→05/10						
2.0 EcoFuel	80	02/06→05/09		1T-6-100 001→; für Rechtslenker		24.4152-0132.3	011025	ATE Ø 22,2 ohne Bremsflüssigkeitsbehälter
2.0 FSI	110	10/03→01/07						
2.0 TDI	103	12/05→05/10						
2.0 TDI 16V	103	08/03→05/10						
1.4 TSI EcoFuel	110	05/09→05/10		für Linkslenker		03.2122-2129.3	010799	ATE Ø 22,2
1.6 FSI	85	02/03→01/07						
				→ 1T-6-100 000; für Rechtslenker; +PR 1ZE / 1ZP		24.2122-1981.3	011024	ATE Ø 22,2 ohne Bremsflüssigkeitsbehälter
				1T-6-100 001→; für Rechtslenker		24.4152-0132.3	011025	ATE Ø 22,2 ohne Bremsflüssigkeitsbehälter
2.0 TDI	100	02/03→05/10		08/03→; für Linkslenker; +PR 1ZE / 1ZP		03.2122-2129.3	010799	ATE Ø 22,2
				08/03→; → 1T-6-100 000; für Rechtslenker; +PR 1ZE / 1ZP		24.2122-1981.3	011024	ATE Ø 22,2 ohne Bremsflüssigkeitsbehälter
				1T-6-100 001→; für Rechtslenker		24.4152-0132.3	011025	ATE Ø 22,2 ohne Bremsflüssigkeitsbehälter
2.0 TDI	125	12/05→05/10		02/06→; für Linkslenker; +PR 1ZE / 1ZP		03.2122-2129.3	010799	ATE Ø 22,2
				02/06→; → 1T-6-100 000; +PR 1ZE / 1ZP; für Rechtslenker		24.2122-1981.3	011024	ATE Ø 22,2 ohne Bremsflüssigkeitsbehälter
				1T-6-100 001→; für Rechtslenker		24.4152-0132.3	011025	ATE Ø 22,2 ohne Bremsflüssigkeitsbehälter
Hydraulikaggregat, Bremsanlage								
1.4 TSI	103	02/06→05/10		09/06→; +PR 1AT / 1AS		24.9145-0001.2	399005	
1.4 TSI	125	11/06→05/10		+PR 1AT / 1AS		24.9145-0001.2	399005	
→								

	kw			 	! #		
VW - TOURAN (1T1, 1T2) 02/03→05/10							
Hydraulikaggregat, Bremsanlage							
1.4 TSI EcoFuel 1.6 1.6 BiFuel 1.6 FSI 1.9 TDI 2.0 EcoFuel 2.0 FSI 2.0 TDI 2.0 TDI 16V 2.0 TDI 2.0 TDI	110 75 75 85 66 - 77 80 110 103 103 100 125	05/09→05/10 07/03→05/10 11/06→05/10 02/03→01/07 02/03→05/10 02/06→05/09 10/03→01/07 12/05→05/10 08/03→05/10 02/03→05/10 12/05→05/10		+PR 1AT / 1AS		24.9145-0001.2 399005	
Drucksensor, Bremskraftverstärker							
1.4 TSI 1.4 TSI 1.4 TSI EcoFuel 1.6 1.6 BiFuel 1.6 FSI 1.9 TDI 2.0 EcoFuel 2.0 FSI 2.0 TDI 2.0 TDI 16V 2.0 TDI 2.0 TDI	103 125 110 75 75 85 66 - 77 80 110 103 103 100 125	02/06→05/10 11/06→05/10 05/09→05/10 07/03→05/10 11/06→05/10 02/03→01/07 02/03→05/10 02/06→05/09 10/03→01/07 12/05→05/10 08/03→05/10 02/03→05/10 12/05→05/10		09/06→; +PR 1AS; für Rechtslenker für Rechtslenker; +PR 1AS 08/03→; für Rechtslenker; +PR 1AS 02/06→; +PR 1AS; für Rechtslenker		03.0655-0101.2 370008 03.0655-0101.2 370008 03.0655-0101.2 370008 03.0655-0101.2 370008	ATE ATE ATE ATE
VW - TOURAN (1T3) 05/10→05/15							
 Bremskraftverstärker							
1.2 TSI 1.4 TSI 1.4 TSI EcoFuel 1.6 TDI 2.0 TDI 2.0 TDI	77 103 - 125 110 66 - 77 81 - 125 130	05/10→05/15 05/10→05/15 05/10→05/15 05/10→05/15 05/10→05/15 01/13→05/15		für Linkslenker; +PR 1AT für Linkslenker		03.7873-4302.4 300312 03.7873-4302.4 300312	ATE Ø 11" pneumatisch ATE Ø 11" pneumatisch
 Hauptbremszylinder							
1.2 TSI 1.4 TSI 1.6 TDI 2.0 TDI 1.4 TSI 1.4 TSI EcoFuel 2.0 TDI	77 125 66 - 77 81 - 125 103 110 130	05/10→05/15 05/10→05/15 05/10→05/15 05/10→05/15 05/10→05/15 05/10→05/15 01/13→05/15		für Linkslenker; +PR 1ZE / 1ZP → 1T-6-100 000; für Rechtslenker; +PR 1ZE / 1ZP 1T-6-100 001→; für Rechtslenker für Linkslenker; +PR 1ZE / 1ZP 1T-6-100 001→; für Rechtslenker für Linkslenker → 1T-6-100 000; für Rechtslenker; +PR 1ZE / 1ZP 1T-6-100 001→; für Rechtslenker für Linkslenker für Rechtslenker		03.2122-2129.3 010799 24.2122-1981.3 011024 24.4152-0132.3 011025 03.2122-2129.3 010799 24.2122-1981.3 011024 24.4152-0132.3 011025 03.2122-2129.3 010799 24.4152-0132.3 011025	ATE Ø 22,2 ATE Ø 22,2 ohne Bremsflüssigkeitsbehälter ATE Ø 22,2 ohne Bremsflüssigkeitsbehälter ATE Ø 22,2 ATE Ø 22,2 ohne Bremsflüssigkeitsbehälter ATE Ø 22,2 ohne Bremsflüssigkeitsbehälter ATE Ø 22,2 ATE Ø 22,2 ohne Bremsflüssigkeitsbehälter ATE Ø 22,2 ohne Bremsflüssigkeitsbehälter ATE Ø 22,2 ohne Bremsflüssigkeitsbehälter
Hydraulikaggregat, Bremsanlage							
1.2 TSI 1.4 TSI 1.4 TSI EcoFuel 1.6 TDI 2.0 TDI	77 103 - 125 110 66 - 77 81 - 125	05/10→05/15 05/10→05/15 05/10→05/15 05/10→05/15 05/10→05/15		→ 12/10; +PR 1AT / 1AS		24.9145-0001.2 399005	
Drucksensor, Bremskraftverstärker							
1.2 TSI 1.4 TSI 1.4 TSI EcoFuel →	77 103 - 125 110	05/10→05/15 05/10→05/15 05/10→05/15		für Rechtslenker; +PR 1AS		03.0655-0101.2 370008	ATE

	kw			 	! #		
VW - TOURAN (1T3) 05/10→05/15							
Drucksensor, Bremskraftverstärker							
1.6 TDI	66 - 77	05/10→05/15		für Rechtslenker; +PR 1AS		03.0655-0101.2 370008	ATE
2.0 TDI	81 - 125	05/10→05/15					
VW - TOURAN (5T1) 05/15→							
 Hauptbremszylinder							
1.0 TSI	85	12/18→		für Linkslenker		24.4123-1719.3 011017	TRW Ø 23,8 ohne Bremsflüssigkeitsbehälter
1.2 TSI	81	05/15→					
1.4 TSI	110	05/15→				24.4153-1522.3 011048	ATE Ø 23,8 ohne Bremsflüssigkeitsbehälter
1.5 TSI	110	11/18→					
1.6 TDI	81 - 85	05/15→					
1.8 TSI	132	11/15→					
2.0 TDI	81 - 140	05/15→					
VW - TOURAN VAN (1T1, 1T2) 02/03→05/10							
 Bremskraftverstärker							
1.9 TDI	66 - 77	08/03→05/10		für Linkslenker; +PR 1AT		03.7873-4302.4 300312	ATE Ø 11" pneumatisch
2.0 EcoFuel	80	02/06→11/06					
2.0 FSI	110	05/04→01/07					
2.0 TDi	103	08/03→05/10					
FSI	85	02/03→11/06					
2.0 TDI	100	02/03→05/10		08/03→; für Linkslenker; +PR 1AT		03.7873-4302.4 300312	ATE Ø 11" pneumatisch
 Hauptbremszylinder							
1.9 TDI	66 - 77	08/03→05/10		+PR 1ZE / 1ZP; für Linkslenker		03.2122-2129.3 010799	ATE Ø 22,2
2.0 EcoFuel	80	02/06→11/06		→ 1T-6-100 000; für Rechtslenker; +PR 1ZE / 1ZP		24.2122-1981.3 011024	ATE Ø 22,2 ohne Bremsflüssigkeitsbehälter
2.0 FSI	110	05/04→01/07					
2.0 TDi	103	08/03→05/10		1T-6-100 001→; für Rechtslenker		24.4152-0132.3 011025	ATE Ø 22,2 ohne Bremsflüssigkeitsbehälter
2.0 TDI	100	02/03→05/10		08/03→; für Linkslenker; +PR 1ZE / 1ZP		03.2122-2129.3 010799	ATE Ø 22,2
				08/03→; → 1T-6-100 000; für Rechtslenker; +PR 1ZE / 1ZP		24.2122-1981.3 011024	ATE Ø 22,2 ohne Bremsflüssigkeitsbehälter
				1T-6-100 001→; für Rechtslenker		24.4152-0132.3 011025	ATE Ø 22,2 ohne Bremsflüssigkeitsbehälter
FSI	85	02/03→11/06		für Linkslenker		03.2122-2129.3 010799	ATE Ø 22,2
				→ 1T-6-100 000; für Rechtslenker; +PR 1ZE / 1ZP		24.2122-1981.3 011024	ATE Ø 22,2 ohne Bremsflüssigkeitsbehälter
				1T-6-100 001→; für Rechtslenker		24.4152-0132.3 011025	ATE Ø 22,2 ohne Bremsflüssigkeitsbehälter
Hydraulikaggregat, Bremsanlage							
1.9 TDI	66 - 77	08/03→05/10		+PR 1AT / 1AS		24.9145-0001.2 399005	
2.0 EcoFuel	80	02/06→11/06					
2.0 FSI	110	05/04→01/07					
2.0 TDi	103	08/03→05/10					
FSI	85	02/03→11/06					
2.0 TDI	100	02/03→05/10		08/03→; +PR 1AT / 1AS		24.9145-0001.2 399005	
Drucksensor, Bremskraftverstärker							
1.9 TDI	66 - 77	08/03→05/10		für Rechtslenker; +PR 1AS		03.0655-0101.2 370008	ATE
2.0 EcoFuel	80	02/06→11/06					
2.0 FSI	110	05/04→01/07					
2.0 TDi	103	08/03→05/10					
FSI	85	02/03→11/06					
2.0 TDI	100	02/03→05/10		08/03→; für Rechtslenker; +PR 1AS		03.0655-0101.2 370008	ATE
VW - TOURAN VAN (1T3) 05/10→05/15							
 Bremskraftverstärker							
1.2 TSI	77	05/10→05/15		für Linkslenker; +PR 1AT		03.7873-4302.4 300312	ATE Ø 11" pneumatisch
1.4 TSI	103 - 125	05/10→05/15					
1.4 TSi EcoFuel	110	05/10→05/15					
1.6 TDI	66 - 77	05/10→05/15					
2.0 TDi	125	05/10→01/13					
2.0 TDI	103	05/10→05/15					
→							

	kw			 	! #		
VW - TOURAN VAN (1T3) 05/10→05/15							
 Hauptbremszylinder							
1.2 TSI	77	05/10→05/15		für Linkslenker; +PR 1ZE / 1ZP	03.2122-2129.3	010799	ATE Ø 22,2
1.4 TSI	103 - 125	05/10→05/15		→ 1T-6-100 000; für Rechtslenker; +PR 1ZE / 1ZP	24.2122-1981.3	011024	ATE Ø 22,2 ohne Bremsflüssigkeitsbehälter
1.4 TSi EcoFuel	110	05/10→05/15					
1.6 TDI	66 - 77	05/10→05/15		1T-6-100 001→; für Rechtslenker	24.4152-0132.3	011025	ATE Ø 22,2 ohne Bremsflüssigkeitsbehälter
2.0 TDi	125	05/10→01/13					
2.0 TDI	103	05/10→05/15					
Hydraulikaggregat, Bremsanlage							
1.2 TSI	77	05/10→05/15		→ 12/10; +PR 1AT / 1AS	24.9145-0001.2	399005	
1.4 TSI	103 - 125	05/10→05/15					
1.4 TSi EcoFuel	110	05/10→05/15					
1.6 TDI	66 - 77	05/10→05/15					
2.0 TDi	125	05/10→01/13					
2.0 TDI	103	05/10→05/15					
Drucksensor, Bremskraftverstärker							
1.2 TSI	77	05/10→05/15		für Rechtslenker; +PR 1AS	03.0655-0101.2	370008	ATE
1.4 TSI	103 - 125	05/10→05/15					
1.4 TSi EcoFuel	110	05/10→05/15					
1.6 TDI	66 - 77	05/10→05/15					
2.0 TDi	125	05/10→01/13					
2.0 TDI	103	05/10→05/15					
VW - TOURAN VAN (5T1) 05/15→							
 Hauptbremszylinder							
2.0 TDI	90 - 110	11/20→		für Linkslenker	24.4123-1719.3	011017	TRW Ø 23,8 ohne Bremsflüssigkeitsbehälter
					24.4153-1522.3	011048	ATE Ø 23,8 ohne Bremsflüssigkeitsbehälter
VW - TRANSPORTER T4 Bus (70B, 70C, 7DB, 7DK, 70J, 70K, 7DC, 7DJ) 09/90→08/04							
 Bremskraftverstärker							
1.9 TD	50	10/92→04/03		→ 70-S-127805	03.7750-7402.4	300084	ATE Ø 9" pneumatisch
2.0	62	09/90→04/03		07/95→; für Rechtslenker; → 70-T-199000	03.7750-7402.4	300084	ATE Ø 9" pneumatisch
2.4 D	57	09/90→04/98					
2.5	81	09/90→06/03		70-T-200001→	03.7755-4202.4	300164	ATE Ø 9 / 8" pneumatisch
2.5 Syncro	81	08/92→04/03		07/95→; für Linkslenker; → 70-T-199000	03.7755-4202.4	300164	ATE Ø 9 / 8" pneumatisch
				70-S-127806→; → 06/95	03.7755-4202.4	300164	ATE Ø 9 / 8" pneumatisch
2.4 D	55	08/97→04/03		→ 70-S-127805	03.7750-7402.4	300084	ATE Ø 9" pneumatisch
2.5	85	08/96→04/03		für Rechtslenker; → 70-T-199000	03.7750-7402.4	300084	ATE Ø 9" pneumatisch
2.5 Syncro	85	07/96→04/03		70-T-200001→	03.7755-4202.4	300164	ATE Ø 9 / 8" pneumatisch
				für Linkslenker; → 70-T-199000	03.7755-4202.4	300164	ATE Ø 9 / 8" pneumatisch
2.4 D Syncro	57	10/92→09/98		11/92→; → 70-S-127805	03.7750-7402.4	300084	ATE Ø 9" pneumatisch
				07/95→; für Rechtslenker; → 70-T-199000	03.7750-7402.4	300084	ATE Ø 9" pneumatisch
				70-T-200001→	03.7755-4202.4	300164	ATE Ø 9 / 8" pneumatisch
				70-S-127806→; → 06/95	03.7755-4202.4	300164	ATE Ø 9 / 8" pneumatisch
				07/95→; für Linkslenker; → 70-T-199000	03.7755-4202.4	300164	ATE Ø 9 / 8" pneumatisch
2.5 TDI	65 - 111	09/95→04/03		für Rechtslenker; → 70-T-199000	03.7750-7402.4	300084	ATE Ø 9" pneumatisch
2.5 TDI Syncro	75	01/96→04/03		70-T-200001→	03.7755-4202.4	300164	ATE Ø 9 / 8" pneumatisch
2.8 VR6	150	04/00→04/03		für Linkslenker; → 70-T-199000	03.7755-4202.4	300164	ATE Ø 9 / 8" pneumatisch
2.8 VR 6	103	11/95→04/00					
 Hauptbremszylinder							
1.9 TD	50	10/92→04/03		→ 70-S-127805; für Linkslenker; - ABS	03.2122-1042.3	010137	Ø 22,2
2.0	62	09/90→04/03		70-S-127806→; + ABS; Herstellereinschränkung nur für TRW-S♦ttel	03.2123-1526.3	010477	Ø 23,8
2.4 D	57	09/90→04/98					
2.5	81	09/90→06/03		70-S-127806→; für Linkslenker; - ABS; Herstellereinschränkung nur für TRW-S♦ttel	03.2123-1548.3	010478	Ø 23,8
2.5 Syncro	81	08/92→04/03		05/96→; - ABS; +PR 1LU; Herstellereinschränkung nur für Ate-S♦ttel	03.2125-8111.3	010479	Ø 25,4
				05/96→; - ESP; Herstellereinschränkung nur für Ate-S♦ttel	03.2125-9704.3	010603	ATE Ø 25,4
				70-Y-027264→; + ESP; Herstellereinschränkung nur für Ate-S♦ttel	03.2125-9704.3	010603	ATE Ø 25,4
→							

	kw			 	! #		
VW - TRANSPORTER T4 Bus (70B, 70C, 7DB, 7DK, 70J, 70K, 7DC, 7DJ) 09/90→08/04							
 Hauptbremszylinder							
2.4 D	55	08/97→04/03		→ 70-S-127805; für Linkslenker; - ABS	03.2122-1042.3	010137	Ø 22,2
2.5	85	08/96→04/03		70-S-127806→; + ABS; Herstellereinschränkung nur für TRW-Sattel	03.2123-1526.3	010477	Ø 23,8
2.5 Syncro	85	07/96→04/03		70-S-127806→; für Linkslenker; - ABS; Herstellereinschränkung nur für TRW-Sattel	03.2123-1548.3	010478	Ø 23,8
				- ABS; +PR 1LU; Herstellereinschränkung nur für Ate-Sattel	03.2125-8111.3	010479	Ø 25,4
				- ESP; Herstellereinschränkung nur für Ate-Sattel	03.2125-9704.3	010603	ATE Ø 25,4
				70-Y-027264→; + ESP; Herstellereinschränkung nur für Ate-Sattel	03.2125-9704.3	010603	ATE Ø 25,4
2.4 D Syncro	57	10/92→09/98		11/92→; → 70-S-127805; für Linkslenker; - ABS	03.2122-1042.3	010137	Ø 22,2
				70-S-127806→; + ABS; Herstellereinschränkung nur für TRW-Sattel	03.2123-1526.3	010477	Ø 23,8
				70-S-127806→; für Linkslenker; - ABS; Herstellereinschränkung nur für TRW-Sattel	03.2123-1548.3	010478	Ø 23,8
				05/96→; - ABS; +PR 1LU; Herstellereinschränkung nur für Ate-Sattel	03.2125-8111.3	010479	Ø 25,4
				05/96→; - ESP; Herstellereinschränkung nur für Ate-Sattel	03.2125-9704.3	010603	ATE Ø 25,4
				70-Y-027264→; + ESP; Herstellereinschränkung nur für Ate-Sattel	03.2125-9704.3	010603	ATE Ø 25,4
2.5 TDI	65 - 111	05/98→04/03		+ ABS; Herstellereinschränkung nur für TRW-Sattel	03.2123-1526.3	010477	Ø 23,8
2.8 VR6	150	04/00→04/03		für Linkslenker; - ABS; Herstellereinschränkung nur für TRW-Sattel	03.2123-1548.3	010478	Ø 23,8
				- ABS; +PR 1LU; Herstellereinschränkung nur für Ate-Sattel	03.2125-8111.3	010479	Ø 25,4
				70-Y-027264→; + ESP; Herstellereinschränkung nur für Ate-Sattel	03.2125-9704.3	010603	ATE Ø 25,4
				- ESP; Herstellereinschränkung nur für Ate-Sattel	03.2125-9704.3	010603	ATE Ø 25,4
2.5 TDI	75	09/95→04/03		+ ABS; Herstellereinschränkung nur für TRW-Sattel	03.2123-1526.3	010477	Ø 23,8
				für Linkslenker; - ABS; Herstellereinschränkung nur für TRW-Sattel	03.2123-1548.3	010478	Ø 23,8
				05/96→; - ABS; +PR 1LU; Herstellereinschränkung nur für Ate-Sattel	03.2125-8111.3	010479	Ø 25,4
				70-Y-027264→; + ESP; Herstellereinschränkung nur für Ate-Sattel	03.2125-9704.3	010603	ATE Ø 25,4
				05/96→; - ESP; Herstellereinschränkung nur für Ate-Sattel	03.2125-9704.3	010603	ATE Ø 25,4
2.5 TDI Syncro	75	01/96→04/03		für Linkslenker; - ABS; Herstellereinschränkung nur für TRW-Sattel	03.2123-1548.3	010478	Ø 23,8
				05/96→; - ABS; +PR 1LU; Herstellereinschränkung nur für Ate-Sattel	03.2125-8111.3	010479	Ø 25,4
				05/96→; - ESP; Herstellereinschränkung nur für Ate-Sattel	03.2125-9704.3	010603	ATE Ø 25,4
				70-Y-027264→; + ESP; Herstellereinschränkung nur für Ate-Sattel	03.2125-9704.3	010603	ATE Ø 25,4
2.8 VR 6	103	11/95→04/00		+ ABS; Herstellereinschränkung nur für TRW-Sattel	03.2123-1526.3	010477	Ø 23,8
				für Linkslenker; - ABS; Herstellereinschränkung nur für TRW-Sattel	03.2123-1548.3	010478	Ø 23,8
				- ABS; +PR 1LU; Herstellereinschränkung nur für Ate-Sattel	03.2125-8111.3	010479	Ø 25,4
				70-Y-027264→; + ESP; Herstellereinschränkung nur für Ate-Sattel	03.2125-9704.3	010603	ATE Ø 25,4
				05/96→; - ESP; Herstellereinschränkung nur für Ate-Sattel	03.2125-9704.3	010603	ATE Ø 25,4
Verschlusschraube, Hauptbremszylinder							
1.9 TD	50	10/92→04/03		→ 70-S-127805; für Linkslenker; - ABS	03.3517-0101.2	390322	
2.0	62	09/90→04/03					
2.4 D	55 - 57	09/90→04/03					
2.5	81 - 85	09/90→06/03					
2.5 Syncro	81 - 85	08/92→04/03					
2.4 D Syncro	57	10/92→09/98		11/92→; → 70-S-127805; für Linkslenker; - ABS	03.3517-0101.2	390322	

	kw			 	! #		
VW - TRANSPORTER T4 Kasten (70A, 70H, 7DA, 7DH) 07/90→04/03							
Bremskraftverstärker							
1.9 TD	50	10/92→04/03		→ 70-S-127805		03.7750-7402.4 300084	ATE Ø 9" pneumatisch
2.0	62	07/90→04/03					
2.4 D	57	07/90→04/98		07/95→; für Rechtslenker; → 70-T-199000		03.7750-7402.4 300084	ATE Ø 9" pneumatisch
2.5	81	11/90→04/03		70-T-200001→		03.7755-4202.4 300164	ATE Ø 9 / 8" pneumatisch
				07/95→; für Linkslenker; → 70-T-199000		03.7755-4202.4 300164	ATE Ø 9 / 8" pneumatisch
				70-S-127806→; → 06/95		03.7755-4202.4 300164	ATE Ø 9 / 8" pneumatisch
2.4 D	55	08/97→04/03		→ 70-S-127805		03.7750-7402.4 300084	ATE Ø 9" pneumatisch
2.5	85	08/96→04/03		für Rechtslenker; → 70-T-199000		03.7750-7402.4 300084	ATE Ø 9" pneumatisch
2.5 Syncro	85	08/96→04/03		70-T-200001→		03.7755-4202.4 300164	ATE Ø 9 / 8" pneumatisch
				für Linkslenker; → 70-T-199000		03.7755-4202.4 300164	ATE Ø 9 / 8" pneumatisch
2.4 D Syncro	57	10/92→09/98		11/92→; → 70-S-127805		03.7750-7402.4 300084	ATE Ø 9" pneumatisch
				07/95→; für Rechtslenker; → 70-T-199000		03.7750-7402.4 300084	ATE Ø 9" pneumatisch
				70-T-200001→		03.7755-4202.4 300164	ATE Ø 9 / 8" pneumatisch
				70-S-127806→; → 06/95		03.7755-4202.4 300164	ATE Ø 9 / 8" pneumatisch
				07/95→; für Linkslenker; → 70-T-199000		03.7755-4202.4 300164	ATE Ø 9 / 8" pneumatisch
2.5 Syncro	81	11/92→11/01		→ 70-S-127805		03.7750-7402.4 300084	ATE Ø 9" pneumatisch
				für Rechtslenker; → 70-T-199000		03.7750-7402.4 300084	ATE Ø 9" pneumatisch
				70-S-127806→		03.7755-4202.4 300164	ATE Ø 9 / 8" pneumatisch
				70-T-200001→		03.7755-4202.4 300164	ATE Ø 9 / 8" pneumatisch
				für Linkslenker; → 70-T-199000		03.7755-4202.4 300164	ATE Ø 9 / 8" pneumatisch
2.5 TDI	65 - 111	09/95→04/03		für Rechtslenker; → 70-T-199000		03.7750-7402.4 300084	ATE Ø 9" pneumatisch
2.5 TDI Syncro	75	09/95→04/03		70-T-200001→		03.7755-4202.4 300164	ATE Ø 9 / 8" pneumatisch
2.8 VR6	103 - 150	05/96→04/03		für Linkslenker; → 70-T-199000		03.7755-4202.4 300164	ATE Ø 9 / 8" pneumatisch
Hauptbremszylinder							
1.9 TD	50	10/92→04/03		→ 70-S-127805; für Linkslenker; - ABS		03.2122-1042.3 010137	Ø 22,2
2.0	62	07/90→04/03					
2.4 D	57	07/90→04/98		70-S-127806→; + ABS; Herstellereinschränkung nur für TRW-S♦ttel		03.2123-1526.3 010477	Ø 23,8
2.5	81	11/90→04/03					
2.5 Syncro	81	11/92→11/01		70-S-127806→; für Linkslenker; - ABS; Herstellereinschränkung nur für TRW-S♦ttel		03.2123-1548.3 010478	Ø 23,8
				05/96→; - ABS; +PR 1LU; Herstellereinschränkung nur für Ate-S♦ttel		03.2125-8111.3 010479	Ø 25,4
				05/96→; - ESP; Herstellereinschränkung nur für Ate-S♦ttel		03.2125-9704.3 010603	ATE Ø 25,4
				70-Y-027264→; + ESP; Herstellereinschränkung nur für Ate-S♦ttel		03.2125-9704.3 010603	ATE Ø 25,4
2.4 D	55	08/97→04/03		→ 70-S-127805; für Linkslenker; - ABS		03.2122-1042.3 010137	Ø 22,2
2.5	85	08/96→04/03					
2.5 Syncro	85	08/96→04/03		70-S-127806→; + ABS; Herstellereinschränkung nur für TRW-S♦ttel		03.2123-1526.3 010477	Ø 23,8
				70-S-127806→; für Linkslenker; - ABS; Herstellereinschränkung nur für TRW-S♦ttel		03.2123-1548.3 010478	Ø 23,8
				- ABS; +PR 1LU; Herstellereinschränkung nur für Ate-S♦ttel		03.2125-8111.3 010479	Ø 25,4
				- ESP; Herstellereinschränkung nur für Ate-S♦ttel		03.2125-9704.3 010603	ATE Ø 25,4
				70-Y-027264→; + ESP; Herstellereinschränkung nur für Ate-S♦ttel		03.2125-9704.3 010603	ATE Ø 25,4
2.4 D Syncro	57	10/92→09/98		11/92→; → 70-S-127805; für Linkslenker; - ABS		03.2122-1042.3 010137	Ø 22,2
				70-S-127806→; + ABS; Herstellereinschränkung nur für TRW-S♦ttel		03.2123-1526.3 010477	Ø 23,8
				70-S-127806→; für Linkslenker; - ABS; Herstellereinschränkung nur für TRW-S♦ttel		03.2123-1548.3 010478	Ø 23,8
				05/96→; - ABS; +PR 1LU; Herstellereinschränkung nur für Ate-S♦ttel		03.2125-8111.3 010479	Ø 25,4
				05/96→; - ESP; Herstellereinschränkung nur für Ate-S♦ttel		03.2125-9704.3 010603	ATE Ø 25,4
				70-Y-027264→; + ESP; Herstellereinschränkung nur für Ate-S♦ttel		03.2125-9704.3 010603	ATE Ø 25,4
2.5 TDI	65 - 111	12/98→04/03		+ ABS; Herstellereinschränkung nur für TRW-S♦ttel		03.2123-1526.3 010477	Ø 23,8
2.8 VR6	103 - 150	05/96→04/03		für Linkslenker; - ABS; Herstellereinschränkung nur für TRW-S♦ttel		03.2123-1548.3 010478	Ø 23,8
				- ABS; +PR 1LU; Herstellereinschränkung nur für Ate-S♦ttel		03.2125-8111.3 010479	Ø 25,4



VW - TRANSPORTER T4 Kasten (70A, 70H, 7DA, 7DH) 07/90→04/03

Hauptbremszylinder

2.5 TDI	65 - 111	12/98→04/03		70-Y-027264→; + ESP; Herstellereinschränkung nur für Ate-Sattel	03.2125-9704.3	010603	ATE Ø 25,4
2.8 VR6	103 - 150	05/96→04/03		- ESP; Herstellereinschränkung nur für Ate-Sattel	03.2125-9704.3	010603	ATE Ø 25,4
2.5 TDI	75	09/95→04/03		+ ABS; Herstellereinschränkung nur für TRW-Sattel	03.2123-1526.3	010477	Ø 23,8
				für Linkslenker; - ABS; Herstellereinschränkung nur für TRW-Sattel	03.2123-1548.3	010478	Ø 23,8
				05/96→; - ABS; +PR 1LU; Herstellereinschränkung nur für Ate-Sattel	03.2125-8111.3	010479	Ø 25,4
				70-Y-027264→; + ESP; Herstellereinschränkung nur für Ate-Sattel	03.2125-9704.3	010603	ATE Ø 25,4
				05/96→; - ESP; Herstellereinschränkung nur für Ate-Sattel	03.2125-9704.3	010603	ATE Ø 25,4
2.5 TDI Syncro	75	09/95→04/03		für Linkslenker; - ABS; Herstellereinschränkung nur für TRW-Sattel	03.2123-1548.3	010478	Ø 23,8
				05/96→; - ABS; +PR 1LU; Herstellereinschränkung nur für Ate-Sattel	03.2125-8111.3	010479	Ø 25,4
				05/96→; - ESP; Herstellereinschränkung nur für Ate-Sattel	03.2125-9704.3	010603	ATE Ø 25,4
				70-Y-027264→; + ESP; Herstellereinschränkung nur für Ate-Sattel	03.2125-9704.3	010603	ATE Ø 25,4

Verschlusschraube, Hauptbremszylinder

1.9 TD	50	10/92→04/03		→ 70-S-127805; für Linkslenker; - ABS	03.3517-0101.2	390322	
2.0	62	07/90→04/03					
2.4 D	55 - 57	07/90→04/03					
2.5	81 - 85	11/90→04/03					
2.5 Syncro	81 - 85	11/92→04/03					
2.4 D Syncro	57	10/92→09/98		11/92→; → 70-S-127805; für Linkslenker; - ABS	03.3517-0101.2	390322	









VW - TRANSPORTER T4 Pritsche/Fahrgestell (70E, 70L, 70M, 7DE, 7DL 07/90→04/03







Bremskraftverstärker











1.9 TD	50	10/92→04/03		→ 70-S-127805	03.7750-7402.4	300084	ATE Ø 9" pneumatisch
2.0	62	07/90→04/03		07/95→; für Rechtslenker; → 70-T-199000	03.7750-7402.4	300084	ATE Ø 9" pneumatisch
2.4 D	57	09/90→04/98					
2.5 Syncro	81	11/90→04/03		70-T-200001→	03.7755-4202.4	300164	ATE Ø 9 / 8" pneumatisch
				07/95→; für Linkslenker; → 70-T-199000	03.7755-4202.4	300164	ATE Ø 9 / 8" pneumatisch
				70-S-127806→; → 06/95	03.7755-4202.4	300164	ATE Ø 9 / 8" pneumatisch
2.4 D	55	08/97→04/03		→ 70-S-127805	03.7750-7402.4	300084	ATE Ø 9" pneumatisch
				für Rechtslenker; → 70-T-199000	03.7750-7402.4	300084	ATE Ø 9" pneumatisch
				70-T-200001→	03.7755-4202.4	300164	ATE Ø 9 / 8" pneumatisch
2.5 Syncro	85	08/96→04/03		für Linkslenker; → 70-T-199000	03.7755-4202.4	300164	ATE Ø 9 / 8" pneumatisch
				11/92→; → 70-S-127805	03.7750-7402.4	300084	ATE Ø 9" pneumatisch
				07/95→; für Rechtslenker; → 70-T-199000	03.7750-7402.4	300084	ATE Ø 9" pneumatisch
2.4 D Syncro	57	10/92→09/98		70-T-200001→	03.7755-4202.4	300164	ATE Ø 9 / 8" pneumatisch
				70-S-127806→; → 06/95	03.7755-4202.4	300164	ATE Ø 9 / 8" pneumatisch
				07/95→; für Linkslenker; → 70-T-199000	03.7755-4202.4	300164	ATE Ø 9 / 8" pneumatisch
				11/92→; → 70-S-127805	03.7750-7402.4	300084	ATE Ø 9" pneumatisch
2.5 TDI	65 - 75	09/95→04/03		für Rechtslenker; → 70-T-199000	03.7750-7402.4	300084	ATE Ø 9" pneumatisch
2.5 TDI Syncro	75	05/98→04/03		70-T-200001→	03.7755-4202.4	300164	ATE Ø 9 / 8" pneumatisch
				für Linkslenker; → 70-T-199000	03.7755-4202.4	300164	ATE Ø 9 / 8" pneumatisch













Hauptbremszylinder









1.9 TD	50	10/92→04/03		→ 70-S-127805; für Linkslenker; - ABS	03.2122-1042.3	010137	Ø 22,2
2.0	62	07/90→04/03		70-S-127806→; + ABS; Herstellereinschränkung nur für TRW-Sattel	03.2123-1526.3	010477	Ø 23,8
2.4 D	57	09/90→04/98					
2.5 Syncro	81	11/90→04/03		70-S-127806→; für Linkslenker; - ABS; Herstellereinschränkung nur für TRW-Sattel	03.2123-1548.3	010478	Ø 23,8
				05/96→; - ABS; +PR 1LU; Herstellereinschränkung nur für Ate-Sattel	03.2125-8111.3	010479	Ø 25,4
				05/96→; - ESP; Herstellereinschränkung nur für Ate-Sattel	03.2125-9704.3	010603	ATE Ø 25,4
				70-Y-027264→; + ESP; Herstellereinschränkung nur für Ate-Sattel	03.2125-9704.3	010603	ATE Ø 25,4
2.4 D	55	08/97→04/03		→ 70-S-127805; für Linkslenker; - ABS	03.2122-1042.3	010137	Ø 22,2

	kw					! #		
VW - TRANSPORTER T4 Pritsche/Fahrgestell (70E, 70L, 70M, 7DE, 7DL 07/90→04/03)								
 Hauptbremszylinder								
2.5 2.5 Syncro	85	08/96→04/03		70-S-127806→; + ABS; Herstellereinschränkung nur für TRW-Sattel		03.2123-1526.3	010477	Ø 23,8
	85	08/96→04/03		70-S-127806→; für Linkslenker; - ABS; Herstellereinschränkung nur für TRW-Sattel		03.2123-1548.3	010478	Ø 23,8
				- ABS; +PR 1LU; Herstellereinschränkung nur für Ate-Sattel		03.2125-8111.3	010479	Ø 25,4
				- ESP; Herstellereinschränkung nur für Ate-Sattel		03.2125-9704.3	010603	ATE Ø 25,4
				70-Y-027264→; + ESP; Herstellereinschränkung nur für Ate-Sattel		03.2125-9704.3	010603	ATE Ø 25,4
2.4 D Syncro	57	10/92→09/98		11/92→; → 70-S-127805; für Linkslenker; - ABS		03.2122-1042.3	010137	Ø 22,2
				70-S-127806→; + ABS; Herstellereinschränkung nur für TRW-Sattel		03.2123-1526.3	010477	Ø 23,8
				70-S-127806→; für Linkslenker; - ABS; Herstellereinschränkung nur für TRW-Sattel		03.2123-1548.3	010478	Ø 23,8
				05/96→; - ABS; +PR 1LU; Herstellereinschränkung nur für Ate-Sattel		03.2125-8111.3	010479	Ø 25,4
				05/96→; - ESP; Herstellereinschränkung nur für Ate-Sattel		03.2125-9704.3	010603	ATE Ø 25,4
2.5 TDI	65	05/98→04/03		+ ABS; Herstellereinschränkung nur für TRW-Sattel		03.2123-1526.3	010477	Ø 23,8
				für Linkslenker; - ABS; Herstellereinschränkung nur für TRW-Sattel		03.2123-1548.3	010478	Ø 23,8
				- ABS; +PR 1LU; Herstellereinschränkung nur für Ate-Sattel		03.2125-8111.3	010479	Ø 25,4
				70-Y-027264→; + ESP; Herstellereinschränkung nur für Ate-Sattel		03.2125-9704.3	010603	ATE Ø 25,4
				- ESP; Herstellereinschränkung nur für Ate-Sattel		03.2125-9704.3	010603	ATE Ø 25,4
2.5 TDI	75	09/95→04/03		+ ABS; Herstellereinschränkung nur für TRW-Sattel		03.2123-1526.3	010477	Ø 23,8
				für Linkslenker; - ABS; Herstellereinschränkung nur für TRW-Sattel		03.2123-1548.3	010478	Ø 23,8
				05/96→; - ABS; +PR 1LU; Herstellereinschränkung nur für Ate-Sattel		03.2125-8111.3	010479	Ø 25,4
				70-Y-027264→; + ESP; Herstellereinschränkung nur für Ate-Sattel		03.2125-9704.3	010603	ATE Ø 25,4
				05/96→; - ESP; Herstellereinschränkung nur für Ate-Sattel		03.2125-9704.3	010603	ATE Ø 25,4
2.5 TDI Syncro	75	05/98→04/03		für Linkslenker; - ABS; Herstellereinschränkung nur für TRW-Sattel		03.2123-1548.3	010478	Ø 23,8
				- ABS; +PR 1LU; Herstellereinschränkung nur für Ate-Sattel		03.2125-8111.3	010479	Ø 25,4
				- ESP; Herstellereinschränkung nur für Ate-Sattel		03.2125-9704.3	010603	ATE Ø 25,4
				70-Y-027264→; + ESP; Herstellereinschränkung nur für Ate-Sattel		03.2125-9704.3	010603	ATE Ø 25,4
Verschlusschraube, Hauptbremszylinder								
1.9 TD	50	10/92→04/03		→ 70-S-127805; für Linkslenker; - ABS		03.3517-0101.2	390322	
2.0	62	07/90→04/03						
2.4 D	55 -	09/90→04/03						
	57							
2.5	81 -	11/90→04/03						
	85							
2.5 Syncro	81 -	11/92→04/03						
	85							
2.4 D Syncro	57	10/92→09/98		11/92→; → 70-S-127805; für Linkslenker; - ABS		03.3517-0101.2	390322	
VW - TRANSPORTER T5 Bus (7HB, 7HJ, 7EB, 7EJ) 04/03→08/15								
 Bremskraftverstärker								
1.9 TDI	62 -	04/03→11/09		+PR 1AJ / 1AE / 1AC / 1AR; → 7H-A-050000		03.7765-1002.4	300246	ATE Ø 10 / 9" pneumatisch
	77							
2.0	85	11/03→08/15		+PR 1AK; → 7H-A-050000		03.7868-3702.4	300208	ATE Ø 10 / 8" pneumatisch
2.0 BiTDI	132	09/09→08/15						
2.0 BiTDI 4motion	132	09/09→08/15						
2.0 CNG	85	01/06→08/15						
2.0 TDI	62 -	09/09→08/15						
	103							
2.0 TDI 4motion	103	09/09→08/15						
→								

	kW					! #		
VW - TRANSPORTER T5 Bus (7HB, 7HJ, 7EB, 7EJ) 04/03→08/15								
Bremskraftverstärker								
2.5 TDi 2.5 TDI	120 96 - 128	11/03→11/09 04/03→11/09		+PR 1AJ / 1AE / 1AC / 1AR; → 7H-A-050000			03.7765-1002.4 300246	ATE Ø 10 / 9" pneumatisch
2.5 TDI 4motion	96 - 128	07/04→11/09		+PR 1AK; → 7H-A-050000			03.7868-3702.4 300208	ATE Ø 10 / 8" pneumatisch
VR6 3.2	173	02/04→11/09						
3.2 V6 4motion	173	11/03→12/09		07/04→; +PR 1AJ / 1AE / 1AC / 1AR; → 7H-A-050000			03.7765-1002.4 300246	ATE Ø 10 / 9" pneumatisch
				07/04→; +PR 1AK; → 7H-A-050000			03.7868-3702.4 300208	ATE Ø 10 / 8" pneumatisch
Pedalwegsensor, Bremspedal								
1.9 TDI	62 - 77	04/03→11/09		+PR 1AT; → 7H-A-050000			03.0655-0006.2 370006	ATE
2.0	85	11/03→08/15						
2.0 BiTDI	132	09/09→08/15						
2.0 BiTDI 4motion	132	09/09→08/15						
2.0 CNG	85	01/06→08/15						
2.0 TDI	62 - 103	09/09→08/15						
2.0 TDI 4motion	103	09/09→08/15						
2.5 TDi	120	11/03→11/09						
2.5 TDI	96 - 128	04/03→11/09						
2.5 TDI 4motion	96 - 128	07/04→11/09						
VR6 3.2	173	02/04→11/09						
3.2 V6 4motion	173	11/03→12/09		07/04→; +PR 1AT; → 7H-A-050000			03.0655-0006.2 370006	ATE
Hauptbremszylinder								
1.9 TDI	62 - 77	04/03→11/09		→ 7H-A-050000			03.2126-3014.3 010811	ATE Ø 27
2.0	85	11/03→08/15		7H-6-000001→ 7H-6-200000; für Rechtslenker; +PR 1AT			03.2126-3014.3 010811	ATE Ø 27
2.0 CNG	85	01/06→08/15						
VR6 3.2	173	02/04→11/09		7H-A-200001→			03.2126-3144.3 010941	ATE Ø 27
2.0 BiTDI	132	09/09→08/15		→ 7H-A-050000			03.2126-3014.3 010811	ATE Ø 27
2.0 BiTDI 4motion	132	09/09→08/15						
2.0 TDI	62 - 103	09/09→08/15		7H-A-200001→			03.2126-3144.3 010941	ATE Ø 27
2.0 TDI 4motion	100 - 103	09/09→08/15						
2.5 TDi	120	11/03→11/09						
2.5 TDI	96 - 128	04/03→11/09						
2.5 TDI 4motion	96 - 128	07/04→11/09						
2.0 TDI	84 - 85	05/11→08/15					03.2126-3144.3 010941	ATE Ø 27
2.0 TSI	110 - 150	05/11→08/15						
2.0 TSI 4motion	150	07/11→08/15						
3.2 V6 4motion	173	11/03→12/09		07/04→; → 7H-A-050000			03.2126-3014.3 010811	ATE Ø 27
				7H-A-200001→			03.2126-3144.3 010941	ATE Ø 27
VW - TRANSPORTER T5 Kasten (7HA, 7HH, 7EA, 7EH) 04/03→								
Bremskraftverstärker								
1.9 TDI	62 - 77	04/03→11/09		+PR 1AJ / 1AE / 1AC / 1AR; → 7H-A-050000			03.7765-1002.4 300246	ATE Ø 10 / 9" pneumatisch
2.0	85	11/03→08/15						
2.0 BiFuel	85	05/11→08/15						
2.0 BiTDI	132	09/09→08/15		+PR 1AK; → 7H-A-050000			03.7868-3702.4 300208	ATE Ø 10 / 8" pneumatisch
2.0 BiTDI 4motion	132	09/09→08/15						
2.0 TDI	62 - 103	09/09→08/15						
2.0 TDI 4motion	103	09/09→08/15						
2.5 TDI	96 - 128	04/03→11/09						
2.5 TDI 4motion	96 - 128	07/04→11/09						
VR6 3.2	173	02/04→11/09						
VR6 3.2 4motion	173	11/03→11/09		07/04→; +PR 1AJ / 1AE / 1AC / 1AR; → 7H-A-050000			03.7765-1002.4 300246	ATE Ø 10 / 9" pneumatisch
				07/04→; +PR 1AK; → 7H-A-050000			03.7868-3702.4 300208	ATE Ø 10 / 8" pneumatisch
Pedalwegsensor, Bremspedal								
1.9 TDI	62 - 77	04/03→11/09		+PR 1AT; → 7H-A-050000			03.0655-0006.2 370006	ATE
2.0	85	11/03→08/15						
2.0 BiFuel	85	05/11→08/15						
→								

	kw			 	! #		
VW - TRANSPORTER T5 Kasten (7HA, 7HH, 7EA, 7EH) 04/03→							
Pedalwegsensord, Bremspedal							
2.0 BiTDI	132	09/09→08/15		+PR 1AT; → 7H-A-050000		03.0655-0006.2 370006	ATE
2.0 BiTDI 4motion	132	09/09→08/15					
2.0 TDI	62 - 103	09/09→08/15					
2.0 TDI 4motion	103	09/09→08/15					
2.5 TDI	96 - 128	04/03→11/09					
2.5 TDI 4motion	96 - 128	07/04→11/09					
VR6 3.2	173	02/04→11/09					
VR6 3.2 4motion	173	11/03→11/09		07/04→; +PR 1AT; → 7H-A-050000		03.0655-0006.2 370006	ATE
 Hauptbremszylinder							
1.9 TDI	62 - 77	04/03→11/09		→ 7H-A-050000		03.2126-3014.3 010811	ATE Ø 27
2.0	85	11/03→08/15		7H-6-000001→ 7H-6-200000; für Rechtslenker; +PR 1AT		03.2126-3014.3 010811	ATE Ø 27
2.0 BiFuel	85	05/11→08/15					
VR6 3.2	173	02/04→11/09		7H-A-200001→		03.2126-3144.3 010941	ATE Ø 27
2.0 BiTDI	132	09/09→08/15		→ 7H-A-050000		03.2126-3014.3 010811	ATE Ø 27
2.0 BiTDI 4motion	132	09/09→08/15					
2.0 TDI	62 - 103	09/09→08/15		7H-A-200001→		03.2126-3144.3 010941	ATE Ø 27
2.0 TDI 4motion	100 - 103	09/09→08/15					
2.5 TDI	96 - 128	04/03→11/09					
2.5 TDI 4motion	96 - 128	07/04→11/09					
2.0 TDI	84	05/11→08/15				03.2126-3144.3 010941	ATE Ø 27
2.0 TSI	110 - 150	05/11→08/15					
2.0 TSI 4motion	150	07/11→08/15					
VR6 3.2 4motion	173	11/03→11/09		07/04→; → 7H-A-050000		03.2126-3014.3 010811	ATE Ø 27
				7H-A-200001→		03.2126-3144.3 010941	ATE Ø 27
VW - TRANSPORTER T5 Pritsche/Fahrgestell (7JD, 7JE, 7JL, 7JY, 7JZ 04/03→08/15							
 Bremskraftverstärker							
1.9 TDI	62 - 77	04/03→11/09		→ 7J-A-010000; +PR 1AJ / 1AE / 1AC / 1AR		03.7765-1002.4 300246	ATE Ø 10 / 9" pneumatisch
2.0	85	11/03→05/13					
2.0 BiTDI	132	09/09→08/15		→ 7J-A-010000; +PR 1AK		03.7868-3702.4 300208	ATE Ø 10 / 8" pneumatisch
2.0 BiTDI 4motion	132	09/09→08/15					
2.0 CNG	85	11/03→05/11					
2.0 TDI	62 - 103	09/09→08/15					
2.0 TDI 4motion	103	09/09→08/15					
2.5 TDI	96 - 128	04/03→11/09					
2.5 TDI 4motion	96	07/04→11/09					
VR6 3.2	173	08/03→11/09					
2.5 TDI 4motion	128	04/04→11/09		07/04→; → 7J-A-010000; +PR 1AJ / 1AE / 1AC / 1AR		03.7765-1002.4 300246	ATE Ø 10 / 9" pneumatisch
				07/04→; → 7J-A-010000; +PR 1AK		03.7868-3702.4 300208	ATE Ø 10 / 8" pneumatisch
Pedalwegsensord, Bremspedal							
1.9 TDI	62 - 77	04/03→11/09		→ 7J-A-010000; +PR 1AT		03.0655-0006.2 370006	ATE
2.0	85	11/03→05/13					
2.0 BiTDI	132	09/09→08/15					
2.0 BiTDI 4motion	132	09/09→08/15					
2.0 CNG	85	11/03→05/11					
2.0 TDI	62 - 103	09/09→08/15					
2.0 TDI 4motion	103	09/09→08/15					
2.5 TDI	96 - 128	04/03→11/09					
2.5 TDI 4motion	96	07/04→11/09					
VR6 3.2	173	08/03→11/09					
2.5 TDI 4motion	128	04/04→11/09		07/04→; → 7J-A-010000; +PR 1AT		03.0655-0006.2 370006	ATE
 Hauptbremszylinder							
1.9 TDI	62 - 77	04/03→11/09		→ 7J-A-010000		03.2126-3014.3 010811	ATE Ø 27
2.0	85	11/03→05/13					
2.0 BiTDI	132	09/09→08/15		7J-A-200001→		03.2126-3144.3 010941	ATE Ø 27
2.0 BiTDI 4motion	132	09/09→08/15					
2.0 CNG	85	11/03→05/11					
2.0 TDI	62 - 103	09/09→08/15					

	kw					! #		
VW - TRANSPORTER T5 Pritsche/Fahrgestell (7JD, 7JE, 7JL, 7JY, 7JZ 04/03→08/15)								
 Hauptbremszylinder								
2.0 TDI 4motion	103	09/09→08/15		→ 7J-A-010000		03.2126-3014.3	010811	ATE Ø 27
2.5 TDI	96	04/03→11/09		7J-A-200001→		03.2126-3144.3	010941	ATE Ø 27
2.5 TDI 4motion	128							
VR6 3.2	96	07/04→11/09						
	173	08/03→11/09						
2.0 TDI	84 - 100	05/10→08/15				03.2126-3144.3	010941	ATE Ø 27
2.0 TDI 4motion	100	05/10→08/15						
2.0 TSI	110	07/12→08/15						
2.5 TDI 4motion	128	04/04→11/09		07/04→; → 7J-A-010000		03.2126-3014.3	010811	ATE Ø 27
				7J-A-200001→		03.2126-3144.3	010941	ATE Ø 27
VW - T-ROC (A11, D11) 07/17→								
 Hauptbremszylinder								
1.0 TSI	81 - 85	07/17→		für Linkslenker		24.4153-1522.3	011048	ATE Ø 23,8 ohne Bremsflüssigkeitsbehälter
1.5 TSI	110	11/17→						
1.5 TSI 4motion	110	05/18→11/19						
1.6 TDI	85	03/18→06/21						
2.0 R 4motion	221	09/19→						
2.0 TDI	110	03/18→						
2.0 TDI 4motion	110 - 140	09/17→						
2.0 TDI SCR	85	11/20→						
2.0 TSI 4motion	140	07/17→						
VW - T-ROC Cabriolet (AC7, AC8) 12/19→								
 Hauptbremszylinder								
1.0 TSI	81 - 85	12/19→		für Linkslenker		24.4153-1522.3	011048	ATE Ø 23,8 ohne Bremsflüssigkeitsbehälter
1.5 TSI	110	12/19→						
VW - UP! (121, 122, BL1, BL2, BL3, 123) 08/11→								
 Hauptbremszylinder								
1.0	44 - 55	08/11→08/20		12/11→; für Linkslenker		24.4120-1703.3	011015	TRW Ø 20,6 ohne Bremsflüssigkeitsbehälter
1.0	48	08/20→		für Linkslenker		24.4120-1703.3	011015	TRW Ø 20,6 ohne Bremsflüssigkeitsbehälter
1.0 EcoFuel	50	11/12→						
1.0 GTI	85	11/17→						
1.0 TSI	66	05/16→09/18						
VW - VENTO (1H2) 11/91→09/98								
 Bremskraftverstärker								
1.4	40 - 44	11/91→09/98		für Linkslenker; - ABS		03.7750-5502.4	300081	ATE Ø 9" pneumatisch
1.6	55 - 74	09/92→09/98		1H-S-385335→; für Linkslenker; + ABS		10.6360-2002.4	300143	ATE Ø 10" pneumatisch
1.9 D	48	11/91→09/98						
1.9 TD	55	11/91→09/98						
1.9 TDI	66	09/93→09/98						
2.0	85	11/91→09/98						
2.0 GL	79	05/96→12/97						
1.8	55 - 66	11/91→09/98		01/92→; für Linkslenker; - ABS		03.7750-5502.4	300081	ATE Ø 9" pneumatisch
				1H-S-385335→; für Linkslenker; + ABS		10.6360-2002.4	300143	ATE Ø 10" pneumatisch
1.9 SDI	47	04/97→09/98		für Linkslenker; - ABS		03.7750-5502.4	300081	ATE Ø 9" pneumatisch
1.9 TDI	81	04/96→09/98		für Linkslenker; + ABS		10.6360-2002.4	300143	ATE Ø 10" pneumatisch
2.8 VR6	128	01/92→09/98		1H-S-385335→; für Linkslenker; + ABS		10.6360-2002.4	300143	ATE Ø 10" pneumatisch
 Hauptbremszylinder								
1.4	40 - 44	11/91→09/98		- ABS		03.2120-3943.3	010532	ATE Ø 20,6
1.9 D	48	11/91→09/98		1H-S-385335→; für Linkslenker; + ABS		03.2122-1144.3	010636	ATE Ø 22,2
1.6	55	09/92→09/98		- ABS		03.2120-3943.3	010532	ATE Ø 20,6
				1H-S-430001→; Automatikgetriebe; - ABS		03.2122-1042.3	010137	Ø 22,2
				1H-S-385335→; für Linkslenker; + ABS		03.2122-1144.3	010636	ATE Ø 22,2
1.6	74	10/94→09/98		- ABS		03.2120-3943.3	010532	ATE Ø 20,6
				1H-S-385335→; für Linkslenker; + ABS		03.2122-1042.3	010137	Ø 22,2
				1H-S-385335→; für Linkslenker; + ABS		03.2123-1424.3	010637	ATE Ø 23,8
				1H-S-385335→; für Rechtslenker; + ABS		03.2123-1484.3	010595	ATE Ø 23,8
				→ 1H-S-385334; für Linkslenker; + ABS		10.6123-0674.3	010639	ATE Ø 23,8
→								

	kw			 	! #		
VW - VENTO (1H2) 11/91→09/98							
 Hauptbremszylinder							
1.8	55	11/91→09/98		01/92→; - ABS; nicht für Ausstattungsvariante: GT	03.2120-3943.3	010532	ATE Ø 20,6
				1H-S-385335→; für Linkslenker; + ABS; nicht für Ausstattungsvariante: GT	03.2122-1144.3	010636	ATE Ø 22,2
1.8	66	11/91→09/98		01/92→; - ABS; nicht für Ausstattungsvariante: GT	03.2120-3943.3	010532	ATE Ø 20,6
				01/92→; - ABS	03.2122-1042.3	010137	Ø 22,2
				1H-S-385335→; für Linkslenker; + ABS; nicht für Ausstattungsvariante: GT	03.2122-1144.3	010636	ATE Ø 22,2
				1H-S-385335→; für Linkslenker; + ABS	03.2123-1424.3	010637	ATE Ø 23,8
				1H-S-385335→; für Rechtslenker; + ABS	03.2123-1484.3	010595	ATE Ø 23,8
				01/92→; → 1H-S-385334; für Linkslenker; + ABS	10.6123-0674.3	010639	ATE Ø 23,8
1.9 SDI	47	04/97→09/98		- ABS	03.2120-3943.3	010532	ATE Ø 20,6
				für Linkslenker; + ABS	03.2122-1144.3	010636	ATE Ø 22,2
1.9 TD	55	11/91→09/98		- ABS	03.2120-3943.3	010532	ATE Ø 20,6
				1H-S-430001→; - ABS	03.2122-1042.3	010137	Ø 22,2
				1H-S-385335→; für Linkslenker; + ABS	03.2122-1144.3	010636	ATE Ø 22,2
1.9 TDI 2.0 2.0 GL	66	09/93→09/98		- ABS	03.2122-1042.3	010137	Ø 22,2
	85	11/91→09/98		1H-S-385335→; für Linkslenker; + ABS	03.2123-1424.3	010637	ATE Ø 23,8
	79	05/96→12/97		1H-S-385335→; für Rechtslenker; + ABS	03.2123-1484.3	010595	ATE Ø 23,8
				→ 1H-S-385334; für Linkslenker; + ABS	10.6123-0674.3	010639	ATE Ø 23,8
1.9 TDI	81	04/96→09/98		- ABS	03.2122-1042.3	010137	Ø 22,2
				für Linkslenker; + ABS	03.2123-1424.3	010637	ATE Ø 23,8
				für Rechtslenker; + ABS	03.2123-1484.3	010595	ATE Ø 23,8
2.8 VR6	128	01/92→09/98		1H-S-385335→; für Linkslenker; + ABS	03.2123-1424.3	010637	ATE Ø 23,8
				1H-S-385335→; für Rechtslenker; + ABS	03.2123-1484.3	010595	ATE Ø 23,8
				→ 1H-S-385334; für Linkslenker; + ABS	10.6123-0674.3	010639	ATE Ø 23,8
Verschlusschraube, Hauptbremszylinder							
1.4 1.6 1.9 D 1.9 SDI 1.9 TDI 2.0 2.0 GL	40 - 44	11/91→09/98		- ABS	03.3517-0101.2	390322	
	74	10/94→09/98					
	48	11/91→09/98					
	47	04/97→09/98					
	66 - 81	09/93→09/98					
	85 79	11/91→09/98 05/96→12/97					
1.6	55	09/92→09/98		- ABS	03.3517-0101.2	390322	
				1H-S-430001→; Automatikgetriebe; - ABS	03.3517-0101.2	390322	
1.8	55	11/91→09/98		01/92→; - ABS; nicht für Ausstattungsvariante: GT	03.3517-0101.2	390322	
1.8	66	11/91→09/98		01/92→; - ABS	03.3517-0101.2	390322	
				01/92→; - ABS; nicht für Ausstattungsvariante: GT	03.3517-0101.2	390322	
1.9 TD	55	11/91→09/98		- ABS	03.3517-0101.2	390322	
				1H-S-430001→; - ABS	03.3517-0101.2	390322	
 Bremskraftregler							
1.4 1.6 1.9 D 1.9 SDI 1.9 TD	40 - 44	11/91→09/98			03.6584-0107.3	320110	ATE lastabhängig 8/4 4x
	55	09/92→09/98					
	48	11/91→09/98					
	47	04/97→09/98					
	55	11/91→09/98					
1.8	55 - 66	11/91→09/98		01/92→; nicht für Ausstattungsvariante: GT	03.6584-0107.3	320110	ATE lastabhängig 8/4 4x
1.9 TDI	66	09/93→09/98		nicht für Ausstattungsvariante: GT	03.6584-0107.3	320110	ATE lastabhängig 8/4 4x



DE Technische Übersetzungen

EN Technical translations

ES Traducciones técnicas

FR Traductions techniques





IT Traduzioni tecniche

2023



Technische Übersetzungen

Technical translations - Traducciones tecnicas - Traductions techniques - Traduzioni tecniche

DE		DE	
	Hauptbremszylinder	Automatikgetriebe	Automatikgetriebe
	Bremskraftregler	BDX	Bremssystem, Bendix
	Bremskraftverstärker	Bördelform	Bördelform
	links	BOS	Bremssystem, Bosch
+ ABS	für Fahrzeuge mit ABS	Bosnien-Herzegowina	Bosnien-Herzegowina
+ ASC	für Fahrzeuge mit ASC	Bremskraftverstärker	Bremskraftverstärker
+ ASR	für Fahrzeuge mit ASR	Brems-system	Bremssystem
+ DSC	für Fahrzeuge mit DSC	CVT-Automatikgetriebe (Stufenlos)	CVT-Automatikgetriebe (Stufenlos)
+ DSTC	für Fahrzeuge mit DSTC	DEL	Bremssystem, Delco
+ EDS	für Fahrzeuge mit EDS	- Diff	ohne Differentialsperre
+ ESP	für Fahrzeuge mit ESP	- DSC	für Fahrzeuge ohne DSC
+ Performance Parts	für Fahrzeuge mit Performance Bremse	- DSTC	für Fahrzeuge ohne DSTC
+PR	für PR-Nummer	E	E
+ RO	Rumänien	- EDS	für Fahrzeuge ohne EDS
+SA	für SA Code	empty/leer	Vorgaben des Fahrzeugherstellers beachten Montageinformation beachten
+ TR	Türkei	Erfüllte Qualitätsstufen	Erfüllte Qualitätsstufen
12Q	12Q	- ESP	für Fahrzeuge ohne ESP
14Q	14Q	F	F
16Q	16Q	Fahrzeugproduktionsland	Fahrzeugproduktionsland
20Q	20Q	Fahrzeugtyp	Fahrzeugtyp
Abfrage Produktbild vorhanden	Abfrage Produktbild vorhanden	Felge Lochzahl	Felge Lochzahl
- ABS	für Fahrzeuge ohne ABS	Felgengröße [Zoll]	Felgengröße [Zoll]
Aluguss	Aluguss	Frankreich	Frankreich
Artikelnummer des empfohlenen Zubehörs	Artikelnummer des empfohlenen Zubehörs	für DAM-Nummer ab →	für DAM-Nummer ab
- ASC	für Fahrzeuge ohne ASC	für Fahr-schulwagen	für Fahrschulwagen
- ASR	für Fahrzeuge ohne ASR		
ausschließlich für Rennsportzwecke	ausschließlich für Rennsportzwecke		
Ausstattungs-Code	Ausstattungs-Code		



Technische Übersetzungen

Technical translations - Traducciones tecnicas - Traductions techniques - Traduzioni tecniche

DE		DE	
für Fahrzeuge mit Adaptive Cruise Control	für Fahrzeuge mit Adaptive Cruise Control	für Fahrzeuge mit Sportfahrwerk	für Fahrzeuge mit Sportfahrwerk
für Fahrzeuge mit AMG-Sportpaket	für Fahrzeuge mit AMG-Sportpaket	für Fahrzeuge mit Sportpaket	für Fahrzeuge mit Sportpaket
für Fahrzeuge mit autom. Distanzregelung	für Fahrzeuge mit autom. Distanzregelung	für Fahrzeuge mit Start-Stopp-Funktion	für Fahrzeuge mit Start-Stopp-Funktion
für Fahrzeuge mit Bremsassistent	für Fahrzeuge mit Bremsassistent	für Fahrzeuge mit STC	für Fahrzeuge mit STC
für Fahrzeuge mit elektr. Dämpferregulierung	für Fahrzeuge mit elektr. Dämpferregulierung	für Fahrzeuge mit Trommelbremse an der Hinterachse	für Fahrzeuge mit Trommelbremse an der Hinterachse
für Fahrzeuge mit elektronischer Fahrdynamikregelung	für Fahrzeuge mit elektronischer Fahrdynamikregelung	für Fahrzeuge mit verstärktem Fahrwerk	für Fahrzeuge mit verstärktem Fahrwerk
für Fahrzeuge mit Kollisionswarner	für Fahrzeuge mit Kollisionswarner	für Fahrzeuge mit verstärkter Bremse	für Fahrzeuge mit verstärkter Bremse
für Fahrzeuge mit M-Sportbremse	für Fahrzeuge mit M-Sportbremse	für Fahrzeuge ohne Aktivlenkung	für Fahrzeuge ohne Aktivlenkung
für Fahrzeuge mit Rußpartikelfilter	für Fahrzeuge mit Rußpartikelfilter	für Fahrzeuge ohne AMG-Sportpaket	für Fahrzeuge ohne AMG-Sportpaket
für Fahrzeuge mit Scheibenbremse an der Hinterachse	für Fahrzeuge mit Scheibenbremse an der Hinterachse	für Fahrzeuge ohne autom. Distanzregelung	für Fahrzeuge ohne autom. Distanzregelung
für Fahrzeuge mit Servolenkung	für Fahrzeuge mit Servolenkung	für Fahrzeuge ohne Bremsassistent	für Fahrzeuge ohne Bremsassistent
		für Fahrzeuge ohne elektronische Fahrdynamikregelung	für Fahrzeuge ohne elektronische Fahrdynamikregelung

Technische Übersetzungen

Technical translations - Traducciones técnicas - Traductions techniques - Traduzioni tecniche

DE		DE	
für Fahrzeuge ohne Keramikbremse	für Fahrzeuge ohne Keramikbremse	Gewindemaß 1	Gewindemaß 1
		Gewindemaß 2	Gewindemaß 2
für Fahrzeuge ohne Kollisionswarner	für Fahrzeuge ohne Kollisionswarner	GG	Bremssattel aus Gusseisen
		Herstellereinschränkung	Herstellereinschränkung
für Fahrzeuge ohne M-Sportbremse	für Fahrzeuge ohne M-Sportbremse	hyd.	Hydraulisch
		Kroatien	Kroatien
für Fahrzeuge ohne Sportfahrwerk	für Fahrzeuge ohne Sportfahrwerk	L=	Länge [mm]
		L=	Länge über Alles [mm]
		L1=	Länge 1 [mm]
für Fahrzeuge ohne Sportpaket	für Fahrzeuge ohne Sportpaket	L2=	Länge 2 [mm]
		Länderspezifische Verpackungs- und Status-Informationen	Länderspezifische Verpackungs- und Status-Informationen
für Fahrzeuge ohne Start-Stopp-Funktion	für Fahrzeuge ohne Start-Stopp-Funktion	lastabhängig	lastabhängig
		mit Bremsflüssigkeitsbehälter	mit Bremsflüssigkeitsbehälter
für Fahrzeuge ohne STC	für Fahrzeuge ohne STC	mm Radnabendurchmesser [mm]	Radnabendurchmesser [mm]
		Motorcode	Motorcode
für Kolben-Ø [mm]	für Kolben-Ø [mm]	Nicht erfüllte Qualitätsstufen	Nicht erfüllte Qualitätsstufen
		nicht für Ausstattungsvariante	nicht für Ausstattungsvariante
für Linkslenker	für Linkslenker	nicht für Facelift	nicht für Facelift
		nicht für Fahrschulwagen	nicht für Fahrschulwagen
für OE-Nummer	für OE-Nummer	nicht für Fahrzeuge mit verstärkter Bremse	nicht für Fahrzeuge mit verstärkter Bremse
		nicht für gepanzerte Fahrzeuge	nicht für gepanzerte Fahrzeuge
für Rechtslenker	für Rechtslenker		
für verkürzten Radstand	für verkürzten Radstand		
für verlängerten Radstand	für verlängerten Radstand		
Gebrauchsnummer	Gebrauchsnummer		
Getriebetyp	Getriebetyp		







Technische Übersetzungen

Technical translations - Traducciones tecnicas - Traductions techniques - Traduzioni tecniche

DE		DE	
nicht für Getriebetyp	nicht für Getriebetyp	Schaltgetriebe, automatisch betätigt	Schaltgetriebe, automatisch betätigt
nicht für Sonderfahrzeuge	nicht für Sonderfahrzeuge	Schaltgetriebe 6 Gang	Schaltgetriebe 6 Gang
Nutzlast [kg]	Nutzlast [kg]	Scheibenbremse	Scheibenbremse
Nutzlast ab [kg]	Nutzlast ab [kg]	Schlüsselweite 1 [mm]	Schlüsselweite 1 [mm]
Nutzlast bis [kg]	Nutzlast bis [kg]	Schrägheck	Schrägheck
Nutzlast-Code	Nutzlast-Code	- SCS	für Fahrzeuge ohne SCS
Nutzlast leicht	Nutzlast leicht	Slowakische Republik	Slowakische Republik
Nutzlast schwer	Nutzlast schwer	Trommelbremse	Trommelbremse
ohne Bremsflüssigkeitsbehälter	ohne Bremsflüssigkeitsbehälter	TRW	Bremssystem, Lucas / TRW
ohne Druckregler	ohne Druckregler	Tschechische Republik	Tschechische Republik
ohne Drucksensor	ohne Drucksensor	Türenanzahl	Türenanzahl
ohne Steuergerät	ohne Steuergerät	Ungarn	Ungarn
Orga →	für Organisationsnummer ab	weiß/lila	weiß/lila
- Performance Parts	für Fahrzeuge ohne Performance Bremse	x	Anschlussanzahl
pneumatisch	pneumatisch	Zubehör	Zubehör
Produkttyp vorhanden	Produkttyp vorhanden	zusätzlich benötigter Artikel (Artikel-Nummer)	zusätzlich benötigter Artikel (Artikel-Nummer)
Radstand [mm]	Radstand [mm]	∅	Durchmesser [mm]
Republik Korea (Südkorea)	Republik Korea (Südkorea)	∅ "	Durchmesser [Zoll]
- RU	Russland	∅1	Durchmesser 1 [mm]
SA Code ab →	SA Code ab	∅2	Durchmesser 2 [mm]
Satz	Satz	→	Baujahr ab Fahrgestellnummer (VIN) ab
Schaltgetriebe	Schaltgetriebe	→	Baujahr bis Fahrgestellnummer (VIN) bis
		→Orga	für Organisationsnummer bis
		→ SA Code bis	SA Code bis

Technische Übersetzungen

Technical translations - Traducciones técnicas - Traductions techniques - Traduzioni tecniche

EN		EN	
	Brake Master Cylinder	Automatikgetriebe	Automatic Transmission
	Brake Force Regulator	BDX	Brake System, Bendix
	Brake Booster	Bördelform	Flange Shape
	Left	BOS	Brake System, Bosch
+ ABS	for vehicles with ABS	Bosnien-Herzegowina	Bosnia-Herzegovina
+ ASC	for vehicles with ASC	Bremskraftverstärker	Brake Booster
+ ASR	for vehicles with ASR	Bremsystem	Brake System
+ DSC	for vehicles with DSC	CVT-Automatikgetriebe (Stufenlos)	CVT Automatic Transmission (stepless)
+ DSTC	for vehicles with DSTC	DEL	Brake System, Delco
+ EDS	for vehicles with EDS	- Diff	without differential lock
+ ESP	for vehicles with ESP	- DSC	for vehicles without DSC
+ Performance Parts	for vehicles with Performance brakes	- DSTC	for vehicles without DSTC
+PR	for PR number	E	E
+ RO	Romania	- EDS	for vehicles without EDS
+SA	for SA code	empty/leer	Observe the vehicle manufacturer specifications Observe mounting information
+ TR	Turkey	Erfüllte Qualitätsstufen	Reached Quality Gates
12Q	12Q	- ESP	for vehicles without ESP
14Q	14Q	F	F
16Q	16Q	Fahrzeugproduktionsland	Vehicle Production Country
20Q	20Q	Fahrzeugtyp	Vehicle type
Abfrage Produktbild vorhanden	Abfrage Produktbild vorhanden	Felge Lochzahl	Rim Hole Number
- ABS	for vehicles without ABS	Felgengröße [Zoll]	Rim Size [in]
Aluguss	Cast Aluminium	Frankreich	France
Artikelnummer des empfohlenen Zubehörs	Article number of recommended accessories	für DAM-Nummer ab →	for DAM number from
- ASC	for vehicles without ASC	für Fahr-schulwagen	for driving school cars
- ASR	for vehicles without ASR		
ausschließlich für Rennsportzwecke	Only for racing purposes		
Ausstattungs-Code	Equipment Code		

Technische Übersetzungen

Technical translations - Traducciones tecnicas - Traductions techniques - Traduzioni tecniche

EN		EN	
für Fahrzeuge mit Adaptive Cruise Control	for vehicles with Adaptive Cruise Control	für Fahrzeuge mit Sportfahrwerk	for vehicles with sports suspension
für Fahrzeuge mit AMG-Sportpaket	for vehicles with AMG Sports Package	für Fahrzeuge mit Sportpaket	for vehicles with sports package
für Fahrzeuge mit autom. Distanzregelung	for vehicles with autom. distance control	für Fahrzeuge mit Start-Stopp-Funktion	for vehicles with start-stop function
für Fahrzeuge mit Bremsassistent	for vehicles with brake assist	für Fahrzeuge mit STC	for vehicles with STC
für Fahrzeuge mit elektr. Dämpferregulierung	for vehicles with electronic suspension control	für Fahrzeuge mit Trommelbremse an der Hinterachse	for vehicles with drum brakes on the rear axle
für Fahrzeuge mit elektronischer Fahrdynamikregelung	for vehicles with electronic drive dynamics control	für Fahrzeuge mit verstärktem Fahrwerk	for vehicles with heavy duty suspension
für Fahrzeuge mit Kollisionswarner	for vehicles with collision warning system	für Fahrzeuge mit verstärkter Bremse	for vehicles with reinforced brakes
für Fahrzeuge mit M-Sportbremse	for vehicles with M-sport brakes	für Fahrzeuge ohne Aktivlenkung	for vehicles without active steering
für Fahrzeuge mit Rußpartikelfilter	for vehicles with soot filter	für Fahrzeuge ohne AMG-Sportpaket	for vehicles without AMG sports package
für Fahrzeuge mit Scheibenbremse an der Hinterachse	for vehicles with disc brakes on the rear axle	für Fahrzeuge ohne autom. Distanzregelung	for vehicles without autom. distance control
für Fahrzeuge mit Servolenkung	for vehicles with power steering	für Fahrzeuge ohne Bremsassistent	for vehicles without brake assist
		für Fahrzeuge ohne elektronische Fahrdynamikregelung	for vehicles without electronic drive dynamics control

Technische Übersetzungen

Technical translations - Traducciones técnicas - Traductions techniques - Traduzioni tecniche

EN		EN	
für Fahrzeuge ohne Keramikbremse for vehicles without ceramic brakes		Gewindemaß 1	Thread Size 1
		Gewindemaß 2	Thread Size 2
für Fahrzeuge ohne Kollisionswarner for vehicles without collision warning system		GG	Cast iron brake caliper
		Herstellereinschränkung	Manufacturer Restriction
für Fahrzeuge ohne M-Sportbremse for vehicles without M-sport brakes		hyd.	Hydraulic
		Kroatien	Croatia
für Fahrzeuge ohne Sportfahrwerk for vehicles without sports suspension		L=	Length [mm]
		L=	Overall Length [mm]
		L1=	Length 1 [mm]
für Fahrzeuge ohne Sportpaket for vehicles without sports package		L2=	Length 2 [mm]
		Länderspezifische Verpackungs- und Status-Informationen	Country specific package and status data
für Fahrzeuge ohne Start-Stopp-Funktion for vehicles without start-stop function		lastabhängig	Load-dependent
für Fahrzeuge ohne STC for vehicles without STC		mit Bremsflüssigkeitsbehälter	with brake fluid reservoir
für Fahrzeuge ohne verstärktes Fahrwerk for vehicles without heavy duty suspension		mm Radnabendurchmesser [mm]	Wheel Hub Diameter [mm]
für Kolben-Ø [mm] for piston Ø [mm]		Motorcode	Engine Code
für Linkslenker for left-hand drive vehicles		Nicht erfüllte Qualitätsstufen	Unreached Quality Gates
für OE-Nummer for OE number		nicht für Ausstattungsvariante	not for trim level
für Rechtslenker for right-hand drive vehicles		nicht für Facelift	not for facelift
für verkürzten Radstand for shortened wheelbase		nicht für Fahrschulwagen	not for driving school cars
für verlängerten Radstand for extended wheelbase		nicht für Fahrzeuge mit verstärkter Bremse	not for vehicles with reinforced brakes
Gebrauchsnummer usage number		nicht für gepanzerte Fahrzeuge	not for armoured vehicles
Getriebetyp Transmission Type			







Technische Übersetzungen

Technical translations - Traducciones técnicas - Traductions techniques - Traduzioni tecniche

EN		EN	
nicht für Getriebetyp	not for transmission type	Schaltgetriebe, automatisch betätigt	Manual Transmission, automatically operated
nicht für Sonderfahrzeuge	not for special-purpose vehicles	Schaltgetriebe 6 Gang	6-Speed Manual Transmission
Nutzlast [kg]	Payload [kg]	Scheibenbremse	Disc Brake
Nutzlast ab [kg]	Payload from [kg]	Schlüsselweite 1 [mm]	Spanner size 1 [mm]
Nutzlast bis [kg]	Payload to [kg]	Schrägheck	Hatchback
Nutzlast-Code	Payload code	- SCS	for vehicles without SCS
Nutzlast leicht	Payload light	Slowakische Republik	Slovakia
Nutzlast schwer	Payload heavy	Trommelbremse	Drum Brake
ohne Bremsflüssigkeitsbehälter	without brake fluid reservoir	TRW	Brake System, Lucas / TRW
ohne Druckregler	without pressure regulator	Tschechische Republik	Czech Republic
ohne Drucksensor	without pressure sensor	Türenanzahl	Number of Doors
ohne Steuergerät	without control unit	Ungarn	Hungary
Orga →	for RPO number (vehicle manufacturing date) from	weiß/lila	White/Purple
- Performance Parts	for vehicles without Performance brakes	x	Number of connectors
pneumatisch	Pneumatic	Zubehör	Accessories
Produkttyp vorhanden	Produkttyp vorhanden	zusätzlich benötigter Artikel (Artikel-Nummer)	Additionally required articles (article numbers)
Radstand [mm]	Wheelbase [mm]	∅	Diameter [mm]
Republik Korea (Südkorea)	Republic of Korea (South Korea)	∅ "	Diameter [in]
- RU	Russia	∅1	Diameter 1 [mm]
SA Code ab →	SA code from	∅2	Diameter 2 [mm]
Satz	Set	→	Construction year from Vehicle Identification Number (VIN) from
Schaltgetriebe	Manual Transmission	→	Construction year to Vehicle Identification Number (VIN) to
		→Orga	for RPO number (vehicle manufacturing date) up to
		→ SA Code bis	SA code to

Technische Übersetzungen

Technical translations - Traducciones técnicas - Traductions techniques - Traduzioni tecniche

ES		ES	
	Cilindro principal de freno	Automatikgetriebe	Transmisión automática
	Regulador de la fuerza de frenado	BDX	Sistema de frenos, Bendix
	Servofrenos	Bördelform	Tipo rebordeado
	izquierda	BOS	Sistema de frenos, Bosch
+ ABS	para vehículos con ABS	Bosnien-Herzegowina	Bosnia y Herzegovina
+ ASC	para vehículos con ASC	Bremskraftverstärker	Servofrenos
+ ASR	para vehículos con ASR	Brems-system	Sistema de frenos
+ DSC	para vehículos con DSC	CVT-Automatikgetriebe (Stufenlos)	Transmisión automática CVT (continua)
+ DSTC	para vehículos con DSTC	DEL	Sistema de frenos, Delco
+ EDS	para vehículos con EDS	- Diff	sin bloqueo de diferencial
+ ESP	para vehículos con ESP	- DSC	para vehículos sin DSC
+ Performance Parts	para vehículos con frenos alto rendimiento	- DSTC	Para vehículos sin DSCT
+PR	Número de PR	E	E
+ RO	Rumania	- EDS	para vehículos sin EDS
+SA	para código SA	empty/leer	Observar las indicaciones del constructor Observar información de montaje
+ TR	Turquía	Erfüllte Qualitätsstufen	Erfüllte Qualitätsstufen
12Q	12Q	- ESP	para vehículos sin ESP
14Q	14Q	F	F
16Q	16Q	Fahrzeugproduktionsland	País producción vehículo
20Q	20Q	Fahrzeugtyp	Tipo de vehículo
Abfrage Produktbild vorhanden	Abfrage Produktbild vorhanden	Felge Lochzahl	Llanta, nº de taladros
- ABS	para vehículos sin ABS	Felgengröße [Zoll]	Tamaño de llanta [in]
Aluguss	Fundición de aluminio	Frankreich	Francia
Artikelnummer des empfohlenen Zubehörs	Nº art. de accesorio recomendado	für DAM-Nummer ab →	para número DAM desde
- ASC	para vehículos sin ASC	für Fahr-schulwagen	para coche de autoescuela
- ASR	para vehículos sin ASR		
ausschließlich für Rennsportzwecke	sólo para competiciones deportivas		
Ausstattungs-Code	Código de equipamiento		



Technische Übersetzungen

Technical translations - Traducciones técnicas - Traductions techniques - Traduzioni tecniche

ES		ES	
für Fahrzeuge mit Adaptive Cruise Control	para vehículos con Adaptive Cruise Control	für Fahrzeuge mit Sportfahrwerk	para vehículos con chasis deportivo
für Fahrzeuge mit AMG-Sportpaket	para vehículos con paquete sport AMG	für Fahrzeuge mit Sportpaket	para vehículos con paquete sport
für Fahrzeuge mit autom. Distanzregelung	para vehículos con regulación automática de distancia	für Fahrzeuge mit Start-Stopp-Funktion	para vehículos con sistema Start&Stop
für Fahrzeuge mit Bremsassistent	para vehículos con asistencia a la frenada	für Fahrzeuge mit STC	para vehículos con STC
für Fahrzeuge mit elektr. Dämpferregulierung	para vehículos con regulación eléctrica de amortiguación	für Fahrzeuge mit Trommelbremse an der Hinterachse	para vehículos con freno de tambor en eje trasero
für Fahrzeuge mit elektronischer Fahrdynamikregelung	para vehículos con regulación dinámica de conducción	für Fahrzeuge mit verstärktem Fahrwerk	para vehículos con chasis reforzado
für Fahrzeuge mit Kollisionswarner	para vehículos con aviso de colisión	für Fahrzeuge mit verstärkter Bremse	para vehículos con freno reforzado
für Fahrzeuge mit M-Sportbremse	Para vehículos con frenos deportivos M	für Fahrzeuge ohne Aktivlenkung	para vehículos sin dirección activo
für Fahrzeuge mit Rußpartikelfilter	para vehículos con filtro de partículas	für Fahrzeuge ohne AMG-Sportpaket	para vehículos sin paquete deportivo AMG
für Fahrzeuge mit Scheibenbremse an der Hinterachse	para vehículos con freno de disco en eje trasero	für Fahrzeuge ohne autom. Distanzregelung	para vehículos sin regulación automática de distancia
für Fahrzeuge mit Servolenkung	para vehículos con dirección asistida	für Fahrzeuge ohne Bremsassistent	Para vehículos sin asistencia a la frenada
		für Fahrzeuge ohne elektronische Fahrdynamikregelung	para vehículos sin control dinámico de conducción

Technische Übersetzungen

Technical translations - Traducciones técnicas - Traduccions techniques - Traduzioni tecniche

ES		ES	
für Fahrzeuge ohne Keramikbremse para vehículos sin frenos de cerámica		Gewindemaß 1	Rosca 1
		Gewindemaß 2	Rosca 2
für Fahrzeuge ohne Kollisionswarner para vehículos sin aviso de colisión		GG	Pinza de frenos de hierro fundido
		Herstellereinschränkung	Restricción de fabricante
für Fahrzeuge ohne M-Sportbremse Para vehículos sin frenos deportivos M		hyd.	hidráulico
		Kroatien	Croacia
für Fahrzeuge ohne Sportfahrwerk para vehículos sin chasis deportivo		L=	Longitud [mm]
		L=	Longitud total [mm]
		L1=	Longitud 1 [mm]
für Fahrzeuge ohne Sportpaket para vehículos sin paquete sport		L2=	Longitud 2 [mm]
		Länderspezifische Verpackungs- und Status-Informationen	Información específica del país sobre el embalaje y sobre el estado
für Fahrzeuge ohne Start-Stopp-Funktion para vehículos sin sistema Start&Stop		lastabhängig	dependiente de la carga
für Fahrzeuge ohne STC para vehículos sin STC		mit Bremsflüssigkeitsbehälter	con depósito líquido frenos
für Fahrzeuge ohne verstärktes Fahrwerk para vehículos sin chasis reforzado		mm Radnabendurchmesser [mm]	Diám. buje de rueda [mm]
		Motorcode	Código de motor
für Kolben-Ø [mm] para pistón - Ø [mm]		Nicht erfüllte Qualitätsstufen	Nicht erfüllte Qualitätsstufen
für Linkslenker para vehic. dirección izquierda		nicht für Ausstattungsvariante	no para variante de equipamiento
für OE-Nummer para OE N°		nicht für Facelift	no para facelift
für Rechtslenker para vehíc. dirección a la derecha		nicht für Fahrschulwagen	no para veh. autoescuela
für verkürzten Radstand para distancia entre ejes acortada		nicht für Fahrzeuge mit verstärkter Bremse	no para vehículos con frenos reforzados
für verlängerten Radstand para distancia entre ejesprolongada		nicht für gepanzerte Fahrzeuge	no para vehículos blindados
Gebrauchsnummer Número de uso			
Getriebetyp Tipo de caja de cambios			







Technische Übersetzungen

Technical translations - Traducciones técnicas - Traductions techniques - Traduzioni tecniche

ES		ES	
nicht für Getriebetyp	no para tipo de transmisión	Schaltgetriebe, automatisch betätigt	Caja de cambios manual, accionamiento automático
nicht für Sonderfahrzeuge	no para veh. especiales	Schaltgetriebe 6 Gang	Caja de cambios manual, 6 marchas
Nutzlast [kg]	Carga útil [kg]	Scheibenbremse	Discos
Nutzlast ab [kg]	carga útil desde [kg]	Schlüsselweite 1 [mm]	Ancho de llave 1 [mm]
Nutzlast bis [kg]	carga útil hasta [kg]	Schrägheck	Fastback
Nutzlast-Code	Código de carga útil	- SCS	para vehículos sin SCS
Nutzlast leicht	Carga útil ligera	Slowakische Republik	República eslovaca
Nutzlast schwer	Carga útil pesada	Trommelbremse	Tambor
ohne Bremsflüssigkeitsbehälter	sin depósito líquido frenos	TRW	Sistema de frenos, Lucas / TRW
ohne Druckregler	sin regulador de presión	Tschechische Republik	República Checa
ohne Drucksensor	sin sensor de presión	Türenanzahl	Número de puertas
ohne Steuergerät	sin unidad de control	Ungarn	Hungría
Orga →	para números de organización desde	weiß/lila	blanco/lila
- Performance Parts	para vehículos sin frenos alto rendimiento	x	Número de conexiones
pneumatisch	neumático	Zubehör	Accesorios
Produkttyp vorhanden	Produkttyp vorhanden	zusätzlich benötigter Artikel (Artikel-Nummer)	Se requiere adicionalmente artículo N°
Radstand [mm]	Distancia entre ejes [mm]	∅	Diámetro [mm]
Republik Korea (Südkorea)	Rep. Corea (Corea del Sur)	∅ "	Diámetro [in]
- RU	Rusia	∅1	Diámetro 1 [mm]
SA Code ab →	código SA a partir de	∅2	Diámetro 2 [mm]
Satz	Kit	→	año construcción desde N.º de chasis (VIN) desde
Schaltgetriebe	Caja de cambios manual	→	año construcción hasta N.º de chasis (VIN) hasta
		→Orga	para n.º de org. hasta
		→ SA Code bis	código SA hasta

Technische Übersetzungen

Technical translations - Traducciones técnicas - Traductions techniques - Traduzioni tecniche

FR		FR	
	Maître-cylindre de frein	Ausstattungs-Code	Code d'équipement
	Régulateur de freinage	Automatikgetriebe	Boîte automatique
	Dispositif d'assistance de frein	BDX	Système de freinage, Bendix
	gauche	Bördelform	Forme du bord relevé
+ ABS	pour véhicules avec système antiblo-cage	BOS	Système de freinage, Bosch
+ ASC	pour véhicules avec ASC	Bosnien-Herzegowina	Bosnie-Herzégovine
+ ASR	pour véhicules avec ASR	Bremskraft-verstärker	Servofrein
+ DSC	pour véhicules avec DSC	Brems-system	Système de freinage
+ DSTC	pour véhicules avec DSTC	CVT-Automa-tikgetriebe (Stufenlos)	Boîte de vitesses à variateur classique (CVT, continu)
+ EDS	pour véhicules avec EDS	DEL	Système de freinage, Delco
+ ESP	pour véhicules avec ESP	- Diff	sans blocage de différentiel
+ Perfor-mance Parts	pour véhicule avec frein Performance	- DSC	pour véhicules sans DSC
+PR	pour numéro PR	- DSTC	pour véhicules sans DSTC
+ RO	Roumanie	E	E
+SA	pour SA code	- EDS	pour véhicules sans EDS
+ TR	Turquie	empty/leer	Attention aux indications du construc-teurs du véhicule Attention au infos de montage!
12Q	12Q	Erfüllte Qualitäts-stufen	Erfüllte Qualitätsstufen
14Q	14Q	- ESP	pour véhicules sans ESP
16Q	16Q	F	F
20Q	20Q	Fahrzeugpro-duk-tionsland	Pays constructeur du véhicule
Abfrage Produktbild vorhanden	Abfrage Produktbild vorhanden	Fahrzeugtyp	Type de véhicule
- ABS	pour véhicules sans système antiblo-cage	Felge Loch-zahl	Jante, nombre de trous
Aluguss	Fonte d'aluminium	Felgengröße [Zoll]	Dimension de la jante [pouces]
Artikel-nummer des empfohlenen Zubehörs	Référence de l'accessoire recommandé	Frankreich	France
- ASC	pour véhicules sans ASC	für DAM-Nummer ab →	pour numéro DAM à partir de
- ASR	pour véhicules sans ASR	für Fahr-schulwagen	pour véhicules d'auto-école
ausschließ-lich für Renn-sportzwecke	exclusivement pour véhicules de courses		



Technische Übersetzungen

Technical translations - Traducciones técnicas - Traductions techniques - Traduzioni tecniche

FR		FR	
für Fahrzeuge mit Adaptive Cruise Control	pour véhicule avec Adaptive Cruise Control	für Fahrzeuge mit Sportfahrwerk	pour véhicules avec châssis sportif
für Fahrzeuge mit AMG-Sportpaket	pour véhicules avec pack sport AMG	für Fahrzeuge mit Sportpaket	pour véhicules avec équipement sport
für Fahrzeuge mit autom. Distanzregelung	pour véhicules avec régulation de distance autom.	für Fahrzeuge mit Start-Stopp-Funktion	pour véhicules avec fonction Stop/Start
für Fahrzeuge mit Bremsassistent	pour véhicules avec assistant au freinage	für Fahrzeuge mit STC	pour véhicules avec STC
für Fahrzeuge mit elektr. Dämpferregulierung	pour véhicules avec réglage d'amortisseur électronique	für Fahrzeuge mit Trommelbremse an der Hinterachse	pour véhicules avec frein à tambour à l'essieu arrière
für Fahrzeuge mit elektronischer Fahrdynamikregelung	p. véhicules avec régulat° électro. de dynamique de conduite	für Fahrzeuge mit verstärktem Fahrwerk	pour véhicules avec châssis renforcé
für Fahrzeuge mit Kollisionswarner	pour véhicules avec système anti-collision	für Fahrzeuge mit verstärkter Bremse	pour véhicules avec frein assisté
für Fahrzeuge mit M-Sportbremse	pour véhicules avec système de freinage sport M	für Fahrzeuge ohne Aktivlenkung	pour véhicules sans direction active
für Fahrzeuge mit Rußpartikelfilter	pour véhicules avec filtre à particules	für Fahrzeuge ohne AMG-Sportpaket	pour véhicules sans pack sport AMG
für Fahrzeuge mit Scheibenbremse an der Hinterachse	pour véhicules avec frein à disques à l'essieu arrière	für Fahrzeuge ohne autom. Distanzregelung	pour véhicules sans régulation de distance autom.
für Fahrzeuge mit Servolenkung	pour véhicules avec direction assistée	für Fahrzeuge ohne Bremsassistent	pour véhicules sans assistant de freinage
		für Fahrzeuge ohne elektronische Fahrdynamikregelung	pr véhicules sans régulation électro. dynamique de conduite

Technische Übersetzungen

Technical translations - Traducciones técnicas - Traductions techniques - Traduzioni tecniche

FR	FR
für Fahrzeuge ohne Keramikbremse pour véhicules sans frein en céramique	Gewindemaß 1 Taraudage/Filetage 1
	Gewindemaß 2 Taraudage/Filetage 2
für Fahrzeuge ohne Kollisionwarner pour véhicules sans système anti-collision	GG Étrier de frein en fonte
	Herstellereinschränkung Montage d'origine
für Fahrzeuge ohne M-Sportbremse pour véhicules sans système de freinage sport M	hyd. hydraulique
	Kroatien Croatie
	L= Longueur [mm]
für Fahrzeuge ohne Sportfahrwerk pour véhicules sans châssis sportif	L= Longueur globale [mm]
	L1= Longueur 1 [mm]
	L2= Longueur 2 [mm]
für Fahrzeuge ohne Sportpaket pour véhicules sans équipement sport	Länderspezifische Verpackungs- und Status-Informationen Informations d'emballage et d'état spécifiques aux pays
für Fahrzeuge ohne Start-Stopp-Funktion pour véhicules sans fonction Stop/Start	lastabhängig Fonction de la charge
für Fahrzeuge ohne STC pour véhicules sans STC	mit Bremsflüssigkeitsbehälter avec filtre déshydratant pour liquide de freins
für Fahrzeuge ohne verstärktes Fahrwerk pour véhicules sans châssis renforcé	mm Radnabendurchmesser [mm] Diamètre moyeu de roue [mm]
	Motorcode Code moteur
für Kolben-Ø [mm] pour piston-Ø [mm]	Nicht erfüllte Qualitätsstufen Nicht erfüllte Qualitätsstufen
für Linkslenker pour véhicules avec direction à gauche	nicht für Ausstattungsvariante pas pour variante d'équipement
für OE-Nummer pour numéro OE	nicht für Facelift pas pour facelift
für Rechtslenker pour véhicules avec direction à droite	nicht für Fahrschulwagen pas pour véhicules d'auto-école
für verkürzten Radstand pour empattement raccourci	nicht für Fahrzeuge mit verstärkter Bremse pas pour véhicules avec frein assisté
für verlängerten Radstand pour empattement rallongé	
Gebrauchsnummer Numéro d'utilisation	
Getriebetyp Type de boîte de vitesses	nicht für gepanzerte Fahrzeuge pas pour véhicules blindés







Technische Übersetzungen

Technical translations - Traducciones técnicas - Traductions techniques - Traduzioni tecniche

FR		FR	
nicht für Getriebetyp	pas pour type de transmission	Schaltgetriebe, automatisch betätigt	Boîte de vitesse commandée automatiquement
nicht für Sonderfahrzeuge	pas pour véhicules spéciaux	Schaltgetriebe 6 Gang	Boîte de vitesses manuelle à 6 vitesses
Nutzlast [kg]	Charge utile [kg]	Scheibenbremse	Frein à disque
Nutzlast ab [kg]	Charge utile à partir de [kg]	Schlüsselweite 1 [mm]	Largeur de clé 1 [mm]
Nutzlast bis [kg]	Charge utile jusqu'à [lb]	Schrägheck	3/5 portes
Nutzlast-Code	Code de charge utile	- SCS	pour véhicules sans SCS
Nutzlast leicht	Charge utile légère	Slowakische Republik	République slovaque
Nutzlast schwer	Charge utile lourde	Trommelbremse	Frein à tambour
ohne Bremsflüssigkeitsbehälter	sans réservoir du liquide de frein	TRW	Système de freinage, Lucas / TRW
ohne Druckregler	sans régulateur de pression	Tschechische Republik	République tchèque
ohne Drucksensor	sans senseur de pression	Türenanzahl	Nombre de portes
ohne Steuergerät	sans appareil de commande	Ungarn	Hongrie
Orga →	pour n° OPR(date de fabrication du véhicule) à partir de	weiß/lila	blanc/violet
- Performance Parts	pour véhicules sans frein Performance	x	Nombre de connexions
pneumatisch	pneumatique	Zubehör	Accessoires
Produkttyp vorhanden	Produkttyp vorhanden	zusätzlich benötigter Artikel (Artikel-Nummer)	article supplémentaire (référence)
Radstand [mm]	Empattement [mm]	∅	Diamètre [mm]
Republik Korea (Südkorea)	République de Corée (Corée du Sud)	∅ "	Diamètre [pouces]
- RU	Russie	∅1	Diamètre 1 [mm]
SA Code ab →	Code SA à partir de	∅2	Diamètre 2[mm]
Satz	Jeu	→	Année à partir de Numéro de châssis (VIN) à partir de
Schaltgetriebe	boîte de vitesses manuelle	→	Année jusqu'à Numéro de châssis (VIN) à
		→Orga	pour numéro OPR (date de fabrication du véhicule) jusqu'à
		→ SA Code bis	Code SA jusqu'à

Technische Übersetzungen

Technical translations - Traducciones técnicas - Traductions techniques - Traduzioni tecniche

IT		IT	
	Cilindro maestro del freno	Automatikgetriebe	Trasmissione automatica
	Modulatore frenata	BDX	Sistema frenante, Bendix
	Servofreno	Bördelform	Forma bordatura
	Sx	BOS	Sistema frenante, Bosch
+ ABS	per veicoli con ABS	Bosnien-Herzegowina	Bosnia ed Erzegovina
+ ASC	per veicoli con ASC	Bremskraftverstärker	Servofreno
+ ASR	per veicoli con ASR	Brems-system	Sistema frenante
+ DSC	per veicoli con DSC	CVT-Automatikgetriebe (Stufenlos)	CVT-Cambio automatico (a variazione continua)
+ DSTC	per veicoli con DSTC	DEL	Sistema frenante, Delco
+ EDS	per veicoli con EDS	- Diff	senza blocco differenziale
+ ESP	per veicoli con ESP	- DSC	per veicoli senza DSC
+ Performance Parts	per veicoli con freno Performance	- DSTC	per veicoli senza DSTC
+PR	per N° PR	E	E
+ RO	Romania	- EDS	per veicoli senza EDS
+SA	per codice SA	empty/leer	Osservare direttive costruttore veicolo Osservare info montaggio
+ TR	Turchia	Erfüllte Qualitätsstufen	Erfüllte Qualitätsstufen
12Q	12Q	- ESP	per veicoli senza ESP
14Q	14Q	F	F
16Q	16Q	Fahrzeugproduktionsland	Paese produzione veicolo
20Q	20Q	Fahrzeugtyp	Tipo veicolo
Abfrage Produktbild vorhanden	Abfrage Produktbild vorhanden	Felge Lochzahl	Cerchione, N° fori
- ABS	per veicoli senza ABS	Felgengröße [Zoll]	Misura cerchione [pollici]
Aluguss	Alluminio pressofuso	Frankreich	Francia
Artikelnummer des empfohlenen Zubehörs	N° articolo accessorio consigliato	für DAM-Nummer ab →	per numero DAM da
- ASC	per veicoli senza ASC	für Fahr-schulwagen	per vettura per scuola guida
- ASR	per veicoli senza ASR		
ausschließlich für Rennsportzwecke	solo per uso agonistico		
Ausstattungs-Code	Codice dotazione		



Technische Übersetzungen

Technical translations - Traducciones técnicas - Traductions techniques - Traduzioni tecniche

IT	IT
für Fahrzeuge mit Adaptive Cruise Control per veicoli con Adaptive Cruise Control	für Fahrzeuge mit Sportfahrwerk per veicoli con autotelaio sportivo
für Fahrzeuge mit AMG-Sportpaket per veicoli con pacchetto sportivo AMG	für Fahrzeuge mit Sportpaket per veicoli con pacchetto sportivo
für Fahrzeuge mit autom. Distanzregelung per veicoli con regolatore automatico distanza	für Fahrzeuge mit Start-Stopp-Funktion per veicoli con funzione di start-stop
für Fahrzeuge mit Bremsassistent per veicoli con brake assist	für Fahrzeuge mit STC per veicoli con STC
für Fahrzeuge mit elektr. Dämpferregulierung per veicoli con regolazione elettr. ammortizzatori	für Fahrzeuge mit Trommelbremse an der Hinterachse per veicoli con freni a tamburo ad assale posteriore
für Fahrzeuge mit elektronischer Fahrdynamikregelung per veicoli con regolazione elettronica dinamica di guida	für Fahrzeuge mit verstärktem Fahrwerk per veicoli con autotelaio rinforzato
für Fahrzeuge mit Kollisionswarner per veicoli con segnale anticollisione	für Fahrzeuge mit verstärkter Bremse per veicoli con freno rinforzato
für Fahrzeuge mit M-Sportbremse per veicoli con freni sportivi M	für Fahrzeuge ohne Aktivlenkung per veicoli senza meccanismo sterzo attivo
für Fahrzeuge mit Rußpartikelfilter per veicoli con filtro antiparticolato	für Fahrzeuge ohne AMG-Sportpaket per veicoli senza pacchetto sportivo AMG
für Fahrzeuge mit Scheibenbremse an der Hinterachse per veicoli con freni a disco ad assale posteriore	für Fahrzeuge ohne autom. Distanzregelung per veicoli senza regolatore automatico distanza
für Fahrzeuge mit Servolenkung per veicoli con servosterzo	für Fahrzeuge ohne Bremsassistent per veicoli senza brake assist
	für Fahrzeuge ohne elektronische Fahrdynamikregelung per veicoli senza regolazione elettronica dinamica guida

Technische Übersetzungen

Technical translations - Traducciones técnicas - Traductions techniques - Traduzioni tecniche

IT		IT	
für Fahrzeuge ohne Keramikbremse per veicoli senza freni in ceramica		Gewindemaß 1	Dimensioni filettatura 1
		Gewindemaß 2	Dimensioni filettatura 2
für Fahrzeuge ohne Kollisionswarner per veicoli senza segnale anticollisione		GG	Pinza freno in ghisa
		Herstellereinschränkung	Limitazione costruttore
für Fahrzeuge ohne M-Sportbremse per veicoli senza freni sportivi M		hyd.	idraulico
		Kroatien	Croazia
für Fahrzeuge ohne Sportfahrwerk per veicoli senza autotelaio sportivo		L=	Lunghezza [mm]
		L=	Lunghezza totale [mm]
für Fahrzeuge ohne Sportpaket per veicoli senza pacchetto sportivo		L1=	Lunghezza 1 [mm]
		L2=	Lunghezza 2 [mm]
für Fahrzeuge ohne Start-Stopp-Funktion per veicoli senza funzione di start-stop		Länderspezifische Verpackungs- und Status-Informationen	Informazioni di imballaggio e di stato specifiche per i diversi Paesi
		lastabhängig	subordinato al carico
für Fahrzeuge ohne STC per veicoli senza STC		mit Bremsflüssigkeitsbehälter	con serbatoio liquido freni
		mm Radnabendurchmesser [mm]	Diametro mozzo ruota [mm]
für Fahrzeuge ohne verstärktes Fahrwerk per veicoli senza autotelaio rinforzato		Motorcode	Codice motore
		Nicht erfüllte Qualitätsstufen	Nicht erfüllte Qualitätsstufen
für Kolben-Ø [mm] per pistone-Ø [mm]		nicht für Ausstattungsvariante	non per tipo equipaggiamento
für Linkslenker per veicolo con guida a Sx		nicht für Facelift	non per Facelift
für OE-Nummer per N° OE		nicht für Fahrschulwagen	Non per vettura per scuola guida
für Rechtslenker per veicolo con guida a Dx		nicht für Fahrzeuge mit verstärkter Bremse	Non per veicoli con freno rinforzato
für verkürzten Radstand per passo accorciato		nicht für gepanzerte Fahrzeuge	Non per veicoli corazzati
für verlängerten Radstand per passo allungato			
Gebrauchsnummer Codice d'uso			
Getriebetyp Tipo di trasmissione			



Technische Übersetzungen

Technical translations - Traducciones técnicas - Traductions techniques - Traduzioni tecniche

IT		IT	
nicht für Getriebetyp	non per tipo di trasmissione	Schaltgetriebe, automatisch betätigt	Cambio manuale, azionamento automatico
nicht für Sonderfahrzeuge	Non per veicoli speciali	Schaltgetriebe 6 Gang	Cambio manuale a 6 marce
Nutzlast [kg]	Portatautile [kg]	Scheibenbremse	Freno a disco
Nutzlast ab [kg]	Portata utile da [kg]	Schlüsselweite 1 [mm]	Apertura chiave 1 [mm]
Nutzlast bis [kg]	Portata utile fino a [kg]	Schrägheck	2 volumi /Coda spiovente
Nutzlast-Code	Codice portata utile	- SCS	per veicoli senza SCS
Nutzlast leicht	Portata utile leggera	Slowakische Republik	Repubblica slovacca
Nutzlast schwer	Portata utile pesante	Trommelbremse	Freno a tamburo
ohne Bremsflüssigkeitsbehälter	senza serbatoio liquido freni	TRW	Sistema frenante, Lucas / TRW
ohne Druckregler	senza regolatore pressione	Tschechische Republik	Repubblica ceca
ohne Drucksensor	senza sensore pressione	Türenanzahl	N° portiere
ohne Steuergerät	senza centralina	Ungarn	Ungheria
Orga →	per numero organizzazione da	weiß/lila	bianco/lilla
- Performance Parts	per veicoli senza freno Performance	x	N° raccordi
pneumatisch	pneumatico	Zubehör	Accessori
Produkttyp vorhanden	Produkttyp vorhanden	zusätzlich benötigter Artikel (Artikel-Nummer)	Articolo supplementare occorrente (N° articolo)
Radstand [mm]	Passo ruote [mm]	Ø	Diametro [mm]
Republik Korea (Südkorea)	Repubblica di Corea(Corea del Sud)	Ø "	Diametro [pollici]
- RU	Russia	Ø1	Diametro 1 [mm]
SA Code ab →	Codice SA da	Ø2	Diametro 2 [mm]
Satz	Serie / Kit	→	Anno da N° telaio (VIN) da
Schaltgetriebe	Cambio manuale	→	Anno fino a N° telaio (VIN) fino a
		→Orga	per numero organizzazione fino a
		→ SA Code bis	Codice SA fino a

ATE – A Trademark of the
Continental Corporation

**Continental Aftermarket &
Services GmbH**

Sodener Straße 9
D-65824 Schwalbach
Tel. +49 (0) 6196 87 0
Fax +49 (0) 6196 865 71

www.ate.de

**Continental Automotive Trading
Italia S.r.l.**

Via Matteotti, 62
I-20092 Cinisello Balsamo (MI)
Tel. +39 02 35680 1
Fax +39 02 35680 325
E-Mail: supporto@continental-corporation.com

www.ate-freni.it

**Continental Automotive Trading
France**

6 rue Jean Moulin
F-78120 Rambouillet
Tél. +33 (0)9 69 37 37 37

www.ate-freinage.fr

Continental Automotive Spain, S.A.

C/ Sepúlveda, 11
E-28108 Alcobendas (Madrid) Phone
+34 (0) 657 21 21
Fax +34 (0)91 657 21 49

www.frenos-ate.es