

Hydraulische Teile

Hydraulic components

2017

K24-H

Bremsen-Ersatzteilprogramm

Brake Parts Program



Brakethrough Technology

Kompetenz und Aktualität

Competence and topicality



ATE macht mobil

Unser Produktportfolio können Sie jetzt auch per Smartphone abrufen. Über Stichwort- Fahrzeug- und Artikelsuche finden Sie schnell den passenden Artikel – und per Händlersuche mit integriertem Routenplaner auch gleich den nächsten ATE Vertragspartner.

Die ATE Katalog CD-Rom

Die zweimal pro Jahr erscheinende ATE Katalog CD-Rom „ETK“ basiert auf der TecDoc-Engine. Wer die TecDoc DVD kennt, kommt also genau so leicht mit der ATE Katalog CD zurecht.

ATE Online-Katalog

Noch aktuellere Informationen finden Sie im Online-Katalog von ATE. Hier werden die Kataloginformationen mindestens monatlich aktualisiert. Sie finden den ATE Online-Katalog unter www.ate.de.

ATE goes mobile

You can call up our product portfolio on your smart-phone. Using keyword, vehicle and article searches, you can quickly find the right article – and then use the dealer search with the integrated route planner to immediately find the nearest ATE authorised distributor.

The ATE catalog CD-Rom

The ATE catalog CD-Rom “ETK” appears twice a year and is based on the TecDoc engine. The ATE catalog CD will thus be easy to use for anyone familiar with the TecDoc DVD.

ATE online-catalog

Even more current information you find in the ATE onlinecatalog. Here the spare part information are posted at least monthly. You find the ATE online-catalog on www.ate-brakes.com.



ATE App
ATE app



ATE Online-Katalog
ATE online-catalog



ATE Katalog CD-Rom
ATE catalog CD-Rom

So benutzen Sie den K24-H

Produktgruppe	Fahrzeugtypen	Einbaue Zeitraum (von/bis)	ATE-Artikelnummer (lang)	Bemerkung (Artikel)				
Vorder-/Hinterachse	Fahrgestellnummer (von/bis)		Bemerkung (Fahrzeug)	ATE-Artikelnummer (kurz)			Artikeldefinition	
kW								
AUDI A4 CABRIO (02-)								
1,8 T 1,8 T Quattro 2,0 2,0 TFSI	◀ 120 ◀ 120 ◀ 96 ◀ 120	8E-55-999999 8E-55-400001	04.02 05.03 08.06 05.04 08.06 08.06	PR: 1LB,1LE PR: 1LB,1LE PR: 1LB,1LE PR: 1LB,1LE PR: 1LB,1LE	11.3571-8522.2 11.3571-8521.2 11.0441-5704.2 11.0101-5409.2	220320 220319 250034 260035	+ ESP + ESP D=57, - Halter D=57, - Halter Dichtungssatz Hülsensatz	ATE ATE ATE ATE
*	**				***		****	

*Produktgruppen



Bremskraftverstärker



Handbremsseil



Hauptbremszylinder



Bremskraftregler



Ausgleichsbehälter



Kupplungs-Geberzylinder



Bremsattel



Kupplungs-Nehmerzylinder



Bremssschlauch



Kupplungs-schlauch



Radzylinder



Kupplungsseil

**Lenkungsart

- ◀ Linkslenker
▶ Rechtslenker

****Herstellerkennung

ADV	Advics
ATE	Continental Teves (ATE)
AKE	Akebono
AIS	Aisin
AP	AP Lockheed
BDX	Bendix
BOS	Bosch
BRE	Brembo
CIT	Citroën
DEL	Delco
FI	Fiat
FTE	FTE Automotive
MAN	Mando
NIS	Nissin
PER	Perrot
SUM	Sumitomo
TOK	Tokico
TRW	Lucas (LUC)
VW	Volkswagen

***Einbauposition



















	vorne
	hinten
	links
	rechts
	links vorne
	links hinten
	rechts vorne
	rechts hinten
	mitte
	oben
	unten
	Vorderachse
	Vorderachse links
	Vorderachse rechts
	Hinterachse
	Hinterachse links
	Hinterachse rechts

Sämtliche Positionsangaben beziehen sich immer auf die Fahrtrichtung.

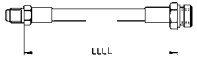
Abkürzungen

-	Ohne / nicht	HEB	Hebel	V	Belüftet	Kombi
+	Mit / nur / für	HZ	Hauptzylinder	WE	Warneinrichtung	Coupe
AUT	Automatische Nachstellung	L	Legiert / hochgekohlt	WK	Warnkontakt	Cabrio
B	Beschichtet	L=	Länge	Zub	Zubehör	Bus
BG	Bremskraftbegrenzer	Nz	Nehmerzylinder			Kastenwagen
BR	Bremskraftregler	PD	PowerDisc			Schrägheck
BRE	Einschraubregler	Rz	Radzylinder	Bremschlauch + Rohrleitung		Pritsche/Fahrgestell
BRES	Einschraubreglersatz	RzR	Radzylinder mit integriertem Regler	2-türig		Reihe
BRL	Bremskraftregler lastabhängig	S	Fixierschraube / Sattelschraube	3-türig		DKW Meisterklasse/Sonderklasse/Universal
D=	Durchmesser	THz	Tandem-Hauptzylinder	4-türig		FAUN Kraftkarren (Kraka)
Gz	Geberzylinder			5-türig		Transporter
				Limousine		

Artikelinformationen

		KURZNUMMER				KURZNUMMER																			
	03.6199-xxxx.4 → 03.61dy-xxxx.4 → 03.67dy-xxxx.4 → 03.68dy-xxxx.4 → 03.69dy-xxxx.4 → 03.77dy-xxxx.4 → 03.78dy-xxxx.4 → 03.78dy-xxxx.4 → 03.78dy-xxxx.4 → 03.78dy-xxxx.4 → 03.78dy-xxxx.4 → 03.78dy-xxxx.4 →	30nnnn 30nnnn 30nnnn 30nnnn 30nnnn 30nnnn 30nnnn 30nnnn 30nnnn 30nnnn 30nnnn	Bremskraftverstärker T50 T51 T52/3 T52 T53 T52/4 T52/4 T52/4Z T52/5 T52/5Z T55/1 T55/1Z		▲ 03.27dd-xxxx.3 → ▲ 03.32dd-xxxx.3 → 03.040x-xxdd.2 → 03.0470-xxdd.2 →	02nnnn 02nnnn 06nnnn 06nnnn	einseitig wirkender Radzylinder Radzylinder Reparatur-Satz (mit Kolben) Dichtungs-Satz (ohne Kolben)																		
			<table border="1"> <thead> <tr> <th>d</th> <th>y</th> </tr> </thead> <tbody> <tr> <td>2 = 6"</td> <td>0 = Einfachgerät</td> </tr> <tr> <td>3 = 7"</td> <td>5 = Tandemgerät</td> </tr> <tr> <td>4 = 8"</td> <td>0 = Einfachgerät</td> </tr> <tr> <td>5 = 9"</td> <td>3 = Einfachgerät BA</td> </tr> <tr> <td>6 = 10"</td> <td>5 = Einfachgerät</td> </tr> <tr> <td></td> <td>8 = Einfachgerät BA</td> </tr> <tr> <td></td> <td>BA = Bremsassistent</td> </tr> <tr> <td></td> <td>Z = Zugankerbremsgeräte</td> </tr> </tbody> </table>	d	y	2 = 6"	0 = Einfachgerät	3 = 7"	5 = Tandemgerät	4 = 8"	0 = Einfachgerät	5 = 9"	3 = Einfachgerät BA	6 = 10"	5 = Einfachgerät		8 = Einfachgerät BA		BA = Bremsassistent		Z = Zugankerbremsgeräte		24.3727-xxxx.2 →	58xxxx	Handbremsseil
d	y																								
2 = 6"	0 = Einfachgerät																								
3 = 7"	5 = Tandemgerät																								
4 = 8"	0 = Einfachgerät																								
5 = 9"	3 = Einfachgerät BA																								
6 = 10"	5 = Einfachgerät																								
	8 = Einfachgerät BA																								
	BA = Bremsassistent																								
	Z = Zugankerbremsgeräte																								
					■ 83.1xxx-xxxx.3 → ■ 83.5yxx-LLLL.3 → ■ 83.6yxx-LLLL.3 → ■ 83.7yxx-LLLL.3 →	33nnnn 33nnnn 33nnnn 33nnnn	Bremserschlauch + Rohrleitung Brems-/Kupplungsschlauch Brems-/Kupplungsschlauch Brems-/Kupplungsschlauch																		
	▲ 03.20dd-xxxx.3 → ▲ 03.21dd-xxxx.3 → ▲ 03.23dd-xxxx.3 → ▲ 03.31dd-xxxx.3 → 03.0370-xxdd.2 →	01nnnn 01nnnn 01nnnn 01nnnn 05xxdd	Tandem-Hauptzylinder gestuft Tandem-Hauptzylinder Stufen-Hauptzylinder Hauptzylinder (z. B. 03.2122-: Ø=22,20) Reparatursatz				y = 1: Gewinde 1× innen/1× außen y = 2: Gewinde 2× innen y = 3: Gewinde 2× außen																		
					03.60xx-xxxx.3 → 03.65xx-xxxx.3 → 03.0101-xxxx.2 →	32nnnn 32nnnn 32nnnn	Bremskraftregler (BR) Bremskraftbegrenzer (BG) Einschraubregler (BRE) Bremskraftregler lastabhängig (BRL) Einschraubregler-Satz (BRES)																		
	03.3508-xxxx.x → 03.3509-xxxx.x → 03.3558-xxxx.x → 03.0101-xxxx.2 →	31nnnn 31nnnn 31nnnn 39nnnn	Ausgleichsbehälter Ausgleichsbehälter Ausgleichsbehälter Reparatursatz			35/3 braun (4)	Kennzeichen, Farbmarkierung (Anzahl der Anschlüsse)																		
	▲ 11.3ddx-xxxx.2 → 11.9ddx-xxxx.2 → ▲ 13.2ddx-xxxx.2 → ▲ 13.4ddx-xxxx.2 → 13.9ddx-xxxx.2 → 24.3ddx-xxxx.5 → 11.0441-ddxx.2 → 13.0441-ddxx.2 → 11.0230-xxxx.2 → 24.0101-xxxx.2 → ▲ 11.0101-xxxx.2 → 11.8116-xxxx.1 →	22nnnn 22nnnn 21nnnn 21nnnn 21nnnn 24nnnn 25nnnn 25nnnn 26nnnn 26nnnn 26nnnn 39nnnn	Faustsattel Faustsattel 2-Zyl. Festsattel 4-Zyl. Festsattel Festsattel Austauschsattel Faustsattel Dichtungs-Satz Dichtungs-Satz Faustsattelhalter-Satz (Halter, Schiebehülzensatz, Führungsbolzen) Einbausatz (Schiebehülzensatz, Führungsbolzen) Schiebehülzensatz Haltefeder		▲ 03.24dd-xxxx.3 → 03.0350-ddxx.2 →	03nnnn 07ddxx	Kupplungs-Geberzylinder (z. B. 03.2419-: Ø=19,05) Dichtungs-Satz																		
					▲ 03.25dd-xxxx.3 → 03.0450-ddxx.2 →	04nnnn 08ddxx	Kupplungs-Nehmerzylinder (z. B. 03.2525-: Ø=25,40) Dichtungs-Satz																		
					24.3728-xxxx.2 →	59xxxx	Kupplungsseil																		

nnnn = Die letzten vier Ziffern entsprechen einer Zählnummer.

dd = Nennmaß

▲ Auch 24. bei gleicher Benummerungssystematik möglich.

■ Auch 03., 24. und 83. bei gleicher Benummerungssystematik möglich.

Nachdruck, auch auszugsweise, nur mit unserer Genehmigung gestattet. Ersatzansprüche auf Grund von Angaben in diesem Katalog können nicht anerkannt werden. Konstruktionsänderungen vorbehalten. Soweit wir in unseren Unterlagen Bezug nehmen auf die Ersatzteilnummer des Fahrzeugherstellers, dient dies nur zu Vergleichszwecken. Eine Verwendung derartiger Angaben in Rechnungen an den Fahrzeugbesitzer ist nicht statthaft.

Die Modell- und Ersatzteilvielfalt einiger Fahrzeughersteller erlaubt nicht immer eine genaue Zuordnung. Bitte beachten Sie daher besonders die im Katalog aufgeführten Bemerkungen und Ersatzteilbeschreibungen.





- D** Neue Artikel
- EN** New parts
- FR** Nouvelles références
- IT** Codici nuovi
- ES** Nuevas referencias
- NL** Nieuwe artikelen
- DA** Nye artikler
- SV** Nya artiklar
- HU** Új termékek
- PT** Novo artigos
- RU** Новые позиции
- CZ** Nové výrobky
- PL** Nowe artykuły
- EL** Νέα Βροϊόν
- TR** Yeni ürün
- ZH** 新件
- JA** 新商品
- AR** المنتجات الجديدة

K24-H

Neue Artikel

New parts - Codici nuovi - Nouvelles références - Nuevas referencias



03.2125-0332.3	010952	SEAT	ALHAMBRA I (96-10)
03.2125-0332.3	010952	FORD	GALAXY I (95-06)
03.2125-0332.3	010952	VOLKSWAGEN	SHARAN I (95-10)
03.2126-3196.3	010968	MERCEDES BENZ	CLS-Klasse (C218) Coupe (10-)
03.2126-3196.3	010968	MERCEDES BENZ	CLS-Klasse (X218) Shooting Brake (12-)
03.2126-3196.3	010968	MERCEDES BENZ	E-Klasse (W212) Limousine (09-)
03.2126-3196.3	010968	MERCEDES BENZ	E-Klasse (S212) Kombi (09-)
03.2126-3196.3	010968	MERCEDES BENZ	SL-Klasse (R231) (12-)
03.4152-0153.3	011006	DAIHATSU	CHARADE (11-13)
03.4152-0153.3	011006	TOYOTA	YARIS (06-11)
03.4152-0158.3	011007	DAIHATSU	CHARADE (11-13)
03.4152-0158.3	011007	TOYOTA	YARIS (06-11)
03.4153-0015.3	011005	MAZDA	2 (DY) (03-07)
03.4153-0015.3	011005	FORD	FIESTA V (02-08)
03.4153-0015.3	011005	FORD	FUSION (02-12)
03.4153-5287.4	010953	MAZDA	2 (DY) (03-07)
03.4153-5287.4	010953	FORD	FIESTA V (02-08)
03.4153-5287.4	010953	FORD	FUSION (02-12)
03.4153-5403.3	010994	AUDI	A3 / A3 (8V) Sportback (12-)
03.4153-5403.3	010994	AUDI	A3 (8V) Cabrio (13-)
03.4153-5403.3	010994	SKODA	OCTAVIA III (5E) (12-)
03.4153-5403.3	010994	SEAT	LEON III (5F) / SC / ST (12-)
03.4153-5403.3	010994	VOLKSWAGEN	GOLF VII (12-)
03.4153-5403.3	010994	VOLKSWAGEN	GOLF VII Variant (13-)
03.4155-5451.3	010995	FORD	C-MAX II (10-)
03.4155-5451.3	010995	FORD	GRAND C-MAX (10-)
03.4155-5451.3	010995	FORD	FOCUS III (11-)
03.4155-5451.3	010995	FORD	TRANSIT CONNECT / TOURNEO CONNECT (13-)
03.4155-5456.3	010996	FORD	GRAND C-MAX (10-)
03.4155-5456.3	010996	FORD	FOCUS III (11-)
03.4155-5456.3	010996	FORD	KUGA II (13-)
03.4155-5456.3	010996	FORD	TRANSIT CONNECT / TOURNEO CONNECT (13-)
03.4156-5106.3	010997	MERCEDES BENZ	E-Klasse (W212) Limousine (09-)
03.4156-5106.3	010997	MERCEDES BENZ	E-Klasse (S212) Kombi (09-)
03.7863-3232.4	300307	SEAT	ALTEA (5P1) (04-15)
03.7863-3232.4	300307	AUDI	A3 / A3 (8P) Sportback (03-13)
03.7863-3232.4	300307	SEAT	ALTEA XL (5P5) (06-15)
03.7863-3232.4	300307	AUDI	A3 (8P) Cabrio (08-13)
03.7863-3232.4	300307	VOLKSWAGEN	EOS (06-)
03.7863-3232.4	300307	SKODA	OCTAVIA II (1Z) (04-13)
03.7863-3232.4	300307	VOLKSWAGEN	GOLF V (03-08)
03.7863-3232.4	300307	SEAT	LEON II (1P1) (05-12)
03.7863-3232.4	300307	VOLKSWAGEN	GOLF V Variant (07-09)
03.7863-3232.4	300307	VOLKSWAGEN	GOLF VI (08-)
03.7863-3232.4	300307	VOLKSWAGEN	GOLF VI Variant (09-)
03.7863-3232.4	300307	VOLKSWAGEN	GOLF VI Cabriolet (11-)
03.7863-3232.4	300307	SKODA	YETI (09-)
03.7863-3232.4	300307	SEAT	TOLEDO III (5P2) (05-09)
03.7863-3232.4	300307	VOLKSWAGEN	GOLF Plus (05-14)
03.7863-3232.4	300307	VOLKSWAGEN	SCIROCCO (08-)
11.9457-7021.2	221051	JAGUAR	XF (CC9) (08-)
11.9457-7021.2	221051	JAGUAR	XF Sportbrake (CC9) (12-)
11.9457-7021.2	221051	JAGUAR	XJ (X350,X358) (03-09)
11.9457-7021.2	221051	JAGUAR	XJ (X351) (09-)
11.9457-7022.2	221052	JAGUAR	XF (CC9) (08-)



11.9457-7022.2	221052	JAGUAR	XF Sportbrake (CC9) (12-)
11.9457-7022.2	221052	JAGUAR	XJ (X350,X358) (03-09)
11.9457-7022.2	221052	JAGUAR	XJ (X351) (09-)
13.9426-7004.2	210272	MERCEDES BENZ	CL-Klasse (C215) Coupe (99-06)
13.9426-7004.2	210272	MERCEDES BENZ	S-Klasse (W220) (98-06)
24.0101-5407.2	260140	DACIA	DOKKER (12-)
24.0101-5407.2	260140	RENAULT	CLIO III (BR_/CR_) (05-12)
24.0101-5407.2	260140	RENAULT	CLIO III Grandtour (KR_) (08-12)
24.1294-0014.3	331448	AUDI	A1 / A1 Sportback (10-)
24.1294-0014.3	331448	SEAT	IBIZA V / ST / SC (08-)
24.1294-0014.3	331448	VOLKSWAGEN	POLO V (09-)
24.1294-0015.3	331449	AUDI	A1 / A1 Sportback (10-)
24.1294-0015.3	331449	SEAT	IBIZA V / ST / SC (08-)
24.1294-0015.3	331449	VOLKSWAGEN	POLO V (09-)
24.2120-1714.3	010455	OPEL	CORSA B / Vauxhall Corsa (93-00)
24.2120-1714.3	010455	OPEL	TIGRA / Vauxhall Tigra (94-00)
24.2120-1762.3	011002	DACIA	LOGAN Express (FS_) (09-13)
24.2120-1762.3	011002	DACIA	LOGAN Limousine (LS_) (04-13)
24.2120-1762.3	011002	DACIA	LOGAN MCV Kombi (KS_) (07-13)
24.2120-1762.3	011002	DACIA	LOGAN Pick-up (US_) (08-13)
24.2120-1762.3	011002	DACIA	SANDERO (08-13)
24.2120-1762.3	011002	RENAULT	LOGAN (LS_) (04-13)
24.2120-1762.3	011002	RENAULT	LOGAN Kombi (KS_) (04-13)
24.2120-1762.3	011002	RENAULT	SANDERO (BS0_) (07-)
24.2120-1765.3	011003	DAEWOO	MATIZ (98-05)
24.2120-1765.3	011003	CHEVROLET	MATIZ (05-10)
24.2120-1765.3	011003	CHEVROLET	SPARK (05-10)
24.2120-1767.3	011004	HYUNDAI	ATOS (98-08)
24.2120-1767.3	011004	HYUNDAI	ATOS PRIME (99-08)
24.2122-1776.3	011001	SUZUKI	JIMNY (98-)
24.2125-1721.3	010673	FORD	TRANSIT (00-06)
24.2125-1722.3	010674	FORD	TRANSIT (00-06)
24.2125-1745.3	010998	MERCEDES BENZ	CLS-Klasse (C219) Coupe (04-10)
24.2125-1745.3	010998	MERCEDES BENZ	E-Klasse (W211) Limousine (02-09)
24.2125-1745.3	010998	MERCEDES BENZ	E-Klasse (S211) Kombi (03-09)
24.2125-1745.3	010998	MERCEDES BENZ	G-Klasse (W463) (90-)
24.2125-1745.3	010998	MERCEDES BENZ	G-Klasse (W463) Cabrio (90-)
24.2126-1705.3	010999	AUDI	A4 (B6/B7) (01-08)
24.2126-1705.3	010999	AUDI	A4 Cabrio (02-08)
24.2126-1705.3	010999	AUDI	A6 / A6 Avant (4B/C5) (97-05)
24.2126-1705.3	010999	AUDI	A6 (4F2/C6) Limousine (04-11)
24.2126-1705.3	010999	AUDI	A6 (4F5/C6) Avant (05-11)
24.2126-1705.3	010999	AUDI	A6 Allroad (06-11)
24.2412-1701.3	030139	RENAULT	KANGOO II (KW_) (08-)
24.2412-1701.3	030139	RENAULT	KANGOO Express/Rapid (FW_) (08-)
24.2415-1714.3	030134	PEUGEOT	207 Limousine (06-12)
24.2415-1714.3	030134	CITROEN	C3 II (09-)
24.2415-1714.3	030134	PEUGEOT	207 CC (07-15)
24.2415-1714.3	030134	CITROEN	C3 PICASSO (09-)
24.2415-1714.3	030134	PEUGEOT	207 SW (07-13)
24.2415-1714.3	030134	PEUGEOT	208 (12-)
24.2415-1714.3	030134	CITROEN	DS3 (09-)
24.2415-1714.3	030134	CITROEN	DS3 Cabrio (13-)
24.2415-1714.3	030134	PEUGEOT	2008 (13-)
24.2415-1715.3	030137	PEUGEOT	207 Limousine (06-12)



Neue Artikel

New parts - Codici nuovi - Nouvelles références - Nuevas referencias



24.2415-1715.3	030137	PEUGEOT	207 CC (07-15)
24.2415-1715.3	030137	PEUGEOT	207 SW (07-13)
24.2415-1716.3	030138	TOYOTA	YARIS (06-11)
24.2415-1716.3	030138	TOYOTA	YARIS (11-)
24.2415-1717.3	030140	PEUGEOT	207 Limousine (06-12)
24.2415-1717.3	030140	CITROEN	C3 II (09-)
24.2415-1717.3	030140	PEUGEOT	207 CC (07-15)
24.2415-1717.3	030140	CITROEN	C3 PICASSO (09-)
24.2415-1717.3	030140	PEUGEOT	207 SW (07-13)
24.2415-1717.3	030140	CITROEN	DS3 (09-)
24.2415-1718.3	030142	TOYOTA	AURIS (06-12)
24.2415-1718.3	030142	TOYOTA	AURIS (12-)
24.2415-1718.3	030142	TOYOTA	AURIS Touring Sports (13-)
24.2415-1718.3	030142	TOYOTA	AVENSIS (09-)
24.2415-1718.3	030142	TOYOTA	COROLLA (13-)
24.2415-1718.3	030142	TOYOTA	VERSO (09-)
24.2415-1719.3	030143	TOYOTA	AURIS (06-12)
24.2415-1719.3	030143	TOYOTA	AURIS (12-)
24.2415-1719.3	030143	TOYOTA	AURIS Touring Sports (13-)
24.2415-1719.3	030143	TOYOTA	AVENSIS (09-)
24.2415-1719.3	030143	TOYOTA	VERSO (09-)
24.2415-1721.3	030144	CITROEN	C3 II (09-)
24.2415-1721.3	030144	CITROEN	C3 PICASSO (09-)
24.2418-1701.3	030135	RENAULT	MEGANE II Limousine 3/5-tuerig (BM/CM_) (02-08)
24.2418-1701.3	030135	RENAULT	MEGANE II Limousine 4-tuerig (LM_) (03-08)
24.2418-1701.3	030135	RENAULT	MEGANE II Coupe/Cabrio (EM_) (03-10)
24.2418-1701.3	030135	RENAULT	MEGANE II Grandtour (KM_) (03-08)
24.2418-1701.3	030135	RENAULT	SCENIC II (JM_) (03-09)
24.2418-1701.3	030135	RENAULT	GRAND SCENIC (JM_) (04-09)
24.2418-1702.3	030136	RENAULT	CLIO III (BR_/CR_) (05-12)
24.2418-1702.3	030136	RENAULT	CLIO III Grandtour (KR_) (08-12)
24.2418-1702.3	030136	RENAULT	MODUS/GRAND MODUS (JP0_) (04-13)
24.2418-1703.3	030141	RENAULT	MODUS/GRAND MODUS (JP0_) (04-13)
24.2419-1738.3	030133	FORD	TRANSIT (06-14)
24.2518-1702.3	040099	PEUGEOT	207 Limousine (06-12)
24.2518-1702.3	040099	CITROEN	C3 II (09-)
24.2518-1702.3	040099	PEUGEOT	207 SW (07-13)
24.2518-1702.3	040099	PEUGEOT	208 (12-)
24.2518-1702.3	040099	PEUGEOT	301 (12-)
24.2518-1702.3	040099	CITROEN	C-ELYSEE (12-)
24.2518-1702.3	040099	CITROEN	DS3 (09-)
24.2518-1702.3	040099	CITROEN	DS3 Cabrio (13-)
24.2518-1702.3	040099	PEUGEOT	2008 (13-)
24.2518-1703.3	040101	PEUGEOT	207 Limousine (06-12)
24.2518-1703.3	040101	PEUGEOT	207 CC (07-15)
24.2518-1703.3	040101	CITROEN	C3 PICASSO (09-)
24.2518-1703.3	040101	PEUGEOT	207 SW (07-13)
24.2518-1703.3	040101	PEUGEOT	301 (12-)
24.2518-1703.3	040101	CITROEN	C-ELYSEE (12-)
24.2518-1703.3	040101	PEUGEOT	2008 (13-)
24.2518-1704.3	040102	CITROEN	C3 II (09-)
24.2518-1704.3	040102	PEUGEOT	208 (12-)
24.2518-1704.3	040102	CITROEN	C4 CACTUS (14-)
24.2518-1704.3	040102	CITROEN	DS3 (09-)
24.2518-1704.3	040102	CITROEN	DS3 Cabrio (13-)



24.2519-1707.3	040100	PEUGEOT	207 Limousine (06-12)
24.2519-1707.3	040100	PEUGEOT	207 CC (07-15)
24.2519-1707.3	040100	PEUGEOT	207 SW (07-13)
24.2520-1707.3	040097	FIAT	500 (07-)
24.2520-1707.3	040097	FIAT	500 C Cabrio (09-)
24.2520-1707.3	040097	FIAT	PANDA (03-13)
24.2522-1707.3	040103	PORSCHE	BOXSTER (986) (96-04)
24.2522-1707.3	040103	AUDI	A6 / A6 Avant (4A/C4) (94-97)
24.2522-1707.3	040103	AUDI	A8 (94-02)
24.2522-1707.3	040103	AUDI	CABRIO (91-00)
24.3217-1732.3	020558	DAIHATSU	COPEN (03-12)
24.3217-1732.3	020558	DAIHATSU	CUORE (98-03)
24.3217-1732.3	020558	DAIHATSU	MOVE (96-02)
24.3217-1732.3	020558	DAIHATSU	SIRION (98-04)
24.3217-1732.3	020558	DAIHATSU	YRV (01-06)
24.3217-1733.3	020559	TOYOTA	COROLLA (92-97)
24.3217-1733.3	020559	TOYOTA	PASEO (95-99)
24.3217-1733.3	020559	TOYOTA	STARLET (96-99)
24.3217-1734.3	020560	TOYOTA	COROLLA (92-97)
24.3217-1734.3	020560	TOYOTA	PASEO (95-99)
24.3217-1734.3	020560	TOYOTA	STARLET (96-99)
24.3217-1735.3	020567	HONDA	LOGO (99-02)
24.3217-1736.3	020568	HONDA	LOGO (99-02)
24.3217-1737.3	020574	DAIHATSU	CHARADE (GB) (03-07)
24.3217-1737.3	020574	DAIHATSU	CUORE (03-07)
24.3217-1737.3	020574	DAIHATSU	CUORE (07-13)
24.3217-1738.3	020577	SUZUKI	ALTO (93-02)
24.3219-1768.3	020561	NISSAN	MICRA (K13K) (10-)
24.3219-1768.3	020561	NISSAN	NOTE (E12E) (13-)
24.3220-1745.3	020579	DAIHATSU	TERIOS (J1) (97-05)
24.3220-1746.3	020580	KIA	SPORTAGE (94-03)
24.3222-1736.3	020562	MITSUBISHI	L 200 (06-15)
24.3222-1737.3	020563	MITSUBISHI	L 200 (06-15)
24.3222-1737.3	020563	MITSUBISHI	L 200 (15-)
24.3222-1738.3	020564	SUZUKI	SAMURAI (98-04)
24.3222-1739.3	020565	SUZUKI	SAMURAI (98-04)
24.3222-1740.3	020566	TOYOTA	HILUX (88-97)
24.3222-1740.3	020566	VOLKSWAGEN	TARO (89-97)
24.3222-1742.3	020569	SUZUKI	VITARA (89-98)
24.3222-1743.3	020575	NISSAN	PATHFINDER (R50) (97-04)
24.3222-1743.3	020575	NISSAN	PICK-UP (D22) (98-07)
24.3222-1743.3	020575	NISSAN	PICK-UP (D22S) (06-)
24.3222-1744.3	020581	HYUNDAI	H-1 KASTEN (00-07)
24.3222-1744.3	020581	HYUNDAI	H-1 STAREX (97-07)
24.3222-1746.3	020582	TOYOTA	HILUX (05-)
24.3222-1747.3	020576	NISSAN	PATHFINDER (R50) (97-04)
24.3222-1747.3	020576	NISSAN	PICK-UP (D22) (98-07)
24.3223-1711.3	020570	MAZDA	B2200/B2500/B2600 (99-02)
24.3223-1711.3	020570	MAZDA	B2500 (02-06)
24.3223-1711.3	020570	MAZDA	BT-50 (06-12)
24.3223-1711.3	020570	FORD	RANGER II (10-11)
24.3223-1711.3	020570	FORD	RANGER (11-)
24.3226-1703.3	020573	VOLKSWAGEN	AMAROK (10-)
24.3304-1712.5	240396	HONDA	CIVIC (3/4-tuerig) (95-01)
24.3304-1712.5	240396	HONDA	CIVIC COUPE (96-01)

Neue Artikel

New parts - Codici nuovi - Nouvelles références - Nuevas referencias



24.3304-1712.5	240396	HONDA	CRX (92-98)
24.3347-1711.5	240699	OPEL	ASTRA G / Vauxhall Astra MKIV (98-05)
24.3347-1712.5	240700	OPEL	ASTRA G / Vauxhall Astra MKIV (98-05)
24.3347-1713.5	240701	OPEL	CORSA C / Vauxhall Corsa MK II (00-06)
24.3347-1713.5	240701	OPEL	TIGRA TWIN TOP / Vau. Tigra Twin Top (04-09)
24.3347-1714.5	240702	OPEL	CORSA C / Vauxhall Corsa MK II (00-06)
24.3347-1714.5	240702	OPEL	TIGRA TWIN TOP / Vau. Tigra Twin Top (04-09)
24.3347-1715.5	240719	FIAT	500 (07-)
24.3347-1715.5	240719	FIAT	500 C Cabrio (09-)
24.3347-1715.5	240719	LANCIA	MUSA (04-13)
24.3347-1715.5	240719	FIAT	IDEA (04-12)
24.3347-1715.5	240719	FIAT	PANDA (03-13)
24.3347-1715.5	240719	FIAT	PANDA Cross (06-11)
24.3347-1715.5	240719	FIAT	PUNTO (00-03)
24.3347-1715.5	240719	FIAT	PUNTO (03-06)
24.3347-1716.5	240720	FIAT	500 (07-)
24.3347-1716.5	240720	FIAT	500 C Cabrio (09-)
24.3347-1716.5	240720	LANCIA	MUSA (04-13)
24.3347-1716.5	240720	FIAT	IDEA (04-12)
24.3347-1716.5	240720	FIAT	PANDA (03-13)
24.3347-1716.5	240720	FIAT	PANDA Cross (06-11)
24.3347-1716.5	240720	FIAT	PUNTO (00-03)
24.3347-1716.5	240720	FIAT	PUNTO (03-06)
24.3384-1749.5	240345	HONDA	ACCORD (98-02)
24.3384-1749.5	240345	HONDA	ACCORD Limousine (03-08)
24.3384-1749.5	240345	HONDA	ACCORD Kombi (03-08)
24.3384-1750.5	240346	HONDA	ACCORD (98-02)
24.3384-1750.5	240346	HONDA	ACCORD Limousine (03-08)
24.3384-1750.5	240346	HONDA	ACCORD Kombi (03-08)
24.3384-1775.5	240711	OPEL	MERIVA B / Vauxhall Meriva Mk II (10-)
24.3384-1776.5	240712	OPEL	MERIVA B / Vauxhall Meriva Mk II (10-)
24.3387-1737.5	240703	TOYOTA	COROLLA (97-02)
24.3387-1738.5	240704	TOYOTA	COROLLA (97-02)
24.3421-1706.5	240354	BMW	3er Reihe/E46 Limousine (98-05)
24.3421-1706.5	240354	BMW	3er Reihe/E46 Touring (99-05)
24.3421-1706.5	240354	BMW	3er Reihe/E46 Coupe (99-06)
24.3421-1706.5	240354	BMW	3er Reihe/E46 Cabrio (00-06)
24.3421-1706.5	240354	BMW	X3/E83 (03-10)
24.3421-1709.5	240697	FORD	TOURNEO (94-00)
24.3421-1709.5	240697	FORD	TRANSIT (95-00)
24.3421-1710.5	240698	FORD	TOURNEO (94-00)
24.3421-1710.5	240698	FORD	TRANSIT (95-00)
24.3421-9965.5	240645	MERCEDES BENZ	GL-Klasse (X164) (06-12)
24.3421-9965.5	240645	MERCEDES BENZ	M-Klasse (W164) (05-11)
24.3421-9965.5	240645	MERCEDES BENZ	R-Klasse (W251,V251) (06-12)
24.3421-9966.5	240646	MERCEDES BENZ	GL-Klasse (X164) (06-12)
24.3421-9966.5	240646	MERCEDES BENZ	M-Klasse (W164) (05-11)
24.3421-9966.5	240646	MERCEDES BENZ	R-Klasse (W251,V251) (06-12)
24.3426-9989.5	240647	MERCEDES BENZ	CLS-Klasse (C218) Coupe (10-)
24.3426-9989.5	240647	MERCEDES BENZ	CLS-Klasse (X218) Shooting Brake (12-)
24.3426-9989.5	240647	MERCEDES BENZ	E-Klasse (W211) Limousine (02-09)
24.3426-9989.5	240647	MERCEDES BENZ	E-Klasse (S211) Kombi (03-09)
24.3426-9989.5	240647	MERCEDES BENZ	E-Klasse (W212) Limousine (09-)
24.3426-9989.5	240647	MERCEDES BENZ	E-Klasse (S212) Kombi (09-)
24.3426-9989.5	240647	MERCEDES BENZ	S-Klasse (W221) (06-13)



24.3426-9989.5	240647	MERCEDES BENZ	SL-Klasse (R230) (01-11)
24.3426-9990.5	240648	MERCEDES BENZ	CLS-Klasse (C218) Coupe (10-)
24.3426-9990.5	240648	MERCEDES BENZ	CLS-Klasse (X218) Shooting Brake (12-)
24.3426-9990.5	240648	MERCEDES BENZ	E-Klasse (W211) Limousine (02-09)
24.3426-9990.5	240648	MERCEDES BENZ	E-Klasse (S211) Kombi (03-09)
24.3426-9990.5	240648	MERCEDES BENZ	E-Klasse (W212) Limousine (09-)
24.3426-9990.5	240648	MERCEDES BENZ	E-Klasse (S212) Kombi (09-)
24.3426-9990.5	240648	MERCEDES BENZ	S-Klasse (W221) (06-13)
24.3426-9990.5	240648	MERCEDES BENZ	SL-Klasse (R230) (01-11)
24.3431-1710.5	240730	HYUNDAI	HIGHWAY VAN (00-04)
24.3431-1710.5	240730	HYUNDAI	TRAJET (00-08)
24.3441-9958.5	240672	BMW	3er Reihe/E90 Limousine (05-12)
24.3441-9958.5	240672	BMW	3er Reihe/E91 Touring (05-12)
24.3441-9958.5	240672	BMW	3er Reihe/E92 Coupe (06-13)
24.3441-9958.5	240672	BMW	3er Reihe/E93 Cabrio (07-13)
24.3441-9958.5	240672	BMW	X1/E84 (09-)
24.3451-1725.5	240619	FIAT	SCUDO (07-)
24.3451-1725.5	240619	CITROEN	JUMPY (07-16)
24.3451-1725.5	240619	PEUGEOT	EXPERT / Expert Tepee (07-15)
24.3451-1726.5	240620	FIAT	SCUDO (07-)
24.3451-1726.5	240620	CITROEN	JUMPY (07-16)
24.3451-1726.5	240620	PEUGEOT	EXPERT / Expert Tepee (07-15)
24.3481-1777.5	240451	OPEL	AGILA / Vauxhall Agila Mk I (00-07)
24.3481-1777.5	240451	SUZUKI	IGNIS II (03-12)
24.3481-1777.5	240451	SUBARU	JUSTY (G3X) (03-07)
24.3481-1777.5	240451	SUZUKI	WAGON R+ (00-08)
24.3481-1778.5	240452	OPEL	AGILA / Vauxhall Agila Mk I (00-07)
24.3481-1778.5	240452	SUZUKI	IGNIS II (03-12)
24.3481-1778.5	240452	SUBARU	JUSTY (G3X) (03-07)
24.3481-1778.5	240452	SUZUKI	WAGON R+ (00-08)
24.3481-1787.5	240621	LAND ROVER	DISCOVERY III (04-09)
24.3481-1787.5	240621	LAND ROVER	DISCOVERY IV (09-)
24.3481-1788.5	240622	LAND ROVER	DISCOVERY III (04-09)
24.3481-1788.5	240622	LAND ROVER	DISCOVERY IV (09-)
24.3481-1791.5	240731	PEUGEOT	107 (05-14)
24.3481-1791.5	240731	PEUGEOT	108 (14-)
24.3481-1791.5	240731	CITROEN	C1 (05-14)
24.3481-1791.5	240731	CITROEN	C1 (14-)
24.3481-1791.5	240731	TOYOTA	AYGO (05-14)
24.3481-1791.5	240731	TOYOTA	AYGO (14-)
24.3481-1792.5	240732	PEUGEOT	107 (05-14)
24.3481-1792.5	240732	PEUGEOT	108 (14-)
24.3481-1792.5	240732	CITROEN	C1 (05-14)
24.3481-1792.5	240732	CITROEN	C1 (14-)
24.3481-1792.5	240732	TOYOTA	AYGO (05-14)
24.3481-1792.5	240732	TOYOTA	AYGO (14-)
24.3481-1794.5	240744	TOYOTA	STARLET (96-99)
24.3511-1715.5	240599	KIA	PICANTO (BA) (04-11)
24.3511-1716.5	240600	KIA	PICANTO (BA) (04-11)
24.3541-1719.5	240057	AUDI	CABRIO (91-00)
24.3541-1720.5	240058	AUDI	CABRIO (91-00)
24.3541-1809.5	240593	LANCIA	DELTA / Chrysler Delta (08-)
24.3541-1809.5	240593	FIAT	BRAVO (07-)
24.3541-1809.5	240593	FIAT	STILO / STILO Multi Wagon (01-08)
24.3541-1829.5	240721	FIAT	500 (07-)



Neue Artikel

New parts - Codici nuovi - Nouvelles références - Nuevas referencias



24.3541-1829.5	240721	FIAT	500 C Cabrio (09-)
24.3541-1829.5	240721	FIAT	500 L Kombi (12-)
24.3541-1829.5	240721	FIAT	DOBLO (01-10)
24.3541-1829.5	240721	FIAT	DOBLO (10-)
24.3541-1829.5	240721	FIAT	FIORINO / QUBO (08-)
24.3541-1829.5	240721	FIAT	LINEA (07-11)
24.3541-1829.5	240721	OPEL	CORSA D / Vauxhall Corsa MK III (06-)
24.3541-1829.5	240721	FIAT	PUNTO / PUNTO EVO (09-)
24.3541-1829.5	240721	FIAT	GRANDE PUNTO (06-11)
24.3541-1830.5	240722	FIAT	500 (07-)
24.3541-1830.5	240722	FIAT	500 C Cabrio (09-)
24.3541-1830.5	240722	FIAT	500 L Kombi (12-)
24.3541-1830.5	240722	FIAT	DOBLO (01-10)
24.3541-1830.5	240722	FIAT	DOBLO (10-)
24.3541-1830.5	240722	FIAT	LINEA (07-11)
24.3541-1830.5	240722	OPEL	CORSA D / Vauxhall Corsa MK III (06-)
24.3541-1830.5	240722	FIAT	GRANDE PUNTO (06-11)
24.3541-1849.5	240707	DACIA	DOKKER (12-)
24.3541-1849.5	240707	DACIA	DOKKER Express (12-)
24.3541-1849.5	240707	RENAULT	CAPTUR (J87) (13-)
24.3541-1849.5	240707	DACIA	DUSTER (HS_) (10-)
24.3541-1849.5	240707	DACIA	LODGY (JS_) (12-)
24.3541-1849.5	240707	DACIA	LOGAN Express (FS_) (09-13)
24.3541-1849.5	240707	DACIA	LOGAN MCV Kombi (KS_) (07-13)
24.3541-1849.5	240707	RENAULT	CLIO III (BR_/CR_) (05-12)
24.3541-1849.5	240707	DACIA	LOGAN Pick-up (US_) (08-13)
24.3541-1849.5	240707	RENAULT	CLIO III Grandtour (KR_) (08-12)
24.3541-1849.5	240707	RENAULT	CLIO IV (B98_) (12-)
24.3541-1849.5	240707	RENAULT	CLIO IV Grandtour (K98_) (12-)
24.3541-1849.5	240707	RENAULT	DOKKER (K67/F67) (12-)
24.3541-1849.5	240707	RENAULT	DUSTER (HS-) (11-)
24.3541-1849.5	240707	RENAULT	KANGOO Be Bop (KW0_) (09-10)
24.3541-1849.5	240707	RENAULT	KANGOO Express/Rapid (FW_) (08-)
24.3541-1849.5	240707	RENAULT	LOGAN Express (07-13)
24.3541-1849.5	240707	RENAULT	MODUS/GRAND MODUS (JP0_) (04-13)
24.3541-1849.5	240707	RENAULT	ZOE (12-)
24.3541-1850.5	240708	DACIA	DOKKER (12-)
24.3541-1850.5	240708	DACIA	DOKKER Express (12-)
24.3541-1850.5	240708	RENAULT	CAPTUR (J87) (13-)
24.3541-1850.5	240708	DACIA	DUSTER (HS_) (10-)
24.3541-1850.5	240708	DACIA	LODGY (JS_) (12-)
24.3541-1850.5	240708	DACIA	LOGAN Express (FS_) (09-13)
24.3541-1850.5	240708	DACIA	LOGAN MCV Kombi (KS_) (07-13)
24.3541-1850.5	240708	RENAULT	CLIO III (BR_/CR_) (05-12)
24.3541-1850.5	240708	DACIA	LOGAN Pick-up (US_) (08-13)
24.3541-1850.5	240708	RENAULT	CLIO III Grandtour (KR_) (08-12)
24.3541-1850.5	240708	RENAULT	CLIO IV (B98_) (12-)
24.3541-1850.5	240708	RENAULT	CLIO IV Grandtour (K98_) (12-)
24.3541-1850.5	240708	RENAULT	DOKKER (K67/F67) (12-)
24.3541-1850.5	240708	RENAULT	DUSTER (HS-) (11-)
24.3541-1850.5	240708	RENAULT	KANGOO Be Bop (KW0_) (09-10)
24.3541-1850.5	240708	RENAULT	KANGOO Express/Rapid (FW_) (08-)
24.3541-1850.5	240708	RENAULT	LOGAN Express (07-13)
24.3541-1850.5	240708	RENAULT	MODUS/GRAND MODUS (JP0_) (04-13)
24.3541-1850.5	240708	RENAULT	ZOE (12-)



24.3541-1851.5	240709	NISSAN	MICRA (K12E) (03-10)
24.3541-1851.5	240709	NISSAN	MICRA C+C (CK12E) (05-10)
24.3541-1851.5	240709	NISSAN	NOTE (E11E) (06-13)
24.3541-1852.5	240710	NISSAN	MICRA (K12E) (03-10)
24.3541-1852.5	240710	NISSAN	MICRA C+C (CK12E) (05-10)
24.3541-1852.5	240710	NISSAN	NOTE (E11E) (06-13)
24.3541-1853.5	240623	MINI	R60 Countryman (10-)
24.3541-1853.5	240623	MINI	R61 Paceman (12-)
24.3541-1854.5	240624	MINI	R60 Countryman (10-)
24.3541-1854.5	240624	MINI	R61 Paceman (12-)
24.3541-1857.5	240733	FORD	FIESTA VI (08-)
24.3541-1858.5	240734	FORD	FIESTA VI (08-)
24.3541-9521.5	240723	BMW	1er Reihe/E81/E87 Limousine (04-11)
24.3541-9521.5	240723	BMW	1er Reihe/E82 Coupe (07-13)
24.3541-9521.5	240723	BMW	1er Reihe/E88 Cabrio (08-13)
24.3541-9521.5	240723	BMW	3er Reihe/E90 Limousine (05-12)
24.3541-9521.5	240723	BMW	3er Reihe/E91 Touring (05-12)
24.3541-9521.5	240723	BMW	3er Reihe/E92 Coupe (06-13)
24.3541-9521.5	240723	BMW	3er Reihe/E93 Cabrio (07-13)
24.3541-9522.5	240724	BMW	1er Reihe/E81/E87 Limousine (04-11)
24.3541-9522.5	240724	BMW	1er Reihe/E82 Coupe (07-13)
24.3541-9522.5	240724	BMW	1er Reihe/E88 Cabrio (08-13)
24.3541-9522.5	240724	BMW	3er Reihe/E90 Limousine (05-12)
24.3541-9522.5	240724	BMW	3er Reihe/E91 Touring (05-12)
24.3541-9522.5	240724	BMW	3er Reihe/E92 Coupe (06-13)
24.3541-9522.5	240724	BMW	3er Reihe/E93 Cabrio (07-13)
24.3571-1755.5	240409	TOYOTA	COROLLA (02-04)
24.3571-1755.5	240409	TOYOTA	COROLLA (04-06)
24.3571-1756.5	240410	TOYOTA	COROLLA (02-04)
24.3571-1756.5	240410	TOYOTA	COROLLA (04-06)
24.3571-1773.5	240625	AUDI	A4 (B8) Limousine (07-)
24.3571-1773.5	240625	AUDI	A4 (B8) Avant (08-)
24.3571-1773.5	240625	AUDI	A4 Allroad (09-)
24.3571-1773.5	240625	AUDI	A5 / A5 Sportback (07-)
24.3571-1773.5	240625	AUDI	A5 Cabrio (09-)
24.3571-1774.5	240626	AUDI	A4 (B8) Limousine (07-)
24.3571-1774.5	240626	AUDI	A4 (B8) Avant (08-)
24.3571-1774.5	240626	AUDI	A4 Allroad (09-)
24.3571-1774.5	240626	AUDI	A5 / A5 Sportback (07-)
24.3571-1775.5	240627	AUDI	A5 Cabrio (09-)
24.3571-1775.5	240627	AUDI	A5 / A5 Sportback (07-)
24.3571-1775.5	240627	AUDI	A5 Cabrio (09-)
24.3571-1776.5	240628	AUDI	A5 / A5 Sportback (07-)
24.3571-1776.5	240628	AUDI	A5 Cabrio (09-)
24.3571-1777.5	240749	ROVER	600-Serie (RH) (93-99)
24.3571-1778.5	240750	ROVER	600-Serie (RH) (93-99)
24.3571-1779.5	240737	CHRYSLER	PT CRUISER (00-10)
24.3571-1780.5	240738	CHRYSLER	PT CRUISER (00-10)
24.3571-1781.5	240745	NISSAN	ALMERA TINO (V10M) (00-05)
24.3571-1781.5	240745	NISSAN	PRIMERA (P12E) Limousine (02-08)
24.3571-1781.5	240745	NISSAN	PRIMERA (W12) Kombi (02-08)
24.3571-1782.5	240746	NISSAN	ALMERA TINO (V10M) (00-05)
24.3571-1782.5	240746	NISSAN	PRIMERA (P12E) Limousine (02-08)
24.3571-1782.5	240746	NISSAN	PRIMERA (W12) Kombi (02-08)
24.3571-1783.5	240751	SAAB	9-3 (YS3D) (98-02)

Neue Artikel

New parts - Codici nuovi - Nouvelles références - Nuevas referencias



24.3571-1783.5	240751	SAAB	9-3 Cabriolet (YS3D) (98-03)
24.3571-1783.5	240751	SAAB	9-5 Limousine (YS3E) (97-10)
24.3571-1783.5	240751	SAAB	9-5 Kombi (YS3E) (98-10)
24.3571-1784.5	240752	SAAB	9-3 (YS3D) (98-02)
24.3571-1784.5	240752	SAAB	9-3 Cabriolet (YS3D) (98-03)
24.3571-1784.5	240752	SAAB	9-5 Limousine (YS3E) (97-10)
24.3571-1784.5	240752	SAAB	9-5 Kombi (YS3E) (98-10)
24.3572-1709.5	240583	CITROEN	C5 I Limousine (01-04)
24.3572-1709.5	240583	CITROEN	C5 I Kombi (01-04)
24.3572-1709.5	240583	CITROEN	C5 II Limousine (04-08)
24.3572-1709.5	240583	CITROEN	C5 II Kombi (04-08)
24.3572-1710.5	240584	CITROEN	C5 I Limousine (01-04)
24.3572-1710.5	240584	CITROEN	C5 I Kombi (01-04)
24.3572-1710.5	240584	CITROEN	C5 II Limousine (04-08)
24.3572-1710.5	240584	CITROEN	C5 II Kombi (04-08)
24.3601-1721.5	240629	MERCEDES BENZ	C-Klasse (W204) Limousine (07-14)
24.3601-1721.5	240629	MERCEDES BENZ	C-Klasse (S204) Kombi (07-14)
24.3601-1721.5	240629	MERCEDES BENZ	C-Klasse (C204) Coupe (11-)
24.3601-1721.5	240629	MERCEDES BENZ	CLS-Klasse (C218) Coupe (10-)
24.3601-1721.5	240629	MERCEDES BENZ	CLS-Klasse (X218) Shooting Brake (12-)
24.3601-1721.5	240629	MERCEDES BENZ	E-Klasse (W212) Limousine (09-)
24.3601-1721.5	240629	MERCEDES BENZ	E-Klasse (S212) Kombi (09-)
24.3601-1721.5	240629	MERCEDES BENZ	E-Klasse (C207) Coupe (09-)
24.3601-1722.5	240630	MERCEDES BENZ	C-Klasse (W204) Limousine (07-14)
24.3601-1722.5	240630	MERCEDES BENZ	C-Klasse (S204) Kombi (07-14)
24.3601-1722.5	240630	MERCEDES BENZ	C-Klasse (C204) Coupe (11-)
24.3601-1722.5	240630	MERCEDES BENZ	CLS-Klasse (C218) Coupe (10-)
24.3601-1722.5	240630	MERCEDES BENZ	CLS-Klasse (X218) Shooting Brake (12-)
24.3601-1722.5	240630	MERCEDES BENZ	E-Klasse (W212) Limousine (09-)
24.3601-1722.5	240630	MERCEDES BENZ	E-Klasse (S212) Kombi (09-)
24.3601-1722.5	240630	MERCEDES BENZ	E-Klasse (C207) Coupe (09-)
24.3601-1723.5	240631	MERCEDES BENZ	C-Klasse (W204) Limousine (07-14)
24.3601-1723.5	240631	MERCEDES BENZ	C-Klasse (S204) Kombi (07-14)
24.3601-1723.5	240631	MERCEDES BENZ	C-Klasse (C204) Coupe (11-)
24.3601-1723.5	240631	MERCEDES BENZ	E-Klasse (W212) Limousine (09-)
24.3601-1723.5	240631	MERCEDES BENZ	E-Klasse (S212) Kombi (09-)
24.3601-1723.5	240631	MERCEDES BENZ	E-Klasse (C207) Coupe (09-)
24.3601-1724.5	240632	MERCEDES BENZ	C-Klasse (W204) Limousine (07-14)
24.3601-1724.5	240632	MERCEDES BENZ	C-Klasse (S204) Kombi (07-14)
24.3601-1724.5	240632	MERCEDES BENZ	C-Klasse (C204) Coupe (11-)
24.3601-1724.5	240632	MERCEDES BENZ	E-Klasse (W212) Limousine (09-)
24.3601-1724.5	240632	MERCEDES BENZ	E-Klasse (S212) Kombi (09-)
24.3601-1724.5	240632	MERCEDES BENZ	E-Klasse (C207) Coupe (09-)
24.3606-1709.7	221045	MERCEDES BENZ	C-Klasse (W204) Limousine (07-14)
24.3606-1709.7	221045	MERCEDES BENZ	C-Klasse (S204) Kombi (07-14)
24.3606-1710.7	221046	MERCEDES BENZ	C-Klasse (W204) Limousine (07-14)
24.3606-1710.7	221046	MERCEDES BENZ	C-Klasse (S204) Kombi (07-14)
24.3606-1711.5	240780	MERCEDES BENZ	C-Klasse (W204) Limousine (07-14)
24.3606-1711.5	240780	MERCEDES BENZ	C-Klasse (S204) Kombi (07-14)
24.3606-1711.5	240780	MERCEDES BENZ	C-Klasse (C204) Coupe (11-)
24.3606-1711.5	240780	MERCEDES BENZ	CLS-Klasse (C218) Coupe (10-)
24.3606-1711.5	240780	MERCEDES BENZ	CLS-Klasse (X218) Shooting Brake (12-)
24.3606-1711.5	240780	MERCEDES BENZ	E-Klasse (W212) Limousine (09-)
24.3606-1711.5	240780	MERCEDES BENZ	E-Klasse (S212) Kombi (09-)
24.3606-1711.5	240780	MERCEDES BENZ	E-Klasse (C207) Coupe (09-)



24.3606-1711.5	240780	MERCEDES BENZ	E-Klasse (A207) Cabrio (10-)
24.3606-1712.5	240781	MERCEDES BENZ	C-Klasse (W204) Limousine (07-14)
24.3606-1712.5	240781	MERCEDES BENZ	C-Klasse (S204) Kombi (07-14)
24.3606-1712.5	240781	MERCEDES BENZ	C-Klasse (C204) Coupe (11-)
24.3606-1712.5	240781	MERCEDES BENZ	CLS-Klasse (C218) Coupe (10-)
24.3606-1712.5	240781	MERCEDES BENZ	CLS-Klasse (X218) Shooting Brake (12-)
24.3606-1712.5	240781	MERCEDES BENZ	E-Klasse (W212) Limousine (09-)
24.3606-1712.5	240781	MERCEDES BENZ	E-Klasse (S212) Kombi (09-)
24.3606-1712.5	240781	MERCEDES BENZ	E-Klasse (C207) Coupe (09-)
24.3606-1712.5	240781	MERCEDES BENZ	E-Klasse (A207) Cabrio (10-)
24.3727-0248.2	580248	BMW	1er Reihe/F20/F21 Limousine (11-)
24.3727-0248.2	580248	BMW	2er Reihe/F22 Coupe (13-)
24.3727-0248.2	580248	BMW	2er Reihe/F23 Cabrio (14-)
24.3727-0485.2	580485	MERCEDES BENZ	A-Klasse (W169) (04-12)
24.3727-0799.2	580799	OPEL	ADAM / Vauxhall Adam (13-)
24.3727-1608.2	581608	HONDA	JAZZ (02-08)
24.3727-1608.2	581608	HONDA	JAZZ (08-15)
24.3727-1609.2	581609	HONDA	JAZZ (02-08)
24.3727-1609.2	581609	HONDA	JAZZ (08-15)
24.3727-1610.2	581610	HONDA	JAZZ (02-08)
24.3727-1611.2	581611	HONDA	JAZZ (02-08)
24.3727-1746.2	581746	NISSAN	ALMERA (N15) (95-00)
24.3727-1747.2	581747	NISSAN	ALMERA (N15) (95-00)
24.3727-1748.2	581748	NISSAN	X-TRAIL (T30) (01-07)
24.3727-1749.2	581749	NISSAN	X-TRAIL (T30) (01-07)
24.3727-1954.2	581954	TOYOTA	URBAN CRUISER (09-)
24.3727-1954.2	581954	TOYOTA	YARIS (06-11)
24.3727-1955.2	581955	TOYOTA	URBAN CRUISER (09-)
24.3727-1955.2	581955	TOYOTA	YARIS (06-11)
24.3727-1956.2	581956	TOYOTA	RAV4 III (05-)
24.3727-1958.2	581958	TOYOTA	COROLLA (06-13)
24.3727-1959.2	581959	TOYOTA	YARIS (06-11)
24.3727-1960.2	581960	TOYOTA	YARIS (06-11)
24.3727-1961.2	581961	TOYOTA	VERSO S (10-)
24.3727-1962.2	581962	TOYOTA	VERSO S (10-)
24.3727-1963.2	581963	TOYOTA	RAV4 II (00-05)
24.3727-2006.2	582006	SUZUKI	SX4 (06-15)
24.3727-2006.2	582006	FIAT	SEDICI (06-)
24.3727-2007.2	582007	SUZUKI	SX4 (06-15)
24.3727-2007.2	582007	FIAT	SEDICI (06-)
24.3727-2008.2	582008	SUZUKI	SWIFT III (05-10)
24.3727-2009.2	582009	SUZUKI	SWIFT III (05-10)
24.3727-2010.2	582010	SUZUKI	SWIFT IV (10-)
24.3727-2011.2	582011	SUZUKI	SWIFT IV (10-)
24.3727-2709.2	582709	SEAT	LEON III (5F) / SC / ST (12-)
24.3727-2709.2	582709	SEAT	LEON III (5F) ST X-Perience (14-)
24.3727-2710.2	582710	SKODA	RAPID / RAPID Spaceback (12-)
24.3727-2710.2	582710	SEAT	TOLEDO IV (KG3) (12-)
24.3727-2711.2	582711	SKODA	RAPID / RAPID Spaceback (12-)
24.3727-2711.2	582711	SEAT	TOLEDO IV (KG3) (12-)
24.3727-3126.2	583126	HYUNDAI	i30 (GD) (11-)
24.3727-3126.2	583126	HYUNDAI	i30 CW Kombi (12-)
24.3727-3405.2	583405	VOLKSWAGEN	BEETLE (11-)
24.3727-3406.2	583406	VOLKSWAGEN	BEETLE (11-)
24.3727-3406.2	583406	VOLKSWAGEN	BEETLE Cabriolet (12-)



Neue Artikel

New parts - Codici nuovi - Nouvelles références - Nuevas referencias



24.4122-1717.3	010993	mitsubishi	COLT (04-12)
24.5101-0346.3	331406	MERCEDES BENZ	E-Klasse (C124) Coupe (93-97)
24.5101-0346.3	331406	MERCEDES BENZ	E-Klasse (A124) Cabrio (93-98)
24.5101-0346.3	331406	MERCEDES BENZ	SL-Klasse (R129) (93-01)
24.5102-0304.3	331407	BMW	5er Reihe/E60 Limousine (03-10)
24.5102-0304.3	331407	BMW	5er Reihe/E61 Touring (04-10)
24.5102-0304.3	331407	BMW	6er Reihe/E63 Coupe (04-11)
24.5102-0304.3	331407	BMW	6er Reihe/E64 Cabrio (04-11)
24.5102-0304.3	331407	BMW	7er Reihe/E65/E66 (02-08)
24.5103-0430.3	331408	BMW	3er Reihe/E36 Limousine (90-98)
24.5103-0430.3	331408	BMW	3er Reihe/E36 Touring (95-99)
24.5103-0430.3	331408	BMW	3er Reihe/E36 Coupe (92-99)
24.5103-0430.3	331408	BMW	3er Reihe/E36 Cabrio (93-99)
24.5103-0430.3	331408	BMW	3er Reihe/E36 Compact (94-00)
24.5103-0430.3	331408	BMW	Z3/E36 (95-02)
24.5105-0442.3	331432	VOLKSWAGEN	CADDY II (96-04)
24.5105-0442.3	331432	SEAT	CORDOBA I (93-99)
24.5105-0442.3	331432	SEAT	CORDOBA II (6K2) (99-02)
24.5105-0442.3	331432	SEAT	IBIZA II (93-99)
24.5105-0442.3	331432	VOLKSWAGEN	GOLF III (92-97)
24.5105-0442.3	331432	SEAT	IBIZA III (6K1) (99-02)
24.5105-0442.3	331432	VOLKSWAGEN	GOLF III Variant (93-99)
24.5105-0442.3	331432	VOLKSWAGEN	GOLF III Cabriolet (94-02)
24.5105-0442.3	331432	SEAT	INCA (6K9) (96-03)
24.5105-0442.3	331432	VOLKSWAGEN	POLO Classic (96-01)
24.5105-0442.3	331432	VOLKSWAGEN	POLO Variant (97-01)
24.5105-0442.3	331432	VOLKSWAGEN	VENTO (92-98)
24.5111-0595.3	331495	RENAULT	MASTER III Kasten/Bus (FV/JV) (10-)
24.5111-0595.3	331495	RENAULT	MASTER III Pritsche/Fahrgestell (EV/UV) (10-)
24.5112-0406.3	331496	FIAT	500 X (14-)
24.5112-0406.3	331496	JEEP	RENEGADE (BU) (14-)
24.5112-0406.3	331496	FIAT	DOBLO (10-)
24.5112-0406.3	331496	OPEL	COMBO D / Vauxhall Combo D (11-)
24.5112-0414.3	331453	ALFA ROMEO	GIULIETTA (10-)
24.5112-0470.3	331460	FIAT	DUCATO (94-02)
24.5112-0470.3	331460	FIAT	DUCATO (02-06)
24.5112-0470.3	331460	CITROEN	JUMPER Bus (94-02)
24.5112-0470.3	331460	CITROEN	JUMPER Kasten (94-02)
24.5112-0470.3	331460	CITROEN	JUMPER Pritsche/Fahrgestell (94-02)
24.5112-0470.3	331460	CITROEN	JUMPER (02-06)
24.5112-0470.3	331460	PEUGEOT	BOXER Bus (94-02)
24.5112-0470.3	331460	PEUGEOT	BOXER Kasten (94-02)
24.5112-0470.3	331460	PEUGEOT	BOXER Pritsche/Fahrgestell (94-02)
24.5112-0470.3	331460	PEUGEOT	BOXER (02-06)
24.5113-0170.3	331361	VOLKSWAGEN	TRANSPORTER (T4) (90-03)
24.5113-0283.3	331395	BMW	7er Reihe/E38 (93-01)
24.5113-0283.3	331395	BMW	Z8/E52 (00-03)
24.5113-0423.3	331396	BMW	8er Reihe/E31 (90-99)
24.5118-0688.3	331419	BMW	5er Reihe/F10 Limousine (10-)
24.5118-0688.3	331419	BMW	5er Reihe/F11 Touring (10-)
24.5118-0688.3	331419	BMW	5er Reihe/F07 GT GRAN TURISMO (09-)
24.5118-0688.3	331419	BMW	6er Reihe/F12 Cabrio (11-)
24.5118-0688.3	331419	BMW	6er Reihe/F13 Coupe (11-)
24.5118-0688.3	331419	BMW	6er Reihe/F06 Gran Coupe (11-)
24.5118-0688.3	331419	BMW	7er Reihe/F01/F02/F03/F04 (08-15)



24.5140-0256.3	331445	MERCEDES BENZ	GL-Klasse / GLS-Klasse (X166) (12-)
24.5140-0256.3	331445	MERCEDES BENZ	GLE-Klasse (C292) Coupe (15-)
24.5140-0256.3	331445	MERCEDES BENZ	M-Klasse/GLE-Klasse (W166) (11-)
24.5140-0495.3	331446	AUDI	A8 (09-)
24.5140-0650.3	331500	AUDI	A6 (4G2/C7) Limousine (11-)
24.5140-0650.3	331500	AUDI	A6 (4G5/C7) Avant (11-)
24.5140-0650.3	331500	AUDI	A6 Allroad (12-)
24.5140-0650.3	331500	AUDI	A7 Sportback (10-)
24.5140-0670.3	331501	AUDI	A6 (4G2/C7) Limousine (11-)
24.5140-0670.3	331501	AUDI	A6 (4G5/C7) Avant (11-)
24.5140-0670.3	331501	AUDI	A7 Sportback (10-)
24.5143-0544.3	331420	SEAT	IBIZA V / ST / SC (08-)
24.5143-0544.3	331420	SKODA	RAPID / RAPID Spaceback (12-)
24.5143-0544.3	331420	SEAT	TOLEDO IV (KG3) (12-)
24.5143-0564.3	331433	SEAT	ALTEA (5P1) (04-15)
24.5143-0564.3	331433	AUDI	A3 / A3 (8P) Sportback (03-13)
24.5143-0564.3	331433	SEAT	ALTEA XL (5P5) (06-15)
24.5143-0564.3	331433	AUDI	A3 (8P) Cabrio (08-13)
24.5143-0564.3	331433	VOLKSWAGEN	CADDY III (04-15)
24.5143-0564.3	331433	VOLKSWAGEN	EOS (06-)
24.5143-0564.3	331433	SKODA	OCTAVIA II (1Z) (04-13)
24.5143-0564.3	331433	VOLKSWAGEN	GOLF V (03-08)
24.5143-0564.3	331433	SEAT	LEON II (1P1) (05-12)
24.5143-0564.3	331433	SKODA	SUPERB II (08-15)
24.5143-0564.3	331433	VOLKSWAGEN	GOLF V Variant (07-09)
24.5143-0564.3	331433	SKODA	SUPERB II Combi (09-15)
24.5143-0564.3	331433	VOLKSWAGEN	GOLF VI (08-)
24.5143-0564.3	331433	VOLKSWAGEN	GOLF VI Variant (09-)
24.5143-0564.3	331433	VOLKSWAGEN	GOLF VI Cabriolet (11-)
24.5143-0564.3	331433	SKODA	YETI (09-)
24.5143-0564.3	331433	SEAT	TOLEDO III (5P2) (05-09)
24.5143-0564.3	331433	VOLKSWAGEN	GOLF Plus (05-14)
24.5143-0564.3	331433	VOLKSWAGEN	JETTA V (05-10)
24.5143-0564.3	331433	VOLKSWAGEN	JETTA VI (10-)
24.5143-0564.3	331433	VOLKSWAGEN	SCIROCCO (08-)
24.5143-0564.3	331433	VOLKSWAGEN	TOURAN I (03-15)
24.5143-0569.3	331398	VOLKSWAGEN	BORA (98-04)
24.5143-0569.3	331398	AUDI	A3 (8L) (96-03)
24.5143-0569.3	331398	SKODA	OCTAVIA I (1U) (97-10)
24.5143-0569.3	331398	VOLKSWAGEN	GOLF IV (98-05)
24.5143-0569.3	331398	VOLKSWAGEN	GOLF IV Variant (99-06)
24.5143-0569.3	331398	SEAT	LEON I (1M1) (99-05)
24.5147-0385.3	331427	SEAT	AROSA (6H) (97-05)
24.5147-0385.3	331427	VOLKSWAGEN	LUPO (98-05)
24.5147-0385.3	331427	VOLKSWAGEN	POLO III (95-01)
24.5148-0406.3	331478	MERCEDES BENZ	CLS-Klasse (C218) Coupe (10-)
24.5148-0406.3	331478	MERCEDES BENZ	CLS-Klasse (X218) Shooting Brake (12-)
24.5148-0406.3	331478	MERCEDES BENZ	E-Klasse (W212) Limousine (09-)
24.5148-0406.3	331478	MERCEDES BENZ	E-Klasse (S212) Kombi (09-)
24.5169-0458.3	331429	BMW	3er Reihe/E46 Limousine (98-05)
24.5169-0458.3	331429	BMW	3er Reihe/E46 Touring (99-05)
24.5169-0458.3	331429	BMW	3er Reihe/E46 Coupe (99-06)
24.5169-0458.3	331429	BMW	3er Reihe/E46 Cabrio (00-06)
24.5169-0458.3	331429	BMW	3er Reihe/E46 Compact (01-05)
24.5169-0475.3	331497	BMW	X1/E84 (09-)

Neue Artikel

New parts - Codici nuovi - Nouvelles références - Nuevas referencias



24.5176-0400.3	331492	OPEL	AMPERA / Vauxhall Ampera (11-)
24.5176-0400.3	331492	CHEVROLET	CRUZE (09-)
24.5176-0400.3	331492	OPEL	ASTRA J / GTC / Vauxhall Astra MK VI (09-)
24.5176-0400.3	331492	OPEL	ASTRA J Sports Tourer/Vau.Astra Sports Tourer (10-)
24.5176-0400.3	331492	CHEVROLET	ORLANDO (11-)
24.5176-0400.3	331492	CHEVROLET	VOLT (11-)
24.5176-0494.3	331447	SAAB	9-5 II (10-12)
24.5176-0494.3	331447	CHEVROLET	MALIBU (V300) (12-)
24.5176-0494.3	331447	OPEL	INSIGNIA / Vauxhall Insignia (08-)
24.5176-0494.3	331447	OPEL	INSIGNIA Country Tourer (13-)
24.5176-0494.3	331447	OPEL	INSIGNIA Sports Tourer / Vauxh. Insignia Sports Tourer (08-)
24.5201-0164.3	331414	SEAT	TOLEDO I (1L) (91-98)
24.5201-0164.3	331414	VOLKSWAGEN	TRANSPORTER (T4) (90-03)
24.5201-0180.3	331498	RENAULT	KANGOO II (KW_) (08-)
24.5201-0180.3	331498	RENAULT	KANGOO Express/Rapid (FW_) (08-)
24.5201-0204.3	331400	VOLVO	C70 Coupe (97-02)
24.5201-0204.3	331400	VOLVO	C70 I Cabrio (98-06)
24.5201-0204.3	331400	VOLVO	S70 (97-00)
24.5201-0204.3	331400	BMW	3er Reihe/E36 Compact (94-00)
24.5201-0204.3	331400	VOLVO	V70 I (97-00)
24.5202-0204.3	331402	BMW	3er Reihe/E36 Limousine (90-98)
24.5202-0204.3	331402	BMW	3er Reihe/E36 Touring (95-99)
24.5202-0204.3	331402	BMW	3er Reihe/E36 Coupe (92-99)
24.5202-0204.3	331402	BMW	3er Reihe/E36 Cabrio (93-99)
24.5204-0200.3	331499	FIAT	DOBLO (10-)
24.5204-0200.3	331499	OPEL	COMBO D / Vauxhall Combo D (11-)
24.5204-0233.3	331430	SEAT	ALTEA (5P1) (04-15)
24.5204-0233.3	331430	AUDI	A3 / A3 (8P) Sportback (03-13)
24.5204-0233.3	331430	SEAT	ALTEA XL (5P5) (06-15)
24.5204-0233.3	331430	AUDI	A3 (8P) Cabrio (08-13)
24.5204-0233.3	331430	SKODA	OCTAVIA II (1Z) (04-13)
24.5204-0233.3	331430	VOLKSWAGEN	GOLF V (03-08)
24.5204-0233.3	331430	SEAT	LEON II (1P1) (05-12)
24.5204-0233.3	331430	SKODA	SUPERB II (08-15)
24.5204-0233.3	331430	VOLKSWAGEN	GOLF V Variant (07-09)
24.5204-0233.3	331430	VOLKSWAGEN	GOLF VI (08-)
24.5204-0233.3	331430	VOLKSWAGEN	GOLF VI Variant (09-)
24.5204-0233.3	331430	VOLKSWAGEN	GOLF VI Cabriolet (11-)
24.5204-0233.3	331430	SEAT	TOLEDO III (5P2) (05-09)
24.5204-0233.3	331430	VOLKSWAGEN	GOLF Plus (05-14)
24.5204-0233.3	331430	VOLKSWAGEN	JETTA V (05-10)
24.5204-0233.3	331430	VOLKSWAGEN	JETTA VI (10-)
24.5204-0233.3	331430	VOLKSWAGEN	PASSAT Limousine (05-10)
24.5204-0233.3	331430	VOLKSWAGEN	PASSAT Variant (05-10)
24.5204-0233.3	331430	VOLKSWAGEN	PASSAT CC (08-11)
24.5204-0233.3	331430	VOLKSWAGEN	PASSAT CC (11-)
24.5204-0233.3	331430	VOLKSWAGEN	PASSAT / PASSAT VARIANT (10-14)
24.5204-0233.3	331430	VOLKSWAGEN	PASSAT ALLTRACK (12-14)
24.5204-0233.3	331430	VOLKSWAGEN	TOURAN I (03-15)
24.5204-0233.3	331430	VOLKSWAGEN	XL1 (14-)
24.5204-0260.3	331423	FORD	B-MAX (12-)
24.5204-0260.3	331423	FORD	FIESTA VI (08-)
24.5225-0160.3	331366	VOLKSWAGEN	TRANSPORTER (T4) (90-03)
24.5231-0391.3	331424	OPEL	VECTRA B / Vauxhall Vectra (96-02)
24.5231-0426.3	331313	SAAB	9-5 Limousine (YS3E) (97-10)



24.5231-0426.3	331313	SAAB	9-5 Kombi (YS3E) (98-10)
24.5237-0183.3	331454	AUDI	A4 (B5) (95-01)
24.5237-0183.3	331454	SKODA	SUPERB I (02-08)
24.5237-0183.3	331454	AUDI	A8 (03-09)
24.5237-0183.3	331454	VOLKSWAGEN	PASSAT (97-05)
24.5237-0273.3	331444	AUDI	A6 / A6 Avant (4A/C4) (94-97)
24.5237-0288.3	331442	AUDI	CABRIO (91-00)
24.5237-0308.3	331435	AUDI	A4 (B6/B7) (01-08)
24.5237-0308.3	331435	SEAT	EXEO / ST (09-13)
24.5237-0308.3	331435	AUDI	A4 Cabrio (02-08)
24.5237-0334.3	331443	VOLKSWAGEN	TRANSPORTER (T4) (90-03)
24.5237-0515.3	331463	PORSCHE	CAYENNE I (03-10)
24.5237-0515.3	331463	AUDI	Q7 (06-15)
24.5237-0515.3	331463	VOLKSWAGEN	TOUAREG I (03-10)
24.5237-0515.3	331463	VOLKSWAGEN	TOUAREG II (10-)
24.5239-0180.3	331464	RENAULT	KANGOO II (KW_) (08-)
24.5239-0180.3	331464	RENAULT	KANGOO Be Bop (KW_) (09-10)
24.5239-0180.3	331464	RENAULT	KANGOO Express/Rapid (FW_) (08-)
24.5256-0318.3	331426	OPEL	MERIVA A / Vauxhall Meriva Mk I (03-10)
24.5265-0347.3	331405	TOYOTA	AURIS (06-12)
24.5265-0347.3	331405	TOYOTA	AVENSIS (09-)
24.5270-0475.3	331467	HONDA	ACCORD VIII Limousine (08-)
24.5270-0475.3	331467	HONDA	ACCORD VIII Kombi (08-)
24.5270-0476.3	331468	HONDA	ACCORD VIII Limousine (08-)
24.5270-0476.3	331468	HONDA	ACCORD VIII Kombi (08-)
24.5270-0496.3	331469	HONDA	ACCORD VIII Limousine (08-)
24.5270-0496.3	331469	HONDA	ACCORD VIII Kombi (08-)
24.5270-0497.3	331470	HONDA	ACCORD VIII Limousine (08-)
24.5270-0497.3	331470	HONDA	ACCORD VIII Kombi (08-)
24.5279-0180.3	331465	RENAULT	KANGOO II (KW_) (08-)
24.5279-0180.3	331465	RENAULT	KANGOO Be Bop (KW_) (09-10)
24.5279-0180.3	331465	RENAULT	KANGOO Express/Rapid (FW_) (08-)
24.5281-0452.3	331436	SUZUKI	ALTO (09-)
24.5281-0453.3	331437	SUZUKI	ALTO (09-)
24.5286-0615.3	331493	MITSUBISHI	ASX (10-)
24.5286-0615.3	331493	MITSUBISHI	LANCER Stufenheck/Sportlimousine (CY_A) (07-)
24.5286-0615.3	331493	MITSUBISHI	LANCER Sportback (CX_A) (08-)
24.5289-0495.3	331457	VOLKSWAGEN	CADDY III (04-15)
24.5293-0567.3	331438	NISSAN	MICRA (K13K) (10-)
24.5293-0635.3	331440	NISSAN	JUKE (F15) (10-)
24.5293-0636.3	331441	NISSAN	JUKE (F15) (10-)
24.5296-0563.3	331483	LEXUS	ES 350 (06-12)
24.5296-0563.3	331483	TOYOTA	CAMRY (06-11)
24.5296-0720.3	331494	TOYOTA	PRIUS (09-15)
24.5309-0540.3	331368	FORD	COUGAR (98-01)
24.5309-0540.3	331368	FORD	MONDEO II (96-00)
24.6241-1711.5	240713	VOLKSWAGEN	PASSAT Limousine (05-10)
24.6241-1711.5	240713	VOLKSWAGEN	PASSAT Variant (05-10)
24.6241-1711.5	240713	VOLKSWAGEN	PASSAT CC (08-11)
24.6241-1711.5	240713	VOLKSWAGEN	PASSAT CC (11-)
24.6241-1711.5	240713	VOLKSWAGEN	PASSAT / PASSAT VARIANT (10-14)
24.6241-1711.5	240713	VOLKSWAGEN	PASSAT ALLTRACK (12-14)
24.6241-1712.5	240714	VOLKSWAGEN	PASSAT Limousine (05-10)
24.6241-1712.5	240714	VOLKSWAGEN	PASSAT Variant (05-10)
24.6241-1712.5	240714	VOLKSWAGEN	PASSAT CC (08-11)



Neue Artikel

New parts - Codici nuovi - Nouvelles références - Nuevas referencias



24.6241-1712.5	240714	VOLKSWAGEN	PASSAT CC (11-)
24.6241-1712.5	240714	VOLKSWAGEN	PASSAT / PASSAT VARIANT (10-14)
24.6241-1712.5	240714	VOLKSWAGEN	PASSAT ALLTRACK (12-14)
24.6243-1709.7	221023	AUDI	A6 (4F2/C6) Limousine (04-11)
24.6243-1709.7	221023	AUDI	A6 (4F5/C6) Avant (05-11)
24.6243-1709.7	221023	AUDI	A6 Allroad (06-11)
24.6243-1710.7	221024	AUDI	A6 (4F2/C6) Limousine (04-11)
24.6243-1710.7	221024	AUDI	A6 (4F5/C6) Avant (05-11)
24.6243-1710.7	221024	AUDI	A6 Allroad (06-11)
24.6243-1714.5	240716	AUDI	A8 (09-)
24.6243-1715.5	240741	AUDI	A6 (4G2/C7) Limousine (11-)
24.6243-1715.5	240741	AUDI	A6 (4G5/C7) Avant (11-)
24.6243-1715.5	240741	AUDI	A7 Sportback (10-)
24.6243-1716.5	240742	AUDI	A6 (4G2/C7) Limousine (11-)
24.6243-1716.5	240742	AUDI	A6 (4G5/C7) Avant (11-)
24.6243-1716.5	240742	AUDI	A7 Sportback (10-)
24.6243-1717.5	240747	AUDI	Q5 (08-)
24.6243-1718.5	240748	AUDI	Q5 (08-)
24.6243-1719.5	240774	AUDI	A8 (03-09)
24.6243-1720.5	240775	AUDI	A8 (03-09)
24.6243-1721.5	240782	AUDI	A4 (B8) Limousine (07-)
24.6243-1721.5	240782	AUDI	A4 (B8) Avant (08-)
24.6243-1721.5	240782	AUDI	A5 / A5 Sportback (07-)
24.6243-1721.5	240782	AUDI	A5 Cabrio (09-)
24.6243-1721.5	240782	AUDI	Q5 (08-)
24.6244-1701.5	240717	BMW	5er Reihe/F10 Limousine (10-)
24.6244-1701.5	240717	BMW	5er Reihe/F11 Touring (10-)
24.6244-1701.5	240717	BMW	6er Reihe/F12 Cabrio (11-)
24.6244-1701.5	240717	BMW	6er Reihe/F13 Coupe (11-)
24.6244-1701.5	240717	BMW	6er Reihe/F06 Gran Coupe (11-)
24.6244-1702.5	240718	BMW	5er Reihe/F10 Limousine (10-)
24.6244-1702.5	240718	BMW	5er Reihe/F11 Touring (10-)
24.6244-1702.5	240718	BMW	6er Reihe/F12 Cabrio (11-)
24.6244-1702.5	240718	BMW	6er Reihe/F13 Coupe (11-)
24.6244-1702.5	240718	BMW	6er Reihe/F06 Gran Coupe (11-)





- D** Ersetzte Artikel
- EN** Replaced parts
- FR** Références remplacées
- IT** Codici sostitutivi
- ES** Referencias de sustitución
- NL** Vervangen artikelen
- DA** Erstattede artikler
- SV** Utbytta artiklar
- HU** Helyettesített alkatrészek
- PT** Artigos substituídos
- RU** Замененные номера
- CZ** Nahrazené výrobky
- PL** Artykuły zastąpione
- EL** Αντικατεστημένοι αριθμοί
- TR** Değiştirilen ürün
- ZH** 替代件
- JA** 販売商品
- AR** المنتجات المعوّضة

K24-H



Ersetzte Artikel





Replaced parts - Codici sostitutivi - Références remplacées - Referencias de sustitución

 Vorgänger Nr. Replaced No. Codice precedente Ancienne référence Número anterior	Nachfolge Nr. Replacing No. Codice nuovo Nouvelle référence Número posterior	 Vorgänger Nr. Replaced No. Codice precedente Ancienne référence Número anterior	Nachfolge Nr. Replacing No. Codice nuovo Nouvelle référence Número posterior
03.2125-0343.3	010896	03.2125-0332.3	010952
03.2126-3146.3	010936	03.2126-3196.3	010968
03.2522-4300.3	040085	24.2522-1707.3	040103
03.4153-0015.4	010784	03.4153-0015.3	011005
03.4153-0029.4	010786	03.4153-5287.4	010953
03.7860-3902.4	300278	03.7860-8802.4	300291
03.7863-9502.4	300204	03.7863-3232.4	300307
11.3381-8502.2	220019	24.3381-8502.5	240664
11.3541-8105.2	220339	24.3541-8105.5	240485
11.3541-8106.2	220340	24.3541-8106.5	240486
11.3571-8506.2	220126	24.3571-8506.5	240490
11.3571-8511.2	220315	24.3571-8511.5	240491
11.3571-8522.2	220320	24.3571-8522.5	240496
11.3601-8502.2	220146	24.3601-8502.5	240534
11.3601-8503.2	220147	24.3601-8503.5	240535
11.3601-8506.2	220150	24.3601-8506.5	240538
11.9401-9978.2	220440	24.3401-9978.5	240524
11.9421-9965.2	220799	24.3421-9965.5	240645
11.9421-9966.2	220800	24.3421-9966.5	240646
11.9426-9977.2	220897	24.3426-9977.5	240567
11.9426-9979.2	220921	24.3426-9979.5	240579
11.9426-9980.2	220922	24.3426-9980.5	240580
11.9426-9989.2	220639	24.3426-9989.5	240647
11.9426-9990.2	220640	24.3426-9990.5	240648
11.9441-9958.2	220828	24.3441-9958.5	240672
11.9457-7011.2	220963	11.9457-7021.2	221051
11.9457-7012.2	220964	11.9457-7022.2	221052
11.9541-9667.2	220421	24.3541-9667.5	240529
11.9571-9802.2	220578	24.3571-9802.5	240498
11.9601-9829.2	220505	24.3601-9829.5	240507
11.9601-9830.2	220506	24.3601-9830.5	240508
11.9606-9955.2	220919	24.3606-9955.5	240577
11.9606-9956.2	220920	24.3606-9956.5	240578
13.2351-8006.2	210015	24.9235-8006.5	230024
13.2381-0087.2	210149	24.9238-0087.5	230035
13.2381-0088.2	210150	24.9238-0088.5	230036
13.2381-8036.2	210038	24.9238-8036.5	230026
13.2421-8007.2	210055	24.9242-8007.5	230029
13.2421-8008.2	210056	24.9242-8008.5	230030
13.2461-8002.2	210227	24.9246-8002.5	230022
13.2571-8027.2	210129	24.9257-8027.5	230039
13.2571-8028.2	210130	24.9257-8028.5	230040
13.2601-8025.2	210157	24.9260-8025.5	230041
13.2601-8029.2	210161	24.9260-8029.5	230043
13.2601-8030.2	210162	24.9260-8030.5	230044
24.3481-1807.7	220777	24.3481-1805.7	220765
24.3541-1809.7	220613	24.3541-1809.5	240593
24.3541-1829.7	220713	24.3541-1829.5	240721
24.3541-1830.7	220714	24.3541-1830.5	240722
24.3571-1725.5	240313	24.3571-1783.5	240751
24.3571-1726.5	240314	24.3571-1784.5	240752
24.5111-0459.3	330683	24.5111-0460.3	330603
24.5250-0313.3	331024	24.5256-0318.3	331426
24.5280-0500.3	330953	24.5289-0495.3	331457
24.6243-1711.5	240739	24.6243-1719.5	240774
24.6243-1712.5	240740		
83.1064-0060.3	330785	24.6243-1720.5	240775
83.6104-0170.3	330500	24.5157-0273.3	331305
83.6124-0275.3	330458	24.5113-0170.3	331361
83.6124-0303.3	330689	24.5113-0283.3	331395
83.6134-0420.3	330279	24.5102-0304.3	331407
83.6150-0426.3	330282	24.5113-0423.3	331396
83.6152-0455.3	330545	24.5103-0430.3	331408
83.6204-0158.3	330773	24.5169-0458.3	331429
83.6204-0200.3	330306	24.5225-0160.3	331366
83.6204-0290.3	330310	24.5201-0204.3	331400
83.6204-0470.3	330312	24.5201-0290.3	331401
83.6213-0515.3	330866	24.5201-0474.3	331434
83.6240-0200.3	330329	24.5237-0515.3	331463
83.6247-0562.3	330594	24.5202-0204.3	331402
83.6308-0270.3	330739	24.5143-0569.3	331398
83.6362-0542.3	330485	24.5310-0270.3	331369
83.6401-0469.3	330749	24.5309-0540.3	331368
83.7213-0307.3	330791	24.5112-0470.3	331460
83.7257-0388.3	330486	24.5237-0308.3	331435
83.7257-0424.3	330985	24.5231-0391.3	331424
83.7704-0421.3	330827	24.5231-0426.3	331313
83.7713-0435.3	330792	24.5170-0426.3	331452
83.7754-0340.3	330794	24.5105-0442.3	331432
83.7804-0160.3	330811	24.5101-0346.3	331406
83.7812-0180.3	330854	24.5201-0164.3	331414
83.7813-0270.3	330797	24.5237-0183.3	331454
83.7813-0285.3	330798	24.5237-0273.3	331444
83.7813-0330.3	330800	24.5237-0288.3	331442
83.7813-0332.3	330801	24.5237-0333.3	331425
83.7834-0440.3	330813	24.5237-0334.3	331443
83.7847-0563.3	331124	24.5224-0440.3	331378
83.7849-0231.3	330872	24.5143-0564.3	331433
83.7852-0377.3	330835	24.5204-0233.3	331430
		24.5147-0385.3	331427



Ersetzte Artikel

Replaced parts - Codici sostitutivi - Références remplacées - Referencias de sustitución

 Nachfolge Nr. Replacing No. Codice nuovo Nouvelle référence Número posterior	 Vorgänger Nr. Replaced No. Codice precedente Ancienne référence Número anterior	 Nachfolge Nr. Replacing No. Codice nuovo Nouvelle référence Número posterior	 Vorgänger Nr. Replaced No. Codice precedente Ancienne référence Número anterior
03.2125-0332.3	010952	03.2125-0343.3	010896
03.2126-3196.3	010968	03.2126-3146.3	010936
03.4153-0015.3	011005	03.4153-0015.4	010784
03.4153-5287.4	010953	03.4153-0029.4	010786
03.7860-8802.4	300291	03.7860-3902.4	300278
03.7863-3232.4	300307	03.7863-9502.4	300204
11.9457-7021.2	221051	11.9457-7011.2	220963
11.9457-7022.2	221052	11.9457-7012.2	220964
24.2522-1707.3	040103	03.2522-4300.3	040085
24.3381-8502.5	240664	11.3381-8502.2	220019
24.3401-9978.5	240524	11.9401-9978.2	220440
24.3421-9965.5	240645	11.9421-9965.2	220799
24.3421-9966.5	240646	11.9421-9966.2	220800
24.3426-9977.5	240567	11.9426-9977.2	220897
24.3426-9979.5	240579	11.9426-9979.2	220921
24.3426-9980.5	240580	11.9426-9980.2	220922
24.3426-9989.5	240647	11.9426-9989.2	220639
24.3426-9990.5	240648	11.9426-9990.2	220640
24.3441-9958.5	240672	11.9441-9958.2	220828
24.3481-1805.7	220765	24.3481-1807.7	220777
24.3541-1809.5	240593	24.3541-1809.7	220613
24.3541-1829.5	240721	24.3541-1829.7	220713
24.3541-1830.5	240722	24.3541-1830.7	220714
24.3541-8105.5	240485	11.3541-8105.2	220339
24.3541-8106.5	240486	11.3541-8106.2	220340
24.3541-9667.5	240529	11.9541-9667.2	220421
24.3571-1783.5	240751	24.3571-1725.5	240313
24.3571-1784.5	240752	24.3571-1726.5	240314
24.3571-8506.5	240490	11.3571-8506.2	220126
24.3571-8511.5	240491	11.3571-8511.2	220315
24.3571-8522.5	240496	11.3571-8522.2	220320
24.3571-9802.5	240498	11.9571-9802.2	220578
24.3601-8502.5	240534	11.3601-8502.2	220146
24.3601-8503.5	240535	11.3601-8503.2	220147
24.3601-8506.5	240538	11.3601-8506.2	220150
24.3601-9829.5	240507	11.9601-9829.2	220505
24.3601-9830.5	240508	11.9601-9830.2	220506
24.3606-9955.5	240577	11.9606-9955.2	220919
24.3606-9956.5	240578	11.9606-9956.2	220920
24.5101-0346.3	331406	83.7754-0340.3	330794
24.5102-0304.3	331407	83.6124-0303.3	330689
24.5103-0430.3	331408	83.6150-0426.3	330282
24.5105-0442.3	331432	83.7713-0435.3	330792
24.5111-0460.3	330603	24.5111-0459.3	330683
24.5112-0470.3	331460	83.6401-0469.3	330749
24.5113-0170.3	331361	83.6104-0170.3	330500
24.5113-0283.3	331395	83.6124-0275.3	330458
24.5113-0423.3	331396	83.6134-0420.3	330279
24.5143-0564.3	331433	83.7847-0563.3	331124
24.5143-0569.3	331398	83.6247-0562.3	330594
24.5147-0385.3	331427	83.7852-0377.3	330835
24.5157-0273.3	331305	83.1064-0060.3	330785
24.5169-0458.3	331429	83.6152-0455.3	330545
24.5170-0426.3	331452	83.7704-0421.3	330827
24.5201-0164.3	331414	83.7804-0160.3	330811
24.5201-0204.3	331400	24.5201-0204.3	331400
24.5201-0290.3	331401	24.5201-0290.3	331401
24.5201-0474.3	331434	24.5201-0474.3	331434
24.5202-0204.3	331402	24.5202-0204.3	331402
24.5204-0233.3	331430	24.5204-0233.3	331430
24.5224-0440.3	331378	24.5224-0440.3	331378
24.5225-0160.3	331366	24.5225-0160.3	331366
24.5231-0391.3	331424	24.5231-0391.3	331424
24.5231-0426.3	331313	24.5231-0426.3	331313
24.5237-0183.3	331454	24.5237-0183.3	331454
24.5237-0273.3	331444	24.5237-0273.3	331444
24.5237-0288.3	331442	24.5237-0288.3	331442
24.5237-0308.3	331435	24.5237-0308.3	331435
24.5237-0333.3	331425	24.5237-0333.3	331425
24.5237-0334.3	331443	24.5237-0334.3	331443
24.5237-0515.3	331463	24.5237-0515.3	331463
24.5256-0318.3	331426	24.5256-0318.3	331426
24.5289-0495.3	331457	24.5289-0495.3	331457
24.5309-0540.3	331368	24.5309-0540.3	331368
24.5310-0270.3	331369	24.5310-0270.3	331369
24.6243-1719.5	240774	24.6243-1719.5	240774
24.6243-1720.5	240775	24.6243-1720.5	240775
24.9235-8006.5	230024	24.9235-8006.5	230024
24.9238-0087.5	230035	24.9238-0087.5	230035
24.9238-0088.5	230036	24.9238-0088.5	230036
24.9238-8036.5	230026	24.9238-8036.5	230026
24.9242-8007.5	230029	24.9242-8007.5	230029
24.9242-8008.5	230030	24.9242-8008.5	230030
24.9246-8002.5	230022	24.9246-8002.5	230022
24.9257-8027.5	230039	24.9257-8027.5	230039
24.9257-8028.5	230040	24.9257-8028.5	230040
24.9260-8025.5	230041	24.9260-8025.5	230041
24.9260-8029.5	230043	24.9260-8029.5	230043
24.9260-8030.5	230044	24.9260-8030.5	230044
83.6204-0200.3	330306	83.6204-0200.3	330306
83.6204-0290.3	330310	83.6204-0290.3	330310
83.6204-0470.3	330312	83.6204-0470.3	330312
83.6240-0200.3	330329	83.6240-0200.3	330329
83.7849-0231.3	330872	83.7849-0231.3	330872
83.7834-0440.3	330813	83.7834-0440.3	330813
83.6204-0158.3	330773	83.6204-0158.3	330773
83.7257-0388.3	330486	83.7257-0388.3	330486
83.7257-0424.3	330985	83.7257-0424.3	330985
83.7812-0180.3	330854	83.7812-0180.3	330854
83.7813-0270.3	330797	83.7813-0270.3	330797
83.7813-0285.3	330798	83.7813-0285.3	330798
83.7213-0307.3	330791	83.7213-0307.3	330791
83.7813-0330.3	330800	83.7813-0330.3	330800
83.7813-0332.3	330801	83.7813-0332.3	330801
83.6213-0515.3	330866	83.6213-0515.3	330866
24.5250-0313.3	331024	24.5250-0313.3	331024
24.5280-0500.3	330953	24.5280-0500.3	330953
83.6362-0542.3	330485	83.6362-0542.3	330485
83.6308-0270.3	330739	83.6308-0270.3	330739
24.6243-1711.5	240739	24.6243-1711.5	240739
24.6243-1712.5	240740	24.6243-1712.5	240740
13.2351-8006.2	210015	13.2351-8006.2	210015
13.2381-0087.2	210149	13.2381-0087.2	210149
13.2381-0088.2	210150	13.2381-0088.2	210150
13.2381-8036.2	210038	13.2381-8036.2	210038
13.2421-8007.2	210055	13.2421-8007.2	210055
13.2421-8008.2	210056	13.2421-8008.2	210056
13.2461-8002.2	210227	13.2461-8002.2	210227
13.2571-8027.2	210129	13.2571-8027.2	210129
13.2571-8028.2	210130	13.2571-8028.2	210130
13.2601-8025.2	210157	13.2601-8025.2	210157
13.2601-8029.2	210161	13.2601-8029.2	210161
13.2601-8030.2	210162	13.2601-8030.2	210162



- D** Fahrzeugregister
- EN** Index of vehicles
- FR** Liste des véhicules
- IT** Indice autovetture
- ES** Índice de vehículos
- NL** Voertuigregister
- DA** Køretøjsregister
- SV** Fordonsregister
- HU** Járműlista
- PT** Registo automóvel
- RU** Перечень автомобилей
- CZ** Rejstřík vozidel
- PL** Indeks pojazdów
- EL** Κατάλογος οχημάτων
- TR** Araç kaydı
- ZH** 汽吹登璦翻
- JA** 然両索引
- AR** سجل العربية

K24-H

**ALFA ROMEO**

145 (94-01)	36
146 (94-01)	37
147 (01-10)	38
155 (92-97)	38
156 (97-05)	39
159 (05-11)	39
164 (92-98)	40
166 (98-07)	40
BRERA (06-11)	41
GIULIETTA (10-)	41
GT (04-10)	42
GTV (95-05)	42
MITO (08-)	42
SPIDER (95-05)	43
SPIDER (06-11)	43

AUDI

A1 / A1 Sportback (10-)	44
A2 (00-05)	45
A3 (8L) (96-03)	46
A3 / A3 (8P) Sportback (03-13)	49
A3 (8P) Cabrio (08-13)	54
A3 / A3 (8V) Sportback (12-)	55
A3 (8V) Cabrio (13-)	57
A4 (B5) (95-01)	57
A4 (B6/B7) (01-08)	61
A4 (B8) Limousine (07-)	67
A4 (B8) Avant (08-)	70
A4 Allroad (09-)	74
A4 Cabrio (02-08)	74
A4 / A4 Avant (B9) (15-)	77
A5 / A5 Sportback (07-)	77
A5 Cabrio (09-)	81
A6 / A6 Avant (4A/C4) (94-97)	84
A6 / A6 Avant (4B/C5) (97-05)	86
A6 Allroad (00-05)	90
A6 (4F2/C6) Limousine (04-11)	90
A6 (4F5/C6) Avant (05-11)	94
A6 Allroad (06-11)	97
A6 (4G2/C7) Limousine (11-)	98
A6 (4G5/C7) Avant (11-)	100
A6 Allroad (12-)	101
A7 Sportback (10-)	102
A8 (94-02)	103
A8 (03-09)	104
A8 (09-)	105
CABRIO (91-00)	106
Q3 (11-)	107
Q5 (08-)	107
Q7 (06-15)	109
TT Coupe (98-06)	110
TT Roadster (99-06)	112
TT Coupe (06-14)	113
TT Roadster (07-14)	114

BMW

1er Reihe/E81/E87 Limousine (04-11)	116
1er Reihe/E82 Coupe (07-13)	118
1er Reihe/E88 Cabrio (08-13)	118
1er Reihe/F20/F21 Limousine (11-)	119
2er Reihe/F22 Coupe (13-)	120
2er Reihe/F23 Cabrio (14-)	121
3er Reihe/E36 Limousine (90-98)	121
3er Reihe/E36 Touring (95-99)	124
3er Reihe/E36 Coupe (92-99)	125
3er Reihe/E36 Cabrio (93-99)	127
3er Reihe/E36 Compact (94-00)	129
3er Reihe/E46 Limousine (98-05)	130
3er Reihe/E46 Touring (99-05)	132
3er Reihe/E46 Coupe (99-06)	135
3er Reihe/E46 Cabrio (00-06)	136
3er Reihe/E46 Compact (01-05)	138
3er Reihe/E90 Limousine (05-12)	139
3er Reihe/E91 Touring (05-12)	142
3er Reihe/E92 Coupe (06-13)	145
3er Reihe/E93 Cabrio (07-13)	147
3er Reihe/F30 Limousine (11-)	148
3er Reihe/F31 Touring (12-)	149
3er Reihe/F34 GT (13-)	150
4er Reihe/F32 Coupe (13-)	151
4er Reihe/F33 Cabrio (14-)	151
4er Reihe/F36 Gran Coupe (14-)	152
5er Reihe/E39 (96-03)	152
5er Reihe/E60 Limousine (03-10)	155
5er Reihe/E61 Touring (04-10)	158
5er Reihe/F10 Limousine (10-)	161
5er Reihe/F11 Touring (10-)	162
5er Reihe/F07 GT GRAN TURISMO (09-)	163
6er Reihe/E63 Coupe (04-11)	164
6er Reihe/E64 Cabrio (04-11)	164
6er Reihe/F12 Cabrio (11-)	165
6er Reihe/F13 Coupe (11-)	165
6er Reihe/F06 Gran Coupe (11-)	166
7er Reihe/E38 (93-01)	166
7er Reihe/E65/E66 (02-08)	167
7er Reihe/F01/F02/F03/F04 (08-15)	168
8er Reihe/E31 (90-99)	169

**BMW**

X1/E84 (09-)	170
X3/E83 (03-10)	171
X5/E53 (00-07)	173
X5/E70 (07-13)	174
X5/F15 (13-)	175
X6/E71/E72 (08-14)	175
X6/F16 (14-)	176
Z3/E36 (95-02)	176
Z4 Roadster/E85 (03-08)	178
Z4 Coupe/E86 (06-08)	179
Z4 Roadster/E89 (09-)	179
Z8/E52 (00-03)	180

CHEVROLET

AVEO (T200,T250) (04-11)	180
AVEO (T300) (11-)	181
COBALT (11-)	181
CRUZE (09-)	181
KALOS (05-08)	182
LANOS (05-10)	182
MALIBU (V300) (12-)	183
MATIZ (05-10)	183
NUBIRA (05-10)	184
ORLANDO (11-)	184
SPARK (05-10)	184
SPARK (10-)	184
TRAX (12-)	185
VOLT (11-)	185

CHRYSLER

PT CRUISER (00-10)	185
--------------------	-----

CITROEN

AX (86-98)	185
BERLINGO (MF) Kombi (96-08)	187
BERLINGO (M_) Kasten (96-08)	190
BERLINGO (B9) (08-)	192
C1 (05-14)	193
C1 (14-)	193
C2 (03-09)	193
C3 (02-09)	194
C3 PLURIEL (03-10)	196
C3 II (09-)	196
C3 PICASSO (09-)	198
C4 I Limousine (LC_) (04-11)	199
C4 I Coupe (04-10)	201
C4 I PICASSO (07-13)	202
C4 I GRAND PICASSO (06-13)	203
C4 II Limousine (B7) (10-)	204
C4 II PICASSO (13-)	204
C4 II GRAND PICASSO (13-)	204
C4 CACTUS (14-)	205
C-ELYSEE (12-)	205
C5 I Limousine (01-04)	206
C5 I Kombi (01-04)	206
C5 II Limousine (04-08)	206
C5 II Kombi (04-08)	206
C5 III Limousine (X7) (08-)	207
C5 III Kombi (X7) (08-)	209
C6 (05-12)	211
C8 (02-14)	211
C-CROSSER (07-13)	212
DS3 (09-)	213
DS3 Cabrio (13-)	214
DS4 (11-)	215
DS5 (11-)	215
EVASION (94-02)	216
JUMPER Bus (94-02)	217
JUMPER Kasten (94-02)	220
JUMPER Pritsche/Fahrgestell (94-02)	223
JUMPER (02-06)	225
JUMPER (06-)	226
JUMPY Kombi (95-06)	227
JUMPY Kasten (95-06)	228
JUMPY Pritsche/Fahrgestell (99-06)	229
JUMPY (07-16)	229
NEMO (08-)	230
SAXO (96-04)	230
XANTIA (X1) Limousine (93-97)	231
XANTIA (X1) Kombi (95-97)	232
XANTIA (X2) Limousine (98-03)	232
XANTIA (X2) Kombi (98-03)	233
XM (Y4) Limousine (94-00)	233
XM (Y4) Kombi (94-00)	233
XSARA (N1) Limousine (97-05)	233
XSARA (N2) Kombi (97-05)	236
XSARA (N0) Coupe (97-05)	238
XSARA Picasso (N68) (00-10)	240
ZX (N2) Limousine (91-97)	241
ZX (N2) Kombi (93-98)	244

DACIA

DOKKER (12-)	245
--------------	-----

**DACIA**

DOKKER Express (12-)	245
DUSTER (HS_) (10-)	245
LODGY (JS_) (12-)	246
LOGAN Express (FS_) (09-13)	246
LOGAN Limousine (LS_) (04-13)	247
LOGAN MCV Kombi (KS_) (07-13)	249
LOGAN Pick-up (US_) (08-13)	250
LOGAN II Limousine (LS2_) (12-)	251
LOGAN II MCV Kombi (13-)	251
SANDERO (08-13)	251
SANDERO II (B52_) (12-)	252

DAEWOO

ARANOS (95-97)	253
ESPERO (95-99)	253
KALOS (02-05)	253
LANOS (97-02)	253
MATIZ (98-05)	253
NEXIA / RACER (95-08)	254
NUBIRA (97-99)	254
NUBIRA (99-05)	254

DAIHATSU

CHARADE (93-01)	254
CHARADE (GB) (03-07)	254
CHARADE (11-13)	254
COPEN (03-12)	254
CUORE (98-03)	254
CUORE (03-07)	255
CUORE (07-13)	255
MATERIA (06-12)	255
MOVE (96-02)	255
SIRION (98-04)	255
SIRION (05-13)	255
TERIOS (J1) (97-05)	255
TREVIS (06-09)	255
YRV (01-06)	255

FIAT

500 (07-)	255
500 C Cabrio (09-)	256
500 L Kombi (12-)	257
500 X (14-)	257
BARCHETTA (95-04)	257
BRAVA (95-01)	258
BRAVO (95-01)	259
BRAVO (07-)	260
CINQUECENTO (92-98)	260
COUPE (94-00)	260
CROMA (05-10)	261
DOBLO (01-10)	261
DOBLO (10-)	262
DUCATO (94-02)	263
DUCATO (02-06)	266
DUCATO (06-)	266
FIORINO (93-01)	266
FIORINO / QUBO (08-)	267
IDEA (04-12)	267
LINEA (07-11)	268
MAREA (96-02)	268
MULTIPLA (98-10)	269
PALIO / PALIO WEEKEND EUROPA (96-06)	270
PALIO SW / SIENA (PL) (98-06)	270
PANDA (86-02)	270
PANDA (03-13)	271
PANDA Cross (06-11)	272
PANDA (12-)	272
PUNTO (93-00)	272
PUNTO (00-03)	273
PUNTO (03-06)	274
PUNTO / PUNTO EVO (09-)	275
GRANDE PUNTO (06-11)	276
SCUDO (95-06)	277
SCUDO (07-)	278
SEDIC (06-)	278
SEICENTO (98-08)	278
STILO / STILO Multi Wagon (01-08)	279
STRADA / PICK-UP (99-11)	279
STRADA (11-)	279
ULYSSE (94-02)	280
ULYSSE (02-11)	280

FORD

B-MAX (12-)	281
C-MAX I (07-10)	281
C-MAX II (10-)	282
GRAND C-MAX (10-)	283
COUGAR (98-01)	284
ESCORT VII (95-00)	285
FIESTA IV (96-02)	286
FIESTA V (02-08)	288
FIESTA VI (08-)	288
FOCUS I (98-04)	289



**FORD**

FOCUS II (05-11)	290
FOCUS III (11-)	292
FOCUS C-MAX (03-07)	293
FUSION (02-12)	294
GALAXY I (95-06)	295
GALAXY II (06-)	296
GALAXY III (15-)	297
KA I (96-08)	297
KA II (08-)	298
KUGA I (08-12)	298
KUGA II (13-)	299
MAVERICK (97-98)	299
MAVERICK (01-07)	299
MONDEO II (96-00)	299
MONDEO III (00-07)	300
MONDEO IV (07-14)	301
PUMA (97-01)	302
RANGER II (10-11)	303
RANGER (11-)	303
SCORPIO / GRANADA (GB) (95-98)	303
S-MAX (06-)	304
S-MAX II (15-)	305
STREET KA (03-06)	305
TOURNEO (94-00)	305
TRANSIT (95-00)	306
TRANSIT (00-06)	308
TRANSIT (06-14)	309
TRANSIT CONNECT / TOURNEO CONNECT (03-13)	309
TRANSIT CONNECT / TOURNEO CONNECT (13-)	309

HONDA

ACCORD (98-02)	309
ACCORD Limousine (03-08)	310
ACCORD Kombi (03-08)	310
ACCORD VIII Limousine (08-)	310
ACCORD VIII Kombi (08-)	310
CITY (08-)	311
CIVIC (3/4-tuerig) (95-01)	311
CIVIC (3-tuerig) (01-05)	311
CIVIC (4-tuerig) (01-05)	311
CIVIC (5-tuerig) (97-01)	311
CIVIC (5-tuerig) (01-05)	312
CIVIC Hatchback (FK/FN) (05-12)	312
CIVIC Stufenheck (FD) (05-12)	312
CIVIC AERODECK (98-01)	313
CIVIC COUPE (96-01)	312
CIVIC COUPE (01-04)	313
CR-V I (97-02)	313
CR-V II (02-06)	313
CR-V III (07-12)	313
CRX (92-98)	313
HR-V (99-05)	313
INSIGHT (09-13)	313
JAZZ (02-08)	314
JAZZ (08-15)	314
LOGO (99-02)	315

HYUNDAI

ACCENT I (94-99)	315
ACCENT II (00-05)	315
ACCENT IV (10-)	315
ATOS (98-08)	315
ATOS PRIME (99-08)	316
ELANTRA (00-06)	316
ELANTRA (06-11)	317
GALLOPER (98-03)	317
GETZ (02-09)	317
H-1 KASTEN (00-07)	318
H-1 STAREX (97-07)	318
HIGHWAY VAN (00-04)	318
i10 (08-13)	318
i20 (08-14)	318
i20 / i20 COUPE (GB) (14-)	318
i30 (07-11)	318
i30 (GD) (11-)	319
i30 CW Kombi (08-12)	319
i30 CW Kombi (12-)	319
LANTRA/ELANTRA (95-00)	319
MATRIX (01-10)	319
SANTA FE I (SM) (01-06)	320
TRAJET (00-08)	320
TUCSON (04-10)	320

ISUZU

D-MAX (8DH) (02-12)	320
D-MAX (TFR / TFS) (12-)	320

IVECO

DAILY I / GRINTA (78-99)	320
--------------------------	-----

JAGUAR

S-Type (CCX) (99-08)	321
----------------------	-----

**JAGUAR**

X-Type (CF1) Limousine (01-09)	321
X-Type (CF1) Kombi (03-09)	321
XE (X760) (15-)	321
XF (CC9) (08-)	322
XF (15-)	322
XF Sportbrake (CC9) (12-)	323
XJ (X300) (94-97)	323
XJ (X350,X358) (03-09)	323
XJ (X351) (09-)	323
XK8 Coupe (QEV) (96-05)	323
XK8 Convertible (QDV) (96-05)	323

JEEP

RENEGADE (BU) (14-)	324
---------------------	-----

KIA

CARENS I (00-02)	324
CARENS II (02-06)	324
CARNIVAL I (99-01)	324
CARNIVAL II (01-06)	324
CEE'D Limousine (06-12)	324
CEE'D Kombi (07-13)	324
MENTOR II (GB) (01-04)	325
PICANTO (BA) (04-11)	325
PRO CEE'D (08-13)	325
RIO I (DC) (00-05)	326
RIO III (UB) (11-)	326
SEDONA I (GB) (99-01)	326
SEDONA II (GB) (01-06)	326
SEPHIA I (93-98)	326
SEPHIA II (01-04)	326
SHUMA I (97-01)	326
SHUMA II (01-04)	326
SORENTO (JC) (02-09)	326
SPORTAGE (94-03)	326
SPORTAGE (04-10)	326
VENGA (10-)	327

LADA

110 Stufenheck (2110) (95-07)	327
111 Kombi (2111) (95-08)	327
112 Fließheck (2112) (95-08)	327
KALINA (1117/1118/1119) (04-)	327
PRIORA (2170/2172) (08-)	327
SAMARA (2108/2109) (86-99)	327
NIVA II (2123) (02-)	328

LANCIA

DEDRA (94-99)	328
DELTA (94-99)	328
DELTA / Chrysler Delta (08-)	328
KAPPA (95-01)	329
LYBRA (99-05)	329
MUSA (04-13)	329
PHEDRA (02-10)	330
Y (96-03)	330
YPSILON (03-11)	331
YPSILON / Chrysler Ypsilon (11-)	331
ZETA (94-02)	332

LAND ROVER

DISCOVERY I (89-98)	332
DISCOVERY II (94-04)	332
DISCOVERY III (04-09)	332
DISCOVERY IV (09-)	332
DISCOVERY SPORT (14-)	333
FREELANDER (LN) (98-06)	333
FREELANDER 2 (FA) (06-)	333
RANGE ROVER II (LP) (94-02)	334
RANGE ROVER III (LM) (02-12)	334
RANGE ROVER EVOQUE (SAL) (11-)	334
RANGE ROVER EVOQUE Cabriolet (16-)	334
RANGE ROVER SPORT (LS) (05-13)	334

LEXUS

ES 350 (06-12)	334
----------------	-----

MAZDA

121 (96-03)	334
2 (DY) (03-07)	335
2 (DE) (07-14)	336
2 (DJ) (14-)	336
3 (BK) (03-09)	336
3 (BL) (09-13)	337
323 Limousine/323 C/323 F/323 S (94-98)	337
323 Limousine/323 F/323 P/323 S (98-03)	338
5 (CR) (05-10)	338

**MAZDA**

5 (CW) (10-)	338
6 Limousine (GG) (02-07)	339
6 Kombi (GY) (02-07)	339
6 (GH) (07-12)	339
626 (GE) (91-97)	339
626 (GF) (97-02)	340
626 Kombi (GV) (92-98)	340
626 Kombi (GW) (98-02)	340
B2200/B2500/B2600 (99-02)	340
B2500 (02-06)	340
BT-50 (06-12)	340
DEMIO (98-02)	340
MX-3 (91-98)	341
MX-5 (NB) (98-05)	341
MX-6 (91-97)	341
PREMACY (CP) (99-05)	341
PREMACY (CR) (05-10)	341
XEDOS 6 (92-00)	342

MERCEDES BENZ

A-Klasse (W168) (97-04)	342
A-Klasse (W169) (04-12)	343
B-Klasse (W245) (05-11)	343
CITAN (W415) (12-)	344
C-Klasse (W202) Limousine (93-00)	344
C-Klasse (S202) Kombi (96-01)	347
C-Klasse (W203) Limousine (00-07)	348
C-Klasse (S203) Kombi (01-07)	351
C-Klasse (CL203) Sportcoupe (01-08)	354
C-Klasse (CLC203) Coupe (08-10)	355
C-Klasse (W204) Limousine (07-14)	356
C-Klasse (S204) Kombi (07-14)	360
C-Klasse (C204) Coupe (11-)	363
CL-Klasse (C140) Coupe (96-99)	364
CL-Klasse (C215) Coupe (99-06)	364
CL-Klasse (C216) Coupe (06-14)	365
CLK-Klasse (C208) Coupe (97-02)	365
CLK-Klasse (A208) Cabrio (98-03)	367
CLK-Klasse (C209) Coupe (02-09)	368
CLK-Klasse (A209) Cabrio (03-09)	369
CLS-Klasse (C219) Coupe (04-10)	370
CLS-Klasse (C218) Coupe (10-)	371
CLS-Klasse (X218) Shooting Brake (12-)	372
E-Klasse (C124) Coupe (93-97)	374
E-Klasse (A124) Cabrio (93-98)	374
E-Klasse (W210) Limousine (95-02)	375
E-Klasse (S210) Kombi (96-03)	378
E-Klasse (W211) Limousine (02-09)	380
E-Klasse (S211) Kombi (03-09)	383
E-Klasse (W212) Limousine (09-)	385
E-Klasse (S212) Kombi (09-)	389
E-Klasse (C207) Coupe (09-)	392
E-Klasse (A207) Cabrio (10-)	394
G-Klasse (W463) (90-)	396
G-Klasse (W463) Cabrio (90-)	398
GL-Klasse (X164) (06-12)	399
GL-Klasse / GLS-Klasse (X166) (12-)	400
GLE-Klasse (C292) Coupe (15-)	400
GLK-Klasse (X204) (08-15)	400
M-Klasse (W163) (98-05)	401
M-Klasse (W164) (05-11)	401
M-Klasse/GLE-Klasse (W166) (11-)	402
R-Klasse (W251,V251) (06-12)	403
S-Klasse (W140) (93-98)	403
S-Klasse (W220) (98-06)	404
S-Klasse (W221) (06-13)	406
S-Klasse (W222) (13-)	408
S-Klasse (C217) Coupe (14-)	408
S-Klasse (A217) Cabrio (15-)	408
SL-Klasse (R129) (93-01)	408
SL-Klasse (R230) (01-11)	409
SL-Klasse (R231) (12-)	410
SLK-Klasse (R170) (96-04)	410
SLK-Klasse (R171) (04-11)	411
SLK-Klasse / SLC-Klasse (R172) (11-)	412
VANEO (BM414) (02-05)	412
V-Klasse (BM638) (96-03)	413
VIANO (BM639) (03-14)	413
VITO (BM638) (96-03)	414
VITO (BM639) (03-14)	415
Transporter (BM 901/902) SPRINTER (95-06)	416
Transporter (BM 903/904) SPRINTER (95-06)	417
Transporter (BM 905) SPRINTER (01-06)	419
Transporter (BM 906) SPRINTER (06-)	419
Transporter VARIO (96-13)	422

MERCEDES NFZ.

UNIMOG 20 (BM 405.050) (07-)	423
UNIMOG 300-400 (BM 405.1) (00-)	423
UNIMOG 3000-5000 (BM 437.4) (02-)	423

MG

ZT Limousine (01-05)	424
ZT-T Kombi (01-05)	424

**MINI**

R50 / R53 (00-06)	424
R52 Cabrio (04-08)	425
R55 Clubman (07-14)	425
R55 Clubvan (12-)	426
R56 (06-14)	426
R57 Cabrio (09-14)	427
R58 Coupe (11-)	427
R59 Roadster (12-)	428
R60 Countryman (10-)	428
R61 Paceman (12-)	428

MITSUBISHI

ASX (10-)	428
CARISMA (95-06)	429
COLT/LANCER Limousine (96-03)	430
COLT (04-12)	430
COLT CZC Cabriolet (06-09)	431
GALANT (96-03)	431
GALLOPER (99-03)	431
i-MiEV (09-14)	431
L 200 (96-06)	432
L 200 (06-15)	432
L 200 (15-)	432
L 300 (94-00) (Kabine und Chassis)	432
L 400 (96-05)	432
LANCER Evolution (04-07)	432
LANCER Limousine (03-07)	432
LANCER Kombi (03-07)	432
LANCER Stufenheck/Sportlimousine (CY_A) (07-)	432
LANCER Sportback (CX_A) (08-)	433
OUTLANDER I (03-06)	433
OUTLANDER II (06-12)	433
OUTLANDER III (12-)	433
PAJERO (90-00)	434
PAJERO (00-07)	434
PAJERO (07-)	434
PAJERO PININ / SHOGUN PININ (GB) (99-05)	434
PAJERO SPORT / MONTERO (USA) (98-09)	435
PAJERO SPORT (KH_) (09-)	435
SANTAMO (99-04)	435
SPACE GEAR (95-02)	435
SPACE RUNNER (91-99)	435
SPACE RUNNER (99-03)	435
SPACE STAR (98-06)	435
SPACE STAR (A05A) (12-)	436
SPACE WAGON (91-98)	436
SPACE WAGON (98-05)	436

NISSAN

ALMERA (N15) (95-00)	436
ALMERA (N16) (00-06)	436
ALMERA (B10RS) (06-)	437
ALMERA TINO (V10M) (00-05)	437
INTERSTAR (X70) (02-10)	438
JUKE (F15) (10-)	438
KUBISTAR (X76) Kombi (03-09)	439
MICRA (K11E) (92-02)	440
MICRA (K12E) (03-10)	440
MICRA C+C (CK12E) (05-10)	441
MICRA (K13K) (10-)	441
NAVARA (D40M) (05-)	441
NOTE (E11E) (06-13)	441
NOTE (E12E) (13-)	442
NP 300 (D40M) (08-)	442
NV 200 (M20) Kasten (10-)	442
NV 200 EVALIA (M20) Bus (10-)	442
PATHFINDER (R50) (97-04)	442
PATHFINDER (R51M) (05-)	442
PICK-UP (D22) (98-07)	443
PICK-UP (D22S) (06-)	443
PIXO (K10B) (09-13)	443
PRIMASTAR (X83) Bus (01-)	443
PRIMASTAR (X83) Kasten/Pritsche (02-)	444
PRIMERA (P11E) Limousine (96-02)	444
PRIMERA (P12E) Limousine (02-08)	445
PRIMERA (W10) Kombi (90-98)	446
PRIMERA (W11) Kombi (98-02)	446
PRIMERA (W12) Kombi (02-08)	446
QASHQAI / QASHQAI +2 (J10, JJ10) (07-14)	447
SERENA/VANETTE CARGO (C23M/963) (92-01)	448
SUNNY (Y10) Kombi (90-00)	448
TERRANO II (R20) (93-06)	448
X-TRAIL (T30) (01-07)	448
X-TRAIL (T31) (07-14)	449

OPEL

ADAM / Vauxhall Adam (13-)	449
AGILA / Vauxhall Agila Mk I (00-07)	450
AGILA / Vauxhall Agila Mk II (08-)	450
AMPERA / Vauxhall Ampera (11-)	450
ARENA / Vauxhall Arena (97-01)	451
ASTRA F / Vauxhall Astra MKIII (91-01)	451
ASTRA F CLASSIC (98-02)	453
ASTRA F CLASSIC Caravan (98-05)	453
ASTRA G / Vauxhall Astra MKIV (98-05)	454

**OPEL**

ASTRA H / GTC / Vauxhall Astra Mk V (04-10)	458
ASTRA H Caravan/Vau. Astra MKV Estate (04-10)	461
ASTRA H TwinTop (06-10)	463
ASTRA J / GTC / Vauxhall Astra MK VI (09-)	464
ASTRA J Sports Tourer/Vau. Astra Sports Tourer (10-)	465
CALIBRA / Vauxhall Calibra (89-97)	467
CAMPO (97-01)	468
CASCADA / Vauxhall Cascada (13-)	468
COMBO / Vauxhall Combo (01-11)	468
COMBO D / Vauxhall Combo D (11-)	469
CORSA B / Vauxhall Corsa (93-00)	470
CORSA C / Vauxhall Corsa MK II (00-06)	471
CORSA D / Vauxhall Corsa MK III (06-)	472
CORSA E / Vauxhall Corsa Mk IV (14-)	473
FRONTERA A (92-98)	473
FRONTERA B (98-04)	474
INSIGNIA / Vauxhall Insignia (08-)	474
INSIGNIA Country Tourer (13-)	475
INSIGNIA Sports Tourer / Vauxh. Insignia SportsTourer (08-)	475
KARL / Vauxhall Viva (15-)	477
MERIVA A / Vauxhall Meriva Mk I (03-10)	477
MERIVA B / Vauxhall Meriva Mk II (10-)	478
MOKKA / Vauxhall Mokka (12-)	479
MONTEREY (92-98)	479
MONTEREY (98-99)	479
MOVANO A (98-10)	479
OMEGA B / Vauxhall Omega (94-03)	480
SIGNUM / Vauxhall Signum (03-08)	481
TIGRA / Vauxhall Tigra (94-00)	483
TIGRA TWIN TOP / Vau. Tigra Twin Top (04-09)	483
VECTRA B / Vauxhall Vectra (96-02)	483
VECTRA C (F68, F69)/Vau. Vectra MK II (02-08)	486
VECTRA C Caravan (F35) / Vau. MK II (03-08)	488
VIVARO (01-14)	489
VIVARO B (14-)	491
ZAFIRA I / Vauxhall Zafira I (99-05)	491
ZAFIRA II / Vauxhall Zafira II (05-)	492
ZAFIRA III Tourer / Vauxhall Zafira III Tourer (11-)	493

PEUGEOT

106 (96-04)	494
107 (05-14)	496
108 (14-)	496
205 (91-98)	496
206 Limousine (98-09)	498
206 CC (00-07)	501
206 SW (02-07)	501
206 PLUS (09-13)	503
207 Limousine (06-12)	504
207 CC (07-15)	505
207 SW (07-13)	506
208 (12-)	507
301 (12-)	509
306 Limousine (3/5-tuerig) (93-01)	509
306 Limousine (4-tuerig) (94-01)	512
306 Cabriolet (94-03)	515
306 Kombi (97-02)	516
307 Limousine (00-07)	518
307 Break (02-08)	519
307 CC (03-09)	520
307 SW (02-08)	520
308 Limousine (07-13)	521
308 SW (08-14)	522
308 CC (09-15)	523
308 II (T9) (13-)	523
308 II SW (T9) (14-)	524
406 Limousine (95-04)	524
406 Kombi (96-04)	527
406 Coupe (97-05)	529
407 Limousine / SW (04-11)	530
407 Coupe (05-11)	532
508 (10-)	533
508 SW (10-)	534
605 (90-99)	534
607 (00-10)	535
806 (94-02)	536
807 (02-14)	537
1007 (05-11)	538
2008 (13-)	539
3008 (09-)	540
4007 (07-12)	540
5008 (09-)	541
BIPPER (08-15)	541
BOXER Bus (94-02)	541
BOXER Kasten (94-02)	544
BOXER Pritsche/Fahrgestell (94-02)	547
BOXER (02-06)	550
BOXER (06-)	551
EXPERT Kombi (95-06)	551
EXPERT Kasten (95-06)	552
EXPERT Pritsche/Fahrgestell (95-06)	553
EXPERT / Expert Tepee (07-15)	554
PARTNER Kombi (96-08)	555
PARTNER Kasten (96-08)	556
PARTNER Tepee/Kasten/Pritsche (B9) (08-)	558
RCZ (10-15)	559

**PORSCHE**

911 (993) (93-97)	559
911 TARGA (993) (95-97)	559
911 CABRIO (993) (94-97)	560
911 (996) (97-05)	560
911 TARGA (996) (01-05)	560
911 CABRIO (996) (98-05)	560
911 COUPE (997) (04-13)	560
911 CABRIO (997) (05-13)	561
911 TARGA (997) (06-13)	561
BOXSTER (986) (96-04)	561
BOXSTER (987) (05-11)	562
CAYENNE I (03-10)	562
CAYENNE II (10-)	562
CAYMAN (987C) (05-12)	563
MACAN (13-)	563

PROTON

PERSONA 300 / 400 (94-00)	563
WIRA (00-05)	563

RENAULT

AVANTIME (01-03)	563
CAPTUR (J87) (13-)	563
CLIO I Limousine (B/C 57_) (90-98)	563
CLIO I Kasten (S 57_) (91-98)	567
CLIO II Limousine (BB_/CB_) (98-12)	567
CLIO II Kasten (SB_) (98-12)	571
CLIO III (BR_/CR_) (05-12)	572
CLIO III Grandtour (KR_) (08-12)	574
CLIO IV (B98_) (12-)	576
CLIO IV Grandtour (K98_) (12-)	576
DOKKER (K67/F67) (12-)	576
DUSTER (HS_) (11-)	576
ESPACE III (JE_) (96-02)	577
ESPACE IV (JK_) (02-)	577
ESPACE V (JR_) (15-)	579
EXPRESS/RAPID (F40_) (85-98)	579
FLUENCE (L30_) (10-)	582
KANGOO I (KC_) (98-07)	582
KANGOO II (KW_) (08-)	584
KANGOO Be Bop (KW0_) (09-10)	585
KANGOO Express/Rapid (FW_) (08-)	586
KOLEOS (HY0_) (08-15)	587
LAGUNA I Limousine (B56/556_) (93-00)	587
LAGUNA I Grandtour (K56_) (95-00)	589
LAGUNA II Limousine (BG_) (01-07)	591
LAGUNA II Grandtour (KG_) (01-07)	594
LAGUNA III Limousine (BT0/1) (07-15)	597
LAGUNA III Coupe (DT0/1) (07-15)	597
LAGUNA III Grandtour (KT0/1) (07-15)	598
LATITUDE (L70_) (11-13)	599
LOGAN (LS_) (04-13)	599
LOGAN Kombi (KS_) (04-13)	600
LOGAN Express (07-13)	600
LOGAN II (L52) (13-)	601
LOGAN II Kombi (L52) (13-)	601
MASTER I Bus (80-98)	601
MASTER I Kasten (80-98)	602
MASTER I Pritsche/Fahrgestell (80-98)	602
MASTER II Bus (JD/ND_) (98-06)	602
MASTER II Kasten (FD_) (98-06)	603
MASTER II Pritsche/Fahrgestell (ED/HD/UD_) (98-06)	604
MASTER II Bus (JD_) (06-10)	605
MASTER II Kasten (FD_) (06-10)	605
MASTER II Pritsche/Fahrgestell (ED/HD/UD_) (06-10)	606
MASTER III Kasten/Bus (FV/JV) (10-)	606
MASTER III Pritsche/Fahrgestell (EV/UV) (10-)	607
MEGANE I Limousine 3/5-tuerig (BA/SA_) (96-02)	606
MEGANE I Classic (LA_) (96-02)	610
MEGANE I Coach (DA_) (95-03)	612
MEGANE I Cabrio (EA_) (96-03)	614
MEGANE I Grandtour (KA_) (98-03)	615
MEGANE II Limousine 3/5-tuerig (BM/CM_) (02-08)	616
MEGANE II Limousine 4-tuerig (LM_) (03-08)	618
MEGANE II Coupe/Cabrio (EM_) (03-10)	620
MEGANE II Grandtour (KM_) (03-08)	621
MEGANE III Schrägheck (BZ0_) (08-)	623
MEGANE III CC (EZ0_) (10-)	624
MEGANE III Coupe (DZ0_) (08-)	625
MEGANE III Grandtour (KZ_) (08-)	627
MEGANE IV (B9_) (15-)	629
MEGANE IV Grandtour (K9_) (15-)	629
MEGANE SCENIC (JA_) (96-99)	629
MODUS/GRAND MODUS (JP0_) (04-13)	630
SAFRANE (B54_) (92-00)	632
SANDERO (BS0_) (07-)	633
SANDERO II (13-)	634
SCENIC I (JA_) (99-03)	634
SCENIC II (JM_) (03-09)	636
SCENIC III (JZ_) (09-)	638
GRAND SCENIC (JM_) (04-09)	639
GRAND SCENIC (JZ_) (09-)	640
SPIDER (95-99)	641
THALIA I (LB_) (98-)	641
THALIA II / SYMBOL (LU_) (08-)	642
TRAFIC I Propulsion (PXX) (89-97)	642
TRAFIC I Kasten (TXX) (89-01)	643





RENAULT

TRAFIC I Bus (TXW) (89-01)	644
TRAFIC II (JL/FL/EL) (01-14)	644
TRAFIC III (14-)	646
TWINGO I Limousine (C06_) (93-07)	646
TWINGO I Kasten (S06_) (93-07)	647
TWINGO II (CNO_) (07-14)	647
VEL SATIS (BJ0_) (02-09)	648
WIND (E4M_) (10-13)	649
ZOE (12-)	649

ROVER

25-Serie (RF) (99-05)	650
45-Serie (RT) (00-05)	650
75-Serie (R/RX) (99-05)	650
200 II-Serie (RF) (95-00)	650
400-Serie (RT) (95-00)	650
600-Serie (RH) (93-99)	650
STREETWISE (03-05)	651

SAAB

9-3 (YS3D) (98-02)	651
9-3 Limousine (YS3F) (03-12)	652
9-3 SportCombi (05-12)	654
9-3 Cabriolet (YS3D) (98-03)	656
9-3 Cabriolet (YS3F) (03-12)	657
9-3 X (09-12)	658
9-5 Limousine (YS3E) (97-10)	659
9-5 Kombi (YS3E) (98-10)	662
9-5 II (10-12)	665
900 (94-98)	665
9000 (94-98)	666

SEAT

ALHAMBRA I (96-10)	667
ALHAMBRA II (10-)	669
ALTEA (5P1) (04-15)	669
ALTEA XL (5P5) (06-15)	672
AROSA (6H) (97-05)	674
CORDOBA I (93-99)	675
CORDOBA II (6K2) (99-02)	677
CORDOBA III (6L2) (02-09)	678
EXEO / ST (09-13)	680
IBIZA II (93-99)	681
IBIZA III (6K1) (99-02)	684
IBIZA IV (6L1) (02-10)	685
IBIZA V / ST / SC (08-)	688
INCA (6K9) (96-03)	691
LEON I (1M1) (99-05)	692
LEON II (1P1) (05-12)	696
LEON III (5F) / SC / ST (12-)	700
LEON III (5F) ST X-Perience (14-)	701
MARBELLA (87-98)	701
Mii (12-)	701
TOLEDO I (1L) (91-98)	701
TOLEDO II (1M2) (98-04)	703
TOLEDO III (5P2) (05-09)	706
TOLEDO IV (KG3) (12-)	707

SKODA

CITIGO (12-)	708
FABIA I (6Y) (99-07)	708
FABIA II (5J) (07-14)	710
FABIA III (NJ) (14-)	713
FELICIA I (791/795) (95-97)	713
FELICIA II (6U) (98-01)	714
FELICIA PICK-UP (797) (97-00)	714
OCTAVIA I (1U) (97-10)	715
OCTAVIA II (1Z) (04-13)	718
OCTAVIA III (5E) (12-)	722
RAPID / RAPID Spaceback (12-)	722
ROOMSTER (5J) (06-15)	723
SUPERB I (02-08)	725
SUPERB II (08-15)	726
SUPERB II Combi (09-15)	727
SUPERB III (15-)	729
SUPERB III Combi (15-)	729
YETI (09-)	729

SMART

CABRIO (BM450) (00-03)	732
CITY COUPE (BM450) (98-04)	732
CROSSBLADE (BM450) (02-04)	733
FORFOUR (BM454) (04-06)	733
FORTWO CABRIO (BM450) (04-07)	734
FORTWO COUPE (BM450) (04-07)	734
FORTWO CABRIO (BM451) (07-)	734
FORTWO COUPE (BM451) (07-)	734
ROADSTER (BM452) (03-05)	735
ROADSTER COUPE (BM452) (03-05)	735



SUBARU

FORESTER (97-02)	735
FORESTER (02-08)	735
JUSTY (95-03)	735
JUSTY (G3X) (03-07)	735
JUSTY (07-11)	735
TREZIA (11-)	735

SUZUKI

ALTO (93-02)	736
ALTO (02-08)	736
ALTO (09-)	736
BALENO (95-02)	736
CARRY (99-04)	736
GRAND VITARA (98-05)	736
GRAND VITARA (05-15)	737
IGNIS I (00-03)	737
IGNIS II (03-12)	737
JIMNY (98-)	737
LIANA (01-07)	738
SAMURAI (98-04)	738
SPLASH (08-)	738
SWIFT II (96-04)	738
SWIFT III (05-10)	738
SWIFT IV (10-)	739
SX4 (06-15)	739
VITARA (89-98)	740
WAGON R+ (98-00)	740
WAGON R+ (00-08)	740

TOYOTA

AURIS (06-12)	741
AURIS (12-)	742
AURIS Touring Sports (13-)	742
AVENSIS (97-03)	742
AVENSIS (03-08)	743
AVENSIS (09-)	743
AVENSIS VERSO (01-09)	744
AYGO (05-14)	744
AYGO (14-)	744
CAMRY (06-11)	744
CARINA E (92-97)	744
CELICA (93-99)	744
CELICA (99-05)	745
COROLLA (92-97)	745
COROLLA (97-02)	745
COROLLA (02-04)	746
COROLLA (04-06)	746
COROLLA (06-13)	746
COROLLA (13-)	747
COROLLA VERSO (02-04)	747
COROLLA VERSO (04-09)	747
HIACE (06-)	747
HILUX (88-97)	747
HILUX (97-05)	747
HILUX (05-)	747
IQ (09-)	747
PASEO (95-99)	748
PICNIC (96-01)	748
PREVIA (00-05)	748
PRIUS (03-09)	748
PRIUS (09-15)	748
RAV4 I (94-00)	748
RAV4 II (00-05)	748
RAV4 III (05-)	748
STARLET (96-99)	749
URBAN CRUISER (09-)	749
VERSO (09-)	749
VERSO S (10-)	749
YARIS (99-05)	749
YARIS (06-11)	750
YARIS (11-)	751
YARIS VERSO (99-05)	751

VOLKSWAGEN

AMAROK (10-)	752
BORA (98-04)	752
CADDY II (96-04)	758
CADDY Pickup (97-02)	759
CADDY III (04-15)	759
CADDY IV (15-)	762
CRAFTER (06-)	762
EOS (06-)	763
FOX (05-11)	765
GOLF III (92-97)	766
GOLF III Variant (93-99)	770
GOLF III Cabriolet (94-02)	772
GOLF IV (98-05)	774
GOLF IV Variant (99-06)	778
GOLF V (03-08)	782
GOLF V Variant (07-09)	786
GOLF VI (08-)	788
GOLF VI Variant (09-)	792
GOLF VI Cabriolet (11-)	794
GOLF VII (12-)	795
GOLF VII Variant (13-)	796



VOLKSWAGEN

GOLF VII Sportsvan (14-)	796
GOLF VII ALLTRACK (14-)	796
GOLF Plus (05-14)	796
JETTA V (05-10)	801
JETTA VI (10-)	803
LT/LT 4x4 (96-06)	804
LUPO (98-05)	805
NEW BEETLE (98-10)	807
NEW BEETLE Cabriolet (03-10)	809
BEETLE (11-)	810
BEETLE Cabriolet (12-)	811
PASSAT (97-05)	812
PASSAT Limousine (05-10)	816
PASSAT Variant (05-10)	820
PASSAT CC (08-11)	823
PASSAT CC (11-)	825
PASSAT / PASSAT VARIANT (10-14)	826
PASSAT ALLTRACK (12-14)	828
PASSAT / PASSAT VARIANT (14-)	829
PASSAT ALLTRACK (15-)	829
PHAETON (02-)	829
POLO III (95-01)	830
POLO IV (02-09)	832
POLO V (09-)	836
POLO Classic (96-01)	839
POLO Variant (97-01)	841
SCIROCCO (08-)	842
SHARAN I (85-10)	845
SHARAN II (10-)	847
TARO (89-97)	848
TIGUAN (07-)	848
TOUAREG I (03-10)	849
TOUAREG II (10-)	850
TOURAN I (03-15)	851
TOURAN II (15-)	853
TRANSPORTER (T4) (90-03)	854
TRANSPORTER (T5) BUS / MULTIVAN / KASTEN (03-)	858
TRANSPORTER (T5) PRITSCHKE / FAHRGESTELL (03-)	862
TRANSPORTER (T6) (15-)	867
VENTO (92-98)	868
UP / LOAD UP (11-)	870
XL1 (14-)	870























VOLVO























940 II Limousine (95-98)	871
940 II Kombi (95-98)	871
C30 Coupe (06-12)	872
C70 Coupe (97-02)	873
C70 I Cabrio (98-06)	874
C70 II Cabrio (06-13)	875
S40 I (95-03)	876
S40 II (04-12)	878
S60 I (00-09)	880
S60 II (10-)	883
S70 (97-00)	885
S80 I (98-06)	888
S80 II (06-)	890
S90 I (97-98)	895
V40 (95-04)	895
V40 (12-)	897
V50 (04-12)	897
V60 (10-)	899
V70 I (97-00)	902
V70 II (00-07)	905
V70 III (07-)	908
V90 I (97-98)	913
XC60 (08-)	913
XC70 I CROSS COUNTRY (00-07)	915
XC70 II CROSS COUNTRY (07-)	915
XC90 (02-14)	918
XC90 (14-)	919





















- D** Fahrzeugverwendungen
- EN** Applications of vehicles
- FR** Applications
- IT** Applicazioni autoveicoli
- ES** Aplicaciones
- NL** Voertuigtoepassingen
- DA** Køretøjsanvendelser
- SV** Fordonsanvändningar
- HU** Járműalkalmazások
- PT** Utilizações do veículo
- RU** Применение в автомобилях
- CZ** Použití vozidel
- PL** Zastosowania pojazdów
- EL** Χρήσεις οχημάτων
- TR** Araç kullanımları
- ZH** 汽车用户
- JA** 車両利用方法
- AR** إستعمالات العربية

K24-H

									
ALFA ROMEO 145 (94-01)									
	1.4 i.e. 1.4 i.e. T.Spark 1.6 i.e. 1.6 i.e. T.Spark 1.7 i.e. 16V 1.8 i.e. T.Spark 1.9 JTD 2.0 i.e. 16V 2.0 TD	66 76 76 77 66	07.94 01.97 07.94 01.97 07.94 01.97 02.99 10.95 07.94	12.96 02.01 12.96 02.01 12.96 02.01 02.01 02.01 02.99	24.2122-1716.3	010485		Thz 22,20	
	1.4 i.e. T.Spark 1.6 i.e. T.Spark 1.9 JTD 2.0 TD	76 77 66	01.97 01.97 02.99 01.97	02.01 02.01 02.01 02.99	24.3541-1789.5 24.3541-1790.5	240291 240292	<input type="checkbox"/> <input type="checkbox"/>	D=54, - Halter D=54, - Halter	ATE ATE
	1.4 i.e. 1.4 i.e. T.Spark 1.6 i.e. 1.6 i.e. T.Spark 1.7 i.e. 16V 1.8 i.e. T.Spark 1.9 JTD 2.0 i.e. 16V 2.0 TD	66 76 76 77 66	07.94 01.97 07.94 01.97 07.94 01.97 02.99 10.95 07.94	12.96 04.99 12.96 04.99 12.96 04.99 04.99 04.99 02.99	24.5112-0388.3	330518	2	L=385	
	1.4 i.e. T.Spark 1.6 i.e. T.Spark 1.8 i.e. T.Spark 1.9 JTD 2.0 i.e. 16V	76 77	05.99 05.99 05.99 05.99	02.01 02.01 02.01 02.01	24.5112-0387.3	330519	2	L=387	
	1.4 i.e. 1.6 i.e. 1.7 i.e. 16V 2.0 TD	66 76 66	07.94 07.94 07.94 07.94	12.96 + ABS 12.96 + ABS 12.96 02.99 + ABS	24.3344-1715.5 24.3344-1703.5 24.3344-1704.5	240327 240117 240118	<input type="checkbox"/> <input type="checkbox"/> <input type="checkbox"/>	D=34, - Halter D=34, - Halter D=34, - Halter	TRW TRW TRW
	1.4 i.e. T.Spark 1.6 i.e. T.Spark 1.8 i.e. T.Spark 1.9 JTD 2.0 i.e. 16V	76 77	01.97 01.97 01.97 02.99 10.95	02.01 + ABS 02.01 + ABS 02.01 02.01 + ABS 02.01	24.3344-1715.5	240327	<input type="checkbox"/>	D=34, - Halter	TRW
	1.4 i.e. 1.4 i.e. T.Spark 1.6 i.e. 1.6 i.e. T.Spark 1.7 i.e. 16V 1.8 i.e. T.Spark 1.9 JTD 2.0 i.e. 16V 2.0 TD	66 76 76 77 66	07.94 01.97 07.94 01.97 07.94 01.97 02.99 10.95 07.94	12.96 02.01 12.96 02.01 12.96 02.01 02.01 02.01 02.99	24.5112-0160.3 83.6401-0159.3	330612 330746	2 2	L=160 L=160	
	1.4 i.e. 1.6 i.e. 2.0 TD	66 76 66	07.94 07.94 07.94	12.96 - ABS 12.96 - ABS 12.96 - ABS	24.3220-1116.3	020313		Rz 20,64	
	1.4 i.e. T.Spark 1.6 i.e. T.Spark 1.9 JTD 2.0 TD	76 77 66	01.97 01.97 02.99 01.97	02.01 - ABS 02.01 - ABS 02.01 - ABS 02.99 - ABS	24.3222-1707.3	020104		Rz 22,20	BDX
	1.4 i.e. T.Spark 1.6 i.e. T.Spark 1.9 JTD 2.0 TD	76 77 66	01.97 01.97 02.99 01.97	02.01 - ABS 02.01 - ABS 02.01 - ABS 02.99 - ABS	24.3727-0521.2 24.3727-0540.2	580521 580540	<input type="checkbox"/> <input type="checkbox"/>	L=1517 L=1383	
	1.4 i.e. 1.4 i.e. T.Spark 1.6 i.e. 1.6 i.e. T.Spark 1.7 i.e. 16V 1.8 i.e. T.Spark 1.9 JTD 2.0 i.e. 16V 2.0 TD	66 76 76 77 66	07.94 01.97 07.94 01.97 07.94 01.97 02.99 10.95 01.97	12.96 + ABS 02.01 + ABS 12.96 + ABS 02.01 + ABS 12.96 02.01 02.01 + ABS 02.01 02.99 + ABS	24.3727-0521.2 24.3727-0006.2	580521 580006	<input type="checkbox"/> <input type="checkbox"/>	L=1517 L=1460	
	1.4 i.e. T.Spark 1.6 i.e. T.Spark 1.8 i.e. T.Spark 1.9 JTD 2.0 i.e. 16V 2.0 TD	76 77 66	01.97 01.97 01.97 02.99 10.95 07.94	02.01 02.01 02.01 02.01 02.01 02.99	24.2419-1721.3	030100		Gz 19,05	
	1.4 i.e. 1.6 i.e. 1.7 i.e. 16V 1.9 JTD	66 76 77	07.94 07.94 07.94 02.99	12.96 12.96 12.96 02.01	03.2525-2201.3	040026		Nz 25,40	
	1.4 i.e. T.Spark 1.6 i.e. T.Spark 1.8 i.e. T.Spark 2.0 i.e. 16V 2.0 TD	76 77 66	01.97 01.97 01.97 10.95 07.94	02.01 02.01 02.01 02.01 02.99	24.2525-1705.3	040083		Nz 25,40	

									
ALFA ROMEO 146 (94-01)									
	1.4 i.e. 1.4 i.e. T.Spark 1.6 i.e. 1.6 i.e. T.Spark 1.7 i.e. 16V 1.8 i.e. T.Spark 1.9 JTD 2.0 i.e. 16V 2.0 TD	66 76 76 77 77 66	12.94 01.97 12.94 01.97 12.94 01.97 02.99 10.95 12.94	12.96 02.01 12.96 02.01 12.96 02.01 02.01 02.01 02.99	24.2122-1716.3	010485		Thz 22,20	
	1.4 i.e. T.Spark 1.6 i.e. T.Spark 1.9 JTD 2.0 TD	76 77 66	01.97 01.97 02.99 07.94	02.01 02.01 02.01 02.99	24.3541-1789.5 24.3541-1790.5	240291 240292	<input type="checkbox"/> <input type="checkbox"/>	D=54, - Halter D=54, - Halter	ATE ATE
	1.4 i.e. 1.4 i.e. T.Spark 1.6 i.e. 1.6 i.e. T.Spark 1.7 i.e. 16V 1.8 i.e. T.Spark 1.9 JTD 2.0 i.e. 16V 2.0 TD	66 76 76 77 77 66	12.94 01.97 12.94 01.97 12.94 01.97 02.99 10.95 12.94	12.96 04.99 12.96 04.99 12.96 04.99 04.99 04.99 02.99	24.5112-0388.3	330518	2	L=385	
	1.4 i.e. T.Spark 1.6 i.e. T.Spark 1.8 i.e. T.Spark 1.9 JTD 2.0 i.e. 16V	76 77	05.99 05.99 05.99 05.99	02.01 02.01 02.01 02.01	24.5112-0387.3	330519	2	L=387	
	1.4 i.e. 1.6 i.e. 1.7 i.e. 16V 2.0 TD	66 76 66	07.94 07.94 07.94	12.96 + ABS 12.96 + ABS 12.96	24.3344-1715.5 24.3344-1703.5 24.3344-1704.5	240327 240117 240118	<input type="checkbox"/> <input type="checkbox"/> <input type="checkbox"/>	D=34, - Halter D=34, - Halter D=34, - Halter	TRW TRW TRW
	1.4 i.e. T.Spark 1.6 i.e. T.Spark 1.8 i.e. T.Spark 1.9 JTD 2.0 i.e. 16V	76 77	01.97 01.97 01.97 02.99 10.95	02.01 + ABS 02.01 + ABS 02.01 02.01 + ABS 02.01	24.3344-1715.5	240327	<input type="checkbox"/>	D=34, - Halter	TRW
	1.4 i.e. 1.4 i.e. T.Spark 1.6 i.e. 1.6 i.e. T.Spark 1.7 i.e. 16V 1.8 i.e. T.Spark 1.9 JTD 2.0 i.e. 16V 2.0 TD	66 76 76 76 77 66	12.94 01.97 12.94 01.97 12.94 01.97 02.99 10.95 12.94	12.96 02.01 12.96 02.01 12.96 02.01 02.01 02.01 02.99	24.5112-0160.3 83.6401-0159.3	330612 330746	2 2	L=160 L=160	
	1.4 i.e. 1.6 i.e. 2.0 TD	66 76 66	12.94 12.94 12.94	12.96 - ABS 12.96 - ABS 12.96 - ABS	24.3220-1116.3	020313		Rz 20,64	
	1.4 i.e. T.Spark 1.6 i.e. T.Spark 1.9 JTD 2.0 TD	76 77 66	01.97 01.97 02.99 01.97	02.01 - ABS 02.01 - ABS 02.01 - ABS 02.99 - ABS	24.3222-1707.3	020104		Rz 22,20	BDX
	1.4 i.e. T.Spark 1.6 i.e. T.Spark 1.9 JTD 2.0 TD	76 77 66	01.97 01.97 02.99 01.97	02.01 - ABS 02.01 - ABS 02.01 - ABS 02.99 - ABS	24.3727-0521.2 24.3727-0540.2	580521 580540	<input type="checkbox"/> <input type="checkbox"/>	L=1517 L=1383	
	1.4 i.e. 1.4 i.e. T.Spark 1.6 i.e. 1.6 i.e. T.Spark 1.7 i.e. 16V 1.8 i.e. T.Spark 1.9 JTD 2.0 i.e. 16V 2.0 TD	66 76 76 76 77 66	12.94 01.97 12.94 01.97 12.94 01.97 02.99 10.95 01.97	12.96 + ABS 02.01 + ABS 12.96 + ABS 02.01 + ABS 12.96 02.01 02.01 + ABS 02.01 02.99 + ABS	24.3727-0521.2 24.3727-0006.2	580521 580006	<input type="checkbox"/> <input type="checkbox"/>	L=1517 L=1460	
	1.4 i.e. T.Spark 1.6 i.e. T.Spark 1.8 i.e. T.Spark 1.9 JTD 2.0 i.e. 16V 2.0 TD	76 77 66	01.97 01.97 01.97 02.99 10.95 12.94	02.01 02.01 02.01 02.01 02.01 02.99	24.2419-1721.3	030100		Gz 19,05	
	1.4 i.e. 1.6 i.e. 1.7 i.e. 16V 1.9 JTD	66 76 77	12.94 12.94 12.94 02.99	12.96 12.96 12.96 02.01	03.2525-2201.3	040026		Nz 25,40	
	1.4 i.e. T.Spark 1.6 i.e. T.Spark 1.8 i.e. T.Spark 2.0 i.e. 16V 2.0 TD	76 77 66	01.97 01.97 01.97 10.95 12.94	02.01 02.01 02.01 02.01 02.99	24.2525-1705.3	040083		Nz 25,40	

	 kW								
ALFA ROMEO 147 (01-10)									
	1.6 i 16V T.Spark	77		01.01	10.10	24.5112-0397.3	330666	2	L=396
	1.6 i 16V T.Spark	88		01.01	10.10				
	1.9 JTD	74		06.03	10.10				
	1.9 JTD	81		11.00	10.10				
	1.9 JTD	85		01.01	10.10				
	1.9 JTD 16V			11.02	10.10				
	1.9 JTDM 16V			07.05	10.10				
	1.9 JTDM 8V	88		07.05	10.10				
	2.0 i 16V T.Spark	110		01.01	10.10				
	3.2 GTA	184		02.03	10.10				
	1.6 i 16V T.Spark	77		01.01	10.10	24.3384-1741.7	220599	<input type="checkbox"/>	D=38, - Halter
	1.6 i 16V T.Spark	88		01.01	10.10	24.3384-1742.7	220600	<input type="checkbox"/>	D=38, - Halter
	1.9 JTD	74		06.03	10.10				TRW
	1.9 JTD	81		11.00	10.10				
	1.9 JTD	85		01.01	10.10				
	1.9 JTD 16V			11.02	10.10				
	1.9 JTDM 16V			07.05	10.10				
	1.9 JTDM 8V	88		07.05	10.10				
	2.0 i 16V T.Spark	110		01.01	10.10				
	3.2 GTA	184		02.03	10.10				
	1.6 i 16V T.Spark	77		01.01	10.10	24.5112-0408.3	330667	2	L=410
	1.6 i 16V T.Spark	88		01.01	10.10				
	1.9 JTD	74		06.03	10.10				
	1.9 JTD	81		11.00	10.10				
	1.9 JTD	85		01.01	10.10				
	1.9 JTD 16V			11.02	10.10				
	1.9 JTDM 16V			07.05	10.10				
	1.9 JTDM 8V	88		07.05	10.10				
	2.0 i 16V T.Spark	110		01.01	10.10				
	3.2 GTA	184		02.03	10.10				
	1.6 i 16V T.Spark	77		01.01	10.10	24.3727-0011.2	580011	<input type="checkbox"/>	L=1235
	1.6 i 16V T.Spark	88		01.01	10.10	24.3727-0010.2	580010	<input type="checkbox"/>	L=1170
	1.9 JTD	74		06.03	10.10				
	1.9 JTD	81		11.00	10.10				
	1.9 JTD	85		01.01	10.10				
	1.9 JTD 16V			11.02	10.10				
	1.9 JTDM 16V			07.05	10.10				
	1.9 JTDM 8V	88		07.05	10.10				
	2.0 i 16V T.Spark	110		01.01	10.10				
	3.2 GTA	184		02.03	10.10				
ALFA ROMEO 155 (92-97)									
	1.7 T.S.			04.93	12.97	24.2122-1716.3	010485		Thz 22,20
	1.8 T.S.			05.92	12.97				
	1.9 TD			03.93	12.97				
	2.0 16V Turbo Q4			11.92	12.97				
	2.0 T.S.			05.92	12.97				
	2.5 TD			03.93	12.97				
	2.5 V6			05.92	12.97				
	1.7 T.S.			04.93	12.97	24.3344-1703.5	240117	<input type="checkbox"/> + GG-Sättel 1)	D=34, - Halter
	1.8 T.S.			05.92	12.97	24.3344-1704.5	240118	<input type="checkbox"/> + GG-Sättel 1)	D=34, - Halter
	1.9 TD			03.93	12.97	24.0101-3601.2	260044		Bremssattel-Zubehör
	2.0 16V Turbo Q4			11.92	12.97				TRW
	2.0 T.S.			05.92	12.97				TRW
	2.5 TD			03.93	12.97				
	2.5 V6			05.92	12.97				
	1.7 T.S.			04.93	12.97	24.5112-0160.3	330612	2	L=160
	1.8 T.S.			05.92	12.97	83.6401-0159.3	330746	2	L=160
	1.9 TD			03.93	12.97				
	2.0 16V Turbo Q4			11.92	12.97				
	2.0 T.S.			05.92	12.97				
	2.5 TD			03.93	12.97				
	2.5 V6			05.92	12.97				
	1.7 T.S.			04.93	12.97	24.3727-0521.2	580521	<input type="checkbox"/>	L=1517
	1.8 T.S.			05.92	12.97	24.3727-0006.2	580006	<input type="checkbox"/>	L=1460
	1.9 TD			03.93	12.97				
	2.0 T.S.			05.92	12.97				
	2.5 TD			03.93	12.97				
	2.5 V6			05.92	12.97				
	1.7 T.S.	◀		04.93	12.97	24.2419-1721.3	030100		Gz 19,05
	1.8 T.S.	◀		05.92	12.97				
	1.9 TD	◀		03.93	12.97				
	2.0 16V Turbo Q4	◀		11.92	12.97				
	2.0 T.S.	◀		05.92	12.97				
	2.5 TD	◀		03.93	12.97				
	1.7 T.S.	◀		04.93	12.97	24.2525-1705.3	040083		Nz 25,40
	1.8 T.S.	◀		05.92	12.97				
	1.9 TD	◀		03.93	12.97				
	2.0 16V Turbo Q4	◀		11.92	12.97				
	2.0 T.S.	◀		05.92	12.97				
	2.5 TD	◀		03.93	12.97	24.2525-1706.3	040088		Nz 25,40

1) + cast iron caliper / + pinza in ghisa / + étriers en fonte grise / + fundición gris-pinza



ALFA ROMEO 156 (97-05)										
	1.6 i 16V T.Spark 1.8 i 16V T.Spark 1.9 JTD			10.97 07.05 10.97 07.05 10.97 07.05		24.2120-1735.3	010726		THz 20,64	
	1.6 i 16V T.Spark 1.8 i 16V T.Spark 1.9 JTD			10.97 02.01 10.97 02.01 10.97 02.01		11.0101-5407.2	260011		Hülsensatz	ATE
	1.6 i 16V T.Spark 1.8 i 16V T.Spark 1.9 JTD 1.9 JTD 16V 1.9 JTD 16V 2.0 16V T.Spark 2.0 JTS 2.4 JTD 2.4 JTD 2.4 JTD 2.4 JTD 2.5 V6 24V 3.2 GTA	103 110		10.97 07.05 10.97 07.05 10.97 07.05 11.02 07.05 07.04 07.05 10.97 07.05 03.02 07.05 10.97 10.00 10.00 07.05 03.02 07.05 10.03 07.05 10.97 07.05 03.02 07.05		24.5112-0397.3	330666	2	L=396	
	1.6 i 16V T.Spark 1.8 i 16V T.Spark 1.9 JTD 1.9 JTD 16V 2.0 16V T.Spark 2.0 JTS 2.4 JTD 2.4 JTD 2.4 JTD 2.5 V6 24V	103		03.02 07.05 03.02 07.05 03.02 07.05 11.02 07.05 03.02 07.05 03.02 07.05 03.02 07.05 03.02 07.05 10.03 07.05 03.02 07.05		24.3384-1741.7 24.3384-1742.7	220599 220600	<input type="checkbox"/> <input type="checkbox"/>	D=38, - Halter D=38, - Halter	TRW TRW
	1.6 i 16V T.Spark 1.8 i 16V T.Spark 1.9 JTD 1.9 JTD 16V 1.9 JTD 16V 2.0 16V T.Spark 2.0 JTS 2.4 JTD 2.4 JTD 2.4 JTD 2.4 JTD 2.5 V6 24V 3.2 GTA	103 110		10.97 07.05 10.97 07.05 10.97 07.05 11.02 07.05 07.04 07.05 10.97 07.05 03.02 07.05 10.97 10.00 10.00 07.05 03.02 07.05 10.03 07.05 10.97 07.05 03.02 07.05		24.5112-0437.3	330886	2	L=435	
	1.6 i 16V T.Spark 1.8 i 16V T.Spark 1.9 JTD 1.9 JTD 16V 1.9 JTD 16V 2.0 16V T.Spark 2.0 JTS 2.4 JTD 2.4 JTD 2.4 JTD 2.4 JTD 2.5 V6 24V 3.2 GTA	103 110		10.97 07.05 10.97 07.05 10.97 07.05 11.02 07.05 07.04 07.05 10.97 07.05 03.02 07.05 10.97 10.00 10.00 07.05 03.02 07.05 10.03 07.05 10.97 07.05 03.02 07.05		24.3727-0005.2 24.3727-0004.2	580005 580004	<input type="checkbox"/> <input type="checkbox"/>	L=1256 L=1196	
	1.6 i 16V T.Spark 1.8 i 16V T.Spark 1.9 JTD 1.9 JTD 16V 1.9 JTD 16V 2.0 16V T.Spark 2.0 JTS 2.4 JTD 2.4 JTD 2.4 JTD 2.4 JTD 2.5 V6 24V 3.2 GTA	103 110		10.97 07.05 10.97 07.05 10.97 07.05 11.02 07.05 07.04 07.05 10.97 07.05 03.02 07.05 10.97 10.00 10.00 07.05 03.02 07.05 10.03 07.05 10.97 07.05 03.02 07.05		03.2525-2201.3	040026		Nz 25,40	

ALFA ROMEO 159 (05-11)										
	1.8 MPI 1.9 JTDM 16V 1.9 JTDM 8V 1.9 JTS 2.2 JTS 2.4 JTDM 20V 2.4 JTDM 20V 2.4 JTDM 20V Q4 3.2 JTS 3.2 JTS Q4	103		03.07 06.08 06.05 06.08 06.05 06.08 06.05 06.08 06.05 06.08 06.05 06.08 05.07 06.08 05.07 06.08 02.08 06.08 12.05 06.08		24.2125-1733.3 24.2125-1732.3	010830 010827	- Dynamic Control 1) + Dynamic Control 2)	THz 25,40 THz 25,40	TRW TRW
	1.8 MPI 1.8 Tbi 1.9 JTDM 16V 1.9 JTDM 8V 1.9 JTS 2.0 JTDM	103 147		07.08 10.11 05.09 10.11 07.08 10.11 07.08 10.11 07.08 10.11 06.10 10.11		24.2125-1733.3	010830		THz 25,40	TRW





















1) - dynamic control / - dynamic control / - dynamic control / - Control dinámico
2) + dynamic control / + dynamic control / + dynamic control / + Control dinámico























ALFA ROMEO 159 (05-11)										
	2.0 JTDM 2.0 JTDM 2.2 JTS 2.4 JTDM 20V 2.4 JTDM 20V 2.4 JTDM 20V Q4 3.2 JTS 3.2 JTS Q4	120 125 136 147 154 154 191 191		05.09 05.09 07.08 07.08 07.08 07.08 07.08 07.08	10.11 10.11 10.11 10.11 10.11 10.11 10.11 10.11	24.2125-1733.3	010830		THz 25,40	TRW
	1.8 MPI 1.9 JTDM 16V 1.9 JTDM 8V 1.9 JTS 2.2 JTS	103 118 136		03.07 06.05 06.05 06.05 06.05	10.11 10.11 10.11 10.11 10.11	11.8171-0008.1 11.0101-5407.2 11.8116-0237.1	990049 260011 390509	2	Führungsbolzen Hülzensatz Haltefeder	ATE ATE ATE
	1.8 MPI 1.9 JTDM 16V 1.9 JTDM 8V 1.9 JTS 2.2 JTS	103 118 136		03.07 06.05 06.05 06.05 06.05	10.11 10.11 10.11 10.11 10.11	83.7101-9504.3	330898	2	L=504	
	1.8 MPI 1.9 JTDM 16V 1.9 JTDM 8V 1.9 JTS 2.0 JTDM 2.0 JTDM 2.0 JTDM 2.2 JTS	103 118 100 120 125 136		03.07 06.05 06.05 06.05 05.09 05.09 06.05	10.11 10.11 10.11 10.11 10.11 10.11 10.11	24.3387-1713.7 24.3387-1714.7	220749 220750	<input type="checkbox"/> <input type="checkbox"/>	D=38, - Halter D=38, - Halter	TRW TRW
	1.8 Tbi 2.4 JTDM 20V 2.4 JTDM 20V 2.4 JTDM 20V Q4 3.2 JTS 3.2 JTS Q4	147 147 154 154 191 191		05.09 06.05 05.07 05.07 02.08 12.05	10.11 10.11 10.11 10.11 10.11 10.11	24.3417-1705.7 24.3417-1706.7	220769 220770	<input type="checkbox"/> <input type="checkbox"/>	D=41, - Halter D=41, - Halter	TRW TRW
	1.8 MPI 1.8 Tbi 1.9 JTDM 16V 1.9 JTDM 8V 1.9 JTS 2.0 JTDM 2.0 JTDM 2.0 JTDM 2.2 JTS 2.4 JTDM 20V 2.4 JTDM 20V 2.4 JTDM 20V Q4 3.2 JTS 3.2 JTS Q4	103 147 118 100 120 125 136 147 154 154 191 191		03.07 05.09 06.05 06.05 06.05 06.10 05.09 05.09 06.05 06.05 05.07 05.07 02.08 12.05	10.11 10.11 10.11 10.11 10.11 10.11 10.11 10.11 10.11 10.11 10.11 10.11 10.11 10.11	83.7101-9399.3	330904	2	L=399	
ALFA ROMEO 164 (92-98)										
	2.0 Turbo			09.91 09.98	09.98 - Serie Super 1)	24.3727-0514.2	580514	1	L=2950	
	2.0 T.Spark 2.5 TD 3.0 i V6 3.0 i V6 3.0 i V6 Q.V. 3.0 i V6 Q.V.	135 156 147 171		09.91 09.91 09.91 12.92 09.91 12.92	09.98 02.93 11.92 - Serie Super 1) 09.98 - Serie Super 1) 11.92 02.93	24.2523-1702.3	040087		Nz 23,81	
	2.0 Turbo 2.5 TD 3.0 i 24V Super 3.0 i V6 Q.V. 3.0 i V6 Q.V. Q4	155 171 171		09.91 03.93 12.92 03.93 04.94	09.98 09.98 09.98 09.98 09.98	03.2525-2201.3	040026		Nz 25,40	
ALFA ROMEO 166 (98-07)										
	2.0 i 16V T.Spark 2.0 i V6 Turbo 2.4 JTD 2.4 JTD 2.4 JTD 2.4 JTD 2.4 JTD 2.4 JTD 2.4 JTD 2.5 i V6 3.0 i V6 3.2 i V6	100 103 110 120 129 132 136		10.98 10.98 10.98 04.02 10.03 10.03 07.06 07.05 10.98 10.98 10.03	10.00 12.07 12.07 12.07 12.07 12.07 12.07 12.07 12.07 12.07 12.07 12.07	24.2125-1723.3	010689	+ ABS	THz 25,40	
	2.0 i 16V T.Spark 2.0 i V6 Turbo 2.5 i V6 3.0 i V6 3.2 i V6			10.98 10.98 10.98 10.03	12.07 12.07 12.07 12.07	24.3727-0013.2 24.3727-0012.2	580013 580012	<input type="checkbox"/> <input type="checkbox"/>	L=1445, + Zub L=1427, + Zub	
	2.4 JTD 2.4 JTD 2.4 JTD 2.4 JTD 2.4 JTD	100 103 110 120 129		10.98 10.00 04.02 10.03 10.03	10.00 12.07 12.07 12.07 12.07	24.3727-0013.2 24.3727-0012.2	580013 580012	<input type="checkbox"/> <input type="checkbox"/>	L=1445, + Zub L=1427, + Zub	

1) - series super / - serie super / - Série super / - serie súper



									
ALFA ROMEO 166 (98-07)									
	2.4 JTD 2.4 JTD	132 136		07.06 07.05	12.07 12.07	24.3727-0013.2 24.3727-0012.2	580013 580012	<input type="checkbox"/> <input checked="" type="checkbox"/>	L=1445, + Zub L=1427, + Zub
	2.0 i 16V T.Spark 2.0 i V6 Turbo 2.4 JTD 2.4 JTD 2.4 JTD 2.4 JTD 2.4 JTD 2.4 JTD 2.4 JTD 2.5 i V6 3.0 i V6 3.2 i V6			10.98 10.98 10.98 10.00 04.02 10.03 10.03 07.06 07.05 10.98 10.98 10.03	12.07 12.07 12.07 12.07 12.07 12.07 12.07 12.07 12.07 12.07 12.07 12.07	24.2525-1706.3	040088		Nz 25,40
ALFA ROMEO BRERA (06-11)									
	1.8 TBi 2.0 JTDM 2.2 JTS 2.4 JTDM 20V 2.4 JTDM 20V 3.2 JTS 3.2 JTS Q4	147 125 136 147 154 191 191		05.09 05.09 12.05 12.05 02.07 03.08 12.05	09.11 09.11 09.11 09.11 09.11 09.11 09.11	24.2125-1732.3	010827		Thz 25,40
	2.2 JTS	136		12.05	09.11	11.8171-0008.1 11.0101-5407.2 11.8116-0237.1	990049 260011 390509	2	Führungsbolzen Hülzensatz Haltefeder
	2.2 JTS	136		12.05	09.11	83.7101-9504.3	330898	2	L=504
	2.0 JTDM 2.2 JTS 1.8 TBi 2.4 JTDM 20V 2.4 JTDM 20V 3.2 JTS 3.2 JTS Q4	125 136 147 147 154 191 191		05.09 12.05 05.09 12.05 02.07 03.08 12.05	09.11 09.11 09.11 09.11 09.11 09.11 09.11	24.3387-1713.7 24.3387-1714.7 24.3417-1705.7 24.3417-1706.7	220749 220750 220769 220770	<input checked="" type="checkbox"/> <input checked="" type="checkbox"/> <input checked="" type="checkbox"/> <input checked="" type="checkbox"/>	D=38, - Halter D=38, - Halter D=41, - Halter D=41, - Halter
	1.8 TBi 2.0 JTDM 2.2 JTS 2.4 JTDM 20V 2.4 JTDM 20V 3.2 JTS 3.2 JTS Q4	147 125 136 147 154 191 191		05.09 05.09 12.05 12.05 02.07 03.08 12.05	09.11 09.11 09.11 09.11 09.11 09.11 09.11	83.7101-9399.3	330904	2	L=399
	1.8 TBi 2.0 JTDM 2.2 JTS 2.4 JTDM 20V 2.4 JTDM 20V 3.2 JTS 3.2 JTS Q4	147 125 136 147 154 191 191		05.09 05.09 12.05 12.05 02.07 03.08 12.05	09.11 09.11 09.11 09.11 09.11 09.11 09.11	24.3727-0014.2 24.3727-0015.2	580014 580015	<input type="checkbox"/> <input checked="" type="checkbox"/>	L=1662 L=1577
ALFA ROMEO GIULIETTA (10-)									
	1.4 BiFuel 1.4 TB 1.4 TB 1.4 TB 1.4 TB MultiAir 1.6 JTDM 1.6 JTDM 1.8 TBi 1.8 TBi 2.0 JTDM 2.0 JTDM 2.0 JTDM	88 77 88 120 125 77 88 173 177 103 110 125		12.11 04.11 04.10 04.10 04.10 04.10 02.15 04.10 09.13 04.10 08.13 04.10		03.2123-3571.3	010962		Thz 23,81
	1.4 BiFuel 1.4 TB 1.6 JTDM 1.6 JTDM 2.0 JTDM 2.0 JTDM 2.0 JTDM	88 88 77 88 103 110 125		12.11 04.10 04.10 02.15 04.10 08.13 04.10		11.9571-9969.2 11.9571-9970.2 11.8171-0008.1	220955 220956 990049	<input checked="" type="checkbox"/> <input checked="" type="checkbox"/> <input checked="" type="checkbox"/>	- Sonderbremszange ¹⁾ - Sonderbremszange ¹⁾ D=57, - Halter D=57, - Halter Führungsbolzen
	1.4 BiFuel 1.4 TB 1.4 TB 1.4 TB 1.4 TB MultiAir 1.6 JTDM 1.6 JTDM 1.8 TBi 1.8 TBi 2.0 JTDM 2.0 JTDM 2.0 JTDM	88 77 88 120 125 77 88 173 177 103 110 125		12.11 04.11 04.10 04.10 04.10 04.10 02.15 04.10 09.13 04.10 08.13 04.10		24.5112-0414.3	331453	2	- Sonderbremszange ¹⁾ L=410

¹⁾ - special brake caliper / - pinza freno speciale / - pince à frein spéciale / - pinza freno especial

									
ALFA ROMEO GT (04-10)									
	1.8 TS 1.9 JTD 1.9 JTD 2.0 JTS	103 110 125 121	11.03 11.03 05.08 11.03	07.10 07.10 07.10 07.10	24.5112-0397.3	330666	2	L=396	
	1.8 TS 1.9 JTD 1.9 JTD 2.0 JTS	103 110 125 121	11.03 11.03 05.08 11.03	07.10 07.10 07.10 07.10	24.3384-1741.7 24.3384-1742.7	220599 220600	<input type="checkbox"/> <input type="checkbox"/>	D=38, - Halter D=38, - Halter	TRW TRW
	1.8 TS 1.9 JTD 1.9 JTD 2.0 JTS 3.2 i V6	103 110 125 121 176	11.03 11.03 05.08 11.03 11.03	07.10 07.10 07.10 07.10 07.10	24.5112-0437.3	330886	2	L=435	
	1.8 TS 1.9 JTD 1.9 JTD 2.0 JTS 3.2 i V6	103 110 125 121 176	11.03 11.03 05.08 11.03 11.03	07.10 07.10 07.10 07.10 07.10	24.3727-0005.2 24.3727-0004.2	580005 580004	<input type="checkbox"/> <input type="checkbox"/>	L=1256 L=1196	
			11.03	07.10	24.3727-0004.2	580004	<input type="checkbox"/>	L=1196	
ALFA ROMEO GTV (95-05)									
	1.8 i 16V 2.0 i 16V 2.0 i V6 Turbo 2.0 JTS 3.0 i V6 3.2 i V6	106 148 148 121 176 176	04.98 05.95 05.95 04.03 10.96 04.03	12.05 12.05 12.05 12.05 12.05 12.05	24.2122-1716.3	010485		THz 22,20	
	1.8 i 16V 2.0 i 16V 2.0 i V6 Turbo 2.0 JTS	106 148 148 121	04.98 05.95 05.95 04.03	12.05 12.05 12.05 12.05	24.5112-0160.3	330612	2	L=160	
	1.8 i 16V 2.0 i 16V 2.0 i V6 Turbo 2.0 JTS 3.0 i V6 3.2 i V6	106 148 148 121 176 176	04.98 05.95 05.95 04.03 10.96 04.03	12.05 12.05 12.05 12.05 12.05 12.05	24.2419-1721.3	030100		Gz 19,05	
	1.8 i 16V 2.0 i 16V 2.0 i V6 Turbo 2.0 JTS 3.0 i V6 3.2 i V6	106 148 148 121 176 176	04.98 05.95 05.95 04.03 10.96 04.03	12.05 12.05 12.05 12.05 12.05 12.05	24.2525-1705.3	040083		Nz 25,40	
ALFA ROMEO MITO (08-)									
	0.9 0.9 1.4 1.4 i 16V 1.4 i 16V 1.4 i 16V	63 77 77 51 58 70	07.11 04.13 08.10 05.11 08.08 08.08		24.4122-1709.3	010871		THz 22,20 - Behälter	BOS
	0.9 0.9 1.4 1.4 i 16V 1.4 i 16V 1.4 i 16V	63 77 77 51 58 70	07.11 04.13 08.10 05.11 08.08 08.08		24.3541-1769.5 24.3541-1770.5	240601 240602	<input type="checkbox"/> <input type="checkbox"/>	D=54, - Halter D=54, - Halter	BOS BOS
	0.9 0.9 1.3 JTDM 1.3 JTDM 1.3 JTDM 1.4 1.4 1.4 1.4 Bifuel 1.4 i 16V 1.4 i 16V 1.4 i 16V 1.4 TB 1.6 JTD 1.6 JTDM	63 77 62 66 70 77 88 88 51 58 70 99 88 85	07.11 04.13 01.11 08.08 10.09 08.10 08.08 07.11 05.11 08.08 08.08 09.09 08.08 09.08		24.5112-0402.3	331297	2	L=402	
	0.9 0.9 1.3 JTDM 1.3 JTDM 1.3 JTDM 1.4 1.4 1.4 1.4 Bifuel 1.4 i 16V 1.4 i 16V 1.4 i 16V 1.4 TB 1.4 TB 1.4 TB 1.4 Turbo 1.6 JTD	63 77 62 66 70 77 88 88 51 58 70 99 114 125 110 88	07.11 04.13 01.11 08.08 10.09 08.10 08.08 07.11 05.11 08.08 08.08 09.09 08.08 10.09 09.08 08.08		24.5112-0142.3 24.5228-0216.3	331016 330908	2 2	am Bremssattel ¹⁾ L=142 L=216	

¹⁾ on the brake caliper / sulla pinza freno / sur l'étrier de frein / a la pinza de freno















ALFA ROMEO MITO (08-)										
	1.6 JTDM	85		09.08		24.5112-0142.3	331016	2	am Bremssattel ¹⁾	L=142 L=216
						24.5228-0216.3	330908	2		
	0.9	63		07.11		24.3727-0579.2	580579	<input type="checkbox"/>		L=1654
	0.9	77		04.13		24.3727-0580.2	580580	<input type="checkbox"/>		L=1673
	1.3 JTDM	62		01.11						
	1.3 JTDM	66		08.08						
	1.3 JTDM	70		10.09						
	1.4	77		08.10						
	1.4	88		08.08						
	1.4 Bifuel	88		07.11						
	1.4 i 16V	51		05.11						
	1.4 i 16V	58		08.08						
	1.4 i 16V	70		08.08						
	1.4 TB	99		09.09						
	1.4 TB	114		08.08						
	1.4 TB	125		10.09						
	1.4 Turbo	110		09.08						
	1.6 JTD	88		08.08						
	1.6 JTDM	85		09.08						

ALFA ROMEO SPIDER (95-05)										
	1.8 i 16V	106		04.98	12.05	24.2122-1716.3	010485			Thz 22,20
	2.0 16V	114		05.98	12.05					
	2.0 i 16V	110		05.95	12.05					
	2.0 i V6 Turbo	148		05.98	12.05					
	2.0 JTS	121		04.03	12.05					
	3.0 i V6	141		05.95	12.05					
	3.0 V6	160		10.00	12.05					
	3.0 V6 24V	162		01.99	12.05					
	3.2 i V6	176		04.03	12.05					
	2.0 i 16V	110		05.95	12.05	24.3344-1703.5	240117	<input type="checkbox"/>	+ GG-Sättel ²⁾	D=34, - Halter
	3.0 i V6	141		05.95	12.05	24.3344-1704.5	240118	<input type="checkbox"/>	+ GG-Sättel ²⁾	D=34, - Halter
										TRW
										TRW
	1.8 i 16V	106		04.98	12.05	24.2419-1721.3	030100			Gz 19,05
	2.0 16V	114		05.98	12.05					
	2.0 i 16V	110		05.95	12.05					
	2.0 i V6 Turbo	148		05.98	12.05					
	2.0 JTS	121		04.03	12.05					
	3.0 i V6	141		05.95	12.05					
	3.0 V6	160		10.00	12.05					
	3.0 V6 24V	162		01.99	12.05					
	3.2 i V6	176		04.03	12.05					
	1.8 i 16V	106		04.98	12.05	24.2525-1705.3	040083			Nz 25,40
	2.0 16V	114		05.98	12.05					
	2.0 i 16V	110		05.95	12.05					
	2.0 i V6 Turbo	148		05.98	12.05					
	2.0 JTS	121		04.03	12.05					
	3.0 i V6	141		05.95	12.05					
	3.0 V6	160		10.00	12.05					
	3.0 V6 24V	162		01.99	12.05					
	3.2 i V6	176		04.03	12.05					

ALFA ROMEO SPIDER (06-11)										
	2.2 JTS	136		04.06	09.06	24.2125-1732.3	010827			Thz 25,40
	3.2 JTS Q4	191		04.06	09.06					TRW
	1.8 TBi	147		05.09	09.11	24.2125-1733.3	010830			Thz 25,40
	2.0 JTDM	120		04.09	09.11					
	2.0 JTDM	125		05.09	09.11					
	2.2 JTS	136		10.06	09.11					
	2.4 JTDM 20V	147		02.07	09.11					
	2.4 JTDM 20V	154		05.07	09.11					
	3.2 JTS	191		03.08	09.11					
	3.2 JTS Q4	191		10.06	09.11					
	2.2 JTS	136		04.06	02.08	11.8171-0008.1	990049			Führungsbolzen
						11.0101-5407.2	260011			Hülzensatz
						11.8116-0237.1	390509	2		Haltefeder
										ATE
										ATE
	2.2 JTS	136		04.06	02.08	83.7101-9504.3	330898	2		L=504
	2.0 JTDM	120		04.09	09.11	24.3387-1713.7	220749	<input type="checkbox"/>		D=38, - Halter
	2.0 JTDM	125		05.09	09.11	24.3387-1714.7	220750	<input type="checkbox"/>		D=38, - Halter
	2.2 JTS	136		04.06	09.11					TRW
	1.8 TBi	147		05.09	09.11	24.3417-1705.7	220769	<input type="checkbox"/>		D=41, - Halter
	2.4 JTDM 20V	147		02.07	09.11	24.3417-1706.7	220770	<input type="checkbox"/>		D=41, - Halter
	2.4 JTDM 20V	154		05.07	09.11					TRW
	3.2 JTS	191		03.08	09.11					TRW
	3.2 JTS Q4	191		04.06	09.11					
	1.8 TBi	147		05.09	09.11	83.7101-9399.3	330904	2		L=399
	2.0 JTDM	120		04.09	09.11					
	2.0 JTDM	125		05.09	09.11					
	2.2 JTS	136		04.06	09.11					
	2.4 JTDM 20V	147		02.07	09.11					
	2.4 JTDM 20V	154		05.07	09.11					
	3.2 JTS	191		03.08	09.11					
	3.2 JTS Q4	191		04.06	09.11					

¹⁾ on the brake caliper / sulla pinza freno / sur l'étrier de frein / a la pinza de freno
²⁾ + cast iron caliper / + pinza in ghisa / + étriers en fonte grise / + fundición gris-pinza

												
ALFA ROMEO SPIDER (06-11)												
	1.8 TBI	147		05.09	09.11		24.3727-0014.2	580014	<input type="checkbox"/>		L=1662	
	2.0 JTDM	120		04.09	09.11		24.3727-0015.2	580015	<input type="checkbox"/>		L=1577	
	2.0 JTDM	125		05.09	09.11							
	2.2 JTS	136		04.06	09.11							
	2.4 JTDM 20V	147		02.07	09.11							
	2.4 JTDM 20V	154		05.07	09.11							
	3.2 JTS	191		03.08	09.11							
	3.2 JTS Q4	191		04.06	09.11							
AUDI A1 / A1 Sportback (10-)												
	2.0 TFSI quattro	188		10.12			03.2125-5112.3	010966			ThZ 25,40	ATE
	1.0 TFSI	70		03.15		PR: 1ZG	11.9541-9549.2	220575	<input type="checkbox"/>		D=54, - Halter	ATE
	1.2 TFSI	63		05.10		PR: 1ZG	11.9541-9550.2	220576	<input type="checkbox"/>		D=54, - Halter	ATE
	1.4 TDI	66		11.14		PR: 1ZG	11.0101-5409.2	260035			Hülsensatz	ATE
	1.4 TFSI	90		05.10		PR: 1ZG	11.8171-0008.1	990049			Führungsbolzen	ATE
	1.4 TFSI	92		11.14		PR: 1ZG						
	1.4 TFSI	103		04.12		PR: 1ZG						
	1.4 TFSI	110		11.14		PR: 1ZG						
	1.4 TFSI	136		11.10		PR: 1ZG						
	1.6 TDI	66		05.10		PR: 1ZG						
	1.6 TDI	77		05.10		PR: 1ZG						
	1.6 TDI	85		11.14		PR: 1ZG						
	1.8 TFSI	141		02.15		PR: 1ZG						
	2.0 TDI	105		09.11		PR: 1ZG						
	2.0 TFSI quattro	188		10.12		PR: 1ZG						
	2.0 TFSI quattro	188		10.12		PR: 1ZG						
	1.0 TFSI	60		01.16		PR: 1ZC	11.9541-9553.2	220563	<input type="checkbox"/>		D=54, - Halter	ATE
	1.0 TFSI	70		03.15		PR: 1ZC	11.9541-9554.2	220564	<input type="checkbox"/>		D=54, - Halter	ATE
	1.2 TFSI	63		05.10		PR: 1ZC	11.0101-5409.2	260035			Hülsensatz	ATE
	1.4 TDI	66		11.14		PR: 1ZC	11.8171-0008.1	990049			Führungsbolzen	ATE
	1.4 TFSI	90		05.10		PR: 1ZC						
	1.4 TFSI	92		11.14		PR: 1ZC						
	1.4 TFSI	103		04.12		PR: 1ZC						
	1.4 TFSI	110		11.14		PR: 1ZC						
	1.4 TFSI	136		11.10		PR: 1ZC						
	1.6 TDI	66		05.10		PR: 1ZC						
	1.6 TDI	77		05.10		PR: 1ZC						
	1.6 TDI	85		11.14		PR: 1ZC						
	1.8 TFSI	141		02.15		PR: 1ZC						
	2.0 TDI	105		09.11		PR: 1ZC						
	2.0 TFSI quattro	188		10.12		PR: 1ZC						
	2.0 TFSI quattro	188		10.12		PR: 1ZC						
	S1	170		03.14		PR: 1ZC						
	1.0 TFSI	60		01.16		PR: 1ZS	11.9541-9553.2	220563	<input type="checkbox"/>		D=54, - Halter	ATE
	1.0 TFSI	70		03.15		PR: 1ZS	11.9541-9554.2	220564	<input type="checkbox"/>		D=54, - Halter	ATE
	1.2 TFSI	63		05.10		PR: 1ZS	11.8116-0351.1	390538	2		Haltefeder	ATE
	1.4 TDI	66		11.14		PR: 1ZS	11.0101-5407.2	260011			Hülsensatz	ATE
	1.4 TFSI	90		05.10		PR: 1ZS	11.8171-0008.1	990049			Führungsbolzen	ATE
	1.4 TFSI	92		11.14		PR: 1ZS						
	1.4 TFSI	103		04.12		PR: 1ZS						
	1.4 TFSI	136		11.10		PR: 1ZS						
	1.6 TDI	66		05.10		PR: 1ZS						
	1.6 TDI	77		05.10		PR: 1ZS						
	1.6 TDI	85		11.14		PR: 1ZS						
	1.8 TFSI	141		02.15		PR: 1ZS						
	2.0 TDI	105		09.11		PR: 1ZS						
	2.0 TFSI quattro	188		10.12		PR: 1ZS						
	2.0 TFSI quattro	188		10.12		PR: 1ZS						
	S1	170		03.14		PR: 1ZS						
	1.2 TFSI	63		05.10		PR: 1LJ	11.9541-9553.2	220563	<input type="checkbox"/>		D=54, - Halter	ATE
	1.4 TFSI	90		05.10		PR: 1LJ	11.9541-9554.2	220564	<input type="checkbox"/>		D=54, - Halter	ATE
	1.4 TFSI	103		04.12		PR: 1LJ	11.0101-5407.2	260011			Hülsensatz	ATE
	1.4 TFSI	136		11.10		PR: 1LJ	11.8171-0008.1	990049			Führungsbolzen	ATE
	1.6 TDI	66		05.10		PR: 1LJ						
	1.6 TDI	77		05.10		PR: 1LJ						
	2.0 TDI	105		09.11		PR: 1LJ						
	2.0 TFSI quattro	188		10.12		PR: 1LJ						
	1.0 TFSI	60		01.16		PR: 1ZM	11.0101-5407.2	260011			Hülsensatz	ATE
	1.0 TFSI	70		03.15		PR: 1ZM	11.8171-0008.1	990049			Führungsbolzen	ATE
	1.2 TFSI	63		05.10		PR: 1ZM	11.8116-0351.1	390538	2		Haltefeder	ATE
	1.4 TDI	66		11.14		PR: 1ZM						
	1.4 TFSI	90		05.10		PR: 1ZM						
	1.4 TFSI	92		11.14		PR: 1ZM						
	1.4 TFSI	103		04.12		PR: 1ZM						
	1.4 TFSI	136		11.10		PR: 1ZM						
	1.6 TDI	66		05.10		PR: 1ZM						
	1.6 TDI	77		05.10		PR: 1ZM						
	1.6 TDI	85		11.14		PR: 1ZM						
	1.8 TFSI	141		02.15		PR: 1ZM						
	2.0 TDI	105		09.11		PR: 1ZM						
	2.0 TFSI quattro	188		10.12		PR: 1ZM						
	2.0 TFSI quattro	188		10.12		PR: 1ZM						
	S1	170		03.14		PR: 1ZM						
	1.0 TFSI	60		01.16		PR: 1ZN	11.0101-5407.2	260011			Hülsensatz	ATE
	1.0 TFSI	70		03.15		PR: 1ZN	11.8171-0008.1	990049			Führungsbolzen	ATE
	1.2 TFSI	63		05.10		PR: 1ZN	11.8116-0351.1	390538	2		Haltefeder	ATE
	1.4 TDI	66		11.14		PR: 1ZN						
	1.4 TFSI	90		05.10		PR: 1ZN						
	1.4 TFSI	92		11.14		PR: 1ZN						



AUDI A1 / A1 Sportback (10-)

	1.4 TFSI	103		04.12	PR: 1ZN	11.0101-5407.2	260011	2		Hülsensatz Führungsbolzen Haltefeder	ATE ATE ATE
	1.4 TFSI	136		11.10	PR: 1ZN	11.8171-0008.1	990049				
	1.6 TDI	66		05.10	PR: 1ZN	11.8116-0351.1	390538				
	1.6 TDI	77		05.10	PR: 1ZN						
	1.6 TDI	85		11.14	PR: 1ZN						
	1.8 TFSI	141		02.15	PR: 1ZN						
	2.0 TDI	105		09.11	PR: 1ZN						
	2.0 TFSI quattro	188		10.12	PR: 1ZN						
	S1	170		03.14	PR: 1ZN						
		1.0 TFSI	60		01.16	PR: 1KT	24.3387-1735.5				
1.0 TFSI		70		03.15	PR: 1KT	24.3387-1736.5	240658				
1.2 TFSI		63		05.10	PR: 1KT						
1.4 TDI		66		11.14	PR: 1KT						
1.4 TFSI		90		05.10	PR: 1KT						
1.4 TFSI		92		11.14	PR: 1KT						
1.4 TFSI		103		04.12	PR: 1KT						
1.4 TFSI		110		11.14	PR: 1KT						
1.4 TFSI		136		11.10	PR: 1KT						
1.6 TDI		66		05.10	PR: 1KT						
1.6 TDI		77		05.10	PR: 1KT						
1.6 TDI		85		11.14	PR: 1KT						
1.8 TFSI		141		02.15	PR: 1KT						
2.0 TDI		105		09.11	PR: 1KT						
2.0 TFSI quattro		188		10.12	PR: 1KT						
		1.0 TFSI	60		01.16	PR: 1KT	83.7858-0140.3	330837	2		L=140
	1.0 TFSI	70		03.15	PR: 1KT						
	1.2 TFSI	63		05.10	PR: 1KT						
	1.4 TDI	66		11.14	PR: 1KT						
	1.4 TFSI	90		05.10	PR: 1KT						
	1.4 TFSI	92		11.14	PR: 1KT						
	1.4 TFSI	103		04.12	PR: 1KT						
	1.4 TFSI	110		11.14	PR: 1KT						
	1.4 TFSI	136		11.10	PR: 1KT						
	1.6 TDI	66		05.10	PR: 1KT						
	1.6 TDI	77		05.10	PR: 1KT						
	1.6 TDI	85		11.14	PR: 1KT						
	1.8 TFSI	141		02.15	PR: 1KT						
	2.0 TDI	105		09.11	PR: 1KT						
2.0 TFSI quattro	188		10.12	PR: 1KT							
	1.2 TFSI	63		05.10	PR: 1KS	83.7847-0254.3	331233	2		L=255 L=255	
	1.4 TFSI	90		05.10	PR: 1KS	83.7847-0257.3	331234				
	1.4 TFSI	103		04.12	PR: 1KS						
	1.4 TFSI	136		11.10	PR: 1KS						
	1.6 TDI	66		05.10	PR: 1KS						
	1.6 TDI	77		05.10	PR: 1KS						
	2.0 TDI	105		09.11	PR: 1KS						
	2.0 TFSI quattro	188		10.12	PR: 1KS						
	1.0 TFSI	60		01.16		24.3727-3403.2	583403	2		L=1642	
	1.0 TFSI	70		03.15							
	1.2 TFSI	63		05.10							
	1.4 TDI	66		11.14							
	1.4 TFSI	90		05.10							
	1.4 TFSI	92		11.14							
	1.4 TFSI	103		04.12							
	1.4 TFSI	110		11.14							
	1.4 TFSI	136		11.10							
	1.6 TDI	66		05.10							
1.6 TDI	77		05.10								
1.6 TDI	85		11.14								
2.0 TDI	105		09.11								
	1.0 TFSI	60		01.16	PR: OEM	24.2519-1706.3	040096			Nz 19,05	
	1.0 TFSI	70		03.15	PR: OEM						
	1.2 TFSI	63		05.10	PR: OEM						
	1.4 TFSI	90		05.10	PR: OEM						
	1.4 TFSI	103		04.12	PR: OEM						
	1.4 TFSI	136		11.10	PR: OEM						
	1.6 TDI	66		05.10	PR: OEM						
	1.6 TDI	77		05.10	PR: OEM						
	2.0 TDI	105		09.11	PR: OEM						
	2.0 TFSI quattro	188		10.12	PR: OEM						
S1	170		03.14	PR: OEM							

AUDI A2 (00-05)

	1.2 TDI	◀ 45	8Z-2-013000	03.01		03.7853-0202.4	300181			9"	ATE
	1.4	◀ 55	8Z-2-013000	06.00							
	1.4 TDI	◀ 55	8Z-2-013000	06.00							
	1.2 TDI	◀ 45	8Z-2-013001		07.05	03.7850-0102.4	300180			9"	ATE
	1.4	◀ 55	8Z-2-013001		07.05						
	1.4 TDI	◀ 55	8Z-2-013001		07.05						
	1.4 TDI	◀ 66			11.03	07.05					
	1.6 FSI	◀ 81			05.02	07.05					
	1.2 TDI	◀ 45	8Z-2-013000	03.01		03.2122-1663.3	010734			Thz 22,20	ATE
	1.4	◀ 55	8Z-2-013000	06.00							
	1.4 TDI	◀ 55	8Z-2-013000	06.00							
	1.2 TDI	◀ 45	8Z-3-019000			03.2122-1883.3	010735			Thz 22,20	ATE
	1.4	◀ 55	8Z-3-019000								

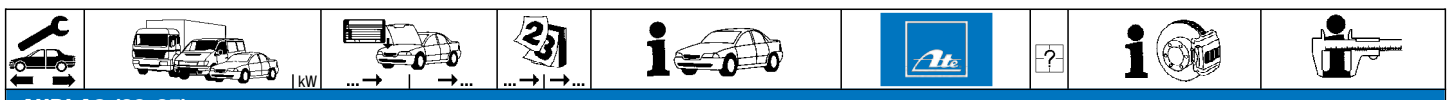































AUDI A2 (00-05)

	1.4 TDI	◀ 55	8Z-2-013001	8Z-3-019000				03.2122-1883.3	010735			Thz 22,20	ATE
	1.6 FSI	◀ 81		8Z-3-019000	05.02								
	1.2 TDI	◀ 45	8Z-3-019001			07.05		03.2122-1888.3	010736			Thz 22,20	ATE
	1.4	◀ 55	8Z-3-019001			07.05							
	1.4 TDI	◀ 55	8Z-3-019001			07.05							
	1.4 TDI	◀ 66			11.03	07.05							
	1.6 FSI	◀ 81	8Z-3-019001			07.05							
	1.2 TDI	▶ 45		8Z-2-013000	03.01			03.2122-1663.3	010734			Thz 22,20	ATE
	1.4	▶ 55		8Z-2-013000	06.00								
	1.4 TDI	▶ 55		8Z-2-013000	06.00								
	1.2 TDI	▶ 45	8Z-3-019001			07.05		03.2122-1888.3	010736			Thz 22,20	ATE
	1.4	▶ 55	8Z-3-019001			07.05							
	1.4 TDI	▶ 55	8Z-3-019001			07.05							
	1.4 TDI	▶ 66			11.03	07.05							
	1.6 FSI	▶ 81	8Z-3-019001			07.05							
	1.2 TDI	45			03.01	07.05		11.9486-0009.2	220841	<input type="checkbox"/>	<input type="checkbox"/>	D=48, - Halter	ATE
								11.9486-0010.2	220842	<input type="checkbox"/>	<input type="checkbox"/>	D=48, - Halter	ATE
								11.0101-5409.2	260035	<input type="checkbox"/>	<input type="checkbox"/>	Hülzensatz	ATE
								11.8171-0008.1	990049	<input type="checkbox"/>	<input type="checkbox"/>	Führungsbolzen	ATE
	1.4	55			06.00	07.05		11.9541-9549.2	220575	<input type="checkbox"/>	<input type="checkbox"/>	D=54, - Halter	ATE
	1.4 TDI	55			06.00	07.05		11.9541-9550.2	220576	<input type="checkbox"/>	<input type="checkbox"/>	D=54, - Halter	ATE
	1.4 TDI	66			11.03	07.05		11.0101-5409.2	260035	<input type="checkbox"/>	<input type="checkbox"/>	Hülzensatz	ATE
	1.6 FSI	81			05.02	07.05		11.8171-0069.1	250152	<input type="checkbox"/>	<input type="checkbox"/>	Führungsbolzen	ATE
	1.2 TDI	45			03.01	07.05		83.6243-0385.3	330632	2		L=385	
	1.4	55			06.00	07.05		83.6238-0508.3	330631	2		L=505	
	1.4 TDI	55			06.00	07.05							
	1.6 FSI	81			11.03	07.05							
	1.4 TDI	66			11.03	07.05		24.3344-1709.7	220537	<input type="checkbox"/>	<input type="checkbox"/>	D=34, - Halter	TRW
	1.6 FSI	81			05.02	07.05		24.3344-1710.7	220538	<input type="checkbox"/>	<input type="checkbox"/>	D=34, - Halter	TRW
	1.2 TDI	45			03.01	07.05		24.5242-0190.3	330675	2		L=190	
	1.4	55			06.00	07.05							
	1.4 TDI	55			06.00	07.05							
	1.4 TDI	66			11.03	07.05							
	1.6 FSI	81			05.02	07.05							
	1.2 TDI	45			03.01	07.05	PR: 1KR	24.3215-0903.3	020154			Rz 15,87	
	1.4 TDI	55			06.00	07.05	PR: 1KR						
	1.4	55			06.00	07.05	PR: 1KB	24.3217-0908.3	020167			Rz 17,46	
	1.4 TDI	55			06.00	07.05	PR: 1KB						
	1.2 TDI	45		8Z-3-010000	03.01			24.3727-0100.2	580100	2	<input checked="" type="checkbox"/>	L=1075	
	1.4	55		8Z-3-010000	06.00								
	1.4 TDI	55		8Z-3-010000	06.00								
	1.2 TDI	45	8Z-3-010001			07.05		24.3727-0185.2	580185		<input type="checkbox"/>	L=1056	
	1.4	55	8Z-3-010001			07.05		24.3727-0100.2	580100		<input type="checkbox"/>	L=1075	
	1.4 TDI	55	8Z-3-010001			07.05							
	1.4	55		8Z-2-011846	06.00			24.2519-1706.3	040096			Nz 19,05	



AUDI A3 (8L) (96-03)



	1.6	◀ 75			09.96	08.00	+ ESP	03.7863-0402.4	300124			10"	ATE
	1.8	◀ 92			09.96	08.00	+ ESP						
	1.8 T	◀ 110			12.96	08.00	+ ESP						
	1.8 T	◀ 132			12.98	08.00	+ ESP						
	1.8 T quattro	◀ 110			08.98	08.00	+ ESP						
	1.8 T quattro	◀ 132			10.98	08.00	+ ESP						
	1.9 TDI	◀ 66			09.96	08.00	+ ESP						
	1.9 TDI	◀ 81			03.97	08.00	+ ESP						
	S3	◀			08.98	08.00	+ ESP						
	1.6	◀ 75	8L-2-037877		09.00		+ ESP	03.7860-0602.4	300141			10"	ATE
	1.8	◀ 92	8L-2-037877		09.00		+ ESP						
	1.8 T	◀ 110	8L-2-037877		09.00		+ ESP						
	1.8 T	◀ 132	8L-2-037877		09.00		+ ESP						
	1.8 T quattro	◀ 110	8L-2-037877		09.00		+ ESP						
	1.8 T quattro	◀ 132	8L-2-037877		09.00		+ ESP						
	1.9 TDI	◀ 66			09.00	06.01	+ ESP						
	1.9 TDI	◀ 74		8L-2-037877	09.00		+ ESP						
	1.9 TDI	◀ 81		8L-2-037877	09.00	06.01	+ ESP						
	1.9 TDI	◀ 96		8L-2-037877	09.00		+ ESP						
1.9 TDI quattro	◀ 96		8L-2-037877	09.00		+ ESP							
S3	◀		8L-2-037877	09.00		+ ESP							
	1.6	◀ 75	8L-2-037878		06.03		+ ESP	03.7863-3502.4	300128			10"	ATE
	1.8	◀ 92	8L-2-037878		06.03		+ ESP						
	1.8 T	◀ 110	8L-2-037878		06.03		+ ESP						
	1.8 T	◀ 132	8L-2-037878		06.03		+ ESP						
	1.8 T quattro	◀ 110	8L-2-037878		06.03		+ ESP						
	1.8 T quattro	◀ 132	8L-2-037878		06.03		+ ESP						
	1.9 TDI	◀ 74	8L-2-037878		06.03		+ ESP						
	1.9 TDI	◀ 96	8L-2-037878		06.03		+ ESP						
	1.9 TDI quattro	◀ 96	8L-2-037878		06.03		+ ESP						
	S3	◀	8L-2-037878		06.03		+ ESP						

AUDI A3 (8L) (96-03)										
	1.6	75		09.96	06.03	- ESP	24.2123-1709.3	010503		THz 23,81
	1.8	92		09.96	06.03	- ESP				
	1.8 T	110		12.96	06.03	- ESP				
	1.8 T	132		12.98	06.03	- ESP				
	1.8 T quattro	110		08.98	06.03	- ESP				
	1.8 T quattro	132		10.98	06.03	- ESP				
	1.9 TDI	66		09.96	06.01	- ESP				
	1.9 TDI	74		09.00	06.03	- ESP				
	1.9 TDI	81		03.97	06.01	- ESP				
	1.9 TDI	96		09.00	06.03	- ESP				
1.9 TDI quattro	96		09.00	06.03	- ESP					
S3			08.98	06.03	- ESP					
	1.6	75		09.96	08.00	+ ESP	03.2123-2024.3	010597		THz 23,81 ATE
	1.8	92		09.96	08.00	+ ESP				
	1.8 T	110		12.96	08.00	+ ESP				
	1.8 T	132		12.98	08.00	+ ESP				
	1.9 TDI	66		09.96	08.00	+ ESP				
	1.9 TDI	81		03.97	08.00	+ ESP				
	S3			08.98	08.00	+ ESP				
	1.6	75		09.00	06.03	+ ESP	03.2123-2715.3	010802		THz 23,81 ATE
	1.8	92		09.00	06.03	+ ESP				
	1.8 T	110		09.00	06.03	+ ESP				
1.8 T	132		09.00	06.03	+ ESP					
1.8 T quattro	110		09.00	06.03	+ ESP					
1.8 T quattro	132		09.00	06.03	+ ESP					
1.9 TDI	66		09.00	06.01	+ ESP					
1.9 TDI	74		09.00	06.03	+ ESP					
1.9 TDI	81		09.00	06.01	+ ESP					
1.9 TDI	96		09.00	06.03	+ ESP					
1.9 TDI quattro	96		09.00	06.03	+ ESP					
S3			09.00	06.03	+ ESP					
	1.6	75		09.96	08.00	+ ESP	03.2123-2064.3	010598		THz 23,81 ATE
	1.8	92		09.96	08.00	+ ESP				
	1.8 T	110		12.96	08.00	+ ESP				
	1.8 T	132		12.98	08.00	+ ESP				
	1.8 T quattro	110		08.98	08.00	+ ESP				
	1.8 T quattro	132		10.98	08.00	+ ESP				
	1.9 TDI	66		09.96	08.00	+ ESP				
	1.9 TDI	81		03.97	08.00	+ ESP				
	S3			08.98	08.00	+ ESP				
		1.6	75		09.00	06.03	+ ESP	03.2123-2774.3	010803	
1.8		92		09.00	06.03	+ ESP				
1.8 T		110		09.00	06.03	+ ESP				
1.8 T		132		09.00	06.03	+ ESP				
1.8 T quattro		110		09.00	06.03	+ ESP				
1.8 T quattro		132		09.00	06.03	+ ESP				
1.9 TDI		66		09.00	06.01	+ ESP				
1.9 TDI		74		09.00	06.03	+ ESP				
1.9 TDI		81		09.00	06.01	+ ESP				
1.9 TDI		96		09.00	06.03	+ ESP				
1.9 TDI quattro	96		09.00	06.03	+ ESP					
S3			09.00	06.03	+ ESP					
	1.6	75	8L-W-094814	09.96		PR: 1LQ,1LR,1LS	11.9541-9549.2	220575		D=54, - Halter ATE
	1.8	92	8L-W-094814	09.96		PR: 1LQ,1LR,1LS	11.9541-9550.2	220576		D=54, - Halter ATE
	1.8 T	110	8L-W-094814	12.96		PR: 1LQ,1LR,1LS	11.0441-5409.2	250031		Dichtungssatz ATE
	1.9 TDI	66	8L-W-094814	09.96		PR: 1LQ,1LR,1LS	11.0101-5409.2	260035		Hülensatz ATE
	1.9 TDI	81	8L-W-094814	03.97		PR: 1LQ,1LR,1LS	11.8171-0008.1	990049		Führungsbolzen ATE
	1.6	75	8L-W-094815		06.03	PR: 1LQ,1LR,1LS,1ZP	11.9541-9549.2	220575		D=54, - Halter ATE
	1.8	92	8L-W-094815		06.03	PR: 1LQ,1LR,1LS,1ZP	11.9541-9550.2	220576		D=54, - Halter ATE
	1.8 T	110	8L-W-094815		06.03	PR: 1LQ,1LR,1LS,1ZP	11.0101-5409.2	260035		Hülensatz ATE
	1.8 T	132		12.98	06.03	PR: 1LQ,1LR,1LS,1ZP	11.8171-0008.1	990049		Führungsbolzen ATE
	1.8 T quattro	110		08.98	06.03	PR: 1LQ,1LR,1LS,1ZP				
1.8 T quattro	132		10.98	06.03	PR: 1LQ,1LR,1LS,1ZP					
1.9 TDI	66	8L-W-094815		06.01	PR: 1LQ,1LR,1LS,1ZP					
1.9 TDI	74		09.00	06.03	PR: 1LQ,1LR,1LS,1ZP					
1.9 TDI	81	8L-W-094815		06.01	PR: 1LQ,1LR,1LS,1ZP					
1.9 TDI	96		09.00	06.03	PR: 1LQ,1LR,1LS,1ZP					
1.9 TDI quattro	96		09.00	06.03	PR: 1LQ,1LR,1LS,1ZP					
S3			08.98	06.03	PR: 1LQ,1LR,1LS,1ZP					
	1.6	75		09.96	06.03	PR: 1LE,1LN,1ZD	11.3541-8523.2	220115		D=54, - Halter ATE
	1.8	92		09.96	06.03	PR: 1LE,1LN,1ZD	11.3541-8524.2	220116		D=54, - Halter ATE
	1.8 T	110		12.96	06.03	PR: 1LE,1LN,1ZD	24.3541-8523.5	240551		D=54, - Halter ATE
	1.8 T	132		12.98	06.03	PR: 1LE,1LN,1ZD	24.3541-8524.5	240552		D=54, - Halter ATE
	1.8 T quattro	110		08.98	06.03	PR: 1LE,1LN,1ZD	11.8170-0306.1	260102		Halter ATE
	1.8 T quattro	132		10.98	06.03	PR: 1LE,1LN,1ZD	11.0441-5409.2	250031		Dichtungssatz ATE
	1.9 TDI	66		09.96	06.01	PR: 1LE,1LN,1ZD	11.0101-5409.2	260035		Hülensatz ATE
	1.9 TDI	74		09.00	06.03	PR: 1LE,1LN,1ZD	11.8171-0008.1	990049		Führungsbolzen ATE
	1.9 TDI	81		03.97	06.01	PR: 1LE,1LN,1ZD	11.8116-0143.1	390513		Haltefeder ATE
	1.9 TDI	96		09.00	06.03	PR: 1LE,1LN,1ZD				
1.9 TDI quattro	96		09.00	06.03	PR: 1LE,1LN,1ZD					
S3			08.98	06.03	PR: 1LE,1LN,1ZD					

									
AUDI A3 (8L) (96-03)									
	S3			08.98	06.03	PR: 1LT	11.9541-9595.2 220501 11.9541-9596.2 220502 11.0441-5409.2 250031 11.0101-5409.2 260035 11.8171-0008.1 990049 11.8116-0143.1 390513	 	D=54, - Halter ATE D=54, - Halter ATE Dichtungssatz ATE Hülzensatz ATE Führungsbolzen ATE Haltefeder ATE
	1.6 1.8 1.8 T 1.8 T 1.9 TDI 1.9 TDI 1.9 TDI 1.9 TDI	75 92 110 132 66 74 81 96		09.96 09.96 12.96 12.98 09.96 09.00 03.97 09.00	06.03 06.03 06.03 06.03 06.01 06.03 06.01 06.03		24.5143-0439.3 331411	2 	L=439
	1.8 T quattro 1.8 T quattro 1.9 TDI quattro S3	110 132 96		08.98 10.98 09.00 08.98	06.03 06.03 06.03 08.00		24.5143-0569.3 331398	2	L=569
	S3			09.00	06.03		83.6252-0560.3 330557	2	L=560
	1.6 1.8 1.8 T 1.8 T 1.9 TDI 1.9 TDI	75 92 110 132 66 81	8L-X-200000 8L-X-200000 8L-X-200000 8L-X-200000 8L-X-200000 8L-X-200000	09.96 09.96 12.96 12.98 09.96 03.97	06.03 06.03 12.96 12.98 09.96 03.97	PR: 1KK PR: 1KK PR: 1KK PR: 1KK PR: 1KK PR: 1KK	24.3384-1723.7 220523 24.3384-1724.7 220524	 	D=38(M12x1), - Halter TRW D=38(M12x1), - Halter TRW
	1.6 1.8 1.8 T 1.8 T 1.9 TDI 1.9 TDI 1.9 TDI 1.9 TDI	75 92 110 132 66 74 81 96	8L-Y-000001 8L-Y-000001 8L-Y-000001 8L-Y-000001 8L-Y-000001 8L-Y-000001 8L-Y-000001 8L-Y-000001	09.96 09.96 12.96 12.98 09.00 06.03 06.03 09.00	06.03 06.03 06.03 06.03 06.01 06.03 06.01 06.03	PR: 1KK,1KV PR: 1KK,1KV PR: 1KK,1KV PR: 1KK,1KV PR: 1KK,1KV PR: 1KK,1KV PR: 1KK,1KV PR: 1KK,1KV	24.3384-1729.7 220541 24.3384-1730.7 220542	 	D=38(M12x1), - Halter TRW D=38(M12x1), - Halter TRW
	1.8 T quattro 1.8 T quattro 1.9 TDI quattro S3	110 132 96		08.98 10.98 09.00 08.98	06.03 06.03 06.03 06.03	PR: 1KE PR: 1KE PR: 1KE	24.3414-1705.7 220549 24.3414-1706.7 220550	 	D=41, - Halter TRW D=41, - Halter TRW
	S3			08.98	06.03	PR: 1KF	24.3384-1745.7 220609 24.3384-1746.7 220610	 	D=38, - Halter TRW D=38, - Halter TRW
	1.6 1.8 1.8 T 1.8 T 1.9 TDI 1.9 TDI 1.9 TDI 1.9 TDI	75 92 110 132 66 74 81 96		09.96 09.96 12.96 12.98 09.96 09.00 03.97 09.00	06.03 06.03 06.03 06.03 06.01 06.03 06.01 06.03		83.7858-0140.3 330837	2 	L=140
	1.8 T quattro 1.8 T quattro 1.9 TDI quattro S3	110 132 96		08.98 10.98 09.00 08.98	06.03 06.03 06.03 06.03		83.7858-0140.3 330837	2	L=140
	1.6 1.8 1.8 T 1.8 T 1.9 TDI 1.9 TDI	75 92 110 132 66 81	8L-X-200000 8L-X-200000 8L-X-200000 8L-X-200000 8L-X-200000 8L-X-200000	09.96 09.96 12.96 12.98 09.96 03.97	06.03 06.03 12.96 12.98 09.96 03.97		24.3727-0149.2 580149	2 	L=1688
	1.6 1.8 1.8 T 1.8 T 1.9 TDI 1.9 TDI 1.9 TDI 1.9 TDI	75 92 110 132 66 74 81 96	8L-Y-000001 8L-Y-000001 8L-Y-000001 8L-Y-000001 8L-Y-000001 8L-Y-000001 8L-Y-000001 8L-Y-000001	09.96 09.96 12.96 12.98 09.00 06.03 06.03 09.00	06.03 06.03 06.03 06.03 06.01 06.03 06.01 06.03		24.3727-0173.2 580173	2 	L=1693
	1.8 T quattro 1.8 T quattro 1.9 TDI quattro S3	110 132 96		08.98 10.98 09.00 08.98	06.03 06.03 06.03 06.03		24.3727-0175.2 580175	2 	L=1723
	1.6 1.8 1.8 T 1.8 T 1.8 T quattro 1.8 T quattro 1.9 TDI 1.9 TDI 1.9 TDI 1.9 TDI 1.9 TDI quattro S3	75 92 110 132 110 132 66 74 81 96 96		09.96 09.96 12.96 12.98 08.98 10.98 09.96 09.00 03.97 09.00 09.00 08.98	06.03 06.03 06.03 06.03 06.03 06.03 06.01 06.03 06.01 06.03 06.03 06.03		24.2415-1701.3 030095		Gz 15,87
	1.6 1.8 1.8 T 1.8 T 1.8 T quattro 1.8 T quattro 1.9 TDI 1.9 TDI 1.9 TDI 1.9 TDI 1.9 TDI quattro S3	75 92 110 132 110 132 66 74 81 96 96		09.96 09.96 12.96 12.98 08.98 10.98 09.96 09.00 03.97 09.00 09.00 08.98	06.03 06.03 06.03 06.03 06.03 06.03 06.01 06.03 06.01 06.03 06.03 06.03		24.2415-1702.3 030096		Gz 15,87



AUDI A3 (8L) (96-03)										
	1.9 TDI	▶ 66		09.96	06.01		24.2415-1702.3	030096		Gz 15,87
	1.9 TDI	▶ 74		09.00	06.03					
	1.9 TDI	▶ 81		03.97	06.01					
	1.9 TDI	▶ 96		09.00	06.03					
	1.9 TDI quattro	▶ 96		09.00	06.03					
	S3	▶		08.98	06.03					
	1.6	75		09.96	06.03		24.2519-1701.3	040075	+ Schaltseilzug ¹⁾	Nz 19,05
	1.8	92		09.96	06.03		24.2523-1701.3	040080	+ Schaltgestänge ²⁾	Nz 23,81
	1.8 T	110		12.96	06.03					
	1.8 T	132		12.98	06.03					
	1.8 T quattro	110		08.98	06.03					
	1.8 T quattro	132		10.98	06.03					
	1.9 TDI	66		09.96	06.01					
	1.9 TDI	74		09.00	06.03					
	1.9 TDI	81		03.97	06.01					
	1.9 TDI	96		09.00	06.03					
	1.9 TDI quattro	96		09.00	06.03					
	S3			08.98	06.03					

AUDI A3 / A3 (8P) Sportback (03-13)										
	1.2 TSI	◀ 77		04.10	08.13	PR: 1AC,1AT	03.7863-3232.4	300307	Kolbendurchmesser Ø 22,20mm ³⁾	10" ATE
	1.4 TFSI	◀ 92		07.07	08.13	PR: 1AC,1AT				
	1.6	◀ 75		05.03	08.13	PR: 1AC,1AT				
	1.6 FSI	◀ 85		08.03	08.13	PR: 1AC,1AT				
	1.6 TDI	◀ 66		05.09	08.13	PR: 1AC,1AT				
	1.6 TDI	◀ 77		05.09	08.13	PR: 1AC,1AT				
	1.8 TFSI	◀ 118		01.07	08.13	PR: 1AC,1AT				
	1.8 TFSI quattro	◀ 118		05.08	08.13	PR: 1AC,1AT				
	1.9 TDI	◀ 77		06.03	08.13	PR: 1AC,1AT				
	2.0 FSI	◀ 110		05.03	08.13	PR: 1AC,1AT				
	2.0 TDI	◀ 100		05.03	08.13	PR: 1AC,1AT				
	2.0 TDI	◀ 103		05.03	08.13	PR: 1AC,1AT				
	2.0 TDI	◀ 120		06.06	06.08	PR: 1AC,1AT				
	2.0 TDI	◀ 125		03.06	08.13	PR: 1AC,1AT				
	2.0 TDI quattro	◀ 100		05.03	08.13	PR: 1AC,1AT				
	2.0 TDI quattro	◀ 103		08.04	08.13	PR: 1AC,1AT				
	2.0 TDI quattro	◀ 125		03.06	08.13	PR: 1AC,1AT				
	2.0 TFSI	◀ 147		06.04	08.13	PR: 1AC,1AT				
	2.0 TFSI quattro	◀ 147		06.04	08.13	PR: 1AC,1AT				
	1.2 TSI	◀ 77		04.10	08.13	PR: 1AS	03.7863-9602.4	300206	Kolbendurchmesser Ø 22,20mm ³⁾	10" ATE
	1.4 TFSI	◀ 92		07.07	08.13	PR: 1AS				
	1.6	◀ 75		05.03	08.13	PR: 1AS				
	1.6 FSI	◀ 85		08.03	08.13	PR: 1AS				
	1.6 TDI	◀ 66		05.09	08.13	PR: 1AS				
	1.6 TDI	◀ 77		05.09	08.13	PR: 1AS				
	1.8 TFSI	◀ 118		01.07	08.13	PR: 1AS				
	1.8 TFSI quattro	◀ 118		05.08	08.13	PR: 1AS				
	1.9 TDI	◀ 77		06.03	08.13	PR: 1AS				
	2.0 FSI	◀ 110		05.03	08.13	PR: 1AS				
	2.0 TDI	◀ 100		05.03	08.13	PR: 1AS				
	2.0 TDI	◀ 103		05.03	08.13	PR: 1AS				
	2.0 TDI	◀ 120		06.06	06.08	PR: 1AS				
	2.0 TDI	◀ 125		03.06	08.13	PR: 1AS				
	2.0 TDI quattro	◀ 100		05.03	08.13	PR: 1AS				
	2.0 TDI quattro	◀ 103		08.04	08.13	PR: 1AS				
	2.0 TDI quattro	◀ 125		03.06	08.13	PR: 1AS				
	2.0 TFSI	◀ 147		06.04	08.13	PR: 1AS				
	2.0 TFSI quattro	◀ 147		06.04	08.13	PR: 1AS				
	3.2 quattro	◀ 184		07.03	08.13		03.7863-3332.4	300308		10" ATE
	S3	◀ 188		07.08	08.13					
	S3	◀ 195		11.06	08.13					
	1.2 TSI	◀ 77	8P-6A094000	04.10	08.13		03.2122-2129.3	010799	PR: 1ZE,1ZF,1ZP,1ZD,1LJ,1ZM	THz 22,20 ATE
	1.6	◀ 75	8P-6A094000	05.03	08.13					
	1.6 FSI	◀ 85	8P-6A094000	08.03	08.13					
	1.6 TDI	◀ 66	8P-6A094000	05.09	08.13					
	1.6 TDI	◀ 77	8P-6A094000	05.09	08.13					
	1.9 TDI	◀ 77	8P-6A094000	06.03	08.13					
	2.0 FSI	◀ 110	8P-6A094000	05.03	08.13					
	2.0 TDI	◀ 100	8P-6A094000	05.03	08.13					
	2.0 TDI	◀ 103	8P-6A094000	05.03	08.13					
	2.0 TDI	◀ 120	8P-6A094000	06.06	08.13					
	2.0 TDI quattro	◀ 100	8P-6A094000	05.03	08.13					
	2.0 TDI quattro	◀ 103	8P-6A094000	08.04	08.13					
	2.0 TFSI	◀ 147	8P-6A094000	06.04	08.13					
	2.0 TFSI quattro	◀ 147	8P-6A094000	06.04	08.13					
	1.2 TSI	◀ 77	8P-6A094001	08.13	08.13		03.2122-2129.3	010799	PR: 1ZE,1ZF,1ZP,1ZD,1LJ,1ZM	THz 22,20 ATE
	1.6	◀ 75	8P-6A094001	08.13	08.13					
	1.6 FSI	◀ 85	8P-6A094001	08.13	08.13					
	1.6 TDI	◀ 66	8P-6A094001	08.13	08.13					
	1.6 TDI	◀ 77	8P-6A094001	08.13	08.13					
	1.9 TDI	◀ 77	8P-6A094001	08.13	08.13					
	2.0 FSI	◀ 110	8P-6A094001	08.13	08.13					
	2.0 TDI	◀ 100	8P-6A094001	08.13	08.13					
	2.0 TDI	◀ 103	8P-6A094001	08.13	08.13					
	2.0 TDI	◀ 120	8P-6A094001	06.08	08.13					
	2.0 TDI quattro	◀ 100	8P-6A094001	08.13	08.13					
	2.0 TDI quattro	◀ 103	8P-6A094001	08.13	08.13					

1) + gearshift cable / + leva cambio con cavo / + câble de changem.de vitesse / + cable de acc. del cambio
2) + gearshift linkage / + leva cambio con tiranteria / + tige de changem.de vitesse / + varillaje del cambio
3) piston diameter Ø 22,20mm / diametro del pistone Ø 22,20mm / diamètre de piston Ø 22,20mm / diametro del pistón Ø 22,20mm

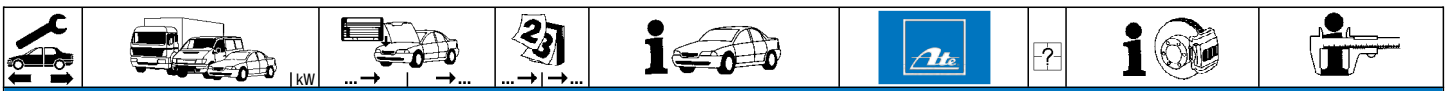

AUDI A3 / A3 (8P) Sportback (03-13)





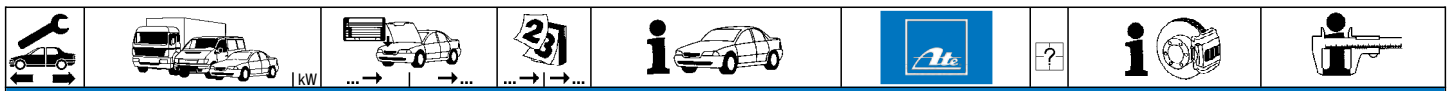







	2.0 TFSI 2.0 TFSI quattro	147 8P-6A094001 147 8P-6A094001	8P-7-103000 8P-7-103000		03.2122-2129.3	010799	PR: 1ZE,1ZF,1ZP,1ZD,1LJ,1ZM	Thz 22,20	ATE
	1.2 TSI 1.6 1.6 FSI 1.6 TDI 1.6 TDI 1.9 TDI 2.0 FSI 2.0 TDI 2.0 TDI 2.0 TDI quattro 2.0 TDI quattro 2.0 TFSI 2.0 TFSI quattro	77 75 85 66 77 77 110 100 103 120 100 103 147 147	8P-6B009600 8P-6B009600 8P-6B009600 8P-6B009600 8P-6B009600 8P-6B009600 8P-6B009600 8P-6B009600 8P-6B009600 8P-6B009600 8P-6B009600 8P-6B009600 8P-6B009600 8P-6B009600	04.10 05.03 08.03 05.09 05.09 06.03 05.03 05.03 05.03 06.06 05.03 08.04 06.04 06.04					
	1.2 TSI 1.4 TFSI 1.6 1.6 FSI 1.6 TDI 1.6 TDI 1.8 TFSI 1.8 TFSI quattro 1.9 TDI 2.0 FSI 2.0 TDI 2.0 TDI 2.0 TDI 2.0 TDI quattro 2.0 TDI quattro 2.0 TFSI 2.0 TFSI quattro	77 92 75 85 66 77 118 118 77 110 100 103 120 100 103 147 147	8P-6B009601 8P-6B009601 8P-6B009601 8P-6B009601 8P-6B009601 8P-6B009601 8P-6B009601 8P-6B009601 8P-6B009601 8P-6B009601 8P-6B009601 8P-6B009601 8P-6B009601 8P-6B009601 8P-6B009601 8P-6B009601 8P-7-103000 8P-7-103000	04.10 07.07 08.13 08.13 08.13 08.13 08.13 01.07 05.08 08.13 08.13 08.13 08.13 06.08 08.13 08.13 08.13 08.13	03.2122-2129.3	010799	PR: 1ZE,1ZF,1ZP,1ZD,1LJ,1ZM	Thz 22,20	ATE
	2.0 TDI 2.0 TDI quattro 2.0 TFSI 2.0 TFSI quattro	125 125 147 147	8P-7-103001 8P-7-103001	03.06 03.06 08.13 08.13	03.2123-3449.3	010808	PR: 1ZE,1ZF,1ZP,1ZD,1LJ,1ZM	Thz 23,81	ATE
	1.2 TSI 1.6 1.6 FSI 1.6 TDI 1.6 TDI 1.9 TDI 2.0 FSI 2.0 TDI 2.0 TDI 2.0 TDI quattro 2.0 TDI quattro 2.0 TFSI 2.0 TFSI quattro	77 75 85 66 77 77 110 100 103 120 100 103 147 147	8P-6A094000 8P-6A094000 8P-6A094000 8P-6A094000 8P-6A094000 8P-6A094000 8P-6A094000 8P-6A094000 8P-6A094000 8P-6A094000 8P-6A094000 8P-6A094000 8P-6A094000 8P-6A094000	04.10 05.03 08.03 05.09 05.09 06.03 05.03 05.03 06.06 05.03 08.04 06.04 06.04					
	1.2 TSI 1.6 1.6 FSI 1.6 TDI 1.6 TDI 1.9 TDI 2.0 FSI 2.0 TDI 2.0 TDI 2.0 TDI quattro 2.0 TDI quattro 2.0 TFSI 2.0 TFSI quattro	77 75 85 66 77 77 110 100 103 120 100 103 147 147	8P-6A094001 8P-6A094001 8P-6A094001 8P-6A094001 8P-6A094001 8P-6A094001 8P-6A094001 8P-6A094001 8P-6A094001 8P-6A094001 8P-6A094001 8P-6A094001 8P-6A094001 8P-6A094001	08.13 08.13 08.13 08.13 08.13 08.13 08.13 06.08 08.13 08.13	03.2123-3449.3	010808	PR: 1LK,1ZK	Thz 23,81	ATE
	1.2 TSI 1.6 1.6 FSI 1.6 TDI 1.6 TDI 1.9 TDI 2.0 FSI 2.0 TDI 2.0 TDI 2.0 TDI quattro 2.0 TDI quattro 2.0 TFSI 2.0 TFSI quattro	77 75 85 66 77 77 110 100 103 120 100 103 147 147	8P-6B009600 8P-6B009600 8P-6B009600 8P-6B009600 8P-6B009600 8P-6B009600 8P-6B009600 8P-6B009600 8P-6B009600 8P-6B009600 8P-6B009600 8P-6B009600 8P-6B009600	04.10 05.03 08.03 05.09 05.09 06.03 05.03 05.03 06.06 05.03 08.04 06.04 06.04					
	1.2 TSI 1.4 TFSI 1.6 1.6 FSI 1.6 TDI 1.6 TDI 1.8 TFSI	77 92 75 85 66 77 118	8P-6B009601 8P-6B009601 8P-6B009601 8P-6B009601 8P-6B009601 8P-6B009601 8P-6B009601	04.10 07.07 08.13 08.13 08.13 08.13 01.07	03.2123-3449.3	010808	PR: 1LK,1ZK	Thz 23,81	ATE



















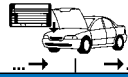



AUDI A3 / A3 (8P) Sportback (03-13)

	1.8 TFSI quattro 1.9 TDI 2.0 FSI 2.0 TDI 2.0 TDI 2.0 TDI 2.0 TDI quattro 2.0 TDI quattro 2.0 TDI quattro 2.0 TFSI 2.0 TFSI quattro	118 77 110 100 103 125 100 103 125 147 147	8P-6B009601 8P-6B009601 8P-6B009601 8P-6B009601 8P-6B009601 8P-6B009601 8P-6B009601 8P-6B009601 8P-6B009601 8P-6B009601 8P-7-103000 8P-7-103000	05.08 08.13 08.13 08.13 08.13 08.13 03.06 08.13 08.13 03.06 08.13	08.13 08.13 08.13 08.13 08.13 08.13 08.13 08.13 08.13 08.13 08.13 08.13	03.2123-3449.3 010808	PR: 1LK,1ZK	THz 23,81	ATE	
	3.2 quattro S3 S3	184 188 195		07.03 07.08 11.06	08.13 08.13 08.13	03.2122-2129.3 03.2123-3449.3 010799 010808	- ESP + ESP	THz 22,20 THz 23,81	ATE ATE	
	RS 3	250		04.11	08.13	03.2125-5112.3 010966		THz 25,40	ATE	
	1.2 TSI 1.4 TFSI 1.6 1.6 FSI 1.6 TDI 1.6 TDI 1.8 TFSI 1.8 TFSI quattro 1.9 TDI 2.0 FSI 2.0 TDI 2.0 TDI 2.0 TDI 2.0 TDI 2.0 TDI quattro 2.0 TDI quattro 2.0 TDI quattro 2.0 TFSI 2.0 TFSI quattro 3.2 quattro	77 92 75 85 66 77 118 118 77 110 100 103 120 125 100 103 125 147 147 184		04.10 07.07 05.03 08.03 05.09 01.07 05.08 06.03 05.03 05.03 06.06 03.06 05.03 08.04 03.06 06.04 06.04 07.03	08.13 08.13	PR: 1ZF,1ZM PR: 1ZF,1ZM	11.9541-9549.2 11.9541-9550.2 11.0101-5409.2 11.8171-0069.1 220575 220576 260035 250152		D=54, - Halter D=54, - Halter Hülzensatz Führungsbolzen	ATE ATE ATE ATE
	1.2 TSI 1.4 TFSI 1.6 1.6 FSI 1.6 TDI 1.6 TDI 1.8 TFSI 1.8 TFSI quattro 1.9 TDI 2.0 FSI 2.0 TDI 2.0 TDI 2.0 TDI 2.0 TDI 2.0 TDI quattro 2.0 TDI quattro 2.0 TDI quattro 2.0 TFSI 2.0 TFSI quattro 3.2 quattro	77 92 75 85 66 77 118 118 77 110 100 103 120 125 100 103 125 147 147 184		04.10 07.07 05.03 08.03 05.09 01.07 05.08 06.03 05.03 05.03 06.06 03.06 05.03 08.04 03.06 06.04 06.04 07.03	08.13 08.13	PR: 1ZE,1ZP PR: 1ZE,1ZP	11.9541-9553.2 11.9541-9554.2 11.0101-5409.2 11.8171-0008.1 220563 220564 260035 990049 390538	2	D=54, - Halter D=54, - Halter Hülzensatz Führungsbolzen Haltefeder	ATE ATE ATE ATE ATE
	1.2 TSI 1.4 TFSI 1.6 1.6 FSI 1.6 TDI 1.6 TDI 1.8 TFSI 1.8 TFSI quattro 1.9 TDI 2.0 FSI 2.0 TDI 2.0 TDI 2.0 TDI 2.0 TDI 2.0 TDI quattro 2.0 TDI quattro 2.0 TDI quattro 2.0 TFSI 2.0 TFSI quattro 3.2 quattro	77 92 75 85 66 77 118 118 77 110 100 103 120 125 100 103 125 147 147 184		04.10 07.07 05.03 08.03 05.09 01.07 05.08 06.03 05.03 05.03 06.06 03.06 05.03 08.04 03.06 06.04 06.04 07.03	08.13 08.13	PR: 1ZD,1LJ,1ZA PR: 1ZD,1LJ,1ZA	11.9541-9553.2 11.9541-9554.2 11.0101-5409.2 11.8171-0008.1 220563 220564 260035 990049 390538	2	D=54, - Halter D=54, - Halter Hülzensatz Führungsbolzen Haltefeder	ATE ATE ATE ATE ATE
	1.2 TSI 1.4 TFSI 1.6 1.6 FSI 1.6 TDI 1.6 TDI 1.8 TFSI 1.8 TFSI quattro 1.9 TDI 2.0 FSI 2.0 TDI 2.0 TDI 2.0 TDI 2.0 TDI 2.0 TDI quattro 2.0 TDI quattro 2.0 TDI quattro 2.0 TFSI 2.0 TFSI quattro 3.2 quattro	77 92 75 85 66 77 118 118 77 110 100 103 120 125 100 103 125 147 147 184		04.10 07.07 05.03 08.03 05.09 01.07 05.08 06.03 05.03 05.03 06.06 03.06 05.03 08.04 03.06 06.04 06.04 07.03	08.13 08.13	PR: 1LK PR: 1LK	11.9576-9995.2 11.9576-9996.2 11.0101-5409.2 11.8171-0008.1 220651 220652 260035 990049 390589	2	D=57, - Halter D=57, - Halter Hülzensatz Führungsbolzen Haltefeder	ATE ATE ATE ATE ATE

									
AUDI A3 / A3 (8P) Sportback (03-13)									
	2.0 TDI	120	06.06	06.08	PR: 1LK	11.9576-9995.2	220651	D=57, - Halter ATE D=57, - Halter ATE Hülsensatz ATE Führungsbolzen ATE Halterfeder ATE	
	2.0 TDI	125	03.06	08.13	PR: 1LK	11.9576-9996.2	220652		
	2.0 TDI quattro	100	05.03	08.13	PR: 1LK	11.0101-5409.2	260035		
	2.0 TDI quattro	103	08.04	08.13	PR: 1LK	11.8171-0008.1	990049		
	2.0 TDI quattro	125	03.06	08.13	PR: 1LK	11.8116-0410.2	390589		
	2.0 TFSI	147	06.04	08.13	PR: 1LK				
	2.0 TFSI quattro	147	06.04	08.13	PR: 1LK				
	3.2 quattro	184	07.03	08.13	PR: 1LK				
	S3	188	07.08	08.13	PR: 12K	11.9576-9948.2	220810		
	S3	195	11.06	08.13	PR: 12K	11.0101-5409.2	260035		
	1.2 TSI	77	04.10	08.13	PR: 1LJ,1ZE,1ZF,1ZM	24.5143-0564.3	331433	L=564	
	1.4 TFSI	92	07.07	08.13	PR: 1LJ,1ZE,1ZF,1ZM				
	1.6	75	05.03	08.13	PR: 1LJ,1ZE,1ZF,1ZM				
	1.6 FSI	85	08.03	08.13	PR: 1LJ,1ZE,1ZF,1ZM				
	1.6 TDI	66	05.09	08.13	PR: 1LJ,1ZE,1ZF,1ZM				
	1.6 TDI	77	05.09	08.13	PR: 1LJ,1ZE,1ZF,1ZM				
	1.8 TFSI	118	01.07	08.13	PR: 1LJ,1ZE,1ZF,1ZM				
	1.8 TFSI quattro	118	05.08	08.13	PR: 1LJ,1ZE,1ZF,1ZM				
	1.9 TDI	77	06.03	08.13	PR: 1LJ,1ZE,1ZF,1ZM				
	2.0 FSI	110	05.03	08.13	PR: 1LJ,1ZE,1ZF,1ZM				
	2.0 TDI	100	05.03	08.13	PR: 1LJ,1ZE,1ZF,1ZM				
	2.0 TDI	103	05.03	08.13	PR: 1LJ,1ZE,1ZF,1ZM				
	2.0 TDI	120	06.06	06.08	PR: 1LJ,1ZE,1ZF,1ZM				
	2.0 TDI	125	03.06	08.13	PR: 1LJ,1ZE,1ZF,1ZM				
	2.0 TDI quattro	100	05.03	08.13	PR: 1LJ,1ZE,1ZF,1ZM				
	2.0 TDI quattro	103	08.04	08.13	PR: 1LJ,1ZE,1ZF,1ZM				
	2.0 TDI quattro	125	03.06	08.13	PR: 1LJ,1ZE,1ZF,1ZM				
	2.0 TFSI	147	06.04	08.13	PR: 1LJ,1ZE,1ZF,1ZM				
	2.0 TFSI quattro	147	06.04	08.13	PR: 1LJ,1ZE,1ZF,1ZM				
	3.2 quattro	184	07.03	08.13	PR: 1LJ,1ZE,1ZF,1ZM				
	S3	188	07.08	08.13	PR: 1LJ,1ZE,1ZF,1ZM				
	S3	195	11.06	08.13	PR: 1LJ,1ZE,1ZF,1ZM				
	1.2 TSI	77	04.10	08.13	PR: 1LK	83.7849-0502.3	331125		L=504
	1.4 TFSI	92	07.07	08.13	PR: 1LK				
	1.6	75	05.03	08.13	PR: 1LK				
	1.6 FSI	85	08.03	08.13	PR: 1LK				
	1.6 TDI	66	05.09	08.13	PR: 1LK				
	1.6 TDI	77	05.09	08.13	PR: 1LK				
	1.8 TFSI	118	01.07	08.13	PR: 1LK				
	1.9 TDI	77	06.03	08.13	PR: 1LK				
	2.0 FSI	110	05.03	08.13	PR: 1LK				
	2.0 TDI	100	05.03	08.13	PR: 1LK				
	2.0 TDI	103	05.03	08.13	PR: 1LK				
	2.0 TDI	120	06.06	06.08	PR: 1LK				
	2.0 TDI	125	03.06	08.13	PR: 1LK				
	2.0 TDI quattro	100	05.03	08.13	PR: 1LK				
	2.0 TDI quattro	103	08.04	08.13	PR: 1LK				
	2.0 TDI quattro	125	03.06	08.13	PR: 1LK				
2.0 TFSI	147	06.04	08.13	PR: 1LK					
2.0 TFSI quattro	147	06.04	08.13	PR: 1LK					
3.2 quattro	184	07.03	08.13	PR: 1LK					
S3	188	07.08	08.13	PR: 1LK					
S3	195	11.06	08.13	PR: 1LK					
1.2 TSI	77	04.10	08.13	PR: 12K	83.7249-0536.3	330900	L=536		
1.4 TFSI	92	07.07	08.13	PR: 12K					
1.6	75	05.03	08.13	PR: 12K					
1.6 FSI	85	08.03	08.13	PR: 12K					
1.6 TDI	66	05.09	08.13	PR: 12K					
1.6 TDI	77	05.09	08.13	PR: 12K					
1.8 TFSI	118	01.07	08.13	PR: 12K					
1.8 TFSI quattro	118	05.08	08.13	PR: 12K					
1.9 TDI	77	06.03	08.13	PR: 12K					
2.0 FSI	110	05.03	08.13	PR: 12K					
2.0 TDI	100	05.03	08.13	PR: 12K					
2.0 TDI	103	05.03	08.13	PR: 12K					
2.0 TDI	120	06.06	06.08	PR: 12K					
2.0 TDI	125	03.06	08.13	PR: 12K					
2.0 TDI quattro	100	05.03	08.13	PR: 12K					
2.0 TDI quattro	103	08.04	08.13	PR: 12K					
2.0 TDI quattro	125	03.06	08.13	PR: 12K					
2.0 TFSI	147	06.04	08.13	PR: 12K					
2.0 TFSI quattro	147	06.04	08.13	PR: 12K					
3.2 quattro	184	03.06	08.13	PR: 12K					
S3	188	07.08	08.13	PR: 12K					
S3	195	11.06	08.13	PR: 12K					
	1.2 TSI	77	04.10	08.13	PR: 1KQ,1KD	24.3384-1755.7		220635	D=38, - Halter TRW D=38, - Halter TRW
	1.4 TFSI	92	07.07	08.13	PR: 1KQ,1KD	24.3384-1756.7		220636	
	1.6	75	05.03	08.13	PR: 1KQ,1KD				
	1.6 FSI	85	08.03	08.13	PR: 1KQ,1KD				
	1.6 TDI	66	05.09	08.13	PR: 1KQ,1KD				
	1.6 TDI	77	05.09	08.13	PR: 1KQ,1KD				
	1.8 TFSI	118	01.07	08.13	PR: 1KQ,1KD				
	1.9 TDI	77	06.03	08.13	PR: 1KQ,1KD				
	2.0 FSI	110	05.03	08.13	PR: 1KQ,1KD				
	2.0 TDI	100	05.03	08.13	PR: 1KQ,1KD				

AUDI A3 / A3 (8P) Sportback (03-13)													
	2.0 TDI	103	05.03	08.13	PR: 1KQ,1KD	24.3384-1755.7	220635	<input type="checkbox"/> <input type="checkbox"/>	D=38, - Halter D=38, - Halter	TRW TRW			
	2.0 TDI	120	06.06	06.08	PR: 1KQ,1KD	24.3384-1756.7	220636						
	2.0 TDI	125	03.06	08.13	PR: 1KQ,1KD								
	2.0 TFSI	147	06.04	08.13	PR: 1KQ,1KD								
	1.2 TSI	77	04.10	08.13	PR: 1KZ	24.3387-1717.7	220757				<input type="checkbox"/> <input type="checkbox"/>	D=38, - Halter D=38, - Halter Bremsattel-Zubehör	TRW TRW TRW
	1.4 TFSI	92	07.07	08.13	PR: 1KZ	24.3387-1718.7	220758						
	1.6	75	05.03	08.13	PR: 1KZ	24.0101-3803.2	260101						
	1.6 FSI	85	08.03	08.13	PR: 1KZ								
	1.6 TDI	66	05.09	08.13	PR: 1KZ								
	1.6 TDI	77	05.09	08.13	PR: 1KZ								
	1.8 TFSI	118	01.07	08.13	PR: 1KZ								
	1.9 TDI	77	06.03	08.13	PR: 1KZ								
	2.0 FSI	110	05.03	08.13	PR: 1KZ								
	2.0 TDI	100	05.03	08.13	PR: 1KZ								
2.0 TDI	103	05.03	08.13	PR: 1KZ									
2.0 TDI	120	06.06	06.08	PR: 1KZ									
2.0 TDI	125	03.06	08.13	PR: 1KZ									
2.0 TFSI	147	06.04	08.13	PR: 1KZ									
	1.2 TSI	77	04.10	08.13	PR: 1KE	24.3414-1709.7	220631	<input type="checkbox"/> <input type="checkbox"/>	D=41, - Halter D=41, - Halter	TRW TRW			
	1.4 TFSI	92	07.07	08.13	PR: 1KE	24.3414-1710.7	220632						
	1.6	75	05.03	08.13	PR: 1KE								
	1.6 FSI	85	08.03	08.13	PR: 1KE								
	1.6 TDI	66	05.09	08.13	PR: 1KE								
	1.6 TDI	77	05.09	08.13	PR: 1KE								
	1.8 TFSI	118	01.07	08.13	PR: 1KE								
	1.8 TFSI quattro	118	05.08	08.13	PR: 1KJ								
	1.9 TDI	77	06.03	08.13	PR: 1KE								
	2.0 FSI	110	05.03	08.13	PR: 1KE								
	2.0 TDI	100	05.03	08.13	PR: 1KE								
	2.0 TDI	103	05.03	08.13	PR: 1KE								
	2.0 TDI	120	06.06	06.08	PR: 1KF,1KJ,1KU								
	2.0 TDI	120	06.06	06.08	PR: 1KE								
	2.0 TDI	125	03.06	08.13	PR: 1KE								
	2.0 TDI quattro	100	05.03	08.13	PR: 1KF,1KJ,1KU								
	2.0 TDI quattro	103	08.04	08.13	PR: 1KF,1KJ,1KU								
	2.0 TDI quattro	125	03.06	08.13	PR: 1KF,1KJ,1KU								
	2.0 TFSI	147	06.04	08.13	PR: 1KE								
	2.0 TFSI quattro	147	06.04	08.13	PR: 1KF,1KJ,1KU								
	3.2 quattro	184	07.03	08.13	PR: 1KJ								
		1.2 TSI	77	04.10	08.13		24.5204-0233.3				331430	2	L=233
1.4 TFSI		92	07.07	08.13									
1.6		75	05.03	08.13									
1.6 FSI		85	08.03	08.13									
1.6 TDI		66	05.09	08.13									
1.6 TDI		77	05.09	08.13									
1.8 TFSI		118	01.07	08.13									
1.8 TFSI quattro		118	05.08	08.13									
1.9 TDI		77	06.03	08.13									
2.0 FSI		110	05.03	08.13									
2.0 TDI		100	05.03	08.13									
2.0 TDI		103	05.03	08.13									
2.0 TDI		120	06.06	06.08									
2.0 TDI		125	03.06	08.13									
2.0 TDI quattro		100	05.03	08.13									
2.0 TDI quattro		103	08.04	08.13									
2.0 TDI quattro	125	03.06	08.13										
2.0 TFSI	147	06.04	08.13										
2.0 TFSI quattro	147	06.04	08.13										
3.2 quattro	184	07.03	08.13										
RS 3	250	04.11	08.13										
S3	188	07.08	08.13										
S3	195	11.06	08.13										
	1.2 TSI	77	04.10	08.13		24.3727-2708.2	582708	2	L=1447				
	1.4 TFSI	92	07.07	08.13									
	1.6	75	05.03	08.13									
	1.6 FSI	85	08.03	08.13									
	1.6 TDI	66	05.09	08.13									
	1.6 TDI	77	05.09	08.13									
	1.8 TFSI	118	01.07	08.13									
	1.8 TFSI quattro	118	05.08	08.13									
	1.9 TDI	77	06.03	08.13									
	2.0 FSI	110	05.03	08.13									
	2.0 TDI	100	05.03	08.13									
	2.0 TDI	103	05.03	08.13									
	2.0 TDI	120	06.06	06.08									
	2.0 TDI	125	03.06	08.13									
	2.0 TDI quattro	100	05.03	08.13									
	2.0 TDI quattro	103	08.04	08.13									
	2.0 TDI quattro	125	03.06	08.13									
2.0 TFSI	147	06.04	08.13										
2.0 TFSI quattro	147	06.04	08.13										
3.2 quattro	184	07.03	08.13										
S3	188	07.08	08.13										
S3	195	11.06	08.13										
RS 3	250	04.11	08.13			24.3727-0195.2	580195	2	L=1447				

AUDI A3 / A3 (8P) Sportback (03-13)									
									
AUDI A3 / A3 (8P) Sportback (03-13)									
	1.2 TSI	77		04.10	08.13	24.2415-1713.3	030132		Gz 15,87, + Sensor
	1.4 TFSI	92		07.07	08.13				
	1.6	75		05.03	08.13				
	1.6 FSI	85		08.03	08.13				
	1.6 TDI	66		05.09	08.13				
	1.6 TDI	77		05.09	08.13				
	1.8 TFSI	118		01.07	08.13				
	1.8 TFSI quattro	118		05.08	08.13				
	1.9 TDI	77		06.03	08.13				
	2.0 FSI	110		05.03	08.13				
	2.0 TDI	100		05.03	08.13				
	2.0 TDI	103		05.03	08.13				
	2.0 TDI	120		06.06	06.08				
	2.0 TDI	125		03.06	08.13				
	2.0 TDI quattro	100		05.03	08.13				
	2.0 TDI quattro	103		08.04	08.13				
	2.0 TDI quattro	125		03.06	08.13				
	2.0 TFSI	147		06.04	08.13				
	2.0 TFSI quattro	147		06.04	08.13				
	3.2 quattro	184		07.03	08.13				
	S3	188		07.08	08.13				
	S3	195		11.06	08.13				
	1.2 TSI	77		04.10	08.13	24.2519-1705.3	040095	+ 5-Gang ¹⁾	Nz 19,05
	1.4 TFSI	92		07.07	08.13	24.2519-1706.3	040096	+ 6-Gang ²⁾	Nz 19,05
	1.6	75		05.03	08.13				
	1.6 FSI	85		08.03	08.13				
	1.6 TDI	66		05.09	08.13				
	1.6 TDI	77		05.09	08.13				
	1.8 TFSI	118		01.07	08.13				
	1.8 TFSI quattro	118		05.08	08.13				
	1.9 TDI	77		06.03	08.13				
	2.0 FSI	110		05.03	08.13				
	2.0 TDI	100		05.03	08.13				
	2.0 TDI	103		05.03	08.13				
	2.0 TDI	120		06.06	06.08				
	2.0 TDI	125		03.06	08.13				
	2.0 TDI quattro	100		05.03	08.13				
	2.0 TDI quattro	103		08.04	08.13				
	2.0 TDI quattro	125		03.06	08.13				
	2.0 TFSI	147		06.04	08.13				
	2.0 TFSI quattro	147		06.04	08.13				
	3.2 quattro	184		07.03	08.13				
	S3	188		07.08	08.13				
	S3	195		11.06	08.13				
AUDI A3 (8P) Cabrio (08-13)									
	1.2 TSI	77		03.10	08.13	PR: 1ZE,1ZF,1LJ,1ZA	03.7863-3232.4	300307	Kolbendurchmesser Ø 22,20mm ³⁾ 10" ATE
	1.4 TFSI	92		01.11	08.13	PR: 1ZE,1ZF,1LJ,1ZA			
	1.6	75		09.08	08.13	PR: 1ZE,1ZF,1LJ,1ZA			
	1.6 TDI	77		05.09	08.13	PR: 1ZE,1ZF,1LJ,1ZA			
	1.8 TFSI	118		04.08	08.13	PR: 1ZE,1ZF,1LJ,1ZA			
	1.9 TDI	77		04.08	08.13	PR: 1ZE,1ZF,1LJ,1ZA			
	2.0 TDI	100		04.08	08.13	PR: 1ZE,1ZF,1LJ,1ZA			
	2.0 TDI	103		04.08	08.13	PR: 1ZE,1ZF,1LJ,1ZA			
	2.0 TFSI	147		04.08	08.13	PR: 1ZE,1ZF,1LJ	03.7863-3332.4	300308	10" ATE
	1.2 TSI	77		03.10	08.13	PR: 1ZE,1ZF,1LJ,1ZA	03.2122-2129.3	010799	10" ATE
	1.4 TFSI	92		01.11	08.13	PR: 1ZE,1ZF,1LJ,1ZA			
	1.6	75		09.08	08.13	PR: 1ZE,1ZF,1LJ,1ZA			
	1.6 TDI	77		05.09	08.13	PR: 1ZE,1ZF,1LJ,1ZA			
	1.8 TFSI	118		04.08	08.13	PR: 1ZE,1ZF,1LJ,1ZA			
	1.9 TDI	77		04.08	08.13	PR: 1ZE,1ZF,1LJ,1ZA			
	2.0 TDI	100		04.08	08.13	PR: 1ZE,1ZF,1LJ,1ZA			
	2.0 TDI	103		04.08	08.13	PR: 1ZE,1ZF,1LJ,1ZA			
	2.0 TFSI	147		04.08	08.13	PR: 1ZE,1ZF,1LJ,1ZA	03.2123-3449.3	010808	10" ATE
	1.2 TSI	77		03.10	08.13	PR: 1ZF	11.9541-9549.2	220575	D=54, - Halter ATE
	1.4 TFSI	92		01.11	08.13	PR: 1ZF	11.9541-9550.2	220576	D=54, - Halter ATE
	1.6	75		09.08	08.13	PR: 1ZF	11.8171-0069.1	250152	Führungsbolzen ATE
	1.6 TDI	77		05.09	08.13	PR: 1ZF	11.0101-5409.2	260035	Hülzensatz ATE
	1.8 TFSI	118		04.08	08.13	PR: 1ZF			
	1.9 TDI	77		04.08	08.13	PR: 1ZF			
	2.0 TDI	100		04.08	08.13	PR: 1ZF			
	2.0 TDI	103		04.08	08.13	PR: 1ZF			
	2.0 TFSI	147		04.08	08.13	PR: 1ZF			
	1.2 TSI	77		03.10	08.13	PR: 1ZE	11.9541-9553.2	220563	D=54, - Halter ATE
	1.4 TFSI	92		01.11	08.13	PR: 1ZE	11.9541-9554.2	220564	D=54, - Halter ATE
	1.6	75		09.08	08.13	PR: 1ZE	11.8171-0008.1	990049	Führungsbolzen ATE
	1.6 TDI	77		05.09	08.13	PR: 1ZE	11.0101-5409.2	260035	Hülzensatz ATE
	1.8 TFSI	118		04.08	08.13	PR: 1ZE	11.8116-0351.1	390538	Haltefeder ATE
	1.9 TDI	77		04.08	08.13	PR: 1ZE			
	2.0 TDI	100		04.08	08.13	PR: 1ZE			
	2.0 TDI	103		04.08	08.13	PR: 1ZE			
	2.0 TFSI	147		04.08	08.13	PR: 1ZE			

¹⁾ + 5 gear / + 5 marce / + 5-vitesses / + 5 velocidades

²⁾ + 6 gear / + 6 marce / + 6-vitesses / + 6 velocidades

³⁾ piston diameter Ø 22,20mm / diametro del pistone Ø 22,20mm / diamètre de piston Ø 22,20mm / diámetro del pistón Ø 22,20mm













AUDI A3 (8P) Cabrio (08-13)

	1.2 TSI	77		03.10	08.13	PR: 1LJ	11.9541-9553.2	220563	2	D=54, - Halter D=54, - Halter Führungsbolzen Hülzensatz Haltefeder	ATE ATE ATE ATE ATE
	1.4 TFSI	92		01.11	08.13	PR: 1LJ	11.9541-9554.2	220564			
	1.6	75		09.08	08.13	PR: 1LJ	11.8171-0008.1	990049			
	1.6 TDI	77		05.09	08.13	PR: 1LJ	11.0101-5409.2	260035			
	1.8 TFSI	118		04.08	08.13	PR: 1LJ	11.8116-0351.1	390538			
	1.9 TDI	77		04.08	08.13	PR: 1LJ					
	2.0 TDI	100		04.08	08.13	PR: 1LJ					
	2.0 TDI	103		04.08	08.13	PR: 1LJ					
	2.0 TFSI	147		04.08	08.13	PR: 1LJ					
	1.2 TSI	77		03.10	08.13		24.5143-0564.3	331433	2	L=564	
	1.4 TFSI	92		01.11	08.13						
	1.6	75		09.08	08.13						
	1.6 TDI	77		05.09	08.13						
	1.8 TFSI	118		04.08	08.13						
	1.9 TDI	77		04.08	08.13						
	2.0 TDI	100		04.08	08.13						
	2.0 TDI	103		04.08	08.13						
	2.0 TFSI	147		04.08	08.13						
	1.2 TSI	77		03.10	08.13	PR: 1KD	24.3384-1755.7	220635	2	D=38, - Halter D=38, - Halter	TRW TRW
	1.4 TFSI	92		01.11	08.13	PR: 1KD	24.3384-1756.7	220636			
	1.6	75		09.08	08.13	PR: 1KD					
	1.6 TDI	77		05.09	08.13	PR: 1KD					
	1.8 TFSI	118		04.08	08.13	PR: 1KD					
	1.9 TDI	77		04.08	08.13	PR: 1KD					
	2.0 TDI	100		04.08	08.13	PR: 1KD					
	2.0 TDI	103		04.08	08.13	PR: 1KD					
	2.0 TFSI	147		04.08	08.13	PR: 1KD					
	1.2 TSI	77		03.10	08.13	PR: 1KZ	24.3387-1717.7	220757	2	D=38, - Halter D=38, - Halter Bremsattel-Zubehör	TRW TRW TRW
	1.4 TFSI	92		01.11	08.13	PR: 1KZ	24.3387-1718.7	220758			
	1.6	75		09.08	08.13	PR: 1KZ	24.0101-3803.2	260101			
	1.6 TDI	77		05.09	08.13	PR: 1KZ					
	1.8 TFSI	118		04.08	08.13	PR: 1KZ					
	1.9 TDI	77		04.08	08.13	PR: 1KZ					
	2.0 TDI	100		04.08	08.13	PR: 1KZ					
	2.0 TDI	103		04.08	08.13	PR: 1KZ					
	2.0 TFSI	147		04.08	08.13	PR: 1KZ					
	1.2 TSI	77		03.10	08.13		24.5204-0233.3	331430	2	L=233	
	1.4 TFSI	92		01.11	08.13						
	1.6	75		09.08	08.13						
	1.6 TDI	77		05.09	08.13						
	1.8 TFSI	118		04.08	08.13						
	1.9 TDI	77		04.08	08.13						
	2.0 TDI	100		04.08	08.13						
	2.0 TDI	103		04.08	08.13						
	2.0 TFSI	147		04.08	08.13						
	1.2 TSI	77		03.10	08.13		24.2415-1713.3	030132		Gz 15,87, + Sensor	
	1.4 TFSI	92		01.11	08.13						
	1.6	75		09.08	08.13						
	1.6 TDI	77		05.09	08.13						
	1.8 TFSI	118		04.08	08.13						
	1.9 TDI	77		04.08	08.13						
	2.0 TDI	100		04.08	08.13						
	2.0 TDI	103		04.08	08.13						
	2.0 TFSI	147		04.08	08.13						
	1.2 TSI	77		03.10	08.13	PR: OEM	24.2519-1706.3	040096		Nz 19,05	
	1.4 TFSI	92		01.11	08.13	PR: OEM					
	1.6	75		09.08	08.13	PR: OEM					
	1.6 TDI	77		05.09	08.13	PR: OEM					
	1.8 TFSI	118		04.08	08.13	PR: OEM					
	1.9 TDI	77		04.08	08.13	PR: OEM					
	2.0 TDI	100		04.08	08.13	PR: OEM					
	2.0 TDI	103		04.08	08.13	PR: OEM					
	2.0 TFSI	147		04.08	08.13	PR: OEM					
	1.2 TSI	77		03.10	07.11	PR: OEJ	24.2519-1705.3	040095		Nz 19,05	
	1.4 TFSI	92		01.11	07.11	PR: OEJ					
	1.6	75		09.08	07.11	PR: OEJ					
	1.6 TDI	77		05.09	07.11	PR: OEJ					
	1.8 TFSI	118		04.08	07.11	PR: OEJ					
	1.9 TDI	77		04.08	07.11	PR: OEJ					
	2.0 TDI	100		04.08	07.11	PR: OEJ					
	2.0 TDI	103		04.08	07.11	PR: OEJ					
	2.0 TFSI	147		04.08	07.11	PR: OEJ					

AUDI A3 / A3 (8V) Sportback (12-)

	1.0 TFSI	◀ 85		07.16			03.4153-5403.3	010994		Thz 23,81	ATE
	1.2 TFSI	◀ 77		02.13							
	1.2 TFSI	◀ 81		05.14							
	1.4 TFSI	◀ 90		08.12							
	1.4 TFSI	◀ 92		09.13							
	1.4 TFSI	◀ 103		10.12							
	1.4 TFSI	◀ 110		05.14							
	1.4 TFSI e-tron	◀ 110		02.14							
	1.4 TFSI g-tron	◀ 81		02.14							
	1.6 TDI	◀ 77		09.12							
	1.6 TDI	◀ 81		08.13							
	1.6 TDI quattro	◀ 81		05.15							

AUDI A3 / A3 (8V) Sportback (12-)											
											
AUDI A3 / A3 (8V) Sportback (12-)											
	1.8 TFSI 1.8 TFSI quattro 2.0 TDI 2.0 TDI 2.0 TDI 2.0 TDI 2.0 TDI 2.0 TDI quattro 2.0 TDI quattro 2.0 TFSI 2.0 TFSI quattro	132 132 81 100 105 110 135 110 135 140 140	08.12 08.12 01.13 05.13 08.12 08.12 12.12 10.12 12.12 05.16 05.16		03.4153-5403.3	010994				THz 23,81	ATE
	1.0 TFSI 1.2 TFSI 1.2 TFSI 1.4 TFSI 1.4 TFSI 1.4 TFSI 1.4 TFSI 1.4 TFSI e-tron 1.4 TFSI g-tron 1.6 TDI 1.6 TDI 1.6 TDI quattro 1.8 TFSI 1.8 TFSI quattro 2.0 TDI 2.0 TDI 2.0 TDI 2.0 TDI 2.0 TDI 2.0 TDI quattro 2.0 TDI quattro 2.0 TFSI 2.0 TFSI S3 S3 S3 S3	85 77 81 90 92 103 110 110 81 77 81 81 132 132 81 100 105 110 135 110 135 140 140 206 210 221 228	07.16 02.13 05.14 08.12 09.13 10.12 05.14 02.14 02.14 09.12 08.13 05.15 08.12 08.12 01.13 05.13 08.12 08.12 12.12 10.12 12.12 05.16 05.16 02.13 05.14 10.12 06.16	PR: 1KE PR: 1KE	11.0101-5407.2 11.8171-0008.1 11.8116-0340.1	260011 990049 390595	2		Hülsensatz Führungsbolzen Haltefeder	ATE ATE ATE	
	1.0 TFSI 1.2 TFSI 1.2 TFSI 1.4 TFSI 1.4 TFSI 1.4 TFSI 1.4 TFSI 1.4 TFSI e-tron 1.4 TFSI g-tron 1.6 TDI 1.6 TDI 1.6 TDI quattro 1.8 TFSI 1.8 TFSI quattro 2.0 TDI 2.0 TDI 2.0 TDI 2.0 TDI 2.0 TDI 2.0 TDI quattro 2.0 TDI quattro 2.0 TFSI 2.0 TFSI S3 S3 S3 S3	85 77 81 90 92 103 110 110 81 77 81 81 132 132 81 100 105 110 135 110 135 140 140 206 210 221 228	07.16 02.13 05.14 08.12 09.13 10.12 05.14 02.14 02.14 09.12 08.13 05.15 08.12 08.12 01.13 05.13 08.12 08.12 12.12 10.12 12.12 05.16 05.16 02.13 05.14 10.12 06.16	PR: 1KY PR: 1KY	11.0101-5407.2 11.8171-0008.1 11.8116-0340.1	260011 990049 390595	2		Hülsensatz Führungsbolzen Haltefeder	ATE ATE ATE	
	1.0 TFSI 1.2 TFSI 1.2 TFSI 1.4 TFSI 1.4 TFSI 1.4 TFSI 1.4 TFSI 1.4 TFSI e-tron 1.4 TFSI g-tron 1.6 TDI 1.6 TDI 1.6 TDI quattro 1.8 TFSI 1.8 TFSI quattro 2.0 TDI 2.0 TDI 2.0 TDI 2.0 TDI 2.0 TDI 2.0 TDI quattro 2.0 TDI quattro 2.0 TFSI 2.0 TFSI S3 S3 S3 S3	85 77 81 90 92 103 110 110 81 77 81 81 132 132 81 100 105 110 135 110 135 140 140 206 210 221 228	07.16 02.13 05.14 08.12 09.13 10.12 05.14 02.14 02.14 09.12 08.13 05.15 08.12 08.12 01.13 05.13 08.12 08.12 12.12 10.12 12.12 05.16 05.16 02.13 05.14 10.12 06.16	PR: 1KJ PR: 1KJ	11.0101-5407.2 11.8171-0008.1 11.8116-0340.1	260011 990049 390595	2		Hülsensatz Führungsbolzen Haltefeder	ATE ATE ATE	



AUDI A3 / A3 (8V) Sportback (12-)

	2.0 TFSI quattro S3 S3 S3 S3	140 206 210 221 228	05.16 02.13 05.14 10.12 06.16	PR: 1KJ PR: 1KJ PR: 1KJ PR: 1KJ PR: 1KJ	11.0101-5407.2 11.8171-0008.1 11.8116-0340.1	260011 990049 390595	2	Hülsensatz Führungsbolzen Haltefeder	ATE ATE ATE
	1.0 TFSI 1.2 TFSI 1.2 TFSI 1.4 TFSI 1.4 TFSI 1.4 TFSI 1.4 TFSI 1.4 TFSI e-tron 1.4 TFSI g-tron 1.6 TDI 1.6 TDI 1.6 TDI quattro 1.8 TFSI 1.8 TFSI quattro 2.0 TDI 2.0 TDI 2.0 TDI 2.0 TDI 2.0 TDI 2.0 TDI quattro 2.0 TDI quattro 2.0 TFSI 2.0 TFSI quattro S3 S3 S3 S3	85 77 81 90 92 103 110 110 81 77 81 81 132 132 81 100 105 110 135 110 135 140 140 206 210 221 228	07.16 02.13 05.14 08.12 09.13 10.12 05.14 02.14 02.14 09.12 08.13 05.15 08.12 08.12 01.13 05.13 08.12 08.12 12.12 10.12 12.12 05.16 05.16 02.13 05.14 10.12 06.16			24.2519-1706.3	040096	PR: OEC	Nz 19,05

AUDI A3 (8V) Cabrio (13-)

	1.4 TFSI 1.4 TFSI 1.4 TFSI 1.4 TFSI 1.6 TDI 1.8 TFSI 1.8 TFSI quattro 2.0 TDI 2.0 TDI 2.0 TDI quattro 2.0 TDI quattro 2.0 TFSI 2.0 TFSI quattro 2.0 TFSI quattro S3 S3	85 92 103 110 81 132 132 110 135 110 135 140 140 162 221 228	02.16 10.13 10.13 05.14 10.13 10.13 03.14 10.13 05.14 03.14 05.14 05.16 05.16 05.14 04.14 07.16		03.4153-5403.3	010994		THz 23,81	ATE
	1.4 TFSI 1.4 TFSI 1.4 TFSI 1.4 TFSI 1.6 TDI 1.8 TFSI 1.8 TFSI quattro 2.0 TDI 2.0 TDI 2.0 TDI quattro 2.0 TDI quattro 2.0 TFSI 2.0 TFSI quattro 2.0 TFSI quattro S3 S3	85 92 103 110 81 132 132 110 135 110 135 140 140 162 221 228	02.16 10.13 10.13 05.14 10.13 10.13 03.14 10.13 05.14 03.14 05.14 05.16 05.16 05.14 04.14 07.16	PR: 1ZF PR: 1ZF PR: 1ZF PR: 1ZF PR: 1ZF PR: 1ZF PR: 1ZF PR: 1ZF PR: 1ZF PR: 1ZF PR: 1ZF PR: 1ZF PR: 1ZF PR: 1ZF	11.8171-0008.1 11.0101-5407.2	990049 260011		Führungsbolzen Hülsensatz	ATE ATE
	1.4 TFSI 1.4 TFSI 1.4 TFSI 1.4 TFSI 1.6 TDI 1.8 TFSI 1.8 TFSI quattro 2.0 TDI 2.0 TDI 2.0 TDI quattro 2.0 TDI quattro 2.0 TFSI 2.0 TFSI quattro 2.0 TFSI quattro S3 S3	85 92 103 110 81 132 132 110 135 110 135 140 140 162 221 228	02.16 10.13 10.13 05.14 10.13 10.13 03.14 10.13 05.14 03.14 05.14 05.16 05.16 05.14 04.14 07.16			24.2519-1706.3	040096	PR: OEC	Nz 19,05

AUDI A4 (B5) (95-01)

	1.6 1.8 1.8 quattro 1.8 quattro 1.8 T	85 92	11.94 11.94 11.94 11.94 05.95	01.99 01.99 - ESP - ESP 01.99	24.2123-1717.3	010521		THz 23,81	
--	---	----------	---	---	----------------	--------	--	-----------	--

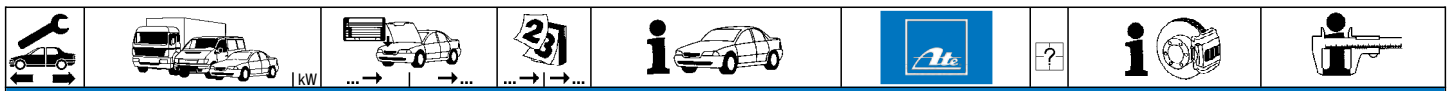















AUDI A4 (B5) (95-01)

	1.6		8D-V-054062		04.01	24.3541-1763.5	240231	 	D=54, - Halter D=54, - Halter	TRW TRW			
	1.6		8D-V-169696		04.01	24.3541-1764.5	240232						
	1.8		85 8D-V-054062		04.01						+ / + GUS-Staaten ¹⁾		
	1.8		92 8D-V-054062		04.01								
	1.8 quattro		85 8D-V-054062		04.01						+ GUS-Staaten ²⁾		
	1.8 quattro		92 8D-V-054062		04.01								
	1.9 TDI		55 8D-V-054062		04.01								
	1.9 TDI		55 8D-V-169696		04.01								
	1.9 TDI		66 8D-V-169696		04.01								
	1.9 TDI		66 8D-V-054062		04.01								
	1.8 T				05.95 04.01	24.3571-8522.5	240496	 	D=57, - Halter D=57, - Halter Dichtungssatz Halter Hülsensatz Führungsbolzen Haltefeder	ATE ATE ATE ATE ATE ATE			
	1.8 T quattro	110			02.95 04.01	24.3571-8521.5	240495						
	1.8 T quattro	132			08.97 04.01	11.0441-5704.2	250034				2		
	1.9 TDI	81			02.96 04.01	11.8170-0306.1	260102						
	1.9 TDI	85			03.00 04.01	11.0101-5409.2	260035				2		
	1.9 TDI quattro	81			07.96 04.01	11.8171-0008.1	990049						
	1.9 TDI quattro	85			03.00 04.01	11.8116-0143.1	390513						
	2.4				07.95 07.97						+		
	2.4	121			08.97 04.01								
	2.4 quattro				08.97 04.01								
	2.5 TDI				08.97 04.01								
	2.5 TDI quattro				11.97 04.01								
	2.6				11.94 04.01								
	2.6 quattro				11.94 04.01								
	2.8	128			11.94 07.97								
	2.8	142			03.96 04.01								
	2.8 quattro	128			11.94 07.96								
	2.8 quattro	142			06.96 04.01								
	RS 4				06.00 04.01							Führungsbolzen Haltefeder	ATE ATE
		1.6				11.94 04.01	83.7813-0295.3				330799	 	L=295
1.8					11.94 04.01								
1.8 quattro		85			11.94 04.01								
1.8 quattro		92			11.94 04.01								
1.8 T					05.95 04.01								
1.8 T quattro		110			02.95 04.01								
1.8 T quattro		132			08.97 04.01								
1.9 TDI		55			03.96 04.01								
1.9 TDI		66			01.95 04.01								
1.9 TDI		81			02.96 04.01								
1.9 TDI		85			03.00 04.01								
1.9 TDI quattro		81			07.96 04.01								
1.9 TDI quattro		85			03.00 04.01								
2.4					07.95 04.01			+					
2.4		121			08.97 04.01								
2.4 quattro					08.97 04.01								
2.5 TDI					08.97 04.01								
2.5 TDI quattro					11.97 04.01								
2.6					11.94 04.01								
2.6 quattro					11.94 04.01								
2.8	128			11.94 07.97									
2.8	142			03.96 04.01									
2.8 quattro	128			11.94 07.96									
2.8 quattro	142			09.96 04.01									
S4				10.97 04.01									
	1.6		8D-V-160000		11.94	24.3384-1719.5	240259	 	D=38, - Halter D=38, - Halter	TRW TRW			
	1.8		8D-V-160000		11.94	24.3384-1720.5	240260						
	1.8 T		8D-V-160000		05.95								
	1.9 TDI	55			03.96								
	1.9 TDI	66			01.95								
	1.9 TDI	81			02.96								
	2.4				07.95						+		
	2.6				11.94								
	2.8	128			11.94								
	2.8	142			03.96								
	1.6		8D-V-160001		04.01	24.3384-1731.7	220543	 	D=38, - Halter D=38, - Halter	TRW TRW			
	1.8		8D-V-160001		04.01	24.3384-1732.7	220544						
	1.8 T		8D-V-160001		04.01								
	1.9 TDI	55			04.01								
	1.9 TDI	66			04.01								
	1.9 TDI	81			04.01								
	1.9 TDI	85			03.00 04.01								
	2.4				07.97						+		
	2.4	121			08.97 04.01								
	2.5 TDI				08.97 04.01								
2.6				04.01									
2.8	128			07.97									
2.8	142			04.01									
	1.8 quattro	85			11.94	24.3384-1725.5	240261	 	D=38, - Halter D=38, - Halter	TRW TRW			
	1.8 quattro	92			11.94	24.3384-1726.5	240262						
	1.8 T quattro	110			02.95 04.01								
	1.8 T quattro	132			08.97 04.01								
	1.9 TDI quattro	81			07.96 04.01								
	1.9 TDI quattro	85			03.00 04.01								
	2.4 quattro				08.97 04.01								
	2.5 TDI quattro				11.97 04.01								
2.6 quattro				11.94 04.01									

¹⁾ + / + GUS States / + / + Stati del GUS / + / + Etats de la CEI / + / + estados del GUS

²⁾ + GUS States / + Stati del GUS / + Etats de la CEI / + estados del GUS

AUDI A4 (B5) (95-01)										
										
	2.8 quattro 2.8 quattro	128 142		11.94 06.96	07.96 04.01	24.3384-1725.5 24.3384-1726.5	240261 240262	 	D=38, - Halter D=38, - Halter	TRW TRW
	1.6 1.8 1.8 T 1.9 TDI 1.9 TDI 1.9 TDI 2.4 2.6 2.8 2.8		8D-V-160000 8D-V-160000 8D-V-160000 8D-V-160000 8D-V-160000 8D-V-160000 8D-V-160000 8D-V-160000 8D-V-160000 8D-V-160000	11.94 11.94 05.95 03.96 01.95 02.96 07.95 11.94 11.94 03.96				2 2	am Bremssattel ¹⁾	L=183 L=200
	1.6 1.8 1.8 T 1.9 TDI 1.9 TDI 1.9 TDI 1.9 TDI 2.4 2.4 2.5 TDI 2.6 2.8 2.8		8D-V-160001 8D-V-160001 8D-V-160001 8D-V-160001 8D-V-160001 8D-V-160001 8D-V-160001 8D-V-160001 8D-V-160001 8D-V-160001 8D-V-160001 8D-V-160001 8D-V-160001		04.01 04.01 04.01 04.01 04.01 04.01 03.00 07.97 08.97 08.97 04.01 04.01 07.97 04.01			2 2	am Bremssattel ¹⁾	L=183 L=240
	1.8 quattro 1.8 quattro 1.8 T quattro 1.8 T quattro 1.9 TDI quattro 1.9 TDI quattro 2.4 quattro 2.5 TDI quattro 2.6 quattro 2.8 quattro 2.8 quattro S4	85 92 110 132 81 85		11.94 11.94 02.95 08.97 07.96 03.00 08.97 11.97 11.94 11.94 06.96 10.97	04.01 04.01 04.01 04.01 04.01 04.01 04.01 04.01 04.01 07.96 04.01 04.01	83.6212-0160.3 24.5113-0220.3	330318 331318	2 2	am Bremssattel ¹⁾	L=160 L=220
	RS 4			06.00	04.01	83.6212-0160.3	330318	2		L=160
	1.6 1.8 1.8 T 1.9 TDI 1.9 TDI 1.9 TDI 1.9 TDI 2.4 2.4 2.5 TDI 2.6 2.8 2.8			11.94 11.94 05.95 03.96 01.95 02.96 03.00 07.95 08.97 08.97 11.94 11.94 03.96	04.01 04.01 04.01 04.01 04.01 04.01 04.01 07.97 04.01 04.01 04.01 04.01 07.97 04.01	24.3727-0155.2	580155	2		L=1812
	1.6 1.8 1.8 quattro 1.8 quattro 1.8 T 1.8 T quattro 1.9 TDI 1.9 TDI 1.9 TDI 1.9 TDI 1.9 TDI 1.9 TDI quattro 2.4 2.5 TDI 2.6 2.6 quattro 2.8 2.8 2.8 quattro 2.8 quattro		8D-V-180000 8D-V-180000 8D-V-170678 8D-V-170678 8D-V-180000 8D-V-170678 8D-V-180000 8D-V-180000 8D-V-180000 8D-V-180000 8D-V-180000 8D-V-277328 8D-V-180000 8D-V-180000 8D-V-180000 8D-V-170678 8D-V-180000 8D-V-180000 8D-V-170678 8D-V-180000 8D-V-170678	11.94 11.94 11.94 11.94 05.95 02.95 03.96 01.95 02.96 03.00 07.96 07.95 08.97 11.94 11.94 11.94 11.94 11.94 03.96 11.94 06.96		24.2419-1706.3	030091			Gz 19,05
	1.6 1.8 1.8 quattro 1.8 quattro 1.8 T 1.8 T quattro 1.9 TDI 1.9 TDI 1.9 TDI 1.9 TDI 1.9 TDI 1.9 TDI quattro 2.4 2.5 TDI 2.6 2.6 quattro 2.8 2.8 2.8 quattro 2.8 quattro		8D-V-180001 8D-V-180001 8D-V-170679 8D-V-170679 8D-V-180001 8D-V-170679 8D-V-180001 8D-V-180001 8D-V-180001 8D-V-180001 8D-V-180001 8D-V-277329 8D-V-180001 8D-V-180001 8D-V-180001 8D-V-170678 8D-V-180001 8D-V-180001 8D-V-170678 8D-V-180001 8D-V-170678		04.01 04.01 04.01 04.01 04.01 04.01 04.01 04.01 04.01 04.01 04.01 04.01 07.97 04.01 04.01 04.01 04.01 04.01 04.01 04.01 07.97 08.97		24.2419-1707.3	030092		Gz 19,05

¹⁾ on the brake caliper / sulla pinza freno / sur l'étrier de frein / a la pinza de freno

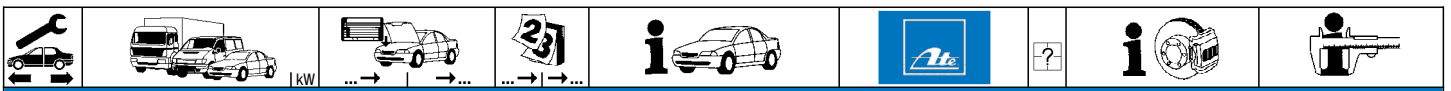

AUDI A4 (B5) (95-01)

	2.4 quattro 2.5 TDI 2.5 TDI quattro 2.6 2.6 quattro 2.8 2.8 2.8 quattro 2.8 quattro RS 4 S4	8D-V-180001 8D-V-180001 8D-V-170679 128 8D-V-180001 142 8D-V-180001 128 8D-V-170679 142 8D-V-170679	08.97 04.01 11.97 04.01 04.01 07.97 04.01 04.01 04.01 06.00 10.97	04.01 04.01 04.01 04.01 04.01 04.01 04.01 04.01 04.01 04.01 04.01	24.2419-1707.3 030092		Gz 19,05
	1.6 1.8 1.8 quattro 1.8 quattro 1.8 T 1.8 T quattro 1.8 T quattro 1.9 TDI quattro 1.9 TDI quattro 2.4 2.4 2.4 quattro 2.5 TDI quattro 2.6 2.6 quattro 2.8 2.8 2.8 quattro 2.8 quattro S4	8D-V-180001 8D-V-180001 85 8D-V-170679 92 8D-V-170679 8D-V-180001 110 8D-V-170679 132 81 8D-V-277329 85 8D-V-180001 121 8D-V-180001 8D-V-170679 8D-V-180001 8D-V-170679 128 8D-V-180001 142 8D-V-180001 128 8D-V-170679 142 8D-V-170679	08.97 04.01 03.00 04.01 07.97 + (T) 08.97 08.97 11.97 04.01 04.01 07.97 07.97 07.97 04.01 04.01 04.01 04.01 04.01 04.01 10.97	04.01 04.01 04.01 04.01 04.01 04.01 04.01 04.01 04.01 04.01 04.01 04.01 04.01 04.01 04.01 04.01 04.01 04.01 04.01 04.01	24.2419-1705.3 030090		Gz 19,05
	1.6 1.8 1.8 quattro 1.8 quattro 1.8 T 1.8 T quattro 1.9 TDI 1.9 TDI 1.9 TDI 1.9 TDI 1.9 TDI 1.9 TDI quattro 2.4 2.5 TDI 2.6 2.6 quattro 2.8 2.8 2.8 quattro 2.8 quattro	8D-V-180000 8D-V-180000 85 8D-V-170678 92 8D-V-170678 8D-V-180000 110 8D-V-170678 55 66 81 81 85 81 8D-V-180000 8D-V-277328 8D-V-180000 8D-V-180000 11.94 11.94 128 8D-V-180000 142 8D-V-180000 128 8D-V-170678 142 8D-V-170678	11.94 11.94 11.94 05.95 02.95 03.96 01.95 02.96 02.96 03.00 07.96 07.95 08.97 11.94 11.94 11.94 03.96 11.94 06.96	04.01 04.01	24.2519-1702.3 040074		Nz 19,05
	1.6 1.8 1.8 quattro 1.8 quattro 1.8 T 1.8 T quattro 1.8 T quattro 1.9 TDI 1.9 TDI 1.9 TDI 1.9 TDI 1.9 TDI 1.9 TDI quattro 2.4 2.4 quattro 2.5 TDI 2.5 TDI quattro 2.6 2.6 quattro 2.8 2.8 2.8 quattro 2.8 quattro RS 4 S4	8D-V-180001 8D-V-180001 85 8D-V-170679 92 8D-V-170679 8D-V-180001 110 8D-V-170679 132 81 8D-V-180001 85 8D-V-180001 81 8D-V-277329 85 8D-V-180001 8D-V-170679 128 8D-V-180001 142 8D-V-180001 128 8D-V-170679 142 8D-V-170679	08.97 04.01 06.00 10.97	04.01 04.01	24.2522-1706.3 040090		Nz 22,20

AUDI A4 (B6/B7) (01-08)

	1.6 1.8 T 1.8 T 1.8 T 1.8 T 1.8 T quattro 1.8 T quattro 1.8 T quattro 1.8 T quattro 1.9 TDI 1.9 TDI	75 8E-3-235001 110 8E-3-235001 120 8E-3-235001 125 8E-3-235001 140 8E-3-235001 110 8E-3-235001 120 8E-3-235001 125 8E-3-235001 140 8E-3-235001 74 8E-3-235001 85	11.08 11.08 11.08 11.08 11.08 11.08 11.08 11.08 11.08 11.08 06.04 11.08	11.08 11.08 11.08 11.08 11.08 11.08 11.08 11.08 11.08 11.08 11.08 11.08	03.7858-4502.4 300202		9/8" Tandem ATE
↓							

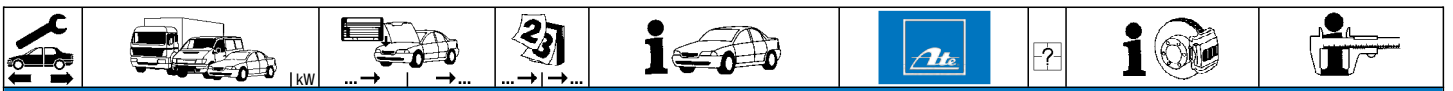

AUDI A4 (B6/B7) (01-08)

	1.9 TDI	96	8E-3-235001		11.08	03.7858-4502.4	300202		9/8" Tandem	ATE
	1.9 TDI quattro	96	8E-3-235001		11.08					
	2.0	96	8E-3-235001		11.08					
	2.0 FSI	110	8E-3-235001		11.08					
	2.0 TFSI	147		11.04	11.08					
	2.0 TFSI	162		06.05	11.08					
	2.4		8E-3-235001		11.08					
	2.5 TDI		8E-3-235001		11.08					
	2.5 TDI quattro		8E-3-235001		11.08					
	3.0		8E-3-235001		11.08					
	3.0 quattro		8E-3-235001		11.08					
	3.2 FSI	188		01.05	11.08					
		2.0 TDI	100	8E-5-400001						
2.0 TDI		103	8E-5-400001		11.08					
2.0 TDI		125		06.06	11.08					
2.0 TDI quattro		103		01.06	11.08					
2.0 TDI quattro		125		06.06	11.08					
2.0 TFSI quattro		147	8E-5-400001		11.08					
2.0 TFSI quattro		162	8E-5-400001		11.08					
2.7 TDI		120		11.05	11.08					
2.7 TDI		132		01.06	11.08					
3.0 TDI quattro		150	8E-5-400001		11.08					
3.0 TDI quattro		171		01.06	11.08					
3.2 FSI quattro		188	8E-5-400001		11.08					
		1.6	75		12.00	11.08	03.2125-0373.3	010810		THz 25,40
	1.8 T	110		12.00	11.08					
	1.8 T	120		07.02	11.08					
	1.8 T	125		07.01	11.08					
	1.8 T	140		11.02	11.08					
	1.8 T quattro	110		12.00	11.08					
	1.8 T quattro	120		07.02	11.08					
	1.8 T quattro	125		07.01	11.08					
	1.8 T quattro	140		11.02	11.08					
	1.9 TDI	74		04.01	11.08					
	1.9 TDI	85		06.04	11.08					
	1.9 TDI	96		12.00	11.08					
	1.9 TDI quattro			12.00	11.08					
	2.0	96		12.00	11.08					
	2.0 FSI	110		07.02	11.08					
	2.0 TDI	100		11.04	11.08					
	2.0 TDI	103		11.03	11.08					
	2.0 TDI	125		06.06	11.08					
	2.0 TDI quattro	103		01.06	11.08					
	2.0 TDI quattro	125		06.06	11.08					
	2.0 TFSI	147		12.04	11.08					
	2.0 TFSI	162		06.05	11.08					
	2.0 TFSI quattro	147		11.04	11.08					
	2.0 TFSI quattro	162		06.05	11.08					
	2.4			09.01	11.08					
	2.5 TDI			12.00	11.08					
	2.5 TDI quattro			12.00	11.08					
	2.7 TDI	120		11.05	11.08					
	2.7 TDI	132		01.06	11.08					
	3.0			12.00	11.08					
	3.0 quattro			12.00	11.08					
	3.0 TDI quattro	150		11.04	11.08					
	3.0 TDI quattro	171		01.06	11.08					
3.2 FSI	188		01.05	11.08						
3.2 FSI quattro	188		01.05	11.08						
RS 4	309		11.05	11.08	24.2126-1705.3	010999		THz 26,99	TRW	
S4	253		03.03	11.08						
	1.6	75	8E-7-300000	12.00	PR: 1LZ	24.3541-1763.5	240231		D=54, - Halter	TRW
	1.8 T	110	8E-7-300000	12.00	PR: 1LZ					
	1.8 T	120	8E-7-300000	07.02	PR: 1LZ					
	1.8 T	125	8E-7-300000	07.01	PR: 1LZ					
	1.8 T	140	8E-7-300000	11.02	PR: 1LZ					
	1.8 T quattro	110	8E-7-300000	12.00	PR: 1LZ					
	1.8 T quattro	120	8E-7-300000	07.02	PR: 1LZ					
	1.8 T quattro	125	8E-7-300000	07.01	PR: 1LZ					
	1.8 T quattro	140	8E-7-300000	11.02	PR: 1LZ					
	1.9 TDI	74	8E-7-300000	04.01	PR: 1LZ					
	1.9 TDI	85	8E-7-300000	06.04	PR: 1LZ					
	1.9 TDI	96	8E-7-300000	12.00	PR: 1LZ					
	1.9 TDI quattro		8E-7-300000	12.00	PR: 1LZ					
	2.0	96	8E-7-300000	12.00	PR: 1LZ					
	2.0 FSI	110	8E-7-300000	07.02	PR: 1LZ					
	2.0 TDI	100	8E-7-300000	11.04	PR: 1LZ					
	2.0 TDI	103	8E-7-300000	11.04	PR: 1LZ					
	2.0 TDI	125	8E-7-300000	06.06	PR: 1LZ					
	2.0 TDI quattro	103	8E-7-300000	01.06	PR: 1LZ					
	2.0 TDI quattro	125	8E-7-300000	06.06	PR: 1LZ					
	2.0 TFSI	147	8E-7-300000	11.04	PR: 1LZ					
2.0 TFSI	162	8E-7-300000	06.05	PR: 1LZ						
2.0 TFSI quattro	147	8E-7-300000	11.04	PR: 1LZ						
2.0 TFSI quattro	162	8E-7-300000	06.05	PR: 1LZ						
2.4		8E-7-300000	09.01	PR: 1LZ						
2.5 TDI		8E-7-300000	12.00	PR: 1LZ						



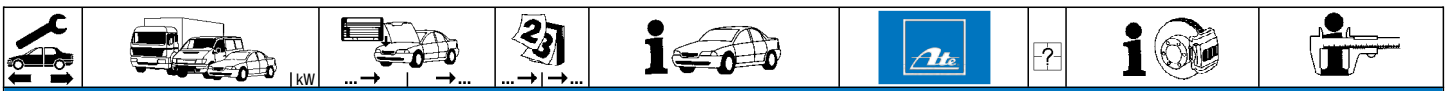

AUDI A4 (B6/B7) (01-08)

	2.5 TDI quattro		8E-7-300000	12.00	PR: 1LZ	24.3541-1763.5	240231		D=54, - Halter D=54, - Halter	TRW TRW	
	2.7 TDI	120	8E-7-300000	11.05	PR: 1LZ	24.3541-1764.5	240232				
	2.7 TDI	132	8E-7-300000	01.06	PR: 1LZ						
	3.0		8E-7-300000	12.00	PR: 1LZ						
	3.0 quattro		8E-7-300000	12.00	PR: 1LZ						
	3.0 TDI quattro	150	8E-7-300000	11.04	PR: 1LZ						
	3.0 TDI quattro	171	8E-7-300000	01.06	PR: 1LZ						
	3.2 FSI	188	8E-7-300000	01.05	PR: 1LZ						
	3.2 FSI quattro	188	8E-7-300000	01.05	PR: 1LZ						
	1.6	75	8E-8-000001		11.08	PR: 1LZ	24.3541-1763.5				240231
	1.8 T	110	8E-8-000001		11.08	PR: 1LZ	24.3541-1764.5				240232
	1.8 T	120	8E-8-000001		11.08	PR: 1LZ					
	1.8 T	125	8E-8-000001		11.08	PR: 1LZ					
	1.8 T	140	8E-8-000001		11.08	PR: 1LZ					
	1.8 T quattro	110	8E-8-000001		11.08	PR: 1LZ					
1.8 T quattro	120	8E-8-000001		11.08	PR: 1LZ						
1.8 T quattro	125	8E-8-000001		11.08	PR: 1LZ						
1.8 T quattro	140	8E-8-000001		11.08	PR: 1LZ						
1.9 TDI	74	8E-8-000001		11.08	PR: 1LZ						
1.9 TDI	85	8E-8-000001		11.08	PR: 1LZ						
1.9 TDI	96	8E-8-000001		11.08	PR: 1LZ						
1.9 TDI quattro		8E-8-000001		11.08	PR: 1LZ						
2.0	96	8E-8-000001		11.08	PR: 1LZ						
2.0 FSI	110	8E-8-000001		11.08	PR: 1LZ						
2.0 TDI	100	8E-8-000001		11.08	PR: 1LZ						
2.0 TDI	103	8E-8-000001		11.08	PR: 1LZ						
2.0 TDI	125	8E-8-000001		11.08	PR: 1LZ						
2.0 TDI quattro	103	8E-8-000001		11.08	PR: 1LZ						
2.0 TDI quattro	125	8E-8-000001		11.08	PR: 1LZ						
2.0 TFSI	147	8E-8-000001		11.08	PR: 1LZ						
2.0 TFSI	162	8E-8-000001		11.08	PR: 1LZ						
2.0 TFSI quattro	147	8E-8-000001		11.08	PR: 1LZ						
2.0 TFSI quattro	162	8E-8-000001		11.08	PR: 1LZ						
2.4		8E-8-000001		11.08	PR: 1LZ						
2.5 TDI		8E-8-000001		11.08	PR: 1LZ						
2.5 TDI quattro		8E-8-000001		11.08	PR: 1LZ						
2.7 TDI	120	8E-8-000001		11.08	PR: 1LZ						
2.7 TDI	132	8E-8-000001		11.08	PR: 1LZ						
3.0		8E-8-000001		11.08	PR: 1LZ						
3.0 quattro		8E-8-000001		11.08	PR: 1LZ						
3.0 TDI quattro	150	8E-8-000001		11.08	PR: 1LZ						
3.0 TDI quattro	171	8E-8-000001		11.08	PR: 1LZ						
3.2 FSI	188	8E-8-000001		11.08	PR: 1LZ						
3.2 FSI quattro	188	8E-8-000001		11.08	PR: 1LZ						
1.6	75		12.00	11.08	PR: 1LB,1LE	24.3571-8522.5	240496		D=57, - Halter D=57, - Halter Dichtungssatz Hülssensatz Führungsbolzen Haltefeder	ATE ATE ATE ATE ATE ATE	
1.8 T	110		12.00	11.08	PR: 1LB,1LE	24.3571-8521.5	240495				
1.8 T	120		07.02	11.08	PR: 1LB,1LE	11.0441-5704.2	250034				
1.8 T	125		07.01	11.08	PR: 1LB,1LE	11.0101-5409.2	260035				
1.8 T	140		11.02	11.08	PR: 1LB,1LE	11.8171-0008.1	990049				
1.8 T quattro	110		12.00	11.08	PR: 1LB,1LE	11.8116-0143.1	390513				
1.8 T quattro	120		07.02	11.08	PR: 1LB,1LE						
1.8 T quattro	125		07.01	11.08	PR: 1LB,1LE						
1.8 T quattro	140		11.02	11.08	PR: 1LB,1LE						
1.9 TDI	74		04.01	11.08	PR: 1LB,1LE						
1.9 TDI	85		06.04	11.08	PR: 1LB,1LE						
1.9 TDI	96		12.00	11.08	PR: 1LB,1LE						
1.9 TDI quattro			12.00	11.08	PR: 1LB,1LE						
2.0	96		12.00	11.08	PR: 1LB,1LE						
2.0 FSI	110		07.02	11.08	PR: 1LB,1LE						
2.0 TDI	100		11.04	11.08	PR: 1LB,1LE						
2.0 TDI	103		11.04	11.08	PR: 1LB,1LE						
2.0 TDI	125		06.06	11.08	PR: 1LB,1LE						
2.0 TDI quattro	103		01.06	11.08	PR: 1LB,1LE						
2.0 TDI quattro	125		06.06	11.08	PR: 1LB,1LE						
2.0 TFSI	147		11.04	11.08	PR: 1LB,1LE						
2.0 TFSI	162		06.05	11.08	PR: 1LB,1LE						
2.0 TFSI quattro	147		11.04	11.08	PR: 1LB,1LE						
2.0 TFSI quattro	162		06.05	11.08	PR: 1LB,1LE						
2.4			09.01	11.08	PR: 1LB,1LE						
2.5 TDI			12.00	11.08	PR: 1LB,1LE						
2.5 TDI quattro			12.00	11.08	PR: 1LB,1LE						
2.7 TDI	120		11.05	11.08	PR: 1LB,1LE						
2.7 TDI	132		01.06	11.08	PR: 1LB,1LE						
3.0			12.00	11.08	PR: 1LB,1LE						
3.0 quattro			12.00	11.08	PR: 1LB,1LE						
3.0 TDI quattro	150		11.04	11.08	PR: 1LB,1LE						
3.0 TDI quattro	171		01.06	11.08	PR: 1LB,1LE						
3.2 FSI	188		01.05	11.08	PR: 1LB,1LE						
3.2 FSI quattro	188		01.05	11.08	PR: 1LB,1LE						
1.6	75		12.00	11.08	PR: 1LF,1LT	11.9571-9836.2	220428		D=57, - Halter D=57, - Halter Dichtungssatz Hülssensatz Führungsbolzen Haltefeder	ATE ATE ATE ATE ATE ATE	
1.8 T	110		12.00	11.08	PR: 1LF,1LT	11.9571-9835.2	220427				
1.8 T	120		07.02	11.08	PR: 1LF,1LT	11.0441-5704.2	250034				
1.8 T	125		07.01	11.08	PR: 1LF,1LT	11.0101-5409.2	260035				
1.8 T	140		11.02	11.08	PR: 1LF,1LT	11.8171-0008.1	990049				
1.8 T quattro	110		12.00	11.08	PR: 1LF,1LT	11.8116-0143.1	390513				
1.8 T quattro	120		07.02	11.08	PR: 1LF,1LT						
1.8 T quattro	125		07.01	11.08	PR: 1LF,1LT						
1.8 T quattro	140		11.02	11.08	PR: 1LF,1LT						
1.8 T quattro	110		12.00	11.08	PR: 1LF,1LT						

AUDI A4 (B6/B7) (01-08)		kW		PR: 1LF,1LT		PR: 1LF,1LT		PR: 1LF,1LT		PR: 1LF,1LT		PR: 1LF,1LT		PR: 1LF,1LT		PR: 1LF,1LT	
	1.8 T quattro	140		11.02	11.08	PR: 1LF,1LT		11.9571-9836.2	220428	2		D=57, - Halter	ATE				
	1.9 TDI	74		04.01	11.08	PR: 1LF,1LT		11.9571-9835.2	220427				ATE				
	1.9 TDI	85		06.04	11.08	PR: 1LF,1LT		11.0441-5704.2	250034				ATE				
	1.9 TDI	96		12.00	11.08	PR: 1LF,1LT		11.0101-5409.2	260035				ATE				
	1.9 TDI quattro			12.00	11.08	PR: 1LF,1LT		11.8171-0008.1	990049				ATE				
	2.0	96		12.00	11.08	PR: 1LF,1LT		11.8116-0143.1	390513				ATE				
	2.0 FSI	110		07.02	11.08	PR: 1LF,1LT											
	2.0 TDI	100		11.04	11.08	PR: 1LF,1LT											
	2.0 TDI	103		11.04	11.08	PR: 1LF,1LT											
	2.0 TDI	125		06.06	11.08	PR: 1LF,1LT											
	2.0 TDI quattro	103		01.06	11.08	PR: 1LF,1LT											
	2.0 TDI quattro	125		06.06	11.08	PR: 1LF,1LT											
	2.0 TFSI	147		11.04	11.08	PR: 1LF,1LT											
	2.0 TFSI	162		06.05	11.08	PR: 1LF,1LT											
	2.0 TFSI quattro	147		11.04	11.08	PR: 1LF,1LT											
	2.0 TFSI quattro	162		06.05	11.08	PR: 1LF,1LT											
	2.4			09.01	11.08	PR: 1LF,1LT											
	2.5 TDI			12.00	11.08	PR: 1LF,1LT											
	2.5 TDI quattro			12.00	11.08	PR: 1LF,1LT											
	2.7 TDI	120		11.05	11.08	PR: 1LF,1LT											
	2.7 TDI	132		01.06	11.08	PR: 1LF,1LT											
	3.0			12.00	11.08	PR: 1LF,1LT											
	3.0 quattro			12.00	11.08	PR: 1LF,1LT											
	3.0 TDI quattro	150		11.04	11.08	PR: 1LF,1LT											
	3.0 TDI quattro	171		01.06	11.08	PR: 1LF,1LT											
	3.2 FSI	188		01.05	11.08	PR: 1LF,1LT											
	3.2 FSI quattro	188		01.05	11.08	PR: 1LF,1LT											
	1.6	75		12.00	11.08	PR: 1LA,1LC		11.9606-9953.2	220587				2		D=60, - Halter	ATE	
	1.8 T	110		12.00	11.08	PR: 1LA,1LC		11.9606-9954.2	220588							ATE	
	1.8 T	120		07.02	11.08	PR: 1LA,1LC		11.0441-6008.2	250038							ATE	
	1.8 T	125		07.01	11.08	PR: 1LA,1LC		11.0101-5409.2	260035							ATE	
	1.8 T	140		11.02	11.08	PR: 1LA,1LC		11.8171-0008.1	990049							ATE	
1.8 T quattro	110		12.00	11.08	PR: 1LA,1LC		11.8116-0410.2	390589	ATE								
1.8 T quattro	120		07.02	11.08	PR: 1LA,1LC												
1.8 T quattro	125		07.01	11.08	PR: 1LA,1LC												
1.8 T quattro	140		11.02	11.08	PR: 1LA,1LC												
1.9 TDI	74		04.01	11.08	PR: 1LA,1LC												
1.9 TDI	85		06.04	11.08	PR: 1LA,1LC												
1.9 TDI	96		12.00	11.08	PR: 1LA,1LC												
1.9 TDI quattro			12.00	11.08	PR: 1LA,1LC												
2.0	96		12.00	11.08	PR: 1LA,1LC												
2.0 FSI	110		07.02	11.08	PR: 1LA,1LC												
2.0 TDI	100		11.04	11.08	PR: 1LA,1LC												
2.0 TDI	103		11.04	11.08	PR: 1LA,1LC												
2.0 TDI	125		06.06	11.08	PR: 1LA,1LC												
2.0 TDI quattro	103		01.06	11.08	PR: 1LA,1LC												
2.0 TDI quattro	125		06.06	11.08	PR: 1LA,1LC												
2.0 TFSI	147		11.04	11.08	PR: 1LA,1LC												
2.0 TFSI	162		06.05	11.08	PR: 1LA,1LC												
2.0 TFSI quattro	147		11.04	11.08	PR: 1LA,1LC												
2.0 TFSI quattro	162		06.05	11.08	PR: 1LA,1LC												
2.4			09.01	11.08	PR: 1LA,1LC												
2.5 TDI			12.00	11.08	PR: 1LA,1LC												
2.5 TDI quattro			12.00	11.08	PR: 1LA,1LC												
2.7 TDI	120		11.05	11.08	PR: 1LA,1LC												
2.7 TDI	132		01.06	11.08	PR: 1LA,1LC												
3.0			12.00	11.08	PR: 1LA,1LC												
3.0 quattro			12.00	11.08	PR: 1LA,1LC												
3.0 TDI quattro	150		11.04	11.08	PR: 1LA,1LC												
3.0 TDI quattro	171		01.06	11.08	PR: 1LA,1LC												
3.2 FSI	188		01.05	11.08	PR: 1LA,1LC												
3.2 FSI quattro	188		01.05	11.08	PR: 1LA,1LC												
S4	253	8H-7-900460	03.03		PR: 1LJ		11.9606-9961.2	220655	2		D=60, - Halter	ATE					
							11.9606-9962.2	220656				ATE					
							11.0441-6008.2	250038				ATE					
							11.0101-5409.2	260035				ATE					
							11.8171-0008.1	990049				ATE					
							11.8116-0410.2	390589				ATE					
S4	253	8H-7-900461		11.08	PR: 1LJ		11.0441-6008.2	250038	2		Dichtungssatz	ATE					
							11.0101-5409.2	260035				ATE					
							11.8171-0008.1	990049				ATE					
							11.8116-0006.2	390601				ATE					
							24.5237-0308.3	331435			L=308						
	1.6	75		12.00	11.08				2								
	1.8 T	110		12.00	11.08												
	1.8 T	120		07.02	11.08												
	1.8 T	125		07.01	11.08												
	1.8 T	140		11.02	11.08												
	1.8 T quattro	110		12.00	11.08												
	1.8 T quattro	120		07.02	11.08												
	1.8 T quattro	125		07.01	11.08												
	1.8 T quattro	140		11.02	11.08												
	1.9 TDI	74		04.01	11.08												
	1.9 TDI	85		06.04	11.08												
	1.9 TDI	96		12.00	11.08												
	1.9 TDI quattro			12.00	11.08												
	2.0	96		12.00	11.08												
2.0 FSI	110		07.02	11.08													

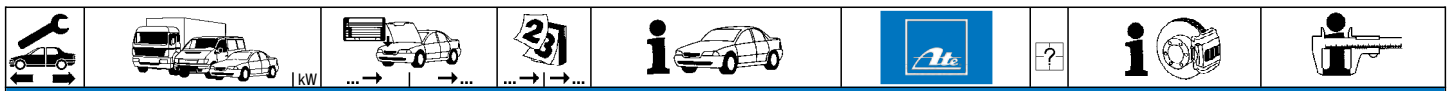

AUDI A4 (B6/B7) (01-08)

	2.0 TDI	100		11.04	11.08		24.5237-0308.3	331435	2		L=308
	2.0 TDI	103		11.04	11.08						
	2.0 TDI	125		06.06	11.08						
	2.0 TDI quattro	103		01.06	11.08						
	2.0 TDI quattro	125		06.06	11.08						
	2.0 TFSI	147		11.04	11.08						
	2.0 TFSI	162		06.05	11.08						
	2.0 TFSI quattro	147		11.04	11.08						
	2.0 TFSI quattro	162		06.05	11.08						
	2.4			09.01	11.08						
	2.5 TDI			12.00	11.08						
	2.5 TDI quattro			12.00	11.08						
	2.7 TDI	120		11.05	11.08						
	2.7 TDI	132		01.06	11.08						
	3.0			12.00	11.08						
	3.0 quattro			12.00	11.08						
	3.0 TDI quattro	150		11.04	11.08						
	3.0 TDI quattro	171		01.06	11.08						
	3.2 FSI	188		01.05	11.08						
	3.2 FSI quattro	188		01.05	11.08						
	S4	253		03.03	11.08						
	RS 4	309		11.05	11.08		83.6169-0418.3	330894	2		L=422
	1.6	75	8E-7-300000	12.00		PR: 1KD,1KP	24.3384-1735.7	220547			D=38, - Halter TRW
	1.8 T	110	8E-7-300000	12.00		PR: 1KD,1KP	24.3384-1736.7	220548			D=38, - Halter TRW
	1.8 T	120	8E-7-300000	07.02		PR: 1KD,1KP					
	1.8 T	125	8E-7-300000	07.01		PR: 1KD,1KP					
	1.8 T	140	8E-7-300000	11.02		PR: 1KD,1KP					
	1.8 T quattro	110	8E-7-300000	12.00		PR: 1KD,1KP					
	1.8 T quattro	120	8E-7-300000	07.02		PR: 1KD,1KP					
	1.8 T quattro	125	8E-7-300000	07.01		PR: 1KD,1KP					
	1.8 T quattro	140	8E-7-300000	11.02		PR: 1KD,1KP					
	1.9 TDI	74	8E-7-300000	04.01		PR: 1KD,1KP					
	1.9 TDI	85	8E-7-300000	06.04		PR: 1KD,1KP					
	1.9 TDI	96	8E-7-300000	12.00		PR: 1KD,1KP					
	1.9 TDI quattro		8E-7-300000	12.00		PR: 1KD,1KP					
	2.0	96	8E-7-300000	12.00		PR: 1KD,1KP					
	2.0 FSI	110	8E-7-300000	07.02		PR: 1KD,1KP					
	2.0 TDI	100	8E-7-300000	11.04		PR: 1KD,1KP					
	2.0 TDI	103	8E-7-300000	11.04		PR: 1KD,1KP					
	2.0 TDI	125	8E-7-300000	06.06		PR: 1KD,1KP					
	2.0 TDI quattro	103	8E-7-300000	01.06		PR: 1KD,1KP					
	2.0 TDI quattro	125	8E-7-300000	06.06		PR: 1KD,1KP					
	2.0 TFSI	147	8E-7-300000	11.04		PR: 1KD,1KP					
	2.0 TFSI	162	8E-7-300000	06.05		PR: 1KD,1KP					
	2.0 TFSI quattro	147	8E-7-300000	11.04		PR: 1KD,1KP					
	2.0 TFSI quattro	162	8E-7-300000	06.05		PR: 1KD,1KP					
	2.4		8E-7-300000	09.01		PR: 1KD,1KP					
	2.5 TDI		8E-7-300000	12.00		PR: 1KD,1KP					
	2.5 TDI quattro		8E-7-300000	12.00		PR: 1KD,1KP					
	2.7 TDI	120	8E-7-300000	11.05		PR: 1KD,1KP					
	2.7 TDI	132	8E-7-300000	01.06		PR: 1KD,1KP					
	3.0		8E-7-300000	12.00		PR: 1KD,1KP					
	3.0 quattro		8E-7-300000	12.00		PR: 1KD,1KP					
	3.0 TDI quattro	150	8E-7-300000	11.04		PR: 1KD,1KP					
	3.0 TDI quattro	171	8E-7-300000	01.06		PR: 1KD,1KP					
	3.2 FSI	188	8E-7-300000	01.05		PR: 1KD,1KP					
	3.2 FSI quattro	188	8E-7-300000	01.05		PR: 1KD,1KP					
	1.6	75	8E-5-400001	11.08		PR: 1KW	24.3414-1713.7	220793			D=41, - Halter TRW
	1.8 T	110	8E-5-400001	11.08		PR: 1KW	24.3414-1714.7	220794			D=41, - Halter TRW
	1.8 T	120	8E-5-400001	11.08		PR: 1KW					
	1.8 T	125	8E-5-400001	11.08		PR: 1KW					
	1.8 T	140	8E-5-400001	11.08		PR: 1KW					
	1.8 T quattro	110	8E-5-400001	11.08		PR: 1KW					
	1.8 T quattro	120	8E-5-400001	11.08		PR: 1KW					
	1.8 T quattro	125	8E-5-400001	11.08		PR: 1KW					
	1.8 T quattro	140	8E-5-400001	11.08		PR: 1KW					
	1.9 TDI	74	8E-5-400001	11.08		PR: 1KW					
	1.9 TDI	85	8E-5-400001	11.08		PR: 1KW					
	1.9 TDI	96	8E-5-400001	11.08		PR: 1KW					
	1.9 TDI quattro		8E-5-400001	11.08		PR: 1KW					
	2.0	96	8E-5-400001	11.08		PR: 1KW					
	2.0 FSI	110	8E-5-400001	11.08		PR: 1KW					
	2.0 TDI	100	8E-5-400001	11.08		PR: 1KW					
	2.0 TDI	103	8E-5-400001	11.08		PR: 1KW					
	2.0 TDI	125		06.06	11.08	PR: 1KW					
	2.0 TDI quattro	103		01.06	11.08	PR: 1KW					
	2.0 TDI quattro	125		06.06	11.08	PR: 1KW					
	2.0 TFSI	147	8E-5-400001	11.08		PR: 1KW					
	2.0 TFSI	162	8E-5-400001	11.08		PR: 1KW					
	2.0 TFSI quattro	147	8E-5-400001	11.08		PR: 1KW					
	2.0 TFSI quattro	162	8E-5-400001	11.08		PR: 1KW					
	2.4		8E-5-400001	11.08		PR: 1KW					
	2.5 TDI		8E-5-400001	11.08		PR: 1KW					
	2.5 TDI quattro		8E-5-400001	11.08		PR: 1KW					
	2.7 TDI	120		11.05	11.08	PR: 1KW					
	2.7 TDI	132		01.06	11.08	PR: 1KW					
	3.0		8E-5-400001	11.08		PR: 1KW					

AUDI A4 (B6/B7) (01-08)										
	3.0 quattro	8E-5-400001		11.08	PR: 1KW	24.3414-1713.7	220793			
	3.0 TDI quattro	150 8E-5-400001		11.08	PR: 1KW	24.3414-1714.7	220794			D=41, - Halter D=41, - Halter
	3.0 TDI quattro	171	01.06	11.08	PR: 1KW					TRW TRW
	3.2 FSI	188 8E-5-400001		11.08	PR: 1KW					
	3.2 FSI quattro	188 8E-5-400001		11.08	PR: 1KW					
	1.6	75		12.00	11.08	24.5138-0263.3	330885	2		L=263
	1.8 T	110		12.00	11.08					
	1.8 T	120		07.02	11.08					
	1.8 T	125		07.01	11.08					
	1.8 T	140		11.02	11.08					
	1.8 T quattro	110		12.00	11.08					
	1.8 T quattro	120		07.02	11.08					
	1.8 T quattro	125		07.01	11.08					
	1.8 T quattro	140		11.02	11.08					
	1.9 TDI	74		04.01	11.08					
	1.9 TDI	85		06.04	11.08					
	1.9 TDI	96		12.00	11.08					
	1.9 TDI quattro			12.00	11.08					
	2.0	96		12.00	11.08					
	2.0 FSI	110		07.02	11.08					
	2.0 TDI	100		11.04	11.08					
	2.0 TDI	103		11.04	11.08					
	2.0 TDI	125		06.06	11.08					
	2.0 TDI quattro	103		01.06	11.08					
	2.0 TDI quattro	125		06.06	11.08					
	2.0 TFSI	147		11.04	11.08					
	2.0 TFSI	162		06.05	11.08					
	2.0 TFSI quattro	147		11.04	11.08					
	2.0 TFSI quattro	162		06.05	11.08					
	2.4			09.01	11.08					
	2.5 TDI			12.00	11.08					
	2.5 TDI quattro			12.00	11.08					
	2.7 TDI	120		11.05	11.08					
	2.7 TDI	132		01.06	11.08					
	3.0			12.00	11.08					
	3.0 quattro			12.00	11.08					
	3.0 TDI quattro	150		11.04	11.08					
	3.0 TDI quattro	171		01.06	11.08					
	3.2 FSI	188		01.05	11.08					
	3.2 FSI quattro	188		01.05	11.08					
	S4	253		03.03	11.08					
	1.6	75		12.00	11.08	24.3727-0182.2	580182	<input type="checkbox"/>		L=1928
	1.8 T	110		12.00	11.08	24.3727-0183.2	580183	<input type="checkbox"/>		L=2005
	1.8 T	120		07.02	11.08					
	1.8 T	140		11.02	11.08					
	1.9 TDI	74		04.01	11.08					
	1.9 TDI	85		06.04	11.08					
	1.9 TDI	96		12.00	11.08					
	2.0	96		12.00	11.08					
	2.0 FSI	110		07.02	11.08					
	2.0 TFSI	147		11.04	11.08					
	2.0 TFSI	162		06.05	11.08					
	2.4			09.01	11.08					
	2.5 TDI			12.00	11.08					
	3.0			12.00	11.08					
	3.2 FSI	188		01.05	11.08					
	1.6	75		12.00	11.08	24.2522-1706.3	040090			Nz 22,20
	1.8 T	110		12.00	11.08					
	1.8 T	120		07.02	11.08					
	1.8 T	125		07.01	11.08					
	1.8 T	140		11.02	11.08					
	1.8 T quattro	110		12.00	11.08					
	1.8 T quattro	120		07.02	11.08					
	1.8 T quattro	125		07.01	11.08					
	1.8 T quattro	140		11.02	11.08					
	1.9 TDI	74		04.01	11.08					
	1.9 TDI	85		06.04	11.08					
	1.9 TDI	96		12.00	11.08					
	1.9 TDI quattro			12.00	11.08					
	2.0	96		12.00	11.08					
	2.0 FSI	110		07.02	11.08					
	2.0 TFSI	147		11.04	11.08					
	2.0 TFSI quattro	147		11.04	11.08					
	2.0 TFSI quattro	162		06.05	11.08					
	2.4			09.01	11.08					
	2.5 TDI			12.00	11.08					
	2.5 TDI quattro			12.00	11.08					
	3.0			12.00	11.08					
	3.0 quattro			12.00	11.08					
	3.2 FSI	188		01.05	11.08					
	3.2 FSI quattro	188		01.05	11.08					

AUDI A4 (B8) Limousine (07-)

	1.8 TFSI	88	01.08		03.7858-4632.4	300273		9/8" Tandem	ATE
	1.8 TFSI	118	11.07						
	1.8 TFSI quattro	118	09.08						
	2.0 TDI	88	06.08						
	2.0 TDI	100	11.07						
	2.0 TDI	105	11.07						
	2.0 TDI	120	08.08						
	2.0 TDI	125	01.08						
	2.0 TDI quattro	125	01.08						
	2.0 TFSI	132	06.08						
	2.0 TFSI	155	06.08						
	2.0 TFSI quattro	132	11.09						
	2.0 TFSI quattro	155	06.08						
	2.7 TDI	120	11.07						
	2.7 TDI	140	11.07						
	3.0 TDI quattro	155	06.08						
3.0 TDI quattro	176	11.07							
3.2 FSI	195	09.08							
3.2 FSI quattro	195	11.07							
S4	245	11.08							
	1.8 TFSI	88	01.08		03.2125-0493.3	010940		THz 25,40	ATE
	1.8 TFSI	118	11.07		24.2125-1739.3	010948		THz 25,40	TRW
	1.8 TFSI quattro	118	09.08						
	2.0 TDI	88	06.08						
	2.0 TDI	100	11.07						
	2.0 TDI	105	11.07						
	2.0 TDI	120	08.08						
	2.0 TDI	125	01.08						
	2.0 TDI quattro	125	01.08						
	2.0 TFSI	132	06.08						
	2.0 TFSI	155	06.08						
	2.0 TFSI quattro	132	11.09						
	2.0 TFSI quattro	155	06.08						
	2.7 TDI	120	11.07						
	2.7 TDI	140	11.07						
	3.0 TDI quattro	155	06.08						
3.0 TDI quattro	176	11.07							
3.2 FSI	195	09.08							
3.2 FSI quattro	195	11.07							
S4	245	11.08							
	1.8 TFSI	88	01.08	PR: 1LT	11.9571-9755.2	220845		D=57, - Halter	ATE
	1.8 TFSI	118	11.07	PR: 1LT	11.9571-9756.2	220846		D=57, - Halter	ATE
	1.8 TFSI	125	01.12	PR: 1LT	11.8171-0008.1	990049		Führungsbolzen	ATE
	1.8 TFSI quattro	118	09.08	PR: 1LT	11.0101-5409.2	260035		Hülzensatz	ATE
	1.8 TFSI quattro	125	01.12	PR: 1LT	11.8116-0351.1	390538	2	Haltefeder	ATE
	2.0 TDI	88	06.08	PR: 1LT					
	2.0 TDI	100	11.07	PR: 1LT					
	2.0 TDI	105	11.07	PR: 1LT					
	2.0 TDI	110	05.13	PR: 1LT					
	2.0 TDI	120	08.08	PR: 1LT					
	2.0 TDI	125	01.08	PR: 1LT					
	2.0 TDI	130	11.11	PR: 1LT					
	2.0 TDI	140	09.13	PR: 1LT					
	2.0 TDI quattro	110	05.13	PR: 1LT					
	2.0 TDI quattro	125	01.08	PR: 1LT					
	2.0 TDI quattro	130	11.11	PR: 1LT					
	2.0 TDI quattro	140	09.13	PR: 1LT					
	2.0 TFSI	132	06.08	PR: 1LT					
	2.0 TFSI	155	06.08	PR: 1LT					
	2.0 TFSI	162	05.13	PR: 1LT					
	2.0 TFSI	165	05.13	PR: 1LT					
	2.0 TFSI quattro	132	11.09	PR: 1LT					
	2.0 TFSI quattro	155	06.08	PR: 1LT					
	2.0 TFSI quattro	162	05.13	PR: 1LT					
	2.0 TFSI quattro	165	05.13	PR: 1LT					
	2.7 TDI	120	11.07	PR: 1LT					
2.7 TDI	140	11.07	PR: 1LT						
3.0 TDI	150	11.11	PR: 1LT						
3.0 TDI quattro	155	06.08	PR: 1LT						
3.0 TDI quattro	176	11.07	PR: 1LT						
3.0 TDI quattro	180	11.11	PR: 1LT						
3.0 TFSI quattro	200	02.12	PR: 1LT						
3.2 FSI	195	09.08	PR: 1LT						
3.2 FSI quattro	195	11.07	PR: 1LT						
	1.8 TFSI	88	01.08	PR: 1LY	11.9571-9755.2	220845		D=57, - Halter	ATE
	1.8 TFSI	118	11.07	PR: 1LY	11.9571-9756.2	220846		D=57, - Halter	ATE
	1.8 TFSI	125	01.12	PR: 1LY	11.8171-0008.1	990049		Führungsbolzen	ATE
	1.8 TFSI quattro	118	09.08	PR: 1LY	11.0101-5409.2	260035		Hülzensatz	ATE
	1.8 TFSI quattro	125	01.12	PR: 1LY	11.8116-0351.1	390538	2	Haltefeder	ATE
	2.0 TDI	88	06.08	PR: 1LY					
	2.0 TDI	100	11.07	PR: 1LY					
	2.0 TDI	105	11.07	PR: 1LY					
	2.0 TDI	110	05.13	PR: 1LY					
	2.0 TDI	120	08.08	PR: 1LY					
	2.0 TDI	125	01.08	PR: 1LY					
	2.0 TDI	130	11.11	PR: 1LY					
	2.0 TDI	140	09.13	PR: 1LY					

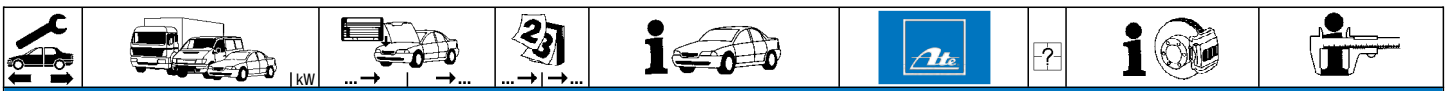

AUDI A4 (B8) Limousine (07-)

	2.0 TDI quattro	110	05.13	PR: 1LY	11.9571-9755.2	220845	2		D=57, - Halter D=57, - Halter Führungsbolzen Hülzensatz Haltefeder	ATE ATE ATE ATE ATE
	2.0 TDI quattro	125	01.08	PR: 1LY	11.9571-9756.2	220846				
	2.0 TDI quattro	130	11.11	PR: 1LY	11.8171-0008.1	990049				
	2.0 TDI quattro	140	09.13	PR: 1LY	11.0101-5409.2	260035				
	2.0 TFSI	132	06.08	PR: 1LY	11.8116-0351.1	390538				
	2.0 TFSI	155	06.08	PR: 1LY						
	2.0 TFSI	162	05.13	PR: 1LY						
	2.0 TFSI	165	05.13	PR: 1LY						
	2.0 TFSI quattro	132	11.09	PR: 1LY						
	2.0 TFSI quattro	155	06.08	PR: 1LY						
	2.0 TFSI quattro	162	05.13	PR: 1LY						
	2.0 TFSI quattro	165	05.13	PR: 1LY						
	2.7 TDI	120	11.07	PR: 1LY						
	2.7 TDI	140	11.07	PR: 1LY						
	3.0 TDI	150	11.11	PR: 1LY						
	3.0 TDI quattro	155	06.08	PR: 1LT						
	3.0 TDI quattro	176	11.07	PR: 1LT						
	3.0 TDI quattro	180	11.11	PR: 1LT						
	3.0 TFSI quattro	200	02.12	PR: 1LY						
	3.2 FSI	195	09.08	PR: 1LT						
3.2 FSI quattro	195	11.07	PR: 1LT							
	1.8 TFSI	88	01.08	PR: 1LA,1LB	24.3571-1773.5	240625	2		D=57, - Halter D=57, - Halter	TRW TRW
	1.8 TFSI	118	11.07	PR: 1LA,1LB	24.3571-1774.5	240626				
	1.8 TFSI	125	01.12	PR: 1LA,1LB						
	1.8 TFSI quattro	118	09.08	PR: 1LA,1LB						
	1.8 TFSI quattro	125	01.12	PR: 1LA,1LB						
	2.0 TDI	88	06.08	PR: 1LA,1LB						
	2.0 TDI	100	11.07	PR: 1LA,1LB						
	2.0 TDI	105	11.07	PR: 1LA,1LB						
	2.0 TDI	110	05.13	PR: 1LA,1LB						
	2.0 TDI	120	08.08	PR: 1LA,1LB						
	2.0 TDI	125	01.08	PR: 1LA,1LB						
	2.0 TDI	130	11.11	PR: 1LA,1LB						
	2.0 TDI	140	09.13	PR: 1LA,1LB						
	2.0 TDI quattro	110	05.13	PR: 1LA,1LB						
	2.0 TDI quattro	125	01.08	PR: 1LA,1LB						
	2.0 TDI quattro	130	11.11	PR: 1LA,1LB						
	2.0 TDI quattro	140	09.13	PR: 1LA,1LB						
	2.0 TFSI	132	06.08	PR: 1LA,1LB						
	2.0 TFSI	155	06.08	PR: 1LA,1LB						
	2.0 TFSI	162	05.13	PR: 1LA,1LB						
	2.0 TFSI	165	05.13	PR: 1LA,1LB						
	2.0 TFSI quattro	132	11.09	PR: 1LA,1LB						
	2.0 TFSI quattro	155	06.08	PR: 1LA,1LB						
	2.0 TFSI quattro	162	05.13	PR: 1LA,1LB						
	2.0 TFSI quattro	165	05.13	PR: 1LA,1LB						
	2.7 TDI	120	11.07	PR: 1LA,1LB						
	2.7 TDI	140	11.07	PR: 1LA,1LB						
	3.0 TDI	150	11.11	PR: 1LA,1LB						
	3.0 TDI quattro	155	06.08	PR: 1LA,1LB						
	3.0 TDI quattro	176	11.07	PR: 1LA,1LB						
3.0 TDI quattro	180	11.11	PR: 1LA,1LB							
3.0 TFSI quattro	200	02.12	PR: 1LA,1LB							
3.2 FSI	195	09.08	PR: 1LA,1LB							
3.2 FSI quattro	195	11.07	PR: 1LA,1LB							
	1.8 TFSI	88	01.08		83.7713-0476.3	331116	2		L=472	
	1.8 TFSI	118	11.07							
	1.8 TFSI	125	01.12							
	1.8 TFSI quattro	118	09.08							
	1.8 TFSI quattro	125	01.12							
	2.0 TDI	88	06.08							
	2.0 TDI	100	11.07							
	2.0 TDI	105	11.07							
	2.0 TDI	110	05.13							
	2.0 TDI	120	08.08							
	2.0 TDI	125	01.08							
	2.0 TDI	130	11.11							
	2.0 TDI	140	09.13							
	2.0 TDI quattro	110	05.13							
	2.0 TDI quattro	125	01.08							
	2.0 TDI quattro	130	11.11							
	2.0 TDI quattro	140	09.13							
	2.0 TFSI	132	06.08							
	2.0 TFSI	155	06.08							
	2.0 TFSI	162	05.13							
	2.0 TFSI	165	05.13							
	2.0 TFSI quattro	132	11.09							
	2.0 TFSI quattro	155	06.08							
	2.0 TFSI quattro	162	05.13							
	2.0 TFSI quattro	165	05.13							
	2.7 TDI	120	11.07							
	2.7 TDI	140	11.07							
	3.0 TDI	150	11.11							
	3.0 TDI quattro	155	06.08							
	3.0 TDI quattro	176	11.07							
3.0 TDI quattro	180	11.11								
3.0 TFSI quattro	200	02.12								



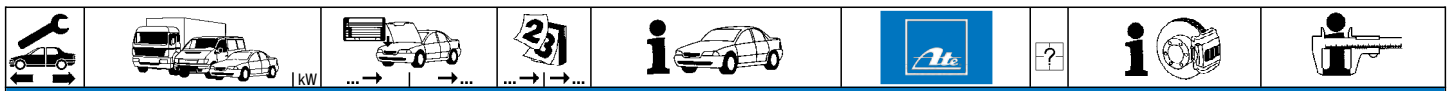





















AUDI A4 (B8) Limousine (07-)

	3.2 FSI	195		09.08		83.7713-0476.3	331116	2		L=472	
	3.2 FSI quattro	195		11.07							
	S4	245		11.08							
	1.8 TFSI	88	8K-C-715000	01.08	PR: 1KW	24.6243-1703.7	220945		<input type="checkbox"/> elektrische Feststellbremse ¹⁾	D=43, - Halter	TRW
	1.8 TFSI	118	8K-C-715000	11.07	PR: 1KW	24.6243-1704.7	220946		<input type="checkbox"/> elektrische Feststellbremse ¹⁾	D=43, - Halter	TRW
	1.8 TFSI	125	8K-C-715000	01.12	PR: 1KW						
	1.8 TFSI quattro	118	8K-C-715000	09.08	PR: 1KW						
	1.8 TFSI quattro	125	8K-C-715000	01.12	PR: 1KW						
	2.0 TDI	88	8K-C-715000	06.08	PR: 1KW						
	2.0 TDI	100	8K-C-715000	11.07	PR: 1KW						
	2.0 TDI	105	8K-C-715000	11.07	PR: 1KW						
	2.0 TDI	120	8K-C-715000	08.08	PR: 1KW						
	2.0 TDI	125	8K-C-715000	01.08	PR: 1KW						
	2.0 TDI	130	8K-C-715000	11.11	PR: 1KW						
	2.0 TDI quattro	125	8K-C-715000	01.08	PR: 1KW						
	2.0 TDI quattro	130	8K-C-715000	11.11	PR: 1KW						
	2.0 TFSI	132	8K-C-715000	06.08	PR: 1KW						
	2.0 TFSI	155	8K-C-715000	06.08	PR: 1KW						
	2.0 TFSI quattro	132	8K-C-715000	11.09	PR: 1KW						
	2.0 TFSI quattro	155	8K-C-715000	06.08	PR: 1KW						
	2.7 TDI	120	8K-C-715000	11.07	PR: 1KW						
	2.7 TDI	140	8K-C-715000	11.07	PR: 1KW						
	3.0 TDI	150	8K-C-715000	11.11	PR: 1KW						
	3.0 TDI quattro	155	8K-C-715000	06.08	PR: 1KW						
	3.0 TDI quattro	176	8K-C-715000	11.07	PR: 1KW						
	3.0 TDI quattro	180	8K-C-715000	11.11	PR: 1KW						
	3.0 TFSI quattro	200	8K-C-715000	02.12	PR: 1KW						
	3.2 FSI	195	8K-C-715000	09.08	PR: 1KW						
	3.2 FSI quattro	195	8K-C-715000	11.07	PR: 1KW						
	S4	245	8K-C-715000	01.08	PR: 1KE	24.6243-1705.7	220947		<input type="checkbox"/> elektrische Feststellbremse ¹⁾	D=43, - Halter	TRW
						24.6243-1706.7	220948		<input type="checkbox"/> elektrische Feststellbremse ¹⁾	D=43, - Halter	TRW
	1.8 TFSI	88	8K-D-000001		PR: 1KW,2EH	24.6243-1703.7	220979		<input type="checkbox"/> elektrische Feststellbremse ¹⁾	D=43, - Halter	TRW
	1.8 TFSI	118	8K-D-000001		PR: 1KW,2EH	24.6243-1708.7	220980		<input type="checkbox"/> elektrische Feststellbremse ¹⁾	D=43, - Halter	TRW
	1.8 TFSI	125	8K-D-000001		PR: 1KW,2EH						
	1.8 TFSI quattro	118	8K-D-000001		PR: 1KW,2EH						
	1.8 TFSI quattro	125	8K-D-000001		PR: 1KW,2EH						
	2.0 TDI	88	8K-D-000001		PR: 1KW,2EH						
	2.0 TDI	100	8K-D-000001		PR: 1KW,2EH						
	2.0 TDI	105	8K-D-000001		PR: 1KW,2EH						
	2.0 TDI	110		05.13	PR: 1KW,2EH						
	2.0 TDI	120	8K-D-000001		PR: 1KW,2EH						
	2.0 TDI	125	8K-D-000001		PR: 1KW,2EH						
	2.0 TDI	130	8K-D-000001		PR: 1KW,2EH						
	2.0 TDI	140		09.13	PR: 1KW,2EH						
	2.0 TDI quattro	110		05.13	PR: 1KW,2EH						
	2.0 TDI quattro	125	8K-D-000001		PR: 1KW,2EH						
	2.0 TDI quattro	130	8K-D-000001		PR: 1KW,2EH						
	2.0 TDI quattro	140		09.13	PR: 1KW,2EH						
	2.0 TFSI	132	8K-D-000001		PR: 1KW,2EH						
	2.0 TFSI	155	8K-D-000001		PR: 1KW,2EH						
	2.0 TFSI	162		05.13	PR: 1KW,2EH						
	2.0 TFSI	165		05.13	PR: 1KW,2EH						
	2.0 TFSI quattro	132	8K-D-000001		PR: 1KW,2EH						
	2.0 TFSI quattro	155	8K-D-000001		PR: 1KW,2EH						
	2.0 TFSI quattro	162		05.13	PR: 1KW,2EH						
	2.0 TFSI quattro	165		05.13	PR: 1KW,2EH						
	2.7 TDI	120	8K-D-000001		PR: 1KW,2EH						
	2.7 TDI	140	8K-D-000001		PR: 1KW,2EH						
	3.0 TDI	150	8K-D-000001		PR: 1KW,2EH						
	3.0 TDI quattro	155	8K-D-000001		PR: 1KW,2EH						
	3.0 TDI quattro	176	8K-D-000001		PR: 1KW,2EH						
	3.0 TDI quattro	180	8K-D-000001		PR: 1KW,2EH						
	3.0 TFSI quattro	200	8K-D-000001		PR: 1KW,2EH						
	3.2 FSI	195	8K-D-000001		PR: 1KW,2EH						
	3.2 FSI quattro	195	8K-D-000001		PR: 1KW,2EH						
	1.8 TFSI	88		01.08	PR: 1KP	24.6243-1721.5	240782		<input type="checkbox"/> elektrische Feststellbremse ¹⁾	D=43, - Halter	TRW
	1.8 TFSI	118		11.07	PR: 1KP						
	1.8 TFSI	125		01.12	PR: 1KP						
	1.8 TFSI quattro	118		09.08	PR: 1KP						
	1.8 TFSI quattro	125		01.12	PR: 1KP						
	2.0 TDI	88		06.08	PR: 1KP						
	2.0 TDI	100		11.07	PR: 1KP						
	2.0 TDI	105		11.07	PR: 1KP						
	2.0 TDI	110		05.13	PR: 1KP						
	2.0 TDI	120		08.08	PR: 1KP						
	2.0 TDI	125		01.08	PR: 1KP						
	2.0 TDI	130		11.11	PR: 1KP						
	2.0 TDI	140		09.13	PR: 1KP						
	2.0 TDI quattro	110		05.13	PR: 1KP						
	2.0 TDI quattro	125		01.08	PR: 1KP						
	2.0 TDI quattro	130		11.11	PR: 1KP						
	2.0 TDI quattro	140		09.13	PR: 1KP						
	2.0 TFSI	132		06.08	PR: 1KP						
	2.0 TFSI	155		06.08	PR: 1KP						
	2.0 TFSI	162		05.13	PR: 1KP						
	2.0 TFSI	165		05.13	PR: 1KP						
	2.0 TFSI quattro	132		11.09	PR: 1KP						

¹⁾ electric parking brake / fr.d/stazionamento elettrico / frein à main électrique / freno de mano eléctrico

AUDI A4 (B8) Limousine (07-)									
	2.0 TFSI quattro	155	06.08	PR: 1KP	24.6243-1721.5	240782	<input checked="" type="checkbox"/> elektrische Feststellbremse ¹⁾	D=43, - Halter	TRW
	2.0 TFSI quattro	162	05.13	PR: 1KP					
	2.0 TFSI quattro	165	05.13	PR: 1KP					
	2.7 TDI	120	11.07	PR: 1KP					
	2.7 TDI	140	11.07	PR: 1KP					
	3.0 TDI	150	11.11	PR: 1KP					
	3.0 TDI quattro	155	06.08	PR: 1KP					
	3.0 TDI quattro	176	11.07	PR: 1KP					
	3.0 TDI quattro	180	11.11	PR: 1KP					
	3.0 TFSI quattro	200	02.12	PR: 1KP					
	3.2 FSI	195	09.08	PR: 1KP					
	3.2 FSI quattro	195	11.07	PR: 1KP					
	1.8 TFSI	88	01.08		24.5140-0396.3	331372	2		L=396
	1.8 TFSI	118	11.07						
	1.8 TFSI	125	01.12						
	1.8 TFSI quattro	118	09.08						
	1.8 TFSI quattro	125	01.12						
	2.0 TDI	88	06.08						
	2.0 TDI	100	11.07						
	2.0 TDI	105	11.07						
	2.0 TDI	110	05.13						
	2.0 TDI	120	08.08						
	2.0 TDI	125	01.08						
	2.0 TDI	130	11.11						
	2.0 TDI	140	09.13						
	2.0 TDI quattro	110	05.13						
	2.0 TDI quattro	125	01.08						
	2.0 TDI quattro	130	11.11						
	2.0 TDI quattro	140	09.13						
	2.0 TFSI	132	06.08						
	2.0 TFSI	155	06.08						
	2.0 TFSI	162	05.13						
	2.0 TFSI	165	05.13						
	2.0 TFSI quattro	132	11.09						
	2.0 TFSI quattro	155	06.08						
	2.0 TFSI quattro	162	05.13						
	2.0 TFSI quattro	165	05.13						
	2.7 TDI	120	11.07						
	2.7 TDI	140	11.07						
	3.0 TDI	150	11.11						
	3.0 TDI quattro	155	06.08						
	3.0 TDI quattro	176	11.07						
	3.0 TDI quattro	180	11.11						
	3.0 TFSI quattro	200	02.12						
	3.2 FSI	195	09.08						
	3.2 FSI quattro	195	11.07						
	S4	245	11.08						
AUDI A4 (B8) Avant (08-)									
	1.8 FSI	88	04.08		03.7858-4632.4	300273		9/8" Tandem	ATE
	1.8 TFSI	118	04.08						
	1.8 TFSI quattro	118	09.08						
	2.0 TDI	88	06.08						
	2.0 TDI	100	04.08						
	2.0 TDI	105	04.08						
	2.0 TDI	125	04.08						
	2.0 TDI quattro	105	04.08						
	2.0 TDI quattro	125	08.08						
	2.0 TFSI	132	06.08						
	2.0 TFSI	155	04.08						
	2.0 TFSI quattro	132	11.09						
	2.0 TFSI quattro	155	04.08						
	2.7 TDI	120	06.08						
	2.7 TDI	140	06.08						
	3.0 TDI quattro	155	06.08						
	3.0 TDI quattro	176	04.08						
	3.2 FSI	195	09.08						
	3.2 FSI quattro	195	04.08						
	S4	245	11.08						
	1.8 FSI	88	04.08		03.2125-0493.3	010940		THz 25,40	ATE
	1.8 TFSI	118	04.08		24.2125-1739.3	010948		THz 25,40	TRW
	1.8 TFSI quattro	118	09.08						
	2.0 TDI	88	06.08						
	2.0 TDI	100	04.08						
	2.0 TDI	105	04.08						
	2.0 TDI	125	04.08						
	2.0 TDI quattro	105	04.08						
	2.0 TDI quattro	125	08.08						
	2.0 TFSI	132	06.08						
	2.0 TFSI	155	04.08						
	2.0 TFSI quattro	132	11.09						
	2.0 TFSI quattro	155	04.08						
	2.7 TDI	120	06.08						
	2.7 TDI	140	06.08						
	3.0 TDI quattro	155	06.08						
	3.0 TDI quattro	176	04.08						
	3.2 FSI	195	09.08						

¹⁾ electric parking brake / fr.di stazionamento elettrico / frein à main électrique / freno de mano eléctrico

AUDI A4 (B8) Avant (08-)											
											
	2.0 TFSI quattro	132		11.09	PR: 1LA,1LB	24.3571-1773.5	240625		D=57, - Halter	TRW	
	2.0 TFSI quattro	155		04.08	PR: 1LA,1LB	24.3571-1774.5	240626		D=57, - Halter	TRW	
	2.0 TFSI quattro	165		05.13	PR: 1LA,1LB						
	2.7 TDI	120		06.08	PR: 1LA,1LB						
	2.7 TDI	140		06.08	PR: 1LA,1LB						
	3.0 TDI	150		11.11	PR: 1LA,1LB						
	3.0 TDI quattro	155		06.08	PR: 1LA,1LB						
	3.0 TDI quattro	176		04.08	PR: 1LA,1LB						
	3.0 TDI quattro	180		11.11	PR: 1LA,1LB						
	3.0 TFSI quattro	200		02.12	PR: 1LA,1LB						
	3.2 FSI	195		09.08	PR: 1LA,1LB						
	3.2 FSI quattro	195		04.08	PR: 1LA,1LB						
	1.8 FSI	88		04.08		83.7713-0476.3	331116	2		L=472	
	1.8 TFSI	118		04.08							
	1.8 TFSI	125		01.12							
	1.8 TFSI quattro	118		09.08							
	1.8 TFSI quattro	125		01.12							
	2.0 TDI	88		06.08							
	2.0 TDI	100		04.08							
	2.0 TDI	105		04.08							
	2.0 TDI	110		05.13							
	2.0 TDI	125		04.08							
	2.0 TDI	130		11.11							
	2.0 TDI	140		09.13							
	2.0 TDI quattro	105		04.08							
	2.0 TDI quattro	110		05.13							
	2.0 TDI quattro	125		08.08							
	2.0 TDI quattro	130		11.11							
	2.0 TDI quattro	140		09.13							
	2.0 TFSI	132		06.08							
	2.0 TFSI	155		04.08							
	2.0 TFSI	165		05.13							
	2.0 TFSI quattro	132		11.09							
	2.0 TFSI quattro	155		04.08							
	2.0 TFSI quattro	165		05.13							
	2.7 TDI	120		06.08							
	2.7 TDI	140		06.08							
	3.0 TDI	150		11.11							
	3.0 TDI quattro	155		06.08							
	3.0 TDI quattro	176		04.08							
	3.0 TDI quattro	180		11.11							
	3.0 TFSI quattro	200		02.12							
	3.2 FSI	195		09.08							
	3.2 FSI quattro	195		04.08							
	S4	245		11.08							
	1.8 FSI	88	8K-C-715000	04.08	PR: 1KW	24.6243-1703.7	220945		elektrische Feststellbremse ¹⁾	D=43, - Halter	TRW
	1.8 TFSI	118	8K-C-715000	04.08	PR: 1KW	24.6243-1704.7	220946		elektrische Feststellbremse ¹⁾	D=43, - Halter	TRW
	1.8 TFSI	125	8K-C-715000	01.12	PR: 1KW						
	1.8 TFSI quattro	118	8K-C-715000	09.08	PR: 1KW						
	1.8 TFSI quattro	125	8K-C-715000	01.12	PR: 1KW						
	2.0 TDI	88	8K-C-715000	06.08	PR: 1KW						
	2.0 TDI	100	8K-C-715000	04.08	PR: 1KW						
	2.0 TDI	105	8K-C-715000	04.08	PR: 1KW						
	2.0 TDI	125	8K-C-715000	04.08	PR: 1KW						
	2.0 TDI	130	8K-C-715000	11.11	PR: 1KW						
	2.0 TDI quattro	105	8K-C-715000	04.08	PR: 1KW						
	2.0 TDI quattro	125	8K-C-715000	08.08	PR: 1KW						
	2.0 TDI quattro	130	8K-C-715000	11.11	PR: 1KW						
	2.0 TFSI	132	8K-C-715000	06.08	PR: 1KW						
	2.0 TFSI	155	8K-C-715000	04.08	PR: 1KW						
	2.0 TFSI quattro	132	8K-C-715000	11.09	PR: 1KW						
	2.0 TFSI quattro	155	8K-C-715000	04.08	PR: 1KW						
	2.7 TDI	120	8K-C-715000	06.08	PR: 1KW						
	2.7 TDI	140	8K-C-715000	06.08	PR: 1KW						
	3.0 TDI	150	8K-C-715000	11.11	PR: 1KW						
	3.0 TDI quattro	155	8K-C-715000	06.08	PR: 1KW						
	3.0 TDI quattro	176	8K-C-715000	04.08	PR: 1KW						
	3.0 TDI quattro	180	8K-C-715000	11.11	PR: 1KW						
	3.0 TFSI quattro	200	8K-C-715000	02.12	PR: 1KW						
	3.2 FSI	195	8K-C-715000	09.08	PR: 1KW						
	3.2 FSI quattro	195	8K-C-715000	04.08	PR: 1KW						
	S4	245	8K-C-715000	11.08	PR: 1KE	24.6243-1705.7	220947		elektrische Feststellbremse ¹⁾	D=43, - Halter	TRW
						24.6243-1706.7	220948		elektrische Feststellbremse ¹⁾	D=43, - Halter	TRW
	1.8 FSI	88	8K-D-000001		PR: 1KW,2EH	24.6243-1707.7	220979		elektrische Feststellbremse ¹⁾	D=43, - Halter	TRW
	1.8 TFSI	118	8K-D-000001		PR: 1KW,2EH	24.6243-1708.7	220980		elektrische Feststellbremse ¹⁾	D=43, - Halter	TRW
	1.8 TFSI	125	8K-D-000001		PR: 1KW,2EH						
	1.8 TFSI quattro	118	8K-D-000001		PR: 1KW,2EH						
	1.8 TFSI quattro	125	8K-D-000001		PR: 1KW,2EH						
	2.0 TDI	88	8K-D-000001		PR: 1KW,2EH						
	2.0 TDI	100	8K-D-000001		PR: 1KW,2EH						
	2.0 TDI	105	8K-D-000001		PR: 1KW,2EH						
	2.0 TDI	110		05.13	PR: 1KW,2EH						
	2.0 TDI	125	8K-D-000001		PR: 1KW,2EH						
	2.0 TDI	130	8K-D-000001		PR: 1KW,2EH						
	2.0 TDI	140		09.13	PR: 1KW,2EH						
	2.0 TDI quattro	105	8K-D-000001		PR: 1KW,2EH						
	2.0 TDI quattro	110		05.13	PR: 1KW,2EH						

¹⁾ electric parking brake / fr.di stazionamento elettrico / frein à main électrique / freno de mano eléctrico



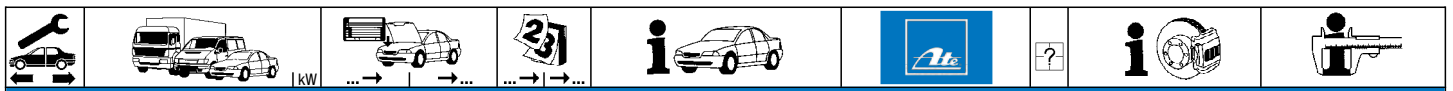























AUDI A4 (B8) Avant (08-)

	2.0 TDI quattro	125	8K-D-000001			PR: 1KW,2EH	24.6243-1707.7	220979	<input type="checkbox"/> elektrische Feststellbremse ¹⁾ <input type="checkbox"/> elektrische Feststellbremse ¹⁾	D=43, - Halter D=43, - Halter	TRW TRW
	2.0 TDI quattro	130	8K-D-000001			PR: 1KW,2EH	24.6243-1708.7	220980			
	2.0 TDI quattro	140			09.13						
	2.0 TFSI	132	8K-D-000001			PR: 1KW,2EH					
	2.0 TFSI	155	8K-D-000001			PR: 1KW,2EH					
	2.0 TFSI	165			05.13						
	2.0 TFSI quattro	132	8K-D-000001			PR: 1KW,2EH					
	2.0 TFSI quattro	155	8K-D-000001			PR: 1KW,2EH					
	2.0 TFSI quattro	165			05.13						
	2.7 TDI	120	8K-D-000001			PR: 1KW,2EH					
	2.7 TDI	140	8K-D-000001			PR: 1KW,2EH					
	3.0 TDI	150	8K-D-000001			PR: 1KW,2EH					
	3.0 TDI quattro	155	8K-D-000001			PR: 1KW,2EH					
	3.0 TDI quattro	176	8K-D-000001			PR: 1KW,2EH					
	3.0 TDI quattro	180	8K-D-000001			PR: 1KW,2EH					
	3.0 TFSI quattro	200	8K-D-000001			PR: 1KW,2EH					
	3.2 FSI	195	8K-D-000001			PR: 1KW,2EH					
3.2 FSI quattro	195	8K-D-000001			PR: 1KW,2EH						
	1.8 FSI	88			04.08	PR: 1KP	24.6243-1721.5	240782	<input type="checkbox"/> elektrische Feststellbremse ¹⁾	D=43, - Halter	TRW
	1.8 TFSI	118			04.08	PR: 1KP					
	1.8 TFSI	125			01.12	PR: 1KP					
	1.8 TFSI quattro	118			09.08	PR: 1KP					
	1.8 TFSI quattro	125			01.12	PR: 1KP					
	2.0 TDI	88			06.08	PR: 1KP					
	2.0 TDI	100			04.08	PR: 1KP					
	2.0 TDI	105			04.08	PR: 1KP					
	2.0 TDI	110			05.13	PR: 1KP					
	2.0 TDI	125			04.08	PR: 1KP					
	2.0 TDI	130			11.11	PR: 1KP					
	2.0 TDI	140			09.13	PR: 1KP					
	2.0 TDI quattro	105			04.08	PR: 1KP					
	2.0 TDI quattro	110			05.13	PR: 1KP					
	2.0 TDI quattro	125			08.08	PR: 1KP					
	2.0 TDI quattro	130			11.11	PR: 1KP					
	2.0 TDI quattro	140			09.13	PR: 1KP					
	2.0 TFSI	132			06.08	PR: 1KP					
	2.0 TFSI	155			04.08	PR: 1KP					
	2.0 TFSI	165			05.13	PR: 1KP					
	2.0 TFSI quattro	132			11.09	PR: 1KP					
	2.0 TFSI quattro	155			04.08	PR: 1KP					
	2.0 TFSI quattro	165			05.13	PR: 1KP					
	2.7 TDI	120			06.08	PR: 1KP					
	2.7 TDI	140			06.08	PR: 1KP					
	3.0 TDI	150			11.11	PR: 1KP					
	3.0 TDI quattro	155			06.08	PR: 1KP					
	3.0 TDI quattro	176			04.08	PR: 1KP					
	3.0 TDI quattro	180			11.11	PR: 1KP					
	3.0 TFSI quattro	200			02.12	PR: 1KP					
	3.2 FSI	195			09.08	PR: 1KP					
	3.2 FSI quattro	195			04.08	PR: 1KP					
	1.8 FSI	88			04.08		24.5140-0396.3	331372	2	L=396	
	1.8 TFSI	118			04.08						
	1.8 TFSI	125			01.12						
	1.8 TFSI quattro	118			09.08						
	1.8 TFSI quattro	125			01.12						
	2.0 TDI	88			06.08						
	2.0 TDI	100			04.08						
	2.0 TDI	105			04.08						
	2.0 TDI	110			05.13						
	2.0 TDI	125			04.08						
	2.0 TDI	130			11.11						
	2.0 TDI	140			09.13						
	2.0 TDI quattro	105			04.08						
	2.0 TDI quattro	110			05.13						
	2.0 TDI quattro	125			08.08						
	2.0 TDI quattro	130			11.11						
	2.0 TDI quattro	140			09.13						
	2.0 TFSI	132			06.08						
	2.0 TFSI	155			04.08						
	2.0 TFSI	165			05.13						
	2.0 TFSI quattro	132			11.09						
	2.0 TFSI quattro	155			04.08						
	2.0 TFSI quattro	165			05.13						
	2.7 TDI	120			06.08						
	2.7 TDI	140			06.08						
	3.0 TDI	150			11.11						
3.0 TDI quattro	155			06.08							
3.0 TDI quattro	176			04.08							
3.0 TDI quattro	180			11.11							
3.0 TFSI quattro	200			02.12							
3.2 FSI	195			09.08							
3.2 FSI quattro	195			04.08							
RS 4	331			05.12							
S4	245			11.08							

¹⁾ electric parking brake / fr.di stazionamento elettrico / frein à main électrique / freno de mano eléctrico





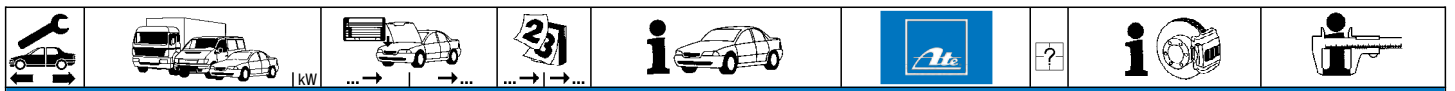







										
AUDI A4 Allroad (09-)										
	2.0 TDI quattro	105		09.09		03.7858-4632.4	300273	9/8" Tandem	ATE	
	2.0 TDI quattro	120		04.09						
	2.0 TDI quattro	125		02.09						
	2.0 TFSI quattro	155		04.09						
	3.0 TDI quattro	176		04.09						
	2.0 TDI quattro	110		05.13		03.7858-4632.4	300273	9/8" Tandem	ATE	
	2.0 TDI quattro	130		01.12						
	2.0 TDI quattro	140		09.13						
	2.0 TFSI quattro	162		05.13						
	2.0 TFSI quattro	165		04.13						
	2.0 TDI quattro	105		09.09		03.2125-0493.3	010940	THz 25,40	ATE	
	2.0 TDI quattro	120		04.09		24.2125-1739.3	010948	THz 25,40	TRW	
	2.0 TDI quattro	125		02.09						
	2.0 TFSI quattro	155		04.09						
	3.0 TDI quattro	176		04.09						
	2.0 TDI quattro	110		05.13		03.2125-0493.3	010940	THz 25,40	ATE	
	2.0 TDI quattro	130		01.12		24.2125-1739.3	010948	THz 25,40	TRW	
	2.0 TDI quattro	140		09.13						
	2.0 TFSI quattro	162		05.13						
	2.0 TFSI quattro	165		04.13						
	2.0 TDI quattro	105		09.09	PR: 1LT	11.9571-9755.2	220845	D=57, - Halter D=57, - Halter Hülzensatz Führungsbolzen Haltefeder	ATE	
	2.0 TDI quattro	110		05.13	PR: 1LT	11.9571-9756.2	220846		ATE	
	2.0 TDI quattro	120		04.09	PR: 1LT	11.0101-5409.2	260035		ATE	
	2.0 TDI quattro	125		02.09	PR: 1LT	11.8171-0008.1	990049		ATE	
	2.0 TDI quattro	130		01.12	PR: 1LT	11.8116-0351.1	390538		ATE	
	2.0 TDI quattro	140		09.13	PR: 1LT					
	2.0 TFSI quattro	155		04.09	PR: 1LT					
	2.0 TFSI quattro	162		05.13	PR: 1LT					
	2.0 TFSI quattro	165		04.13	PR: 1LT					
	3.0 TDI quattro	176		04.09	PR: 1LT					
	3.0 TDI quattro	180		01.12	PR: 1LT					
	2.0 TDI quattro	105		09.09	PR: 1LA	24.3571-1773.5	240625	D=57, - Halter	TRW	
	2.0 TDI quattro	110		05.13	PR: 1LA	24.3571-1774.5	240626	D=57, - Halter	TRW	
	2.0 TDI quattro	120		04.09	PR: 1LA					
	2.0 TDI quattro	125		02.09	PR: 1LA					
	2.0 TDI quattro	130		01.12	PR: 1LA					
	2.0 TDI quattro	140		09.13	PR: 1LA					
	2.0 TFSI quattro	155		04.09	PR: 1LA					
	2.0 TFSI quattro	162		05.13	PR: 1LA					
	2.0 TFSI quattro	165		04.13	PR: 1LA					
	3.0 TDI quattro	176		04.09	PR: 1LA					
	3.0 TDI quattro	180		01.12	PR: 1LA					
	2.0 TDI quattro	105		09.09		83.7713-0476.3	331116	L=472		
	2.0 TDI quattro	110		05.13						
	2.0 TDI quattro	120		04.09						
	2.0 TDI quattro	125		02.09						
	2.0 TDI quattro	130		01.12						
	2.0 TDI quattro	140		09.13						
	2.0 TFSI quattro	155		04.09						
	2.0 TFSI quattro	162		05.13						
	2.0 TFSI quattro	165		04.13						
	3.0 TDI quattro	176		04.09						
	3.0 TDI quattro	180		01.12						
	2.0 TDI quattro	105		09.09	PR: 1KW,GP0,GP1	24.6243-1703.7	220945	☐ elektrische Feststellbremse 1) ☐ elektrische Feststellbremse 1)	D=43, - Halter	TRW
	2.0 TDI quattro	110		05.13	PR: 1KW,GP0,GP1	24.6243-1704.7	220946		D=43, - Halter	TRW
2.0 TDI quattro	120		04.09	PR: 1KW,GP0,GP1						
2.0 TDI quattro	125		02.09	PR: 1KW,GP0,GP1						
2.0 TDI quattro	130		01.12	PR: 1KW,GP0,GP1						
2.0 TDI quattro	140		09.13	PR: 1KW,GP0,GP1						
2.0 TFSI quattro	155		04.09	PR: 1KW,GP0,GP1						
2.0 TFSI quattro	162		05.13	PR: 1KW,GP0,GP1						
2.0 TFSI quattro	165		04.13	PR: 1KW,GP0,GP1						
3.0 TDI quattro	176		04.09	PR: 1KW,GP0,GP1						
3.0 TDI quattro	180		01.12	PR: 1KW,GP0,GP1						
	2.0 TDI quattro	105		09.09	PR: 1KW,GP2	24.6243-1707.7	220979	☐ elektrische Feststellbremse 1) ☐ elektrische Feststellbremse 1)	D=43, - Halter	TRW
	2.0 TDI quattro	110		05.13	PR: 1KW,GP2	24.6243-1708.7	220980		D=43, - Halter	TRW
	2.0 TDI quattro	120		04.09	PR: 1KW,GP2					
	2.0 TDI quattro	125		02.09	PR: 1KW,GP2					
	2.0 TDI quattro	130		01.12	PR: 1KW,GP2					
2.0 TDI quattro	140		09.13	PR: 1KW,GP2						
2.0 TFSI quattro	155		04.09	PR: 1KW,GP2						
2.0 TFSI quattro	162		05.13	PR: 1KW,GP2						
2.0 TFSI quattro	165		04.13	PR: 1KW,GP2						
3.0 TDI quattro	176		04.09	PR: 1KW,GP2						
3.0 TDI quattro	180		01.12	PR: 1KW,GP2						
AUDI A4 Cabrio (02-08)										
	1.8 T	120	8H-3-017415		11.08	03.7858-4502.4	300202	9/8" Tandem	ATE	
	1.8 T quattro	120		05.03	11.08					
	2.0	96		05.04	11.08					
	2.0 TDI			10.05	11.08					
	2.0 TFSI	147		01.06	11.08					
	2.0 TFSI quattro	147		11.05	11.08					
2.4	120	8H-3-017415			11.08					
↓										

















1) electric parking brake / fr.di stazionamento elettrico / frein à main électrique / freno de mano eléctrico



AUDI A4 Cabrio (02-08)

	2.4	125	8H-3-017415		11.08		03.7858-4502.4	300202		9/8" Tandem	ATE																																													
	2.5 TDI	120	8H-3-017415		11.08																																																			
	2.7 TDI	132		06.06	11.08																																																			
	3.0	162	8H-3-017415		11.08																																																			
	3.0 quattro	162		05.03	11.08																																																			
	3.0 TDI quattro	150		01.06	11.08																																																			
	3.0 TDI quattro	171		10.05	11.08																																																			
	3.2 FSI	188		10.05	11.08																																																			
	3.2 FSI quattro	188		10.05	11.08																																																			
		1.8 T	120			04.02						11.08	24.2125-1720.3	010688		THz 25,40	TRW																																							
1.8 T quattro		120			05.03	11.08																																																		
2.0		96			05.04	11.08																																																		
2.0 TDI					10.05	11.08																																																		
2.0 TFSI		147			01.06	11.08																																																		
2.0 TFSI quattro		147			11.05	11.08																																																		
2.4		120			04.02	11.08																																																		
2.4		125			04.02	11.08																																																		
2.5 TDI		120			08.02	11.08																																																		
2.7 TDI		132			06.06	11.08																																																		
3.0		162			04.02	11.08																																																		
3.0 quattro		162			05.03	11.08																																																		
3.0 TDI quattro		150			01.06	11.08																																																		
3.0 TDI quattro		171			10.05	11.08																																																		
3.2 FSI		188			10.05	11.08																																																		
3.2 FSI quattro		188			10.05	11.08																																																		
		1.8 T	120	8H-3-017415	8H-7-022000			03.2125-0373.3	010810		THz 25,40	ATE																																												
		1.8 T quattro	120		8H-7-022000	05.03																																																		
		2.0	96		8H-7-022000	05.04																																																		
		2.0 TDI			8H-7-022000	10.05																																																		
	2.0 TFSI	147		8H-7-022000	01.06																																																			
	2.0 TFSI quattro	147		8H-7-022000	11.05																																																			
	2.4	120	8H-3-017415	8H-7-022000																																																				
	2.4	125	8H-3-017415	8H-7-022000																																																				
	2.5 TDI	120	8H-3-017415	8H-7-022000																																																				
	2.7 TDI	132		8H-7-022000	06.06																																																			
	3.0	162	8H-3-017415	8H-7-022000																																																				
	3.0 quattro	162		8H-7-022000	05.03																																																			
	3.0 TDI quattro	150		8H-7-022000	01.06																																																			
	3.0 TDI quattro	171		8H-7-022000	10.05																																																			
	3.2 FSI	188		8H-7-022000	10.05																																																			
3.2 FSI quattro	188		8H-7-022000	10.05																																																				
	1.8 T	120	8H-7-022001				03.2125-0373.3	010810		THz 25,40	ATE																																													
	1.8 T quattro	120	8H-7-022001																																																					
	2.0	96	8H-7-022001																																																					
	2.0 TDI		8H-7-022001																																																					
	2.0 TFSI	147	8H-7-022001																																																					
	2.0 TFSI quattro	147	8H-7-022001																																																					
	2.4	120	8H-7-022001																																																					
	2.4	125	8H-7-022001																																																					
	2.5 TDI	120	8H-7-022001																																																					
	2.7 TDI	132	8H-7-022001																																																					
	3.0	162	8H-7-022001																																																					
	3.0 quattro	162	8H-7-022001																																																					
	3.0 TDI quattro	150	8H-7-022001																																																					
	3.0 TDI quattro	171	8H-7-022001																																																					
	3.2 FSI	188	8H-7-022001																																																					
3.2 FSI quattro	188	8H-7-022001																																																						
	RS 4	309			05.06	11.08	24.2126-1705.3	010999		THz 26,99	TRW																																													
	S4	253			02.04	11.08																																																		
	1.8 T	120			04.02	11.08	24.3571-8522.5	240496		D=57, - Halter	ATE																																													
	1.8 T quattro	120			05.03	11.08																																																		
	2.0	96			05.04	11.08						11.0441-5704.2	250034		Dichtungssatz	ATE																																								
	2.0 TDI				10.05	11.08																																																		
	2.0 TFSI	147			01.06	11.08											11.0101-5409.2	260035	2	Hülsensatz	ATE																																			
	2.0 TFSI quattro	147			11.05	11.08																																																		
	2.4	120			04.02	11.08																11.8171-0008.1	990049		Führungsbolzen	ATE																														
	2.4	125			04.02	11.08																																																		
	2.5 TDI	120			08.02	11.08																					11.8116-0143.1	390513		Haltefeder	ATE																									
	2.7 TDI	132			06.06	11.08																																																		
	3.0	162			04.02	11.08																																																		
	3.0 quattro	162			05.03	11.08																																																		
	3.0 TDI quattro	150			01.06	11.08																																																		
	3.0 TDI quattro	171			10.05	11.08																																																		
	3.2 FSI	188			10.05	11.08																																																		
	3.2 FSI quattro	188			10.05	11.08																																																		
		1.8 T	120			04.02																										11.08	11.9571-9836.2	220428		D=57, - Halter	ATE																			
		1.8 T quattro	120			05.03																										11.08						11.9571-9835.2	220427		D=57, - Halter	ATE														
		2.0	96			05.04																										11.08											11.0441-5704.2	250034		Dichtungssatz	ATE									
		2.0 TDI				10.05																										11.08																11.0101-5409.2	260035		Hülsensatz	ATE				
2.0 TFSI		147			01.06	11.08	11.8171-0008.1	990049		Führungsbolzen	ATE																																													
2.0 TFSI quattro		147			11.05	11.08																										11.8116-0143.1																					390513		Haltefeder	ATE
2.4		120			04.02	11.08																																																		
2.4		125			04.02	11.08																																																		
2.5 TDI		120			08.02	11.08																																																		
2.7 TDI		132			06.06	11.08																																																		
3.0		162			04.02	11.08																																																		
3.0 quattro		162			05.03	11.08																																																		

											
AUDI A4 Cabrio (02-08)											
	3.0 TDI quattro	150		01.06	11.08	PR: 1LF,1LT	11.9571-9836.2	220428	D=57, - Halter D=57, - Halter Dichtungssatz Hülensatz Führungsbolzen Haltefeder	ATE	
	3.0 TDI quattro	171		10.05	11.08	PR: 1LF,1LT	11.9571-9835.2	220427		ATE	
	3.2 FSI	188		10.05	11.08	PR: 1LF,1LT	11.0441-5704.2	250034		ATE	
	3.2 FSI quattro	188		10.05	11.08	PR: 1LF,1LT	11.0101-5409.2	260035		ATE	
							11.8171-0008.1	990049		ATE	
							11.8116-0143.1	390513		ATE	
	1.8 T	120		04.02	11.08	PR: 1LA	11.9606-9957.2	220815		D=60, - Halter D=60, - Halter Dichtungssatz Hülensatz Führungsbolzen Haltefeder	ATE
	1.8 T quattro	120		05.03	11.08	PR: 1LA	11.9606-9958.2	220816			ATE
	2.0	96		05.04	11.08	PR: 1LA	11.0441-6008.2	250038			ATE
	2.0 TDI			10.05	11.08	PR: 1LA	11.0101-5409.2	260035			ATE
2.0 TFSI	147		01.06	11.08	PR: 1LA	11.8171-0008.1	990049	ATE			
2.0 TFSI quattro	147		11.05	11.08	PR: 1LA	11.8116-0410.2	390589	ATE			
2.4	120		04.02	11.08	PR: 1LA						
2.4	125		04.02	11.08	PR: 1LA						
2.5 TDI	120		08.02	11.08	PR: 1LA						
2.7 TDI	132		06.06	11.08	PR: 1LA						
3.0	162		04.02	11.08	PR: 1LA						
3.0 quattro	162		05.03	11.08	PR: 1LA						
3.0 TDI quattro	150		01.06	11.08	PR: 1LA						
3.0 TDI quattro	171		10.05	11.08	PR: 1LA						
3.2 FSI	188		10.05	11.08	PR: 1LA						
3.2 FSI quattro	188		10.05	11.08	PR: 1LA						
S4	253		02.04	11.08			11.9606-9961.2	220655	D=60, - Halter D=60, - Halter Dichtungssatz Hülensatz Führungsbolzen Haltefeder	ATE	
							11.9606-9962.2	220656		ATE	
							11.0441-6008.2	250038		ATE	
							11.0101-5409.2	260035		ATE	
							11.8171-0008.1	990049		ATE	
							11.8116-0410.2	390589		ATE	
							11.8116-0006.2	390601		ATE	
	1.8 T	120		04.02	11.08		24.5237-0308.3	331435	L=308		
	1.8 T quattro	120		05.03	11.08						
	2.0	96		05.04	11.08						
	2.0 TDI			10.05	11.08						
	2.0 TFSI	147		01.06	11.08						
	2.0 TFSI quattro	147		11.05	11.08						
	2.4	120		04.02	11.08						
	2.4	125		04.02	11.08						
	2.5 TDI	120		08.02	11.08						
	2.7 TDI	132		06.06	11.08						
3.0	162		04.02	11.08							
3.0 quattro	162		05.03	11.08							
3.0 TDI quattro	150		01.06	11.08							
3.0 TDI quattro	171		10.05	11.08							
3.2 FSI	188		10.05	11.08							
3.2 FSI quattro	188		10.05	11.08							
S4	253		02.04	11.08							
RS 4	309		05.06	11.08			83.6169-0418.3	330894	L=422		
	1.8 T	120		04.02	11.08	PR: 1KD,1KP	24.3384-1735.7	220547	D=38, - Halter D=38, - Halter	TRW	
	1.8 T quattro	120		05.03	11.08	PR: 1KD,1KP	24.3384-1736.7	220548		TRW	
	2.0	96		05.04	11.08	PR: 1KD,1KP					
	2.0 TDI			10.05	11.08	PR: 1KD,1KP					
	2.0 TFSI	147		01.06	11.08	PR: 1KD,1KP					
	2.0 TFSI quattro	147		11.05	11.08	PR: 1KD,1KP					
	2.4	120		04.02	12.05						
	2.4	125		04.02	12.05						
	2.5 TDI	120		08.02	12.05						
	3.0	162		04.02	12.05						
3.0 quattro	162		05.03	12.05							
1.8 T	120	8E-5-400001		11.08	PR: 1KW	24.3414-1713.7	220793	D=41, - Halter D=41, - Halter	TRW		
1.8 T quattro	120	8E-5-400001		11.08	PR: 1KW	24.3414-1714.7	220794		TRW		
2.0	96	8E-5-400001		11.08	PR: 1KW						
2.0 TDI		8E-5-400001		11.08	PR: 1KW						
2.0 TFSI	147	8E-5-400001		11.08	PR: 1KW						
2.0 TFSI quattro	147	8E-5-400001		11.08	PR: 1KW						
2.4	120	8E-5-400001		11.08	PR: 1KW						
2.4	125	8E-5-400001		11.08	PR: 1KW						
2.5 TDI	120	8E-5-400001		11.08	PR: 1KW						
2.7 TDI	132	8E-5-400001		11.08	PR: 1KW						
3.0	162	8E-5-400001		11.08	PR: 1KW						
3.0 quattro	162	8E-5-400001		11.08	PR: 1KW						
3.0 TDI quattro	150		01.06	11.08	PR: 1KW						
3.0 TDI quattro	171	8E-5-400001		11.08	PR: 1KW						
3.2 FSI	188	8E-5-400001		11.08	PR: 1KW						
3.2 FSI quattro	188	8E-5-400001		11.08	PR: 1KW						
	1.8 T	120		04.02	11.08		24.5138-0263.3	330885	L=263		
	1.8 T quattro	120		05.03	11.08						
	2.0	96		05.04	11.08						
	2.0 TDI			10.05	11.08						
	2.0 TFSI	147		01.06	11.08						
	2.0 TFSI quattro	147		11.05	11.08						
	2.4	120		04.02	11.08						
	2.4	125		04.02	11.08						
	2.5 TDI	120		08.02	11.08						
	2.7 TDI	132		06.06	11.08						
3.0	162		04.02	11.08							
3.0 quattro	162		05.03	11.08							
3.0 TDI quattro	150		01.06	11.08							

										
AUDI A4 Cabrio (02-08)										
	3.0 TDI quattro 3.2 FSI 3.2 FSI quattro S4	171 188 188 253		10.05 10.05 10.05 02.04	11.08 11.08 11.08 11.08	24.5138-0263.3	330885	2	L=263	
	1.8 T 2.0 2.0 TDI 2.0 TFSI 2.4 2.4 2.5 TDI 2.7 TDI 3.0 3.2 FSI	120 96 147 120 125 120 132 162 188		04.02 05.04 10.05 01.06 04.02 04.02 08.02 06.06 04.02 10.05	11.08 11.08 11.08 11.08 11.08 11.08 11.08 11.08 11.08 11.08	24.3727-0182.2 24.3727-0183.2	580182 580183	<input type="checkbox"/> <input type="checkbox"/>	L=1928 L=2005	
	1.8 T 1.8 T quattro 2.0 2.0 TDI 2.4 2.4 2.5 TDI 3.0 3.0 quattro 3.2 FSI	120 120 96 120 125 120 162 162 188		04.02 05.03 05.04 10.05 04.02 04.02 08.02 04.02 05.03 10.05	11.08 11.08 11.08 11.08 11.08 11.08 11.08 11.08 11.08 11.08	24.2522-1706.3	040090		Nz 22,20	
AUDI A4 / A4 Avant (B9) (15-)										
	1.4 TFSI 2.0 TDI 2.0 TDI 2.0 TDI 2.0 TDI 2.0 TDI quattro 2.0 TFSI 2.0 TFSI 2.0 TFSI quattro 3.0 TDI 3.0 TDI quattro 3.0 TDI quattro S4	110 90 100 110 140 140 140 185 185 160 160 200 260		08.15 04.16 05.15 05.15 05.15 09.15 05.15 05.15 05.15 09.15 09.15 05.15 05.16	PR: 1LA,1LB PR: 1LA,1LB PR: 1LA,1LB PR: 1LA,1LB PR: 1LA,1LB PR: 1LA,1LB PR: 1LA,1LB PR: 1LA,1LB PR: 1LA,1LB PR: 1LA,1LB PR: 1LA,1LB PR: 1LA,1LB	11.0101-5407.2 11.8116-0071.1 11.8171-0008.1	260011 390605 990049	2	Hülensatz Haltefeder Führungsbolzen	ATE ATE ATE
AUDI A5 / A5 Sportback (07-)										
	1.8 TFSI 1.8 TFSI 2.0 TDI 2.0 TDI 2.0 TDI 2.0 TDI 2.0 TDI quattro 2.0 TFSI 2.0 TFSI quattro 2.7 TDI 2.7 TDI 3.0 TDI 3.0 TDI quattro 3.0 TDI quattro 3.0 TDI quattro 3.2 FSI 3.2 FSI quattro S5 S5	118 125 105 120 125 130 125 155 155 120 140 150 155 176 180 195 195 245 260		05.09 10.07 09.09 10.08 08.08 07.11 08.08 11.08 06.08 06.08 09.07 05.07 07.11 03.08 05.07 07.11 05.07 05.07 01.10 05.07		03.7858-4632.4	300273		9/8" Tandem	ATE
	1.8 TFSI 1.8 TFSI 2.0 TDI 2.0 TDI 2.0 TDI 2.0 TDI 2.0 TDI quattro 2.0 TFSI 2.0 TFSI quattro 2.7 TDI 2.7 TDI 3.0 TDI 3.0 TDI quattro 3.0 TDI quattro 3.0 TDI quattro 3.2 FSI 3.2 FSI quattro S5 S5	118 125 105 120 125 130 125 155 155 120 140 150 155 176 180 195 195 245 260		05.09 10.07 09.09 10.08 08.08 07.11 08.08 11.08 06.08 06.08 09.07 05.07 07.11 03.08 05.07 07.11 05.07 05.07 01.10 05.07		03.2125-0493.3 24.2125-1739.3	010940 010948		Thz 25,40 Thz 25,40	ATE TRW
	1.8 TFSI 1.8 TFSI 1.8 TFSI 1.8 TFSI 2.0 TDI 2.0 TDI	106 118 125 130 105 110		06.14 05.09 10.07 05.15 09.09 05.13	PR: 1LT PR: 1LT PR: 1LT PR: 1LT PR: 1LT PR: 1LT	11.9571-9755.2 11.9571-9756.2 11.8171-0008.1 11.0101-5409.2 11.8116-0351.1	220845 220846 990049 260035 390538	2	D=57, - Halter D=57, - Halter Führungsbolzen Hülensatz Haltefeder	ATE ATE ATE ATE ATE

AUDI A5 / A5 Sportback (07-)

	2.0 TDI	120		10.08	PR: 1LT	11.9571-9755.2	220845					
	2.0 TDI	125		08.08	PR: 1LT	11.9571-9756.2	220846					D=57, - Halter ATE
	2.0 TDI	130		07.11	PR: 1LT	11.8171-0008.1	990049					Führungsbolzen ATE
	2.0 TDI	140		09.13	PR: 1LT	11.0101-5409.2	260035					Hülzensatz ATE
	2.0 TDI quattro	125		08.08	PR: 1LT	11.8116-0351.1	390538	2				Haltefeder ATE
	2.0 TDI quattro	130		12.11	PR: 1LT							
	2.0 TDI quattro	140		09.13	PR: 1LT							
	2.0 TFSI	132		11.08	PR: 1LT							
	2.0 TFSI	155		06.08	PR: 1LT							
	2.0 TFSI	165		05.13	PR: 1LT							
	2.0 TFSI	169		08.15	PR: 1LT							
	2.0 TFSI quattro	155		06.08	PR: 1LT							
	2.0 TFSI quattro	165		05.13	PR: 1LT							
	2.0 TFSI quattro	169		08.15	PR: 1LT							
	2.7 TDI	120		09.07	PR: 1LT							
	2.7 TDI	140		05.07	PR: 1LT							
	3.0 TDI	150		07.11	PR: 1LT							
	3.0 TDI quattro	155		03.08	PR: 1LT							
	3.0 TDI quattro	160		05.15	PR: 1LT							
	3.0 TDI quattro	176		05.07	PR: 1LT							
	3.0 TDI quattro	180		07.11	PR: 1LT							
	3.0 TFSI quattro	200		12.11	PR: 1LT							
	3.2 FSI	195		05.07	PR: 1LT							
	3.2 FSI quattro	195		06.07	PR: 1LT							
	2.7 TDI	140		05.07	PR: 1LA	24.3571-1773.5	240625					D=57, - Halter TRW
	3.0 TDI quattro	176		05.07	PR: 1LA	24.3571-1774.5	240626					D=57, - Halter TRW
	3.2 FSI	195		05.07	PR: 1LA							
	3.2 FSI quattro	195		05.07	PR: 1LA							
	1.8 TFSI	106		06.14	PR: 1LA,1LB	24.3571-1773.5	240625					D=57, - Halter TRW
	1.8 TFSI	118		07.11	PR: 1LA,1LB	24.3571-1774.5	240626					D=57, - Halter TRW
	1.8 TFSI	125		07.11	PR: 1LA,1LB							
	1.8 TFSI	130		05.15	PR: 1LA,1LB							
	2.0 TDI	105		07.11	PR: 1LA,1LB							
	2.0 TDI	110		05.13	PR: 1LA,1LB							
	2.0 TDI	120		07.11	PR: 1LA,1LB							
	2.0 TDI	125		07.11	PR: 1LA,1LB							
	2.0 TDI	130		07.11	PR: 1LA,1LB							
	2.0 TDI	140		09.13	PR: 1LA,1LB							
	2.0 TDI quattro	125		07.11	PR: 1LA,1LB							
	2.0 TDI quattro	130		12.11	PR: 1LA,1LB							
	2.0 TDI quattro	140		09.13	PR: 1LA,1LB							
	2.0 TFSI	132		07.11	PR: 1LA,1LB							
	2.0 TFSI	155		07.11	PR: 1LA,1LB							
	2.0 TFSI	165		05.13	PR: 1LA,1LB							
	2.0 TFSI	169		08.15	PR: 1LA,1LB							
	2.0 TFSI quattro	155		07.11	PR: 1LA,1LB							
	2.0 TFSI quattro	165		05.13	PR: 1LA,1LB							
	2.0 TFSI quattro	169		08.15	PR: 1LA,1LB							
	2.7 TDI	120		07.11	PR: 1LA,1LB							
	2.7 TDI	140		07.07	PR: 1LA,1LB							
	3.0 TDI	150		07.11	PR: 1LA,1LB							
	3.0 TDI quattro	155		07.11	PR: 1LA,1LB							
	3.0 TDI quattro	160		05.15	PR: 1LA,1LB							
	3.0 TDI quattro	176		07.07	PR: 1LA,1LB							
	3.0 TDI quattro	180		07.11	PR: 1LA,1LB							
	3.0 TFSI quattro	200		12.11	PR: 1LA,1LB							
	3.2 FSI	195		07.07	PR: 1LA,1LB							
	3.2 FSI quattro	195		07.07	PR: 1LA,1LB							
	1.8 TFSI	106		06.14	PR: 1LJ	24.3571-1775.5	240627					D=57, - Halter TRW
	1.8 TFSI	118		05.09	PR: 1LJ	24.3571-1776.5	240628					D=57, - Halter TRW
	1.8 TFSI	125		08.08	PR: 1LJ							
	1.8 TFSI	130		05.15	PR: 1LJ							
	2.0 TDI	105		09.09	PR: 1LJ							
	2.0 TDI	110		05.13	PR: 1LJ							
	2.0 TDI	120		10.08	PR: 1LJ							
	2.0 TDI	125		08.08	PR: 1LJ							
	2.0 TDI	130		07.11	PR: 1LJ							
	2.0 TDI	140		09.13	PR: 1LJ							
	2.0 TDI quattro	125		08.08	PR: 1LJ							
	2.0 TDI quattro	130		12.11	PR: 1LJ							
	2.0 TDI quattro	140		09.13	PR: 1LJ							
	2.0 TFSI	132		11.08	PR: 1LJ							
	2.0 TFSI	155		06.08	PR: 1LJ							
	2.0 TFSI	165		05.13	PR: 1LJ							
	2.0 TFSI	169		08.15	PR: 1LJ							
	2.0 TFSI quattro	155		06.08	PR: 1LJ							
	2.0 TFSI quattro	165		05.13	PR: 1LJ							
	2.0 TFSI quattro	169		08.15	PR: 1LJ							
	2.7 TDI	120		09.07	PR: 1LJ							
	2.7 TDI	140		05.07	PR: 1LJ							
	3.0 TDI	150		07.11	PR: 1LJ							
	3.0 TDI quattro	155		03.08	PR: 1LJ							
	3.0 TDI quattro	160		05.15	PR: 1LJ							
	3.0 TDI quattro	176		05.07	PR: 1LJ							
	3.0 TDI quattro	180		07.11	PR: 1LJ							
	3.0 TFSI quattro	200		12.11	PR: 1LJ							
	3.2 FSI	195		05.07	PR: 1LJ							

AUDI A5 / A5 Sportback (07-)

	3.2 FSI quattro S5 S5	195 245 260		05.07 01.10 12.09	PR: 1LJ PR: 1LJ,1ZT PR: 1LJ,1ZT	24.3571-1775.5 24.3571-1776.5	240627 240628		D=57, - Halter D=57, - Halter	TRW TRW
	1.8 TFSI 1.8 TFSI 1.8 TFSI 1.8 TFSI 2.0 TDI 2.0 TDI 2.0 TDI 2.0 TDI 2.0 TDI 2.0 TDI 2.0 TDI quattro 2.0 TDI quattro 2.0 TDI quattro 2.0 TFSI 2.0 TFSI 2.0 TFSI 2.0 TFSI quattro 2.0 TFSI quattro 2.0 TFSI quattro 2.7 TDI 2.7 TDI 3.0 TDI 3.0 TDI quattro 3.0 TDI quattro 3.0 TDI quattro 3.0 TDI quattro 3.0 TFSI quattro 3.2 FSI 3.2 FSI quattro S5 S5	106 118 125 130 105 110 120 125 130 140 125 130 140 125 130 140 125 130 140 125 132 155 165 169 155 165 169 120 140 150 155 160 176 180 200 195 195 245 260		06.14 05.09 10.07 05.15 09.09 05.13 10.08 08.08 07.11 09.13 08.08 12.11 09.13 11.08 06.08 05.13 08.15 06.08 05.13 08.15 09.07 05.07 07.11 03.08 05.15 05.07 07.11 12.11 05.07 05.07 01.10 05.07		83.7713-0476.3	331116	2	L=472	
	1.8 TFSI 1.8 TFSI 2.0 TDI 2.0 TDI 2.0 TDI 2.0 TDI 2.0 TDI quattro 2.0 TFSI 2.0 TFSI 2.0 TFSI quattro 2.7 TDI 2.7 TDI 3.0 TDI 3.0 TDI quattro 3.0 TDI quattro 3.0 TDI quattro 3.2 FSI 3.2 FSI quattro	118 125 105 120 125 130 125 132 155 155 120 140 150 155 176 180 195 195	8K-B-999999 8K-B-999999 8K-B-999999 8K-B-999999 8K-B-999999 8K-B-999999 8K-B-999999 8K-B-999999 8K-B-999999 8K-B-999999 8K-B-999999 8K-B-999999 8K-B-999999 8K-B-999999 8K-B-999999 8K-B-999999 8K-B-999999 8K-B-999999	05.09 10.07 09.09 10.08 08.08 07.11 08.08 11.08 06.08 06.08 09.07 05.07 07.11 03.08 05.07 07.11 05.07 06.07	PR: 1KW PR: 1KW PR: 1KW PR: 1KW PR: 1KW PR: 1KW PR: 1KW PR: 1KW PR: 1KW PR: 1KW PR: 1KW PR: 1KW PR: 1KW PR: 1KW PR: 1KW PR: 1KW PR: 1KW	24.6243-1703.7 24.6243-1704.7	220945 220946	elektrische Feststellbremse 1) elektrische Feststellbremse 1)	D=43, - Halter D=43, - Halter	TRW TRW
	1.8 TFSI 1.8 TFSI 1.8 TFSI 2.0 TDI 2.0 TDI 2.0 TDI 2.0 TDI 2.0 TDI 2.0 TDI 2.0 TDI quattro 2.0 TDI quattro 2.0 TDI quattro 2.0 TFSI 2.0 TFSI 2.0 TFSI 2.0 TFSI quattro 2.0 TFSI quattro 2.0 TFSI quattro 2.7 TDI 2.7 TDI 3.0 TDI 3.0 TDI quattro 3.0 TDI quattro 3.0 TDI quattro 3.2 FSI 3.2 FSI quattro	106 118 125 130 105 110 120 125 130 140 125 130 140 132 155 165 169 155 165 169 120 140 150 155 176 180 195 195	8K-C-000001 8K-C-000001 8K-C-000001 8K-C-000001 8K-C-000001 8K-C-000001 8K-C-000001 8K-C-000001 8K-C-000001 8K-C-000001 8K-C-000001 8K-C-000001 8K-C-000001 8K-C-000001 8K-C-000001 8K-C-000001 8K-C-000001 8K-C-000001 8K-C-000001	06.14 05.15 05.13 09.13 12.11 09.13 08.15 05.13 08.15 05.13 08.15 05.15 12.11 05.15	PR: 1KW,2EH PR: 1KW,2EH	24.6243-1707.7 24.6243-1708.7	220979 220980	elektrische Feststellbremse 1) elektrische Feststellbremse 1)	D=43, - Halter D=43, - Halter	TRW TRW
	1.8 TFSI 1.8 TFSI 1.8 TFSI 1.8 TFSI	106 118 125 130		06.14 05.09 10.07 05.15	PR: 1KE PR: 1KE PR: 1KE PR: 1KE	24.6243-1705.7 24.6243-1706.7	220947 220948	elektrische Feststellbremse 1) elektrische Feststellbremse 1)	D=43, - Halter D=43, - Halter	TRW TRW

1) electric parking brake / fr.di stazionamento elettrico / frein à main électrique / freno de mano eléctrico



AUDI A5 / A5 Sportback (07-)

	2.0 TDI	105	09.09	PR: 1KE	24.6243-1705.7	220947	<input type="checkbox"/> elektrische Feststellbremse ¹⁾	D=43, - Halter	TRW						
	2.0 TDI	110	05.13	PR: 1KE											
	2.0 TDI	120	10.08	PR: 1KE											
	2.0 TDI	125	08.08	PR: 1KE											
	2.0 TDI	130	07.11	PR: 1KE											
	2.0 TDI	140	09.13	PR: 1KE											
	2.0 TDI quattro	125	08.08	PR: 1KE											
	2.0 TDI quattro	130	12.11	PR: 1KE											
	2.0 TDI quattro	140	09.13	PR: 1KE											
	2.0 TFSI	132	11.08	PR: 1KE											
	2.0 TFSI	155	06.08	PR: 1KE											
	2.0 TFSI	165	05.13	PR: 1KE											
	2.0 TFSI	169	08.15	PR: 1KE											
	2.0 TFSI quattro	155	06.08	PR: 1KE											
	2.0 TFSI quattro	165	05.13	PR: 1KE											
	2.0 TFSI quattro	169	08.15	PR: 1KE											
	2.7 TDI	120	09.07	PR: 1KE											
	2.7 TDI	140	05.07	PR: 1KE											
	3.0 TDI	150	07.11	PR: 1KE											
	3.0 TDI quattro	155	03.08	PR: 1KE											
	3.0 TDI quattro	160	05.15	PR: 1KE											
	3.0 TDI quattro	176	05.07	PR: 1KE											
	3.0 TDI quattro	180	07.11	PR: 1KE											
	3.0 TFSI quattro	200	12.11	PR: 1KE											
	3.2 FSI	195	05.07	PR: 1KE											
	3.2 FSI quattro	195	05.07	PR: 1KE											
	RS 5	331	03.10	PR: GP1											
	S5	245	01.10	PR: 1KE											
	S5	260	05.07	PR: 1KE											
		1.8 TFSI	106	06.14						PR: 1KP	24.6243-1721.5	240782	<input type="checkbox"/> elektrische Feststellbremse ¹⁾	D=43, - Halter	TRW
		1.8 TFSI	118	05.09						PR: 1KP					
		1.8 TFSI	125	10.07						PR: 1KP					
		1.8 TFSI	130	05.15						PR: 1KP					
		2.0 TDI	105	09.09						PR: 1KP					
2.0 TDI		110	05.13	PR: 1KP											
2.0 TDI		120	10.08	PR: 1KP											
2.0 TDI		125	08.08	PR: 1KP											
2.0 TDI		130	07.11	PR: 1KP											
2.0 TDI		140	09.13	PR: 1KP											
2.0 TDI quattro		125	08.08	PR: 1KP											
2.0 TDI quattro		130	12.11	PR: 1KP											
2.0 TDI quattro		140	09.13	PR: 1KP											
2.0 TFSI		132	11.08	PR: 1KP											
2.0 TFSI		155	06.08	PR: 1KP											
2.0 TFSI		165	05.13	PR: 1KP											
2.0 TFSI		169	08.15	PR: 1KP											
2.0 TFSI quattro		155	06.08	PR: 1KP											
2.0 TFSI quattro		165	05.13	PR: 1KP											
2.0 TFSI quattro		169	08.15	PR: 1KP											
2.7 TDI		120	09.07	PR: 1KP											
2.7 TDI		140	05.07	PR: 1KP											
3.0 TDI		150	07.11	PR: 1KP											
3.0 TDI quattro		155	03.08	PR: 1KP											
3.0 TDI quattro		160	05.15	PR: 1KP											
3.0 TDI quattro		176	05.07	PR: 1KP											
3.0 TDI quattro		180	07.11	PR: 1KP											
3.0 TFSI quattro		200	12.11	PR: 1KP											
3.2 FSI		195	05.07	PR: 1KP											
3.2 FSI quattro		195	05.07	PR: 1KP											
RS 5		331	03.10	PR: 1KP											
S5		245	01.10	PR: 1KP											
S5		260	05.07	PR: 1KP											
		1.8 TFSI	106	06.14		24.5140-0396.3	331372	2	L=396						
	1.8 TFSI	118	05.09												
	1.8 TFSI	125	10.07												
	1.8 TFSI	130	05.15												
	2.0 TDI	105	09.09												
	2.0 TDI	110	05.13												
	2.0 TDI	120	10.08												
	2.0 TDI	125	08.08												
	2.0 TDI	130	07.11												
	2.0 TDI	140	09.13												
	2.0 TDI quattro	125	08.08												
	2.0 TDI quattro	130	12.11												
	2.0 TDI quattro	140	09.13												
	2.0 TFSI	132	11.08												
	2.0 TFSI	155	06.08												
	2.0 TFSI	165	05.13												
	2.0 TFSI	169	08.15												
	2.0 TFSI quattro	155	06.08												
	2.0 TFSI quattro	165	05.13												
	2.0 TFSI quattro	169	08.15												
	2.7 TDI	120	09.07												
	2.7 TDI	140	05.07												
	3.0 TDI	150	07.11												
	3.0 TDI quattro	155	03.08												
	3.0 TDI quattro	160	05.15												
	3.0 TDI quattro	176	05.07												
	3.0 TDI quattro	180	07.11												
	3.0 TFSI quattro	200	12.11												
	3.2 FSI	195	05.07												
	3.2 FSI quattro	195	05.07												
	RS 5	331	03.10												
	S5	245	01.10												
	S5	260	05.07												

¹⁾ electric parking brake / fr.di stazionamento elettrico / frein à main électrique / freno de mano eléctrico



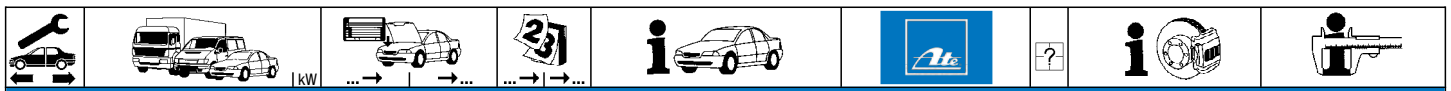

AUDI A5 / A5 Sportback (07-)

	3.0 TDI quattro	176		05.07		24.5140-0396.3	331372	2		L=396
	3.0 TDI quattro	180		07.11						
	3.0 TFSI quattro	200		12.11						
	3.2 FSI	195		05.07						
	3.2 FSI quattro	195		05.07						
	RS 5	331		03.10						
	S5	245		01.10						
	S5	260		05.07						

AUDI A5 Cabrio (09-)

	1.8 TFSI	118		09.09		03.7858-4632.4	300273			9/8" Tandem	ATE
	1.8 TFSI	125		07.11							
	2.0 TDI	120		05.09							
	2.0 TDI	125		05.09							
	2.0 TDI	130		07.11							
	2.0 TFSI	132		03.09							
	2.0 TFSI	155		03.09							
	2.0 TFSI quattro	155		03.09							
	2.7 TDI	120		05.09							
	2.7 TDI	140		03.09							
	3.0 TDI	150		07.11							
	3.0 TDI quattro	176		03.09							
	3.0 TDI quattro	180		07.11							
	3.2 FSI	195		03.09							
	3.2 FSI quattro	195		03.09							
	S5	245		04.09							

	1.8 TFSI	118		09.09		03.2125-0493.3	010940			THz 25,40	ATE
	1.8 TFSI	125		07.11		24.2125-1739.3	010948			THz 25,40	TRW
	2.0 TDI	120		05.09							
	2.0 TDI	125		05.09							
	2.0 TDI	130		07.11							
	2.0 TFSI	132		03.09							
	2.0 TFSI	155		03.09							
	2.0 TFSI quattro	155		03.09							
	2.7 TDI	120		05.09							
	2.7 TDI	140		03.09							
	3.0 TDI	150		07.11							
	3.0 TDI quattro	176		03.09							
	3.0 TDI quattro	180		07.11							
	3.2 FSI	195		03.09							
	3.2 FSI quattro	195		03.09							
	S5	245		04.09							

	1.8 TFSI	118		09.09	PR: 1LT	11.9571-9755.2	220845	<input type="checkbox"/>		D=57, - Halter	ATE
	1.8 TFSI	125		07.11	PR: 1LT	11.9571-9756.2	220846	<input type="checkbox"/>		D=57, - Halter	ATE
	1.8 TFSI	130		05.15	PR: 1LT	11.8171-0008.1	990049			Führungsbolzen	ATE
	2.0 TDI	105		11.11	PR: 1LT	11.0101-5409.2	260035			Hülzensatz	ATE
	2.0 TDI	110		05.13	PR: 1LT	11.8116-0351.1	390538	2		Haltefeder	ATE
	2.0 TDI	120		05.09	PR: 1LT						
	2.0 TDI	125		05.09	PR: 1LT						
	2.0 TDI	130		07.11	PR: 1LT						
	2.0 TDI	140		09.13	PR: 1LT						
	2.0 TDI quattro	130		01.12	PR: 1LT						
	2.0 TDI quattro	140		09.13	PR: 1LT						
	2.0 TFSI	132		03.09	PR: 1LT						
	2.0 TFSI	155		03.09	PR: 1LT						
	2.0 TFSI	165		05.13	PR: 1LT						
	2.0 TFSI	169		08.15	PR: 1LT						
	2.0 TFSI quattro	155		03.09	PR: 1LT						
	2.0 TFSI quattro	165		05.13	PR: 1LT						
	2.0 TFSI quattro	169		08.15	PR: 1LT						
	2.7 TDI	120		05.09	PR: 1LT						
	2.7 TDI	140		03.09	PR: 1LT						
	3.0 TDI	150		07.11	PR: 1LT						
	3.0 TDI quattro	160		05.15	PR: 1LT						
	3.0 TDI quattro	176		03.09	PR: 1LT						
	3.0 TDI quattro	180		07.11	PR: 1LT						
	3.0 TFSI quattro	200		11.11	PR: 1LT						
	3.2 FSI	195		03.09	PR: 1LT						
	3.2 FSI quattro	195		03.09	PR: 1LT						

	1.8 TFSI	118		09.09	PR: 1LA,1LB	24.3571-1773.5	240625	<input type="checkbox"/>		D=57, - Halter	TRW
	1.8 TFSI	125		07.11	PR: 1LA,1LB	24.3571-1774.5	240626	<input type="checkbox"/>		D=57, - Halter	TRW
	1.8 TFSI	130		05.15	PR: 1LA,1LB						
	2.0 TDI	105		11.11	PR: 1LA,1LB						
	2.0 TDI	110		05.13	PR: 1LA,1LB						
	2.0 TDI	120		05.09	PR: 1LA,1LB						
	2.0 TDI	125		05.09	PR: 1LA,1LB						
	2.0 TDI	130		07.11	PR: 1LA,1LB						
	2.0 TDI	140		09.13	PR: 1LA,1LB						
	2.0 TDI quattro	130		01.12	PR: 1LA,1LB						
	2.0 TDI quattro	140		09.13	PR: 1LA,1LB						
	2.0 TFSI	132		03.09	PR: 1LA,1LB						
	2.0 TFSI	155		03.09	PR: 1LA,1LB						
	2.0 TFSI	165		05.13	PR: 1LA,1LB						
	2.0 TFSI	169		08.15	PR: 1LA,1LB						
	2.0 TFSI quattro	155		03.09	PR: 1LA,1LB						
	2.0 TFSI quattro	165		05.13	PR: 1LA,1LB						
	2.0 TFSI quattro	169		08.15	PR: 1LA,1LB						

AUDI A5 Cabrio (09-)											
	2.7 TDI	120		05.09	PR: 1LA,1LB	24.3571-1773.5	240625			D=57, - Halter	TRW
	2.7 TDI	140		03.09	PR: 1LA,1LB	24.3571-1774.5	240626			D=57, - Halter	TRW
	3.0 TDI	150		07.11	PR: 1LA,1LB						
	3.0 TDI quattro	160		05.15	PR: 1LA,1LB						
	3.0 TDI quattro	176		07.11	PR: 1LA,1LB						
	3.0 TDI quattro	180		07.11	PR: 1LA,1LB						
	3.0 TFSI quattro	200		11.11	PR: 1LA,1LB						
	3.2 FSI	195		03.09	PR: 1LA,1LB						
	3.2 FSI quattro	195		03.09	PR: 1LA,1LB						
	1.8 TFSI	118		09.09	PR: 1LJ	24.3571-1775.5	240627			D=57, - Halter	TRW
	1.8 TFSI	125		07.11	PR: 1LJ	24.3571-1776.5	240628			D=57, - Halter	TRW
	1.8 TFSI	130		05.15	PR: 1LJ						
	2.0 TDI	105		11.11	PR: 1LJ						
	2.0 TDI	110		05.13	PR: 1LJ						
	2.0 TDI	120		05.09	PR: 1LJ						
2.0 TDI	125		05.09	PR: 1LJ							
2.0 TDI	130		07.11	PR: 1LJ							
2.0 TDI	140		09.13	PR: 1LJ							
2.0 TDI quattro	130		01.12	PR: 1LJ							
2.0 TDI quattro	140		09.13	PR: 1LJ							
2.0 TFSI	132		03.09	PR: 1LJ							
2.0 TFSI	155		03.09	PR: 1LJ							
2.0 TFSI	165		05.13	PR: 1LJ							
2.0 TFSI	169		08.15	PR: 1LJ							
2.0 TFSI quattro	155		03.09	PR: 1LJ							
2.0 TFSI quattro	165		05.13	PR: 1LJ							
2.0 TFSI quattro	169		08.15	PR: 1LJ							
2.7 TDI	120		05.09	PR: 1LJ							
2.7 TDI	140		03.09	PR: 1LJ							
3.0 TDI	150		07.11	PR: 1LJ							
3.0 TDI quattro	160		05.15	PR: 1LJ							
3.0 TDI quattro	176		03.09	PR: 1LJ							
3.0 TDI quattro	180		07.11	PR: 1LJ							
3.0 TFSI quattro	200		11.11	PR: 1LJ							
3.2 FSI	195		03.09	PR: 1LJ							
3.2 FSI quattro	195		03.09	PR: 1LJ							
S5	245		04.09	PR: 1LJ,1ZT							
	1.8 TFSI	118		09.09		83.7713-0476.3	331116	2		L=472	
	1.8 TFSI	125		07.11							
	1.8 TFSI	130		05.15							
	2.0 TDI	105		11.11							
	2.0 TDI	110		05.13							
	2.0 TDI	120		05.09							
	2.0 TDI	125		05.09							
	2.0 TDI	130		07.11							
	2.0 TDI	140		09.13							
	2.0 TDI quattro	130		01.12							
	2.0 TDI quattro	140		09.13							
	2.0 TFSI	132		03.09							
	2.0 TFSI	155		03.09							
	2.0 TFSI	165		05.13							
	2.0 TFSI	169		08.15							
	2.0 TFSI quattro	155		03.09							
	2.0 TFSI quattro	165		05.13							
	2.0 TFSI quattro	169		08.15							
	2.7 TDI	120		05.09							
	2.7 TDI	140		03.09							
	3.0 TDI	150		07.11							
3.0 TDI quattro	160		05.15								
3.0 TDI quattro	176		03.09								
3.0 TDI quattro	180		07.11								
3.0 TFSI quattro	200		11.11								
3.2 FSI	195		03.09								
3.2 FSI quattro	195		03.09								
S5	245		04.09								
	1.8 TFSI	118	8F-B-999999	09.09	PR: 1KW,2EH	24.6243-1703.7	220945		elektrische Feststellbremse 1)	D=43, - Halter	TRW
	1.8 TFSI	125	8F-B-999999	07.11	PR: 1KW,2EH	24.6243-1704.7	220946		elektrische Feststellbremse 1)	D=43, - Halter	TRW
	2.0 TDI	120	8F-B-999999	05.09	PR: 1KW,2EH						
	2.0 TDI	125	8F-B-999999	05.09	PR: 1KW,2EH						
	2.0 TDI	130	8F-B-999999	07.11	PR: 1KW,2EH						
	2.0 TFSI	132	8F-B-999999	03.09	PR: 1KW,2EH						
	2.0 TFSI	155	8F-B-999999	03.09	PR: 1KW,2EH						
	2.0 TFSI quattro	155	8F-B-999999	03.09	PR: 1KW,2EH						
	2.7 TDI	120	8F-B-999999	05.09	PR: 1KW,2EH						
	2.7 TDI	140	8F-B-999999	03.09	PR: 1KW,2EH						
	3.0 TDI	150	8F-B-999999	07.11	PR: 1KW,2EH						
	3.0 TDI quattro	176	8F-B-999999	03.09	PR: 1KW,2EH						
3.0 TDI quattro	180	8F-B-999999	07.11	PR: 1KW,2EH							
3.2 FSI	195	8F-B-999999	03.09	PR: 1KW,2EH							
3.2 FSI quattro	195	8F-B-999999	03.09	PR: 1KW,2EH							
	1.8 TFSI	118	8F-C-000001		PR: 1KW,2EH	24.6243-1707.7	220979		elektrische Feststellbremse 1)	D=43, - Halter	TRW
	1.8 TFSI	125	8F-C-000001		PR: 1KW,2EH	24.6243-1708.7	220980		elektrische Feststellbremse 1)	D=43, - Halter	TRW
	1.8 TFSI	130		05.15	PR: 1KW,2EH						
	2.0 TDI	105		11.11	PR: 1KW,2EH						
	2.0 TDI	110		05.13	PR: 1KW,2EH						
	2.0 TDI	120	8F-C-000001		PR: 1KW,2EH						
2.0 TDI	125	8F-C-000001		PR: 1KW,2EH							

1) electric parking brake / fr.di stazionamento elettrico / frein à main électrique / freno de mano eléctrico



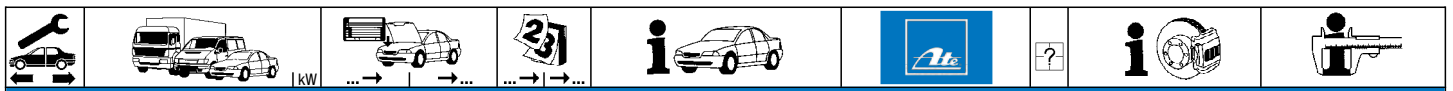

























AUDI A5 Cabrio (09-)

	2.0 TDI	130	8F-C-000001		PR: 1KW,2EH	24.6243-1707.7	220979	<input type="checkbox"/> elektrische Feststellbremse ¹⁾	D=43, - Halter	TRW
	2.0 TDI	140		09.13	PR: 1KW,2EH	24.6243-1708.7	220980			
	2.0 TDI quattro	130		01.12	PR: 1KW,2EH					
	2.0 TDI quattro	140		09.13	PR: 1KW,2EH					
	2.0 TFSI	132	8F-C-000001		PR: 1KW,2EH					
	2.0 TFSI	155	8F-C-000001		PR: 1KW,2EH					
	2.0 TFSI	165		05.13	PR: 1KW,2EH					
	2.0 TFSI	169		08.15	PR: 1KW,2EH					
	2.0 TFSI quattro	155	8F-C-000001		PR: 1KW,2EH					
	2.0 TFSI quattro	165		05.13	PR: 1KW,2EH					
	2.0 TFSI quattro	169		08.15	PR: 1KW,2EH					
	2.7 TDI	120	8F-C-000001		PR: 1KW,2EH					
	2.7 TDI	140	8F-C-000001		PR: 1KW,2EH					
	3.0 TDI	150	8F-C-000001		PR: 1KW,2EH					
	3.0 TDI quattro	160		05.15	PR: 1KW,2EH					
3.0 TDI quattro	176	8F-C-000001		PR: 1KW,2EH						
3.0 TDI quattro	180	8F-C-000001		PR: 1KW,2EH						
3.0 TFSI quattro	200		11.11	PR: 1KW,2EH						
3.2 FSI	195	8F-C-000001		PR: 1KW,2EH						
3.2 FSI quattro	195	8F-C-000001		PR: 1KW,2EH						
	1.8 TFSI	118		09.09	PR: 1KE	24.6243-1705.7	220947	<input type="checkbox"/> elektrische Feststellbremse ¹⁾	D=43, - Halter	TRW
	1.8 TFSI	125		07.11	PR: 1KE	24.6243-1706.7	220948			
	1.8 TFSI	130		05.15	PR: 1KE					
	2.0 TDI	120		05.09	PR: 1KE					
	2.0 TDI	125		05.09	PR: 1KE					
	2.0 TDI	130		07.11	PR: 1KE					
	2.0 TFSI	132		03.09	PR: 1KE					
	2.0 TFSI	155		03.09	PR: 1KE					
	2.0 TFSI	169		08.15	PR: 1KE					
	2.0 TFSI quattro	155		03.09	PR: 1KE					
	2.0 TFSI quattro	169		08.15	PR: 1KE					
	2.7 TDI	120		05.09	PR: 1KE					
	2.7 TDI	140		03.09	PR: 1KE					
	3.0 TDI	150		07.11	PR: 1KE					
	3.0 TDI quattro	160		05.15	PR: 1KE					
3.0 TDI quattro	176		03.09	PR: 1KE						
3.0 TDI quattro	180		07.11	PR: 1KE						
3.2 FSI	195		03.09	PR: 1KE						
3.2 FSI quattro	195		03.09	PR: 1KE						
S5	245	8F-B-999999	04.09	PR: 1KE						
	1.8 TFSI	118		09.09	PR: 1KP	24.6243-1721.5	240782	<input type="checkbox"/> elektrische Feststellbremse ¹⁾	D=43, - Halter	TRW
	1.8 TFSI	125		07.11	PR: 1KP					
	1.8 TFSI	130		05.15	PR: 1KP					
	2.0 TDI	105		11.11	PR: 1KP					
	2.0 TDI	110		05.13	PR: 1KP					
	2.0 TDI	120		05.09	PR: 1KP					
	2.0 TDI	125		05.09	PR: 1KP					
	2.0 TDI	130		07.11	PR: 1KP					
	2.0 TDI	140		09.13	PR: 1KP					
	2.0 TDI quattro	130		01.12	PR: 1KP					
	2.0 TDI quattro	140		09.13	PR: 1KP					
	2.0 TFSI	132		03.09	PR: 1KP					
	2.0 TFSI	155		03.09	PR: 1KP					
	2.0 TFSI	165		05.13	PR: 1KP					
	2.0 TFSI	169		08.15	PR: 1KP					
2.0 TFSI quattro	155		03.09	PR: 1KP						
2.0 TFSI quattro	165		05.13	PR: 1KP						
2.0 TFSI quattro	169		08.15	PR: 1KP						
2.7 TDI	120		05.09	PR: 1KP						
2.7 TDI	140		03.09	PR: 1KP						
3.0 TDI	150		07.11	PR: 1KP						
3.0 TDI quattro	160		05.15	PR: 1KP						
3.0 TDI quattro	176		03.09	PR: 1KP						
3.0 TDI quattro	180		07.11	PR: 1KP						
3.0 TFSI quattro	200		11.11	PR: 1KP						
3.2 FSI	195		03.09	PR: 1KP						
3.2 FSI quattro	195		03.09	PR: 1KP						
S5	245		04.09	PR: 1KP						
	1.8 TFSI	118		09.09		24.5140-0396.3	331372	2	L=396	
	1.8 TFSI	125		07.11						
	1.8 TFSI	130		05.15						
	2.0 TDI	105		11.11						
	2.0 TDI	110		05.13						
	2.0 TDI	120		05.09						
	2.0 TDI	125		05.09						
	2.0 TDI	130		07.11						
	2.0 TDI	140		09.13						
	2.0 TDI quattro	130		01.12						
	2.0 TDI quattro	140		09.13						
	2.0 TFSI	132		03.09						
	2.0 TFSI	155		03.09						
	2.0 TFSI	165		05.13						
	2.0 TFSI	169		08.15						
2.0 TFSI quattro	155		03.09							
2.0 TFSI quattro	165		05.13							
2.0 TFSI quattro	169		08.15							
2.7 TDI	120		05.09							

¹⁾ electric parking brake / fr.di stazionamento elettrico / frein à main électrique / freno de mano eléctrico

										
AUDI A5 Cabrio (09-)										
	2.7 TDI	140		03.09		24.5140-0396.3	331372	2		L=396
	3.0 TDI	150		07.11						
	3.0 TDI quattro	160		05.15						
	3.0 TDI quattro	176		03.09						
	3.0 TDI quattro	180		07.11						
	3.0 TFSI quattro	200		11.11						
	3.2 FSI	195		03.09						
	3.2 FSI quattro	195		03.09						
	RS 5	331		02.13						
	S5	245		04.09						
AUDI A6 / A6 Avant (4A/C4) (94-97)										
	S6	169		06.94	12.97	10.0124-3202.3	340011			Hydraulik Verstärker
	S6	213		09.94	12.97					
	S6 plus	235		06.96	12.97					
	1.9 TDI			06.94	06.95	03.2123-0491.3	010167			THz 23,81 ATE
	2.0			06.94	06.95					
	2.0 16V			06.94	06.95					
	2.3			06.94	06.95					
	2.5 TDI			06.94	06.95					
	2.6			06.94	06.95					
	2.8	128		06.94	06.95					
	1.9 TDI			06.94	06.95	24.2123-1602.3	010384			THz 23,81 TRW
	2.0			06.94	06.95					
	2.0 16V			06.94	06.95					
	2.3			06.94	06.95					
	2.5 TDI			06.94	06.95					
	2.6			06.94	06.95					
	2.8	128		06.94	06.95					
	1.8			10.95	12.97	24.2123-1731.3	010621			THz 23,81
	1.8 quattro			10.95	12.97					
	1.9 TDI			07.95	12.97					
	1.9 TDI			06.94	06.95					
	2.0			07.95	12.97					
	2.0			06.94	06.95					
	2.0 16V			07.95	12.97					
	2.0 16V			06.94	06.95					
	2.0 quattro			06.94	12.97					
	2.3			07.95	12.95					
	2.3			06.94	06.95					
	2.3 quattro			08.94	12.95					
	2.5 TDI			07.95	12.97					
	2.5 TDI			06.94	06.95					
	2.5 TDI quattro			07.95	12.97					
	2.6			07.95	12.97					
	2.6			06.94	06.95					
	2.6 quattro			06.94	12.97					
	2.8	128		07.95	12.97					
	2.8	128		06.94	06.95					
	2.8	142		10.95	12.97					
	2.8 quattro	142		06.94	12.97					
	1.8			10.95	12.97	24.3571-8505.5	240489			D=57, - Halter ATE
	1.9 TDI			06.94	12.97	24.3571-8506.5	240490			D=57, - Halter ATE
	2.0			06.94	12.97	11.0441-5704.2	250034			Dichtungssatz ATE
	2.0 16V			06.94	12.97	11.0101-5409.2	260035			Hülssensatz ATE
	2.3			06.94	12.95	11.8171-0008.1	990049			Führungsbolzen ATE
	2.5 TDI	85		06.94	12.97	11.8116-0143.1	390513	2		Haltefeder ATE
	2.5 TDI	103		10.94	12.97	11.3571-8508.2	220128			D=57, - Halter ATE
	2.6			06.94	12.97	24.3571-8507.5	240555			D=57, - Halter ATE
	2.8	128		06.94	12.97	24.3571-8508.5	240556			D=57, - Halter ATE
	2.8	142		10.95	12.97	11.8170-0306.1	260102	2		Halter ATE
						11.0441-5704.2	250034			Dichtungssatz ATE
						11.0101-5409.2	260035			Hülssensatz ATE
						11.8171-0008.1	990049			Führungsbolzen ATE
						11.8116-0143.1	390513	2		Haltefeder ATE
	1.8 quattro			10.95	12.97	24.3571-8505.5	240489			D=57, - Halter ATE
	2.0 quattro			06.94	12.97	24.3571-8506.5	240490			D=57, - Halter ATE
	2.3 quattro			08.94	12.95	11.0441-5704.2	250034			Dichtungssatz ATE
						11.0101-5409.2	260035			Hülssensatz ATE
						11.8171-0008.1	990049			Führungsbolzen ATE
						11.8116-0143.1	390513	2		Haltefeder ATE
	2.5 TDI quattro			07.95	12.97	11.3571-8508.2	220128			D=57, - Halter ATE
	2.6 quattro			06.94	12.97	24.3571-8507.5	240555			D=57, - Halter ATE
	2.8 quattro			06.94	12.97	24.3571-8508.5	240556			D=57, - Halter ATE
						11.8170-0306.1	260102	2		Halter ATE
						11.0441-5704.2	250034			Dichtungssatz ATE
						11.0101-5409.2	260035			Hülssensatz ATE
						11.8171-0008.1	990049			Führungsbolzen ATE
						11.8116-0143.1	390513	2		Haltefeder ATE
	1.8			10.95	12.97	24.5237-0273.3	331444	2		L=273
	1.8 quattro			10.95	12.97					
	1.9 TDI			06.94	12.97					
	2.0			06.94	12.97					
	2.0 16V			06.94	12.97					
	2.0 quattro			06.94	12.97					
	2.3			06.94	12.95					
	2.3 quattro			08.94	12.95					

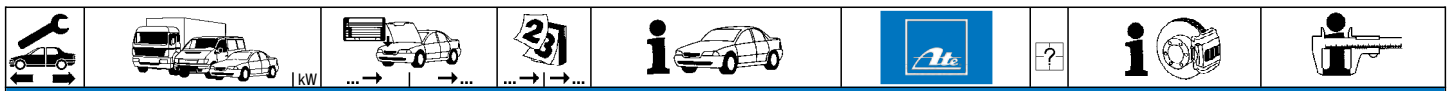

AUDI A6 / A6 Avant (4A/C4) (94-97)

	2.5 TDI 2.5 TDI quattro 2.6 2.6 quattro 2.8 2.8 2.8 quattro S6 S6 S6 plus	128 142 169 213 235	06.94 07.95 06.94 06.94 06.94 10.95 06.94 06.94 09.94 06.96	12.97 12.97 12.97 12.97 12.97 12.97 12.97 12.97 12.97 12.97	24.5237-0273.3	331444	2		L=273	
	1.8 1.9 TDI 2.0 2.0 16V 2.3 2.5 TDI 2.6 2.8 2.8	128 142	10.95 06.94 06.94 06.94 06.94 06.94 06.94 10.95	12.97 12.97 12.97 12.97 12.95 12.97 12.97 12.97	24.3384-1709.5 24.3384-1710.5	240257 240258		D=38, - Halter D=38, - Halter	TRW TRW	
	1.8 quattro 2.0 quattro 2.3 quattro 2.5 TDI quattro 2.6 quattro 2.8 quattro S6 S6	169 213	10.95 06.94 08.94 07.95 06.94 06.94 06.94 09.94	12.97 12.97 12.95 12.97 12.97 12.97 12.97 12.97	24.3384-1704.5 24.3384-1703.5	240056 240055		D=38, - Halter D=38, - Halter	TRW TRW	
	1.8 1.9 TDI 2.0 2.0 16V 2.3 2.5 TDI 2.6 2.8 2.8	128 142	10.95 06.94 06.94 06.94 06.94 06.94 06.94 06.94 10.95	12.97 12.97 12.97 12.97 12.95 12.97 12.97 12.97 12.97	83.7824-0180.3 83.6104-0180.3	330812 330510	2 2	am Bremssattel ¹⁾	L=180 L=180	
	1.8 quattro 2.0 quattro 2.3 quattro 2.5 TDI quattro 2.6 quattro 2.8 quattro S6 S6 S6 plus	169 213 235	10.95 06.94 08.94 07.95 06.94 06.94 06.94 09.94 06.96	12.97 12.97 12.95 12.97 12.97 12.97 12.97 12.97 12.97	24.5113-0209.3	331300	2		L=209	
	1.8 1.9 TDI 2.0 2.0 16V 2.3 2.5 TDI 2.6 2.8 2.8	128 142	10.95 06.94 06.94 06.94 06.94 06.94 06.94 06.94 10.95	12.97 12.97 12.97 12.97 12.95 12.97 12.97 12.97 12.97	24.3727-0154.2	580154	2		L=1491	
	1.8 1.9 TDI 2.0 2.0 16V 2.3 2.5 TDI 2.6 2.8 2.8	128 142	10.95 06.94 06.94 06.94 06.94 06.94 06.94 06.94 10.95	12.97 12.97 12.97 12.97 12.95 12.97 12.97 12.97 12.97	03.6585-0108.3	320115		- Niveauregulierung ²⁾ - Niveauregulierung ²⁾ - Niveauregulierung ²⁾ - Niveauregulierung ²⁾ - Niveauregulierung ²⁾ - Niveauregulierung ²⁾ - Niveauregulierung ²⁾ - Niveauregulierung ²⁾	BRL 8/5 (4)	ATE
	1.8 1.8 quattro 1.9 TDI 2.0 2.0 16V 2.0 quattro 2.3 2.3 quattro 2.5 TDI 2.5 TDI 2.5 TDI 2.5 TDI quattro 2.6 2.6 quattro 2.8 2.8 2.8 quattro S6	85 103	10.95 10.95 06.94 06.94 06.94 06.94 06.94 08.94 06.94 06.94 10.94 07.95 06.94 06.94 06.94 10.95 06.94	12.97 12.97 12.97 12.97 12.97 12.97 12.95 12.95 12.97 12.97 12.97 12.97 12.97 12.97 12.97 12.97 12.97	24.2419-1731.3	030121			Gz 19,05	
	1.8 1.8 quattro 1.9 TDI 2.0		10.95 10.95 06.94 06.94	12.97 12.97 12.97 12.97	03.2419-9610.3	030029			Gz 19,05	

¹⁾ on the brake caliper / sulla pinza freno / sur l'étrier de frein / a la pinza de freno
²⁾ - suspension level control / - correttore assetto / - correcteur d'assiette / - regulación altura suspensión

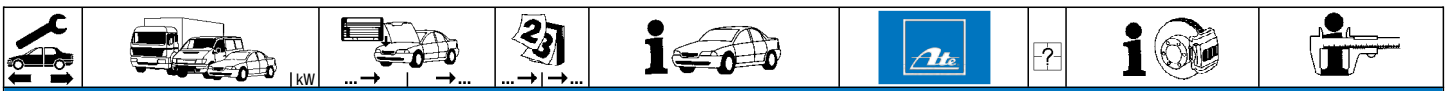

AUDI A6 / A6 Avant (4A/C4) (94-97)

	2.0 16V			06.94	12.97		03.2419-9610.3	030029		Gz 19,05
	2.0 quattro			06.94	12.97					
	2.3			06.94	12.95					
	2.3 quattro			08.94	12.95					
	2.5 TDI			06.94	12.97					
	2.5 TDI	85		06.94	12.97					
	2.5 TDI	103		10.94	12.97					
	2.5 TDI quattro			07.95	12.97					
	2.6			06.94	12.97					
	2.6 quattro			06.94	12.97					
	2.8	128		06.94	12.97					
	2.8	142		10.95	12.97					
	2.8 quattro			06.94	12.97					
	S6	169		06.94	12.97					
	1.8			10.95	12.97		24.2522-1707.3	040103		Nz 22,20
	1.8 quattro			10.95	12.97					
	1.9 TDI			06.94	12.97					
	2.0			06.94	12.97					
	2.0 16V			06.94	12.97					
	2.0 quattro			06.94	12.97					
	2.3			06.94	12.95					
	2.3 quattro			08.94	12.95					
	2.5 TDI			06.94	12.97					
	2.5 TDI quattro			07.95	12.97					
	2.6			06.94	12.97					
	2.6 quattro			06.94	12.97					
	2.8	128		06.94	12.97					
	2.8	142		10.95	12.97					
	2.8 quattro			06.94	12.97					
	S6	169		06.94	12.97					
	S6	213		09.94	12.97					
	S6 plus	235		06.96	12.97					

AUDI A6 / A6 Avant (4B/C5) (97-05)

	1.8	4B-2-130001			01.05		03.7858-4502.4	300202		9/8" Tandem	ATE
	1.8 T	110 4B-2-130001			01.05						
	1.8 T	132 4B-2-130001			01.05						
	1.8 T quattro	4B-2-130001			01.05						
	1.9 TDI	4B-2-130001			01.05						
	2.0	4B-2-130001			01.05						
	2.4	100 4B-2-130001			01.05						
	2.4	115 4B-2-130001			01.05						
	2.4	121 4B-2-130001			01.05						
	2.4 quattro	4B-2-130001			01.05						
	2.5 TDI	110 4B-2-130001			01.05						
	2.5 TDI	120 4B-2-130001			01.05						
	2.5 TDI	132 4B-2-130001			01.05						
	2.5 TDI quattro	4B-2-130001			01.05						
	2.7 T	4B-2-130001			01.05						
	2.7 T quattro	4B-2-130001			01.05						
	2.8	4B-2-130001			01.05						
	2.8 quattro	4B-2-130001			01.05						
	3.0	4B-2-130001			01.05						
	3.0 quattro	4B-2-130001			01.05						
	4.2 quattro	4B-2-130001			01.05						
	S6	4B-2-130001			01.05						
	1.8		4B-X-130000	04.97		+ EDS	24.2123-1717.3	010521		Thz 23,81	
	1.8 T	110	4B-X-130000	04.97		+ EDS					
	1.8 T	132	4B-X-130000	12.97		+ EDS					
	1.8 T quattro		4B-X-130000	04.97		+ EDS					
	1.9 TDI		4B-X-130000	04.97		+ EDS					
	2.4	100	4B-X-130000	07.98		+ EDS					
	2.4	115	4B-X-130000	04.97		+ EDS					
	2.4	121	4B-X-130000	04.97		+ EDS					
	2.4 quattro		4B-X-130000	04.97		+ EDS					
	2.5 TDI	110	4B-X-130000	04.97		+ EDS					
	2.5 TDI quattro		4B-X-130000	07.97		+ EDS					
	2.7 T quattro		4B-X-130000	10.97		+ EDS					
	2.8		4B-X-130000	04.97		+ EDS					
	2.8 quattro		4B-X-130000	04.97		+ EDS					
	1.8		4B-X-130001		05.01	+ EDS	24.2125-1712.3	010622		Thz 25,40	
	1.8 T	110	4B-X-130001		05.01	+ EDS					
	1.8 T	132	4B-X-130001		05.01	+ EDS					
	1.8 T quattro		4B-X-130001		05.01	+ EDS					
	1.9 TDI		4B-X-130001		05.01	+ EDS					
	2.4	100	4B-X-130001		05.01	+ EDS					
	2.4	115	4B-X-130001		05.01	+ EDS					
	2.4	121	4B-X-130001		05.01	+ EDS					
	2.4 quattro		4B-X-130001		05.01	+ EDS					
	2.5 TDI	110	4B-X-130001		05.01	+ EDS					
	2.5 TDI	132			02.00	05.01	+ EDS				
	2.5 TDI quattro		4B-X-130001		05.01	+ EDS					
	2.7 T				03.98	05.01	+ EDS				
	2.7 T quattro				10.97	05.01	+ EDS				
	2.8		4B-X-130001		05.01	+ EDS					
	2.8 quattro		4B-X-130001		05.01	+ EDS					
	4.2 quattro				11.98	05.01	+ EDS				



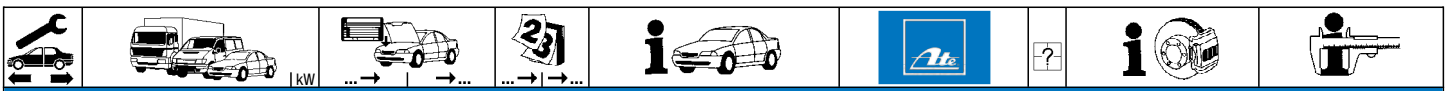

AUDI A6 / A6 Avant (4B/C5) (97-05)



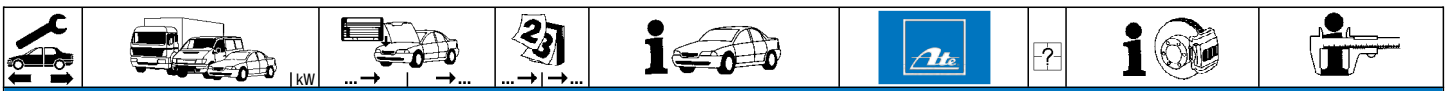











				09.99	05.01						
	S6					24.2125-1712.3	010622			THz 25,40	
	1.8		4B-X-130000	04.97	+ ESP	24.2123-1730.3	010620			THz 23,81	
	1.8 T	110	4B-X-130000	04.97	+ ESP						
	1.8 T	132	4B-X-130000	12.97	+ ESP						
	1.8 T quattro		4B-X-130000	04.97	+ ESP						
	1.9 TDI		4B-X-130000	04.97	+ ESP						
	2.4	100	4B-X-130000	07.98	+ ESP						
	2.4	115	4B-X-130000	04.97	+ ESP						
	2.4	121	4B-X-130000	04.97	+ ESP						
	2.4 quattro		4B-X-130000	04.97	+ ESP						
	2.5 TDI	110	4B-X-130000	04.97	+ ESP						
	2.5 TDI quattro		4B-X-130000	07.97	+ ESP						
	2.7 T quattro		4B-X-130000	10.97	+ ESP						
	2.8		4B-X-130000	04.97	+ ESP						
	2.8 quattro		4B-X-130000	04.97	+ ESP						
	1.8	◀	4B-X-130001		05.01 + ESP	24.2125-1713.3	010623			THz 25,40	
	1.8 T	◀110	4B-X-130001		05.01 + ESP						
	1.8 T	◀132	4B-X-130001		05.01 + ESP						
	1.8 T quattro	◀	4B-X-130001		05.01 + ESP						
	1.9 TDI	◀	4B-X-130001		05.01 + ESP						
	2.4	◀100	4B-X-130001		05.01 + ESP						
	2.4	◀115	4B-X-130001		05.01 + ESP						
	2.4	◀121	4B-X-130001		05.01 + ESP						
	2.4 quattro	◀	4B-X-130001		05.01 + ESP						
	2.5 TDI	◀110	4B-X-130001		05.01 + ESP						
	2.5 TDI	◀132		02.00	05.01 + ESP						
	2.5 TDI quattro	◀	4B-X-130001		05.01 + ESP						
	2.7 T	◀		03.98	05.01 + ESP						
	2.7 T quattro	◀	4B-X-130001		05.01 + ESP						
	2.8	◀	4B-X-130001		05.01 + ESP						
	2.8 quattro	◀	4B-X-130001		05.01 + ESP						
	4.2 quattro			11.98	05.01 + ESP						
	S6			09.99	05.01						
	1.8			06.01	01.05	24.2125-1720.3	010688			THz 25,40	TRW
	1.8 T	110		06.01	01.05						
	1.8 T	132		06.01	01.05						
	1.8 T quattro			06.01	01.05						
	1.9 TDI			06.01	01.05						
	2.0			08.01	01.05						
	2.4	100		06.01	01.05						
	2.4	115		06.01	01.05						
	2.4	121		06.01	01.05						
	2.4 quattro			06.01	01.05						
	2.5 TDI	110		06.01	01.05						
	2.5 TDI	120		07.02	01.05						
	2.5 TDI	132		06.01	01.05						
	2.5 TDI quattro			06.01	01.05						
	2.7 T			06.01	01.05						
	2.7 T quattro			06.01	01.05						
	2.8			06.01	01.05						
	2.8 quattro			06.01	01.05						
	3.0			06.01	01.05						
	3.0 quattro			06.01	01.05						
	4.2 quattro			06.01	01.05						
	S6			06.01	01.05						
	1.8		4B-2-130136		01.05	03.2125-0373.3	010810			THz 25,40	ATE
	1.8 T	110	4B-2-130136		01.05						
	1.8 T	132	4B-2-130136		01.05						
	1.8 T quattro		4B-2-130136		01.05						
	1.9 TDI		4B-2-130136		01.05						
	2.0		4B-2-130136		01.05						
	2.4	100	4B-2-130136		01.05						
	2.4	115	4B-2-130136		01.05						
	2.4	121	4B-2-130136		01.05						
	2.4 quattro		4B-2-130136		01.05						
	2.5 TDI	110	4B-2-130136		01.05						
	2.5 TDI	120	4B-2-130136		01.05						
	2.5 TDI	132	4B-2-130136		01.05						
	2.5 TDI quattro		4B-2-130136		01.05						
	2.7 T		4B-2-130136		01.05						
	2.7 T quattro		4B-2-130136		01.05						
	2.8		4B-2-130136		01.05						
	2.8 quattro		4B-2-130136		01.05						
	3.0		4B-2-130136		01.05						
	3.0 quattro		4B-2-130136		01.05						
	4.2 quattro		4B-2-130136		01.05						
	S6		4B-2-130136		01.05						
	RS 6			07.02	01.05	24.2126-1705.3	010999			THz 26,99	TRW
	1.8		4B-2-031500	04.97	PR: 1LB,1LE	24.3571-8522.5	240496			D=57, - Halter	ATE
	1.8 T	110	4B-2-031500	04.97	PR: 1LB,1LE	24.3571-8521.5	240495			D=57, - Halter	ATE
	1.8 T	132	4B-2-031500	12.97	PR: 1LB,1LE	11.8170-0306.1	260102	2		Halter	ATE
	1.8 T quattro		4B-2-031500	04.97	PR: 1LB,1LE	11.0441-5704.2	250034			Dichtungssatz	ATE
	1.9 TDI		4B-2-031500	04.97	PR: 1LB,1LE	11.0101-5409.2	260035			Hülsensatz	ATE
	2.0		4B-2-031500	08.01	PR: 1LB,1LE	11.8171-0008.1	990049			Führungsbolzen	ATE
	2.4	100	4B-2-031500	07.98	PR: 1LB,1LE	11.8116-0143.1	390513	2		Haltefeder	ATE
	2.4	115	4B-2-031500	04.97	PR: 1LB,1LE						



AUDI A6 / A6 Avant (4B/C5) (97-05)

	2.4	121	4B-2-031500	04.97	PR: 1LB,1LE	24.3571-8522.5	240496	2	D=57, - Halter D=57, - Halter Halter Dichtungssatz Hülzensatz Führungsbolzen Haltefeder	ATE ATE ATE ATE ATE ATE ATE	
	2.4 quattro		4B-2-031500	04.97	PR: 1LB,1LE	24.3571-8521.5	240495				
	2.5 TDI	110	4B-2-031500	04.97	PR: 1LB,1LE	11.8170-0306.1	260102				
	2.5 TDI	120	4B-2-031500	07.02	PR: 1LB,1LE	11.0441-5704.2	250034				
	2.5 TDI	132	4B-2-031500	02.00	PR: 1LB,1LE	11.0101-5409.2	260035				
	2.5 TDI quattro		4B-2-031500	07.97	PR: 1LB,1LE	11.8171-0008.1	990049				
	2.8		4B-2-031500	04.97	PR: 1LB,1LE	11.8116-0143.1	390513				
	2.8 quattro		4B-2-031500	04.97	PR: 1LB,1LE						
	1.8		4B-2-031501		01.05	PR: 1LB,1LE	24.3571-8522.5				240496
	1.8 T	110	4B-2-031501		01.05	PR: 1LB,1LE	24.3571-8521.5				240495
1.8 T	132	4B-2-031501		01.05	PR: 1LB,1LE	11.0441-5704.2	250034				
1.8 T quattro		4B-2-031501		01.05	PR: 1LB,1LE	11.0101-5409.2	260035				
1.9 TDI		4B-2-031501		01.05	PR: 1LB,1LE	11.8171-0008.1	990049				
2.0		4B-2-031501		01.05	PR: 1LB,1LE	11.8116-0143.1	390513				
2.4	100	4B-2-031501		01.05	PR: 1LB,1LE						
2.4	115	4B-2-031501		01.05	PR: 1LB,1LE						
2.4	121	4B-2-031501		01.05	PR: 1LB,1LE						
2.4 quattro		4B-2-031501		01.05	PR: 1LB,1LE						
2.5 TDI	110	4B-2-031501		01.05	PR: 1LB,1LE						
2.5 TDI	120	4B-2-031501		01.05	PR: 1LB,1LE						
2.5 TDI	132	4B-2-031501		01.05	PR: 1LB,1LE						
2.5 TDI quattro		4B-2-031501		01.05	PR: 1LB,1LE						
2.8		4B-2-031501		01.05	PR: 1LB,1LE						
2.8 quattro		4B-2-031501		01.05	PR: 1LB,1LE						
1.8		4B-2-031500	04.97	PR: 1LF,1LT		11.9571-9836.2	220428	2	D=57, - Halter D=57, - Halter Dichtungssatz Hülzensatz Führungsbolzen Haltefeder	ATE ATE ATE ATE ATE ATE	
1.8 T	110	4B-2-031500	04.97	PR: 1LF,1LT		11.9571-9835.2	220427				
1.8 T	132	4B-2-031500	12.97	PR: 1LF,1LT		11.0441-5704.2	250034				
1.8 T quattro		4B-2-031500	04.97	PR: 1LF,1LT		11.0101-5409.2	260035				
1.9 TDI		4B-2-031500	04.97	PR: 1LF,1LT		11.8171-0008.1	990049				
2.0		4B-2-031500	08.01	PR: 1LF,1LT		11.8116-0143.1	390513				
2.4	100	4B-2-031500	07.98	PR: 1LF,1LT							
2.4	115	4B-2-031500	04.97	PR: 1LF,1LT							
2.4	121	4B-2-031500	04.97	PR: 1LF,1LT							
2.4 quattro		4B-2-031500	04.97	PR: 1LF,1LT							
2.5 TDI	110	4B-2-031500	04.97	PR: 1LF,1LT							
2.5 TDI	120	4B-2-031500	07.02	PR: 1LF,1LT							
2.5 TDI	132	4B-2-031500	02.00	PR: 1LF,1LT							
2.5 TDI quattro		4B-2-031500	07.97	PR: 1LF,1LT							
2.8		4B-2-031500	04.97	PR: 1LF,1LT							
2.8 quattro		4B-2-031500	04.97	PR: 1LF,1LT							
1.8		4B-2-031501		01.05	PR: 1LF,1LT	11.9571-9836.2	220428	2	D=57, - Halter D=57, - Halter Dichtungssatz Hülzensatz Führungsbolzen Haltefeder	ATE ATE ATE ATE ATE ATE	
1.8 T	110	4B-2-031501		01.05	PR: 1LF,1LT	11.9571-9835.2	220427				
1.8 T	132	4B-2-031501		01.05	PR: 1LF,1LT	11.0441-5704.2	250034				
1.8 T quattro		4B-2-031501		01.05	PR: 1LF,1LT	11.0101-5409.2	260035				
1.9 TDI		4B-2-031501		01.05	PR: 1LF,1LT	11.8171-0008.1	990049				
2.0		4B-2-031501		01.05	PR: 1LF,1LT	11.8116-0143.1	390513				
2.4	100	4B-2-031501		01.05	PR: 1LF,1LT						
2.4	115	4B-2-031501		01.05	PR: 1LF,1LT						
2.4	121	4B-2-031501		01.05	PR: 1LF,1LT						
2.4 quattro		4B-2-031501		01.05	PR: 1LF,1LT						
2.5 TDI	110	4B-2-031501		01.05	PR: 1LF,1LT						
2.5 TDI	120	4B-2-031501		01.05	PR: 1LF,1LT						
2.5 TDI	132	4B-2-031501		01.05	PR: 1LF,1LT						
2.5 TDI quattro		4B-2-031501		01.05	PR: 1LF,1LT						
2.8		4B-2-031501		01.05	PR: 1LF,1LT						
2.8 quattro		4B-2-031501		01.05	PR: 1LF,1LT						
3.0			06.01	01.05		11.9606-9965.2	220817	2	D=60, - Halter D=60, - Halter Dichtungssatz Hülzensatz Führungsbolzen Haltefeder	ATE ATE ATE ATE ATE ATE	
						11.9606-9966.2	220818				
						11.0441-6008.2	250038				
						11.0101-5409.2	260035				
						11.8171-0008.1	990049				
						11.8116-0299.1	390446				
3.0 Lim. quattro			06.01	01.05		11.9606-9965.2	220817	2	D=60, - Halter D=60, - Halter Dichtungssatz Hülzensatz Führungsbolzen Haltefeder	ATE ATE ATE ATE ATE ATE	
3.0 quattro			06.01	01.05		11.9606-9966.2	220818				
						11.0441-6008.2	250038				
						11.0101-5409.2	260035				
						11.8171-0008.1	990049				
						11.8116-0299.1	390446				
	1.8			04.97	01.05	83.7813-0295.3	330799	2	L=295		
	1.8 T	110		04.97	01.05						
	1.8 T	132		12.97	01.05						
	1.8 T quattro			04.97	01.05						
	1.9 TDI			04.97	01.05						
	2.0			08.01	01.05						
	2.4	100		07.98	01.05						
	2.4	115		04.97	01.05						
	2.4	121		04.97	01.05						
	2.4 quattro			04.97	01.05						
	2.5 TDI	110		04.97	01.05						
	2.5 TDI	120		07.02	01.05						
	2.5 TDI	132		02.00	01.05						
2.5 TDI quattro			07.97	01.05							
2.7 T			03.98	01.05							
2.7 T quattro			10.97	01.05							
2.8			04.97	01.05							
2.8 quattro			04.97	01.05							
3.0			06.01	01.05							



								
AUDI A6 / A6 Avant (4B/C5) (97-05)								
	3.0 quattro 4.2 quattro S6 RS 6			06.01 01.05 11.98 01.05 09.99 01.05 07.02 01.05		83.7813-0295.3 330799 24.3384-0418.3 330894	2 2	L=295 L=422
	1.8 1.8 T 110 1.8 T 132 1.9 TDI 2.0 2.4 100 2.4 115 2.4 121 2.5 TDI 110 2.5 TDI 120 2.5 TDI 132 2.7 T 2.8 3.0			04.97 01.05 04.97 01.05 12.97 01.05 04.97 01.05 08.01 01.05 07.98 01.05 04.97 01.05 04.97 01.05 04.97 01.05 07.02 01.05 02.00 01.05 03.98 01.05 04.97 01.05 06.01 01.05		24.3384-1731.7 220543 24.3384-1732.7 220544	<input type="checkbox"/> <input type="checkbox"/>	D=38, - Halter TRW D=38, - Halter TRW
	1.8 T quattro 2.4 quattro 2.5 TDI quattro 2.7 T quattro 2.8 quattro 3.0 quattro			04.97 01.05 04.97 01.05 07.97 01.05 10.97 01.05 04.97 01.05 06.01 01.05		24.3384-1733.7 220545 24.3384-1734.7 220546	<input type="checkbox"/> <input type="checkbox"/>	D=38, - Halter TRW D=38, - Halter TRW
	4.2 quattro S6			11.98 01.05 09.99 01.05		24.3437-1701.7 220761 24.3437-1702.7 220762	<input type="checkbox"/> <input type="checkbox"/>	D=43, - Halter TRW D=43, - Halter TRW
	1.8 1.8 T 110 1.8 T 132 1.9 TDI 2.0 2.4 100 2.4 115 2.4 121 2.5 TDI 110 2.5 TDI 120 2.5 TDI 132 2.7 T 2.8 3.0			04.97 01.05 04.97 01.05 12.97 01.05 04.97 01.05 08.01 01.05 07.98 01.05 04.97 01.05 04.97 01.05 04.97 01.05 07.02 01.05 02.00 01.05 03.98 01.05 04.97 01.05 06.01 01.05		83.6212-0170.3 330625	2	L=170
	1.8 T quattro 2.4 quattro 2.5 TDI quattro 2.7 T quattro 2.8 quattro 3.0 quattro 4.2 quattro S6			04.97 01.05 04.97 01.05 07.97 01.05 10.97 01.05 04.97 01.05 06.01 01.05 11.98 01.05 09.99 01.05		24.5243-0310.3 330755	2	L=310
	1.8 1.8 T 110 1.8 T 132 1.9 TDI 2.0 2.4 100 2.4 115 2.4 121 2.5 TDI 110 2.5 TDI 120 2.5 TDI 132 2.7 T 2.8 3.0			04.97 01.05 04.97 01.05 12.97 01.05 04.97 01.05 08.01 01.05 07.98 01.05 04.97 01.05 04.97 01.05 04.97 01.05 07.02 01.05 02.00 01.05 03.98 01.05 04.97 01.05 06.01 01.05		24.3727-0171.2 580171 24.3727-0172.2 580172	<input type="checkbox"/> <input type="checkbox"/>	L=1958 L=1958
	1.8 T quattro 2.4 quattro 2.5 TDI quattro 2.7 T quattro 2.8 quattro 3.0 quattro 4.2 quattro S6			04.97 01.05 04.97 01.05 07.97 01.05 10.97 01.05 04.97 01.05 06.01 01.05 11.98 01.05 09.99 01.05		24.3727-0178.2 580178	2 	L=1925
	1.9 TDI 1.8 1.8 T 1.8 T 1.8 T quattro 1.9 TDI 2.0 2.4 2.4 2.4 2.4 quattro 2.5 TDI 2.5 TDI 2.5 TDI 2.5 TDI quattro 2.7 T	4B-W-019484 4B-W-019485	04.97	04.97 01.05 04.97 01.05 12.97 01.05 04.97 01.05 01.05 08.01 01.05 07.98 01.05 04.97 01.05 04.97 01.05 04.97 01.05 04.97 01.05 07.02 01.05 02.00 01.05 07.97 01.05 03.98 01.05		24.2419-1706.3 030091 24.2419-1707.3 030092		Gz 19,05 Gz 19,05



AUDI A6 / A6 Avant (4B/C5) (97-05)

	2.7 T quattro		10.97	01.05		24.2419-1707.3	030092		Gz 19,05
	2.8		04.97	01.05					
	2.8 quattro		04.97	01.05					
	3.0		06.01	01.05					
	3.0 quattro		06.01	01.05					
	4.2 quattro		11.98	01.05					
	S6		09.99	01.05					
	1.8		04.97			24.2419-1705.3	030090		Gz 19,05
	1.8 T	▶110	04.97						
	1.8 T	▶132	12.97						
	1.8 T quattro		04.97	10.04					
	1.9 TDI	▶ 4B-W-019485	04.97						
	2.4	▶100	07.98						
	2.4	▶115	04.97						
	2.4	▶121	04.97						
	2.4 quattro		04.97	10.04					
	2.5 TDI	▶110	04.97						
	2.5 TDI quattro		07.97	10.04					
	2.7 T		03.98						
	2.7 T quattro		10.97	10.04					
	2.8		04.97						
	2.8 quattro		04.97	10.04					
	3.0 quattro		06.01	10.04					
	4.2 quattro		11.98	10.04					
	S6		09.99	10.04					
	1.9 TDI		04.97			24.2519-1702.3	040074		Nz 19,05
	1.8		04.97	01.05		24.2522-1706.3	040090		Nz 22,20
	1.8 T	110	04.97	01.05					
	1.8 T	132	12.97	01.05					
	1.8 T quattro		04.97	01.05					
	1.9 TDI	4B-W-019485		01.05					
	2.0		08.01	01.05					
	2.4	100	07.98	01.05					
	2.4	115	04.97	01.05					
	2.4	121	04.97	01.05					
	2.4 quattro		04.97	01.05					
	2.5 TDI	110	04.97	01.05					
	2.5 TDI	120	07.02	01.05					
	2.5 TDI	132	02.00	01.05					
	2.5 TDI quattro		07.97	01.05					
	2.7 T		03.98	01.05					
	2.7 T quattro		10.97	01.05					
	2.8		04.97	01.05					
	2.8 quattro		04.97	01.05					
	3.0		06.01	01.05					
	3.0 quattro		06.01	01.05					
	4.2 quattro		11.98	01.05					
	S6		09.99	01.05					

AUDI A6 Allroad (00-05)

	2.5 TDI		05.00	07.05		24.2125-1713.3	010623		Thz 25,40	
	2.7 T		05.00	07.05						
	4.2		07.02	07.05						
	2.5 TDI		05.00	07.05	PR: 1LA	11.9606-9965.2	220817	<input type="checkbox"/>	D=60, - Halter	ATE
	2.7 T		05.00	07.05	PR: 1LA	11.9606-9966.2	220818	<input type="checkbox"/>	D=60, - Halter	ATE
	4.2		07.02	07.05	PR: 1LA	11.0441-6008.2	250038		Dichtungssatz	ATE
						11.0101-5409.2	260035		Hülzensatz	ATE
						11.8171-0008.1	990049		Führungsbolzen	ATE
						11.8116-0299.1	390446	2	Haltefeder	ATE
	2.5 TDI		05.00	07.05		83.6213-0335.3	330459	2	L=335	
	2.7 T		05.00	07.05						
	4.2		07.02	07.05						
	2.5 TDI		05.00	07.05		24.3384-1733.7	220545	<input type="checkbox"/>	D=38, - Halter	TRW
	2.7 T		05.00	07.05		24.3384-1734.7	220546	<input type="checkbox"/>	D=38, - Halter	TRW
	4.2		07.02	07.05		24.3437-1701.7	220761	<input type="checkbox"/>	D=43, - Halter	TRW
						24.3437-1702.7	220762	<input type="checkbox"/>	D=43, - Halter	TRW
	2.5 TDI		05.00	07.05		24.3727-0178.2	580178	2	L=1925	
	2.7 T		05.00	07.05						
	4.2		07.02	07.05						
	2.5 TDI		05.00	07.05		24.2419-1707.3	030092		Gz 19,05	
	2.7 T		05.00	07.05						
	4.2		07.02	07.05						
	2.5 TDI		05.00	07.05		24.2522-1706.3	040090		Nz 22,20	
	2.7 T		05.00	07.05						
	4.2		07.02	07.05						

AUDI A6 (4F2/C6) Limousine (04-11)

	2.0 TDI	100	06.05	03.11		24.2126-1705.3	010999		Thz 26,99	TRW
	2.0 TDI	103	07.04	03.11						
	2.0 TDI	125	10.08	03.11						
	2.0 TFSI	125	06.05	03.11						
	2.4	130	04.04	03.11						
	2.4 quattro	130	01.05	03.11						
	2.7 TDI	120	11.04	03.11						
	2.7 TDI	132	11.04	03.11						
	2.7 TDI	140	10.08	03.11						



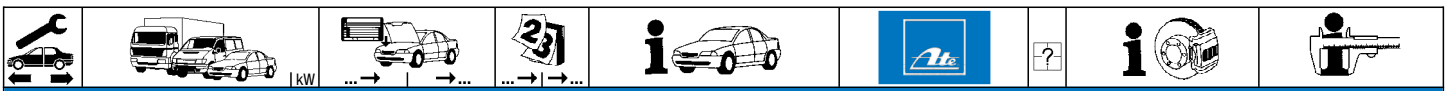

AUDI A6 (4F2/C6) Limousine (04-11)

	2.7 TDI quattro 120		06.05	03.11		24.2126-1705.3	010999			Thz 26,99	TRW
	2.7 TDI quattro 132		11.04	03.11							
	2.7 TDI quattro 140		10.08	03.11							
	2.8 FSI 140		10.08	03.11							
	2.8 FSI 154		11.06	03.11							
	2.8 FSI 162		10.08	03.11							
	2.8 FSI quattro 140		10.08	03.11							
	2.8 FSI quattro 154		04.07	03.11							
	2.8 FSI quattro 162		10.08	03.11							
	3.0 160		04.04	03.11							
	3.0 quattro 160		04.04	03.11							
	3.0 TDI 171		06.06	03.11							
	3.0 TDI quattro 155		04.04	03.11							
	3.0 TDI quattro 165		04.04	03.11							
	3.0 TDI quattro 171		06.06	03.11							
	3.0 TDI quattro 176		10.08	03.11							
	3.0 TFSI quattro		10.08	03.11							
	3.2 FSI 188		04.04	03.11							
	3.2 FSI quattro 257		04.04	03.11							
	4.2 FSI quattro 246		06.06	03.11							
	4.2 quattro 426		04.04	03.11							
	RS 6 320		04.08	03.11							
	S6		03.06	03.11							
	2.0 TDI 100		06.05	03.11	PR: 1LT	11.9571-9836.2	220428			D=57, - Halter	ATE
	2.0 TDI 103		07.04	03.11	PR: 1LT	11.9571-9835.2	220427			D=57, - Halter	ATE
	2.0 TDI 125		10.08	03.11	PR: 1LT	11.0441-5704.2	250034			Dichtungssatz	ATE
	2.0 TFSI 125		06.05	03.11	PR: 1LT	11.0101-5409.2	260035			Hülsensatz	ATE
	2.4 130		04.04	03.11	PR: 1LT	11.8171-0008.1	990049			Führungsbolzen	ATE
	2.4 quattro 130		01.05	03.11	PR: 1LT	11.8116-0347.2	390535	2		Haltefeder	ATE
	2.7 TDI 120		11.04	03.11	PR: 1LT						
	2.7 TDI 132		11.04	03.11	PR: 1LT						
	2.7 TDI 140		10.08	03.11	PR: 1LT						
	2.7 TDI quattro 120		06.05	03.11	PR: 1LT						
	2.7 TDI quattro 132		11.04	03.11	PR: 1LT						
	2.7 TDI quattro 140		10.08	03.11	PR: 1LT						
	2.8 FSI 140		10.08	03.11	PR: 1LT						
	2.8 FSI 154		11.06	03.11	PR: 1LT						
	2.8 FSI 162		10.08	03.11	PR: 1LT						
	2.8 FSI quattro 140		10.08	03.11	PR: 1LT						
	2.8 FSI quattro 154		04.07	03.11	PR: 1LT						
	2.8 FSI quattro 162		10.08	03.11	PR: 1LT						
	3.0 160		04.04	03.11	PR: 1LT						
	3.0 quattro 160		04.04	03.11	PR: 1LT						
	3.0 TDI quattro 155		04.04	03.11	PR: 1LT						
	3.0 TDI quattro 165		04.04	03.11	PR: 1LT						
	3.0 TDI quattro 171		06.06	03.11	PR: 1LT						
	3.0 TDI quattro 176		10.08	03.11	PR: 1LT						
	3.0 TFSI quattro		10.08	03.11	PR: 1LT						
	3.2 FSI 188		04.04	03.11	PR: 1LT						
	3.2 FSI quattro 257		04.04	03.11	PR: 1LT						
	4.2 FSI quattro 246		06.06	03.11	PR: 1LT						
	4.2 quattro		04.04	03.11	PR: 1LT						
	2.0 TDI 100		06.05	03.11	PR: 1LG,1LD	11.9606-9953.2	220587			D=60, - Halter	ATE
	2.0 TDI 103		07.04	03.11	PR: 1LG,1LD	11.9606-9954.2	220588			D=60, - Halter	ATE
	2.0 TDI 125		10.08	03.11	PR: 1LG	11.0441-6008.2	250038			Dichtungssatz	ATE
	2.0 TFSI 125		06.05	03.11	PR: 1LG,1LD	11.0101-5409.2	260035			Hülsensatz	ATE
	2.4 130		04.04	03.11	PR: 1LG,1LD	11.8171-0008.1	990049			Führungsbolzen	ATE
	2.4 quattro 130		01.05	03.11	PR: 1LG,1LD	11.8116-0347.2	390535	2		Haltefeder	ATE
	2.7 TDI 120		11.04	03.11	PR: 1LG,1LD						
	2.7 TDI 132		11.04	03.11	PR: 1LG,1LD						
	2.7 TDI 140		10.08	03.11	PR: 1LG						
	2.7 TDI quattro 120		06.05	03.11	PR: 1LG,1LD						
	2.7 TDI quattro 132		11.04	03.11	PR: 1LG,1LD						
	2.7 TDI quattro 140		10.08	03.11	PR: 1LG						
	2.8 FSI 140		10.08	03.11	PR: 1LG						
	2.8 FSI 154		11.06	03.11	PR: 1LG,1LD						
	2.8 FSI 162		10.08	03.11	PR: 1LG						
	2.8 FSI quattro 140		10.08	03.11	PR: 1LG						
	2.8 FSI quattro 154		04.07	03.11	PR: 1LG,1LD						
	2.8 FSI quattro 162		10.08	03.11	PR: 1LG						
	3.0 160		04.04	03.11	PR: 1LG,1LD						
	3.0 quattro 160		04.04	03.11	PR: 1LG,1LD						
	3.0 TDI quattro 155		04.04	03.11	PR: 1LG,1LD						
	3.0 TDI quattro 165		04.04	03.11	PR: 1LG,1LD						
	3.0 TDI quattro 171		06.06	03.11	PR: 1LG,1LD						
	3.0 TDI quattro 176		10.08	03.11	PR: 1LG						
	3.0 TFSI quattro		10.08	03.11	PR: 1LG						
	3.2 FSI 188		04.04	03.11	PR: 1LG,1LD						
	3.2 FSI quattro 257		04.04	03.11	PR: 1LG,1LD						
	4.2 FSI quattro 246		06.06	03.11	PR: 1LG,1LD						
	4.2 quattro		04.04	03.11	PR: 1LG,1LD						
	2.0 TDI 100		06.05	03.11	PR: 1ZL,1LH	11.9606-9961.2	220655			D=60, - Halter	ATE
	2.0 TDI 103		07.04	03.11	PR: 1ZL,1LH	11.9606-9962.2	220656			D=60, - Halter	ATE
	2.0 TDI 125		10.08	03.11	PR: 1ZL	11.0441-6008.2	250038			Dichtungssatz	ATE
	2.0 TFSI 125		06.05	03.11	PR: 1ZL,1LH	11.0101-5409.2	260035			Hülsensatz	ATE
	2.4 130		04.04	03.11	PR: 1ZL,1LH	11.8171-0008.1	990049			Führungsbolzen	ATE
	2.4 quattro 130		01.05	03.11	PR: 1ZL,1LH	11.8116-0410.2	390589	2		Haltefeder	ATE

AUDI A6 (4F2/C6) Limousine (04-11)											
	2.7 TDI	120		11.04	03.11	PR: 1ZL,1LH	11.9606-9961.2	220655	2	D=60, - Halter D=60, - Halter Dichtungssatz Hülsensatz Führungsbolzen Haltefeder	ATE ATE ATE ATE ATE ATE
	2.7 TDI	132		11.04	03.11	PR: 1ZL,1LH	11.9606-9962.2	220656			
	2.7 TDI	140		10.08	03.11	PR: 1ZL	11.0441-6008.2	250038			
	2.7 TDI quattro	120		06.05	03.11	PR: 1ZL,1LH	11.0101-5409.2	260035			
	2.7 TDI quattro	132		11.04	03.11	PR: 1ZL,1LH	11.8171-0008.1	990049			
	2.7 TDI quattro	140		10.08	03.11	PR: 1ZL	11.8116-0410.2	390589			
	2.8 FSI	140		10.08	03.11	PR: 1ZL					
	2.8 FSI	154		11.06	03.11	PR: 1ZL,1LH					
	2.8 FSI	162		10.08	03.11	PR: 1ZL					
	2.8 FSI quattro	140		10.08	03.11	PR: 1ZL					
	2.8 FSI quattro	154		04.07	03.11	PR: 1ZL,1LH					
	2.8 FSI quattro	162		10.08	03.11	PR: 1ZL					
	3.0	160		04.04	03.11	PR: 1ZL,1LH					
	3.0 quattro	160		04.04	03.11	PR: 1ZL,1LH					
	3.0 TDI quattro	155		04.04	03.11	PR: 1ZL,1LH					
	3.0 TDI quattro	165		04.04	03.11	PR: 1ZL,1LH					
	3.0 TDI quattro	171		06.06	03.11	PR: 1ZL,1LH					
	3.0 TDI quattro	176		10.08	03.11	PR: 1ZL					
	3.0 TFSI quattro			10.08	03.11	PR: 1ZL					
	3.2 FSI			04.04	03.11	PR: 1ZL,1LH					
3.2 FSI quattro	188		04.04	03.11	PR: 1ZL,1LH						
4.2 FSI quattro	257		06.06	03.11	PR: 1ZL,1LH						
4.2 quattro	246		04.04	03.11	PR: 1ZL,1LH						
S6	320		03.06	03.11		11.8171-0067.1	250153		Führungsbolzen	ATE	
	2.0 TDI	100		06.05	03.11		83.7813-0315.3	330870	2	L=315	
	2.0 TDI	103		07.04	03.11						
	2.0 TDI	125		10.08	03.11						
	2.0 TFSI	125		06.05	03.11						
	2.4	130		04.04	03.11						
	2.4 quattro	130		01.05	03.11						
	2.7 TDI	120		11.04	03.11						
	2.7 TDI	132		11.04	03.11						
	2.7 TDI	140		10.08	03.11						
	2.7 TDI quattro	120		06.05	03.11						
	2.7 TDI quattro	132		11.04	03.11						
	2.7 TDI quattro	140		10.08	03.11						
	2.8 FSI	140		10.08	03.11						
	2.8 FSI	154		11.06	03.11						
	2.8 FSI	162		10.08	03.11						
	2.8 FSI quattro	140		10.08	03.11						
	2.8 FSI quattro	154		04.07	03.11						
	2.8 FSI quattro	162		10.08	03.11						
	3.0	160		04.04	03.11						
	3.0 quattro	160		04.04	03.11						
3.0 TDI quattro	155		04.04	03.11							
3.0 TDI quattro	165		04.04	03.11							
3.0 TDI quattro	171		06.06	03.11							
3.0 TDI quattro	176		10.08	03.11							
3.0 TFSI quattro			10.08	03.11							
3.2 FSI			04.04	03.11							
3.2 FSI quattro	188		04.04	03.11							
4.2 FSI quattro	257		06.06	03.11							
4.2 quattro	246		04.04	03.11							
S6	320		03.06	03.11							
	2.0 TDI	100	4F-7-016200	06.05		PR: 1KD,2ED	24.6241-1701.7	220821	2	D=41, - Halter D=41, - Halter	TRW TRW
	2.0 TDI	103	4F-7-016200	07.04		PR: 1KD,2ED	24.6241-1702.7	220822			
	2.0 TFSI	125	4F-7-016200	06.05		PR: 1KD,2ED					
	2.4	130	4F-7-016200	04.04		PR: 1KD,2ED					
	2.4 quattro	130	4F-7-016200	01.05		PR: 1KD,2ED					
	2.7 TDI	120	4F-7-016200	11.04		PR: 1KD,2ED					
	2.7 TDI	132	4F-7-016200	11.04		PR: 1KD,2ED					
	2.7 TDI quattro	120	4F-7-016200	06.05		PR: 1KD,2ED					
	2.7 TDI quattro	132	4F-7-016200	11.04		PR: 1KD,2ED					
	2.8 FSI	154	4F-7-016200	11.06		PR: 1KD,2ED					
	2.8 FSI quattro	154	4F-7-016200	04.07		PR: 1KD,2ED					
	3.0	160	4F-7-016200	04.04		PR: 1KD,2ED					
	3.0 quattro	160	4F-7-016200	04.04		PR: 1KD,2ED					
	3.0 TDI quattro	155	4F-7-016200	04.04		PR: 1KD,2ED					
	3.0 TDI quattro	165	4F-7-016200	04.04		PR: 1KD,2ED					
	3.0 TDI quattro	171	4F-7-016200	06.06		PR: 1KD,2ED					
	3.2 FSI		4F-7-016200	04.04		PR: 1KD,2ED					
	3.2 FSI quattro	188	4F-7-016200	04.04		PR: 1KD,2ED					
	4.2 FSI quattro	257	4F-7-016200	06.06		PR: 1KD,2ED					
	4.2 quattro	246	4F-7-016200	04.04		PR: 1KD,2ED					
	2.0 TDI	100	4F-7-016201		03.11	PR: 1KD,2ED,1KQ	24.6241-1707.7	220943	2	D=41, - Halter D=41, - Halter	TRW TRW
	2.0 TDI	103	4F-7-016201		03.11	PR: 1KD,2ED,1KQ	24.6241-1708.7	220944			
	2.0 TDI	125		10.08		PR: 1KD,1KQ					
	2.0 TFSI	125	4F-7-016201		03.11	PR: 1KD,2ED,1KQ					
	2.4	130	4F-7-016201		03.11	PR: 1KD,2ED,1KQ					
	2.4 quattro	130	4F-7-016201		03.11	PR: 1KD,2ED,1KQ					
	2.7 TDI	120	4F-7-016201		03.11	PR: 1KD,2ED,1KQ					
	2.7 TDI	132	4F-7-016201		03.11	PR: 1KD,2ED,1KQ					
	2.7 TDI	140		10.08		PR: 1KD,1KQ					
	2.7 TDI quattro	120	4F-7-016201		03.11	PR: 1KD,2ED,1KQ					
2.7 TDI quattro	132	4F-7-016201		03.11	PR: 1KD,2ED,1KQ						
2.7 TDI quattro	140		10.08		PR: 1KD,1KQ						
2.8 FSI	140		10.08		PR: 1KD,1KQ						

1) electric parking brake / fr.dl stazionamento elettrico / frein à main électrique / freno de mano eléctrico



AUDI A6 (4F2/C6) Limousine (04-11)											
	2.8 FSI	154	4F-7-016201		03.11	PR: 1KD,2ED,1KQ	24.6241-1707.7	220943	<input type="checkbox"/> elektrische Feststellbremse 1)	D=41, - Halter	TRW
	2.8 FSI	162		10.08	03.11	PR: 1KD,1KQ	24.6241-1708.7	220944	<input type="checkbox"/> elektrische Feststellbremse 1)	D=41, - Halter	TRW
	2.8 FSI quattro	140		10.08	03.11	PR: 1KD,1KQ					
	2.8 FSI quattro	154	4F-7-016201		03.11	PR: 1KD,2ED,1KQ					
	2.8 FSI quattro	162		10.08	03.11	PR: 1KD,1KQ					
	3.0	160	4F-7-016201		03.11	PR: 1KD,2ED,1KQ					
	3.0 quattro	160	4F-7-016201		03.11	PR: 1KD,2ED,1KQ					
	3.0 TDI quattro	155	4F-7-016201		03.11	PR: 1KD,2ED,1KQ					
	3.0 TDI quattro	165	4F-7-016201		03.11	PR: 1KD,2ED,1KQ					
	3.0 TDI quattro	171	4F-7-016201		03.11	PR: 1KD,2ED,1KQ					
	3.0 TDI quattro	176		10.08	03.11	PR: 1KD,1KQ					
	3.0 TFSI quattro			10.08	03.11	PR: 1KD,1KQ					
	3.2 FSI		4F-7-016201		03.11	PR: 1KD,2ED,1KQ					
	3.2 FSI quattro	188	4F-7-016201		03.11	PR: 1KD,2ED,1KQ					
	4.2 FSI quattro	257	4F-7-016201		03.11	PR: 1KD,2ED,1KQ					
	4.2 quattro	246	4F-7-016201		03.11	PR: 1KD,2ED,1KQ					
		2.0 TDI	100	4F-7-016201	06.05		PR: 1KW,2EE	24.6243-1701.7	220823	<input type="checkbox"/> elektrische Feststellbremse 1)	D=43, - Halter
2.0 TDI		103	4F-7-016200	07.04		PR: 1KW,2EE	24.6243-1702.7	220824	<input type="checkbox"/> elektrische Feststellbremse 1)	D=43, - Halter	TRW
2.0 TFSI		125	4F-7-016200	06.05		PR: 1KW,2EE					
2.4		130	4F-7-016200	04.04		PR: 1KW,2EE					
2.4 quattro		130	4F-7-016200	01.05		PR: 1KW,2EE					
2.7 TDI		120	4F-7-016200	11.04		PR: 1KW,2EE					
2.7 TDI		132	4F-7-016200	11.04		PR: 1KW,2EE					
2.7 TDI quattro		120	4F-7-016200	06.05		PR: 1KW,2EE					
2.7 TDI quattro		132	4F-7-016200	11.04		PR: 1KW,2EE					
2.8 FSI		154	4F-7-016200	11.06		PR: 1KW,2EE					
2.8 FSI quattro		154	4F-7-016201	04.07		PR: 1KW,2EE					
3.0		160	4F-7-016200	04.04		PR: 1KW,2EE					
3.0 quattro		160	4F-7-016200	04.04		PR: 1KW,2EE					
3.0 TDI quattro		155	4F-7-016200	04.04		PR: 1KW,2EE					
3.0 TDI quattro		165	4F-7-016200	04.04		PR: 1KW,2EE					
3.0 TDI quattro		171	4F-7-016200	06.06		PR: 1KW,2EE					
3.2 FSI			4F-7-016200	04.04		PR: 1KW,2EE					
3.2 FSI quattro	188	4F-7-016200	04.04		PR: 1KW,2EE						
4.2 FSI quattro	257	4F-7-016200	06.06		PR: 1KW,2EE						
4.2 quattro	246	4F-7-016200	04.04		PR: 1KW,2EE						
	2.0 TDI	100	4F-7-016201		03.11	PR: 1KW,2EE	24.6243-1709.7	221023	<input type="checkbox"/> elektrische Feststellbremse 1)	D=43, - Halter	TRW
	2.0 TDI	103	4F-7-016201		03.11	PR: 1KW,2EE	24.6243-1710.7	221024	<input type="checkbox"/> elektrische Feststellbremse 1)	D=43, - Halter	TRW
	2.0 TDI	125		10.08	03.11	PR: 1KW					
	2.0 TFSI	125	4F-7-016201		03.11	PR: 1KW,2EE					
	2.4	130	4F-7-016201		03.11	PR: 1KW,2EE					
	2.4 quattro	130	4F-7-016201		03.11	PR: 1KW,2EE					
	2.7 TDI	120	4F-7-016201		03.11	PR: 1KW,2EE					
	2.7 TDI	132	4F-7-016201		03.11	PR: 1KW,2EE					
	2.7 TDI	140		10.08	03.11	PR: 1KW					
	2.7 TDI quattro	120	4F-7-016201		03.11	PR: 1KW,2EE					
	2.7 TDI quattro	132	4F-7-016201		03.11	PR: 1KW,2EE					
	2.7 TDI quattro	140		10.08	03.11	PR: 1KW					
	2.8 FSI	140		10.08	03.11	PR: 1KW					
	2.8 FSI	154	4F-7-016201		03.11	PR: 1KW,2EE					
	2.8 FSI	162		10.08	03.11	PR: 1KW					
	2.8 FSI quattro	140		10.08	03.11	PR: 1KW					
	2.8 FSI quattro	154	4F-7-016201		03.11	PR: 1KW,2EE					
2.8 FSI quattro	162		10.08	03.11	PR: 1KW						
3.0	160	4F-7-016201		03.11	PR: 1KW,2EE						
3.0 quattro	160	4F-7-016201		03.11	PR: 1KW,2EE						
3.0 TDI quattro	155	4F-7-016201		03.11	PR: 1KW,2EE						
3.0 TDI quattro	165	4F-7-016201		03.11	PR: 1KW,2EE						
3.0 TDI quattro	171	4F-7-016201		03.11	PR: 1KW,2EE						
3.0 TDI quattro	176		10.08	03.11	PR: 1KW						
3.0 TFSI quattro			10.08	03.11	PR: 1KW						
3.2 FSI		4F-7-016201		03.11	PR: 1KW,2EE						
3.2 FSI quattro	188	4F-7-016201		03.11	PR: 1KW,2EE						
4.2 FSI quattro	257	4F-7-016201		03.11	PR: 1KW,2EE						
4.2 quattro	246	4F-7-016201		03.11	PR: 1KW,2EE						
	2.0 TDI	100		06.05	03.11		24.5125-0323.3	330911	2		L=323
	2.0 TDI	103		07.04	03.11						
	2.0 TDI	125		10.08	03.11						
	2.0 TFSI	125		06.05	03.11						
	2.4	130		04.04	03.11						
	2.4 quattro	130		01.05	03.11						
	2.7 TDI	120		11.04	03.11						
	2.7 TDI	132		11.04	03.11						
	2.7 TDI	140		10.08	03.11						
	2.7 TDI quattro	120		06.05	03.11						
	2.7 TDI quattro	132		11.04	03.11						
	2.7 TDI quattro	140		10.08	03.11						
	2.8 FSI	140		10.08	03.11						
	2.8 FSI	154		11.06	03.11						
	2.8 FSI	162		10.08	03.11						
	2.8 FSI quattro	140		10.08	03.11						
	2.8 FSI quattro	154		04.07	03.11						
2.8 FSI quattro	162		10.08	03.11							
3.0	160		04.04	03.11							
3.0 quattro	160		04.04	03.11							
3.0 TDI quattro	155		04.04	03.11							
3.0 TDI quattro	165		04.04	03.11							

1) electric parking brake / fr.di stazionamento elettrico / frein à main électrique / freno de mano eléctrico

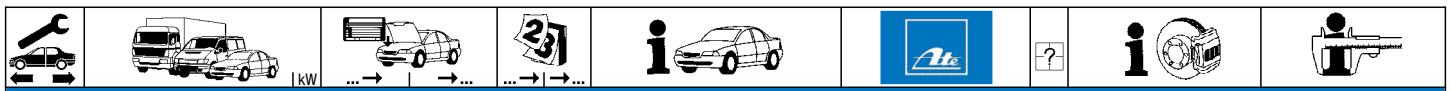

AUDI A6 (4F2/C6) Limousine (04-11)										
	3.0 TDI quattro	171		06.06	03.11		24.5125-0323.3	330911	2	L=323
	3.0 TDI quattro	176		10.08	03.11					
	3.0 TFSI quattro			10.08	03.11					
	3.2 FSI			04.04	03.11					
	3.2 FSI quattro	188		04.04	03.11					
	4.2 FSI quattro	257		06.06	03.11					
	4.2 quattro	246		04.04	03.11					
	S6	320		03.06	03.11					

AUDI A6 (4F5/C6) Avant (05-11)										
	2.0 TDI	100		06.05	08.11		24.2126-1705.3	010999		Thz 26,99 TRW
	2.0 TDI	103		03.05	08.11					
	2.0 TDI	125		10.08	08.11					
	2.0 TFSI	125		06.05	08.11					
	2.4	130		03.05	08.11					
	2.4 quattro	130		03.05	08.11					
	2.7 TDI	120		03.05	08.11					
	2.7 TDI	132		03.05	08.11					
	2.7 TDI	140		10.08	08.11					
	2.7 TDI quattro	120		06.05	08.11					
	2.7 TDI quattro	132		03.05	08.11					
	2.7 TDI quattro	140		10.08	08.11					
	2.8 FSI	140		10.08	08.11					
	2.8 FSI	154		11.06	08.11					
	2.8 FSI	162		10.08	08.11					
	2.8 FSI quattro	140		10.08	08.11					
	2.8 FSI quattro	154		04.07	08.11					
	2.8 FSI quattro	162		10.08	08.11					
	3.0	160		03.05	08.11					
	3.0 quattro	160		03.05	08.11					
	3.0 TDI	171		06.06	08.11					
	3.0 TDI quattro	155		03.05	08.11					
	3.0 TDI quattro	165		03.05	08.11					
	3.0 TDI quattro	171		06.06	08.11					
	3.0 TDI quattro	176		10.08	08.11					
	3.0 TFSI quattro			10.08	08.11					
	3.2 FSI	188		03.05	08.11					
	3.2 FSI quattro	188		03.05	08.11					
	4.2 FSI quattro	257		06.06	08.11					
	4.2 quattro	246		03.05	08.11					
	RS 6	426		04.08	08.11					
	S6	320		03.06	08.11					
	2.0 TDI	100		06.05	08.11	PR: 1LT	11.9571-9836.2	220428		D=57, - Halter ATE
	2.0 TDI	103		03.05	08.11	PR: 1LT	11.9571-9835.2	220427		D=57, - Halter ATE
	2.0 TDI	125		10.08	08.11	PR: 1LT	11.0441-5704.2	250034		Dichtungssatz ATE
	2.0 TFSI	125		06.05	08.11	PR: 1LT	11.0101-5409.2	260035		Hülsensatz ATE
	2.4	130		03.05	08.11	PR: 1LT	11.8171-0008.1	990049		Führungsbolzen ATE
	2.4 quattro	130		03.05	08.11	PR: 1LT	11.8116-0347.2	390535	2	Haltefeder ATE
	2.7 TDI	120		03.05	08.11	PR: 1LT				
	2.7 TDI	132		03.05	08.11	PR: 1LT				
	2.7 TDI	140		10.08	08.11	PR: 1LT				
	2.7 TDI quattro	120		06.05	08.11	PR: 1LT				
	2.7 TDI quattro	132		03.05	08.11	PR: 1LT				
	2.7 TDI quattro	140		10.08	08.11	PR: 1LT				
	2.8 FSI	140		10.08	08.11	PR: 1LT				
	2.8 FSI	154		11.06	08.11	PR: 1LT				
	2.8 FSI	162		10.08	08.11	PR: 1LT				
	2.8 FSI quattro	140		10.08	08.11	PR: 1LT				
	2.8 FSI quattro	154		04.07	08.11	PR: 1LT				
	2.8 FSI quattro	162		10.08	08.11	PR: 1LT				
	3.0	160		03.05	08.11	PR: 1LT				
	3.0 quattro	160		03.05	08.11	PR: 1LT				
	3.0 TDI quattro	155		03.05	08.11	PR: 1LT				
	3.0 TDI quattro	165		03.05	08.11	PR: 1LT				
	3.0 TDI quattro	171		06.06	08.11	PR: 1LT				
	3.0 TDI quattro	176		10.08	08.11	PR: 1LT				
	3.0 TFSI quattro			10.08	08.11	PR: 1LT				
	3.2 FSI	188		03.05	08.11	PR: 1LT				
	3.2 FSI quattro	188		03.05	08.11	PR: 1LT				
	4.2 FSI quattro	257		06.06	08.11	PR: 1LT				
	4.2 quattro	246		03.05	08.11	PR: 1LT				
	2.0 TDI	100		06.05	08.11	PR: 1LG,1LD	11.9606-9953.2	220587		D=60, - Halter ATE
	2.0 TDI	103		03.05	08.11	PR: 1LG,1LD	11.9606-9954.2	220588		D=60, - Halter ATE
	2.0 TDI	125		10.08	08.11	PR: 1LG	11.0441-6008.2	250038		Dichtungssatz ATE
	2.0 TFSI	125		06.05	08.11	PR: 1LG,1LD	11.0101-5409.2	260035		Hülsensatz ATE
	2.4	130		03.05	08.11	PR: 1LG,1LD	11.8171-0008.1	990049		Führungsbolzen ATE
	2.4 quattro	130		03.05	08.11	PR: 1LG,1LD	11.8116-0347.2	390535	2	Haltefeder ATE
	2.7 TDI	120		03.05	08.11	PR: 1LG,1LD				
	2.7 TDI	132		03.05	08.11	PR: 1LG,1LD				
	2.7 TDI	140		10.08	08.11	PR: 1LG				
	2.7 TDI quattro	120		06.05	08.11	PR: 1LG,1LD				
	2.7 TDI quattro	132		03.05	08.11	PR: 1LG,1LD				
	2.7 TDI quattro	140		10.08	08.11	PR: 1LG				
	2.8 FSI	140		10.08	08.11	PR: 1LG				
	2.8 FSI	154		11.06	08.11	PR: 1LG,1LD				
	2.8 FSI	162		10.08	08.11	PR: 1LG				
	2.8 FSI quattro	140		10.08	08.11	PR: 1LG				



AUDI A6 (4F5/C6) Avant (05-11)												
	2.8 FSI quattro	154	04.07	08.11	PR: 1LG,1LD	11.9606-9953.2	220587	2	D=60, - Halter D=60, - Halter Dichtungssatz Hülzensatz Führungsbolzen Haltefeder	ATE		
	2.8 FSI quattro	162	10.08	08.11	PR: 1LG	11.9606-9954.2	220588			ATE		
	3.0	160	03.05	08.11	PR: 1LG,1LD	11.0441-6008.2	250038			ATE		
	3.0 quattro	160	03.05	08.11	PR: 1LG,1LD	11.0101-5409.2	260035			ATE		
	3.0 TDI quattro	155	03.05	08.11	PR: 1LG,1LD	11.8171-0008.1	990049			ATE		
	3.0 TDI quattro	165	03.05	08.11	PR: 1LG,1LD	11.8116-0347.2	390535			ATE		
	3.0 TDI quattro	171	06.06	08.11	PR: 1LG,1LD							
	3.0 TDI quattro	176	10.08	08.11	PR: 1LG							
	3.0 TFSI quattro		10.08	08.11	PR: 1LG							
	3.2 FSI	188	03.05	08.11	PR: 1LG,1LD							
	3.2 FSI quattro	188	03.05	08.11	PR: 1LG,1LD							
	4.2 FSI quattro	257	06.06	08.11	PR: 1LG,1LD							
	4.2 quattro	246	03.05	08.11	PR: 1LG,1LD							
	2.0 TDI	100	06.05	08.11	PR: 1ZL,1LH	11.9606-9961.2	220655			2	D=60, - Halter D=60, - Halter Dichtungssatz Hülzensatz Führungsbolzen Haltefeder	ATE
	2.0 TDI	103	03.05	08.11	PR: 1ZL,1LH	11.9606-9962.2	220656					ATE
	2.0 TDI	125	10.08	08.11	PR: 1ZL	11.0441-6008.2	250038					ATE
	2.0 TFSI	125	06.05	08.11	PR: 1ZL,1LH	11.0101-5409.2	260035					ATE
2.4	130	03.05	08.11	PR: 1ZL,1LH	11.8171-0008.1	990049	ATE					
2.4 quattro	130	03.05	08.11	PR: 1ZL,1LH	11.8116-0410.2	390589	ATE					
2.7 TDI	120	03.05	08.11	PR: 1ZL,1LH								
2.7 TDI	132	03.05	08.11	PR: 1ZL,1LH								
2.7 TDI	140	10.08	08.11	PR: 1ZL								
2.7 TDI quattro	120	06.05	08.11	PR: 1ZL,1LH								
2.7 TDI quattro	132	03.05	08.11	PR: 1ZL,1LH								
2.7 TDI quattro	140	10.08	08.11	PR: 1ZL								
2.8 FSI	140	10.08	08.11	PR: 1ZL								
2.8 FSI	154	11.06	08.11	PR: 1ZL,1LH								
2.8 FSI	162	10.08	08.11	PR: 1ZL								
2.8 FSI quattro	140	10.08	08.11	PR: 1ZL								
2.8 FSI quattro	154	04.07	08.11	PR: 1ZL,1LH								
2.8 FSI quattro	162	10.08	08.11	PR: 1ZL								
3.0	160	03.05	08.11	PR: 1ZL,1LH								
3.0 quattro	160	03.05	08.11	PR: 1ZL,1LH								
3.0 TDI quattro	155	03.05	08.11	PR: 1ZL,1LH								
3.0 TDI quattro	165	03.05	08.11	PR: 1ZL,1LH								
3.0 TDI quattro	171	06.06	08.11	PR: 1ZL,1LH								
3.0 TDI quattro	176	10.08	08.11	PR: 1ZL								
3.0 TFSI quattro		10.08	08.11	PR: 1ZL								
3.2 FSI	188	03.05	08.11	PR: 1ZL,1LH								
3.2 FSI quattro	188	03.05	08.11	PR: 1ZL,1LH								
4.2 FSI quattro	257	06.06	08.11	PR: 1ZL,1LH								
4.2 quattro	246	03.05	08.11	PR: 1ZL,1LH								
S6	320	03.06	08.11		11.8171-0067.1	250153		Führungsbolzen	ATE			
	2.0 TDI	100	06.05	08.11		83.7813-0315.3	330870	2	L=315			
	2.0 TDI	103	03.05	08.11								
	2.0 TDI	125	10.08	08.11								
	2.0 TFSI	125	06.05	08.11								
	2.4	130	03.05	08.11								
	2.4 quattro	130	03.05	08.11								
	2.7 TDI	120	03.05	08.11								
	2.7 TDI	132	03.05	08.11								
	2.7 TDI	140	10.08	08.11								
	2.7 TDI quattro	120	06.05	08.11								
	2.7 TDI quattro	132	03.05	08.11								
	2.7 TDI quattro	140	10.08	08.11								
	2.8 FSI	140	10.08	08.11								
	2.8 FSI	154	11.06	08.11								
	2.8 FSI	162	10.08	08.11								
	2.8 FSI quattro	140	10.08	08.11								
	2.8 FSI quattro	154	04.07	08.11								
2.8 FSI quattro	162	10.08	08.11									
3.0	160	03.05	08.11									
3.0 quattro	160	03.05	08.11									
3.0 TDI quattro	155	03.05	08.11									
3.0 TDI quattro	165	03.05	08.11									
3.0 TDI quattro	171	06.06	08.11									
3.0 TDI quattro	176	10.08	08.11									
3.0 TFSI quattro		10.08	08.11									
3.2 FSI	188	03.05	08.11									
3.2 FSI quattro	188	03.05	08.11									
4.2 FSI quattro	257	06.06	08.11									
4.2 quattro	246	03.05	08.11									
S6	320	03.06	08.11									
	2.0 TDI	100	4F-7-016200	06.05	PR: 1KD,2ED	24.6241-1701.7	220821	2	D=41, - Halter D=41, - Halter	TRW		
	2.0 TDI	103	4F-7-016200	03.05	PR: 1KD,2ED	24.6241-1702.7	220822			TRW		
	2.0 TFSI	125	4F-7-016200	06.05	PR: 1KD,2ED							
	2.4	130	4F-7-016200	03.05	PR: 1KD,2ED							
	2.4 quattro	130	4F-7-016200	03.05	PR: 1KD,2ED							
	2.7 TDI	120	4F-7-016200	03.05	PR: 1KD,2ED							
	2.7 TDI	132	4F-7-016200	03.05	PR: 1KD,2ED							
	2.7 TDI quattro	120	4F-7-016200	06.05	PR: 1KD,2ED							
	2.7 TDI quattro	132	4F-7-016200	03.05	PR: 1KD,2ED							
	2.8 FSI	154	4F-7-016200	11.06	PR: 1KD,2ED							
	2.8 FSI quattro	154	4F-7-016200	04.07	PR: 1KD,2ED							
	3.0	160	4F-7-016200	03.05	PR: 1KD,2ED							
	3.0 quattro	160	4F-7-016200	03.05	PR: 1KD,2ED							
	3.0 TDI quattro	155	4F-7-016200	03.05	PR: 1KD,2ED							

1) electric parking brake / fr/di stazionamento elettrico / frein à main électrique / freno de mano eléctrico



AUDI A6 (4F5/C6) Avant (05-11)

	3.0 TDI quattro	165	4F-7-016200	03.05	PR: 1KD,2ED	24.6241-1701.7	220821	<input type="checkbox"/> elektrische Feststellbremse ¹⁾	D=41, - Halter	TRW
	3.0 TDI quattro	171	4F-7-016200	06.06	PR: 1KD,2ED	24.6241-1702.7	220822	<input type="checkbox"/> elektrische Feststellbremse ¹⁾	D=41, - Halter	TRW
	3.2 FSI	188	4F-7-016200	03.05	PR: 1KD,2ED					
	3.2 FSI quattro	188	4F-7-016200	03.05	PR: 1KD,2ED					
	4.2 FSI quattro	257	4F-7-016200	06.06	PR: 1KD,2ED					
	4.2 quattro	246	4F-7-016200	03.05	PR: 1KD,2ED					
	2.0 TDI	100	4F-7-016201	10.08	08.11 PR: 1KD,2ED,1KQ	24.6241-1707.7	220943	<input type="checkbox"/> elektrische Feststellbremse ¹⁾	D=41, - Halter	TRW
	2.0 TDI	103	4F-7-016201		08.11 PR: 1KD,2ED,1KQ	24.6241-1708.7	220944	<input type="checkbox"/> elektrische Feststellbremse ¹⁾	D=41, - Halter	TRW
	2.0 TDI	125			08.11 PR: 1KD,1KQ					
	2.0 TFSI	125	4F-7-016201		08.11 PR: 1KD,2ED,1KQ					
	2.4	130	4F-7-016201		08.11 PR: 1KD,2ED,1KQ					
	2.4 quattro	130	4F-7-016201		08.11 PR: 1KD,2ED,1KQ					
	2.7 TDI	120	4F-7-016201		08.11 PR: 1KD,2ED,1KQ					
	2.7 TDI	132	4F-7-016201		08.11 PR: 1KD,2ED,1KQ					
	2.7 TDI	140			08.11 PR: 1KD,1KQ					
	2.7 TDI quattro	120	4F-7-016201		08.11 PR: 1KD,2ED,1KQ					
	2.7 TDI quattro	132	4F-7-016201		08.11 PR: 1KD,2ED,1KQ					
	2.7 TDI quattro	140			08.11 PR: 1KD,1KQ					
	2.8 FSI	140			08.11 PR: 1KD,1KQ					
	2.8 FSI	154	4F-7-016201		08.11 PR: 1KD,2ED,1KQ					
	2.8 FSI	162			08.11 PR: 1KD,1KQ					
	2.8 FSI quattro	140			08.11 PR: 1KD,1KQ					
	2.8 FSI quattro	154	4F-7-016201		08.11 PR: 1KD,2ED,1KQ					
	2.8 FSI quattro	162			08.11 PR: 1KD,1KQ					
	3.0	160	4F-7-016201		08.11 PR: 1KD,2ED,1KQ					
	3.0 quattro	160	4F-7-016201		08.11 PR: 1KD,2ED,1KQ					
	3.0 TDI quattro	155	4F-7-016201		08.11 PR: 1KD,2ED,1KQ					
	3.0 TDI quattro	165	4F-7-016201		08.11 PR: 1KD,2ED,1KQ					
	3.0 TDI quattro	171	4F-7-016201		08.11 PR: 1KD,2ED,1KQ					
	3.0 TDI quattro	176			10.08 08.11 PR: 1KD,1KQ					
	3.0 TFSI quattro				10.08 08.11 PR: 1KD,1KQ					
	3.2 FSI	188	4F-7-016201		08.11 PR: 1KD,2ED,1KQ					
	3.2 FSI quattro	188	4F-7-016201		08.11 PR: 1KD,2ED,1KQ					
	4.2 FSI quattro	257	4F-7-016201		08.11 PR: 1KD,2ED,1KQ					
	4.2 quattro	246	4F-7-016201		08.11 PR: 1KD,2ED,1KQ					
		2.0 TDI	100		4F-7-016200	06.05	PR: 1KW,2EE	24.6243-1701.7	220823	<input type="checkbox"/> elektrische Feststellbremse ¹⁾
2.0 TDI		103	4F-7-016200	03.05	PR: 1KW,2EE	24.6243-1702.7	220824	<input type="checkbox"/> elektrische Feststellbremse ¹⁾	D=43, - Halter	TRW
2.0 TFSI		125	4F-7-016200	06.05	PR: 1KW,2EE					
2.4		130	4F-7-016200	03.05	PR: 1KW,2EE					
2.4 quattro		130	4F-7-016200	03.05	PR: 1KW,2EE					
2.7 TDI		120	4F-7-016200	03.05	PR: 1KW,2EE					
2.7 TDI		132	4F-7-016200	03.05	PR: 1KW,2EE					
2.7 TDI quattro		120	4F-7-016200	06.05	PR: 1KW,2EE					
2.7 TDI quattro		132	4F-7-016200	03.05	PR: 1KW,2EE					
2.8 FSI		154	4F-7-016200	11.06	PR: 1KW,2EE					
2.8 FSI quattro		154	4F-7-016200	04.07	PR: 1KW,2EE					
3.0		160	4F-7-016200	03.05	PR: 1KW,2EE					
3.0 quattro		160	4F-7-016200	03.05	PR: 1KW,2EE					
3.0 TDI quattro		155	4F-7-016200	03.05	PR: 1KW,2EE					
3.0 TDI quattro		165	4F-7-016200	03.05	PR: 1KW,2EE					
3.0 TDI quattro		171	4F-7-016200	06.06	PR: 1KW,2EE					
3.2 FSI		188	4F-7-016200	03.05	PR: 1KW,2EE					
3.2 FSI quattro		188	4F-7-016200	03.05	PR: 1KW,2EE					
4.2 FSI quattro		257	4F-7-016200	06.06	PR: 1KW,2EE					
4.2 quattro		246	4F-7-016200	03.05	PR: 1KW,2EE					
	2.0 TDI	100	4F-7-016201	10.08	08.11 PR: 1KW,2EE	24.6243-1709.7	221023	<input type="checkbox"/> elektrische Feststellbremse ¹⁾	D=43, - Halter	TRW
	2.0 TDI	103	4F-7-016201		08.11 PR: 1KW,2EE	24.6243-1710.7	221024	<input type="checkbox"/> elektrische Feststellbremse ¹⁾	D=43, - Halter	TRW
	2.0 TDI	125			08.11 PR: 1KW					
	2.0 TFSI	125	4F-7-016201		08.11 PR: 1KW,2EE					
	2.4	130	4F-7-016201		08.11 PR: 1KW,2EE					
	2.4 quattro	130	4F-7-016201		08.11 PR: 1KW,2EE					
	2.7 TDI	120	4F-7-016201		08.11 PR: 1KW,2EE					
	2.7 TDI	132	4F-7-016201		08.11 PR: 1KW,2EE					
	2.7 TDI	140			08.11 PR: 1KW					
	2.7 TDI quattro	120	4F-7-016201		08.11 PR: 1KW,2EE					
	2.7 TDI quattro	132	4F-7-016201		08.11 PR: 1KW,2EE					
	2.7 TDI quattro	140			08.11 PR: 1KW					
	2.8 FSI	140			10.08 08.11 PR: 1KW					
	2.8 FSI	154	4F-7-016201		08.11 PR: 1KW,2EE					
	2.8 FSI	162			10.08 08.11 PR: 1KW					
	2.8 FSI quattro	140			10.08 08.11 PR: 1KW					
	2.8 FSI quattro	154	4F-7-016201		08.11 PR: 1KW,2EE					
	2.8 FSI quattro	162			10.08 08.11 PR: 1KW					
	3.0	160	4F-7-016201		08.11 PR: 1KW,2EE					
	3.0 quattro	160	4F-7-016201		08.11 PR: 1KW,2EE					
	3.0 TDI quattro	155	4F-7-016201		08.11 PR: 1KW,2EE					
	3.0 TDI quattro	165	4F-7-016201		08.11 PR: 1KW,2EE					
	3.0 TDI quattro	171	4F-7-016201		08.11 PR: 1KW,2EE					
	3.0 TDI quattro	176			10.08 08.11 PR: 1KW					
	3.0 TFSI quattro				10.08 08.11 PR: 1KW					
	3.2 FSI	188	4F-7-016201		08.11 PR: 1KW,2EE					
3.2 FSI quattro	188	4F-7-016201	08.11 PR: 1KW,2EE							
4.2 FSI quattro	257	4F-7-016201	08.11 PR: 1KW,2EE							
4.2 quattro	246	4F-7-016201	08.11 PR: 1KW,2EE							

¹⁾ electric parking brake / fr.dl stazionamento elettrico / frein à main électrique / freno de mano eléctrico





AUDI A6 (4F5/C6) Avant (05-11)										
	2.0 TDI	100		06.05	08.11		24.5125-0323.3	330911	2	L=323
	2.0 TDI	103		03.05	08.11					
	2.0 TDI	125		10.08	08.11					
	2.0 TFSI	125		06.05	08.11					
	2.4	130		03.05	08.11					
	2.4 quattro	130		03.05	08.11					
	2.7 TDI	120		03.05	08.11					
	2.7 TDI	132		03.05	08.11					
	2.7 TDI	140		10.08	08.11					
	2.7 TDI quattro	120		06.05	08.11					
	2.7 TDI quattro	132		03.05	08.11					
	2.7 TDI quattro	140		10.08	08.11					
	2.8 FSI	140		10.08	08.11					
	2.8 FSI	154		11.06	08.11					
	2.8 FSI	162		10.08	08.11					
	2.8 FSI quattro	140		10.08	08.11					
	2.8 FSI quattro	154		04.07	08.11					
	2.8 FSI quattro	162		10.08	08.11					
	3.0	160		03.05	08.11					
	3.0 quattro	160		03.05	08.11					
	3.0 TDI quattro	155		03.05	08.11					
	3.0 TDI quattro	165		03.05	08.11					
	3.0 TDI quattro	171		06.06	08.11					
	3.0 TDI quattro	176		10.08	08.11					
	3.0 TFSI quattro			10.08	08.11					
	3.2 FSI	188		03.05	08.11					
	3.2 FSI quattro	188		03.05	08.11					
	4.2 FSI quattro	257		06.06	08.11					
	4.2 quattro	246		03.05	08.11					
	S6	320		03.06	08.11					

AUDI A6 Allroad (06-11)										
	2.7 TDI	120		05.06	05.11		24.2126-1705.3	010999		Thz 26,99 TRW
	2.7 TDI	132		05.06	05.11					
	2.7 TDI	140		10.08	05.11					
	3.0 TDI	155		05.06	05.11					
	3.0 TDI	171		05.06	05.11					
	3.0 TDI	176		10.08	05.11					
	3.0 TFSI	213		10.08	05.11					
	3.2 FSI	188		05.06	05.11					
	4.2 FSI	257		05.06	05.11					
	2.7 TDI	120		05.06	05.11	PR: 1LG	11.9606-9953.2	220587	<input type="checkbox"/>	D=60, - Halter ATE
	2.7 TDI	132		05.06	05.11	PR: 1LG	11.9606-9954.2	220588	<input type="checkbox"/>	D=60, - Halter ATE
	2.7 TDI	140		10.08	05.11	PR: 1LG	11.0441-6008.2	250038		Dichtungssatz ATE
	3.0 TDI	155		05.06	05.11	PR: 1LG	11.0101-5409.2	260035		Hülsensatz ATE
	3.0 TDI	171		05.06	05.11	PR: 1LG	11.8171-0008.1	990049		Führungsbolzen ATE
	3.0 TDI	176		10.08	05.11	PR: 1LG	11.8116-0410.2	390589	2	Haltefeder ATE
	3.0 TFSI	213		10.08	05.11	PR: 1LG				
	3.2 FSI	188		05.06	05.11	PR: 1LG				
	4.2 FSI	257		05.06	05.11	PR: 1LG				
	2.7 TDI	120		05.06	05.11	PR: 1ZL	11.9606-9961.2	220655	<input type="checkbox"/>	D=60, - Halter ATE
	2.7 TDI	132		05.06	05.11	PR: 1ZL	11.9606-9962.2	220656	<input type="checkbox"/>	D=60, - Halter ATE
	2.7 TDI	140		10.08	05.11	PR: 1ZL	11.0441-6008.2	250038		Dichtungssatz ATE
	3.0 TDI	155		05.06	05.11	PR: 1ZL	11.0101-5409.2	260035		Hülsensatz ATE
	3.0 TDI	171		05.06	05.11	PR: 1ZL	11.8171-0008.1	990049		Führungsbolzen ATE
	3.0 TDI	176		10.08	05.11	PR: 1ZL	11.8116-0410.2	390589	2	Haltefeder ATE
	3.0 TFSI	213		10.08	05.11	PR: 1ZL				
	3.2 FSI	188		05.06	05.11	PR: 1ZL				
	4.2 FSI	257		05.06	05.11	PR: 1ZL				
	2.7 TDI	120		05.06	05.11		83.7813-0315.3	330870	2	L=315
	2.7 TDI	132		05.06	05.11					
	2.7 TDI	140		10.08	05.11					
	3.0 TDI	155		05.06	05.11					
	3.0 TDI	171		05.06	05.11					
	3.0 TDI	176		10.08	05.11					
	3.0 TFSI	213		10.08	05.11					
	3.2 FSI	188		05.06	05.11					
	4.2 FSI	257		05.06	05.11					
	2.7 TDI	120	4F-7-032500	05.06		PR: 1KD	24.6241-1701.7	220821	<input type="checkbox"/>	elektrische Feststellbremse 1) D=41, - Halter TRW
	2.7 TDI	132	4F-7-032500	05.06		PR: 1KD	24.6241-1702.7	220822	<input type="checkbox"/>	elektrische Feststellbremse 1) D=41, - Halter TRW
	3.0 TDI	155	4F-7-032500	05.06		PR: 1KD				
	3.0 TDI	171	4F-7-032500	05.06		PR: 1KD				
	3.2 FSI	188	4F-7-032500	05.06		PR: 1KD				
	4.2 FSI	257	4F-7-032500	05.06		PR: 1KD				
	2.7 TDI	120	4F-7-032501		05.11	PR: 1KD	24.6241-1707.7	220943	<input type="checkbox"/>	elektrische Feststellbremse 1) D=41, - Halter TRW
	2.7 TDI	132	4F-7-032501		05.11	PR: 1KD	24.6241-1708.7	220944	<input type="checkbox"/>	elektrische Feststellbremse 1) D=41, - Halter TRW
	2.7 TDI	140		10.08		PR: 1KD				
	3.0 TDI	155	4F-7-032501		05.11	PR: 1KD				
	3.0 TDI	171	4F-7-032501		05.11	PR: 1KD				
	3.0 TDI	176		10.08		PR: 1KD				
	3.0 TFSI	213		10.08		PR: 1KD				
	3.2 FSI	188	4F-7-032501		05.11	PR: 1KD				
	4.2 FSI	257	4F-7-032501		05.11	PR: 1KD				
	2.7 TDI	120	4F-7-032500	05.06		PR: 1KW,2EE	24.6243-1701.7	220823	<input type="checkbox"/>	elektrische Feststellbremse 1) D=43, - Halter TRW
	2.7 TDI	132	4F-7-032500	05.06		PR: 1KW,2EE	24.6243-1702.7	220824	<input type="checkbox"/>	elektrische Feststellbremse 1) D=43, - Halter TRW
	3.0 TDI	155	4F-7-032500	05.06		PR: 1KW,2EE				
	3.0 TDI	171	4F-7-032500	05.06		PR: 1KW,2EE				

1) electric parking brake / fr.di stazionamento elettrico / frein à main électrique / freno de mano eléctrico



AUDI A6 Allroad (06-11)

	3.2 FSI	188	4F-7-032500	05.06	PR: 1KW,2EE	24.6243-1701.7	220823	<input type="checkbox"/> elektrische Feststellbremse 1)	D=43, - Halter	TRW		
	4.2 FSI	257	4F-7-032500	05.06	PR: 1KW,2EE	24.6243-1702.7	220824	<input type="checkbox"/> elektrische Feststellbremse 1)	D=43, - Halter	TRW		
	2.7 TDI	120	4F-7-032501	10.08	05.11	PR: 1KW,2EE	24.6243-1709.7	221023	<input type="checkbox"/> elektrische Feststellbremse 1)	D=43, - Halter	TRW	
	2.7 TDI	132	4F-7-032501		05.11	PR: 1KW,2EE	24.6243-1710.7	221024				
	2.7 TDI	140										
	3.0 TDI	155	4F-7-032501									
	3.0 TDI	171	4F-7-032501									
	3.0 TDI	176										
	3.0 TFSI	213										
	3.2 FSI	188	4F-7-032501									
4.2 FSI	257	4F-7-032501										
	2.7 TDI	120		05.06	05.11		24.5125-0323.3	330911	2		L=323	
	2.7 TDI	132		05.06	05.11							
	2.7 TDI	140		10.08	05.11							
	3.0 TDI	155		05.06	05.11							
	3.0 TDI	171		05.06	05.11							
	3.0 TDI	176		10.08	05.11							
	3.0 TFSI	213		10.08	05.11							
	3.2 FSI	188		05.06	05.11							
4.2 FSI	257		05.06	05.11								

AUDI A6 (4G2/C7) Limousine (11-)

	1.8 TFSI	140		09.14	PR: 1LL	11.9426-9905.2	220985	<input type="checkbox"/>	D=42, - Halter	ATE				
	2.0 TDI	100		01.12	PR: 1LL	11.9426-9906.2	220986							
	2.0 TDI	110		09.14	PR: 1LL	11.8171-0096.1	250155	<input type="checkbox"/>	D=42, - Halter Führungsbolzen	ATE				
	2.0 TDI	120		04.11	PR: 1LL									
	2.0 TDI	130		04.11	PR: 1LL									
	2.0 TDI quattro	140		04.15	PR: 1LL									
	2.0 TDI ultra	140		11.13	PR: 1LL									
	2.0 TFSI	132		04.11	PR: 1LL									
	2.0 TFSI	155		04.11	PR: 1LL									
	2.0 TFSI	162		05.13	PR: 1LL									
	2.0 TFSI	185		09.14	PR: 1LL									
	2.0 TFSI hybrid	155		11.11	PR: 1LL									
	2.0 TFSI quattro	155		05.12	PR: 1LL									
	2.0 TFSI quattro	162		05.13	PR: 1LL									
	2.0 TFSI quattro	185		05.14	PR: 1LL									
	2.8 FSI	150		04.11	PR: 1LL									
	2.8 FSI quattro	150		04.11	PR: 1LL									
	2.8 FSI quattro	162		09.14	PR: 1LL									
	3.0 TDI	150		04.11	PR: 1LL									
	3.0 TDI	155		09.14	PR: 1LL									
	3.0 TDI	160		09.14	PR: 1LL									
	3.0 TDI quattro	150		04.11	PR: 1LL									
	3.0 TDI quattro	155		09.14	PR: 1LL									
	3.0 TDI quattro	160		09.14	PR: 1LL									
	3.0 TDI quattro	176		05.13	PR: 1LL									
	3.0 TDI quattro	180		04.11	PR: 1LL									
	3.0 TDI quattro	200		09.14	PR: 1LL									
	3.0 TDI quattro	230		12.11	PR: 1LL									
	3.0 TDI quattro	235		09.14	PR: 1LL									
	3.0 TDI quattro	240		09.14	PR: 1LL									
	3.0 TFSI quattro			04.11	PR: 1LL									
	3.0 TFSI quattro	245		09.14	PR: 1LL									
	S6	309		04.12	PR: 1LL									
	S6	331		10.14	PR: 1LL									
		1.8 TFSI	140		09.14	PR: 1LF	11.8171-0096.1				250155	<input type="checkbox"/>	Führungsbolzen	ATE
		2.0 TDI	100		01.12	PR: 1LF								
		2.0 TDI	110		09.14	PR: 1LF								
		2.0 TDI	120		07.11	PR: 1LF								
		2.0 TDI	130		07.11	PR: 1LF								
		2.0 TDI quattro	140		04.15	PR: 1LF								
2.0 TDI ultra		140		11.13	PR: 1LF									
2.0 TFSI		132		07.11	PR: 1LF									
2.0 TFSI		155		07.11	PR: 1LF									
2.0 TFSI		162		05.13	PR: 1LF									
2.0 TFSI		185		09.14	PR: 1LF									
2.0 TFSI hybrid		155		11.11	PR: 1LF									
2.0 TFSI quattro		155		05.12	PR: 1LF									
2.0 TFSI quattro		162		05.13	PR: 1LF									
2.0 TFSI quattro		185		05.14	PR: 1LF									
2.8 FSI		150		07.11	PR: 1LF									
2.8 FSI quattro		150		07.11	PR: 1LF									
2.8 FSI quattro		162		09.14	PR: 1LF									
3.0 TDI		150		07.11	PR: 1LF									
3.0 TDI		155		09.14	PR: 1LF									
3.0 TDI		160		09.14	PR: 1LF									
3.0 TDI quattro		150		07.11	PR: 1LF									
3.0 TDI quattro		155		09.14	PR: 1LF									
3.0 TDI quattro		160		09.14	PR: 1LF									
3.0 TDI quattro		176		05.13	PR: 1LF									
3.0 TDI quattro		180		07.11	PR: 1LF									
3.0 TDI quattro		200		09.14	PR: 1LF									
3.0 TDI quattro		230		12.11	PR: 1LF									
3.0 TDI quattro	235		09.14	PR: 1LF										
3.0 TDI quattro	240		09.14	PR: 1LF										
3.0 TFSI quattro			07.11	PR: 1LF										















1) electric parking brake / fr.di stazionamento elettrico / frein à main électrique / freno de mano eléctrico



AUDI A6 (4G2/C7) Limousine (11-)

	3.0 TFSI quattro	245	09.14	PR: 1LF	11.8171-0096.1	250155		Führungsbolzen	ATE
	S6	309	04.12	PR: 1LF					
	S6	331	10.14	PR: 1LF					
	1.8 TFSI	140	09.14	PR: 12K	11.8171-0096.1	250155		Führungsbolzen	ATE
	2.0 TDI	100	01.12	PR: 12K					
	2.0 TDI	110	09.14	PR: 12K					
	2.0 TDI	120	04.11	PR: 12K					
	2.0 TDI	130	04.11	PR: 12K					
	2.0 TDI quattro	140	04.15	PR: 12K					
	2.0 TDI ultra	140	11.13	PR: 12K					
	2.0 TFSI	132	04.11	PR: 12K					
	2.0 TFSI	155	04.11	PR: 12K					
	2.0 TFSI	162	05.13	PR: 12K					
	2.0 TFSI	185	09.14	PR: 12K					
	2.0 TFSI hybrid	155	11.11	PR: 12K					
	2.0 TFSI quattro	155	05.12	PR: 12K					
	2.0 TFSI quattro	162	05.13	PR: 12K					
	2.0 TFSI quattro	185	05.14	PR: 12K					
	2.8 FSI	150	04.11	PR: 12K					
	2.8 FSI quattro	150	04.11	PR: 12K					
	2.8 FSI quattro	162	09.14	PR: 12K					
	3.0 TDI	150	04.11	PR: 12K					
	3.0 TDI	155	09.14	PR: 12K					
	3.0 TDI	160	09.14	PR: 12K					
	3.0 TDI quattro	150	04.11	PR: 12K					
	3.0 TDI quattro	155	09.14	PR: 12K					
	3.0 TDI quattro	160	09.14	PR: 12K					
	3.0 TDI quattro	176	05.13	PR: 12K					
	3.0 TDI quattro	180	04.11	PR: 12K					
	3.0 TDI quattro	200	09.14	PR: 12K					
	3.0 TDI quattro	230	12.11	PR: 12K					
	3.0 TDI quattro	235	09.14	PR: 12K					
	3.0 TDI quattro	240	09.14	PR: 12K					
	3.0 TFSI quattro		04.11	PR: 12K					
	3.0 TFSI quattro	245	09.14	PR: 12K					
S6	309	04.12	PR: 12K						
S6	331	10.14	PR: 12K						
	1.8 TFSI	140	09.14		24.5140-0650.3	331500	2	PR: 1LA,1LJ,1LL,1LF,1LP PR: 1LU,1LW	L=650 L=670
	2.0 TDI	100	01.12						
	2.0 TDI	110	09.14						
	2.0 TDI	120	04.11						
	2.0 TDI	130	04.11						
	2.0 TDI quattro	140	04.15						
	2.0 TDI ultra	140	11.13						
	2.0 TFSI	132	04.11						
	2.0 TFSI	155	04.11						
	2.0 TFSI	162	05.13						
	2.0 TFSI	185	09.14						
	2.0 TFSI hybrid	155	11.11						
	2.0 TFSI quattro	155	05.12						
	2.0 TFSI quattro	162	05.13						
	2.0 TFSI quattro	185	05.14						
	2.8 FSI	150	04.11						
	2.8 FSI quattro	150	04.11						
	2.8 FSI quattro	162	09.14						
	3.0 TDI	150	04.11						
	3.0 TDI	155	09.14						
	3.0 TDI	160	09.14						
	3.0 TDI quattro	150	04.11						
	3.0 TDI quattro	155	09.14						
	3.0 TDI quattro	160	09.14						
	3.0 TDI quattro	176	05.13						
	3.0 TDI quattro	180	04.11						
	3.0 TDI quattro	200	09.14						
	3.0 TDI quattro	230	12.11						
	3.0 TDI quattro	235	09.14						
	3.0 TDI quattro	240	09.14						
	3.0 TFSI quattro		04.11						
	3.0 TFSI quattro	245	09.14						
S6	309	04.12							
S6	331	10.14							
	1.8 TFSI	140	09.14	PR: 1KW	24.6243-1715.5	240741		D=43, - Halter	TRW
	2.0 TDI	100	01.12	PR: 1KW					
	2.0 TDI	110	09.14	PR: 1KW					
	2.0 TDI	120	04.11	PR: 1KW					
	2.0 TDI	130	04.11	PR: 1KW					
	2.0 TDI quattro	140	04.15	PR: 1KW					
	2.0 TDI ultra	140	11.13	PR: 1KW					
	2.0 TFSI	132	04.11	PR: 1KW					
	2.0 TFSI	155	04.11	PR: 1KW					
	2.0 TFSI	162	05.13	PR: 1KW					
	2.0 TFSI	185	09.14	PR: 1KW					
	2.0 TFSI hybrid	155	11.11	PR: 1KW					
	2.0 TFSI quattro	155	05.12	PR: 1KW					
	2.0 TFSI quattro	162	05.13	PR: 1KW					
	2.0 TFSI quattro	185	05.14	PR: 1KW					
	2.8 FSI	150	04.11	PR: 1KW					

1) electric parking brake / fr.di stazionamento elettrico / frein à main électrique / freno de mano eléctrico

										
AUDI A6 (4G2/C7) Limousine (11-)										
	2.8 FSI quattro	150	04.11	PR: 1KW	24.6243-1715.5	240741		elektrische Feststellbremse ¹⁾	D=43, - Halter	TRW
	2.8 FSI quattro	162	09.14	PR: 1KW	24.6243-1716.5	240742		elektrische Feststellbremse ¹⁾	D=43, - Halter	TRW
	3.0 TDI	150	04.11	PR: 1KW						
	3.0 TDI	155	09.14	PR: 1KW						
	3.0 TDI	160	09.14	PR: 1KW						
	3.0 TDI quattro	150	04.11	PR: 1KW						
	3.0 TDI quattro	155	09.14	PR: 1KW						
	3.0 TDI quattro	160	09.14	PR: 1KW						
	3.0 TDI quattro	176	05.13	PR: 1KW						
	3.0 TDI quattro	180	04.11	PR: 1KW						
	3.0 TDI quattro	200	09.14	PR: 1KW						
	3.0 TDI quattro	230	12.11	PR: 1KW						
	3.0 TDI quattro	235	09.14	PR: 1KW						
	3.0 TDI quattro	240	09.14	PR: 1KW						
	3.0 TFSI quattro		04.11	PR: 1KW						
	3.0 TFSI quattro	245	09.14	PR: 1KW						
	S6	309	04.12	PR: 1KW						
	S6	331	10.14	PR: 1KW						
AUDI A6 (4G5/C7) Avant (11-)										
	1.8 TFSI	140	09.14	PR: 1LL	11.9426-9905.2	220985			D=42, - Halter	ATE
	2.0 TDI	100	01.12	PR: 1LL	11.9426-9906.2	220986			D=42, - Halter	ATE
	2.0 TDI	110	09.14	PR: 1LL	11.8171-0096.1	250155	2		Führungsbolzen	ATE
	2.0 TDI	120	09.11	PR: 1LL						
	2.0 TDI	130	09.11	PR: 1LL						
	2.0 TDI quattro	140	04.15	PR: 1LL						
	2.0 TDI ultra	140	11.13	PR: 1LL						
	2.0 TFSI	132	06.11	PR: 1LL						
	2.0 TFSI	185	09.14	PR: 1LL						
	2.0 TFSI quattro	185	05.15	PR: 1LL						
	2.8 FSI	150	09.11	PR: 1LL						
	2.8 FSI quattro	150	09.11	PR: 1LL						
	2.8 FSI quattro	162	09.14	PR: 1LL						
	3.0 TDI	150	09.11	PR: 1LL						
	3.0 TDI	155	09.14	PR: 1LL						
	3.0 TDI	160	09.14	PR: 1LL						
	3.0 TDI quattro	150	09.11	PR: 1LL						
	3.0 TDI quattro	155	09.14	PR: 1LL						
	3.0 TDI quattro	160	09.14	PR: 1LL						
	3.0 TDI quattro	180	09.11	PR: 1LL						
	3.0 TDI quattro	200	09.14	PR: 1LL						
	3.0 TDI quattro	230	12.11	PR: 1LL						
	3.0 TDI quattro	235	09.14	PR: 1LL						
	3.0 TDI quattro	240	09.14	PR: 1LL						
	3.0 TFSI quattro		09.11	PR: 1LL						
	3.0 TFSI quattro	245	09.14	PR: 1LL						
	S6	309	04.12	PR: 1LL						
	S6	331	09.14	PR: 1LL						
	1.8 TFSI	140	09.14	PR: 1LF	11.8171-0096.1	250155	2		Führungsbolzen	ATE
	2.0 TDI	100	01.12	PR: 1LF						
	2.0 TDI	110	09.14	PR: 1LF						
	2.0 TDI	120	09.11	PR: 1LF						
	2.0 TDI	130	09.11	PR: 1LF						
	2.0 TDI quattro	140	04.15	PR: 1LF						
	2.0 TDI ultra	140	11.13	PR: 1LF						
	2.0 TFSI	132	06.11	PR: 1LF						
	2.0 TFSI	185	09.14	PR: 1LF						
	2.0 TFSI quattro	185	05.15	PR: 1LF						
	2.8 FSI	150	09.11	PR: 1LF						
	2.8 FSI quattro	150	09.11	PR: 1LF						
	2.8 FSI quattro	162	09.14	PR: 1LF						
	3.0 TDI	150	09.11	PR: 1LF						
	3.0 TDI	155	09.14	PR: 1LF						
	3.0 TDI	160	09.14	PR: 1LF						
	3.0 TDI quattro	150	09.11	PR: 1LF						
	3.0 TDI quattro	155	09.14	PR: 1LF						
	3.0 TDI quattro	160	09.14	PR: 1LF						
	3.0 TDI quattro	180	09.11	PR: 1LF						
	3.0 TDI quattro	200	09.14	PR: 1LF						
	3.0 TDI quattro	230	12.11	PR: 1LF						
	3.0 TDI quattro	235	09.14	PR: 1LF						
	3.0 TDI quattro	240	09.14	PR: 1LF						
	3.0 TFSI quattro		09.11	PR: 1LF						
	3.0 TFSI quattro	245	09.14	PR: 1LF						
	S6	309	04.12	PR: 1LF						
	S6	331	09.14	PR: 1LF						
	1.8 TFSI	140	09.14	PR: 12K	11.8171-0096.1	250155	2		Führungsbolzen	ATE
	2.0 TDI	100	01.12	PR: 12K						
	2.0 TDI	110	09.14	PR: 12K						
	2.0 TDI	120	09.11	PR: 12K						
	2.0 TDI	130	09.11	PR: 12K						
	2.0 TDI quattro	140	04.15	PR: 12K						
	2.0 TDI ultra	140	11.13	PR: 12K						
	2.0 TFSI	132	06.11	PR: 12K						
	2.0 TFSI	185	09.14	PR: 12K						
	2.0 TFSI quattro	185	05.15	PR: 12K						
	2.8 FSI	150	09.11	PR: 12K						

¹⁾ electric parking brake / fr.di stazionamento elettrico / frein à main électrique / freno de mano eléctrico





















AUDI A6 (4G5/C7) Avant (11-)

	2.8 FSI quattro	150	09.11	PR: 12K	11.8171-0096.1	250155	2		Führungsbolzen	ATE
	2.8 FSI quattro	162	09.14	PR: 12K						
	3.0 TDI	150	09.11	PR: 12K						
	3.0 TDI	155	09.14	PR: 12K						
	3.0 TDI	160	09.14	PR: 12K						
	3.0 TDI quattro	150	09.11	PR: 12K						
	3.0 TDI quattro	155	09.14	PR: 12K						
	3.0 TDI quattro	160	09.14	PR: 12K						
	3.0 TDI quattro	180	09.11	PR: 12K						
	3.0 TDI quattro	200	09.14	PR: 12K						
	3.0 TDI quattro	230	12.11	PR: 12K						
	3.0 TDI quattro	235	09.14	PR: 12K						
	3.0 TDI quattro	240	09.14	PR: 12K						
	3.0 TFSI quattro	245	09.11	PR: 12K						
	3.0 TFSI quattro	245	09.14	PR: 12K						
S6	309	04.12	PR: 12K							
S6	331	09.14	PR: 12K							
	1.8 TFSI	140	09.14		24.5140-0650.3	331500	2	PR: 1LA,1LJ,1LL,1LF,1LP PR: 1LU,1LW	L=650 L=670	
	2.0 TDI	100	01.12							
	2.0 TDI	110	09.14							
	2.0 TDI	120	09.11							
	2.0 TDI	130	09.11							
	2.0 TDI quattro	140	04.15							
	2.0 TDI ultra	140	11.13							
	2.0 TFSI	132	06.11							
	2.0 TFSI	185	09.14							
	2.0 TFSI quattro	185	05.15							
	2.8 FSI	150	09.11							
	2.8 FSI quattro	150	09.11							
	2.8 FSI quattro	162	09.14							
	3.0 TDI	150	09.11							
	3.0 TDI	155	09.14							
	3.0 TDI	160	09.14							
	3.0 TDI quattro	150	09.11							
	3.0 TDI quattro	155	09.14							
	3.0 TDI quattro	160	09.14							
	3.0 TDI quattro	180	09.11							
	3.0 TDI quattro	200	09.14							
	3.0 TDI quattro	230	12.11							
	3.0 TDI quattro	235	09.14							
	3.0 TDI quattro	240	09.14							
	3.0 TFSI quattro	245	09.11							
	3.0 TFSI quattro	245	09.14							
	S6	309	04.12							
	S6	331	09.14							
	1.8 TFSI	140	09.14	PR: 1KW	24.6243-1715.5	240741	2	☐ elektrische Feststellbremse 1) ☐ elektrische Feststellbremse 1)	D=43, - Halter D=43, - Halter	TRW TRW
	2.0 TDI	100	01.12	PR: 1KW						
	2.0 TDI	110	09.14	PR: 1KW						
	2.0 TDI	120	09.11	PR: 1KW						
	2.0 TDI	130	09.11	PR: 1KW						
	2.0 TDI quattro	140	04.15	PR: 1KW						
	2.0 TDI ultra	140	11.13	PR: 1KW						
	2.0 TFSI	132	06.11	PR: 1KW						
	2.0 TFSI	185	09.14	PR: 1KW						
	2.0 TFSI quattro	185	05.15	PR: 1KW						
	2.8 FSI	150	09.11	PR: 1KW						
	2.8 FSI quattro	150	09.11	PR: 1KW						
	2.8 FSI quattro	162	09.14	PR: 1KW						
	3.0 TDI	150	09.11	PR: 1KW						
	3.0 TDI	155	09.14	PR: 1KW						
	3.0 TDI	160	09.14	PR: 1KW						
	3.0 TDI quattro	150	09.11	PR: 1KW						
	3.0 TDI quattro	155	09.14	PR: 1KW						
	3.0 TDI quattro	160	09.14	PR: 1KW						
	3.0 TDI quattro	180	09.11	PR: 1KW						
	3.0 TDI quattro	200	09.14	PR: 1KW						
	3.0 TDI quattro	230	12.11	PR: 1KW						
	3.0 TDI quattro	235	09.14	PR: 1KW						
	3.0 TDI quattro	240	09.14	PR: 1KW						
	3.0 TFSI quattro	245	09.11	PR: 1KW						
	3.0 TFSI quattro	245	09.14	PR: 1KW						
	S6	309	04.12	PR: 1KW						
	S6	331	09.14	PR: 1KW						















AUDI A6 Allroad (12-)

	3.0 TDI quattro	140	11.15	PR: 1LL	11.9426-9905.2	220985	☐		D=42, - Halter	ATE
	3.0 TDI quattro	150	01.12	PR: 1LL						
	3.0 TDI quattro	155	09.14	PR: 1LL						
	3.0 TDI quattro	160	09.14	PR: 1LL						
	3.0 TDI quattro	180	01.12	PR: 1LL						
	3.0 TDI quattro	200	09.14	PR: 1LL						
	3.0 TDI quattro	230	01.12	PR: 1LL						
	3.0 TFSI quattro	228	01.12	PR: 1LL						
	3.0 TFSI quattro	245	09.14	PR: 1LL						
	3.0 TDI quattro	140	11.15	PR: 12K						
3.0 TDI quattro	150	01.12	PR: 12K							
3.0 TDI quattro	155	09.14	PR: 12K							

1) electric parking brake / fr.di stazionamento elettrico / frein à main électrique / freno de mano eléctrico

									
AUDI A6 Allroad (12-)									
	3.0 TDI quattro 3.0 TDI quattro 3.0 TDI quattro 3.0 TDI quattro 3.0 TFSI quattro 3.0 TFSI quattro	160 180 200 230 228 245	09.14 01.12 09.14 01.12 01.12 09.14	PR: 1ZK PR: 1ZK PR: 1ZK PR: 1ZK PR: 1ZK PR: 1ZK	11.8171-0096.1	250155		Führungsbolzen ATE	
	3.0 TDI quattro 3.0 TDI quattro 3.0 TDI quattro 3.0 TDI quattro 3.0 TDI quattro 3.0 TDI quattro 3.0 TDI quattro 3.0 TFSI quattro 3.0 TFSI quattro	140 150 155 160 180 200 230 228 245	11.15 01.12 09.14 09.14 01.12 09.14 01.12 01.12 09.14		24.5140-0650.3	331500	2	L=650	
AUDI A7 Sportback (10-)									
	1.8 TFSI 2.0 TFSI 2.0 TFSI quattro 2.8 FSI 2.8 FSI quattro 3.0 TDI 3.0 TDI 3.0 TDI 3.0 TDI quattro 3.0 TFSI quattro 3.0 TFSI quattro S7 S7	140 185 185 150 150 140 150 155 140 150 160 176 180 200 230 235 240 160 245 309 331	04.15 09.14 05.15 05.11 07.10 11.15 11.10 11.15 11.15 07.10 05.14 05.13 07.10 05.14 11.11 05.14 08.14 05.14 07.10 05.14 10.11 05.14	PR: 1LL,1LF PR: 1LL,1LF	11.9426-9905.2 11.9426-9906.2 11.8171-0096.1	220985 220986 250155	 	D=42, - Halter D=42, - Halter Führungsbolzen	ATE ATE ATE
	1.8 TFSI 2.0 TFSI 2.0 TFSI quattro 2.8 FSI 2.8 FSI quattro 3.0 TDI 3.0 TDI 3.0 TDI 3.0 TDI quattro 3.0 TDI quattro 3.0 TDI quattro 3.0 TDI quattro 3.0 TDI quattro 3.0 TDI quattro 3.0 TDI quattro 3.0 TDI quattro 3.0 TDI quattro 3.0 TDI quattro 3.0 TDI quattro 3.0 TDI quattro 3.0 TFSI quattro 3.0 TFSI quattro S7 S7	140 185 185 150 150 140 150 155 140 150 160 176 180 200 230 235 240 160 245 309 331	04.15 09.14 05.15 05.11 07.10 11.15 11.10 11.15 11.15 07.10 05.14 05.13 07.10 05.14 11.11 05.14 08.14 05.14 07.10 05.14 10.11 05.14		24.5140-0650.3 24.5140-0670.3	331500 331501	2 2	PR: 1LA,1LJ,1LL,1LF,1LP,1ZK,1LG PR: 1LU,1LW	L=650 L=670
	1.8 TFSI 2.0 TFSI 2.0 TFSI quattro 2.8 FSI 2.8 FSI quattro 3.0 TDI 3.0 TDI 3.0 TDI 3.0 TDI quattro 3.0 TDI quattro 3.0 TDI quattro 3.0 TDI quattro 3.0 TDI quattro 3.0 TDI quattro 3.0 TDI quattro 3.0 TDI quattro 3.0 TDI quattro 3.0 TDI quattro 3.0 TDI quattro 3.0 TDI quattro 3.0 TFSI quattro 3.0 TFSI quattro S7 S7	140 185 185 150 150 140 150 155 140 150 160 176 180 200 230 235 240 160 245 309 331	04.15 09.14 05.15 05.11 07.10 11.15 11.10 11.15 11.15 07.10 05.14 05.13 07.10 05.14 11.11 05.14 08.14 05.14 07.10 05.14 10.11 05.14	PR: 1KW PR: 1KW	24.6243-1715.5 24.6243-1716.5	240741 240742	 	D=43, - Halter D=43, - Halter	TRW TRW



















¹⁾ electric parking brake / fr.di stazionamento elettrico / frein à main électrique / freno de mano eléctrico

AUDI A8 (94-02)											
											
	2.5 TDI 2.5 TDI quattro 2.8 2.8 2.8 30V 2.8 30V quattro 2.8 quattro 2.8 quattro 3.3 TDI quattro 3.7 3.7 quattro 4.2 quattro 6.0 W12 quattro S8			06.97 06.97 07.95 06.94 04.96 04.96 07.95 06.94 12.99 07.95 10.95 06.94 01.01 06.96	09.02 09.02 03.96 03.96 09.02 09.02 03.96 03.96 09.02 09.02 09.02 09.02 09.02 09.02	- ESP - ESP - ESP - ESP - ESP - ESP - ESP - ESP - ESP - ESP - ESP - ESP - ESP - ESP	24.2125-1712.3	010622		Thz 25,40	
	2.5 TDI 2.5 TDI quattro 2.8 2.8 2.8 30V 2.8 30V quattro 2.8 quattro 2.8 quattro 3.3 TDI quattro 3.7 3.7 quattro 4.2 quattro 6.0 W12 quattro S8			06.97 06.97 07.95 06.94 04.96 04.96 07.95 06.94 12.99 07.95 10.95 06.94 01.01 06.96	09.02 09.02 03.96 03.96 09.02 09.02 03.96 03.96 09.02 09.02 09.02 09.02 09.02 09.02	+ ESP + ESP + ESP + ESP + ESP + ESP + ESP + ESP + ESP + ESP + ESP + ESP + ESP + ESP	24.2125-1713.3	010623		Thz 25,40	
	6.0 W12 quattro			01.01	09.02		11.8171-0008.1 11.8116-0260.1	990049 390597	2	Führungsbolzen Haltefeder	ATE ATE
	2.5 TDI 2.5 TDI quattro 2.8 2.8 2.8 30V 2.8 30V quattro 2.8 quattro 2.8 quattro 3.3 TDI quattro 3.7 3.7 quattro 4.2 quattro 6.0 W12 quattro S8			06.97 06.97 07.95 06.94 04.96 04.96 07.95 06.94 12.99 07.95 10.95 06.94 01.01 06.96	09.02 09.02 03.96 03.96 09.02 09.02 03.96 03.96 09.02 09.02 09.02 09.02 09.02 09.02		24.5237-0360.3	331212	2	L=360	
	2.5 TDI 2.8 2.8	120 128		06.97 07.95 06.94	09.98 03.96 03.96	- 18" Rad ¹⁾ - 18" Rad ¹⁾ - 18" Rad ¹⁾	24.3384-1704.5 24.3384-1703.5 24.0101-3601.2	240056 240055 260044		D=38, - Halter D=38, - Halter Bremsattel-Zubehör	TRW TRW TRW
	2.5 TDI 2.8 2.8 2.8 30V	120 128 128	4D-R-000346	06.97 07.95 03.96 04.96	09.98 03.96 03.96 09.98		83.6124-0282.3	330490	2	L=280	
	2.5 TDI quattro 2.8 30V quattro 2.8 quattro 2.8 quattro 3.7 3.7 quattro 4.2 quattro S8	142 120 128		06.97 04.96 07.95 06.94 07.95 10.95 06.94 06.96	09.98 09.98 03.96 03.96 09.98 09.98 09.98 09.98		83.6124-0252.3	330456	2	L=250	
	2.5 TDI 2.5 TDI quattro 2.8 30V 2.8 30V quattro 3.3 TDI quattro 3.7 3.7 quattro 4.2 quattro 6.0 W12 quattro S8	142 142		10.98 10.98 10.98 12.99 10.98 10.98 10.98 01.01 10.98	09.02 09.02 09.02 09.02 09.02 09.02 09.02 09.02 09.02		24.5135-0280.3	330775	2	L=280	
	2.8 2.8 2.8 30V 2.8 30V quattro 2.8 quattro 2.8 quattro 3.7 3.7 quattro	120 128 142 142 120 128		07.95 06.94 04.96 04.96 07.95 06.94 07.95 10.95	03.96 03.96 09.02 09.02 03.96 03.96 09.02 03.02		24.2522-1707.3	040103		Nz 22,20	
	2.5 TDI 2.5 TDI quattro 3.3 TDI quattro			06.97 06.97 12.99	09.02 09.02 09.02		24.2522-1706.3	040090		Nz 22,20	

¹⁾ - 18" wheel / - ruota 18" / - roue 18" / - rueda 18"

AUDI A8 (03-09)										
	3.0 3.0 TDI quattro 3.2 FSI 3.2 FSI quattro 3.7 quattro 4.0 TDI quattro 4.2 FSI quattro 4.2 quattro 4.2 TDI quattro 6.0 W12 quattro	191 191 257	4E-5-003250 4E-5-003250 4E-5-003250 4E-5-003250 4E-5-003250 4E-5-003250 4E-5-003250 4E-5-003250 4E-5-003250 4E-5-003250	07.03 11.03 06.05 06.05 11.02 03.03 06.06 11.02 07.05 02.04	PR: 1LG PR: 1LG PR: 1LG PR: 1LG PR: 1LG PR: 1LG PR: 1LG PR: 1LG PR: 1LG PR: 1LG	11.9606-9957.2 11.9606-9958.2 11.0441-6008.2 11.0101-5409.2 11.8171-0008.1 11.8116-0410.2	220815 220816 250038 260035 990049 390589	2 2	D=60, - Halter D=60, - Halter Dichtungssatz Hülzensatz Führungsbolzen Haltefeder	ATE ATE ATE ATE ATE ATE ATE ATE ATE ATE
	2.8 FSI 3.0 3.0 TDI quattro 3.2 FSI 3.2 FSI quattro 3.7 quattro 4.0 TDI quattro 4.2 FSI quattro 4.2 quattro 4.2 TDI quattro 6.0 W12 quattro	154 191 191 257	4E-5-003251 4E-5-003251 4E-5-003251 4E-5-003251 4E-5-003251 4E-5-003251 4E-5-003251 4E-5-003251 4E-5-003251 4E-5-003251	08.07 10.09 10.09 10.09 10.09 10.09 10.09 10.09 10.09 10.09 10.09	PR: 1LG PR: 1LG PR: 1LG PR: 1LG PR: 1LG PR: 1LG PR: 1LG PR: 1LG PR: 1LG PR: 1LG PR: 1LG	11.9606-9953.2 11.9606-9954.2 11.0441-6008.2 11.0101-5409.2 11.8171-0008.1 11.8116-0410.2	220587 220588 250038 260035 990049 390589	2 2	D=60, - Halter D=60, - Halter Dichtungssatz Hülzensatz Führungsbolzen Haltefeder	ATE ATE ATE ATE ATE ATE ATE ATE ATE ATE
	2.8 FSI 3.0 3.0 TDI quattro 3.2 FSI 3.2 FSI quattro 3.7 quattro 4.0 TDI quattro 4.2 FSI quattro 4.2 quattro 4.2 TDI quattro 6.0 W12 quattro	154 191 191 257	08.07 07.03 11.03 06.05 06.05 11.02 03.03 06.06 11.02 07.05 02.04	10.09 PR: 1LL,1LM 10.09 PR: 1LL,1LM 10.09 PR: 1LL,1LM 10.09 PR: 1LL,1LM 10.09 PR: 1LL,1LM 10.09 PR: 1LL,1LM 10.09 PR: 1LL,1LM 10.09 PR: 1LL,1LM 10.09 PR: 1LL,1LM 10.09 PR: 1LL,1LM 10.09 PR: 1LL,1LM	11.8171-0067.1 11.8116-0347.2	250153 390535	2	Führungsbolzen Haltefeder	ATE ATE	
	2.8 FSI 3.0 3.0 TDI quattro 3.2 FSI 3.2 FSI quattro 3.7 quattro 4.0 TDI quattro 4.2 FSI quattro 4.2 quattro 4.2 TDI quattro 6.0 W12 quattro	154 191 191 257	08.07 07.03 11.03 06.05 06.05 11.02 03.03 06.06 11.02 07.05 02.04	10.09 PR: 1LJ 10.09 PR: 1LJ 10.09 PR: 1LJ 10.09 PR: 1LJ 10.09 PR: 1LJ 10.09 PR: 1LJ 10.09 PR: 1LJ 10.09 PR: 1LJ 10.09 PR: 1LJ 10.09 PR: 1LJ 10.09 PR: 1LJ	11.8171-0067.1	250153		Führungsbolzen	ATE	
	S8	331	06.06	10.09		11.8171-0067.1	250153		Führungsbolzen	ATE
	2.8 FSI 3.0 3.0 TDI quattro 3.2 FSI 3.2 FSI quattro 3.7 quattro 4.0 TDI quattro 4.2 FSI quattro 4.2 quattro 4.2 TDI quattro 6.0 W12 quattro S8	154 191 191 257 331	08.07 07.03 11.03 06.05 06.05 11.02 03.03 06.06 11.02 07.05 02.04 06.06	10.09 PR: 1LJ,1LL,1LK 10.09 PR: 1LJ,1LL,1LK 10.09 PR: 1LJ,1LL,1LK 10.09 PR: 1LJ,1LL,1LK 10.09 PR: 1LJ,1LL,1LK 10.09 PR: 1LJ,1LL,1LK 10.09 PR: 1LJ,1LL,1LK 10.09 PR: 1LJ,1LL,1LK 10.09 PR: 1LJ,1LL,1LK 10.09 PR: 1LJ,1LL,1LK 10.09 PR: 1LJ,1LL,1LK 10.09 PR: 1LJ,1LL,1LK	83.7855-0354.3	331236	2	L=355		
	2.8 FSI 3.0 3.0 TDI quattro 3.2 FSI 3.2 FSI quattro 3.7 quattro 4.0 TDI quattro 4.2 FSI quattro 4.2 quattro 4.2 TDI quattro 6.0 W12 quattro S8	154 191 191 257 331	4E-7-009000 4E-7-009000 4E-7-009000 4E-7-009000 4E-7-009000 4E-7-009000 4E-7-009000 4E-7-009000 4E-7-009000 4E-7-009000 4E-7-009000 4E-7-009000	08.07 07.03 11.03 06.05 06.05 11.02 03.03 06.06 11.02 07.05 02.04 06.06	PR: 1LW PR: 1LW PR: 1LW PR: 1LW PR: 1LW PR: 1LW PR: 1LW PR: 1LW PR: 1LW PR: 1LW PR: 1LW PR: 1LW	83.7849-0419.3	331114	2	L=422	
	2.8 FSI 3.0 3.0 TDI quattro 3.2 FSI 3.2 FSI quattro 3.7 quattro 4.0 TDI quattro 4.2 FSI quattro 4.2 quattro 4.2 TDI quattro 6.0 W12 quattro S8	154 191 191 257 331	4E-7-009001 4E-7-009001 4E-7-009001 4E-7-009001 4E-7-009001 4E-7-009001 4E-7-009001 4E-7-009001 4E-7-009001 4E-7-009001 4E-7-009001 4E-7-009001	10.09 10.09 10.09 10.09 10.09 10.09 10.09 10.09 10.09 10.09 10.09 10.09	PR: 1LW PR: 1LW PR: 1LW PR: 1LW PR: 1LW PR: 1LW PR: 1LW PR: 1LW PR: 1LW PR: 1LW PR: 1LW PR: 1LW	83.7849-0426.3	331235	2	L=422	
	2.8 FSI 3.0 3.0 TDI quattro 3.2 FSI 3.2 FSI quattro 3.7 quattro	154 191 191	08.07 07.03 11.03 06.05 06.05 11.02	10.09 PR: 1KE,1KW,1KY,1KZ 10.09 PR: 1KE,1KW,1KY,1KZ 10.09 PR: 1KE,1KW,1KY,1KZ 10.09 PR: 1KE,1KW,1KY,1KZ 10.09 PR: 1KE,1KW,1KY,1KZ 10.09 PR: 1KE,1KW,1KY,1KZ	24.6243-1719.5 24.6243-1720.5	240774 240775	2 2	elektrische Feststellbremse 1) elektrische Feststellbremse 1)	D=43, - Halter D=43, - Halter	TRW TRW





























1) electric parking brake / fr.di stazionamento elettrico / frein à main électrique / freno de mano eléctrico

										
AUDI A8 (03-09)										
	4.0 TDI quattro 4.2 FSI quattro 4.2 quattro 4.2 TDI quattro 6.0 W12 quattro S8	257 331	03.03 06.06 11.02 07.05 02.04 06.06	10.09 10.09 10.09 10.09 10.09 10.09	PR: 1KE,1KW,1KY,1KZ PR: 1KE,1KW,1KY,1KZ PR: 1KE,1KW,1KY,1KZ PR: 1KE,1KW,1KY,1KZ PR: 1KE,1KW,1KY,1KZ PR: 1KE,1KW,1KY,1KZ	24.6243-1719.5 24.6243-1720.5	240774 240775	<input type="checkbox"/> elektrische Feststellbremse ¹⁾ <input type="checkbox"/> elektrische Feststellbremse ¹⁾	D=43, - Halter D=43, - Halter	TRW TRW
	2.8 FSI 3.0 3.0 TDI quattro 3.2 FSI 3.2 FSI quattro 3.7 quattro 4.0 TDI quattro 4.2 FSI quattro 4.2 quattro 4.2 TDI quattro	154 191 191 257	08.07 07.03 11.03 06.05 06.05 11.02 03.03 06.06 11.02 07.05	10.09 10.09 10.09 10.09 10.09 10.09 10.09 10.09 10.09 10.09		24.5237-0183.3 24.5154-0190.3	331454 331056	2 2	am Bremsattel ²⁾	L=183 L=190
AUDI A8 (09-)										
	2.0 TFSI hybrid 3.0 TDI 3.0 TDI quattro 3.0 TDI quattro 3.0 TFSI quattro 4.0 TFSI quattro 4.0 TFSI quattro 4.2 FSI quattro 4.2 TDI quattro 4.2 TDI quattro 6.3 W12 quattro S8	155 150 190 190 309 320 273 258 283 368	05.12 09.11 07.10 09.13 07.10 03.12 09.13 11.09 11.09 09.13 01.11 04.12			24.2125-1739.3	010948	- gepanzerte Fahrzeuge ³⁾	THz 25,40	TRW
	4.2 FSI quattro 4.2 TDI quattro	273 258	11.09 11.09	06.10 06.10	PR: 1LL PR: 1LL	11.9426-9905.2 11.9426-9906.2 11.8171-0096.1	220985 220986 250155	<input type="checkbox"/> <input type="checkbox"/>	D=42, - Halter D=42, - Halter Führungsbolzen	ATE ATE ATE
	2.0 TFSI hybrid 3.0 TDI 3.0 TDI quattro 3.0 TDI quattro 3.0 TFSI quattro 4.0 TFSI quattro 4.0 TFSI quattro 4.2 FSI quattro 4.2 TDI quattro 4.2 TDI quattro 6.3 W12 quattro S8	155 150 190 190 309 320 273 258 283 368	05.12 09.11 07.10 09.13 07.10 03.12 09.13 07.10 07.10 09.13 01.11 04.12		PR: 1LL PR: 1LL PR: 1LL PR: 1LL PR: 1LL PR: 1LL PR: 1LL PR: 1LL PR: 1LL PR: 1LL PR: 1LL	11.9426-9905.2 11.9426-9906.2 11.8171-0096.1	220985 220986 250155	<input type="checkbox"/> <input type="checkbox"/> <input type="checkbox"/>	D=42, - Halter D=42, - Halter Führungsbolzen	ATE ATE ATE
	4.2 FSI quattro 4.2 TDI quattro	273 258	11.09 11.09	06.10 06.10	PR: 1LJ PR: 1LJ	11.8171-0096.1 11.8116-0018.2	250155 390604	2	Führungsbolzen Haltefeder	ATE ATE
	2.0 TFSI hybrid 3.0 TDI 3.0 TDI quattro 3.0 TDI quattro 3.0 TFSI quattro 4.0 TFSI quattro 4.0 TFSI quattro 4.2 FSI quattro 4.2 TDI quattro 4.2 TDI quattro 6.3 W12 quattro S8	155 150 190 190 309 320 273 258 283 368	05.12 09.11 07.10 09.13 07.10 03.12 09.13 07.10 07.10 09.13 01.11 04.12		PR: 1LJ PR: 1LJ PR: 1LJ PR: 1LJ PR: 1LJ PR: 1LJ PR: 1LJ PR: 1LJ PR: 1LJ PR: 1LJ PR: 1LJ	11.8171-0096.1 11.8116-0018.2	250155 390604	2	Führungsbolzen Haltefeder	ATE ATE
	2.0 TFSI hybrid 3.0 TDI 3.0 TDI quattro 3.0 TDI quattro 3.0 TFSI quattro 4.0 TFSI quattro 4.0 TFSI quattro 4.2 FSI quattro 4.2 TDI quattro 4.2 TDI quattro 6.3 W12 quattro S8	155 150 190 190 309 320 273 258 283 368	05.12 09.11 07.10 09.13 07.10 03.12 09.13 11.09 11.09 09.13 01.11 04.12			24.5140-0495.3	331446	2		L=495
	2.0 TFSI hybrid 3.0 TDI 3.0 TDI quattro 3.0 TDI quattro 3.0 TFSI quattro 4.0 TFSI quattro 4.0 TFSI quattro 4.2 FSI quattro 4.2 TDI quattro 4.2 TDI quattro 6.3 W12 quattro S8	155 150 190 190 309 320 273 258 283 368	05.12 09.11 07.10 09.13 07.10 03.12 09.13 11.09 11.09 09.13 01.11 04.12		PR: 1KW PR: 1KW PR: 1KW PR: 1KW PR: 1KW PR: 1KW PR: 1KW PR: 1KW PR: 1KW PR: 1KW PR: 1KW	24.6243-1714.5	240716	<input type="checkbox"/> elektrische Feststellbremse ¹⁾	D=43, - Halter	TRW

¹⁾ electric parking brake / fr.di stazionamento elettrico / frein à main électrique / freno de mano eléctrico

²⁾ on the brake caliper / sulla pinza freno / sur l'étrier de frein / a la pinza de freno







³⁾ - armoured vehicles / - veicoli blindati / - véhicule blindé / - vehículo blindado

													
AUDI CABRIO (91-00)													
	2.3		8G-N-000001	8G-N-015000			03.7750-0302.4	300071	9"	ATE			
	1.9 TDI 2.0 2.3 2.3		85	8G-V-010000 8G-V-010000 8G-V-010000 8G-N-015000	07.95 01.93 07.91 07.91		- ABS - ABS - ABS - ABS	03.2122-9612.3	010159	THz 22,20	ATE		
	1.9 TDI 2.0 2.0 2.3		85 103	8G-P-000001 8G-P-000001 8G-P-000001 8G-P-000001	8G-V-010000 8G-V-010000 8G-V-010000 8G-V-010000		- ABS - ABS - ABS/+ ⊕ - ABS	03.2123-0491.3 03.3517-0101.2	010167 390322	THz 23,81 Verschlußschraube	ATE		
	1.9 TDI 2.0 2.3 2.6 2.8		103	8G-P-000001	8G-R-012000	07.95 05.95	08.00 + ABS + ABS + ABS	24.2123-1602.3	010384	THz 23,81	TRW		
	2.6 2.8			8G-V-010000 8G-V-010000	01.94 11.92			03.2123-0566.3	010169	THz 23,81	ATE		
	2.3			8G-N-025000	07.91			11.3541-8521.2 24.3541-1720.5 24.3541-1719.5 11.0441-5405.2 11.0101-5409.2 24.0101-4301.2 11.0101-5403.2	220113 240058 240057 250030 260035 260047 260010		D=54, - Halter D=54, - Halter D=54, - Halter Dichtungssatz Hülensatz Bremsattel-Zubehör Fallenbalgsatz	ATE TRW TRW ATE ATE TRW TRW	
	1.8 1.9 TDI 2.0 2.0 2.3 2.6 2.8		85 103	8G-P-000001	04.97 07.95 01.93 05.95 01.94	08.00 08.00 07.98 07.96 + ⊕ 08.00		24.3541-1720.5 24.3541-1719.5 24.0101-4301.2	240058 240057 260047		D=54, - Halter D=54, - Halter Bremsattel-Zubehör	TRW TRW TRW	
	1.8 1.9 TDI 2.0 2.0 2.3 2.6 2.8		85 103		04.97 07.95 01.93 05.95 07.91 01.94 11.92	08.00 08.00 07.98 07.96 + ⊕ 08.00		24.5237-0288.3 24.5170-0161.3	331442 331308	2 2	am Bremsattel 1)	L=288 L=161	ATE TRW TRW
	2.0 2.3 2.8		85	8G-P-005533 8G-P-005533 8G-P-005533	01.93 07.91 11.92			24.3384-1601.5 24.3384-1602.5 24.0101-3601.2	240013 240014 260044		D=38, - Halter D=38, - Halter Bremsattel-Zubehör	TRW TRW TRW	
	1.8 1.9 TDI 2.0 2.0 2.3 2.6 2.8		85 103	8G-P-005534 8G-P-005534 8G-P-005534	04.97 07.95 01.93 05.95 01.94	08.00 08.00 07.98 07.96 + ⊕ 08.00		24.3384-1709.5 24.3384-1710.5	240257 240258		D=38, - Halter D=38, - Halter	TRW TRW	
	1.8 1.9 TDI 2.0 2.0 2.3 2.6 2.8		85 103		04.97 07.95 01.93 05.95 07.91 01.94 11.92	08.00 08.00 07.98 07.96 + ⊕ 08.00		83.6224-0200.3 83.7804-0150.3 24.5170-0161.3	330729 330853 331308	2	am Bremsattel 1)	L=200 L=150 L=161	ATE TRW TRW
	2.0 2.3 2.8		85	8G-P-005533 8G-P-005533 8G-P-005533	01.93 07.91 11.92			24.3727-0143.2 24.3727-0144.2	580143 580144		L=1398 L=1358	ATE	
	1.8 1.9 TDI 2.0 2.0 2.3 2.6		85 103		04.97 07.95 01.93 05.95 07.91 01.94	08.00 08.00 07.98 07.96 + ⊕ 08.00		03.6585-0108.3	320115		BRL 8/5 (4)	ATE	
	1.8 1.9 TDI 2.0 2.0 2.3 2.6 2.8		85 103		04.97 07.95 01.93 05.95 07.91 01.94 11.92	08.00 08.00 07.98 07.96 + ⊕ 08.00		03.2419-9210.3	030026		Gz 19,05	ATE	
	1.8 1.9 TDI 2.0 2.0 2.3 2.6 2.8		85 103		04.97 07.95 01.93 05.95 07.91 01.94 11.92	08.00 08.00 07.98 07.96 + ⊕ 08.00		24.2522-1707.3	040103		Nz 22,20	ATE	

1) on the brake caliper / sulla pinza freno / sur l'étrier de frein / a la pinza de freno

AUDI Q3 (11-)																	
	1.4 TFSI	◀ 92		07.16				03.2123-3549.3	010809					THz 23,81			ATE
	1.4 TFSI	◀110		09.13													
	2.0 TDI	◀ 88		03.15													
	2.0 TDI	◀103		06.11													
	2.0 TDI	◀110		11.14													
	2.0 TDI	◀130		05.13													
	2.0 TDI	◀135		05.15													
	2.0 TDI quattro	◀103		01.12													
	2.0 TDI quattro	◀110		11.14													
	2.0 TDI quattro	◀130		06.11													
2.0 TDI quattro	◀135		11.14														
	2.0 TFSI	◀132		05.15				03.4153-0186.3	010816					THz 23,81			ATE
	2.0 TFSI quattro	◀125		06.11													
	2.0 TFSI quattro	◀132		11.14													
	2.0 TFSI quattro	◀155		06.11													
	2.0 TFSI quattro	◀162		11.14													
	RS 2.5	◀228		09.13				03.2125-5112.3	010966					THz 25,40			ATE
	RS 2.5	◀250		03.15													
	RS 2.5 performance	◀270		01.15													
	1.4 TFSI	92		07.16		PR: 1LJ,1ZD		11.9571-9759.2	220847	<input type="checkbox"/>							ATE
	1.4 TFSI	110		09.13		PR: 1LJ,1ZD		11.9571-9760.2	220848	<input type="checkbox"/>							ATE
	2.0 TDI	88		03.15		PR: 1LJ,1ZD		11.8171-0008.1	990049								ATE
	2.0 TDI	103		06.11		PR: 1LJ,1ZD		11.0101-5409.2	260035								ATE
	2.0 TDI	110		11.14		PR: 1LJ,1ZD		11.8116-0071.1	390605	2							ATE
	2.0 TDI	130		05.13		PR: 1LJ,1ZD											
	2.0 TDI	135		05.15		PR: 1LJ,1ZD											
	2.0 TDI quattro	103		01.12		PR: 1LJ,1ZD											
	2.0 TDI quattro	110		11.14		PR: 1LJ,1ZD											
	2.0 TDI quattro	130		06.11		PR: 1LJ,1ZD											
	2.0 TDI quattro	135		11.14		PR: 1LJ,1ZD											
	2.0 TFSI	132		05.15		PR: 1LJ,1ZD											
	2.0 TFSI quattro	125		06.11		PR: 1LJ,1ZD											
2.0 TFSI quattro	132		11.14		PR: 1LJ,1ZD												
2.0 TFSI quattro	155		06.11		PR: 1LJ,1ZD												
2.0 TFSI quattro	162		11.14		PR: 1LJ,1ZD												
	1.4 TFSI	92		07.16		PR: 1KU		24.6241-1709.7	221021	<input type="checkbox"/>	elektrische Feststellbremse ¹⁾			D=57, - Halter			ATE
	1.4 TFSI	110		09.13		PR: 1KU		24.6241-1710.7	221022	<input type="checkbox"/>	elektrische Feststellbremse ¹⁾			D=57, - Halter			ATE
	2.0 TDI	88		03.15		PR: 1KU								D=41, - Halter			TRW
	2.0 TDI	103		06.11		PR: 1KU											
	2.0 TDI	110		11.14		PR: 1KU											
	2.0 TDI	130		05.13		PR: 1KU											
	2.0 TDI	135		05.15		PR: 1KU											
	2.0 TDI quattro	103		01.12		PR: 1KU											
	2.0 TDI quattro	110		11.14		PR: 1KU											
	2.0 TDI quattro	130		06.11		PR: 1KU											
	2.0 TDI quattro	135		11.14		PR: 1KU											
	2.0 TFSI	132		05.15		PR: 1KU											
	2.0 TFSI quattro	125		06.11		PR: 1KU											
2.0 TFSI quattro	132		11.14		PR: 1KU												
2.0 TFSI quattro	155		06.11		PR: 1KU												
2.0 TFSI quattro	162		11.14		PR: 1KU												
	1.4 TFSI	110		09.13				24.5143-0257.3	331167	2							L=257
	2.0 TDI	103		06.11													
	2.0 TDI	130		05.13													
	2.0 TDI quattro	103		01.12													
	2.0 TDI quattro	130		06.11													
	2.0 TFSI quattro	125		06.11													
	2.0 TFSI quattro	155		06.11													

¹⁾ electric parking brake / fr.di stazionamento elettrico / frein à main électrique / freno de mano eléctrico

AUDI Q5 (08-)										
	SQ5 TDI quattro SQ5 TDI quattro SQ5 TFSI quattro 2.0 TFSI hybr.quattro	230 260 260 155	04.15 12.12 05.13 06.11		03.7858-4432.4 03.7858-4632.4	300304 300273			9/8" Tandem 9/8" Tandem	ATE ATE
	2.0 TDI 2.0 TDI 2.0 TDI 2.0 TDI 2.0 TDI quattro 2.0 TDI quattro 2.0 TDI quattro 2.0 TDI quattro 2.0 TDI quattro 2.0 TDI quattro 2.0 TFSI quattro 2.0 TFSI quattro 2.0 TFSI quattro 2.0 TFSI quattro 3.0 TDI quattro 3.0 TDI quattro 3.0 TDI quattro 3.0 TDI quattro 3.0 TFSI quattro 3.2 FSI quattro SQ5 TDI quattro SQ5 TDI quattro SQ5 TFSI quattro	100 105 110 140 100 105 110 120 125 130 132 155 162 165 155 176 180 190 200 199 230 260	08.09 08.09 05.13 09.15 08.09 08.09 05.13 03.09 03.09 09.12 08.09 03.09 05.13 09.12 03.09 03.09 11.13 09.12 03.09 03.09 04.15 12.12 05.13		03.2125-0493.2	010940			THz 25,40	ATE
	SQ5 TDI quattro SQ5 TDI quattro SQ5 TFSI quattro	230 260 260	04.15 12.12 05.13	PR: 1LV,1ZK PR: 1LV,1ZK PR: 1LV,1ZK	11.8171-0096.1 11.8116-0018.2	250155 390604	2		Führungsbolzen Haltefeder	ATE ATE
	2.0 TDI 2.0 TDI 2.0 TDI 2.0 TDI 2.0 TDI quattro 2.0 TDI quattro 2.0 TDI quattro 2.0 TDI quattro 2.0 TDI quattro 2.0 TDI quattro 2.0 TFSI hybr.quattro 2.0 TFSI quattro 2.0 TFSI quattro 2.0 TFSI quattro 2.0 TFSI quattro 3.0 TDI quattro 3.0 TDI quattro 3.0 TDI quattro 3.0 TDI quattro 3.0 TFSI quattro 3.2 FSI quattro SQ5 TDI quattro SQ5 TDI quattro SQ5 TFSI quattro	100 105 110 140 100 105 110 120 125 130 155 132 155 162 165 169 155 176 180 190 200 199 230 260	08.09 08.09 05.13 09.15 08.09 08.09 05.13 03.09 03.09 09.12 06.11 08.09 03.09 05.13 09.12 08.15 03.09 03.09 11.13 09.12 03.09 04.15 12.12 05.13		83.7713-0483.3	331229	2		L=485	
	2.0 TDI 2.0 TDI 2.0 TDI quattro 2.0 TDI quattro 2.0 TDI quattro 2.0 TDI quattro 2.0 TFSI hybr.quattro 2.0 TFSI quattro 2.0 TFSI quattro 3.0 TDI quattro 3.0 TDI quattro 3.2 FSI quattro	100 105 100 105 120 125 155 132 155 155 176 199	08.09 08.09 08.09 03.09 03.09 06.11 08.09 03.09 03.09 03.09 03.09 03.09	PR: 1KW PR: 1KW PR: 1KW PR: 1KW PR: 1KW PR: 1KW PR: 1KW PR: 1KW PR: 1KW PR: 1KW PR: 1KW	24.6243-1703.7 24.6243-1704.7	220945 220946		<input type="checkbox"/> elektrische Feststellbremse 1) <input type="checkbox"/> elektrische Feststellbremse 1)	D=43, - Halter D=43, - Halter	TRW TRW
	2.0 TDI 2.0 TDI 2.0 TDI 2.0 TDI 2.0 TDI quattro 2.0 TDI quattro 2.0 TDI quattro 2.0 TDI quattro 2.0 TDI quattro 2.0 TDI quattro 2.0 TFSI hybr.quattro 2.0 TFSI quattro 2.0 TFSI quattro 2.0 TFSI quattro 2.0 TFSI quattro 3.0 TDI quattro 3.0 TDI quattro 3.0 TDI quattro	100 105 110 140 100 105 110 120 125 130 155 132 155 162 169 155 176 180	06.12 06.12 05.13 09.15 06.12 06.12 05.13 06.12 06.12 09.12 06.12 06.12 09.12 05.13 08.15 06.12 06.12 09.12	PR: 1KW,2EK PR: 1KW,2EK PR: 1KW,2EK PR: 1KW,2EK PR: 1KW,2EK PR: 1KW,2EK PR: 1KW,2EK PR: 1KW,2EK PR: 1KW,2EK PR: 1KW,2EK PR: 1KW,2EK PR: 1KW,2EK PR: 1KW,2EK PR: 1KW,2EK PR: 1KW,2EK PR: 1KW,2EK PR: 1KW,2EK	24.6243-1707.7 24.6243-1708.7	220979 220980		<input type="checkbox"/> elektrische Feststellbremse 1) <input type="checkbox"/> elektrische Feststellbremse 1)	D=43, - Halter D=43, - Halter	TRW TRW

1) electric parking brake / fr.di stazionamento elettrico / frein à main électrique / freno de mano eléctrico





AUDI Q5 (08-)										
	3.0 TDI quattro	190	11.13	PR: 1KW,2EK	24.6243-1707.7	220979	<input type="checkbox"/> elektrische Feststellbremse ¹⁾	D=43, - Halter	TRW	
	3.0 TFSI quattro	200	09.12	PR: 1KW,2EK	24.6243-1708.7	220980	<input type="checkbox"/> elektrische Feststellbremse ¹⁾	D=43, - Halter	TRW	
	3.2 FSI quattro	199	06.12	PR: 1KW,2EK						
	2.0 TDI	100	08.09	12.12 PR: 1KE,2EL	24.6243-1717.5	240747	<input type="checkbox"/> elektrische Feststellbremse ¹⁾	D=43, - Halter	TRW	
	2.0 TDI	105	08.09	12.12 PR: 1KE,2EL	24.6243-1718.5	240748	<input type="checkbox"/> elektrische Feststellbremse ¹⁾	D=43, - Halter	TRW	
	2.0 TDI quattro	100	08.09	12.12 PR: 1KE,2EL						
	2.0 TDI quattro	105	08.09	12.12 PR: 1KE,2EL						
	2.0 TDI quattro	120	03.09	12.12 PR: 1KE,2EL						
	2.0 TDI quattro	125	03.09	12.12 PR: 1KE,2EL						
	2.0 TDI quattro	130	09.12	12.12 PR: 1KE,2EL						
	2.0 TFSI hybr.quattro	155	06.11	12.12 PR: 1KE,2EL						
	2.0 TFSI quattro	132	08.09	12.12 PR: 1KE,2EL						
	2.0 TFSI quattro	155	03.09	12.12 PR: 1KE,2EL						
	2.0 TFSI quattro	165	09.12	12.12 PR: 1KE,2EL						
	3.0 TDI quattro	155	03.09	12.12 PR: 1KE,2EL						
	3.0 TDI quattro	176	03.09	12.12 PR: 1KE,2EL						
	3.0 TDI quattro	180	09.12	12.12 PR: 1KE,2EL						
	3.0 TFSI quattro	200	09.12	12.12 PR: 1KE,2EL						
	3.2 FSI quattro	199	03.09	12.12 PR: 1KE,2EL						
	2.0 TDI	100	01.13	PR: 1KE,2EL	24.6243-1721.5	240782	<input type="checkbox"/> elektrische Feststellbremse ¹⁾	D=43, - Halter	TRW	
	2.0 TDI	105	01.13	PR: 1KE,2EL						
	2.0 TDI	110	05.13	PR: 1KE,2EL						
	2.0 TDI	140	09.15	PR: 1KE,2EL						
	2.0 TDI quattro	100	01.13	PR: 1KE,2EL						
	2.0 TDI quattro	105	01.13	PR: 1KE,2EL						
	2.0 TDI quattro	110	05.13	PR: 1KE,2EL						
	2.0 TDI quattro	120	01.13	PR: 1KE,2EL						
2.0 TDI quattro	125	01.13	PR: 1KE,2EL							
2.0 TDI quattro	130	01.13	PR: 1KE,2EL							
2.0 TFSI hybr.quattro	155	01.13	PR: 1KE,2EL							
2.0 TFSI quattro	132	01.13	PR: 1KE,2EL							
2.0 TFSI quattro	155	01.13	PR: 1KE,2EL							
2.0 TFSI quattro	162	05.13	PR: 1KE,2EL							
2.0 TFSI quattro	165	01.13	PR: 1KE,2EL							
2.0 TFSI quattro	169	08.15	PR: 1KE,2EL							
3.0 TDI quattro	155	01.13	PR: 1KE,2EL							
3.0 TDI quattro	176	01.13	PR: 1KE,2EL							
3.0 TDI quattro	180	01.13	PR: 1KE,2EL							
3.0 TDI quattro	190	11.13	PR: 1KE,2EL							
3.0 TFSI quattro	200	01.13	PR: 1KE,2EL							
3.2 FSI quattro	199	01.13	PR: 1KE,2EL							
	2.0 TDI	100	08.09		24.5140-0396.3	331372	2	L=396		
	2.0 TDI	105	08.09							
	2.0 TDI	110	05.13							
	2.0 TDI	140	09.15							
	2.0 TDI quattro	100	08.09							
	2.0 TDI quattro	105	08.09							
	2.0 TDI quattro	110	05.13							
	2.0 TDI quattro	120	03.09							
	2.0 TDI quattro	125	03.09							
	2.0 TDI quattro	130	09.12							
	2.0 TFSI hybr.quattro	155	06.11							
	2.0 TFSI quattro	132	08.09							
	2.0 TFSI quattro	155	03.09							
	2.0 TFSI quattro	162	05.13							
	2.0 TFSI quattro	165	09.12							
	2.0 TFSI quattro	169	08.15							
	3.0 TDI quattro	155	03.09							
	3.0 TDI quattro	176	03.09							
	3.0 TDI quattro	180	09.12							
	3.0 TDI quattro	190	11.13							
	3.0 TFSI quattro	200	09.12							
	3.2 FSI quattro	199	03.09							
	SQ5 TDI quattro			04.15						
	SQ5 TDI quattro	230		12.12						
SQ5 TFSI quattro	260		05.13							

AUDI Q7 (06-15)									
	3.0 TDI	◀150	05.10	- automatische Distanzregelung ²⁾	03.7868-4503.4	300245		10/8" Tandem	ATE
	3.0 TDI	◀155	03.06	- automatische Distanzregelung ²⁾					
	3.0 TDI	◀165	06.09	- automatische Distanzregelung ²⁾					
	3.0 TDI	◀171	03.06	- automatische Distanzregelung ²⁾					
	3.0 TDI	◀176	11.07	- automatische Distanzregelung ²⁾					
	3.0 TDI	◀180	05.11	- automatische Distanzregelung ²⁾					
	3.0 TDI	◀200	03.15	- automatische Distanzregelung ²⁾					
	3.0 TFSI	◀200	05.10	- automatische Distanzregelung ²⁾					
	3.0 TFSI	◀245	05.10	- automatische Distanzregelung ²⁾					
	3.6 FSI	◀206	08.06	- automatische Distanzregelung ²⁾					
	4.2 FSI	◀257	03.06	- automatische Distanzregelung ²⁾					
	4.2 TDI	◀240	03.07	- automatische Distanzregelung ²⁾					
	6.0 TDI	◀368	09.08	- automatische Distanzregelung ²⁾					
	3.0 TDI	◀150	05.10	+ automatische Distanzregelung ³⁾	03.7868-4702.4	300253		10/8" Tandem	ATE
3.0 TDI	◀155	03.06	+ automatische Distanzregelung ³⁾	03.0655-0006.2	370006		Wegsensor	ATE	
3.0 TDI	◀165	06.09	+ automatische Distanzregelung ³⁾						
3.0 TDI	◀171	03.06	+ automatische Distanzregelung ³⁾						
3.0 TDI	◀176	11.07	+ automatische Distanzregelung ³⁾						
3.0 TDI	◀180	05.11	+ automatische Distanzregelung ³⁾						

¹⁾ electric parking brake / fr.di stazionamento elettrico / frein à main électrique / freno de mano eléctrico
²⁾ - autom. distance control / - regolazione della distanza autom. / - compensation de distance autom. / - regulación de distancia autom.
³⁾ + autom. distance control / + regolazione della distanza autom. / + compensation de distance autom. / + regulación de distancia autom.















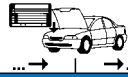





AUDI Q7 (06-15)

	3.0 TDI	◀200		03.15	+ automatische Distanzregelung ¹⁾	03.7868-4702.4	300253		10/8" Tandem Wegsensor	ATE
	3.0 TFSI	◀200		05.10	+ automatische Distanzregelung ¹⁾					
	3.0 TFSI	◀245		05.10	+ automatische Distanzregelung ¹⁾					
	3.6 FSI	◀206		08.06	+ automatische Distanzregelung ¹⁾					
	4.2 FSI	◀257		03.06	+ automatische Distanzregelung ¹⁾					
	4.2 TDI	◀240		03.07	+ automatische Distanzregelung ¹⁾					
	6.0 TDI	◀368		09.08	+ automatische Distanzregelung ¹⁾					
	3.0 TDI	▶150		05.10	+ automatische Distanzregelung ¹⁾					
	3.0 TDI	▶155		03.06	+ automatische Distanzregelung ¹⁾					
	3.0 TDI	▶165		06.09	+ automatische Distanzregelung ¹⁾					
3.0 TDI	▶171		03.06	+ automatische Distanzregelung ¹⁾						
3.0 TDI	▶176		11.07	+ automatische Distanzregelung ¹⁾						
3.0 TDI	▶180		05.11	+ automatische Distanzregelung ¹⁾						
3.0 TDI	▶200		03.15	+ automatische Distanzregelung ¹⁾						
3.0 TFSI	▶200		05.10	+ automatische Distanzregelung ¹⁾						
3.0 TFSI	▶245		05.10	+ automatische Distanzregelung ¹⁾						
3.6 FSI	▶206		08.06	+ automatische Distanzregelung ¹⁾						
4.2 FSI	▶257		03.06	+ automatische Distanzregelung ¹⁾						
4.2 TDI	▶240		03.07	+ automatische Distanzregelung ¹⁾						
6.0 TDI	▶368		09.08	+ automatische Distanzregelung ¹⁾						
	3.0 TDI	◀150		05.10		03.2126-3063.3	010812		THz 26,99	ATE
	3.0 TDI	◀155		03.06						
	3.0 TDI	◀165		06.09						
	3.0 TDI	◀171		03.06						
	3.0 TDI	◀176		11.07						
	3.0 TDI	◀180		05.11						
	3.0 TDI	◀200		03.15						
	3.0 TFSI	◀200		05.10						
	3.0 TFSI	◀245		05.10						
	3.6 FSI	◀206		08.06						
4.2 FSI	◀257		03.06							
4.2 TDI	◀240		03.07							
6.0 TDI	◀368		09.08							
	3.0 TDI	150		05.10		24.5237-0515.3	331463	2	L=515	
	3.0 TDI	155		03.06						
	3.0 TDI	165		06.09						
	3.0 TDI	171		03.06						
	3.0 TDI	176		11.07						
	3.0 TDI	180		05.11						
	3.0 TDI	200		03.15						
	3.0 TFSI	200		05.10						
	3.0 TFSI	245		05.10						
	3.6 FSI	206		08.06						
4.2 FSI	257		03.06							
4.2 TDI	240		03.07							
6.0 TDI	368		09.08							
	3.0 TDI	150		05.10		83.7812-0400.3	331214	2	L=400	
	3.0 TDI	155		03.06						
	3.0 TDI	165		06.09						
	3.0 TDI	171		03.06						
	3.0 TDI	176		11.07						
	3.0 TDI	180		05.11						
	3.0 TDI	200		03.15						
	3.0 TFSI	200		05.10						
	3.0 TFSI	245		05.10						
	3.6 FSI	206		08.06						
4.2 FSI	257		03.06							
4.2 TDI	240		03.07							
6.0 TDI	368		09.08							
	3.0 TDI	150		06.10	PR: 1KF,2EA,1KD,2EF	24.3727-3400.2	583400	2 ↓	L=1890	
	3.0 TDI	155		06.10	PR: 1KF,2EA,1KD,2EF					
	3.0 TDI	165		06.10	PR: 1KF,2EA,1KD,2EF					
	3.0 TDI	171		06.10	PR: 1KF,2EA,1KD,2EF					
	3.0 TDI	176		06.10	PR: 1KF,2EA,1KD,2EF					
	3.0 TDI	180		05.11	PR: 1KF,2EA,1KD,2EF					
	3.0 TFSI	200		06.10	PR: 1KF,2EA,1KD,2EF					
	3.0 TFSI	245		06.10	PR: 1KF,2EA,1KD,2EF					
	3.6 FSI	206		06.10	PR: 1KF,2EA,1KD,2EF					
	4.2 FSI	257		06.10	PR: 1KF,2EA,1KD,2EF					
4.2 TDI	240		06.10	PR: 1KF,2EA,1KD,2EF						
6.0 TDI	368		06.10	PR: 1KF,2EA,1KD,2EF						

AUDI TT Coupe (98-06)

	1.8 T	◀132	8N-2-014300	10.98	+ ESP	03.7863-0402.4	300124		10"	ATE
	1.8 T quattro	◀132	8N-2-014300	10.98	+ ESP					
	1.8 T quattro	◀165	8N-2-014300	10.98	+ ESP					
	1.8 T	◀110		09.02	06.06	03.7860-0602.4	300141		10"	ATE
	1.8 T	◀120		09.05	06.06					
	1.8 T	◀132	8N-2-014301		06.06					
	1.8 T	◀140		09.05	06.06					
	1.8 T quattro	◀132	8N-2-014301		06.06					
	1.8 T quattro	◀140		09.05	06.06					
	1.8 T quattro	◀165	8N-2-014301		06.06					
	1.8 T quattro	◀176		03.05	06.06					
	3.2 quattro	◀184		04.03	06.06					

¹⁾ + autom. distance control / + regolazione della distanza autom. / + compensation de distance autom. / + regulaci3n de distancia autom.



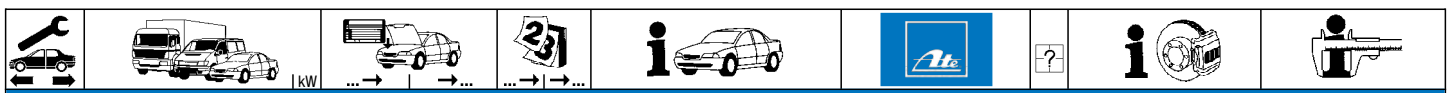































										
AUDI TT Coupe (98-06)										
	1.8 T	132	8N-2-014300	10.98	- ESP	24.2123-1709.3	010503	Thz 23,81		
	1.8 T quattro	132	8N-2-014300	10.98	- ESP					
	1.8 T quattro	165	8N-2-014300	10.98	- ESP					
	1.8 T	132	8N-2-014300	10.98	+ ESP	03.2123-2024.3	010597	Thz 23,81		
	1.8 T quattro	132	8N-2-014300	10.98	+ ESP			ATE		
	1.8 T quattro	165	8N-2-014300	10.98	+ ESP					
	1.8 T	132	8N-2-014300	10.98	+ ESP	03.2123-2064.3	010598	Thz 23,81		
	1.8 T quattro	132	8N-2-014300	10.98	+ ESP			ATE		
	1.8 T quattro	165	8N-2-014300	10.98	+ ESP					
	1.8 T	132	8N-2-014301		08.02	03.2123-2715.3	010802	Thz 23,81		
	1.8 T quattro	132	8N-2-014301		08.02			ATE		
	1.8 T quattro	165	8N-2-014301		08.02					
	1.8 T	132	8N-2-014301		08.02	03.2123-2774.3	010803	Thz 23,81		
	1.8 T quattro	132	8N-2-014301		08.02			ATE		
	1.8 T quattro	165	8N-2-014301		08.02					
	1.8 T	110			09.02	03.2123-2654.3	010801	Thz 23,81		
	1.8 T	120			09.05			ATE		
	1.8 T	132			09.02					
	1.8 T	140			09.05					
	1.8 T quattro	132			09.02					
	1.8 T quattro	140			09.05					
	1.8 T quattro	165			09.02					
	1.8 T quattro	176			03.05					
	3.2 quattro	184			04.03					
	1.8 T	110		09.02	06.06	PR: 1LD,1LT,1LV	11.9541-9595.2	220501	D=54, - Halter	
	1.8 T	120		09.05	06.06	PR: 1LD,1LT,1LV	11.9541-9596.2	220502	D=54, - Halter	
	1.8 T	132		10.98	06.06	PR: 1LD,1LT,1LV	11.0101-5409.2	260035	Hülzensatz	
	1.8 T	140		09.05	06.06	PR: 1LD,1LT,1LV	11.8171-0008.1	990049	Führungsbolzen	
	1.8 T quattro	132		10.98	06.06	PR: 1LD,1LT,1LV	11.8116-0143.1	390513	Haltefeder	
	1.8 T quattro	140		09.05	06.06	PR: 1LD,1LT,1LV				
	1.8 T quattro	165		10.98	06.06	PR: 1LD,1LT,1LV				
	1.8 T quattro	176		03.05	06.06	PR: 1LD,1LT,1LV				
	3.2 quattro	184		04.03	06.06		11.9421-9915.2	220869	D=42, - Halter	
							11.9421-9916.2	220870	D=42, - Halter	
							11.8171-0008.1	990049	Führungsbolzen	
									ATE	
	1.8 T	110		09.02	06.06		83.6252-0560.3	330557	L=560	
	1.8 T	120		09.05	06.06					
	1.8 T	132		10.98	06.06					
	1.8 T	140		09.05	06.06					
	1.8 T quattro	132		10.98	06.06					
	1.8 T quattro	140		09.05	06.06					
	1.8 T quattro	165		10.98	06.06					
	1.8 T quattro	176		03.05	06.06					
	3.2 quattro	184		04.03	06.06		83.7769-0561.3	331105	L=560	
		1.8 T	110	8N-Y-011100	09.02	PR: 1KK	24.3384-1723.7	220523	D=38(M12x1), - Halter	
		1.8 T	120	8N-Y-011100	09.05	PR: 1KK	24.3384-1724.7	220524	D=38(M12x1), - Halter	
		1.8 T	132	8N-Y-011100	10.98	PR: 1KK				
1.8 T		140	8N-Y-011100	09.05	PR: 1KK					
1.8 T		110	8N-Y-011101		06.06	PR: 1KK,2EK	24.3384-1729.7	220541	D=38(M12x1), - Halter	
1.8 T		120	8N-Y-011101		06.06	PR: 1KK,2EK	24.3384-1730.7	220542	D=38(M12x1), - Halter	
1.8 T		132	8N-Y-011101		06.06	PR: 1KK,2EK				
1.8 T		140	8N-Y-011101		06.06	PR: 1KK,2EK				
1.8 T quattro		132		10.98	06.06	PR: 1KE	24.3414-1705.7	220549	D=41, - Halter	
1.8 T quattro		140		09.05	06.06	PR: 1KE	24.3414-1706.7	220550	D=41, - Halter	
1.8 T quattro		165		10.98	06.06	PR: 1KE				
1.8 T quattro		176		03.05	06.06	PR: 1KE				
3.2 quattro	184		04.03	06.06	PR: 1KE					
	1.8 T quattro	132		10.98	06.06	PR: 1KF	24.3384-1745.7	220609	D=38, - Halter	
	1.8 T quattro	140		09.05	06.06	PR: 1KF	24.3384-1746.7	220610	D=38, - Halter	
	1.8 T quattro	165		10.98	06.06	PR: 1KF				
	1.8 T quattro	176		03.05	06.06	PR: 1KF				
	3.2 quattro	184		04.03	06.06	PR: 1KF				
		1.8 T	110		09.02	06.06		83.7858-0140.3	330837	L=140
		1.8 T	120		09.05	06.06				
		1.8 T	132		10.98	06.06				
		1.8 T	140		09.05	06.06				
		1.8 T quattro	132		10.98	06.06		83.7858-0140.3	330837	L=140
		1.8 T quattro	140		09.05	06.06				
		1.8 T quattro	165		10.98	06.06				
1.8 T quattro		176		03.05	06.06					
3.2 quattro		184		04.03	06.06					
		1.8 T	132	8N-Y-011100	10.98		24.3727-0190.2	580190	L=1612	
		1.8 T	110		09.02	06.06	24.3727-0189.2	580189	L=1617	
		1.8 T	120		09.05	06.06				
	1.8 T	132	8N-Y-011101		06.06					
	1.8 T	140		09.05	06.06					
	1.8 T	110		09.02	06.06		24.2415-1701.3	030095	Gz 15,87	
	1.8 T	120		09.05	06.06					
	1.8 T	132		10.98	06.06					
	1.8 T	140		09.05	06.06					
	1.8 T quattro	132		10.98	06.06					
	1.8 T quattro	140		09.05	06.06					
	1.8 T quattro	165		10.98	06.06					
	1.8 T quattro	176		03.05	06.06					



AUDI TT Coupe (98-06)										
	1.8 T	▶110		09.02	06.06	24.2415-1702.3	030096			Gz 15,87
	1.8 T	▶120		09.05	06.06					
	1.8 T	▶132		10.98	06.06					
	1.8 T	▶140		09.05	06.06					
	1.8 T quattro	▶132		10.98	06.06					
	1.8 T quattro	▶140		09.05	06.06					
	1.8 T quattro	▶165		10.98	06.06					
1.8 T quattro	▶176		03.05	06.06						
	1.8 T	132		10.98	08.02	24.2519-1701.3	040075			Nz 19,05

AUDI TT Roadster (99-06)																															
	1.8 T	◀110	8N-2-014300	01.01	+ ESP	03.7863-0402.4	300124			10"	ATE																				
	1.8 T	◀132	8N-2-014300	04.99	+ ESP																										
	1.8 T quattro	◀132	8N-2-014300	02.00	+ ESP																										
	1.8 T quattro	◀165	8N-2-014300	10.99	+ ESP																										
	1.8 T	◀110	8N-2-014301		06.06	03.7860-0602.4	300141			10"	ATE																				
	1.8 T	◀120		09.05	06.06																										
	1.8 T	◀132	8N-2-014301		06.06																										
	1.8 T	◀140		09.05	06.06																										
	1.8 T quattro	◀132	8N-2-014301		06.06																										
	1.8 T quattro	◀140		09.05	06.06																										
	1.8 T quattro	◀165	8N-2-014301		06.06																										
	3.2 quattro	◀184		04.03	06.06																										
	1.8 T	◀110	8N-2-014300	01.01	- ESP	24.2123-1709.3	010503			THz 23,81																					
	1.8 T	◀132	8N-2-014300	04.99	- ESP																										
	1.8 T quattro	◀132	8N-2-014300	02.00	- ESP																										
	1.8 T quattro	◀165	8N-2-014300	10.99	- ESP																										
	1.8 T	◀110	8N-2-014300	01.01	+ ESP							03.2123-2024.3	010597			THz 23,81	ATE														
	1.8 T	◀132	8N-2-014300	04.99	+ ESP																										
	1.8 T quattro	◀132	8N-2-014300	02.00	+ ESP																										
	1.8 T quattro	◀165	8N-2-014300	10.99	+ ESP																										
		1.8 T	▶110	8N-2-014300	01.01							+ ESP	03.2123-2064.3	010598			THz 23,81	ATE													
		1.8 T	▶132	8N-2-014300	04.99							+ ESP																			
		1.8 T quattro	▶132	8N-2-014300	02.00							+ ESP																			
		1.8 T quattro	▶165	8N-2-014300	10.99							+ ESP																			
	1.8 T	◀110	8N-2-014301		08.02	03.2123-2715.3	010802			THz 23,81	ATE																				
	1.8 T	◀132	8N-2-014301		08.02																										
	1.8 T quattro	◀132	8N-2-014301		08.02																										
	1.8 T quattro	◀165	8N-2-014301		08.02																										
	1.8 T	▶110	8N-2-014301		08.02	03.2123-2774.3	010803			THz 23,81	ATE																				
	1.8 T	▶132	8N-2-014301		08.02																										
	1.8 T quattro	▶132	8N-2-014301		08.02																										
	1.8 T quattro	▶165	8N-2-014301		08.02																										
	1.8 T	◀110		09.02	06.06	03.2123-2654.3	010801			THz 23,81	ATE																				
	1.8 T	◀120		09.05	06.06																										
	1.8 T	◀132		09.02	06.06																										
	1.8 T	◀140		09.05	06.06																										
	1.8 T quattro	◀132		09.02	06.06																										
	1.8 T quattro	◀140		09.05	06.06																										
	1.8 T quattro	◀165		09.02	06.06																										
	3.2 quattro	◀184		04.03	06.06																										
		1.8 T	110		01.01							06.06	11.9541-9595.2	220501	☐	2	D=54, - Halter	ATE													
		1.8 T	120		09.05							06.06							11.9541-9596.2	220502	☐	D=54, - Halter	ATE								
1.8 T		132		04.99	06.06	11.0101-5409.2	260035	☐	Hülzensatz	ATE																					
1.8 T		140		09.05	06.06						11.8171-0008.1	990049												☐	Führungsbolzen	ATE					
1.8 T quattro		132		02.00	06.06																						11.8116-0143.1	390513	☐	Haltefeder	ATE
1.8 T quattro		140		09.05	06.06																										
1.8 T quattro		165		10.99	06.06																										
3.2 quattro		184		04.03	06.06																										
	1.8 T	110		01.01	06.06								83.6252-0560.3	330557	2		L=560														
	1.8 T	120		09.05	06.06																										
	1.8 T	132		04.99	06.06																										
	1.8 T	140		09.05	06.06																										
	1.8 T quattro	132		02.00	06.06																										
	1.8 T quattro	140		09.05	06.06																										
	1.8 T quattro	165		10.99	06.06																										
	3.2 quattro	184		04.03	06.06																										
	1.8 T	110	8N-Y-011100	01.01	PR: 1KK	24.3384-1723.7	220523	☐	2	D=38(M12x1), - Halter	TRW																				
	1.8 T	120	8N-Y-011100	09.05	PR: 1KK							24.3384-1724.7	220524	☐	D=38(M12x1), - Halter	TRW															
	1.8 T	132	8N-Y-011100	04.99	PR: 1KK																										
	1.8 T	140	8N-Y-011100	09.05	PR: 1KK																										
	1.8 T	110	8N-Y-011101		06.06												24.3384-1729.7	220541	☐	D=38(M12x1), - Halter	TRW										
	1.8 T	120	8N-Y-011101		06.06																										
	1.8 T	132	8N-Y-011101		06.06																										
	1.8 T	140	8N-Y-011101		06.06																										
		1.8 T quattro	132		02.00												06.06	24.3414-1705.7	220549	☐	D=41, - Halter	TRW									
		1.8 T quattro	140		09.05												06.06														
		1.8 T quattro	165		10.99												06.06														
		3.2 quattro	184		04.03												06.06														
	1.8 T quattro	132		02.00	06.06	24.3384-1745.7	220609	☐	D=38, - Halter	TRW																					
	1.8 T quattro	140		09.05	06.06						24.3384-1746.7	220610	☐	D=38, - Halter	TRW																





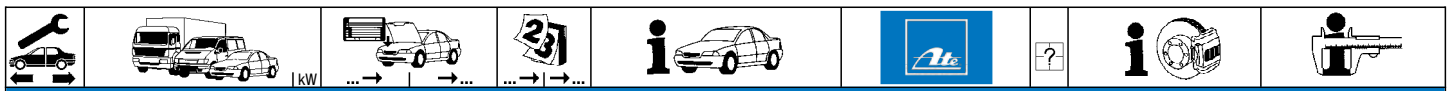











												
AUDI TT Roadster (99-06)												
	1.8 T quattro 3.2 quattro	165 184		10.99 04.03	06.06 06.06	PR: 1KF PR: 1KF	24.3384-1745.7 24.3384-1746.7	220609 220610	 	D=38, - Halter D=38, - Halter	TRW TRW	
	1.8 T 1.8 T 1.8 T 1.8 T	110 120 132 140			01.01 09.05 04.99 09.05	06.06 06.06 06.06 06.06	83.7858-0140.3	330837	2		L=140	
	1.8 T quattro 1.8 T quattro 1.8 T quattro 3.2 quattro	132 140 165 184			02.00 09.05 10.99 04.03	06.06 06.06 06.06 06.06	83.7858-0140.3	330837	2		L=140	
	1.8 T 1.8 T 1.8 T 1.8 T	132 110 120 132	8N-Y-011100 8N-Y-011101	04.99	01.01 09.05	06.06 06.06	24.3727-0190.2 24.3727-0189.2	580190 580189	2 2	 	L=1612 L=1617	
	1.8 T 1.8 T 1.8 T 1.8 T 1.8 T quattro 1.8 T quattro 1.8 T quattro	110 120 132 140 132 140 165			01.01 09.05 04.99 09.05 02.00 09.05 10.99	06.06 06.06 06.06 06.06 06.06 06.06 06.06	24.2415-1701.3	030095			Gz 15,87	
	1.8 T 1.8 T 1.8 T 1.8 T 1.8 T quattro 1.8 T quattro 1.8 T quattro	110 120 132 140 132 140 165			01.01 09.05 04.99 09.05 02.00 09.05 10.99	06.06 06.06 06.06 06.06 06.06 06.06 06.06	24.2415-1702.3	030096			Gz 15,87	
	1.8 T 1.8 T	110 132		01.01 04.99	12.02 12.02		24.2519-1701.3	040075			Nz 19,05	
AUDI TT Coupe (06-14)												
	1.8 TFSI 2.0 quattro 2.0 TDI quattro 2.0 TFSI 2.0 TFSI 2.0 TFSI quattro 2.0 TFSI quattro	118 195 125 147 155 147 155			06.08 05.08 06.08 07.06 05.10 05.08 05.10	06.14 06.14 06.14 06.14 06.14 06.14 06.14	03.7860-4203.4	300243			10"	ATE
	3.2 quattro RS 2.5 TFSI RS 2.5 TFSI plus TTS 2.0 TFSI	184 250 265 200		07.06 05.09 02.12 05.08	06.14 06.14 06.14 06.14		03.7870-0602.4 03.7870-0602.4	300310 300310	PR: 1AT		11" 11"	ATE ATE
	1.8 TFSI 2.0 quattro 2.0 TDI quattro 2.0 TFSI 2.0 TFSI 2.0 TFSI quattro 2.0 TFSI quattro	118 195 125 147 155 147 155			06.08 05.08 06.08 07.06 05.10 05.08 05.10	06.14 06.14 06.14 06.14 06.14 06.14 06.14	03.2123-3549.3	010809			Thz 23,81	ATE
	3.2 quattro RS 2.5 TFSI RS 2.5 TFSI plus TTS 2.0 TFSI	184 250 265 200		07.06 05.09 05.11 05.08	06.14 06.14 06.14 06.14		03.2125-5112.3	010966			Thz 25,40	ATE
	1.8 TFSI 2.0 quattro 2.0 TDI quattro 2.0 TFSI 2.0 TFSI 2.0 TFSI quattro 2.0 TFSI quattro 3.2 quattro	118 195 125 147 155 147 155 184		06.08 05.08 06.08 07.06 05.10 05.08 05.10 07.06	06.14 06.14 06.14 06.14 06.14 06.14 06.14 06.14	PR: 1LJ PR: 1LJ PR: 1LJ PR: 1LJ PR: 1LJ PR: 1LJ PR: 1LJ	11.9541-9553.2 11.9541-9554.2 11.0101-5409.2 11.8171-0008.1 11.8116-0351.1	220563 220564 260035 990049 390538	2 2	 	D=54, - Halter D=54, - Halter Hülensatz Führungsbolzen Haltefeder	ATE ATE ATE ATE ATE
	1.8 TFSI 2.0 quattro 2.0 TDI quattro 2.0 TFSI 2.0 TFSI 2.0 TFSI quattro 2.0 TFSI quattro 3.2 quattro	118 195 125 147 155 147 155 184		06.08 05.08 06.08 07.06 05.10 05.08 05.10 07.06	06.14 06.14 06.14 06.14 06.14 06.14 06.14 06.14	PR: 1LL PR: 1LL PR: 1LL PR: 1LL PR: 1LL PR: 1LL PR: 1LL	11.9541-9553.2 11.9541-9554.2 11.0101-5409.2 11.8171-0008.1 11.8116-0351.1	220563 220564 260035 990049 390538	2	 	D=54, - Halter D=54, - Halter Hülensatz Führungsbolzen Haltefeder	ATE ATE ATE ATE ATE
	1.8 TFSI 2.0 quattro 2.0 TDI quattro 2.0 TFSI 2.0 TFSI 2.0 TFSI quattro 3.2 quattro	118 195 125 147 147 155 184		06.08 05.08 06.08 07.06 05.08 05.10 07.06	06.14 06.14 06.14 06.14 06.14 06.14 06.14	PR: 1LK PR: 1LK PR: 1LK PR: 1LK,1LM PR: 1LK PR: 1LK,1LM	11.9576-9948.2 11.0101-5409.2 11.8171-0008.1 11.8116-0410.2	220810 260035 990049 390589	2		D=57, - Halter Hülensatz Führungsbolzen Haltefeder	ATE ATE ATE ATE
	1.8 TFSI 2.0 quattro 2.0 TDI quattro 2.0 TFSI 2.0 TFSI	118 195 125 147 155		06.08 05.08 06.08 07.06 05.10	06.14 06.14 06.14 06.14 06.14	PR: 1LM PR: 1LM PR: 1LM PR: 1LM PR: 1LM	11.9576-9948.2 11.0101-5409.2 11.8171-0008.1 11.8116-0410.2	220810 260035 990049 390589	2		D=57, - Halter Hülensatz Führungsbolzen Haltefeder	ATE ATE ATE ATE



AUDI TT Roadster (07-14)

	1.8 TFSI 2.0 quattro 2.0 TDI quattro 2.0 TFSI 2.0 TFSI quattro	118 195 125 147 147	06.08 05.08 06.08 02.07 05.08	06.14 06.14 06.14 06.14 06.14		03.2123-3549.3 010809			Thz 23,81	ATE
	3.2 quattro RS 2.5 TFSI RS 2.5 TFSI plus TTS 2.0 TFSI	184 250 265 200	02.07 05.09 02.12 05.08	06.14 06.14 06.14 06.14		03.2125-5112.3 010966			Thz 25,40	ATE
	1.8 TFSI 2.0 quattro 2.0 TDI quattro 2.0 TFSI 2.0 TFSI 2.0 TFSI quattro 2.0 TFSI quattro 3.2 quattro	118 195 125 147 155 147 155 184	06.08 05.08 06.08 02.07 05.10 05.08 05.10 02.07	06.14 06.14 06.14 06.14 06.14 06.14 06.14 06.14	PR: 1LJ PR: 1LJ PR: 1LJ PR: 1LJ PR: 1LJ PR: 1LJ PR: 1LJ	11.9541-9553.2 11.9541-9554.2 11.0101-5409.2 11.8171-0008.1 11.8116-0351.1	220563 220564 260035 990049 390538	2	D=54, - Halter D=54, - Halter Hülensatz Führungsbolzen Haltefeder	ATE ATE ATE ATE ATE
	1.8 TFSI 2.0 quattro 2.0 TDI quattro 2.0 TFSI 2.0 TFSI 2.0 TFSI quattro 2.0 TFSI quattro 3.2 quattro	118 195 125 147 155 147 155 184	06.08 05.08 06.08 02.07 05.10 05.08 05.10 02.07	06.14 06.14 06.14 06.14 06.14 06.14 06.14 06.14	PR: 1LL PR: 1LL PR: 1LL PR: 1LL PR: 1LL PR: 1LL PR: 1LL	11.9541-9553.2 11.9541-9554.2 11.0101-5409.2 11.8171-0008.1 11.8116-0351.1	220563 220564 260035 990049 390538	2	D=54, - Halter D=54, - Halter Hülensatz Führungsbolzen Haltefeder	ATE ATE ATE ATE ATE
	1.8 TFSI 2.0 quattro 2.0 TDI quattro 2.0 TFSI 2.0 TFSI 2.0 TFSI quattro 2.0 TFSI quattro 3.2 quattro	118 195 125 147 147 147 184	06.08 05.08 06.08 02.07 05.08 05.08 02.07	06.14 06.14 06.14 06.14 06.14 06.14 06.14	PR: 1LK PR: 1LK PR: 1LK PR: 1LK,1LM PR: 1LK PR: 1LK,1LM	11.9576-9948.2 11.0101-5409.2 11.8171-0008.1 11.8116-0410.2	220810 260035 990049 390589	2	D=57, - Halter Hülensatz Führungsbolzen Haltefeder	ATE ATE ATE ATE
	1.8 TFSI 2.0 quattro 2.0 TDI quattro 2.0 TFSI 2.0 TFSI 2.0 TFSI quattro 2.0 TFSI quattro TTS 2.0 TFSI	118 195 125 147 155 147 155 200	06.08 05.08 06.08 02.07 05.10 05.08 05.10 02.07	06.14 06.14 06.14 06.14 06.14 06.14 06.14 06.14	PR: 1LM PR: 1LM PR: 1LM PR: 1LM PR: 1LM PR: 1LM PR: 1LM	11.9576-9948.2 11.0101-5409.2 11.8171-0008.1 11.8116-0410.2	220810 260035 990049 390589	2	D=57, - Halter Hülensatz Führungsbolzen Haltefeder	ATE ATE ATE ATE
	TTS 2.0 TFSI	200	05.08	06.14	PR: 1LN	11.9576-9948.2 11.0101-5409.2 11.8171-0008.1 11.8116-0006.2	220810 260035 990049 390601	2	D=57, - Halter Hülensatz Führungsbolzen Haltefeder	ATE ATE ATE ATE
	1.8 TFSI 2.0 quattro 2.0 TDI quattro 2.0 TFSI 2.0 TFSI 2.0 TFSI quattro 2.0 TFSI quattro 3.2 quattro TTS 2.0 TFSI	118 195 125 147 155 147 155 184 200	06.08 05.08 06.08 02.07 05.10 05.08 05.10 02.07 05.08	06.14 06.14 06.14 06.14 06.14 06.14 06.14 06.14 06.14	PR: 1LJ,1LL PR: 1LJ,1LL PR: 1LJ,1LL PR: 1LJ,1LL PR: 1LJ,1LL PR: 1LJ,1LL PR: 1LJ,1LL PR: 1LJ,1LL	83.7847-0620.3	331110	2	L=620	
	1.8 TFSI 2.0 quattro 2.0 TDI quattro 2.0 TFSI 2.0 TFSI 2.0 TFSI quattro 2.0 TFSI quattro 3.2 quattro TTS 2.0 TFSI	118 195 125 147 155 147 155 184 200	06.08 05.08 06.08 02.07 05.10 05.08 05.10 02.07 05.08	06.14 06.14 06.14 06.14 06.14 06.14 06.14 06.14 06.14	PR: 1LK,1LM PR: 1LK,1LM PR: 1LK,1LM PR: 1LK,1LM PR: 1LK,1LM PR: 1LK,1LM PR: 1LK,1LM	83.7849-0554.3	331112	2	L=554	
	1.8 TFSI 2.0 TFSI 2.0 TFSI	118 147 155	06.08 02.07 05.10	06.14 06.14 06.14	PR: 1KZ,2ED PR: 1KZ,2ED PR: 1KZ,2ED	24.3387-1717.7 24.3387-1718.7 24.0101-3803.2	220757 220758 260101		D=38, - Halter D=38, - Halter Bremsattel-Zubehör	TRW TRW TRW
	2.0 quattro 2.0 TDI quattro 2.0 TFSI quattro 2.0 TFSI quattro 3.2 quattro	195 125 147 155 184	05.08 06.08 05.05 05.10 02.07	06.14 06.14 06.14 06.14 06.14	PR: 1KJ PR: 1KJ PR: 1KJ PR: 1KJ	24.3414-1709.7 24.3414-1710.7	220631 220632		D=41, - Halter D=41, - Halter	TRW TRW
	2.0 quattro 2.0 TDI quattro 2.0 TFSI quattro 3.2 quattro RS 2.5 TFSI	195 125 147 184 250	05.08 06.08 05.08 02.07 05.09	06.14 06.14 06.14 06.14 06.14	PR: 2EA,2EF PR: 2EA,2EF PR: 2EA,2EF PR: 2EA,2EF PR: 2EF	24.3417-1711.7 24.3417-1712.7	220883 220884		D=41, - Halter D=41, - Halter	TRW TRW
	1.8 TFSI 2.0 quattro 2.0 TDI quattro 2.0 TFSI 2.0 TFSI 2.0 TFSI quattro 2.0 TFSI quattro 3.2 quattro RS 2.5 TFSI RS 2.5 TFSI plus TTS 2.0 TFSI	118 195 125 147 155 147 155 184 250 265 200	06.08 05.08 06.08 02.07 05.10 05.08 05.10 02.07 05.09 02.12 05.08	06.14 06.14 06.14 06.14 06.14 06.14 06.14 06.14 06.14 06.14 06.14		83.7849-0250.3	331111	2	L=250	















								
AUDI TT Roadster (07-14)								
	1.8 TFSI 118 2.0 quattro 195 2.0 TDI quattro 125 2.0 TFSI 147 2.0 TFSI 155 2.0 TFSI quattro 147 2.0 TFSI quattro 155 3.2 quattro 184 RS 2.5 TFSI 250 RS 2.5 TFSI plus 265 TTS 2.0 TFSI 200		06.08 05.08 06.08 02.07 05.10 05.08 05.10 02.07 05.09 02.12 05.08	06.14 06.14 06.14 06.14 06.14 06.14 06.14 06.14 06.14 06.14 06.14	24.2415-1713.3	030132		Gz 15,87, + Sensor
	1.8 TFSI 118 2.0 quattro 195 2.0 TDI quattro 125 2.0 TFSI 147 2.0 TFSI 155 2.0 TFSI quattro 147 2.0 TFSI quattro 155 3.2 quattro 184 TTS 2.0 TFSI 200		06.08 05.08 06.08 02.07 05.10 05.08 05.10 02.07 05.09 02.12 05.08	06.14 06.14 06.14 06.14 06.14 06.14 06.14 06.14 06.14 06.14 06.14	24.2519-1705.3	040095	PR: 0EJ	Nz 19,05
BMW 1er Reihe/E81/E87 Limousine (04-11)								
	116 d 85 116 i 85 116 i 90 116 i 90 118 d 90 118 d 105 118 i 95 118 i 105 120 d 120 120 d 130 120 i 110 120 i 125		03.09 09.04 09.07 01.09 09.04 04.07 09.04 04.07 09.04 03.07 09.04 04.07	08.09 08.07 12.08 08.09 03.07 08.09 03.07 08.09 02.07 08.09 03.07 08.09	03.7848-4003.4	300235		8" ATE
	116 d 66 116 d 85 116 i 90 118 d 105 118 i 105 120 d 130 120 i 125		01.11 09.09 09.09 09.09 09.09 09.09 09.09	12.11 05.11 05.11 05.11 05.11 05.11 05.11	03.7848-4003.4	300235	- Start/Stop-Anlage ¹⁾	8" ATE
	123 d 150 130 i 190 130 i 195		10.07 03.05 09.05	08.09 05.11 05.11	03.7848-5003.4	300236		8" ATE
	123 d 150		09.09	05.11	03.7848-5003.4	300236	- Start/Stop-Anlage ¹⁾	8" ATE
	116 d ◀ 66 116 d ◀ 85 116 i ◀ 85 116 i ◀ 90 116 i ◀ 90 118 d ◀ 90 118 d ◀ 105 118 i ◀ 95 118 i ◀ 105 120 d ◀ 120 120 d ◀ 130 120 i ◀ 110 120 i ◀ 125		01.11 03.09 09.04 09.07 01.09 09.04 04.07 09.04 04.07 09.04 03.07 09.04 04.07	12.11 05.11 08.07 12.08 05.11 03.07 05.11 03.07 05.11 02.07 05.11 03.07 05.11	03.2023-2407.3	010796		THz 23,81/22,20 ATE
	123 d ◀ 150 130 i ◀ 190 130 i ◀ 195		10.07 03.05 09.05	05.11 05.11 05.11	03.2025-1904.3	010797		THz 25,40/22,20 ATE
	116 d 66 116 d 85 116 i 85 116 i 90 118 d 90 118 i 95		01.11 03.09 09.04 09.07 09.04 09.04	12.11 05.11 05.11 12.08 05.11 03.07	24.3541-1835.7 24.3541-1836.7	220739 220740	<input checked="" type="checkbox"/> - Performance Parts <input type="checkbox"/> - Performance Parts	D=54, - Halter D=54, - Halter TRW
	120 d 120 120 i 110		09.04 09.04	02.07 12.05	11.9541-9575.2 11.9541-9576.2 11.0101-5402.2 11.8171-0008.1 11.8116-0206.1	220829 220830 260009 990049 390593	<input checked="" type="checkbox"/> - Performance Parts <input type="checkbox"/> - Performance Parts 2 Länge 177mm ³⁾	D=54, - Halter D=54, - Halter Hülsensatz Führungsbolzen Haltefeder ATE
	116 i 90 118 d 90 118 d 105 118 i 95 118 i 105 120 i 110		01.09 09.04 04.07 09.04 04.07 01.06	05.11 03.07 05.11 03.07 05.11 03.07	24.3541-1835.7 24.3541-1836.7	220739 220740	<input checked="" type="checkbox"/> - Performance Parts <input type="checkbox"/> - Performance Parts	D=54, - Halter D=54, - Halter TRW
	120 d 120 120 d 130 120 i 110 120 i 125		09.04 03.07 09.04 04.07	02.07 05.11 03.07 05.11	24.3541-9521.5 24.3541-9522.5 11.0101-5402.2 11.8171-0008.1 11.8116-0339.2	240723 240724 260009 990049 390528	<input checked="" type="checkbox"/> - Performance Parts <input type="checkbox"/> - Performance Parts 2	D=54, - Halter D=54, - Halter Hülsensatz Führungsbolzen Haltefeder ATE

¹⁾ - idling stop system / - dispositivo start/stop / - unité marche/arrêt / - unidad arranque/paro

²⁾ + 5 door / + 5 porte / + 5 portes / + 5 puertas

























³⁾ length 177mm / lunghezza 177mm / longueur 177mm / largo 177mm

⁴⁾ + 3 door / + 3 porte / + 3 portes / + 3 puertas

										
BMW 1er Reihe/E81/E87 Limousine (04-11)										
	123 d 130 i 130 i	150 190 195		10.07 03.05 09.05	05.11 05.11 05.11	24.3541-9521.5 24.3541-9522.5 11.0101-5402.2 11.8171-0008.1 11.8116-0339.2	240723 240724 260009 990049 390528	2	- Performance Parts - Performance Parts D=54, - Halter D=54, - Halter Hülzensatz Führungsbolzen Haltefeder	ATE ATE ATE ATE ATE
	116 d 116 d 116 i 116 i 116 i 118 d 118 d 118 i 118 i 120 d 120 d 120 i 120 i 123 d 130 i 130 i	66 85 85 90 90 90 105 95 105 120 130 110 125 150 190 195		01.11 03.09 09.04 09.07 01.09 09.04 04.07 09.04 04.07 09.04 03.07 09.04 04.07 10.07 03.05 09.05	12.11 05.11 08.07 12.08 05.11 03.07 05.11 05.11 02.07 05.11 03.07 03.07 05.11 05.11 05.11 05.11	24.5174-0526.3	331365	2	L=526	
	116 d 116 d 116 i 116 i 118 d 118 i	66 85 85 90 90 95		01.11 03.09 09.04 09.07 09.04 09.04	12.11 05.11 08.07 12.08 03.07 03.07	24.3401-1707.7 24.3401-1708.7	220775 220776	2	- Performance Parts - Performance Parts D=40, - Halter D=40, - Halter	TRW TRW
	116 i 118 i 118 i 120 i 120 i	90 95 105 110 125		01.09 09.04 04.07 09.04 04.07	05.11 03.07 05.11 03.07 05.11	24.3401-1707.7 24.3401-1708.7	220775 220776	2	- Performance Parts - Performance Parts D=40, - Halter D=40, - Halter	TRW TRW
	118 d 118 d 120 d 120 d	90 105 120 130		09.04 04.07 09.04 03.07	03.07 05.11 02.07 05.11	11.8170-0755.1 11.0101-5402.2 11.8171-0008.1 11.8116-0066.1	260119 260009 990049 390577	2	Halter Hülzensatz Führungsbolzen Haltefeder	ATE ATE ATE ATE
	120 d 123 d 130 i 130 i	130 150 190 195		03.07 10.07 03.05 09.05	05.11 02.10 05.11 05.11	11.9421-9911.2 11.9421-9912.2 11.8170-0755.1 11.0101-5402.2 11.8171-0008.1 11.8116-0066.1	220825 220826 260119 260009 990049 390577	2	- Performance Parts - Performance Parts D=42, - Halter D=42, - Halter Halter Hülzensatz Führungsbolzen Haltefeder	ATE ATE ATE ATE ATE ATE
	116 d 116 d 116 i 116 i 116 i 118 d 118 d 118 i 118 i 120 d 120 d 120 i 120 i 123 d 130 i 130 i	66 85 85 90 90 90 105 95 105 120 130 110 125 150 190 195		01.11 03.09 09.04 09.07 01.09 09.04 04.07 09.04 04.07 09.04 03.07 09.04 04.07 10.07 03.05 09.05	12.11 05.11 08.07 12.08 05.11 03.07 05.11 03.07 05.11 02.07 05.11 03.07 05.11 05.11 05.11 05.11	24.5137-0221.3 24.5125-0230.3	331302 331277	2 2	L=221 L=230	
	116 d 116 d 116 i 116 i 116 i 118 d 118 d 118 i 118 i 120 d 120 d 120 i 120 i 123 d 130 i 130 i	66 85 85 90 90 90 105 95 105 120 130 110 125 150 190 195		01.11 03.09 09.04 09.07 01.09 09.04 04.07 09.04 04.07 09.04 03.07 09.04 04.07 10.07 03.05 09.05	12.11 05.11 08.07 12.08 05.11 03.07 05.11 03.07 05.11 02.07 05.11 03.07 05.11 05.11 05.11 05.11	24.3727-0234.2	580234	2	L=1435	
	116 d 116 d 116 i 116 i 116 i 118 d 118 d 118 i 118 i 120 d 120 d 120 i 120 i	66 85 85 90 90 90 105 95 105 120 130 110 125		01.11 03.09 09.04 09.07 01.09 09.04 04.07 09.04 04.07 09.04 03.07 09.04 04.07	12.11 05.11 08.07 12.08 05.11 03.07 05.11 03.07 05.11 02.07 05.11 03.07 05.11	24.2419-1713.3	030093		Gz 19,05	

























1) + 5 door / + 5 porte / + 5 portes / + 5 puertas

2) + 3 door / + 3 porte / + 3 portes / + 3 puertas

									
BMW 1er Reihe/E81/E87 Limousine (04-11)									
	123 d 130 i 130 i	150 190 195	10.07 03.05 09.05	05.11 05.11 05.11	24.2419-1713.3	030093		Gz 19,05	
BMW 1er Reihe/E82 Coupe (07-13)									
	123 d 125 i 118 d 120 d 120 i 120 i 123 d 135 i	150 160 105 130 115 125 150 225	10.07 03.08 09.09 10.07 09.09 09.09 09.09 10.07	08.09 10.13 10.13 10.13 10.13 10.13 10.13 10.13	03.7848-4003.4	300235		8" ATE	
					03.7848-4003.4	300235	- Start/Stop-Anlage ¹⁾	8" ATE	
					03.7848-4003.4	300235	- Start/Stop-Anlage ¹⁾	8" ATE	
					03.7848-5003.4	300236	- Start/Stop-Anlage ¹⁾	8" ATE	
					03.7845-0103.4	300268		8" ATE	
	118 d 120 d 120 i 120 i 125 i 123 d 135 i	105 130 115 125 160 150 225	09.09 10.07 09.09 09.09 03.08 10.07 10.07	10.13 10.13 10.13 10.13 10.13 10.13 10.13	03.2023-2407.3	010796		THz 23,81/22,20 ATE	
					03.2025-1904.3	010797		THz 25,40/22,20 ATE	
	120 d 120 i 120 i 125 i 118 d 123 d M	130 115 125 160 105 150 250	10.07 09.09 09.09 03.08 09.09 10.07 05.11	10.13 10.13 10.13 10.13 10.13 10.13 10.13	24.3541-9521.5 24.3541-9522.5 11.0101-5402.2 11.8171-0008.1 11.8116-0339.2 24.3541-1835.7 24.3541-1836.7 24.3541-9521.5 24.3541-9522.5 11.0101-5402.2 11.8171-0008.1 11.8116-0339.2 11.0441-6008.2 11.8171-0008.1	240723 240724 260009 990049 390528 220739 220740 240723 240724 260009 990049 390528 250038 990049	 - Performance Parts  - Performance Parts  - Performance Parts  - Performance Parts 2	D=54, - Halter D=54, - Halter Hülzensatz Führungsbolzen Haltefeder D=54, - Halter D=54, - Halter D=54, - Halter D=54, - Halter Hülzensatz Führungsbolzen Haltefeder Dichtungssatz Führungsbolzen	ATE ATE ATE ATE TRW TRW ATE ATE ATE ATE ATE ATE
	118 d 120 d 120 i 120 i 123 d 125 i 135 i M	105 130 115 125 150 160 225 250	09.09 10.07 09.09 09.09 10.07 03.08 10.07 05.11	10.13 10.13 10.13 10.13 10.13 10.13 10.13 10.13	24.5174-0526.3	331365	2	L=526	
	118 d 120 d 120 i 120 i 125 i 123 d	105 130 115 125 160 150	09.09 10.07 09.09 09.09 03.08 10.07	10.13 10.13 10.13 10.13 10.13 10.13	11.8170-0755.1 11.0101-5402.2 11.8171-0008.1 11.8116-0066.1	260119 260009 990049 390577	2	Halter Hülzensatz Führungsbolzen Haltefeder ATE ATE ATE ATE	
					11.9421-9911.2 11.9421-9912.2 11.8170-0755.1 11.0101-5402.2 11.8171-0008.1 11.8116-0066.1	220825 220826 260119 260009 990049 390577	 - Performance Parts  - Performance Parts 2	D=42, - Halter D=42, - Halter Halter Hülzensatz Führungsbolzen Haltefeder ATE ATE ATE ATE	
	118 d 120 d 120 i 120 i 123 d 125 i 135 i M	105 130 115 125 150 160 225 250	09.09 10.07 09.09 09.09 10.07 03.08 10.07 05.11	10.13 10.13 10.13 10.13 10.13 10.13 10.13 10.13	83.7850-0180.3 24.5137-0221.3 24.5125-0230.3	331054 331302 331277	2 2 2	am Bremsattel ²⁾ am Bremsattel ²⁾ L=180 L=221 L=230	
	118 d 120 d 120 i 120 i 123 d 125 i 135 i M	105 130 115 125 150 160 225 250	09.09 10.07 09.09 09.09 10.07 03.08 10.07 05.11	10.13 10.13 10.13 10.13 10.13 10.13 10.13 10.13	24.3727-0234.2	580234	2	L=1435	
BMW 1er Reihe/E88 Cabrio (08-13)									
	118 d 118 i 120 d 120 d 120 i 120 i 128 i 125 i 123 d 135 i 135 i	105 105 130 145 115 125 171 160 150 225 240	09.08 03.08 03.08 03.08 03.08 03.08 03.08 03.08 09.08 03.08 03.08	10.13 10.13 10.13 10.13 10.13 10.13 10.13 10.13 10.13 10.13 10.13	03.7848-4003.4	300235	- Start/Stop-Anlage ¹⁾	8" ATE	
					03.7848-4003.4	300235		8" ATE	
					03.7848-5003.4	300236	- Start/Stop-Anlage ¹⁾	8" ATE	
					03.7845-0103.4	300268		8" ATE	

¹⁾ - idling stop system / - dispositivo start/stop / - unité marche/arrêt / - unidad arranque/paro

²⁾ on the brake caliper / sulla pinza freno / sur l'étrier de frein / a la pinza de freno

								
BMW 1er Reihe/E88 Cabrio (08-13)								
	118 d 118 i 120 d 120 d 120 i 120 i 125 i 128 i	105 105 130 145 115 125 160 171	09.08 03.08 03.08 03.08 03.08 03.08 03.08 03.08	10.13 10.13 10.13 10.13 10.13 10.13 10.13 10.13	03.2023-2407.3	010796		Thz 23,81/22,20 ATE
	123 d 135 i 135 i	150 225 240	09.08 03.08 03.08	10.13 10.13 10.13	03.2025-1904.3	010797		Thz 25,40/22,20 ATE
	118 d 118 i 120 d 120 d 120 i 120 i 125 i 128 i	105 105 130 145 115 125 160 171	09.08 03.08 03.08 03.08 03.08 03.08 03.08 03.08	10.13 10.13 10.13 10.13 10.13 10.13 10.13 10.13	24.3541-1835.7 24.3541-1836.7	220739 220740	 - Performance Parts  - Performance Parts	D=54, - Halter D=54, - Halter TRW TRW
	120 d 120 d 120 i 120 i 125 i 128 i	130 145 115 125 160 171	03.08 03.08 03.08 03.08 03.08 03.08	10.13 10.13 10.13 10.13 10.13 10.13	24.3541-9521.5 24.3541-9522.5 11.0101-5402.2 11.8171-0008.1 11.8116-0339.2	240723 240724 260009 990049 390528	 - Performance Parts  - Performance Parts	D=54, - Halter D=54, - Halter Hülensatz Führungsbolzen Halterfeder ATE ATE ATE ATE
	123 d	150	09.08	10.13	24.3541-9521.5 24.3541-9522.5 11.0101-5402.2 11.8171-0008.1 11.8116-0339.2	240723 240724 260009 990049 390528	 - Performance Parts  - Performance Parts	D=54, - Halter D=54, - Halter Hülensatz Führungsbolzen Halterfeder ATE ATE ATE ATE
	118 d 118 i 120 d 120 d 120 i 120 i 123 d 125 i 128 i 135 i 135 i	105 105 130 145 115 125 150 160 171 225 240	09.08 03.08 03.08 03.08 03.08 03.08 09.08 03.08 03.08 03.08 03.08	10.13 10.13 10.13 10.13 10.13 10.13 10.13 10.13 10.13 10.13 10.13	24.5174-0526.3	331365	2	L=526
	118 d 118 i 120 d 120 d 120 i 120 i 125 i 128 i	105 105 130 145 115 125 160 171	09.08 03.08 03.08 03.08 03.08 03.08 03.08 03.08	10.13 10.13 10.13 10.13 10.13 10.13 10.13 10.13	11.8170-0755.1 11.0101-5402.2 11.8171-0008.1 11.8116-0066.1	260119 260009 990049 390577	2	Halter Hülensatz Führungsbolzen Halterfeder ATE ATE ATE ATE
	123 d	150	09.08	10.13	11.9421-9911.2 11.9421-9912.2 11.8170-0755.1 11.0101-5402.2 11.8171-0008.1 11.8116-0066.1	220825 220826 260119 260009 990049 390577	 - Performance Parts  - Performance Parts	D=42, - Halter D=42, - Halter Halter Hülensatz Führungsbolzen Halterfeder ATE ATE ATE ATE
	118 d 118 i 120 d 120 d 120 i 120 i 123 d 125 i 128 i 135 i 135 i	105 105 130 145 115 125 150 160 171 225 240	09.08 03.08 03.08 03.08 03.08 03.08 09.08 03.08 03.08 03.08 03.08	10.13 10.13 10.13 10.13 10.13 10.13 10.13 10.13 10.13 10.13 10.13	83.7850-0180.3 24.5125-0230.3 24.5137-0221.3	331054 331277 331302	2 2 2	am Bremssattel ¹⁾ am Bremssattel ¹⁾ L=180 L=230 L=221
	118 d 118 i 120 d 120 d 120 i 120 i 123 d 125 i 128 i 135 i 135 i	105 105 130 145 115 125 150 160 171 225 240	09.08 03.08 03.08 03.08 03.08 03.08 09.08 03.08 03.08 03.08 03.08	10.13 10.13 10.13 10.13 10.13 10.13 10.13 10.13 10.13 10.13 10.13	24.3727-0234.2	580234	2	L=1435
BMW 1er Reihe/F20/F21 Limousine (11-)								
	114 d 114 i 116 d 116 d 116 d ed 116 i 116 i 118 d 118 d 118 d xDrive 118 d xDrive 118 i 118 i 120 d	70 75 85 85 85 80 100 105 110 105 110 100 125 120	10.12 09.12 06.11 03.15 03.12 03.15 06.11 06.11 03.15 05.13 03.15 03.15 06.11 06.11		24.5169-0590.3	331422	2	L=590

¹⁾ on the brake caliper / sulla pinza freno / sur l'étrier de frein / a la pinza de freno

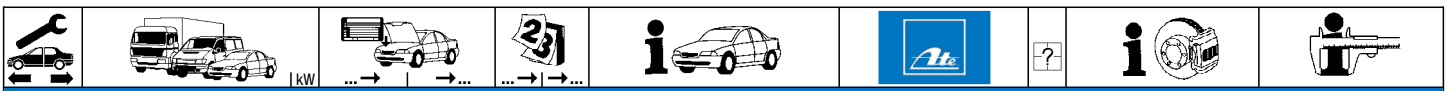

BMW 1er Reihe/F20/F21 Limousine (11-)

















↔	120 d	135	06.11	24.5169-0590.3	331422	2		L=590
	120 d	140	03.15					
	120 d xDrive	135	07.12					
	120 d xDrive	140	03.15					
	120 i	130	03.15					
	120 i	135	09.15					
	125 d	160	03.12					
	125 d	165	03.15					
	125 i	160	03.12					
	125 i	165	09.15					
	M 135 i	235	09.12					
	M 135 i	240	03.15					
	M 135 i xDrive	235	07.12					
	M 135 i xDrive	240	03.15					
	M 140 i	250	09.15					
	M 140 i xDrive	250	09.15					
↔	114 d	70	10.12	24.5125-0230.3	331277	2		L=230
	114 i	75	09.12					
	116 d	85	06.11					
	116 d	85	03.15					
	116 d ed	85	03.12					
	116 i	80	03.15					
	116 i	100	06.11					
	118 d	105	06.11					
	118 d	110	03.15					
	118 d xDrive	105	05.13					
	118 d xDrive	110	03.15					
	118 i	100	03.15					
	118 i	125	06.11					
	120 d	120	06.11					
	120 d	135	06.11					
	120 d	140	03.15					
	120 d xDrive	135	07.12					
	120 d xDrive	140	03.15					
	120 i	130	03.15					
	120 i	135	09.15					
	125 d	160	03.12					
	125 d	165	03.15					
	125 i	160	03.12					
	125 i	165	09.15					
	M 135 i	235	09.12					
	M 135 i	240	03.15					
	M 135 i xDrive	235	07.12					
	M 135 i xDrive	240	03.15					
M 140 i	250	09.15						
M 140 i xDrive	250	09.15						
↔	114 i	75	09.12	24.3727-0248.2	580248	2 ↓		L=1463
	M 135 i	235	01.15					
	M 135 i	240	03.15					
	M 135 i xDrive	235	01.15					
	M 135 i xDrive	240	03.15					
	M 140 i	250	09.15					
	M 140 i xDrive	250	09.15					
↔	114 d	70	10.12	24.3727-0248.2	580248	2 ↓	- Heissstandausführung ¹⁾	L=1463
	116 d	85	06.11					
	116 d	85	03.15					
	116 d ed	85	03.12					
	116 i	80	03.15					
	116 i	100	06.11					
	118 d	105	06.11					
	118 d	110	03.15					
	118 d xDrive	105	05.13					
	118 d xDrive	110	03.15					
	118 i	100	03.15					
	118 i	125	06.11					
	120 d	120	06.11					
	120 d	135	06.11					
	120 d	140	03.15					
	120 d xDrive	135	07.12					
	120 d xDrive	140	03.15					
	120 i	130	03.15					
	120 i	135	09.15					
	125 d	160	03.12					
	125 d	165	03.15					
125 i	160	03.12						
125 i	165	09.15						

BMW 2er Reihe/F22 Coupe (13-)

↔	218 d	100	07.15	24.5169-0590.3	331422	2		L=590
	218 d	105	10.13					
	218 d	110	07.15					
	218 i	100	03.15					
	220 d	120	11.14					
	220 d	135	10.13					
	220 d	140	11.14					
	220 d xDrive	120	03.15					
	220 d xDrive	140	03.15					
	↓							
	↓							

¹⁾ - hot country version / - versione per paesi tropicali / - version pour pays chauds / - equipamiento para países cálidos



								
BMW 2er Reihe/F22 Coupe (13-)								
	220 i 225 d 225 d 228 i 230 i M 235 i M 235 i xDrive M 240 i M 240 i xDrive	135 160 165 180 185 240 240 250 250	10.13 10.13 07.14 07.14 09.15 10.13 07.14 09.15 09.15		24.5169-0590.3	331422	2	L=590
	218 d 218 d 218 d 218 i 220 d 220 d 220 d 220 d xDrive 220 d xDrive 220 i 225 d 225 d 228 i 230 i M 235 i M 235 i xDrive M 240 i M 240 i xDrive	100 105 110 100 120 135 140 120 140 135 160 165 180 185 240 240 250 250	07.15 10.13 07.15 03.15 11.14 10.13 11.14 03.15 03.15 10.13 10.13 07.14 07.14 09.15 10.13 07.14 09.15 09.15		24.5125-0230.3	331277	2	L=230
	218 d 218 d 218 d 218 i M 240 i M 240 i xDrive	100 105 110 100 250 250	07.15 10.13 07.15 03.15 09.15 09.15		24.3727-0248.2	580248	2 ↓ - Heisslandausführung ¹⁾	L=1463
	220 d 220 d 220 d 220 d xDrive 220 d xDrive 225 d 225 d	120 135 140 120 140 160 165	11.14 10.13 11.14 03.15 03.15 10.13 07.14		24.3727-0248.2	580248	2 ↓ - Anhängerkupplung ²⁾	L=1463
BMW 2er Reihe/F23 Cabrio (14-)								
	218 d 218 d 218 i 220 d 220 d 220 i 225 d 228 i 228 i xDrive 230 i M 235 i M 235 i xDrive M 240 i M 240 i xDrive	100 110 100 120 140 135 165 180 180 185 240 240 250 250	07.15 07.15 03.15 07.15 11.14 11.14 07.15 11.14 11.14 09.15 11.14 07.15 09.15 09.15		24.5169-0590.3	331422	2	L=590
	218 d 218 d 218 i 220 d 220 d 220 i 225 d 228 i 228 i xDrive 230 i M 235 i M 235 i xDrive M 240 i M 240 i xDrive	100 110 100 120 140 135 165 180 180 185 240 240 250 250	07.15 07.15 03.15 11.14 11.14 11.14 07.15 11.14 11.14 09.15 11.14 07.15 09.15 09.15		24.5125-0230.3	331277	2	L=230
	218 d 218 d 218 i	100 110 100	07.15 07.15 03.15		24.3727-0248.2	580248	2 ↓ - Heisslandausführung ¹⁾	L=1463
	220 d 220 d 225 d	120 140 165	11.14 11.14 07.15		24.3727-0248.2	580248	2 ↓ - Anhängerkupplung ²⁾	L=1463
BMW 3er Reihe/E36 Limousine (90-98)								
	316 i 316 i 318 i 318 i 318 is 320 i 320 i 323 i 325 i	73 75 83 85 103 110 110 125 141	09.90 09.90 12.90 10.93 03.93 09.90 09.90 03.95 09.90	09.93 + ABS 08.94 + ABS 10.93 + ABS 08.94 + ABS 08.94 + ABS 08.96 + ASC 08.94 - ASC 08.96 + ASC 08.96 + ASC	10.6360-1903.4	300093		10" (MKIV) ATE

¹⁾ - hot country version / - versione per paesi tropicali / - version pour pays chauds / - equipamiento para países cálidos

²⁾ - trailer hitch / - giunto rimorchio / - attache de remorque / - enganche de remorque

















BMW 3er Reihe/E36 Limousine (90-98)

	325 i	141		09.90	08.94	- ASC	10.6360-1903.4	300093		10" (MKIV)	ATE					
	325 td	85		09.91	08.96	+ ASC										
	325 td	85		09.91	08.94	- ASC										
	325 tds	105		05.93	08.96	+ ASC										
	325 tds	105		05.93	08.94	- ASC										
	328 i	142		01.95	08.96	+ ASC										
	M3 3.0	210		08.94	09.95											
	316 i	75		09.94	02.98	+ ABS						03.7760-3102.4	300139		10"	ATE
	318 i	85		09.94	02.98	+ ABS										
	318 is	103		09.94	02.98	+ ABS										
	318 is	103		09.95	02.98	+ ABS										
	318 tds	66		01.95	02.98	+ ABS										
	320 i	110		09.96	02.98	+ ASC										
	320 i	110		09.94	02.98	- ASC										
323 i	125		09.96	02.98	+ ASC											
323 i	125		03.95	02.98	- ASC											
325 i	141		09.96	02.98	+ ASC											
325 i	141		09.94	02.98	- ASC											
325 td	85		09.96	02.98	+ ASC											
325 td	85		09.94	02.98	- ASC											
325 tds	105		09.96	02.98	+ ASC											
325 tds	105		09.94	02.98	- ASC											
328 i	142		09.96	02.98	+ ASC											
328 i	142		01.95	02.98	- ASC											
	316 i	73		09.90	09.93	- ABS	24.2023-1601.3	010341		Thz 23,81	TRW					
	318 i	83		12.90	10.93	- ABS										
	320 i	110		09.90	02.98	- ABS										
	325 td	85		09.91	02.98	- ABS										
	316 i	73		09.90	09.93	+ ABS						10.6123-0239.3	010335		Thz 23,81 (MKIV)	ATE
	316 i	75		09.90	08.94	+ ABS										
	318 i	83		12.90	10.93	+ ABS										
	318 i	85		10.93	08.94	+ ABS										
	318 is	103		03.93	08.94	+ ABS										
	320 i	110		09.90	08.96	+ ASC										
	320 i	110		09.90	08.94	- ASC										
	323 i	125		03.95	08.96	+ ASC										
	325 i	141		09.90	08.96	+ ASC										
	325 i	141		09.90	08.94	- ASC										
325 td	85		09.91	08.96	+ ASC											
325 td	85		09.91	08.94	- ASC											
325 tds	105		05.93	08.96	+ ASC											
325 tds	105		05.93	08.94	- ASC											
328 i	142		01.95	08.96	+ ASC											
	316 i	75		09.94	02.98	+ ABS	03.2023-0987.3	010473		Thz 23,81/20,64	ATE					
	318 i	85		09.94	02.98	+ ABS										
	318 is	103		09.94	02.98	+ ABS										
	318 is	103		09.95	02.98	+ ABS										
	318 tds	66		01.95	02.98	+ ABS										
	320 i	110		09.96	02.98	+ ASC										
	320 i	110		09.94	02.98	- ASC										
	323 i	125		09.96	02.98	+ ASC										
	323 i	125		03.95	02.98	- ASC										
	325 i	141		09.96	02.98	+ ASC										
	325 i	141		09.94	02.98	- ASC										
	325 td	85		09.96	02.98	+ ASC										
	325 td	85		09.94	02.98	- ASC										
	325 tds	105		09.96	02.98	+ ASC										
325 tds	105		09.94	02.98	- ASC											
328 i	142		09.96	02.98	+ ASC											
328 i	142		01.95	02.98	- ASC											
	316 i	73		09.90	09.93		11.9541-9668.2	220422	2	 	D=54, - Halter	ATE				
	316 i	75		09.90	02.98								24.3541-9667.5	240529	D=54, - Halter	ATE
	318 i	83		12.90	10.93	- erhöhte Zuladung ³⁾							24.3541-9668.5	240530	D=54, - Halter	ATE
	318 i	85		10.93	02.98	- erhöhte Zuladung ³⁾							11.0230-0444.1	260104	Halter	ATE
	318 tds	66		01.95	02.98	- erhöhte Zuladung ³⁾							11.0441-5402.2	250028	Dichtungssatz	ATE
													11.8171-0008.1	990049	Führungsbolzen	ATE
													11.0101-5402.2	260009	Hülzensatz	ATE
													11.8116-0109.1	390495	Haltefeder	ATE
													11.8116-0206.1	390593	Haltefeder	ATE
															Länge 150mm ¹⁾	
															Länge 177mm ²⁾	
	318 i	83		12.90	10.93	+ erhöhte Zuladung ⁴⁾	11.9541-9588.2	220420	2	 	D=54, - Halter	ATE				
	318 i	85		10.93	02.98	+ erhöhte Zuladung ⁴⁾							24.3541-9587.5	240527	D=54, - Halter	ATE
	318 is	103		03.93	02.98								24.3541-9588.5	240528	D=54, - Halter	ATE
	318 is	103		09.95	02.98								11.8170-0729.1	260107	Halter	ATE
	318 tds	66		01.95	02.98	+ erhöhte Zuladung ⁴⁾							11.0441-5402.2	250028	Dichtungssatz	ATE
	320 i	110		09.90	02.98								11.8171-0008.1	990049	Führungsbolzen	ATE
	323 i	125		03.95	02.98								11.0101-5402.2	260009	Hülzensatz	ATE
	325 i	141		09.90	09.95								11.8116-0109.1	390495	Haltefeder	ATE
	325 td	85		09.91	02.98								11.8116-0206.1	390593	Haltefeder	ATE
	325 tds	105		05.93	02.98										Länge 150mm ¹⁾	
	325 tds	105		05.93	02.98										Länge 177mm ²⁾	
	328 i	142		01.95	02.98											
		M3 3.0	210		08.94	09.95								11.3601-8515.2	220323	
M3 3.2		236		09.95	02.98		11.3601-8516.2	220324		D=60, - Halter	ATE					
							11.8171-0008.1	990049		Führungsbolzen	ATE					
							11.0441-6003.2	250037		Dichtungssatz	ATE					
							11.0101-5402.2	260009		Hülzensatz	ATE					
							11.8116-0083.1	390501		Haltefeder	ATE					
	316 i	73		09.90	09.93		24.5103-0430.3	331408	2		L=430					

1) length 150mm / lunghezza 150mm / longueur 150mm / largo 150mm
 2) length 177mm / lunghezza 177mm / longueur 177mm / largo 177mm
 3) - increased payload / - carico utile maggiorato / - charge utile augmentée / - incremento de carga
 4) + increased payload / + carico utile maggiorato / + charge utile augmentée / + incremento de carga



																
BMW 3er Reihe/E36 Limousine (90-98)																
	316 i	75	07.93	02.98	24.5103-0430.3	331408	2	L=430								
	318 i	83	12.90	10.93												
	318 i	85	10.93	02.98												
	318 is	103	03.93	02.98												
	318 is	103	09.95	02.98												
	318 tds	66	01.95	02.98												
	320 i	110	09.90	02.98												
	323 i	125	03.95	02.98												
	325 i	141	09.90	09.95												
	325 td	85	09.91	02.98												
	325 tds	105	05.93	02.98												
	328 i	142	01.95	02.98												
	M3 3.0	210	08.94	09.95					83.6150-0451.3	330283	2	L=450				
M3 3.2	236	09.95	02.98													
	320 i	110	09.90	02.98	- ABS	11.0441-3602.2	250008	2	Dichtungssatz Führungsbolzen Hülzensatz Haltefeder	ATE ATE						
	325 td	85	09.91	02.98	- ABS	11.8171-0008.1	990049									
	316 i	73	09.90	09.93	+ ABS	11.3361-8503.2	220016				2	D=36, - Halter D=36, - Halter D=36, - Halter Dichtungssatz Führungsbolzen Hülzensatz Haltefeder	ATE ATE			
	316 i	75	09.90	02.98	+ ABS	11.3361-8504.2	220017									
	318 i	83	12.90	10.93	+ ABS	24.3361-8503.5	240513									
	318 i	85	10.93	02.98	+ ABS	24.3361-8504.5	240514									
	318 is	103	03.93	02.98		11.0441-3602.2	250008									
	318 is	103	09.95	02.98		11.8171-0008.1	990049									
	318 tds	66	01.95	02.98	+ ABS	11.0101-5402.2	260009									
	320 i	110	09.90	02.98	+ ABS	11.8116-0066.1	390577									
	325 i	141	09.90	09.95												
	325 td	85	09.91	02.98	+ ABS											
	325 tds	105	05.93	02.98												
	323 i	125	03.95	02.98		11.9381-9959.2	220433							2	D=38, - Halter D=38, - Halter	ATE ATE
	328 i	142	01.95	02.98		11.9381-9960.2	220434									
	M3 3.0	210	08.94	09.95		11.8116-0066.1	390577							2	Haltefeder	ATE
	M3 3.2	236	09.95	02.98		11.0101-5402.2	260009								Hülzensatz	ATE
						11.8171-0008.1	990049								Führungsbolzen	ATE
						11.0441-4002.2	250011								Dichtungssatz	ATE
		316 i	73	09.90	09.93	+ Trommelbremse ¹⁾	24.5202-0204.3							331402	2	L=204
		316 i	75	09.90	02.98	+ Trommelbremse ¹⁾										
		318 i	83	12.90	09.93	+ Trommelbremse ¹⁾										
318 i		85	10.93	02.98	+ Trommelbremse ¹⁾											
318 tds		66	01.95	02.98	+ Trommelbremse ¹⁾											
316 i		73	09.90	09.93	+ ABS	24.5202-0204.3		331402	2	L=204 L=200						
316 i		75	09.90	02.98	+ ABS	83.7704-0200.3		330825								
318 i		83	12.90	10.93	+ ABS											
318 i		85	10.93	02.98	+ ABS											
318 is		103	03.93	02.98												
318 is		103	09.95	02.98												
318 tds		66	01.95	02.98	+ ABS											
320 i		110	09.90	02.98												
323 i	125	03.95	02.98													
325 i	141	09.90	09.95													
325 td	85	09.91	02.98													
325 tds	105	05.93	02.98													
328 i	142	01.95	02.98													
M3 3.0	210	08.94	09.95		24.5202-0204.3	331402	2	L=204								
M3 3.2	236	09.95	02.98		83.6124-0218.3	330455	2	L=215								
	316 i	73	09.90	09.93		24.3223-1601.3	020293	2	Rz 23,81							
	316 i	75	09.90	02.98												
	318 i	83	12.90	09.93												
	318 i	85	10.93	02.98												
	318 tds	66	01.95	02.98												
	316 i	73	09.90	09.93		24.3727-0218.2	580218	2	+ Trommelbremse ¹⁾	L=1764						
	316 i	75	09.90	02.98												
	318 i	83	12.90	09.93												
	318 i	85	10.93	02.98												
	318 tds	66	01.95	02.98												
	316 i	73	09.90	09.93	+ ABS						24.3727-0214.2	580214	2	+ Scheibenbremse ³⁾	L=1631	
	316 i	75	09.90	02.98	+ ABS											
	318 i	83	12.90	10.93	+ ABS											
	318 i	85	10.93	02.98	+ ABS											
	318 is	103	03.93	02.98												
	318 is	103	09.95	02.98												
	318 tds	66	01.95	02.98	+ ABS											
	320 i	110	09.90	02.98												
323 i	125	03.95	02.98													
325 i	141	09.90	09.95													
325 td	85	09.91	02.98													
325 tds	105	05.93	02.98													
328 i	142	01.95	02.98													
M3 3.0	210	08.94	09.95													
M3 3.2	236	09.95	02.98													

1) + drum brake / + freno a tamburo / + freins à tambour / + tambores de freno
2) on the brake caliper / sulla pinza freno / sur l'étrier de frein / a la pinza de freno
3) + disc brake / + disco freno / + disques de frein / + disco de freno



BMW 3er Reihe/E36 Limousine (90-98)

	316 i	73		09.90	09.93	24.2419-1702.3	030086		Gz 19,05
	316 i	75		09.90	09.94				
	318 i	83		12.90	10.93				
	318 i	85		10.93	09.94				
	318 is	103		03.93	09.94				
	320 i	110		09.90	09.94				
	325 i	141		09.90	09.94				
	325 td	85		09.91	09.94				
	325 tds	105		05.93	09.94				
	M3 3.0	210		08.94	09.94				
	316 i	75		10.94	02.98	24.2419-1718.3	030094		Gz 19,05
	318 i	85		10.94	02.98				
	318 is	103		10.94	02.98				
	318 is	103		09.95	02.98				
	318 tds	66		01.95	02.98				
	320 i	110		10.94	02.98				
	323 i	125		03.95	02.98				
	325 i	141		10.94	09.95				
	325 td	85		10.94	02.98				
	325 tds	105		10.94	02.98				
	328 i	142		01.95	02.98				
	M3 3.0	210		10.94	09.95				
	M3 3.2	236		09.95	02.98				
	316 i	73		09.90	09.93	24.2520-1701.3	040072		Nz 20,64
	316 i	75		07.93	02.98				
	318 i	83		12.90	10.93				
	318 i	85		10.93	02.98				
	318 is	103		03.93	02.98				
	318 is	103		09.95	02.98				
	318 tds	66		01.95	02.98				
	320 i	110		09.90	02.98				
	323 i	125		03.95	02.98				
	325 i	141		09.90	09.95				
	325 td	85		09.91	02.98				
	325 tds	105		05.93	02.98				
	328 i	142		01.95	02.98				
	M3 3.0	210		08.94	09.95	24.2522-0905.3	040042		Nz 22,20
	M3 3.2	236		09.95	02.98				
	316 i	73		09.90	09.93	24.5905-0320.3	330058	ohne Rohrleitung ¹⁾	L=320
	316 i	75		09.90	02.98				
	318 i	83		12.90	10.93				
	318 i	85		10.93	02.98				
	318 is	103		03.93	02.98				
	318 is	103		09.95	02.98				
	320 i	110		09.90	02.98				
	323 i	125		03.95	02.98				
	325 i	141		09.90	09.95				

BMW 3er Reihe/E36 Touring (95-99)



















	316 i	75		01.96	10.99	03.7760-3102.4	300139		10"	ATE
	318 i	85		07.95	10.99					
	318 tds	66		01.95	10.99					
	320 i	110		01.95	10.99			- ASC		
	323 i	125		09.95	10.99			- ASC		
	325 tds	105		01.95	10.99					
	328 i	142		01.95	10.99			- ASC		
	320 i	110		01.95	08.96	10.6360-1903.4	300093	+ ASC	10" (MKIV)	ATE
	323 i	125		09.95	08.96					
	328 i	142		01.95	08.96					
	320 i	110		09.96	10.99	03.7760-3102.4	300139	+ ASC	10"	ATE
	323 i	125		09.96	10.99					
	328 i	142		09.96	10.99					
	320 i	110		01.95	08.96	10.6123-0239.3	010335	+ ASC	THz 23,81 (MKIV)	ATE
	323 i	125		09.95	08.96					
	328 i	142		01.95	08.96					
	320 i	110		09.96	10.99	03.2023-0987.3	010473	+ ASC	THz 23,81/20,64	ATE
	323 i	125		09.96	10.99					
	328 i	142		09.96	10.99					
	316 i	75		01.96	10.99	03.2023-0987.3	010473		THz 23,81/20,64	ATE
	318 i	85		07.95	10.99					
	318 tds	66		01.95	10.99					
	320 i	110		10.96	10.99			- ASC		
	323 i	125		10.96	10.99			- ASC		
	325 tds	105		01.95	10.99					
	328 i	142		10.96	10.99			- ASC		
	316 i	75		01.96	10.99	24.3541-9667.5	240529	<input type="checkbox"/>	D=54, - Halter	ATE
	318 i	85		07.95	10.99	11.9541-9668.2	220422	<input type="checkbox"/>	D=54, - Halter	ATE
	318 tds	66		01.95	10.99	24.3541-9668.5	240530	<input type="checkbox"/>	D=54, - Halter	ATE
						11.0230-0444.1	260104	2	Halter	ATE
						11.0441-5402.2	250028		Dichtungssatz	ATE
						11.0101-5402.2	260009		Hülzensatz	ATE
						11.8171-0008.1	990049		Führungsbolzen	ATE
						11.8116-0109.1	390495	2	Länge 150mm ³⁾	ATE
						11.8116-0206.1	390593	2	Länge 177mm ⁴⁾	ATE

¹⁾ without pipe line / senza tubazione / sans conduite de frein rigide / sin latiguillo

²⁾ - increased payload / - carico utile maggiorato / - charge utile augmentée / - incremento de carga

³⁾ length 150mm / lunghezza 150mm / longueur 150mm / largo 150mm

⁴⁾ length 177mm / lunghezza 177mm / longueur 177mm / largo 177mm

										
BMW 3er Reihe/E36 Touring (95-99)										
	316 i 318 i 318 tds 320 i 323 i 325 tds 328 i	75 85 66 110 125 105 142	01.96 07.95 01.95 01.95 09.95 01.95 01.95	10.99 10.99 10.99 10.99 10.99 10.99 10.99	+ erhöhte Zuladung ¹⁾ + erhöhte Zuladung ¹⁾ + erhöhte Zuladung ¹⁾	24.3541-9587.5 11.9541-9588.2 24.3541-9588.5 11.8170-0729.1 11.0441-5402.2 11.0101-5402.2 11.8171-0008.1	240527 220420 240528 260107 250028 260009 990049	D=54, - Halter D=54, - Halter D=54, - Halter Halter Dichtungssatz Hülzensatz Führungsbolzen Halterfeder Halterfeder	ATE ATE ATE ATE ATE ATE ATE	
	316 i 318 i 318 tds 320 i 323 i 325 tds 328 i	75 85 66 110 125 105 142	01.96 07.95 01.95 01.95 09.95 01.95 01.95	10.99 10.99 10.99 10.99 10.99 10.99 10.99		24.5103-0430.3	331408	Länge 150mm ²⁾ Länge 177mm ³⁾	L=430	
	316 i 318 i 318 tds 320 i 325 tds	75 85 66 110 105	01.96 07.95 01.95 01.95 01.95	10.99 10.99 10.99 10.99 10.99		11.9381-9961.2 11.9381-9962.2 11.0441-3803.2 11.0101-5402.2 11.8171-0008.1	220435 220436 250010 260009 990049	D=38, - Halter D=38, - Halter Dichtungssatz Hülzensatz Führungsbolzen Halterfeder	ATE ATE ATE ATE ATE	
	323 i 328 i	125 142	09.95 01.95	10.99 10.99		11.9381-9959.2 11.9381-9960.2 11.0441-3803.2 11.0101-5402.2 11.8171-0008.1	220433 220434 250010 260009 990049	D=38, - Halter D=38, - Halter Dichtungssatz Hülzensatz Führungsbolzen Halterfeder	ATE ATE ATE ATE ATE	
	316 i 318 i 318 tds 320 i 323 i 325 tds 328 i	75 85 66 110 125 105 142	01.96 07.95 01.95 01.95 09.95 01.95 01.95	10.99 10.99 10.99 10.99 10.99 10.99 10.99		83.7704-0200.3 24.5202-0204.3	330825 331402	am Bremsattel ⁴⁾	L=200 L=204	
	316 i 318 i 318 tds 320 i 323 i 325 tds 328 i	75 85 66 110 125 105 142	01.96 07.95 01.95 01.95 09.95 01.95 01.95	10.99 10.99 10.99 10.99 10.99 10.99 10.99		24.3727-0214.2	580214		L=1631	
	316 i 318 i 318 tds 320 i 323 i 325 tds 328 i	75 85 66 110 125 105 142	01.96 07.95 01.95 01.95 09.95 01.95 01.95	04.97 04.97 04.97 04.97 04.97 04.97 04.97		24.2419-1718.3	030094		Gz 19,05	
	316 i 318 i 318 tds 320 i 323 i 325 tds 328 i	75 85 66 110 125 105 142	01.96 07.95 01.95 01.95 09.95 01.95 01.95	10.99 10.99 10.99 10.99 10.99 10.99 10.99		24.2520-1701.3	040072		Nz 20,64	
	316 i 318 i 320 i 323 i	75 85 110 125	01.96 07.95 01.95 09.95	10.99 10.99 10.99 10.99		24.5905-0320.3	330058	ohne Rohrleitung ⁵⁾	L=320	
BMW 3er Reihe/E36 Coupe (92-99)										
	316 i 316 i 318 is 318 is 318 is 320 i 320 i 323 i 325 i 325 i 328 i M3 3.0 M3 3.0	75 75 103 103 103 110 110 125 141 141 142 210 217	09.93 09.93 03.92 03.92 09.95 03.92 03.92 03.95 03.92 03.92 01.95 10.92 01.95	08.96 08.94 + ASC + ASC - ASC + ASC - ASC + ASC + ASC - ASC + ASC 01.95 10.95	+ ASC - ASC + ASC - ASC + ASC - ASC + ASC - ASC + ASC - ASC + ASC - ASC + ASC	10.6360-1903.4	300093		10" (MKIV)	ATE
	316 i 316 i 318 is 318 is 320 i 320 i 323 i 323 i 325 i 325 i 328 i 328 i	75 75 103 103 110 110 125 125 141 141 142 142	09.96 09.94 09.94 09.96 09.96 09.94 09.96 03.95 06.96 09.94 09.96 01.95	04.99 04.99 - ASC - ASC + ASC - ASC + ASC - ASC + ASC - ASC + ASC - ASC	+ ASC - ASC - ASC + ASC - ASC + ASC - ASC + ASC - ASC + ASC - ASC	03.7760-3102.4	300139		10"	ATE

¹⁾ + increased payload / + carico utile maggiorato / + charge utile augmentée / + incremento de carga

²⁾ length 150mm / lunghezza 150mm / longueur 150mm / largo 150mm

³⁾ length 177mm / lunghezza 177mm / longueur 177mm / largo 177mm

⁴⁾ on the brake caliper / sulla pinza freno / sur l'étrier de frein / a la pinza de freno

⁵⁾ without pipe line / senza tubazione / sans conduite de frein rigide / sin latiguillo



BMW 3er Reihe/E36 Coupe (92-99)

	316 i 316 i 318 is 318 is 318 is 320 i 320 i 323 i 325 i 325 i 328 i	75 75 103 103 103 110 110 125 141 141 142	09.93 09.93 03.92 03.92 09.95 03.92 03.92 03.95 03.92 03.92 01.95	08.96 + ASC 08.94 - ASC 10.95 + ASC 08.94 - ASC 08.96 + ASC 08.96 + ASC 08.94 - ASC 08.96 + ASC 08.96 + ASC 08.94 - ASC 08.96 + ASC	10.6123-0239.3	010335			THz 23,81 (MKIV)	ATE
	316 i 316 i 318 is 318 is 320 i 320 i 323 i 323 i 325 i 325 i 328 i 328 i	75 75 103 103 110 110 125 125 141 141 142 142	09.96 09.94 09.94 09.96 09.96 09.94 09.96 09.94 03.95 06.96 09.94 09.96 01.95	04.99 + ASC 04.99 - ASC 10.95 - ASC 04.99 + ASC 04.99 + ASC 04.99 - ASC 04.99 + ASC 04.99 - ASC 04.99 + ASC 04.99 + ASC 04.99 - ASC 04.99 + ASC 04.99 - ASC	03.2023-0987.3	010473			THz 23,81/20,64	ATE
	316 i	75	03.93	04.99	11.9541-9668.2 24.3541-9667.5 24.3541-9668.5 11.0230-0444.1 11.0101-5402.2 11.8171-0008.1 11.0441-5402.2 11.8116-0109.1 11.8116-0206.1	220422 240529 240530 260104 260009 990049 250028 390495 390593	2 2 2		D=54, - Halter D=54, - Halter D=54, - Halter Halter Hülensatz Führungsbolzen Dichtungssatz Halterfeder Halterfeder	ATE ATE ATE ATE ATE ATE ATE ATE ATE
	318 is 318 is 320 i 323 i 325 i 328 i	103 103 110 125 141 142	03.92 09.95 03.92 03.95 03.92 01.95	10.95 04.99 04.99 04.99 04.99 04.99	11.9541-9588.2 24.3541-9587.5 24.3541-9588.5 11.8170-0729.1 11.0101-5402.2 11.8171-0008.1 11.0441-5402.2 11.8116-0109.1 11.8116-0206.1	220420 240527 240528 260107 260009 990049 250028 390495 390593	2 2 2		D=54, - Halter D=54, - Halter D=54, - Halter Halter Hülensatz Führungsbolzen Dichtungssatz Halterfeder Halterfeder	ATE ATE ATE ATE ATE ATE ATE ATE ATE
	M3 3.0 M3 3.0 M3 3.2	210 217 236	10.92 01.95 10.95	01.95 10.95 04.99	11.3601-8515.2 11.3601-8516.2 11.0101-5402.2 11.8171-0008.1 11.0441-6003.2 11.8116-0083.1	220323 220324 260009 990049 250037 390501	2 2 2		D=60, - Halter D=60, - Halter Hülensatz Führungsbolzen Dichtungssatz Halterfeder	ATE ATE ATE ATE ATE ATE
	316 i 318 is 318 is 320 i 323 i 325 i 328 i	75 103 103 110 125 141 142	09.93 03.92 09.95 03.92 03.95 03.92 01.95	04.99 10.95 04.99 04.99 04.99 04.99 04.99	24.5103-0430.3	331408	2		L=430	
	M3 3.0 M3 3.0 M3 3.2	210 217 236	10.92 01.95 10.95	01.95 10.95 04.99	83.6150-0451.3	330283	2		L=450	
	316 i 318 is 318 is 320 i 325 i	75 103 103 110 141	09.93 03.92 09.95 03.92 03.92	04.99 10.95 04.99 04.99 + Motorcode M52 ³⁾ 04.99	11.3361-8503.2 11.3361-8504.2 24.3361-8503.5 24.3361-8504.5 11.0441-3602.2 11.0101-5402.2 11.8171-0008.1 11.8116-0066.1	220016 220017 240513 240514 250008 260009 990049 390577	2 2		D=36, - Halter D=36, - Halter D=36, - Halter D=36, - Halter Dichtungssatz Hülensatz Führungsbolzen Halterfeder	ATE ATE ATE ATE ATE ATE ATE ATE
	320 i	110	03.92	04.99 + Motorcode M50 ⁴⁾	11.0441-3602.2 11.0101-5402.2 11.8171-0008.1 11.8116-0066.1	250008 260009 990049 390577	2		Dichtungssatz Hülensatz Führungsbolzen Halterfeder	ATE ATE ATE ATE
	323 i 328 i	125 142	03.95 01.95	04.99 04.99	11.9381-9959.2 11.9381-9960.2 11.0441-3803.2 11.0101-5402.2 11.8171-0008.1 11.8116-0066.1	220433 220434 250010 260009 990049 390577	2 2		D=38, - Halter D=38, - Halter Dichtungssatz Hülensatz Führungsbolzen Halterfeder	ATE ATE ATE ATE ATE ATE
	M3 3.0 M3 3.0 M3 3.2	210 217 236	10.92 01.95 10.95	01.95 10.95 04.99	11.8116-0066.1 11.0101-5402.2 11.8171-0008.1 11.0441-4002.2	390577 260009 990049 250011	2		Halterfeder Hülensatz Führungsbolzen Dichtungssatz	ATE ATE ATE ATE
	316 i	75	09.93	04.99 + Trommelbremse ⁵⁾	24.5202-0204.3	331402	2		L=204	
	316 i 318 is 318 is 320 i 323 i 325 i 328 i	75 103 103 110 125 141 142	09.93 03.92 09.95 03.92 03.95 03.92 01.95	04.99 + Scheibenbremse ⁶⁾	24.5202-0204.3 83.7704-0200.3	331402 330825	2 2		L=204 L=200	am Bremssattel ⁷⁾

¹⁾ length 150mm / lunghezza 150mm / longueur 150mm / largo 150mm

²⁾ length 177mm / lunghezza 177mm / longueur 177mm / largo 177mm

³⁾ + engine code M52 / + codice motore M52 / + moteur code M52 / + motor code M52

⁴⁾ + engine code M50 / + codice motore M50 / + moteur code M50 / + motor code M50

⁵⁾ + drum brake / + freno a tamburo / + freins à tambour / + tambores de freno

⁶⁾ + disc brake / + disco freno / + disques de frein / + disco de freno

⁷⁾ on the brake caliper / sulla pinza freno / sur l'étrier de frein / a la pinza de freno





BMW 3er Reihe/E36 Coupe (92-99)

	M3 3.0	210	10.92	01.95	24.5202-0204.3	331402	2		L=204	
	M3 3.0	217	01.95	10.95	83.6124-0218.3	330455	2	am Bremsattel ¹⁾	L=215	
	M3 3.2	236	10.95	04.99						
	316 i	75	09.93	04.99	24.3223-1601.3	020293			Rz 23,81	
	316 i	75	09.93	04.99	+ Trommelbremse ²⁾	24.3727-0218.2	580218	2	↓	L=1764
	316 i	75	09.93	04.99	+ Scheibenbremse ³⁾	24.3727-0214.2	580214	2	↓	L=1631
	318 is	103	03.92	10.95						
	318 is	103	09.95	04.99						
	320 i	110	03.92	04.99						
	323 i	125	03.95	04.99						
	325 i	141	03.92	04.99						
	328 i	142	01.95	04.99						
	M3 3.0	210	10.92	01.95						
	M3 3.0	217	01.95	10.95						
	M3 3.2	236	10.95	04.99						
	316 i	75	09.93	09.94	24.2419-1702.3	030086			Gz 19,05	
	318 is	103	03.92	09.94						
	320 i	110	03.92	09.94						
	325 i	141	03.92	09.94						
	M3 3.0	210	10.92	09.94						
	316 i	75	10.94	04.99	24.2419-1718.3	030094			Gz 19,05	
	318 is	103	10.94	10.95						
	318 is	103	09.95	04.99						
	320 i	110	10.94	04.99						
	323 i	125	03.95	04.99						
	325 i	141	10.94	04.99						
	328 i	142	01.95	04.99						
	M3 3.0	210	10.94	01.95						
	M3 3.0	217	01.95	10.95						
	M3 3.2	236	10.95	04.99						
	316 i	75	09.93	04.99	24.2520-1701.3	040072			Nz 20,64	
	318 is	103	03.92	10.95						
	318 is	103	09.95	04.99						
	320 i	110	03.92	04.99						
	323 i	125	03.95	04.99						
	325 i	141	03.92	04.99						
	328 i	142	01.95	04.99						
	M3 3.0	210	10.92	01.95	24.2522-0905.3	040042			Nz 22,20	
	M3 3.0	217	01.95	10.95						
	M3 3.2	236	10.95	04.99						
	316 i	75	09.93	04.99	24.5905-0320.3	330058		ohne Rohrleitung ⁴⁾	L=320	
	318 is	103	03.92	10.95						
	318 is	103	09.95	04.99						
	320 i	110	03.92	04.99						
	323 i	125	03.95	04.99						
	325 i	141	03.92	04.99						
	M3 3.0	210	10.92	05.94						

BMW 3er Reihe/E36 Cabrio (93-99)

	318 i	85	01.94	08.96	+ ASC	10.6360-1903.4	300093		10" (MKIV)	ATE
	318 i	85	01.94	08.94	- ASC					
	320 i	110	12.93	08.96	+ ASC					
	320 i	110	12.93	08.94	- ASC					
	323 i	125	06.95	08.96	+ ASC					
	325 i	141	03.93	08.96	+ ASC					
	325 i	141	03.93	08.94	- ASC					
	328 i	142	03.95	08.96	+ ASC					
	M3 3.0	210	01.94	04.99						
	318 i	85	09.96	04.99	+ ASC	03.7760-3102.4	300139		10"	ATE
	318 i	85	09.94	04.99	- ASC					
	320 i	110	09.96	04.99	+ ASC					
	320 i	110	09.94	04.99	- ASC					
	323 i	125	09.96	04.99	+ ASC					
	323 i	125	06.95	04.99	- ASC					
	325 i	141	09.96	04.99	+ ASC					
	325 i	141	09.94	04.99	- ASC					
	328 i	142	09.96	04.99	+ ASC					
	328 i	142	03.95	04.99	- ASC					
	318 i	85	01.94	08.94		10.6123-0239.3	010335	+ ASC	THz 23,81 (MKIV)	ATE
	320 i	110	12.93	08.94						
	323 i	125	06.95	08.96						
	325 i	141	03.93	08.94						
	328 i	142	03.95	08.96						
	318 i	85	09.94	04.99		03.2023-0987.3	010473	+ ASC	THz 23,81/20,64	ATE
	320 i	110	09.94	04.99						
	323 i	125	09.96	04.99						
	325 i	141	09.94	04.99						
	328 i	142	09.96	04.99						
	318 i	85	01.94	04.99		03.2023-0987.3	010473	- ASC	THz 23,81/20,64	ATE
	320 i	110	12.93	04.99						
	323 i	125	06.95	04.99						
	325 i	141	03.93	04.99						
	328 i	142	03.95	04.99						

¹⁾ on the brake caliper / sulla pinza freno / sur l'étrier de frein / a la pinza de freno

²⁾ + drum brake / + freno a tamburo / + freins à tambour / + tambores de freno

³⁾ + disc brake / + disco freno / + disques de frein / + disco de freno

⁴⁾ without pipe line / senza tubazione / sans conduite de frein rigide / sin latiguillo

BMW 3er Reihe/E36 Cabrio (93-99)												
	318 i	85		01.94	04.99							
	320 i	110		12.93	04.99	+ Motorcode M50 ³⁾	24.3541-9667.5 240529 11.9541-9668.2 220422 24.3541-9668.5 240530 11.0230-0444.1 260104 11.0441-5402.2 250028 11.0101-5402.2 260009 11.8171-0008.1 990049 11.8116-0109.1 390495 11.8116-0206.1 390593	2	D=54, - Halter D=54, - Halter D=54, - Halter Halter Dichtungssatz Hülssensatz Führungsbolzen Halterfeder	ATE ATE ATE ATE ATE ATE ATE ATE		
	320 i	110		12.93	04.99	+ Motorcode M52 ⁴⁾	24.3541-9587.5 240527 11.9541-9588.2 220420 24.3541-9588.5 240528 11.8170-0729.1 260107 11.0441-5402.2 250028 11.0101-5402.2 260009 11.8171-0008.1 990049 11.8116-0109.1 390495 11.8116-0206.1 390593	2	D=54, - Halter D=54, - Halter D=54, - Halter Halter Dichtungssatz Hülssensatz Führungsbolzen Halterfeder	ATE ATE ATE ATE ATE ATE ATE ATE		
	323 i	125		06.95	04.99							
	325 i	141		03.93	04.99							
	328 i	142		03.95	04.99							
	M3 3.0	210		01.94	04.99		11.3601-8515.2 220323 11.3601-8516.2 220324 11.0441-6003.2 250037 11.0101-5402.2 260009 11.8171-0008.1 990049 11.8116-0083.1 390501	2	D=60, - Halter D=60, - Halter Dichtungssatz Hülssensatz Führungsbolzen Halterfeder	ATE ATE ATE ATE ATE ATE		
	M3 3.2	236		10.95	04.99							
	318 i	85		01.94	04.99		24.5103-0430.3 331408	2		L=430		
	320 i	110		12.93	04.99							
	323 i	125		06.95	04.99							
	325 i	141		03.93	04.99							
	328 i	142		03.95	04.99							
	M3 3.0	210		01.94	04.99		83.6150-0451.3 330283	2		L=450		
	M3 3.2	236		10.95	04.99							
		318 i	85		01.94	04.99		11.9381-9961.2 220435 11.9381-9962.2 220436 11.0441-3803.2 250010 11.0101-5402.2 260009 11.8171-0008.1 990049 11.8116-0066.1 390577	2	D=38, - Halter D=38, - Halter Dichtungssatz Hülssensatz Führungsbolzen Halterfeder	ATE ATE ATE ATE ATE ATE	
		320 i	110		12.93	04.99						
		323 i	125		06.95	04.99						
		328 i	142		03.95	04.99						
	318 i	85		01.94	04.99		11.9381-9959.2 220433 11.9381-9960.2 220434 11.0441-3803.2 250010 11.0101-5402.2 260009 11.8171-0008.1 990049 11.8116-0066.1 390577	2	D=38, - Halter D=38, - Halter Dichtungssatz Hülssensatz Führungsbolzen Halterfeder	ATE ATE ATE ATE ATE ATE		
	320 i	110		12.93	04.99							
	323 i	125		06.95	04.99							
	328 i	142		03.95	04.99							
	318 i	85		01.94	04.99		83.7704-0200.3 330825 24.5202-0204.3 331402	2	am Bremssattel ⁵⁾	L=200 L=204		
	320 i	110		12.93	04.99							
	323 i	125		06.95	04.99							
	325 i	141		03.93	04.99							
	328 i	142		03.95	04.99							
	M3 3.0	210		01.94	04.99		83.6124-0218.3 330455	2	am Bremssattel ⁵⁾	L=215 L=204		
	M3 3.2	236		10.95	04.99		24.5202-0204.3 331402	2				
	318 i	85		01.94	04.99		24.3727-0214.2 580214	2		L=1631		
	320 i	110		12.93	04.99							
	323 i	125		06.95	04.99							
	325 i	141		03.93	04.99							
	328 i	142		03.95	04.99							
	M3 3.0	210		01.94	04.99							
	M3 3.2	236		10.95	04.99							
	318 i	85		01.94	09.94		24.2419-1702.3 030086			Gz 19,05		
	320 i	110		12.93	09.94							
	325 i	141		03.93	09.94							
	M3 3.0	210		01.94	09.94							
		318 i	85		10.94	04.99		24.2419-1718.3 030094			Gz 19,05	
320 i		110		10.94	04.99							
323 i		125		06.95	04.99							
325 i		141		10.94	04.99							
328 i		142		03.95	04.99							
M3 3.0		210		10.94	04.99							
M3 3.2		236		10.95	04.99							
		318 i	85		01.94	04.99		24.2520-1701.3 040072			Nz 20,64	
	320 i	110		12.93	04.99							
	323 i	125		06.95	04.99							
	325 i	141		03.93	04.99							
	328 i	142		03.95	04.99							
	M3 3.0	210		01.94	04.99		24.2522-0905.3 040042			Nz 22,20		
	M3 3.2	236		10.95	04.99							

























¹⁾ length 150mm / lunghezza 150mm / longueur 150mm / largo 150mm

²⁾ length 177mm / lunghezza 177mm / longueur 177mm / largo 177mm

³⁾ + engine code M50 / + codice motore M50 / + moteur code M50 / + motor code M50

⁴⁾ + engine code M52 / + codice motore M52 / + moteur code M52 / + motor code M52

⁵⁾ on the brake caliper / sulla pinza freno / sur l'étrier de frein / a la pinza de freno

										
BMW 3er Reihe/E36 Cabrio (93-99)										
	318 i 320 i 323 i 325 i M3 3.0	85 110 125 141 210		01.94 12.93 06.95 03.93 01.94	04.99 04.99 04.99 04.99 04.94	24.5905-0320.3	330058	ohne Rohrleitung ¹⁾	L=320	
BMW 3er Reihe/E36 Compact (94-00)										
	316 g 316 i 1.6 316 i 1.9 318 tds 318 ti 318 ti 318 ti 318 ti 323 ti	75 75 77 66 103 103 103 103 125		03.94 09.96 12.98 01.95 09.96 07.95 09.96 11.94 08.97	08.00 + ABS 08.00 08.00 + ASC - ASC + ASC - ASC 08.00	03.7760-3102.4	300139		10" ATE	
	316 i 1.6 318 ti 318 ti	75 103 103		03.94 07.95 11.94	08.96 + ABS + ASC + ASC	10.6360-1903.4	300093		10" (MKIV) ATE	
	316 i 1.6 316 g 316 i 1.6 316 i 1.9 318 tds 318 ti 318 ti 323 ti	75 75 75 77 66 103 103 125		03.94 09.94 12.98 01.95 07.95 11.94 08.97	08.94 + ABS 08.00 + ABS 08.00 08.00 08.00	10.6123-0239.3	010335		Thz 23,81 (MKIV) ATE	
	316 i 1.6	75		03.94	08.00 - ABS	24.2023-1601.3	010341		Thz 23,81 TRW	
	316 g 316 i 1.6 316 i 1.9 318 tds 318 ti 318 ti	75 75 77 66 103 103		03.94 09.94 12.98 01.95 07.95 11.94	08.00 08.00 08.00 08.00 + Motorcode M44 ⁴⁾ + Motorcode M42 ⁵⁾	24.3541-9667.5 11.9541-9668.2 24.3541-9668.5 11.0230-0444.1 11.0441-5402.2 11.0101-5402.2 11.8171-0008.1 11.8116-0109.1 11.8116-0206.1	240529 220422 240530 260104 250028 260009 990049 390495 390593	2 2 2 2 2 2	   Halter Dichtungssatz Hülzensatz Führungsbolzen Haltefeder Haltefeder Länge 150mm ²⁾ Länge 177mm ³⁾	D=54, - Halter D=54, - Halter D=54, - Halter ATE ATE ATE ATE ATE ATE ATE
	318 ti 323 ti	103 125		05.98 08.97	08.00 + Motorcode M44 ⁴⁾ 08.00	11.9541-9588.2 24.3541-9587.5 24.3541-9588.5 11.8170-0729.1 11.0441-5402.2 11.0101-5402.2 11.8171-0008.1 11.8116-0109.1 11.8116-0206.1	220420 240527 240528 260107 250028 260009 990049 390495 390593	2 2 2 2 2 2	   Halter Dichtungssatz Hülzensatz Führungsbolzen Haltefeder Haltefeder Länge 150mm ²⁾ Länge 177mm ³⁾	D=54, - Halter D=54, - Halter D=54, - Halter ATE ATE ATE ATE ATE ATE ATE
	316 g 316 i 1.6 316 i 1.9 318 tds 318 ti 318 ti 323 ti	75 75 77 66 103 103 125		03.94 03.94 12.98 01.95 07.95 11.94 08.97	08.00 08.00 08.00 08.00 08.00 08.00	24.5103-0430.3	331408	2	L=430	
	316 g 316 i 1.6 316 i 1.9 318 tds 318 ti 318 ti 323 ti	75 75 77 66 103 103 125		03.94 03.94 12.98 01.95 07.95 11.94 08.97	08.00 08.00 08.00 08.00 08.00 08.00	11.0441-3401.2 11.0101-5402.2 11.8171-0008.1 11.8116-0066.1	250151 260009 990049 390577	2	Dichtungssatz Hülzensatz Führungsbolzen Haltefeder ATE ATE ATE	
	316 g 316 i 1.6 316 i 1.9 318 tds 318 ti 318 ti 323 ti	75 75 77 66 103 103 125		03.94 03.94 12.98 01.95 07.95 11.94 08.97	08.00 + ABS 08.00 + ABS 08.00 08.00	83.7704-0200.3 24.5201-0204.3	330825 331400	2 2	am Bremsattel ⁶⁾ L=200 L=204	
	316 i 1.6 318 tds	75 66		03.94 01.95	08.00 - ABS 08.00 - ABS	24.5201-0204.3	331400	2	L=204	
	316 g 316 i 1.6 318 tds	75 75 66		03.94 03.94 01.95	08.00 08.00 08.00	24.3222-1616.3	020322		Rz 22,20	
	316 g 316 i 1.6 316 i 1.9 318 tds 318 ti 318 ti 323 ti	75 75 77 66 103 103 125		03.94 03.94 12.98 01.95 07.95 11.94 08.97	08.00 08.00 08.00 08.00 08.00 08.00	24.3727-0227.2 24.3727-0222.2	580227 580222	2 2	+ Scheibenbremse ⁷⁾ + Trommelbremse ⁸⁾ L=1683 L=1740	
	316 g 316 i 1.6 318 tds 318 ti 318 ti	75 75 66 103 103		03.94 03.94 01.95 07.95 11.94	04.97 04.97 04.97 04.97 04.97	24.2419-1718.3	030094		Gz 19,05	

¹⁾ without pipe line / senza tubazione / sans conduite de frein rigide / sin latiguillo

²⁾ length 150mm / lunghezza 150mm / longueur 150mm / largo 150mm

³⁾ length 177mm / lunghezza 177mm / longueur 177mm / largo 177mm













⁴⁾ + engine code M44 / + codice motore M44 / + moteur code M44 / + motor code M44

⁵⁾ + engine code M42 / + codice motore M42 / + moteur code M42 / + motor code M42

⁶⁾ on the brake caliper / sulla pinza freno / sur l'étrier de frein / a la pinza de freno

⁷⁾ + disc brake / + disco freno / + disques de frein / + disco de freno

⁸⁾ + drum brake / + freno a tamburo / + freins à tambour / + tambores de freno

									
BMW 3er Reihe/E36 Compact (94-00)									
	316 g	75		03.94	08.00	24.2520-1701.3	040072		Nz 20,64
	316 i 1.6	75		03.94	08.00				
	318 tds	66		01.95	08.00				
	318 ti	103		07.95	08.00				
	318 ti	103		11.94	08.00				
	323 ti	125		08.97	11.98				
	316 i 1.9	77		12.98	08.00	24.2522-0905.3	040042		Nz 22,20
	323 ti	125		12.98	08.00				
	316 g	75		03.94	08.00	24.5905-0320.3	330058	ohne Rohrleitung ¹⁾	L=320
	316 i 1.6	75		03.94	08.00				
	316 i 1.9	77		12.98	08.00				
	318 ti	103		07.95	08.00				
	318 ti	103		11.94	08.00				
BMW 3er Reihe/E46 Limousine (98-05)									
	316 i	85		02.02	02.05	03.7860-0702.4	300123		10" ATE
	316 i 1.6	77		04.00	02.05				
	316 i 1.9	77		09.98	02.05				
	318 d	85		09.01	02.05				
	318 i	87		02.98	02.05				
	318 i	105		09.01	02.05				
	320 d	95		02.98	02.05				
	320 d	100		04.98	02.05				
	320 d	110		09.01	02.05				
	320 i	110		03.98	02.05				
	320 i	125		09.00	02.05				
	323 i	125		03.98	02.05				
	325 i	141		09.00	02.05				
	325 xi	141		09.00	02.05				
	328 i	142		02.98	02.05				
	330 d	135		10.99	02.05				
	330 d	150		03.03	02.05				
	330 i	170		06.00	02.05				
	330 xd	135		06.00	02.05				
	330 xd	150		03.03	02.05				
330 xi	170		06.00	02.05					
	316 i 1.6	77		04.00	08.01	03.2022-2624.3	010588	- DSC	THz 22,20/20,64 ATE
	316 i 1.9	77		09.98	08.01				
	318 i	87		02.98	02.05				
	320 d	95		02.98	02.05				
	320 d	100		04.98	02.05				
	320 i	110		03.98	02.05				
	320 i	125		09.00	08.01				
	323 i	125		03.98	02.05				
	325 i	141		09.00	08.01				
	328 i	142		02.98	02.05				
	330 d	135		10.99	08.01	03.2023-2304.3	010646	- DSC	THz 23,81/22,20 ATE
	330 i	170		06.00	08.01				
	316 i	85		02.02	02.05	03.2023-2344.3	010647	- DSC	THz 23,81/22,20 ATE
	316 i 1.6	77		09.01	02.05				
316 i 1.9	77		09.01	02.05					
318 d	85		09.01	02.05					
318 i	105		09.01	02.05					
320 d	110		09.01	02.05					
320 i	125		09.01	02.05					
325 i	141		09.01	02.05					
330 d	135		09.01	02.05					
330 i	170		09.01	02.05					
	316 i 1.6	77		04.00	08.00	03.2022-2829.3	010589	+ DSC	THz 22,20/20,64 ATE
	316 i 1.9	77		09.98	08.00				
	318 i	87		02.98	08.00				
	320 d	95		02.98	08.00				
	320 d	100		04.98	08.00				
	320 i	110		03.98	08.00				
	323 i	125		03.98	02.05				
	328 i	142		02.98	02.05				
	330 d	135		10.99	08.00	03.2023-2204.3	010644	+ DSC	THz 23,81/22,20 ATE
	330 i	170		06.00	08.00				
	316 i	85		02.02	02.05	03.2023-2256.3	010870	+ DSC	THz 23,81/22,20 ATE
	316 i 1.6	77		02.01	02.05				
	316 i 1.9	77		02.01	02.05				
	318 d	85		09.01	02.05				
	318 i	105		09.01	02.05				
	320 d	95		02.01	02.05				
	320 d	100		02.01	02.05				
	320 d	110		09.01	02.05				
	320 i	125		02.01	02.05				
	325 i	141		02.01	02.05				
	330 d	135		02.01	02.05				
	330 d	150		03.03	02.05				
	330 i	170		02.01	02.05				

¹⁾ without pipe line / senza tubazione / sans conduite de frein rigide / sin latiguillo

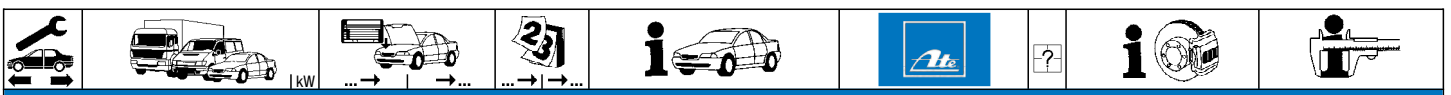

BMW 3er Reihe/E46 Limousine (98-05)

	316 i	85	02.02	02.05		11.9541-9588.2	220420	2	Länge 150mm ¹⁾ Länge 177mm ²⁾	D=54, - Halter D=54, - Halter D=54, - Halter Halter Hülzensatz Führungsbolzen Dichtungssatz Haltefeder	ATE ATE ATE ATE ATE ATE ATE ATE	
	316 i 1.6	77	04.00	02.05		24.3541-9587.5	240527					
	316 i 1.9	77	09.98	02.05		24.3541-9588.5	240528					
	318 d	85	09.01	02.05		11.8170-0729.1	260107					
	318 i	87	02.98	02.05		11.0101-5402.2	260009					
	318 i	105	09.01	02.05	- erhöhte Zuladung ³⁾	11.8171-0008.1	990049					
	320 d	95	02.98	02.05		11.0441-5402.2	250028					
	320 d	100	04.98	02.05		11.8116-0109.1	390495					
	320 i	110	03.98	02.05		11.8116-0206.1	390593					
	320 i	125	09.00	02.05	- erhöhte Zuladung ³⁾							
	323 i	125	03.98	02.05								
	318 i	105	09.01	02.05	+ erhöhte Zuladung ⁴⁾	11.9541-9588.2	220420					
	320 d	110	09.01	02.05		24.3541-9587.5	240527					
	320 i	125	09.00	02.05	+ erhöhte Zuladung ⁴⁾	24.3541-9588.5	240528					
325 i	141	09.00	02.05	- erhöhte Zuladung ³⁾	11.8170-0730.1	260108						
325 xi	141	09.00	02.05	- erhöhte Zuladung ³⁾	11.0101-5402.2	260009						
328 i	142	02.98	02.05	- erhöhte Zuladung ³⁾	11.8171-0008.1	990049						
325 i	141	09.00	02.05	+ erhöhte Zuladung ⁴⁾	11.0441-5402.2	250028						
325 xi	141	09.00	02.05	+ erhöhte Zuladung ⁴⁾	11.8116-0109.1	390495						
330 d	135	10.99	02.05		11.8116-0206.1	390593						
330 d	150	03.03	02.05									
330 i	170	06.00	02.05		24.3571-1733.5	240349						
330 xd	135	06.00	02.05		24.3571-1734.5	240350						
330 xd	150	03.03	02.05		11.8116-0273.1	390515						
330 xi	170	06.00	02.05		11.0101-5402.2	260009						
330 xi	170	06.00	02.05		11.8171-0008.1	990049						
	316 i	85	02.02	02.05		83.6152-0406.3	330789	2		L=405		
	316 i 1.6	77	04.00	02.05								
	316 i 1.9	77	09.98	02.05								
	318 d	85	09.01	02.05								
	318 i	87	02.98	02.05								
	318 i	105	09.01	02.05								
	320 d	95	02.98	02.05								
	320 d	100	04.98	02.05								
	320 d	110	09.01	02.05								
	320 i	110	03.98	02.05								
	320 i	125	09.00	02.05								
	323 i	125	03.98	02.05								
	325 i	141	09.00	02.05								
	328 i	142	02.98	02.05								
	330 d	135	10.99	02.05								
	330 d	150	03.03	02.05								
	330 i	170	06.00	02.05								
		316 i	85	02.02	02.05	- erhöhte Zuladung ³⁾	24.3401-1705.5	240423	2		D=40, - Halter D=40, - Halter Haltefeder Hülzensatz Führungsbolzen Dichtungssatz	ATE ATE ATE ATE ATE ATE
		316 i 1.6	77	04.00	02.05		24.3401-1706.5	240424				
		316 i 1.9	77	09.98	02.05	- erhöhte Zuladung ³⁾	11.8116-0066.1	390577				
		318 i	87	02.98	02.05	- erhöhte Zuladung ³⁾	11.0101-5402.2	260009				
316 i		85	02.02	02.05	+ erhöhte Zuladung ⁴⁾	24.3401-1703.5	240351					
316 i 1.9		77	09.98	02.05	+ erhöhte Zuladung ⁴⁾	24.3401-1704.5	240352					
318 d		85	09.01	02.05		11.8116-0066.1	390577					
318 i		87	02.98	02.05	+ erhöhte Zuladung ⁴⁾	11.0101-5402.2	260009					
318 i		105	09.01	02.05	- erhöhte Zuladung ³⁾	11.8171-0008.1	990049					
320 d		95	02.98	02.05		11.0441-4002.2	250011					
320 d		100	04.98	02.05								
320 i		110	03.98	02.05	- erhöhte Zuladung ³⁾							
320 i		125	09.00	02.05	- erhöhte Zuladung ³⁾							
323 i		125	03.98	02.05	- erhöhte Zuladung ³⁾							
318 i		105	09.01	02.05	+ erhöhte Zuladung ⁴⁾	24.3401-1703.5	240351					
320 d		110	09.01	02.05		24.3401-1704.5	240352					
320 i		110	03.98	02.05	+ erhöhte Zuladung ⁴⁾	11.8116-0066.1	390577					
320 i		125	09.00	02.05	+ erhöhte Zuladung ⁴⁾	11.0101-5402.2	260009					
323 i		125	03.98	02.05	+ erhöhte Zuladung ⁴⁾	11.8171-0008.1	990049					
325 i		141	09.00	02.05	- erhöhte Zuladung ³⁾	11.0441-4002.2	250011					
325 xi		141	09.00	02.05	- erhöhte Zuladung ³⁾							
328 i	142	02.98	02.05	- erhöhte Zuladung ³⁾								
325 i	141	09.00	02.05	+ erhöhte Zuladung ⁴⁾	11.9401-9951.2	220463						
325 xi	141	09.00	02.05	+ erhöhte Zuladung ⁴⁾	11.9401-9952.2	220464						
330 xd	135	06.00	02.05		11.8116-0094.1	390504						
330 xd	150	03.03	02.05		11.0101-5402.2	260009						
330 xi	170	06.00	02.05		11.8171-0008.1	990049						
330 d	135	10.99	02.05		11.9401-9951.2	220463						
330 d	150	03.03	02.05		11.9401-9952.2	220464						
330 i	170	06.00	02.05		11.8116-0094.1	390504						
330 i	170	06.00	02.05		11.0101-5402.2	260009						
330 i	170	06.00	02.05		11.8171-0008.1	990049						
330 d	135	10.99	02.05		24.3421-1706.5	240354						
330 d	150	03.03	02.05		11.8116-0296.1	390445						
330 i	170	06.00	02.05		11.0101-5402.2	260009						
330 i	170	06.00	02.05		11.8171-0008.1	990049						
	316 i	85	02.02	02.05		24.5169-0458.3	331429	2		L=458		
	316 i 1.6	77	04.00	02.05								
	316 i 1.9	77	09.98	02.05								
	318 d	85	09.01	02.05								

¹⁾ length 150mm / lunghezza 150mm / longueur 150mm / largo 150mm
²⁾ length 177mm / lunghezza 177mm / longueur 177mm / largo 177mm
³⁾ - increased payload / - carico utile maggiorato / - charge utile augmentée / - incremento de carga
⁴⁾ + increased payload / + carico utile maggiorato / + charge utile augmentée / + incremento de carga



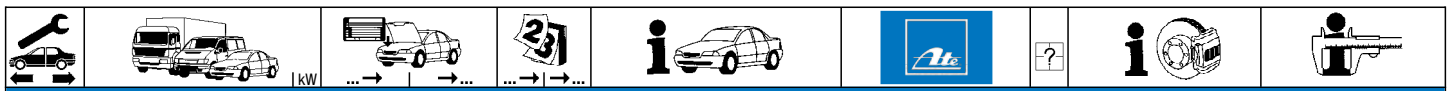







































































BMW 3er Reihe/E46 Limousine (98-05)

	318 i	87	02.98	02.05	24.5169-0458.3	331429	2		L=458
	318 i	105	09.01	02.05					
	320 d	95	02.98	02.05					
	320 d	100	04.98	02.05					
	320 d	110	09.01	02.05					
	320 i	110	03.98	02.05					
	320 i	125	09.00	02.05					
	323 i	125	03.98	02.05					
	325 i	141	09.00	02.05					
	325 xi	141	09.00	02.05					
	328 i	142	02.98	02.05					
	330 d	135	10.99	02.05					
	330 d	150	03.03	02.05					
	330 i	170	06.00	02.05					
	330 xd	135	06.00	02.05					
	330 xd	150	03.03	02.05					
	330 xi	170	06.00	02.05					
	316 i	85	02.02	02.05	24.3727-0224.2	580224	<input type="checkbox"/>	L=1693	
	316 i 1.6	77	04.00	02.05					
	316 i 1.9	77	09.98	02.05					
	318 d	85	09.01	02.05					
	318 i	87	02.98	02.05					
	318 i	105	09.01	02.05					
	320 d	95	02.98	02.05					
	320 d	100	04.98	02.05					
	320 d	110	09.01	02.05					
	320 i	110	03.98	02.05					
	320 i	125	09.00	02.05					
	323 i	125	03.98	02.05					
	325 i	141	09.00	02.05					
	325 xi	141	09.00	02.05					
	328 i	142	02.98	02.05					
	330 d	135	10.99	02.05					
	330 d	150	03.03	02.05					
	330 i	170	06.00	02.05					
	330 xd	135	06.00	02.05					
	330 xd	150	03.03	02.05					
	330 xi	170	06.00	02.05					
	316 i	85	02.02	02.05	24.2419-1713.3	030093		Gz 19,05	
	316 i 1.6	77	04.00	02.05					
	316 i 1.9	77	09.98	02.05					
	318 d	85	09.01	02.05					
	318 i	87	02.98	02.05					
	318 i	105	09.01	02.05					
	320 d	95	02.98	02.05					
	320 d	100	04.98	02.05					
	320 d	110	09.01	02.05					
	320 i	110	03.98	02.05					
	320 i	125	09.00	02.05					
	323 i	125	03.98	02.05					
	325 i	141	09.00	02.05					
	325 xi	141	09.00	02.05					
	328 i	142	02.98	02.05					
	330 d	135	10.99	02.05					
	330 d	150	03.03	02.05					
	330 i	170	06.00	02.05					
	330 xd	135	06.00	02.05					
	330 xd	150	03.03	02.05					
	330 xi	170	06.00	02.05					
	316 i	85	02.02	02.05	24.2522-1705.3	040079		Nz 22,20	
	316 i 1.6	77	04.00	02.05					
	316 i 1.9	77	09.98	02.05					
	318 d	85	09.01	02.05					
	318 i	87	02.98	02.05					
	318 i	105	09.01	02.05					
	320 d	95	02.98	02.05					
	320 d	100	04.98	02.05					
	320 d	110	09.01	02.05					
	320 i	110	03.98	02.05					
	320 i	125	09.00	02.05					
	323 i	125	03.98	02.05					
	325 i	141	09.00	02.05					
	325 xi	141	09.00	02.05					
	328 i	142	02.98	02.05					
	330 d	135	10.99	02.05					
	330 d	150	03.03	02.05					
	330 i	170	06.00	02.05					
	330 xd	135	06.00	02.05					
	330 xd	150	03.03	02.05					
	330 xi	170	06.00	02.05					

BMW 3er Reihe/E46 Touring (99-05)

	316 i	85	03.02	02.05	03.7860-0702.4	300123		10"	ATE
	318 d	85	03.02	02.05					
	318 i	87	10.99	02.05					
	318 i	105	09.01	02.05					
	320 d	100	03.00	02.05					
↓	↓								

















												
BMW 3er Reihe/E46 Touring (99-05)												
	320 d 320 i 320 i 325 i 325 xi 328 i 330 d 330 d 330 i 330 xd 330 xd 330 xi	110 110 125 141 141 142 135 150 170 135 150 170		09.01 10.99 09.00 09.00 09.00 10.99 10.99 03.03 06.00 06.00 03.03 06.00	02.05 02.05 02.05 02.05 02.05 02.05 02.05 02.05 02.05 02.05 02.05 02.05	03.7860-0702.4	300123	10"	ATE			
	316 i 318 d 318 i 320 d 320 i 325 i 330 d 330 i	85 85 105 110 125 141 135 170		03.02 03.02 09.01 09.01 09.01 09.01 09.01 09.01	02.05 02.05 02.05 02.05 02.05 02.05 02.05 02.05	03.2023-2344.3	010647	- DSC	Thz 23,81/22,20	ATE		
	318 i 320 d 320 i 320 i 325 i 328 i	87 100 110 125 141 142		10.99 03.00 10.99 09.00 09.00 10.99	02.05 02.05 02.05 08.01 08.01 02.05	03.2022-2624.3	010588	- DSC	Thz 22,20/20,64	ATE		
	330 d 330 i	135 170		10.99 06.00	08.01 08.01	03.2023-2304.3	010646	- DSC	Thz 23,81/22,20	ATE		
	316 i 318 d 318 i 320 d 320 i 325 i 330 d 330 d 330 i	85 85 105 110 125 141 135 150 170		03.02 03.02 09.01 09.01 09.00 02.01 09.00 03.03 09.01	02.05 02.05 02.05 02.05 02.05 02.05 02.05 02.05 02.05	03.2023-2256.3	010870	+ DSC	Thz 23,81/22,20	ATE		
	318 i 320 d 320 i 328 i	87 100 110 142		10.99 03.00 10.99 10.99	08.00 08.00 08.00 02.05	03.2022-2829.3	010589	+ DSC	Thz 22,20/20,64	ATE		
	330 d 330 i	135 170		10.99 06.00	08.00 08.01	03.2023-2204.3	010644	+ DSC	Thz 23,81/22,20	ATE		
	316 i 318 d 318 i 318 i 320 d 320 i	85 85 87 105 100 110		03.02 03.02 10.99 09.01 03.00 10.99	02.05 02.05 02.05 02.05 02.05 02.05	- erhöhte Zuladung ³⁾	11.9541-9588.2 24.3541-9587.5 24.3541-9588.5 11.8170-0729.1 11.0101-5402.2 11.8171-0008.1 11.0441-5402.2 11.8116-0109.1 11.8116-0206.1	220420 240527 240528 260107 260009 990049 250028 390495 390593	2 2 2 2 2 2 2 2	                    	D=54, - Halter D=54, - Halter D=54, - Halter Halter Hülzensatz Führungsbolzen Dichtungssatz Haltefeder Haltefeder	ATE ATE ATE ATE ATE ATE ATE ATE ATE ATE
	318 d 320 d 320 i 325 i 325 xi 328 i	85 110 125 141 141 142		03.02 09.01 09.00 09.00 09.00 10.99	02.05 02.05 02.05 02.05 02.05 02.05	+ erhöhte Zuladung ⁴⁾	11.9541-9588.2 24.3541-9587.5 24.3541-9588.5 11.8170-0730.1 11.0101-5402.2 11.8171-0008.1 11.0441-5402.2 11.8116-0109.1 11.8116-0206.1	220420 240527 240528 260108 260009 990049 250028 390495 390593	2 2 2 2 2 2 2 2	                	D=54, - Halter D=54, - Halter D=54, - Halter Halter Hülzensatz Führungsbolzen Dichtungssatz Haltefeder Haltefeder	ATE ATE ATE ATE ATE ATE ATE ATE ATE ATE
	330 d 330 d 330 i 330 xd 330 xd 330 xi	135 150 170 135 150 170		10.99 03.03 06.00 06.00 03.03 06.00	02.05 02.05 02.05 02.05 02.05 02.05		24.3571-1733.5 24.3571-1734.5 11.8116-0273.1 11.0101-5402.2 11.8171-0008.1	240349 240350 390515 260009 990049	2 2 2 2	            	D=57, - Halter D=57, - Halter Haltefeder Hülzensatz Führungsbolzen	ATE ATE ATE ATE ATE
	316 i 318 d 318 i 318 i 320 d 320 d 320 i 320 i 325 i 328 i 330 d 330 d 330 i	85 85 87 105 100 110 110 125 141 142 135 150 170		03.02 03.02 10.99 09.01 09.01 09.01 10.99 09.00 09.00 10.99 10.99 03.03 06.00	02.05 02.05 02.05 02.05 02.05 02.05 02.05 02.05 02.05 02.05 02.05 02.05 02.05		83.6152-0406.3	330789	2	L=405		
	316 i 318 d 318 i 318 i 320 d 320 i	85 85 87 105 100 110		03.02 03.02 10.99 09.01 03.00 10.99	02.05 02.05 02.05 02.05 02.05 02.05	- erhöhte Zuladung ³⁾	24.3401-1703.5 24.3401-1704.5 11.0101-5402.2 11.8171-0008.1 11.8116-0066.1 11.0441-4002.2	240351 240352 260009 990049 390577 250011	2 2 2 2	     	D=40, - Halter D=40, - Halter Hülzensatz Führungsbolzen Haltefeder Dichtungssatz	ATE ATE ATE ATE ATE ATE

¹⁾ length 150mm / lunghezza 150mm / longueur 150mm / largo 150mm

²⁾ length 177mm / lunghezza 177mm / longueur 177mm / largo 177mm

³⁾ - increased payload / - carico utile maggiorato / - charge utile augmentée / - incremento de carga

⁴⁾ + increased payload / + carico utile maggiorato / + charge utile augmentée / + incremento de carga

										
BMW 3er Reihe/E46 Touring (99-05)										
	318 d	85	03.02	02.05	+ erhöhte Zuladung ¹⁾	24.3401-1703.5	240351	2	D=40, - Halter D=40, - Halter Hülzensatz Führungsbolzen Haltefeder Dichtungssatz	ATE
	320 d	110	09.01	02.05		24.3401-1704.5	240352			ATE
	320 i	125	09.00	02.05		11.0101-5402.2	260009			ATE
	325 i	141	09.00	02.05		11.8171-0008.1	990049			ATE
	325 xi	141	09.00	02.05		11.8116-0066.1	390577			ATE
	328 i	142	10.99	02.05		11.0441-4002.2	250011			ATE
	330 d	135	10.99	02.05		24.3421-1706.5	240354			ATE
	330 d	150	03.03	02.05		11.0101-5402.2	260009			ATE
	330 i	170	06.00	02.05		11.8171-0008.1	990049			ATE
	330 xd	135	06.00	02.05		11.8116-0296.1	390445			ATE
	330 xd	150	03.03	02.05		11.9401-9951.2	220463			ATE
	330 xi	170	06.00	02.05		11.9401-9952.2	220464			ATE
	316 i	85	03.02	02.05		24.5169-0458.3	331429	2	L=458	
	318 d	85	03.02	02.05						
	318 i	87	10.99	02.05						
	318 i	105	09.01	02.05						
	320 d	100	03.00	02.05						
	320 d	110	09.01	02.05						
	320 i	110	10.99	02.05						
	320 i	125	09.00	02.05						
	325 i	141	09.00	02.05						
	325 xi	141	09.00	02.05						
	328 i	142	10.99	02.05						
	330 d	135	10.99	02.05						
	330 d	150	03.03	02.05						
	330 i	170	06.00	02.05						
	330 xd	135	06.00	02.05						
	330 xd	150	03.03	02.05						
	330 xi	170	06.00	02.05						
		316 i	85	03.02	02.05		24.3727-0224.2			580224
318 d		85	03.02	02.05		24.3727-0223.2	580223			
318 i		87	10.99	02.05						
318 i		105	09.01	02.05						
320 d		100	03.00	02.05						
320 d		110	09.01	02.05						
320 i		110	10.99	02.05						
320 i		125	09.00	02.05						
325 i		141	09.00	02.05						
325 xi		141	09.00	02.05						
328 i		142	10.99	02.05						
330 d		135	10.99	02.05						
330 d		150	03.03	02.05						
330 i		170	06.00	02.05						
330 xd		135	06.00	02.05						
330 xd	150	03.03	02.05							
330 xi	170	06.00	02.05							
	316 i	85	03.02	02.05		24.2419-1713.3	030093	2	Gz 19,05	
	318 d	85	03.02	02.05						
	318 i	87	10.99	02.05						
	318 i	105	09.01	02.05						
	320 d	100	03.00	02.05						
	320 d	110	09.01	02.05						
	320 i	110	10.99	02.05						
	320 i	125	09.00	02.05						
	325 i	141	09.00	02.05						
	325 xi	141	09.00	02.05						
	328 i	142	10.99	02.05						
	330 d	135	10.99	02.05						
	330 d	150	03.03	02.05						
	330 i	170	06.00	02.05						
	330 xd	135	06.00	02.05						
330 xd	150	03.03	02.05							
330 xi	170	06.00	02.05							
	316 i	85	03.02	02.05		24.2522-1705.3	040079	2	Nz 22,20	
	318 d	85	03.02	02.05						
	318 i	87	10.99	02.05						
	318 i	105	09.01	02.05						
	320 d	100	03.00	02.05						
	320 d	110	09.01	02.05						
	320 i	110	10.99	02.05						
	320 i	125	09.00	02.05						
	325 i	141	09.00	02.05						
	325 xi	141	09.00	02.05						
	328 i	142	10.99	02.05						
	330 d	135	10.99	02.05						
	330 d	150	03.03	02.05						
	330 i	170	06.00	02.05						
	330 xd	135	06.00	02.05						
330 xd	150	03.03	02.05							
330 xi	170	06.00	02.05							













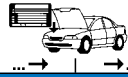







¹⁾ + increased payload / + carico utile maggiorato / + charge utile augmentée / + incremento de carga



BMW 3er Reihe/E46 Coupe (99-06)













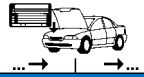
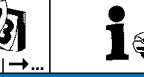

	316 Ci	77		04.00	09.06		03.7860-0702.4	300123			10"	ATE
	316 Ci	85		06.02	09.06							
	318 Ci	87		11.99	09.01							
	318 Ci	105		09.01	09.06							
	318 Ci	110		03.05	09.06							
	320 Cd	110		11.03	09.06							
	320 Ci	110		08.99	09.00							
	320 Ci	125		09.00	09.06							
	323 Ci	125		04.99	09.00							
	325 Ci	141		09.00	09.06							
	328 Ci	142		04.99	06.00							
	330 Cd	150		03.03	09.06							
	330 Ci	170		06.00	09.06							
	330 xi	170		06.00	09.06							
	316 Ci	77		04.00	08.01		03.2022-2624.3	010588		- DSC	THz 22,20/20,64	ATE
	318 Ci	87		11.99	09.01							
	320 Ci	110		08.99	09.00							
	320 Ci	125		09.00	08.01							
	323 Ci	125		04.99	09.00							
	325 Ci	141		09.00	08.01							
	328 Ci	142		04.99	06.00							
	316 Ci	77		09.01	09.06		03.2023-2344.3	010647		- DSC	THz 23,81/22,20	ATE
	316 Ci	85		06.02	09.06							
	318 Ci	105		09.01	09.06							
	320 Ci	125		09.01	09.06							
	325 Ci	141		09.01	09.06							
	330 Ci	170		09.01	09.06							
	330 xi	170		09.01	09.06							
	316 Ci	77		04.00	08.00		03.2022-2829.3	010589		+ DSC	THz 22,20/20,64	ATE
	318 Ci	87		11.99	08.00							
	320 Ci	110		08.99	09.00							
	323 Ci	125		04.99	09.00							
	328 Ci	142		04.99	06.00							
	316 Ci	77		02.01	09.06	+ DSC	03.2023-2256.3	010870			THz 23,81/22,20	ATE
	316 Ci	85		06.02	09.06	+ DSC						
	318 Ci	87		02.01	09.06	+ DSC						
	318 Ci	105		09.01	09.06	+ DSC						
	318 Ci	110		03.05	09.06							
	320 Cd	110		11.03	09.06							
	320 Ci	125		09.00	09.06	+ DSC						
	325 Ci	141		09.00	09.06	+ DSC						
	330 Cd	150		03.03	09.06							
	330 Ci	170		09.00	09.06	+ DSC						
	330 xi	170		09.00	09.06	+ DSC						
	330 Ci	170		06.00	08.01	- DSC	03.2023-2304.3	010646			THz 23,81/22,20	ATE
	330 xi	170		06.00	08.01	- DSC						
	330 Ci	170		06.00	08.00	+ DSC	03.2023-2204.3	010644			THz 23,81/22,20	ATE
	330 xi	170		06.00	08.00	+ DSC						
	316 Ci	77		04.00	09.06		24.3541-9587.5	240527			D=54, - Halter	ATE
	316 Ci	85		06.02	09.06		11.9541-9588.2	220420			D=54, - Halter	ATE
	318 Ci	87		11.99	09.01		24.3541-9588.5	240528			D=54, - Halter	ATE
	318 Ci	105		09.01	09.06		11.8170-0729.1	260107		2	Halter	ATE
	318 Ci	110		03.05	09.06		11.0101-5402.2	260009			Hülzensatz	ATE
	320 Ci	110		08.99	09.00		11.8116-0206.1	390593		2	Haltefeder	ATE
	320 Ci	125		09.00	09.06		11.0441-5402.2	250028			Dichtungssatz	ATE
	323 Ci	125		04.99	09.00							
	320 Cd	110		11.03	09.06		24.3541-9587.5	240527			D=54, - Halter	ATE
	325 Ci	141		09.00	09.06		11.9541-9588.2	220420			D=54, - Halter	ATE
	328 Ci	142		04.99	06.00		24.3541-9588.5	240528			D=54, - Halter	ATE
							11.8170-0730.1	260108		2	Halter	ATE
							11.0101-5402.2	260009			Hülzensatz	ATE
							11.8116-0206.1	390593		2	Haltefeder	ATE
							11.0441-5402.2	250028			Dichtungssatz	ATE
	328 Ci	142		03.03	09.06		24.3571-1733.5	240349			D=57, - Halter	ATE
	330 Cd	150		03.03	09.06		24.3571-1734.5	240350			D=57, - Halter	ATE
	330 Ci	170		06.00	09.06		11.0101-5402.2	260009			Hülzensatz	ATE
	330 xi	170		06.00	09.06		11.8116-0273.1	390515		2	Haltefeder	ATE
	M3	252		06.00	09.06		11.0101-5402.2	260009			Hülzensatz	ATE
							11.8116-0083.1	390501		2	Haltefeder	ATE
							11.0441-6003.2	250037			Dichtungssatz	ATE
	M3 CSL	265		06.03	09.06		11.0101-5402.2	260009			Hülzensatz	ATE
							11.8116-0083.1	390501		2	Haltefeder	ATE
							11.0441-6003.2	250037			Dichtungssatz	ATE
	316 Ci	77		04.00	09.06		83.6152-0406.3	330789			L=405	
	316 Ci	85		06.02	09.06							
	318 Ci	87		11.99	09.01							
	318 Ci	105		09.01	09.06							
	318 Ci	110		03.05	09.06							
	320 Cd	110		11.03	09.06							
	320 Ci	110		08.99	09.00							
	320 Ci	125		09.00	09.06							
	323 Ci	125		04.99	09.00							
	325 Ci	141		09.00	09.06							
	328 Ci	142		04.99	06.00							
	330 Cd	150		03.03	09.06							
	330 Ci	170		06.00	09.06							

1) length 177mm / lunghezza 177mm / longueur 177mm / largo 177mm





























													
BMW 3er Reihe/E46 Coupe (99-06)													
	330 xi	170		06.00	09.06		83.6152-0406.3	330789	2		L=405		
	316 Ci	77		04.00	09.06		24.3401-1705.5	240423	2	 	D=40, - Halter	ATE	
	316 Ci	85		06.02	09.06		24.3401-1706.5	240424			D=40, - Halter	ATE	
	318 Ci	87		11.99	09.01		11.8171-0008.1	990049			Führungsbolzen	ATE	
							11.0101-5402.2	260009			Hülzensatz	ATE	
							11.8116-0066.1	390577			Haltefeder	ATE	
							11.0441-4002.2	250011			Dichtungssatz	ATE	
	318 Ci	105		09.01	09.06		24.3401-1703.5	240351			D=40, - Halter	ATE	
	318 Ci	110		03.05	09.06		24.3401-1704.5	240352			D=40, - Halter	ATE	
	320 Ci	110		08.99	09.00		11.8171-0008.1	990049			Führungsbolzen	ATE	
	320 Ci	125		09.00	09.06		11.0101-5402.2	260009			Hülzensatz	ATE	
							11.8116-0066.1	390577			Haltefeder	ATE	
							11.0441-4002.2	250011			Dichtungssatz	ATE	
	320 Cd	110		11.03	09.06		24.3401-1703.5	240351			D=40, - Halter	ATE	
	323 Ci	125		04.99	09.00		24.3401-1704.5	240352			D=40, - Halter	ATE	
	325 Ci	141		09.00	09.06		11.8171-0008.1	990049			Führungsbolzen	ATE	
328 Ci	142		04.99	06.00		11.0101-5402.2	260009	Hülzensatz	ATE				
						11.8116-0066.1	390577	Haltefeder	ATE				
						11.0441-4002.2	250011	Dichtungssatz	ATE				
330 Cd	150		03.03	09.06		24.3421-1706.5	240354	D=42, - Halter	ATE				
330 Ci	170		06.00	09.06		11.8171-0008.1	990049	Führungsbolzen	ATE				
330 xi	170		06.00	09.06		11.0101-5402.2	260009	Hülzensatz	ATE				
						11.8116-0296.1	390445	Haltefeder	ATE				
M3	252		06.00	09.06		11.9421-9953.2	220837	 - Competition Paket 1)  - Competition Paket 1)	D=42, - Halter	ATE			
						11.9421-9954.2	220838		D=42, - Halter	ATE			
						11.8171-0008.1	990049		Führungsbolzen	ATE			
						11.0101-5402.2	260009		Hülzensatz	ATE			
						11.8116-0296.1	390445	Haltefeder	ATE				
M3 CSL	265		06.03	09.06		11.8171-0008.1	990049	Führungsbolzen	ATE				
						11.0101-5402.2	260009	Hülzensatz	ATE				
						11.8116-0296.1	390445	Haltefeder	ATE				
	316 Ci	77		04.00	09.06		24.5169-0458.3	331429	2		L=458		
	316 Ci	85		06.02	09.06								
	318 Ci	87		11.99	09.01								
	318 Ci	105		09.01	09.06								
	318 Ci	110		03.05	09.06								
	320 Cd	110		11.03	09.06								
	320 Ci	110		08.99	09.00								
	320 Ci	125		09.00	09.06								
	323 Ci	125		04.99	09.00								
	325 Ci	141		09.00	09.06								
	328 Ci	142		04.99	06.00								
	330 Cd	150		03.03	09.06								
	330 Ci	170		06.00	09.06								
	330 xi	170		06.00	09.06								
	M3	252		06.00	09.06								
	M3 CSL	265		06.03	09.06								
		316 Ci	77		04.00	09.06		24.3727-0224.2	580224	2	 	L=1693	
		316 Ci	85		06.02	09.06		24.3727-0223.2	580223			L=1708	
318 Ci		87		11.99	09.01								
318 Ci		105		09.01	09.06								
318 Ci		110		03.05	09.06								
320 Cd		110		11.03	09.06								
320 Ci		110		08.99	09.00								
320 Ci		125		09.00	09.06								
323 Ci		125		04.99	09.00								
325 Ci		141		09.00	09.06								
328 Ci		142		04.99	06.00								
330 Cd		150		03.03	09.06								
330 Ci		170		06.00	09.06								
330 xi		170		06.00	09.06								
M3		252		06.00	09.06								
M3 CSL		265		06.03	09.06								
BMW 3er Reihe/E46 Cabrio (00-06)													
		318 Ci	105		09.01	09.06		03.7860-0702.4	300123				
	318 Ci	110		02.05	09.06								
	320 Cd	110		02.05	09.06								
	320 Ci	125		09.00	09.06								
	323 Ci	125		04.00	09.00								
	325 Ci	141		09.00	09.06								
	330 Cd	150		08.05	09.06								
	318 Ci	105		09.01	09.06		03.2023-2344.3	010647	- DSC + DSC	THz 23,81/22,20	ATE		
							03.2023-2256.3	010870		THz 23,81/22,20	ATE		
	318 Ci	110		02.05	09.06		03.2023-2256.3	010870		THz 23,81/22,20	ATE		
	320 Cd	110		02.05	09.06								
	330 Cd	150		08.05	09.06								
	320 Ci	125		09.00	08.01		03.2022-2624.3	010588	- DSC	THz 22,20/20,64	ATE		
	323 Ci	125		04.00	09.00								
	325 Ci	141		09.00	08.01								
320 Ci	125		09.01	09.06		03.2023-2344.3	010647	- DSC	THz 23,81/22,20	ATE			
325 Ci	141		09.01	09.06									
330 Ci	170		09.01	09.06									

1) - Competition package / - pacco Competition / - version Competition / - paquete Competition



											
BMW 3er Reihe/E46 Cabrio (00-06)											
	330 Ci	170		06.00	08.00		03.2023-2204.3	010644	+ DSC	THz 23,81/22,20	ATE
	320 Ci	125		09.00	09.06		03.2023-2256.3	010870	+ DSC	THz 23,81/22,20	ATE
	325 Ci	141		09.00	09.06						
	330 Ci	170		09.00	09.06						
	323 Ci	125		04.00	09.00		03.2022-2829.3	010589	+ DSC	THz 22,20/20,64	ATE
	330 Ci	170		06.00	08.01		03.2023-2304.3	010646	- DSC	THz 23,81/22,20	ATE
	318 Ci	105		09.01	09.06		24.3541-9587.5	240527	<input type="checkbox"/>	D=54, - Halter	ATE
	318 Ci	110		02.05	09.06		11.9541-9588.2	220420	<input type="checkbox"/>	D=54, - Halter	ATE
							24.3541-9588.5	240528	<input type="checkbox"/>	D=54, - Halter	ATE
							11.8170-0729.1	260107	2	Halter	ATE
							11.0101-5402.2	260009		Hülzensatz	ATE
							11.8171-0008.1	990049		Führungsbolzen	ATE
							11.8116-0206.1	390593	2	Haltefeder	ATE
							11.0441-5402.2	250028		Dichtungssatz	ATE
										Länge 177mm ¹⁾	
	320 Cd	110		02.05	09.06		24.3541-9587.5	240527	<input type="checkbox"/>	D=54, - Halter	ATE
	320 Ci	125		09.00	09.06		11.9541-9588.2	220420	<input type="checkbox"/>	D=54, - Halter	ATE
	323 Ci	125		04.00	09.00		24.3541-9588.5	240528	<input type="checkbox"/>	D=54, - Halter	ATE
	325 Ci	141		09.00	09.06		11.8170-0730.1	260108	2	Halter	ATE
							11.0101-5402.2	260009		Hülzensatz	ATE
							11.8171-0008.1	990049		Führungsbolzen	ATE
							11.8116-0206.1	390593	2	Haltefeder	ATE
							11.0441-5402.2	250028		Dichtungssatz	ATE
	330 Cd	150		08.05	09.06		24.3571-1733.5	240349	<input type="checkbox"/>	D=57, - Halter	ATE
	330 Ci	170		06.00	09.06		24.3571-1734.5	240350	<input type="checkbox"/>	D=57, - Halter	ATE
							11.0101-5402.2	260009		Hülzensatz	ATE
							11.8171-0008.1	990049		Führungsbolzen	ATE
							11.8116-0273.1	390515	2	Haltefeder	ATE
	M3 3.2	252		04.01	09.06		11.0101-5402.2	260009		Hülzensatz	ATE
							11.8171-0008.1	990049		Führungsbolzen	ATE
							11.8116-0083.1	390501	2	Haltefeder	ATE
							11.0441-6003.2	250037		Dichtungssatz	ATE
	318 Ci	105		09.01	09.06		83.6152-0406.3	330789	2		L=405
	318 Ci	110		02.05	09.06						
	320 Cd	110		02.05	09.06						
	320 Ci	125		09.00	09.06						
	323 Ci	125		04.00	09.00						
	325 Ci	141		09.00	09.06						
	330 Cd	150		08.05	09.06						
	330 Ci	170		06.00	09.06						
	318 Ci	105		09.01	09.06		24.3401-1703.5	240351	<input type="checkbox"/>	D=40, - Halter	ATE
	318 Ci	110		02.05	09.06		24.3401-1704.5	240352	<input type="checkbox"/>	D=40, - Halter	ATE
							11.0101-5402.2	260009		Hülzensatz	ATE
							11.8171-0008.1	990049		Führungsbolzen	ATE
							11.8116-0066.1	390577	2	Haltefeder	ATE
							11.0441-4002.2	250011		Dichtungssatz	ATE
	320 Cd	110		02.05	09.06		24.3401-1703.5	240351	<input type="checkbox"/>	D=40, - Halter	ATE
	320 Ci	125		09.00	09.06		24.3401-1704.5	240352	<input type="checkbox"/>	D=40, - Halter	ATE
	323 Ci	125		04.00	09.00		11.0101-5402.2	260009		Hülzensatz	ATE
	325 Ci	141		09.00	09.06		11.8171-0008.1	990049		Führungsbolzen	ATE
							11.8116-0066.1	390577	2	Haltefeder	ATE
							11.0441-4002.2	250011		Dichtungssatz	ATE
	330 Cd	150		08.05	09.06		24.3421-1706.5	240354	<input type="checkbox"/>	D=42, - Halter	ATE
	330 Ci	170		06.00	09.06		11.0101-5402.2	260009		Hülzensatz	ATE
							11.8171-0008.1	990049		Führungsbolzen	ATE
							11.8116-0296.1	390445	2	Haltefeder	ATE
	M3 3.2	252		04.01	09.06		11.9421-9953.2	220837	<input type="checkbox"/>	D=42, - Halter	ATE
							11.9421-9954.2	220838	<input type="checkbox"/>	D=42, - Halter	ATE
							11.0101-5402.2	260009		Hülzensatz	ATE
							11.8171-0008.1	990049		Führungsbolzen	ATE
							11.8116-0296.1	390445	2	Haltefeder	ATE
	318 Ci	105		09.01	09.06		24.5169-0458.3	331429	2		L=458
	318 Ci	110		02.05	09.06						
	320 Cd	110		02.05	09.06						
	320 Ci	125		09.00	09.06						
	323 Ci	125		04.00	09.00						
	325 Ci	141		09.00	09.06						
	330 Cd	150		08.05	09.06						
	330 Ci	170		06.00	09.06						
	M3 3.2	252		04.01	09.06						
	318 Ci	105		09.01	09.06		24.3727-0224.2	580224	<input type="checkbox"/>		L=1693
	318 Ci	110		02.05	09.06		24.3727-0223.2	580223	<input type="checkbox"/>		L=1708
	320 Cd	110		02.05	09.06						
	320 Ci	125		09.00	09.06						
	323 Ci	125		04.00	09.00						
	325 Ci	141		09.00	09.06						
	330 Cd	150		08.05	09.06						
	330 Ci	170		06.00	09.06						
	M3 3.2	252		04.01	09.06						
	318 Ci	105		09.01	09.06		24.2522-1705.3	040079			Nz 22,20
	318 Ci	110		02.05	09.06						
	320 Cd	110		02.05	09.06						
	320 Ci	125		09.00	09.06						
	323 Ci	125		04.00	09.00						
	325 Ci	141		09.00	09.06						
	330 Cd	150		08.05	09.06						
	330 Ci	170		06.00	09.06						
	M3 3.2	252		04.01	09.06						

¹⁾ length 177mm / lunghezza 177mm / longueur 177mm / largo 177mm

								
BMW 3er Reihe/E46 Compact (01-05)								
	316 ti 316 ti 318 td 318 ti 320 td 325 ti	77 85 85 105 110 141		06.02 06.01 03.03 09.01 09.01 06.01	02.05 02.05 02.05 02.05 02.05 02.05	03.7860-0702.4	300123	10" ATE
	316 ti 325 ti	85 141		06.01 06.01	08.01 08.01	03.2022-2624.3	010588	- DSC THz 22,20/20,64 ATE
	316 ti 316 ti 318 ti 320 td 325 ti	77 85 105 110 141		06.02 09.01 09.01 09.01 09.01	02.05 02.05 02.05 02.05 02.05	03.2023-2344.3	010647	- DSC THz 23,81/22,20 ATE
	316 ti 316 ti 318 td 318 ti 320 td 325 ti	77 85 85 105 110 141		06.02 09.01 03.03 09.01 09.01 09.01	02.05 02.05 02.05 02.05 02.05 02.05	03.2023-2256.3	010870	+ DSC THz 23,81/22,20 ATE
	316 ti 316 ti 318 td 318 ti	77 85 85 105		06.02 06.01 03.03 09.01	02.05 02.05 02.05 02.05	24.3541-9587.5 24.3541-9588.5 11.9541-9588.2 11.8170-0729.1 11.0101-5402.2 11.8171-0008.1 11.0441-5402.2 11.8116-0206.1	240527 240528 220420 260107 260009 990049 250028 390593	   2 Halter Hülzensatz Führungsbolzen Dichtungssatz Haltefeder ATE ATE ATE ATE ATE ATE
	320 td 325 ti	110 141		09.01 06.01	02.05 02.05	24.3541-9587.5 24.3541-9588.5 11.9541-9588.2 11.8170-0730.1 11.0101-5402.2 11.8171-0008.1 11.0441-5402.2 11.8116-0206.1	240527 240528 220420 260108 260009 990049 250028 390593	2 Länge 177mm ¹⁾ D=54, - Halter D=54, - Halter D=54, - Halter Halter Hülzensatz Führungsbolzen Dichtungssatz Haltefeder ATE ATE ATE ATE ATE ATE
	316 ti 316 ti 318 td 318 ti 320 td 325 ti	77 85 85 105 110 141		06.02 06.01 03.03 09.01 09.01 06.01	02.05 02.05 02.05 02.05 02.05 02.05	83.6152-0406.3	330789	2 L=405
	316 ti 316 ti	77 85		06.02 06.01	02.05 02.05	24.3401-1705.5 24.3401-1706.5 11.0101-5402.2 11.8171-0008.1 11.8116-0066.1 11.0441-4002.2	240423 240424 260009 990049 390577 250011	  2 D=40, - Halter D=40, - Halter Hülzensatz Führungsbolzen Haltefeder Dichtungssatz ATE ATE ATE ATE ATE
	318 td 318 ti	85 105		03.03 09.01	02.05 02.05	24.3401-1703.5 24.3401-1704.5 11.0101-5402.2 11.8171-0008.1 11.8116-0066.1 11.0441-4002.2	240351 240352 260009 990049 390577 250011	  2 D=40, - Halter D=40, - Halter Hülzensatz Führungsbolzen Haltefeder Dichtungssatz ATE ATE ATE ATE ATE
	320 td 325 ti	110 141		09.01 06.01	02.05 02.05	24.3401-1703.5 24.3401-1704.5 11.0101-5402.2 11.8171-0008.1 11.8116-0066.1 11.0441-4002.2	240351 240352 260009 990049 390577 250011	  2 D=40, - Halter D=40, - Halter Hülzensatz Führungsbolzen Haltefeder Dichtungssatz ATE ATE ATE ATE ATE
	316 ti 316 ti 318 td 318 ti 320 td 325 ti	77 85 85 105 110 141		06.02 06.01 03.03 09.01 09.01 06.01	02.05 02.05 02.05 02.05 02.05 02.05	24.5169-0458.3	331429	2 L=458
	316 ti 316 ti 318 td 318 ti 320 td 325 ti	77 85 85 105 110 141		06.02 06.01 03.03 09.01 09.01 06.01	02.05 02.05 02.05 02.05 02.05 02.05	24.3727-0224.2 24.3727-0223.2	580224 580223	  L=1693 L=1708
	316 ti 316 ti 318 td 318 ti 320 td 325 ti	77 85 85 105 110 141		06.02 06.01 03.03 09.01 09.01 06.01	02.05 02.05 02.05 02.05 02.05 02.05	24.2419-1713.3	030093	Gz 19,05
	316 ti 316 ti 318 td 318 ti 320 td 325 ti	77 85 85 105 110 141		06.02 06.01 03.03 09.01 09.01 06.01	02.05 02.05 02.05 02.05 02.05 02.05	24.2522-1705.3	040079	Nz 22,20

¹⁾ length 177mm / lunghezza 177mm / longueur 177mm / largo 177mm



BMW 3er Reihe/E90 Limousine (05-12)

	316 d	85		07.09	03.12	03.7848-4003.4	300235	-	Start/Stop-Anlage ¹⁾	8"	ATE							
	316 i	85		01.05	08.07													
	316 i	90		09.07	03.12													
	318 d			09.07	03.12													
	318 d	90		09.05	08.07													
	318 i	95		09.05	08.07													
	318 i	105		09.07	03.12													
	320 i	110		12.04	08.07													
	320 i	125		09.07	03.12													
	320 d	120		12.04	03.12													
	320 si	127		06.06	03.12													
	325 d	145		09.06	03.12													
	325 i	160		12.04	03.12													
	325 xi	160		09.07	03.12 + Motorcode N53 ²⁾													
	325 xi	160		01.05	08.07 + Motorcode N52 ³⁾													
330 d	170		09.05	03.12														
330 d	180		09.09	03.12														
330 i	190		12.04	08.07														
330 i	200		09.09	03.12														
330 xd	170		09.05	03.12														
330 xd	180		09.09	03.12														
330 xi	190		01.05	08.07														
330 xi	200		09.07	03.12														
	320 d	110		09.05	03.12	03.7845-0103.4	300268	-	Start/Stop-Anlage ¹⁾	8"	ATE							
	320 d	130		09.07	03.12													
	320 xd			09.07	03.12													
	325 xi	160		01.05	08.07 + Motorcode N52N ⁴⁾													
	330 d	180		09.08	08.09													
	330 i	200		09.07	08.09													
	330 xd	180		01.09	08.09													
	335 d	210		09.06	03.12													
	335 i	225		09.06	03.12													
	335 xi	225		03.07	03.12													
		316 d	85		07.09							03.12	03.2023-2407.3	010796	-		Thz 23,81/22,20	ATE
		316 i	85		01.05							08.07						
		316 i	90		09.07							03.12						
		318 d			09.07							03.12						
		318 d	90		09.05							08.07						
318 i		95		09.05	08.07													
318 i		105		09.07	03.12													
320 i		110		12.04	08.07													
320 i		125		09.07	03.12													
320 d		110		09.05	03.12													
320 d		120		12.04	03.12													
320 d		130		09.07	03.12													
320 si		127		06.06	03.12													
320 xd				09.07	03.12													
325 d		145		09.06	03.12													
325 i		160		12.04	03.12													
325 xi		160		01.05	03.12													
330 d		170		09.05	03.12													
330 d		180		09.08	03.12													
330 i		190		12.04	08.07													
330 i		200		09.07	03.12													
330 xd		170		01.05	03.12													
330 xd		180		01.09	03.12													
330 xi		190		01.05	08.07													
330 xi		200		09.07	03.12													
335 d	210		09.06	03.12														
335 i	225		09.06	03.12														
335 xi	225		03.07	03.12														
	316 i	85		01.05	08.07	11.9541-9575.2	220829	-		D=54, - Halter	ATE							
	318 d	90		09.05	08.07 - erhöhte Zuladung ⁶⁾													
	318 i	95		09.05	08.07 - erhöhte Zuladung/ + Motorcode N46 ⁷⁾													
	320 i	110		12.04	08.07 - erhöhte Zuladung/ + Motorcode N46 ⁷⁾													
	316 d	85		07.09	03.12													
	316 i	90		09.07	03.12													
	318 d			09.07	03.12													
	318 i	95		03.07	08.07 - erhöhte Zuladung/ + Motorcode N46N ⁸⁾													
	318 i	105		09.07	03.12													
	320 i	125		09.07	03.12 - erhöhte Zuladung ⁶⁾													
	320 i	110		03.07	08.07 - erhöhte Zuladung/ + Motorcode N46N ⁸⁾													
	318 d	90		09.05	08.07 + erhöhte Zuladung ⁹⁾													
	318 i	95		03.07	08.07 + erhöhte Zuladung/ + Motorcode N46N ¹⁰⁾													
	318 i	95		09.05	08.07 + erhöhte Zuladung/ + Motorcode N46 ¹¹⁾													
	320 d	110		09.05	03.12 - Behörde ¹²⁾													
	320 d	120		12.04	03.12 - Behörde ¹²⁾													
	320 d	130		09.07	03.12 - Behörde ¹²⁾													
	320 i	110		03.07	08.07 + erhöhte Zuladung/ + Motorcode N46N ¹⁰⁾													
	320 i	110		12.04	08.07 + erhöhte Zuladung/ + Motorcode N46 ¹¹⁾													
	320 i	125		09.07	03.12 + erhöhte Zuladung ⁹⁾													
320 si	127		06.06	03.12														

1) - idling stop system / - dispositivo start/stop / - unité marche/arrêt / - unidad arranque/pa
2) + engine code N53 / + codice motore N53 / + moteur code N53 / + motor code N53
3) + engine code N52 / + codice motore N52 / + moteur code N52 / + motor code N52
4) + engine code N52N / + codice motore N52N / + moteur code N52N / + motor code N52N
5) length 177mm / lunghezza 177mm / longueur 177mm / largo 177mm
6) - increased payload / - carico utile maggiorato / - charge utile augmentée / - incremento de carga
7) - increased payload/+engine co.N46 / - carico utile maggior./+codic.mot.N46 / - charge utile augmentée/+moteur co.N46 / - incremento de carga/+motor co.N46
8) - increased payload/+engine co.N46N / - carico utile maggior./+codic.mot.N46N / - charge utile augmentée/+moteur co.N46N / - incremento de carga/+motor co.N46N
9) + increased payload / + carico utile maggiorato / + charge utile augmentée / + incremento de carga
10) + increased payload/+engine co.N46N / + carico utile maggior./+codic.mot.N46N / + charge utile augmentée/+moteur co.N46N / + incremento de carga/+motor co.N46N
11) + increased payload/+engine co.N46 / + carico utile maggior./+codic.mot.N46 / + charge utile augmentée/+moteur co.N46 / + incremento de carga/+motor co.N46
12) - authority cars / - enti statali / - véhicule communal / - vehiculos oficiales

8) - increased payload/+engine co.N46N / - carico utile maggior./+codic.mot.N46N / - charge utile augmentée/+moteur co.N46N / - incremento de carga/+motor co.N46N
9) + increased payload / + carico utile maggiorato / + charge utile augmentée / + incremento de carga
10) + increased payload/+engine co.N46N / + carico utile maggior./+codic.mot.N46N / + charge utile augmentée/+moteur co.N46N / + incremento de carga/+motor co.N46N
11) + increased payload/+engine co.N46 / + carico utile maggior./+codic.mot.N46 / + charge utile augmentée/+moteur co.N46 / + incremento de carga/+motor co.N46
12) - authority cars / - enti statali / - véhicule communal / - vehiculos oficiales

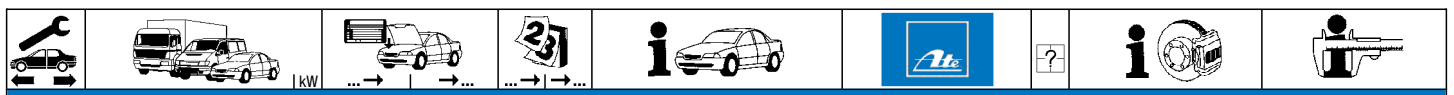













BMW 3er Reihe/E90 Limousine (05-12)

	320 xd	160	09.07	03.12	- Behörde ¹⁾	11.9571-9753.2	220929	2	D=57, - Halter	ATE
	325 i	160	12.04	03.12	- erhöhte Zuladung ²⁾	11.9571-9754.2	220930			ATE
	325 xi	160	01.05	03.12	- erhöhte Zuladung ²⁾	11.0101-5402.2	260009	2	Hülsensatz	ATE
						11.8171-0008.1	990049			ATE
						11.8116-0339.2	390528	ATE	Haltefeder	ATE
	320 d	110	09.05	03.12	+ Behörde ³⁾	11.0101-5402.2	260009	2	Hülsensatz	ATE
	320 d	120	12.04	03.12	+ Behörde ³⁾	11.8171-0008.1	990049			ATE
	320 d	130	09.07	03.12	+ Behörde ³⁾	11.8116-0339.2	390528	ATE	Haltefeder	ATE
	320 xd							2	Hülsensatz	ATE
	325 d	145	09.06	03.12	- Behörde ¹⁾					ATE
	325 i	160	12.04	03.12	+ erhöhte Zuladung ⁴⁾			2	Hülsensatz	ATE
	325 xi	160	01.05	03.12	+ erhöhte Zuladung ⁴⁾					ATE
	330 d	170	09.05	03.12	- erhöhte Zuladung ²⁾			2	Hülsensatz	ATE
	330 d	180	09.08	03.12	- erhöhte Zuladung ²⁾					ATE
	330 i	190	12.04	03.12	- erhöhte Zuladung ²⁾			2	Hülsensatz	ATE
	330 xd	170	09.05	08.07	- erhöhte Zuladung ²⁾					ATE
330 xd	180	01.09	03.12	- erhöhte Zuladung ²⁾			2	Hülsensatz	ATE	
330 xi	190	01.05	08.07	- erhöhte Zuladung ²⁾					ATE	
330 xi	200	09.07	03.12	- erhöhte Zuladung ²⁾			2	Hülsensatz	ATE	
									ATE	
325 d	145	09.06	03.12	+ Behörde ³⁾	11.0101-6006.2	260098	2	Hülsensatz	ATE	
330 d	170	09.05	03.12	+ erhöhte Zuladung ⁴⁾	11.8116-0315.2	390447			ATE	
330 d	180	09.08	03.12	+ erhöhte Zuladung ⁴⁾	11.8171-0008.1	990049	2	Hülsensatz	ATE	
330 i	200	09.07	03.12	+ erhöhte Zuladung ⁴⁾	11.8171-0067.1	250153			ATE	
330 xd	170	09.07	03.12				2	Hülsensatz	ATE	
330 xd	180	01.09	03.12	+ erhöhte Zuladung ⁴⁾					ATE	
330 xi	200	09.07	03.12	+ erhöhte Zuladung ⁴⁾			2	Hülsensatz	ATE	
335 d	210	09.06	03.12						ATE	
335 i	225	09.06	03.12				2	Hülsensatz	ATE	
335 xi	225	03.07	03.12						ATE	
M3	309	12.07	03.12		11.0441-6008.2	250038	2	Dichtungssatz	ATE	
					11.0101-6006.2	260098			ATE	
					11.8171-0008.1	990049	2	Hülsensatz	ATE	
					11.8116-0315.2	390447			ATE	
	316 d	85	07.09	03.12		24.5174-0526.3	331365	2	L=526	
	316 i	85	07.05	08.07						
	316 i	90	09.07	03.12				2	L=440	
	318 d	90	09.07	03.12						
	318 d	90	09.05	08.07				2	L=502	
	318 i	95	09.05	08.07						
	318 i	105	09.07	03.12				2	L=526	
	320 d	110	09.05	03.12						
	320 d	120	07.05	03.12				2	L=440	
	320 d	130	09.07	03.12						
	320 i	110	07.05	08.07				2	L=502	
	320 i	125	09.07	03.12						
	320 si	127	06.06	03.12				2	L=526	
	325 d	145	09.06	03.12						
	325 i	160	07.05	03.12				2	L=440	
	330 d	170	09.06	03.12						
330 d	180	09.08	03.12				2	L=502		
330 i	190	07.05	08.07							
330 i	200	09.07	03.12				2	L=526		
335 d	210	09.06	03.12							
335 i	225	09.06	03.12				2	L=440		
M3	309	12.07	03.12		83.7751-0502.3	331109	2	L=502		
	316 d	85	07.09	03.12		24.3401-1707.7	220775	2	D=40, - Halter	TRW
	316 i	85	01.05	08.07		24.3401-1708.7	220776			TRW
	316 i	90	09.07	03.12				2	D=40, - Halter	
	318 d	90	09.05	08.07	- erhöhte Zuladung ²⁾					
	318 i	95	09.05	08.07	- erhöhte Zuladung/ + Motorcode N46 ⁵⁾			2	D=42, - Halter	ATE
	320 i	110	12.04	08.07	- erhöhte Zuladung/ + Motorcode N46 ⁵⁾					ATE
	318 d	90	09.07	03.12		11.9421-9911.2	220825	2	D=42, - Halter	ATE
	318 d	90	09.05	08.07	+ erhöhte Zuladung ⁴⁾	11.9421-9912.2	220826			ATE
	318 i	95	03.07	08.07	+ Motorcode N46N ⁶⁾	11.8170-0755.1	260119	2	Halter	ATE
	318 i	95	09.05	08.07	+ erhöhte Zuladung/ + Motorcode N46N ⁷⁾	11.0101-5402.2	260009			ATE
	318 i	105	09.07	03.12		11.8171-0008.1	990049	2	Hülsensatz	ATE
	320 d	110	09.05	03.12	- Behörde ¹⁾	11.8116-0066.1	390577			ATE
	320 d	120	12.04	03.12				2	Hülsensatz	ATE
	320 d	130	09.07	03.12	- Behörde ¹⁾					ATE
	320 i	110	03.07	08.07	+ Motorcode N46N ⁶⁾			2	Halter	ATE
	320 i	110	12.04	08.07	+ erhöhte Zuladung/ + Motorcode N46 ⁵⁾					ATE
320 i	125	09.07	03.12				2	Hülsensatz	ATE	
320 si	127	06.06	03.12						ATE	
320 xd							2	Hülsensatz	ATE	
325 i	160	09.07	03.12	- Behörde ¹⁾					ATE	
325 i	160	12.04	03.12	- erhöhte Zuladung ²⁾			2	Hülsensatz	ATE	
325 xi	160	09.07	03.12	- erhöhte Zuladung/ + Motorcode N53 ⁹⁾					ATE	
325 xi	160	01.05	08.07	- erhöhte Zuladung/ + Motorcode N52N ¹⁰⁾			2	Halter	ATE	
325 xi	160	01.05	08.07	- erhöhte Zuladung/ + Motorcode N52 ¹¹⁾					ATE	

1) - authority cars / - enti statali / - véhicule communal / - vehiculos oficiales
 2) - increased payload / - carico utile maggiorato / - charge utile augmentée / - incremento de carga
 3) + authority cars / + enti statali / + véhicule communal / + vehiculos oficiales
 4) + increased payload / + carico utile maggiorato / + charge utile augmentée / + incremento de carga
 5) - increased payload/+engine co.N46 / - carico utile maggior./+codic.mot.N46 / - charge utile augmentée/+moteur co.N46 / - incremento de carga/+motor co.N46
 6) + engine code N46N / + codice motore N46N / + moteur code N46N / + motor code N46N
 7) + increased payload/+engine co.N46N / + carico utile maggior./+codic.mot.N46N / + charge utile augmentée/+moteur co.N46N / + incremento de carga/+motor co.N46N

8) + increased payload/+engine co.N46 / + carico utile maggior./+codic.mot.N46 / + charge utile augmentée/+moteur co.N46 / + incremento de carga/+motor co.N46
 9) - increased payload/+engine co.N53 / - carico utile maggior./+codic.mot.N53 / - charge utile augmentée/+ moteur co.N53 / - incremento de carga/+motor co.N53
 10) - increased payload/+engine co.N52N / - carico utile maggior./+codic.mot.N52N / - charge utile augmentée/+moteur co.N52N / - incremento de carga/+motor co.N52N
 11) - increased payload/+engine co.N52 / - carico utile maggior./+codic.mot.N52 / - charge utile augmentée/+moteur co.N52 / - incremento de carga/+motor co.N52



        											
BMW 3er Reihe/E90 Limousine (05-12)											
	320 d	110	09.05	03.12	+ Behörde ¹⁾	11.9441-9957.2	220827	2	D=44, - Halter D=44, - Halter Hülsensatz Führungsbolzen Haltefeder	ATE	
	320 d	130	09.07	03.12	+ Behörde ¹⁾	24.3441-9958.5	240672			ATE	
	320 xd		09.07	03.12	+ Behörde ¹⁾	11.0101-5402.2	260009			ATE	
	325 d	145	09.06	03.12		11.8171-0008.1	990049			ATE	
	325 i	160	12.04	03.12	+ erhöhte Zuladung ²⁾	11.8116-0296.1	390445			ATE	
	325 xi	160	01.05	03.12	+ erhöhte Zuladung ²⁾						
	330 d	170	09.05	03.12							
	330 d	180	09.08	03.12							
	330 i	190	12.04	08.07							
	330 i	200	09.07	03.12							
	330 xd	170	09.05	03.12							
	330 xd	180	01.09	03.12							
	330 xi	190	01.05	08.07							
	330 xi	200	09.07	03.12							
	335 d	210	09.06	03.12							
335 i	225	09.06	03.12								
335 xi	225	03.07	03.12								
M3	309	12.07	03.12		11.0101-5402.2	260009		Hülsensatz	ATE		
					11.8171-0008.1	990049		Führungsbolzen	ATE		
					11.8116-0296.1	390445		Haltefeder	ATE		
	316 d	85	07.09	03.12		83.7850-0180.3	331054	2	L=180 L=230 L=221		
	316 i	85	01.05	08.07		24.5125-0230.3	331277	2		am Bremssattel ³⁾	
	316 i	90	09.07	03.12		24.5137-0221.3	331302	2		am Bremssattel ³⁾	
	318 d		09.07	03.12							
	318 d	90	09.05	08.07							
	318 i	95	09.05	08.07							
	318 i	105	09.07	03.12							
	320 d	110	09.05	03.12							
	320 d	120	12.04	03.12							
	320 d	130	09.07	03.12							
	320 i	110	12.04	08.07							
	320 i	125	09.07	03.12							
	320 si	127	06.06	03.12							
	320 xd		09.07	03.12							
	325 d	145	09.06	03.12							
	325 i	160	12.04	03.12							
	325 xi	160	01.05	03.12							
	330 d	170	09.05	03.12							
	330 d	180	09.08	03.12							
	330 i	190	12.04	08.07							
	330 i	200	09.07	03.12							
	330 xd	170	09.05	03.12							
	330 xd	180	01.09	03.12							
	330 xi	190	01.05	08.07							
	330 xi	200	09.07	03.12							
	335 d	210	09.06	03.12							
	335 i	225	09.06	03.12							
335 xi	225	03.07	03.12								
M3	309	12.07	03.12		83.7850-0180.3	331054	2		L=180		
					83.7752-0236.3	331118	2		L=235		
									L=1535		
	316 d	85	07.09	03.12		24.3727-0233.2	580233	2	am Bremssattel ³⁾		
	316 i	85	01.05	08.07							
	316 i	90	09.07	03.12							
	318 d		09.07	03.12							
	318 d	90	09.05	08.07							
	318 i	95	09.05	08.07							
	318 i	105	09.07	03.12							
	320 d	110	09.05	03.12							
	320 d	120	12.04	03.12							
	320 d	130	09.07	03.12							
	320 i	110	12.04	08.07							
	320 i	125	09.07	03.12							
	320 si	127	06.06	03.12							
	320 xd		09.07	03.12							
	325 d	145	09.06	03.12							
	325 i	160	12.04	03.12							
	325 xi	160	01.05	03.12							
	330 d	170	09.05	03.12							
	330 d	180	09.08	03.12							
	330 i	190	12.04	08.07							
	330 i	200	09.07	03.12							
330 xd	170	09.05	03.12								
330 xd	180	01.09	03.12								
330 xi	190	01.05	08.07								
330 xi	200	09.07	03.12								
335 d	210	09.06	03.12								
335 i	225	09.06	03.12								
335 xi	225	03.07	03.12								
M3	309	12.07	03.12								
	316 d	85	07.09	03.12		24.2419-1713.3	030093		Gz 19,05		
	316 i	85	01.05	08.07							
	316 i	90	09.07	03.12							
	318 d		09.07	03.12							
	318 d	90	09.05	08.07							
	318 i	95	09.05	08.07							
	318 i	105	09.07	03.12							
320 d	110	09.05	03.12								

¹⁾ + authority cars / + enti statali / + véhicule communal / + vehiculos oficiales
²⁾ + increased payload / + carico utile maggiorato / + charge utile augmentée / + incremento de carga
³⁾ on the brake caliper / sulla pinza freno / sur l'étrier de frein / a la pinza de freno



BMW 3er Reihe/E90 Limousine (05-12)

	320 d	120		12.04	03.12		24.2419-1713.3	030093		Gz 19,05
	320 d	130		09.07	03.12					
	320 i	110		12.04	08.07					
	320 i	125		09.07	03.12					
	320 si	127		06.06	03.12					
	320 xd			09.07	03.12					
	325 d	145		09.06	03.12					
	325 i	160		12.04	03.12					
	325 xi	160		01.05	03.12					
	330 d	170		09.05	03.12					
	330 d	180		09.08	03.12					
	330 i	190		12.04	08.07					
	330 i	200		09.07	03.12					
	330 xd	170		09.05	03.12					
	330 xd	180		01.09	03.12					
	330 xi	190		01.05	08.07					
	330 xi	200		09.07	03.12					
	335 i	225		09.06	03.12					
	335 xi	225		03.07	03.12					
	M3	309		12.07	03.12					
	318 d	90		09.05	08.07		24.2522-0905.3	040042		Nz 22,20
	318 i	95		09.05	08.07					
	320 d	110		09.05	03.12					
	320 d	120		12.04	03.12					
	320 i	110		12.04	08.07					
	320 si	127		06.06	03.12					
	325 i	160		12.04	03.12	+ Motorcode N52 ¹⁾				
	325 xi	160		01.05	08.07					
	330 d	170		09.05	03.12					
	330 i	190		12.04	08.07					
	330 xd	170		09.05	03.12					
	330 xi	190		01.05	08.07					

BMW 3er Reihe/E91 Touring (05-12)

	316 d	85		09.09	05.12		03.7848-4003.4	300235	- Start/Stop-Anlage ²⁾	8"	ATE
	316i	90		09.07	05.12						
	318 d	90		09.05	08.07		03.7848-5003.4	300236		8"	ATE
	318 i	95		01.06	08.07	+ Motorcode N46 ³⁾					
	320 d	120		06.05	08.07						
	320 i	110		06.05	08.07	+ Motorcode N46 ³⁾					
	325 d	145		09.06	05.12						
	325 i	155		01.12	05.12						
	325 i	160		06.05	05.12						
	325 xi	160		06.05	05.12						
	330 d	170		06.05	05.12						
	330 i	190		06.05	08.07						
	330 xd			06.05	05.12						
	330 xi	190		06.05	08.07						
	330 xi	200		09.07	05.12						
	318 d	105		09.07	05.12		03.7845-0103.4	300268		8"	ATE
	318 i	95		03.07	08.07	+ Motorcode N46N ⁴⁾					
	318 i	100		09.07	05.12						
	318 i	105		09.07	05.12						
	320 d			09.07	05.12						
	320 i	110		06.05	08.07	+ Motorcode N46N ⁴⁾					
	320 i	125		09.07	05.12						
	320 xd	130		09.07	05.12						
	323 i	130		09.06	05.12						
	330 d	180		09.08	05.12						
	330 i	200		09.07	05.12						
	335 d	210		09.06	05.12						
	335 i	225		09.06	05.12						
	335 xi	225		03.07	05.12						
	316 d	85		09.09	05.12		03.2023-2407.3	010796		Thz 23,81/22,20	ATE
	316i	90		09.07	05.12						
	318 d	90		09.05	08.07		03.2025-1904.3	010797		Thz 25,40/22,20	ATE
	318 d	105		09.07	05.12						
	318 i	95		01.06	08.07						
	318 i	100		09.07	05.12						
	318 i	105		09.07	05.12						
	320 d			09.07	05.12						
	320 d	120		06.05	08.07						
	320 i	110		06.05	08.07						
	320 i	125		09.07	05.12						
	320 xd	130		09.07	05.12						
	325 d	145		09.06	05.12						
	325 i	155		01.12	05.12						
	325 i	160		06.05	05.12						
	325 xi	160		06.05	05.12						
	330 d	170		06.05	05.12						
	330 d	180		09.08	05.12						
	330 i	190		06.05	08.07						
	330 i	200		09.07	05.12						
	330 xd			06.05	05.12						
	330 xi	190		06.05	08.07						
	330 xi	200		09.07	05.12						
	335 d	210		09.06	05.12						

1) + engine code N52 / + codice motore N52 / + moteur code N52 / + motor code N52
 2) - idling stop system / - dispositivo start/stop / - unité marche/arrêt / - unidad arranque/paño
 3) + engine code N46 / + codice motore N46 / + moteur code N46 / + motor code N46
 4) + engine code N46N / + codice motore N46N / + moteur code N46N / + motor code N46N

















BMW 3er Reihe/E91 Touring (05-12)													
	335 i 335 xi	225 225		09.06 03.07	05.12 05.12			03.2025-1904.3	010797		Thz 25,40/22,20	ATE	
	318 d 318 d 318 i 318 i 318 i 318 i 318 i 318 i 320 d 320 d 320 i 320 i 320 i 320 xd 323 i 325 i 325 i 325 xi	90 105 95 95 100 100 105 105 120 110 110 125 130 130 155 160 160		09.05 09.07 03.07 01.06 09.07 09.07 09.07 09.07 09.07 06.05 06.05 06.05 09.07 09.07 01.12 06.05 06.05	08.07 05.12 08.07 08.07 05.12 02.08 05.12 02.08 05.12 05.12 08.07 05.12 05.12 05.12 05.12 05.12 08.07	+ Motorcode N46N ¹⁾ + Motorcode N43 ²⁾ + erhöhte Zuladung ³⁾ - erhöhte Zuladung ⁴⁾ + erhöhte Zuladung ³⁾ - erhöhte Zuladung ⁴⁾ - Behörde ⁵⁾ - Behörde ⁵⁾ + Motorcode N46N ¹⁾ + Motorcode N46 ⁶⁾ - Behörde ⁵⁾ - erhöhte Zuladung ⁴⁾ - erhöhte Zuladung/ + Motorcode N52N/N53 ⁷⁾ - erhöhte Zuladung/ + Motorcode N52N ⁸⁾		11.9571-9753.2 11.9571-9754.2 11.0101-5402.2 11.8171-0008.1 11.8116-0339.2	220929 220930 260009 990049 390528	2		ATE ATE ATE ATE	
	316 d 316i 318 i 318 i	85 90 100 105		09.09 09.07 03.08 03.08	05.12 05.12 05.12 05.12	- erhöhte Zuladung ⁴⁾ - erhöhte Zuladung ⁴⁾		24.3541-9521.5 24.3541-9522.5 11.0101-5402.2 11.8171-0008.1	240723 240724 260009 990049	2		ATE ATE ATE ATE	
	320 d 320 d 320 xd 325 d 325 i 325 i 325 xi 325 xi 330 d 330 i 330 xd 330 xi	120 130 145 155 160 160 160 170 190 190		09.07 06.05 09.07 09.06 01.12 06.05 06.05 06.05 06.05 06.05 06.05	05.12 08.07 05.12 05.12 05.12 05.12 08.07 05.12 08.07 08.07 08.07	+ Behörde ⁹⁾ + Behörde ⁹⁾ + Behörde ⁹⁾ - Behörde ⁵⁾ + erhöhte Zuladung ³⁾ + erhöhte Zuladung ³⁾ + erhöhte Zuladung/ + Motorcode N52N ¹⁰⁾ + Motorcode N52N/N53 ¹¹⁾		11.0101-5402.2 11.8171-0008.1 11.8116-0339.2	260009 990049 390528	2		ATE ATE ATE	
	325 d 330 d 330 d 330 i 330 xd 330 xi 335 d 335 i 335 xi	145 170 180 200 200 210 225 225		09.06 09.07 09.08 09.07 09.07 09.07 09.06 09.06 03.07	05.12 05.12 05.12 05.12 05.12 05.12 05.12 05.12	+ Behörde ⁹⁾		11.0101-6006.2 11.8116-0315.2 11.8171-0008.1 11.8171-0067.1	260098 390447 990049 250153	2		ATE ATE ATE ATE	
	316 d 316i 318 d 318 d 318 i 318 i 318 i 320 d 320 d 320 i 320 i 323 i 325 d 325 i 325 i 330 d 330 d 330 i 330 i 335 d 335 i	85 90 90 105 95 100 105 120 110 125 130 145 155 160 170 180 190 200 210 225		09.09 09.07 09.05 09.07 01.06 09.07 09.07 09.07 07.05 07.05 09.07 09.06 01.12 07.05 07.05 09.08 07.05 09.07 09.06 09.06	05.12 05.12 08.07 05.12 08.07 05.12 05.12 05.12 08.07 08.07 05.12 05.12 05.12 05.12 05.12 05.12 05.12 05.12 05.12			24.5174-0526.3	331365	2		L=526	
	320 xd 325 xi 330 xd 330 xi 330 xi 335 xi	130 160 190 200 225		09.07 06.05 06.05 06.05 09.07 03.07	05.12 05.12 05.12 08.07 05.12			24.5113-0440.3	331239	2		L=440	
	316 d 316i 318 d 318 d 318 i 318 i 318 i 320 d 320 d 320 i 320 i 320 xd	85 90 90 105 95 100 105 120 110 125 130		09.09 09.07 09.05 09.07 01.06 09.07 09.07 09.07 06.05 06.05 09.07 09.07	05.12 05.12 08.07 05.12 08.07 05.12 05.12 05.12 08.07 08.07 05.12 05.12	- Behörde ⁵⁾ - Behörde ⁵⁾		11.9421-9911.2 11.9421-9912.2 11.8170-0755.1 11.0101-5402.2 11.8171-0008.1 11.8116-0066.1	220825 220826 260119 260009 990049 390577	2 2		ATE ATE ATE ATE ATE ATE	

1) + engine code N46N / + codice motore N46N / + moteur code N46N / + motor code N46N
2) + engine code N43 / + codice motore N43 / + moteur code N43 / + motor code N43
3) + increased payload / + carico utile maggiorato / + charge utile augmentée / + incremento de carga
4) - increased payload / - carico utile maggiorato / - charge utile augmentée / - incremento de carga
5) - authority cars / - enti statali / - véhicules communal / - vehiculos oficiales
6) + engine code N46 / + codice motore N46 / + moteur code N46 / + motor code N46
7) - increased payload / + eng.co.N52N/N53 / - caric.uti.magg./+codic.mot.N52N/N53 / - charge utile augment./+moteur N52N/N53 / - incremento de carga/+motor co.N52N/N53

8) - increased payl./+engine co.N52N / - carico utile maggior./+codic.mot.N52N / - charge utile augmentée/+moteur co.N52N / - incremento de carga/+motor co.N52N
9) + authority cars / + enti statali / + véhicule communal / + vehiculos oficiales
10) + increased payload/+engine co.N52N / + carico utile maggior./+codic.mot.N52N / + charge utile augmentée/+moteur co.N52N / + incremento de carga/+motor co.N52N
11) + engine code N52N/N53 / + codice motore N52N/N53 / + moteur code N52N/N53 / + motor code N52N/N53

												
BMW 3er Reihe/E91 Touring (05-12)												
	323 i	130	09.06	05.12	11.9421-9911.2	220825	2	D=42, - Halter ATE				
	325 i	155	01.12	05.12					- erhöhte Zuladung ¹⁾	220826	ATE	
	325 i	160	06.05	05.12					- erhöhte Zuladung ¹⁾	11.8170-0755.1	260119	ATE
	325 xi	160	06.05	08.07					- erhöhte Zuladung/ + Motorcode N52N ²⁾	11.0101-5402.2	260009	ATE
										11.8171-0008.1	990049	ATE
										11.8116-0066.1	390577	ATE
	320 d		09.07	05.12					+ Behörde ³⁾	11.9441-9957.2	220827	ATE
	320 d	120	06.05	08.07					+ Behörde ³⁾	24.3441-9958.5	240672	ATE
	320 xd	130	09.07	05.12					+ Behörde ³⁾	11.0101-5402.2	260009	ATE
	325 d	145	09.06	05.12						11.8171-0008.1	990049	ATE
	325 i	155	01.12	05.12					+ erhöhte Zuladung ⁴⁾	11.8116-0296.1	390445	ATE
	325 i	160	06.05	05.12					+ erhöhte Zuladung ⁴⁾			
	325 xi	160	06.05	08.07					+ erhöhte Zuladung/ + Motorcode N52N ⁵⁾			
	325 xi	160	06.05	05.12					+ Motorcode N52N/N53 ⁶⁾			
	330 d	170	06.05	05.12								
	330 d	180	09.08	05.12								
	330 i	190	06.05	08.07								
	330 i	200	09.07	05.12								
	330 xd		06.05	05.12								
	330 xi	190	06.05	08.07								
330 xi	200	09.07	05.12									
335 d	210	09.06	05.12									
335 i	225	09.06	05.12									
335 xi	225	03.07	05.12									
	316 d	85	09.09	05.12	83.7850-0180.3	331054	2	L=180				
	316i	90	09.07	05.12	24.5137-0221.3	331302	2	L=221				
	318 d	90	09.05	08.07	24.5125-0230.3	331277	2	L=230				
	318 d	105	09.07	05.12								
	318 i	95	01.06	08.07								
	318 i	100	09.07	05.12								
	318 i	105	09.07	05.12								
	320 d		09.07	05.12								
	320 d	120	06.05	08.07								
	320 i	110	06.05	08.07								
	320 i	125	09.07	05.12								
	320 xd	130	09.07	05.12								
	323 i	130	09.06	05.12								
	325 d	145	09.06	05.12								
	325 i	155	01.12	05.12								
	325 i	160	06.05	05.12								
	325 xi	160	06.05	05.12								
	330 d	170	06.05	05.12								
	330 d	180	09.08	05.12								
	330 i	190	06.05	08.07								
330 i	200	09.07	05.12									
330 xd		06.05	05.12									
330 xi	190	06.05	08.07									
330 xi	200	09.07	05.12									
335 d	210	09.06	05.12									
335 i	225	09.06	05.12									
335 xi	225	03.07	05.12									
	316 d	85	09.09	05.12	24.3727-0233.2	580233	2	L=1535				
	316i	90	09.07	05.12								
	318 d	90	09.05	08.07								
	318 d	105	09.07	05.12								
	318 i	95	01.06	08.07								
	318 i	100	09.07	05.12								
	318 i	105	09.07	05.12								
	320 d		09.07	05.12								
	320 d	120	06.05	08.07								
	320 i	110	06.05	08.07								
	320 i	125	09.07	05.12								
	320 xd	130	09.07	05.12								
	323 i	130	09.06	05.12								
	325 d	145	09.06	05.12								
	325 i	155	01.12	05.12								
	325 i	160	06.05	05.12								
	325 xi	160	06.05	05.12								
	330 d	170	06.05	05.12								
	330 d	180	09.08	05.12								
	330 i	190	06.05	08.07								
330 i	200	09.07	05.12									
330 xd		06.05	05.12									
330 xi	190	06.05	08.07									
330 xi	200	09.07	05.12									
335 d	210	09.06	05.12									
335 i	225	09.06	05.12									
335 xi	225	03.07	05.12									
	316 d	85	09.09	05.12	24.2419-1713.3	030093		Gz 19,05				
	316i	90	09.07	05.12								
	318 d	90	09.05	08.07								
	318 d	105	09.07	05.12								
	318 i	95	01.06	08.07								
	318 i	100	09.07	05.12								
	318 i	105	09.07	05.12								
	320 d		09.07	05.12								
	320 d	120	06.05	08.07								

¹⁾ - increased payload / - carico utile maggiorato / - charge utile augmentée / - incremento de carga
²⁾ - increased payload/+engine co.N52N / - carico utile maggior./+codic.mot.N52N / - charge utile augmentée/+moteur co.N52N / - incremento de carga/+motor co.N52N
³⁾ + authority cars / + enti statali / + véhicule communal / + vehiculos oficiales
⁴⁾ + increased payload / + carico utile maggiorato / + charge utile augmentée / + incremento de carga
⁵⁾ + increased payload/+engine co.N52N / + carico utile maggior./+codic.mot.N52N / + charge utile augmentée/+moteur co.N52N / + incremento de carga/+motor co.N52N
⁶⁾ + engine code N52N/N53 / + codice motore N52N/N53 / + moteur code N52N/N53 / + motor code N52N/N53
⁷⁾ on the brake caliper / sulla pinza freno / sur l'étrier de frein / a la pinza de freno





BMW 3er Reihe/E91 Touring (05-12)

	320 i	110		06.05	08.07		24.2419-1713.3	030093			Gz 19,05
	320 i	125		09.07	05.12						
	320 xd	130		09.07	05.12						
	323 i	130		09.06	05.12						
	325 d	145		09.06	05.12						
	325 i	155		01.12	05.12						
	325 i	160		06.05	05.12						
	325 xi	160		06.05	05.12						
	330 d	170		06.05	05.12						
	330 d	180		09.08	05.12						
	330 i	190		06.05	08.07						
	330 i	200		09.07	05.12						
	330 xd			06.05	05.12						
	330 xi	190		06.05	08.07						
	330 xi	200		09.07	05.12						
	335 i	225		09.06	05.12						
	335 xi	225		03.07	05.12						
	318 d	90		09.05	08.07		24.2522-0905.3	040042			Nz 22,20
	318 i	95		01.06	08.07						
	320 d	120		06.05	08.07						
	320 i	110		06.05	08.07						
	325 i	155		01.12	05.12						
	325 i	160		06.05	05.12						
	330 d	170		06.05	05.12						
	330 i	190		06.05	08.07						
	330 xd			06.05	05.12						
	330 xi	190		06.05	08.07						

BMW 3er Reihe/E92 Coupe (06-13)

	316 i	90		09.09	06.13		03.7848-4003.4	300235		- Start/Stop-Anlage ¹⁾	8"	ATE
	318 i	105		03.10	06.13							
	320 i			09.09	06.13							
	316 i	90		09.07	08.09		03.7848-4003.4	300235			8"	ATE
	320 i			03.07	08.09							
	320 d			03.07	08.09		03.7848-5003.4	300236			8"	ATE
	323 i			09.06	08.07							
	325 d			03.07	06.13							
	325 i	160		09.06	06.13							
	325 xi	160		09.06	06.13							
	330 d			09.09	06.13							
	330 i			09.09	06.13							
	330 xd			09.09	06.13							
	330 xi			09.09	06.13							
	320 xd			03.07	08.09		03.7845-0103.4	300268			8"	ATE
	323 i			09.07	06.13							
	330 d			09.06	08.09							
	330 i			09.06	08.09							
	330 xd			09.06	08.09							
	330 xi			09.06	08.09							
	335 d	210		09.06	06.13							
	335 i	225		09.06	06.13							
	335 xi	225		09.07	06.13							
	320 d			09.09	06.13		03.7845-0103.4	300268		- Start/Stop-Anlage ¹⁾	8"	ATE
	320 xd			09.09	06.13							
	316 i	90		09.07	06.13		03.2023-2407.3	010796			Thz 23,81/22,20	ATE
	318 i	105		03.10	06.13							
	320 i			09.07	06.13							
	320 d			03.07	06.13		03.2025-1904.3	010797			Thz 25,40/22,20	ATE
	320 i			03.07	08.07							
	320 xd			03.07	06.13							
	325 d			03.07	06.13							
	325 i	160		09.06	06.13							
	325 xi	160		09.06	06.13							
	330 d			09.06	06.13							
	330 i			09.06	06.13							
	330 xd			09.06	06.13							
	330 xi			09.06	06.13							
	335 d	210		09.06	06.13							
	335 i	225		09.06	06.13							
	335 xi	225		09.07	06.13							
	316 i	90		09.07	06.13		24.3541-9521.5	240723			D=54, - Halter	ATE
	318 i	105		03.10	06.13		24.3541-9522.5	240724			D=54, - Halter	ATE
	320 i			03.07	06.13		11.0101-5402.2	260009			Hülsensatz	ATE
							11.8171-0008.1	990049			Führungsbolzen	ATE
							11.8116-0339.2	390528	2		Haltefeder	ATE
	320 d			03.07	06.13		11.9571-9753.2	220929			D=57, - Halter	ATE
	320 xd			03.07	06.13		11.9571-9754.2	220930			D=57, - Halter	ATE
	323 i			09.06	06.13		11.0101-5402.2	260009			Hülsensatz	ATE
	325 i	160		09.07	06.13	+ Motorcode N52N ²⁾	11.8171-0008.1	990049			Führungsbolzen	ATE
	325 xi	160		09.07	06.13	+ Motorcode N52N ²⁾	11.8116-0339.2	390528	2		Haltefeder	ATE
	325 d			03.07	06.13		11.0101-5402.2	260009			Hülsensatz	ATE
	325 i	160		09.06	08.07	+ Motorcode N52N ²⁾	11.8171-0008.1	990049			Führungsbolzen	ATE
	325 i	160		09.06	06.13	+ Motorcode N53 ³⁾	11.8116-0339.2	390528	2		Haltefeder	ATE
	325 xi	160		09.06	08.07	+ Motorcode N52N ²⁾						
	325 xi	160		09.06	06.13	+ Motorcode N53 ³⁾						
	330 d			09.09	06.13	- erhöhte Zuladung ⁴⁾						

1) - idling stop system / - dispositivo start/stop / - unité marche/arrêt / - unidad arranque/paro
 2) + engine code N52N / + codice motore N52N / + moteur code N52N / + motor code N52N
 3) + engine code N53 / + codice motore N53 / + moteur code N53 / + motor code N53
 4) - increased payload / - carico utile maggiorato / - charge utile augmentée / - incremento de carga



BMW 3er Reihe/E92 Coupe (06-13)

	330 i		09.09	06.13	- erhöhte Zuladung/ + Motorcode N53 ¹⁾	11.0101-5402.2	260009	2		Hülzensatz Führungsbolzen Haltefeder	ATE ATE ATE				
	330 i		09.06	06.13	+ Motorcode N52N ²⁾	11.8171-0008.1	990049								
	330 xd		09.09	06.13	- erhöhte Zuladung ³⁾	11.8116-0339.2	390528								
	330 xi		09.06	06.13											
	330 d		09.09	06.13	+ erhöhte Zuladung ⁴⁾	11.0101-6006.2	260098								
	330 d		09.06	08.09		11.8116-0315.2	390447								
	330 i		09.09	06.13	+ erhöhte Zuladung/ + Motorcode N53 ⁵⁾	11.8171-0008.1	990049								
	330 i		09.06	08.09	+ Motorcode N53 ⁶⁾	11.8171-0067.1	250153								
	330 xd		09.09	06.13	+ erhöhte Zuladung ⁴⁾										
	330 xd		09.06	08.09											
335 d	210		09.06	06.13											
335 i	225		09.06	06.13											
335 xi	225		09.07	06.13											
M3			03.07	06.13		11.0441-6008.2 11.0101-6006.2 11.8116-0315.2 11.8171-0008.1 11.8171-0067.1	250038 260098 390447 990049 250153	2	Dichtungssatz Hülzensatz Haltefeder Führungsbolzen Führungsbolzen	ATE ATE ATE ATE ATE					
	316 i	90	09.07	06.13		24.5174-0526.3	331365				2		L=526		
	318 i	105	03.10	06.13											
	320 d		03.07	06.13											
	320 i		03.07	06.13											
	323 i		09.06	06.13											
	325 d		03.07	06.13											
	325 i	160	09.06	06.13											
	330 d		09.06	06.13											
	330 i		09.06	06.13											
	335 d	210	09.06	06.13											
335 i	225	09.06	06.13												
320 xd	160		03.07	06.13		24.5113-0440.3	331239	2		L=440					
325 xi		09.06	06.13												
330 xd		09.06	06.13												
330 xi		09.06	06.13												
335 xi	225	09.07	06.13												
M3		03.07	06.13		83.7751-0502.3	331109									
	316 i	90	09.07	06.13		24.3401-1707.7 24.3401-1708.7	220775 220776				2		D=40, - Halter D=40, - Halter	TRW TRW	
	318 i	105	03.10	06.13		11.9421-9911.2	220825								
	320 d		03.07	06.13		11.9421-9912.2	220826								
	320 i		03.07	06.13		11.8170-0755.1	260119								
	320 xd		03.07	06.13		11.0101-5402.2	260009								
	323 i		09.06	06.13		11.8171-0008.1	990049								
	325 i	160	09.06	06.13		11.8116-0066.1	390577								
	325 xi	160	09.06	06.13											
	325 d		03.07	06.13		11.9441-9957.2	220827								
	330 d		09.06	06.13		24.3441-9958.5	240672								
330 i		09.06	06.13		11.0101-5402.2	260009									
330 xd		09.06	06.13		11.8171-0008.1	990049									
330 xi		09.06	06.13		11.8116-0296.1	390445									
335 d	210	09.06	06.13												
335 i	225	09.06	06.13												
335 xi	225	09.07	06.13												
M3		03.07	06.13		11.0101-5402.2 11.8171-0008.1 11.8116-0296.1	260009 990049 390445	2		Hülzensatz Führungsbolzen Haltefeder	ATE ATE ATE					
	316 i	90	09.07	06.13		83.7850-0180.3					331054	2		L=180	
	318 i	105	03.10	06.13		24.5125-0230.3					331277				
	320 d		03.07	06.13		24.5137-0221.3					331302				
	320 i		03.07	06.13											
	320 xd		03.07	06.13											
	323 i		09.06	06.13											
	325 d		03.07	06.13											
	325 i	160	09.06	06.13											
	325 xi	160	09.06	06.13											
	330 d		09.06	06.13											
330 i		09.06	06.13												
330 xd		09.06	06.13												
330 xi		09.06	06.13												
335 d	210	09.06	06.13												
335 i	225	09.06	06.13												
335 xi	225	09.07	06.13												
M3		03.07	06.13		83.7850-0180.3 83.7752-0236.3	331054 331118	2	am Bremssattel ⁷⁾	L=180 L=230 L=221						
	316 i	90	09.07	06.13		24.3727-0233.2					580233	2		L=1535	
	318 i	105	03.10	06.13											
	320 d		03.07	06.13											
	320 i		03.07	06.13											
	320 xd		03.07	06.13											
	323 i		09.06	06.13											
	325 d		03.07	06.13											
	325 i	160	09.06	06.13											
	325 xi	160	09.06	06.13											
	330 d		09.06	06.13											
330 i		09.06	06.13												
330 xd		09.06	06.13												
330 xi		09.06	06.13												
335 d	210	09.06	06.13												
335 i	225	09.06	06.13												
335 xi	225	09.07	06.13												

¹⁾ - increased payload/+engine co.N53 / - carico utile maggiorato/+codic.mot.N53 / - charge utile augmentée/+ moteur co.N53 / - incremento de carga/+motor co.N53
²⁾ + engine code N52N / + codice motore N52N / + moteur code N52N / + motor code N52N
³⁾ - increased payload / - carico utile maggiorato / - charge utile augmentée / - incremento de carga
⁴⁾ + increased payload / + carico utile maggiorato / + charge utile augmentée / + incremento de carga
⁵⁾ + increased payload/+engine co.N53 / + carico utile maggiorato/+codic.mot.N53 / + charge utile augmentée/+moteur co.N53 / + incremento de carga/+motor co.N53
⁶⁾ + engine code N53 / + codice motore N53 / + moteur code N53 / + motor code N53
⁷⁾ on the brake caliper / sulla pinza freno / sur l'étrier de frein / a la pinza de freno

























BMW 3er Reihe/E92 Coupe (06-13)

	335 d 335 i 335 xi M3	210 225 225		09.06 09.06 09.07 03.07	06.13 06.13 06.13 06.13		24.3727-0233.2	580233	2 ↓		L=1535
	316 i 318 i 320 d 320 i 320 xd 323 i 325 d 325 i 325 xi 330 d 330 i 330 xd 330 xi 335 i 335 xi M3	90 105 160 160 225 225		09.07 03.10 03.07 03.07 03.07 09.06 03.07 09.06 09.06 09.06 09.06 09.06 09.06 09.06 09.07 03.07	06.13 06.13 06.13 06.13 06.13 06.13 06.13 06.13 06.13 06.13 06.13 06.13 06.13 06.13 06.13 06.13		24.2419-1713.3	030093			Gz 19,05

BMW 3er Reihe/E93 Cabrio (07-13)

	318 i 320 i	105		03.10 04.08	11.13 11.13		03.7848-4003.4	300235		- Start/Stop-Anlage ¹⁾	8"	ATE
	320 i 323 i 325 i 330 d 330 d 330 i 335 i	130 160 170 180 200 225		03.07 03.07 03.07 01.09 03.07 03.07	03.08 11.13 11.13 08.09 08.09 11.13	+ Motorcode N43 ²⁾ + Motorcode N52N ³⁾ + Motorcode N53 ⁴⁾	03.7845-0103.4	300268			8"	ATE
	320 i 325 d 325 d 325 i 330 d 330 d 330 i 330 i	145 150 160 170 180 200 200		03.07 09.07 03.10 03.07 09.09 09.09 09.09 03.07	03.08 11.13 11.13 11.13 11.13 11.13 11.13 11.13	+ Motorcode N46N ⁵⁾ + Motorcode N53 ⁴⁾ + Motorcode N53 ⁴⁾ + Motorcode N52N ³⁾	03.7848-5003.4	300236			8"	ATE
	320 d 320 d 320 d	120 130 135		01.08 03.08 01.10	11.13 11.13 11.13		03.7845-0103.4	300268		- Start/Stop-Anlage ¹⁾	8"	ATE
	318 i 320 i	105		03.10 06.08	11.13 11.13		03.2023-2407.3	010796			Thz 23,81/22,20	ATE
	320 d 320 d 320 d 320 i 325 d 325 d 325 i 330 d 330 d 330 i 335 i	120 130 135 145 150 160 170 180 200 225		01.08 03.08 01.10 03.07 09.07 03.10 03.07 03.07 01.09 03.07 03.07	11.13 11.13 11.13 05.08 11.13 11.13 11.13 11.13 11.13 11.13 11.13		03.2025-1904.3	010797			Thz 25,40/22,20	ATE
	320 d 320 d 320 d 320 i 323 i 325 i	120 130 135 130 160		01.08 03.08 01.10 03.07 03.07 03.07	11.13 11.13 11.13 02.08 11.13 11.13		11.9571-9753.2 11.9571-9754.2 11.0101-5402.2 11.8171-0008.1 11.8116-0339.2	220929 220930 260009 990049 390528	 		D=57, - Halter D=57, - Halter Hülsensatz Führungsbolzen Haltefeder	ATE ATE ATE ATE ATE
	318 i 320 i	105		03.10 03.08	11.13 11.13		24.3541-9521.5 24.3541-9522.5 11.0101-5402.2 11.8171-0008.1 11.8116-0339.2	240723 240724 260009 990049 390528	 		D=54, - Halter D=54, - Halter Hülsensatz Führungsbolzen Haltefeder	ATE ATE ATE ATE ATE
	325 d 325 d 325 i 330 d 330 d 330 i 330 i	145 150 160 170 180 200 200		09.07 03.10 03.07 09.09 01.09 09.09 03.07	11.13 11.13 11.13 11.13 11.13 11.13 11.13	+ Motorcode N53 ⁴⁾ - erhöhte Zuladung ⁶⁾ - erhöhte Zuladung/ + Motorcode N53 ⁷⁾ + Motorcode N52N ³⁾	11.0101-5402.2 11.8171-0008.1 11.8116-0339.2	260009 990049 390528	2		Hülsensatz Führungsbolzen Haltefeder	ATE ATE ATE
	330 d 330 d 330 i 330 i 335 i M3	170 170 200 200 225 309		09.09 03.07 09.09 03.07 03.07 03.08	11.13 08.09 11.13 08.09 11.13 11.13	+ erhöhte Zuladung ⁸⁾ + erhöhte Zuladung/ + Motorcode N53 ⁹⁾ + Motorcode N53 ⁴⁾	11.0101-6006.2 11.8171-0008.1 11.8171-0067.1 11.8116-0315.2	260098 990049 250153 390447	2		Hülsensatz Führungsbolzen Führungsbolzen Haltefeder	ATE ATE ATE ATE
	318 i 320 d 320 d	105 120 130		03.10 01.08 03.08	11.13 11.13 11.13		24.5174-0526.3	331365	2		L=526	

1) - idling stop system / - dispositivo start/stop / - unité marche/arrêt / - unidad arranque/paro
2) + engine code N43 / + codice motore N43 / + moteur code N43 / + motor code N43
3) + engine code N52N / + codice motore N52N / + moteur code N52N / + motor code N52N
4) + engine code N53 / + codice motore N53 / + moteur code N53 / + motor code N53
5) + engine code N46N / + codice motore N46N / + moteur code N46N / + motor code N46N
6) - increased payload / - carico utile maggiorato / - charge utile augmentée / - incremento de carga
7) - increased payload/+engine co.N53 / - carico utile maggior./+codic.mot.N53 / - charge utile augmentée/+moteur co.N53 / - incremento de carga/+motor co.N53
8) + increased payload / + carico utile maggiorato / + charge utile augmentée / + incremento de carga
9) + increased payload/+engine co.N53 / + carico utile maggior./+codic.mot.N53 / + charge utile augmentée/+moteur co.N53 / + incremento de carga/+motor co.N53

											
BMW 3er Reihe/E93 Cabrio (07-13)											
	320 d	135		01.10	11.13	24.5174-0526.3	331365	2		L=526	
	320 i			03.07	11.13						
	323 i	130		03.07	11.13						
	325 d	145		09.07	11.13						
	325 d	150		03.10	11.13						
	325 i	160		03.07	11.13						
	330 d	170		03.07	11.13						
	330 d	180		01.09	11.13						
	330 i	200		03.07	11.13						
	335 i	225		03.07	11.13						
	M3	309		03.08	11.13	83.7751-0502.3	331109	2		L=502	
	318 i	105		03.10	11.13	11.9421-9911.2	220825			D=42, - Halter	ATE
	320 d	120		01.08	11.13	11.9421-9912.2	220826			D=42, - Halter	ATE
	320 d	130		03.08	11.13	11.8170-0755.1	260119			Halter	ATE
	320 d	135		01.10	11.13	11.0101-5402.2	260009			Hülsensatz	ATE
	320 i			03.07	11.13	11.8171-0008.1	990049			Führungsbolzen	ATE
	323 i	130		03.07	11.13	11.8116-0066.1	390577	2		Haltefeder	ATE
	325 i	160		03.07	11.13						
	325 d	145		09.07	11.13	11.9441-9957.2	220827			D=44, - Halter	ATE
	325 d	150		03.10	11.13	24.3441-9958.5	240672			D=44, - Halter	ATE
	330 d	170		03.07	11.13	11.0101-5402.2	260009			Hülsensatz	ATE
	330 d	180		01.09	11.13	11.8171-0008.1	990049			Führungsbolzen	ATE
	330 i	200		03.07	11.13	11.8116-0296.1	390445	2		Haltefeder	ATE
	335 i	225		03.07	11.13						
	M3	309		03.08	11.13	11.0101-5402.2	260009			Hülsensatz	ATE
						11.8171-0008.1	990049			Führungsbolzen	ATE
						11.8116-0296.1	390445	2		Haltefeder	ATE
	318 i	105		03.10	11.13	83.7850-0180.3	331054	2		L=180	
	320 d	120		01.08	11.13	24.5125-0230.3	331277	2	am Bremssattel ¹⁾	L=230	
	320 d	130		03.08	11.13	24.5137-0221.3	331302	2	am Bremssattel ¹⁾	L=221	
	320 d	135		01.10	11.13						
	320 i			03.07	11.13						
	323 i	130		03.07	11.13						
	325 d	145		09.07	11.13						
	325 d	150		03.10	11.13						
	325 i	160		03.07	11.13						
	330 d	170		03.07	11.13						
	330 d	180		01.09	11.13						
	330 i	200		03.07	11.13						
	335 i	225		03.07	11.13						
	M3	309		03.08	11.13	83.7850-0180.3	331054	2		L=180	
						83.7752-0236.3	331118	2	am Bremssattel ¹⁾	L=235	
	318 i	105		03.10	11.13	24.3727-0233.2	580233	2		L=1535	
	320 d	120		01.08	11.13						
	320 d	130		03.08	11.13						
	320 d	135		01.10	11.13						
	320 i			03.07	11.13						
	323 i	130		03.07	11.13						
	325 d	145		09.07	11.13						
	325 d	150		03.10	11.13						
	325 i	160		03.07	11.13						
	330 d	170		03.07	11.13						
	330 d	180		01.09	11.13						
	330 i	200		03.07	11.13						
	335 i	225		03.07	11.13						
	M3	309		03.08	11.13						
	318 i	105		03.10	11.13	24.2419-1713.3	030093			Gz 19,05	
	320 d	120		01.08	11.13						
	320 d	130		03.08	11.13						
	320 d	135		01.10	11.13						
	320 i			03.07	11.13						
	323 i	130		03.07	11.13						
	325 d	145		09.07	11.13						
	325 d	150		03.10	11.13						
	325 i	160		03.07	11.13						
	330 d	170		03.07	11.13						
	330 d	180		01.09	11.13						
	330 i	200		03.07	11.13						
	335 i	225		03.07	11.13						
	M3	309		03.08	11.13						
BMW 3er Reihe/F30 Limousine (11-)											
	316 d	85		02.12		24.5169-0590.3	331422	2		L=590	
	316 i	100		11.12							
	318 d	105		02.12							
	318 d	110		07.15							
	318 d xDrive	105		05.13							
	318 d xDrive	110		07.15							
	318 i	100		07.15							
	320 d	120		02.12							
	320 d	135		02.12							
	320 d	140		07.15							
	320 d xDrive	135		02.12							
	320 d xDrive	140		07.15							
	320 i	135		02.12							
	320 i ed	125		11.12							
	320 i xDrive	135		02.12							

¹⁾ on the brake caliper / sulla pinza freno / sur l'étrier de frein / a la pinza de freno



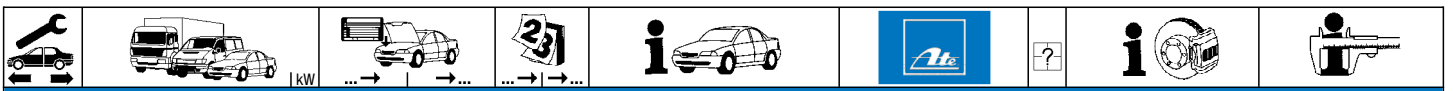

BMW 3er Reihe/F30 Limousine (11-)

	325 d	160	04.13	24.5169-0590.3	331422	2	L=590
	325 d	165	03.16				
	328 i	180	02.12				
	328 i xDrive	180	02.12				
	330 d	190	07.12				
	330 d	210	09.15				
	330 d xDrive	190	03.13				
	330 d xDrive	210	09.15				
	330 e		01.16				
	330 i	185	07.15				
	330 i xDrive	185	07.15				
	335 d xDrive	230	07.13				
	335 i	225	02.12				
	335 i	250	07.13				
	335 i xDrive	225	02.12				
	340 i	240	07.15				
	340 i xDrive	240	07.15				
	ActiveHybrid 3	250	07.12				

	316 d	85	02.12	24.5137-0221.3	331302	2	L=221
	316 i	100	11.12	24.5125-0230.3	331277	2	L=230
	318 d	105	02.12				
	318 d	110	07.15				
	318 d xDrive	105	05.13				
	318 d xDrive	110	07.15				
	318 i	100	07.15				
	320 d	120	02.12				
	320 d	135	02.12				
	320 d	140	07.15				
	320 d xDrive	135	02.12				
	320 d xDrive	140	07.15				
	320 i	135	02.12				
	320 i ed	125	11.12				
	320 i xDrive	135	02.12				
	325 d	160	04.13				
	325 d	165	03.16				
	328 i	180	02.12				
	328 i xDrive	180	02.12				
	330 d	190	07.12				
	330 d	210	09.15				
	330 d xDrive	190	03.13				
	330 d xDrive	210	09.15				
	330 e		01.16				
	330 i	185	07.15				
	330 i xDrive	185	07.15				
	335 d xDrive	230	07.13				
	335 i	225	02.12				
	335 i	250	07.13				
	335 i xDrive	225	02.12				
	340 i	240	07.15				
	340 i xDrive	240	07.15				
	ActiveHybrid 3	250	07.12				

	316 d	85	02.12	24.2419-1713.3	030093		Gz 19,05
	316 i	100	11.12				
	318 d	105	02.12				
	318 d	110	07.15				
	318 d xDrive	105	05.13				
	318 d xDrive	110	07.15				
	318 i	100	07.15				
	320 d	120	02.12				
	320 d	135	02.12				
	320 d	140	07.15				
	320 d xDrive	135	02.12				
	320 d xDrive	140	07.15				
	320 i	135	02.12				
	320 i ed	125	11.12				
	320 i xDrive	135	02.12				
	325 d	160	04.13				
	325 d	165	03.16				
	328 i	180	02.12				
	328 i xDrive	180	02.12				
	330 i	185	07.15				
	330 i xDrive	185	07.15				
	335 i	225	02.12				
	335 i	250	07.13				
	335 i xDrive	225	02.12				
	340 i	240	07.15				
	340 i xDrive	240	07.15				
	M3	317	01.14				
	M3	331	03.16				

BMW 3er Reihe/F31 Touring (12-)

	316 d	85	05.12	24.5169-0590.3	331422	2	L=590
	316 i	100	03.13				
	318 d	105	05.12				
	318 d	110	07.15				
	318 d xDrive	105	05.13				
	318 d xDrive	110	07.15				

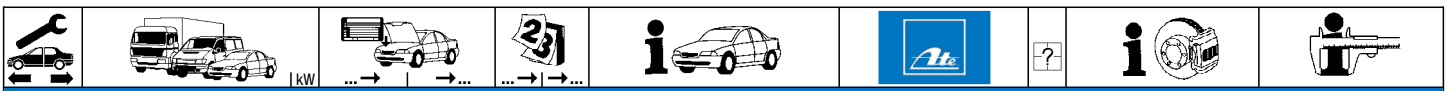

BMW 3er Reihe/F31 Touring (12-)

	318 i	100	07.15	24.5169-0590.3	331422	2		L=590
	320 d	120	05.12					
	320 d	135	05.12					
	320 d	140	07.15					
	320 d xDrive	135	03.13					
	320 d xDrive	140	07.15					
	320 i	135	05.12					
	320 i xDrive	135	03.13					
	325 d	160	04.13					
	325 d	165	03.16					
	328 i	180	05.12					
	328 i xDrive	180	03.13					
	330 d	190	05.12					
	330 d	210	09.15					
	330 d xDrive	190	03.13					
	330 d xDrive	210	09.15					
	330 i	185	07.15					
	330 i xDrive	185	07.15					
	335 d xDrive	230	11.13					
	335 i	225	03.13					
335 i xDrive	225	03.13						
340 i	240	07.15						
340 i xDrive	240	07.15						
	316 d	85	05.12	24.5125-0230.3	331277	2		L=230
	316 i	100	03.13					
	318 d	105	05.12					
	318 d	110	07.15					
	318 d xDrive	105	05.13					
	318 d xDrive	110	07.15					
	318 i	100	07.15					
	320 d	120	05.12					
	320 d	135	05.12					
	320 d	140	07.15					
	320 d xDrive	135	03.13					
	320 d xDrive	140	07.15					
	320 i	135	05.12					
	320 i xDrive	135	03.13					
	325 d	160	04.13					
	325 d	165	03.16					
	328 i	180	05.12					
	328 i xDrive	180	03.13					
	330 d	190	05.12					
	330 d	210	09.15					
	330 d xDrive	190	03.13					
	330 d xDrive	210	09.15					
	330 i	185	07.15					
	330 i xDrive	185	07.15					
	335 d xDrive	230	11.13					
	335 i	225	03.13					
335 i xDrive	225	03.13						
340 i	240	07.15						
340 i xDrive	240	07.15						

BMW 3er Reihe/F34 GT (13-)

	318 d	105	03.13	24.5169-0590.3	331422	2		L=590
	318 d	110	07.15					
	320 d	135	03.13					
	320 d	140	07.15					
	320 i	135	03.13					
	325 d	160	03.13					
	325 d	165	07.16					
	328 i	180	03.13					
	330 d	190	03.14					
	330 d	210	09.15					
	330 i	185	10.15					
	335 i	225	03.13					
	340 i	240	10.15					
		320 d xDrive	▶135					
320 d xDrive		▶140	07.15					
320 i xDrive		▶135	03.13					
328 i xDrive		▶180	03.13					
330 d xDrive		▶190	03.14					
330 d xDrive		▶210	09.15					
330 i xDrive		▶185	10.15					
335 d xDrive		▶230	03.14					
335 i xDrive		▶225	03.13					
340 i xDrive		▶240	10.15					
	318 d	105	03.13	24.5125-0230.3	331277	2		L=230
	318 d	110	07.15					
	320 d	135	03.13					
	320 d	140	07.15					
	320 d xDrive	135	03.13					
	320 d xDrive	140	07.15					
	320 i	135	03.13					
	320 i xDrive	135	03.13					
325 d	160	03.13						
325 d	165	07.16						





BMW 3er Reihe/F34 GT (13-)















	328 i	180	03.13	24.5125-0230.3	331277	2	L=230
	328 i xDrive	180	03.13				
	330 d	190	03.14				
	330 d	210	09.15				
	330 d xDrive	190	03.14				
	330 d xDrive	210	09.15				
	330 i	185	10.15				
	330 i xDrive	185	10.15				
	335 d xDrive	230	03.14				
	335 i	225	03.13				
	335 i xDrive	225	03.13				
	340 i	240	10.15				
	340 i xDrive	240	10.15				
	318 d	105	03.13	24.2419-1713.3	030093		Gz 19,05
	318 d	110	07.15				
	320 d	135	03.13				
	320 d	140	07.15				
	320 d xDrive	135	03.13				
	320 d xDrive	140	07.15				
	320 i	135	03.13				
	320 i xDrive	135	03.13				
	325 d	160	03.13				
	328 i	180	03.13				
	335 i	225	03.13				













BMW 4er Reihe/F32 Coupe (13-)

	418 d	110	03.15	24.5169-0590.3	331422	2	L=590
	418 i	100	02.16				
	420 d	135	07.13				
	420 d	140	03.15				
	420 d xDrive	135	07.13				
	420 d xDrive	140	03.15				
	420 i	135	02.16				
	420 i	135	07.13				
	420 i xDrive	135	02.16				
	420 i xDrive	135	07.13				
	425 d	160	03.14				
	425 d	165	03.16				
	428 i	180	07.13				
	428 i xDrive	180	07.13				
	430 d	190	07.13				
	430 d xDrive	190	03.14				
	430 i	185	03.16				
	430 i xDrive	185	03.16				
	435 d xDrive	230	07.13				
	435 i	225	07.13				
	435 i xDrive	225	07.13				
	440 i	240	03.16				
	440 i xDrive	240	03.16				
	418 d	110	03.15	24.5125-0230.3	331277	2	L=230
	418 i	100	02.16				
	420 d	135	07.13				
	420 d	140	03.15				
	420 d xDrive	135	07.13				
	420 d xDrive	140	03.15				
	420 i	135	02.16				
	420 i	135	07.13				
	420 i xDrive	135	02.16				
	420 i xDrive	135	07.13				
	425 d	160	03.14				
	425 d	165	03.16				
	428 i	180	07.13				
	428 i xDrive	180	07.13				
	430 d	190	07.13				
	430 d xDrive	190	03.14				
	430 i	185	03.16				
	430 i xDrive	185	03.16				
	435 d xDrive	230	07.13				
	435 i	225	07.13				
	435 i xDrive	225	07.13				
	440 i	240	03.16				
	440 i xDrive	240	03.16				













BMW 4er Reihe/F33 Cabrio (14-)

	420 d	135	10.13	24.5169-0590.3	331422	2	L=590
	420 d	140	07.15				
	420 i	135	02.16				
	420 i	135	07.14				
	425 d	160	07.14				
	425 d	165	03.16				
	428 i	180	10.13				
	428 i xDrive	180	10.13				
	430 d	190	07.14				
	430 i	185	03.16				
	430 i xDrive	185	03.16				
	435 d xDrive	230	07.14				
	435 i	225	10.13				
↓	↓						

								
BMW 4er Reihe/F33 Cabrio (14-)								
	435 i xDrive 440 i 440 i xDrive	225 240 240	10.13 03.16 03.16		24.5169-0590.3	331422	2	L=590
	420 d 420 d 420 i 420 i 425 d 425 d 428 i 428 i xDrive 430 d 430 i 430 i xDrive 435 d xDrive 435 i 435 i xDrive 440 i 440 i xDrive	135 140 135 135 160 165 180 180 190 185 185 230 225 225 240 240	10.13 07.15 02.16 07.14 07.14 03.16 10.13 10.13 07.14 03.16 03.16 07.14 10.13 10.13 03.16 03.16		24.5125-0230.3	331277	2	L=230
BMW 4er Reihe/F36 Gran Coupe (14-)								
	418 d 418 d 418 i 420 d 420 d 420 d xDrive 420 d xDrive 420 i 420 i 420 i xDrive 420 i xDrive 425 d 428 i 428 i xDrive 430 d 430 d xDrive 430 i 430 i xDrive 435 d xDrive 435 i 435 i xDrive 440 i 440 i xDrive	105 110 100 135 140 135 140 135 135 135 135 165 180 180 190 190 185 185 230 225 225 240 240	03.14 07.15 07.15 03.14 03.15 03.14 03.15 02.16 03.14 02.16 07.14 03.16 03.14 03.14 07.14 07.14 03.16 03.16 07.14 03.14 07.14 03.16 03.16		24.5169-0590.3	331422	2	L=590
	418 d 418 d 418 i 420 d 420 d 420 d xDrive 420 d xDrive 420 i 420 i 420 i xDrive 420 i xDrive 425 d 428 i 428 i xDrive 430 d 430 d xDrive 430 i 430 i xDrive 435 d xDrive 435 i 435 i xDrive 440 i 440 i xDrive	105 110 100 135 140 135 140 135 135 135 135 165 180 180 190 190 185 185 230 225 225 240 240	03.14 07.15 07.15 03.14 03.15 03.14 03.15 02.16 03.14 02.16 07.14 03.16 03.14 03.14 07.14 07.14 03.16 03.16 07.14 03.14 07.14 03.16 03.16		24.5137-0221.3 24.5125-0230.3	331302 331277	2 2	L=221 L=230
BMW 5er Reihe/E39 (96-03)								
	520 i 520 i Touring 523 i 523 i Touring 525 td 525 tds 528 i 528 i Touring 535 i 540 i 540 i Touring		03.96 08.97 05.97 08.97 12.95 08.97 05.97 08.97 01.97 08.97 02.96 08.97 12.95 08.97 05.97 08.97 05.96 08.97 05.96 08.97 05.97 08.97	- DSC - DSC - DSC - DSC - DSC - DSC - DSC - DSC - DSC - DSC	24.2120-1721.3	010553		Thz 20,64
	520 d 520 d Touring 520 i 520 i Touring 523 i 523 i Touring 525 d	100 100 125 125 120	04.00 07.03 04.00 07.03 09.97 07.03 09.97 07.03 09.97 09.00 09.97 09.00 04.00 07.03	- DSC - DSC - DSC - DSC	24.2025-1705.3	010624		Thz 25,40/20,64 TRW

									
BMW 5er Reihe/E39 (96-03)									
	525 d Touring 120 525 i 141 525 i Touring 141 525 td 85 525 tds 105 525 tds Touring 105 528 i 142 528 i Touring 142 530 d 170 530 d Touring 170 530 i 170 530 i Touring 170		04.00 07.03 10.00 07.03 10.00 07.03 09.97 09.00 09.97 09.00 06.98 09.00 09.97 09.00 09.97 09.00 09.98 07.03 09.98 07.03 10.00 07.03 10.00 07.03	- DSC - DSC - DSC - DSC - DSC - DSC - DSC - DSC - DSC - DSC - DSC - DSC	24.2025-1705.3	010624		THz 25,40/20,64	TRW
	520 i 520 i Touring 523 i 125 523 i Touring 125 525 d 120 525 d Touring 120 525 i 141 525 i Touring 141 528 i 142 528 i Touring 142 530 d 170 530 d Touring 170 530 i 170 530 i Touring 170 535 i 210 540 i 210 540 i Touring 210 M5 294		03.96 07.03 05.97 07.03 12.95 09.00 05.97 09.00 04.00 07.03 04.00 07.03 10.00 07.03 10.00 07.03 12.95 09.00 05.97 09.00 09.98 07.03 09.98 07.03 10.00 07.03 10.00 07.03 09.97 07.03 09.97 07.03 09.97 07.03 10.98 07.03	+ DSC + DSC + DSC + DSC + DSC + DSC + DSC + DSC + DSC + DSC + DSC + DSC + DSC + DSC + DSC + DSC + DSC + DSC	24.2025-1704.3	010619		THz 25,40	
	520 i 125 523 i 105 525 tds 105 528 i 142 535 i 142		03.96 10.96 12.95 10.96 02.96 10.96 12.95 10.96 05.96 10.96	- Behörde ¹⁾ - Behörde ¹⁾ - Behörde ¹⁾ - Behörde ¹⁾ - Behörde ¹⁾	11.0441-6008.2 11.0101-5402.2 11.8171-0008.1 11.8116-0239.2	250038 260009 990049 390510	2	Dichtungssatz Hülzensatz Führungsbolzen Haltefeder	ATE ATE ATE ATE
	520 d 100 520 d Touring 100 520 i 125 520 i Touring 125 523 i 125 523 i Touring 125 525 d 120 525 d Touring 120 525 i 141 525 i Touring 141 525 td 85 525 tds 105 525 tds Touring 105 528 i 142 528 i Touring 142 530 d 170 530 d Touring 170 535 i 210		04.00 07.03 04.00 07.03 11.96 07.03 05.97 07.03 11.96 09.00 05.97 09.00 04.00 07.03 04.00 07.03 10.00 07.03 10.00 07.03 01.97 09.00 11.96 09.00 06.98 09.00 11.96 09.00 05.97 09.00 09.98 09.00 09.98 09.00 11.96 08.97	- Behörde ¹⁾ - Behörde ¹⁾ - Behörde ¹⁾ - Behörde ¹⁾ - Behörde ¹⁾ - Behörde ¹⁾ - Behörde ¹⁾ - Behörde ¹⁾ - Behörde ¹⁾ - Behörde ¹⁾ - Behörde ¹⁾ - Behörde ¹⁾ - Behörde ¹⁾ - Behörde ¹⁾ - Behörde ¹⁾ - Behörde ¹⁾ - Behörde ¹⁾	11.0441-6008.2 11.0101-5402.2 11.8171-0008.1 11.8116-0239.2	250038 260009 990049 390510	2	Dichtungssatz Hülzensatz Führungsbolzen Haltefeder	ATE ATE ATE ATE
	520 i 100 520 i Touring 100 535 i 210 540 i 210 540 i Touring 210		03.96 03.00 05.97 03.00 09.97 03.00 05.96 03.00 05.97 03.00	+ Behörde ²⁾ + Behörde ²⁾ + Behörde ²⁾ + Behörde ²⁾ + Behörde ²⁾	24.3601-1713.5 24.3601-1714.5 11.0101-5402.2 11.8171-0008.1 11.8116-0197.1 11.0441-6003.2	240355 240356 260009 990049 390523 250037	2	D=60, - Halter D=60, - Halter Hülzensatz Führungsbolzen Haltefeder Dichtungssatz	ATE ATE ATE ATE ATE
	520 d 100 520 d Touring 100 520 i 125 520 i Touring 125 523 i 141 523 i Touring 141 525 d 120 525 d Touring 120 525 i 170 525 i Touring 170 530 d 170 530 d Touring 170 530 i 170 530 i Touring 170 535 i 210 540 i 210 540 i Touring 210 M5 294		04.00 07.03 04.00 07.03 04.00 07.03 04.00 07.03 10.00 07.03 10.00 07.03 04.00 07.03 04.00 07.03 10.00 07.03 10.00 07.03 10.00 07.03 10.00 07.03 10.00 07.03 04.00 07.03 04.00 07.03 04.00 07.03 10.98 07.03	+ Behörde ²⁾ + Behörde ²⁾ + Behörde ²⁾ + Behörde ²⁾ + Behörde ²⁾ + Behörde ²⁾ + Behörde ²⁾ + Behörde ²⁾ + Behörde ²⁾ + Behörde ²⁾ + Behörde ²⁾ + Behörde ²⁾ + Behörde ²⁾ + Behörde ²⁾ + Behörde ²⁾ + Behörde ²⁾ + Behörde ²⁾	24.3601-1713.5 24.3601-1714.5 11.0101-5402.2 11.8171-0008.1 11.8116-0290.2 11.0441-6003.2	240355 240356 260009 990049 390520 250037	2	D=60, - Halter D=60, - Halter Hülzensatz Führungsbolzen Haltefeder Dichtungssatz	ATE ATE ATE ATE ATE
	520 d 100 520 d Touring 100 520 i 125 520 i Touring 125 523 i 125 523 i Touring 125 525 d 120 525 d Touring 120 525 i 141 525 i Touring 141		04.00 07.03 04.00 07.03 03.96 07.03 05.97 07.03 12.95 09.00 05.97 09.00 04.00 07.03 04.00 07.03 10.00 07.03 10.00 07.03		83.6235-0100.3 83.6204-0100.3 83.6151-0411.3	330463 330441 330461	2	L=100 L=100 L=410	ATE ATE ATE
	520 d 100 520 d Touring 100 520 i 125 520 i Touring 125 523 i 125 523 i Touring 125 525 d 120 525 d Touring 120 525 i 141		04.00 07.03 04.00 07.03 03.96 07.03 05.97 07.03 12.95 09.00 05.97 09.00 04.00 07.03 04.00 07.03 10.00 07.03		83.6235-0100.3 83.6204-0100.3 83.6151-0411.3	330463 330441 330461	2	+ ASC/ M12X1 + ASC/ M10X1 am Bremsattel ³⁾	

1) - authority cars / - enti statali / - véhicule communal / - vehiculos oficiales
2) + authority cars / + enti statali / + véhicule communal / + vehiculos oficiales
3) on the brake caliper / sulla pinza freno / sur l'étrier de frein / a la pinza de freno

									
BMW 5er Reihe/E39 (96-03)									
	525 i Touring 141 525 td 85 525 tds 105 525 tds Touring 105 528 i 142 528 i Touring 142 530 d 530 d Touring 530 i 170 530 i Touring 170 535 i 540 i 210 540 i Touring 210 M5 294		10.00 07.03 01.97 09.00 02.96 09.00 06.98 09.00 12.95 09.00 05.97 09.00 09.98 07.03 09.98 07.03 10.00 07.03 10.00 07.03 05.96 07.03 05.96 07.03 05.97 07.03 10.98 07.03		83.6235-0100.3 330463 83.6204-0100.3 330441 83.6151-0411.3 330461		2	+ ASC/ M12X1 + ASC/ M10X1 am Bremssattel ¹⁾	L=100 L=100 L=410
	520 d 100 520 i 523 i 125 525 td 85 525 tds 105		04.00 07.03 - Behörde ²⁾ 03.96 07.03 - Behörde ²⁾ 12.95 08.98 - Behörde ²⁾ 01.97 09.00 - Behörde ²⁾ 02.96 09.00 - Behörde ²⁾	11.9406-9995.2 220415 11.9406-9996.2 220416 11.0441-4004.2 250012 11.0101-5402.2 260009 11.8171-0008.1 990049 11.8116-0168.1 390499		2		D=40, - Halter D=40, - Halter Dichtungssatz Hülssensatz Führungsbolzen Haltefeder	ATE ATE ATE ATE ATE
	520 d 100 520 i 523 i 125 523 i 125 525 d 120 525 i 141 525 td 85 525 tds 105 528 i 142 530 d 530 i 170 535 i 540 i 210		04.00 07.03 + Behörde ³⁾ 03.96 07.03 + Behörde ³⁾ 09.98 09.00 12.95 08.98 + Behörde ³⁾ 04.00 07.03 10.00 07.03 01.97 09.00 + Behörde ³⁾ 02.96 09.00 + Behörde ³⁾ 12.95 09.00 09.98 07.03 10.00 07.03 05.96 07.03 05.96 07.03	11.9406-9993.2 220413 11.9406-9994.2 220414 11.0441-4004.2 250012 11.0101-5402.2 260009 11.8171-0008.1 990049 11.8116-0168.1 390499		2		D=40, - Halter D=40, - Halter Dichtungssatz Hülssensatz Führungsbolzen Haltefeder	ATE ATE ATE ATE ATE
	520 d Touring 100 520 i Touring 523 i Touring 125 525 d Touring 120 525 i Touring 141 525 tds Touring 105 528 i Touring 142 530 d Touring 530 i Touring 170 540 i Touring 210 M5 294		04.00 07.03 05.97 07.03 05.97 09.00 04.00 07.03 10.00 07.03 06.98 09.00 05.97 09.00 09.98 07.03 10.00 07.03 05.97 07.03 10.98 07.03	11.0441-4203.2 250013 11.0101-5402.2 260009 11.8171-0008.1 990049 11.8116-0168.1 390499		2		Dichtungssatz Hülssensatz Führungsbolzen Haltefeder	ATE ATE ATE ATE
	520 d 100 520 i 520 i Touring 523 i 125 523 i Touring 125 525 d 120 525 i 141 525 td 85 525 tds 105 525 tds Touring 105 528 i 142 528 i Touring 142 530 d 530 i 170 535 i 540 i 210 M5 294		04.00 07.03 03.96 07.03 05.97 07.03 12.95 09.00 05.97 09.00 04.00 07.03 10.00 07.03 01.97 09.00 02.96 09.00 06.98 09.00 12.95 09.00 05.97 09.00 09.98 07.03 10.00 07.03 05.96 07.03 05.96 07.03 10.98 07.03	83.6113-0276.3 330538 83.6235-0100.3 330463 83.6204-0100.3 330441		2	am Bremssattel ¹⁾ M12X1 M10X1	L=275 L=100 L=100	
	520 d Touring 100 525 d Touring 120 525 i Touring 141 530 d Touring 530 i Touring 170 540 i Touring 210		04.00 07.03 04.00 07.03 10.00 07.03 09.98 07.03 10.00 07.03 05.97 07.03	24.5113-0275.3 330653 83.6235-0100.3 330463 83.6204-0100.3 330441		2	am Bremssattel ¹⁾ M12X1 M10X1	L=275 L=100 L=100	
	520 d 100 520 d Touring 100 520 i 520 i Touring 523 i 125 523 i Touring 125 525 d 120 525 d Touring 120 525 i 141 525 i Touring 141 525 td 85 525 tds 105 525 tds Touring 105 528 i 142 528 i Touring 142 530 d 530 d Touring 530 i 170		04.00 07.03 04.00 07.03 03.96 07.03 05.97 07.03 12.95 09.00 05.97 09.00 04.00 07.03 04.00 07.03 10.00 07.03 10.00 07.03 01.97 09.00 02.96 09.00 06.98 09.00 12.95 09.00 05.97 09.00 09.98 07.03 09.98 07.03 10.00 07.03	24.3727-0247.2 580247 24.3727-0246.2 580246				L=1924, + Zub L=1877, + Zub	

¹⁾ on the brake caliper / sulla pinza freno / sur l'étrier de frein / a la pinza de freno

²⁾ - authority cars / - enti statali / - véhicule communal / - vehiculos oficiales

³⁾ + authority cars / + enti statali / + véhicule communal / + vehiculos oficiales



BMW 5er Reihe/E39 (96-03)

	530 i Touring 535 i 540 i 540 i Touring M5	170 210 210 294	10.00 05.96 05.97 10.98	07.03 07.03 07.03 07.03	24.3727-0247.2 24.3727-0246.2	580247 580246	<input type="checkbox"/> <input type="checkbox"/>	L=1924, + Zub L=1877, + Zub
	520 i 520 i Touring 523 i 523 i Touring 525 td 525 tds 528 i 528 i Touring 535 i 540 i 540 i Touring	 125 125 85 105 142 142 210 210	03.96 05.97 12.95 05.97 01.97 02.96 12.95 05.97 05.96 05.96 05.97	08.97 08.97 08.97 08.97 08.97 08.97 08.97 08.97 08.97 08.97 08.97	24.2419-1710.3	030104		Gz 19,05
	520 d 520 d Touring 520 i 520 i Touring 523 i 523 i Touring 525 d 525 d Touring 525 i 525 i Touring 525 td 525 tds 525 tds Touring 528 i 528 i Touring 530 d 530 d Touring 530 i 530 i Touring 535 i 540 i 540 i Touring M5	100 100 125 125 120 120 141 141 85 105 105 105 142 142 170 170 170 210 210 294	04.00 04.00 09.97 09.97 09.97 04.00 04.00 10.00 10.00 09.97 09.97 06.98 09.97 09.97 09.98 09.98 10.00 10.00 09.97 09.97 10.98	07.03 07.03 07.03 07.03 09.00 09.00 07.03 07.03 07.03 07.03 09.00 09.00 09.00 09.00 07.03 07.03 07.03 07.03 07.03 07.03 07.03	24.2419-1713.3	030093		Gz 19,05
	520 d 520 d Touring 520 i 520 i Touring 523 i 523 i Touring 525 d 525 d Touring 525 i 525 i Touring 525 td 525 tds 525 tds Touring 528 i 528 i Touring 530 d 530 d Touring 530 i 530 i Touring 535 i 540 i 540 i Touring	100 100 125 125 120 120 141 141 85 105 105 142 142 170 170 170 210 210	04.00 04.00 03.96 05.97 12.95 05.97 04.00 04.00 10.00 10.00 01.97 02.96 06.98 12.95 05.97 09.98 09.98 10.00 10.00 05.96 05.96 05.97	07.03 07.03 07.03 07.03 09.00 07.03 07.03 07.03 07.03 07.03 09.00 09.00 09.00 09.00 07.03 07.03 07.03 07.03 07.03 07.03 07.03	24.2522-0905.3	040042		Nz 22,20

BMW 5er Reihe/E60 Limousine (03-10)

	520 i 525 i 530 i	125 141 170	07.03 07.03 07.03	03.05 06.05 03.05	24.2025-1710.3	010833		Thz 25,40/22,20 TRW
	520 d 520 d 523 i 523 i 525 d 525 d 525 i 525 xd 525 xi 530 d 530 d 530 d 530 i 530 i 530 xd 530 xd 530 xi 530 xi 535 d 535 d 540 i	120 130 130 140 130 145 160 145 160 160 170 173 190 200 170 173 190 200 200 210 225	07.05 09.07 07.05 03.07 10.03 03.07 07.05 03.07 07.05 07.03 07.03 03.07 07.05 01.07 07.05 03.07 07.05 03.07 09.04 03.07 07.05	02.10 02.10 03.07 02.10 03.07 02.10 02.10 02.10 02.10 08.05 03.07 02.10 03.07 02.10 02.10 02.10 03.07 02.10 03.07 02.10 02.10	24.2026-1702.3	010850		Thz 26,99/22,20 TRW



BMW 5er Reihe/E60 Limousine (03-10)

	520 d	120		07.05	02.10	24.3426-9977.5	240567	2	D=42, - Halter Haltefeder Dichtungssatz Hülsensatz Führungsbolzen	ATE
	520 d	130		09.07	02.10	11.8116-0330.1	390472	2		ATE
	520 i	125		07.03	03.05	11.0441-4203.2	250013			ATE
	523 i	130		07.05	03.07	11.0101-5402.2	260009			ATE
	523 i	140		03.07	02.10	11.8171-0008.1	990049			ATE
	525 d	130		10.03	03.07					
	525 d	145		03.07	02.10	- Behörde ¹⁾				
	525 i	141		07.03	06.05					
	525 i	160		03.07	02.10	- Behörde/ + Motorcode N53 ²⁾				
	525 i	160		03.07	02.10	+ Motorcode N52N ³⁾				
	525 i	160		07.05	03.07					
	525 xd	145		03.07	02.10					
	525 xi	160		07.05	02.10					
	530 d	160		07.03	08.05	- Behörde ¹⁾				
	530 d	170		07.03	03.07	- Behörde ¹⁾				
	530 d	173		03.07	02.10	- Behörde ¹⁾				
	530 i	170		07.03	03.05					
	530 i	190		07.05	03.07	- Behörde ¹⁾				
	530 i	200		01.07	02.10	- Behörde/ + Motorcode N52N ⁴⁾				
	530 xd	170		07.05	03.07					
530 xd	173		03.07	02.10						
530 xi	190		07.05	03.07						
530 xi	200		03.07	02.10						
525 d	145		03.07	02.10	+ Behörde ⁵⁾	11.0230-0176.2	260088	2	Haltersatz	ATE
525 i	160		03.07	02.10	+ Behörde/ + Motorcode N53 ⁶⁾	11.0441-4203.2	250013		Dichtungssatz	ATE
530 d	160		07.03	08.05	+ Behörde ⁵⁾	11.0101-5402.2	260009		Hülsensatz	ATE
530 d	170		07.03	03.07	+ Behörde ⁵⁾	11.8171-0008.1	990049		Führungsbolzen	ATE
530 d	173		03.07	02.10	+ Behörde ⁵⁾	11.8116-0296.1	390445	2	Haltefeder	ATE
530 i	190		07.05	03.07	+ Behörde ⁵⁾					
530 i	200		01.07	02.10	+ Motorcode N53 ⁷⁾					
530 i	200		01.07	02.10	+ Behörde/ + Motorcode N52N ⁸⁾					
535 d	200		09.04	03.07						
540 i	225		03.07	02.10						
545 i	245		07.03	08.05						
540 i	225		07.05	03.07		11.0101-5402.2	260009		Hülsensatz	ATE
						11.8171-0008.1	990049		Führungsbolzen	ATE
						11.8116-0296.1	390445	2	Haltefeder	ATE
535 d	210		03.07	02.10		11.0230-0176.2	260088	2	Haltersatz	ATE
550 i	270		07.05	02.10		11.0101-5402.2	260009		Hülsensatz	ATE
						11.8171-0008.1	990049		Führungsbolzen	ATE
						11.8116-0296.1	390445	2	Haltefeder	ATE
M5	373		09.04	02.10		11.0101-5402.2	260009		Hülsensatz	ATE
						11.8171-0008.1	990049		Führungsbolzen	ATE
						11.8116-0296.1	390445	2	Haltefeder	ATE
	520 d	120		07.05	02.10	24.5102-0304.3	331407	2	L=304	
	520 d	130		09.07	02.10					
	520 i	125		07.03	03.05					
	523 i	130		07.05	03.07					
	523 i	140		03.07	02.10					
	525 d	130		10.03	03.07					
	525 d	145		03.07	02.10					
	525 i	141		07.03	06.05					
	525 i	160		07.05	02.10					
	525 xd	145		03.07	02.10					
	525 xi	160		07.05	02.10					
	530 d	160		07.03	08.05					
	530 d	170		07.03	03.07					
	530 d	173		03.07	02.10					
	530 i	170		07.03	03.05					
	530 i	190		07.05	03.07					
	530 i	200		01.07	02.10					
	530 xd	170		07.05	03.07					
	530 xd	173		03.07	02.10					
	530 xi	190		07.05	03.07					
530 xi	200		03.07	02.10						
535 d	200		09.04	03.07						
535 d	210		03.07	02.10						
540 i	225		07.05	02.10						
545 i	245		07.03	08.05						
550 i	270		07.05	02.10						
M5	373		09.04	02.10						
	520 d	120		07.05	02.10	24.3727-0236.2	580236	<input type="checkbox"/>	L=1681 L=1673	
	520 d	130		09.07	02.10	24.3727-0237.2	580237	<input type="checkbox"/>		
	520 i	125		07.03	03.05					
	523 i	130		07.05	03.07					
	523 i	140		03.07	02.10					
	525 d	130		10.03	03.07					
	525 d	145		03.07	02.10					
	525 i	141		07.03	06.05					
	525 i	160		07.05	02.10					
	525 xd	145		03.07	02.10					
	525 xi	160		07.05	02.10					
	530 d	160		07.03	08.05					
	530 d	170		07.03	03.07					
	530 d	173		03.07	02.10					
	530 i	170		07.03	03.05					
530 i	190		07.05	03.07						

¹⁾ - authority cars / - enti statali / - véhicule communal / - vehiculos oficiales

²⁾ - authority cars/+engine co.N53 / - enti statali/+codice mot.N53 / - véhicule communal/+moteur co.N53 / - vehiculos oficiales/+motor co.N53

³⁾ + engine code N52N / + codice motore N52N / + moteur code N52N / + motor code N52N













⁴⁾ - authority cars/+engine co. N52N / - enti statali/+codice mot.N52N / - véhicule communal/+moteur co.N52N / - vehiculos oficiales/+motor co.N52N

⁵⁾ + authority cars / + enti statali / + véhicule communal / + vehiculos oficiales

⁶⁾ + authority cars/+engine no.N53 / + enti statali/+codice mot.N53 / + véhicule communal/+moteur co.N53 / + vehiculos oficiales/+motor co.N53

⁷⁾ + engine code N53 / + codice motore N53 / + moteur code N53 / + motor code N53

⁸⁾ + authority cars/+engine no.N52N / + enti statali/+codice mot.N52N / + véhicule communal/+moteur co.N52N / + vehiculos oficiales/+motor co.N52N

									
BMW 5er Reihe/E60 Limousine (03-10)									
	530 i	200		01.07	02.10	24.3727-0236.2	580236	L=1681 L=1673	
	530 xd	170		07.05	03.07	24.3727-0237.2	580237		
	530 xd	173		03.07	02.10				
	530 xi	190		07.05	03.07				
	530 xi	200		03.07	02.10				
	535 d	200		09.04	03.07				
	535 d	210		03.07	02.10				
	540 i	225		07.05	02.10				
	545 i	245		07.03	08.05				
	550 i	270		07.05	02.10				
	M5	373		09.04	02.10				
	520 d	120		07.05	02.10	24.2522-0905.3	040042		Nz 22,20
	520 i	125		07.03	03.05				
	523 i	130		07.05	03.07				
	523 i	140		03.07	02.10				
	525 d	130		10.03	03.07				
	525 d	145		03.07	02.10				
	525 i	141		07.03	06.05				
	525 i	160		07.05	02.10				
	525 xi	160		07.05	02.10				
	530 d	160		07.03	08.05				
	530 d	170		07.03	03.07				
	530 d	173		03.07	02.10				
	530 i	170		07.03	03.05				
	530 i	190		07.05	03.07				
	530 i	200		01.07	02.10				
	530 xd	170		07.05	03.07				
	530 xd	173		03.07	02.10				
	530 xi	190		07.05	03.07				
	530 xi	200		03.07	02.10				
	540 i	225		07.05	02.10				
	545 i	245		07.03	08.05				
	550 i	270		07.05	02.10				
BMW 5er Reihe/E61 Touring (04-10)									
	523 i	130		07.05	03.07	24.2025-1710.3	010833	Thz 25,40/22,20	TRW
	525 i	141		05.04	03.05				
	525 i	160		07.05	03.07				
	530 i	190		07.05	03.07				
	520 d	110		09.05	05.10	24.2026-1702.3	010850	Thz 26,99/22,20	TRW
	520 d	120		07.05	05.10				
	520 d	130		09.07	05.10				
	520 i	125		06.04	05.10				
	523 i	140		03.07	05.10				
	525 d	120		12.04	05.10				
	525 d	130		05.04	03.07				
	525 d	145		03.07	05.10				
	525 i	160		03.07	05.10				
	525 xd	145		03.07	05.10				
	525 xi	160		07.05	05.10				
	530 d	160		05.04	08.05				
	530 d	170		07.05	05.10				
	530 d	173		03.07	05.10				
	530 i	200		03.07	05.10				
	530 xd	170		07.05	03.07				
	530 xd	173		03.07	05.10				
	530 xi	190		07.05	03.07				
	530 xi	200		03.07	05.10				
	535 d	200		09.04	03.07				
	535 d	210		03.07	05.10				
	545 i	245		05.04	08.05				
	550 i	270		07.05	05.10				
	M5	373		02.07	05.10				
	520 d	110		09.05	05.10	11.9606-9967.2	220905	D=60, - Halter D=60, - Halter D=60, - Halter D=60, - Halter Dichtungssatz Hülsensatz Führungsbolzen Haltefeder	ATE ATE ATE ATE ATE ATE ATE ATE
	520 d	120		07.05	05.10	11.9606-9968.2	220906		
	520 i	125		06.04	05.10	24.3606-9967.5	240571		
	523 i	130		07.05	03.07	24.3606-9968.5	240572		
	523 i	140		03.07	05.10	11.0441-6008.2	250038		
	525 d	120		12.04	05.10	11.0101-5402.2	260009		
	525 d	130		05.04	03.07	11.8171-0008.1	990049		
	525 i	141		05.04	03.05	11.8116-0339.2	390528		
	525 i	160		03.07	05.10				
	520 d	110		09.05	05.10	11.9606-9979.2	220907		
	520 d	120		07.05	05.10	11.9606-9980.2	220908		
	520 d	130		09.07	05.10	24.3606-9979.5	240575		
	520 i	125		06.04	05.10	24.3606-9980.5	240576		
	523 i	130		07.05	03.07	11.0441-6008.2	250038		
	523 i	140		03.07	05.10	11.0101-6006.2	260098		
	523 i	140		03.07	05.10	11.8171-0008.1	990049		
	525 d	120		12.04	05.10	11.8116-0315.2	390447		
	525 d	130		05.04	03.07				
	525 d	145		03.07	05.10				
	525 i	141		05.04	03.05				
	525 i	160		03.07	05.10				
	525 i	160		03.07	05.10				
	525 i	160		07.05	03.07				
	530 d	160		05.04	08.05				

1) - authority cars / - enti statali / - véhicule communal / - vehiculos oficiales

2) - authority cars/+engine co.N52N / - enti statali/+codice mot.N52N / - véhicule communal/+moteur co.N52N / - vehiculos oficiales/+motor co.N52N





















3) + authority cars / + enti statali / + véhicule communal / + vehiculos oficiales

4) + engine code N53 / + codice motore N53 / + moteur code N53 / + motor code N53

5) + authority cars/+engine no.N52N / + enti statali/+codice mot.N52N / + véhicule communal/+moteur co.N52N / + vehiculos oficiales/+motor co.N52N

6) - authority cars/+engine co.N53 / - enti statali/+codice mot.N53 / - véhicule communal/+moteur co.N53 / - vehiculos oficiales/+motor co.N53



											
BMW 5er Reihe/E61 Touring (04-10)											
	530 d	170	07.05	05.10	- Behörde ¹⁾	11.9606-9979.2	220907	 D=60, - Halter D=60, - Halter D=60, - Halter D=60, - Halter Dichtungssatz Hülsensatz Führungsbolzen Haltefeder	ATE		
	530 d	173	03.07	05.10	- Behörde ¹⁾	11.9606-9980.2	220908		ATE		
	530 i	190	07.05	03.07		24.3606-9979.5	240575		ATE		
	530 i	200	03.07	05.10	- Behörde/ + Motorcode N52N ²⁾	24.3606-9980.5	240576		ATE		
						11.0441-6008.2	250038		ATE		
						11.0101-6006.2	260098		ATE		
						11.8171-0008.1	990049		ATE		
						11.8116-0315.2	390447		ATE		
	525 d	145	03.07	05.10	+ Behörde ³⁾	24.3606-9977.5	240573		 D=60, - Halter D=60, - Halter Dichtungssatz Hülsensatz Führungsbolzen Haltefeder	ATE	
	525 i	160	03.07	05.10	+ Behörde/ + Motorcode N53 ⁴⁾	24.3606-9978.5	240574			ATE	
	530 d	160	05.04	08.05	+ Behörde ³⁾	11.0441-6008.2	250038			ATE	
	530 d	170	07.05	05.10	+ Behörde ³⁾	11.0101-6006.2	260098			ATE	
	530 d	173	03.07	05.10	+ Behörde ³⁾	11.8171-0008.1	990049			ATE	
	530 i	200	03.07	05.10	+ Motorcode N53 ⁵⁾	11.8171-0067.1	250153			ATE	
	530 i	200	03.07	05.10	+ Behörde/ + Motorcode N52N ⁶⁾	11.8116-0315.2	390447			ATE	
	545 i	245	05.04	08.05						ATE	
	550 i	270	03.07	05.10	+ (USA)					ATE	
	525 xd	145	03.07	05.10		24.3606-9955.5	240577			 D=60, - Halter D=60, - Halter Dichtungssatz Hülsensatz Führungsbolzen Haltefeder	ATE
	525 xi	160	07.05	05.10		24.3606-9956.5	240578		ATE		
	530 xd	170	07.05	03.07		11.0441-6008.2	250038		ATE		
530 xd	173	03.07	05.10		11.0101-6006.2	260098	ATE				
530 xi	190	07.05	03.07		11.8171-0008.1	990049	ATE				
530 xi	200	03.07	05.10		11.8171-0067.1	250153	ATE				
					11.8116-0315.2	390447	ATE				
535 d	200	09.04	03.07		11.0101-5706.2	260097	 Hülsensatz Führungsbolzen Haltefeder	ATE			
535 d	210	03.07	05.10		11.8171-0067.1	250153		ATE			
550 i	270	03.07	05.10	- (USA)	11.8116-0353.2	390585		ATE			
550 i	270	07.05	03.07					ATE			
M5	373	02.07	05.10		11.0101-5706.2	260097		ATE			
					11.8171-0067.1	250153	ATE				
					11.8116-0353.2	390585	ATE				
	520 d	110	09.05	05.10		83.6151-0552.3	330857	 L=550	ATE		
	520 d	120	07.05	05.10					ATE		
	520 d	130	09.07	05.10					ATE		
	520 i	125	06.04	05.10					ATE		
	523 i	130	07.05	03.07					ATE		
	523 i	140	03.07	05.10					ATE		
	525 d	120	12.04	05.10					ATE		
	525 d	130	05.04	03.07					ATE		
	525 d	145	03.07	05.10					ATE		
	525 i	141	05.04	03.05					ATE		
	525 i	160	07.05	05.10					ATE		
	530 d	160	05.04	08.05					ATE		
	530 d	170	07.05	05.10					ATE		
	530 d	173	03.07	05.10					ATE		
	530 i	190	07.05	03.07					ATE		
	530 i	200	03.07	05.10					ATE		
	535 d	200	09.04	03.07					ATE		
	535 d	210	03.07	05.10					ATE		
	545 i	245	05.04	08.05					ATE		
	550 i	270	07.05	05.10					ATE		
M5	373	02.07	05.10				ATE				
525 xd	525 xd	145	03.07	05.10		83.7751-0495.3	331104	 L=495	ATE		
	525 xi	160	07.05	05.10					ATE		
	530 xd	170	07.05	03.07					ATE		
	530 xd	173	03.07	05.10					ATE		
	530 xi	190	07.05	03.07					ATE		
	530 xi	200	03.07	05.10					ATE		
		520 d	110	09.05	05.10		11.9426-9957.2		220895	 D=42, - Halter D=42, - Halter D=42, - Halter D=42, - Halter Dichtungssatz Hülsensatz Führungsbolzen Haltefeder	ATE
		520 d	120	07.05	05.10		11.9426-9958.2		220896		ATE
520 d		130	09.07	05.10		24.3426-9957.5	240565	ATE			
520 i		125	06.04	05.10		24.3426-9958.5	240566	ATE			
523 i		130	07.05	03.07		11.0441-4203.2	250013	ATE			
523 i		140	03.07	05.10		11.0101-5402.2	260009	ATE			
525 d		120	12.04	05.10		11.8171-0008.1	990049	ATE			
525 d		130	05.04	03.07		11.8116-0330.1	390472	ATE			
525 d		145	03.07	05.10	- Behörde ¹⁾			ATE			
525 i		141	05.04	03.05				ATE			
525 i		160	03.07	05.10	- Behörde/ + Motorcode N53 ⁷⁾			ATE			
525 i		160	03.07	05.10	+ Motorcode N52N ⁸⁾			ATE			
525 i		160	07.05	03.07				ATE			
525 xd		145	03.07	05.10				ATE			
525 xi		160	07.05	05.10				ATE			
530 d		160	05.04	08.05	- Behörde ¹⁾			ATE			
530 d		170	07.05	05.10	- Behörde ¹⁾			ATE			
530 d		173	03.07	05.10	- Behörde ¹⁾			ATE			
530 i		190	07.05	03.07				ATE			
530 i		200	03.07	05.10	- Behörde/ + Motorcode N52N ²⁾			ATE			
530 xd	170	07.05	03.07				ATE				
530 xd	173	03.07	05.10				ATE				
530 xi	190	07.05	03.07				ATE				
530 xi	200	03.07	05.10				ATE				
525 d	525 d	145	03.07	05.10	+ Behörde ³⁾	11.0230-0176.2	260088	 Haltersatz Dichtungssatz Hülsensatz Führungsbolzen Haltefeder	ATE		
	525 i	160	03.07	05.10	+ Behörde/ + Motorcode N53 ⁴⁾	11.0441-4203.2	250013		ATE		
	530 d	160	05.04	08.05	+ Behörde ³⁾	11.0101-5402.2	260009		ATE		
	530 d	170	07.05	05.10	+ Behörde ³⁾	11.8171-0008.1	990049		ATE		
	530 i	200	03.07	05.10	+ Motorcode N53 ⁵⁾	11.8116-0296.1	390445		ATE		

¹⁾ - authority cars / - enti statali / - véhicule communal / - vehiculos oficiales

²⁾ - authority cars/+engine co. N52N / - enti statali/+codice mot.N52N / - véhicule communal/+moteur co.N52N / - vehiculos oficiales/+motor co.N52N

³⁾ + authority cars / + enti statali / + véhicule communal / + vehiculos oficiales













⁴⁾ + authority cars/+engine no.N53 / + enti statali/+codice mot.N53 / + véhicule communal/+moteur co.N53 / + vehiculos oficiales/+motor co.N53

⁵⁾ + engine code N53 / + codice motore N53 / + moteur code N53 / + motor code N53

⁶⁾ + authority cars/+engine no.N52N / + enti statali/+codice mot.N52N / + véhicule communal/+moteur co.N52N / + vehiculos oficiales/+motor co.N52N

⁷⁾ - authority cars/+engine co.N53 / - enti statali/+codice mot.N53 / - véhicule communal/+moteur co.N53 / - vehiculos oficiales/+motor co.N53





⁸⁾ + engine code N52N / + codice motore N52N / + moteur code N52N / + motor code N52N

												
BMW 5er Reihe/E61 Touring (04-10)												
	530 i	200		03.07	05.10	+ Behörde/ + Motorcode N52N ¹⁾	11.0230-0176.2	260088	2		Haltersatz	ATE
	535 d	200		09.04	03.07		11.0441-4203.2	250013			Dichtungssatz	ATE
	545 i	245		05.04	08.05		11.0101-5402.2	260009			Hülssensatz	ATE
							11.8171-0008.1	990049			Führungsbolzen	ATE
							11.8116-0296.1	390445	2		Haltefeder	ATE
	530 d	173		03.07	05.10	+ Behörde ²⁾	11.0230-0176.2	260088	2		Haltersatz	ATE
	535 d	210		03.07	05.10		11.0101-5402.2	260009			Führungsbolzen	ATE
	550 i	270		07.05	05.10		11.8171-0008.1	990049			Haltefeder	ATE
							11.8116-0296.1	390445	2			ATE
	M5	373		02.07	05.10		11.0101-5402.2	260009			Hülssensatz	ATE
							11.8171-0008.1	990049			Führungsbolzen	ATE
							11.8116-0296.1	390445	2		Haltefeder	ATE
	520 d	110		09.05	05.10		83.6104-0315.3	330889	2	am Bremssattel ³⁾	L=315	
	520 d	120		07.05	03.07							
	520 d	130		09.07	05.10							
	520 i	125		06.04	05.10							
	523 i	130		07.05	03.07							
	525 d	120		12.04	05.10							
	525 d	130		05.04	03.07							
	525 i	141		05.04	03.05							
	525 i	160		07.05	03.07							
	525 xi	160		07.05	03.07							
	530 d	160		05.04	08.05							
	530 d	170		07.05	05.10							
	530 i	190		07.05	03.07							
	530 xd	170		07.05	03.07							
	530 xi	190		07.05	03.07							
	535 d	200		09.04	03.07							
	535 d	210		03.07	05.10							
	545 i	245		05.04	08.05							
	550 i	270		07.05	03.07							
	M5	373		02.07	05.10							
	520 d	110		09.05	05.10		24.5102-0304.3	331407	2		L=304	
	520 d	120		03.07	05.10							
	520 d	130		09.07	05.10							
	520 i	125		06.04	05.10							
	523 i	140		03.07	05.10							
	525 d	145		03.07	05.10							
	525 i	160		03.07	05.10							
	525 xd	145		03.07	05.10							
	525 xi	160		03.07	05.10							
	530 d	173		03.07	05.10							
	530 i	200		03.07	05.10							
	530 xd	173		03.07	05.10							
	530 xi	200		03.07	05.10							
	550 i	270		03.07	05.10							
	520 d	110		09.05	05.10		24.3727-0236.2	580236		<input type="checkbox"/>	L=1681	
	520 d	120		07.05	05.10		24.3727-0237.2	580237		<input type="checkbox"/>	L=1673	
	520 d	130		09.07	05.10							
	520 i	125		06.04	05.10							
	523 i	130		07.05	03.07							
	523 i	140		03.07	05.10							
	525 d	120		12.04	05.10							
	525 d	130		05.04	03.07							
	525 d	145		03.07	05.10							
	525 i	141		05.04	03.05							
	525 i	160		07.05	05.10							
	525 xd	145		03.07	05.10							
	525 xi	160		07.05	05.10							
	530 d	160		05.04	08.05							
	530 d	170		07.05	05.10							
	530 d	173		03.07	05.10							
	530 i	190		07.05	03.07							
	530 i	200		03.07	05.10							
	530 xd	170		07.05	03.07							
	530 xd	173		03.07	05.10							
530 xi	190		07.05	03.07								
530 xi	200		03.07	05.10								
535 d	200		09.04	03.07								
535 d	210		03.07	05.10								
545 i	245		05.04	08.05								
550 i	270		07.05	05.10								
M5	373		02.07	05.10								
	520 d	110		09.05	05.10		24.2522-0905.3	040042			Nz 22,20	
	520 d	120		07.05	05.10							
	520 d	130		09.07	05.10							
	520 i	125		06.04	05.10							
	523 i	130		07.05	03.07							
	523 i	140		03.07	05.10							
	525 d	120		12.04	05.10							
	525 d	130		05.04	03.07							
	525 d	145		03.07	05.10							
	525 i	141		05.04	03.05							
	525 i	160		07.05	05.10							
	525 xi	160		07.05	05.10							
	530 d	160		05.04	08.05							
	530 d	170		07.05	05.10							













1) + authority cars/+engine no.N52N / + enti statali/+codice mot.N52N / + véhicule communal/+moteur co.N52N / + vehiculos oficiales/+motor co.N52N

2) + authority cars / + enti statali / + véhicule communal / + vehiculos oficiales

3) on the brake caliper / sulla pinza freno / sur l'étrier de frein / a la pinza de freno

BMW 5er Reihe/E61 Touring (04-10)								
	530 d 173 530 i 190 530 i 200 530 xd 170 530 xd 173 530 xi 190 530 xi 200 535 d 200 545 i 245 550 i 270	03.07 07.05 03.07 07.05 03.07 07.05 03.07 09.04 05.04 07.05	05.10 03.07 05.10 03.07 05.10 03.07 05.10 03.07 08.05 05.10	24.2522-0905.3	040042		Nz 22,20	
BMW 5er Reihe/F10 Limousine (10-)								
	M5 412 M5 Competition 423	09.11 01.14		24.4126-1703.3	010991		Thz 26,99	TRW
	518 d 105 518 d 110 520 d 135 520 d 140 520 d xDrive 135 520 d xDrive 140 520 i 120 520 i 135 523 i 150	01.13 07.14 03.10 07.14 02.13 07.14 09.11 09.11 03.10		11.0441-6008.2 11.0101-5402.2 11.8171-0008.1	250038 260009 990049		Dichtungssatz Hülsensatz Führungsbolzen	ATE ATE ATE
	525 d 150 525 d 160 525 d xDrive 160 528 i 180 528 i 190 528 i xDrive 180 530 d 180 530 d 190 530 d 210 530 d xDrive 190 530 d xDrive 210 530 i 200	03.10 09.11 09.11 09.11 03.10 09.11 03.10 09.11 10.15 03.11 10.15 09.11	- verstärkte Bremse ¹⁾ - verstärkte Bremse ¹⁾ - verstärkte Bremse ¹⁾ - verstärkte Bremse ¹⁾ - verstärkte Bremse ¹⁾ - verstärkte Bremse ¹⁾ - verstärkte Bremse ¹⁾ - verstärkte Bremse ¹⁾ - verstärkte Bremse ¹⁾ - verstärkte Bremse ¹⁾ - verstärkte Bremse ¹⁾	11.0441-6008.2 11.0101-5402.2 11.8171-0008.1	250038 260009 990049		Dichtungssatz Hülsensatz Führungsbolzen	ATE ATE ATE
	525 d 150 525 d 160 525 d xDrive 160 530 d 180 530 d 190 530 d 210 530 d xDrive 190 530 d xDrive 210 535 d 220 535 d 230 535 d xDrive 230 535 i 225 535 i xDrive 225 550 i 300 550 i xDrive 300	03.10 09.11 09.11 03.10 09.11 10.15 03.11 10.15 09.10 09.11 09.11 03.10 03.11 03.10 09.10	+ verstärkte Bremse ²⁾ + verstärkte Bremse ²⁾ + verstärkte Bremse ²⁾ + verstärkte Bremse ²⁾ + verstärkte Bremse ²⁾ + verstärkte Bremse ²⁾ + verstärkte Bremse ²⁾ + verstärkte Bremse ²⁾ + verstärkte Bremse ²⁾ + verstärkte Bremse ²⁾ + verstärkte Bremse ²⁾ + verstärkte Bremse ²⁾ + verstärkte Bremse ²⁾ + verstärkte Bremse ²⁾ + verstärkte Bremse ²⁾	11.8116-0007.2 11.0101-7003.2 11.8171-0096.1 11.0441-6008.2	390602 260124 250155 250038	2	Haltefeder Hülsensatz Führungsbolzen Dichtungssatz	ATE ATE ATE ATE
	550 i xDrive 330 Active Hybrid 5 250	05.13 09.11		11.8116-0007.2 11.0101-7003.2 11.8171-0096.1 11.0441-6008.2	390602 260124 250155 250038	2	Haltefeder Hülsensatz Führungsbolzen Dichtungssatz	ATE ATE ATE ATE
	550 i 330 M 550 d xDrive 280	05.13 03.12		11.8116-0007.2 11.0101-7003.2 11.8171-0096.1 11.0441-6008.2	390602 260124 250155 250038	2	Haltefeder Hülsensatz Führungsbolzen Dichtungssatz	ATE ATE ATE ATE
	518 d 105 518 d 110 520 d 135 520 d 140 520 d xDrive 135 520 d xDrive 140 520 i 120 520 i 135 523 i 150 525 d 150 525 d 160 525 d xDrive 160 528 i 180 528 i 190 528 i xDrive 180 530 d 180 530 d 190 530 d 210 530 d xDrive 190 530 d xDrive 210 530 i 200 535 d 220 535 d 230 535 d xDrive 230 535 i 225 535 i xDrive 225 550 i 300 550 i 330	01.13 07.14 03.10 07.14 02.13 07.14 09.11 09.11 03.10 03.10 09.11 09.11 03.10 03.10 09.11 09.11 10.15 03.11 10.15 09.11 09.11 03.10 03.11 03.10 05.13		24.5118-0688.3	331419	2	L=688	

¹⁾ - heavy duty brake / - freno rinforzato / - frein renforcé / - freno reforzado
²⁾ + heavy duty brake / + freno rinforzato / + frein renforcé / + freno reforzado

								
BMW 5er Reihe/F10 Limousine (10-)								
	550 i xDrive	300	09.10		24.5118-0688.3	331419	2	L=688
	550 i xDrive	330	05.13					
	Active Hybrid 5	250	09.11					
	M 550 d xDrive	280	03.12					
	530 d xDrive	190	03.11		24.6244-1701.5	240717	<input type="checkbox"/> elektrische Feststellbremse ¹⁾	D=44, - Halter
	535 d	220	09.10		24.6244-1702.5	240718	<input type="checkbox"/> elektrische Feststellbremse ¹⁾	D=44, - Halter
	535 d	230	09.11					
	535 d xDrive	230	09.11					
	535 i	225	03.10					
	535 i xDrive	225	03.11					
	550 i	300	03.10					
	550 i	330	05.13					
	550 i xDrive	300	09.10					
	550 i xDrive	330	05.13					
	Active Hybrid 5	250	09.11					
	M 550 d xDrive	280	03.12					
BMW 5er Reihe/F11 Touring (10-)								
	518 d	105	01.13	- verstärkte Bremse ²⁾	11.0101-5402.2	260009		Hülsensatz
	518 d	110	05.14	- verstärkte Bremse ²⁾	11.8171-0008.1	990049		Führungsbolzen
	520 d	135	09.10	- verstärkte Bremse ²⁾	11.0441-6008.2	250038		Dichtungssatz
	520 d	140	05.14	- verstärkte Bremse ²⁾				
	520 d xDrive	135	02.13	- verstärkte Bremse ²⁾				
	520 d xDrive	140	05.14	- verstärkte Bremse ²⁾				
	520 i	135	09.11	- verstärkte Bremse ²⁾				
	523 i	150	09.10	- verstärkte Bremse ²⁾				
	518 d	105	01.13	+ verstärkte Bremse ³⁾	11.0101-5402.2	260009		Hülsensatz
	518 d	110	05.14	+ verstärkte Bremse ³⁾	11.8171-0008.1	990049		Führungsbolzen
	520 d	135	09.10	+ verstärkte Bremse ³⁾	11.0441-6008.2	250038		Dichtungssatz
	520 d xDrive	135	02.13	+ verstärkte Bremse ³⁾				
	525 d	150	09.10	- verstärkte Bremse ²⁾				
	525 d	160	09.11	- verstärkte Bremse ²⁾				
	525 d xDrive	160	09.11	- verstärkte Bremse ²⁾				
	528 i	180	09.11	- verstärkte Bremse ²⁾				
	528 i	190	09.10	- verstärkte Bremse ²⁾				
	528 i xDrive	180	09.11	- verstärkte Bremse ²⁾				
	530 d	180	09.10	- verstärkte Bremse ²⁾				
	530 d	190	09.11	- verstärkte Bremse ²⁾				
	530 d	210	10.15	- verstärkte Bremse ²⁾				
	530 d xDrive	190	03.11	- verstärkte Bremse ²⁾				
	530 d xDrive	210	10.15	- verstärkte Bremse ²⁾				
	530 i	200	09.11	- verstärkte Bremse ²⁾				
	520 d	140	05.14	+ verstärkte Bremse ³⁾	11.8116-0007.2	390602	2	Haltefeder
	520 d xDrive	140	05.14	+ verstärkte Bremse ³⁾	11.0101-7003.2	260124		Hülsensatz
	525 d	160	09.11	+ verstärkte Bremse ³⁾	11.8171-0096.1	250155		Führungsbolzen
	525 d xDrive	160	09.11	+ verstärkte Bremse ³⁾	11.0441-6008.2	250038		Dichtungssatz
	530 d	190	09.11	+ verstärkte Bremse ³⁾				
	530 d	210	10.15	+ verstärkte Bremse ³⁾				
	530 d xDrive	190	03.11	+ verstärkte Bremse ³⁾				
	530 d xDrive	210	10.15	+ verstärkte Bremse ³⁾				
	535 d	220	09.10	+ verstärkte Bremse ³⁾				
	535 d	230	09.11	+ verstärkte Bremse ³⁾				
	535 d xDrive	230	09.11	+ verstärkte Bremse ³⁾				
	535 i	225	09.10	+ verstärkte Bremse ³⁾				
	535 i	240	10.15	+ verstärkte Bremse ³⁾				
	535 i xDrive	225	09.11	+ verstärkte Bremse ³⁾				
	535 i xDrive	240	10.15	+ verstärkte Bremse ³⁾				
	550 i	300	09.11		11.8116-0007.2	390602	2	Haltefeder
	550 i	330	05.13		11.0101-7003.2	260124		Hülsensatz
	M 550 d xDrive	280	03.12		11.8171-0096.1	250155		Führungsbolzen
					11.0441-6008.2	250038		Dichtungssatz
	518 d	105	01.13		24.5118-0688.3	331419	2	L=688
	518 d	110	05.14					
	520 d	135	09.10					
	520 d	140	05.14					
	520 d xDrive	135	02.13					
	520 d xDrive	140	05.14					
	520 i	135	09.11					
	523 i	150	09.10					
	525 d	150	09.10					
	525 d	160	09.11					
	525 d xDrive	160	09.11					
	528 i	180	09.11					
	528 i	190	09.10					
	528 i xDrive	180	09.11					
	530 d	180	09.10					
	530 d	190	09.11					
	530 d	210	10.15					
	530 d xDrive	190	03.11					
	530 d xDrive	210	10.15					
	530 i	200	09.11					
	535 d	220	09.10					
	535 d	230	09.11					
	535 d xDrive	230	09.11					
	535 i	225	09.10					
	535 i	240	10.15					
	535 i xDrive	225	09.11					

¹⁾ electric parking brake / fr.di stazionamento elettrico / frein à main électrique / freno de mano eléctrico

²⁾ - heavy duty brake / - freno rinforzato / - frein renforcé / - freno reforzado

³⁾ + heavy duty brake / + freno rinforzato / + frein renforcé / + freno reforzado









































BMW 5er Reihe/F11 Touring (10-)											
	535 i xDrive	240		10.15		24.5118-0688.3	331419	2		L=688	
	550 i	300		09.11							
	550 i	330		05.13							
	M 550 d xDrive	280		03.12							
	518 d	105		01.13	+ verstärkte Bremse ¹⁾	24.6244-1701.5	240717		<input type="checkbox"/> elektrische Feststellbremse ²⁾	D=44, - Halter	TRW
	518 d	110		05.14	+ verstärkte Bremse ¹⁾	24.6244-1702.5	240718		<input type="checkbox"/> elektrische Feststellbremse ²⁾	D=44, - Halter	TRW
	520 d	135		09.10	+ verstärkte Bremse ¹⁾						
	520 d	140		05.14	+ verstärkte Bremse ¹⁾						
	520 d xDrive	135		02.13	+ verstärkte Bremse ¹⁾						
	520 d xDrive	140		05.14	+ verstärkte Bremse ¹⁾						
	525 d	160		09.11	+ verstärkte Bremse ¹⁾						
	525 d xDrive	160		09.11	+ verstärkte Bremse ¹⁾						
	530 d	190		09.11	+ verstärkte Bremse ¹⁾						
	530 d	210		10.15	+ verstärkte Bremse ¹⁾						
	530 d xDrive	190		03.11							
	530 d xDrive	210		10.15							
	535 d	220		09.10							
	535 d	230		09.11							
	535 d xDrive	230		09.11							
	535 i	225		09.10							
	535 i	240		10.15							
	535 i xDrive	225		09.11							
	535 i xDrive	240		10.15							
	550 i	300		09.11							
	550 i	330		05.13							
	M 550 d xDrive	280		03.12							

BMW 5er Reihe/F07 GT GRAN TURISMO (09-)											
	520 d	135		10.11		24.2026-1702.3	010850			Thz 26,99/22,20	TRW
	530 d	155		07.10							
	530 d	180		10.09							
	530 d	190		10.09							
	530 d xDrive	180		09.10							
	530 d xDrive	190		10.09							
	535 d	220		03.10							
	535 d	230		02.12							
	535 d xDrive	220		09.10							
	535 d xDrive	230		02.12							
	535 i	225		10.09							
	535 i xDrive	225		09.10							
	550 i	300		10.09							
	550 i	330		05.12							
	550 i xDrive	300		09.10							
	550 i xDrive	330		05.12							
	520 d	135		10.11		11.8116-0007.2	390602	2		Haltefeder	ATE
	530 d	155		07.10		11.0101-7003.2	260124			HülSENSsatz	ATE
	530 d	180		10.09		11.8171-0096.1	250155			Führungsbolzen	ATE
	530 d	190		10.09		11.0441-6008.2	250038			Dichtungssatz	ATE
	530 d xDrive	180		09.10							
	530 d xDrive	190		10.09							
	535 d	220		03.10							
	535 d	230		02.12							
	535 d xDrive	220		09.10							
	535 d xDrive	230		02.12							
	535 i	225		10.09							
	535 i xDrive	225		09.10							
	550 i	300		10.09		11.8116-0008.2	390603	2		Haltefeder	ATE
	550 i	330		05.12		11.0101-7003.2	260124			HülSENSsatz	ATE
	550 i xDrive	300		09.10		11.8171-0096.1	250155			Führungsbolzen	ATE
	550 i xDrive	330		05.12		11.0441-6008.2	250038			Dichtungssatz	ATE
	520 d	135		10.11		24.5118-0688.3	331419	2		L=688	
	530 d	155		07.10							
	530 d	180		10.09							
	530 d	190		10.09							
	530 d xDrive	180		09.10							
	530 d xDrive	190		10.09							
	535 d	220		03.10							
	535 d	230		02.12							
	535 d xDrive	220		09.10							
	535 d xDrive	230		02.12							
	535 i	225		10.09							
	535 i xDrive	225		09.10							
	550 i	300		10.09							
	550 i	330		05.12							
	550 i xDrive	300		09.10							
	550 i xDrive	330		05.12							
	520 d	135		10.11		11.0101-5402.2	260009			HülSENSsatz	ATE
	530 d	155		07.10		11.8171-0008.1	990049			Führungsbolzen	ATE
	530 d	180		10.09		11.8116-0296.1	390445	2		Haltefeder	ATE
	530 d	190		10.09							
	530 d xDrive	180		09.10							
	530 d xDrive	190		10.09							
	535 d	220		03.10							
	535 d	230		02.12							
	535 d xDrive	220		09.10							
	535 d xDrive	230		02.12							
	535 i	225		10.09							

















¹⁾ + heavy duty brake / + freno rinforzato / + frein renforcé / + freno reforzado

²⁾ electric parking brake / fr.di stazionamento elettrico / frein à main électrique / freno de mano eléctrico

									
BMW 5er Reihe/F07 GT GRAN TURISMO (09-)									
	535 i xDrive	225		09.10		11.0101-5402.2 260009 11.8171-0008.1 990049 11.8116-0296.1 390445	2	Hülsensatz Führungsbolzen Haltefeder	ATE ATE ATE
	550 i	300		10.09		11.0101-5402.2 260009 11.8171-0008.1 990049		Hülsensatz Führungsbolzen	ATE ATE
	550 i xDrive	300		09.10		11.8116-0296.1 390445	2	Haltefeder	ATE
	550 i xDrive	330		05.12					
BMW 6er Reihe/E63 Coupe (04-11)									
	630 i	190		07.04	08.07	24.2026-1702.3 010850		Thz 26,99/22,20	TRW
	630 i	200		09.07	05.11				
	635 d	210		09.07	05.11				
	645 Ci	245		12.03	08.07				
	650 i	270		07.05	05.11				
	M6	373		06.05	05.11				
	630 i	190		07.04	08.07	11.9606-9979.2 220907 11.9606-9980.2 220908 24.3606-9979.5 240575 24.3606-9980.5 240576 11.0441-6008.2 250038 11.0101-6006.2 260098 11.8171-0008.1 990049 11.8171-0067.1 250153 11.8116-0315.2 390447	2	D=60, - Halter D=60, - Halter D=60, - Halter D=60, - Halter Dichtungssatz Hülsensatz Führungsbolzen Führungsbolzen Haltefeder	ATE ATE ATE ATE ATE ATE ATE ATE ATE
	630 i	200		09.07	05.11	24.3606-9977.5 240573 24.3606-9978.5 240574 11.0441-6008.2 250038 11.0101-6006.2 260098 11.8171-0008.1 990049 11.8171-0067.1 250153 11.8116-0315.2 390447	2	D=60, - Halter D=60, - Halter Dichtungssatz Hülsensatz Führungsbolzen Führungsbolzen Haltefeder	ATE ATE ATE ATE ATE ATE ATE
	645 Ci	245		12.03	08.07				
	635 d	210		09.07	05.11	11.0101-5706.2 260097 11.8171-0067.1 250153 11.8116-0353.2 390585	2	Hülsensatz Führungsbolzen Haltefeder	ATE ATE ATE
	650 i	270		07.05	05.11				
	M6	373		06.05	05.11	11.0101-5706.2 260097 11.8171-0067.1 250153 11.8116-0353.2 390585	2	Hülsensatz Führungsbolzen Haltefeder	ATE ATE ATE
	630 i	190		07.04	08.07	83.6151-0552.3 330857	2	L=550	
	630 i	200		09.07	05.11				
	635 d	210		09.07	05.11				
	645 Ci	245		12.03	08.07				
	650 i	270		07.05	05.11				
	M6	373		06.05	05.11				
	630 i	190		07.04	08.07	24.3426-9977.5 240567 11.0441-4203.2 250013 11.0101-5402.2 260009 11.8171-0008.1 990049 11.8116-0330.1 390472	2	D=42, - Halter Dichtungssatz Hülsensatz Führungsbolzen Haltefeder	ATE ATE ATE ATE ATE
	630 i	200		09.07	05.11	11.0230-0176.2 260088 11.0101-5402.2 260009 11.8171-0008.1 990049 11.8116-0296.1 390445	2	Haltersatz Hülsensatz Führungsbolzen Haltefeder	ATE ATE ATE ATE
	635 d	210		09.07	05.11				
	645 Ci	245		12.03	08.07				
	650 i	270		07.05	05.11				
	M6	373		06.05	05.11	11.0101-5402.2 260009 11.8171-0008.1 990049 11.8116-0296.1 390445	2	Hülsensatz Führungsbolzen Haltefeder	ATE ATE ATE
	630 i	190		07.04	08.07	24.5102-0304.3 331407	2	L=304	
	630 i	200		09.07	05.11				
	635 d	210		09.07	05.11				
	645 Ci	245		12.03	08.07				
	650 i	270		07.05	05.11				
	M6	373		06.05	05.11				
	630 i	190		07.04	08.07	24.2522-0905.3 040042		Nz 22,20	
	630 i	200		09.07	06.08				
	645 Ci	245		12.03	08.07				
	650 i	270		07.05	06.08				
BMW 6er Reihe/E64 Cabrio (04-11)									
	630 i	190		07.04	08.07	24.2026-1702.3 010850		Thz 26,99/22,20	TRW
	630 i	200		09.07	02.11				
	635 d	210		09.07	02.11				
	645 Ci	245		04.04	08.07				
	650 i	270		07.05	02.11				
	M6	373		07.06	02.11				
	630 i	190		07.04	08.07	11.9606-9979.2 220907 11.9606-9980.2 220908 24.3606-9979.5 240575 24.3606-9980.5 240576 11.0441-6008.2 250038 11.0101-6006.2 260098 11.8171-0008.1 990049 11.8171-0067.1 250153 11.8116-0315.2 390447	2	D=60, - Halter D=60, - Halter D=60, - Halter D=60, - Halter Dichtungssatz Hülsensatz Führungsbolzen Führungsbolzen Haltefeder	ATE ATE ATE ATE ATE ATE ATE ATE ATE



















									
BMW 6er Reihe/E64 Cabrio (04-11)									
	630 i	200		09.07	02.11	24.3606-9977.5	240573	D=60, - Halter D=60, - Halter Dichtungssatz Hülzensatz Führungsbolzen Führungsbolzen Haltefeder	ATE
	645 Ci	245		04.04	08.07	24.3606-9978.5	240574		ATE
						11.0441-6008.2	250038		ATE
	635 d	210		09.07	02.11	11.0101-6006.2	260098	Hülzensatz Führungsbolzen Haltefeder	ATE
	650 i	270		07.05	02.11	11.8171-0067.1	250153		ATE
						11.8116-0315.2	390447		ATE
	M6	373		07.06	02.11	11.0101-5706.2	260097	Hülzensatz Führungsbolzen Haltefeder	ATE
						11.8171-0067.1	250153		ATE
						11.8116-0353.2	390585		ATE
	630 i	190		07.04	08.07	83.6151-0552.3	330857	L=550	
	630 i	200		09.07	02.11				
	635 d	210		09.07	02.11				
	645 Ci	245		04.04	08.07				
	650 i	270		07.05	02.11				
	M6	373		07.06	02.11				
	630 i	190		07.04	08.07	24.3426-9977.5	240567	D=42, - Halter Dichtungssatz Hülzensatz Führungsbolzen Haltefeder	ATE
	630 i	200		09.07	02.11	11.0441-4203.2	250013		ATE
	635 d	210		09.07	02.11	11.0101-5402.2	260009		ATE
	645 Ci	245		04.04	08.07	11.8171-0008.1	990049		ATE
	650 i	270		07.05	02.11	11.8116-0296.1	390445		ATE
	M6	373		07.06	02.11	11.0101-5402.2	260009		Hülzensatz Führungsbolzen Haltefeder
	630 i	190		07.04	08.07	24.5102-0304.3	331407	L=304	
	630 i	200		09.07	02.11				
	635 d	210		09.07	02.11				
	645 Ci	245		04.04	08.07				
	650 i	270		07.05	02.11				
	M6	373		07.06	02.11				
	630 i	190		07.04	08.07	24.2522-0905.3	040042	Nz 22,20	
	645 Ci	245		04.04	08.07				
	650 i	270		07.05	08.07				
BMW 6er Reihe/F12 Cabrio (11-)									
	M6	412		06.12		24.4126-1703.3	010991	Thz 26,99	TRW
	M6	441		07.15					
	M6 Competition	423		02.14					
	640 d	230		06.11		11.8116-0007.2	390602	Haltefeder Hülzensatz Führungsbolzen Dichtungssatz	ATE
	640 d xDrive	230		03.12		11.0101-7003.2	260124		ATE
	640 i	235		03.11		11.8171-0096.1	250155		ATE
	640 i xDrive	235		01.13		11.0441-6008.2	250038		ATE
	650 i	300		03.11					
	650 i	330		10.11					
	650 i xDrive	300		06.11					
	650 i xDrive	330		09.12					
	640 d	230		06.11		24.5118-0688.3	331419	L=688	
	640 d xDrive	230		03.12					
	640 i	235		03.11					
	640 i xDrive	235		01.13					
	650 i	300		03.11					
	650 i	330		10.11					
	650 i xDrive	300		06.11					
	650 i xDrive	330		09.12					
	640 d	230		03.12		24.6244-1701.5	240717	D=44, - Halter D=44, - Halter	TRW
	640 d xDrive	230		03.12		24.6244-1702.5	240718		TRW
	640 i	235		03.11					
	640 i xDrive	235		01.13					
	650 i	300		03.11					
	650 i	330		10.11					
	650 i xDrive	300		06.11					
	650 i xDrive	330		09.12					
BMW 6er Reihe/F13 Coupe (11-)									
	M6	412		06.12		24.4126-1703.3	010991	Thz 26,99	TRW
	M6	441		07.15					
	M6 Competition	423		02.14					
	640 d	230		06.11		11.8116-0007.2	390602	Haltefeder Hülzensatz Führungsbolzen Dichtungssatz	ATE
	640 d xDrive	230		03.12		11.0101-7003.2	260124		ATE
	640 i	235		06.11		11.8171-0096.1	250155		ATE
	640 i xDrive	235		01.13		11.0441-6008.2	250038		ATE
	650 i	300		06.11					
	650 i	330		09.12					
	650 i xDrive	300		06.11					
	650 i xDrive	330		09.12					

1) - sport package / - pacchetto sportivo / - version sport / - kit deportivo

								
BMW 6er Reihe/F13 Coupe (11-)								
	640 d 640 d xDrive 640 i 640 i xDrive 650 i 650 i 650 i xDrive 650 i xDrive	230 230 235 235 300 330 300 330	06.11 03.12 06.11 01.13 06.11 09.12 06.11 09.12		24.5118-0688.3	331419	2	L=688
	640 d 640 d xDrive 640 i 640 i xDrive 650 i 650 i 650 i xDrive 650 i xDrive	230 230 235 235 300 330 300 330	06.11 03.12 06.11 01.13 06.11 09.12 06.11 09.12		24.6244-1701.5 24.6244-1702.5	240717 240718	<input type="checkbox"/> - Sportpaket ¹⁾ <input type="checkbox"/> - Sportpaket ¹⁾	D=44, - Halter D=44, - Halter TRW TRW
BMW 6er Reihe/F06 Gran Coupe (11-)								
	M6 M6 M6 Competition	412 441 423	12.12 07.15 02.14		24.4126-1703.3	010991		THz 26,99 TRW
	640 d 640 d xDrive 640 i 640 i xDrive 650 i 650 i xDrive	230 230 235 235 330 330	09.11 01.13 03.12 01.13 11.11 11.11		24.5118-0688.3	331419	2	L=688
	640 d 640 d xDrive 640 i 640 i xDrive 650 i 650 i xDrive	230 230 235 235 330 330	09.11 01.13 03.12 01.13 11.11 11.11		24.6244-1701.5 24.6244-1702.5	240717 240718	<input type="checkbox"/> - M Sportbremse ²⁾ <input type="checkbox"/> - M Sportbremse ²⁾	D=44, - Halter D=44, - Halter TRW TRW
BMW 7er Reihe/E38 (93-01)								
	725 tds 728 i 728 iL 730 i 730 iL 735 i 735 iL 740 i 740 iL 750 i 750 iL	105 142 142 173 173 210 210 240 240	05.96 08.97 07.95 08.97 01.96 08.97 07.93 08.97 05.94 08.97 01.96 08.97 01.96 08.97 07.93 08.97 05.94 08.97 11.93 08.97 01.94 08.97		24.2120-1721.3	010553		THz 20,64
	725 tds 728 i 728 iL 730 d 730 i 730 iL 735 i 735 iL 740 d 740 i 740 iL 750 i 750 iL	105 142 142 173 173 180 210 210 240 240	09.97 08.98 09.97 08.98 09.97 08.98 09.98 11.01 - DSC 09.97 08.98 09.97 08.98 09.97 08.98 05.99 11.01 - DSC 09.97 08.98 09.97 08.98 09.97 08.98		24.2025-1705.3	010624		THz 25,40/20,64 TRW
	725 tds 728 i 728 iL 730 d 730 i 730 iL 735 i 735 iL 740 d 740 i 740 iL 750 i 750 iL	105 142 142 173 173 180 210 210 240 240	09.98 11.01 09.98 11.01 09.98 11.01 09.98 11.01 + DSC 09.98 11.01 09.98 11.01 09.98 11.01 05.99 11.01 + DSC 09.98 11.01 09.98 11.01 09.98 11.01 09.98 11.01		24.2025-1704.3	010619		THz 25,40
	740 i 740 iL	210 210	07.93 11.01 05.94 11.01		24.3601-1713.5 24.3601-1714.5 11.0101-5402.2 11.8171-0008.1 11.8116-0290.2	240355 240356 260009 990049 390520	<input type="checkbox"/> <input type="checkbox"/>	D=60, - Halter D=60, - Halter Hülsensatz Führungsbolzen Haltefeder ATE ATE ATE ATE
	740 d 750 i 750 iL	180 240 240	05.99 11.01 11.93 11.01 01.94 11.01		11.0101-6004.2 11.8171-0008.1 11.8116-0133.1	260014 990049 390511	2 2	Hülsensatz Führungsbolzen Haltefeder ATE ATE ATE
	725 tds 728 i 728 iL 730 d 730 i 730 iL	105 142 142 	05.96 11.01 07.95 11.01 01.96 11.01 09.98 11.01 07.93 11.01 05.94 11.01		83.6235-0100.3 83.6204-0100.3 24.5169-0355.3	330463 330441 331307	<input type="checkbox"/> + ASC/ M12X1 <input type="checkbox"/> + ASC/ M10X1 am Bremsattel ³⁾	L=100 L=100 L=355

1) - sport package / - pacchetto sportivo / - version sport / - kit deportivo
2) - M sport brake / - M freno sportivo / - M frein de sport / - M freno deportiva
3) on the brake caliper / sulla pinza freno / sur l'étrier de frein / a la pinza de freno



										
BMW 7er Reihe/E38 (93-01)										
	735 i 735 iL 740 d 740 i 740 iL 750 i 750 iL	173 173 180 210 210 240 240		01.96 11.01 01.96 11.01 05.99 11.01 07.93 11.01 05.94 11.01 11.93 11.01 01.94 11.01		83.6235-0100.3 330463 83.6204-0100.3 330441 24.5169-0355.3 331307	2	+ ASC/ M12X1 + ASC/ M10X1 am Bremsattel ¹⁾	L=100 L=100 L=355	
	725 tds 728 i 728 iL 730 d 730 i 730 iL 735 i 735 iL 740 i 740 iL 740 d 750 i 750 iL	105 142 142 173 173 173 180 210 210 240 240		05.96 11.01 07.95 11.01 01.96 11.01 09.98 11.01 07.93 11.01 05.94 11.01 01.96 11.01 01.96 11.01 09.96 11.01 09.96 11.01 05.99 11.01 11.93 11.01 01.94 11.01		24.3401-9977.5 240523 24.3401-9978.5 240524 11.0441-4003.2 250001 11.0101-5402.2 260009 11.8171-0008.1 990049 11.8116-0094.1 390504	2		D=40, - Halter D=40, - Halter Dichtungssatz Hülzensatz Führungsbolzen Haltefeder	ATE ATE ATE ATE ATE
	725 tds 728 i 728 iL 730 d 730 i 730 iL 735 i 735 iL 740 d 740 i 740 iL 750 i 750 iL	105 142 142 173 173 173 180 210 210 240 240		05.96 11.01 07.95 11.01 01.96 11.01 09.98 11.01 07.93 11.01 05.94 11.01 01.96 11.01 01.96 11.01 05.99 11.01 07.93 11.01 05.94 11.01 11.93 11.01 01.94 11.01		83.6235-0100.3 330463 83.6204-0100.3 330441 24.5113-0283.3 331395	2	M12X1 M10X1 am Bremsattel ¹⁾	L=100 L=100 L=283	
	725 tds 728 i 728 iL 730 d 730 i 730 iL 735 i 735 iL 740 d 740 i 740 iL 750 i 750 iL	105 142 142 173 173 173 180 210 210 240 240		05.96 11.01 07.95 11.01 01.96 11.01 09.98 11.01 07.93 11.01 05.94 11.01 01.96 11.01 01.96 11.01 05.99 11.01 07.93 11.01 05.94 11.01 11.93 11.01 01.94 11.01		24.3727-0232.2 580232 24.3727-0239.2 580239			L=1265 L=1119	
	728 i 730 i 730 iL 735 i 740 i	142 173 210		07.95 04.96 07.93 11.01 05.94 11.01 01.96 08.96 07.93 08.96		24.2419-1717.3 030108			Gz 19,05	
	725 tds 728 i	105 142		05.96 08.97 05.96 08.97		24.2419-1710.3 030104			Gz 19,05	
	725 tds 728 i 730 i 730 iL 735 i 740 i	105 142 173 210		05.96 11.01 07.95 11.01 07.93 11.01 05.94 11.01 01.96 11.01 07.93 11.01		24.2522-0905.3 040042 24.2526-0902.3 040052			Nz 22,20 Nz 26,99	
BMW 7er Reihe/E65/E66 (02-08)										
	730 d 730 d,Ld 730 i,Li 730 i,Li 735 i,Li 740 d 740 i,Li 745 d 745 i,Li 750 i,Li 760 i,Li 730 i,Li	160 170 170 190 200 190 225 245 270 327 170		09.02 08.08 03.05 08.08 03.03 08.08 07.05 08.08 11.01 08.08 09.02 08.08 03.05 08.08 03.05 08.08 11.01 08.08 03.05 08.08 03.03 08.08 03.03 08.08		24.2026-1701.3 010746 24.2026-1705.3 010992			THz 26,99/20,64	
	730 d 730 i,Li 730 i,Li 735 i,Li	160 170 190 200		09.02 02.05 03.03 08.08 07.05 08.08 11.01 08.08		11.9606-9979.2 220907 11.9606-9980.2 220908 24.3606-9979.5 240575 24.3606-9980.5 240576 11.0441-6008.2 250038 11.0101-6006.2 260098 11.8171-0067.1 250153 11.8171-0008.1 990049 11.8116-0315.2 390447	2		D=60, - Halter D=60, - Halter D=60, - Halter D=60, - Halter Dichtungssatz Hülzensatz Führungsbolzen Führungsbolzen Haltefeder	ATE ATE ATE ATE ATE ATE ATE ATE

¹⁾ on the brake caliper / sulla pinza freno / sur l'étrier de frein / a la pinza de freno

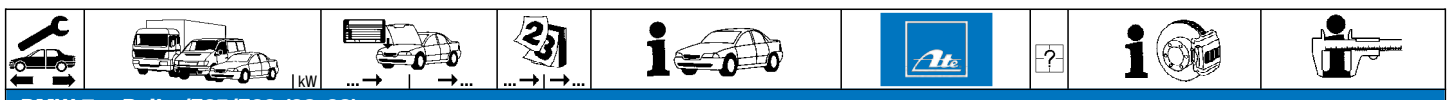

BMW 7er Reihe/E65/E66 (02-08)

	730 d,Ld	170		03.05	08.08		24.3606-9977.5	240573	2	D=60, - Halter D=60, - Halter Dichtungssatz Hülsensatz Führungsbolzen Führungsbolzen Haltefeder	ATE	
	740 d	190		09.02	08.08		24.3606-9978.5	240574			ATE	
	740 i,Li	225		03.05	08.08		11.0441-6008.2	250038			ATE	
	745 i,Li	245		11.01	08.08		11.0101-6006.2	260098			ATE	
	750 i,Li	270		03.05	08.08	- Europa 1)	11.8171-0067.1	250153			ATE	
	760 i,Li	327		03.03	08.08	- Europa 1)	11.8171-0008.1	990049			ATE	
							11.8116-0315.2	390447			ATE	
	745 d			03.05	08.08		11.0101-5706.2	260097			Hülsensatz	ATE
	760 i,Li	327		03.03	08.08	+ Europa 2)	11.8171-0067.1	250153			Führungsbolzen Haltefeder	ATE ATE
						11.8116-0353.2	390585	ATE				
	730 d	160		09.02	08.08		83.6150-0556.3	330712	2	L=555		
	730 d,Ld	170		03.05	08.08							
	730 i,Li	170		03.03	08.08							
	730 i,Li	190		07.05	08.08							
	735 i,Li	200		11.01	08.08							
	740 d	190		09.02	08.08							
	740 i,Li	225		03.05	08.08							
	745 d			03.05	08.08							
	745 i,Li	245		11.01	08.08							
	750 i,Li	270		03.05	08.08							
	760 i,Li	327		03.03	08.08							
	730 d	160		09.02	02.05		11.9461-9981.2	220899	2	D=46, - Halter D=46, - Halter D=46, - Halter D=46, - Halter Hülsensatz Führungsbolzen Haltefeder	ATE	
	730 i,Li	170		03.03	08.08		11.9461-9982.2	220900			ATE	
	730 i,Li	190		07.05	08.08		24.3461-9981.5	240569			ATE	
	735 i,Li	200		11.01	08.08		24.3461-9982.5	240570			ATE	
							11.0101-5402.2	260009			ATE	
							11.8171-0008.1	990049			ATE	
							11.8116-0296.1	390445			ATE	
	730 d,Ld	170		03.05	08.08		11.0230-0176.2	260088			Haltersatz	ATE
	740 d	190		09.02	08.08		11.0101-5402.2	260009			Hülsensatz	ATE
740 i,Li	225		03.05	08.08		11.8171-0008.1	990049	Führungsbolzen Haltefeder	ATE ATE			
745 i,Li	245		11.01	08.08		11.8116-0296.1	390445	ATE				
750 i,Li	270		03.05	08.08								
760 i,Li	327		03.03	08.08	- Europa 1)							
						11.0101-5402.2	260009	Hülsensatz	ATE			
						11.8171-0008.1	990049	Führungsbolzen Haltefeder	ATE ATE			
						11.8116-0296.1	390445	ATE				
	730 d	160		09.02	08.08		24.5102-0304.3	331407	2	L=304		
	730 d,Ld	170		03.05	08.08							
	730 i,Li	170		03.03	08.08							
	730 i,Li	190		07.05	08.08							
	735 i,Li	200		11.01	08.08							
	740 d	190		09.02	08.08							
	740 i,Li	225		03.05	08.08							
	745 d			03.05	08.08							
	745 i,Li	245		11.01	08.08							
	750 i,Li	270		03.05	08.08							
	760 i,Li	327		03.03	08.08							

BMW 7er Reihe/F01/F02/F03/F04 (08-15)

	730 d	180		09.08			24.2026-1702.3	010850	2	Thz 26,99/22,20	TRW
	730 d	190		06.12							
	730 d xDrive	190		06.12							
	730 i	190		09.08							
	740 d	225		09.09							
	740 d	230		06.12							
	740 d xDrive	225		09.10							
	740 d xDrive	230		06.12							
	740 i	235		06.12							
	740 i	240		09.08							
	740 i,Li xDrive	235		07.12							
	750 d xDrive	280		06.12							
	750 i	300		09.08							
	750 i	330		06.12							
	750 i xDrive	300		09.09							
	750 i xDrive	330		10.12							
760 i	400		09.09								
	730 d	180		09.08			11.0441-6008.2	250038	2	Dichtungssatz Hülsensatz Führungsbolzen Haltefeder	ATE
	730 d	190		06.12			11.0101-7003.2	260124			ATE
	730 d xDrive	190		06.12			11.8171-0096.1	250155			ATE
	730 i	190		09.08			11.8116-0007.2	390602			ATE
	740 d	225		09.09							
	740 d	230		06.12							
	740 d xDrive	225		09.10							
	740 d xDrive	230		06.12							
	740 i	235		06.12							
	740 i	240		09.08							
	740 i,Li xDrive	235		07.12							
ActiveHybrid 7	260		06.12								
ActiveHybrid 7	342		03.10		- Hochgeschwindigkeitsbremsanlage 3)						
750 i	300		09.08		- verstärkte Bremse 4)	11.0441-6008.2	250038	Dichtungssatz	ATE		
750 i	330		06.12		- verstärkte Bremse 4)	11.0101-7003.2	260124	Hülsensatz	ATE		
750 i xDrive	300		09.09		- verstärkte Bremse 4)	11.8171-0096.1	250155	Führungsbolzen	ATE		
750 i xDrive	330		10.12		- verstärkte Bremse 4)	11.8116-0007.2	390602	Haltefeder	ATE		

1) - Europe / - Europa / - Europe / - Europa

2) + Europe / + Europa / + Europe / + Europa

3) - high-speed brake system / - impianto fr.ad alta velocità / - système fr. à haute vitesse / - sistema fr.para alta velocità.













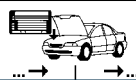





4) - heavy duty brake / - freno rinforzato / - frein renforcé / - freno reforzado



BMW 7er Reihe/F01/F02/F03/F04 (08-15)												
	750 d xDrive	280	06.12			+ verstärkte Bremse ¹⁾	11.0441-6008.2	250038			Dichtungssatz Hülensatz Führungsbolzen Haltefeder	ATE ATE ATE ATE
	750 i	300	09.08			+ verstärkte Bremse ¹⁾	11.0101-7003.2	260124				
	750 i	330	06.12			+ verstärkte Bremse ¹⁾	11.8171-0096.1	250155				
	750 i xDrive	300	09.09			+ verstärkte Bremse ¹⁾	11.8116-0008.2	390603	2			
	750 i xDrive	330	10.12			+ verstärkte Bremse ¹⁾						
	760 i	400	09.09									
	ActiveHybrid 7	342	03.10			+ verstärkte Bremse ¹⁾						
	730 d	180	09.08				24.5118-0688.3	331419	2		L=688	
	730 d	190	06.12									
	730 d xDrive	190	06.12									
	730 i	190	09.08									
	740 d	225	09.09									
	740 d	230	06.12									
	740 d xDrive	225	09.10									
	740 d xDrive	230	06.12									
	740 i	235	06.12									
	740 i	240	09.08									
	740 i, Li xDrive	235	07.12									
	750 d xDrive	280	06.12									
	750 i	300	09.08									
	750 i	330	06.12									
	750 i xDrive	300	09.09									
750 i xDrive	330	10.12										
760 i	400	09.09										
	ActiveHybrid 7	260	06.12									
	ActiveHybrid 7	342	03.10									
	730 d	180	09.08				11.8171-0008.1	990049	2		Führungsbolzen Haltefeder	ATE ATE
	730 d	190	06.12				11.8116-0296.1	390445				
	730 d xDrive	190	06.12									
	730 i	190	09.08									
	740 d	225	09.09									
	740 d	230	06.12									
	740 d xDrive	225	09.10									
	740 d xDrive	230	06.12									
	740 i	235	06.12									
	740 i	240	09.08									
	740 i, Li xDrive	235	07.12									
	ActiveHybrid 7	260	06.12									
	750 i	300	09.08	11.08			11.8171-0008.1	990049	2		Führungsbolzen Haltefeder	ATE ATE
							11.8116-0296.1	390445				
	750 d xDrive	280	06.12				11.8171-0008.1	990049	2		Führungsbolzen Haltefeder	ATE ATE
	750 i	300	12.08				11.8116-0296.1	390445				
	750 i	330	06.12									
	750 i xDrive	300	09.09									
	750 i xDrive	330	10.12									
	760 i	400	09.09									
	ActiveHybrid 7	342	03.10									

BMW 8er Reihe/E31 (90-99)													
	840 Ci	210	01.96	08.99			10.0522-4005.1	340029			Warnschalter M10x1 Warnschalter M12x1 Hydraulikspeicher	ATE	
	840 i	210	02.93	02.96			10.0522-4002.1	340028					
	850 Ci	240	09.94	12.99			10.0515-9002.3	340026					
	850 CSi	280	09.92	10.96			10.0522-4005.1	340029			Warnschalter M10x1 Warnschalter M12x1 Hydraulikspeicher	ATE	
	850 i/Ci	220	04.90	10.94			10.0522-4002.1	340028					
							10.0515-9002.3	340026					
	840 i	210	02.93	02.94			11.3601-8512.2	220156			D-60, - Halter Dichtungssatz Hülensatz Führungsbolzen Haltefeder	ATE ATE ATE ATE	
	850 Ci	240	09.94	12.99			11.0441-6003.2	250037					
	850 i/Ci	220	04.90	02.94			11.0101-5402.2	260009					
							11.8171-0008.1	990049					
	840 Ci	210	01.96	08.99			24.5113-0423.3	331396	2	<input checked="" type="checkbox"/> + ASC/ M12X1 <input checked="" type="checkbox"/> + ASC/ M10X1	L=423 L=100 L=100		
	840 i	210	02.93	02.96			83.6235-0100.3	330463					
	850 Ci	240	09.94	12.99			83.6204-0100.3	330441					
	850 CSi	280	09.92	10.96									
	850 i/Ci	220	04.90	10.94									
	840 Ci	210	01.96	08.99			11.0441-4002.2	250011	2		Dichtungssatz Hülensatz Führungsbolzen Haltefeder	ATE ATE ATE ATE	
	840 i	210	02.93	02.96			11.0101-5402.2	260009					
	850 Ci	240	09.94	12.99			11.8171-0008.1	990049					
	850 i/Ci	220	04.90	10.94			11.8116-0094.1	390504					
	850 CSi	280	09.92	10.96			11.0441-4002.2	250011					
	840 Ci	210	01.96	08.99			83.6235-0100.3	330463	2	<input checked="" type="checkbox"/> + ASC/ M12X1 <input checked="" type="checkbox"/> + ASC/ M10X1 am Bremsattel ²⁾	L=100 L=100 L=200		
	840 i	210	02.93	02.96			83.6204-0100.3	330441					
	850 Ci	240	09.94	12.99			83.7704-0200.3	330825					
	850 i/Ci	220	04.90	10.94									
	850 CSi	280	09.92	10.96			83.7724-0204.3	331206	2		L=200		
	840 Ci	210	01.96	08.99			24.2419-0922.3	030051			Gz 19,05		
	840 i	210	02.93	02.96									
	850 Ci	240	09.94	12.99									
	850 CSi	280	09.92	10.96									
	850 i/Ci	220	04.90	10.94									

¹⁾ + heavy duty brake / + freno rinforzato / + frein renforcé / + freno reforzado
²⁾ on the brake caliper / sulla pinza freno / sur l'étrier de frein / a la pinza de freno

										
BMW 8er Reihe/E31 (90-99)										
	840 Ci	210		01.96	08.99	24.2526-0902.3	040052		Nz 26,99	
	840 i	210		02.93	02.96					
	850 Ci	240		09.94	12.99					
	850 CSi	280		09.92	10.96					
	850 i/Ci	220		04.90	10.94					
	850 Ci	▶240		09.94	12.99	24.5905-0320.3	330058		L=320	
	850 CSi	▶280		09.92	10.96					
	850 i/Ci	▶220		04.90	10.94					
BMW X1/E84 (09-)										
	sDrive 16 d	85		07.12		03.7845-0103.4	300268	- Start/Stop-Anlage ¹⁾	8"	ATE
	sDrive 18 d	105		10.09						
	sDrive 18 i	110		03.10						
	sDrive 20 d	130		10.09						
	sDrive 20 d	135		07.12						
	sDrive 20 d ed	120		03.10						
	sDrive 20 i	135		09.11						
	xDrive 18 d	105		10.09						
	xDrive 20 d	130		10.09						
	xDrive 20 d	135		07.12						
	xDrive 20 i	135		09.11						
	xDrive 25 i	160		03.10						
	xDrive 28 i	180		04.11						
	xDrive 28 i	190		10.09						
	xDrive 23 d	150		10.09		03.7848-5003.4	300236	- Start/Stop-Anlage ¹⁾	8"	ATE
	sDrive 16 i	105		03.13		03.7845-0103.4	300268	+ Automatikgetriebe ²⁾	8"	ATE
	xDrive 25 d	160		07.12						
		sDrive 16 d	◀ 85		07.12		03.2025-1904.3	010797		THz 25,40/22,20
sDrive 16 i		◀ 105		03.13						
sDrive 18 d		◀ 105		10.09						
sDrive 18 i		◀ 110		03.10						
sDrive 20 d		◀ 130		10.09						
sDrive 20 d		◀ 135		07.12						
sDrive 20 d ed		◀ 120		03.10						
sDrive 20 i		◀ 135		09.11						
xDrive 18 d		◀ 105		10.09						
xDrive 20 d		◀ 130		10.09						
xDrive 20 d		◀ 135		07.12						
xDrive 20 i		◀ 135		09.11						
xDrive 23 d		◀ 150		10.09						
xDrive 25 d		◀ 160		07.12						
xDrive 25 i		◀ 160		03.10						
xDrive 28 i		◀ 180		04.11						
xDrive 28 i		◀ 190		10.09						
		sDrive 16 d	85		07.12		11.9571-9753.2	220929		D=57, - Halter
	sDrive 16 i	105		03.13		11.9571-9754.2	220930		D=57, - Halter	ATE
	sDrive 18 d	105		10.09		11.0101-5402.2	260009		Hülsensatz	ATE
	sDrive 18 i	110		03.10		11.8171-0008.1	990049		Führungsbolzen	ATE
	sDrive 20 d	130		10.09		11.8116-0339.2	390528	2	Haltefeder	ATE
	sDrive 20 d	135		07.12						
	sDrive 20 d ed	120		03.10						
	sDrive 20 i	135		09.11						
	xDrive 18 d	105		10.09						
	xDrive 20 d	130		10.09						
	xDrive 20 d	135		07.12						
	xDrive 20 i	135		09.11						
	xDrive 23 d	150		10.09	02.12	11.0101-5402.2	260009		Hülsensatz	ATE
	xDrive 25 i	160		03.10	02.12	11.8171-0008.1	990049		Führungsbolzen	ATE
	xDrive 28 i	180		04.11	02.12	11.8116-0339.2	390528	2	Haltefeder	ATE
	xDrive 28 i	190		10.09		11.0101-6006.2	260098		Hülsensatz	ATE
						11.8171-0008.1	990049		Führungsbolzen	ATE
						11.8171-0067.1	250153		Führungsbolzen	ATE
					11.8116-0315.2	390447	2	Haltefeder	ATE	
xDrive 23 d	150		03.12		11.9571-9753.2	220929		D=57, - Halter	ATE	
xDrive 25 d	160		07.12		11.9571-9754.2	220930		D=57, - Halter	ATE	
xDrive 25 i	160		03.12		11.0101-5402.2	260009		Hülsensatz	ATE	
xDrive 28 i	180		03.12		11.8171-0008.1	990049		Führungsbolzen	ATE	
					11.8116-0339.2	390528	2	Haltefeder	ATE	
	sDrive 16 d	85		07.12		24.5125-0555.3	331348	2	L=555	
	sDrive 16 i	105		03.13						
	sDrive 18 d	105		10.09						
	sDrive 18 i	110		03.10						
	sDrive 20 d	130		10.09						
	sDrive 20 d	135		07.12						
	sDrive 20 d ed	120		03.10						
	sDrive 20 i	135		09.11						
	xDrive 18 d	105		10.09		24.5169-0475.3	331497	2	L=475	
	xDrive 20 d	130		10.09						
	xDrive 20 d	135		07.12						
	xDrive 20 i	135		09.11						
	xDrive 23 d	150		10.09						
	xDrive 25 d	160		07.12						
	xDrive 25 i	160		03.10						
	xDrive 28 i	180		04.11						
	xDrive 28 i	190		10.09						

¹⁾ - idling stop system / - dispositivo start/stop / - unité marche/arrêt / - unidad arranque/paro

²⁾ + autom.transmission / + scatola cambio automatico / + transmission automatique / + cambio automático







































BMW X1/E84 (09-)											
	sDrive 16 d	85		07.12		11.9421-9911.2	220825				
	sDrive 16 i	105		03.13		11.9421-9912.2	220826				
	sDrive 18 d	105		10.09		11.8170-0755.1	260119	2			
	sDrive 18 i	110		03.10		11.0101-5402.2	260009				
	sDrive 20 d	130		10.09		11.8171-0008.1	990049				
	sDrive 20 d	135		07.12		11.8116-0066.1	390577	2			
	sDrive 20 d ed	120		03.10							
	sDrive 20 i	135		09.11							
	xDrive 18 d	105		10.09							
	xDrive 20 d	130		10.09							
	xDrive 20 d	135		07.12							
	xDrive 20 i	135		09.11							
	xDrive 23 d	150		10.09							
	xDrive 25 d	160		07.12							
	xDrive 25 i	160		03.10							
	xDrive 28 i	180		04.11							
	xDrive 28 i	190		10.09							
							11.9441-9957.2	220827			D=42, - Halter
							24.3441-9958.5	240672			D=44, - Halter
						11.0101-5402.2	260009			Hülzensatz	
						11.8171-0008.1	990049			Führungsbolzen	
						11.8116-0296.1	390445			Haltefeder	
	sDrive 16 d	85		07.12		83.7850-0180.3	331054	2			
	sDrive 16 i	105		03.13		24.5137-0221.3	331302	2		am Bremsattel ¹⁾	
	sDrive 18 d	105		10.09		24.5125-0230.3	331277	2		am Bremsattel ¹⁾	
	sDrive 18 i	110		03.10							
	sDrive 20 d	130		10.09							
	sDrive 20 d	135		07.12							
	sDrive 20 d ed	120		03.10							
	sDrive 20 i	135		09.11							
	xDrive 18 d	105		10.09							
	xDrive 20 d	130		10.09							
	xDrive 20 d	135		07.12							
	xDrive 20 i	135		09.11							
	xDrive 23 d	150		10.09							
	xDrive 25 d	160		07.12							
	xDrive 25 i	160		03.10							
	xDrive 28 i	180		04.11							
	xDrive 28 i	190		10.09							
		sDrive 16 d	85		07.12		24.2419-1713.3	030093			
		sDrive 16 i	105		03.13						
sDrive 18 d		105		10.09							
sDrive 18 i		110		03.10							
sDrive 20 d		130		10.09							
sDrive 20 d		135		07.12							
sDrive 20 d ed		120		03.10							
sDrive 20 i		135		09.11							
xDrive 18 d		105		10.09							
xDrive 20 d		130		10.09							
xDrive 20 d		135		07.12							
xDrive 20 i		135		09.11							
xDrive 23 d		150		10.09							
xDrive 25 d		160		07.12							
xDrive 25 i		160		03.10							
xDrive 28 i		180		04.11							
xDrive 28 i		190		10.09							













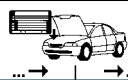



BMW X3/E83 (03-10)										
	2.0 d	110		08.04	08.10	24.2025-1710.3	010833			
	2.0 d	130		09.07	08.10					
	2.0 i	110		07.05	08.10					
	2.5 i	141		03.04	08.06					
	2.5 si	160		09.06	08.10					
	3.0 d	150		10.03	08.06					
	3.0 d	160		01.04	08.10					
	3.0 i	170		10.03	08.06					
	3.0 sd	210		09.06	08.10					
	3.0 si	200		09.06	08.10					
	xDrive 18 d	105		09.08	08.10					
	xDrive 20 d	120		09.08	08.10					
	xDrive 20 d	130		09.08	08.10					
	xDrive 20 i	110		09.08	08.10					
	xDrive 25 i	160		09.08	08.10					
	xDrive 30 d	155		09.08	08.10					
	xDrive 30 d	160		09.08	08.10					
	xDrive 30 i	200		09.08	08.10					
	xDrive 35 d	210		09.08	08.10					
	2.0 d	110		08.04	08.10	24.3571-1733.5	240349			
	2.0 d	130		09.07	08.10	24.3571-1734.5	240350			
	2.0 i	110		07.05	08.10	11.0101-5402.2	260009			
	2.5 i	141		03.04	08.06	11.8171-0008.1	990049			
	2.5 si	160		09.06	08.10	11.8116-0273.1	390515	2		
	3.0 d	150		10.03	08.06					
	3.0 d	160		01.04	08.10					
	3.0 i	170		10.03	08.06					
	3.0 si	200		09.06	08.10					
	xDrive 18 d	105		09.08	08.10					
	xDrive 20 d	120		09.08	08.10					

¹⁾ on the brake caliper / sulla pinza freno / sur l'étrier de frein / a la pinza de freno

								
BMW X3/E83 (03-10)								
	xDrive 20 d xDrive 20 i xDrive 25 i xDrive 30 d xDrive 30 d xDrive 30 i	130 110 160 155 160 200		09.08 08.10 09.08 08.10 09.08 08.10 09.08 08.10 09.08 08.10 09.08 08.10		24.3571-1733.5 240349 24.3571-1734.5 240350 11.0101-5402.2 260009 11.8171-0008.1 990049 11.8116-0273.1 390515	2	D=57, - Halter D=57, - Halter Hülensatz Führungsbolzen Haltefeder ATE ATE ATE ATE ATE
	3.0 sd xDrive 35 d	210 210		09.06 08.10 09.08 08.10		24.3601-1713.5 240355 24.3601-1714.5 240356 11.8170-0530.1 260115 11.0441-6007.2 250146 11.0101-5402.2 260009 11.8171-0008.1 990049 11.8116-0290.2 390520	2	D=60, - Halter D=60, - Halter Halter Dichtungssatz Hülensatz Führungsbolzen Haltefeder ATE ATE ATE ATE ATE
	2.0 d 2.0 d 2.0 i 2.5 i 2.5 si 3.0 d 3.0 d 3.0 i 3.0 i 3.0 si xDrive 18 d xDrive 20 d xDrive 20 d xDrive 20 i xDrive 25 i xDrive 30 d xDrive 30 d xDrive 30 i	110 130 110 141 160 150 160 170 170 200 105 120 130 110 160 155 160 200		08.04 08.10 09.07 08.10 07.05 08.10 03.04 08.06 09.06 08.10 10.03 08.06 01.04 08.10 10.03 08.06 09.06 08.10 09.08 08.10 09.08 08.10 09.08 08.10 09.08 08.10 09.08 08.10 09.08 08.10 09.08 08.10 09.08 08.10		83.7751-0520.3 331052	2	L=520
	3.0 sd xDrive 35 d	210 210		09.06 08.10 09.08 08.10		83.7751-0553.3 331103	2	L=550
	2.0 d 2.0 d 2.0 i 2.5 i 2.5 si 3.0 d 3.0 d 3.0 i 3.0 sd 3.0 si xDrive 18 d xDrive 20 d xDrive 20 d xDrive 20 i xDrive 25 i xDrive 30 d xDrive 30 d xDrive 30 i xDrive 35 d	110 130 110 141 160 150 160 170 210 200 105 120 130 110 160 155 160 200 210		08.04 08.10 09.07 08.10 07.05 08.10 03.04 08.06 09.06 08.10 10.03 08.06 01.04 08.10 10.03 08.06 09.06 08.10 09.06 08.10 09.08 08.10 09.08 08.10 09.08 08.10 09.08 08.10 09.08 08.10 09.08 08.10 09.08 08.10 09.08 08.10		24.3421-1706.5 240354 11.0101-5402.2 260009 11.8171-0008.1 990049 11.8116-0296.1 390445	2	D=42, - Halter Hülensatz Führungsbolzen Haltefeder ATE ATE ATE ATE
	2.0 d 2.0 d 2.0 i 2.5 i 2.5 si 3.0 d 3.0 d 3.0 i 3.0 sd 3.0 si xDrive 18 d xDrive 20 d xDrive 20 d xDrive 20 i xDrive 25 i xDrive 30 d xDrive 30 d xDrive 30 i xDrive 35 d	110 130 110 141 160 150 160 170 210 200 105 120 130 110 160 155 160 200 210		08.04 08.10 09.07 08.10 07.05 08.10 03.04 08.06 09.06 08.10 10.03 08.06 01.04 08.10 10.03 08.06 09.06 08.10 09.06 08.10 09.08 08.10 09.08 08.10 09.08 08.10 09.08 08.10 09.08 08.10 09.08 08.10 09.08 08.10 09.08 08.10		83.7750-0513.3 331051	2	L=513
	2.0 d 2.0 d 2.0 i 2.5 i 2.5 si 3.0 d 3.0 d 3.0 i 3.0 sd 3.0 si xDrive 18 d xDrive 20 d xDrive 20 d xDrive 20 i xDrive 25 i xDrive 30 d xDrive 30 d xDrive 30 d	110 130 110 141 160 150 160 170 210 200 105 120 130 110 160 155 160 160		08.04 08.10 09.07 08.10 07.05 08.10 03.04 08.06 09.06 08.10 10.03 08.06 01.04 08.10 10.03 08.06 09.06 08.10 09.06 08.10 09.08 08.10 09.08 08.10 09.08 08.10 09.08 08.10 09.08 08.10 09.08 08.10 09.08 08.10		24.3727-0235.2 580235 24.3727-0238.2 580238		L=1613 L=1634



















									
BMW X3/E83 (03-10)									
	xDrive 30 i xDrive 35 d	200 210		09.08 09.08	08.10 08.10	24.3727-0235.2 24.3727-0238.2	580235 580238	<input type="checkbox"/> <input type="checkbox"/>	L=1613 L=1634
	2.0 d 2.0 d 2.0 i 2.5 i 2.5 si 3.0 d 3.0 d 3.0 i 3.0 si xDrive 18 d xDrive 20 d xDrive 20 d xDrive 20 i xDrive 25 i xDrive 30 d xDrive 30 d xDrive 30 i	110 130 110 141 160 150 160 170 200 105 120 130 110 160 155 160 200		08.04 09.07 07.05 03.04 09.06 10.03 01.04 10.03 09.06 09.08 09.08 09.08 09.08 09.08 09.08 09.08	08.10 08.10 08.10 08.06 08.10 08.06 08.10 08.06 08.10 08.10 08.10 08.10 08.10 08.10 08.10 08.10	24.2419-1713.3	030093	<input type="checkbox"/>	Gz 19,05
	2.0 d 2.0 d 2.0 i 2.5 i 2.5 si 3.0 d 3.0 d 3.0 i 3.0 si	110 130 110 141 160 150 160 170 200		08.04 09.07 07.05 03.04 09.06 10.03 01.04 10.03 09.06	02.08 02.08 02.08 08.06 02.08 08.06 02.08 08.06 08.06	24.2522-1705.3	040079	<input type="checkbox"/>	Nz 22,20
BMW X5/E53 (00-07)									
	3.0 d 3.0 i 4.4 i	135 170 210		05.01 04.00 04.00	08.01 08.01 08.01	24.2025-1704.3	010619	<input type="checkbox"/>	Thz 25,40
	3.0 d 3.0 d 3.0 i 4.4 i 4.4 i 4.6 iS 4.8 iS	135 160 170 210 235 255 265		09.01 10.03 09.01 09.01 10.03 12.01 03.04	09.03 12.06 12.06 12.06 12.06 09.03 12.06	24.2025-1707.3	010691	<input type="checkbox"/>	Thz 25,40
	3.0 d 3.0 d 3.0 i 4.4 i 4.4 i	135 160 170 210 235		05.01 10.03 04.00 04.00 10.03	09.03 10.05 10.05 09.03 10.05	24.3601-1713.5 24.3601-1714.5 11.8170-0530.1 11.0441-6003.2 11.0101-5402.2 11.8171-0008.1 11.8116-0290.2	240355 240356 260115 250037 260009 990049 390520	<input checked="" type="checkbox"/> <input checked="" type="checkbox"/> <input type="checkbox"/> <input type="checkbox"/> <input type="checkbox"/> <input type="checkbox"/> <input type="checkbox"/>	D=60, - Halter D=60, - Halter Halter Dichtungssatz Hülzensatz Führungsbolzen Haltefeder ATE ATE ATE ATE ATE ATE ATE
	3.0 d 3.0 i 4.4 i	160 170 235		11.05 11.05 11.05	12.06 12.06 12.06	24.3601-1713.5 24.3601-1714.5 11.8170-0530.1 11.0441-6007.2 11.0101-5402.2 11.8171-0008.1 11.8116-0290.2	240355 240356 260115 250146 260009 990049 390520	<input checked="" type="checkbox"/> <input checked="" type="checkbox"/> <input type="checkbox"/>	D=60, - Halter D=60, - Halter Halter Dichtungssatz Hülzensatz Führungsbolzen Haltefeder ATE ATE ATE ATE ATE
	4.4 i 4.6 iS 4.8 iS	235 255 265		10.03 12.01 03.04	12.06 09.03 12.06	11.0101-5706.2 11.8171-0067.1 11.8116-0334.2	260097 250153 390475	<input type="checkbox"/> <input type="checkbox"/> <input type="checkbox"/>	Hülzensatz Führungsbolzen Haltefeder ATE ATE ATE
	3.0 d 3.0 d 3.0 i 4.4 i 4.4 i 4.6 iS 4.8 iS	135 160 170 210 235 255 265		05.01 10.03 04.00 04.00 10.03 12.01 03.04	09.03 12.06 12.06 09.03 12.06 09.03 12.06	83.6150-0481.3	330542	<input type="checkbox"/> <input type="checkbox"/> <input type="checkbox"/> <input type="checkbox"/> <input type="checkbox"/> <input type="checkbox"/> <input type="checkbox"/>	L=480
	3.0 d 3.0 d 3.0 i 4.4 i	135 160 170 210		05.01 10.03 04.00 04.00	09.03 12.06 12.06 09.03	11.9421-9963.2 11.9421-9964.2 11.0230-0119.2 11.0101-5402.2 11.8171-0008.1 11.8116-0296.1	220465 220466 260089 260009 990049 390445	<input checked="" type="checkbox"/> <input checked="" type="checkbox"/> <input type="checkbox"/> <input type="checkbox"/> <input type="checkbox"/> <input type="checkbox"/>	D=42, - Halter D=42, - Halter Haltersatz Hülzensatz Führungsbolzen Haltefeder ATE ATE ATE ATE ATE ATE
	4.4 i 4.6 iS 4.8 iS	235 255 265		10.03 12.01 03.04	12.06 09.03 12.06	24.3421-9937.5 24.3421-9938.5 11.9421-9937.2 11.9421-9938.2 11.0101-5402.2 11.8171-0008.1 11.8116-0296.1	240563 240564 220909 220910 260009 990049 390445	<input checked="" type="checkbox"/> <input checked="" type="checkbox"/> <input checked="" type="checkbox"/> <input checked="" type="checkbox"/> <input type="checkbox"/> <input type="checkbox"/> <input type="checkbox"/>	D=42, - Halter D=42, - Halter D=42, - Halter D=42, - Halter Hülzensatz Führungsbolzen Haltefeder ATE ATE ATE ATE ATE
	3.0 d 3.0 d 3.0 i 4.4 i 4.4 i 4.6 iS 4.8 iS	135 160 170 210 235 255 265		05.01 10.03 04.00 04.00 10.03 12.01 03.04	09.03 12.06 12.06 09.03 12.06 09.03 12.06	24.5157-0272.3 24.5157-0273.3	331304 331305	<input checked="" type="checkbox"/> <input checked="" type="checkbox"/> <input type="checkbox"/> <input type="checkbox"/> <input type="checkbox"/> <input type="checkbox"/> <input type="checkbox"/>	L=570, + Rohrleitung L=570, + Rohrleitung

1) - special vehicles / - veicoli speciali / - vehicule special / - vehiculo especial
2) + special vehicles / + veiculo speciale / + vehicule special / + vehiculo especial























									
BMW X5/E53 (00-07)									
	3.0 d	135	05.01	09.03	24.3727-0231.2	580231	2 ↓	L=1942	
	3.0 d	160	10.03	12.06					
	3.0 i	170	04.00	12.06					
	4.4 i	210	04.00	09.03					
	4.4 i	235	10.03	12.06					
	4.6 iS	255	12.01	09.03					
	4.8 iS	265	03.04	12.06					
	3.0 d	135	05.01	09.03	24.2419-1713.3	030093		Gz 19,05	
	3.0 d	160	10.03	12.06					
	3.0 i	170	04.00	12.06					
	3.0 d	135	05.01	09.03	24.2522-0905.3	040042		Nz 22,20	
	3.0 d	160	10.03	12.06					
	3.0 i	170	04.00	12.06					
BMW X5/E70 (07-13)									
	3.0 d	173	01.07	07.13	24.2026-1703.3	010910		Thz 26,99/22,20 TRW	
	3.0 sd	210	09.07	09.08					
	3.0 si	200	01.07	07.13					
	4.8 i	261	01.07	07.13					
	M	408	09.09	07.13					
	M 50 d	280	06.12	07.13					
	xDrive 30 d	173	09.08	07.13					
	xDrive 30 d	180	09.10	07.13					
	xDrive 30 i	200	09.08	07.13					
	xDrive 35 d	210	09.08	07.13					
	xDrive 35 i	225	09.10	07.13					
	xDrive 40 d	225	09.10	07.13					
	xDrive 48 i	261	09.08	07.13					
	xDrive 50 i	300	03.10	07.13					
	3.0 d	173	01.07	07.13	11.0441-6008.2	250038		Dichtungssatz ATE	
	3.0 sd	210	10.08	07.13	11.0101-5402.2	260009		Hülsensatz ATE	
	4.8 i	261	01.07	07.13	11.8171-0008.1	990049		Führungsbolzen ATE	
	xDrive 35 d	210	09.08	07.13					
	xDrive 35 i	225	09.10	07.13					
	xDrive 40 d	225	09.10	07.13					
	xDrive 48 i	261	09.08	07.13					
	3.0 si	200	01.07	07.13	11.0441-6008.2	250038		Dichtungssatz ATE	
	xDrive 30 d	173	09.08	07.13	11.0101-5402.2	260009		Hülsensatz ATE	
	xDrive 30 d	180	09.10	07.13	11.8171-0008.1	990049		Führungsbolzen ATE	
	xDrive 30 i	200	09.08	07.13					
	3.0 sd	210	09.07	09.08	11.0101-7003.2	260124		Hülsensatz ATE	
	4.8 i	261	01.07	07.13	11.8171-0096.1	250155		Führungsbolzen ATE	
	xDrive 48 i	261	09.08	07.13					
	xDrive 50 i	300	03.10	07.13					
			+ gepanzerte Fahrzeuge ¹⁾						
	3.0 d	173	01.07	07.13	83.6151-0602.3	330893	2	L=600	
	3.0 sd	210	09.07	09.08					
	3.0 si	200	01.07	07.13					
	4.8 i	261	01.07	07.13					
	M	408	09.09	07.13					
	M 50 d	280	06.12	07.13					
	xDrive 30 d	173	09.08	07.13					
	xDrive 30 d	180	09.10	07.13					
	xDrive 30 i	200	09.08	07.13					
	xDrive 35 d	210	09.08	07.13					
	xDrive 35 i	225	09.10	07.13					
	xDrive 40 d	225	09.10	07.13					
	xDrive 48 i	261	09.08	07.13					
	xDrive 50 i	300	03.10	07.13					
	3.0 d	173	01.07	07.13	11.0101-5402.2	260009	2	Hülsensatz ATE	
	3.0 sd	210	10.09	07.13	11.8171-0008.1	990049		Führungsbolzen ATE	
	3.0 si	200	01.07	07.13	11.8116-0330.1	390472		Haltefeder ATE	
	xDrive 30 d	173	09.08	07.13					
	xDrive 30 d	180	09.10	07.13					
	xDrive 30 i	200	09.08	07.13					
	xDrive 35 d	210	09.08	07.13					
	xDrive 35 i	225	09.10	07.13					
	xDrive 40 d	225	09.10	07.13					
	3.0 sd	210	09.07	09.09	11.0101-5402.2	260009		Hülsensatz ATE	
	4.8 i	261	01.07	07.13	11.8171-0008.1	990049		Führungsbolzen ATE	
	M 50 d	280	06.12	07.13	11.8116-0330.1	390472	2	Haltefeder ATE	
	xDrive 48 i	261	09.08	07.13					
	xDrive 50 i	300	03.10	07.13					
	3.0 d	173	01.07	04.07	83.6255-0200.3	330896	2	L=200	
	3.0 si	200	01.07	04.07	83.6150-0436.3	330890	2	L=435	
	4.8 i	261	01.07	04.07					
	3.0 d	173	05.07	07.13	83.7850-0205.3	331115	2	L=205	
	3.0 sd	210	09.07	09.08	83.7827-0245.3	331113		L=245	
	3.0 si	200	05.07	07.13	83.6150-0436.3	330890	2	L=435	
	4.8 i	261	05.07	07.13					
	M	408	09.09	07.13					
	M 50 d	280	06.12	07.13					
	xDrive 30 d	173	09.08	07.13					
	xDrive 30 d	180	09.10	07.13					
	xDrive 30 i	200	09.08	07.13					
	xDrive 35 d	210	09.08	07.13					
	xDrive 35 i	225	09.10	07.13					
			am Bremsattel ²⁾						

¹⁾ + armoured vehicles / + veicoli blindati / + véhicule blindé / + vehículo blindado

²⁾ on the brake caliper / sulla pinza freno / sur l'étrier de frein / a la pinza de freno

















								
BMW X5/E70 (07-13)								
	xDrive 40 d xDrive 48 i xDrive 50 i	225 261 300	09.10 09.08 03.10	07.13 07.13 07.13	83.7850-0205.3 83.7827-0245.3 83.6150-0436.3	331115 331113 330890	2 am Bremsattel ¹⁾	L=205 L=245 L=435
BMW X5/F15 (13-)								
	M M 50 d sDrive 25 d sDrive 25 d xDrive 25 d xDrive 25 d xDrive 30 d xDrive 35 i xDrive 40 d xDrive 50 i	423 280 160 170 160 170 190 225 230 330	12.14 08.13 08.13 07.15 08.13 07.15 08.13 08.13 08.13 08.13		24.2026-1703.3	010910		THz 26,99/22,20 TRW
	sDrive 25 d sDrive 25 d xDrive 25 d xDrive 25 d xDrive 30 d xDrive 35 i xDrive 40 d	160 170 160 170 190 225 230	08.13 07.15 08.13 07.15 08.13 08.13 08.13		11.8171-0008.1 11.0101-5402.2 11.0441-6008.2	990049 260009 250038		Führungsbolzen Hülzensatz Dichtungssatz ATE
	M 50 d xDrive 50 i	280 330	08.13 08.13		11.8171-0096.1 11.0101-7003.2 11.8116-0008.2 11.0441-6008.2	250155 260124 390603 250038	2	Führungsbolzen Hülzensatz Haltefeder Dichtungssatz ATE
	xDrive 40 e xDrive 40 e	180 230	09.15 09.15		11.8171-0008.1 11.0101-5402.2 11.0441-6008.2	990049 260009 250038		Führungsbolzen Hülzensatz Dichtungssatz ATE
	sDrive 25 d sDrive 25 d xDrive 25 d xDrive 25 d xDrive 30 d xDrive 40 e xDrive 40 e	160 170 160 170 190 180 230	08.13 07.15 08.13 07.15 08.13 09.15 09.15		11.8171-0008.1 11.0101-5402.2 11.8116-0330.1	990049 260009 390472	2	Führungsbolzen Hülzensatz Haltefeder ATE
	M 50 d xDrive 35 i xDrive 40 d xDrive 50 i	280 225 230 330	08.13 08.13 08.13 08.13		11.8171-0008.1 11.8116-0330.1	990049 390472	2	Führungsbolzen Haltefeder ATE
	xDrive 40 e xDrive 40 e	180 230	09.15 09.15		83.7850-0205.3 83.7827-0245.3	331115 331113		L=205 L=245
BMW X6/E71/E72 (08-14)								
	ActiveHybrid	357	10.10	07.14	03.0655-0001.2	370001		Wegsensor ATE
	30 d 35 d 35 i 50 i M M 50 d xDrive 30 d xDrive 30 d xDrive 35 d xDrive 35 i xDrive 40 d xDrive 50 i	173 210 225 300 408 280 180 210 225 225 300	05.08 01.08 01.08 05.08 09.09 06.12 09.08 09.10 09.08 09.08 10.10 09.08	07.14 07.14 07.14 07.14 07.14 07.14 07.14 07.14 07.14 07.14 07.14 07.14	24.2026-1703.3	010910		THz 26,99/22,20 TRW
	30 d 35 d 35 i xDrive 30 d xDrive 35 d xDrive 35 i	173 210 225 210 225	05.08 01.08 01.08 09.08 09.08 09.08	10.08 10.08 10.08 10.08 10.08 10.08	11.0101-7003.2 11.8171-0096.1	260124 250155		Hülzensatz Führungsbolzen ATE
	30 d 35 d 35 i xDrive 30 d xDrive 30 d xDrive 35 d xDrive 35 i xDrive 40 d	173 210 225 180 210 225 225	11.08 11.08 11.08 11.08 09.10 11.08 11.08 10.10	07.14 07.14 07.14 07.14 07.14 07.14 07.14 07.14	11.0441-6008.2 11.0101-5402.2 11.8171-0008.1	250038 260009 990049		Dichtungssatz Hülzensatz Führungsbolzen ATE
	50 i ActiveHybrid M 50 d xDrive 50 i	300 357 280 300	05.08 09.08 06.12 09.08	07.14 07.14 07.14 07.14	11.0441-6008.2 11.0101-7003.2 11.8171-0096.1	250038 260124 250155		Dichtungssatz Hülzensatz Führungsbolzen ATE
	30 d 35 d 35 i 50 i ActiveHybrid M M 50 d xDrive 30 d	173 210 225 300 357 408 280	05.08 01.08 01.08 05.08 10.10 09.09 06.12 09.08	07.14 07.14 07.14 07.14 07.14 07.14 07.14 07.14	83.6151-0602.3	330893	2	L=600

¹⁾ on the brake caliper / sulla pinza freno / sur l'étrier de frein / a la pinza de freno

										
BMW X6/E71/E72 (08-14)										
	xDrive 30 d xDrive 35 d xDrive 35 i xDrive 40 d xDrive 50 i	180 210 225 225 300		09.10 09.08 09.08 10.10 09.08	07.14 07.14 07.14 07.14 07.14	83.6151-0602.3	330893	2	L=600	
	30 d 35 d 35 i xDrive 30 d xDrive 30 d xDrive 35 d xDrive 35 i xDrive 40 d	173 210 225 180 210 225 225 225		05.08 10.09 10.09 09.08 09.10 10.09 10.09 10.10	07.14 07.14 07.14 07.14 07.14 07.14 07.14 07.14	11.0101-5402.2 11.8171-0008.1 11.8116-0330.1	260009 990049 390472	2	Hülensatz Führungsbolzen Haltefeder	ATE ATE ATE
	35 d 35 i 50 i M 50 d xDrive 35 d xDrive 35 i xDrive 50 i	210 225 300 280 210 225 300		01.08 01.08 10.09 06.12 09.08 09.08 10.09	09.09 09.09 07.14 07.14 09.09 09.09 07.14	11.0101-5402.2 11.8171-0008.1 11.8116-0330.1	260009 990049 390472	2	Hülensatz Führungsbolzen Haltefeder	ATE ATE ATE
	50 i ActiveHybrid xDrive 50 i	300 357 300		05.08 10.10 09.08	09.09 07.14 09.09	11.0101-5402.2 11.8171-0008.1 11.8116-0330.1	260009 990049 390472	2	Hülensatz Führungsbolzen Haltefeder	ATE ATE ATE
	30 d 35 d 35 i 50 i ActiveHybrid M M 50 d xDrive 30 d xDrive 30 d xDrive 35 d xDrive 35 i xDrive 40 d xDrive 50 i	173 210 225 300 357 408 280 180 210 225 225 225 300		05.08 01.08 01.08 05.08 10.10 09.09 06.12 09.08 09.10 09.08 09.08 10.10 09.08	07.14 07.14 07.14 07.14 07.14 07.14 07.14 07.14 07.14 07.14 07.14 07.14 07.14	83.7850-0205.3 83.7827-0245.3 83.6150-0436.3	331115 331113 330890	2	am Bremsattel ¹⁾	L=205 L=245 L=435
BMW X6/F16 (14-)										
	M M 50 d xDrive 30 d xDrive 30 d xDrive 35 i xDrive 40 d xDrive 50 i	423 280 155 190 225 230 330		12.14 08.14 08.14 08.14 12.14 08.14 08.14		24.2026-1703.3	010910		ThZ 26,99/22,20	TRW
	xDrive 30 d xDrive 30 d xDrive 35 i xDrive 40 d M 50 d xDrive 50 i	155 190 225 230 280 330		08.14 08.14 12.14 08.14 08.14 08.14		11.0101-5402.2 11.0441-6008.2	260009 250038		Hülensatz Dichtungssatz	ATE ATE
	xDrive 30 d xDrive 30 d M 50 d xDrive 50 i	155 190 280 330		08.14 08.14 08.14 08.14		11.0101-5402.2 11.8116-0008.2 11.0441-6008.2	260009 390603 250038	2	Hülensatz Haltefeder Dichtungssatz	ATE ATE ATE
	xDrive 30 d xDrive 30 d M 50 d xDrive 35 i xDrive 40 d xDrive 50 i	155 190 280 225 230 330		08.14 08.14 08.14 12.14 08.14 08.14		11.0101-5402.2 11.8116-0330.1	260009 390472	2	Hülensatz Haltefeder	ATE ATE
BMW Z3/E36 (95-02)										
	1.8 1.9 2.0 2.2 2.8 Coupe 2.8 Roadster 3.0 Coupe 3.0 Roadster	85 110 125 141 141 170 170		10.95 10.95 04.99 10.00 07.97 05.97 06.00 06.00	10.98 12.02 08.00 12.02 06.00 06.00 12.02 12.02	03.7760-3102.4	300139		10"	ATE
	M Coupe M Roadster			02.98 03.97	12.02 + S54 12.02 + S54	03.7860-1202.4	300187		10"	ATE
	1.8 1.9 2.0 2.2 2.8 Coupe 2.8 Roadster 3.0 Coupe 3.0 Roadster	85 110 125 141 141 170 170		10.95 10.95 04.99 10.00 07.97 05.97 06.00 06.00	10.98 12.02 08.00 - DSC 12.02 - DSC 06.00 - DSC 06.00 - DSC 12.02 - DSC	03.2023-0987.3	010473		ThZ 23,81/20,64	ATE
	2.0 2.8 Coupe 2.8 Roadster 3.0 Coupe 3.0 Roadster	110 141 141 170 170		04.99 07.97 05.97 06.00 06.00	08.00 + DSC 06.00 + DSC 06.00 + DSC 08.00 + DSC 08.00 + DSC	03.2023-1904.3	010724		ThZ 23,81/20,64	ATE
	1.9 2.2	125		09.00 10.00	12.02 + DSC 12.02 + DSC	03.2023-1949.3	010725		ThZ 23,81/20,64	ATE

¹⁾ on the brake caliper / sulla pinza freno / sur l'étrier de frein / a la pinza de freno



								
BMW Z3/E36 (95-02)								
	3.0 Coupe 3.0 Roadster	170 170		09.00 09.00	12.02 + DSC 12.02 + DSC	03.2023-1949.3 010725		THz 23,81/20,64 ATE
	1.8 1.9	85		10.95 10.95	10.98 12.02	11.9541-9668.2 220422 24.3541-9667.5 240529 24.3541-9668.5 240530 11.0441-5402.2 250028 11.0230-0444.1 260104 11.0101-5402.2 260009 11.8171-0008.1 990049 11.8116-0109.1 390495 11.8116-0206.1 390593	2 2 2 2 2 2 2 2 2 2	D=54, - Halter D=54, - Halter D=54, - Halter Dichtungssatz Halter Hülzensatz Führungsbolzen Halterfeder Halterfeder D=54, - Halter D=54, - Halter D=54, - Halter Dichtungssatz Halter Hülzensatz Führungsbolzen Halterfeder Halterfeder D=60, - Halter D=60, - Halter Dichtungssatz Hülzensatz Führungsbolzen Halterfeder L=430 L=450
	2.0 2.2 2.8 Coupe 2.8 Roadster	110 125 141 141		04.99 10.00 07.97 05.97	08.00 12.02 06.00 06.00	11.9541-9588.2 220420 24.3541-9587.5 240527 24.3541-9588.5 240528 11.0441-5402.2 250028 11.8170-0729.1 260107 11.0101-5402.2 260009 11.8171-0008.1 990049 11.8116-0109.1 390495 11.8116-0206.1 390593	2 2 2 2 2 2 2 2 2	D=54, - Halter D=54, - Halter D=54, - Halter Dichtungssatz Halter Hülzensatz Führungsbolzen Halterfeder Halterfeder D=54, - Halter D=54, - Halter D=54, - Halter Dichtungssatz Halter Hülzensatz Führungsbolzen Halterfeder Halterfeder D=60, - Halter D=60, - Halter Dichtungssatz Hülzensatz Führungsbolzen Halterfeder L=430 L=450
	3.0 Coupe 3.0 Roadster	170 170		06.00 06.00	12.02 12.02	11.9541-9588.2 220420 24.3541-9587.5 240527 24.3541-9588.5 240528 11.0441-5402.2 250028 11.8170-0730.1 260108 11.0101-5402.2 260009 11.8171-0008.1 990049 11.8116-0109.1 390495 11.8116-0206.1 390593	2 2 2 2 2 2 2 2 2	D=54, - Halter D=54, - Halter D=54, - Halter Dichtungssatz Halter Hülzensatz Führungsbolzen Halterfeder Halterfeder D=54, - Halter D=54, - Halter D=54, - Halter Dichtungssatz Halter Hülzensatz Führungsbolzen Halterfeder Halterfeder D=60, - Halter D=60, - Halter Dichtungssatz Hülzensatz Führungsbolzen Halterfeder L=430 L=450
	M Coupe M Roadster			02.98 03.97	12.02 12.02	11.3601-8515.2 220323 11.3601-8516.2 220324 11.0441-6003.2 250037 11.0101-5402.2 260009 11.8171-0008.1 990049 11.8116-0083.1 390501	2 2 2 2 2 2	D=60, - Halter D=60, - Halter Dichtungssatz Hülzensatz Führungsbolzen Halterfeder L=430 L=450
	1.8 1.9 2.0 2.2 2.8 Coupe 2.8 Roadster 3.0 Coupe 3.0 Roadster	85 85 110 125 141 141 170 170		10.95 10.95 04.99 10.00 07.97 05.97 06.00 06.00	10.98 12.02 08.00 12.02 06.00 06.00 12.02 12.02	24.5103-0430.3 331408	2	L=430 L=450
	1.8 1.9 2.0 2.2 2.8 Coupe 2.8 Roadster 3.0 Coupe 3.0 Roadster	85 85 110 125 141 141 170 170		10.95 10.95 04.99 07.97 05.97 06.00 06.00	10.98 12.02 08.00 12.02 06.00 06.00 12.02 12.02	11.3361-8505.2 220024 11.3361-8506.2 220025 11.0441-3602.2 250008 11.0101-5402.2 260009 11.8171-0008.1 990049 11.8116-0185.1 390592	2	D=36, - Halter D=36, - Halter Dichtungssatz Hülzensatz Führungsbolzen Halterfeder D=40, - Halter D=40, - Halter Dichtungssatz Hülzensatz Führungsbolzen
	1.8 1.9 2.0 2.2 2.8 Coupe 2.8 Roadster 3.0 Coupe 3.0 Roadster	85 85 110 125 141 141 170 170		10.95 10.95 04.99 10.00 07.97 05.97 06.00 06.00	10.98 12.02 08.00 12.02 06.00 06.00 12.02 12.02	83.6240-0220.3 330465 83.7704-0200.3 330825	2 2	am Bremsattel ³⁾ L=220 L=200
	1.8 1.9	85		10.95 10.95	10.98 12.02	24.3727-0228.2 580228	2	L=1255
	1.9 2.0 2.2 2.8 Coupe 2.8 Roadster 3.0 Coupe 3.0 Roadster M Coupe M Roadster	85 110 125 141 141 170 170		10.95 04.99 10.00 07.97 05.97 06.00 06.00 02.98 03.97	12.02 + Motorcode M44 ⁴⁾ 12.02 + Motorcode M43 ⁵⁾ 08.00 12.02 06.00 06.00 12.00 12.00 12.00 12.02	24.3727-0229.2 580229	2	L=1283
	1.8 1.9 2.0 2.2 2.8 Coupe 2.8 Roadster 3.0 Coupe 3.0 Roadster M Coupe M Roadster	85 85 110 125 141 141 170 170		10.95 10.95 04.99 10.00 07.97 05.97 06.00 06.00 02.98 03.97	10.98 12.02 08.00 12.02 06.00 06.00 12.02 12.02 12.02 12.02	24.2419-1718.3 030094		Gz 19,05

¹⁾ length 150mm / lunghezza 150mm / longueur 150mm / largo 150mm

²⁾ length 177mm / lunghezza 177mm / longueur 177mm / largo 177mm

³⁾ on the brake caliper / sulla pinza freno / sur l'étrier de frein / a la pinza de freno

⁴⁾ + engine code M44 / + codice motore M44 / + moteur code M44 / + motor code M44

⁵⁾ + engine code M43 / + codice motore M43 / + moteur code M43 / + motor code M43

BMW Z3/E36 (95-02)									
	1.8 1.9 2.8 Coupe 2.8 Roadster	85 141 141	10.95 10.95 07.97 05.97	10.98 12.02 01.99 01.99	+ Motorcode M44 ¹⁾	24.2520-1701.3	040072	Nz 20,64	
	1.9 2.0 2.2 2.8 Coupe 2.8 Roadster 3.0 Coupe 3.0 Roadster M Coupe M Roadster	110 125 141 141 170 170	10.95 04.99 10.00 02.99 02.99 06.00 06.00 02.98 03.97	12.02 08.00 12.02 06.00 06.00 12.02 12.02	+ Motorcode M43 ²⁾	24.2522-0905.3	040042	Nz 22,20	
	1.8 1.9 2.0 2.8 Coupe 2.8 Roadster	85 110 141 141	10.95 10.95 04.99 07.97 05.97	10.98 12.02 08.00 06.00 06.00		24.5905-0320.3	330058	L=320	
BMW Z4 Roadster/E85 (03-08)									
	2.0 i 2.2 i 2.5 i 2.5 i 2.5 si 3.0 i 3.0 si	◀110 ◀125 ◀130 ◀141 ◀160 ◀170 ◀195	04.05 10.03 01.06 12.02 01.06 12.02 01.06	12.08 12.08 12.08 12.08 12.08 12.08 12.08		03.7860-1302.4	300222	10" ATE	
	2.0 i 2.2 i 2.5 i 2.5 i 2.5 si 3.0 i 3.0 si	▶110 ▶125 ▶130 ▶141 ▶160 ▶170 ▶195	04.05 10.03 01.06 12.02 01.06 12.02 01.06	12.08 12.08 12.08 12.08 12.08 12.08 12.08		03.7860-0702.4	300123	10" ATE	
	2.0 i 2.2 i 2.5 i 3.0 i	110 125 141 170	04.05 10.03 12.02 12.02	12.08 12.08 12.08 12.08		03.2023-2249.3	010869	Thz 23,81/22,20 ATE	
	2.5 i 2.5 si 3.0 si	130 160 195	01.06 01.06 01.06	12.08 12.08 12.08		03.2023-2256.3	010870	Thz 23,81/22,20 ATE	
	2.0 i 2.2 i 2.5 i 2.5 i	110 125 130 141	04.05 10.03 01.06 12.02	12.08 12.08 12.08 12.08		11.9541-9588.2 24.3541-9587.5 24.3541-9588.5 11.0441-5402.2 11.8170-0729.1 11.0101-5402.2 11.8171-0008.1 11.8116-0109.1 11.8116-0206.1	220420 240527 240528 250028 260107 260009 990049 390495 390593	<input type="checkbox"/> <input type="checkbox"/> <input type="checkbox"/> <input type="checkbox"/> 2 2 2 2 2	D=54, - Halter ATE D=54, - Halter ATE D=54, - Halter ATE Dichtungssatz ATE Halter ATE Hülensatz ATE Führungsbolzen ATE Haltefeder ATE Haltefeder ATE
	2.5 si 3.0 i	160 170	01.06 12.02	12.08 12.08		11.9541-9588.2 24.3541-9587.5 24.3541-9588.5 11.0441-5402.2 11.8170-0730.1 11.0101-5402.2 11.8171-0008.1 11.8116-0109.1 11.8116-0206.1	220420 240527 240528 250028 260108 260009 990049 390495 390593	<input type="checkbox"/> <input type="checkbox"/> <input type="checkbox"/> <input type="checkbox"/> 2 2 2 2 2	D=54, - Halter ATE D=54, - Halter ATE D=54, - Halter ATE Dichtungssatz ATE Halter ATE Hülensatz ATE Führungsbolzen ATE Haltefeder ATE Haltefeder ATE
	3.0 si	195	01.06	12.08		24.3571-1733.5 24.3571-1734.5 11.0101-5402.2 11.8171-0008.1 11.8116-0273.1	240349 240350 260009 990049 390515	<input type="checkbox"/> <input type="checkbox"/> <input type="checkbox"/> <input type="checkbox"/> 2	D=57, - Halter ATE D=57, - Halter ATE Hülensatz ATE Führungsbolzen ATE Haltefeder ATE
	M	252	01.06	12.08		11.0441-6003.2 11.0101-5402.2 11.8171-0008.1 11.8116-0083.1	250037 260009 990049 390501	<input type="checkbox"/> <input type="checkbox"/> <input type="checkbox"/> 2	Dichtungssatz ATE Hülensatz ATE Führungsbolzen ATE Haltefeder ATE
	2.0 i 2.2 i 2.5 i 2.5 i 2.5 si 3.0 i 3.0 si	110 125 130 141 160 170 195	04.05 10.03 01.06 12.02 01.06 12.02 01.06	12.08 12.08 12.08 12.08 12.08 12.08 12.08		83.6152-0406.3	330789	2	L=405
	2.0 i 2.2 i 2.5 i 2.5 i	110 125 130 141	04.05 10.03 01.06 12.02	12.08 12.08 12.08 12.08		24.3401-1705.5 24.3401-1706.5 11.0441-4002.2 11.0101-5402.2 11.8171-0008.1 11.8116-0066.1	240423 240424 250011 260009 990049 390577	<input type="checkbox"/> <input type="checkbox"/> <input type="checkbox"/> <input type="checkbox"/> 2	D=40, - Halter ATE D=40, - Halter ATE Dichtungssatz ATE Hülensatz ATE Führungsbolzen ATE Haltefeder ATE
	2.5 si 3.0 i 3.0 si	160 170 195	01.06 12.02 01.06	12.08 12.08 12.08		24.3401-1703.5 24.3401-1704.5 11.0441-4002.2 11.0101-5402.2 11.8171-0008.1 11.8116-0066.1	240351 240352 250011 260009 990049 390577	<input type="checkbox"/> <input type="checkbox"/> <input type="checkbox"/> <input type="checkbox"/> 2	D=40, - Halter ATE D=40, - Halter ATE Dichtungssatz ATE Hülensatz ATE Führungsbolzen ATE Haltefeder ATE

1) + engine code M44 / + codice motore M44 / + moteur code M44 / + motor code M44





















2) + engine code M43 / + codice motore M43 / + moteur code M43 / + motor code M43



















3) length 150mm / lunghezza 150mm / longueur 150mm / largo 150mm

4) length 177mm / lunghezza 177mm / longueur 177mm / largo 177mm

BMW Z4 Roadster/E85 (03-08)										
	M	252		01.06	12.08	11.0101-5402.2 260009 11.8171-0008.1 990049 11.8116-0296.1 390445	2		Hülzensatz Führungsbolzen Haltefeder	ATE ATE ATE
	2.0 i 2.2 i 2.5 i 2.5 i 2.5 si 3.0 i 3.0 si M	110 125 130 141 160 170 195 252		04.05 10.03 01.06 12.02 01.06 12.02 01.06 01.06	12.08 12.08 12.08 12.08 12.08 12.08 12.08 12.08	83.1294-0250.3 331267 83.1294-0260.3 331268 83.6150-0206.3 330978	2	am Bremssattel ¹⁾	L=443, + Rohrleitung L=443, + Rohrleitung L=205	
	M	252		03.06	12.08	83.6150-0206.3 330978	2	am Bremssattel ¹⁾	L=205	
	2.0 i 2.2 i 2.5 i 2.5 i 2.5 si 3.0 i 3.0 si M	110 125 130 141 160 170 195 252		04.05 10.03 01.06 12.02 01.06 12.02 01.06 01.06	12.08 12.08 12.08 12.08 12.08 12.08 12.08 12.08	24.2419-1733.3 030125			Gz 19,05	
	2.0 i 2.2 i 2.5 i 2.5 i 2.5 si 3.0 i 3.0 si M	110 125 130 141 160 170 195 252		04.05 10.03 01.06 12.02 01.06 12.02 01.06 01.06	12.08 12.08 12.08 12.08 12.08 12.08 12.08 12.08	24.2522-1705.3 040079			Nz 22,20	
BMW Z4 Coupe/E86 (06-08)										
	3.0 si	195		03.06	09.08	03.7860-1302.4 300222			10"	ATE
	3.0 si	195		03.06	09.08	03.7860-0702.4 300123			10"	ATE
	3.0 si	195		03.06	09.08	03.2023-2256.3 010870			ThZ 23,81/22,20	ATE
	3.0 si	195		03.06	09.08	24.3571-1733.5 240349 24.3571-1734.5 240350 11.0101-5402.2 260009 11.8171-0008.1 990049 11.8116-0273.1 390515	2		D=57, - Halter D=57, - Halter Hülzensatz Führungsbolzen Haltefeder	ATE ATE ATE ATE ATE
	M	252		03.06	09.08	11.0441-6003.2 250037 11.0101-5402.2 260009 11.8171-0008.1 990049 11.8116-0083.1 390501	2		Dichtungssatz Hülzensatz Führungsbolzen Haltefeder	ATE ATE ATE ATE
	3.0 si	195		03.06	09.08	83.6152-0406.3 330789	2		L=405	
	3.0 si	195		03.06	09.08	24.3401-1703.5 240351 24.3401-1704.5 240352 11.0441-4002.2 250011 11.0101-5402.2 260009 11.8171-0008.1 990049 11.8116-0066.1 390577	2		D=40, - Halter D=40, - Halter Dichtungssatz Hülzensatz Führungsbolzen Haltefeder	ATE ATE ATE ATE ATE ATE
	M	252		03.06	09.08	11.0101-5402.2 260009 11.8171-0008.1 990049 11.8116-0296.1 390445	2		Hülzensatz Führungsbolzen Haltefeder	ATE ATE ATE
	3.0 si	195		03.06	09.08	83.6150-0206.3 330978 83.1294-0250.3 331267 83.1294-0260.3 331268	2	am Bremssattel ¹⁾	L=205 L=443, + Rohrleitung L=443, + Rohrleitung	
	M	252		03.06	09.08	83.6150-0206.3 330978	2	am Bremssattel ¹⁾	L=205	
	3.0 si	195		03.06	09.08	24.2419-1713.3 030093			Gz 19,05	
	M	252		03.06	09.08					
	3.0 si	195		03.06	09.08	24.2522-1705.3 040079			Nz 22,20	
	M	252		03.06	09.08					
BMW Z4 Roadster/E89 (09-)										
	sDrive 18i sDrive 20i sDrive 23i sDrive 28i sDrive 30i sDrive 35i sDrive 35is	115 135 150 180 190 225 250		03.13 09.11 01.09 09.11 01.09 01.09 09.10		03.2025-5826.3 010960			ThZ 25,40/22,20	ATE
	sDrive 18i sDrive 20i sDrive 23i	115 135 150		03.13 09.11 01.09		11.9571-9753.2 220929 11.9571-9754.2 220930 11.8171-0008.1 990049 11.0101-5402.2 260009 11.8116-0339.2 390528	2		D=57, - Halter D=57, - Halter Führungsbolzen Hülzensatz Haltefeder	ATE ATE ATE ATE ATE
	sDrive 28i sDrive 30i	180 190		09.11 01.09		11.8171-0008.1 990049 11.0101-5402.2 260009 11.8116-0339.2 390528	2		Führungsbolzen Hülzensatz Haltefeder	ATE ATE ATE

¹⁾ on the brake caliper / sulla pinza freno / sur l'étrier de frein / a la pinza de freno

	 kW							
BMW Z4 Roadster/E89 (09-)								
	sDrive 35i 225 sDrive 35is 250		01.09 09.10		11.0101-6006.2 260098 11.8171-0008.1 990049 11.8116-0315.2 390447	2		Hülsensatz Führungsbolzen Haltefeder ATE ATE ATE
	sDrive 18i 115 sDrive 20i 135 sDrive 23i 150 sDrive 28i 180 sDrive 30i 190 sDrive 35i 225 sDrive 35is 250		03.13 09.11 01.09 09.11 01.09 01.09 09.10		24.5174-0526.3 331365	2		L=526
BMW Z8/E52 (00-03)								
	4.9 294		06.00 08.03		24.2026-1705.3 010992			THz 26,99/20,64 TRW
	4.9 294		06.00 08.03		11.0101-6004.2 260014 11.8171-0008.1 990049 11.8116-0260.1 390597	2		Hülsensatz Führungsbolzen Haltefeder ATE ATE ATE
	4.9 294		06.00 08.03		11.0101-5402.2 260009 11.8171-0008.1 990049 11.8116-0296.1 390445	2		Hülsensatz Führungsbolzen Haltefeder ATE ATE ATE
	4.9 294		06.00 08.03		24.5113-0283.3 331395	2		L=283
	4.9 294		06.00 08.03		24.2419-1713.3 030093			Gz 19,05
	4.9 294		06.00 08.03		24.2522-0905.3 040042			Nz 22,20
CHEVROLET AVEO (T200,T250) (04-11)								
	1.2 i 53 1.2 i 55 1.2 i 56 1.2 i 62 1.2 LPG 62 1.4 CNG 69 1.4 i 16V 69 1.4 i 16V 74 1.5 i 62 1.6 i 16V 75 1.6 i 16V 76 1.6 i 16V 77		03.06 07.11 01.08 07.11 03.06 07.11 01.08 07.11 04.08 07.11 01.10 07.11 03.06 07.11 01.08 07.11 05.05 07.11 03.06 07.11 05.05 07.11 12.04 07.11		24.5286-0342.3 331138	2		L=341
	1.2 i 53 1.2 i 55 1.2 i 56 1.2 i 62 1.2 LPG 62 1.4 CNG 69 1.4 i 16V 69 1.4 i 16V 74 1.5 i 62 1.6 i 16V 75 1.6 i 16V 76 1.6 i 16V 77		03.06 07.11 01.08 07.11 03.06 07.11 01.08 07.11 04.08 07.11 01.10 07.11 03.06 07.11 01.08 07.11 05.05 07.11 03.06 07.11 05.05 07.11 12.04 07.11		24.5247-0205.3 331094	2		L=205
	1.2 i 53 1.2 i 55 1.2 i 56 1.2 i 62 1.2 LPG 62 1.4 CNG 69 1.4 i 16V 69 1.4 i 16V 74 1.5 i 62 1.6 i 16V 75 1.6 i 16V 76 1.6 i 16V 77		03.06 07.11 01.08 07.11 03.06 07.11 01.08 07.11 04.08 07.11 01.10 07.11 03.06 07.11 01.08 07.11 05.05 07.11 03.06 07.11 05.05 07.11 12.04 07.11		24.3219-1767.3 020552			Rz 19,05
	1.2 i 53 1.2 i 55 1.2 i 56 1.2 i 62 1.2 LPG 62 1.4 CNG 69 1.4 i 16V 69 1.4 i 16V 74 1.5 i 62 1.6 i 16V 75 1.6 i 16V 76 1.6 i 16V 77		03.06 07.11 01.08 07.11 03.06 07.11 01.08 07.11 04.08 07.11 01.10 07.11 03.06 07.11 01.08 07.11 05.05 07.11 03.06 07.11 05.05 07.11 12.04 07.11		24.3728-2901.2 592901			L=888

								
CHEVROLET AVEO (T300) (11-)								
	1.2 16V	51	03.11		11.9601-2603.2	220915	+ 15" Rad ¹⁾	D=60, - Halter ATE
	1.2 16V	63	03.11		11.9601-2604.2	220916		
	1.2 LPG	63	11.12					
	1.3 D	55	07.11					
	1.3 D	70	07.11					
	1.4 16V	74	03.11					
	1.4 16V	76	12.12					
	1.6 16V	85	03.11					
	1.6 16V	88	06.11					
	1.6 16V	89	12.12					
	1.4 Turbo	103	08.13		11.9601-2603.2	220915	+ 15" Rad ¹⁾	D=60, - Halter ATE
					11.9601-2604.2	220916		
	1.4 Turbo	103	08.13		11.9382-7003.2	220891	+ 15" Rad ¹⁾	D=38, - Halter ATE
					11.9382-7004.2	220892		
	1.2 16V	51	03.11		24.3219-1766.3	020555	+ 14" Rad ²⁾	Rz 19,05
	1.2 16V	63	03.11					
	1.2 LPG	63	11.12					
	1.3 D	55	07.11					
	1.3 D	70	07.11					
	1.4 16V	74	03.11					
	1.4 16V	76	12.12					
	1.6 16V	85	03.11					
	1.6 16V	88	06.11					
	1.6 16V	89	12.12					
	1.2 16V	51	03.11		24.3220-1742.3	020549	+ 15" Rad ¹⁾	Rz 20,64
	1.2 16V	63	03.11					
	1.2 LPG	63	11.12					
	1.3 D	55	07.11					
	1.3 D	70	07.11					
	1.4 16V	74	03.11					
	1.4 16V	76	12.12					
	1.6 16V	85	03.11					
	1.6 16V	88	06.11					
	1.6 16V	89	12.12					
CHEVROLET COBALT (11-)								
	1.5	78	01.14		24.3219-1766.3	020555		Rz 19,05
CHEVROLET CRUZE (09-)								
	1.4 16V	80	08.12		03.7858-0732.4	300272		9/8" Tandem ATE
	1.6 16V	80	05.09					
	1.6 16V	83	05.09					
	1.6 16V	91	05.09					
	1.7 D	96	01.12					
	1.8 16V	103	11.09					
	1.8 16V	104	05.09					
	1.8 16V LPG	104	06.11					
	1.8 Flex	106	01.11					
	2.0 CDI	90	05.09					
	2.0 CDI	92	05.09					
	2.0 CDI	110	05.09					
	1.4 16V	80	08.12		03.2125-0421.3	010934	+ ESP	THz 25,40 ATE
	1.6 16V	80	05.09					
	1.6 16V	83	05.09					
	1.6 16V	91	05.09					
	1.7 D	96	01.12					
	1.8 16V	103	11.09					
	1.8 16V	104	05.09					
	1.8 16V LPG	104	06.11					
	1.8 Flex	106	01.11					
	2.0 CDI	90	05.09					
	2.0 CDI	92	05.09					
	2.0 CDI	110	05.09					
	1.4 16V	80	08.12	+ Bremsscheibendurchm. 276 mm ³⁾	11.9601-2603.2	220915	+ 15" Rad ¹⁾	D=60, - Halter ATE
	1.6 16V	80	05.09	+ Bremsscheibendurchm. 276 mm ³⁾				
	1.6 16V	83	05.09	+ Bremsscheibendurchm. 276 mm ³⁾				
	1.6 16V	91	05.09	+ Bremsscheibendurchm. 276 mm ³⁾				
	1.7 D	96	01.12	+ Bremsscheibendurchm. 276 mm ³⁾				
	1.8 16V	103	11.09	+ Bremsscheibendurchm. 276 mm ³⁾				
	1.8 16V	104	05.09	+ Bremsscheibendurchm. 276 mm ³⁾				
	1.8 16V LPG	104	06.11	+ Bremsscheibendurchm. 276 mm ³⁾				
	1.8 Flex	106	01.11	+ Bremsscheibendurchm. 276 mm ³⁾				
	2.0 CDI	90	05.09	+ Bremsscheibendurchm. 276 mm ³⁾				
	2.0 CDI	92	05.09	+ Bremsscheibendurchm. 276 mm ³⁾				
	2.0 CDI	110	05.09	+ Bremsscheibendurchm. 276 mm ³⁾				
	1.4 16V	80	08.12	+ Bremsscheibendurchm. 300 mm ⁴⁾	11.9601-2601.2	220913	+ 15" Rad ¹⁾	D=60, - Halter ATE
	1.6 16V	80	05.09	+ Bremsscheibendurchm. 300 mm ⁴⁾				
	1.6 16V	83	05.09	+ Bremsscheibendurchm. 300 mm ⁴⁾				
	1.6 16V	91	05.09	+ Bremsscheibendurchm. 300 mm ⁴⁾				
	1.7 D	96	01.12	+ Bremsscheibendurchm. 300 mm ⁴⁾				

¹⁾ + 15" wheel / + ruota 15" / + roue 15" / + rueda 15"

²⁾ + 14" wheel / + ruota 14" / + roue 14" / + rueda 14"

³⁾ + brake disc diameter 276 mm / + disco fr.diam. 276mm / + disques fr.diam. 276mm / + disco fr.diam. 276mm

⁴⁾ + brake disc diameter 300mm / + diametro dischi freno 300mm / + diamètre disques frein 300mm / + diámetro disco freno 300mm



CHEVROLET CRUZE (09-)

	1.8 16V 1.8 16V 1.8 16V LPG 1.8 Flex 2.0 CDI 2.0 CDI 2.0 CDI	103 104 104 106 90 92 110 120		11.09 05.09 06.11 01.11 05.09 05.09 05.09 08.10	+ Bremsscheibendurchm. 300 mm ¹⁾ + Bremsscheibendurchm. 300 mm ¹⁾ + Bremsscheibendurchm. 300 mm ¹⁾ + Bremsscheibendurchm. 300 mm ¹⁾ + Bremsscheibendurchm. 300 mm ¹⁾ + Bremsscheibendurchm. 300 mm ¹⁾ + Bremsscheibendurchm. 300 mm ¹⁾	11.9601-2601.2 11.9601-2602.2	220913 220914			D=60, - Halter D=60, - Halter	ATE ATE
	1.6 16V 1.6 16V 1.6 16V 1.7 D 1.8 16V 1.8 16V 1.8 16V LPG 1.8 Flex 2.0 CDI 2.0 CDI 2.0 CDI 2.0 CDI	80 83 91 96 103 104 104 106 90 92 110 120		05.09 05.09 05.09 01.12 11.09 05.09 06.11 01.11 05.09 05.09 05.09 08.10	07.12 07.12 07.12 07.12 07.12 07.12 07.12 07.12 07.12 07.12 07.12 07.12	24.5176-0400.3	331492	2		L=400	
	1.4 16V 1.6 16V 1.6 16V 1.6 16V 1.7 D 1.8 16V 1.8 16V 1.8 16V LPG 1.8 Flex 2.0 CDI 2.0 CDI 2.0 CDI	80 83 91 96 103 104 104 106 90 92 110 120		08.12 05.09 05.09 05.09 01.12 11.09 05.09 06.11 01.11 05.09 05.09 05.09 08.10	+ Bremsscheibendurchm. 268 mm ²⁾ + Bremsscheibendurchm. 268 mm ²⁾ + Bremsscheibendurchm. 268 mm ²⁾ + Bremsscheibendurchm. 268 mm ²⁾ + Bremsscheibendurchm. 268 mm ²⁾ + Bremsscheibendurchm. 268 mm ²⁾ + Bremsscheibendurchm. 268 mm ²⁾ + Bremsscheibendurchm. 268 mm ²⁾ + Bremsscheibendurchm. 268 mm ²⁾ + Bremsscheibendurchm. 268 mm ²⁾ + Bremsscheibendurchm. 268 mm ²⁾ + Bremsscheibendurchm. 268 mm ²⁾	11.9382-7001.2 11.9382-7002.2	220889 220890			D=38, - Halter D=38, - Halter	ATE ATE
	1.4 16V 1.6 16V 1.6 16V 1.6 16V 1.7 D 1.8 16V 1.8 16V 1.8 16V LPG 1.8 Flex 2.0 CDI 2.0 CDI 2.0 CDI	80 83 91 96 103 104 104 106 90 92 110 120		08.12 05.09 05.09 05.09 01.12 11.09 05.09 06.11 01.11 05.09 05.09 05.09 08.10	+ Bremsscheibendurchm. 292mm ³⁾ + Bremsscheibendurchm. 292mm ³⁾ + Bremsscheibendurchm. 292mm ³⁾ + Bremsscheibendurchm. 292mm ³⁾ + Bremsscheibendurchm. 292mm ³⁾ + Bremsscheibendurchm. 292mm ³⁾ + Bremsscheibendurchm. 292mm ³⁾ + Bremsscheibendurchm. 292mm ³⁾ + Bremsscheibendurchm. 292mm ³⁾ + Bremsscheibendurchm. 292mm ³⁾ + Bremsscheibendurchm. 292mm ³⁾ + Bremsscheibendurchm. 292mm ³⁾	11.9382-7003.2 11.9382-7004.2	220891 220892			D=38, - Halter D=38, - Halter	ATE ATE
	1.6 16V 1.6 16V 1.6 16V 1.8 16V 1.8 16V 2.0 CDI 2.0 CDI 2.0 CDI	80 83 91 103 104 90 92 110		05.09 05.09 05.09 05.09 05.09 05.09 05.09 05.09		24.3727-0798.2 24.3727-0794.2 24.3727-0795.2	580798 580794 580795	1		L=1798 L=1812 L=1814	

CHEVROLET KALOS (05-08)

	1.2 i 1.4 i 1.4 i 16V	53 61 69		03.05 03.05 03.05	05.08 05.08 05.08	24.5286-0342.3	331138	2		L=341	
	1.2 i 1.4 i 1.4 i 16V	53 61 69		03.05 03.05 03.05	05.08 05.08 05.08	24.5247-0205.3	331094	2		L=205	
	1.2 i 1.4 i 1.4 i 16V	53 61 69		03.05 03.05 03.05	05.08 05.08 05.08	24.3219-1767.3	020552			Rz 19,05	
	1.2 i 1.4 i 1.4 i 16V	53 61 69		03.05 03.05 03.05	05.08 05.08 05.08	24.3728-2901.2	592901			L=888	













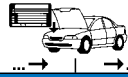







CHEVROLET LANOS (05-10)



























	1.4 1.5 1.6 i 16V	55 63 78		11.05 11.05 11.05	12.10 12.10 12.10	11.9481-9871.2 11.9481-9872.2	220681 220682			D=48, - Halter D=48, - Halter	ATE ATE
	1.4 1.5 1.6 i 16V	55 63 78		11.05 11.05 11.05	12.10 12.10 12.10	24.3521-1701.5 24.3521-1702.5	240001 240002			D=52, - Halter D=52, - Halter	ATE ATE
	1.4 1.5	55 63		11.05 11.05	12.10 12.10	24.5233-0180.3	330888	2		L=180	
	1.4 1.5	55 63		11.05 11.05	12.10 12.10	03.3217-3512.3	020032			Rz 17,46	TRW
	1.4 1.5 1.6 i 16V	55 63 78		11.05 11.05 11.05	12.10 12.10 12.10	24.3727-2900.2 24.3727-2901.2	582900 582901			L=1655 L=1587	

¹⁾ + brake disc diameter 300mm / + diametro dischi freno 300mm / + diamètre disques frein 300mm / + diámetro disco freno 300mm































²⁾ + brake disc diameter 268 mm / + disco fr.diam. 268mm / + disques fr.diam. 268mm / + disco fr.diam. 268mm

³⁾ + brake disc diameter 292mm / + diametro dischi freno 292mm / + diamètre disques frein 292mm / + diámetro disco freno 292mm

								
CHEVROLET MALIBU (V300) (12-)								
	2.0 16V 2.0 16V 2.0 LPG 2.0 VDCi 2.4 16V 2.4 16V 2.4 16V	104 108 101 118 123 125 137		02.12 12.12 02.12 04.12 01.12 01.12 01.12		03.7858-0732.4	300272	9/8" Tandem ATE
	2.0 16V 2.0 16V 2.0 LPG 2.0 VDCi 2.4 16V 2.4 16V 2.4 16V	104 108 101 118 123 125 137		02.12 12.12 02.12 04.12 01.12 01.12 01.12		03.2125-0421.3	010934	THz 25,40 ATE
	2.0 16V 2.0 16V 2.0 LPG 2.0 VDCi 2.4 16V 2.4 16V 2.4 16V	104 108 101 118 123 125 137		02.12 12.12 02.12 04.12 01.12 01.12 01.12		24.5176-0494.3	331447	2 L=494
	2.0 16V 2.0 16V 2.0 LPG 2.0 VDCi 2.4 16V 2.4 16V 2.4 16V	104 108 101 118 123 125 137		02.12 12.12 02.12 04.12 01.12 01.12 01.12		24.5176-0384.3	331373	2 L=384
CHEVROLET MATIZ (05-10)								
	0.8 0.8 LPG 1.0 1.0 1.0 1.0 LPG 1.0 LPG	38 38 47 48 49 44 49	645871 645871 645871 645871 645871 645871 645871	03.05 03.05 03.05 01.07 03.05 01.07 03.05		24.2120-1765.3 24.2120-1755.3	011003 010974	- ABS + ABS THz 20,64 - Behälter THz 20,64 - Behälter
	0.8 0.8 LPG 1.0 1.0 1.0 1.0 LPG 1.0 LPG	38 38 47 48 49 44 49	645872 645872 645872 645872 645872 645872 645872	12.10 12.10 12.10 12.10 12.10 12.10 12.10		24.2120-1765.3 24.2120-1755.3	011003 010974	- ABS + ABS THz 20,64 - Behälter THz 20,64 - Behälter
	0.8 0.8 LPG 1.0 1.0 1.0 1.0 LPG 1.0 LPG	38 38 47 48 49 44 49		03.05 03.05 03.05 01.07 03.05 01.07 03.05	12.10 12.10 12.10 12.10 12.10 12.10 12.10	24.3481-1773.5 24.3481-1774.5	240377 240378	<input type="checkbox"/> <input type="checkbox"/> D=48, - Halter D=48, - Halter
	0.8 0.8 LPG 1.0 1.0 1.0 1.0 LPG 1.0 LPG	38 38 47 48 49 44 49		03.05 03.05 03.05 01.07 03.05 01.07 03.05	12.10 12.10 12.10 12.10 12.10 12.10 12.10	24.5283-0403.3 24.5291-0425.3	331136 331029	2 2 - ABS + ABS L=404 L=425
	0.8 0.8 LPG 1.0 1.0 1.0 1.0 LPG 1.0 LPG	38 38 47 48 49 44 49		03.05 03.05 03.05 01.07 03.05 01.07 03.05	12.10 12.10 12.10 12.10 12.10 12.10 12.10	24.5284-0220.3	330970	2 L=220
	0.8 0.8 LPG 1.0 1.0 1.0 1.0 LPG 1.0 LPG	38 38 47 48 49 44 49		03.05 03.05 03.05 01.07 03.05 01.07 03.05	12.10 12.10 12.10 12.10 12.10 12.10 12.10	24.3217-1712.3	020475	Rz 17,46
	0.8 0.8 LPG 1.0 1.0 1.0 1.0 LPG 1.0 LPG	38 38 47 48 49 44 49		03.05 03.05 03.05 01.07 03.05 01.07 03.05	12.10 12.10 12.10 12.10 12.10 12.10 12.10	24.3727-2902.2	582902	1 L=2825
	0.8 0.8 LPG	38 38		03.05 03.05	12.10 12.10	24.3728-2900.2	592900	L=851

									
CHEVROLET NUBIRA (05-10)									
	1.4 i 16V 1.4 i 16V 1.5 i 16V 1.6 i 16V 1.6 i 16V 1.8 i 16V 1.8 i 16V 2.0 i 16V 2.0 TCDi	69 70 78 76 80 89 90 88 89		01.05 12.10 01.06 12.10 01.05 12.10 01.10 12.10 03.05 12.10 08.05 12.10 03.05 12.10 01.05 12.10 01.05 12.10		24.3220-1719.3	020448		Rz 20,64
CHEVROLET ORLANDO (11-)									
	1.8 16V 1.8 LPG 2.0 D 2.0 D 2.0 LPG	104 104 96 120 103		02.11 06.11 02.11 02.11 02.12		03.7858-0732.4	300272		9/8" Tandem ATE
	1.8 16V 1.8 LPG 2.0 D 2.0 D 2.0 LPG	104 104 96 120 103		02.11 06.11 02.11 02.11 02.12		03.2125-0421.3	010934	+ ESP	THz 25,40 ATE
	1.4 16V 1.8 16V 1.8 LPG 2.0 D 2.0 D 2.0 LPG	103 104 104 96 120 103		06.12 02.11 06.11 02.11 02.11 02.12		11.9601-2601.2 11.9601-2602.2	220913 220914	 	D=60, - Halter ATE D=60, - Halter ATE D=60, - Halter ATE
	1.8 16V 1.8 LPG 2.0 D 2.0 D 2.0 LPG	104 104 96 120 103		02.11 06.11 02.11 02.11 02.12		24.5176-0400.3	331492	2	L=400
CHEVROLET SPARK (05-10)									
	0.8 1.0 LPG 1.0 SX 1.0 SX 1.0 SX	37 46 44 46 49	645871 645871 645871 645871 645871	05.05 05.05 06.09 05.05 05.05	+ Schaltgetriebe ¹⁾	24.2120-1765.3	011003	- ABS	THz 20,64 - Behälter
	0.8 1.0 LPG 1.0 SX 1.0 SX 1.0 SX	37 46 44 46 49	645872 645872 645872 645872 645872	02.10 02.10 02.10 02.10 02.10	+ Schaltgetriebe ¹⁾	24.2120-1765.3	011003	- ABS	THz 20,64 - Behälter
	0.8 1.0 LPG 1.0 SX 1.0 SX 1.0 SX	37 46 44 46 49	645871 645871 645871 645871 645871	05.05 05.05 06.09 05.05 05.05	+ Schaltgetriebe ¹⁾	24.2120-1755.3	010974	+ ABS	THz 20,64 - Behälter
	0.8 1.0 LPG 1.0 SX 1.0 SX 1.0 SX	37 46 44 46 49	645872 645872 645872 645872 645872	02.10 02.10 02.10 02.10 02.10	+ Schaltgetriebe ¹⁾	24.2120-1755.3	010974	+ ABS	THz 20,64 - Behälter
	0.8 1.0 LPG 1.0 SX 1.0 SX 1.0 SX	37 46 44 46 49		05.05 02.10 05.05 02.10 06.09 02.10 05.05 02.10 05.05 02.10		24.3481-1773.5 24.3481-1774.5	240377 240378	 	D=48, - Halter D=48, - Halter
	0.8 1.0 LPG 1.0 SX 1.0 SX 1.0 SX	37 46 44 46 49		05.05 02.10 05.05 02.10 06.09 02.10 05.05 02.10 05.05 02.10		24.5283-0403.3	331136	2	L=404
	0.8 1.0 LPG 1.0 SX 1.0 SX 1.0 SX	37 46 44 46 49		05.05 02.10 05.05 02.10 06.09 02.10 05.05 02.10 05.05 02.10		24.5284-0220.3	330970	2	L=220
	0.8 1.0 LPG 1.0 SX 1.0 SX 1.0 SX	37 46 44 46 49		05.05 02.10 05.05 02.10 06.09 02.10 05.05 02.10 05.05 02.10		24.3217-1712.3	020475		Rz 17,46
CHEVROLET SPARK (10-)									
	1.0 1.0 16V 1.2 16V 1.2 16V 1.2 LPG 1.2 LPG	50 50 60 61 59 60		03.10 03.12 03.10 03.12 03.10 03.12 01.11 03.12 01.11 03.12 03.10 03.12		24.3219-1767.3	020552		Rz 19,05

¹⁾ + manual transmission / + scatola cambio velocità / + transmission mécanique / + cambio de velocidad

										
CHEVROLET TRAX (12-)										
	1.4	103		12.12		11.9601-2601.2	220913		D=60, - Halter	ATE
	1.4 AWD	103		12.12		11.9601-2602.2	220914		D=60, - Halter	ATE
	1.4 LPG	103		04.13						
	1.6	85		12.12						
	1.6 AWD	85		12.12						
	1.7 TD	96		12.12						
	1.7 TD AWD	96		12.12						
	1.8	103		03.13						
	1.8 AWD	103		03.13						
	1.4	103		12.12		11.9382-7003.2	220891		D=38, - Halter	ATE
	1.4 LPG	103		04.13		11.9382-7004.2	220892		D=38, - Halter Bremsattel-Zubehör	ATE
	1.6	85		12.12		11.0103-0001.2	250156			ATE
	1.7 TD	96		12.12						
	1.8	103		03.13						
	1.4 AWD	103		12.12		11.9382-7003.2	220891		D=38, - Halter	ATE
	1.6 AWD	85		12.12		11.9382-7004.2	220892		D=38, - Halter	ATE
	1.7 TD AWD	96		12.12		11.0103-0001.2	250156		Bremsattel-Zubehör	ATE
	1.8 AWD	103		03.13						
CHEVROLET VOLT (11-)										
	EV 150	111		11.11		11.9601-2601.2	220913		D=60, - Halter	ATE
						11.9601-2602.2	220914		D=60, - Halter	ATE
	EV 150	111		11.11		24.5176-0400.3	331492	2	L=400	
	EV 150	111		11.11		11.9382-7001.2	220889		D=38, - Halter	ATE
						11.9382-7002.2	220890		D=38, - Halter	ATE
CHRYSLER PT CRUISER (00-10)										
	1.6 16V	85		11.01	09.10	24.3571-1779.5	240737		D=57, - Halter	ATE
	2.0 16V	100		10.04	09.10	24.3571-1780.5	240738		D=57, - Halter	
	2.0 16V	104		06.00	09.10					
	2.2 CRD	89		03.02	09.10					
	2.2 CRD	110		08.05	09.10					
	2.4 16V	105		03.04	09.10					
	2.4 16V	110		06.00	09.10					
	2.4 16V	169		09.04	09.10					
	2.4 GT Turbo	164		08.03	09.10					
CITROEN AX (86-98)										
	10	33	ORGA 03826		12.98	03.2120-2031.3	010106		Thz 20,64	ATE
	10	37			07.92					
	10 E	30	ORGA 03825		12.88					
	11	40			12.86					
	11	44			10.89					
	13 Sport		ORGA 04073		04.87					
	14	44			12.86					
	14	49			06.88					
	14	51			01.89					
	14	55			03.89					
	14	61			01.88					
	14 GT	62	ORGA 04098		01.88					
	14 GTI				06.91				- ABS	
	Electric	25			04.93					
	Electric	28			11.96					
	1.4 Allure	48			08.92					
	13 Sport		ORGA 04074		04.94					
	14 D		ORGA 05188		09.88					
	14 GT	59			12.91					
	14 GT	62	ORGA 04099		12.92					
	15 D				08.94					
	10	32	ORGA 05089		09.86					
	10	33	ORGA 05089		07.86					
	10 E	30			12.86					
	11	40	ORGA 05089		12.86					
	11	44	ORGA 05089		10.89					
	13 Sport		ORGA 05089		04.87					
	14	44	ORGA 05089		12.86					
	14	49	ORGA 05089		06.88					
	14	51	ORGA 05089		01.89					
	14	55	ORGA 05089		03.89					
	14	61	ORGA 05089		01.88					
	14 D		ORGA 05089		09.88					
	14 GT	62	ORGA 05089		01.88					
	10	32	ORGA 05090		06.92					
	10	33	ORGA 05090		12.98					
	10	37			07.92					
	11	44	ORGA 05090		12.98					
	14	51	ORGA 05090		12.97					
	14	55	ORGA 05277							
	14	61	ORGA 05277							
	14 D		ORGA 05277							
	14 GT	62	ORGA 05090		12.92					
	Electric	25			04.93					
										

¹⁾ electric parking brake / fr.di stazionamento elettrico / frein à main électrique / freno de mano eléctrico



CITROEN AX (86-98)

	Electric	28		11.96	04.97		11.0441-4501.2	250015		Dichtungssatz	ATE
	10	33	ORGA 05105	07.86		+ Bremsgerät ¹⁾	83.6196-0325.3	330727	2	L=325	
	10	33	ORGA 03825	07.86		- Bremsgerät ²⁾					
	10 E	30	ORGA 03825	12.86		- Bremsgerät ²⁾					
	10 E	30		12.86	12.88	+ Bremsgerät ¹⁾					
	11	40	ORGA 05105	12.86							
	11	44	ORGA 05105	10.89							
	13 Sport			04.87	12.88						
	14	44	ORGA 05105	12.86							
	14	49	ORGA 05105	06.88							
	14	51	ORGA 05105	01.89							
	14	55	ORGA 05105	03.89							
	14	61	ORGA 05105	01.88							
	14 D		ORGA 05105	09.88							
	14 GT	62	ORGA 05105	01.88							
	10	33	ORGA 03826		12.98		24.5111-0336.3	330570	2	L=335	
	10	37		07.92	12.98						
	10 E	30	ORGA 03826		12.88						
	11	44	ORGA 05106		12.97						
	14	51	ORGA 05106	ORGA 05277							
	14	55	ORGA 05106		04.91						
	14	61	ORGA 05106	ORGA 05277							
	14 D		ORGA 05106		04.91						
	14 GT	62	ORGA 05106		12.92						
	1.4 Allure	48		08.92	04.94		24.5111-0290.3	330108	2	L=290	
	14	51	ORGA 05278		12.91						
	14	55	ORGA 05278		12.96						
	14	61	ORGA 05278		12.92						
	14 4x4	55		08.91	12.96						
	14 D		ORGA 05278		12.97						
	14 GT	59		12.91	12.98						
	14 GTI			06.91	12.96						
	15 D			08.94	12.97						
	Electric	25		04.93	10.96						
	Electric	28		11.96	04.97						
	1.4 Allure	48	ORGA 06321	08.92			24.5228-0200.3	330470	2	L=200	
	10	33	ORGA 06321	07.86		+ Bremsgerät ¹⁾					
	10	33	ORGA 03825	07.86		- Bremsgerät ²⁾					
	10	37	ORGA 06321	07.92							
	10 E	30	ORGA 03825	12.86		- Bremsgerät ²⁾					
	10 E	30		12.86	12.88	+ Bremsgerät ¹⁾					
	11	40	ORGA 06321	12.86							
	11	44	ORGA 06321	10.89							
	13 Sport			04.87	12.88						
	14	44		12.86	12.88						
	14	49		06.88	12.89						
	14	51		01.89	12.91						
	14	55	ORGA 06321	03.89							
	14	61		01.88	12.92						
	14 D		ORGA 06321	09.88							
	14 GT	59	ORGA 06321	12.91							
	14 GT	62		01.86	12.92						
	14 GTI		ORGA 06321	06.91		- ABS					
	1.4 Allure	48	ORGA 06322		04.94		24.5229-0199.3	330534	2	L=200	
	10	33	ORGA 06322		12.98						
	10	37	ORGA 06322		12.98						
	11	44	ORGA 06322		12.97						
	14	55	ORGA 06322		12.96						
	14 D		ORGA 06322		12.97						
	14 GT	59	ORGA 06322		12.98						
	14 GTI		ORGA 06322		12.96						
	15 D			08.94	12.97						
	Electric	25		04.93	10.96						
	Electric	28		11.96	04.97						
	14 4x4	55		08.91	12.96		24.5229-0265.3	330540	2	L=265	
	14 GTI		ORGA 06321	06.91		+ ABS	24.5228-0195.3	330469	2	L=202	
	1.4 Allure	48		08.92	04.94		24.3219-1119.3	020333	2	Rz 19,05	BDX
	10	32		09.86	06.92		24.3219-1603.3	020200		RzR 19,05	BDX
	10	33		07.86	12.98		24.3219-1604.3	020201		RzR 19,05	BDX
	10	37		07.92	12.98						
	10 E	30		12.86	12.88						
	11	40		12.86	06.90						
	11	44		10.89	12.97						
	13 Sport			04.87	12.88						
	14	44		12.86	12.88						
	14	49		06.88	12.89						
	14 D			09.88	12.97						
	14 GT	62		01.88	12.92						
	15 D			08.94	12.97						
	Electric	25		04.93	10.96						
	Electric	28		11.96	04.97						
	14	51		01.89	12.91		24.3219-1609.3	020319		RzR 19,05	
	14	55		03.89	12.96		24.3219-1610.3	020320		RzR 19,05	
	14	61		01.88	12.92						

1) + booster unit / + servofreno / + servo-frein / + servofreno
 2) - booster unit / - servofreno / - servo-frein / - servofreno



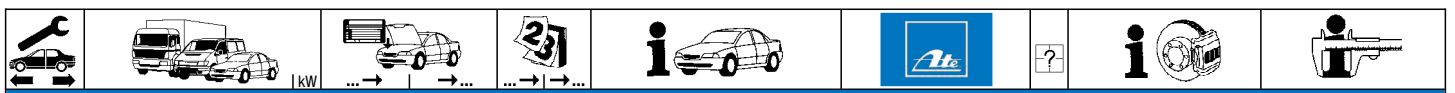

CITROEN AX (86-98)

	14 GT	59		12.91	12.98		24.3219-1609.3	020319			RzR 19,05
	14 GTI			06.91	12.96	- ABS	24.3219-1610.3	020320			RzR 19,05
	14 GTI			06.91	12.96	+ ABS	24.3220-1117.3	020314			Rz 20,64
	1.4 Allure	48		08.92	04.94		24.3727-0303.2	580303	2		L=1395
	10	33		07.86	12.98						
	10	37		07.92	12.98						
	10 E	30		12.86	12.88						
	11	40		12.86	06.90						
	11	44		10.89	12.97						
	13 Sport			04.87	12.88						
	14	44		12.86	12.88						
	14	49		06.88	12.89						
	14	51		01.89	12.91						
	14	55		03.89	12.96						
	14	61		01.88	12.92						
	14 D			09.88	12.97						
	14 GT	59		12.91	12.98						
	14 GT	62		01.88	12.92						
	14 GTI			06.91	12.96						
	15 D			08.94	12.97						
	10	33		07.86	12.88		24.3728-0301.2	590301			L=664
	10 E	30		12.86	12.88						
	11	40	ORGA 05047	12.86							
	11	44	ORGA 05047	10.89							
	13 Sport			04.87	12.88						
	14	44	ORGA 05047	12.86							
	14	49	ORGA 05047	06.88							
	14	51	ORGA 05047	01.89							
	14	55	ORGA 05047	03.89							
	14	61	ORGA 05047	01.88							
	14 D		ORGA 05047	09.88							
	14 GT	62	ORGA 05047	01.88							
	1.4 Allure	48		08.92	04.94		24.3728-0308.2	590308			L=635
	10	37		07.92	12.98						
	11	44	ORGA 05048	12.97							
	14	51	ORGA 05048	12.91							
	14	55	ORGA 05048	12.96							
	14	61	ORGA 05048	12.92							
	14 D		ORGA 05048	12.97							
	14 GT	59		12.91	12.98						
	14 GT	62	ORGA 05048	12.92							
	15 D			08.94	12.97						

CITROEN BERLINGO (MF) Kombi (96-08)



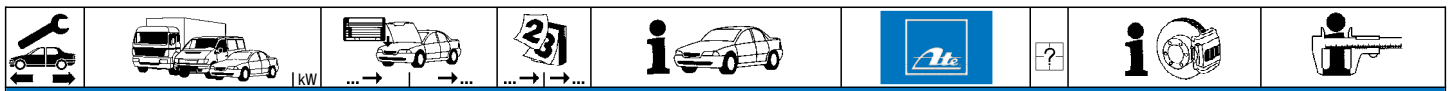









	1.1 i	44	ORGA 08609	07.96		- ABS	24.2123-1710.3	010504			Thz 23,81	BOS
	1.4 GNC	48	ORGA 08609	11.02		- ABS						
	1.4 Hybrid	54	ORGA 08609	05.05		- ABS						
	1.4 i	55	ORGA 08609	07.96		- ABS						
	1.8 D	43	ORGA 08609	07.98		- ABS						
	1.8 i	66	ORGA 08609	05.97		- ABS						
	1.9 D	50	ORGA 08609	07.96		- ABS						
	1.9 D	51	ORGA 08609	07.98		- ABS						
	1.1 i	44	ORGA 08609	07.96		+ ABS	24.2123-1713.3	010505			Thz 23,81	BOS
	1.4 GNC	48	ORGA 08609	11.02		+ ABS						
	1.4 i	55	ORGA 08609	07.96		+ ABS						
	1.8 D	43	ORGA 08609	07.98		+ ABS						
	1.8 i	66	ORGA 08609	05.97		+ ABS						
	1.9 D	50	ORGA 08609	07.96		+ ABS						
	1.9 D	51	ORGA 08609	07.98		+ ABS						
	1.1 i	44	ORGA 08610		03.08		03.2123-2781.3	010631		- ABS	Thz 23,81	ATE
	1.4	53		11.02	03.08		24.2123-1714.3	010587		- ABS	Thz 23,81	BDX
	1.4 Bivalent			11.02	03.08		24.2123-1715.3	010520		- ESP	Thz 23,81	BDX
	1.4 GNC	48	ORGA 08610		03.08							
	1.4 Hybrid	54	ORGA 08610		03.08							
	1.4 i	55	ORGA 08610		03.08							
	1.6 16V	80		10.00	03.08							
	1.6 HDi	80		08.05	03.08							
	1.6 HDi 75	55		07.05	03.08							
	1.6 HDi 90	66		07.05	03.08							
	1.8 D	43	ORGA 08610		03.08							
	1.8 i	66	ORGA 08610		03.08							
	1.9 D	50	ORGA 08610		03.08							
	1.9 D	51	ORGA 08610		03.08							
	2.0 HDi	66		12.99	03.08							
	Electric	16		01.00	03.08							
	Electric	27		11.02	03.08							
	1.1 i	44	ORGA 09428	07.96			24.3541-1777.5	240247			D=54, - Halter	TRW
	1.4 GNC	48	ORGA 09428	11.02			24.3541-1778.5	240248			D=54, - Halter	TRW
	1.4 Hybrid	54	ORGA 09428	05.05								
	1.4 i	55	ORGA 09428	07.96								
	Electric	16		01.00	03.08							
	Electric	27		11.02	03.08							
	1.1 i	44	ORGA 09127	07.96			24.3541-1757.7	220483			D=54, - Halter	TRW
	1.4 GNC	48	ORGA 09127	11.02			24.3541-1758.7	220484			D=54, - Halter	TRW
	1.4 Hybrid	54	ORGA 09127	05.05								
	1.4 i	55	ORGA 09127	07.96								



CITROEN BERLINGO (MF) Kombi (96-08)

	1.6 16V	80	ORGA 09127	10.00		24.3541-1757.7	220483		D=54, - Halter D=54, - Halter	TRW TRW			
	1.8 D	43	ORGA 09127	07.98		24.3541-1758.7	220484						
	1.8 i	66	ORGA 09127	05.97									
	1.9 D	50	ORGA 09127	07.96									
	1.9 D	51	ORGA 09127	07.98									
	2.0 HDi	66	ORGA 09127	12.99									
	1.1 i	44	ORGA 09429		03.08	24.3541-1771.5	240239						
	1.1 i	44	ORGA 09128		03.08	24.3541-1772.5	240240						
	1.4	53		11.02	03.08								
	1.4 Bivalent			11.02	03.08								
1.4 GNC	48	ORGA 09429		03.08									
1.4 GNC	48	ORGA 09128		03.08									
1.4 Hybrid	54	ORGA 09429		03.08									
1.4 Hybrid	54	ORGA 09128		03.08									
1.4 i	55	ORGA 09128		03.08									
1.4 i	55	ORGA 09429		03.08									
1.6 16V	80	ORGA 09128		03.08			- ESP						
1.6 HDi	80		08.05	03.08			- ESP						
1.6 HDi 75	55		07.05	03.08									
1.6 HDi 90	66		07.05	03.08			- ESP						
1.8 D	43	ORGA 09128		03.08									
1.8 i	66	ORGA 09128		03.08									
1.9 D	50	ORGA 09128		03.08									
1.9 D	51	ORGA 09128		03.08									
2.0 HDi	66	ORGA 09128		03.08			- ESP						
1.6 16V	80	ORGA 09128		03.08	24.3541-1761.5	240233	+ ESP	D=54, - Halter D=54, - Halter	BOS BOS				
1.6 HDi	80		08.05	03.08	24.3541-1762.5	240234	+ ESP						
1.6 HDi 90	66		07.05	03.08			+ ESP						
2.0 HDi	66	ORGA 09128		03.08			+ ESP						
	1.1 i	44		07.96	03.08	24.5111-0438.3	330568		L=445				
	1.4	53		11.02	03.08								
	1.4 Bivalent			11.02	03.08								
	1.4 GNC	48		11.02	03.08								
	1.4 Hybrid	54		05.05	03.08								
	1.4 i	55		07.96	03.08								
	1.6 16V	80		10.00	03.08						- ESP		
	1.6 HDi	80		08.05	03.08						- ESP		
	1.6 HDi 75	55		07.05	03.08								
	1.6 HDi 90	66		07.05	03.08						- ESP		
	1.8 D	43		07.98	03.08								
	1.8 i	66		05.97	03.08								
	1.9 D	50		07.96	03.08								
	1.9 D	51		07.98	03.08								
	2.0 HDi	66		12.99	03.08						- ESP		
	Electric	16		01.00	03.08								
	Electric	27		11.02	03.08								
	1.6 16V	80		10.00	03.08	24.5111-0460.3	330603				+ ESP	L=460	
	1.6 HDi	80		08.05	03.08						+ ESP		
	1.6 HDi 90	66		07.05	03.08						+ ESP		
2.0 HDi	66		12.99	03.08			+ ESP						
	1.6 16V	80		10.00	03.08	24.3387-1711.7	220747		D=38, - Halter D=38, - Halter	TRW TRW			
	1.6 HDi	80		08.05	03.08	24.3387-1712.7	220748						
	1.6 HDi 90	66		07.05	03.08								
	2.0 HDi	66		12.99	03.08								
	1.1 i	44	ORGA 09533	07.96		24.5229-0255.3	330581		L=255				
	1.4 Bivalent		ORGA 09533	11.02									
	1.4 GNC	48	ORGA 09533	11.02									
	1.4 Hybrid	54	ORGA 09533	05.05									
	1.4 i	55	ORGA 09533	07.96									
	1.6 16V	80	ORGA 09533	10.00									
	1.8 D	43	ORGA 09533	07.98									
	1.8 i	66	ORGA 09533	05.97									
	1.9 D	50	ORGA 09533	07.96									
	1.9 D	51	ORGA 09533	07.98									
	2.0 HDi	66	ORGA 09533	12.99									
	Electric	16	ORGA 09533	01.00									
	Electric	27	ORGA 09533	11.02									
	1.1 i	44	ORGA 09534		03.08	24.5246-0260.3	330782		L=260				
	1.4	53		11.02	03.08								
	1.4 Bivalent		ORGA 09534		03.08								
	1.4 GNC	48	ORGA 09534		03.08								
	1.4 Hybrid	54	ORGA 09534		03.08								
	1.4 i	55	ORGA 09534		03.08								
	1.6 16V	80	ORGA 09534		03.08								
	1.6 HDi	80		08.05	03.08								
	1.6 HDi 75	55		07.05	03.08								
	1.6 HDi 90	66		07.05	03.08								
	1.8 D	43	ORGA 09534		03.08								
	1.8 i	66	ORGA 09534		03.08								
	1.9 D	50	ORGA 09534		03.08								
	1.9 D	51	ORGA 09534		03.08								
	2.0 HDi	66	ORGA 09534		03.08								
	Electric	16	ORGA 09534		03.08								
	Electric	27	ORGA 09534		03.08								



        											
CITROEN BERLINGO (MF) Kombi (96-08)											
	1.1 i	44		07.96	03.08		24.3222-1711.3	020413	+ GG ¹⁾	Rz 22,20	TRW
	1.4	53		11.02	03.08		24.3222-1734.3	020539	+ ALU ²⁾	Rz 22,20	
	1.4 Bivalent			11.02	03.08						
	1.4 GNC	48		11.02	03.08						
	1.4 Hybrid	54		05.05	03.08						
	1.4 i	55		07.96	03.08						
	1.6 16V	80		10.00	03.08	- ESP					
	1.6 HDi	80		08.05	03.08	- ESP					
	1.6 HDi 75	55		07.05	03.08						
	1.6 HDi 90	66		07.05	03.08	- ESP					
	1.8 D	43		07.98	03.08						
	1.8 i	66		05.97	03.08						
	1.9 D	50		07.96	03.08						
	1.9 D	51		07.98	03.08						
2.0 HDi	66		12.99	03.08	- ESP						
Electric	16		01.00	03.08							
Electric	27		11.02	03.08							
	1.1 i	44	ORGA 08393	07.96			24.3727-0314.2	580314	<input type="checkbox"/>	L=1745	
	1.4 GNC	48	ORGA 08393	11.02			24.3727-0315.2	580315	<input type="checkbox"/>	L=1818	
	1.4 Hybrid	54	ORGA 08393	05.05							
	1.4 i	55	ORGA 08393	07.96							
	1.8 D	43	ORGA 08393	07.98							
	1.8 i	66	ORGA 08393	05.97							
	1.9 D	50	ORGA 08393	07.96							
	1.9 D	51	ORGA 08393	07.98							
	1.1 i	44	ORGA 08394		03.08		24.3727-0314.2	580314	<input type="checkbox"/>	L=1745	
	1.4	53		11.02	03.08		24.3727-0339.2	580339	<input type="checkbox"/>	L=1850	
	1.4 Bivalent			11.02	03.08						
	1.4 GNC	48	ORGA 08394		03.08						
	1.4 Hybrid	54	ORGA 08394		03.08						
	1.4 i	55	ORGA 08394		03.08						
1.6 16V	80	ORGA 08394		03.08	- ESP						
1.6 HDi	80		08.05	03.08	- ESP						
1.6 HDi 75	55		07.05	03.08							
1.6 HDi 90	66		07.05	03.08	- ESP						
1.8 D	43	ORGA 08394		03.08							
1.8 i	66	ORGA 08394		03.08							
1.9 D	50	ORGA 08394		03.08							
1.9 D	51	ORGA 08394		03.08							
2.0 HDi	66	ORGA 08394		03.08	- ESP						
1.6 16V	80		10.00	03.08	+ ESP	24.3727-0349.2	580349	<input type="checkbox"/>	L=1820		
1.6 HDi	80		08.05	03.08	+ ESP	24.3727-0347.2	580347	<input type="checkbox"/>	L=1923		
1.6 HDi 90	66		07.05	03.08	+ ESP						
2.0 HDi	66		12.00	03.08	+ ESP						
	1.1 i	44		07.96	03.08	- Mehrfunktionsdach ³⁾	03.6582-0010.3	320145	- verstärktes Fahrwerk ⁴⁾	BRL 8/1,5 (4)	ATE
	1.4	53		11.02	03.08	- Mehrfunktionsdach ³⁾					
	1.4 Bivalent			11.02	03.08	- Mehrfunktionsdach ³⁾					
	1.4 GNC	48		11.02	03.08	- Mehrfunktionsdach ³⁾					
	1.4 Hybrid	54		05.05	03.08	- Mehrfunktionsdach ³⁾					
	1.4 i	55		07.96	03.08	- Mehrfunktionsdach ³⁾					
	1.6 16V	80		10.00	03.08	- Mehrfunktionsdach ³⁾					
	1.6 HDi	80		08.05	03.08	- Mehrfunktionsdach ³⁾					
	1.6 HDi 75	55		07.05	03.08	- Mehrfunktionsdach ³⁾					
	1.6 HDi 90	66		07.05	03.08	- Mehrfunktionsdach ³⁾					
	1.8 D	43		07.98	03.08	- Mehrfunktionsdach ³⁾					
	1.8 i	66		05.97	03.08	- Mehrfunktionsdach ³⁾					
	1.9 D	50		07.96	03.08	- Mehrfunktionsdach ³⁾					
	1.9 D	51		07.98	03.08	- Mehrfunktionsdach ³⁾					
	2.0 HDi	66		12.99	03.08	- Mehrfunktionsdach ³⁾					
	Electric	16		01.00	03.08	- Mehrfunktionsdach ³⁾					
	Electric	27		01.00	03.08	- Mehrfunktionsdach ³⁾					
	1.1 i	44		07.96	03.08	+ Mehrfunktionsdach ⁵⁾	03.6582-0015.3	320227	- verstärktes Fahrwerk ⁴⁾	BRL 8/1,5 (4)	
	1.4	53		11.02	03.08	+ Mehrfunktionsdach ⁵⁾					
	1.4 Bivalent			11.02	03.08	+ Mehrfunktionsdach ⁵⁾					
	1.4 GNC	48		11.02	03.08	+ Mehrfunktionsdach ⁵⁾					
	1.4 Hybrid	54		05.05	03.08	+ Mehrfunktionsdach ⁵⁾					
	1.4 i	55		07.96	03.08	+ Mehrfunktionsdach ⁵⁾					
	1.6 16V	80		10.00	03.08	+ Mehrfunktionsdach ⁵⁾					
1.6 HDi	80		08.05	03.08	+ Mehrfunktionsdach ⁵⁾						
1.6 HDi 75	55		07.05	03.08	+ Mehrfunktionsdach ⁵⁾						
1.6 HDi 90	66		07.05	03.08	+ Mehrfunktionsdach ⁵⁾						
1.8 D	43		07.98	03.08	+ Mehrfunktionsdach ⁵⁾						
1.8 i	66		05.97	03.08	+ Mehrfunktionsdach ⁵⁾						
1.9 D	50		07.96	03.08	+ Mehrfunktionsdach ⁵⁾						
1.9 D	51		07.98	03.08	+ Mehrfunktionsdach ⁵⁾						
2.0 HDi	66		12.99	03.08	+ Mehrfunktionsdach ⁵⁾						
Electric	16		01.00	03.08	+ Mehrfunktionsdach ⁵⁾						
Electric	27		11.02	03.08	+ Mehrfunktionsdach ⁵⁾						
1.1 i	44		07.96	03.08	- ABS	03.6582-0011.3	320232	+ verstärktes Fahrwerk ⁶⁾	BRL 8/1,5 (4)		
1.4	53		11.02	03.08	- ABS						
1.4 Bivalent			11.02	03.08	- ABS						
1.4 GNC	48		11.02	03.08	- ABS						
1.4 Hybrid	54		05.05	03.08	- ABS						
1.4 i	55		07.96	03.08	- ABS						
1.6 16V	80		10.00	03.08	- ABS						
1.6 HDi	80		08.05	03.08	- ABS						
1.6 HDi 75	55		07.05	03.08	- ABS						

¹⁾ + cast iron / + ghisa / + fonte grise / + fundición de gris

²⁾ + aluminium / + alluminio / + aluminium / + aluminio

³⁾ - multifunction roof / - tetto multifunzionale / - toit multifonctionnel / - techo multifuncional

⁴⁾ - reinforced suspension / - sospensione rinforzata / - châssis renforcé / - suspensión reforzada

⁵⁾ + multifunction roof / + tetto multifunzionale / + toit multifonctionnel / + techo multifuncional

⁶⁾ + reinforced suspension / + sospensione rinforzata / + châssis renforcé / + suspensión reforzada



CITROEN BERLINGO (MF) Kombi (96-08)



























	1.6 HDi 90	66		07.05	03.08	- ABS	03.6582-0011.3	320232	+ verstärktes Fahrwerk ¹⁾	BRL 8/1,5 (4)	ATE							
	1.8 D	43		07.98	03.08	- ABS												
	1.8 i	66		05.97	03.08	- ABS												
	1.9 D	50		07.96	03.08	- ABS												
	1.9 D	51		07.98	03.08	- ABS												
	2.0 HDi	66		12.99	03.08	- ABS												
	Electric	16		01.00	03.08													
	Electric	27		11.02	03.08													
	1.1 i	44		07.96	03.08	+ ABS												
	1.4	53		11.02	03.08	+ ABS												
	1.4 Bivalent		11.02	03.08	+ ABS	03.6582-0012.3	320233	+ verstärktes Fahrwerk ¹⁾	BRL 8/1,5 (4)	ATE								
	1.4 GNC	48		11.02	03.08						+ ABS							
	1.4 Hybrid	54		05.05	03.08						+ ABS							
	1.4 i	55		07.96	03.08						+ ABS							
	1.6 16V	80		10.00	03.08						+ ABS							
	1.6 HDi	80		08.05	03.08						+ ABS							
	1.6 HDi 75	55		07.05	03.08						+ ABS							
	1.6 HDi 90	66		07.05	03.08						+ ABS							
	1.8 D	43		07.98	03.08						+ ABS							
	1.8 i	66		05.97	03.08						+ ABS							
	1.9 D	50		07.96	03.08	+ ABS	24.3728-0328.2	590328		L=617								
	1.9 D	51		07.98	03.08	+ ABS												
	2.0 HDi	66		12.99	03.08	+ ABS												
	1.6 16V	80		10.00	03.08						24.3728-0850.2	590850		L=909, + AUT				
	1.6 HDi	80		08.05	03.08													
	1.6 HDi 75	55		07.05	03.08													
	1.6 HDi 90	66		07.05	03.08													
	1.6 HDi	80	ORGA 11190	08.05											24.3728-0850.2	590850	+ BE4-Getriebe ²⁾	L=909, + AUT
	1.6 HDi 75	55	ORGA 11190	07.05														
	1.6 HDi 90	66	ORGA 11190	07.05														
1.9 D	50		07.96	03.08														
1.9 D	51		07.98	03.08														
2.0 HDi	66	ORGA 11190	12.99															
1.6 HDi	80	ORGA 11191		03.08		24.3728-0343.2	590343	+ BE4-Getriebe ²⁾	L=882, + AUT									
1.6 HDi 75	55	ORGA 11191		03.08														
1.6 HDi 90	66	ORGA 11191		03.08														
2.0 HDi	66	ORGA 11191		03.08														
1.8 D	43		04.98	03.08						24.3728-0329.2	590329		L=653, + AUT					
1.9 D	50		07.96	03.08	+ BE3-Getriebe ³⁾													
1.9 D	51		07.98	03.08	+ BE3-Getriebe ³⁾													
1.8 i	66		05.97	03.08														
CITROEN BERLINGO (M_) Kasten (96-08)																		
	1.1 i	44	ORGA 08609	07.96										- ABS	24.2123-1710.3	010504		THz 23,81
	1.4 i	55	ORGA 08609	07.96		- ABS												
	1.8 D	43	ORGA 08609	07.96		- ABS												
	1.9 D	51	ORGA 08609	07.96		- ABS												
	2.0 HDi 90	66	ORGA 08609	12.99		- ABS												
	1.1 i	44	ORGA 08609	07.96		+ ABS	24.2123-1713.3	010505		THz 23,81	BOS							
	1.4 i	55	ORGA 08609	07.96		+ ABS												
	1.8 D	43	ORGA 08609	07.96		+ ABS												
	1.9 D	51	ORGA 08609	07.96		+ ABS												
	2.0 HDi 90	66	ORGA 08609	12.99		+ ABS												
1.1 i	44	ORGA 08610		03.08		03.2123-2781.3						010631		THz 23,81	ATE			
1.4	48		11.02	03.08														
1.4 Bivalent	55		11.02	03.08														
1.4 i	55	ORGA 08610		03.08														
1.6 16V			10.00	03.08														
1.6 HDi 75	55		07.05	03.08														
1.8 D	43	ORGA 08610		03.08														
1.9 D	51	ORGA 08610		03.08														
2.0 HDi 90	66	ORGA 08610		03.08														
	1.1 i	44	ORGA 09428	07.96				24.3541-1777.5	240247		D=54, - Halter					TRW		
	1.4 i	55	ORGA 09428	07.96														
	Electric	27		11.04	03.08													
	1.1 i	44	ORGA 09127	07.96			24.3541-1757.7					220483		D=54, - Halter	TRW			
	1.4 i	55	ORGA 09127	07.96														
	1.6 16V		ORGA 09127	10.00														
	1.8 D	43	ORGA 09127	07.96														
	1.8 i	66	ORGA 09127	08.99														
	1.9 D	51	ORGA 09127	07.96														
	2.0 HDi 90	66	ORGA 09127	12.99														
1.1 i	44	ORGA 09429		03.08		24.3541-1771.5		240239		D=54, - Halter	BOS							
1.1 i	44	ORGA 09128		03.08														
1.4	48		11.02	03.08														
1.4 Bivalent	55		11.02	03.08														
1.4 i	55	ORGA 09429		03.08														
1.4 i	55	ORGA 09128		03.08														
1.6 16V		ORGA 09128		03.08														

¹⁾ + reinforced suspension / + sospensione rinforzata / + châssis renforcé / + suspensión reforzada

²⁾ + BE4 transmission / + scatola cambio BE4 / + boîte de vitesse BE4 / + cambio BE4

³⁾ + BE3 transmission / + scatola cambio BE3 / + boîte de vitesse BE3 / + cambio BE3



										
CITROEN BERLINGO (M_) Kasten (96-08)										
	1.6 HDi 75 1.6 HDi 90 1.8 D 1.8 i 1.9 D 2.0 HDi 90	55 66 43 ORGA 09128 66 ORGA 09128 51 ORGA 09128 66 ORGA 09128		07.05 07.05 03.08 03.08 03.08 03.08		24.3541-1771.5 24.3541-1772.5	240239 240240	 	D=54, - Halter D=54, - Halter	BOS BOS
	1.1 i 1.4 1.4 Bivalent 1.4 i 1.6 16V 1.6 HDi 75 1.6 HDi 90 1.8 D 1.8 i 1.9 D 2.0 HDi 90 Electric 2.0 HDi 90	44 48 55 55 55 66 66 43 66 51 66 27 66		07.96 11.02 11.02 07.96 10.00 07.05 07.05 07.96 08.99 07.96 12.99 07.03 12.99	03.08 03.08 03.08 03.08 03.08 03.08 03.08 03.08 03.08 03.08 03.08 03.08 03.08 + ESP	24.5111-0438.3	330568	2	L=445	
	2.0 HDi 90	66		12.99	03.08 + ESP	24.3387-1711.7 24.3387-1712.7	220747 220748	 	D=38, - Halter D=38, - Halter	TRW TRW
	1.1 i 1.4 1.4 Bivalent 1.4 i 1.6 16V 1.8 D 1.8 i 1.9 D 2.0 HDi 90 Electric	44 48 55 55 55 43 66 51 66 27	ORGA 09533 ORGA 09533 ORGA 09533 ORGA 09533 ORGA 09533 ORGA 09533 ORGA 09533 ORGA 09533 ORGA 09533 ORGA 09533	07.96 11.02 11.02 07.96 10.00 07.96 08.99 07.96 12.99 11.04		24.5229-0255.3	330581	2	L=255	
	1.1 i 1.4 1.4 Bivalent 1.4 i 1.6 16V 1.6 HDi 75 1.6 HDi 90 1.8 D 1.8 i 1.9 D 2.0 HDi 90 Electric	44 48 55 55 55 66 66 43 66 51 66 27	ORGA 09534 ORGA 09534 ORGA 09534 ORGA 09534 ORGA 09534 ORGA 09534 ORGA 09534 ORGA 09534 ORGA 09534 ORGA 09534 ORGA 09534	07.05 07.05 03.08 03.08 03.08 03.08 03.08 03.08 03.08 03.08 03.08		24.5246-0260.3	330782	2	L=260	
	1.1 i 1.4 1.4 Bivalent 1.4 i 1.6 16V 1.6 HDi 75 1.6 HDi 90 1.8 D 1.8 i 1.9 D 2.0 HDi 90 Electric	44 48 55 55 55 66 66 43 66 51 66 27		07.96 11.02 11.02 07.96 10.00 07.05 07.05 07.96 08.99 07.96 12.99 07.03	03.08 03.08 03.08 03.08 03.08 03.08 03.08 03.08 03.08 03.08 03.08 - ESP	24.3222-1711.3 24.3222-1734.3	020413 020539	+ GG ¹⁾ + ALU ²⁾	Rz 22,20 Rz 22,20	TRW TRW
	1.1 i 1.4 i 1.8 D 1.8 i 1.9 D	44 55 43 66 51	ORGA 08393 ORGA 08393 ORGA 08393 ORGA 08393 ORGA 08393	07.96 07.96 07.96 08.99 07.96		24.3727-0314.2 24.3727-0315.2	580314 580315	 	L=1745 L=1818	
	1.1 i 1.4 1.4 Bivalent 1.4 i 1.6 16V 1.6 HDi 75 1.6 HDi 90 1.8 D 1.8 i 1.9 D 2.0 HDi 90	44 48 55 55 55 66 66 43 66 51 66	ORGA 08394 ORGA 08394 ORGA 08394 ORGA 08394 ORGA 08394 ORGA 08394 ORGA 08394 ORGA 08394 ORGA 08394 ORGA 08394	11.02 11.02 03.08 03.08 10.00 07.05 07.05 03.08 03.08 03.08 03.08		24.3727-0314.2 24.3727-0339.2	580314 580339	 	L=1745 L=1850	
	1.1 i 1.4 1.4 Bivalent 1.4 i 1.6 16V 1.6 HDi 75 1.8 D 1.9 D 2.0 HDi 90	44 48 55 55 55 43 51 66		07.96 11.02 11.02 07.96 10.00 07.05 07.96 07.96 12.99	03.08 + 0,5/0,6 t/ -verstärktes Fahrwerk ³⁾ 03.08 + 0,5/0,6 t/ -verstärktes Fahrwerk ³⁾ 03.08 + 0,5/0,6 t/ -verstärktes Fahrwerk ³⁾ 03.08 + 0,5/0,6 t/ -verstärktes Fahrwerk ³⁾ 03.08 + 0,6 t/ -verstärktes Fahrwerk ⁴⁾ 03.08 + 0,6 t/ -verstärktes Fahrwerk ⁴⁾ 03.08 + 0,6 t/ -verstärktes Fahrwerk ⁴⁾ 03.08 + 0,6 t/ -verstärktes Fahrwerk ⁴⁾ 03.08 + 0,6 t/ -verstärktes Fahrwerk ⁴⁾	03.6582-0009.3	320143		BRL 8/1,5 (4)	ATE
	1.1 i 1.4 1.4 Bivalent 1.4 i 1.6 16V	44 48 55 55 55		07.96 11.02 11.02 07.96 10.00	03.08 + 0,5/0,6 t/ +verstärktes Fahrwerk ⁵⁾ 03.08 + 0,5/0,6 t/ +verstärktes Fahrwerk ⁵⁾ 03.08 + 0,5/0,6 t/ +verstärktes Fahrwerk ⁵⁾ 03.08 + 0,5/0,6 t/ +verstärktes Fahrwerk ⁵⁾ 03.08 + 0,6 t/ +verstärktes Fahrwerk ⁶⁾	03.6582-0012.3	320233		BRL 8/1,5 (4)	ATE

¹⁾ + cast iron / + ghisa / + fonte grise / + fundición de gris

²⁾ + aluminium / + alluminio / + aluminium / + aluminium

³⁾ + 0,5/0,6 t/ -reinforc.suspens. / + 0,5/0,6 t/ - sospensione rinforzata / + 0,5/0,6 t/ - châssis renforcé / + 0,5/0,6 t/ - suspensión reforzada

⁴⁾ + 0,6 t/ -reinforced suspens. / + 0,6 t/ - sospensione rinforzata / + 0,6 t/ - châssis renforcé / + 0,6 t/ - suspensión reforzada

⁵⁾ + 0,5/0,6 t/ +reinforc.suspens. / + 0,5/0,6 t/ + sospensione rinforzata / + 0,5/0,6 t/ + châssis renforcé / + 0,5/0,6 t/ + suspensión reforzada

⁶⁾ + 0,6 t/ +reinforced suspens. / + 0,6 t/ + sospensione rinforzata / + 0,6 t/ + châssis renforcé / + 0,6 t/ + suspensión reforzada



CITROEN BERLINGO (M_) Kasten (96-08)

	1.6 HDi 75	55		07.05	03.08	+ 0,6 t / + verstärktes Fahrwerk ¹⁾	03.6582-0012.3	320233		BRL 8/1,5 (4)	ATE
	1.8 D	43		07.96	03.08	+ 0,6 t / + verstärktes Fahrwerk ¹⁾					
	1.9 D	51		07.96	03.08	+ 0,6 t / + verstärktes Fahrwerk ¹⁾					
	2.0 HDi 90	66		12.99	03.08	+ 0,6 t / + verstärktes Fahrwerk ¹⁾					
	1.6 16V			10.00	03.08	+ 0,8 t					
	1.6 HDi 75	55		07.05	03.08	+ 0,8 t					
1.8 D	43		07.96	03.08	+ 0,8 t						
1.9 D	51		07.96	03.08	+ 0,8 t						
2.0 HDi 90	66		12.99	03.08	+ 0,8 t						
	1.1 i	44		07.96	03.08		24.3728-0328.2	590328		L=617	
	1.4	48		11.02	03.08						
	1.4 Bivalent	55		11.02	03.08						
	1.4 i	55		07.96	03.08						
	1.6 16V		ORGA 11192	10.00			24.3728-0850.2	590850		L=909, + AUT	
	1.6 HDi 75	55	ORGA 11192	07.05							
	1.8 D	43	ORGA 11192	07.96							
	1.9 D	51	ORGA 11192	07.96							
	2.0 HDi 90	66	ORGA 11192	12.99							
	1.6 16V		ORGA 11193		03.08		24.3728-0343.2	590343		L=882, + AUT	
	1.6 HDi 75	55	ORGA 11193		03.08						
	1.8 D	43	ORGA 11193		03.08						
	1.9 D	51	ORGA 11193		03.08						
	2.0 HDi 90	66	ORGA 11193		03.08						
1.8 D	43			07.96	03.08	+ BE3-Getriebe ²⁾	24.3728-0329.2	590329		L=653, + AUT	
1.8 D	43			07.96	03.08	+ BE3-Getriebe ²⁾					
1.9 D	51			07.96	03.08	+ BE3-Getriebe ²⁾					

CITROEN BERLINGO (B9) (08-)

	1.2 PureTech 110	81		02.16			24.4123-1714.3	010979		+ ESP	THz 23,81	TRW
	1.6 BlueHDi 100	73		12.14								
	1.6 BlueHDi 120	88		12.14								
	1.6 BlueHDi 75	55		04.15								
	1.6 HDi 110	80		04.08								
	1.6 HDi 110	82		07.10								
	1.6 HDi 115	84		07.10								
	1.6 HDi 75	55		04.08								
	1.6 HDi 90	66		04.08								
	1.6 HDi 90	68		07.10								
	1.6 HDi 92	68		07.10								
	1.6 i 16V	66		04.08								
	1.6 i 16V	80		04.08								
	1.6 VTi 120	88		11.09								
	1.6 VTi 95	72		07.10								
	Electric			02.13								
	1.2 PureTech 110	81		02.16			11.9601-9717.2	220901	2		D=60, - Halter	ATE
	1.6 BlueHDi 100	73		12.14								
	1.6 BlueHDi 120	88		12.14								
	1.6 BlueHDi 75	55		04.15								
	1.6 HDi 110	80		04.08								
	1.6 HDi 110	82		07.10								
	1.6 HDi 115	84		07.10								
	1.6 HDi 75	55		04.08								
	1.6 HDi 90	66		04.08								
	1.6 HDi 90	68		07.10								
	1.6 HDi 92	68		07.10								
	1.6 i 16V	66		04.08								
	1.6 i 16V	80		04.08								
	1.6 VTi 120	88		11.09								
	1.6 VTi 95	72		07.10								
	Electric			02.13								
	1.2 PureTech 110	81		02.16			24.5111-0424.3	331014	2		L=424	
	1.6 BlueHDi 100	73		12.14								
	1.6 BlueHDi 120	88		12.14								
	1.6 BlueHDi 75	55		04.15								
	1.6 HDi 110	80		04.08								
	1.6 HDi 110	82		07.10								
	1.6 HDi 115	84		07.10								
	1.6 HDi 75	55		04.08								
	1.6 HDi 90	66		04.08								
	1.6 HDi 90	68		07.10								
	1.6 HDi 92	68		07.10								
	1.6 i 16V	66		04.08								
	1.6 i 16V	80		04.08								
	1.6 VTi 120	88		11.09								
	1.6 VTi 95	72		07.10								
	Electric			02.13								
	1.2 PureTech 110	81		02.16			24.5246-0216.3	331022	2		L=216	
	1.6 BlueHDi 100	73		12.14								
	1.6 BlueHDi 120	88		12.14								
	1.6 BlueHDi 75	55		04.15								
	1.6 HDi 110	80		04.08								
	1.6 HDi 110	82		07.10								
	1.6 HDi 115	84		07.12								
	1.6 HDi 75	55		04.08								
	1.6 HDi 90	66		04.08								
	1.6 HDi 90	68		07.10								

¹⁾ + 0,6 t / + reinforced suspens. / + 0,6 t / + sospensione rinforzata / + 0,6 t / + châssis renforcé / + 0,6 t / + suspensión reforzada

²⁾ + BE3 transmission / + scatola cambio BE3 / + boîte de vitesse BE3 / + cambio BE3





CITROEN BERLINGO (B9) (08-)

	1.6 HDi 92	68		07.10		24.5246-0216.3	331022	2		L=216
	1.6 i 16V	66		04.08						
	1.6 i 16V	80		04.08						
	1.6 VTi 120	88		11.09						
	1.6 VTi 95	72		07.10						
	Electric			02.13						
	1.6 BlueHdi 100	73	ORGA 14083	12.14		24.3727-0853.2	580853	2	↓	L=2398
	1.6 BlueHdi 120	88	ORGA 14083	12.14						
	1.6 BlueHdi 75	55	ORGA 14083	04.15						
	1.6 HDi 110	80	ORGA 14083	04.08						
	1.6 HDi 110	82	ORGA 14083	07.10						
	1.6 HDi 115	84	ORGA 14083	07.10						
	1.6 HDi 75	55	ORGA 14083	04.08						
	1.6 HDi 90	66	ORGA 14083	04.08						
	1.6 HDi 90	68	ORGA 14083	07.10						
	1.6 HDi 92	68	ORGA 14083	07.10						
	1.6 i 16V	66	ORGA 14083	04.08						
	1.6 i 16V	80	ORGA 14083	04.08						
	1.6 VTi 120	88	ORGA 14083	11.09						
	1.6 VTi 95	72	ORGA 14083	07.10						
	Electric		ORGA 14083	02.13						

CITROEN C1 (05-14)

	1.0	50		06.05	04.14	24.4120-1701.3	010846		- ESP	THz 20,64	BOS
	1.4 HDi	40		06.05	12.08						
	1.0	50		06.05	04.14	24.3481-1791.5	240731		☐	D=48, - Halter	
	1.4 HDi	40		06.05	12.08	24.3481-1792.5	240732		☐	D=48, - Halter	
	1.0	50		06.05	04.14	24.5295-0496.3	331033		☐	L=496	
	1.4 HDi	40		06.05	12.08	24.5262-0501.3	331025		☐	L=501	
	1.0	50		06.05	04.14	24.5261-0225.3	330909	2		L=225	
	1.4 HDi	40		06.05	12.08						
	1.0	50		06.05	04.14	24.3217-1719.3	020482			Rz 17,46	BOS
	1.4 HDi	40		06.05	12.08						
	1.0	50		06.05	04.14	24.3728-0851.2	590851			L=1596	
	1.4 HDi	40		06.05	12.08	24.3728-0852.2	590852			L=1479	

CITROEN C1 (14-)

	1.0 VTi 68	51		04.14		24.3481-1791.5	240731		☐	D=48, - Halter	
	1.2 VTi 82	60		04.14		24.3481-1792.5	240732		☐	D=48, - Halter	

CITROEN C2 (03-09)

	1.1 i	44		09.03	12.09	24.2120-1741.3	010775		- ABS	THz 20,64	
	1.4 16V	65		06.06	12.09						
	1.4 HDi	50		09.03	12.09						
	1.4 i			09.03	12.09						
	1.6 16V	80		09.03	12.09						
	1.1 i	44	ORGA 10800	09.03		24.2122-1766.3	010840		- ESP	THz 22,20	TRW
	1.4 HDi	50	ORGA 10800	09.03		24.2122-1767.3	010841		+ ESP	THz 22,20	TRW
	1.4 i		ORGA 10800	09.03							
	1.6 16V	80	ORGA 10800	09.03							
	1.6 VTS	90	ORGA 10800	01.05							
	1.1 i	44	ORGA 10801			24.4122-1708.3	010865		- ESP	THz 22,20	BOS
	1.4 16V	65	ORGA 10801								
	1.4 HDi	50	ORGA 10801								
	1.4 i		ORGA 10801								
	1.1 i	44	ORGA 10808			24.4122-1704.3	010847		- ESP	THz 22,20	TRW
	1.4 16V	65	ORGA 10808								
	1.4 HDi	50	ORGA 10808								
	1.4 i		ORGA 10808								
	1.6 16V	80	ORGA 10801		12.09						
	1.1 i	44	ORGA 10811			24.4122-1708.3	010865		- ESP	THz 22,20	BOS
	1.4 16V	65	ORGA 10811								
	1.4 HDi	50	ORGA 10811								
	1.4 i		ORGA 10811								
	1.1 i	44	ORGA 10815			24.2122-1764.3	010851		- ESP	THz 22,20	BOS
	1.4 16V	65	ORGA 10815								
	1.4 HDi	50	ORGA 10815								
	1.4 i		ORGA 10815								
	1.1 i	44	ORGA 11193			24.4122-1708.3	010865		- ESP	THz 22,20	BOS
	1.4 16V	65	ORGA 11193								
	1.4 HDi	50	ORGA 11193								
	1.4 i		ORGA 11193								
	1.1 i	44	ORGA 10801			24.4122-1704.3	010847		- ESP	THz 22,20	TRW
	1.4 16V	65	ORGA 10801								
	1.4 HDi	50	ORGA 10801								
	1.4 i		ORGA 10801								
	1.1 i	44	ORGA 10801			24.4122-1703.3	010843		+ ESP	THz 22,20	TRW
	1.4 16V	65	ORGA 10801								



CITROEN C2 (03-09)

	1.4 HDi 1.4 i 1.6 16V 1.6 HDi 1.6 VTS	50 ORGA 10801 80 ORGA 10801 80 ORGA 10801 90 ORGA 10801		12.09 12.09 12.09 12.09 12.09		24.4122-1703.3 010843		+ ESP	THz 22,20	TRW
	1.1 i 1.4 HDi 1.4 i	44 50		09.03 12.09 09.03 12.09	- belüftete Scheiben ¹⁾ - belüftete Scheiben ¹⁾ - belüftete Scheiben ¹⁾	24.3481-1761.5 240393 24.3481-1762.5 240394	<input type="checkbox"/>		D=48, - Halter D=48, - Halter	TRW TRW
	1.4 16V 1.4 HDi 1.4 i 1.6 16V	65 50	ORGA 10800	06.06 09.03 09.03 12.09	+ belüftete Scheiben ²⁾ + belüftete Scheiben ²⁾ + belüftete Scheiben ²⁾	24.3541-1803.7 220603 24.3541-1804.7 220604	<input type="checkbox"/>		D=54, - Halter D=54, - Halter	TRW TRW
	1.4 HDi 1.6 16V 1.6 HDi 1.6 VTS	50 80 80 90	ORGA 10801 ORGA 10801	12.09 12.09 09.05 12.09	+ belüftete Scheiben ²⁾	24.3541-1771.5 240239 24.3541-1772.5 240240	<input type="checkbox"/>		D=54, - Halter D=54, - Halter	BOS BOS
	1.1 i 1.4 16V 1.4 HDi 1.4 i 1.6 16V 1.6 HDi 1.6 VTS	44 65 50 80 80 90		09.03 12.09 06.06 12.09 09.03 12.09 09.05 12.09		24.5111-0460.3 330603 24.5111-0446.3 331055	2 2	- 16" Rad ³⁾ + 16" Rad ⁴⁾	L=460 L=445	
	1.4 16V 1.4 HDi 1.4 i 1.6 16V 1.6 HDi 1.6 VTS	65 50 80 80 90		06.06 12.09 09.03 12.09 09.05 12.09		24.3387-1705.7 220675 24.3387-1706.7 220676	<input type="checkbox"/>		D=38, - Halter D=38, - Halter	TRW TRW
	1.1 i 1.4 HDi 1.4 i 1.6 16V 1.6 VTS	44 50 80 90	ORGA 10569 ORGA 10569 ORGA 10569 ORGA 10569	09.03 09.03 09.03 01.05		24.5246-0185.3 330881	2		L=185	
	1.1 i 1.4 16V 1.4 HDi 1.4 i 1.6 16V 1.6 HDi 1.6 VTS	44 65 50 80 80 90	ORGA 10570 ORGA 10570 ORGA 10570 ORGA 10570 ORGA 10570	06.06 12.09 12.09 12.09 12.09 12.09		24.5246-0190.3 330697	2		L=190	
	1.1 i 1.4 16V 1.4 HDi 1.4 i	44 65 50		09.03 12.09 06.06 12.09 09.03 12.09 09.03 12.09	- ABS - ABS - ABS	24.3219-1739.3 020472 24.3219-1740.3 020473	<input type="checkbox"/>	nur paarweise austauschen ⁵⁾ nur paarweise austauschen ⁵⁾	RzR 19,05 RzR 19,05	TRW TRW
	1.1 i 1.4 16V 1.4 HDi 1.4 i	44 65 50		09.03 12.09 06.06 12.09 09.03 12.09 09.03 12.09	+ ABS + ABS + ABS	24.3220-1724.3 020476 24.3220-1717.3 020430		+ ALU ⁶⁾	Rz 20,64 Rz 20,64	BOS TRW
	1.1 i 1.4 16V 1.4 HDi 1.4 i	44 65 50		09.03 12.09 06.06 12.09 09.03 12.09 09.03 12.09	+ HA-Trommelbremse ⁷⁾ + HA-Trommelbremse ⁷⁾ + HA-Trommelbremse ⁷⁾ + HA-Trommelbremse ⁷⁾	24.3727-0843.2 580843	2		L=1612	

CITROEN C3 (02-09)

	1.1 i 1.4 16V 1.4 16V HDi 90 1.4 bivalent 1.4 HDi 1.4 i 1.6 16V	44 65 66 54 54 54 80		02.02 08.09 12.03 08.09 02.02 08.09 09.05 08.09 02.02 08.09 02.02 08.09		24.2120-1741.3 010775		- ABS	THz 20,64	
	1.1 i 1.4 16V 1.4 16V HDi 90 1.4 bivalent 1.4 HDi 1.4 i 1.6 16V 1.6 16V HDi 110 1.6 16V HDi 90	44 65 66 54 54 80 80 66	ORGA 10800 ORGA 10800 ORGA 10800 ORGA 10800 ORGA 10800 ORGA 10800 ORGA 10800 ORGA 10800	02.02 12.03 02.02 09.05 02.02 02.02 05.05 10.05		24.2122-1766.3 010840		- ESP	THz 22,20	TRW
	1.1 i 1.1 i 1.4 16V 1.4 16V HDi 90 1.4 16V HDi 90 1.4 bivalent 1.4 HDi 1.4 HDi 1.4 i 1.4 i 1.6 16V 1.6 16V HDi 110 1.6 16V HDi 90	44 44 65 66 66 54 54 80 80 66	ORGA 10815 ORGA 10815 ORGA 10815 ORGA 10815 ORGA 10815 ORGA 10815 ORGA 10815 ORGA 10815 ORGA 10815 ORGA 10815 ORGA 10815 ORGA 10815	02.02 08.09 12.03 02.02 08.09 09.05 02.02 08.09 02.02 08.09 02.02 09.05 10.05		24.2122-1764.3 010851		- ESP	THz 22,20	BOS
	1.1 i	44	ORGA 10801	ORGA 10807		24.4122-1708.3 010865		- ESP	THz 22,20	BOS

¹⁾ - ventilated discs / - dischi ventilati / - disques ventilés / - disco ventilado

²⁾ + ventilated discs / + dischi ventilati / + disques ventilés / + disco ventilado

³⁾ - 16" wheel / - ruota 16" / - roue 16" / - rueda 16"

⁴⁾ + 16" wheel / + ruota 16" / + roue 16" / + rueda 16"

⁵⁾ to change only by pairs / sostituire solo a coppie / à changer seulement par paires / cambiar solamente por parejas

⁶⁾ + aluminium / + alluminio / + aluminium / + aluminio

⁷⁾ + RA drum brake / + P freno a tamburo / + frein à tambour essieu AR / + ET-tambores de freno



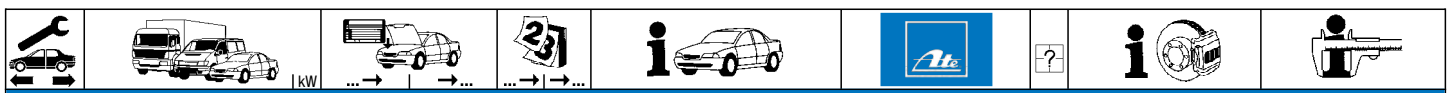

CITROEN C3 (02-09)

	1.4 16V HDi 90 1.4 bivalent 1.4 HDi 1.4 i 1.6 16V HDi 110	66 54 ORGA 10801 54 80	ORGA 10801 ORGA 10801 ORGA 10801 ORGA 10801 ORGA 10801	ORGA 10807 ORGA 10807 ORGA 10807 ORGA 10807 ORGA 10807			24.4122-1708.3	010865	- ESP	THz 22,20	BOS	
	1.1 i 1.1 i 1.4 16V 1.4 16V HDi 90 1.4 bivalent 1.4 HDi 1.4 HDi 1.4 i 1.4 i 1.6 16V 1.6 16V HDi 110 1.6 16V HDi 90	44 44 65 66 54 ORGA 10808 54 54 54 80 80 66	ORGA 10808 ORGA 10808 ORGA 10814 ORGA 10814 ORGA 10814 ORGA 10814 ORGA 10814 ORGA 10814 ORGA 10814 ORGA 10814 ORGA 10814 ORGA 10814	ORGA 10814 ORGA 10814 ORGA 10814 ORGA 10814 ORGA 10814 ORGA 10814 ORGA 10814 ORGA 10814 ORGA 10814 ORGA 10814 ORGA 10814 ORGA 10814	02.02 08.09 12.03 08.09 02.02 08.09 09.05 08.09 02.02 08.09 02.02 08.09 02.02 08.09 09.05 08.09 10.05 08.09		24.4122-1704.3	010847	- ESP	THz 22,20	TRW	
	1.1 i 1.4 16V 1.4 16V HDi 90 1.4 bivalent 1.4 HDi 1.4 i 1.6 16V 1.6 16V HDi 110 1.6 16V HDi 90	44 65 66 54 54 80 80 66	ORGA 10800 ORGA 10800 ORGA 10800 ORGA 10800 ORGA 10800 ORGA 10800 ORGA 10800 ORGA 10800 ORGA 10800	ORGA 10800 ORGA 10800 ORGA 10800 ORGA 10800 ORGA 10800 ORGA 10800 ORGA 10800 ORGA 10800 ORGA 10800	02.02 12.03 02.02 09.05 02.02 02.02 02.02 09.05 10.05		24.2122-1767.3	010841	+ ESP	THz 22,20	TRW	
	1.1 i 1.4 16V 1.4 16V HDi 90 1.4 bivalent 1.4 HDi 1.4 i 1.6 16V 1.6 16V HDi 110 1.6 16V HDi 90	44 65 66 54 ORGA 10801 54 80 80 66	ORGA 10801 ORGA 10801 ORGA 10801 ORGA 10801 ORGA 10801 ORGA 10801 ORGA 10801 ORGA 10801 ORGA 10801	ORGA 10801 ORGA 10801 ORGA 10801 ORGA 10801 ORGA 10801 ORGA 10801 ORGA 10801 ORGA 10801 ORGA 10801	08.09 08.09 08.09 08.09 08.09 08.09 08.09 08.09 08.09		24.4122-1703.3	010843	+ ESP	THz 22,20	TRW	
	1.1 i 1.4 bivalent 1.4 HDi 1.4 i	44 54 54 54			02.02 09.05 02.02 02.02	08.09 08.09 08.09 08.09	24.3481-1761.5 24.3481-1762.5	240393 240394	 	D=48, - Halter D=48, - Halter	TRW TRW	
	1.4 16V 1.4 16V HDi 90 1.6 16V 1.6 16V HDi 110 1.6 16V HDi 90	65 66 80 80 66			12.03 02.02 02.02 09.05 10.05	08.09 08.09 08.09 08.09 08.09	24.3541-1803.7 24.3541-1804.7	220603 220604	 	- 16" Rad ¹⁾ - 16" Rad ¹⁾	D=54, - Halter D=54, - Halter	TRW TRW
	1.6 16V 1.6 16V HDi 110	80 80	ORGA 10800 ORGA 10800		02.02 09.05	08.09 08.09	24.3541-1761.5 24.3541-1762.5	240233 240234	 	+ Automatikgetriebe ³⁾	D=54, - Halter D=54, - Halter	BOS BOS
	1.6 16V 1.6 16V HDi 110	80 80	ORGA 10801 ORGA 10801		08.09 08.09	08.09 08.09	24.3541-1761.5 24.3541-1762.5	240233 240234	 	+ Automatikgetriebe ³⁾	D=54, - Halter D=54, - Halter	BOS BOS
	1.6 16V 1.6 16V HDi 90	65 80 66			12.03 02.02 10.05	08.09 08.09 08.09	24.3541-1771.5 24.3541-1772.5	240239 240240	 	+ 16" Rad ⁴⁾ + 16" Rad ⁴⁾	D=54, - Halter D=54, - Halter	BOS BOS
	1.1 i 1.4 16V 1.4 16V HDi 90 1.4 bivalent 1.4 HDi 1.4 i 1.6 16V 1.6 16V HDi 110 1.6 16V HDi 90	44 65 66 54 54 80 80 66			02.02 12.03 02.02 09.05 02.02 02.02 02.02 09.05 10.05	08.09 08.09 08.09 08.09 08.09 08.09 08.09 08.09 08.09	24.5111-0460.3	330603	2		L=460	
	1.6 16V 1.6 16V HDi 110	80 80			02.02 09.05	08.09 08.09	24.5111-0446.3	331055	2		L=445	
	1.6 16V 1.6 16V HDi 110 1.6 16V HDi 90	80 80 66			02.02 09.05 10.05	08.09 08.09 08.09	24.3387-1705.7 24.3387-1706.7	220675 220676	 	D=38, - Halter D=38, - Halter	TRW TRW	
	1.1 i 1.4 16V 1.4 16V HDi 90 1.4 bivalent 1.4 HDi 1.4 i 1.6 16V 1.6 16V HDi 110 1.6 16V HDi 90	44 65 66 54 54 80 80 66	ORGA 10569 ORGA 10569 ORGA 10569 ORGA 10569 ORGA 10569 ORGA 10569 ORGA 10569 ORGA 10569 ORGA 10569	ORGA 10569 ORGA 10569 ORGA 10569 ORGA 10569 ORGA 10569 ORGA 10569 ORGA 10569 ORGA 10569 ORGA 10569	02.02 12.03 02.02 09.05 02.02 02.02 02.02 09.05 10.05	08.09 08.09 08.09 08.09 08.09 08.09 08.09 08.09 08.09	24.5246-0185.3	330881	2		L=185	
	1.1 i 1.4 16V 1.4 16V HDi 90 1.4 bivalent 1.4 HDi 1.4 i 1.6 16V 1.6 16V HDi 110 1.6 16V HDi 90	44 65 66 54 ORGA 10570 54 80 80 66	ORGA 10570 ORGA 10570 ORGA 10570 ORGA 10570 ORGA 10570 ORGA 10570 ORGA 10570 ORGA 10570 ORGA 10570	ORGA 10570 ORGA 10570 ORGA 10570 ORGA 10570 ORGA 10570 ORGA 10570 ORGA 10570 ORGA 10570 ORGA 10570	08.09 08.09 08.09 08.09 08.09 08.09 08.09 08.09 08.09		24.5246-0190.3	330697	2		L=190	

¹⁾ - 16" wheel / - ruota 16" / - roue 16" / - rueda 16"



























²⁾ + manual transmission / + scatola cambio velocità / + transmission mécanique / + cambio de velocidad

³⁾ + autom.transmission / + scatola cambio automatico / + transmission automatique / + cambio automático

⁴⁾ + 16" wheel / + ruota 16" / + roue 16" / + rueda 16"

⁵⁾ - 16" wheel / + manual transm. / - ruota 16" / + scatola camb.velocità / - roue 16" / + transm.mécanique / - rueda 16" / + cambio velocidad





















⁶⁾ + 16" wheel / + autom.transm. / + ruota 16" / + scatola camb.autom. / + roue 16" / + transm.automatique / + rueda 16" / + cambio automático

											
CITROEN C3 (02-09)											
	1.1 i	44		02.02	08.09	- ABS	24.3219-1739.3	020472	<input type="checkbox"/> nur paarweise austauschen ¹⁾	RzR 19,05	TRW
	1.4 bivalent	54		09.05	08.09	- ABS	24.3219-1740.3	020473	<input type="checkbox"/> nur paarweise austauschen ¹⁾	RzR 19,05	TRW
	1.4 HDi			02.02	08.09	- ABS					
	1.4 i	54		02.02	08.09	- ABS					
	1.1 i	44		02.02	08.09	+ ABS	24.3220-1724.3	020476		Rz 20,64	BOS
	1.4 16V	65		12.03	08.09		24.3220-1717.3	020430	+ ALU ²⁾	Rz 20,64	TRW
1.4 16V HDi 90	66		02.02	08.09							
1.4 bivalent	54		09.05	08.09	+ ABS						
1.4 HDi	54		02.02	08.09	+ ABS						
1.4 i	54		02.02	08.09	+ ABS						
1.6 16V HDi 90	66		10.05	08.09							
	1.1 i	44	ORGA 10422	02.02			24.3727-0346.2	580346	2 ↓	L=1716	
	1.4 16V	65	ORGA 10422	12.03							
	1.4 16V HDi 90	66	ORGA 10422	02.02							
	1.4 bivalent	54	ORGA 10422	09.05							
	1.4 HDi	54	ORGA 10422	02.02							
	1.4 i	54	ORGA 10422	02.02							
1.6 16V HDi 90	66	ORGA 10422	10.05		+ HA-Trommelbremse ³⁾						
	1.1 i	44	ORGA 10423		08.09		24.3727-0352.2	580352	2 ↓	L=1693	
	1.4 16V	65	ORGA 10423		08.09						
	1.4 16V HDi 90	66	ORGA 10423		08.09						
	1.4 bivalent	54	ORGA 10423		08.09						
	1.4 HDi	54	ORGA 10423		08.09						
	1.4 i	54	ORGA 10423		08.09						
1.6 16V HDi 90	66	ORGA 10423		08.09	+ HA-Trommelbremse ³⁾						
CITROEN C3 PLURIEL (03-10)											
	1.4 HDi	50		04.04	07.10	- ABS	24.2120-1741.3	010775		Thz 20,64	
	1.4 Hybrid	54		05.05	07.10	- ABS					
	1.4 i	54		05.03	07.10	- ABS					
	1.6 16V	80		05.03	07.10	- ABS					
	1.4 HDi	50	ORGA 10800	04.04		- ESP	24.2122-1766.3	010840		Thz 22,20	TRW
	1.4 Hybrid	54	ORGA 10800	05.05		- ESP	24.2122-1764.3	010851		Thz 22,20	BOS
	1.4 i	54	ORGA 10800	05.03		- ESP					
	1.6 16V	80	ORGA 10800	05.03		- ESP					
	1.4 HDi	50	ORGA 10801		07.10	- ESP	24.4122-1704.3	010847		Thz 22,20	TRW
	1.4 Hybrid	54	ORGA 10801		07.10	- ESP					
	1.4 i	54	ORGA 10801		07.10	- ESP					
	1.6 16V	80	ORGA 10801		07.10	- ESP					
	1.4 HDi	50	ORGA 10800	04.04		+ ESP	24.2122-1767.3	010841		Thz 22,20	TRW
	1.4 Hybrid	54	ORGA 10800	05.05		+ ESP					
	1.4 i	54	ORGA 10800	05.03		+ ESP					
	1.6 16V	80	ORGA 10800	05.03		+ ESP					
	1.4 HDi	50	ORGA 10801		07.10	+ ESP	24.4122-1703.3	010843		Thz 22,20	TRW
	1.4 Hybrid	54	ORGA 10801		07.10	+ ESP					
	1.4 i	54	ORGA 10801		07.10	+ ESP					
	1.6 16V	80	ORGA 10801		07.10	+ ESP					
	1.4 HDi	50		04.04	07.10		24.3541-1803.7	220603	<input type="checkbox"/>	D=54, - Halter	TRW
	1.4 Hybrid	54		05.05	07.10		24.3541-1804.7	220604	<input type="checkbox"/>	D=54, - Halter	TRW
	1.4 i	54		05.03	07.10						
	1.6 16V	80		05.03	07.10						
	1.4 HDi	50		04.04	07.10		24.5111-0460.3	330603	2	L=460	
	1.4 Hybrid	54		05.05	07.10						
	1.4 i	54		05.03	07.10						
	1.6 16V	80		05.03	07.10						
	1.6 16V	80		05.03	07.10		24.3387-1705.7	220675	<input type="checkbox"/>	D=38, - Halter	TRW
							24.3387-1706.7	220676	<input type="checkbox"/>	D=38, - Halter	TRW
	1.4 HDi	50	ORGA 10569	04.04			24.5246-0185.3	330881	2	L=185	
	1.4 Hybrid	54	ORGA 10569	05.05							
	1.4 i	54	ORGA 10569	05.03							
	1.6 16V	80	ORGA 10569	05.03							
	1.4 HDi	50	ORGA 10570		07.10		24.5246-0190.3	330697	2	L=190	
	1.4 Hybrid	54	ORGA 10570		07.10						
	1.4 i	54	ORGA 10570		07.10						
	1.6 16V	80	ORGA 10570		07.10						
	1.4 HDi	50		04.04	07.10	- ABS	24.3219-1739.3	020472	<input type="checkbox"/> nur paarweise austauschen ¹⁾	RzR 19,05	TRW
	1.4 Hybrid	54		05.05	07.10	- ABS	24.3219-1740.3	020473	<input type="checkbox"/> nur paarweise austauschen ¹⁾	RzR 19,05	TRW
	1.4 i	54		05.03	07.10	- ABS					
	1.4 HDi	50		04.04	07.10	+ ABS	24.3220-1724.3	020476		Rz 20,64	BOS
1.4 Hybrid	54		05.05	07.10	+ ABS	24.3220-1717.3	020430	+ ALU ²⁾	Rz 20,64	TRW	
1.4 i	54		05.03	07.10	+ ABS						
	1.4 HDi	50	ORGA 10233	04.04			24.3727-0346.2	580346	2 ↓	L=1716	
	1.4 Hybrid	54	ORGA 10233	05.05							
	1.4 i	54	ORGA 10233	05.03							
	1.4 HDi	50	ORGA 10234		07.10		24.3727-0352.2	580352	2 ↓	L=1693	
	1.4 Hybrid	54	ORGA 10234		07.10						
	1.4 i	54	ORGA 10234		07.10						
CITROEN C3 II (09-)											
	1.1	44	ORGA 13153				24.4122-1704.3	010847	- DSC	Thz 22,20	TRW
	1.4	54	ORGA 13153				24.4122-1703.3	010843	+ DSC	Thz 22,20	TRW
	1.4 Flex	58	ORGA 13153								
	1.4 HDi 70	50	ORGA 13153								
	1.6 BlueHDi 100	73		07.14							

¹⁾ to change only by pairs / sostituire solo a coppie / à changer seulement par paires / cambiar solamente por parejas

²⁾ + aluminium / + alluminio / + aluminium / + aluminio

³⁾ + RA drum brake / + P freno a tamburo / + frein à tambour essieu AR / + ET-tambores de freno

										
CITROEN C3 II (09-)										
	1.6 BlueHDi 75 1.6 HDi 1.6 HDi 90	55 68 ORGA 13153 66 ORGA 13153		04.15		24.4122-1704.3 24.4122-1703.3	010847 010843	- DSC + DSC	THz 22,20 THz 22,20	TRW TRW
	1.4 VTI 95 1.6 Flex 1.6 HDi 1.6 HDi 110 1.6 HDi 115 1.6 VTI 120	ORGA 13153 81 ORGA 13153 68 ORGA 13153 82 ORGA 13153 84 ORGA 13153 88 ORGA 13153				24.4123-1705.3 24.4123-1704.3	010832 010828	- DSC + DSC	THz 23,81 THz 23,81	TRW TRW
	1.0 VTI 68 1.1 1.2 VTI 110 1.2 VTI 82 1.4 1.4 Flex 1.4 HDi 70 1.4 LPG 1.4 VTI 95 1.6 BlueHDi 100 1.6 BlueHDi 75 1.6 HDi 1.6 HDi 110 1.6 HDi 90	50 44 81 60 54 58 50 70 73 55 68 82 84 66		10.12 09.09 10.14 10.12 09.09 11.09 11.09 06.13 09.09 07.14 04.15 11.09 09.09 09.09		24.3541-1771.5 24.3541-1772.5	240239 240240	 	D=54, - Halter D=54, - Halter	BOS BOS
	1.0 VTI 68 1.1 1.2 VTI 110 1.2 VTI 82 1.4 1.4 Flex 1.4 HDi 70 1.4 LPG 1.4 VTI 95 1.6 BlueHDi 100 1.6 BlueHDi 75 1.6 Flex 1.6 HDi 1.6 HDi 110 1.6 HDi 115 1.6 HDi 90 1.6 VTI 120	50 44 81 60 54 58 50 70 73 55 81 68 82 84 66 88		10.12 09.09 10.14 10.12 09.09 11.09 11.09 06.13 09.09 07.14 04.15 11.09 11.09 09.09 09.12 09.09 09.09		24.5111-0496.3	331371	2	L=495	
	1.2 VTI 110 1.4 LPG 1.6 BlueHDi 100 1.6 BlueHDi 75 1.6 HDi 110 1.6 HDi 115 1.6 VTI 120	81 70 73 55 82 84 88		10.14 06.13 07.14 04.15 09.09 09.12 09.09		24.3387-1733.5 24.3387-1734.5	240655 240656	 	D=38, - Halter D=38, - Halter	TRW TRW
	1.0 VTI 68 1.1 1.2 VTI 110 1.2 VTI 82 1.4 1.4 Flex 1.4 HDi 70 1.4 LPG 1.4 VTI 95 1.6 BlueHDi 100 1.6 BlueHDi 75 1.6 Flex 1.6 HDi 1.6 HDi 110 1.6 HDi 115 1.6 HDi 90 1.6 VTI 120	50 44 81 60 54 58 50 70 73 55 81 68 82 84 66 88		10.12 09.09 10.14 10.12 09.09 11.09 11.09 06.13 09.09 07.14 04.15 11.09 11.09 09.09 09.12 09.09 09.09		24.5239-0165.3	330606	2	L=165	
	1.0 VTI 68 1.1 1.2 VTI 110 1.2 VTI 82 1.4 1.4 Flex 1.4 HDi 70 1.4 LPG 1.6 BlueHDi 100 1.6 BlueHDi 75 1.6 HDi 1.6 HDi 90	50 44 81 60 54 58 50 70 73 55 68 66		10.12 09.09 10.14 10.12 09.09 11.09 11.09 06.13 07.14 04.15 11.09 09.09		24.3220-1741.3	020548		für Trommeldurchmesser 203 mm ⁴⁾	Rz 20,64
	1.2 VTI 110 1.4 LPG 1.4 VTI 95 1.6 BlueHDi 100 1.6 BlueHDi 75	81 70 73 55		10.14 06.13 09.09 07.14 04.15		24.3220-1732.3	020514		für Trommeldurchmesser 228 mm ⁵⁾	Rz 20,64
	1.0 VTI 68 1.1 1.2 VTI 82 1.4 1.4 Flex 1.4 HDi 70	▶ 50 ▶ 44 ▶ 60 ▶ 54 ▶ 58 ▶ 50		10.12 09.09 10.12 09.09 11.09 11.09		24.2415-1714.3	030134		+ BVM MA-Getriebe ⁶⁾ + BVM MA-Getriebe ⁶⁾ + BVM MA-Getriebe ⁶⁾ + BVM MA-Getriebe ⁶⁾ + BVM MA-Getriebe ⁶⁾ + BVM MA-Getriebe ⁶⁾	Gz 15,87

¹⁾ + drum brake / + freno a tamburo / + freins à tambour / + tambores de freno

²⁾ + disc brake / + disco freno / + disques de frein / + disco de freno

³⁾ + brake disc diameter 266 mm / + disco fr.diam. 266mm / + disques fr.diam. 266mm / + disco fr.diam. 266mm

⁴⁾ for drum diameter 203mm / per tamburi diametro 203mm / pour tambour diamètre 203mm / para tambores diámetro 203mm

⁵⁾ for drum diameter 228mm / per tamburi diametro 228mm / pour tambour diamètre 228mm / para tambores diámetro 228mm

⁶⁾ + BVM MA transmission / + scatola cambio BVM MA / + boîte de vitesse BVM MA / + cambio BVM MA



CITROEN C3 II (09-)										
	1.4 LPG	70		06.13	+ BVM MA-Getriebe ¹⁾	24.2415-1714.3	030134		Gz 15,87	
	1.4 VTI 95			09.09	+ BVM MA-Getriebe ¹⁾					
	1.6 BlueHdi 100	73		07.14	+ BVM MA-Getriebe ¹⁾					
	1.6 BlueHdi 75	55		04.15	+ BVM MA-Getriebe ¹⁾					
	1.6 Flex	81		11.09	+ BVM MA-Getriebe ¹⁾					
	1.6 Hdi	68		11.09	+ BVM MA-Getriebe ¹⁾					
	1.6 Hdi 110	82		09.09	+ BVM MA-Getriebe ¹⁾					
	1.6 Hdi 115	84		09.12	+ BVM MA-Getriebe ¹⁾					
	1.6 Hdi 90	66		09.09	+ BVM MA-Getriebe ¹⁾					
	1.6 VTI 120	88		09.09	+ BVM MA-Getriebe ¹⁾					
1.6 Hdi 90	66		09.09	+ BE4R-Getriebe ²⁾	24.2415-1721.3	030144		Gz 15,87		
1.6 Hdi 110	82	ORGA 12775	09.09	+ BVM6 und Schaltgetriebe MC ³⁾	24.2415-1717.3	030140		- Start/Stop-Anlage ⁴⁾	Gz 15,87	
1.6 VTI 120	88	ORGA 12775	09.09	+ BVM6 und Schaltgetriebe MC ³⁾						
	1.0 VTI 68	50		10.12	+ BVM MA-Getriebe ¹⁾	24.2518-1702.3	040099		Nz 18,90	
	1.1	44		09.09	+ BVM MA-Getriebe ¹⁾					
	1.2 VTI 82	60		10.12	+ BVM MA-Getriebe ¹⁾					
	1.4	54		09.09	+ BVM MA-Getriebe ¹⁾					
	1.4 Flex	58		11.09	+ BVM MA-Getriebe ¹⁾					
	1.4 Hdi 70	50		11.09	+ BVM MA-Getriebe ¹⁾					
	1.4 LPG	70		06.13	+ BVM MA-Getriebe ¹⁾					
	1.4 VTI 95			09.09	+ BVM MA-Getriebe ¹⁾					
	1.6 BlueHdi 100	73		07.14	+ BVM MA-Getriebe ¹⁾					
	1.6 Flex	81		11.09	+ BVM MA-Getriebe ¹⁾					
	1.6 Hdi	68		11.09	+ BVM MA-Getriebe ¹⁾					
	1.6 Hdi 110	82		09.09	+ BVM MA-Getriebe ¹⁾					
	1.6 Hdi 115	84		09.12	+ BVM MA-Getriebe ¹⁾					
	1.6 Hdi 90	66		09.09	+ BVM MA-Getriebe ¹⁾					
	1.6 VTI 120	88		09.09	+ BVM MA-Getriebe ¹⁾	24.2518-1704.3	040102		Nz 18,90	
CITROEN C3 PICASSO (09-)										
	1.2 THP 110	81		01.15		24.4123-1705.3	010832	- ESP	THz 23,81	TRW
	1.4 Vti 95	70		02.09		24.4123-1704.3	010828	+ ESP	THz 23,81	TRW
	1.4 VTI 95 LPG	70		01.12						
	1.6 BlueHdi 100	73		01.15						
	1.6 Flex	78		11.09						
	1.6 Hdi	80		02.09						
	1.6 Hdi 110	82		05.10						
	1.6 Hdi 115	84		11.12						
	1.6 Hdi 90	66		02.09						
	1.6 Hdi 90	68		07.10						
	1.6 VTI 120	88		02.09						
	1.2 THP 110	81		01.15	+ Bremsscheibendurchm. 266 mm ⁵⁾	24.3541-1771.5	240239		D=54, - Halter	BOS
	1.4 VTI 95	70		02.09	+ Bremsscheibendurchm. 266 mm ⁵⁾	24.3541-1772.5	240240		D=54, - Halter	BOS
	1.4 VTI 95 LPG	70		01.12	+ Bremsscheibendurchm. 266 mm ⁵⁾					
	1.6 BlueHdi 100	73		01.15	+ Bremsscheibendurchm. 266 mm ⁵⁾					
	1.6 Flex	78		11.09	+ Bremsscheibendurchm. 266 mm ⁵⁾					
	1.6 Hdi	80		02.09	+ Bremsscheibendurchm. 266 mm ⁵⁾					
	1.6 Hdi 110	82		05.10	+ Bremsscheibendurchm. 266 mm ⁵⁾					
	1.6 Hdi 115	84		11.12	+ Bremsscheibendurchm. 266 mm ⁵⁾					
	1.6 Hdi 90	66		02.09	+ Bremsscheibendurchm. 266 mm ⁵⁾					
	1.6 Hdi 90	68		07.10	+ Bremsscheibendurchm. 266 mm ⁵⁾					
	1.6 VTI 120	88		02.09	+ Bremsscheibendurchm. 266 mm ⁵⁾					
	1.2 THP 110	81		01.15		24.5144-0480.3	330961	2	L=480	
	1.4 VTI 95	70		02.09						
	1.4 VTI 95 LPG	70		01.12						
	1.6 BlueHdi 100	73		01.15						
	1.6 Flex	78		11.09						
	1.6 Hdi	80		02.09						
	1.6 Hdi 110	82		05.10						
	1.6 Hdi 115	84		11.12						
	1.6 Hdi 90	66		02.09						
	1.6 Hdi 90	68		07.10						
	1.6 VTI 120	88		02.09						
	1.2 THP 110	81		01.15		24.3387-1733.5	240655		D=38, - Halter	TRW
	1.4 VTI 95	70		02.09		24.3387-1734.5	240656		D=38, - Halter	TRW
	1.4 VTI 95 LPG	70		01.12						
	1.6 BlueHdi 100	73		01.15						
	1.6 Flex	78		11.09						
	1.6 Hdi	80		02.09						
	1.6 Hdi 110	82		05.10						
	1.6 Hdi 115	84		11.12						
	1.6 Hdi 90	66		02.09						
	1.6 Hdi 90	68		07.10						
	1.6 VTI 120	88		02.09						
	1.2 THP 110	81		01.15		24.5239-0190.3	330966	2	L=190	
	1.4 VTI 95	70		02.09						
	1.4 VTI 95 LPG	70		01.12						
	1.6 BlueHdi 100	73		01.15						
	1.6 Flex	78		11.09						
	1.6 Hdi	80		02.09						
	1.6 Hdi 110	82		05.10						
	1.6 Hdi 115	84		11.12						
	1.6 Hdi 90	66		02.09						
	1.6 Hdi 90	68		07.10						
	1.6 VTI 120	88		02.09						

¹⁾ + BVM MA transmission / + scatola cambio BVM MA / + boîte de vitesse BVM MA / + cambio BVM MA

²⁾ + BE4R transmission / + scatola cambio BE4R / + boîte de vitesse BE4R / + cambio BE4R

³⁾ + BVM6 + manual transm. MC / + BVM6 + scatola camb.velocità MC / + BVM6 + transm.mécanique MC / + BVM6 + camb.de velocidad MC

⁴⁾ - idling stop system / - dispositivo start/stop / - unité marche/arrêt / - unidad arranque/paro

⁵⁾ + brake disc diameter 266 mm / + disco fr.diam. 266mm / + disques fr.diam. 266mm / + disco fr.díam. 266mm





















CITROEN C3 PICASSO (09-)

	1.4 VTi 95	70		02.09		24.2415-1721.3	030144		Gz 15,87
	1.4 VTi 95 LPG	70		01.12					
	1.6 Flex	78		11.09					
	1.6 HDi 90	66		02.09					
	1.6 HDi 90	68		07.10					
	1.6 VTi 120	88		02.09					
	1.6 HDi	80		02.09		24.2415-1717.3	030140		Gz 15,87
	1.6 HDi 110	82		05.10					
	1.6 HDi 115	84	ORGA 13145	11.12					
	1.4 VTi 95	70		02.09		24.2415-1714.3	030134		Gz 15,87
	1.4 VTi 95 LPG	70		01.12					
	1.6 Flex	78		11.09					
1.6 HDi 90	66		02.09						
1.6 HDi 90	68		07.10						
1.6 VTi 120	88		02.09						
	1.4 VTi 95	70		02.09		24.2518-1703.3	040101		Nz 18,90
	1.6 Flex	78		11.09					
	1.6 HDi	80		02.09					
	1.6 HDi 110	82		05.10					
	1.6 HDi 115	84		11.12					
	1.6 HDi 90	66		02.09					
	1.6 HDi 90	68		07.10					
	1.6 VTi 120	88		02.09					

CITROEN C4 I Limousine (LC_) (04-11)































	1.4 16V	65	ORGA 11192	10.04		24.4123-1706.3	010848	+ ESP	Thz 23,81	BOS
	1.6 16V	80	ORGA 11192	07.06						
	1.6 16V	80	ORGA 11192	10.04						
	1.6 16V Flex	80	ORGA 11192	09.07						
	1.6 HDi	66	ORGA 11192	10.04						
	1.6 HDi	80	ORGA 11192	07.06						
	1.6 HDi	80	ORGA 11192	10.04						
	2.0 16V	100		10.04	07.11					
	2.0 16V	103	ORGA 11192	07.06						
	2.0 16V	103	ORGA 11192	10.04						
	2.0 16V	130	ORGA 11192	11.04						
	2.0 HDi	103	ORGA 11192	07.08						
	2.0 HDi 135	100	ORGA 11192	10.04						
	1.4 16V	65	ORGA 10551	07.11	+ ESP	24.3541-1771.5	240239	<input checked="" type="checkbox"/>	D=54, - Halter	BOS
	1.4 16V	65		10.04	- ESP	24.3541-1772.5	240240	<input checked="" type="checkbox"/>	D=54, - Halter	BOS
	1.6 16V	80	ORGA 11018	07.06						
	1.6 16V	80	ORGA 10551	07.11	+ ESP					
	1.6 16V	80		10.04	- ESP					
	1.6 16V Flex	80	ORGA 10551	07.11	+ ESP					
	1.6 16V Flex	80		09.07	- ESP					
	1.6 HDi	66	ORGA 10551	07.11	+ ESP					
	1.6 HDi	66		10.04	- ESP					
	1.6 VTi	88		07.08	+ Schaltgetriebe 1)					
	1.4 16V	65	ORGA 10550	10.04	+ ESP	24.3541-1761.5	240233	<input checked="" type="checkbox"/>	D=54, - Halter	BOS
	1.6 16V	80	ORGA 12053	07.06	+ ESP	24.3541-1762.5	240234	<input checked="" type="checkbox"/>	D=54, - Halter	BOS
	1.6 16V	80	ORGA 10550	10.04	+ ESP					
	1.6 16V Flex	80	ORGA 10550	09.07	+ ESP					
	1.6 HDi	66	ORGA 10550	10.04	+ ESP					
	1.6 HDi	80	ORGA 12053	07.06	+ ESP					
	1.6 HDi	80	ORGA 12053	10.04	+ ESP					
	1.6 THP 140	103		07.08	07.11					
	1.6 THP 150	110		07.08	07.11					
	1.6 VTi	88		07.08	07.11	+ Automatikgetriebe 2)				
	2.0 16V	100		10.04	07.11					
	2.0 16V	103	ORGA 12053	07.06						
2.0 16V	103	ORGA 12053	10.04							
2.0 HDi	81		04.07	07.08						
	2.0 16V	130	ORGA 10487	11.04		11.9571-9765.2	220663	<input checked="" type="checkbox"/>	D=57, - Halter	ATE
	2.0 HDi	103	ORGA 10487	07.08		11.9571-9766.2	220664	<input checked="" type="checkbox"/>	D=57, - Halter	ATE
	2.0 HDi 135	100	ORGA 10487	10.04		11.8116-0351.1	390538	2	Haltefeder	ATE
						11.8171-0008.1	990049		Führungsbolzen	ATE
	2.0 16V	130	ORGA 10488			11.9571-9765.2	220663	<input checked="" type="checkbox"/>	D=57, - Halter	ATE
	2.0 HDi	103	ORGA 10488			11.9571-9766.2	220664	<input checked="" type="checkbox"/>	D=57, - Halter	ATE
	2.0 HDi 135	100	ORGA 10488			11.8116-0351.1	390538	2	Haltefeder	ATE
						11.8171-0008.1	990049		Führungsbolzen	ATE
	2.0 16V	130	ORGA 11578		07.11	11.9571-9939.2	220923	<input checked="" type="checkbox"/>	D=57, - Halter	ATE
	2.0 HDi	103	ORGA 11578		07.11	11.9571-9940.2	220924	<input checked="" type="checkbox"/>	D=57, - Halter	ATE
	2.0 HDi 135	100	ORGA 11578		07.11	11.0101-5704.2	260095		Hülzensatz	ATE
						11.8171-0008.1	990049		Führungsbolzen	ATE
						11.8116-0356.1	390586	2	Haltefeder	ATE
	1.4 16V	65		10.04	07.11	24.5111-0420.3	330682	2	L=420	
	1.6 16V	80		07.06	07.11					
	1.6 16V	80		10.04	07.11					
	1.6 16V Flex	80		09.07	07.11					
	1.6 HDi	66		10.04	07.11					
	1.6 HDi	80		07.06	07.11					
	1.6 HDi	80		10.04	07.11					
	1.6 THP 140	103		07.08	07.11					
	1.6 THP 150	110		07.08	07.11					
	1.6 VTi	88		07.08	07.11					
	2.0 16V	100		10.04	07.11					
	2.0 16V	103		07.06	07.11					

1) + manual transmission / + scatola cambio velocità / + transmission mécanique / + cambio de velocidad
 2) + autom.transmission / + scatola cambio automatico / + transmission automatique / + cambio automático

										
CITROEN C4 I Limousine (LC) (04-11)										
	2.0 16V 2.0 16V 2.0 HDi 2.0 HDi 2.0 HDi 135	103 130 81 103 100		10.04 07.11 11.04 07.11 04.07 07.08 07.08 07.11 10.04 07.11		24.5111-0420.3	330682	2	L=420	
	1.4 16V 1.6 16V 1.6 16V 1.6 16V Flex 1.6 HDi 1.6 HDi 1.6 HDi 1.6 THP 140 1.6 THP 150 1.6 VTi 2.0 16V 2.0 16V 2.0 16V 2.0 16V 2.0 HDi 2.0 HDi 2.0 HDi 135	65 80 80 80 66 80 80 103 110 88 100 103 103 130 81 103 100	ORGA 11584 ORGA 11584 ORGA 11584 ORGA 11584 ORGA 11584 ORGA 11584 ORGA 11584 ORGA 11584 ORGA 11584 ORGA 11584 ORGA 11584 ORGA 11584 ORGA 11584 ORGA 11584 ORGA 11584 ORGA 11584 ORGA 11584	10.04 07.06 10.04 09.07 10.04 07.06 10.04 07.08 07.08 07.08 10.04 07.06 10.04 11.04 04.07 07.08 10.04		24.3387-1709.7 24.3387-1710.7	220743 220744	<input type="checkbox"/> <input type="checkbox"/>	D=38, - Halter D=38, - Halter	TRW TRW
	1.4 16V 1.6 16V 1.6 16V 1.6 16V Flex 1.6 HDi 1.6 HDi 1.6 HDi 1.6 THP 140 1.6 THP 150 1.6 VTi 2.0 16V 2.0 16V 2.0 16V 2.0 16V 2.0 HDi 2.0 HDi 135	65 ORGA 11431 80 ORGA 11431 80 ORGA 11431 80 ORGA 11431 66 ORGA 11431 80 ORGA 11431 80 ORGA 11431 103 ORGA 11431 110 ORGA 11431 88 ORGA 11431 100 ORGA 11431 103 ORGA 11431 103 ORGA 11431 103 ORGA 11431 130 ORGA 11431 103 ORGA 11431 100 ORGA 11431	ORGA 12333 ORGA 12333 ORGA 12333 ORGA 12333 ORGA 12333 ORGA 12333 ORGA 12333 ORGA 12333 ORGA 12333 ORGA 12333 ORGA 12333 ORGA 12333 ORGA 12333 ORGA 12333 ORGA 12333 ORGA 12333 ORGA 12333			24.3387-1731.7 24.3387-1732.7	221009 221010	<input type="checkbox"/> <input type="checkbox"/>	D=38, - Halter D=38, - Halter	TRW TRW
	1.4 16V 1.6 16V 1.6 16V 1.6 16V Flex 1.6 HDi 1.6 HDi 1.6 HDi 1.6 THP 140 1.6 THP 150 1.6 VTi 2.0 16V 2.0 16V 2.0 16V 2.0 16V 2.0 HDi 2.0 HDi 135	65 ORGA 12334 80 ORGA 12334 80 ORGA 12334 80 ORGA 12334 66 ORGA 12334 80 ORGA 12334 80 ORGA 12334 103 ORGA 12334 110 ORGA 12334 88 ORGA 12334 100 ORGA 12334 103 ORGA 12334 103 ORGA 12334 130 ORGA 12334 103 ORGA 12334 100 ORGA 12334		07.11 07.11 07.11 07.11 07.11 07.11 07.11 07.11 07.11 07.11 07.11 07.11 07.11 07.11 07.11 07.11 07.11		24.3387-1709.7 24.3387-1710.7	220743 220744	<input type="checkbox"/> <input type="checkbox"/>	D=38, - Halter D=38, - Halter	TRW TRW
	1.4 16V 1.6 16V 1.6 16V 1.6 16V Flex 1.6 HDi 1.6 HDi 1.6 HDi 1.6 THP 140 1.6 THP 150 1.6 VTi 2.0 16V 2.0 16V 2.0 16V 2.0 16V 2.0 HDi 2.0 HDi 2.0 HDi 135	65 80 80 80 66 80 80 103 110 88 100 103 103 130 81 103 100		10.04 07.11 10.04 07.11 09.07 07.11 10.04 07.11 07.06 07.11 10.04 07.11 07.08 07.11 07.08 07.11 10.04 07.11 11.04 07.11 04.07 07.08 07.08 07.11 10.04 07.11		24.5246-0190.3	330697	2	L=190	
	1.6 16V 1.6 HDi 2.0 16V 2.0 HDi	80 80 103 81		07.06 07.11 07.06 07.11 07.06 07.11 04.07 07.08	+ 4 türig ¹⁾	24.3727-0839.2	580839	2 	L=2115	
	1.4 16V 1.6 16V 1.6 16V Flex 1.6 HDi 1.6 HDi 1.6 THP 140 1.6 THP 150 1.6 VTi 2.0 16V 2.0 16V 2.0 16V 2.0 HDi	65 80 80 66 80 103 110 88 100 103 130 81		10.04 07.11 10.04 07.11 09.07 07.11 10.04 07.11 07.08 07.11 07.08 07.11 10.04 07.11 11.04 07.11 04.07 07.08	+ 5 türig ²⁾	24.3727-0832.2	580832	2 	L=2035	

¹⁾ + 4 door / + 4 porte / + 4 portes / + 4 puertas

²⁾ + 5 door / + 5 porte / + 5 portes / + 5 puertas

									
CITROEN C4 I Limousine (LC) (04-11)									
	2.0 HdI 2.0 HdI 135	103 100		07.08 10.04	07.11 07.11	24.3727-0832.2	580832	2 ↓	L=2035
CITROEN C4 I Coupe (04-10)									
	1.4 16V 1.6 16V 1.6 HdI 110 1.6 HdI 90 2.0 16V 2.0 16V 2.0 HdI 2.0 HdI 135	65 80 80 66 100 103 130 103 100	ORGA 11192 ORGA 11192 ORGA 11192 ORGA 11192 ORGA 11192 ORGA 11192 ORGA 11192 ORGA 11192	10.04 10.04 10.04 10.04 12.05 10.04 07.08 10.04		24.4123-1706.3	010848	+ ESP	Thz 23,81 BOS
	1.4 16V 1.4 16V 1.6 16V 1.6 16V 1.6 HdI 90 1.6 HdI 90 1.6 VTI 120	65 65 80 80 66 66 88	ORGA 10551 ORGA 10551 ORGA 10551 ORGA 10551 ORGA 10551	10.04 10.04 10.04 10.04 10.04 07.08 07.08	07.10 + ESP 07.10 - ESP 07.10 + ESP 07.10 - ESP 07.10 + ESP 07.10 - ESP 07.10 + Schaltgetriebe 1)	24.3541-1771.5 24.3541-1772.5	240239 240240	 	D=54, - Halter D=54, - Halter BOS BOS
	1.4 16V 1.6 16V 1.6 HdI 110 1.6 HdI 90 1.6 THP 150 1.6 VTI 120 2.0 16V 2.0 16V	65 80 80 66 110 88 100 103	ORGA 10550 ORGA 10550 ORGA 12053 ORGA 10550 ORGA 12053	10.04 10.04 10.04 10.04 07.08 07.08 10.04 12.05	+ ESP + ESP + ESP + ESP + ESP + Automatikgetriebe 2)	24.3541-1761.5 24.3541-1762.5	240233 240234	 	D=54, - Halter D=54, - Halter BOS BOS
	2.0 16V 2.0 HdI 2.0 HdI 135	130 103 100	ORGA 10487 ORGA 10487 ORGA 10487	10.04 07.08 10.04		11.9571-9765.2 11.9571-9766.2 11.8116-0351.1 11.8171-0008.1	220663 220664 390538 990049	  2	D=57, - Halter D=57, - Halter Halterfeder Führungsbolzen ATE ATE ATE ATE
	2.0 16V 2.0 HdI 2.0 HdI 135	130 103 100	ORGA 10488 ORGA 10488 ORGA 10488	ORGA 11577 ORGA 11577 ORGA 11577		11.9571-9765.2 11.9571-9766.2 11.8116-0351.1 11.8171-0008.1	220663 220664 390538 990049	  2	D=57, - Halter D=57, - Halter Halterfeder Führungsbolzen ATE ATE ATE ATE
	2.0 16V 2.0 HdI 2.0 HdI 135	130 103 100	ORGA 11578 ORGA 11578 ORGA 11578		07.10 07.10 07.10	11.9571-9939.2 11.9571-9940.2 11.0101-5704.2 11.8171-0008.1 11.8116-0356.1	220923 220924 260095 990049 390586	  2	D=57, - Halter D=57, - Halter Hülensatz Führungsbolzen Halterfeder ATE ATE ATE ATE
	1.4 16V 1.6 16V 1.6 HdI 110 1.6 HdI 90 1.6 THP 150 1.6 VTI 120 2.0 16V 2.0 16V 2.0 HdI 2.0 HdI 135	65 80 80 66 110 88 100 103 103 100		10.04 10.04 10.04 10.04 07.08 07.08 10.04 12.05 10.04 07.08 10.04	07.10 07.10 07.10 07.10 07.10 07.10 07.10 07.10 07.10 07.10	24.5111-0420.3	330682	2	L=420
	1.4 16V 1.6 16V 1.6 HdI 110 1.6 HdI 90 1.6 THP 150 1.6 VTI 120 2.0 16V 2.0 16V 2.0 16V 2.0 HdI 2.0 HdI 135	65 80 80 66 110 88 100 103 130 103 100	ORGA 11584 ORGA 11584 ORGA 11584 ORGA 11584 ORGA 11584 ORGA 11584 ORGA 11584 ORGA 11584 ORGA 11584 ORGA 11584 ORGA 11584	10.04 10.04 10.04 10.04 07.08 07.08 10.04 12.05 10.04 07.08 10.04		24.3387-1709.7 24.3387-1710.7	220743 220744	 	D=38, - Halter D=38, - Halter TRW TRW
	1.4 16V 1.6 16V 1.6 HdI 110 1.6 HdI 90 1.6 THP 150 1.6 VTI 120 2.0 16V 2.0 16V 2.0 16V 2.0 HdI 2.0 HdI 135	65 80 80 66 110 88 100 103 130 103 100	ORGA 11431 ORGA 11431 ORGA 11431 ORGA 11431 ORGA 11431 ORGA 11431 ORGA 11431 ORGA 11431 ORGA 11431 ORGA 11431 ORGA 11431	ORGA 12333 ORGA 12333 ORGA 12333 ORGA 12333 ORGA 12333 ORGA 12333 ORGA 12333 ORGA 12333 ORGA 12333 ORGA 12333 ORGA 12333		24.3387-1731.7 24.3387-1732.7	221009 221010	 	D=38, - Halter D=38, - Halter TRW TRW
	1.4 16V 1.6 16V 1.6 HdI 110 1.6 HdI 90 1.6 THP 150 1.6 VTI 120 2.0 16V 2.0 16V 2.0 16V 2.0 HdI 2.0 HdI 135	65 80 80 66 110 88 100 103 130 103 100	ORGA 12334 ORGA 12334 ORGA 12334 ORGA 12334 ORGA 12334 ORGA 12334 ORGA 12334 ORGA 12334 ORGA 12334 ORGA 12334 ORGA 12334		07.10 07.10 07.10 07.10 07.10 07.10 07.10 07.10 07.10 07.10 07.10	24.3387-1709.7 24.3387-1710.7	220743 220744	 	D=38, - Halter D=38, - Halter TRW TRW

1) + manual transmission / + scatola cambio velocità / + transmission mécanique / + cambio de velocidad
2) + autom.transmission / + scatola cambio automatico / + transmission automatique / + cambio automático



















CITROEN C4 I Coupe (04-10)										
	1.4 16V	65		10.04	07.10	24.5246-0190.3	330697	2		L=190
	1.6 16V	80		10.04	07.10					
	1.6 HDi 110	80		10.04	07.10					
	1.6 HDi 90	66		10.04	07.10					
	1.6 THP 150	110		07.08	07.10					
	1.6 VTi 120	88		07.08	07.10					
	2.0 16V	100		10.04	07.10					
	2.0 16V	103		12.05	07.10					
	2.0 16V	130		10.04	07.10					
	2.0 HDi	103		07.08	07.10					
2.0 HDi 135	100		10.04	07.10						
	1.4 16V	65		10.04	07.10	24.3727-0832.2	580832	2	↓	L=2035
	1.6 16V	80		10.04	07.10					
	1.6 HDi 110	80		10.04	07.10					
	1.6 HDi 90	66		10.04	07.10					
	1.6 THP 150	110		07.08	07.10					
	1.6 VTi 120	88		07.08	07.10					
	2.0 16V	100		10.04	07.10					
	2.0 16V	103		12.05	07.10					
	2.0 16V	130		10.04	07.10					
	2.0 HDi	103		07.08	07.10					
2.0 HDi 135	100		10.04	07.10						















CITROEN C4 I PICASSO (07-13)													
	1.6 HDi	80	ORGA 11437	02.07		03.7860-4103.4	300242			10"	ATE		
	2.0 HDi 138	100	ORGA 11437	02.07									
	1.6 16V	110		07.08	07.13	03.7860-5702.4	300279		- Start/Stop-Anlage ¹⁾	10"	ATE		
	1.6 e-HDi 110	82		11.10	07.13								
	1.6 HDi	80	ORGA 11438		07.13								
	1.6 HDi 110	82		11.10	07.13								
	1.6 THP 140	103		07.08	07.13								
	1.6 THP 150	110		10.08	07.13								
	1.6 THP 155	115		11.10	07.13								
	1.6 VTi 120	88		07.08	07.13								
	2.0 HDi 138	100	ORGA 11438		07.13								
	2.0 HDi 150	110		07.09	07.13								
	2.0 HDi 165	120		11.10	07.13								
	1.8 i 16V	92		02.07	07.13							03.7870-1002.4	300282
2.0 i 16V	103		02.07	07.13									
	1.6 16V	110		07.08	07.13	03.4153-0173.3	010815			Thz 23,81	ATE		
	1.6 e-HDi 110	82		11.10	07.13								
	1.6 HDi	80		02.07	07.13								
	1.6 HDi 110	82		11.10	07.13								
	1.6 THP 140	103		07.08	07.13								
	1.6 THP 150	110		10.08	07.13								
	1.6 THP 155	115		11.10	07.13								
	1.6 VTi 120	88		07.08	07.13								
	1.8 i 16V	92		02.07	07.13								
	2.0 HDi 138	100		02.07	07.13								
	2.0 HDi 150	110		07.09	07.13								
	2.0 HDi 165	120		11.10	07.13								
	2.0 i 16V	103		02.07	07.13								
		1.6 HDi	80	ORGA 11766	02.07								11.8116-0356.1
1.6 VTi 120		88	ORGA 11766	07.08		11.0101-5704.2	260095						
1.8 i 16V		92	ORGA 11766	02.07				11.8171-0008.1	990049				
						11.0441-6008.2	250038						
1.6 16V		110	ORGA 11920	07.08		11.8116-0356.1	390586	2		Haltefeder	ATE		
1.6 THP 140		103	ORGA 11920	07.08								11.0101-5704.2	260095
1.6 THP 150		110	ORGA 11920	10.08		11.8171-0008.1	990049						
2.0 HDi 138		100	ORGA 11920	02.07				11.0441-6008.2	250038				
2.0 i 16V		103	ORGA 11920	02.07									
1.6 e-HDi 110		82		11.10	07.13	11.9601-9717.2	220901	2		D=60, - Halter	ATE		
1.6 HDi	80	ORGA 11767		07.13	11.9601-9718.2							220902	
1.6 HDi 110	82		11.10	07.13		11.8116-0356.1	390586						
1.6 VTi 120	88	ORGA 11767		07.13	11.0101-5704.2			260095					
1.8 i 16V	92	ORGA 11767		07.13		11.8171-0008.1	990049						
					11.0441-6008.2			250038					
1.6 16V	110	ORGA 11921		07.13		11.9601-9717.2	220901		2		D=60, - Halter	ATE	
1.6 THP 140	103	ORGA 11921		07.13	11.9601-9718.2			220902					
1.6 THP 150	110	ORGA 11921		07.13		11.8116-0356.1	390586						
1.6 THP 155	115		11.10	07.13	11.0101-5704.2			260095					
2.0 HDi 138	100	ORGA 11921		07.13		11.8171-0008.1	990049						
2.0 HDi 150	110		07.09	07.13	11.0441-6008.2			250038					
2.0 HDi 165	120		11.10	07.13									
2.0 i 16V	103	ORGA 11921		07.13									
	1.6 16V	110		07.08	07.13	24.5111-0424.3	331014	2		L=424			
	1.6 e-HDi 110	82		11.10	07.13								
	1.6 HDi	80		02.07	07.13								
	1.6 HDi 110	82		11.10	07.13								
	1.6 THP 140	103		07.08	07.13								
	1.6 THP 150	110		10.08	07.13								
	1.6 THP 155	115		11.10	07.13								
	1.6 VTi 120	88		07.08	07.13								
	1.8 i 16V	92		02.07	07.13								
	2.0 HDi 138	100		02.07	07.13								
	2.0 HDi 150	110		07.09	07.13								

¹⁾ - idling stop system / - dispositivo start/stop / - unité marche/arrêt / - unidad arranque/paro



									
CITROEN C4 I PICASSO (07-13)									
	2.0 HDi 165 2.0 i 16V	120 103		11.10 02.07	07.13 07.13		24.5111-0424.3 331014	2	L=424
	1.6 16V 1.6 e-HDi 110 1.6 HDi 1.6 HDi 110 1.6 THP 140 1.6 THP 150 1.6 THP 155 1.6 VTi 120 1.8 i 16V 2.0 HDi 138 2.0 HDi 150 2.0 HDi 165 2.0 i 16V	110 82 80 82 103 110 115 88 92 100 110 120 103		07.08 11.10 02.07 11.10 07.08 10.08 11.10 07.08 02.07 02.07 07.09 11.10 02.07	07.13 07.13 07.13 07.13 07.13 07.13 07.13 07.13 07.13 07.13 07.13 07.13 07.13		24.5246-0216.3 331022	2	L=216
CITROEN C4 I GRAND PICASSO (06-13)									
	1.6 HDi 2.0 HDi 135	80 100	ORGA 11437 ORGA 11437	10.06 10.06			03.7860-4103.4 300242		10" ATE
	1.6 16V 1.6 16V 1.6 e-HDi 110 1.6 HDi 1.6 HDi 110 1.6 THP 155 1.6 VTi 120 2.0 HDi 135 2.0 HDi 150 2.0 HDi 165 1.8 i 16V 2.0 i 16V	103 110 82 80 ORGA 11438 82 115 88 100 ORGA 11438 110 120 92 103		07.08 10.08 11.10 07.13 09.10 11.10 07.08 07.13 07.09 11.10 10.06 10.06	07.13 07.13 07.13 07.13 07.13 07.13 07.13 07.13 07.13 07.13 07.13 07.13		03.7860-5702.4 300279		- Start/Stop-Anlage ¹⁾ 10" ATE
	1.6 16V 1.6 16V 1.6 e-HDi 110 1.6 HDi 1.6 HDi 110 1.6 THP 155 1.6 VTi 120 1.8 i 16V 2.0 HDi 135 2.0 HDi 150 2.0 HDi 165 2.0 i 16V	103 110 82 80 82 115 88 92 100 110 120 103		07.08 10.08 11.10 10.06 09.10 11.10 07.08 10.06 10.06 07.09 11.10 10.06	07.13 07.13 07.13 07.13 07.13 07.13 07.13 07.13 07.13 07.13 07.13 07.13		03.4153-0173.3 010815		Thz 23,81 ATE
	1.6 HDi 1.6 VTi 120 1.8 i 16V	80 88 92	ORGA 11766 ORGA 11766 ORGA 11766	10.06 07.08 10.06			11.8116-0356.1 390586 11.0101-5704.2 260095 11.8171-0008.1 990049	2	Haltefeder Hülzensatz Führungsbolzen ATE
	1.6 16V 1.6 16V 2.0 HDi 135 2.0 i 16V	103 110 100 103	ORGA 11920 ORGA 11920 ORGA 11920 ORGA 11920	07.08 10.08 10.06 10.06			11.8116-0356.1 390586 11.0101-5704.2 260095 11.8171-0008.1 990049	2	Haltefeder Hülzensatz Führungsbolzen ATE
	1.6 e-HDi 110 1.6 HDi 1.6 HDi 110 1.6 VTi 120 1.8 i 16V	82 80 ORGA 11767 82 88 ORGA 11767 92 ORGA 11767		11.10 09.10	07.13 07.13 07.13 07.13 07.13		11.9601-9717.2 220901 11.9601-9718.2 220902 11.8116-0356.1 390586 11.0101-5704.2 260095 11.0441-6008.2 250038 11.8171-0008.1 990049	2	D=60, - Halter ATE D=60, - Halter ATE Haltefeder ATE Hülzensatz ATE Dichtungssatz ATE Führungsbolzen ATE
	1.6 16V 1.6 16V 1.6 THP 155 2.0 HDi 135 2.0 HDi 150 2.0 HDi 165 2.0 i 16V	103 ORGA 11921 110 ORGA 11921 115 100 ORGA 11921 110 120 103 ORGA 11921		07.13 07.13 11.10 07.09 11.10 07.13	07.13 07.13 07.13 07.13 07.13 07.13		11.9601-9717.2 220901 11.9601-9718.2 220902 11.8116-0356.1 390586 11.0441-6008.2 250038 11.0101-5704.2 260095 11.8171-0008.1 990049	2	D=60, - Halter ATE D=60, - Halter ATE Haltefeder ATE Dichtungssatz ATE Hülzensatz ATE Führungsbolzen ATE
	1.6 16V 1.6 16V 1.6 e-HDi 110 1.6 HDi 1.6 HDi 110 1.6 THP 155 1.6 VTi 120 1.8 i 16V 2.0 HDi 135 2.0 HDi 150 2.0 HDi 165 2.0 i 16V	103 110 82 80 82 115 88 92 100 110 120 103		07.08 10.08 11.10 10.06 09.10 11.10 07.08 10.06 10.06 07.09 11.10 10.06	07.13 07.13 07.13 07.13 07.13 07.13 07.13 07.13 07.13 07.13 07.13 07.13		24.5111-0424.3 331014	2	L=424
	1.6 16V 1.6 16V 1.6 e-HDi 110 1.6 HDi 1.6 HDi 110 1.6 THP 155 1.6 VTi 120 1.8 i 16V 2.0 HDi 135 2.0 HDi 150	103 110 82 80 82 115 88 92 100 110		07.08 10.08 11.10 10.06 09.10 11.10 07.08 10.06 10.06 07.09	07.13 07.13 07.13 07.13 07.13 07.13 07.13 07.13 07.13 07.13		24.5246-0216.3 331022	2	L=216

¹⁾ - idling stop system / - dispositivo start/stop / - unité marche/arrêt / - unidad arranque/paro

CITROEN C4 I GRAND PICASSO (06-13)										
										
	2.0 HDi 165 2.0 i 16V	120 103		11.10 10.06	07.13 07.13	24.5246-0216.3	331022	2	L=216	
CITROEN C4 II Limousine (B7) (10-)										
	1.2 THP 1.6 BlueHDi 100 1.6 BlueHDi 115 1.6 BlueHDi 120 1.6 Flex 1.6 HDi 110 1.6 HDi 115 1.6 HDi 90 1.6 VTi 120 1.6 VTi 120 LPG 2.0 Flex	96 73 85 88 81 82 84 68 88 88 103		04.14 07.14 08.14 02.15 11.09 11.09 07.12 11.09 11.09 09.11 11.09		11.9601-9717.2 11.9601-9718.2 11.0441-6008.2 11.8171-0008.1 11.0101-5704.2 11.8116-0356.1	220901 220902 250038 990049 260095 390586	2	D=60, - Halter D=60, - Halter Dichtungssatz Führungsbolzen Hülzensatz Haltefeder	ATE ATE ATE ATE ATE ATE
	1.6 THP 155 2.0 HDi 150	115 110		11.09 11.09		11.9601-9717.2 11.9601-9718.2 11.0441-6008.2 11.8171-0008.1 11.0101-5704.2 11.8116-0356.1	220901 220902 250038 990049 260095 390586	2	D=60, - Halter D=60, - Halter Dichtungssatz Führungsbolzen Hülzensatz Haltefeder	ATE ATE ATE ATE ATE ATE
	1.2 THP 1.2 THP 110 1.4 VTi 95 1.6 BlueHDi 100 1.6 BlueHDi 120 1.6 Flex 1.6 HDi 110 1.6 HDi 115 1.6 HDi 90 1.6 VTi 120 1.6 VTi 120 LPG 2.0 Flex	96 81 70 73 88 81 82 84 68 88 88 103		04.14 02.15 11.09 07.14 02.15 11.09 11.09 07.12 11.09 11.09 09.11 11.09		24.3387-1731.7 24.3387-1732.7	221009 221010	2	D=38, - Halter D=38, - Halter	TRW TRW
	1.2 THP 1.2 THP 110 1.4 VTi 95 1.6 BlueHDi 100 1.6 BlueHDi 115 1.6 BlueHDi 120 1.6 Flex 1.6 HDi 110 1.6 HDi 115 1.6 HDi 90 1.6 THP 155 1.6 VTi 120 1.6 VTi 120 LPG 2.0 Flex 2.0 HDi 150	96 81 70 73 85 88 81 82 84 68 115 88 88 103 110		04.14 02.15 11.09 07.14 08.14 02.15 11.09 11.09 07.12 11.09 11.09 09.11 11.09 11.09		24.5246-0190.3	330697	2	L=190	
CITROEN C4 II PICASSO (13-)										
	1.2 THP 110 1.2 THP 130 1.6 BlueHDi 100 1.6 BlueHDi 120 1.6 HDi 115 1.6 HDi 90 1.6 THP 150 1.6 THP 155 1.6 THP 165 1.6 VTi 120 2.0 BlueHDi 135 2.0 BlueHDi 135 Hybr. 2.0 HDi 150	81 96 73 88 84 68 110 115 121 88 100 100 110		04.16 04.14 12.14 07.14 06.13 06.13 09.14 07.14 07.14 06.13 09.13 09.13 09.13		11.0441-6008.2 11.0101-5407.2 11.8116-0237.1 11.8171-0008.1	250038 260011 390509 990049	2	Dichtungssatz Hülzensatz Haltefeder Führungsbolzen	ATE ATE ATE ATE
	1.2 THP 110 1.2 THP 130 1.6 BlueHDi 100 1.6 BlueHDi 120 1.6 HDi 115 1.6 HDi 90 1.6 THP 150 1.6 THP 155 1.6 THP 165 1.6 VTi 120 2.0 BlueHDi 135 2.0 BlueHDi 135 Hybr. 2.0 HDi 150	81 96 73 88 84 68 110 115 121 88 100 100 110		04.16 04.14 12.14 07.14 06.13 06.13 09.14 06.13 07.14 06.13 09.13 09.13 09.13		11.0441-6008.2 11.0101-5407.2 11.8116-0237.1 11.8171-0008.1	250038 260011 390471 990049	2	Dichtungssatz Hülzensatz Haltefeder Führungsbolzen	ATE ATE ATE ATE
CITROEN C4 II GRAND PICASSO (13-)										
	1.2 THP 130 1.6 BlueHDi 100 1.6 BlueHDi 120 1.6 HDi 115 1.6 HDi 90 1.6 THP 150 1.6 THP 155 1.6 THP 165	96 73 88 84 68 110 115 121		04.14 01.15 07.14 08.13 08.13 09.14 08.13 07.14		11.0441-6008.2 11.0101-5407.2 11.8116-0237.1 11.8171-0008.1	250038 260011 390509 990049	2	Dichtungssatz Hülzensatz Haltefeder Führungsbolzen	ATE ATE ATE ATE

1) + electric parking brake / + freno a mano elettrico / + frein à main électrique / + freno de mano eléctrico

2) - electric parking brake / - freno a mano elettrico / - frein à main électrique / - freno de mano eléctrico

3) + brake disc diameter 283 mm / + disco fr.diam. 283mm / + disques fr.diam. 283mm / + disco fr.diam. 283mm

4) + brake disc diameter 304 mm / + disco fr.diam. 304mm / + disques fr.diam. 304mm / + disco fr.diam. 304mm

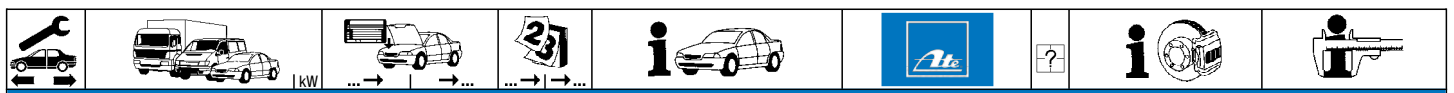

CITROEN C4 II GRAND PICASSO (13-)

	1.6 VTI 120	88	08.13	+ Bremsscheibendurchm. 283 mm ¹⁾	11.0441-6008.2	250038	2		Dichtungssatz	ATE
	2.0 BlueHdi 135	100	09.13	+ Bremsscheibendurchm. 283 mm ¹⁾	11.0101-5407.2	260011				
	2.0 BlueHdi 135 Hybr.	100	09.13	+ Bremsscheibendurchm. 283 mm ¹⁾	11.8116-0237.1	390509	2		Haltefeder	ATE
	2.0 Hdi 150	110	09.13	+ Bremsscheibendurchm. 283 mm ¹⁾	11.8171-0008.1	990049				
	1.2 THP 130	96	04.14	+ Bremsscheibendurchm. 304 mm ²⁾	11.0441-6008.2	250038				
	1.6 BlueHdi 100	73	01.15	+ Bremsscheibendurchm. 304 mm ²⁾	11.0101-5407.2	260011				
	1.6 BlueHdi 120	88	07.14	+ Bremsscheibendurchm. 304 mm ²⁾	11.8116-0326.1	390471				
	1.6 Hdi 115	84	08.13	+ Bremsscheibendurchm. 304 mm ²⁾	11.8171-0008.1	990049				
	1.6 Hdi 90	68	08.13	+ Bremsscheibendurchm. 304 mm ²⁾						
	1.6 THP 150	110	09.14	+ Bremsscheibendurchm. 304 mm ²⁾						
	1.6 THP 155	115	08.13	+ Bremsscheibendurchm. 304 mm ²⁾						
	1.6 THP 165	121	07.14	+ Bremsscheibendurchm. 304 mm ²⁾						
	1.6 Vti 120	88	08.13	+ Bremsscheibendurchm. 304 mm ²⁾						
	2.0 BlueHdi 135	100	09.13	+ Bremsscheibendurchm. 304 mm ²⁾						
	2.0 BlueHdi 135 Hybr.	100	09.13	+ Bremsscheibendurchm. 304 mm ²⁾						
	2.0 Hdi 150	110	09.13	+ Bremsscheibendurchm. 304 mm ²⁾						



































CITROEN C4 CACTUS (14-)













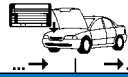

	1.2 THP 110	81	09.14		24.4122-1703.3	010843	2		+ Trommelbremse ³⁾ + Scheibenbremse ⁴⁾	THz 22,20 THz 23,81	TRW TRW
	1.2 Vti 75	55	05.14		24.4123-1704.3	010828					
	1.2 Vti 82	60	05.14								
	1.6 e-HDi 92	68	05.14								
	1.6 Hdi 100	73	09.14								
	1.2 THP 110	81	09.14	+ belüftete Scheiben ⁵⁾	24.3541-1771.5	240239	2			D=54, - Halter D=54, - Halter	BOS BOS
	1.2 Vti 75	55	05.14	+ belüftete Scheiben ⁵⁾	24.3541-1772.5	240240					
	1.2 Vti 82	60	05.14	+ belüftete Scheiben ⁵⁾							
	1.6 e-HDi 92	68	05.14	+ belüftete Scheiben ⁵⁾							
	1.6 Hdi 100	73	09.14	+ belüftete Scheiben ⁵⁾							
	1.2 THP 110	81	09.14		24.5111-0496.3	331371	2			L=495	
	1.2 Vti 75	55	05.14								
	1.2 Vti 82	60	05.14								
	1.6 e-HDi 92	68	05.14								
	1.6 Hdi 100	73	09.14								
	1.2 THP 110	81	09.14		24.3387-1733.5	240655	2			D=38, - Halter D=38, - Halter	TRW TRW
	1.2 Vti 75	55	05.14		24.3387-1734.5	240656					
	1.2 Vti 82	60	05.14								
	1.6 e-HDi 92	68	05.14								
	1.6 Hdi 100	73	09.14								
	1.2 THP 110	81	09.14		24.5239-0165.3	330606	2			L=165	
	1.2 Vti 75	55	05.14								
	1.2 Vti 82	60	05.14								
	1.6 e-HDi 92	68	05.14								
	1.6 Hdi 100	73	09.14								
	1.2 THP 110	81	09.14		24.3220-1741.3	020548	2			Rz 20,64	
	1.2 Vti 75	55	05.14								
	1.2 Vti 82	60	05.14								
	1.6 e-HDi 92	68	05.14								
	1.6 Hdi 100	73	09.14								
	1.2 Vti 75	55	05.14		24.2518-1704.3	040102	2			Nz 18,90	
	1.2 Vti 82	60	05.14								
	1.6 e-HDi 92	68	05.14								

CITROEN C-ELYSEE (12-)



















	1.6 Hdi 92	68	11.12		24.4122-1703.3	010843	2		+ ESP	THz 22,20	TRW
	1.2 Vti 72	53	11.12		24.3541-1771.5	240239					
	1.2 Vti 82	60	12.14		24.3541-1772.5	240240	2		+ belüftete Scheiben ⁵⁾ + belüftete Scheiben ⁵⁾	D=54, - Halter D=54, - Halter	BOS BOS
	1.6 BlueHdi 100	73	11.14								
	1.6 Hdi 92	68	11.12								
	1.6 Vti 115	85	11.12								
	1.2 Vti 72	53	11.12		24.5239-0190.3	330966					
	1.2 Vti 82	60	12.14		24.3220-1617.3	020244	2		- ABS - ABS + ABS	RzR 20,64 RzR 20,64 Rz 20,64	BDX BDX
	1.6 BlueHdi 100	73	11.14		24.3220-1618.3	020245					
	1.6 Hdi 92	68	11.12		24.3220-1743.3	020556					
	1.6 Vti 115	85	11.12								
	1.2 Vti 72	53	11.12		24.2518-1702.3	040099					
	1.2 Vti 82	60	12.14	+ BVM MA-Getriebe ⁶⁾	24.2518-1703.3	040101	2			Nz 18,90	
	1.6 BlueHdi 100	73	11.14	+ BVM MA-Getriebe ⁶⁾							
	1.6 Hdi 92	68	11.12	+ BVM MA-Getriebe ⁶⁾							
	1.6 Vti 115	85	11.12	+ BVM MA-Getriebe ⁶⁾							
	1.2 Vti 72	53	11.12	+ BE4R-Getriebe ⁷⁾							
	1.2 Vti 82	60	12.14	+ BE4R-Getriebe ⁷⁾							
1.6 BlueHdi 100	73	11.14	+ BE4R-Getriebe ⁷⁾								
1.6 Hdi 92	68	11.12	+ BE4R-Getriebe ⁷⁾								
1.6 Vti 115	85	11.12	+ BE4R-Getriebe ⁷⁾								

¹⁾ + brake disc diameter 283 mm / + disco fr.diam. 283mm / + disques fr.diam. 283mm / + disco fr.diam. 283mm
²⁾ + brake disc diameter 304 mm / + disco fr.diam. 304mm / + disques fr.diam. 304mm / + disco fr.diam. 304mm
³⁾ + drum brake / + freno a tamburo / + freins à tambour / + tambores de freno
⁴⁾ + disc brake / + disco freno / + disques de frein / + disco de freno
⁵⁾ + ventilated discs / + dischi ventilati / + disques ventilés / + disco ventilado
⁶⁾ + BVM MA transmission / + scatola cambio BVM MA / + boîte de vitesse BVM MA / + cambio BVM MA
⁷⁾ + BE4R transmission / + scatola cambio BE4R / + boîte de vitesse BE4R / + cambio BE4R

										
CITROEN C5 I Limousine (01-04)										
	2.2 HDi 3.0 V6	98 152		03.01 03.01	08.04 08.04	24.3572-1709.5 24.3572-1710.5	240583 240584	 	D=57, - Halter D=57, - Halter	BOS BOS
	1.8 16V 2.0 16V 2.0 16V 2.0 HDi 110 2.0 HDi 90 2.2 HDi 3.0 V6	85 100 103 80 66 98 152		03.01 03.01 03.01 03.01 03.01 03.01 03.01	08.04 08.04 08.04 08.04 08.04 08.04 08.04	24.5111-0550.3	330665	2		L=550
	1.8 16V 2.0 16V 2.0 16V 2.0 HDi 110 2.0 HDi 90 2.2 HDi 3.0 V6	85 100 103 80 66 98 152		03.01 03.01 03.01 03.01 03.01 03.01 03.01	08.04 08.04 08.04 08.04 08.04 08.04 08.04	24.3727-0335.2	580335	2 		L=1840
CITROEN C5 I Kombi (01-04)										
	2.2 HDi 3.0 V6 3.0 V6 Carlsson	98 152 173		06.01 06.01 09.03	08.04 08.04 08.04	24.3572-1709.5 24.3572-1710.5	240583 240584	 	D=57, - Halter D=57, - Halter	BOS BOS
	1.8 16V 2.0 16V 2.0 16V 2.0 HDi 110 2.0 HDi 90 2.2 HDi 3.0 V6 3.0 V6 Carlsson	85 100 103 80 66 98 152 173		06.01 06.01 06.01 06.01 06.01 06.01 06.01 09.03	08.04 08.04 08.04 08.04 08.04 08.04 08.04 08.04	24.5111-0550.3	330665	2		L=550
	1.8 16V 2.0 16V 2.0 16V 2.0 HDi 110 2.0 HDi 90 2.2 HDi 3.0 V6 3.0 V6 Carlsson	85 100 103 80 66 98 152 173		06.01 06.01 06.01 06.01 06.01 06.01 06.01 09.03	08.04 08.04 08.04 08.04 08.04 08.04 08.04 08.04	24.3727-0335.2	580335	2 		L=1840
CITROEN C5 II Limousine (04-08)										
	2.0 HDi 2.2 HDi 2.2 HDi 2.2 HDi 3.0 Carlsson 3.0 V6	100 98 120 125 173 173		09.04 09.04 05.06 04.06 09.04 09.04	01.08 01.08 01.08 01.08 01.08 01.08	24.3572-1709.5 24.3572-1710.5	240583 240584	 	D=57, - Halter D=57, - Halter	BOS BOS
	1.6 HDi 1.8 16V 1.8 16V 2.0 16V 2.0 HDi 2.2 HDi 2.2 HDi 2.2 HDi 3.0 Carlsson 3.0 V6	80 85 92 103 100 98 120 125 173 173		09.04 09.04 09.05 09.04 09.04 09.04 05.06 04.06 09.04 09.04	01.08 01.08 01.08 01.08 01.08 01.08 01.08 01.08 01.08 01.08	24.5111-0550.3	330665	2		L=550
	1.6 HDi 1.8 16V 1.8 16V 2.0 16V 2.0 HDi 2.2 HDi 2.2 HDi 2.2 HDi 3.0 Carlsson 3.0 V6	80 85 92 103 100 98 120 125 173 173		09.04 09.04 09.05 09.04 09.04 09.04 05.06 04.06 09.04 09.04	01.08 01.08 01.08 01.08 01.08 01.08 01.08 01.08 01.08 01.08	24.3727-0335.2	580335	2 		L=1840
CITROEN C5 II Kombi (04-08)										
	2.0 HDi 2.2 HDi 2.2 HDi 2.2 HDi 3.0 V6	100 98 120 125 173		09.04 09.04 05.06 04.06 09.04	01.08 01.08 01.08 01.08 01.08	24.3572-1709.5 24.3572-1710.5	240583 240584	 	D=57, - Halter D=57, - Halter	BOS BOS
	1.6 HDi 1.8 16V 1.8 16V 2.0 16V 2.0 HDi 2.2 HDi 2.2 HDi 2.2 HDi 3.0 V6	80 85 92 103 100 98 120 125 173		09.04 09.04 09.05 09.04 09.04 09.04 05.06 04.06 09.04	01.08 01.08 01.08 01.08 01.08 01.08 01.08 01.08 01.08	24.5111-0550.3	330665	2		L=550
	1.6 HDi 1.8 16V 1.8 16V 2.0 16V	80 85 92 103		09.04 09.04 09.05 09.04	01.08 01.08 01.08 01.08	24.3727-0335.2	580335	2 		L=1840
										

























									
CITROEN C5 II Kombi (04-08)									
	2.0 HDi	100		09.04	01.08	24.3727-0335.2	580335	2 ↑	L=1840
	2.2 HDi	98		09.04	01.08				
	2.2 HDi	120		05.06	01.08				
	2.2 HDi	125		04.06	01.08				
	3.0 V6			09.04	01.08				
CITROEN C5 III Limousine (X7) (08-)									
	1.6 HDi	◀ 80		02.08		03.7860-7802.4	300280		10" ATE
	1.6 THP 155	◀115		04.09					
	1.6 VTI 120	◀ 88		07.10					
	1.8 16V	◀ 92		02.08					
	2.0 16V	◀103		02.08					
	2.0 16V BioFlex	◀103		02.08					
	2.0 HDi	◀100		02.08					
	2.0 HDi 140	◀103		11.08					
	2.0 HDi 165	◀120		04.09					
	2.2 HDi	◀125		02.08					
	2.2 HDi 200	◀150		07.10					
	2.7 HDi	◀150		02.08					
	3.0	◀152		02.08					
	3.0 HDi 240	◀177		04.09					
	3.0 V6	◀155		02.08					
	1.6 HDi 110	◀ 82		07.10		03.7860-7802.4	300280	- Start/Stop-Anlage ¹⁾	10" ATE
	1.6 HDi 115	◀ 84		01.12					
	2.0 HDi 180	◀133		03.15					
	1.6 HDi	80	ORGA 12347	02.08		03.2123-3123.3	010806		THz 23,81 ATE
	1.6 HDi 110	82	ORGA 12347	07.10					
	1.6 THP 155	115	ORGA 12347	04.09					
	1.6 VTI 120	88	ORGA 12347	07.10					
	1.8 16V	92	ORGA 12347	02.08					
	2.0 16V	103	ORGA 12347	02.08					
	2.0 16V BioFlex	103	ORGA 12347	02.08					
	2.0 HDi	100	ORGA 12347	02.08					
	2.0 HDi 140	103	ORGA 12347	11.08					
	2.0 HDi 165	120	ORGA 12347	04.09					
	2.2 HDi	125	ORGA 12347	02.08					
	2.2 HDi 200	150	ORGA 12347	07.10					
	2.7 HDi	150	ORGA 12347	02.08					
	3.0	152	ORGA 12347	02.08					
	3.0 HDi 240	177	ORGA 12347	04.09					
	3.0 V6	155	ORGA 12347	02.08					
	1.6 HDi	80	ORGA 12998	02.08		11.9601-9731.2	220853	☐	D=60, - Halter ATE
	1.6 HDi 110	82	ORGA 12998	07.10		11.9601-9732.2	220854	☐	D=60, - Halter ATE
	1.6 HDi 115	84	ORGA 12998	01.12		11.0441-6008.2	250038		Dichtungssatz ATE
	1.6 THP 155	115	ORGA 12998	04.09		11.0101-5407.2	260011		Hülssensatz ATE
	1.6 VTI 120	88	ORGA 12998	07.10		11.8171-0008.1	990049		Führungsbolzen ATE
	1.8 16V	92	ORGA 12998	02.08		11.8116-0356.1	390586	2	Haltefeder ATE
	2.0 16V	103	ORGA 12998	02.08					
	2.0 16V BioFlex	103	ORGA 12998	02.08					
	2.0 HDi	100	ORGA 12998	02.08					
	2.0 HDi 140	103	ORGA 12998	11.08					
	2.0 HDi 165	120	ORGA 12998	04.09					
	1.6 HDi	80 ORGA 12999				11.0441-6008.2	250038		Dichtungssatz ATE
	1.6 HDi 110	82 ORGA 12999				11.0101-5704.2	260095		Hülssensatz ATE
	1.6 HDi 115	84 ORGA 12999				11.8171-0008.1	990049		Führungsbolzen ATE
	1.6 THP 155	115 ORGA 12999				11.8116-0356.1	390586	2	Haltefeder ATE
	1.6 VTI 120	88 ORGA 12999							
	1.8 16V	92 ORGA 12999							
	2.0 16V	103 ORGA 12999							
	2.0 16V BioFlex	103 ORGA 12999							
	2.0 BlueHDi 150	110		05.15					
	2.0 HDi	100 ORGA 12999							
	2.0 HDi 140	103 ORGA 12999							
	2.0 HDi 165	120 ORGA 12999							
	2.2 HDi	125		02.08		24.3451-1719.7	220763	☐	D=45/45, - Halter TRW
	2.7 HDi	150		02.08		24.3451-1720.7	220764	☐	D=45/45, - Halter TRW
	3.0	152		02.08		24.0101-3802.2	260100		Bremssattel-Zubehör TRW
	3.0 V6	155		02.08					
	2.0 HDi 180	133		03.15		11.9601-9883.2	220917	☐	D=60, - Halter ATE
	2.2 HDi 200	150	ORGA 12774	07.10		11.9601-9884.2	220918	☐	D=60, - Halter ATE
	3.0 HDi 240	177	ORGA 12774	04.09		11.0441-6008.2	250038		Dichtungssatz ATE
						11.0101-5407.2	260011		Hülssensatz ATE
						11.8171-0008.1	990049		Führungsbolzen ATE
	1.6 HDi	80	ORGA 12998	02.08		24.5161-0314.3	331220	☐	L=310/275, + Rohrleitung
	1.6 HDi 110	82	ORGA 12998	07.10		24.5161-0313.3	331219	☐	L=310/275, + Rohrleitung
	1.6 HDi 115	84	ORGA 12998	01.12					
	1.6 THP 155	115	ORGA 12998	04.09					
	1.6 VTI 120	88	ORGA 12998	07.10					
	1.8 16V	92	ORGA 12998	02.08					
	2.0 16V	103	ORGA 12998	02.08					
	2.0 16V BioFlex	103	ORGA 12998	02.08					
	2.0 HDi	100	ORGA 12998	02.08					
	2.0 HDi 140	103	ORGA 12998	11.08					
	2.0 HDi 165	120	ORGA 12998	04.09					
	2.2 HDi	125	ORGA 12998	02.08					
	2.2 HDi 200	150	ORGA 12998	07.10					
	2.7 HDi	150	ORGA 12998	02.08					

¹⁾ - idling stop system / - dispositivo start/stop / - unité marche/arrêt / - unidad arranque/paro

									
CITROEN C5 III Limousine (X7) (08-)									
	3.0	152	ORGA 12998	02.08		24.5161-0314.3	331220		L=310/275, + Rohrleitung L=310/275, + Rohrleitung
	3.0 HDi 240	177	ORGA 12998	04.09		24.5161-0313.3	331219		
	3.0 V6	155	ORGA 12998	02.08					
	1.6 HDi	80	ORGA 12999			24.5161-0775.3	331412		L=775 L=775
	1.6 HDi 110	82	ORGA 12999			24.5161-0776.3	331413		
	1.6 HDi 115	84	ORGA 12999						
	1.6 THP 155	115	ORGA 12999						
	1.6 VTI 120	88	ORGA 12999						
	1.8 16V	92	ORGA 12999						
	2.0 16V	103	ORGA 12999						
	2.0 16V BioFlex	103	ORGA 12999						
	2.0 BlueHDi 150	110		05.15					
	2.0 HDi	100	ORGA 12999						
	2.0 HDi 140	103	ORGA 12999						
	2.0 HDi 165	120	ORGA 12999						
	2.0 HDi 180	133		03.15					
	2.2 HDi	125	ORGA 12999						
	2.2 HDi 200	150	ORGA 12999						
	2.7 HDi	150	ORGA 12999						
	3.0	152	ORGA 12999						
	3.0 HDi 240	177	ORGA 12999						
	3.0 V6	155	ORGA 12999						
	1.6 HDi	80		02.08	+ elektrische Feststellbremse ¹⁾	11.9387-7087.2	220975		D=38, - Halter ATE D=38, - Halter ATE Hülzensatz ATE Führungsbolzen ATE Haltefeder ATE
	1.6 HDi 110	82		07.10	+ elektrische Feststellbremse ¹⁾	11.9387-7088.2	220976		
	1.6 HDi 115	84		01.12	+ elektrische Feststellbremse ¹⁾	11.0101-5407.2	260011		
	1.6 THP 155	115		04.09	+ elektrische Feststellbremse ¹⁾	11.8171-0008.1	990049		
	1.6 VTI 120	88		07.10	+ elektrische Feststellbremse ¹⁾	11.8116-0340.1	390595		
	1.8 16V	92		02.08	+ elektrische Feststellbremse ¹⁾				
	2.0 16V	103		02.08	+ elektrische Feststellbremse ¹⁾				
	2.0 16V BioFlex	103		02.08	+ elektrische Feststellbremse ¹⁾				
	2.0 BlueHDi 150	110		05.15	+ elektrische Feststellbremse ¹⁾				
	2.0 HDi	100		02.08	+ elektrische Feststellbremse ¹⁾				
	2.0 HDi 140	103		11.08	+ elektrische Feststellbremse ¹⁾				
	2.0 HDi 165	120		04.09	+ elektrische Feststellbremse ¹⁾				
	2.0 HDi 180	133		03.15	+ elektrische Feststellbremse ¹⁾				
	2.2 HDi	125		02.08	+ elektrische Feststellbremse ¹⁾				
	2.2 HDi 200	150		07.10	+ elektrische Feststellbremse ¹⁾				
	2.7 HDi	150		02.08	+ elektrische Feststellbremse ¹⁾				
3.0	152		02.08	+ elektrische Feststellbremse ¹⁾					
3.0 HDi 240	177		04.09	+ elektrische Feststellbremse ¹⁾					
3.0 V6	155		02.08	+ elektrische Feststellbremse ¹⁾					
	1.6 HDi	80		02.08	- elektrische Feststellbremse ²⁾	24.3387-1707.7	220701		D=38, - Halter TRW D=38, - Halter TRW Bremsattel-Zubehör TRW
	1.6 HDi 110	82		07.10	- elektrische Feststellbremse ²⁾	24.3387-1708.7	220702		
	1.6 HDi 115	84		01.12	- elektrische Feststellbremse ²⁾	24.0101-3803.2	260101		
	1.6 THP 155	115		04.09	- elektrische Feststellbremse ²⁾				
	1.6 VTI 120	88		07.10	- elektrische Feststellbremse ²⁾				
	1.8 16V	92		02.08	- elektrische Feststellbremse ²⁾				
	2.0 16V	103		02.08	- elektrische Feststellbremse ²⁾				
	2.0 16V BioFlex	103		02.08	- elektrische Feststellbremse ²⁾				
	2.0 BlueHDi 150	110		05.15	- elektrische Feststellbremse ²⁾				
	2.0 HDi	100		02.08	- elektrische Feststellbremse ²⁾				
	2.0 HDi 140	103		11.08	- elektrische Feststellbremse ²⁾				
	2.0 HDi 165	120		04.09	- elektrische Feststellbremse ²⁾				
	2.0 HDi 180	133		03.15	- elektrische Feststellbremse ²⁾				
	2.2 HDi	125		02.08	- elektrische Feststellbremse ²⁾				
	2.2 HDi 200	150		07.10	- elektrische Feststellbremse ²⁾				
	2.7 HDi	150		02.08	- elektrische Feststellbremse ²⁾				
	3.0	152		02.08	- elektrische Feststellbremse ²⁾				
	3.0 HDi 240	177		04.09	- elektrische Feststellbremse ²⁾				
	3.0 V6	155		02.08	- elektrische Feststellbremse ²⁾				
	1.6 HDi	80	ORGA 11682	02.08		24.5151-0583.3	331019		L=584 L=584
	1.6 HDi 110	82	ORGA 11682	07.10		24.5151-0584.3	331020		
	1.6 HDi 115	84	ORGA 11682	01.12					
	1.6 THP 155	115	ORGA 11682	04.09					
	1.6 VTI 120	88	ORGA 11682	07.10					
	1.8 16V	92	ORGA 11682	02.08					
	2.0 16V	103	ORGA 11682	02.08					
	2.0 16V BioFlex	103	ORGA 11682	02.08					
	2.0 HDi	100	ORGA 11682	02.08					
	2.0 HDi 140	103	ORGA 11682	11.08					
	2.0 HDi 165	120	ORGA 11682	04.09					
	2.2 HDi	125	ORGA 11682	02.08					
	2.2 HDi 200	150	ORGA 11682	07.10					
	2.7 HDi	150	ORGA 11682	02.08					
	3.0	152	ORGA 11682	02.08					
	3.0 HDi 240	177	ORGA 11682	04.09					
3.0 V6	155	ORGA 11682	02.08						
	1.6 HDi	80	ORGA 11683			24.5151-0638.3	331141		L=638 L=638
	1.6 HDi 110	82	ORGA 11683			24.5151-0639.3	331142		
	1.6 HDi 115	84	ORGA 11683						
	1.6 THP 155	115	ORGA 11683						
	1.6 VTI 120	88	ORGA 11683						
	1.8 16V	92	ORGA 11683						
	2.0 16V	103	ORGA 11683						
	2.0 16V BioFlex	103	ORGA 11683						
	2.0 BlueHDi 150	110		05.15					
	2.0 HDi	100	ORGA 11683						

¹⁾ + electric parking brake / + freno a mano elettrico / + frein à main électrique / + freno de mano eléctrico

²⁾ - electric parking brake / - freno a mano elettrico / - frein à main électrique / - freno de mano eléctrico

								
CITROEN C5 III Limousine (X7) (08-)								
	2.0 HDi 140 2.0 HDi 165 2.0 HDi 180 2.2 HDi 2.2 HDi 200 2.7 HDi 3.0 3.0 HDi 240 3.0 V6	103 ORGA 11683 120 ORGA 11683 133 125 ORGA 11683 150 ORGA 11682 150 ORGA 11683 152 ORGA 11683 177 ORGA 11683 155 ORGA 11683	03.15		24.5151-0638.3 24.5151-0639.3	331141 331142	 	L=638 L=638
CITROEN C5 III Kombi (X7) (08-)								
	1.6 HDi 1.6 THP 155 1.6 VTI 120 1.8 16V 2.0 16V 2.0 16V BioFlex 2.0 HDi 2.0 HDi 140 2.0 HDi 150 2.0 HDi 165 2.2 HDi 2.2 HDi 200 2.7 HDi 3.0 3.0 HDi 240 3.0 V6	◀ 80 ◀115 ◀ 88 ◀ 92 ◀103 ◀103 ◀100 ◀103 ◀110 ◀120 ◀125 ◀150 ◀150 ◀152 ◀177 ◀155	02.08 04.09 07.10 02.08 02.08 02.08 02.08 11.08 04.09 04.09 02.08 07.10 02.08 02.08 04.09 02.08		03.7860-7802.4	300280		10" ATE
	1.6 HDi 110 1.6 HDi 115 2.0 HDi 180	◀ 82 ◀ 84 ◀133	07.10 01.12 03.15		03.7860-7802.4	300280	- Start/Stop-Anlage ¹⁾	10" ATE
	1.6 HDi 1.6 HDi 110 1.6 THP 155 1.6 VTI 120 1.8 16V 2.0 16V 2.0 16V BioFlex 2.0 HDi 2.0 HDi 140 2.0 HDi 150 2.0 HDi 165 2.2 HDi 2.2 HDi 200 2.7 HDi 3.0 3.0 HDi 240 3.0 V6	80 82 115 88 92 103 103 100 103 110 120 125 150 150 152 177 155	ORGA 12347 02.08 ORGA 12347 07.10 ORGA 12347 04.09 ORGA 12347 07.10 ORGA 12347 02.08 ORGA 12347 02.08 ORGA 12347 02.08 ORGA 12347 02.08 ORGA 12347 11.08 ORGA 12347 04.09 ORGA 12347 04.09 ORGA 12347 02.08 ORGA 12347 07.10 ORGA 12347 02.08 ORGA 12347 02.08 ORGA 12347 04.09 ORGA 12347 02.08		03.2123-3123.3	010806		Thz 23,81 ATE
	1.6 HDi 1.6 HDi 110 1.6 HDi 115 1.6 THP 155 1.6 VTI 120 1.8 16V 2.0 16V 2.0 16V BioFlex 2.0 HDi 2.0 HDi 140 2.0 HDi 150 2.0 HDi 165 2.0 HDi 165	80 82 84 115 88 92 103 103 100 103 110 120 120	ORGA 12998 02.08 ORGA 12998 07.10 ORGA 12998 01.12 ORGA 12998 04.09 ORGA 12998 07.10 ORGA 12998 02.08 ORGA 12998 02.08 ORGA 12998 02.08 ORGA 12998 02.08 ORGA 12998 11.08 ORGA 12998 04.09 ORGA 12998 04.09 ORGA 12998 04.09		11.9601-9731.2 11.9601-9732.2 11.0441-6008.2 11.0101-5407.2 11.8171-0008.1 11.8116-0356.1	220853 220854 250038 260011 990049 390586	 	D=60, - Halter ATE D=60, - Halter ATE Dichtungssatz ATE Hülssensatz ATE Führungsbolzen ATE Haltefeder ATE
	1.6 HDi 1.6 HDi 110 1.6 HDi 115 1.6 THP 155 1.6 VTI 120 1.8 16V 2.0 16V 2.0 16V BioFlex 2.0 HDi 2.0 HDi 140 2.0 HDi 150 2.0 HDi 165 2.0 HDi 165	80 ORGA 12999 82 ORGA 12999 84 ORGA 12999 115 ORGA 12999 88 ORGA 12999 92 ORGA 12999 103 ORGA 12999 103 ORGA 12999 100 ORGA 12999 103 ORGA 12999 110 ORGA 12999 120 ORGA 12999 120 ORGA 12999			11.0441-6008.2 11.0101-5704.2 11.8171-0008.1 11.8116-0356.1	250038 260095 990049 390586	2	Dichtungssatz ATE Hülssensatz ATE Führungsbolzen ATE Haltefeder ATE
	2.2 HDi 2.7 HDi 3.0 3.0 V6	125 150 152 155	02.08 02.08 02.08 02.08		24.3451-1719.7 24.3451-1720.7	220763 220764	 	D=45/45, - Halter TRW D=45/45, - Halter TRW
	2.0 HDi 180 2.2 HDi 200 3.0 HDi 240	133 150 177	03.15 07.10 04.09		11.9601-9883.2 11.9601-9884.2 11.0441-6008.2 11.0101-5407.2 11.8171-0008.1	220917 220918 250038 260011 990049	 	D=60, - Halter ATE D=60, - Halter ATE Dichtungssatz ATE Hülssensatz ATE Führungsbolzen ATE
 	1.6 HDi 1.6 HDi 110 1.6 HDi 115 1.6 THP 155 1.6 VTI 120	80 82 84 115 88	ORGA 12998 02.08 ORGA 12998 07.10 ORGA 12998 01.12 ORGA 12998 04.09 ORGA 12998 07.10		24.5161-0314.3 24.5161-0313.3	331220 331219	 	L=310/275, + Rohrleitung ATE L=310/275, + Rohrleitung ATE

¹⁾ - idling stop system / - dispositivo start/stop / - unité marche/arrêt / - unidad arranque/paro



CITROEN C5 III Kombi (X7) (08-)





















	3.0 V6	155	ORGA 11682	02.08			24.5151-0583.3	331019			L=584
							24.5151-0584.3	331020			L=584
	1.6 HDi	80	ORGA 11683				24.5151-0638.3	331141			L=638
	1.6 HDi 110	82	ORGA 11683				24.5151-0639.3	331142			L=638
	1.6 HDi 115	84	ORGA 11683								
	1.6 THP 155	115	ORGA 11683								
	1.6 VTi 120	88	ORGA 11683								
	1.8 16V	92	ORGA 11683								
	2.0 16V	103	ORGA 11683								
	2.0 16V BioFlex	103	ORGA 11683								
	2.0 HDi	100	ORGA 11683								
	2.0 HDi 140	103	ORGA 11683								
	2.0 HDi 150	110	ORGA 11683								
	2.0 HDi 165	120	ORGA 11683								
	2.0 HDi 180	133			03.15						
	2.2 HDi	125	ORGA 11683								
	2.2 HDi 200	150	ORGA 11683								
	2.7 HDi	150	ORGA 11683								
	3.0	152	ORGA 11683								
3.0 HDi 240	177	ORGA 11683									
3.0 V6	155	ORGA 11683									

CITROEN C6 (05-12)

	2.2 HDi	125	ORGA 11192	06.06			03.7860-3402.4	300217			10"	ATE
	2.7 HDi	150	ORGA 11073	09.05								
	3.0 V6	155	ORGA 11192	09.05								
	2.2 HDi	125	ORGA 11193				03.7860-5102.4	300218			10"	ATE
	2.7 HDi	150	ORGA 11074		12.12							
	3.0 V6	155	ORGA 11193		12.12							
	2.2 HDi	125	ORGA 12047		12.12		03.7860-8002.4	300258			10"	ATE
	3.0 HDi	177		07.09	12.12							
	2.2 HDi	125	ORGA 12347	06.06			03.2123-3123.3	010806			THz 23,81	ATE
	2.7 HDi	150	ORGA 12347	09.05								
	3.0 HDi	177	ORGA 12347	07.09								
	3.0 V6	155	ORGA 12347	09.05								
	2.2 HDi	125		06.06	12.12		24.3451-1719.7	220763			D=45/45, - Halter	TRW
	2.7 HDi	150		09.05	12.12		24.3451-1720.7	220764			D=45/45, - Halter	TRW
	3.0 V6	155		09.05	12.12							
	3.0 HDi	177		07.09	12.12		11.9601-9883.2	220917			D=60, - Halter	ATE
							11.9601-9884.2	220918			D=60, - Halter	ATE
							11.0101-5407.2	260011			Hülzensatz	ATE
							11.8171-0008.1	990049			Führungsbolzen	ATE
							11.0441-6008.2	250038			Dichtungssatz	ATE
	2.2 HDi	125	ORGA 11125	06.06			24.5161-0315.3	331186			L=310/275, + Rohrleitung	
	2.7 HDi	150	ORGA 11125	09.05			24.5161-0316.3	331187			L=310/275, + Rohrleitung	
	3.0 V6	155	ORGA 11125	09.05								
	2.2 HDi	125	ORGA 11126		12.12		24.5161-0314.3	331220			L=310/275, + Rohrleitung	
	2.7 HDi	150	ORGA 11126		12.12		24.5161-0313.3	331219			L=310/275, + Rohrleitung	
	3.0 V6	155	ORGA 11126		12.12							
	3.0 HDi	177		07.09	12.12		24.5161-0775.3	331412			L=775	
							24.5161-0776.3	331413			L=775	
	2.2 HDi	125		06.06	12.12		24.3384-1769.7	220791			D=38, - Halter	TRW
	2.7 HDi	150		09.05	12.12		24.3384-1770.7	220792			D=38, - Halter	TRW
	3.0 HDi	177		07.09	12.12		24.0101-3802.2	260100			Bremssattel-Zubehör	TRW
	3.0 V6	155		09.05	12.12							
	2.2 HDi	125	ORGA 11682	06.06			24.5151-0583.3	331019			L=584	
	2.7 HDi	150	ORGA 11682	09.05			24.5151-0584.3	331020			L=584	
	3.0 HDi	177	ORGA 11682	07.09								
	3.0 V6	155	ORGA 11682	09.05								
	2.2 HDi	125	ORGA 11683		12.12		24.5151-0638.3	331141			L=638	
	2.7 HDi	150	ORGA 11683		12.12		24.5151-0639.3	331142			L=638	
	3.0 HDi	177	ORGA 11683		12.12							
3.0 V6	155	ORGA 11683		12.12								

CITROEN C8 (02-14)

	2.0 16V	103	ORGA 10919	09.05			03.7860-2002.4	300216			10"	ATE
	2.0 HDi	79	ORGA 10528		07.14							
	2.0 HDi 135	100	ORGA 10919	03.06								
	2.2 HDi	94	ORGA 10528		07.14							
	2.0 16V	103	ORGA 10920		07.14		03.7860-4302.4	300231			10"	ATE
	2.0 HDi	88		02.07	07.14							
	2.0 HDi 135	100	ORGA 10920		07.14							
	2.2 HDi 165	120		03.06	07.14		03.7870-1602.4	300311			11"	ATE
	2.0 16V	103		09.05	07.14		03.2122-2163.3	010800			THz 22,20	ATE
	2.0 HDi	79	ORGA 10528		07.14							
	2.0 HDi	88		02.07	07.14							
	2.0 HDi 135	100		03.06	07.14							
	2.2 HDi	94	ORGA 10528		07.14							
	2.0 HDi 165	120		03.06	07.14		03.2123-3421.3	010933			THz 23,81	ATE
	2.2 HDi	125		06.06	07.14							
	2.0 16V	100		07.02	07.14		24.3601-1711.7	220607			D=60, - Halter	TRW
	2.0 16V	103		09.05	07.14		24.3601-1712.7	220608			D=60, - Halter	TRW
	2.0 HDi	79		07.02	07.14							
	2.0 HDi	88		02.07	07.14							
2.0 HDi 135	100		03.06	07.14								

										
CITROEN C8 (02-14)										
	2.2 16V	116		07.02	07.14	24.3601-1711.7	220607	<input type="checkbox"/>	D=60, - Halter	TRW
	2.2 HDi	94		07.02	07.14	24.3601-1712.7	220608	<input type="checkbox"/>	D=60, - Halter	TRW
	2.0 HDi 165	120		03.06	07.14	24.3451-1855.5	240659	<input type="checkbox"/>	D=40/45, - Halter	TRW
	2.2 HDi	125		06.06	07.14	24.3451-1856.5	240660	<input type="checkbox"/>	D=40/45, - Halter	TRW
	2.0 16V	100		07.02	07.14	24.5111-0462.3	330555	2		L=460
	2.0 16V	103		09.05	07.14					
	2.0 HDi	79		07.02	07.14					
	2.0 HDi	88		02.07	07.14					
	2.0 HDi 135	100		03.06	07.14					
	2.2 16V	116		07.02	07.14					
	2.2 HDi	94		07.02	07.14					
	2.0 HDi 165	120		03.06	07.14					
2.2 HDi	125		06.06	07.14						
	2.0 HDi 165	120		03.06	07.14	24.5144-0500.3	331169	2		L=500
	2.2 HDi	125		06.06	07.14					
	2.0 16V	100		07.02	07.14	24.3384-1761.7	220671	<input type="checkbox"/>		D=38, - Halter
	2.0 16V	103		09.05	07.14					
	2.0 HDi	79		07.02	07.14					
	2.0 HDi	88		02.07	07.14					
	2.0 HDi 135	100		03.06	07.14					
	2.0 HDi 165	120		03.06	07.14					
	2.2 16V	116		07.02	07.14					
	2.2 HDi	94		07.02	07.14					
	2.2 HDi	125		06.06	07.14					
	3.0 V6	150		07.02	07.14					
	2.0 16V	100		07.02	07.14	24.5229-0251.3	330535	2		L=250
	2.0 16V	103		09.05	07.14					
	2.0 HDi	79		07.02	07.14					
	2.0 HDi	88		02.07	07.14					
	2.0 HDi 135	100		03.06	07.14					
	2.0 HDi 165	120		03.06	07.14					
	2.2 16V	116		07.02	07.14					
	2.2 HDi	94		07.02	07.14					
	2.2 HDi	125		06.06	07.14					
	3.0 V6	150		07.02	07.14					
	2.0 16V	◀100	ORGA 10284	07.02		24.3727-0847.2	580847	<input type="checkbox"/>		L=1068
	2.0 16V	◀103	ORGA 10284	09.05						
	2.0 HDi	◀79	ORGA 10284	07.02						
	2.0 HDi	◀88	ORGA 10284	02.07						
	2.0 HDi 135	◀100	ORGA 10284	03.06						
	2.0 HDi 165	◀120	ORGA 10284	03.06						
	2.2 16V	◀116	ORGA 10284	07.02						
	2.2 HDi	◀94	ORGA 10284	07.02						
	2.2 HDi	◀125	ORGA 10284	06.06						
	3.0 V6	◀150	ORGA 10284	07.02						
	2.0 16V	◀100	ORGA 10285		ORGA 11043	24.3727-0850.2	580850	<input type="checkbox"/>		L=1041
	2.0 16V	◀103	ORGA 10285		ORGA 11043					
	2.0 HDi	◀79	ORGA 10285		ORGA 11043					
	2.0 HDi	◀88	ORGA 10285		ORGA 11043					
	2.0 HDi 135	◀100	ORGA 10285		ORGA 11043					
	2.0 HDi 165	◀120	ORGA 10285		ORGA 11043					
	2.2 16V	◀116	ORGA 10285		ORGA 11043					
	2.2 HDi	◀94	ORGA 10285		ORGA 11043					
	2.2 HDi	◀125	ORGA 10285		ORGA 11043					
	3.0 V6	◀150	ORGA 10285		ORGA 11043					
	2.0 16V	▶100	ORGA 10284	07.02		24.3727-0848.2	580848	<input type="checkbox"/>		L=2360
	2.0 16V	▶100	ORGA 10284	07.02						
	2.0 16V	▶103	ORGA 10284	09.05						
	2.0 HDi	▶79	ORGA 10284	07.02						
	2.0 HDi 135	▶100	ORGA 10284	03.06						
	2.0 HDi 165	▶120	ORGA 10284	03.06						
	2.2 16V	▶116	ORGA 10284	07.02						
	2.2 HDi	▶94	ORGA 10284	07.02						
	2.2 HDi	▶125	ORGA 10284	06.06						
	3.0 V6	▶150	ORGA 10284	07.02						
	2.0 16V	▶100	ORGA 10285		07.14	24.3727-0849.2	580849	<input type="checkbox"/>		L=2308
	2.0 16V	▶103	ORGA 10285		07.14					
	2.0 HDi	▶79	ORGA 10285		07.14					
	2.0 HDi	▶88	ORGA 10285		07.14					
	2.0 HDi 135	▶100	ORGA 10285		07.14					
	2.0 HDi 165	▶120	ORGA 10285		07.14					
	2.2 16V	▶116	ORGA 10285		07.14					
	2.2 HDi	▶94	ORGA 10285		07.14					
	2.2 HDi	▶125	ORGA 10285		07.14					
	3.0 V6	▶150	ORGA 10285		07.14					
CITROEN C-CROSSER (07-13)										
	2.0 2WD	108		11.10	01.13	24.3431-1701.5	240437	<input type="checkbox"/>		D=43/43, - Halter
	2.0 4WD	108		11.10	01.13					
	2.2 HDi	115		02.07	01.13					
	2.4	125		08.08	01.13					
	2.0 2WD	108		11.10	01.13	24.5286-0600.3	331173	<input type="checkbox"/>		L=600
	2.0 4WD	108		11.10	01.13					
	2.2 HDi	115		02.07	01.13					
	2.4	125		08.08	01.13					























CITROEN C-CROSSER (07-13)

	2.2 HDi	115	ORGA 12718	02.07		24.5112-0280.3	331200	2	am Bremsattel ¹⁾	L=280	
	2.4	125	ORGA 12718	08.08		24.5247-0275.3	331244	<input type="checkbox"/>		L=275	
	2.0 2WD	▶108		11.10	01.13 + ESP	24.5247-0275.3	331244	<input type="checkbox"/>		L=275	
	2.0 4WD	▶108		11.10	01.13 + ESP	24.5247-0276.3	331245	<input type="checkbox"/>		L=275	
	2.2 HDi	115	ORGA 12719		01.13			<input type="checkbox"/>			
	2.4	125	ORGA 12719		01.13			<input type="checkbox"/>			

CITROEN DS3 (09-)

	1.4 HDi 70	50	ORGA 12999	ORGA 13341		24.4123-1704.3	010828			THz 23,81	TRW	
	1.6 HDi 110	82	ORGA 12999	ORGA 13341								
	1.6 HDi 115	84		ORGA 13341	08.12							
	1.6 HDi 90	68	ORGA 12999	ORGA 13341								
	1.6 Racing		ORGA 12999	ORGA 13341								
	1.6 THP 150	115	ORGA 12999	ORGA 13341								
	1.6 VTi 120	88	ORGA 12999	ORGA 13341								
1.4 VTi 95	70	ORGA 12999	ORGA 13341			24.4122-1703.3	010843			THz 22,20	TRW	
	1.2 THP 130	96			09.15	+ Bremsscheibendurchm. 266 mm ²⁾	24.3541-1771.5	240239	<input type="checkbox"/>		D=54, - Halter	BOS
	1.2 VTi 110	81			10.14	+ Bremsscheibendurchm. 266 mm ²⁾	24.3541-1772.5	240240	<input type="checkbox"/>		D=54, - Halter	BOS
	1.2 VTi 82	60			10.12							
	1.4 HDi 70	50			04.10							
	1.4 VTi 95	70			04.10							
	1.6 BlueHDi 100	73			07.14	+ Bremsscheibendurchm. 266 mm ²⁾						
	1.6 BlueHDi 75	55			03.15	+ Bremsscheibendurchm. 266 mm ²⁾						
	1.6 HDi 90	68			11.09							
	1.6 THP 163	121			10.14	+ Bremsscheibendurchm. 266 mm ²⁾						
	1.6 THP 208	153			09.15	+ Bremsscheibendurchm. 266 mm ²⁾						
	1.2 THP 130	96			09.15		24.5111-0496.3	331371	2		L=495	
1.2 VTi 110	81			10.14								
1.2 VTi 82	60			10.12								
1.4 HDi 70	50			04.10								
1.4 VTi 95	70			04.10								
1.6 BlueHDi 100	73			07.14								
1.6 BlueHDi 120	88			10.13								
1.6 BlueHDi 75	55			03.15								
1.6 HDi 110	82			11.09								
1.6 HDi 115	84			08.12								
1.6 HDi 115	85			10.13								
1.6 HDi 90	68			11.09								
1.6 THP 150	115			04.10								
1.6 THP 163	121			10.14								
1.6 THP 208	153			09.15								
1.6 VTi 120	88			04.10								
	1.2 THP 130	96			09.15		24.3387-1733.5	240655	<input type="checkbox"/>		D=38, - Halter	TRW
	1.2 VTi 110	81			10.14		24.3387-1734.5	240656	<input type="checkbox"/>		D=38, - Halter	TRW
	1.6 BlueHDi 100	73			07.14							
	1.6 BlueHDi 120	88			10.13							
	1.6 BlueHDi 75	55			03.15							
	1.6 HDi 110	82			11.09							
	1.6 HDi 115	84			08.12							
	1.6 HDi 115	85			10.13							
	1.6 Racing				02.11							
	1.6 THP 150	115			04.10							
	1.6 THP 163	121			10.14							
1.6 THP 208	153			09.15								
1.6 VTi 120	88			04.10								
	1.2 THP 130	96			09.15		24.5239-0165.3	330606	2		L=165	
	1.2 VTi 110	81			10.14							
	1.2 VTi 82	60			10.12							
	1.4 HDi 70	50			04.10							
	1.4 VTi 95	70			04.10							
	1.6 BlueHDi 100	73			07.14							
	1.6 BlueHDi 120	88			10.13							
	1.6 BlueHDi 75	55			03.15							
	1.6 HDi 110	82			11.09							
	1.6 HDi 115	84			08.12							
	1.6 HDi 115	85			10.13							
1.6 HDi 90	68			11.09								
1.6 Racing				02.11								
1.6 THP 150	115			04.10								
1.6 THP 163	121			10.14								
1.6 THP 208	153			09.15								
1.6 VTi 120	88			04.10								
	1.2 THP 130	96			09.15		24.3220-1732.3	020514		für Trommeldurchmesser 228 mm ³⁾	Rz 20,64	BOS
	1.2 VTi 110	81			10.14							
	1.4 VTi 95	70			04.10							
	1.6 BlueHDi 75	55			03.15							
	1.2 THP 130	96			09.15		24.3220-1741.3	020548		für Trommeldurchmesser 203 mm ⁴⁾	Rz 20,64	
	1.2 VTi 110	81			10.14							
	1.2 VTi 82	60			10.12							
	1.4 HDi 70	50			04.10							
	1.6 BlueHDi 100	73			07.14							
	1.6 BlueHDi 75	55			03.15							
	1.6 HDi 90	68			11.09							

1) on the brake caliper / sulla pinza freno / sur l'étrier de frein / a la pinza de freno
 2) + brake disc diameter 266 mm / + disco fr.diam. 266mm / + disques fr.diam. 266mm / + disco fr.diam. 266mm
 3) for drum diameter 228mm / per tamburi diametro 228mm / pour tambour diamètre 228mm / para tambores diámetro 228mm
 4) for drum diameter 203mm / per tamburi diametro 203mm / pour tambour diamètre 203mm / para tambores diámetro 203mm

										
CITROEN DS3 (09-)										
	1.2 THP 130	▶ 96		09.15	+ BVM MA-Getriebe ¹⁾	24.2415-1714.3	030134		Gz 15,87	
	1.2 VTi 82	▶ 60		10.12	+ BVM MA-Getriebe ¹⁾					
	1.4 VTi 95	▶ 70		04.10	+ BVM MA-Getriebe ¹⁾					
	1.6 BlueHDi 75	▶ 55		03.15	+ BVM MA-Getriebe ¹⁾					
	1.6 HDi 110	▶ 82		11.09	+ BVM MA-Getriebe ¹⁾					
	1.6 HDi 115	▶ 84		08.12	+ BVM MA-Getriebe ¹⁾					
	1.6 HDi 90	▶ 68		11.09	+ BVM MA-Getriebe ¹⁾					
	1.6 Racing	▶		02.11	+ BVM MA-Getriebe ¹⁾					
	1.6 THP 150	▶115		04.10	+ BVM MA-Getriebe ¹⁾					
	1.6 THP 163	▶121		10.14	+ BVM MA-Getriebe ¹⁾					
	1.6 THP 208	▶153		09.15	+ BVM MA-Getriebe ¹⁾					
	1.6 VTi 120	▶ 88		04.10	+ BVM MA-Getriebe ¹⁾					
	1.2 VTi 110	◀ 81		10.14	+ BE4R-Getriebe ²⁾	24.2415-1717.3	030140	- Start/Stop-Anlage ³⁾	Gz 15,87	
	1.4 VTi 95	◀ 70	ORGA 12775	04.10	+ BE4R-Getriebe ²⁾					
	1.6 HDi 110	◀ 82	ORGA 12775	11.09	+ BE4R-Getriebe ²⁾					
	1.6 HDi 90	◀ 68	ORGA 12775	11.09	+ BE4R-Getriebe ²⁾					
	1.6 Racing	◀	ORGA 12775	02.11	+ BE4R-Getriebe ²⁾					
	1.6 THP 150	◀115	ORGA 12775	04.10	+ BE4R-Getriebe ²⁾					
	1.6 VTi 120	◀ 88	ORGA 12775	04.10	+ BE4R-Getriebe ²⁾					
	1.4 VTi 95	◀ 70	ORGA 12775	04.10	+ BVM6 und Schaltgetriebe MC ⁴⁾	24.2415-1717.3	030140	- Start/Stop-Anlage ³⁾	Gz 15,87	
	1.6 HDi 110	◀ 82	ORGA 12775	11.09	+ BVM6 und Schaltgetriebe MC ⁴⁾					
	1.6 HDi 90	◀ 68	ORGA 12775	11.09	+ BVM6 und Schaltgetriebe MC ⁴⁾					
	1.6 Racing	◀	ORGA 12775	02.11	+ BVM6 und Schaltgetriebe MC ⁴⁾					
	1.6 THP 150	◀115	ORGA 12775	04.10	+ BVM6 und Schaltgetriebe MC ⁴⁾					
1.6 VTi 120	◀ 88	ORGA 12775	04.10	+ BVM6 und Schaltgetriebe MC ⁴⁾						
	1.2 THP 130	96		09.15	+ BVM MA-Getriebe ¹⁾	24.2518-1702.3	040099		Nz 18,90	
	1.2 VTi 110	81		10.14	+ BVM MA-Getriebe ¹⁾					
	1.4 VTi 95	70		04.10	+ BVM MA-Getriebe ¹⁾					
	1.6 BlueHDi 75	55		03.15	+ BVM MA-Getriebe ¹⁾					
	1.6 HDi 110	82		11.09	+ BVM MA-Getriebe ¹⁾					
	1.6 HDi 115	84		08.12	+ BVM MA-Getriebe ¹⁾					
	1.6 HDi 90	68		11.09	+ BVM MA-Getriebe ¹⁾					
	1.6 Racing			02.11	+ BVM MA-Getriebe ¹⁾					
	1.6 THP 150	115		04.10	+ BVM MA-Getriebe ¹⁾					
	1.6 THP 163	121		10.14	+ BVM MA-Getriebe ¹⁾					
	1.6 VTi 120	88		04.10	+ BVM MA-Getriebe ¹⁾	24.2518-1704.3	040102		Nz 18,90	
	CITROEN DS3 Cabrio (13-)									
	1.2 THP 130	96		09.15		24.4123-1704.3	010828		THz 23,81 TRW	
	1.2 VTi 110	81		10.14						
	1.6 BlueHDi 100	73		07.14						
	1.6 BlueHDi 115	85		10.13						
	1.6 BlueHDi 120	88		07.14						
	1.6 e-HDi 90	68		03.13						
	1.6 Racing	152		03.14						
	1.6 THP 155	115		03.13						
	1.6 THP 163	121		10.14						
	1.6 THP 208	153		09.15						
	1.6 VTi 120	88		03.13						
		1.2 THP 130	96		09.15	+ Bremsscheibendurchm. 266 mm ⁵⁾	24.3541-1771.5	240239		D=54, - Halter BOS
1.2 VTi 110		81		10.14	+ Bremsscheibendurchm. 266 mm ⁵⁾	24.3541-1772.5	240240		D=54, - Halter BOS	
1.2 VTi 82		60		03.13						
1.6 BlueHDi 100		73		07.14	+ Bremsscheibendurchm. 266 mm ⁵⁾					
1.6 BlueHDi 115		85		10.13	+ Bremsscheibendurchm. 266 mm ⁵⁾					
1.6 e-HDi 90		68		03.13						
1.6 THP 163		121		10.14	+ Bremsscheibendurchm. 266 mm ⁵⁾					
1.6 THP 208		153		09.15	+ Bremsscheibendurchm. 266 mm ⁵⁾					
1.2 THP 130		96		09.15		24.5111-0496.3	331371	2	L=495	
1.2 VTi 110		81		10.14						
1.2 VTi 82		60		03.13						
1.6 BlueHDi 100		73		07.14						
1.6 BlueHDi 115	85		10.13							
1.6 BlueHDi 120	88		07.14							
1.6 e-HDi 90	68		03.13							
1.6 THP 155	115		03.13							
1.6 THP 163	121		10.14							
1.6 THP 208	153		09.15							
1.6 VTi 120	88		03.13							
	1.2 THP 130	96		09.15		24.3387-1733.5	240655		D=38, - Halter TRW	
	1.2 VTi 110	81		10.14		24.3387-1734.5	240656		D=38, - Halter TRW	
	1.6 BlueHDi 100	73		07.14						
	1.6 BlueHDi 115	85		10.13						
	1.6 BlueHDi 120	88		07.14						
	1.6 Racing	152		03.14						
	1.6 THP 155	115		03.13						
	1.6 THP 163	121		10.14						
	1.6 THP 208	153		09.15						
	1.6 VTi 120	88		03.13						
		1.2 THP 130	96		09.15		24.5239-0165.3	330606	2	L=165
		1.2 VTi 110	81		10.14					
1.2 VTi 82		60		03.13						
1.6 BlueHDi 100		73		07.14						
1.6 BlueHDi 115		85		10.13						
1.6 BlueHDi 120		88		07.14						
1.6 e-HDi 90		68		03.13						
1.6 Racing		152		03.14						
↓										

¹⁾ + BVM MA transmission / + scatola cambio BVM MA / + boîte de vitesse BVM MA / + cambio BVM MA

²⁾ + BE4R transmission / + scatola cambio BE4R / + boîte de vitesse BE4R / + cambio BE4R

³⁾ - idling stop system / - dispositivo start/stop / - unité marche/arrêt / - unidad arranque/paro

⁴⁾ + BVM6 + manual transm. MC / + BVM6 + scatola camb.velocità MC / + BVM6 + transm.mécanique MC / + BVM6 + camb.de velocidad MC

⁵⁾ + brake disc diameter 266 mm / + disco fr.diam. 266mm / + disques fr.diam. 266mm / + disco fr.diam. 266mm

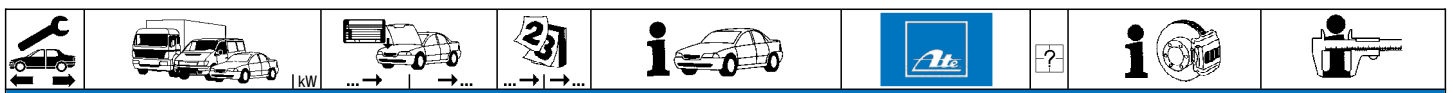

CITROEN DS3 Cabrio (13-)

	1.6 THP 155 1.6 THP 163 1.6 THP 208 1.6 VTi 120	115 121 153 88	03.13 10.14 09.15 03.13		24.5239-0165.3	330606	2		L=165
	1.2 THP 130 1.2 VTi 82 1.6 BlueHdi 100 1.6 BlueHdi 115 1.6 e-HDi 90	96 60 73 85 68	09.15 03.13 07.14 10.13 03.13		24.3220-1741.3	020548		für Trommeldurchmesser 203 mm ¹⁾	Rz 20,64
	1.2 THP 130 1.6 BlueHdi 115	96 85	09.15 10.13		24.3220-1732.3	020514		für Trommeldurchmesser 228 mm ²⁾	Rz 20,64 BOS
	1.2 THP 130 1.2 VTi 82 1.6 BlueHdi 115 1.6 e-HDi 90 1.6 THP 155 1.6 THP 208 1.6 VTi 120	▶ 96 ▶ 60 ▶ 85 ▶ 68 ▶ 115 ▶ 153 ▶ 88	09.15 03.13 10.13 03.13 03.13 09.15 03.13	+ BVM MA-Getriebe ³⁾ + BVM MA-Getriebe ³⁾ + BVM MA-Getriebe ³⁾ + BVM MA-Getriebe ³⁾ + BVM MA-Getriebe ³⁾ + BVM MA-Getriebe ³⁾ + BVM MA-Getriebe ³⁾	24.2415-1714.3	030134			Gz 15,87
	1.2 THP 130 1.2 VTi 82 1.6 BlueHdi 115 1.6 e-HDi 90 1.6 THP 155 1.6 THP 208	96 60 85 68 115 153	09.15 03.13 10.13 03.13 03.13 09.15	+ BVM MA-Getriebe ³⁾ + BVM MA-Getriebe ³⁾ + BVM MA-Getriebe ³⁾ + BVM MA-Getriebe ³⁾ + BVM MA-Getriebe ³⁾ + BVM MA-Getriebe ³⁾	24.2518-1702.3	040099			Nz 18,90
	1.6 VTi 120	88	03.13	+ BVM MA-Getriebe ³⁾	24.2518-1704.3	040102			Nz 18,90























CITROEN DS4 (11-)

	1.2 1.6 BlueHdi 115 1.6 BlueHdi 120 1.6 e-HDi 110 1.6 HDi 110 1.6 HDi 115 1.6 HDi 90 1.6 VTi 120 2.0 BlueHdi 150 2.0 BlueHdi 150 Hybr.	96 85 88 81 82 84 68 88 110 110	07.14 08.14 07.14 04.11 04.11 08.12 05.11 04.11 07.14 07.14		11.9601-9717.2 11.9601-9718.2 11.8116-0356.1 11.8171-0008.1 11.0101-5704.2 11.0441-6008.2	220901 220902 390586 990049 260095 250038	2		D=60, - Halter D=60, - Halter Haltefeder Führungsbolzen Hülzensatz Dichtungssatz	ATE ATE ATE ATE ATE ATE
	1.6 THP 200 1.6 THP 210 2.0 BlueHdi 180 2.0 HDi 135 2.0 HDi 165	147 155 133 100 120	04.11 07.15 07.14 09.11 04.11	+ 19" Rad ⁴⁾ + 19" Rad ⁴⁾ + 19" Rad ⁴⁾	11.9601-9883.2 11.9601-9884.2 11.0101-5407.2 11.8171-0008.1 11.0441-6008.2	220917 220918 260011 990049 250038			D=60, - Halter D=60, - Halter Hülzensatz Führungsbolzen Dichtungssatz	ATE ATE ATE ATE ATE
	1.6 THP 155 1.6 THP 163 2.0 BlueHdi 180 2.0 HDi 135 2.0 HDi 165	115 133 100 120	04.11 04.12 07.14 09.11 04.11	- 19" Rad ⁵⁾ - 19" Rad ⁵⁾ - 19" Rad ⁵⁾	11.9601-9717.2 11.9601-9718.2 11.8116-0356.1 11.8171-0008.1 11.0101-5704.2 11.0441-6008.2	220901 220902 390586 990049 260095 250038	2		D=60, - Halter D=60, - Halter Haltefeder Führungsbolzen Hülzensatz Dichtungssatz	ATE ATE ATE ATE ATE ATE
	1.6 e-HDi 110 1.6 HDi 110 1.6 HDi 115 1.6 HDi 90 1.6 THP 155 1.6 THP 163 1.6 THP 200 1.6 THP 210 1.6 VTi 120 2.0 BlueHdi 180 2.0 HDi 135 2.0 HDi 165	81 82 84 68 115 147 155 88 133 100 120	04.11 04.11 08.12 05.11 04.11 04.12 07.15 04.11 04.11 07.14 09.11 04.11	- elektrische Feststellbremse ⁶⁾ - elektrische Feststellbremse ⁶⁾ - elektrische Feststellbremse ⁶⁾ - elektrische Feststellbremse ⁶⁾ - elektrische Feststellbremse ⁶⁾ - elektrische Feststellbremse ⁶⁾ - elektrische Feststellbremse ⁶⁾ - elektrische Feststellbremse ⁶⁾ - elektrische Feststellbremse ⁶⁾ - elektrische Feststellbremse ⁶⁾ - elektrische Feststellbremse ⁶⁾ - elektrische Feststellbremse ⁶⁾	24.3387-1731.7 24.3387-1732.7	221009 221010			D=38, - Halter D=38, - Halter	TRW TRW
	1.2 1.6 BlueHdi 115 1.6 BlueHdi 120 1.6 e-HDi 110 1.6 HDi 110 1.6 HDi 115 1.6 HDi 90 1.6 THP 155 1.6 THP 163 1.6 THP 200 1.6 THP 210 1.6 VTi 120 2.0 BlueHdi 150 2.0 BlueHdi 150 Hybr. 2.0 BlueHdi 180 2.0 HDi 135 2.0 HDi 165	96 85 88 81 82 84 68 115 147 155 88 133 110 110 133 100 120	07.14 08.14 07.14 04.11 04.11 08.12 05.11 04.11 04.12 07.15 04.11 04.11 07.14 07.14 07.14 09.11 04.11		24.5246-0190.3	330697	2		L=190	

CITROEN DS5 (11-)

	1.6 HDi 110 1.6 HDi 115 1.6 HDi 120 1.6 THP 155 1.6 THP 165 1.6 THP 200 1.6 THP 210	82 84 115 121 147 155	11.11 08.12 11.13 11.11 01.12 11.11 11.14		03.7860-3732.4	300306		- Start/Stop-Anlage ⁷⁾	10"	ATE
--	---	--------------------------------------	---	--	----------------	--------	--	-----------------------------------	-----	------------

¹⁾ for drum diameter 203mm / per tamburi diametro 203mm / pour tambour diamètre 203mm / para tambores diámetro 203mm
²⁾ for drum diameter 228mm / per tamburi diametro 228mm / pour tambour diamètre 228mm / para tambores diámetro 228mm
³⁾ + BVM MA transmission / + scatola cambio BVM MA / + boîte de vitesse BVM MA / + cambio BVM MA
⁴⁾ + 19" wheel / + ruota 19" / + roue 19" / + rueda 19"
⁵⁾ - 19" wheel / - ruota 19" / - roue 19" / - rueda 19"
⁶⁾ - electric parking brake / - freno a mano elettrico / - frein à main électrique / - freno de mano eléctrico
⁷⁾ - idling stop system / - dispositivo start/stop / - unité marche/arrêt / - unidad arranque/pa





























								
CITROEN DS5 (11-)								
	2.0 HDi 135 2.0 HDi 150 2.0 HDi 165 2.0 HDi 180	100 110 120 133		11.11 07.14 11.11 08.13		03.7860-3732.4	300306	- Start/Stop-Anlage ¹⁾ 10" ATE
	1.6 HDi 110 1.6 HDi 115 1.6 HDi 120 1.6 THP 155 1.6 THP 165 1.6 THP 200 1.6 THP 210 2.0 HDi 135 2.0 HDi 135 Hybrid4 2.0 HDi 150 2.0 HDi 165 2.0 HDi 165 Hybr.4x4 2.0 HDi 180 2.0 HDi Hybrid4	82 84 115 121 147 155 100 100 110 120 120 133 147		11.11 08.12 11.13 11.11 01.12 11.11 11.14 11.11 12.11 07.14 11.11 12.11 08.13 11.11		03.4153-0173.3	010815	Naben D=82 ²⁾ THz 23,81 ATE
	1.6 HDi 110 1.6 HDi 115 1.6 THP 155 1.6 THP 165 1.6 THP 200 2.0 HDi 135 2.0 HDi 135 Hybrid4 2.0 HDi 150 2.0 HDi 165 2.0 HDi 165 Hybr.4x4 2.0 HDi 180 2.0 HDi Hybrid4	82 84 115 121 147 100 100 110 120 120 133 147	ORGA 13342 ORGA 13342	11.11 08.12 11.11 01.12 11.11 11.11 12.11 07.14 11.11 12.11 08.13 11.11		11.9601-9717.2 11.9601-9718.2 11.0101-5704.2 11.8171-0008.1 11.0441-6008.2 11.8116-0356.1	220901 220902 260095 990049 250038 390586	<input checked="" type="checkbox"/> Naben D=82 ²⁾ <input type="checkbox"/> Naben D=82 ²⁾ D=60, - Halter D=60, - Halter Hülssensatz Führungsbolzen Dichtungssatz Haltefeder ATE ATE ATE ATE ATE
	1.6 HDi 110 1.6 HDi 115 1.6 HDi 120 1.6 THP 210	82 84 155	ORGA 13343 ORGA 13343	11.13 11.14		11.9601-9717.2 11.9601-9718.2 11.0101-5704.2 11.8171-0008.1 11.0441-6008.2 11.8116-0356.1	220901 220902 260095 990049 250038 390586	<input checked="" type="checkbox"/> Naben D=82 ²⁾ <input type="checkbox"/> Naben D=82 ²⁾ D=60, - Halter D=60, - Halter Hülssensatz Führungsbolzen Dichtungssatz Haltefeder ATE ATE ATE ATE ATE
	1.6 HDi 110 1.6 HDi 115 1.6 THP 155 1.6 THP 165 1.6 THP 200 1.6 THP 210 2.0 HDi 135 2.0 HDi 135 Hybrid4 2.0 HDi 150 2.0 HDi 165 2.0 HDi 165 Hybr.4x4 2.0 HDi 180 2.0 HDi Hybrid4	82 84 115 121 147 155 100 100 110 120 120 133 147		11.11 08.12 11.11 01.12 11.11 11.14 11.11 12.11 07.14 11.11 12.11 08.13 11.11		11.9601-9883.2 11.9601-9884.2 11.0101-5407.2 11.0441-6008.2 11.8171-0008.1	220917 220918 260011 250038 990049	<input checked="" type="checkbox"/> Naben D=83 ³⁾ <input type="checkbox"/> Naben D=83 ³⁾ D=60, - Halter D=60, - Halter Hülssensatz Dichtungssatz Führungsbolzen ATE ATE ATE ATE ATE
	1.6 HDi 110 1.6 HDi 115 1.6 HDi 120 1.6 THP 155 1.6 THP 165 2.0 HDi 135 2.0 HDi 150 2.0 HDi 165	82 84 115 121 100 110 120		11.11 08.12 11.13 11.11 01.12 11.11 07.14 11.11		24.5246-0216.3	331022	2 L=216
	1.6 THP 200 1.6 THP 210 2.0 HDi 180	147 155 133		11.11 11.14 08.13		24.5246-0216.3	331022	2 L=216
CITROEN EVASION (94-02)								
	1.8 1.8	73 76	ORGA 08206 ORGA 08206	05.97 02.96		24.2122-1703.3 24.2122-1708.3	010422 010437	- ABS + ABS THz 22,20 THz 22,20
	1.8 1.8	73 76	ORGA 08207 ORGA 08207	07.02 12.96		24.2122-1741.3 24.2122-1742.3	010695 010696	- ABS + ABS THz 22,20 THz 22,20
	1.9 i 1.9 TD 2.0 16V 2.0 i 2.0 Turbo 2.1 TD		ORGA 08206 ORGA 08206 ORGA 08206 ORGA 08206 ORGA 08206	10.95 02.95 12.98 06.94 06.94 05.96	12.98	24.2123-1707.3	010492	- ABS THz 23,81
	1.9 TD 2.0 16V 2.0 HDi 2.0 i 2.0 Turbo 2.1 TD		ORGA 08207 ORGA 08207 ORGA 08207 ORGA 08207 ORGA 08207	07.02 07.02 08.99 07.02 07.02 07.02		24.2123-1738.3 24.2123-1733.3	010658 010657	- ABS + ABS THz 23,81 THz 23,81
	1.8 1.8	73 76		05.97 02.96	07.02 12.96	24.3571-1711.5 24.3571-1712.5	240159 240160	<input checked="" type="checkbox"/> <input type="checkbox"/> D=57, - Halter D=57, - Halter BDX BDX
	1.9 i 1.9 TD 2.0 16V 2.0 HDi 2.0 i 2.0 Turbo			10.95 02.95 12.98 08.99 06.94 06.94	12.98 07.02 07.02 07.02 07.02	24.3571-1709.5 24.3571-1710.5	240153 240154	<input checked="" type="checkbox"/> <input type="checkbox"/> D=57, - Halter D=57, - Halter TRW TRW

¹⁾ - idling stop system / - dispositivo start/stop / - unité marche/arrêt / - unidad arranque/paro

²⁾ hub diameter=82 / diametro mozzo=82 / diamètre du moyeu=82 / diametro del buje=82

³⁾ hub diameter=83 / diametro mozzo=83 / diamètre du moyeu=83 / diametro del buje=83



										
CITROEN EVASION (94-02)										
	2.1 TD			05.96	07.02	24.3571-1709.5	240153		D=57, - Halter D=57, - Halter	TRW TRW
	1.8 1.8 1.9 i 1.9 TD 2.0 16V 2.0 HDi 2.0 i 2.0 Turbo 2.1 TD	73 76		05.97 02.96 10.95 02.95 12.98 08.99 06.94 06.94 05.96	07.02 12.96 12.98 07.02 07.02 07.02 07.02 07.02	24.5118-0471.3	330528	2	L=473	
	1.8 1.8 1.9 i 1.9 TD 2.0 16V 2.0 HDi 2.0 i 2.0 Turbo 2.1 TD	73 76		05.97 02.96 10.95 02.95 12.98 08.99 06.94 06.94 05.96	07.02 12.96 12.98 07.02 07.02 07.02 07.02 07.02	11.3361-9975.2 11.3361-9976.2 11.0441-3602.2 11.0101-5407.2 11.8116-0073.1 11.8171-0008.1 24.3361-9975.5 24.3361-9976.5	220281 220282 250008 260011 390498 990049 240541 240542	2  	D=36, - Halter D=36, - Halter Dichtungssatz Hülzensatz Haltefeder Führungsbolzen D=36, - Halter D=36, - Halter	ATE ATE ATE ATE ATE ATE ATE
	1.8 1.8 1.9 i 1.9 TD 2.0 HDi 2.0 i	73 76		05.97 02.96 10.95 02.95 08.99 06.94	07.02 12.96 12.98 07.02 07.02 07.02	24.5229-0251.3	330535	2	+ HA-Trommelbremse ¹⁾	L=250
	1.8 1.8 1.9 i 1.9 TD 2.0 16V 2.0 HDi 2.0 i 2.0 Turbo 2.1 TD	73 76		05.97 02.96 10.95 02.95 08.99 06.94 06.94 05.96	07.02 12.96 12.98 07.02 07.02 07.02 07.02	24.5229-0251.3 24.5111-0301.3	330535 330499	2 2	+ HA-Scheibenbremse ²⁾ + HA-Scheibenbremse ²⁾	L=250 L=300
	1.8 1.8 1.9 i 1.9 TD 2.0 HDi 2.0 i	73 76		05.97 02.96 10.95 02.95 08.99 06.94	07.02 12.96 12.98 07.02 07.02 07.02	24.3219-1704.3	020374		- ABS - ABS - ABS - ABS - ABS - ABS	Rz 19,05
	1.8 1.8 1.9 i 1.9 TD 2.0 HDi 2.0 i	73 76		05.97 02.96 10.95 02.95 08.99 06.94	07.02 12.96 12.98 07.02 07.02 07.02	24.3727-0532.2 24.3727-0531.2	580532 580531	 	+ HA-Trommelbremse ¹⁾ + HA-Trommelbremse ¹⁾	L=1063 L=2286
	1.8 1.8 1.9 i 1.9 TD 2.0 HDi 2.0 i	73 76		05.97 02.96 10.95 02.95 08.99 06.94	07.02 12.96 12.98 07.02 07.02 07.02	24.3727-0532.2	580532		+ HA-Trommelbremse ¹⁾	L=1063
	1.8 1.8 1.9 i 1.9 TD 2.0 16V 2.0 HDi 2.0 i 2.0 Turbo 2.1 TD	73 76		05.97 02.96 10.95 02.95 12.98 08.99 06.94 06.94 05.96	07.02 12.96 12.98 07.02 07.02 07.02 07.02	24.3727-0336.2 24.3727-0530.2 24.3727-0529.2	580336 580530 580529	1   	+ HA-Scheibenbremse ²⁾ + HA-Scheibenbremse ²⁾ + HA-Scheibenbremse ²⁾	L=500 L=1255 L=2205
	1.8 1.8 2.0 i	73 76		05.97 02.96 06.94	07.02 12.96 07.02	24.3728-0341.2	590341			L=739, + AUT
	2.0 i			05.00	07.02	24.3728-0336.2	590336		+ BE4-Getriebe ³⁾	L=973, + AUT
	1.9 TD 2.0 Turbo			02.95 06.94	07.02 07.02	24.3728-0342.2	590342		+ ME5K-Getriebe ⁴⁾ + ME5K-Getriebe ⁴⁾	L=864, + AUT
	1.9 TD 2.0 16V 2.0 Turbo 2.1 TD			02.96 12.98 09.95 05.96	07.02 07.02 07.02 07.02	24.3728-0340.2	590340		+ ML5E-Getriebe ⁵⁾ + ML5E-Getriebe ⁵⁾	L=1088, + AUT
CITROEN JUMPER Bus (94-02)										
	1.9 D (10) 1.9 TD (10/14) 1.9 TD (10/14) 2.0 i (10) 2.5 D (14) 2.5 TD (14) 2.8 D (14)	51 66 68 80 63 76 64	S 15064995 S 15064995 S 15064995 S 15064995 S 15064995 S 15064995 S 15064995	01.99 08.94 02.94 02.94 08.94 08.94 01.99	- ABS - ABS - ABS - ABS - ABS - ABS - ABS	24.2122-1715.3	010481			ThZ 22,20
	1.9 D (10) 1.9 TD (10/14) 1.9 TD (10/14)	51 66 68	S 15064996 S 15064996 S 15064996	01.99 08.94 02.94	- ABS - ABS - ABS	24.2125-1703.3	010483			ThZ 25,40

1) + RA drum brake / + P freno a tamburo / + frein à tambour essieu AR / + ET-tambores de freno
2) + RA disc brake / + P disco freno / + frein à disque essieu AR / + ET-disco de freno
3) + BE4 transmission / + scatola cambio BE4 / + boîte de vitesse BE4 / + cambio BE4
4) + ME5K transmission / + scatola cambio ME5K / + boîte de vitesse ME5K / + cambio ME5K
5) + ML5E transmission / + scatola cambio ML5E / + boîte de vitesse ML5E / + cambio ML5E



CITROEN JUMPER Bus (94-02)

	1.9 D (10) 1.9 TD (10/14) 1.9 TD (10/14) 2.0 i (10/14/18) 2.5 D (14/18) 2.5 TD (14/18) 2.8 D (14/18) 2.8 HDi (14/18)	51 66 68 80 63 76 64 S 16205353 94		11.01 11.01 11.01 11.01 11.01 11.01 02.02 11.01	03.02 03.02 03.02 03.02 03.02 03.02 02.02 03.02	24.5112-0477.3 24.5112-0470.3	331299 331460	2 2		L=477 L=470
	1.9 D (10) 1.9 TD (10/14) 1.9 TD (10/14) 2.0 i (10/14/18) 2.5 D (14/18) 2.5 TD (14/18) 2.8 D (14/18) 2.8 HDi (14/18)	51 66 68 80 63 76 64 S 16194400 94		11.01 11.01 11.01 11.01 11.01 11.01 02.02 11.01	03.02 03.02 03.02 03.02 03.02 03.02 02.02 03.02	24.3461-1701.5 24.3461-1702.5	240449 240450	<input type="checkbox"/> <input type="checkbox"/>	D=46, - Halter D=46, - Halter	
	1.9 D (10) 1.9 TD (10/14) 1.9 TD (10/14) 2.0 i (10/14/18) 2.5 D (14/18) 2.5 TD (14/18) 2.5 TDi (14/18) 2.8 D (14/18) 2.8 HDi (14/18)	51 66 68 80 63 76 79 64 94	S 16206244	01.99 08.94 02.94 02.94 08.94 08.94 12.96 01.99 09.00	10.01 - ABS 10.01 - ABS 10.01 - ABS 10.01 - ABS 10.01 - ABS 10.01 - ABS 11.00 - ABS 10.01 - ABS 10.01 - ABS	24.5112-0340.3 24.5112-0361.3	330511 330649	1 1	- verstärktes Fahrwerk ¹⁾ + verstärktes Fahrwerk ²⁾	L=340 L=360
	1.9 D (10) 1.9 TD (10/14) 1.9 TD (10/14) 2.0 i (10/14/18) 2.5 D (14/18) 2.5 TD (14/18) 2.8 D (14/18) 2.8 HDi (14/18)	51 66 68 80 63 76 64 94	S 16206244	11.01 11.01 11.01 11.01 11.01 11.01 01.99 11.01	03.02 - ABS 03.02 - ABS 03.02 - ABS 03.02 - ABS 03.02 - ABS 03.02 - ABS - ABS 03.02 - ABS	24.5112-0361.3 83.6401-0159.3	330649 330746	1 2	+ HA-Trommelbremse ³⁾ + HA-Scheibenbremse ⁴⁾	L=360 L=160
	1.9 D (10) 1.9 TD (10/14) 1.9 TD (10/14) 2.0 i (10/14/18) 2.5 D (14/18) 2.5 TD (14/18) 2.5 TDi (14/18) 2.8 D (14/18) 2.8 HDi (14/18)	51 66 68 80 63 76 79 64 94	S 16206253	01.99 08.94 02.94 02.94 08.94 08.94 12.96 01.99 09.00	10.01 + ABS 10.01 + ABS 10.01 + ABS 10.01 + ABS 10.01 + ABS 10.01 + ABS 11.00 + ABS + ABS + ABS	24.5112-0315.3	330509	<input type="checkbox"/>	- verstärktes Fahrwerk ¹⁾	L=315
	1.9 D (10) 1.9 TD (10/14) 1.9 TD (10/14) 2.0 i (10/14/18) 2.5 D (14/18) 2.5 TD (14/18) 2.8 D (14/18) 2.8 HDi (14/18)	51 66 68 80 63 76 64 S 16194400 94		11.01 11.01 11.01 11.01 11.01 11.01 02.02 11.01	03.02 + ABS 03.02 + ABS 03.02 + ABS 03.02 + ABS 03.02 + ABS 03.02 + ABS + ABS 03.02 + ABS	83.6401-0159.3	330746	2	+ HA-Scheibenbremse ⁴⁾	L=160
	1.9 D (10) 1.9 TD (10/14) 1.9 TD (10/14) 2.0 i (10/14) 2.5 D (14) 2.8 D (14)	51 66 68 80 63 64	S 16206253	01.99 08.94 02.94 02.94 08.94 01.99	10.01 10.01 10.01 10.01 10.01 10.01	24.3225-1701.3	020399			Rz 25,40
	2.5 TD (14) 2.5 TDi (14) 2.8 D (14) 2.8 HDi (14)	76 79 64 94	S 16206253	08.94 12.96 01.99 09.00	10.01 11.00 10.01 10.01	24.3226-1702.3	020469			Rz 26,99
	1.9 D (10) 1.9 TD (10/14) 1.9 TD (10/14) 2.0 i (10/14) 2.5 D (14) 2.5 TD (14) 2.8 D (14) 2.8 HDi (14)	51 66 68 80 63 76 64 S 16204256 94		11.01 11.01 11.01 11.01 11.01 11.01 11.01 11.01	03.02 03.02 03.02 03.02 03.02 03.02 02.02 03.02	24.3226-1702.3	020469			Rz 26,99
	2.0 i (18) 2.5 D (18) 2.5 TD (18) 2.5 TDi (18) 2.8 D (18) 2.8 HDi (18)	80 63 76 79 64 94	S 16209999	02.94 08.94 08.94 12.96 01.99 09.00	10.01 10.01 10.01 11.00 10.01 10.01	24.3228-1701.3	020401			Rz 28,57
	1.9 D (10) 1.9 TD (10/14) 1.9 TD (10/14) 2WD 2.0 i (10/14/18) 2WD 2.5 D (14/18) 2WD 2.5 TD (14/18) 2WD 2.5 TDi (14/18) 2WD 2.8 D (14/18) 2.8 HDi (14/18) 2WD	51 66 68 80 63 76 79 64 94	S 16158427 S 16158427 S 16158427 S 16158427 S 16158427 S 16158427 S 16158427 S 16158427 S 16158427	01.99 08.94 02.94 02.94 08.94 08.94 12.96 01.99 09.00		24.3727-0345.2	580345	1	<input type="checkbox"/>	L=3045
	1.9 D (10) 1.9 TD (10/14) 1.9 TD (10/14) 2WD	51 S 16158428 66 S 16158428 68 S 16158428			03.02 03.02 03.02	24.3727-0350.2	580350	1	<input type="checkbox"/>	L=2827

1) - reinforced suspension / - sospensione rinforzata / - châssis renforcé / - suspensión reforzada
 2) + reinforced suspension / + sospensione rinforzata / + châssis renforcé / + suspensión reforzada
 3) + RA drum brake / + P freno a tamburo / + frein à tambour essieu AR / + ET-tambores de freno
 4) + RA disc brake / + P disco freno / + frein à disque essieu AR / + ET-disco de freno



CITROEN JUMPER Bus (94-02)

	2.0 i (10/14/18) 2WD	80 S 16158428			03.02		24.3727-0350.2	580350	1 ↓		L=2827	
	2.5 D (14/18) 2WD	63 S 16158428			03.02							
	2.5 TD (14/18) 2WD	76 S 16158428			03.02							
	2.5 TDi (14/18) 2WD	79 S 16158428			11.00							
	2.8 D (14/18)	64 S 16158428			02.02							
	2.8 HDi (14/18) 2WD	94 S 16158428			03.02							
	1.9 TD 4x4 (10/14)	68			08.96	03.02		24.3727-0842.2	580842	1 ↓		L=4100
	2.0 i 4x4 (10/14/18)	80			08.96	03.02						
	2.5 D 4x4 (14/18)	63			08.96	03.02						
2.5 TD 4x4 (14/18)	76			08.96	03.02							
2.5 TDi 4x4 (14/18)	79			12.96	11.00							
2.8 HDi 4x4 (14/18)	94			09.00	03.02							
	1.9 D (10)	51	S 16206244	01.99			24.6512-1701.3	320153		- ABS	BRL (2)	
	1.9 TD (10/14)	66	S 16206244	08.94								
	1.9 TD (10/14)	68	S 16206244	02.94								
	2.0 i (10/14/18)	80	S 16206244	02.94								
	2.5 D (14/18)	63	S 16206244	08.94								
	2.5 TD (14/18)	76	S 16206244	08.94								
	2.5 TDi (14/18)	79		12.96	11.00							
	2.8 D (14/18)	64	S 16206244	01.99								
2.8 HDi (14/18)	94	S 16206244	09.00									
	1.9 D (10)	51		01.99	03.02	+ ML5T-Getriebe ¹⁾	24.3728-0300.2	590300			L=1478	
	1.9 TD (10/14)	66		08.94	03.02	+ ML5T-Getriebe ¹⁾						
	1.9 TD (10/14) 2WD	68		02.94	03.02	+ ML5T-Getriebe ¹⁾						
	1.9 D (10)	51		01.99	03.02	+ MEST-Getriebe ²⁾	24.3728-0518.2	590518			L=1034	
	2.0 i (10/14/18) 2WD	80		02.94	03.02	+ MEST-Getriebe ²⁾						
	2.5 D (14/18) 2WD	63		08.94	03.02	+ MEST-Getriebe ²⁾						
	2.5 TD (14/18) 2WD	76		08.94	03.02	+ MEST-Getriebe ²⁾						
	1.9 TD (10/14)	66		08.94	03.02	+ MEST-Getriebe ²⁾	24.3728-0337.2	590337			L=1058	
	1.9 TD (10/14) 2WD	68		02.94	03.02	+ MEST-Getriebe ²⁾						
	2.0 i (10/14/18) 2WD	80		02.94	03.02	+ MG5TU-Getriebe ³⁾	24.3728-0519.2	590519			L=1090	
	2.5 D (14/18) 2WD	63		08.94	03.02	+ MG5TU-Getriebe ³⁾						
	2.5 TD (14/18) 2WD	76		08.94	03.02	+ MG5TU-Getriebe ³⁾						
	2.8 HDi (14/18) 2WD	94		09.00	03.02	+ MG5TU-Getriebe ³⁾						
	2.0 i (10/14/18) 2WD	80		02.94	03.02	+ ML5T-Getriebe ¹⁾	24.3728-0335.2	590335			L=1435	
2.5 D (14/18) 2WD	63		08.94	03.02	+ ML5T-Getriebe ¹⁾							
2.8 D (14/18)	64		01.99	02.02	+ ML5T-Getriebe ¹⁾							
2.8 HDi (14/18) 2WD	94		09.00	03.02	+ ML5T-Getriebe ¹⁾							

CITROEN JUMPER Kasten (94-02)

	1.9 D (10)	50	S 15064995	07.99		- ABS	24.2122-1715.3	010481			Thz 22,20
	1.9 D (10)	51	S 15064995	02.94		- ABS					
	1.9 TD (10/14)	66	S 15064995	03.94		- ABS					
	1.9 TD (10/14)	68	S 15064995	03.94		- ABS					
	2.0 i (10/14)	80	S 15064995	03.94		- ABS					
	2.5 D (14)	63	S 15064995	03.94		- ABS					
	2.5 TD (14)	76	S 15064995	03.94		- ABS					
	2.8 D (14)	64	S 15064995	01.99		- ABS					
	1.9 D (10)	50	S 16205754			- ABS	24.2125-1703.3	010483			Thz 25,40
	1.9 D (10)	51	S 16205754			- ABS					
	1.9 TD (10/14)	66	S 16205754			- ABS					
	1.9 TD (10/14)	68	S 16205754			- ABS					
	2.0 i (10/14)	80	S 16205754			- ABS					
	2.0 i (18)	80	S 16205754	03.94		- ABS					
2.5 D (14)	63	S 16205754			- ABS						
2.5 D (18)	63	S 16205754	03.94		- ABS						
2.5 TD (14)	76	S 16205754			- ABS						
2.5 TD (18)	76	S 16205754	03.94		- ABS						
2.5 TDi (14/18)	79	S 16205754	12.96		- ABS						
2.8 D (14)	64	S 16205754			- ABS						
2.8 D (18)	64	S 16205352	01.99		- ABS						
2.8 HDi (14/18)	94	S 16205754	09.00		- ABS						
1.9 D (10)	50	S 16205755			- ABS	24.2125-1725.3	010717			Thz 25,40	
1.9 D (10)	51	S 16205755			- ABS						
1.9 TD (10/14)	66	S 16205755			- ABS						
1.9 TD (10/14)	68	S 16205755			- ABS						
2.0 HDi (10/14/18)	62		11.01		- ABS						
2.0 i (10/14)	80	S 16205755			- ABS						
2.0 i (18)	80	S 16205353			- ABS						
2.5 D (14)	63	S 16205755			- ABS						
2.5 D (18)	63	S 16205353			- ABS						
2.5 TD (14)	76	S 16205755			- ABS						
2.5 TD (18)	76	S 16205353			- ABS						
2.5 TDi (14)	79	S 16205755			- ABS						
2.5 TDi (18)	79	S 16205353			- ABS						
2.8 D (14)	64	S 16205755			- ABS						
2.8 D (18)	64	S 16205353			- ABS						
2.8 HDi (14)	94	S 16205755			- ABS						
2.8 HDi (18)	94	S 16205353			- ABS						
1.9 D (10)	50	S 15064995	07.99		+ ABS	24.2122-1714.3	010480			Thz 22,20	
1.9 D (10)	51	S 15064995	02.94		+ ABS						
1.9 TD (10/14)	66	S 15064995	03.94		+ ABS						
1.9 TD (10/14)	68	S 15064995	03.94		+ ABS						
2.0 i (10/14)	80	S 15064995	03.94		+ ABS						
2.5 D (14)	63	S 15064995	03.94		+ ABS						
2.5 TD (14)	76	S 15064995	03.94		+ ABS						

¹⁾ + ML5T transmission / + scatola cambio ML5T / + boîte de vitesse ML5T / + cambio ML5T
²⁾ + MEST transmission / + scatola cambio MEST / + boîte de vitesse MEST / + cambio MEST
³⁾ + MG5TU transmission / + scatola cambio MG5TU / + boîte de vitesse MG5TU / + cambio MG5TU





CITROEN JUMPER Kasten (94-02)

	2.8 D (14)	64	S 15064995	01.99	+ ABS	24.2122-1714.3	010480		THz 22,20
	1.9 D (10)	50 S 15064996	S 16206233		+ ABS	24.2125-1702.3	010482		THz 25,40
	1.9 D (10)	51 S 15064996	S 16206233		+ ABS				
	1.9 TD (10/14)	66 S 15064996	S 16206233		+ ABS				
	1.9 TD (10/14)	68 S 15064996	S 16206233		+ ABS				
	2.0 i (10/14)	80 S 15064996	S 16206233		+ ABS				
	2.0 i (18)	80	S 16194399	03.94	+ ABS				
	2.5 D (14)	63 S 15064996	S 16206233		+ ABS				
	2.5 D (18)	63	S 16194399	03.94	+ ABS				
	2.5 TD (14)	76 S 15064996	S 16206233		+ ABS				
	2.5 TD (18)	76	S 16194399	03.94	+ ABS				
	2.5 TDi (14)	79 S 15064996	S 16206233		+ ABS				
	2.5 TDi (18)	79	S 16194399	12.96	+ ABS				
	2.8 D (14)	64 S 15064996	S 16206253		+ ABS				
	2.8 D (18)	64	S 16194399	01.99	+ ABS				
	2.8 HDi (14)	94 S 15064996	S 16206233		+ ABS				
	2.8 HDi (18)	94	S 16194399	09.00	+ ABS				
	1.9 D (10)	50 S 16206234			03.02 + ABS	24.2125-1726.3	010718		THz 25,40
	1.9 D (10)	51 S 16206234			03.02 + ABS				
	1.9 TD (10/14)	66 S 16206234			03.02 + ABS				
	1.9 TD (10/14)	68 S 16206234			03.02 + ABS				
	2.0 HDi (10/14/18)	62		11.01	03.02 + ABS				
	2.0 i (10/14)	80 S 16206234			03.02 + ABS				
	2.0 i (18)	80 S 16194400			03.02 + ABS				
	2.5 D (14)	63 S 16206234			03.02 + ABS				
	2.5 D (18)	63 S 16194400			03.02 + ABS				
	2.5 TD (14)	76 S 16206234			03.02 + ABS				
	2.5 TD (18)	76 S 16194400			03.02 + ABS				
	2.5 TDi (14)	79 S 16206234			11.00 + ABS				
	2.5 TDi (18)	79 S 16194400			11.00 + ABS				
	2.8 D (14)	64 S 16206254			02.02 + ABS				
	2.8 D (18)	64 S 16194400			02.02 + ABS				
	2.8 HDi (14)	94 S 16206234			03.02 + ABS				
	2.8 HDi (18)	94 S 16194400			03.02 + ABS				
	1.9 D (10)	50		07.99	10.01 + ABS	24.0101-4804.2	260050		Bremssattel-Zubehör TRW
	1.9 D (10)	51		02.94	10.01 + ABS				
	1.9 TD (10/14)	66		03.94	10.01 + ABS				
	1.9 TD (10/14)	68		03.94	10.01 + ABS				
	2.0 i (10/14)	80		03.94	10.01 + ABS				
	2.5 D (14)	63		03.94	10.01 + ABS				
	2.8 D (14)	64	S 16206253	01.99	+ ABS				
	1.9 D (10)	50	S 15866409	07.99		24.5112-0466.3	330579	2	L=462
	1.9 D (10)	51	S 15866409	02.94		24.5112-0465.3	330526	2	L=465, + Clip
	1.9 TD (10/14)	66	S 15866409	03.94					
	1.9 TD (10/14)	68	S 15866409	03.94					
	2.0 i (10/14/18)	80	S 15866409	03.94					
	2.5 D (14/18)	63	S 15866409	03.94					
	2.5 TD (14/18)	76	S 15866409	03.94					
	2.5 TDi (14/18)	79	S 15866409	12.96					
	2.8 D (14/18)	64	S 15866409	01.99					
	1.9 D (10)	50 S 15866410			10.01	24.5112-0466.3	330579	2	L=462
	1.9 D (10)	51 S 15866410			10.01	24.5112-0461.3	330616	2	L=460, + Clip
	1.9 TD (10/14)	66 S 15866410			10.01				
	1.9 TD (10/14)	68 S 15866410			10.01				
	2.0 i (10/14/18)	80 S 15866410			10.01				
	2.5 D (14/18)	63 S 15866410			10.01				
	2.5 TD (14/18)	76 S 15866410			10.01				
	2.5 TDi (14/18)	79 S 15866410			11.00				
	2.8 D (14/18)	64 S 15866410	S 16206244		10.01				
	2.8 HDi (14/18)	94		09.00	10.01				
	1.9 D (10)	50		11.01	03.02	24.5112-0477.3	331299	2	L=477
	1.9 D (10)	51		11.01	03.02	24.5112-0470.3	331460	2	L=470
	1.9 TD (10/14)	66		11.01	03.02				
	1.9 TD (10/14)	68		11.01	03.02				
	2.0 HDi (10/14/18)	62		11.01	03.02				
	2.0 i (10/14/18)	80		11.01	03.02				
	2.5 D (14/18)	63		11.01	03.02				
	2.5 TD (14/18)	76		11.01	03.02				
	2.8 D (14/18)	64 S 16205353			02.02				
	2.8 HDi (14/18)	94		11.01	03.02				
	1.9 D (10)	50		11.01	03.02	24.3461-1701.5	240449		D=46, - Halter
	1.9 D (10)	51		11.01	03.02	24.3461-1702.5	240450		D=46, - Halter
	1.9 TD (10/14)	66		11.01	03.02				
	1.9 TD (10/14)	68		11.01	03.02				
	2.0 HDi (10/14/18)	62		11.01	03.02				
	2.0 i (10/14/18)	80		11.01	03.02				
	2.5 D (14/18)	63		11.01	03.02				
	2.5 TD (14/18)	76		11.01	03.02				
	2.8 D (14/18)	64 S 16194400			02.02				
	2.8 HDi (14/18)	94		11.01	03.02				
	1.9 D (10)	50		07.99	10.01 - ABS	24.5112-0340.3	330511	1	- verstärktes Fahrwerk ¹⁾
	1.9 D (10)	51		02.94	10.01 - ABS	24.5112-0361.3	330649	1	+ verstärktes Fahrwerk ²⁾
	1.9 TD (10/14)	66		03.94	10.01 - ABS				
	1.9 TD (10/14)	68		03.94	10.01 - ABS				
	2.0 i (10/14/18)	80		03.94	10.01 - ABS				
	2.5 D (14/18)	63		03.94	10.01 - ABS				

1) - reinforced suspension / - sospensione rinforzata / - châssis renforcé / - suspensión reforzada
 2) + reinforced suspension / + sospensione rinforzata / + châssis renforcé / + suspensión reforzada



CITROEN JUMPER Kasten (94-02)

	2.5 TD (14/18)	76		03.94	10.01	- ABS	24.5112-0340.3	330511	1	- verstärktes Fahrwerk ¹⁾ + verstärktes Fahrwerk ²⁾	L=340 L=360		
	2.5 TDi (14/18)	79		12.96	11.00	- ABS	24.5112-0361.3	330649	1				
	2.8 D (14/18)	64	S 16206244	01.99		- ABS							
	2.8 HDi (14/18)	94		09.00	10.01	- ABS							
	1.9 D (10)	50		11.01	03.02	- ABS	24.5112-0361.3	330649	1	+ HA-Trommelbremse ³⁾ + HA-Scheibenbremse ⁴⁾	L=360 L=160		
	1.9 D (10)	51		11.01	03.02	- ABS	83.6401-0159.3	330746	1				
	1.9 TD (10/14)	66		11.01	03.02	- ABS							
	1.9 TD (10/14)	68		11.01	03.02	- ABS							
	2.0 HDi (10/14/18)	62		11.01	03.02	- ABS							
	2.0 i (10/14/18)	80		11.01	03.02	- ABS							
2.5 D (14/18)	63		11.01	03.02	- ABS								
2.5 TD (14/18)	76		11.01	03.02	- ABS								
2.8 D (14/18)	64	S 16205353	02.02		- ABS								
2.8 HDi (14/18)	94		11.01	03.02	- ABS								
	1.9 D (10)	50		07.99	10.01	+ ABS	24.5112-0315.3	330509		- verstärktes Fahrwerk ¹⁾	L=315		
	1.9 D (10)	51		02.94	10.01	+ ABS							
	1.9 TD (10/14)	66		03.94	10.01	+ ABS							
	1.9 TD (10/14)	68		03.94	10.01	+ ABS							
	2.0 i (10/14/18)	80		03.94	10.01	+ ABS							
	2.5 D (14/18)	63		03.94	10.01	+ ABS							
	2.5 TD (14/18)	76		03.94	10.01	+ ABS							
	2.5 TDi (14/18)	79		12.96	11.00	+ ABS							
	2.8 D (14/18)	64	S 16206253	01.99		+ ABS							
	2.8 HDi (14/18)	94		09.00	10.01	+ ABS							
	1.9 D (10)	50		11.01	03.02	+ ABS	83.6401-0159.3	330746	2	+ HA-Scheibenbremse ⁴⁾	L=160		
	1.9 D (10)	51		11.01	03.02	+ ABS							
	1.9 TD (10/14)	66		11.01	03.02	+ ABS							
	1.9 TD (10/14)	68		11.01	03.02	+ ABS							
	2.0 HDi (10/14/18)	62		11.01	03.02	+ ABS							
	2.0 i (10/14/18)	80		11.01	03.02	+ ABS							
	2.5 D (14/18)	63		11.01	03.02	+ ABS							
	2.5 TD (14/18)	76		11.01	03.02	+ ABS							
	2.8 D (14/18)	64	S 16194400	02.02		+ ABS							
	2.8 HDi (14/18)	94		11.01	03.02	+ ABS							
	1.9 D (10)	50		07.99	10.01		24.3225-1701.3	020399			Rz 25,40		
	1.9 D (10)	51		02.94	10.01								
	1.9 TD (10/14)	66		03.94	10.01								
	1.9 TD (10/14)	68		03.94	10.01								
	2.0 i (10/14)	80		03.94	10.01								
	2.5 D (14)	63		03.94	10.01								
	2.8 D (14)	64	S 16206253	01.99									
	2.5 TD (14)	76		03.94	10.01		24.3226-1702.3	020469					Rz 26,99
	2.5 TDi (14)	79		12.96	11.00								
	2.8 D (14)	64	S 16206253	01.99									
2.8 HDi (14)	94		09.00	10.01									
1.9 D (10)	50		11.01	03.02		24.3226-1702.3	020469						
1.9 D (10)	51		11.01	03.02									
1.9 TD (10/14)	66		11.01	03.02									
1.9 TD (10/14)	68		11.01	03.02									
2.0 HDi (10/14)	62		11.01	03.02									
2.0 i (10/14)	80		11.01	03.02									
2.5 D (14)	63		11.01	03.02									
2.5 TD (14)	76		11.01	03.02									
2.8 D (14)	64	S 16204256	02.02										
2.8 HDi (14)	94		11.01	03.02									
	2.0 i (18)	80		03.94	10.01		24.3228-1701.3	020401			Rz 28,57		
	2.5 D (18)	63		03.94	10.01								
	2.5 TD (18)	76		03.94	10.01								
	2.5 TDi (18)	79		12.96	11.00								
	2.8 D (18)	64	S 16209999	01.99									
	2.8 HDi (18)	94		09.00	10.01								
	1.9 D (10)	50	S 16158427	07.99			24.3727-0340.2	580340	1		L=3025		
	1.9 D (10)	51	S 16158427	02.94									
	1.9 TD (10/14)	66	S 16158427	03.94									
	1.9 TD (10/14)	68	S 16158427	03.94									
	2.0 i (10/14/18)	80	S 16158427	03.94									
	2.5 D (14/18)	63	S 16158427	03.94									
	2.5 TD (14/18)	76	S 16158427	03.94									
	2.5 TDi (14/18)	79	S 16158427	12.96									
	2.8 D (14/18)	64	S 16158427	01.99									
	2.8 HDi (14/18)	94	S 16158427	09.00									
	1.9 D (10)	50	S 16194399				24.3727-0344.2	580344	1		L=2806		
	1.9 D (10)	51	S 16194399										
	1.9 TD (10/14)	66	S 16194399										
	1.9 TD (10/14)	68	S 16194399										
	2.0 i (10/14/18)	80	S 16194399										
	2.5 D (14/18)	63	S 16194399										
	2.5 TD (14/18)	76	S 16194399										
	2.5 TDi (14/18)	79	S 16194399										
	2.8 D (14/18)	64	S 16194399										
	2.8 HDi (14/18)	94	S 16194399										
	1.9 D (10)	50	S 16194400		03.02		24.3727-0343.2	580343	1	+ HA-Trommelbremse ³⁾	L=2827		
	1.9 D (10)	51	S 16194400		03.02		24.3727-0348.2	580348	1			+ HA-Scheibenbremse ⁴⁾	L=2715
	1.9 TD (10/14)	66	S 16194400		03.02								
	1.9 TD (10/14)	68	S 16194400		03.02								
	2.0 HDi (10/14/18)	62		11.01	03.02								

1) - reinforced suspension / - sospensione rinforzata / - châssis renforcé / - suspensión reforzada
 2) + reinforced suspension / + sospensione rinforzata / + châssis renforcé / + suspensión reforzada
 3) + RA drum brake / + P freno a tamburo / + frein à tambour essieu AR / + ET-tambores de freno
 4) + RA disc brake / + P disco freno / + frein à disque essieu AR / + ET-disco de freno





CITROEN JUMPER Kasten (94-02)

	2.0 i (10/14/18)	80 S 16194400			03.02		24.3727-0343.2	580343	1	+ HA-Trommelbremse ¹⁾	L=2827
	2.5 D (14/18)	63 S 16194400			03.02		24.3727-0348.2	580348	1	+ HA-Scheibenbremse ²⁾	L=2715
	2.5 TD (14/18)	76 S 16194400			03.02						
	2.5 TDi (14/18)	79 S 16194400			11.00						
	2.8 D (14/18)	64 S 16194400			02.02						
	2.8 HDi (14/18)	94 S 16194400			03.02						
	2.5 D 4x4 (14/18)	63			03.00	03.02	24.3727-0842.2	580842	1		L=4100
2.5 TDi 4x4 (14/18)	79			03.00	11.00						
2.8 HDi 4x4 (14/18)	94			09.00	03.02						
	1.9 D (10)	50	S 16206244	07.99			24.6512-1701.3	320153		- ABS	BRL (2)
	1.9 D (10)	51	S 16206244	02.94							
	1.9 TD (10/14)	66	S 16206244	03.94							
	1.9 TD (10/14)	68	S 16206244	03.94							
	2.0 i (10/14/18)	80	S 16206244	03.94							
	2.5 D (14/18)	63	S 16206244	03.94							
	2.5 TD (14/18)	76	S 16206244	03.94							
	2.5 TDi (14/18)	79	S 16206244	12.96							
	2.8 D (14/18)	64	S 16206244	01.99							
2.8 HDi (14/18)	94	S 16206244	09.00								
	1.9 D (10)	50		07.99	03.02	+ ML5T-Getriebe ³⁾	24.3728-0300.2	590300			L=1478
	1.9 D (10)	51		02.94	03.02	+ ML5T-Getriebe ³⁾					
	1.9 TD (10/14)	66		03.94	03.02	+ ML5T-Getriebe ³⁾					
	1.9 TD (10/14)	68		03.94	03.02	+ ML5T-Getriebe ³⁾					
	1.9 D (10)	50		07.99	03.02	+ ME5T-Getriebe ⁴⁾	24.3728-0518.2	590518			L=1034
	1.9 D (10)	51		02.94	03.02	+ ME5T-Getriebe ⁴⁾					
	2.0 i (10/14/18)	80		03.94	03.02	+ ME5T-Getriebe ⁴⁾					
	2.5 D (14/18)	63		03.94	03.02	+ ME5T-Getriebe ⁴⁾					
	2.5 TD (14/18)	76		03.94	03.02	+ ME5T-Getriebe ⁴⁾					
	1.9 TD (10/14)	66		03.94	03.02	+ ME5T-Getriebe ⁴⁾	24.3728-0337.2	590337			L=1058
	1.9 TD (10/14)	68		03.94	03.94	+ ME5T-Getriebe ⁴⁾					
	2.0 i (10/14/18)	80		03.94	03.02	+ MG5TU-Getriebe ⁵⁾	24.3728-0519.2	590519			L=1090
2.5 D (14/18)	63		03.94	03.02	+ MG5TU-Getriebe ⁵⁾						
2.5 TD (14/18)	76		03.94	03.02	+ MG5TU-Getriebe ⁵⁾						
2.8 HDi (14/18)	94		09.00	03.02	+ MG5TU-Getriebe ⁵⁾						
2.0 i (10/14/18)	80		03.94	03.02	+ ML5T-Getriebe ³⁾	24.3728-0335.2	590335			L=1435	
2.5 D (14/18)	63		03.94	03.02	+ ML5T-Getriebe ³⁾						
2.8 D (14/18)	64		01.99	02.02	+ ML5T-Getriebe ³⁾						
2.8 HDi (14/18)	94		09.00	03.02	+ ML5T-Getriebe ³⁾						

CITROEN JUMPER Pritsche/Fahrgestell (94-02)

	1.9 TD (10/14)	66	S 15064995	03.94		- ABS	24.2122-1715.3	010481			Thz 22,20
	1.9 TD (10/14)	68	S 15064995	03.94		- ABS					
	2.0 i (10/14)	80	S 15064995	03.94		- ABS					
	2.5 D (14)	63	S 15064995	03.94		- ABS					
	2.5 TD (14)	76	S 15064995	03.94		- ABS					
	2.8 D (14)	64	S 15064995	01.99		- ABS					
	1.9 TD (10/14)	66	S 16205754			- ABS	24.2125-1703.3	010483			Thz 25,40
	1.9 TD (10/14)	68	S 16205754			- ABS					
	2.0 i (10/14)	80	S 16205754			- ABS					
	2.0 i (18)	80	S 16205754	03.94		- ABS					
	2.5 D (14)	63	S 16205754			- ABS					
	2.5 D (18)	63	S 16205754	03.94		- ABS					
2.5 TD (14)	76	S 16205754			- ABS						
2.5 TD (18)	76	S 16205754	03.94		- ABS						
2.5 TDi (14/18)	79	S 16205754	12.96		- ABS						
2.8 D (14)	64	S 16205754			- ABS						
2.8 D (18)	64	S 16205352	01.99		- ABS						
2.8 HDi (14/18)	94	S 16205754	09.00		- ABS						
1.9 TD (10/14)	66	S 16205755			03.02	- ABS	24.2125-1725.3	010717			Thz 25,40
1.9 TD (10/14)	68	S 16205755			03.02	- ABS					
2.0 i (10/14)	80	S 16205755			03.02	- ABS					
2.0 i (18)	80	S 16205353			03.02	- ABS					
2.5 D (14)	63	S 16205755			03.02	- ABS					
2.5 D (18)	63	S 16205353			03.02	- ABS					
2.5 TD (14)	76	S 16205755			03.02	- ABS					
2.5 TD (18)	76	S 16205353			03.02	- ABS					
2.5 TDi (14)	79	S 16205755			03.02	- ABS					
2.5 TDi (18)	79	S 16205353			03.02	- ABS					
2.8 D (14)	64	S 16205755			02.02	- ABS					
2.8 D (18)	64	S 16205353			02.02	- ABS					
2.8 HDi (14)	94	S 16205755			03.02	- ABS					
2.8 HDi (18)	94	S 16205353			03.02	- ABS					
1.9 TD (10/14)	66	S 15064995	03.94			+ ABS	24.2122-1714.3	010480			Thz 22,20
1.9 TD (10/14)	68	S 15064995	03.94			+ ABS					
2.0 i (10/14)	80	S 15064995	03.94			+ ABS					
2.5 D (14)	63	S 15064995	03.94			+ ABS					
2.5 TD (14)	76	S 15064995	03.94			+ ABS					
2.8 D (14)	64	S 15064995	01.99			+ ABS					
1.9 TD (10/14)	66	S 16206233				+ ABS	24.2125-1702.3	010482			Thz 25,40
1.9 TD (10/14)	68	S 16206233				+ ABS					
2.0 i (10/14)	80	S 16206233				+ ABS					
2.0 i (18)	80	S 16194399	03.94			+ ABS					
2.5 D (14)	63	S 16206233				+ ABS					
2.5 D (18)	63	S 16194399	03.94			+ ABS					
2.5 TD (14)	76	S 16206233				+ ABS					
2.5 TD (18)	76	S 16194399	03.94			+ ABS					

1) + RA drum brake / + P freno a tamburo / + frein à tambour essieu AR / + ET-tambores de freno
 2) + RA disc brake / + P disco freno / + frein à disque essieu AR / + ET-disco de freno
 3) + ML5T transmission / + scatola cambio ML5T / + boîte de vitesse ML5T / + cambio ML5T
 4) + ME5T transmission / + scatola cambio ME5T / + boîte de vitesse ME5T / + cambio ME5T
 5) + MG5TU transmission / + scatola cambio MG5TU / + boîte de vitesse MG5TU / + cambio MG5TU

















CITROEN JUMPER Pritsche/Fahrgestell (94-02)

	2.5 TDi (14)	79	S 16206233	12.96	+ ABS	24.2125-1702.3	010482		THz 25,40				
	2.5 TDi (18)	79	S 16194399	12.96	+ ABS								
	2.8 D (14)	64 S 15064996	S 16206253		+ ABS								
	2.8 D (18)	64	S 16194399	01.99	+ ABS								
	2.8 HDi (14)	94	S 16206233	09.00	+ ABS								
	2.8 HDi (18)	94	S 16194399	09.00	+ ABS								
	1.9 TD (10/14)	66	S 16206234		03.02 + ABS	24.2125-1726.3	010718		THz 25,40				
	1.9 TD (10/14)	68	S 16206234		03.02 + ABS								
	2.0 i (10/14)	80	S 16206234		03.02 + ABS								
	2.0 i (18)	80	S 16194400		03.02 + ABS								
	2.5 D (14)	63	S 16206234		03.02 + ABS								
	2.5 D (18)	63	S 16194400		03.02 + ABS								
	2.5 TD (14)	76	S 16206234		03.02 + ABS								
	2.5 TD (18)	76	S 16194400		03.02 + ABS								
	2.5 TDi (14)	79	S 16206234		03.02 + ABS								
	2.5 TDi (18)	79	S 16194400		03.02 + ABS								
	2.8 D (14)	64	S 16206254		02.02 + ABS								
	2.8 D (18)	64	S 16194400		02.02 + ABS								
	2.8 HDi (14)	94	S 16206234		03.02 + ABS								
	2.8 HDi (18)	94	S 16194400		03.02 + ABS								
		1.9 TD (10/14)	66		03.94					10.01 + ABS	24.0101-4804.2	260050	
1.9 TD (10/14)		68		03.94	10.01 + ABS								
2.0 i (10/14)		80		03.94	10.01 + ABS								
2.5 D (14)		63		03.94	10.01 + ABS								
2.8 D (14)		64	S 16206253	01.99	+ ABS								
	1.9 TD (10/14)	66	S 15866409	03.94		24.5112-0466.3	330579	2	L=462				
	1.9 TD (10/14)	68	S 15866409	03.94									
	2.0 i (10/14/18)	80	S 15866409	03.94									
	2.5 D (14/18)	63	S 15866409	03.94									
	2.5 TD (14/18)	76	S 15866409	03.94									
	2.5 TDi (14/18)	79	S 15866409	12.96									
	2.8 D (14/18)	64	S 15866409	01.99									
	1.9 TD (10/14)	66	S 15866410		10.01	24.5112-0466.3	330579	2	L=462				
	1.9 TD (10/14)	68	S 15866410		10.01								
	2.0 i (10/14/18)	80	S 15866410		10.01								
	2.5 D (14/18)	63	S 15866410		10.01								
	2.5 TD (14/18)	76	S 15866410		10.01								
	2.5 TDi (14/18)	79	S 15866410		10.01								
	2.8 D (14/18)	64	S 15866410		02.02								
	2.8 HDi (14/18)	94		09.00	10.01								
	1.9 TD (10/14)	66		11.01	03.02	24.5112-0477.3	331299	2	L=477				
	1.9 TD (10/14)	68		11.01	03.02								
	2.0 i (10/14/18)	80		11.01	03.02								
	2.5 D (14/18)	63		11.01	03.02								
	2.5 TD (14/18)	76		11.01	03.02								
	2.5 TDi (14/18)	79		11.01	03.02								
	2.8 D (14/18)	64 S 16205353			02.02								
	2.8 HDi (14/18)	94		11.01	03.02								
	1.9 TD (10/14)	66		11.01	03.02	24.3461-1701.5	240449	<input type="checkbox"/>	D=46, - Halter				
	1.9 TD (10/14)	68		11.01	03.02								
	2.0 i (10/14/18)	80		11.01	03.02								
	2.5 D (14/18)	63		11.01	03.02								
	2.5 TD (14/18)	76		11.01	03.02								
	2.5 TDi (14/18)	79		11.01	03.02								
	2.8 D (14/18)	64 S 16194400			02.02								
	2.8 HDi (14/18)	94		11.01	03.02								
	1.9 TD (10/14)	66		03.94	10.01 - ABS	24.5112-0340.3	330511	1	- verstärktes Fahrwerk ¹⁾				
	1.9 TD (10/14)	68		03.94	10.01 - ABS								
	2.0 i (10/14/18)	80		03.94	10.01 - ABS								
	2.5 D (14/18)	63		03.94	10.01 - ABS								
	2.5 TD (14/18)	76		03.94	10.01 - ABS								
	2.5 TDi (14/18)	79		12.96	10.01 - ABS								
	2.8 D (14/18)	64	S 16206244	01.99	- ABS								
	2.8 HDi (14/18)	94		09.00	10.01 - ABS								
	1.9 TD (10/14)	66		11.01	03.02 - ABS					83.6401-0159.3	330746	2	+ HA-Trommelbremse ³⁾
	1.9 TD (10/14)	68		11.01	03.02 - ABS								
	2.0 i (10/14/18)	80		11.01	03.02 - ABS								
	2.5 D (14/18)	63		11.01	03.02 - ABS								
	2.5 TD (14/18)	76		11.01	03.02 - ABS								
	2.5 TDi (14/18)	79		11.01	03.02 - ABS								
2.8 D (14/18)	64 S 16205353			02.02 - ABS									
2.8 HDi (14/18)	94		11.01	03.02 - ABS									
1.9 TD (10/14)	66		03.94	10.01 + ABS	24.5112-0315.3	330509	<input type="checkbox"/>	- verstärktes Fahrwerk ¹⁾					
1.9 TD (10/14)	68		03.94	10.01 + ABS									
2.0 i (10/14/18)	80		03.94	10.01 + ABS									
2.5 D (14/18)	63		03.94	10.01 + ABS									
2.5 TD (14/18)	76		03.94	10.01 + ABS									
2.5 TDi (14/18)	79		12.96	10.01 + ABS									
2.8 D (14/18)	64	S 16206253	01.99	+ ABS									
2.8 HDi (14/18)	94		09.00	10.01 + ABS									
1.9 TD (10/14)	66		11.01	03.02 + ABS					83.6401-0159.3	330746	2	+ HA-Scheibenbremse ⁴⁾	
1.9 TD (10/14)	68		11.01	03.02 + ABS									
2.0 i (10/14/18)	80		11.01	03.02 + ABS									
2.5 D (14/18)	63		11.01	03.02 + ABS									
2.5 TD (14/18)	76		11.01	03.02 + ABS									
2.5 TDi (14/18)	79		11.01	03.02 + ABS									

1) - reinforced suspension / - sospensione rinforzata / - châssis renforcé / - suspensión reforzada
 2) + reinforced suspension / + sospensione rinforzata / + châssis renforcé / + suspensión reforzada
 3) + RA drum brake / + P freno a tamburo / + frein à tambour essieu AR / + ET-tambores de freno
 4) + RA disc brake / + P disco freno / + frein à disque essieu AR / + ET-disco de freno



									
CITROEN JUMPER Pritsche/Fahrgestell (94-02)									
	2.8 D (14/18) 2.8 HDi (14/18)	64 S 16194400 94		11.01	02.02 + ABS 03.02 + ABS	83.6401-0159.3	330746	2 + HA-Scheibenbremse ¹⁾	L=160
	1.9 TD (10/14) 1.9 TD (10/14) 2.0 i (10/14) 2.5 D (14) 2.8 D (14)	66 68 80 63 64	S 16206253	03.94 03.94 03.94 03.94 01.99	10.01 10.01 10.01 10.01	24.3225-1701.3	020399		Rz 25,40
	2.5 TD (14) 2.5 TDi (14) 2.8 D (14) 2.8 HDi (14)	76 79 64 94	S 16206253	03.94 12.96 01.99 09.00	10.01 10.01 10.01	24.3226-1702.3	020469		Rz 26,99
	1.9 TD (10/14) 1.9 TD (10/14) 2.0 i (10/14) 2.5 D (14) 2.5 TD (14) 2.5 TDi (14) 2.8 D (14) 2.8 HDi (14)	66 68 80 63 76 79 64 S 16204256 94		11.01 11.01 11.01 11.01 11.01 11.01 11.01	03.02 03.02 03.02 03.02	24.3226-1702.3	020469		Rz 26,99
	2.0 i (18) 2.5 D (18) 2.5 TD (18) 2.5 TDi (18) 2.8 D (18) 2.8 HDi (18)	80 63 76 79 64 94	S 16209999	03.94 03.94 03.94 12.96 01.99 09.00	10.01 10.01 10.01 10.01	24.3228-1701.3	020401		Rz 28,57
	1.9 TD (10/14) 1.9 TD (10/14) 2.0 i (10/14/18) 2.5 D (14/18) 2.5 TD (14/18) 2.5 TDi (14/18) 2.8 D (14/18) 2.8 HDi (14/18)	66 68 80 63 76 79 64 94	S 16158427 S 16158427 S 16158427 S 16158427 S 16158427 S 16158427 S 16158427 S 16158427	03.94 03.94 03.94 03.94 12.96 01.99 09.00		24.3727-0340.2	580340	1 ↕	L=3025
	1.9 TD (10/14) 1.9 TD (10/14) 2.0 i (10/14/18) 2.5 D (14/18) 2.5 TD (14/18) 2.5 TDi (14/18) 2.8 D (14/18) 2.8 HDi (14/18)	66 S 16158428 68 S 16158428 80 S 16158428 63 S 16158428 76 S 16158428 79 S 16158428 64 S 16158428 94 S 16158428	S 16194399 S 16194399 S 16194399 S 16194399 S 16194399 S 16194399 S 16194399 S 16194399			24.3727-0344.2	580344	1 ↕	L=2806
	1.9 TD (10/14) 1.9 TD (10/14) 2.0 i (10/14/18) 2.5 D (14/18) 2.5 TD (14/18) 2.5 TDi (14/18) 2.8 D (14/18) 2.8 HDi (14/18)	66 S 16194400 68 S 16194400 80 S 16194400 63 S 16194400 76 S 16194400 79 S 16194400 64 S 16194400 94 S 16194400		03.02 03.02 03.02 03.02 03.02 02.02 03.02		24.3727-0343.2 24.3727-0348.2	580343 580348	1 ↕ 1 ↕	L=2827 L=2715
	2.5 D 4x4 (14/18) 2.5 TDi 4x4 (14/18)	63 79		03.94 12.96	03.02 03.02	24.3727-0842.2	580842	1 ↕	L=4100
	1.9 TD (10/14) 1.9 TD (10/14) 2.0 i (10/14/18) 2.5 D (14/18) 2.5 TD (14/18) 2.5 TDi (14/18) 2.8 D (14/18) 2.8 HDi (14/18)	66 68 80 63 76 79 64 94	S 16206244 S 16206244 S 16206244 S 16206244 S 16206244 S 16206244 S 16206244 S 16206244	03.94 03.94 03.94 03.94 12.96 01.99 09.00		24.6512-1701.3	320153	- ABS	BRL (2)
	1.9 TD (10/14) 1.9 TD (10/14) 1.9 TD (10/14) 1.9 TD (10/14) 2.0 i (10/14/18) 2.5 D (14/18) 2.5 TD (14/18) 2.0 i (10/14/18) 2.5 D (14/18) 2.5 TD (14/18) 2.8 HDi (14/18) 2.0 i (10/14/18) 2.5 D (14/18) 2.8 D (14/18) 2.8 HDi (14/18)	◀ 66 ◀ 68 ◀ 66 ◀ 68 ◀ 80 ◀ 63 ◀ 76 ◀ 80 ◀ 63 ◀ 76 ◀ 94 ◀ 80 ◀ 63 ◀ 64 ◀ 94		03.94 03.94 03.94 03.94 03.94 03.94 03.94 03.94 03.94 03.94 09.00 03.94 03.94 01.99 09.00	03.02 + ML5T-Getriebe ³⁾ 03.02 + ML5T-Getriebe ³⁾ 03.02 + ME5T-Getriebe ⁴⁾ 03.02 + ME5T-Getriebe ⁴⁾ 03.02 + ME5T-Getriebe ⁴⁾ 03.02 + ME5T-Getriebe ⁴⁾ 03.02 + MG5TU-Getriebe ⁵⁾ 03.02 + MG5TU-Getriebe ⁵⁾ 03.02 + MG5TU-Getriebe ⁵⁾ 03.02 + MG5TU-Getriebe ⁵⁾ 03.02 + ML5T-Getriebe ³⁾ 03.02 + ML5T-Getriebe ³⁾ 02.02 + ML5T-Getriebe ³⁾ 03.02 + ML5T-Getriebe ³⁾	24.3728-0300.2 24.3728-0337.2 24.3728-0518.2 24.3728-0519.2 24.3728-0335.2	590300 590337 590518 590519 590335		L=1478 L=1058 L=1034 L=1090 L=1435
CITROEN JUMPER (02-06)									
	2.0 HDi (10/14/18) 2.0 i (10/14/18) 2.2 HDi (10/14/18) 2.8 HDi (10/14/18) 2.8 HDi 4x4(10/14/18)	62 81 74		04.02 04.02 04.02 04.02	03.06 03.06 03.06 03.06	24.2125-1725.3 24.2125-1726.3	010717 010718	- ABS + ABS	THz 25,40 THz 25,40

¹⁾ + RA disc brake / + P disco freno / + frein à disque essieu AR / + ET-disco de freno
²⁾ + RA drum brake / + P freno a tamburo / + frein à tambour essieu AR / + ET-tambores de freno
³⁾ + ML5T transmission / + scatola cambio ML5T / + boîte de vitesse ML5T / + cambio ML5T
⁴⁾ + ME5T transmission / + scatola cambio ME5T / + boîte de vitesse ME5T / + cambio ME5T
⁵⁾ + MG5TU transmission / + scatola cambio MG5TU / + boîte de vitesse MG5TU / + cambio MG5TU



CITROEN JUMPER (02-06)



















	2.0 HDi (10/14/18) 2.0 i (10/14/18) 2.2 HDi (10/14/18) 2.8 HDi (10/14/18) 2.8 HDi 4x4(10/14/18)	62 81 74		04.02 04.02 04.02 04.02 04.02	03.06 03.06 03.06 03.06 03.06	24.5112-0477.3 24.5112-0470.3	331299 331460	2 2		L=477 L=470
	2.0 Bifuel 2.0 HDi (10/14/18) 2.0 i (10/14/18) 2.2 HDi (10/14/18) 2.8 HDi (10/14/18) 2.8 HDi 4x4(10/14/18)	81 62 81 74		02.03 04.02 04.02 04.02 04.02 04.02	03.06 03.06 03.06 03.06 03.06 03.06	24.3461-1701.5 24.3461-1702.5	240449 240450	<input type="checkbox"/> <input type="checkbox"/>		D=46, - Halter D=46, - Halter
	2.0 HDi (10/14/18) 2.0 i (10/14/18) 2.2 HDi (10/14/18) 2.8 HDi (10/14/18) 2.8 HDi 4x4(10/14/18)	62 81 74		04.02 04.02 04.02 04.02 04.02	03.06 - ABS 03.06 - ABS 03.06 - ABS 03.06 - ABS 03.06 - ABS	24.5112-0361.3 83.6401-0159.3	330649 330746	1 2	+ HA-Trommelbremse ¹⁾ + HA-Scheibenbremse ²⁾	L=360 L=160
	2.0 HDi (10/14/18) 2.0 i (10/14/18) 2.2 HDi (10/14/18) 2.8 HDi (10/14/18) 2.8 HDi 4x4(10/14/18)	62 81 74		04.02 04.02 04.02 04.02 04.02	03.06 + ABS 03.06 + ABS 03.06 + ABS 03.06 + ABS 03.06 + ABS	83.6401-0159.3	330746	2	+ HA-Scheibenbremse ²⁾	L=160
	2.0 HDi (10/14) 2.0 i (10/14) 2.2 HDi (10/14) 2.8 HDi (10/14) 2.8 HDi 4x4(10/14/18)	62 81 74		04.02 04.02 04.02 04.02 04.02	03.06 03.06 03.06 03.06 03.06	24.3226-1702.3	020469			Rz 26,99
	2.0 HDi (10/14/18) 2.0 i (10/14/18) 2.2 HDi (10/14/18) 2.8 HDi (10/14/18)	62 81 74		04.02 04.02 04.02 04.02	03.06 03.06 03.06 03.06	24.3727-0300.2 24.3727-0343.2	580300 580343	1 1	<input type="checkbox"/> <input type="checkbox"/> + HA-Trommelbremse ¹⁾	L=1078 L=2827
	2.0 HDi (10/14/18) 2.0 i (10/14/18) 2.2 HDi (10/14/18) 2.8 HDi (10/14/18)	62 81 74	S 17103012 S 17103012 S 17103012 S 17103012	04.02 04.02 04.02 04.02		24.3727-0300.2 24.3727-0348.2	580300 580348	1 1	<input type="checkbox"/> <input type="checkbox"/> + HA-Scheibenbremse ²⁾	L=1078 L=2715
	2.0 HDi (10/14/18) 2.0 i (10/14/18) 2.2 HDi (10/14/18) 2.8 HDi (10/14/18)	62 81 74	S 17103013 S 17103013 S 17103013 S 17103013		03.06 03.06 03.06 03.06	24.3727-0300.2	580300	1	<input type="checkbox"/>	L=1078
	2.8 HDi 4x4(10/14/18)		S 17103012	04.02		24.3727-0562.2 24.3727-0348.2	580562 580348	1 1	<input type="checkbox"/> <input type="checkbox"/> + HA-Scheibenbremse ²⁾	L=1059 L=2715
	2.8 HDi 4x4(10/14/18)		S 17103013		03.06	24.3727-0562.2	580562	1	<input type="checkbox"/>	L=1059
	2.8 HDi 4x4(10/14/18)			04.02	03.06	24.6512-1701.3	320153		- ABS	BRL (2)

CITROEN JUMPER (06-)

	2.2 HDi 100 2.2 HDi 110 2.2 HDi 120 2.2 HDi 130 2.2 HDi 150 3.0 HDi 145 3.0 HDi 155 3.0 HDi 160 3.0 HDi 180	74 81 88 96 110 107 115 116 130		04.06 07.11 04.06 07.11 07.11 07.10 07.10 09.06 07.11	Nutzlast 120/140 ³⁾ Nutzlast 120/140 ³⁾ Nutzlast 120/140 ³⁾ Nutzlast 120/140 ³⁾ Nutzlast 120/140 ³⁾ Nutzlast 120/140 ³⁾ Nutzlast 120/140 ³⁾ Nutzlast 120/140 ³⁾ Nutzlast 120/140 ³⁾	24.4126-1701.3	010868		+ ESP	Thz 26,99 + Behälter BOS
	2.2 HDi 100 2.2 HDi 110 2.2 HDi 120 2.2 HDi 130 2.2 HDi 150 3.0 HDi 145 3.0 HDi 155 3.0 HDi 160 3.0 HDi 180	74 81 88 96 110 107 115 116 130		04.06 07.11 04.06 07.11 07.11 07.10 07.10 09.06 07.11	Nutzlast 160/200 ⁴⁾ Nutzlast 160/200 ⁴⁾ Nutzlast 160/200 ⁴⁾ Nutzlast 160/200 ⁴⁾ Nutzlast 160/200 ⁴⁾ Nutzlast 160/200 ⁴⁾ Nutzlast 160/200 ⁴⁾ Nutzlast 160/200 ⁴⁾ Nutzlast 160/200 ⁴⁾	24.4125-1701.3	010867		+ ESP	Thz 25,40 + Behälter BOS
	2.0 BlueHDI 110 2.0 BlueHDI 130 2.0 BlueHDI 160 2.2 HDi 100 2.2 HDi 110 2.2 HDi 120 2.2 HDi 130 2.2 HDi 150 3.0 HDi 145 3.0 HDi 155 3.0 HDi 160 3.0 HDi 180	81 96 120 74 81 88 96 110 107 115 116 130		07.15 07.15 07.15 04.06 07.11 04.06 07.11 07.11 07.10 07.10 09.06 07.11		24.5112-0492.3	331217	2		L=492
	2.0 BlueHDI 110 2.0 BlueHDI 130 2.0 BlueHDI 160 2.2 HDi 100 2.2 HDi 110 2.2 HDi 120 2.2 HDi 130 2.2 HDi 150 3.0 HDi 145	81 96 120 74 81 88 96 110 107		07.15 07.15 07.15 04.06 07.11 04.06 07.11 07.11 07.10		24.5112-0417.3 83.7101-9489.3	331298 330906	2 2	+ kurzer Radstand ⁵⁾ + langer Radstand ⁶⁾	L=417 L=489

¹⁾ + RA drum brake / + P freno a tamburo / + frein à tambour essieu AR / + ET-tambores de freno
²⁾ + RA disc brake / + P disco freno / + frein à disque essieu AR / + ET-disco de freno
³⁾ payload 120/140 / carico utile 120/140 / charge utile 120/140 / carga útil 120/140
⁴⁾ payload 160/200 / carico utile 160/200 / charge utile 160/200 / carga útil 160/200
⁵⁾ + short wheel base / + passo lungo / + empattement court / + distancia corta entre ejes
⁶⁾ + long wheel base / + passo lungo / + empattement long / + distancia larga entre ejes























											
CITROEN JUMPER (06-)											
	3.0 HDi 155 3.0 HDi 160 3.0 HDi 180	115 116 130		07.10 09.06 07.11		24.5112-0417.3 83.7101-9489.3	331298 330906	2 2	+ kurzer Radstand ¹⁾ + langer Radstand ²⁾	L=417 L=489	
CITROEN JUMPY Kombi (95-06)											
	1.6 1.9 D 1.9 TD 1.9 TD		ORGA 08206 ORGA 08206 ORGA 08206 ORGA 08206	10.95 10.95 10.95 04.96		24.2122-1703.3 24.2122-1708.3 24.2123-1707.3	010422 010437 010492		- ABS/ + 0,8 t + ABS/ + 0,8 t - ABS/ + 0,9 t	THz 22,20 THz 22,20 THz 23,81	
	1.6 1.9 D 1.9 TD 1.9 TD		ORGA 08207 ORGA 08207 ORGA 08207 ORGA 08207	12.06 12.06 12.06 12.06		24.2122-1741.3 24.2122-1742.3 24.2123-1738.3 24.2123-1733.3	010695 010696 010658 010657		- ABS/ + 0,8 t + ABS/ + 0,8 t - ABS/ + 0,9 t + ABS/ + 0,9 t	THz 22,20 THz 22,20 THz 23,81 THz 23,81	
	2.0 16V 2.0 16V 2.0 HDi 2.0 HDi	100 102 69 80		04.00 12.06 10.99 03.00	12.06 12.06 12.06 12.06	24.2123-1738.3 24.2123-1733.3	010658 010657		- ABS + ABS	THz 23,81 THz 23,81	
	1.6 1.9 D 1.9 TD 1.9 TD 2.0 16V 2.0 16V 2.0 HDi 2.0 HDi		ORGA 09792 ORGA 09155 ORGA 09792 ORGA 09792 ORGA 09792 ORGA 09792 ORGA 09792 ORGA 09792	10.95 10.95 10.95 04.96 04.00 03.00 10.99 03.00		24.3571-1709.5 24.3571-1710.5	240153 240154			D=57, - Halter D=57, - Halter	TRW TRW
	1.9 D	51	ORGA 09156	12.06		24.3571-1711.5 24.3571-1712.5	240159 240160			D=57, - Halter D=57, - Halter	BDX BDX
	1.6 1.9 TD 1.9 TD 2.0 16V 2.0 16V 2.0 HDi 2.0 HDi		ORGA 09793 ORGA 09793 ORGA 09793 ORGA 09793 ORGA 09793 ORGA 09793 ORGA 09793	12.06 12.06 12.06 12.06 12.06 12.06 12.06		24.3601-1711.7 24.3601-1712.7	220607 220608			D=60, - Halter D=60, - Halter	TRW TRW
	1.6 1.9 D 1.9 TD 1.9 TD 2.0 16V 2.0 16V 2.0 HDi 2.0 HDi		ORGA 09792 ORGA 09792 ORGA 09792 ORGA 09792 ORGA 09792 ORGA 09792 ORGA 09792 ORGA 09792	10.95 10.95 10.95 04.96 04.00 03.00 10.99 03.00	12.06 12.06	24.5118-0471.3	330528	2		L=473	
	1.6 1.9 TD 1.9 TD 2.0 16V 2.0 16V 2.0 HDi 2.0 HDi		ORGA 09793 ORGA 09793 ORGA 09793 ORGA 09793 ORGA 09793 ORGA 09793 ORGA 09793	12.06 12.06 12.06 12.06 12.06 12.06 12.06		24.5111-0462.3	330555	2		L=460	
	1.6 1.9 D 1.9 TD 1.9 TD 2.0 16V 2.0 16V 2.0 HDi 2.0 HDi			10.95 10.95 10.95 04.96 04.00 03.00 10.99 03.00	12.06 12.06 12.06 12.06 12.06 12.06 12.06 12.06	24.5229-0251.3	330535	2		L=250	
	1.6 1.9 D 1.9 TD 1.9 TD 2.0 16V 2.0 16V 2.0 HDi 2.0 HDi			10.95 10.95 10.95 04.96 04.00 03.00 10.99 03.00	12.06 12.06 12.06 12.06 12.06 12.06 12.06 12.06	24.3219-1704.3	020374			Rz 19,05	
	1.6 1.9 D 1.9 TD 1.9 TD 2.0 16V 2.0 16V 2.0 HDi 2.0 HDi			10.95 10.95 10.95 04.96 04.00 03.00 10.99 03.00	12.06 12.06 12.06 12.06 12.06 12.06 12.06 12.06	24.3727-0336.2 24.3727-0341.2 24.3727-0532.2 24.3727-0531.2	580336 580341 580532 580531	1 1	- langer Radstand ³⁾ + langer Radstand ²⁾	L=500 L=900 L=1063 L=2286	
	1.6 1.9 D 1.9 TD 1.9 TD 2.0 16V 2.0 16V 2.0 HDi 2.0 HDi			10.95 10.95 10.95 04.96 04.00 03.00 10.99 03.00	12.06 12.06 12.06 12.06 12.06 12.06 12.06 12.06	24.3727-0336.2 24.3727-0341.2 24.3727-0532.2	580336 580341 580532	1 1	- langer Radstand ³⁾ + langer Radstand ²⁾	L=500 L=900 L=1063	
	1.6 2.0 16V 2.0 16V			10.95 04.00 03.00	12.06 12.06 + BE3-Getriebe ⁴⁾ 12.06 + BE3-Getriebe ⁴⁾	24.3728-0341.2	590341			L=739, + AUT	
	1.9 D	51		10.95	12.06	24.3728-0336.2	590336			L=973, + AUT	

¹⁾ + short wheel base / + passo lungo / + empattement court / + distancia corta entre ejes



































²⁾ + long wheel base / + passo lungo / + empattement long / + distancia larga entre ejes

³⁾ - long wheel base / - passo lungo / - empattement long / - distancia larga entre ejes























⁴⁾ + BE3 transmission / + scatola cambio BE3 / + boîte de vitesse BE3 / + cambio BE3

											
CITROEN JUMPY Kombi (95-06)											
	2.0 16V	◀100		04.00	12.06	+ BE4-Getriebe ¹⁾	24.3728-0336.2	590336		L=973, + AUT	
	2.0 16V	◀102		03.00	12.06	+ BE4-Getriebe ¹⁾					
	2.0 HDi	◀69		10.99	12.06	+ ML5-Getriebe ²⁾	24.3728-0333.2	590333		L=1003, + AUT	
	2.0 HDi	◀80		03.00	12.06	+ ML5-Getriebe ²⁾					
	1.9 TD	◀66		10.95	12.06		24.3728-0342.2	590342	+ ME5K-Getriebe ³⁾	L=864, + AUT	
1.9 TD	◀68		04.96	12.06		24.3728-0340.2	590340	+ ML5T-Getriebe ⁴⁾	L=1088, + AUT		
CITROEN JUMPY Kasten (95-06)											
	1.6		ORGA 08206	10.95			24.2122-1703.3	010422	- ABS/+ 0,8 t	THz 22,20	
	1.9 D 70	51	ORGA 08206	04.98			24.2122-1708.3	010437	+ ABS/+ 0,8 t	THz 22,20	
	1.9 TD	66	ORGA 08206	10.95			24.2123-1707.3	010492	- ABS/+ 0,9 t	THz 23,81	
	1.6		ORGA 08207		12.06		24.2122-1741.3	010695	- ABS/+ 0,8 t	THz 22,20	
	1.9 D 70	51	ORGA 08207		12.06		24.2122-1742.3	010696	+ ABS/+ 0,8 t	THz 22,20	
	1.9 TD	66	ORGA 08207		12.06		24.2123-1738.3	010658	- ABS/+ 0,9 t	THz 23,81	
							24.2123-1733.3	010657	+ ABS/+ 0,9 t	THz 23,81	
	2.0 16V			03.00	12.06		24.2123-1738.3	010658	- ABS	THz 23,81	
	2.0 HDi 110	80		01.02	12.06		24.2123-1733.3	010657	+ ABS	THz 23,81	
	2.0 HDi 95	69		10.99	12.06						
	1.6		ORGA 09792	10.95		+ 0,8/0,9 t	24.3571-1709.5	240153	<input type="checkbox"/>	D=57, - Halter	TRW
	1.9 D	51	ORGA 09155	10.95		+ 0,8/0,9 t	24.3571-1710.5	240154	<input type="checkbox"/>	D=57, - Halter	TRW
	1.9 D 70	51	ORGA 09155	04.98		+ 0,8/0,9 t					
	1.9 TD	66	ORGA 09155	10.95		+ 0,8/0,9 t					
	2.0 16V		ORGA 09792	03.00		+ 0,8/0,9 t					
	2.0 HDi 110	80	ORGA 09792	01.02		+ 0,8/0,9 t					
	2.0 HDi 95	69	ORGA 09792	10.99		+ 0,8/0,9 t					
	1.9 D	51	ORGA 09156		12.06	+ 0,8/0,9 t	24.3571-1711.5	240159	<input type="checkbox"/>	D=57, - Halter	BDX
	1.9 D 70	51	ORGA 09156		12.06	+ 0,8/0,9 t	24.3571-1712.5	240160	<input type="checkbox"/>	D=57, - Halter	BDX
	1.9 TD	66	ORGA 09156		12.06	+ 0,8/0,9 t					
	1.6		ORGA 09793		12.06	+ 0,8/0,9 t	24.3601-1711.7	220607	<input type="checkbox"/>	D=60, - Halter	TRW
	2.0 16V		ORGA 09793		12.06	+ 0,8/0,9 t	24.3601-1712.7	220608	<input type="checkbox"/>	D=60, - Halter	TRW
	2.0 HDi 110	80	ORGA 09793		12.06	+ 0,8/0,9 t					
	2.0 HDi 95	69	ORGA 09793		12.06	+ 0,8/0,9 t					
	1.6		ORGA 09792	10.95	12.06		24.5229-0251.3	330535	2	L=250	
	1.9 D	51		10.95	12.06						
	1.9 D 70	51		04.98	12.06						
	1.9 TD	66		10.95	12.06						
	2.0 16V		ORGA 09792	03.00	12.06						
	2.0 HDi 110	80	ORGA 09792	01.02	12.06						
	1.6		ORGA 09793		12.06		24.5111-0462.3	330555	2	L=460	
	2.0 16V		ORGA 09793		12.06						
	2.0 HDi 110	80	ORGA 09793		12.06						
	2.0 HDi 95	69	ORGA 09793		12.06						
	1.6			10.95	12.06		24.5229-0251.3	330535	2	L=250	
	1.9 D	51		10.95	12.06						
	1.9 D 70	51		04.98	12.06						
	1.9 TD	66		10.95	12.06						
	2.0 16V			03.00	12.06						
	2.0 HDi 110	80		01.02	12.06						
	1.6			10.95	12.06		24.3219-1704.3	020374		Rz 19,05	
	1.9 D	51		10.95	12.06						
	1.9 D 70	51		04.98	12.06						
	1.9 TD	66		10.95	12.06						
	2.0 16V			03.00	12.06						
	2.0 HDi 110	80		01.02	12.06						
	1.6	◀		10.95	12.06		24.3727-0336.2	580336	1 <input type="checkbox"/>	- langer Radstand ⁵⁾	L=500
	1.9 D	◀51		10.95	12.06		24.3727-0341.2	580341	1 <input type="checkbox"/>	+ langer Radstand ⁶⁾	L=900
	1.9 D 70	◀51		04.98	12.06		24.3727-0532.2	580532	<input type="checkbox"/>		L=1063
	1.9 TD	◀66		10.95	12.06		24.3727-0531.2	580531	<input type="checkbox"/>		L=2286
	2.0 16V	◀		03.00	12.06						
	2.0 HDi 110	◀80		01.02	12.06						
	2.0 HDi 95	◀69		10.99	12.06						
	1.6	▶		10.95	12.06		24.3727-0336.2	580336	1 <input type="checkbox"/>	- langer Radstand ⁵⁾	L=500
	1.9 D	▶51		10.95	12.09		24.3727-0341.2	580341	1 <input type="checkbox"/>	+ langer Radstand ⁶⁾	L=900
	1.9 D 70	▶51		04.98	12.06		24.3727-0532.2	580532	<input type="checkbox"/>		L=1063
1.9 TD	▶66		10.95	12.06							
2.0 16V	▶		03.00	12.06							
2.0 HDi 110	▶80		01.02	12.06							
2.0 HDi 95	▶69		10.99	12.06							
	1.6	◀		10.95	12.06	+ BE3-Getriebe ⁷⁾	24.3728-0341.2	590341		L=739, + AUT	
	2.0 16V	◀		03.00	12.06						
	1.6	◀		10.95	12.06		24.3728-0336.2	590336		L=973, + AUT	
	1.9 D 70	◀51		04.98	12.06						
	2.0 16V	◀		03.00	12.06	+ BE4-Getriebe ¹⁾					
	1.9 TD	◀66		10.95	12.06		24.3728-0342.2	590342	+ ME5K-Getriebe ³⁾	L=864, + AUT	
							24.3728-0340.2	590340	+ ML5T-Getriebe ⁴⁾	L=1088, + AUT	
	2.0 HDi 110	◀80		01.02	12.06		24.3728-0340.2	590340	+ ML5-Getriebe ²⁾	L=1088, + AUT	
2.0 HDi 95	◀69		10.99	12.06							

¹⁾ + BE4 transmission / + scatola cambio BE4 / + boîte de vitesse BE4 / + cambio BE4
²⁾ + ML5 transmission / + scatola cambio ML5 / + boîte de vitesse ML5 / + cambio ML5
³⁾ + ME5K transmission / + scatola cambio ME5K / + boîte de vitesse ME5K / + cambio ME5K
⁴⁾ + ML5T transmission / + scatola cambio ML5T / + boîte de vitesse ML5T / + cambio ML5T
⁵⁾ - long wheel base / - passo lungo / - empattement long / - distancia larga entre ejes
⁶⁾ + long wheel base / + passo lungo / + empattement long / + distancia larga entre ejes
⁷⁾ + BE3 transmission / + scatola cambio BE3 / + boîte de vitesse BE3 / + cambio BE3

										
CITROEN JUMPY Pritsche/Fahrgestell (99-06)										
	1.9 TD	68		10.99	12.06	24.2122-1741.3	010695	- ABS/ + 0,8 t	THz 22,20	
	2.0	100		12.03	10.06	24.2122-1742.3	010696	+ ABS/ + 0,8 t	THz 22,20	
	2.0 HDi	69		10.99	12.06	24.2123-1738.3	010658	- ABS/ + 0,9 t	THz 23,81	
	2.0 HDi	80		12.03	10.06	24.2123-1733.3	010657	+ ABS/ + 0,9 t	THz 23,81	
	1.9 TD	68	ORGA 09792	10.99		24.3571-1709.5	240153		D=57, - Halter	TRW
	2.0 HDi	69	ORGA 09792	10.99		24.3571-1710.5	240154		D=57, - Halter	TRW
	1.9 TD	68	ORGA 09793		12.06	24.3601-1711.7	220607		D=60, - Halter	TRW
	2.0	100		12.03	10.06	24.3601-1712.7	220608		D=60, - Halter	TRW
	2.0 HDi	69	ORGA 09793		12.06					
	2.0 HDi	80		12.03	10.06					
	1.9 TD	68	ORGA 09792	10.99		24.5118-0471.3	330528		L=473	
	2.0 HDi	69	ORGA 09792	10.99						
	1.9 TD	68	ORGA 09793		12.06	24.5111-0462.3	330555		L=460	
	2.0	100		12.03	10.06					
	2.0 HDi	69	ORGA 09793		12.06					
	2.0 HDi	80		12.03	10.06					
	1.9 TD	68		10.99	12.06	24.5229-0251.3	330535		L=250	
	2.0	100		12.03	10.06					
	2.0 HDi	69		10.99	12.06					
	2.0 HDi	80		12.03	10.06					
	1.9 TD	68		10.99	12.06	24.3219-1704.3	020374		Rz 19,05	
	2.0	100		12.03	10.06					
	2.0 HDi	69		10.99	12.06					
	2.0 HDi	80		12.03	10.06					
	1.9 TD	◀ 68		10.99	12.06	24.3727-0336.2	580336	1 ⬆ - langer Radstand ¹⁾	L=500	
	2.0	◀ 100		12.03	10.06	24.3727-0341.2	580341	1 ⬆ + langer Radstand ²⁾	L=900	
	2.0 HDi	◀ 69		10.99	12.06	24.3727-0532.2	580532	1 ⬆	L=1063	
	2.0 HDi	◀ 80		12.03	10.06	24.3727-0531.2	580531	1 ⬆	L=2286	
	1.9 TD	▶ 68		10.99	12.06	24.3727-0336.2	580336	1 ⬆ - langer Radstand ¹⁾	L=500	
	2.0	▶ 100		12.03	10.06	24.3727-0341.2	580341	1 ⬆ + langer Radstand ²⁾	L=900	
	2.0 HDi	▶ 69		10.99	12.06	24.3727-0532.2	580532	1 ⬆	L=1063	
	2.0 HDi	▶ 80		12.03	10.06					
	1.9 TD	◀ 68		10.99	12.06	24.3728-0342.2	590342	+ MESK-Getriebe ³⁾	L=864, + AUT	
						24.3728-0340.2	590340	+ ML5T-Getriebe ⁴⁾	L=1088, + AUT	
						24.3728-0333.2	590333	+ ML5-Getriebe ⁵⁾	L=1003, + AUT	
CITROEN JUMPY (07-16)										
	1.6 HDi 90	◀ 66		01.07		03.2125-0298.3	010818	- ESP	THz 25,40	ATE
	2.0 HDi 120	◀ 88		01.07		03.2125-0293.3	010817	+ ESP	THz 25,40	ATE
	2.0 HDi 120 4x4	◀ 88		01.10						
	2.0 HDi 125	◀ 94		07.11						
	2.0 HDi 140	◀ 100		01.07						
	2.0 HDi 165	◀ 120		07.10						
	2.0 HDi 95	◀ 72		07.11						
	2.0 i	◀ 103		01.07						
	1.6 HDi 90	66		01.07		24.3451-1725.5	240619	+ HA-Trommelbremse ⁶⁾	D=45/48, - Halter	TRW
	2.0 HDi 120	88		01.07		24.3451-1726.5	240620		D=45/48, - Halter	TRW
	2.0 HDi 120 4x4	88		01.10		24.3481-1785.5	240595	+ HA-Scheibenbremse ⁷⁾	D=48/45, - Halter	TRW
	2.0 HDi 125	94		07.11		24.3481-1786.5	240596		D=48/45, - Halter	TRW
	2.0 HDi 140	100		01.07						
	2.0 HDi 165	120		07.10						
	2.0 HDi 95	72		07.11						
	2.0 i	103		01.07						
	1.6 HDi 90	66	ORGA 10933	01.07		24.5144-0455.3	331201		L=455	
	2.0 HDi 120	88		01.07						
	2.0 HDi 120 4x4	88		01.10						
	2.0 HDi 125	94		07.11						
	2.0 HDi 140	100		01.07						
	2.0 HDi 165	120		07.10						
	2.0 HDi 95	72		07.11						
	2.0 i	103		01.07						
	1.6 HDi 90	66	ORGA 10934	01.07		24.3414-1715.5	240589		D=41, - Halter	TRW
	2.0 HDi 120	88	ORGA 10934	01.07		24.3414-1716.5	240590		D=41, - Halter	TRW
	2.0 HDi 120 4x4	88		01.10						
	2.0 HDi 125	94		07.11						
	2.0 HDi 140	100		01.07						
	2.0 HDi 165	120		07.10						
	2.0 HDi 95	72		07.11						
	2.0 i	103		01.07						
	1.6 HDi 90	66	ORGA 10933	01.07		24.5239-0260.3	331171	+ kurzer Radstand ⁸⁾	L=260	
	2.0 HDi 120	88	ORGA 10933	01.07		24.5239-0365.3	331281	+ langer Radstand ²⁾	L=365	
	2.0 HDi 140	100	ORGA 10933	01.07						
	2.0 HDi 165	120	ORGA 10933	07.10						
	2.0 i	103	ORGA 10933	01.07						
	1.6 HDi 90	66	ORGA 10934			24.5239-0240.3	331170	+ kurzer Radstand ⁸⁾	L=240	
	2.0 HDi 120	88	ORGA 10934			24.5239-0355.3	331243	+ langer Radstand ²⁾	L=355	
	2.0 HDi 120 4x4	88		01.10						
	2.0 HDi 125	94		07.11						
	2.0 HDi 140	100	ORGA 10934							
	2.0 HDi 165	120		07.10						

¹⁾ - long wheel base / - passo lungo / - empattement long / - distancia larga entre ejes
²⁾ - long wheel base / + passo lungo / + empattement long / + distancia larga entre ejes
³⁾ - MESK transmission / + scatola cambio ME5K / + boîte de vitesse ME5K / + cambio ME5K
⁴⁾ - ML5T transmission / + scatola cambio ML5T / + boîte de vitesse ML5T / + cambio ML5T
⁵⁾ - ML5 transmission / + scatola cambio ML5 / + boîte de vitesse ML5 / + cambio ML5
⁶⁾ - RA drum brake / + P freno a tamburo / + frein à tambour essieu AR / + ET-tambores de freno
⁷⁾ - RA disc brake / + P disco freno / + frein à disque essieu AR / + ET-disco de freno
⁸⁾ - short wheel base / + passo lungo / + empattement court / + distancia corta entre ejes

										
CITROEN JUMPY (07-16)										
	2.0 HDi 95 2.0 i	72 103 ORGA 10934		07.11	24.5239-0240.3 24.5239-0355.3	331170 331243	2 2	+ kurzer Radstand ¹⁾ + langer Radstand ²⁾	L=240 L=355	
	1.6 HDi 90	66		01.07	24.3222-1726.3	020518			Rz 22,20 TRW	
CITROEN NEMO (08-)										
	1.3 HDi 75 1.3 HDi 80 1.4 HDi 1.4 i	55 59 50 54		10.10 10.15 02.08 02.08	24.3541-1769.5 24.3541-1770.5	240601 240602	<input type="checkbox"/> <input type="checkbox"/>		D=54, - Halter D=54, - Halter	BOS BOS
	1.3 HDi 75 1.3 HDi 80 1.4 HDi 1.4 i	55 59 50 54		10.10 10.15 02.08 02.08	24.5112-0402.3	331297	2		L=402	
	1.3 HDi 75 1.3 HDi 80 1.4 HDi 1.4 i	55 59 50 54		10.10 10.15 02.08 02.08	24.5228-0181.3	331279	2		L=180	
	1.3 HDi 75 1.3 HDi 80 1.4 HDi 1.4 i	55 59 50 54		10.10 10.15 02.08 02.08	24.3220-1728.3	020509			Rz 20,64	
CITROEN SAXO (96-04)										
	1.0 i 1.1 X/SX 1.5 D 1.6 1.6 1.6 1.6 16V VTS 1.6 i 1.6 i VTS Electric	 43 66 74 88 87 65 72 20		02.96 03.04 02.96 03.04 07.01 04.04 02.96 06.03 02.01 04.04 02.96 04.04 07.96 03.04 02.96 03.04 09.00 03.04 11.96 06.03	03.7740-3302.4	300107		- ABS	8"	ATE
	1.0 i 1.1 X/SX 1.4 i VTS 1.5 D 1.5 D 1.6 1.6 1.6 16V VTS 1.6 i 1.6 i VTS Electric	 55 43 66 74 88 87 65 72 20		02.96 03.04 02.96 03.04 02.96 03.04 04.96 03.04 07.01 04.04 02.96 06.03 02.01 04.04 02.96 04.04 07.96 03.04 02.96 03.04 09.00 03.04 11.96 06.03	03.2120-4166.3 24.2120-1722.3 24.2119-1708.3	010452 010544 010543		für 3-Loch-Felge ³⁾ für 3-Loch-Felge ³⁾ für 4-Loch-Felge ⁴⁾	THz 20,64 THz 20,64 THz 19,05	ATE BDX BDX
	1.0 i 1.1 X/SX 1.4 i VTS 1.5 D 1.5 D 1.6 1.6 1.6 i SX/VSX	 55 43 66 74 88 65		02.96 03.04 02.96 03.04 02.96 03.04 04.96 03.04 07.01 04.04 02.96 06.03 02.96 03.04	24.2120-1728.3	010626		+ ABS	THz 20,64	
	1.0 i 1.1 X/SX Electric 1.4 i VTS 1.6 1.6 1.6 1.6 16V VTS 1.6 i 1.6 i VTS Electric	 20 55 66 74 88 87 65 72 20		02.96 03.04 02.96 03.04 11.96 06.03 05.96 03.04 02.96 06.03 02.01 04.04 02.96 04.04 07.96 03.04 02.96 03.04 09.00 03.04 11.96 06.03	11.0441-4501.2	250015			Dichtungssatz	ATE
	1.0 i 1.1 X/SX Electric 1.4 i VTS 1.6 1.6 1.6 1.6 16V VTS 1.6 i 1.6 i VTS Electric	 20 55 66 74 88 87 65 72 20		02.96 03.04 02.96 03.04 11.96 06.03 05.96 03.04 02.96 06.03 02.01 04.04 02.96 04.04 07.96 03.04 02.96 03.04 09.00 03.04 11.96 06.03	11.3481-9833.2 11.3481-9834.2 24.3481-9833.5 24.3481-9834.5 11.0441-4811.2 11.0101-5407.2 11.8171-0008.1 11.8116-0129.1	220561 220562 240479 240480 250024 260011 990049 390591	<input type="checkbox"/> <input type="checkbox"/> <input type="checkbox"/> <input type="checkbox"/>	D=48, - Halter D=48, - Halter D=48, - Halter D=48, - Halter Dichtungssatz Hülzensatz Führungsbolzen Haltefeder	ATE ATE ATE ATE ATE ATE ATE ATE	
	1.0 i 1.1 X/SX 1.4 i VTS 1.5 D 1.5 D 1.6 1.6 1.6 16V VTS 1.6 i Electric	 55 43 66 88 87 65 20	ORGA 08093 ORGA 08093	02.96 02.96	24.5111-0330.3 24.5111-0301.3	330160 330499	2 2	für 3-Loch-Felge ³⁾ für 4-Loch-Felge ⁴⁾	L=330 L=300	
	1.0 i 1.1 X/SX 1.4 i VTS 1.5 D 1.5 D 1.6 1.6 1.6 16V VTS 1.6 i Electric	 55 43 66 88 87 65 20	ORGA 08094 ORGA 08094 ORGA 08094 ORGA 08094 ORGA 08094 ORGA 08094 ORGA 08094	03.04 03.04 03.04 04.04 06.03 04.04 04.04	24.5111-0290.3	330108	2		L=290	

¹⁾ + short wheel base / + passo lungo / + empattement court / + distancia corta entre ejes

²⁾ + long wheel base / + passo lungo / + empattement long / + distancia larga entre ejes

³⁾ for 3 bore wheel rim / per cerchione a 3 fori / pour jante à 3 trous / para Liantas de 3 taladros

⁴⁾ for 4 bore wheel rim / per cerchione a 4 fori / pour jante à 4 trous / para Liantas de 4 taladros



CITROEN SAXO (96-04)											
	1.6 16V VTS	87	ORGA 08094		03.04		24.5111-0290.3	330108	2	L=290	
	1.6 i	65	ORGA 08094		03.04						
	1.6 i VTS	72		09.00	03.04						
	Electric	20	ORGA 08094		06.03						
	1.0 i				02.96	03.04	24.5229-0199.3	330534	2	L=200	
	1.1 X/SX				02.96	03.04					
	1.4 i VTS	55			02.96	03.04					
	1.5 D				04.96	03.04					
	1.5 D	43			07.01	04.04					
	1.6	66			02.96	06.03					
	1.6	74			02.01	04.04					
	1.6	88			02.96	04.04					
	1.6 16V VTS	87			07.96	03.04					
	1.6 i	65			02.96	03.04					
	1.6 i VTS	72			09.00	03.04					
	Electric	20			11.96	06.03					
		1.0 i				02.96	03.04	24.3219-1603.3	020200		RzR 19,05
		1.1 X/SX				02.96	03.04	24.3219-1604.3	020201		RzR 19,05
Electric		20			11.96	06.03	24.3219-1609.3	020319		RzR 19,05	
							24.3219-1610.3	020320		RzR 19,05	
1.4 i VTS		55			02.96	03.04	24.3219-1609.3	020319		RzR 19,05	
1.5 D					04.96	03.04	24.3219-1610.3	020320		RzR 19,05	
1.5 D		43			07.01	04.04					
1.6		66			02.96	06.03					
1.6 i SX/VTL/VSX		65			02.96	03.04					
	1.0 i		ORGA 08095		02.96	+ ABS	24.3220-1711.3	020409		Rz 20,64	
	1.1 X/SX		ORGA 08095		02.96	+ ABS					
	1.4 i VTS	55	ORGA 08095		02.96	+ ABS					
	1.5 D		ORGA 08095		04.96	+ ABS					
	1.5 D	43	ORGA 08095		07.01	+ ABS					
	1.6	66	ORGA 08095		02.96	+ ABS					
	1.6 i SX/VTL/VSX	65	ORGA 08095		02.96	+ ABS					
	Electric	20	ORGA 08095		11.96	+ ABS					
	1.0 i		ORGA 08096		03.04	+ ABS	24.3220-1717.3	020430		Rz 20,64	
	1.1 X/SX		ORGA 08096		03.04	+ ABS					
	1.4 i VTS	55	ORGA 08096		03.04	+ ABS					
	1.5 D		ORGA 08096		03.04	+ ABS					
	1.5 D	43	ORGA 08096		04.04	+ ABS					
	1.6	66	ORGA 08096		04.04	+ ABS					
	1.6 i SX/VTL/VSX	65	ORGA 08096		03.04	+ ABS					
	Electric	20	ORGA 08096		06.03	+ ABS					
	1.0 i				02.96	03.04	24.3727-0816.2	580816	2	L=1442	
	1.1 X/SX				02.96	03.04					
	1.4 i VTS	55			02.96	03.04					
	1.5 D				04.96	03.04					
	1.5 D	43			07.01	04.04					
	1.6	66			02.96	06.03					
	1.6 i SX/VTL/VSX	65			02.96	03.04					
	1.6	66			02.96	06.03	24.3727-0817.2	580817	2	L=1505	
	1.6	74			02.01	04.04					
	1.6	88			02.96	04.04					
	1.6 16V VTS	87			07.96	03.04					
	1.6 i VTR	65			02.96	03.04					
	1.6 i VTS	72			09.00	03.04					
	Electric	20			11.96	06.03					
	1.0 i				02.96	03.04	24.3728-0313.2	590313		L=673	
	1.1 X/SX				02.96	03.04					
	1.4 i VTS	55			02.96	03.04					
	1.6	66			02.96	06.03					
	1.6	88			02.96	04.04					
	1.6 16V VTS	87			07.96	03.04					
	1.6 i	65			02.96	03.04					
	1.5 D				04.96	03.04	24.3728-0315.2	590315		L=673	
	1.5 D	43			07.01	04.04					
	1.6	74			02.01	04.04					
	1.6 i VTS	72			09.00	03.04					
	Electric	20			11.96	06.03					
CITROEN XANTIA (X1) Limousine (93-97)											
	1.6 i	65			03.93	12.97	24.5111-0355.3	330757	2	L=360	
	1.8 16V	81			06.95	12.97	24.5111-0375.3	331128	2	L=375	
	1.8 i	66			04.97	12.97					
	1.8 i	74			03.93	12.97					
	1.9 D	50			06.94	12.97					
	1.9 D	51			06.94	12.97					
	1.9 SD	55			02.96	12.97					
	1.9 TD	66			10.94	12.97					
	2.0	95			03.93	05.95					
	2.0 16V	97			06.95	12.97					
	2.0 16V	110			06.94	12.97					
	2.0 16V	112			03.93	12.97					
	2.0 i	89			03.93	12.97					
	2.0 Turbo	108			06.95	12.97					
	2.1 TD	80			06.95	12.97					
	3.0 V6	140			01.97	12.97					

1) for 3 bore wheel rim / per cerchione a 3 fori / pour jante à 3 trous / para Llantas de 3 taladros

2) for 4 bore wheel rim / per cerchione a 4 fori / pour jante à 4 trous / para Llantas de 4 taladros

3) + cast iron / + ghisa / + fonte grise / + fundición de gris

4) + aluminium / + alluminio / + aluminium / + aluminio



CITROEN XANTIA (X1) Limousine (93-97)

	1.6 i	65	03.93	12.97	24.3727-0312.2	580312	<input type="checkbox"/>	L=1262 L=1333
	1.8 16V	81	06.95	12.97	24.3727-0311.2	580311	<input type="checkbox"/>	
	1.8 i	66	04.97	12.97				
	1.8 i	74	03.93	12.97				
	1.9 D	50	06.94	12.97				
	1.9 D	51	06.94	12.97				
	1.9 SD	55	02.96	12.97				
	1.9 TD	66	10.94	12.97				
	2.0	95	03.93	05.95				
	2.0 16V	97	06.95	12.97				
	2.0 16V	110	06.94	12.97				
	2.0 16V	112	03.93	12.97				
2.0 i	89	03.93	12.97					
2.0 Turbo	108	06.95	12.97	24.3727-0330.2	580330	<input type="checkbox"/>	L=1313	
2.1 TD	80	06.95	12.97	24.3727-0311.2	580311	<input type="checkbox"/>	L=1333	
3.0 V6	140	01.97	12.97	24.3727-0330.2	580330	<input type="checkbox"/>	L=1313	
	1.6 i	65	03.93	12.97	24.3728-0310.2	590310		L=778
	1.8 16V	81	06.95	12.97				
	1.8 i	66	04.97	12.97				
	1.8 i	74	03.93	12.97				
	1.9 D	50	06.94	04.95				
	1.9 D	51	06.94	04.95				
	2.0 i	89	03.93	12.97				

CITROEN XANTIA (X1) Kombi (95-97)

	1.8 16V	81	06.95	12.97	24.5111-0355.3	330757	2	L=360
	1.8 i	66	04.97	12.97	24.5111-0375.3	331128	2	L=375
	1.8 i	74	06.95	12.97				
	1.9 SD	55	04.97	12.97				
	1.9 TD	66	06.95	12.97				
	2.0 16V	97	06.95	12.97				
	2.0 i	89	06.95	12.97				
	2.0 Turbo	108	06.95	12.97				
	2.1 TD	80	06.96	12.97				
	1.8 16V	81	06.95	12.97	24.3727-0312.2	580312	<input type="checkbox"/>	L=1262
	1.8 i	66	04.97	12.97	24.3727-0311.2	580311	<input type="checkbox"/>	L=1333
	1.8 i	74	06.95	12.97				
	1.9 SD	55	04.97	12.97				
	1.9 TD	66	06.95	12.97				
	2.0 16V	97	06.95	12.97				
	2.0 i	89	06.95	12.97				
	2.0 Turbo	108	06.95	12.97	24.3727-0330.2	580330	<input type="checkbox"/>	L=1313
	2.1 TD	80	06.96	12.97	24.3727-0311.2	580311	<input type="checkbox"/>	L=1333
	1.8 16V	81	06.95	12.97	24.3728-0310.2	590310		L=778
	1.8 i	66	04.97	12.97				
	1.8 i	74	06.95	12.97				
	2.0 i	89	06.95	12.97				

















CITROEN XANTIA (X2) Limousine (98-03)

	1.6 i SX	65	01.98	03.01	24.5111-0355.3	330757	2	L=360	
	1.8 16V	81	01.98	09.01	24.5111-0375.3	331128	2	L=375	
	1.8 i	66	01.98	09.01					
	1.9 SD	55	01.98	09.01					
	1.9 TD	66	01.98	09.01					
	2.0 16V	97	01.98	09.01					
	2.0 HDi 110	109	02.99	09.01					
	2.0 HDi 90	66	03.99	09.01					
	2.0 i	89	01.98	09.01					
	2.0 Turbo	108	01.98	09.01					
	2.1 TD	80	01.98	02.99					
	3.0 V6	140	01.98	09.01					
		1.6 i SX	65	01.98	03.01	24.3727-0312.2	580312	<input type="checkbox"/>	L=1262
1.8 16V		81	01.98	09.01	24.3727-0311.2	580311	<input type="checkbox"/>	L=1333	
1.8 i		66	01.98	09.01					
1.9 SD		55	01.98	09.01					
1.9 TD		66	01.98	09.01	+ Schaltgetriebe ¹⁾				
2.0 16V		97	01.98	09.01	+ Schaltgetriebe ¹⁾				
2.0 HDi 90		66	03.99	09.01	+ Schaltgetriebe ¹⁾				
2.0 i		89	01.98	09.01					
1.8 16V		81	01.98	09.01	+ Automatikgetriebe ²⁾	24.3727-0351.2	580351	<input type="checkbox"/>	L=1285
1.9 TD		66	01.98	09.01	+ Automatikgetriebe ²⁾	24.3727-0311.2	580311	<input type="checkbox"/>	L=1333
2.0 16V		97	01.98	09.01	+ Automatikgetriebe ²⁾				
2.0 HDi 110		109	02.99	09.01	24.3727-0330.2	580330	<input type="checkbox"/>	L=1313	
2.0 HDi 90		66	03.99	09.01	24.3727-0311.2	580311	<input type="checkbox"/>	L=1333	
2.0 Turbo	108	01.98	09.01						
2.1 TD	80	01.98	02.99						
3.0 V6	140	01.98	09.01	24.3727-0330.2	580330	<input type="checkbox"/>	L=1313		
3.0 V6	140	01.98	09.01	24.3727-0330.2	580330	<input type="checkbox"/>	L=1313		
	1.8 16V	81	01.98	09.01	24.3728-0310.2	590310		L=778	
	1.8 i	66	01.98	09.01					



























¹⁾ + manual transmission / + scatola cambio velocità / + transmission mécanique / + cambio de velocidad

²⁾ + autom.transmission / + scatola cambio automatico / + transmission automatique / + cambio automático



											
CITROEN XANTIA (X2) Kombi (98-03)											
	1.8 16V	81	01.98	09.01	24.5111-0355.3	330757	2	L=360 L=375			
	1.8 i	66	01.98	09.01	24.5111-0375.3	331128	2				
	1.9 SD	55	01.98	09.01							
	1.9 TD	66	01.98	09.01							
	2.0 16V	97	01.98	09.01							
	2.0 HDi 110	109	02.99	09.01							
	2.0 HDi 90	66	03.99	09.01							
	2.0 i	89	01.98	09.01							
	2.0 Turbo	108	01.98	09.01							
	2.1 TD	80	01.98	02.99							
3.0 V6	140	01.98	09.01								
	1.8 16V	81	01.98	09.01	24.3727-0312.2	580312	<input type="checkbox"/>	L=1262 L=1333			
	1.8 i	66	01.98	09.01	24.3727-0311.2	580311	<input type="checkbox"/>				
	1.9 SD	55	01.98	09.01							
	1.9 TD	66	01.98	09.01							
	2.0 16V	97	01.98	09.01							
	2.0 i	89	01.98	09.01							
	1.8 16V	81	01.98	09.01	24.3727-0351.2	580351	<input type="checkbox"/>		L=1285 L=1333		
	1.9 TD	66	01.98	09.01	24.3727-0311.2	580311	<input type="checkbox"/>				
	2.0 16V	97	01.98	09.01							
	2.0 HDi 110	109	02.99	09.01	24.3727-0330.2	580330	<input type="checkbox"/>		L=1313 L=1333		
2.0 HDi 90	66	03.99	09.01	24.3727-0311.2	580311	<input type="checkbox"/>					
2.0 Turbo	108	01.98	09.01								
2.1 TD	80	01.98	02.99								
3.0 V6	140	01.98	09.01	24.3727-0330.2	580330	<input type="checkbox"/>	L=1313				
3.0 V6	140	01.98	09.01	24.3727-0330.2	580330	<input type="checkbox"/>	L=1313				
	1.8 16V	81	01.98	09.01	24.3728-0310.2	590310		L=778			
	1.8 i	66	01.98	09.01							
CITROEN XM (Y4) Limousine (94-00)											
	2.0 16V	97	05.94	10.00	24.5411-0550.3	330567	2	L=550			
	2.0 Turbo	108	05.94	10.00							
	2.1 D12	60	03.96	08.96							
	2.1 TD	80	05.94	10.00							
	2.5 TD	95	05.94	10.00							
	3.0 24V	147	05.94	10.00							
	3.0 V6	123	05.94	10.00							
	3.0 V6	140	04.97	10.00							
	2.0 16V	97	05.94	10.00	24.3727-0309.2	580309	<input type="checkbox"/>		L=1030 L=1230		
	2.0 Turbo	108	05.94	10.00	24.3727-0308.2	580308	<input type="checkbox"/>				
2.1 D12	60	03.96	08.96								
2.1 TD	80	05.94	10.00								
2.5 TD	95	05.94	10.00								
3.0 V6	123	05.94	10.00								
3.0 V6	140	04.97	10.00								
3.0 24V	147	05.94	10.00	24.3727-0308.2	580308	<input type="checkbox"/>	L=1230				
CITROEN XM (Y4) Kombi (94-00)											
	2.0 16V	97	05.94	10.00	24.5411-0550.3	330567	2	L=550			
	2.0 Turbo	108	05.94	10.00							
	2.1 D	60	07.94	06.96							
	2.1 TD	80	05.94	10.00							
	2.5 TD	95	05.94	10.00							
	3.0 V6	123	05.94	10.00							
	3.0 V6	140	04.97	10.00							
	CITROEN XSARA (N1) Limousine (97-05)										
	1.4 i	55	04.97	08.00	03.7750-9302.4	300116		9"	ATE		
	1.5 D	42	04.97	08.00							
	1.6 i	65	04.97	08.00							
	1.8 D	43	04.97	08.00							
	1.8 i	66	04.97	08.00							
	1.8 i	74	04.97	08.00							
	1.8 TD	66	10.97	08.00							
	1.9 D	50	04.97	08.00							
	1.9 D	51	07.98	08.00							
	1.9 SD	55	01.98	08.00							
	1.9 TD	66	04.97	08.00							
	2.0 HDi 90	66	02.99	08.00							
	1.4 HDi 70	50	01.03	03.05	03.7853-0902.4	300150	+ ABS			9"	ATE
	1.4 i	55 ORGA 09002		03.05							
1.6 16V	80 ORGA 09002		03.05								
1.9 D	51 ORGA 09002		03.05								
2.0 16V	100 ORGA 09002		03.05								
2.0 HDi 110	80 ORGA 09002		03.05								
2.0 HDi 90	66 ORGA 09002		03.05								
	1.4 i	55	04.97	08.00	03.2122-1356.3	010529	- ABS	THz 22,20 THz 22,20 THz 22,20 THz 22,20	ATE BOS		
	1.5 D	42	04.97	08.00	24.2122-1743.3	010712	- ABS				
	1.6 i	65	04.97	08.00	03.2122-1351.3	010528	+ ABS				
	1.8 D	43	04.97	08.00	24.2122-1733.3	010668	+ ABS				
	1.8 i	66	04.97	08.00							
	1.8 i	74	04.97	08.00							
	1.8 TD	66	10.97	08.00							
	1.9 D	50	04.97	08.00							

1) + manual transmission / + scatola cambio velocità / + transmission mécanique / + cambio de velocidad
2) + autom.transmission / + scatola cambio automatico / + transmission automatique / + cambio automático











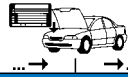

										
CITROEN XSARA (N1) Limousine (97-05)										
	1.9 D	51		07.98	08.00	03.2122-1356.3	010529	- ABS	THz 22,20	ATE
	1.9 SD	55		01.98	08.00	24.2122-1743.3	010712	- ABS	THz 22,20	
	1.9 TD	66		04.97	08.00	03.2122-1351.3	010528	+ ABS	THz 22,20	ATE
	2.0 HDi 90	66		02.99	08.00	24.2122-1733.3	010668	+ ABS	THz 22,20	BOS
	1.4 i	55	ORGA 09001	09.00		24.2123-1714.3	010587	- ABS	THz 23,81	BDX
	1.6 16V	80	ORGA 09001	09.00		24.2123-1715.3	010520	+ ABS	THz 23,81	BDX
	1.8 16V	81		04.97	08.00					
	1.9 D	51	ORGA 09001	09.00						
	2.0 16V	97		07.98	08.00					
	2.0 16V	120		04.97	08.00					
	2.0 HDi 110	80	ORGA 09001	05.01						
	2.0 HDi 90	66	ORGA 09001	09.00						
	1.4 HDi 70	50		01.03	03.05	03.2123-2781.3	010631	- ABS	THz 23,81	ATE
	1.4 i	55 ORGA 09002			03.05	03.2123-2721.3	010632	- ESP	THz 23,81	ATE
	1.6 16V	80 ORGA 09002			03.05					
	1.9 D	51 ORGA 09002			03.05					
	2.0 16V	100 ORGA 09002			03.05					
	2.0 HDi 110	80 ORGA 09002			03.05					
2.0 HDi 90	66 ORGA 09002			03.05						
1.4 HDi 70	50		01.03	03.05	03.2123-2761.3	010886	+ ESP	THz 23,81	ATE	
1.4 i	55 ORGA 09065			03.05						
1.6 16V	80 ORGA 09065			03.05						
1.9 D	51 ORGA 09065			03.05						
2.0 16V	100 ORGA 09065			03.05						
2.0 HDi 110	80 ORGA 09065			03.05						
2.0 HDi 90	66 ORGA 09065			03.05						
	1.4 i	55		04.97	08.00	24.3481-1741.5	240245		D=48, - Halter	BOS
	1.5 D	42		04.97	08.00	24.3481-1742.5	240246		D=48, - Halter	BOS
	1.4 i	55		04.97	08.00	11.3481-9833.2	220561		D=48, - Halter	ATE
	1.5 D	42		04.97	08.00	11.3481-9834.2	220562		D=48, - Halter	ATE
	1.6 i	65		04.97	08.00	24.3481-9833.5	240479		D=48, - Halter	ATE
	1.8 D	43		04.97	08.00	24.3481-9834.5	240480		D=48, - Halter	ATE
	1.8 i	66		04.97	08.00	11.0441-4811.2	250024		Dichtungssatz	ATE
	1.8 i	74		04.97	08.00	11.0101-5407.2	260011		Hülssensatz	ATE
	1.8 TD	66		10.97	08.00	11.8171-0008.1	990049		Führungsbolzen	ATE
	1.9 D	50		04.97	08.00	11.8116-0129.1	390591	2	Haltefeder	ATE
	1.9 D	51		07.98	08.00					
	1.9 SD	55		01.98	08.00					
	1.9 TD	66		04.97	08.00					
	1.8 16V	81		04.97	08.00	24.3541-1767.5	240237		D=54, - Halter	BOS
	1.8 i	74		04.97	08.00	24.3541-1768.5	240238		D=54, - Halter	BOS
	2.0 16V	97		07.98	08.00	24.3541-1757.7	220483		D=54, - Halter	TRW
	2.0 HDi 90	66		02.99	08.00	24.3541-1758.7	220484		D=54, - Halter	TRW
	1.4 HDi 70	50		01.03	03.05	24.3541-1771.5	240239		D=54, - Halter	BOS
	1.4 i	55		09.00	03.05	24.3541-1772.5	240240		D=54, - Halter	BOS
	1.6 16V	80		09.00	03.05					
	1.9 D	51		09.00	03.05					
	2.0 HDi 90	66		09.00	03.05					
	2.0 16V	100 ORGA 09185			03.05	24.3541-1761.5	240233		D=54, - Halter	BOS
	2.0 16V	120 ORGA 09185			03.05	24.3541-1762.5	240234		D=54, - Halter	BOS
2.0 HDi 110	80 ORGA 09185			03.05						
	1.4 i	55	ORGA 08091	04.97		24.5111-0438.3	330568	2	L=445	
	1.5 D	42	ORGA 08091	04.97						
	1.4 i	55 ORGA 08092	ORGA 09470		08.00	24.5111-0460.3	330603	2	L=460	
	1.5 D	42 ORGA 08092								
	1.6 16V	80	ORGA 09470	09.00						
	1.6 i	65		04.97	08.00					
	1.8 16V	81		04.97	08.00					
	1.8 D	43		04.97	08.00					
	1.8 i	66		04.97	08.00					
	1.8 i	74		04.97	08.00					
	1.8 TD	66		10.97	08.00					
	1.9 D	50		04.97	08.00					
	1.9 D	51	ORGA 09470	07.98						
	1.9 SD	55		01.98	08.00					
	1.9 TD	66		07.97	08.00					
	2.0 16V	97		07.98	08.00					
	2.0 16V	100	ORGA 09470	09.00						
	2.0 16V	100	ORGA 09184	09.00						
	2.0 16V	120		04.97	08.00					
	2.0 HDi 110	80	ORGA 09470	05.01						
	2.0 HDi 110	80	ORGA 09184	05.01						
	2.0 HDi 90	66	ORGA 09470	02.99						
	1.4 HDi 70	50		01.03	03.05	24.5111-0460.3	330603	2	L=460	
	1.4 i	55 ORGA 09471			03.05					
1.9 D	51 ORGA 09471			03.05						
2.0 16V	100 ORGA 09471			03.05						
2.0 16V	100 ORGA 09185			03.05						
2.0 HDi 110	80 ORGA 09471			03.05						
2.0 HDi 110	80 ORGA 09185			03.05						
2.0 HDi 90	66 ORGA 09471			03.05						
	1.4 i	55		04.97	08.00	24.5228-0195.3	330469	2	L=202	
	1.5 D	42		04.97	08.00					
	1.6 i	65		04.97	08.00					
	1.8 D	43		04.97	08.00					



CITROEN XSARA (N1) Limousine (97-05)

	1.8 i	66		04.97	08.00	- ABS	24.5228-0195.3	330469	2		L=202
	1.8 i	74		04.97	08.00	- ABS / -					
	1.8 TD	66		10.97	08.00	- ABS					
	1.9 D	50		04.97	08.00	- ABS					
	1.9 D	51		07.98	08.00	- ABS					
	1.9 SD	55		01.98	08.00	- ABS					
	1.9 TD	66		07.97	08.00	- ABS					
	1.4 HDi 70	50		01.03	03.05						
	1.4 i	55		09.00	03.05						
	1.4 i	55		04.97	08.00	+ ABS					
	1.5 D	42		04.97	08.00	+ ABS					
	1.6 16V	80		09.00	03.05						
	1.6 i	65		04.97	08.00	+ ABS					
	1.8 16V	81		04.97	08.00						
	1.8 D	43		04.97	08.00	+ ABS					
	1.8 i	66		04.97	08.00	+ ABS					
	1.8 i	74		04.97	08.00	+ ABS / +					
	1.8 TD	66		10.97	08.00	+ ABS					
	1.9 D	50		04.97	08.00	+ ABS					
	1.9 D	51		09.00	03.05						
1.9 D	51		07.98	08.00	+ ABS						
1.9 SD	55		01.98	08.00	+ ABS						
1.9 TD	66		04.97	08.00	+ ABS						
2.0 16V	97		07.98	08.00							
2.0 16V	100		09.00	03.05							
2.0 16V	120		04.97	08.00							
2.0 HDi 110	80		05.01	03.05							
2.0 HDi 90	66		02.99	03.05							
	1.4 i	55		04.97	08.00	- ABS	24.3220-1617.3	020244		RzR 20,64	BDX
	1.5 D	42		04.97	08.00	- ABS					
	1.6 i	65		04.97	08.00	- ABS					
	1.8 D	43		04.97	08.00	- ABS					
	1.8 i	66		04.97	08.00	- ABS					
	1.8 i	74		04.97	08.00	- ABS / -					
	1.8 TD	66		10.97	08.00	- ABS					
	1.9 D	50		04.97	08.00	- ABS					
	1.9 D	51		07.98	08.00	- ABS					
	1.4 i	55		04.97	08.00	+ ABS					
	1.5 D	42		04.97	08.00	+ ABS					
	1.6 i	65		04.97	08.00	+ ABS					
	1.8 D	43		04.97	08.00	+ ABS					
	1.8 i	66		04.97	08.00	+ ABS					
	1.8 i	74		04.97	08.00	+ ABS					
	1.8 TD	66		10.97	08.00	+ ABS					
	1.9 D	50		04.97	08.00	+ ABS					
	1.9 D	51		07.98	08.00	+ ABS					
	1.9 SD	55		01.98	08.00	+ ABS					
	1.9 TD	66		04.97	08.00	+ ABS					
1.4 i	55	ORGA 08728	09.00								
1.9 D	51	ORGA 08728	09.00								
1.4 HDi 70	50		01.03	03.05							
1.4 i	55	ORGA 08729		03.05							
1.9 D	51	ORGA 08729		03.05							
	1.4 HDi 70	50		01.03	03.05		24.3727-0322.2	580322		L=1591	
	1.4 i	55		04.97	03.05						
	1.5 D	42		04.97	08.00						
	1.6 i	65		04.97	08.00						
	1.8 D	43		04.97	08.00						
	1.8 i	66		04.97	08.00						
	1.8 i	74		04.97	08.00	-					
	1.8 TD	66		10.97	08.00						
	1.9 D	50		04.97	08.00						
	1.9 D	51		07.98	03.05						
	1.9 SD	55		01.98	08.00						
	1.9 TD	66		04.97	08.00						
	1.6 16V	80		09.00	03.05						
	1.8 16V	81		04.97	08.00						
	1.8 i	74		04.97	08.00	+					
	2.0 16V	97		07.98	08.00						
	2.0 16V	100		09.00	03.05						
	2.0 16V	120		04.97	08.00						
	2.0 HDi 110	80		05.01	03.05						
	2.0 HDi 90	66		02.99	03.05						
	1.4 i	55		04.97	03.05		24.3728-0332.2	590332		L=625	
	1.5 D	42		04.97	08.00						
	1.6 16V	80		09.00	03.05	- Fahrschule ³⁾					
	1.6 i	65		04.97	08.00						
	1.8 16V	81		04.97	08.00						
	1.8 D	43		04.97	08.00						
	1.8 i	66		04.97	08.00						
	1.9 D	50		04.97	08.00						
	1.9 D	51		07.98	08.00						
	1.9 SD	55		01.98	08.00						
1.9 TD	66		04.97	08.00							
2.0 16V	97		07.98	08.00							
2.0 16V	120		04.97	08.00							

1) + cast iron / + ghisa / + fonte grise / + fundición de gris
 2) + aluminium / + alluminio / + aluminium / + aluminio
 3) - driving school / - scuola guida / - auto école / - autoescuela

									
CITROEN XSARA (N1) Limousine (97-05)									
	1.6 16V	80		09.00	03.05	+ Fahrschule ¹⁾	24.3728-0839.2	590839	L=906, + AUT
	2.0 16V	100		09.00	03.05				
	2.0 HDi 110	80		05.01	03.05				
	2.0 HDi 90	66		09.00	03.05				
CITROEN XSARA (N2) Kombi (97-05)									
	1.4 i	55		10.97	08.00		03.7750-9302.4	300116	- ABS 9" ATE
	1.5 D	42		10.97	08.00				
	1.6 i	65		10.97	08.00				
	1.8 D	43		10.97	08.00				
	1.9 D	50		10.97	08.00				
	1.9 D	51		07.98	08.00				
	1.9 SD	55		01.98	08.00				
	1.9 TD	66		10.97	08.00				
	2.0 HDi 90	66		02.99	08.00				
	1.4 HDi 70	50		01.03	08.05		03.7853-0902.4	300150	+ ABS 9" ATE
	1.4 i	55 ORGA 09002		08.05					
	1.6 16V	80 ORGA 09002		08.05					
	1.9 D	51 ORGA 09002		08.05					
	2.0 16V	100 ORGA 09002		08.05					
	2.0 HDi 110	80 ORGA 09002		08.05					
	2.0 HDi 90	66 ORGA 09002		08.05					
	1.4 i	55		10.97	08.00		03.2122-1356.3	010529	- ABS THz 22,20 ATE
	1.5 D	42		10.97	08.00				
	1.6 i	65		10.97	08.00				
	1.8 D	43		10.97	08.00				
	1.9 D	50		10.97	08.00				
	1.4 i	55	ORGA 09001	10.97	08.00		24.2123-1714.3	010587	- ABS THz 23,81 BDX
	1.5 D	42		10.97	08.00		24.2123-1715.3	010520	+ ABS THz 23,81 BDX
	1.6 16V	80	ORGA 09001	09.00					
	1.6 i	65		10.97	08.00				
	1.8 16V	81		10.97	08.00				
	1.8 D	43		10.97	08.00				
	1.8 i	66		10.97	08.00				
	1.8 i	74		10.97	08.00				
	1.9 D	50		10.97	08.00				
	1.9 SD	55		01.98	08.00				
	1.9 TD	66		10.97	08.00				
	2.0 16V	97		07.98	08.00				
	2.0 16V	100	ORGA 09001	09.00					
	2.0 HDi 110	80	ORGA 09001	05.01					
	2.0 HDi 90	66	ORGA 09001	09.98					
	1.4 HDi 70	50		01.03	08.05		03.2123-2781.3	010631	- ABS THz 23,81 ATE
	1.4 i	55 ORGA 09002		08.05			03.2123-2721.3	010632	- ESP THz 23,81 ATE
	1.6 16V	80 ORGA 09002		08.05					
	1.9 D	51 ORGA 09002		08.05					
	2.0 16V	100 ORGA 09002		08.05					
	2.0 HDi 110	80 ORGA 09002		08.05					
	2.0 HDi 90	66 ORGA 09002		08.05					
	1.4 HDi 70	50		01.03	08.05		03.2123-2761.3	010886	+ ESP THz 23,81 ATE
	1.4 i	55 ORGA 09065		08.05					
	1.6 16V	80 ORGA 09065		08.05					
	1.9 D	51 ORGA 09065		08.05					
	2.0 16V	100 ORGA 09065		08.05					
	2.0 HDi 110	80 ORGA 09065		08.05					
	2.0 HDi 90	66 ORGA 09065		08.05					
	1.4 i	55		10.97	08.00	- ABS	11.3481-9833.2	220561	<input checked="" type="checkbox"/> D=48, - Halter ATE
	1.5 D	42		10.97	08.00	- ABS	11.3481-9834.2	220562	<input checked="" type="checkbox"/> D=48, - Halter ATE
	1.6 i	65		10.97	08.00	- ABS	24.3481-9833.5	240479	<input checked="" type="checkbox"/> D=48, - Halter ATE
	1.8 D	43		10.97	08.00	- ABS	24.3481-9834.5	240480	<input checked="" type="checkbox"/> D=48, - Halter ATE
	1.9 D	50		10.97	08.00	- ABS	11.0441-4811.2	250024	<input checked="" type="checkbox"/> Dichtungssatz ATE
	1.9 D	51		07.98	08.00	- ABS	11.0101-5407.2	260011	<input checked="" type="checkbox"/> Hülzensatz ATE
							11.8171-0008.1	990049	<input checked="" type="checkbox"/> Führungsbolzen ATE
							11.8116-0129.1	390591	<input checked="" type="checkbox"/> Halterfeder ATE
	1.4 i	55		10.97	08.00	+ ABS	24.3541-1767.5	240237	<input checked="" type="checkbox"/> D=54, - Halter BOS
	1.5 D	42		10.97	08.00	+ ABS	24.3541-1768.5	240238	<input checked="" type="checkbox"/> D=54, - Halter BOS
	1.6 i	65		10.97	08.00	+ ABS	24.3541-1757.7	220483	<input checked="" type="checkbox"/> D=54, - Halter TRW
	1.8 16V	81		10.97	08.00		24.3541-1758.7	220484	<input checked="" type="checkbox"/> D=54, - Halter TRW
	1.8 D	43		10.97	08.00	+ ABS			
	1.8 i	66		10.97	08.00				
	1.8 i	74		10.97	08.00				
	1.9 D	50		10.97	08.00	+ ABS			
	1.9 D	51		07.98	08.00				
	1.9 SD	55		01.98	08.00				
	1.9 TD	66		10.97	08.00				
	2.0 16V	97		07.98	08.00				
	2.0 HDi 90	66		09.98	08.00				
	1.4 HDi 70	50		01.03	08.05		24.3541-1771.5	240239	<input checked="" type="checkbox"/> D=54, - Halter BOS
	1.4 i	55		09.00	08.05		24.3541-1772.5	240240	<input checked="" type="checkbox"/> D=54, - Halter BOS
	1.6 16V	80		09.00	08.05				
	1.9 D	51		09.00	08.05				
	2.0 HDi 90	66		09.00	08.05				
	2.0 16V	100 ORGA 09185		08.05			24.3541-1761.5	240233	<input checked="" type="checkbox"/> D=54, - Halter BOS
	2.0 HDi 110	80 ORGA 09185		08.05			24.3541-1762.5	240234	<input checked="" type="checkbox"/> D=54, - Halter BOS

¹⁾ + driving school / + scuola guida / + auto école / + autoescuela



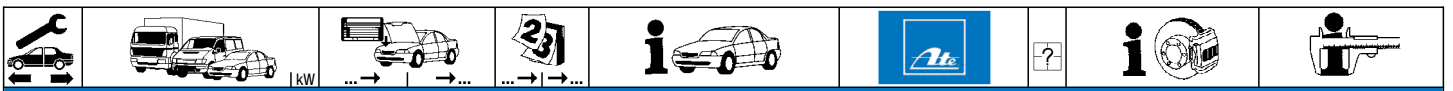

CITROEN XSARA (N2) Kombi (97-05)

	1.4 i	55	ORGA 08091	10.97		24.5111-0438.3	330568	2		L=445
	1.4 i	55	ORGA 08092			24.5111-0460.3	330603	2		L=460
	1.5 D	42	ORGA 09470	10.97	08.00					
	1.6 16V	80	ORGA 09470	09.00						
	1.6 i	65		10.97	08.00					
	1.8 16V	81		10.97	08.00					
	1.8 D	43		10.97	08.00					
	1.8 i	66		10.97	08.00					
	1.8 i	74		10.97	08.00					
	1.9 D	50		10.97	08.00					
	1.9 D	51	ORGA 09470	07.98						
	1.9 SD	55		01.98	08.00					
	1.9 TD	66		10.97	08.00					
	2.0 16V	97		07.98	08.00					
	2.0 16V	100	ORGA 09470	09.00						
	2.0 16V	100	ORGA 09184	09.00						
	2.0 HDi 110	80	ORGA 09470	05.01						
	2.0 HDi 110	80	ORGA 09184	05.01						
	2.0 HDi 90	66	ORGA 09470	09.98						
	1.4 HDi 70	50		01.03	08.05	24.5111-0460.3	330603	2		L=460
	1.4 i	55	ORGA 09471		08.05					
	1.6 16V	80	ORGA 09471		08.05					
	1.9 D	51	ORGA 09471		08.05					
	2.0 16V	100	ORGA 09185		08.05 + ESP					
	2.0 16V	100	ORGA 09471		08.05 - ESP					
	2.0 HDi 110	80	ORGA 09185		08.05 + ESP					
	2.0 HDi 110	80	ORGA 09471		08.05 - ESP					
	2.0 HDi 90	66	ORGA 09471		08.05					
	1.4 i	55		10.97	08.00	24.5228-0195.3	330469	2		L=202
	1.5 D	42		10.97	08.00					
	1.6 i	65		10.97	08.00					
	1.8 D	43		10.97	08.00					
	1.8 i	66		10.97	08.00					
	1.8 i	74		10.97	08.00					
	1.9 D	50		10.97	08.00					
	1.9 D	51		07.98	08.00					
	1.9 SD	55		01.98	08.00					
	1.9 TD	66		10.97	08.00					
	1.4 HDi 70	50		01.03	08.05	24.5228-0195.3	330469		<input type="checkbox"/>	L=202
	1.4 i	55		09.00	08.05	24.5228-0245.3	330531		<input type="checkbox"/>	L=245
	1.4 i	55		10.97	08.00					
	1.5 D	42		10.97	08.00					
	1.6 16V	80		09.00	08.05					
	1.6 i	65		10.97	08.00					
	1.6 16V	81		10.97	08.00					
	1.8 D	43		10.97	08.00					
	1.8 i	66		10.97	08.00					
	1.8 i	74		10.97	08.00					
	1.9 D	50		10.97	08.00					
	1.9 D	51		09.00	08.05					
	1.9 D	51		07.98	08.00					
	1.9 SD	55		10.97	08.00					
	1.9 TD	66		10.97	08.00					
	2.0 16V	97		07.98	08.00					
	2.0 16V	100		09.00	08.05					
	2.0 HDi 110	80		05.01	08.05					
	2.0 HDi 90	66		09.98	08.05					
	1.4 i	55		10.97	08.00	24.3220-1702.3	020375			Rz 20,64 BDX
	1.5 D	42		10.97	08.00					
	1.6 i	65		10.97	08.00					
	1.8 D	43		10.97	08.00					
	1.9 D	50		10.97	08.00					
	1.9 D	51		07.98	08.00					
	1.4 HDi 70	50		01.03	08.05	24.3222-1714.3	020432			Rz 22,00 BDX
	1.4 i	55		09.00	08.05					
	1.4 i	55		10.97	08.00					
	1.5 D	42		10.97	08.00					
	1.6 i	65		10.97	08.00					
	1.8 D	43		10.97	08.00					
	1.8 i	66		10.97	08.00					
	1.8 i	74		10.97	08.00					
	1.9 D	50		10.97	08.00					
	1.9 D	51		09.00	08.05					
	1.9 D	51		07.98	08.00					
	1.9 SD	55		01.98	08.00					
	1.9 TD	66		10.97	08.00					
	1.4 HDi 70	50		01.03	08.05	24.3727-0337.2	580337		<input type="checkbox"/>	L=1610
	1.4 i	55		10.97	08.05	24.3727-0338.2	580338		<input type="checkbox"/>	L=1520
	1.5 D	42		10.97	08.00					
	1.6 i	65		10.97	08.00					
	1.8 D	43		10.97	08.00					
	1.8 i	66		10.97	08.00					
	1.8 i	74		10.97	08.00					
	1.9 D	50		10.97	08.00					
	1.9 D	51		07.98	08.05					
	1.9 SD	55		01.98	08.00					



CITROEN XSARA (N2) Kombi (97-05)

	1.9 TD	66		10.97	08.00		24.3727-0337.2	580337	<input type="checkbox"/>		L=1610
							24.3727-0338.2	580338	<input type="checkbox"/>		L=1520
	1.6 16V	80		09.00	08.05		24.3727-0326.2	580326	<input type="checkbox"/>		L=1635
	1.8 16V	81		10.97	08.00		24.3727-0327.2	580327	<input type="checkbox"/>		L=1545
	1.8 i	74		10.97	08.00 + BR						
	2.0 16V	97		07.98	08.00						
	2.0 16V	100		09.00	08.05						
	2.0 HDi 110	80		05.01	08.05						
2.0 HDi 90	66		09.98	08.05							
	1.4 HDi 70	50		01.03	08.05		24.3728-0332.2	590332			L=625
	1.4 i	55		10.97	08.05						
	1.5 D	42		10.97	08.00						
	1.6 16V	80		09.00	08.05						
	1.6 i	65		10.97	08.00						
	1.8 16V	81		10.97	08.00		24.3728-0329.2	590329			L=653, + AUT
	1.8 D	43		10.97	08.00						
	1.8 i	66		10.97	08.00						
	1.9 D	50		10.97	08.00						
	1.9 SD	55		01.98	08.00						
	1.9 TD	66		10.97	08.00		24.3728-0339.2	590339			L=717, + AUT
	2.0 16V	97		07.98	08.00						
	1.9 D	50		09.00	08.05		24.3728-0839.2	590839			L=906, + AUT
	2.0 16V	100		09.00	08.05						
	2.0 HDi 110	80		05.01	08.05						
	2.0 HDi 90	66		09.00	08.05						

CITROEN XSARA (N0) Coupe (97-05)

	1.4 i	55		02.98	08.00		03.7750-9302.4	300116			9"	ATE
	1.6 i	65		02.98	08.00							
	1.8 16V	81		02.98	08.00							
	1.8 i	66		02.98	08.00							
	1.8 i	74		04.97	08.00							
	1.9 D	50		02.98	08.00							
	1.9 D	51		02.98	08.00							
	1.9 TD	66		02.98	08.00							
	2.0 HDi 90	66		02.99	08.00							
	1.4 HDi 70	50		01.03	03.05		03.7853-0902.4	300150		+ ABS	9"	ATE
1.4 i	55	ORGA 09002		03.05								
1.6 16V	80	ORGA 09002		03.05								
1.9 D	51	ORGA 09002		03.05								
2.0	97	ORGA 09002		08.00								
2.0 16V	100	ORGA 09002		03.05								
2.0 16V	120	ORGA 09002		03.05								
2.0 HDi 110	80	ORGA 09002		03.05								
2.0 HDi 90	66	ORGA 09002		03.05								
	1.4 i	55		02.98	08.00		03.2122-1356.3	010529		- ABS	THz 22,20	ATE
	1.6 i	65		02.98	08.00		24.2122-1743.3	010712		- ABS	THz 22,20	
	1.8 i	66		02.98	08.00		03.2122-1351.3	010528		+ ABS	THz 22,20	ATE
	1.8 i	74		04.97	08.00		24.2122-1733.3	010668		+ ABS	THz 22,20	BOS
	1.9 D	50		02.98	08.00							
	1.9 D	51		02.98	08.00							
	1.9 TD	66		02.98	08.00							
	2.0 HDi 90	66		02.99	08.00							
	1.4 i	55	ORGA 09001		09.00		24.2123-1714.3	010587		- ABS	THz 23,81	BDX
	1.6 16V	80	ORGA 09001		09.00		24.2123-1715.3	010520		+ ABS	THz 23,81	BDX
	1.8 16V	81		02.98	08.00							
	1.9 D	51	ORGA 09001		09.00							
	2.0	97	ORGA 09001		08.98							
	2.0 16V	100	ORGA 09001		09.00							
	2.0 16V	120	ORGA 09001		02.98							
	2.0 HDi 110	80	ORGA 09001		05.01							
2.0 HDi 90	66	ORGA 09001		09.00								
1.4 HDi 70	50		01.03	03.05		03.2123-2781.3	010631		- ABS	THz 23,81	ATE	
1.4 i	55	ORGA 09002		03.05		03.2123-2721.3	010632		+ ABS	THz 23,81	ATE	
1.6 16V	80	ORGA 09002		03.05								
1.9 D	51	ORGA 09002		03.05								
2.0	97	ORGA 09002		08.00								
2.0 16V	100	ORGA 09002		03.05								
2.0 16V	120	ORGA 09002		03.05								
2.0 HDi 110	80	ORGA 09002		03.05								
2.0 HDi 90	66	ORGA 09002		03.05								
1.4 HDi 70	50		01.03	03.05		03.2123-2761.3	010886		+ ESP	THz 23,81	ATE	
1.4 i	55	ORGA 09065		03.05								
1.6 16V	80	ORGA 09065		03.05								
1.9 D	51	ORGA 09065		03.05								
2.0	97	ORGA 09065		08.00								
2.0 16V	100	ORGA 09065		03.05								
2.0 16V	120	ORGA 09065		03.05								
2.0 HDi 110	80	ORGA 09065		03.05								
2.0 HDi 90	66	ORGA 09065		03.05								
	1.4 i	55		02.98	08.00	- ABS	24.3481-1741.5	240245	<input type="checkbox"/>		D=48, - Halter	BOS
							24.3481-1742.5	240246	<input type="checkbox"/>		D=48, - Halter	BOS





CITROEN XSARA (N0) Coupe (97-05)

	1.9 TD	66	ORGA 08210	02.98	03.10	+ ABS	24.3220-1711.3	020409	+ GG ¹⁾	Rz 20,64	TRW
	1.9 TD	66		02.98	08.00	- ABS					
	1.4 i	55	ORGA 08211		08.00	+ ABS	24.3220-1717.3	020430	+ ALU ²⁾	Rz 20,64	TRW
	1.6 i	65	ORGA 08211		08.00	+ ABS					
	1.8 i	66	ORGA 08211		08.00	+ ABS					
	1.8 i	74		04.97	08.00	+ ABS/ - ^{BR}					
	1.9 D	50		02.98	08.00	+ ABS					
	1.9 D	51		02.99	08.00	+ ABS					
	1.9 TD	66	ORGA 08211		08.00	+ ABS					
	1.4 i	55	ORGA 08728	09.00			24.3220-1711.3	020409	+ GG ¹⁾	Rz 20,64	TRW
1.9 D	51	ORGA 08728	09.00								
	1.4 HDi 70	50		01.03	03.05		24.3220-1717.3	020430	+ ALU ²⁾	Rz 20,64	TRW
	1.4 i	55	ORGA 08729		03.05						
	1.9 D	51	ORGA 08729		03.05						
	1.9 D	51			03.05						
	1.4 HDi 70	50		01.03	03.05		24.3727-0322.2	580322	<input type="checkbox"/>	L=1591	
	1.4 i	55		02.98	03.05		24.3727-0323.2	580323	<input type="checkbox"/>	L=1500	
	1.6 i	65		02.98	08.00						
	1.8 i	66		02.98	08.00						
	1.8 i	74		04.97	08.00	- ^{BR}					
	1.9 D	50		02.98	08.00						
	1.9 D	51		02.99	03.05						
	1.9 TD	66		02.98	08.00						
	1.6 16V	80		09.00	03.05		24.3727-0326.2	580326	<input type="checkbox"/>	L=1635	
	1.8 16V	81		02.98	08.00		24.3727-0327.2	580327	<input type="checkbox"/>	L=1545	
	1.8 i	74		04.97	08.00	+ ^{BR}					
2.0	97		08.98	08.00							
2.0 16V	100		09.00	03.05							
2.0 16V	120		02.98	03.05							
2.0 HDi 110	80		05.01	03.05							
2.0 HDi 90	66		02.99	03.05							
	1.4 HDi 70	50		01.03	03.05		24.3728-0332.2	590332		L=625	
	1.4 i	55		02.98	03.05						
	1.6 16V X/SX/VTR	80		09.00	03.05						
	1.6 i	65		02.98	08.00						
	1.8 i	66		02.98	08.00		24.3728-0329.2	590329		L=653, + AUT	
	1.9 D	50		02.98	08.00						
	1.9 D	51		02.99	08.00						
	1.6 16V VTS	80		09.00	03.05		24.3728-0339.2	590339		L=717, + AUT	
	1.9 TD	66		02.98	08.00						
	2.0 16V	120		02.98	03.05						
1.9 D	51		09.00	03.05		24.3728-0839.2	590839		L=906, + AUT		
2.0	97		08.98	08.00							
2.0 16V	100		09.00	03.05							
2.0 HDi 110	80		05.01	03.05							
2.0 HDi 90	66		09.00	03.05							

CITROEN XSARA Picasso (N68) (00-10)

	1.6	65		06.00	03.10		24.2123-1714.3	010587	- ABS	THz 23,81	BDX
	1.6	67		06.02	03.10						
	1.6	70		09.00	03.10						
	1.6 16V			09.05	03.10						
	1.6 HDi 110	80		05.04	03.10						
	1.6 HDi 90	66		09.05	03.10						
	1.8 16V	85		02.00	03.10						
	2.0 16V	100		01.03	03.10						
	2.0 HDi			06.00	03.10						
	1.6	65	ORGA 0882078		03.10		03.2123-2781.3	010631	- ABS	THz 23,81	ATE
	1.6	67	ORGA 08820		03.10						
1.6	70	ORGA 0882078		03.10							
1.6 16V			09.05	03.10							
1.6 HDi 110	80		05.04	03.10							
1.6 HDi 90	66		09.05	03.10							
1.8 16V	85	ORGA 0882078		03.10							
2.0 16V	100		01.03	03.10							
2.0 HDi		ORGA 0882078		03.10							
	1.6	65	ORGA 11340	06.00			24.3541-1757.7	220483	<input type="checkbox"/>	D=54, - Halter	TRW
	1.6	67	ORGA 11340	06.02			24.3541-1758.7	220484	<input type="checkbox"/>	D=54, - Halter	TRW
	1.6	70	ORGA 11340	09.00							
	1.6 16V		ORGA 11340	09.05							
	1.6 HDi 110	80	ORGA 11340	05.04							
	1.6 HDi 90	66	ORGA 11340	09.05							
	1.8 16V	85	ORGA 11340	02.00							
	2.0 16V	100	ORGA 11340	01.03							
	2.0 HDi		ORGA 11340	06.00							
	1.6	65		06.00	03.10	- ESP	24.3541-1771.5	240239	<input type="checkbox"/>	D=54, - Halter	BOS
	1.6	67		06.02	03.10	- ESP	24.3541-1772.5	240240	<input type="checkbox"/>	D=54, - Halter	BOS
1.6	70		09.00	03.10	- ESP						
1.6 16V			09.05	03.10	- ESP						
1.6 HDi 110	80		05.04	03.10	- ESP						
1.6 HDi 90	66		09.05	03.10	- ESP						
1.8 16V	85		02.00	03.10	- ESP						
2.0 16V	100		01.03	03.10	- ESP/ + Schaltgetriebe ³⁾						
2.0 16V	100		01.03	03.10	+ Automatikgetriebe ⁴⁾						
2.0 HDi			06.00	03.10	- ESP						

























¹⁾ + cast iron / + ghisa / + fonte grise / + fundición de gris

²⁾ + aluminium / + alluminio / + aluminium / + aluminio













³⁾ - ESP/ + manual transm. / - ESP/+ scatola cambio velocità / - ESP/ + transmission mécanique / - ESP/ + cambio de velocidad

⁴⁾ + autom.transmission / + scatola cambio automatico / + transmission automatique / + cambio automático



												
CITROEN XSARA Picasso (N68) (00-10)												
	1.6 1.6 1.6 1.6 16V 1.6 HDi 110 1.6 HDi 90 1.8 16V 2.0 16V 2.0 HDi	65 67 70 80 66 85 100 100		06.00 06.02 09.00 09.05 05.04 09.05 02.00 01.03 01.03 06.00	03.10 03.10 03.10 03.10 03.10 03.10 03.10 03.10 03.10 03.10	+ ESP + ESP + ESP + ESP + ESP + ESP + ESP + ESP/ + Schaltgetriebe ¹⁾ + Automatikgetriebe ²⁾ + ESP	24.3541-1761.5 24.3541-1762.5	240233 240234		D=54, - Halter D=54, - Halter	BOS BOS	
	1.6 1.6 1.6 1.6 16V 1.6 HDi 110 1.6 HDi 90 1.8 16V 2.0 16V 2.0 HDi	65 67 70 80 66 85 100		06.00 06.02 09.00 09.05 05.04 09.05 02.00 01.03 06.00	03.10 03.10 03.10 03.10 03.10 03.10 03.10 03.10 03.10		24.5111-0438.3 24.5111-0460.3	330568 330603	2 2	- ESP + ESP	L=445 L=460	
	1.6 16V 1.6 HDi 110 1.6 HDi 90 1.8 16V 2.0 16V 2.0 HDi	80 66 85 100		09.05 05.04 09.05 02.00 01.03 06.00	03.10 03.10 03.10 03.10 03.10 03.10		24.3387-1711.7 24.3387-1712.7	220747 220748		D=38, - Halter D=38, - Halter	TRW TRW	
	1.6 1.6 1.6 1.8 16V 2.0 HDi	65 67 70 85	ORGA 09526 ORGA 09526 ORGA 09526 ORGA 09526 ORGA 09526	06.00 06.02 09.00 02.00 06.00			24.5229-0255.3	330581	2		L=255	
	1.6 1.6 1.6 1.6 16V 1.6 HDi 110 1.6 HDi 90 1.8 16V 2.0 16V 2.0 HDi	65 67 70 80 66 85 100	ORGA 09527 ORGA 09527 ORGA 09527 ORGA 09527 ORGA 09527 ORGA 09527	06.00 06.02 09.00 09.05 05.04 09.05 01.03 06.00	03.10 03.10 03.10 03.10 03.10 03.10 03.10 03.10		24.5246-0260.3	330782	2		L=260	
	1.6 1.6 1.6 1.8 16V 2.0 HDi	65 67 70 85		06.00 06.02 09.00 02.00 06.00	03.10 03.10 03.10 03.10 03.10		24.3222-1711.3 24.3222-1734.3	020413 020539		+ GG ³⁾ + ALU ⁴⁾	Rz 22,20 Rz 22,20	TRW TRW
	1.6 1.6 1.6 1.8 16V 2.0 16V 2.0 HDi	65 67 70 85 100		06.00 06.02 09.00 02.00 01.03 06.00	03.10 03.10 03.10 03.10 03.10 03.10		24.3727-0332.2	580332			L=1864	
	1.6 16V 1.6 HDi 110 1.6 HDi 90 1.8 16V 2.0 16V 2.0 HDi	80 66 85 100		09.05 05.04 09.05 02.00 01.03 06.00	03.10 03.10 03.10 03.10 03.10 03.10	+ Trommelbremse ⁵⁾ + Trommelbremse ⁵⁾ + Trommelbremse ⁵⁾	24.3727-0333.2 24.3727-0334.2 24.3727-0353.2 24.3727-0354.2	580333 580334 580353 580354			L=1860 L=1948 L=1860 L=1950	
	1.6 1.6 1.6 1.6 16V 1.6 HDi 110 1.6 HDi 90 1.8 16V 2.0 16V 2.0 HDi	65 67 70 80 66 85 100		06.00 06.02 09.00 09.05 05.04 09.05 02.00 01.03 06.00	03.10 03.10 03.10 03.10 03.10 03.10 03.10 03.10 03.10	- ABS - ABS - ABS - ABS - ABS - ABS - ABS - ABS - ABS	03.6582-0015.3	320227			BRL 8/1,5 (4)	ATE
	1.6 1.6 1.6 1.6 16V 1.6 HDi 110 1.6 HDi 90 1.8 16V 2.0 16V 2.0 HDi	65 67 70 80 66 85		06.00 06.02 09.00 09.05 05.04 09.05 02.00 06.00	03.10 03.10 03.10 03.10 03.10 03.10 03.10 03.10		24.3728-0330.2	590330			L=903, + AUT	
CITROEN ZX (N2) Limousine (91-97)												
	1.1 1.1 1.4 1.4 i 1.6 i 1.8 D 1.8 i 1.9 1.9 D 1.9 D 1.9 i	40 44 55 55 65 44 74 96 47 50 88		03.91 03.91 03.91 03.91 03.91 06.93 07.92 03.91 03.91 06.94 03.91	06.97 06.97 06.97 06.97 06.97 06.97 06.97 06.97 06.97 06.97 06.97 06.97	- ABS - ABS - ABS - ABS - ABS - ABS - ABS - ABS - ABS - ABS - ABS	03.7740-4002.4	300108			8"	ATE

1) + ESP/ + manual transm. / + ESP/+ scatola cambio velocità / + ESP/ + transmission mécanique / + ESP/ + cambio de velocidad
2) + autom.transmission / + scatola cambio automatico / + transmission automatique / + cambio automático
3) + cast iron / + ghisa / + fonte grise / + fundición de gris
4) + aluminium / + alluminio / + aluminium / + aluminio
5) + drum brake / + freno a tamburo / + freins à tambour / + tambores de freno
6) + disc brake / + disco freno / + disques de frein / + disco de freno

										
CITROEN ZX (N2) Limousine (91-97)										
	1.9 TD 2.0 i	66 89		07.92 07.92	06.97 - ABS 06.97 - ABS	03.7740-4002.4	300108	8"	ATE	
	1.1 1.1 1.4 1.4 i 1.6 i 1.8 16V 1.8 D 1.8 i 1.9 1.9 D 1.9 D 1.9 i 1.9 TD 2.0 i	40 44 55 55 65 81 44 74 96 47 50 88 66 89	ORGA 07125 ORGA 07125 ORGA 07125 ORGA 07125 ORGA 07125 ORGA 07125 ORGA 07125 ORGA 07125 ORGA 07125 ORGA 07125 ORGA 07125 ORGA 07125 ORGA 07125 ORGA 07125	03.91 03.91 03.91 03.91 01.96 06.93 07.92 03.91 03.91 06.94 03.91 07.92	- ABS - ABS - ABS - ABS - ABS - ABS - ABS - ABS - ABS - ABS - ABS - ABS - ABS - ABS	03.2120-2031.3 24.2120-1722.3	010106 010544	THz 20,64 THz 20,64	ATE BDX	
	1.1 1.1 1.4 1.4 i 1.6 i 1.8 16V 1.8 D 1.8 i 1.9 1.9 D 1.9 D 1.9 i 1.9 TD 2.0 i	40 ORGA 07126 44 ORGA 07126 55 ORGA 07126 55 ORGA 07126 65 ORGA 07126 81 ORGA 07126 44 ORGA 07126 74 ORGA 07126 96 ORGA 07126 47 ORGA 07126 50 ORGA 07126 88 ORGA 07126 66 ORGA 07126 89 ORGA 07126		08.93 06.97 06.97 06.97 06.97 06.97 06.97 06.97 06.97 06.97 06.97 06.97 06.97 06.97	- ABS - ABS - ABS - ABS - ABS - ABS - ABS - ABS - ABS - ABS - ABS - ABS - ABS - ABS	03.2120-4221.3	010605	THz 20,64	ATE	
	1.1 1.1 1.4 1.4 i 1.6 i 1.8 16V 1.8 D 1.8 i 1.9 1.9 D 1.9 D 1.9 i 1.9 TD 2.0 i	40 44 55 55 65 81 44 74 96 47 50 88 66 89	ORGA 07069 ORGA 07069 ORGA 07069 ORGA 07069 ORGA 07069 ORGA 07069 ORGA 07069 ORGA 07069 ORGA 07069 ORGA 07069 ORGA 07069 ORGA 07069 ORGA 07069 ORGA 07069	03.91 03.91 03.91 03.91 01.96 06.93 07.92 03.91 03.91 06.94 03.91 07.92 07.92	+ ABS + ABS + ABS + ABS + ABS + ABS + ABS + ABS + ABS + ABS + ABS + ABS + ABS + ABS	24.2122-1704.3	010423	THz 22,20		
	1.1 1.1 1.4 1.4 i 1.6 i 1.8 16V 1.8 D 1.8 i 1.9 1.9 D 1.9 D 1.9 i 1.9 TD 2.0 i	40 ORGA 07070 44 ORGA 07070 55 ORGA 07070 55 ORGA 07070 65 ORGA 07070 81 ORGA 07070 44 ORGA 07070 74 ORGA 07070 96 ORGA 07070 47 ORGA 07070 50 ORGA 07070 88 ORGA 07070 66 ORGA 07070 89 ORGA 07070		08.93 06.97 06.97 06.97 06.97 06.97 06.97 06.97 06.97 06.97 06.97 06.97 06.97 06.97	+ ABS + ABS + ABS + ABS + ABS + ABS + ABS + ABS + ABS + ABS + ABS + ABS + ABS + ABS	03.2122-1331.3	010607	THz 22,20	ATE	
	1.6 i 1.8 16V 1.8 i 1.9 1.9 i 1.9 TD 2.0 i	65 81 74 96 88 66 89		03.91 01.96 07.92 03.91 03.91 07.92 07.92	06.97 + ABS 06.97 06.97 06.97 06.97 06.97 06.97	24.3481-1615.5 24.3481-1616.5 24.0101-4806.2	240031 240032 260052	D=48, - Halter D=48, - Halter Bremsattel-Zubehör	TRW TRW TRW	
	1.8 D 1.9 D	44 47	ORGA 06049 ORGA 06049	06.93 03.91		24.3481-1609.7 24.3481-1610.7	220197 220198	D=48, + Halter D=48, + Halter	TRW TRW	
	1.1 1.1 1.4 1.4 i 1.6 i 1.8 16V 1.8 D 1.8 i 1.9 1.9 1.9 D 1.9 D 1.9 i 1.9 i 1.9 TD 1.9 TD 2.0 i 2.0 i	40 44 55 55 65 81 44 74 96 96 ORGA 06749 47 50 88 88 ORGA 06749 66 66 ORGA 06749 89 89 ORGA 06749		03.91 03.91 03.91 03.91 03.91 01.96 06.93 07.92 03.91 03.91 06.94 03.91 07.92 07.92	08.93 06.97 06.97 06.97 06.97 06.97 06.97 06.97 06.97 06.97 06.97 06.97 06.97 06.97 06.97 06.97 06.97	- ABS - ABS - ABS - ABS - ABS - ABS - ABS - ABS - ABS - ABS - ABS - ABS - ABS - ABS - ABS - ABS - ABS	24.5111-0425.3	330278	2	L=425

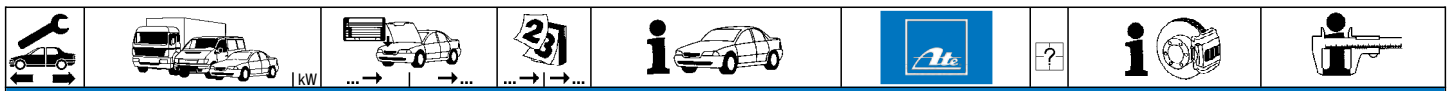

CITROEN ZX (N2) Limousine (91-97)

	1.8 16V	81		01.96	06.97 + ABS	24.5111-0438.3	330568	2		L=445
	1.9	96	ORGA 06749		06.97 + ABS					
	1.9 i	88	ORGA 06749		06.97 + ABS					
	1.9 TD	66	ORGA 06749		06.97 + ABS					
	2.0 16V	110		06.94	06.97					
	2.0 16V	112		07.92	10.94					
	2.0 16V	114		07.92	10.97					
	2.0 i	89	ORGA 06749		06.97 + ABS					
	2.0	122		09.96	10.97	24.5111-0460.3	330603	2		L=460
	2.0 16V	120		05.96	06.97					
	1.1	40		03.91	08.93	24.5228-0195.3	330469	2		L=202
	1.1	44	ORGA 09748	03.91						
	1.4	55	ORGA 06748	03.91						
	1.4 i	55	ORGA 06748	03.91						
	1.6 i	65	ORGA 06748	03.91						
	1.8 D	44	ORGA 06748	06.93						
	1.8 i	74	ORGA 06748	07.92						
	1.9 D	47	ORGA 06748	03.91						
	1.9 D	50	ORGA 06748	06.94						
		1.9	96	ORGA 06748	03.91					
1.9		96		03.91	06.97 - ABS					
1.9 i		88	ORGA 06748	03.91	+ ABS					
1.9 i		88		03.91	06.97 - ABS					
1.9 TD		66	ORGA 09748	07.92	+ ABS					
1.9 TD		66		07.92	06.97 - ABS					
2.0 16V		110	ORGA 06748	03.91	+ ABS					
2.0 16V		110		06.94	06.97 - ABS					
2.0 16V		112		07.92	10.94					
2.0 16V		114		07.92	10.97					
2.0 i		89	ORGA 06748	07.92	+ ABS					
2.0 i		89		07.92	06.97 - ABS					
	1.1	44	ORGA 06749		06.97	24.5228-0245.3	330531			L=245
	1.4	55	ORGA 06749		06.97					
	1.4 i	55	ORGA 06749		06.97					
	1.6 i	65	ORGA 06749		06.97					
	1.8 16V	81		01.96	06.97					
	1.8 D	44	ORGA 06749		06.97					
	1.8 i	74	ORGA 06749		06.97					
	1.9	96	ORGA 06749		06.97 + ABS					
	1.9 D	47	ORGA 06749		06.97					
	1.9 D	50	ORGA 06749		06.97					
	1.9 i	88	ORGA 06749		06.97 + ABS					
	1.9 TD	66	ORGA 06749		06.97 + ABS					
	2.0	122		09.96	10.97					
	2.0 16V	110	ORGA 06749		06.97 + ABS					
	2.0 16V	120		05.96	06.97					
	2.0 i	89	ORGA 06749		06.97 + ABS					
	1.1	40	ORGA 05718	03.91	- ABS	24.3220-1603.3	020230			RzR 20,64
	1.1	44	ORGA 05718	03.91	- ABS					
	1.4	55	ORGA 05718	03.91	- ABS					
	1.4 i	55	ORGA 05718	03.91	- ABS					
	1.6 i	65	ORGA 05718	03.91	- ABS					
	1.9 D	47	ORGA 05718	03.91	- ABS					
	1.9 D	50	ORGA 05718	06.94	- ABS					
	1.9 D	50	ORGA 05718	06.94	- ABS					
	1.1	40	ORGA 05719		08.93 - ABS	24.3220-1617.3	020244			RzR 20,64
	1.1	44	ORGA 05719		06.97 - ABS					
	1.4	55	ORGA 05719		06.97 - ABS					
	1.4 i	55	ORGA 05719		06.97 - ABS					
	1.6 i	65	ORGA 05719		06.97 - ABS					
	1.9 D	47	ORGA 05719		06.97 - ABS					
	1.9 D	50	ORGA 05719		06.97 - ABS					
	1.9 TD	66		07.92	06.97 - ABS					
	1.1	44	ORGA 06749		06.97 + ABS	24.3220-1711.3	020409		+ GG ²⁾	Rz 20,64
	1.4	55	ORGA 06749		06.97 + ABS					
	1.4 i	55	ORGA 06749		06.97 + ABS					
	1.6 i	65	ORGA 06749		06.97 + ABS					
	1.8 16V	81		01.96	06.97					
	1.8 D	44	ORGA 06749		06.97 + ABS					
	1.8 i	74	ORGA 06749		06.97 + ABS					
	1.9 D	47	ORGA 06749		06.97 + ABS					
1.9 D	50	ORGA 06749		06.97 + ABS						
1.9 TD	66	ORGA 06749		06.97 + ABS						
	1.1	40		03.91	08.93	24.3727-0307.2	580307			L=1585
	1.1	44	ORGA 07330	03.91						
	1.4	55	ORGA 07330	03.91						
	1.4 i	55	ORGA 07330	03.91						
	1.6 i	65	ORGA 07330	03.91						
	1.8 16V	81	ORGA 07330	01.96						
	1.8 D	44	ORGA 07330	06.93						
	1.8 i	74	ORGA 07330	07.92						
	1.9	96	ORGA 07330	03.91						
	1.9 D	47	ORGA 07330	03.91						
	1.9 D	50	ORGA 07330	06.94						
	1.9 i	88	ORGA 07330	03.91						
1.9 TD	66	ORGA 07330	07.92							
2.0	122		09.96	10.97						

¹⁾ notice length / attenzione lunghezza / faire attention longueur / atención largo

²⁾ + cast iron / + ghisa / + fonte grise / + fundición de gris

³⁾ + RA drum brake / + P freno a tamburo / + frein à tambour essieu AR / + ET-tambores de freno

⁴⁾ + RA disc brake / + P disco freno / + frein à disque essieu AR / + ET-disco de freno



CITROEN ZX (N2) Limousine (91-97)



































	2.0 16V	110	ORGA 07330	06.94		24.3727-0307.2	580307	<input type="checkbox"/> + HA-Trommelbremse 1)	L=1585
	2.0 16V	112		07.92	10.94	24.3727-0306.2	580306	<input type="checkbox"/> + HA-Trommelbremse 1)	L=1493
	2.0 16V	114	ORGA 07330	07.92		24.3727-0304.2	580304	<input type="checkbox"/> + HA-Scheibenbremse 2)	L=1612
	2.0 16V	120	ORGA 07330	05.96		24.3727-0305.2	580305	<input type="checkbox"/> + HA-Scheibenbremse 2)	L=1533
	2.0 i	89	ORGA 07330	03.91					
	1.1	44	ORGA 07331		06.97	24.3727-0316.2	580316	<input type="checkbox"/> + HA-Trommelbremse 1)	L=1582
	1.4	55	ORGA 07331		06.97	24.3727-0317.2	580317	<input type="checkbox"/> + HA-Trommelbremse 1)	L=1488
	1.4 i	55	ORGA 07331		06.97				
	1.6 i	65	ORGA 07331		06.97				
	1.8 16V	81	ORGA 07331		06.97				
	1.8 D	44	ORGA 07331		06.97				
	1.8 i	74	ORGA 07331		06.97				
	1.9	96	ORGA 07331		06.97				
	1.9 D	47	ORGA 07331		06.97				
	1.9 D	50	ORGA 07331		06.97				
	1.9 i	88	ORGA 07331		06.97				
	1.9 TD	66	ORGA 07331		06.97				
	2.0	122	ORGA 07331		09.96				
	2.0 16V	110	ORGA 07331		06.97				
	2.0 16V	114	ORGA 07331		10.97				
	2.0 16V	120	ORGA 07331		06.97				
	2.0 i	89	ORGA 07331		06.97				
	1.1	40		03.91	08.93	24.3728-0305.2	590305		L=606
	1.1	44	ORGA 06567	03.91					
	1.4	55	ORGA 06567	03.91					
	1.4 i	55	ORGA 06567	03.91					

CITROEN ZX (N2) Kombi (93-98)

	1.4 i	55	ORGA 07070		10.97	- ABS	03.2122-1331.3	010607		THz 22,20	ATE
	1.6 i	65	ORGA 07070		10.97	- ABS					
	1.8 16V	81		01.96	02.98	- ABS					
	1.8 D	44	ORGA 07070		10.97	- ABS					
	1.8 i	74	ORGA 07070		10.97	- ABS					
	1.9 D	47	ORGA 07070		10.97	- ABS					
	1.9 D	50	ORGA 07070		10.97	- ABS					
	1.9 TD	66	ORGA 07070		10.97	- ABS					
	1.4 i	55	ORGA 07069	10.93		+ ABS	24.2122-1704.3	010423		THz 22,20	
	1.6 i	65	ORGA 07069	10.93		+ ABS					
	1.8 16V	81	ORGA 07069	01.96		+ ABS					
	1.8 D	44	ORGA 07069	10.93		+ ABS					
	1.8 i	74	ORGA 07069	10.93		+ ABS					
	1.9 D	47	ORGA 07069	10.93		+ ABS					
	1.9 D	50	ORGA 07069	06.94		+ ABS					
	1.9 TD	66	ORGA 07069	10.93		+ ABS					
	1.4 i	55	ORGA 07070		10.97	+ ABS	03.2122-1331.3	010607		THz 22,20	ATE
	1.6 i	65	ORGA 07070		10.97	+ ABS					
	1.8 16V	81	ORGA 07070		02.98	+ ABS					
	1.8 D	44	ORGA 07070		10.97	+ ABS					
	1.8 i	74	ORGA 07070		10.97	+ ABS					
	1.9 D	47	ORGA 07070		10.97	+ ABS					
	1.9 D	50	ORGA 07070		10.97	+ ABS					
	1.9 TD	66	ORGA 07070		10.97	+ ABS					
	1.6 i	65		10.93	10.97	+ ABS	24.3481-1615.5	240031	<input type="checkbox"/>	D=48, - Halter	TRW
	1.8 16V	81		01.96	02.98		24.3481-1616.5	240032	<input type="checkbox"/>	D=48, - Halter	TRW
	1.8 D	44		10.93	10.97		24.0101-4806.2	260052		Bremssattel-Zubehör	TRW
	1.8 i	74		10.93	10.97						
	1.9 D	47		10.93	10.97						
	1.9 TD	66		06.94	10.97						
	1.4 i	55		10.93	10.97		24.5111-0425.3	330278	2		L=425
	1.6 i	65		10.93	10.97						
	1.8 16V	81		01.96	02.98	- ABS					
	1.8 D	44		10.93	10.97						
	1.8 i	74		10.93	10.97						
	1.9 D	47		10.93	10.97						
	1.9 D	50		06.94	10.97						
	1.9 TD	66	ORGA 06748	10.93							
	1.8 16V	81		01.96	02.98	+ ABS	24.5111-0438.3	330568	2		L=445
1.9 TD	66	ORGA 06749		10.97	+ ABS						
	1.4 i	55		10.93	10.97		24.5228-0245.3	330531	<input type="checkbox"/>		L=245
	1.6 i	65		10.93	10.97		24.5228-0195.3	330469	<input type="checkbox"/>		L=202
	1.8 16V	81		01.96	02.98						
	1.8 D	44		10.93	10.97						
	1.8 i	74		10.93	10.97						
	1.9 D	47		10.93	10.97						
	1.4 i	55		10.93	10.97		24.3220-1702.3	020375			Rz 20,64
	1.6 i	65		10.93	10.97						
	1.8 16V	81		01.96	02.98						
	1.8 D	44		10.93	10.97						
	1.8 i	74		10.93	10.97						
	1.9 D	47		10.93	10.97						
1.9 D	50		06.94	10.97							
1.9 TD	66		10.93	10.97							

1) + RA drum brake / + P freno a tamburo / + frein à tambour essieu AR / + ET-tambores de freno
 2) + RA disc brake / + P disco freno / + frein à disque essieu AR / + ET-disco de freno



















											
CITROEN ZX (N2) Kombi (93-98)											
	1.4 i	55	ORGA 07330	10.93		24.3727-0313.2	580313	1  + HA-Trommelbremse ¹⁾	L=1621/1531		
	1.6 i	65	ORGA 07330	10.93		24.3727-0304.2	580304	 + HA-Scheibenbremse ²⁾	L=1612		
	1.8 16V	81	ORGA 07330	01.96		24.3727-0305.2	580305	 + HA-Scheibenbremse ²⁾	L=1533		
	1.8 D	44	ORGA 07330	10.93							
	1.8 i	74	ORGA 07330	10.93							
	1.9 D	47	ORGA 07330	10.93							
	1.9 D	50	ORGA 07330	06.94							
	1.9 TD	66	ORGA 07330	10.93							
	1.4 i	55	ORGA 07331		10.97		24.3727-0320.2	580320	 + HA-Trommelbremse ¹⁾	L=1610	
	1.6 i	65	ORGA 07331		10.97		24.3727-0321.2	580321	 + HA-Trommelbremse ¹⁾	L=1520	
1.8 16V	81	ORGA 07331		02.98							
1.8 D	44	ORGA 07331		10.97							
1.8 i	74	ORGA 07331		10.97							
1.9 D	47	ORGA 07331		10.97							
1.9 D	50	ORGA 07331		10.97							
1.9 TD	66	ORGA 07331		10.97							
	1.4 i	55	ORGA 06567	10.93		24.3728-0305.2	590305		L=606		
DACIA DOKKER (12-)											
	1.5 dCi 75	55		11.12	- ESP	24.3541-1849.5	240707		D=54, - Halter	TRW	
	1.5 dCi 90	66		11.12	- ESP	24.3541-1850.5	240708		D=54, - Halter	TRW	
	1.6	61		11.12	- ESP	24.0101-5407.2	260140		Bremssattel-Zubehör		
	1.6	75		04.15	- ESP						
	1.6 LPG	75		04.15	- ESP						
	1.2 TCe 115	85		11.12		11.9541-9950.2	220843		D=54, - Halter	ATE	
	1.5 dCi 75	55		11.12	+ ESP	11.9541-9951.2	220844		D=54, - Halter	ATE	
	1.5 dCi 90	66		11.12	+ ESP	11.8170-0002.1	260110		Halter	ATE	
	1.6	61		11.12	+ ESP	11.8116-0356.1	390586	2	Halterfeder	ATE	
	1.6	75		04.15	+ ESP						
1.6 LPG	75		04.15	+ ESP							
	1.2 TCe 115	85		11.12		24.3222-1729.3	020526		Rz 22,20		
	1.5 dCi 75	55		11.12							
	1.5 dCi 90	66		11.12							
	1.6	61		11.12							
	1.6	75		04.15							
	1.6 LPG	75		04.15							
	DACIA DOKKER Express (12-)										
		1.5 dCi	55		12.12	- ESP	24.3541-1849.5	240707		D=54, - Halter	TRW
		1.5 dCi	66		12.12	- ESP	24.3541-1850.5	240708		D=54, - Halter	TRW
		1.6	61		12.12	- ESP	11.9541-9950.2	220843		D=54, - Halter	ATE
1.6		75		04.15	- ESP	11.9541-9951.2	220844		D=54, - Halter	ATE	
1.6 LPG		75		04.15	- ESP	11.8170-0002.1	260110		Halter	ATE	
						11.8116-0356.1	390586	2	Halterfeder	ATE	
	1.2 TCe 115	85		12.12		11.9541-9950.2	220843		D=54, - Halter	ATE	
	1.5 dCi	55		12.12	+ ESP	11.9541-9951.2	220844		D=54, - Halter	ATE	
	1.5 dCi	66		12.12	+ ESP	11.8170-0002.1	260110		Halter	ATE	
	1.6	61		12.12	+ ESP	11.8116-0356.1	390586	2	Halterfeder	ATE	
	1.6	75		04.15	+ ESP						
	1.6 LPG	75		04.15	+ ESP						
DACIA DUSTER (HS_) (10-)											
	1.5 dCi	63		04.10	10.13 + ABS	03.7853-4602.4	300302		9"	ATE	
	1.5 dCi	66		10.10	10.13 + ABS						
	1.5 dCi	79		06.10	10.13 + ABS						
	1.5 dCi 4x4	66		10.10	10.13 + ABS						
	1.5 dCi 4x4	79		06.10	10.13 + ABS						
	1.5 dCi 4x4	80		08.13	+ ABS						
	1.5 dCi 4x4	81		10.10	10.13 + ABS						
	1.6 16V	77		04.10	10.13 + ABS						
	1.6 16V 4x4	77		06.10	10.13 + ABS						
	1.6 16V Flexifuel	77		04.11	10.13 + ABS						
	1.6 16V LPG	77		04.11	10.13 + ABS						
		1.5 dCi	63		04.10	10.13 + ABS/ - ESP	03.2122-2031.3	010938		THz 22,20	ATE
		1.5 dCi	66		10.10	10.13 + ABS/ - ESP					
		1.5 dCi	79		06.10	10.13 + ABS/ - ESP					
		1.5 dCi 4x4	66		10.10	10.13 + ABS/ - ESP					
1.5 dCi 4x4		79		06.10	10.13 + ABS/ - ESP						
1.5 dCi 4x4		80		08.13	+ ABS/ - ESP						
1.5 dCi 4x4		81		10.10	10.13 + ABS/ - ESP						
1.6 16V		77		04.10	10.13 + ABS/ - ESP						
1.6 16V 4x4		77		06.10	10.13 + ABS/ - ESP						
1.6 16V Flexifuel		77		04.11	10.13 + ABS/ - ESP						
1.6 16V LPG	77		04.11	10.13 + ABS/ - ESP							
	1.5 dCi	63		04.10	10.13 + ABS/ + ESP	03.2122-2261.3	010964		THz 22,20	ATE	
	1.5 dCi	66		10.10	10.13 + ABS/ + ESP						
	1.5 dCi	79		06.10	10.13 + ABS/ + ESP						
	1.5 dCi 4x4	66		10.10	10.13 + ABS/ + ESP						
	1.5 dCi 4x4	66		10.10	10.13 + ABS/ + ESP						

1) + RA drum brake / + P freno a tamburo / + frein à tambour essieu AR / + ET-tambores de freno

2) + RA disc brake / + P disco freno / + frein à disque essieu AR / + ET-disco de freno

3) - increased payload / - carico utile maggiorato / - charge utile augmentée / - incremento de carga

4) + increased payload / + carico utile maggiorato / + charge utile augmentée / + incremento de carga

									
DACIA DUSTER (HS_) (10-)									
	1.5 dCi 4x4	79	06.10	10.13	+ ABS/ + ESP	03.2122-2261.3	010964	Thz 22,20	ATE
	1.5 dCi 4x4	80	08.13		+ ABS/ + ESP				
	1.5 dCi 4x4	81	10.10	10.13	+ ABS/ + ESP				
	1.6 16V	77	04.10	10.13	+ ABS/ + ESP				
	1.6 16V 4x4	77	06.10	10.13	+ ABS/ + ESP				
	1.6 16V LPG	77	04.11	10.13	+ ABS/ + ESP				
	1.6 16V LPG	77	04.11	10.13	+ ABS/ + ESP				
	1.5 dCi	63	04.10		- ABS	24.3541-1849.5	240707	D=54, - Halter	TRW
	1.5 dCi	66	10.10		- ABS	24.3541-1850.5	240708	D=54, - Halter	TRW
	1.5 dCi	79	06.10		- ABS				
	1.5 dCi	80	09.13		- ABS				
	1.6 16V	77	04.10		- ESP				
	1.6 16V 4x4	77	06.10		- ESP				
	1.6 16V Flexifuel	77	04.11		- ESP				
	1.6 16V LPG	77	04.11		- ESP				
	1.6 SCe 115	84	06.15		- ESP				
	1.6 SCe 115 4x4	84	06.15		- ESP				
	1.2 TCe 125	92	09.13			11.9541-9950.2	220843	D=54, - Halter	ATE
	1.2 TCe 125 4x4	92	06.15			11.9541-9951.2	220844	D=54, - Halter	ATE
	1.5 dCi	63	04.10		+ ABS	11.8170-0002.1	260110	Halter	ATE
	1.5 dCi	66	10.10		+ ABS	11.8116-0356.1	390586	Halterfeder	ATE
	1.5 dCi	79	06.10		+ ABS				
	1.5 dCi	80	09.13		+ ABS				
	1.5 dCi 4x4	66	10.10						
	1.5 dCi 4x4	79	06.10						
	1.5 dCi 4x4	80	08.13						
	1.5 dCi 4x4	81	10.10						
	1.6 16V	77	04.10		+ ESP				
	1.6 16V 4x4	77	06.10		+ ESP				
	1.6 16V Flexifuel	77	04.11		+ ESP				
	1.6 16V LPG	77	04.11		+ ESP				
	1.6 SCe 115	84	06.15		+ ESP				
	1.6 SCe 115 4x4	84	06.15		+ ESP				
	1.5 dCi	63	04.10			24.5229-0285.3	330032	L=285	
	1.5 dCi	66	10.10						
	1.5 dCi	79	06.10						
	1.5 dCi 4x4	66	10.10						
	1.5 dCi 4x4	79	06.10						
	1.5 dCi 4x4	81	10.10						
	1.6 16V	77	04.10						
	1.6 16V 4x4	77	06.10						
	1.6 16V Flexifuel	77	04.11						
	1.6 16V LPG	77	04.11						
	1.6 SCe 115	84	06.15						
	1.6 SCe 115 4x4	84	06.15						
	1.2 TCe 125	92	09.13			24.3219-1761.3	020536	Rz 19,05	
	1.5 dCi	63	04.10						
	1.5 dCi	66	10.10						
	1.5 dCi	79	06.10						
	1.5 dCi	80	09.13						
	1.6 16V	77	04.10						
	1.6 16V Flexifuel	77	04.11						
	1.6 16V LPG	77	04.11						
	1.6 SCe 115	84	06.15						
	1.2 TCe 125 4x4	92	06.15			24.3219-1763.3	020543	Rz 19,05	
	1.5 dCi 4x4	66	10.10			24.3219-1764.3	020544	Rz 19,05	
	1.5 dCi 4x4	79	06.10						
	1.5 dCi 4x4	80	08.13						
	1.5 dCi 4x4	81	10.10						
	1.6 16V 4x4	77	06.10						
	1.6 SCe 115 4x4	84	06.15						
DACIA LODGY (JS_) (12-)									
	1.5 dCi	66	03.12		- ESP	24.3541-1849.5	240707	D=54, - Halter	TRW
	1.6	61	03.12		- ESP	24.3541-1850.5	240708	D=54, - Halter	TRW
	1.6 LPG	75	04.15						
	1.6 SCe 115	75	06.15						
	1.2 TCe	85	03.12			11.9541-9950.2	220843	D=54, - Halter	ATE
	1.5 dCi	63	03.12			11.9541-9951.2	220844	D=54, - Halter	ATE
	1.5 dCi	66	03.12		+ ESP	11.8170-0002.1	260110	Halter	ATE
	1.6	61	03.12		+ ESP	11.8116-0356.1	390586	Halterfeder	ATE
	1.2 TCe	85	03.12			24.3222-1729.3	020526	Rz 22,20	
	1.5 dCi	66	03.12						
	1.5 dCi	61	03.12						
	1.6	61	03.12						
	1.6 LPG	75	04.15						
	1.6 SCe 115	75	06.15						
DACIA LOGAN Express (FS_) (09-13)									
	1.4	55	03.09	06.13		03.7750-8532.4	300264	9"	ATE
	1.5 dCi	50	03.09	06.13	+ ABS				
	1.5 dCi	55	05.10	06.13	+ ABS				
	1.5 dCi	63	03.09	06.13	+ ABS				
	1.5 dCi	65	05.10	06.13	+ ABS				
	1.6 MPI 85	62	05.10	06.13	+ ABS				



DACIA LOGAN Express (FS_) (09-13)

	1.4	55		03.09	06.13	- ABS	24.2120-1762.3	011002			THz 20,64 - Behälter
	1.4	55		03.09	06.13	+ ABS	03.2122-2031.3	010938			ATE
	1.5 dCi	50		03.09	06.13	+ ABS					
	1.5 dCi	55		05.10	06.13	+ ABS					
	1.5 dCi	63		03.09	06.13	+ ABS					
	1.5 dCi	65		05.10	06.13	+ ABS					
1.6 MPI 85	62		05.10	06.13	+ ABS						
	1.4	55		03.09	06.13		24.3541-1849.5	240707	<input type="checkbox"/>	+ belüftete Scheiben ¹⁾	D=54, - Halter
	1.5 dCi	50		03.09	06.13		24.3541-1850.5	240708	<input type="checkbox"/>	+ belüftete Scheiben ¹⁾	D=54, - Halter
	1.5 dCi	55		05.10	06.13						
	1.5 dCi	63		03.09	06.13						
	1.5 dCi	65		05.10	06.13						
	1.6 MPI 85	62		03.09	06.13						
	1.4	55		03.09	06.13		24.5111-0310.3	331393	2		L=310
	1.5 dCi	50		03.09	06.13						
	1.5 dCi	55		05.10	06.13						
	1.5 dCi	63		03.09	06.13						
	1.5 dCi	65		05.10	06.13						
	1.6 MPI 85	62		03.09	06.13						
	1.4	55		03.09	06.13		24.5229-0285.3	330032	2		L=285
	1.5 dCi	50		03.09	06.13						
	1.5 dCi	55		05.10	06.13						
	1.5 dCi	63		03.09	06.13						
	1.5 dCi	65		05.10	06.13						
	1.6 MPI 85	62		03.09	06.13						
	1.4	55		03.09	06.13	- ABS	24.3219-1761.3	020536			Rz 19,05
	1.5 dCi	50		03.09	06.13	- ABS					
	1.4	55		03.09	06.13	+ ABS	24.3222-1729.3	020526			Rz 22,20
	1.5 dCi	50		03.09	06.13	+ ABS					
	1.5 dCi	55		05.10	06.13						
	1.5 dCi	63		03.09	06.13						
	1.5 dCi	65		05.10	06.13						
	1.6 MPI 85	62		03.09	06.13						
	1.6 MPI 85	62		05.10	06.13						
	1.6	64		03.09	06.13		24.3727-1073.2	581073	2	↓	L=1680
	1.4	55		03.09	06.13		24.3727-1074.2	581074	2	↓	L=1993
	1.5 dCi	50		03.09	06.13						
	1.5 dCi	55		05.10	06.13						
	1.5 dCi	63		03.09	06.13						
	1.5 dCi	65		05.10	06.13						
	1.6 MPI 85	62		03.09	06.13						
	1.6 MPI 85	62		05.10	06.13						

DACIA LOGAN Limousine (LS_) (04-13)

	1.2 16V	55		02.06	04.13	+ ABS	03.7853-4102.4	300271			9"	
	1.5 dCi	55		05.10	04.13	+ ABS	03.7853-4602.4	300302			ATE	
	1.5 dCi	65		05.10	04.13	+ ABS						
	1.6 16V Flexifuel	77		01.11	04.13	+ ABS						
	1.6 Bifuel	62		05.10	04.13	+ ABS						
	1.6 MPI 85	62		05.10	04.13	+ ABS						
	1.5 dCi	63		09.07	04.13	+ ABS	03.7750-8532.4	300264			9"	
	1.6 16V	64		09.04	04.13	+ ABS					ATE	
		1.2 16V	55		02.06	04.13	- ABS	24.2120-1762.3	011002			THz 20,64 - Behälter
		1.4	55		09.04	04.13	- ABS					
		1.4 MPI LPG	55		02.06	04.13	- ABS					
		1.5 dCi	48		09.05	04.13	- ABS					
1.5 dCi		50		01.06	04.13	- ABS						
1.5 dCi		55		05.10	04.13	- ABS						
1.5 dCi		63		09.07	04.13	- ABS						
1.5 dCi		65		05.10	04.13	- ABS						
1.6 16V		64		09.04	04.13	- ABS						
1.6 16V		77		02.06	04.13	- ABS						
1.6 16V Flexifuel		77		01.11	04.13	- ABS						
1.6 Bifuel		62		05.10	04.13	- ABS						
1.6 MPI 85	62		05.10	04.13	- ABS							
	1.4	55		09.04	04.13	+ ABS	24.2120-1754.3	010949			THz 20,64	
	1.4 MPI LPG	55		02.06	04.13	+ ABS						
	1.5 dCi	48		09.05	04.13	+ ABS						
	1.5 dCi	50		01.06	04.13	+ ABS						
	1.6 16V	64		09.04	04.13	+ ABS						
	1.6 16V	77		02.06	04.13	+ ABS						
	1.2 16V	55		02.06	04.13	+ ABS	03.2120-4611.3	010937			THz 20,64	
	1.5 dCi	55		05.10	04.13	+ ABS					ATE	
	1.5 dCi	63		09.07	04.13	+ ABS						
	1.5 dCi	65		05.10	04.13	+ ABS						
	1.6 16V Flexifuel	77		01.11	04.13	+ ABS						
	1.6 Bifuel	62		05.10	04.13	+ ABS						
	1.6 MPI 85	62		05.10	04.13	+ ABS						
		1.2 16V	55		02.06	04.13	- belüftete Scheiben ²⁾	24.3481-1611.5	240029	<input type="checkbox"/>		D=48, - Halter
		1.4	55		09.04	04.13	- belüftete Scheiben ²⁾	24.3481-1612.5	240030	<input type="checkbox"/>		TRW
		1.4 MPI LPG	55		02.06	04.13	- belüftete Scheiben ²⁾					
		1.5 dCi	48		09.05	04.13	- belüftete Scheiben ²⁾					
		1.5 dCi	50		09.05	04.13	- belüftete Scheiben ²⁾					
↓	↓		09.05	04.13	- belüftete Scheiben ²⁾							

¹⁾ + ventilated discs / + dischi ventilati / + disques ventilés / + disco ventilado

²⁾ - ventilated discs / - dischi ventilati / - disques ventilés / - disco ventilado



DACIA LOGAN Limousine (LS_) (04-13)

	1.5 dCi	55	05.10	04.13	- belüftete Scheiben ¹⁾	24.3481-1611.5	240029		D=48, - Halter D=48, - Halter	TRW			
	1.5 dCi	63	09.07	04.13	- belüftete Scheiben ¹⁾	24.3481-1612.5	240030						
	1.5 dCi	65	05.10	04.13	- belüftete Scheiben ¹⁾								
	1.6 16V	64	09.04	04.13	- belüftete Scheiben ¹⁾								
	1.6 16V	77	02.06	04.13	- belüftete Scheiben ¹⁾								
	1.6 16V Flexifuel	77	01.11	04.13	- belüftete Scheiben ¹⁾								
	1.6 Bifuel	62	05.10	04.13	- belüftete Scheiben ¹⁾								
	1.6 MPI 85	62	05.10	04.13	- belüftete Scheiben ¹⁾								
	1.2 16V	55	02.06	04.13	+ belüftete Scheiben ²⁾	24.3481-1615.5	240031					D=48, - Halter D=48, - Halter	TRW
	1.4	55	09.04	04.13	+ belüftete Scheiben ²⁾	24.3481-1616.5	240032						
1.4 MPI LPG	55	02.06	04.13	+ belüftete Scheiben ²⁾									
1.5 dCi	48	09.05	04.13	+ belüftete Scheiben ²⁾									
1.5 dCi	50	08.06	04.13	+ belüftete Scheiben ²⁾									
1.5 dCi	55	05.10	04.13	+ belüftete Scheiben ²⁾									
1.5 dCi	63	09.07	04.13	+ belüftete Scheiben ²⁾									
1.5 dCi	65	05.10	04.13	+ belüftete Scheiben ²⁾									
1.6 16V	64	09.04	04.13	+ belüftete Scheiben ²⁾									
1.6 16V	77	02.06	04.13	+ belüftete Scheiben ²⁾									
1.6 16V Flexifuel	77	01.11	04.13	+ belüftete Scheiben ²⁾									
1.6 Bifuel	62	05.10	04.13	+ belüftete Scheiben ²⁾									
1.6 MPI 85	62	05.10	04.13	+ belüftete Scheiben ²⁾									
	1.2 16V	55	02.06	04.13		24.5111-0300.3	330407	2	L=300				
	1.4	55	09.04	04.13									
	1.4 MPI LPG	55	02.06	04.13									
	1.5 dCi	48	09.05	04.13									
	1.5 dCi	50	01.06	04.13									
	1.5 dCi	55	05.10	04.13									
	1.5 dCi	63	09.07	04.13									
	1.5 dCi	65	05.10	04.13									
	1.6 16V	64	09.04	04.13									
	1.6 16V	77	02.06	04.13									
1.6 16V Flexifuel	77	01.11	04.13										
1.6 Bifuel	62	05.10	04.13										
1.6 MPI 85	62	05.10	04.13										
	1.2 16V	55	02.06	04.13		24.5229-0285.3	330032	2	L=285				
	1.4	55	09.04	04.13									
	1.4 MPI LPG	55	02.06	04.13									
	1.5 dCi	48	09.05	04.13									
	1.5 dCi	50	01.06	04.13									
	1.5 dCi	55	05.10	04.13									
	1.5 dCi	63	09.07	04.13									
	1.5 dCi	65	05.10	04.13									
	1.6 16V	64	09.04	04.13									
	1.6 16V	77	02.06	04.13									
1.6 16V Flexifuel	77	01.11	04.13										
1.6 Bifuel	62	05.10	04.13										
1.6 MPI 85	62	05.10	04.13										
	1.2 16V	55	02.06	04.13	- ABS	24.3219-1722.3	020426		Rz 19,05	BDX			
	1.4	55	09.04	04.13	- ABS								
	1.4 MPI LPG	55	02.06	04.13	- ABS								
	1.5 dCi	48	09.05	04.13	- ABS								
	1.5 dCi	50	01.06	04.13	- ABS								
	1.5 dCi	55	05.10	04.13	- ABS								
	1.5 dCi	63	09.07	04.13	- ABS								
	1.5 dCi	65	05.10	04.13	- ABS								
	1.6 16V	64	09.04	04.13	- ABS								
	1.6 16V	77	02.06	04.13	- ABS								
1.6 16V Flexifuel	77	01.11	04.13	- ABS									
1.6 Bifuel	62	05.10	04.13	- ABS									
1.6 MPI 85	62	05.10	04.13	- ABS									
	1.2 16V	55	02.06	04.13	+ ABS	24.3217-1711.3	020449		Rz 17,46	BOS			
	1.4	55	09.04	04.13	+ ABS								
	1.4 MPI LPG	55	02.06	04.13	+ ABS								
	1.5 dCi	48	09.05	04.13	+ ABS								
	1.5 dCi	50	01.06	04.13	+ ABS								
	1.5 dCi	55	05.10	04.13	+ ABS								
	1.5 dCi	63	09.07	04.13	+ ABS								
	1.5 dCi	65	05.10	04.13	+ ABS								
	1.6 16V	64	09.04	04.13	+ ABS								
	1.6 16V	77	02.06	04.13	+ ABS								
1.6 16V Flexifuel	77	01.11	04.13	+ ABS									
1.6 MPI 85	62	05.10	04.13	+ ABS									
	1.2 16V	55	02.06	04.13	+ ABS	24.3217-1710.3	020420		Rz 17,78	TRW			
	1.4	55	09.04	04.13	+ ABS								
	1.4 MPI LPG	55	02.06	04.13	+ ABS								
	1.5 dCi	48	09.05	04.13	+ ABS								
	1.5 dCi	50	01.06	04.13	+ ABS								
	1.5 dCi	63	09.07	04.13	+ ABS								
	1.5 dCi	65	05.10	04.13	+ ABS								
	1.6 16V	64	09.04	04.13	+ ABS								
	1.6 16V	77	02.06	04.13	+ ABS								
	1.6 16V Flexifuel	77	01.11	04.13	+ ABS								
1.6 Bifuel	62	05.10	04.13	+ ABS									
1.6 MPI 85	62	05.10	04.13	+ ABS									

¹⁾ - ventilated discs / - dischi ventilati / - disques ventilés / - disco ventilado
²⁾ + ventilated discs / + dischi ventilati / + disques ventilés / + disco ventilado





DACIA LOGAN Limousine (LS_) (04-13)



















	1.2 16V	55	02.06	04.13	+ ABS	24.3727-1073.2	581073	2 ↓	L=1680
	1.4	55	09.04	04.13	+ ABS				
	1.4 MPI LPG	55	02.06	04.13	+ ABS				
	1.5 dCi	48	09.05	04.13	+ ABS				
	1.5 dCi	50	01.06	04.13	+ ABS				
	1.5 dCi	55	05.10	04.13	+ ABS				
	1.5 dCi	63	09.07	04.13	+ ABS				
	1.5 dCi	65	05.10	04.13	+ ABS				
	1.6 16V	64	09.04	04.13	+ ABS				
	1.6 16V	77	02.06	04.13	+ ABS				
	1.6 16V Flexifuel	77	01.11	04.13	+ ABS				
	1.6 Bifuel	62	05.10	04.13	+ ABS				
1.6 MPI 85	62	05.10	04.13	+ ABS					
	1.2 16V	55	02.06	04.13		24.3728-1031.2	591031		L=1033
	1.4	55	09.04	04.13					
	1.4 MPI LPG	55	02.06	04.13					
	1.5 dCi	55	05.10	04.13					
	1.6 16V	64	09.04	04.13					
	1.6 Bifuel	62	05.10	04.13					
	1.6 MPI 85	62	05.10	04.13					























DACIA LOGAN MCV Kombi (KS_) (07-13)

	1.4	55	02.07	04.13		03.7750-8532.4	300264	+ ABS	9"	ATE					
	1.5 dCi	50	02.07	04.13											
	1.5 dCi	55	05.10	04.13											
	1.5 dCi	63	09.07	04.13											
	1.5 dCi	65	05.10	04.13											
	1.6	64	02.07	04.13											
	1.6 16V	77	02.07	04.13											
	1.6 16V Flexifuel	77	11.09	04.13											
	1.6 Bifuel	64	11.08	04.13											
	1.6 MPI 85	62	05.10	04.13											
	1.4	55	02.07	04.13	- ABS	24.2120-1762.3	011002		THz 20,64 - Behälter						
	1.5 dCi	50	02.07	04.13	- ABS										
	1.5 dCi	55	05.10	04.13	- ABS										
	1.5 dCi	63	09.07	04.13	- ABS										
	1.5 dCi	65	05.10	04.13	- ABS										
	1.6	64	02.07	04.13	- ABS										
	1.6 16V	77	02.07	04.13	- ABS										
	1.6 16V Flexifuel	77	11.09	04.13	- ABS										
	1.6 Bifuel	64	11.08	04.13	- ABS										
	1.6 MPI 85	62	05.10	04.13	- ABS										
	1.6 Bifuel	64	11.08	04.13	+ ABS	24.2120-1754.3	010949		THz 20,64						
	1.6 MPI 85	62	05.10	04.13	+ ABS										
	1.5 dCi	55	05.10	04.13	+ ABS					03.2122-2031.3	010938		THz 22,20	ATE	
	1.5 dCi	63	09.07	04.13	+ ABS										
	1.5 dCi	65	05.10	04.13	+ ABS										
	1.6 16V Flexifuel	77	11.09	04.13	+ ABS										
		1.4	55	02.07	04.13					+ Bremsscheibendurchm. 259 mm ¹⁾	24.3481-1615.5	240031	<input type="checkbox"/>	D=48, - Halter	TRW
		1.5 dCi	50	02.07	04.13					+ Bremsscheibendurchm. 259 mm ¹⁾					
		1.5 dCi	55	05.10	04.13					+ Bremsscheibendurchm. 259 mm ¹⁾					
		1.5 dCi	65	05.10	04.13					+ Bremsscheibendurchm. 259 mm ¹⁾					
1.6		64	02.07	04.13	+ Bremsscheibendurchm. 259 mm ¹⁾										
1.6 MPI 85		62	05.10	04.13	+ Bremsscheibendurchm. 259 mm ¹⁾										
	1.5 dCi	50	12.08	04.13	+ Bremsscheibendurchm. 260 mm ²⁾	24.3541-1849.5	240707	<input type="checkbox"/>	D=54, - Halter	TRW					
	1.6 16V	77	12.08	04.13	+ Bremsscheibendurchm. 260 mm ²⁾										
	1.6 16V Flexifuel	77	11.09	04.13	+ Bremsscheibendurchm. 260 mm ²⁾										
	1.4	55	02.07	04.13		24.5111-0300.3	330407	2	L=300						
	1.5 dCi	50	02.07	04.13											
	1.5 dCi	55	05.10	04.13											
	1.5 dCi	63	09.07	04.13											
	1.5 dCi	65	05.10	04.13											
	1.6	64	02.07	04.13											
	1.6 16V	77	02.07	04.13											
	1.6 16V Flexifuel	77	11.09	04.13											
	1.6 Bifuel	64	11.08	04.13											
	1.6 MPI 85	62	05.10	04.13											
	1.4	55	02.07	04.13		24.5229-0285.3	330032	2	L=285						
	1.5 dCi	50	02.07	04.13											
	1.5 dCi	55	05.10	04.13											
	1.5 dCi	63	09.07	04.13											
	1.5 dCi	65	05.10	04.13											
	1.6	64	02.07	04.13											
	1.6 16V	77	02.07	04.13											
	1.6 16V Flexifuel	77	11.09	04.13											
	1.6 Bifuel	64	11.08	04.13											
	1.6 MPI 85	62	05.10	04.13											
	1.4	55	02.07	04.13		24.3219-1761.3	020536	- ABS	Rz 19,05						
	1.5 dCi	50	02.07	04.13											
	1.5 dCi	55	05.10	04.13											
	1.5 dCi	63	09.07	04.13											
	1.5 dCi	65	05.10	04.13											
	1.6	64	02.07	04.13											
	1.6 16V	77	02.07	04.13											
	1.6 16V Flexifuel	77	11.09	04.13											
	1.6 Bifuel	64	11.08	04.13											

¹⁾ + brake disc diameter 259mm / + diametro dischi freno 259mm / + diamètre disques frein 259mm / + diámetro disco freno 259mm

²⁾ + brake disc diameter 260mm / + diametro dischi freno 260mm / + diamètre disques frein 260mm / + diámetro disco freno 260mm

									
DACIA LOGAN MCV Kombi (KS_) (07-13)									
	1.6 MPI 85	62		05.10	04.13	24.3219-1761.3	020536	- ABS	Rz 19,05
	1.4	55		02.07	04.13	24.3222-1729.3	020526	+ ABS	Rz 22,20
	1.5 dCi	50		02.07	04.13				
	1.5 dCi	55		05.10	04.13				
	1.5 dCi	63		09.07	04.13				
	1.5 dCi	65		05.10	04.13				
	1.6	64		02.07	04.13				
	1.6 16V	77		02.07	04.13				
	1.6 16V Flexifuel	77		11.09	04.13				
	1.6 Bifuel	64		11.08	04.13				
	1.6 MPI 85	62		05.10	04.13				
	1.4	55		02.07	04.13	24.3727-1074.2	581074	2 ↓	L=1993
	1.5 dCi	50		02.07	04.13				
	1.5 dCi	55		05.10	04.13				
	1.5 dCi	63		09.07	04.13				
	1.5 dCi	65		05.10	04.13				
	1.6 Bifuel	64		11.08	04.13				
	1.6 MPI 85	62		05.10	04.13				
	1.6	64		02.07	04.13	24.3727-1073.2	581073	2 ↓	L=1680
	1.6 16V	77		02.07	04.13				
	1.6 16V Flexifuel	77		11.09	04.13				
	1.6	64		02.07	04.13	24.3728-1031.2	591031		L=1033
	1.6 Bifuel	64		11.08	04.13				
	1.6 MPI 85	62		05.10	04.13				
DACIA LOGAN Pick-up (US_) (08-13)									
	1.4	55		01.09	06.13 + ABS	03.7750-8532.4	300264		9" ATE
	1.5 dCi	50		03.08	06.13 + ABS				
	1.5 dCi	55		05.10	06.13 + ABS				
	1.5 dCi	63		03.08	06.13 + ABS				
	1.5 dCi	65		05.10	06.13 + ABS				
	1.6	64		03.08	06.13 + ABS				
	1.6 Bifuel	62		05.10	06.13 + ABS				
	1.6 MPI 85	62		05.10	06.13 + ABS				
	1.4	55		01.09	06.13 - ABS	24.2120-1762.3	011002		THz 20,64 - Behälter
	1.4	55		01.09	06.13 + ABS	03.2122-2031.3	010938		THz 22,20 ATE
	1.5 dCi	50		03.08	06.13 + ABS				
	1.5 dCi	55		05.10	06.13 + ABS				
	1.5 dCi	63		03.08	06.13 + ABS				
	1.5 dCi	65		05.10	06.13 + ABS				
	1.6	64		03.08	06.13 + ABS				
	1.6 Bifuel	62		05.10	06.13 + ABS				
	1.6 MPI 85	62		05.10	06.13 + ABS				
	1.4	55		01.09	06.13	24.3541-1849.5	240707	<input type="checkbox"/>	D=54, - Halter TRW
	1.5 dCi	50		12.08	06.13	24.3541-1850.5	240708	<input type="checkbox"/>	D=54, - Halter TRW
	1.5 dCi	55		05.10	06.13				
	1.5 dCi	63		12.08	06.13				
	1.5 dCi	65		05.10	06.13				
	1.6	64		12.08	06.13				
	1.6 Bifuel	62		05.10	06.13				
	1.6 MPI 85	62		05.10	06.13				
	1.5 dCi	50		03.08	11.08	24.5111-0300.3	330407	2	L=300
	1.5 dCi	63		03.08	11.08				
	1.6	64		03.08	11.08				
	1.4	55		01.09	06.13	24.5111-0310.3	331393	2	L=310
	1.5 dCi	50		12.08	06.13				
	1.5 dCi	55		05.10	06.13				
	1.5 dCi	63		12.08	06.13				
	1.5 dCi	65		05.10	06.13				
	1.6	64		12.08	06.13				
	1.6 Bifuel	62		05.10	06.13				
	1.6 MPI 85	62		05.10	06.13				
	1.4	55		01.09	06.13	24.5229-0285.3	330032	2	L=285
	1.5 dCi	50		03.08	06.13				
	1.5 dCi	55		05.10	06.13				
	1.5 dCi	63		03.08	06.13				
	1.5 dCi	65		05.10	06.13				
	1.6	64		03.08	06.13				
	1.6 Bifuel	62		05.10	06.13				
	1.6 MPI 85	62		05.10	06.13				
	1.4	55		01.09	06.13	24.3222-1729.3	020526		Rz 22,20
	1.5 dCi	50		03.08	06.13				
	1.5 dCi	55		05.10	06.13				
	1.5 dCi	63		03.08	06.13				
	1.5 dCi	65		05.10	06.13				
	1.6	64		03.08	06.13				
	1.6 Bifuel	62		05.10	06.13				
	1.6 MPI 85	62		05.10	06.13				
	1.4	55		01.09	06.13	24.3727-1074.2	581074	2 ↓	L=1993
	1.5 dCi	50		03.08	06.13				
	1.5 dCi	55		05.10	06.13				
	1.5 dCi	63		03.08	06.13				
	1.5 dCi	65		05.10	06.13				
	1.6	64		03.08	06.13				
	1.6 Bifuel	62		05.10	06.13				
↓									

								
DACIA LOGAN Pick-up (US_) (08-13)								
	1.6 MPI 85	62		05.10 06.13	24.3727-1074.2	581074	2 ↓	L=1993
DACIA LOGAN II Limousine (L52_) (12-)								
	0.9 TCe 90	66		11.12	24.3217-1711.3	020449		Rz 17,46 BOS
	1.2 16V 75	55		11.12				
	1.5 dCi 75	55		11.12				
	1.5 dCi 90	66		11.12				
	1.2 16V 75	55		11.12	24.3219-1761.3	020536		Rz 19,05
	1.2 16V LPG	55		11.12				
	1.5 DCi 85	63		01.13				
	1.6 16V	75		04.15				
	1.6 16V	77		01.13				
	0.9 TCe 90	66		11.12	24.3727-1073.2	581073	2 ↓	L=1680
	1.2 16V 75	55		11.12				
	1.5 dCi 75	55		11.12				
	1.5 DCi 85	63		01.13				
	1.5 dCi 90	66		11.12				
	1.6 16V	75		04.15				
	1.6 16V	77		01.13				
DACIA LOGAN II MCV Kombi (13-)								
	0.9 TCe 90	66		02.13	11.8116-0264.1	390594	2	Haltefeder ATE
	0.9 TCe 90 LPG	66		09.15				
	1.2 16V	55		02.13				
	1.2 16V LPG	55		02.13				
	1.5 dCi 75	55		02.13				
	1.5 dCi 85	63		02.13				
	1.5 dCi 90	66		02.13				
	0.9 TCe 90	66		02.13	24.3219-1761.3	020536		Rz 19,05
	0.9 TCe 90 LPG	66		09.15				
	1.2 16V	55		02.13				
	1.2 16V LPG	55		02.13				
	1.5 dCi 75	55		02.13				
	1.5 dCi 85	63		02.13				
	1.5 dCi 90	66		02.13				
	1.5 dCi 85	63		02.13	24.3727-1073.2	581073	2 ↓	L=1680
DACIA SANDERO (08-13)								
	1.2 16V	55		11.08 02.13	03.7853-4102.4	300271	+ ABS	9" ATE
	1.2 16V Bifuel	55		11.08 02.13	03.7853-4602.4	300302	+ ABS	9" ATE
	1.4	55		06.08 02.13				
	1.4 MPI LPG	53		01.09 02.13				
	1.5 dCi	50		11.08 02.13				
	1.5 dCi	55		05.10 02.13				
	1.5 dCi	65		05.10 02.13				
	1.6	64		06.08 02.13				
	1.6 16V	77		01.11 02.13				
	1.6 LPG	62		05.10 10.12				
	1.6 MPI 85	62		05.10 02.13				
	1.5 dCi	63		11.08 02.13	03.7750-8532.4	300264	+ ABS	9" ATE
	1.2 16V	55		11.08 02.13	24.2120-1762.3	011002	- ABS	THz 20,64 - Behälter
	1.2 16V Bifuel	55		11.08 02.13	03.2120-4611.3	010937	+ ABS	THz 20,64 ATE
	1.4	55		06.08 02.13				
	1.4 MPI LPG	53		01.09 02.13				
	1.5 dCi	50		11.08 02.13				
	1.5 dCi	55		05.10 02.13				
	1.5 dCi	65		05.10 02.13				
	1.6	64		06.08 02.13				
	1.6 16V	77		01.11 02.13				
	1.6 LPG	62		05.10 10.12				
	1.6 MPI 85	62		05.10 02.13				
	1.5 dCi	63		11.08 02.13	03.2122-2031.3	010938	+ ABS	THz 22,20 ATE
	1.2 16V	55		11.08 02.13	24.3481-1611.5	240029		D=48, - Halter TRW
	1.2 16V Bifuel	55		11.08 02.13	24.3481-1612.5	240030		D=48, - Halter TRW
	1.4	55		06.08 02.13				
	1.4 MPI LPG	53		01.09 02.13				
	1.5 dCi	50		11.08 02.13				
	1.5 dCi	55		05.10 02.13			- belüftete Scheiben ¹⁾	
	1.5 dCi	65		05.10 02.13			- belüftete Scheiben ¹⁾	
	1.6	64		06.08 02.13				
	1.6 16V	77		01.11 02.13			- belüftete Scheiben ¹⁾	
	1.6 LPG	62		05.10 10.12				
	1.6 MPI 85	62		05.10 02.13			- belüftete Scheiben ¹⁾	
	1.2 16V	55		11.08 02.13	24.3481-1615.5	240031	 + belüftete Scheiben ²⁾	D=48, - Halter TRW
	1.2 16V Bifuel	55		11.08 02.13	24.3481-1616.5	240032	 + belüftete Scheiben ²⁾	D=48, - Halter TRW
	1.5 dCi	55		05.10 02.13				
	1.5 dCi	65		05.10 02.13				
	1.6 16V	77		01.11 02.13				
	1.6 MPI 85	62		05.10 02.13				

¹⁾ - ventilated discs / - dischi ventilati / - disques ventilés / - disco ventilado
²⁾ + ventilated discs / + dischi ventilati / + disques ventilés / + disco ventilado



DACIA SANDERO (08-13)





























	1.2 16V	55	11.08	02.13	24.5111-0300.3	330407	2		L=300
	1.2 16V Bifuel	55	11.08	02.13					
	1.4	55	06.08	02.13					
	1.4 MPI LPG	53	01.09	02.13					
	1.5 dCi	50	11.08	02.13					
	1.5 dCi	55	05.10	02.13					
	1.5 dCi	63	11.08	02.13					
	1.5 dCi	65	05.10	02.13					
	1.6	64	06.08	02.13					
	1.6 16V	77	01.11	02.13					
1.6 LPG	62	05.10	10.12	24.5229-0285.3	330032	2		L=285	
1.6 MPI 85	62	05.10	02.13						
1.2 16V	55	11.08	02.13						
1.2 16V Bifuel	55	11.08	02.13						
1.4	55	06.08	02.13						
1.4 MPI LPG	53	01.09	02.13						
1.5 dCi	50	11.08	02.13						
1.5 dCi	55	05.10	02.13						
1.5 dCi	63	11.08	02.13						
1.5 dCi	65	05.10	02.13						
1.6	64	06.08	02.13						
1.6 16V	77	01.11	02.13						
1.6 LPG	62	05.10	10.12	24.3219-1722.3	020426		+ 7" Bremse ¹⁾	Rz 19,05	BDX
1.6 MPI 85	62	05.10	02.13						
1.2 16V	55	11.08	02.13						
1.2 16V Bifuel	55	11.08	02.13						
1.4	55	06.08	02.13						
1.4 MPI LPG	53	01.09	02.13						
1.5 dCi	50	11.08	02.13						
1.5 dCi	55	05.10	02.13						
1.5 dCi	63	11.08	02.13						
1.5 dCi	65	05.10	02.13						
1.6	64	06.08	02.13						
1.6 16V	77	01.11	02.13						
1.6 LPG	62	05.10	10.12	24.3217-1711.3	020449		+ 8" Bremse ²⁾	Rz 17,46	BOS
1.6 MPI 85	62	05.10	02.13						
1.2 16V	55	11.08	02.13						
1.2 16V Bifuel	55	11.08	02.13						
1.4	55	06.08	02.13						
1.4 MPI LPG	53	01.09	02.13						
1.5 dCi	50	11.08	02.13						
1.5 dCi	55	05.10	02.13						
1.5 dCi	63	11.08	02.13						
1.5 dCi	65	05.10	02.13						
1.6	64	06.08	02.13						
1.6 16V	77	01.11	02.13						
1.6 LPG	62	05.10	10.12	24.3217-1710.3	020420		+ 8" Bremse ²⁾	Rz 17,78	TRW
1.6 MPI 85	62	05.10	02.13						
1.2 16V	55	11.08	02.13						
1.2 16V Bifuel	55	11.08	02.13						
1.4	55	06.08	02.13						
1.4 MPI LPG	53	01.09	02.13						
1.5 dCi	50	11.08	02.13						
1.5 dCi	55	05.10	02.13						
1.5 dCi	63	11.08	02.13						
1.5 dCi	65	05.10	02.13						
1.6	64	06.08	02.13						
1.6 16V	77	01.11	02.13						
1.6 LPG	62	05.10	10.12	24.3222-1729.3	020526		+ 9" Bremse ³⁾	Rz 22,20	
1.6 MPI 85	62	05.10	02.13						
1.5 dCi	63	11.08	02.13	24.3727-1074.2	581074	2 ↓		L=1993	
1.5 dCi	63	11.08	02.13						
	1.2 16V	55	11.08	02.13	24.3728-1031.2	591031			L=1033
	1.2 16V Bifuel	55	11.08	02.13					
	1.4	55	06.08	02.13					
	1.4 MPI LPG	53	01.09	02.13					
	1.5 dCi	50	11.08	02.13					
	1.5 dCi	55	05.10	02.13					
	1.5 dCi	65	05.10	02.13					
	1.6	64	06.08	02.13					
	1.6 LPG	62	05.10	10.12					
	1.6 MPI 85	62	05.10	02.13					



























DACIA SANDERO II (B52_) (12-)

	0.9 TCe 90	66	11.12		24.3217-1711.3	020449			Rz 17,46	BOS
	0.9 TCe 90 LPG	66	09.15							
	1.2 16V	55	11.12							
	1.2 16V LPG	53	11.12							
	1.5 dCi 75	55	11.12							
	1.5 dCi 85	63	01.13							
	1.5 dCi 90	66	11.12							
	1.6	61	11.12							
	1.6 16V	75	04.15							
	1.6 16V	77	01.13							
0.9 TCe 90	66	11.12		24.3219-1761.3	020536			Rz 19,05		
0.9 TCe 90 LPG	66	09.15								
1.2 16V	55	11.12								























1) + 7" brake / + freno de 7" / + frein de 7" / + freno de 7"
 2) + 8" brake / + servofreno da 8" / + frein de 8" / + freno de 8"
 3) + 9" brake / + servofreno da 9" / + frein de 9" / + freno de 9"



										
DACIA SANDERO II (B52_) (12-)										
	1.2 16V LPG 1.5 dCi 75 1.5 dCi 85 1.5 dCi 90 1.6 1.6 16V 1.6 16V	53 55 63 66 61 75 77		11.12 11.12 01.13 11.12 11.12 04.15 01.13		24.3219-1761.3	020536	Rz 19,05		
DAEWOO ARANOS (95-97)										
	1.5 1.8 2.0	66 70 77		01.95 11.97 01.95 11.97 01.95 11.97		24.3219-1767.3	020552	Rz 19,05		
DAEWOO ESPERO (95-99)										
	1.5 i 1.8 i 2.0 i			02.95 06.99 02.95 06.99 02.95 06.99		24.3521-1701.5 24.3521-1702.5 11.0441-5202.2 11.0101-5407.2 11.8171-0008.1	240001 240002 250026 260011 990049	D=52, - Halter D=52, - Halter Dichtungssatz Hülzensatz Führungsbolzen	ATE ATE ATE ATE	
	1.5 i 1.8 i 2.0 i			02.95 06.99 02.95 06.99 02.95 06.99		24.3219-1767.3	020552	Rz 19,05		
DAEWOO KALOS (02-05)										
	1.2 i 1.4 i 1.4 i 16V	53 61 69		04.03 02.05 09.02 02.05 04.03 02.05		24.5286-0342.3	331138	2	L=341	
	1.2 i 1.4 i 1.4 i 16V	53 61 69		04.03 02.05 09.02 02.05 04.03 02.05		24.5247-0205.3	331094	2	L=205	
	1.2 i 1.4 i 1.4 i 16V	53 61 69		04.03 02.05 09.02 02.05 04.03 02.05		24.3219-1767.3	020552		Rz 19,05	
	1.2 i 1.4 i 1.4 i 16V	53 61 69		04.03 02.05 09.02 02.05 04.03 02.05		24.3728-2901.2	592901		L=888	
DAEWOO LANOS (97-02)										
	1.4 i 1.5 i	55	447433 447433	05.97 05.97		11.9481-9871.2 11.9481-9872.2 11.0441-4811.2 11.0101-5407.2 11.8171-0008.1 11.8116-0129.1	220681 220682 250024 260011 990049 390591	D=48, - Halter D=48, - Halter Dichtungssatz Hülzensatz Führungsbolzen Haltefeder	ATE ATE ATE ATE ATE	
	1.6 i 16V	78	447433	05.97		24.3521-1701.5 24.3521-1702.5 11.0441-5202.2 11.0101-5407.2 11.8171-0008.1 11.8116-0097.1	240001 240002 250026 260011 990049 390590	D=52, - Halter D=52, - Halter Dichtungssatz Hülzensatz Führungsbolzen Haltefeder	ATE ATE ATE ATE ATE	
	1.4 i 1.5 i 1.6 i 16V	55 78		05.97 12.02 05.97 12.02 05.97 12.02		24.5233-0180.3	330888	2	L=180	
	1.4 i 1.5 i	55	447433 447433	05.97 05.97		03.3217-3512.3	020032		Rz 17,46	TRW
	1.4 i 1.5 i 1.6 i 16V 1.6 i 16V	55 447434 447434 78	447434 447434	12.02 12.02 05.97		24.3219-1767.3	020552		Rz 19,05	
	1.4 i 1.5 i 1.6 i 16V	55 78		05.97 12.02 05.97 12.02 05.97 12.02		24.3220-1719.3 24.3727-2900.2 24.3727-2901.2	020448 582900 582901		Rz 20,64 L=1655 L=1587	
DAEWOO MATIZ (98-05)										
	0.8 (KLA4) 1.0 (KLA0)	38 47		07.98 02.05 01.03 02.05		24.2120-1765.3 24.2120-1755.3	011003 010974	- ABS + ABS	THz 20,64 - Behälter THz 20,64 - Behälter	
	0.8 (KLA4) 1.0 (KLA0)	38 47		07.98 02.05 01.03 02.05		24.3481-1773.5 24.3481-1774.5	240377 240378		D=48, - Halter D=48, - Halter	
	0.8 (KLA4) 1.0 (KLA0)	38 47		07.98 02.05 01.03 02.05		24.5283-0403.3 24.5291-0425.3	331136 331029	2 2	- ABS + ABS	L=404 L=425
	0.8 (KLA4) 1.0 (KLA0)	38 47		07.98 02.05 01.03 02.05		24.5284-0220.3	330970	2	L=220	
	0.8 (KLA4) 1.0 (KLA0)	38 47		07.98 02.05 01.03 02.05		24.3217-1712.3	020475		Rz 17,46	
	0.8 (KLA4) 1.0 (KLA0)	38 47		07.98 02.05 01.03 02.05		24.3727-2902.2	582902	1	L=2825	

											
DAEWOO MATIZ (98-05)											
	0.8 (KLA4) 1.0 (KLA0)	◀ 38 ◀ 47		07.98 01.03	02.05 02.05		24.3728-2900.2	592900	L=851		
DAEWOO NEXIA / RACER (95-08)											
	1.5 i			02.95 10.95	08.97 06.08		11.9481-9871.2 11.9481-9872.2 11.0441-4811.2 11.0101-5407.2 11.8171-0008.1 11.8116-0129.1	220681 220682 250024 260011 990049 390591	2 2	D=48, - Halter D=48, - Halter Dichtungssatz Hülzensatz Führungsbolzen Haltefeder	ATE ATE ATE ATE ATE
	1.5 i 16V 1.8 i	66 74		02.95 10.95	08.97 06.08		24.3521-1701.5 24.3521-1702.5 11.0441-5202.2 11.0101-5407.2 11.8171-0008.1 11.8116-0097.1	240001 240002 250026 260011 990049 390590	2 2	D=52, - Halter D=52, - Halter Dichtungssatz Hülzensatz Führungsbolzen Haltefeder	ATE ATE ATE ATE ATE
	1.5 i 1.5 i 16V 1.8 i	66 74		02.95 10.95	08.97 06.08		03.3217-3512.3 24.3219-1767.3	020032 020552		Rz 17,46 Rz 19,05	TRW
	1.5 i 1.5 i 16V 1.8 i	66 74		02.95 10.95	08.97 06.08		24.3727-0730.2	580730	1	L=1272/1676, + Zub	
DAEWOO NUBIRA (97-99)											
	1.6 i 16V 1.6 i 16V Kombi	78 78		06.97 06.97	05.99 05.99		24.3220-1719.3	020448		Rz 20,64	
DAEWOO NUBIRA (99-05)											
	1.6 i 16V 1.6 i 16V	76 78		07.00 06.99	02.05 - ABS 02.05 - ABS		24.3220-1719.3	020448		Rz 20,64	
DAIHATSU CHARADE (93-01)											
	1.3 16V (G200) 1.3 16V (G200) 1.3 16V (G204) 1.5 16V (G203) 1.5 16V (G203) 1.6 GTi (G201)	55 62 44 55 66 77		05.96 01.93 09.96 10.94 08.94 03.93	11.99 - ABS 04.01 - ABS 04.01 - ABS 11.99 - ABS 11.99 - ABS 03.96 - ABS		24.2119-1710.3	010880		THz 19,05 + Behälter	TRW
DAIHATSU CHARADE (GB) (03-07)											
	1.0 i (L251)	43		05.03	08.07		24.3217-1737.3	020574		Rz 17,46	
DAIHATSU CHARADE (11-13)											
	1.33 16V	◀ 73		05.11	01.13		03.7853-3203.4 03.7750-7132.4	300241 300255	- ESP + ESP	9" 9"	ATE ATE
	1.33 16V	◀ 73		05.11	01.13		03.4152-0153.3 03.4152-0158.3	011006 011007	- ESP + ESP	THz 22,20 - Behälter THz 22,20 - Behälter	ATE ATE
	1.33 16V	73		05.11	01.13		11.9541-9569.2 11.9541-9570.2	220725 220726		D=54, - Halter D=54, - Halter	ATE ATE
	1.33 16V	73		05.11	01.13		24.5286-0489.3 24.5286-0488.3	331222 331221		L=488 L=488	
	1.33 16V	73		05.11	01.13		11.9347-7005.2 11.9347-7006.2	220643 220644		D=34, - Halter D=34, - Halter	ATE ATE
	1.33 16V	73		05.11	01.13		24.5261-0195.3 24.5261-0255.3	331077 331078		L=195 L=255	
	1.33 16V	73		05.11	01.13		24.3220-1728.3	020509		Rz 20,64	
	1.33 16V	73		05.11	01.13		24.3727-1937.2 24.3727-1938.2	581937 581938	+ HA-Trommelbremse ¹⁾ + HA-Trommelbremse ¹⁾	L=1555 L=1600	
DAIHATSU COPEN (03-12)											
	0.7 16V 0.7 16V 1.3 16V	47 50 64		09.03 09.03 03.06	07.12 07.12 07.12		24.3217-1732.3	020558		Rz 17,46	
DAIHATSU CUORE (98-03)											
	1.0 (L701) 1.0 i (L701)	40 41		11.98 10.98	09.00 + ABS 05.03 + ABS		24.3217-1732.3	020558		Rz 17,46	

¹⁾ + RA drum brake / + P freno a tamburo / + frein à tambour essieu AR / + ET-tambores de freno

									
DAIHATSU CUORE (03-07)									
	1.0 i (L251)	43		05.03	08.07		24.3217-1737.3	020574	Rz 17,46
DAIHATSU CUORE (07-13)									
	1.0 DVVT (L276)	51		09.07	01.13	- ESP	24.3217-1737.3	020574	Rz 17,46
	1.0 DVVT (L276)	51		09.07	01.13	+ ESP	24.3217-1721.3	020489	Rz 17,46
							24.3217-1722.3	020490	Rz 17,46
DAIHATSU MATERIA (06-12)									
	1.3 DVVT	67		10.06	07.12		24.5262-0520.3	331349	L=520
	1.5 DVVT	76		10.06	07.12		24.5262-0521.3	331350	L=520
	1.5 DVVT 4WD	76		10.06	07.12				
	1.3 DVVT	67		10.06	07.12		24.5235-0205.3	331093	L=205
	1.5 DVVT	76		10.06	07.12				
	1.5 DVVT 4WD	76		10.06	07.12				
	1.3 DVVT	67		10.06	07.12		24.3217-1721.3	020489	Rz 17,46
	1.5 DVVT	76		10.06	07.12		24.3217-1722.3	020490	Rz 17,46
	1.5 DVVT 4WD	76		10.06	07.12				
DAIHATSU MOVE (96-02)									
	1.0 i (L901)	41		10.98	11.00	+ ABS	24.3217-1732.3	020558	Rz 17,46
DAIHATSU SIRION (98-04)									
	1.0 i (M100)	41		04.98	08.00		24.3217-1732.3	020558	Rz 17,46
	1.0 i (M100)	43		09.00	01.02				
	1.3 i 16V (M101)	75		08.00	01.02				
	1.0 i (M100)	43		02.02	12.04		24.3217-1732.3	020558	Rz 17,46
	1.0 i 4WD (M110)	43		02.02	12.04				
	1.3 i 16V (M101)	75		02.02	12.04				
	1.3 i 16V 4WD (M111)	75		08.00	12.04				
DAIHATSU SIRION (05-13)									
	1.0 DVVT	51		01.05	01.13		24.5235-0205.3	331093	L=205
	1.0 DVVT 4WD	51		04.05	01.13				
	1.3 DVVT	64		01.05	01.13				
	1.3 DVVT	67		03.08	01.13				
	1.5 DVVT	76		03.08	01.13				
	1.0 DVVT	51		01.05	01.13		24.3217-1721.3	020489	Rz 17,46
	1.0 DVVT 4WD	51		04.05	01.13		24.3217-1722.3	020490	Rz 17,46
	1.3 DVVT	64		01.05	01.13				
	1.3 DVVT	67		03.08	01.13				
	1.5 DVVT	76		03.08	01.13				
DAIHATSU TERIOS (J1) (97-05)									
	1.3 16V	63		09.01	10.05		24.3220-1745.3	020579	Rz 20,64
	1.3 16V 4WD	61		10.97	09.00				
	1.3 16V 4WD	63		10.00	10.05				
	1.3 DVVT FWD	63		10.02	10.05				
	1.3 DVVT Turbo 4WD	103		10.02	10.05				
DAIHATSU TREVIS (06-09)									
	1.0 i 12V (L651)	43		06.06	09.09		24.3217-1724.3	020523	Rz 17,46
DAIHATSU YRV (01-06)									
	1.0 i (M200)	43		01.01	01.02		24.3217-1732.3	020558	Rz 17,46
	1.3 i 16V (M201)	64		01.01	01.02				
FIAT 500 (07-)									
	1.2 i	51		07.07			24.4120-1702.3	010913	THz 20,64 - Behälter TRW
	1.2 LPG	51		12.10					
	1.3 D Multijet	55		07.07					
	1.3 D Multijet	70		12.09					
	0.9	48		09.12			24.4122-1714.3	010914	THz 22,20 - Behälter TRW
	0.9	63		07.10					
	0.9	77		12.13					
	1.4 Abarth	99		07.08					
	1.4 Abarth	103		05.10					
	1.4 Abarth	118		08.08					
	1.4 Abarth Assetto C.	139		08.08					
	1.4 Abarth Tributo F.	132		08.08					
	1.4 i 16V	74		07.07					
	0.9	48		09.12			11.9541-9831.2	220953	D=54, - Halter ATE
	0.9	63		07.10			11.9541-9832.2	220954	D=54, - Halter ATE
	0.9	77		12.13			11.8116-0264.1	390594	Haltefeder ATE
							11.8171-0008.1	990049	Führungsbolzen ATE
	1.2 i	51		07.07			24.3481-1743.5	240305	D=48, - Halter BDX
	1.2 LPG	51		12.10			24.3481-1744.5	240306	D=48, - Halter BDX
	1.3 D Multijet	70		12.09			24.3541-1769.5	240601	D=54, - Halter BOS
	1.4 i 16V	74		07.07			24.3541-1770.5	240602	D=54, - Halter BOS

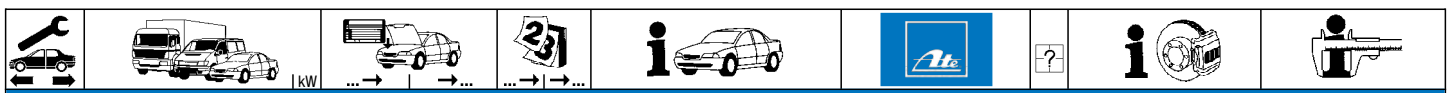

FIAT 500 (07-)

	1.4 Abarth	99		07.08		24.3541-1829.5	240721			D=54, - Halter	BOS
	1.4 Abarth	103		05.10		24.3541-1830.5	240722			D=54, - Halter	BOS
	1.4 Abarth	118		08.08							
	0.9	48		09.12		24.5112-0356.3	331129	2		L=355	
	0.9	63		07.10							
	0.9	77		12.13							
	1.2 i	51		07.07							
	1.2 LPG	51		12.10							
	1.2 LPG	51		07.10							
	1.3 D Multijet	55		07.07							
	1.3 D Multijet	70		08.08							
	1.4 Abarth	99		07.08							
	1.4 Abarth	103		05.10							
	1.4 Abarth	118		08.08							
	1.4 i 16V	74		07.07							
	1.4 Abarth	99		07.08		24.3347-1715.5	240719			D=34, - Halter	TRW
	1.4 Abarth	103		05.10		24.3347-1716.5	240720			D=34, - Halter	TRW
	1.4 Abarth	118		08.08							
	1.4 i 16V	74		07.07							
	0.9	48		09.12		24.5228-0165.3	330879	2		L=165	
	0.9	63		07.10							
	0.9	77		12.13							
	1.2 i	51		07.07							
	1.2 LPG	51		12.10							
	1.3 D Multijet	55		07.07							
	1.3 D Multijet	70		12.09							
	1.4 Abarth	99		07.08		83.7101-9219.3	330903	2		L=219	
	1.4 Abarth	103		05.10							
	1.4 Abarth	118		08.08							
	1.4 Abarth Assetto C.	139		08.08							
	1.4 Abarth Tributo F.	132		08.08							
	1.4 i 16V	74		07.07							
	1.2 i	51		07.07	05.10	24.3220-1108.3	020219			Rz 20,64	BDX
	1.3 D Multijet	55		07.07	05.10						
	1.3 D Multijet	70		12.09	05.10						
	0.9	48		09.12		24.3220-1738.3	020545			Rz 20,64	
	0.9	63		07.10							
	0.9	77		12.13							
	1.2 i	51		06.10							
	1.2 LPG	51		12.10							
	1.3 D Multijet	55		06.10							
	1.3 D Multijet	70		06.10							
	0.9	48		09.12		24.2520-1705.3	040093			Nz 20,64	
	0.9	63		07.10							
	0.9	77		12.13							
	1.2 i	51		07.07		24.2520-1707.3	040097			Nz 20,64	
	1.2 LPG	51		12.10							
	1.4 i 16V	74		07.07							
	1.2 i	51		07.07	12.09	24.3728-0532.2	590532			L=995	

FIAT 500 C Cabrio (09-)

	1.2	51		09.09		24.4120-1702.3	010913			THz 20,64 - Behälter	TRW
	0.9	63		09.09		24.4122-1714.3	010914			THz 22,20 - Behälter	TRW
	0.9	77		12.13							
	1.3 D Multijet	55		09.09							
	1.3 D Multijet	70		09.09							
	1.4	74		09.09							
	1.4 Abarth	99		01.11							
	1.4 Abarth	118		05.11							
	1.4 Abarth	132		09.09							
	0.9	63		09.09		11.9541-9831.2	220953			D=54, - Halter	ATE
	0.9	77		12.13		11.9541-9832.2	220954			D=54, - Halter	ATE
						11.8116-0264.1	390594	2		Haltefeder	ATE
						11.8171-0008.1	990049			Führungsbolzen	ATE
	1.3 D Multijet	70		09.09		24.3541-1769.5	240601			D=54, - Halter	BOS
	1.4	74		09.09		24.3541-1770.5	240602			D=54, - Halter	BOS
	1.4 Abarth	99		01.11		24.3541-1829.5	240721			D=54, - Halter	BOS
	1.4 Abarth	118		05.11		24.3541-1830.5	240722			D=54, - Halter	BOS
	1.4 Abarth	132		09.09							
	0.9	63		09.09		24.5112-0356.3	331129	2		L=355	
	0.9	77		12.13							
	1.2	51		09.09							
	1.3 D Multijet	55		09.09							
	1.3 D Multijet	70		09.09							
	1.4	74		09.09							
	1.4 Abarth	99		01.11							
	1.4 Abarth	118		05.11							
	1.4 Abarth	132		09.09							
	1.4	74		09.09		24.3347-1715.5	240719			D=34, - Halter	TRW
	1.4 Abarth	99		01.11		24.3347-1716.5	240720			D=34, - Halter	TRW
	1.4 Abarth	118		05.11							
	1.4 Abarth	132		09.09							



























FIAT 500 C Cabrio (09-)										
	0.9	63		09.09		24.5228-0165.3	330879	2		L=165
	0.9	77		12.13						
	1.2	51		09.09						
	1.3 D Multijet	55		09.09						
	1.3 D Multijet	70		09.09						
	1.4	74		09.09		83.7101-9219.3	330903	2		L=219
	1.4 Abarth	99		01.11						
	1.4 Abarth	118		05.11						
	1.4 Abarth	132		09.09						
	0.9	63		09.09	05.10	24.3220-1108.3	020219			Rz 20,64 BDX
	1.2	51		09.09	05.10					
	1.3 D Multijet	55		09.09	05.10					
	1.3 D Multijet	70		09.09	05.10					
	0.9	63		06.10		24.3220-1738.3	020545			Rz 20,64
	0.9	77		12.13						
	1.2	51		06.10						
	1.3 D Multijet	55		06.10						
	1.3 D Multijet	70		06.10						
	0.9	63		09.09		24.2520-1705.3	040093			Nz 20,64
	0.9	77		12.13						
	1.2	51		09.09		24.2520-1707.3	040097			Nz 20,64
	1.4	74		09.09						
	1.2	51		09.09	12.09	24.3728-0532.2	590532			L=995

FIAT 500 L Kombi (12-)										
	0.9	77		08.12		24.3541-1829.5	240721	<input type="checkbox"/>		D=54, - Halter BOS
	0.9 CNG	63		03.13		24.3541-1830.5	240722	<input type="checkbox"/>		D=54, - Halter BOS
	1.3 D Multijet	62		08.12						
	1.4	70		08.12						
	1.6 D Multijet	77		08.12						
	1.4	88		01.14		11.9571-9953.2	220871	<input type="checkbox"/>		D=57, - Halter ATE
	1.6 D Multijet	88		09.13		11.9571-9954.2	220872	<input type="checkbox"/>		D=57, - Halter ATE
						11.8171-0008.1	990049	<input type="checkbox"/>		Führungsbolzen ATE
	0.9	77		08.12		24.5112-0402.3	331297	2		L=402
	0.9 CNG	63		03.13						
	1.3 D Multijet	62		08.12						
	1.4	70		08.12						
	1.4	88		01.14						
	1.6 D Multijet	77		08.12						
	1.6 D Multijet	88		09.13						
	0.9	77		08.12		24.5112-0142.3	331016	2	am Bremsattel ¹⁾	L=142
	0.9 CNG	63		03.13						
	1.3 D Multijet	62		08.12						
	1.4	70		08.12						
	1.4	88		01.14						
	1.6 D Multijet	77		08.12						
	1.6 D Multijet	88		09.13						
	1.6 D Multijet	88		09.13						





















FIAT 500 X (14-)										
	1.3 D Multijet	70		06.15		11.9571-9969.2	220955	<input type="checkbox"/>		D=57, - Halter ATE
	1.4	100		09.14		11.9571-9970.2	220956	<input type="checkbox"/>		D=57, - Halter ATE
	1.4	103		09.14		11.8171-0008.1	990049	<input type="checkbox"/>		Führungsbolzen ATE
	1.6 D Multijet	84		09.14						
	1.6 D MultiJet	88		09.14						
	1.3 D Multijet	70		06.15		24.5112-0406.3	331496	2		L=405
	1.4	100		09.14						
	1.4	103		09.14						
	1.4 4x4	120		09.14						
	1.4 4x4	125		09.14						
	1.6	81		11.14						
	1.6	82		09.14						
	1.6 D Multijet	84		09.14						
	1.6 D MultiJet	88		09.14						
	2.0 D MultiJet 4x4	100		09.14						
2.0 D MultiJet 4x4	103		09.14							

FIAT BARCHETTA (95-04)										
	1.8 i 16V			04.95	10.04	24.2122-1716.3	010485			THz 22,20
	1.8 i 16V			06.95	10.04	24.3541-1789.5	240291	<input type="checkbox"/>		D=54, - Halter ATE
						24.3541-1790.5	240292	<input type="checkbox"/>		D=54, - Halter ATE
	1.8 i 16V			04.95	10.04	24.5112-0395.3	330521	<input type="checkbox"/>		L=395
						24.5112-0396.3	330520	<input type="checkbox"/>		L=397
	1.8 i 16V			04.95	10.04	24.3344-1703.5	240117	<input type="checkbox"/>	+ GG-Sättel ²⁾	D=34, - Halter TRW
						24.3344-1704.5	240118	<input type="checkbox"/>	+ GG-Sättel ²⁾	D=34, - Halter TRW
	1.8 i 16V			04.95	10.04	24.5112-0160.3	330612	2		L=160

¹⁾ on the brake caliper / sulla pinza freno / sur l'étrier de frein / a la pinza de freno
²⁾ + cast iron caliper / + pinza in ghisa / + étriers en fonte grise / + fundición gris-pinza

										
FIAT BARCHETTA (95-04)										
	1.8 i 16V			04.95	10.04	24.3727-0549.2	580549	2 ↓	L=1521	
	1.8 i 16V			04.95	10.04 + ABS	24.6513-1705.3	320237	←	BRL (2)	
FIAT BRAVA (95-01)										
	1.2 i 16V 1.4 i 12V 1.6 16 V 1.6 i 16V 1.8 i 16V 1.9 D 1.9 JTD 1.9 TD 2.0	76 76 76 76 76 76 76 76 76 113		12.98 09.95 01.99 09.95 09.95 09.95 12.98 06.96 09.98	10.01 10.01 12.02 10.01 10.01 10.01 10.01 10.01 10.01	24.2122-1716.3	010485		Thz 22,20	
	1.2 i 16V 1.4 i 12V 1.6 16 V 1.6 i 16V 1.9 D 1.9 JTD 1.9 TD 2.0	76 76 76 76 76 76 76 76		12.98 09.95 01.99 09.95 09.95 12.98 06.96 09.98	10.01 + Schaltgetriebe ¹⁾ 10.01 + Schaltgetriebe ¹⁾ 12.02 + Schaltgetriebe ¹⁾ 10.01 + Schaltgetriebe ¹⁾ 10.01 + Schaltgetriebe ¹⁾ 10.01 + Schaltgetriebe ¹⁾ 10.01 + Schaltgetriebe ¹⁾ 08.00	24.3541-1787.5 24.3541-1788.5	240289 240290	<input type="checkbox"/> <input type="checkbox"/>	D=54, - Halter D=54, - Halter	ATE ATE
	1.2 i 16V 1.4 i 12V 1.6 16 V 1.6 i 16V 1.8 i 16V 1.9 D 1.9 JTD 1.9 TD 2.0	76 76 76 76 76 76 76 76 76		12.98 09.95 01.99 09.95 09.95 09.95 12.98 06.96 09.98	10.01 + Automatikgetriebe ²⁾ 10.01 + Automatikgetriebe ²⁾ 12.02 + Automatikgetriebe ²⁾ 10.01 + Automatikgetriebe ²⁾ 10.01 + Automatikgetriebe ²⁾ 10.01 + Automatikgetriebe ²⁾ 10.01 + Automatikgetriebe ²⁾ 10.01 + Automatikgetriebe ²⁾ 08.00	24.3541-1789.5 24.3541-1790.5	240291 240292	<input type="checkbox"/> <input type="checkbox"/>	D=54, - Halter D=54, - Halter	ATE ATE
	1.2 i 16V 1.4 i 12V 1.6 16 V 1.6 i 16V 1.8 i 16V 1.9 D 1.9 JTD 1.9 TD 2.0	76 76 76 76 76 76 76 76 76		12.98 09.95 01.99 09.95 09.95 09.95 12.98 06.96 09.98	10.01 10.01 12.02 10.01 10.01 10.01 10.01 10.01 08.00	24.5112-0387.3 24.5112-0388.3	330519 330518	<input type="checkbox"/> <input type="checkbox"/>	L=387 L=385	
	1.2 i 16V 1.4 i 12V 1.6 16 V 1.6 i 16V 1.8 i 16V 1.9 D 1.9 JTD 1.9 TD 2.0	76 76 76 76 76 76 76 76 76		12.98 09.95 01.99 09.95 09.95 09.95 12.98 06.96 09.98	10.01 10.01 12.02 10.01 10.01 10.01 10.01 10.01 08.00	24.5228-0223.3	330530	2	L=223	
	1.2 i 16V 1.4 i 12V 1.9 D			12.98 09.95 09.95	10.01 - ABS 10.01 - ABS 10.01 - ABS	24.3222-1126.3 24.3222-1724.3	020358 020466	<input type="checkbox"/> <input type="checkbox"/>	Rz 22,20 Rz 22,20	AP
	1.4 i 12V 1.6 16 V 1.8 i 16V 1.9 D 1.9 TD			09.95 09.95 09.95 09.95 06.96	+ ABS / VET: - 4255655 VET: - 4255655 VET: - 4255655 + ABS / VET: - 4255655 VET: - 4255655	24.3222-1707.3	020104		Rz 22,20	BDX
	1.2 i 16V 1.4 i 12V 1.6 16 V 1.6 i 16V 1.8 i 16V 1.9 D 1.9 JTD 1.9 TD 2.0	76 76 76 76 76 76 76 76 76		12.98 10.01 01.99 10.01 10.01 10.01 12.98 10.01 09.98	+ ABS + ABS / VET: 4255656 - VET: 4255656 - VET: 4255656 - VET: 4255656 - + ABS / VET: 4255656 - VET: 4255656 - VET: 4255656 - 08.00	24.3222-1724.3	020466		Rz 22,20	
	1.2 i 16V 1.4 i 12V 1.9 D			12.98 09.95 09.95	- ABS - ABS - ABS	24.3727-0536.2 24.3727-0535.2	580536 580535	<input type="checkbox"/> <input type="checkbox"/>	L=1424 L=1370	
	1.2 i 16V 1.4 i 12V 1.6 16 V 1.6 i 16V 1.8 i 16V 1.9 D 1.9 JTD 1.9 TD 2.0	76 76 76 76 76 76 76 76 76		12.98 09.95 01.99 09.95 09.95 09.95 12.98 06.96 09.98	+ ABS + ABS + ABS + ABS + ABS + ABS + ABS + ABS 08.00	24.3727-0539.2 24.3727-0540.2	580539 580540	<input type="checkbox"/> <input type="checkbox"/>	L=1428 L=1383	
	1.9 JTD			12.98	10.01	24.2419-1721.3	030100		Gz 19,05	
	1.9 JTD			12.98	10.01	24.2525-1705.3	040083		Nz 25,40	

1) + manual transmission / + scatola cambio velocità / + transmission mécanique / + cambio de velocidad
2) + autom.transmission / + scatola cambio automatico / + transmission automatique / + cambio automático
3) + cast iron / + ghisa / + fonte grise / + fundición de gris
4) + aluminium / + alluminio / + aluminium / + aluminio

								
FIAT BRAVA (95-01)								
	1.2 i 16V	◀		12.98	10.01	24.3728-0523.2	590523	L=937
	1.4 i 12V	◀		09.95	10.01			
	1.6 i 16V	◀		09.95	10.01	24.3728-0524.2	590524	L=860
	1.8 i 16V	◀		09.95	10.01	24.3728-0528.2	590528	L=1545
	1.9 D	◀		09.95	10.01			
1.9 TD	◀	74		06.96	10.01			
FIAT BRAVO (95-01)								
	1.2 i 16V	◀		12.98	10.01	24.2122-1716.3	010485	Thz 22,20
	1.4 i 12V	◀		09.95	10.01			
	1.6 i 16V	◀		09.95	10.01			
	1.8 i 16V	◀		09.95	10.01			
	1.9 D	◀		09.95	10.01			
	1.9 JTD	◀		12.98	10.01			
	1.9 TD	◀		06.96	10.01			
	2.0 i 20V	◀		09.95	10.01			
	1.2 i 16V			12.98	10.01	24.3541-1787.5	240289	D=54, - Halter
	1.4 i 12V			09.95	10.01	24.3541-1788.5	240290	D=54, - Halter
	1.6 i 16V			09.95	10.01			
	1.9 D		55	09.95	10.01			
	1.9 TD			06.96	10.01			
	1.8 i 16V			09.95	10.01	24.3541-1789.5	240291	D=54, - Halter
	1.9 JTD			12.98	10.01	24.3541-1790.5	240292	D=54, - Halter
	1.9 TD		74	06.96	10.01			
	1.2 i 16V			12.98	10.01	24.5112-0387.3	330519	L=387
	1.4 i 12V			09.95	10.01	24.5112-0388.3	330518	L=385
	1.6 i 16V			09.95	10.01			
	1.8 i 16V			09.95	10.01			
	1.9 D			09.95	10.01			
	1.9 JTD			12.98	10.01			
	1.9 TD			06.96	10.01			
	2.0 i 20V			09.95	10.01			
	2.0 i 20V			09.95	10.01	24.3344-1703.5	240117	+ GG-Sättel ¹⁾
						24.3344-1704.5	240118	+ GG-Sättel ¹⁾
	1.2 i 16V			12.98	10.01	24.5228-0223.3	330530	L=223
	1.4 i 12V			09.95	10.01			
	1.6 i 16V			09.95	10.01			
	1.8 i 16V			09.95	10.01			
	1.9 D			09.95	10.01			
	1.9 JTD			12.98	10.01			
	1.9 TD			06.96	10.01			
	2.0 i 20V			09.95	10.01			
	1.2 i 16V			12.98	10.01	24.3222-1126.3	020358	Rz 22,20
	1.4 i 12V			09.95	10.01	24.3222-1724.3	020466	Rz 22,20
	1.9 D			09.95	10.01			
	1.4 i 12V			09.95	11.98	24.3222-1707.3	020104	Rz 22,20
	1.6 i 16V			09.95	11.98			
	1.8 i 16V			09.95	11.98			
	1.9 D			09.95	11.98			
	1.9 TD			06.96	11.98			
	1.2 i 16V			12.98	10.01	24.3222-1724.3	020466	Rz 22,20
	1.4 i 12V			12.98	10.01			
	1.2 i 16V			12.98	10.01	24.3727-0536.2	580536	L=1424
	1.4 i 12V			09.95	10.01	24.3727-0535.2	580535	L=1370
	1.9 D			09.95	10.01			
	1.2 i 16V			12.98	10.01	24.3727-0539.2	580539	L=1428
	1.4 i 12V			09.95	10.01	24.3727-0540.2	580540	L=1383
	1.6 i 16V			09.95	10.01			
	1.8 i 16V			09.95	10.01			
	1.9 D			09.95	10.01			
1.9 JTD			12.98	10.01				
1.9 TD			06.96	10.01				
	1.9 JTD	◀		12.98	10.01	24.2419-1721.3	030100	Gz 19,05
	2.0 i 20V	◀		09.95	10.01			
	1.9 JTD	◀		12.98	10.01	24.2525-1705.3	040083	Nz 25,40
	2.0 i 20V	◀		09.95	10.01			
	1.2 i 16V	◀		12.98	10.01	24.3728-0523.2	590523	L=937
	1.4 i 12V	◀		09.95	10.01			
	1.6 i 16V	◀		09.95	10.01	24.3728-0524.2	590524	L=860
	1.8 i 16V	◀		09.95	10.01	24.3728-0528.2	590528	L=1545
	1.9 D	◀		09.95	10.01			
1.9 TD	◀	74		06.96	10.01			

¹⁾ + cast iron caliper / + pinza in ghisa / + étriers en fonte grise / + fundición gris-pinza

²⁾ + cast iron / + ghisa / + fonte grise / + fundición de gris

³⁾ + aluminium / + alluminio / + aluminium / + aluminio



FIAT BRAVO (07-)										
	1.4 16V 1.4 i 16V 1.4 LPG 1.4 T-Jet 1.4 T-Jet 1.6 D Multijet 1.9 D Multijet 1.9 D Multijet 1.9 D Multijet 2.0 D Multijet	103 66 66 88 110 66 110		04.08 01.08 11.09 01.08 01.08 03.08 01.08 01.08 01.08 09.08			24.4123-1710.3	010866		THz 23,81 - Behälter BOS
	1.4 i 16V 1.4 LPG 1.4 T-Jet 1.6 D Multijet 1.9 D Multijet 1.9 D Multijet	66 66 88 66 66		04.07 11.09 09.07 03.08 04.07 04.07			24.3541-1811.5 24.3541-1812.5	240429 240430	<input type="checkbox"/> <input type="checkbox"/>	D=54, - Halter BOS D=54, - Halter BOS D=54, - Halter BOS D=54, - Halter BOS
	1.4 16V 1.4 i 16V 1.4 LPG 1.4 T-Jet 1.4 T-Jet 1.6 D Multijet 1.9 D Multijet 1.9 D Multijet 1.9 D Multijet 2.0 D Multijet	103 66 66 88 110 66 110		04.08 04.07 11.09 09.07 09.07 03.08 04.07 04.07 04.07 09.08			24.5112-0413.3	331151	2	L=412
	1.4 16V 1.4 i 16V 1.4 LPG 1.4 T-Jet 1.4 T-Jet 1.6 D Multijet 1.9 D Multijet 1.9 D Multijet 1.9 D Multijet 2.0 D Multijet	103 66 66 88 110 66 110		04.08 04.07 11.09 09.07 09.07 03.08 04.07 04.07 04.07 09.08			24.5112-0187.3	331150	2	L=187
	1.4 16V 1.4 i 16V 1.4 LPG 1.4 T-Jet 1.4 T-Jet 1.6 D Multijet 1.9 D Multijet 1.9 D Multijet 1.9 D Multijet 2.0 D Multijet	103 66 66 88 110 66 110		04.08 04.07 11.09 09.07 09.07 03.08 04.07 04.07 04.07 09.08			24.3727-0553.2 24.3727-0554.2	580553 580554	<input type="checkbox"/> <input type="checkbox"/>	L=1786 L=1668
FIAT CINQUECENTO (92-98)										
	1100 Sporting 700 900 i.e.			11.94 05.98 02.92 05.98 02.92 05.98			24.2119-0833.3	010418		THz 19,05
	1100 Sporting 700 900 i.e.			11.94 05.98 02.92 05.98 02.92 05.98			24.3481-1743.5 24.3481-1744.5	240305 240306	<input type="checkbox"/> <input type="checkbox"/>	D=48, - Halter BDX D=48, - Halter BDX
	1100 Sporting 700 900 i.e.			11.94 05.98 02.92 05.98 02.92 05.98			24.5112-0445.3	330564	2	L=445
	1100 Sporting 700 900 i.e.			11.94 05.98 02.92 05.98 02.92 05.98			24.5228-0275.3	330035	2	L=275
	1100 Sporting 700 900 i.e.			11.94 05.98 02.92 05.98 02.92 05.98			24.3219-0803.3	020183		Rz 19,05
	1100 Sporting 700 900 i.e.			11.94 09.97 02.92 09.97 02.92 09.97			24.3727-0523.2	580523	1	L=2988
	1100 Sporting 700 900 i.e.			10.97 05.98 10.97 05.98 10.97 05.98			24.3727-0544.2	580544	1	L=2670
	900 i.e.			02.92 05.98			24.3728-0507.2	590507		L=570
	1100 Sporting			11.94 05.98			24.3728-0517.2	590517		L=776
FIAT COUPE (94-00)										
	1.8 i 16V 2.0 i 16V 2.0 i 16V Turbo			07.96 12.00 12.93 06.96 12.93 06.96			24.2122-1716.3	010485		THz 22,20
	2.0 i 16V 2.0 i 16V Turbo			12.93 06.96 12.93 06.96			24.3344-1703.5 24.3344-1704.5	240117 240118	<input type="checkbox"/> + GG-Sättel ¹⁾ <input type="checkbox"/> + GG-Sättel ¹⁾	D=34, - Halter TRW D=34, - Halter TRW
	1.8 i 16V 2.0 i 16V 2.0 i 16V Turbo 2.0 i 20V 2.0 i 20V Turbo			07.96 12.00 12.93 06.96 12.93 06.96 01.97 12.00 01.97 12.00			83.6401-0159.3	330746	2	L=160

¹⁾ + cast iron caliper / + pinza in ghisa / + étriers en fonte grise / + fundición gris-pinza





FIAT DOBLO (01-10)																		
	1.3 JTD	55		10.05	01.10	24.5112-0490.3	330876	2		L=490								
	1.3 JTD	62		10.05	01.10													
	1.4 i	57		10.05	01.10													
	1.6 i 16V	76		10.05	01.10													
	1.6 Natural Power	76		09.02	01.10													
	1.9 JTD	74		10.05	01.10													
	1.9 JTD	77		10.05	01.10													
	1.9 JTD	88		10.05	01.10													
	1.9 JTD	88		10.05	01.10													
	1.2 i.e.	48		01.01	01.04	24.3220-1722.3	020458			Rz 20,64								
	1.6 i 16V	76		10.01	01.04													
	1.6 Natural Power	76		09.02	01.04													
	1.9 D	46		01.01	01.04													
	1.9 JTD	74		10.01	01.04													
	1.9 JTD	77		07.03	01.04													
		1.3 D Multijet	55		02.04						09.05	24.3220-1107.3	020218			Rz 20,64	AP	
		1.3 D Multijet	62		02.04						09.05							
		1.3 JTD	55		02.04						09.05							
		1.3 JTD	62		02.04						09.05							
1.4 i		57		02.04	09.05													
1.6 i 16V		76		02.04	09.05													
1.6 Natural Power		76		02.04	09.05													
1.9 D Multijet		88		02.04	09.05													
1.9 JTD		74		02.04	09.05													
1.9 JTD		77		02.04	09.05													
1.9 JTD		88		02.04	09.05													
		1.3 D Multijet	55		10.05	01.10	24.3220-1728.3	020509			Rz 20,64							
		1.3 D Multijet	62		10.05	01.10												
		1.3 JTD	55		10.05	01.10												
		1.3 JTD	62		10.05	01.10												
	1.4 i	57		10.05	01.10													
	1.6 i 16V	76		10.05	01.10													
	1.6 Natural Power	76		10.05	01.10													
	1.9 D Multijet	88		10.05	01.10													
	1.9 JTD	74		10.05	01.10													
	1.9 JTD	77		10.05	01.10													
	1.9 JTD	88		10.05	01.10													
		1.2 i.e.	48		01.01	01.10						24.3727-0560.2	580560	2	☐		L=1741	
		1.3 JTD	51		05.04	01.10												
		1.4 i	57		10.05	01.10												
		1.6 i 16V	76		10.01	01.10												
1.9 D		46		01.01	01.10													
1.9 JTD		74		10.01	01.10													
1.9 JTD		77		07.03	01.10													
		1.2 i.e.	48		01.01	01.10	24.3727-0561.2	580561	☐	☐								L=1788
		1.3 JTD	51		05.04	01.10												
		1.4 i	57		12.09	01.10												
		1.6 i 16V	76		10.01	01.10												
		1.9 D	46		01.01	01.10												
		1.9 JTD	74		10.01	01.10												
		1.9 JTD	77		07.03	01.10												
			1.2 i.e. Kastenw.	48		01.01												
	1.3 JTD Kastenw.		51		05.04	01.10												
	1.6 i 16V Kastenw.		76		10.01	01.10												
	1.9 D Kastenw.		46		01.01	01.10												
	1.9 JTD Kastenw.		74		10.01	01.10												
	1.9 JTD Kastenw.		77		07.03	01.10												

FIAT DOBLO (10-)																		
	1.3 D Multijet			02.10		24.3541-1829.5	240721	☐	☐	D=54, - Halter	BOS							
	1.4	70		02.10														
	1.4	88		10.11														
	1.4 Natural Power	88		02.10														
	1.6 D Multijet	66		02.10														
	1.6 D Multijet	70		03.15														
	1.6 D Multijet	74		02.10														
	1.6 D Multijet	77		02.10														
	1.6 D Multijet	88		03.15														
	2.0 D Multijet	99		02.10														
		1.3 D Multijet			02.10								11.9571-9953.2	220871	☐	☐	D=57, - Halter	ATE
		1.4	70		02.10													
1.4		88		10.11														
1.4 Natural Power		88		02.10														
1.6 D Multijet		66		02.10														
1.6 D Multijet		70		03.15														
1.6 D Multijet		74		02.10														
1.6 D Multijet		77		02.10														
1.6 D Multijet		88		03.15														
2.0 D Multijet		99		02.10														
		1.3 D Multijet			02.10		24.5112-0406.3	331496	2		L=405							
		1.4	70		02.10													
	1.4	88		10.11														
	1.4 Natural Power	88		02.10														
	1.6 D Multijet	66		02.10														
	1.6 D Multijet	74		03.15														

1) - bus / - autobus / - autobus/car / - autobús
2) + bus / + autobus / + autobus/car / + autobús
3) - armoured vehicles / - veicoli blindati / - vehículo blindado
4) + brake disc diameter 284mm / + diametro dischi freno 284mm / + diamètre disques frein 284mm / + diametro disco freno 284mm
5) + brake disc diameter 305mm / + diametro dischi freno 305mm / + diamètre disques frein 305mm / + diametro disco freno 305mm



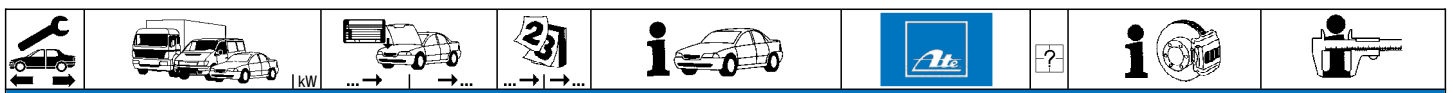

FIAT DOBLO (10-)

	1.6 D Multijet	77		02.10		24.5112-0406.3	331496	2		L=405	
	1.6 D Multijet	88		03.15							
	2.0 D Multijet	99		02.10							
	1.3 D Multijet			02.10		24.5204-0200.3	331499	2		L=200	
	1.4	70		02.10							
	1.4	88		10.11							
	1.4 Natural Power	88		02.10							
	1.6 D Multijet	66		02.10							
	1.6 D Multijet	70		03.15							
	1.6 D Multijet	74		02.10							
	1.6 D Multijet	77		02.10							
	1.6 D Multijet	88		03.15							
	2.0 D Multijet	99		02.10							
	1.3 D Multijet			02.10	+ 9" Bremse 1)	24.3220-1728.3	020509			Rz 20,64	
	1.4	70		02.10	+ 9" Bremse 1)						
	1.4	88		10.11	+ 9" Bremse 1)						
	1.4 Natural Power	88		02.10	+ 9" Bremse 1)						
	1.6 D Multijet	66		02.10	+ 9" Bremse 1)						
	1.6 D Multijet	70		03.15	+ 9" Bremse 1)						
	1.6 D Multijet	74		02.10	+ 9" Bremse 1)						
	1.6 D Multijet	77		02.10	+ 9" Bremse 1)						
	1.6 D Multijet	88		03.15	+ 9" Bremse 1)						
	2.0 D Multijet	99		02.10	+ 9" Bremse 1)						
	1.3 D Multijet			02.10	+ 10" Bremse 2)	24.3222-1725.3	020510		- erhöhte Zuladung 3)	Rz 22,00	AP
	1.4	70		02.10	+ 10" Bremse 2)	24.3225-1704.3	020541		+ erhöhte Zuladung 4)	Rz 25,40	
	1.4	88		10.11	+ 10" Bremse 2)						
	1.4 Natural Power	88		02.10	+ 10" Bremse 2)						
	1.6 D Multijet	66		02.10	+ 10" Bremse 2)						
	1.6 D Multijet	70		03.15	+ 10" Bremse 2)						
	1.6 D Multijet	74		02.10	+ 10" Bremse 2)						
	1.6 D Multijet	77		02.10	+ 10" Bremse 2)						
	1.6 D Multijet	88		03.15	+ 10" Bremse 2)						
	2.0 D Multijet	99		02.10	+ 10" Bremse 2)						

FIAT DUCATO (94-02)

	1.9 D (10)			02.94	10.94	24.2122-1715.3	010481		- ABS	THz 22,20	
	1.9 TD (10)			02.94	10.94	24.2122-1714.3	010480		+ ABS	THz 22,20	
	1.9 TD CAT (10)			02.94	10.94						
	2.0 i (10/14)			02.94	10.94						
	2.5 D (14)			02.94	10.94						
	2.5 TDI (14)			02.94	10.94						
	2.5 TDI ECO (14)			02.94	10.94						
	1.9 D (10)			11.94	10.01	24.2125-1703.3	010483		- ABS	THz 25,40	
	1.9 TD (10)			11.94	10.01	24.2125-1702.3	010482		+ ABS	THz 25,40	
	1.9 TD CAT (10)			11.94	10.01						
	2.0 i (10/14)			11.94	10.01						
	2.0 i (18)			02.94	10.01						
	2.5 D (14)			11.94	10.01						
	2.5 D (18)			02.94	10.01						
	2.5 TDI (14)			11.94	10.01						
	2.5 TDI (18)			02.94	10.01						
	2.5 TDI ECO (14)			11.94	10.01						
	2.5 TDI ECO (18)			02.94	10.01						
	2.8 D (14)			02.98	10.01						
	2.8 D (18)			02.98	10.01						
	2.8 iDTD 4x4			05.98	09.01						
	2.8 JTD (14)			11.00	10.01						
2.8 JTD (18)			11.00	10.01							
2.8 TDI (14)			10.97	10.01							
2.8 TDI (18)			10.97	10.01							
	1.9 D (10)			11.01	03.02	24.2125-1725.3	010717		- ABS	THz 25,40	
	1.9 TD (10)			11.01	03.02	24.2125-1726.3	010718		+ ABS	THz 25,40	
	1.9 TD CAT (10)			11.01	03.02						
	2.0 i (10/14)			11.01	03.02						
	2.0 i (18)			11.01	03.02						
	2.0 JTD (14)			10.01	03.02						
	2.0 JTD (18)			10.01	03.02						
	2.5 D (14)			11.01	03.02						
	2.5 D (18)			11.01	03.02						
	2.5 TDI (14)			11.01	03.02						
	2.5 TDI (18)			11.01	03.02						
	2.5 TDI ECO (14)			11.01	03.02						
	2.5 TDI ECO (18)			11.01	03.02						
	2.8 D (14)			11.01	03.02						
	2.8 D (18)			11.01	03.02						
2.8 JTD (14)			11.01	03.02							
2.8 JTD (18)			11.01	03.02							
2.8 TDI (14)			11.01	03.02							
2.8 TDI (18)			11.01	03.02							
	1.9 D (10)			02.94	10.01	24.0101-4804.2	260050			Bremssattel-Zubehör	TRW
	1.9 TD (10)			02.94	10.01						
	1.9 TD CAT (10)			02.94	10.01						
	2.0 i (10/14)			02.94	10.01						
	2.5 D (14)			02.94	10.01						
	2.8 D (14)			02.98	10.01						

1) + 9" brake / + servofreno da 9" / + frein de 9" / + freno de 9"
 2) + 10" brake / + freno 10" / + frein de 10" / + freno de 10"
 3) - increased payload / - carico utile maggiorato / - charge utile augmentée / - incremento de carga
 4) + increased payload / + carico utile maggiorato / + charge utile augmentée / + incremento de carga



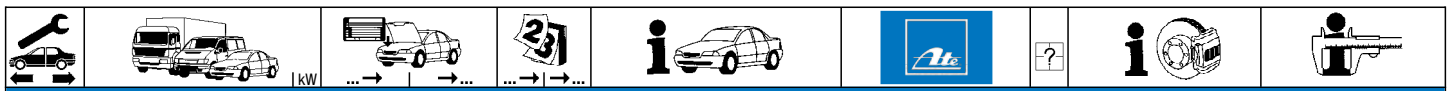





















FIAT DUCATO (94-02)



























	1.9 D (10)			02.94	01.00	24.5112-0466.3	330579	2	L=462 L=465, + Clip
	1.9 TD (10)			02.94	01.00	24.5112-0465.3	330526	2	
	1.9 TD CAT (10)			02.94	01.00				
	2.0 i (10/14/18)			02.94	01.00				
	2.5 D (14/18)			02.94	01.00				
	2.5 TDI (14/18)			02.94	01.00				
	2.5 TDI ECO (14/18)			02.94	01.00				
	2.8 D (14/18)			02.98	01.00				
	2.8 IDTD 4x4			05.98	01.00				
	2.8 TDI (14/18)			10.97	01.00				
	1.9 D (10)			02.00	10.01	24.5112-0466.3	330579	2	L=462 L=460, + Clip
	1.9 TD (10)			02.00	10.01	24.5112-0461.3	330616	2	
	1.9 TD CAT (10)			02.00	10.01				
	2.0 i (10/14/18)			02.00	10.01				
	2.5 D (14/18)			02.00	10.01				
	2.5 TDI (14/18)			02.00	10.01				
	2.5 TDI ECO (14/18)			02.00	10.01				
	2.8 D (14/18)			02.00	10.01				
	2.8 IDTD 4x4			02.00	10.01				
	2.8 JTD (14/18)			11.00	10.01				
2.8 TDI (14/18)			02.00	10.01					
	1.9 D (10)			11.01	03.02	24.5112-0477.3	331299	2	L=477 L=470
	1.9 TD (10)			11.01	03.02	24.5112-0470.3	331460	2	
	1.9 TD CAT (10)			11.01	03.02				
	2.0 i (10/14/18)			11.01	03.02				
	2.0 JTD (14/18)			10.01	03.02				
	2.5 D (14/18)			11.01	03.02				
	2.5 TDI (14/18)			11.01	03.02				
	2.5 TDI ECO (14/18)			11.01	03.02				
	2.8 D (14/18)			11.01	03.02				
	2.8 JTD (14/18)			11.01	03.02				
2.8 TDI (14/18)			11.01	03.02					
	1.9 D (10)			11.01	03.02	24.3461-1701.5	240449	<input type="checkbox"/>	D=46, - Halter D=46, - Halter
	1.9 TD (10)			11.01	03.02	24.3461-1702.5	240450	<input type="checkbox"/>	
	1.9 TD CAT (10)			11.01	03.02				
	2.0 i (10/14/18)			11.01	03.02				
	2.0 JTD (14/18)			10.01	03.02				
	2.5 D (14/18)			11.01	03.02				
	2.5 TDI (14/18)			11.01	03.02				
	2.5 TDI ECO (14/18)			11.01	03.02				
	2.8 D (14/18)			11.01	03.02				
	2.8 JTD (14/18)			11.01	03.02				
2.8 TDI (14/18)			11.01	03.02					
	1.9 D (10)			02.94	10.01	24.5112-0340.3	330511	1 <input type="checkbox"/>	L=340
	1.9 TD (10)			02.94	10.01				
	1.9 TD CAT (10)			02.94	10.01				
	2.0 i (10/14/18)			02.94	10.01				
	2.5 D (14/18)			02.94	10.01				
	2.5 TDI (14/18)			02.94	10.01				
	2.5 TDI ECO (14/18)			02.94	10.01				
	2.8 D (14/18)			02.98	10.01				
	2.8 IDTD 4x4			05.98	09.01				
	2.8 JTD (14/18)			11.00	10.01				
2.8 TDI (14/18)			10.97	10.01					
	1.9 D (10)			11.01	03.02	83.6401-0159.3	330746	1 <input type="checkbox"/>	L=160
	1.9 TD (10)			11.01	03.02				
	1.9 TD CAT (10)			11.01	03.02				
	2.0 i (10/14/18)			11.01	03.02				
	2.0 JTD (14/18)			10.01	03.02				
	2.5 D (14/18)			11.01	03.02				
	2.5 TDI (14/18)			11.01	03.02				
	2.5 TDI ECO (14/18)			11.01	03.02				
	2.8 D (14/18)			11.01	03.02				
	2.8 JTD (14/18)			11.01	03.02				
2.8 TDI (14/18)			11.01	03.02					
	1.9 D (10)			02.94	10.01	24.3225-1701.3	020399		Rz 25,40
	1.9 TD (10)			02.94	10.01				
	1.9 TD CAT (10)			02.94	10.01				
	2.0 i (10/14)			02.94	10.01				
	2.5 D (14)			02.94	10.01				
	2.5 TDI (14)			02.94	10.01	24.3226-1702.3	020469		
	2.5 TDI ECO (14)			02.94	10.01				
	2.8 D (14)			02.98	10.01				
	2.8 IDTD 4x4			05.98	09.01				
	2.8 JTD (14)			11.00	10.01				
2.8 TDI (14)			10.97	10.01					
	2.0 i (18)			02.94	10.01	24.3228-1701.3	020401		Rz 28,57
	2.5 D (18)			02.94	10.01				
	2.5 TDI (18)			02.94	10.01				
	2.5 TDI ECO (18)			02.94	10.01				
	2.8 D (18)			02.98	10.01				
	2.8 IDTD 4x4			05.98	09.01				
2.8 JTD (18)			11.00	10.01					
2.8 TDI (18)			10.97	10.01					
	1.9 D (10)			11.01	03.02	24.3226-1702.3	020469		Rz 26,99
	1.9 TD (10)			11.01	03.02				



									
FIAT DUCATO (94-02)									
	1.9 TD CAT (10) 2.0 i (10/14) 2.0 JTD (14) 2.5 D (14) 2.5 TDI (14) 2.5 TDI ECO (14) 2.8 D (14) 2.8 JTD (14) 2.8 TDI (14)			11.01 03.02 11.01 03.02 10.01 03.02 11.01 03.02 11.01 03.02 11.01 03.02 11.01 03.02 11.01 03.02 11.01 03.02		24.3226-1702.3	020469		Rz 26,99
	1.9 D (10) 1.9 TD (10) 1.9 TD CAT (10) 2.0 i (10/14/18) 2.5 D (14/18) 2.5 TDI (14/18) 2.5 TDI ECO (14/18) 2.8 D (14/18) 2.8 iDTD 4x4 2.8 TDI (14/18)			02.94 09.99 02.94 09.99 02.94 09.99 02.94 09.99 02.94 09.99 02.94 09.99 02.94 09.99 02.98 09.99 05.98 09.99 10.97 09.99		24.3727-0300.2 24.3727-0345.2	580300 580345	1  1  + HA-Trommelbremse ¹⁾	L=1078 L=3045
	1.9 D (10) 1.9 TD (10) 1.9 TD CAT (10) 2.0 i (10/14/18) 2.5 D (14/18) 2.5 TDI (14/18) 2.5 TDI ECO (14/18) 2.8 D (14/18) 2.8 iDTD 4x4 2.8 JTD (14/18) 2.8 TDI (14/18)			10.99 10.01 10.99 10.01 10.99 10.01 10.99 10.01 10.99 10.01 10.99 10.01 10.99 10.01 10.99 10.01 10.99 10.01 11.00 10.01 10.99 10.01		24.3727-0300.2 24.3727-0344.2	580300 580344	1  1  + HA-Trommelbremse ¹⁾	L=1078 L=2806
	1.9 D (10) 1.9 TD (10) 1.9 TD CAT (10) 2.0 i (10/14/18) 2.0 JTD (14/18) 2.5 D (14/18) 2.5 TDI (14/18) 2.5 TDI ECO (14/18) 2.8 D (14/18) 2.8 JTD (14/18) 2.8 TDI (14/18)			11.01 03.02 11.01 03.02 11.01 03.02 11.01 03.02 10.01 03.02 11.01 03.02 11.01 03.02 11.01 03.02 11.01 03.02 11.01 03.02 11.01 03.02		24.3727-0300.2 24.3727-0343.2	580300 580343	1  1  + HA-Trommelbremse ¹⁾	L=1078 L=2827
	1.9 D (10) 1.9 TD (10) 1.9 TD CAT (10) 2.0 i (10/14/18) 2.0 JTD (14/18) 2.5 D (14/18) 2.5 TDI (14/18) 2.5 TDI ECO (14/18) 2.8 D (14/18) 2.8 iDTD 4x4 2.8 JTD (14/18) 2.8 TDI (14/18)			02.94 03.02 02.94 03.02 02.94 03.02 02.94 03.02 10.01 03.02 02.94 03.02 02.94 03.02 02.94 03.02 02.94 03.02 02.98 03.02 05.98 09.01 11.00 03.02 10.97 03.02		24.3727-0300.2 24.3727-0340.2	580300 580340	1  1  + HA-Scheibenbremse ²⁾	L=1078 L=3025
	1.9 D (10) 1.9 TD (10) 1.9 TD CAT (10) 2.0 i (10/14/18) 2.5 D (14/18) 2.5 TDI (14/18) 2.5 TDI ECO (14/18) 2.8 D (14/18) 2.8 iDTD 4x4 2.8 JTD (14/18) 2.8 TDI (14/18)			02.94 10.01 02.94 10.01 02.94 10.01 02.94 10.01 02.94 10.01 02.94 10.01 02.94 10.01 02.98 10.01 05.98 09.01 11.00 10.01 10.97 10.01		24.6512-1701.3	320153	- ABS	BRL (2)
	1.9 D (10) 1.9 TD (10) 1.9 TD CAT (10)			02.94 03.02 02.94 03.02 02.94 03.02		24.3728-0337.2	590337		L=1058
	2.0 i (10/14) 2.0 JTD (14) 2.5 D (14) 2.5 TDI (14) 2.5 TDI ECO (14) 2.8 iDTD 4x4 2.8 JTD (14) 2.8 TDI (14)			02.94 03.02 10.01 03.02 02.94 03.02 02.94 03.02 02.94 03.02 05.98 09.01 11.00 03.02 10.97 03.02		24.3728-0518.2 24.3728-0534.2	590518 590534		L=1034 L=1080
	2.8 D (14)			02.98 03.02		24.3728-0518.2	590518		L=1034
	2.0 i (18) 2.0 JTD (18) 2.5 D (18) 2.5 TDI (18) 2.5 TDI ECO (18) 2.8 D (18) 2.8 iDTD 4x4 2.8 JTD (18) 2.8 TDI (18)			02.94 03.02 10.01 03.02 02.94 03.02 02.94 03.02 02.94 03.02 02.98 03.02 05.98 09.01 11.00 03.02 10.97 03.02		24.3728-0519.2 24.3728-0534.2	590519 590534		L=1090 L=1080

¹⁾ + RA drum brake / + P freno a tamburo / + frein à tambour essieu AR / + ET-tambores de freno

²⁾ + RA disc brake / + P disco freno / + frein à disque essieu AR / + ET-disco de freno

									
FIAT DUCATO (02-06)									
	2.0 i (11/15/18)	81		04.02	07.06	24.2125-1725.3	010717	- ABS	THz 25,40
	2.0 JTD (11/15/18)	62		04.02	07.06	24.2125-1726.3	010718	+ ABS	THz 25,40
	2.3 JTD (11/15/18)	81		04.02	07.06				
	2.8 JTD (11/15/18)			04.02	07.06				
	2.8 JTD 4x4(11/15/18)	94		07.02	07.06				
	2.0 i (11/15/18)	81		04.02	07.06	24.5112-0477.3	331299	2	L=477
	2.0 JTD (11/15/18)	62		04.02	07.06	24.5112-0470.3	331460	2	L=470
	2.3 JTD (11/15/18)	81		04.02	07.06				
	2.8 JTD (11/15/18)			04.02	07.06				
	2.8 JTD 4x4(11/15/18)	94		07.02	07.06				
	2.0 i (11/15/18)	81		04.02	07.06	24.3461-1701.5	240449		D=46, - Halter
	2.0 JTD (11/15/18)	62		04.02	07.06	24.3461-1702.5	240450		D=46, - Halter
	2.3 JTD (11/15/18)	81		04.02	07.06				
	2.8 JTD (11/15/18)			04.02	07.06				
	2.8 JTD 4x4(11/15/18)	94		07.02	07.06				
	2.0 i (11/15/18)	81		04.02	07.06	83.6401-0159.3	330746	2	L=160
	2.0 JTD (11/15/18)	62		04.02	07.06				
	2.3 JTD (11/15/18)	81		04.02	07.06				
	2.8 JTD (11/15/18)			04.02	07.06				
	2.8 JTD 4x4(11/15/18)	94		07.02	07.06				
	2.0 i (11/15)	81		04.02	07.06	24.3226-1702.3	020469		Rz 26,99
	2.0 JTD (11/15)	62		04.02	07.06				
	2.3 JTD (11/15)	81		04.02	07.06				
	2.8 JTD (11/15)			04.02	07.06				
	2.8 JTD 4x4 (11/15)	94		07.02	07.06				
	2.0 i (11/15/18)	81		04.02	07.06	24.3727-0300.2	580300	1 	L=1078
	2.0 JTD (11/15/18)	62		04.02	07.06	24.3727-0343.2	580343	1 	L=2827
	2.3 JTD (11/15/18)	81		04.02	07.06				
	2.8 JTD (11/15/18)			04.02	07.06				
	2.8 JTD 4x4(11/15/18)	94		07.02	07.06	24.3727-0562.2	580562	1 	L=1059
						24.3727-0343.2	580343	1 	L=2827
	2.0 i (11/15/18)	81		04.02	07.06	24.3728-0300.2	590300		L=1478
	2.0 JTD (11/15/18)	62		04.02	07.06				
	2.3 JTD (11/15/18)	81		04.02	07.06				
	2.8 JTD (11/15/18)			04.02	07.06	24.3728-0335.2	590335		L=1435
	2.8 JTD 4x4(11/15/18)	94		07.02	07.06				
FIAT DUCATO (06-)									
	140 Natural Power	100		04.09		24.4125-1701.3	010867	+ Dynamic Control ²⁾	THz 25,40 + Behälter BOS
	2.0 D 115 Multijet	85		06.11					
	2.2 D 100 Multijet	74		07.06					
	2.3 D 120 Multijet	88		07.06					
	2.3 D 130 Multijet	96		01.07					
	3.0 D 150 Multijet	107		04.10					
	3.0 D 150 Multijet	107		06.11					
	3.0 D 160 Multijet	116		07.06					
	3.0 D Multijet	130		06.11					
	140 Natural Power	100		04.09		24.4126-1701.3	010868	+ Dynamic Control ²⁾	THz 26,99 + Behälter BOS
	2.0 D 115 Multijet	85		06.11					
	2.2 D 100 Multijet	74		07.06					
	2.3 D 120 Multijet	88		07.06					
	2.3 D 130 Multijet	96		01.07					
	2.3 D 150 Multijet	109		06.11					
	3.0 D 150 Multijet	107		04.10					
	3.0 D 160 Multijet	116		07.06					
	3.0 D Multijet	130		06.11					
	140 Natural Power	100		04.09		24.5112-0492.3	331217	2	L=492
	2.0 D 115 Multijet	85		06.11					
	2.2 D 100 Multijet	74		07.06					
	2.3 D 120 Multijet	88		07.06					
	2.3 D 130 Multijet	96		01.07					
	2.3 D 150 Multijet	109		06.11					
	2.3 D 150 Multijet	110		12.15					
	2.3 D 180 Multijet	130		12.15					
	3.0 D 150 Multijet	107		04.10					
	3.0 D 160 Multijet	116		07.06					
	3.0 D Multijet	130		06.11					
	140 Natural Power	100		04.09		24.5112-0417.3	331298	2	L=417
	2.0 D 115 Multijet	85		06.11		83.7101-9489.3	330906	2	L=489
	2.2 D 100 Multijet	74		07.06					
	2.3 D 120 Multijet	88		07.06					
	2.3 D 130 Multijet	96		01.07					
	2.3 D 150 Multijet	109		06.11					
	2.3 D 150 Multijet	110		12.15					
	2.3 D 180 Multijet	130		12.15					
	3.0 D 150 Multijet	107		04.10					
	3.0 D 160 Multijet	116		07.06					
	3.0 D Multijet	130		06.11					
FIAT FIORINO (93-01)									
	1.3			09.93	03.01	20.5522-1093.3	010731	+ ABS	THz 22,20 ATE
	1.4			09.93	03.01				
	1.6			09.93	03.01				
	1.7 D			09.93	03.01	20.5522-1093.3	010731	+ ABS	THz 22,20 ATE
	1.7 TD			11.96	03.01				

¹⁾ + RA drum brake / + P freno a tamburo / + frein à tambour essieu AR / + ET-tambores de freno

²⁾ + dynamic control / + dynamic control / + dynamic control / + Control dinámico

³⁾ + short wheel base / + passo lungo / + empattement court / + distancia corta entre ejes

⁴⁾ + long wheel base / + passo lungo / + empattement long / + distancia larga entre ejes













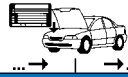

























FIAT FIORINO (93-01)										
	1.3 1.4 1.6 1.7 D 1.7 TD			09.93 09.93 09.93 09.93 11.96	03.01 03.01 03.01 03.01 03.01	24.5112-0355.3	330758	2		L=355
	1.3 1.4 1.6 1.7 D 1.7 TD			09.93 09.93 09.93 09.93 11.96	03.01 03.01 03.01 03.01 03.01	24.3220-1704.3	020097			Rz 20,64
	1.3 1.4 1.6 1.7 D 1.7 TD			09.93 09.93 09.93 09.93 11.96	03.01 03.01 03.01 03.01 03.01	24.3727-0541.2	580541	1	↓	L=3105
	1.3 1.4 1.6 1.7 D 1.7 TD	◀ ◀ ◀ ◀ ◀		09.93 09.93 09.93 09.93 11.96	03.01 03.01 03.01 03.01 03.01	24.3728-0531.2	590531			L=678

FIAT FIORINO / QUBO (08-)											
	1.3 D Multijet 1.3 D Multijet 1.3 MPI 1.4 1.4	55 59 52 54 57		09.08 03.15 01.07 09.08 10.09		24.3541-1769.5 24.3541-1770.5	240601 240602			D=54, - Halter D=54, - Halter	BOS BOS
	1.3 D Multijet 1.3 D Multijet 1.3 D Multijet 1.3 MPI 1.4 1.4	70 55 59 70 52 54 57		07.10 09.08 03.15 07.10 01.07 09.08 10.09		24.3541-1829.5	240721			D=54, - Halter	BOS
	1.3 D Multijet 1.3 D Multijet 1.3 D Multijet 1.3 MPI 1.4 1.4	55 59 70 52 54 57		09.08 03.15 07.10 01.07 09.08 10.09		24.5112-0402.3	331297	2		L=402	
	1.3 D Multijet 1.3 D Multijet 1.3 D Multijet 1.3 MPI 1.4 1.4	55 59 70 52 54 57		09.08 03.15 07.10 01.07 09.08 10.09		24.5228-0181.3	331279	2		L=180	
	1.3 D Multijet 1.3 D Multijet 1.3 D Multijet 1.3 MPI 1.4 1.4	55 59 70 52 54 57		09.08 03.15 07.10 01.07 09.08 10.09		24.3220-1728.3	020509			Rz 20,64	





















FIAT IDEA (04-12)											
	1.2 i 16V 1.3 D Multijet 1.3 JTD 1.4 1.4 1.9 JTD	59 66 51 57 70 74		01.04 11.05 01.04 11.05 01.04 01.04	11.06 11.06 11.06 11.06 11.06 11.06	24.2123-1763.3 24.2123-1769.3	010842 010863		- Dynamic Control ¹⁾ + Dynamic Control ²⁾	THz 23,81 THz 23,81	BOS
	1.2 i 16V 1.3 D Multijet 1.3 D Multijet 1.3 JTD 1.4 1.4 1.4 LPG 1.6 D Multijet 1.8 1.9 JTD	59 66 70 51 57 70 57 88 81 74		01.04 12.06 05.08 12.06 11.05 12.06 03.09 05.08 01.08 01.04	02.08 02.08 09.10 02.08 02.08 02.08 09.10 09.10 07.10 02.08	24.4123-1708.3	010859			THz 23,81	BOS
	1.3 D Multijet 1.4 LPG 1.6 D Multijet	70 57 88		10.10 10.10 10.10	07.12 07.12 07.12	24.4123-1708.3	010859			THz 23,81	BOS
	1.2 i 16V 1.3 JTD 1.4 1.4 1.4 LPG 1.8	59 51 57 70 57 81		01.04 01.04 11.05 01.04 06.09 01.08	02.08 02.08 02.08 02.08 07.12 07.10	24.3541-1811.5 24.3541-1812.5	240429 240430			D=54, - Halter D=54, - Halter	BOS BOS
	1.2 i 16V 1.3 D Multijet 1.3 D Multijet 1.3 JTD 1.4 1.4 1.4 LPG 1.6 D Multijet 1.8 1.9 JTD	59 66 70 51 57 70 57 88 81 74		01.04 11.05 05.08 01.04 11.05 01.04 03.09 05.08 01.08 01.04	02.08 02.08 07.12 02.08 02.08 02.08 07.12 07.12 07.10 02.08	24.5112-0456.3	330875	2		L=455	

¹⁾ - dynamic control / - dynamic control / - dynamic control / - Control dinámico
²⁾ + dynamic control / + dynamic control / + dynamic control / + Control dinámico

										
FIAT IDEA (04-12)										
	1.6 D Multijet 1.8	88 81		05.08 01.08	07.12 07.10	24.3347-1715.5 24.3347-1716.5	240719 240720	 	D=34, - Halter D=34, - Halter	TRW TRW
	1.2 i 16V 1.3 D Multijet 1.3 D Multijet 1.3 JTD 1.4 1.4 1.4 LPG 1.8 1.9 JTD 1.6 D Multijet	59 66 70 51 57 70 57 81 74 88		01.04 11.05 05.08 01.04 11.05 01.04 03.09 01.08 01.04 05.08	02.08 02.08 07.12 02.08 02.08 07.12 07.10 02.08	83.7201-9173.3	330868	2  	L=173	
	1.2 i 16V 1.3 JTD 1.4 1.4 1.2 i 16V 1.3 JTD 1.4 1.4 1.4 LPG 1.3 D Multijet 1.3 D Multijet 1.9 JTD 1.3 D Multijet 1.3 D Multijet 1.9 JTD	59 51 57 70 59 51 57 70 57 66 70 74 66 70 74		01.04 01.04 11.05 01.04 06.08 06.08 06.08 06.08 03.09 11.05 05.08 01.04 06.08 06.08 06.08	05.08 05.08 05.08 05.08 07.12 07.12 07.12 07.12 07.12 05.08 05.08 06.05 07.12 07.12 07.12	24.3222-1724.3	020466	 	Rz 22,20	
	1.2 i 16V 1.3 JTD 1.4 1.4 1.4 LPG 1.3 D Multijet 1.3 D Multijet 1.9 JTD 1.3 D Multijet 1.3 D Multijet 1.9 JTD	59 51 57 70 57 66 70 74 66 70 74		01.04 01.04 11.05 01.04 06.08 06.08 06.08 06.08 03.09 11.05 05.08 01.04 06.08 06.08 06.08	02.08 02.08 02.08 02.08 07.12 07.12 07.12 07.12 07.12 05.08 05.08 06.05 07.12 07.12 07.12	24.3222-1725.3	020510		Rz 22,00	AP
	1.3 D Multijet 1.3 D Multijet 1.9 JTD 1.3 D Multijet 1.3 D Multijet 1.9 JTD	66 70 74 66 70 74		11.05 05.08 01.04 06.08 06.08 06.08	05.08 05.08 06.05 07.12 07.12 07.12	24.3220-1107.3	020218		Rz 20,64	AP
	1.2 i 16V 1.4 1.4 1.4 LPG 1.8	59 57 70 57 81		01.04 11.05 01.04 03.09 01.08	02.08 02.08 02.08 07.12 07.10	24.2520-1705.3	040093		Nz 20,64	
FIAT LINEA (07-11)										
	1.3 D Multijet 1.4 1.4 T-Jet 1.6 1.6 D Multijet 1.9 16V	66 80 77		07.07 07.07 07.07 07.08 01.09 07.08	05.11 05.11 05.11 05.11 05.11 05.11	24.4122-1709.3	010871	+ Dynamic Control 1)	THz 22,20 - Behälter	BOS
	1.3 D Multijet 1.4 1.4 T-Jet 1.6 1.6 D Multijet 1.9 16V	66 80 77		07.07 07.07 07.07 07.08 01.09 07.08	05.11 05.11 05.11 05.11 05.11 05.11	24.3541-1769.5 24.3541-1770.5	240601 240602	 	D=54, - Halter D=54, - Halter	BOS BOS
	1.4 T-Jet 1.6 1.6 D Multijet 1.9 16V	80 77		07.07 07.08 01.09 07.08	05.11 05.11 05.11 05.11	24.3541-1829.5 24.3541-1830.5	240721 240722	 	D=54, - Halter D=54, - Halter	BOS BOS
	1.3 D Multijet 1.4 1.4 T-Jet 1.6 1.6 D Multijet 1.9 16V	66 80 77		07.07 07.07 07.07 07.08 01.09 07.08	05.11 05.11 05.11 05.11 05.11 05.11	24.5112-0402.3	331297	2	L=402	
	1.4 T-Jet 1.6 1.6 D Multijet 1.9 16V	80 77		07.07 07.08 01.09 07.08	05.11 05.11 05.11 05.11	24.3384-1741.7 24.3384-1742.7	220599 220600	 	D=38, - Halter D=38, - Halter	TRW TRW
	1.3 D Multijet 1.4 1.4 T-Jet 1.6 1.6 D Multijet 1.9 16V	66 80 77		07.07 07.07 07.07 07.08 01.09 07.08	05.11 05.11 05.11 05.11 05.11 05.11	24.5228-0181.3	331279	2	L=180	
	1.3 D Multijet 1.4	66		07.07 07.07	05.11 05.11	24.3220-1728.3	020509		Rz 20,64	
	1.3 D Multijet 1.4 1.4 T-Jet 1.6 1.6 D Multijet 1.9 16V	66 80 77		07.07 07.07 07.07 07.08 01.09 07.08	05.11 05.11 05.11 05.11 05.11 05.11	24.3727-0566.2 24.3727-0567.2	580566 580567	 	L=1712 L=1725	
	1.4 T-Jet 1.6 1.6 D Multijet 1.9 16V	80 77		07.07 07.08 01.09 07.08	05.11 05.11 05.11 05.11	24.3727-0564.2 24.3727-0565.2	580564 580565	 	L=1520 L=1528	
FIAT MAREA (96-02)										
	1.2 i 16V 1.4 i 12V 1.6 1.6 i 16V 1.8 i 16V 1.9 JTD 1.9 TD 2.0 i 20V 2.4 JTD 2.4 TD	76		04.99 09.96 09.00 09.96 09.96 04.99 09.96 09.96 04.99 09.96	12.02 12.02 12.02 12.02 12.02 12.02 12.02 12.02 12.02 12.02	24.2122-1716.3	010485		THz 22,20	























1) + dynamic control / + dynamic control / + dynamic control / + Control dinámico



















									
FIAT MAREA (96-02)									
	1.2 i 16V Lim. 1.4 i 12V 1.6 1.6 i 16V Lim. 1.9 TD	76 55	04.99 09.96 09.00 09.96 09.96	12.02 12.02 12.02 12.02 12.02	24.3541-1787.5 24.3541-1788.5	240289 240290	<input type="checkbox"/>	D=54, - Halter D=54, - Halter	ATE ATE
	1.2 i 16V Kombi 1.6 i 16V Kombi 1.8 i 16V 1.9 JTD 1.9 TD	74	04.99 09.96 09.96 04.99 09.96	12.02 12.02 12.02 12.02 12.02	24.3541-1789.5 24.3541-1790.5	240291 240292	<input type="checkbox"/>	D=54, - Halter D=54, - Halter	ATE ATE
	1.2 i 16V 1.4 i 12V 1.6 1.6 i 16V 1.8 i 16V 1.9 JTD 1.9 TD 2.0 i 20V 2.4 JTD 2.4 TD	76	04.99 09.96 09.00 09.96 09.96 04.99 09.96 09.96 04.99 09.96	12.02 12.02 12.02 12.02 12.02 12.02 12.02 12.02 12.02 04.99	83.6401-0413.3	330748	2	L=408	
	2.0 i 20V 2.4 TD		09.96 09.96	04.97 04.97	24.3344-1715.5	240327	<input type="checkbox"/>	D=34, - Halter	TRW
	1.2 i 16V 1.4 i 12V 1.6 1.6 i 16V 1.8 i 16V 1.9 JTD 1.9 TD 2.0 i 20V 2.4 JTD 2.4 TD	76	04.99 09.96 09.00 09.96 09.96 04.99 09.96 09.96 04.99 09.96	12.02 12.02 12.02 12.02 12.02 12.02 12.02 12.02 12.02 04.99	24.5228-0223.3	330530	2	L=223	
	1.4 i 12V 1.6 i 16V Lim. 1.8 i 16V Lim. 1.9 TD Lim.		09.96 09.96 09.96 09.96	03.97 03.97 03.97 03.97	24.3222-1707.3	020104		Rz 22,20	BDX
	1.2 i 16V 1.4 i 12V 1.6 1.6 i 16V Lim. 1.8 i 16V Lim. 1.9 JTD Lim. 1.9 TD Lim.	76	04.99 04.97 09.00 04.97 04.97 04.99 04.97	12.02 12.02 12.02 12.02 12.02 12.02 12.02	24.3222-1126.3 24.3222-1724.3	020358 020466	+ GG ¹⁾ + ALU ²⁾	Rz 22,20 Rz 22,20	AP
	1.6 i 16V Kombi 1.8 i 16V Kombi 1.9 JTD Kombi 1.9 TD Kombi		09.96 09.96 04.99 09.96	12.02 12.02 12.02 12.02	24.3220-1116.3	020313		Rz 20,64	
	1.2 i 16V 1.4 i 12V Kombi 1.4 i 12V Lim. 1.6 1.6 i 16V Lim. 1.8 i 16V Lim. 1.9 JTD 1.9 TD Lim.	76	04.99 09.96 09.96 09.00 09.96 09.96 04.99 09.96	12.02 12.02 12.02 + ABS 12.02 12.02 12.02 12.02 12.02	24.3727-0539.2 24.3727-0540.2	580539 580540	<input type="checkbox"/> <input type="checkbox"/>	L=1428 L=1383	
	1.6 i 16V Kombi 1.8 i 16V Kombi 1.9 JTD Kombi 1.9 TD Kombi		09.96 09.96 04.99 09.96	12.02 12.02 12.02 12.02	24.3727-0543.2 24.3727-0542.2	580543 580542	<input type="checkbox"/> <input type="checkbox"/>	L=1459 L=1404	
	1.9 JTD 2.0 i 20V 2.4 JTD		04.99 09.96 04.99	12.02 12.02 12.02	24.2419-1721.3	030100		Gz 19,05	
	1.9 JTD 2.0 i 20V 2.4 JTD		04.99 09.96 04.99	12.02 12.02 12.02	24.2525-1705.3 24.2525-1706.3	040083 040088		Nz 25,40 Nz 25,40	
	1.2 i 16V 1.4 i 12V 1.6 1.6 i 16V 1.8 i 16V 1.9 TD	76 74	04.99 09.96 09.00 09.96 09.96 09.96	12.02 12.02 12.02 12.02 12.02 12.02	24.3728-0523.2 24.3728-0528.2	590523 590528		L=937 L=1545	
FIAT MULTIPLA (98-10)									
	1.6 1.6 16V 1.6 16V Bipower 1.6 16V Bluepower 1.9 JTD		09.00 02.99 04.99 04.99 02.99	06.10 06.10 06.10 06.10 06.10	24.5112-0437.3	330886	2	L=435	
	1.6 1.6 16V 1.6 16V Bipower 1.6 16V Bluepower 1.9 JTD		09.00 02.99 04.99 04.99 02.99	06.10 06.10 06.10 06.10 06.10	24.5228-0223.3	330530	2	L=223	

¹⁾ + cast iron / + ghisa / + fonte grise / + fundición de gris























²⁾ + aluminium / + alluminio / + aluminium / + aluminio

									
FIAT MULTIPLA (98-10)									
	1.6 1.6 16V 1.6 16V Bipower 1.6 16V Bluepower 1.9 JTD		09.00 02.99 04.99 04.99 02.99	06.10 06.10 06.10 06.10 06.10	24.3220-1116.3	020313		Rz 20,64	
	1.6 1.6 16V 1.9 JTD 1.6 16V Bipower 1.6 16V Bluepower		09.00 02.99 02.99 04.99 04.99	02.01 02.02 02.02 06.10 06.10	24.3727-0550.2 24.3727-0551.2	580550 580551	<input type="checkbox"/> <input checked="" type="checkbox"/>	L=1165 L=2014 L=1143 L=2014	
	1.6 1.6 16V 1.6 16V Bipower 1.6 16V Bluepower 1.9 JTD		09.00 02.99 04.99 04.99 02.99	06.10 06.10 06.10 06.10 06.10	24.3728-0530.2	590530	<input type="checkbox"/> mit Schutzschlauch ¹⁾ <input checked="" type="checkbox"/>	L=866	
FIAT PALIO / PALIO WEEKEND EUROPA (96-06)									
	1.2 1.5 1.6 i 16V 1.7 TD 1.9 D 1.9 JTD		10.97 02.02 10.97 10.97 03.01 09.01	12.06 12.06 12.06 12.06 12.06 12.06	20.5522-1093.3	010731	+ ABS + ABS	THz 22,20 THz 22,20	ATE ATE
	1.0 1.2 1.5 1.6 i 16V 1.7 TD 1.9 D 1.9 JTD		04.96 10.97 02.02 10.97 10.97 03.01 09.01	12.06 12.06 12.06 12.06 12.06 12.06 12.06	24.5112-0460.3	330599	2	L=460	
	1.0 1.2 1.5 1.6 i 16V 1.7 TD 1.9 D 1.9 JTD		04.96 10.97 02.02 10.97 10.97 03.01 09.01	12.06 12.06 12.06 12.06 12.06 12.06 12.06	24.5112-0220.3	330613	2	L=220	
	1.0 1.2 1.5 1.6 i 16V 1.7 TD 1.9 D 1.9 JTD		04.96 10.97 02.02 10.97 10.97 03.01 09.01	12.06 12.06 12.06 12.06 12.06 12.06 12.06	24.3220-1116.3	020313		Rz 20,64	
	1.0 1.2 1.6 i 16V		04.96 10.97 10.97	03.99 03.99 12.06	24.3728-0533.2 24.3728-0535.2	590533 590535		L=684 L=678 L=684	
FIAT PALIO SW / SIENA (PL) (98-06)									
	1.4 1.6 i 16V		02.98 02.98	12.06 12.06	24.3728-0533.2 24.3728-0535.2	590533 590535		L=684 L=678	
FIAT PANDA (86-02)									
	1000 1000 i.e. 1100 750 900 4x4	◀ ◀ ◀ ◀ ◀ ◀	01.86 10.87 02.91 01.86 04.92 01.86	12.92 12.02 12.02 12.97 12.96 12.02	24.2119-0826.3	010349		THz 19,05	
	1000 1000 i.e. 1100 4x4 750 900		01.86 10.87 02.91 01.86 01.86 04.92	12.92 12.02 12.02 12.02 12.97 12.96	24.5112-0433.3	330522	2	L=434	
	1000 1000 i.e. 1100 4x4 750 900		01.86 10.87 02.91 01.86 01.86 04.92	12.92 12.02 12.02 12.02 12.97 12.96	24.5112-0185.3	330654	2	L=185	
	1000 1000 i.e. 1100 4x4 750 900		01.86 10.87 02.91 01.86 01.86 04.92	12.92 12.02 12.02 12.02 12.97 12.96	24.3219-0803.3	020183		Rz 19,05	
	1000 1000 i.e. 1100 4x4 750 900		01.86 10.87 02.91 01.86 01.86 04.92	12.92 12.02 12.02 12.02 12.97 12.96	24.3727-0519.2	580519	1 ↕	L=2385	



















¹⁾ with protecting cover / con flessibile di protezione / avec gaine protectrice / con manguera de protección

								
FIAT PANDA (86-02)								
	4x4			01.86 12.02		24.6046-0801.3	320116	BR 4/6 (2)
	1000 1000 i.e. 1100 4x4 750 900	◀ ◀ ◀ ◀ ◀ ◀		01.86 12.92 01.87 12.02 02.91 12.02 01.86 12.02 01.86 12.97 04.92 12.96		24.3728-0505.2	590505	L=560
FIAT PANDA (03-13)								
	1.1 1.2 1.2 1.2 LPG 1.2 LPG 1.2 Natural Power 1.3 D Multijet 1.3 JTD 1.3 JTD 1.4 Natural Power 1.4 1.2 4x4 1.2 4x4 1.3 D Multijet 4x4	40 44 51 44 51 44 51 51 55 74 44 51 44		09.03 06.13 09.03 06.13 03.10 06.13 04.09 06.13 11.10 06.13 01.07 06.13 09.03 06.13 09.03 06.13 06.06 06.13 01.07 06.13 11.06 06.13 10.04 06.13 10.10 06.13 10.04 06.13		24.2120-1744.3 24.2120-1747.3 24.2120-1746.3	010820 010836 010835	- ABS + ABS + Dynamic Control ¹⁾ THz 20,64 THz 20,64 THz 20,64 THz 22,20 THz 22,20 THz 20,64 - Behälter THz 20,64
	1.1 1.2 1.1 1.2 1.3 D Multijet 4x4 1.4	40 44 40 44 74 74		09.03 06.07 09.03 06.07 07.07 06.13 07.07 06.13 10.04 06.13 11.06 06.13		24.3481-1743.5 24.3481-1744.5 24.3481-1743.5 24.3481-1744.5 24.3541-1769.5 24.3541-1770.5	240305 240306 240305 240306 240601 240602	D=48, - Halter D=48, - Halter D=48, - Halter D=48, - Halter D=54, - Halter D=54, - Halter
	1.1 1.2 1.2 1.2 LPG 1.2 LPG 1.2 Natural Power 1.3 D Multijet 1.3 JTD 1.3 JTD 1.4 1.4 Natural Power 1.2 4x4 1.2 4x4 1.3 D Multijet 4x4	40 44 51 44 51 44 51 51 55 74 44 51 44		09.03 06.13 09.03 06.13 03.10 06.13 04.09 06.13 11.10 06.13 01.07 06.13 09.03 06.13 09.03 06.13 06.06 06.13 11.06 06.13 01.07 06.13 10.04 06.13 10.10 06.13 10.04 06.13		24.5112-0440.3	330887	2 L=440 L=477
	1.2 4x4 1.2 4x4 1.3 D Multijet 4x4 1.4	44 51 51 74		10.04 06.13 10.10 06.13 10.04 06.13 11.06 06.13		24.3347-1715.5 24.3347-1716.5	240719 240720	D=34, - Halter D=34, - Halter
	1.1 1.2 1.2 1.2 LPG 1.2 LPG 1.2 Natural Power 1.3 D Multijet 1.3 JTD 1.3 JTD 1.4 1.4 Natural Power 1.2 4x4 1.2 4x4 1.3 D Multijet 4x4	40 44 51 44 51 44 51 51 55 74 44 51 44		09.03 06.13 09.03 06.13 03.10 06.13 04.09 06.13 11.10 06.13 01.07 06.13 09.03 06.13 09.03 06.13 06.06 06.13 11.06 06.13 01.07 06.13 10.04 06.13 10.10 06.13 10.04 06.13		24.5228-0165.3	330879	2 L=165 L=219
	1.1 1.2 1.2 1.3 D Multijet 1.3 JTD 1.3 JTD 1.4 Natural Power 1.1 1.2 1.2 1.3 D Multijet 1.3 JTD 1.3 JTD 1.4 Natural Power 1.1 1.2 1.2 1.3 D Multijet 1.3 JTD 1.3 JTD	40 44 51 51 51 55 74 40 44 51 51 55 40 44 51 51 51 55		09.03 06.13 09.03 06.13 03.10 06.13 09.03 06.13 09.03 06.13 06.06 06.13 01.07 06.13 09.03 05.10 09.03 05.10 03.10 05.10 09.03 05.10 09.03 05.10 06.06 05.10 01.07 05.10 06.10 06.13 06.10 06.13 06.10 06.13 06.10 06.13 06.10 06.13 06.10 06.13		24.3220-1107.3 24.3220-1108.3 24.3220-1738.3	020218 020219 020545	- ABS + ABS + ABS Rz 20,64 Rz 20,64 Rz 20,64

1) + dynamic control / + dynamic control / + dynamic control / + Control dinámico
2) - dynamic control / - dynamic control / - dynamic control / - Control dinámico
3) - differential lock / - differenziale autobloccante / - blocage de différentiel / - bloqueo diferencial
4) + differential lock / + differenziale autobloccante / + blocage de différentiel / + bloqueo diferencial

									
FIAT PANDA (03-13)									
	1.2 LPG 1.2 LPG 1.2 Natural Power 1.4 Natural Power	44 51 44		04.09 06.13 11.10 06.13 01.07 06.13 06.10 06.13		24.3220-1728.3 020509		Rz 20,64	
	1.1 1.2 1.2 1.3 D Multijet 1.3 JTD 1.3 JTD 1.4 Natural Power	40 44 51 51 55		09.03 06.13 09.03 06.13 03.10 06.13 09.03 06.13 09.03 06.13 06.06 06.13 01.07 06.13		24.3727-0556.2 580556 24.3727-0557.2 580557	<input type="checkbox"/> <input type="checkbox"/>	L=1405 L=1435	
	1.1 1.2 1.2 LPG 1.4 1.2 Natural Power	▶ 40 ▶ 44 ▶ 44 ▶ 74 44		09.03 06.13 09.03 06.13 04.09 06.13 11.06 06.13 01.07 06.13		24.2520-1707.3 040097 24.2520-1707.3 040097		Nz 20,64 Nz 20,64	
	1.1 1.2 1.2 LPG 1.2 Natural Power	40 44 44 44		09.03 06.13 09.03 06.13 04.09 06.13 01.07 06.13		24.3728-0532.2 590532		L=995	
FIAT PANDA Cross (06-11)									
	1.3 D Multijet 4x4 1.3 D Multijet 4x4	51 51		04.06 08.11 04.06 08.11		24.2120-1744.3 010820 24.2120-1747.3 010836 24.2120-1746.3 010835 24.4122-1714.3 010914	- ABS + ABS + Dynamic Control 1)	THz 20,64 THz 20,64 THz 20,64 THz 22,20 - Behälter	BOS BOS
	1.3 D Multijet 4x4	51		04.06 08.11		24.3541-1769.5 240601 24.3541-1770.5 240602	<input type="checkbox"/> <input type="checkbox"/>	D=54, - Halter D=54, - Halter	BOS BOS
	1.3 D Multijet 4x4	51		04.06 08.11		24.5119-0477.3 330991	2	L=477	
	1.3 D Multijet 4x4	51		04.06 08.11		24.3347-1715.5 240719 24.3347-1716.5 240720	<input type="checkbox"/> <input type="checkbox"/>	D=34, - Halter D=34, - Halter	TRW TRW
	1.3 D Multijet 4x4	51		04.06 08.11		83.7101-9219.3 330903	2	L=219	
FIAT PANDA (12-)									
	0.9 1.2 1.2 LPG	48 51 51		02.12 02.12 02.12		11.9541-9831.2 220953 11.9541-9832.2 220954 11.8116-0264.1 390594 11.8171-0008.1 990049	<input type="checkbox"/> <input type="checkbox"/> 2	D=54, - Halter D=54, - Halter Haltefeder Führungsbolzen	ATE ATE ATE ATE
	0.9 0.9 0.9 0.9 4x4 0.9 Natural Power 0.9 Natural Power 1.2 1.2 LPG 1.3 D Multijet 1.3 D Multijet 1.3 D Multijet 4x4 1.3 D Multijet 4x4	48 57 63 63 59 63 51 51 70 70		02.12 02.12 02.12 09.12 02.12 07.12 02.12 02.12 02.12 04.15 06.12 04.15		24.5112-0356.3 331129	2	L=355	
	0.9 0.9 0.9 0.9 Natural Power 0.9 Natural Power 1.2 1.2 LPG 1.3 D Multijet 1.3 D Multijet	48 57 63 59 63 51 51 70 70		02.12 02.12 02.12 02.12 07.12 02.12 02.12 02.12 04.15		24.3220-1728.3 020509		Rz 20,64	
	0.9 0.9 0.9 0.9 4x4 0.9 Natural Power 0.9 Natural Power 1.2 1.2 LPG 1.3 D Multijet 1.3 D Multijet 1.3 D Multijet 4x4 1.3 D Multijet 4x4	▶ 48 ▶ 57 ▶ 63 ▶ 63 ▶ 59 ▶ 63 ▶ 51 ▶ 51 ▶ 70 ▶ 70		02.12 02.12 02.12 09.12 02.12 07.12 02.12 02.12 02.12 04.15 06.12 04.15		24.2520-1705.3 040093		Nz 20,64	
FIAT PUNTO (93-00)									
	1.1 i (55) 1.2 i (60) Cabrio 1.2 i (60/75) Lim. 1.2 i 16V (85) Cabrio 1.2 i 16V (85) Lim. 1.4 GT 1.6 i (90) Cabrio			11.93 09.99 03.94 06.00 11.93 09.99 06.97 06.00 06.97 09.99 06.97 09.99 03.94 05.97		24.2120-1710.3 010468		THz 20,64	

1) + dynamic control / + dynamic control / + dynamic control / + Control dinámico

















									
FIAT PUNTO (93-00)									
	1.6 i (90) Lim. 1.7 D 1.7 TD 1.4 GT		03.94 05.97 01.95 05.97 11.93 09.99 11.93 05.97		24.2120-1710.3 010468			THz 20,64	
	1.1 i (55) 1.2 i (60) Cabrio 1.2 i (60/75) Lim. 1.7 D 1.2 i (60) Cabrio 1.2 i (60/75) Lim. 1.6 i (90) Cabrio 1.6 i (90) Lim. 1.7 TD 1.2 i 16V (85) Cabrio 1.2 i 16V (85) Lim. 1.7 TD		11.93 09.99 03.94 06.00 11.93 09.99 01.95 05.97 03.94 06.00 11.93 09.99 03.94 05.97 03.94 05.97 11.93 05.97 06.97 06.00 06.97 09.99 06.97 09.99		24.2122-1716.3 010485 24.3481-1743.5 240305 24.3481-1744.5 240306 24.3481-1703.5 240051 24.3481-1704.5 240052 24.0101-4301.2 260047 24.3481-1751.5 240285 24.3481-1752.5 240286	<input type="checkbox"/> <input type="checkbox"/> <input type="checkbox"/> <input type="checkbox"/> <input type="checkbox"/> <input type="checkbox"/> <input type="checkbox"/> <input type="checkbox"/> <input type="checkbox"/> <input type="checkbox"/> <input type="checkbox"/> <input type="checkbox"/>		THz 22,20 D=48, - Halter D=48, - Halter D=48, - Halter D=48, - Halter D=48, - Halter D=48, - Halter D=48, - Halter D=48, - Halter D=48, - Halter D=48, - Halter D=48, - Halter	BDX BDX TRW TRW TRW BDX BDX
	1.1 i (55) 1.2 i (60) Cabrio 1.2 i (60/75) Lim. 1.2 i 16V (85) Cabrio 1.2 i 16V (85) Lim. 1.4 GT 1.6 i (90) Cabrio 1.6 i (90) Lim. 1.7 D 1.7 TD		11.93 09.99 03.94 06.00 11.93 09.99 06.97 06.00 06.97 09.99 11.93 06.00 03.94 05.97 03.94 05.97 01.95 05.97 11.93 09.99		24.5112-0376.3 330514 24.5112-0370.3 330515 24.5112-0395.3 330521 24.5112-0396.3 330520	<input type="checkbox"/> <input type="checkbox"/> <input type="checkbox"/> <input type="checkbox"/> <input type="checkbox"/> <input type="checkbox"/> <input type="checkbox"/> <input type="checkbox"/> <input type="checkbox"/> <input type="checkbox"/>	Länge beachten/Schaltgetriebe 1) Länge beachten/Schaltgetriebe 1) Länge beachten/Automatikgetr. 2) Länge beachten/Automatikgetr. 2)	L=362 L=372 L=395 L=397	
	1.1 i (55) 1.2 i (60) Cabrio 1.2 i (60/75) Lim. 1.2 i 16V (85) Cabrio 1.2 i 16V (85) Lim. 1.6 i (90) Cabrio 1.6 i (90) Lim. 1.7 D 1.7 TD		11.93 09.99 03.94 06.00 11.93 09.99 06.97 06.00 06.97 09.99 03.94 05.97 03.94 05.97 01.95 05.97 11.93 09.99		24.3220-1108.3 020219 24.3220-1107.3 020218			Rz 20,64 Rz 20,64	BDX AP
	1.1 i (55) 1.2 i (60) Cabrio 1.2 i (60/75) Lim. 1.2 i 16V (85) Cabrio 1.2 i 16V (85) Lim. 1.6 i (90) Cabrio 1.6 i (90) Lim. 1.7 D 1.7 TD		11.93 09.99 03.94 06.00 11.93 09.99 06.97 06.00 06.97 09.99 03.94 05.97 03.94 05.97 01.95 05.97 11.93 09.99		24.3727-0526.2 580526 24.3727-0525.2 580525	<input type="checkbox"/> <input type="checkbox"/>		L=1456 L=1469	
	1.1 i (55) 1.1 i (55) 1.2 i (60) Cabrio 1.2 i (60) Lim. 1.2 i (60/75) Lim. 1.2 i 16V (85) Lim. 1.4 GT		06.97 09.99 11.93 05.97 03.94 05.95 06.97 09.99 11.93 05.97 06.97 09.99 06.97 09.99 06.97 09.99	- ABS - ABS - ABS - ABS - ABS	24.6513-1705.3 320237	<input type="checkbox"/>		BRL (2)	
	1.1 i (55) 1.2 i (60) Cabrio 1.2 i (60/75) Lim. 1.6 i (90) Cabrio 1.6 i (90) Lim. 1.1 i (55) 1.2 i (60) Cabrio 1.2 i (60/75) Lim. 1.2 i 16V (85) Cabrio 1.2 i 16V (85) Lim. 1.6 i (90) Cabrio 1.6 i (90) Lim.	◀ ◀ ◀ ◀ ◀ ◀ ◀ ◀ ◀ ◀ ◀ ◀	11.93 08.94 03.94 08.94 11.93 08.94 03.94 08.94 03.94 08.94 09.94 09.99 09.94 06.00 09.94 09.99 06.97 06.00 06.97 09.99 09.94 05.97 09.94 05.97		24.3728-0521.2 590521 24.3728-0516.2 590516			L=854 L=856	
FIAT PUNTO (00-03)									
	1.2 1.2 16V 1.8 i 16V 1.9 D 1.9 JTD		10.99 06.03 10.99 06.03 10.99 06.03 10.99 06.03 10.99 06.03		24.2120-1742.3 010776			THz 20,64	
	1.2 1.2 16V 1.2 16V 1.9 D 1.9 JTD		10.99 06.03 10.99 06.03 10.99 06.03 10.99 06.03 10.99 06.03		24.3481-1743.5 240305 24.3481-1744.5 240306 24.3481-1751.5 240285 24.3481-1752.5 240286 24.3541-1787.5 240289 24.3541-1788.5 240290 24.3541-1789.5 240291 24.3541-1790.5 240292	<input type="checkbox"/> <input type="checkbox"/> <input type="checkbox"/> <input type="checkbox"/> <input type="checkbox"/> <input type="checkbox"/> <input type="checkbox"/> <input type="checkbox"/> <input type="checkbox"/>	D=48, - Halter D=48, - Halter D=48, - Halter D=48, - Halter D=54, - Halter D=54, - Halter D=54, - Halter D=54, - Halter	BDX BDX BDX BDX ATE ATE ATE ATE	
	1.2 1.2 16V 1.8 i 16V 1.9 D 1.9 JTD		10.99 06.03 10.99 06.03 10.99 06.03 10.99 06.03 10.99 06.03		24.5112-0454.3 331360	2		L=454	

1) notice length/ manual transm. / attenz.lunghezza/cambio veloc. / fair.att.longueur/trans.mécan. / atención largo/camb.velocidad

2) notice length/ autom.transm. / attenz.lunghezza/cambio autom. / fair.att.longueur/trans.autom. / atención largo/cambio autom.

3) + manual transmission / + scatola cambio velocità / + transmission mécanique / + cambio de velocidad

4) + autom.transmission / + scatola cambio automatico / + transmission automatique / + cambio automático

								
FIAT PUNTO / PUNTO EVO (09-)								
	0.9 0.9 Bifuel 0.9 Twinair Turbo 1.2 1.2 1.3 D Multijet 1.3 D Multijet 1.3 D Multijet 1.3 D Multijet 1.3 D Multijet 1.4 1.4 16V 1.4 16V 1.4 LPG 1.4 MultiAir 1.4 MultiAir 1.4 Natural Power 1.6 D Multijet	77 63 63 48 51 51 55 62 66 70 77 99 57 77 99 57 88	11.13 03.12 03.12 10.09 10.09 07.08 10.09 10.09 10.09 10.09 10.09 10.09 06.09 03.12 03.12 10.09 10.09		24.4122-1709.3	010871		THz 22,20 - Behälter BOS
	0.9 0.9 Bifuel 0.9 Twinair Turbo 1.2 1.2 1.3 D Multijet 1.3 D Multijet 1.3 D Multijet 1.3 D Multijet 1.4 1.4 16V 1.4 16V 1.4 LPG 1.4 MultiAir 1.4 MultiAir 1.4 Natural Power 1.6 D Multijet	77 63 63 48 51 51 55 62 66 70 77 99 57 77 99 57 88	11.13 03.12 03.12 10.09 10.09 07.08 10.09 10.09 10.09 10.09 10.09 10.09 06.09 03.12 03.12 10.09 10.09		24.3541-1769.5 24.3541-1770.5	240601 240602	 	D=54, - Halter BOS D=54, - Halter BOS
	0.9 0.9 Bifuel 0.9 Twinair Turbo 1.2 1.2 1.3 D Multijet 1.3 D Multijet 1.3 D Multijet 1.3 D Multijet 1.4 1.4 16V 1.4 16V 1.4 LPG 1.4 MultiAir 1.4 MultiAir 1.4 Natural Power 1.6 D Multijet	77 63 63 48 51 51 55 62 66 70 77 99 57 77 99 57 88	11.13 03.12 03.12 10.09 10.09 07.08 10.09 10.09 10.09 10.09 10.09 10.09 06.09 03.12 03.12 10.09 10.09		24.5112-0402.3	331297	2	L=402
	0.9 0.9 Bifuel 0.9 Twinair Turbo 1.2 1.2 1.3 D Multijet 1.3 D Multijet 1.3 D Multijet 1.3 D Multijet 1.3 D Multijet 1.3 D Multijet 1.4 1.4 16V 1.4 16V 1.4 Abarth 1.4 LPG 1.4 MultiAir 1.4 MultiAir 1.4 Natural Power 1.6 D Multijet	77 63 63 48 51 51 55 62 66 70 77 99 57 77 99 57 88	11.13 03.12 03.12 10.09 10.09 07.08 10.09 10.09 10.09 10.09 10.09 10.09 10.09 10.09 06.09 03.12 03.12 10.09 10.09		24.5112-0142.3 24.5228-0216.3	331016 330908	2 2	am Bremsattel ¹⁾ L=142 L=216
	0.9 0.9 Bifuel 0.9 Twinair Turbo 1.2 1.3 D Multijet 1.3 D Multijet 1.3 D Multijet 1.3 D Multijet 1.4 1.4 16V 1.4 16V 1.4 MultiAir	77 63 63 48 51 55 62 70 77 99 99	11.13 03.12 03.12 10.09 07.08 10.09 10.09 10.09 10.09 10.09 10.09 03.12		24.3220-1728.3	020509		Rz 20,64

¹⁾ on the brake caliper / sulla pinza freno / sur l'étrier de frein / a la pinza de freno



FIAT PUNTO / PUNTO EVO (09-)

	1.4 MultiAir	99		03.12		24.3220-1728.3	020509			Rz 20,64
	0.9	77		11.13		24.3727-0575.2	580575	<input type="checkbox"/>		L=1642
	0.9 Bifuel	63		03.12		24.3727-0576.2	580576	<input type="checkbox"/>		L=1660
	0.9 Twinair Turbo	63		03.12						
	1.2	48		10.09						
	1.3 D Multijet	51		07.08		24.3727-0577.2	580577	<input type="checkbox"/>		L=1674
	1.3 D Multijet	55		10.09		24.3727-0578.2	580578	<input type="checkbox"/>		L=1689
	1.3 D Multijet	62		10.09						
	1.3 D Multijet	66		10.09						
	1.3 D Multijet	70		10.09						
	1.4			10.09						
	1.4 16V	77		10.09						
	1.4 16V	99		10.09						
	1.4 MultiAir	77		03.12						
	1.4 MultiAir	99		03.12						
	1.2	51		10.09		24.3727-0579.2	580579	<input type="checkbox"/>		L=1654
	1.3 D Multijet	51		07.08		24.3727-0580.2	580580	<input type="checkbox"/>		L=1673
	1.3 D Multijet	55		10.09						
	1.3 D Multijet	62		10.09						
1.3 D Multijet	66		10.09							
1.3 D Multijet	70		10.09							
1.4			10.09							
1.4 16V	77		10.09							
1.4 16V	99		10.09							
1.4 Abarth			10.09							
1.4 LPG	57		06.09							
1.4 MultiAir	77		03.12							
1.4 MultiAir	99		03.12							
1.4 Natural Power	57		10.09							
1.6 D Multijet	88		10.09							



















FIAT GRANDE PUNTO (06-11)

	1.2			10.05	08.10	24.4122-1709.3	010871		+ Dynamic Control ²⁾	THz 22,20 - Behälter	BOS
	1.3 D Multijet	51		10.05	08.10						
	1.3 D Multijet	55		04.08	08.10						
	1.3 D Multijet	62		04.10	08.10						
	1.3 D Multijet	66		10.05	08.10						
	1.4			10.05	08.10						
	1.4 16V			10.05	08.10						
	1.4 LPG	57		12.08	08.10						
	1.4 Natural Power	57		07.08	08.10						
	1.4 T-Jet	88		07.07	08.10						
	1.6 D Multijet	88		07.08	08.10						
	1.9 JTD	88		10.05	08.10						
	1.9 JTD	96		02.06	08.10						
		1.2			09.10	01.11	24.4122-1709.3	010871			THz 22,20 - Behälter
1.2		51		09.10	01.11						
1.3 D Multijet		51		09.10	01.11						
1.3 D Multijet		55		09.10	01.11						
1.3 D Multijet		62		09.10	01.11						
1.3 D Multijet		66		09.10	01.11						
1.4 16V				09.10	01.11						
1.4 LPG		57		09.10	01.11						
1.4 Natural Power		57		09.10	01.11						
1.4 T-Jet		88		09.10	01.11						
1.6 D Multijet		88		09.10	01.11						
1.9 JTD		88		09.10	01.11						
1.9 JTD		96		09.10	01.11						
		1.3 D Multijet	51		10.05	01.11	24.3541-1769.5	240601	<input type="checkbox"/>		D=54, - Halter
	1.3 D Multijet	55		04.08	01.11	24.3541-1770.5	240602	<input type="checkbox"/>		D=54, - Halter	BOS
	1.4			10.05	01.11						
	1.4 16V			10.05	01.11						
	1.4 LPG	57		12.08	01.11						
	1.4 Natural Power	57		07.08	01.11						
	1.3 D Multijet	62		04.10	01.11	24.3541-1829.5	240721	<input type="checkbox"/>		D=54, - Halter	BOS
	1.3 D Multijet	66		10.05	01.11	24.3541-1830.5	240722	<input type="checkbox"/>		D=54, - Halter	BOS
	1.4 T-Jet	88		07.07	01.11						
	1.6 D Multijet	88		07.08	01.11						
	1.9 JTD	88		10.05	01.11						
	1.9 JTD	96		02.06	01.11						
	1.2			10.05	01.11	24.5112-0402.3	331297	2		L=402	
	1.2	51		09.10	01.11						
	1.3 D Multijet	51		10.05	01.11						
	1.3 D Multijet	55		04.08	01.11						
	1.3 D Multijet	62		04.10	01.11						
	1.3 D Multijet	66		10.05	01.11						
	1.4			10.05	01.11						
	1.4 16V			10.05	01.11						
1.4 LPG	57		12.08	01.11							
1.4 Natural Power	57		07.08	01.11							
1.4 T-Jet	88		07.07	01.11							
1.6 D Multijet	88		07.08	01.11							
1.9 JTD	88		10.05	01.11							
1.9 JTD	96		02.06	01.11							

¹⁾ + RA disc brake / + P disco freno / + frein à disque essieu AR / + ET-disco de freno

²⁾ + dynamic control / + dynamic control / + dynamic control / + Control dinámico



	 kW									
FIAT GRANDE PUNTO (06-11)										
	1.2	51		10.05	01.11	24.5112-0142.3	331016	2	am Bremssattel ¹⁾	L=142 L=216
	1.2	51		09.10	01.11	24.5228-0216.3	330908	2		
	1.3 D Multijet	51		10.05	01.11					
	1.3 D Multijet	55		04.08	01.11					
	1.3 D Multijet	62		04.10	01.11					
	1.3 D Multijet	66		10.05	01.11					
	1.4			10.05	01.11					
	1.4 16V			10.05	01.11					
	1.4 Abarth	114		10.07	01.11					
	1.4 Abarth	132		12.07	01.11					
	1.4 LPG	57		12.08	01.11					
	1.4 Natural Power	57		07.08	01.11					
	1.4 T-Jet	88		07.07	01.11					
	1.6 D Multijet	88		07.08	01.11					
	1.9 JTD	88		10.05	01.11					
	1.9 JTD	96		02.06	01.11					
	1.2			10.05	01.11	24.3220-1728.3	020509			Rz 20,64
	1.2	51		09.10	01.11					
	1.3 D Multijet	51		10.05	01.11					
	1.3 D Multijet	55		04.08	01.11					
	1.3 D Multijet	62		04.10	01.11					
	1.3 D Multijet	66		10.05	01.11					
	1.4			10.05	01.11					
	1.4 16V			10.05	01.11					
	1.4 LPG	57		12.08	01.11					
	1.4 Natural Power	57		07.08	01.11					
	1.2			10.05	01.11	24.3727-0575.2	580575	<input type="checkbox"/>		L=1642
						24.3727-0576.2	580576	<input type="checkbox"/>		L=1660
	1.2	51		09.10	01.11	24.3727-0577.2	580577	<input type="checkbox"/>		L=1674
	1.3 D Multijet	51		10.05	01.11	24.3727-0578.2	580578	<input type="checkbox"/>		L=1689
	1.3 D Multijet	55		04.08	01.11					
	1.3 D Multijet	62		04.10	01.11					
	1.3 D Multijet	66		10.05	01.11					
	1.4			10.05	01.11					
	1.4 16V			10.05	01.11					
	1.4 LPG	57		12.08	01.11					
	1.4 Natural Power	57		07.08	01.11					
	1.4 Abarth	114		10.07	01.11	24.3727-0579.2	580579	<input type="checkbox"/>		L=1654
	1.4 Abarth	132		12.07	01.11	24.3727-0580.2	580580	<input type="checkbox"/>		L=1673
	1.4 T-Jet	88		07.07	01.11					
	1.6 D Multijet	88		07.08	01.11					
	1.9 JTD	88		10.05	01.11					
	1.9 JTD	96		02.06	01.11					
FIAT SCUDO (95-06)										
	1.6 i.e.			11.95	12.06	24.2122-1703.3	010422		- ABS	THz 22,20
	1.9 D			11.95	12.06	24.2122-1708.3	010437		+ ABS	THz 22,20
	1.9 TD			11.95	12.06					
	2.0 i 16V			06.00	12.06					
	2.0 JTD			12.99	12.06					
	1.6 i.e.			11.95	12.06	24.3571-1711.5	240159	<input type="checkbox"/>		D=57, - Halter
	1.9 D			11.95	12.06	24.3571-1712.5	240160	<input type="checkbox"/>		D=57, - Halter
	1.9 TD			11.95	12.06					
	2.0 i 16V			06.00	12.06					
	2.0 JTD			12.99	12.06					
	1.6 i.e.			11.95	09.03	24.3571-1709.5	240153	<input type="checkbox"/>		D=57, - Halter
	1.9 D			11.95	09.03	24.3571-1710.5	240154	<input type="checkbox"/>		D=57, - Halter
	1.9 TD			11.95	09.03					
	2.0 i 16V			06.00	09.03					
	2.0 JTD			12.99	09.03					
	1.6 i.e.			10.03	12.06	24.3601-1711.7	220607	<input type="checkbox"/>		D=60, - Halter
	1.9 D			10.03	12.06	24.3601-1712.7	220608	<input type="checkbox"/>		D=60, - Halter
	1.9 TD			10.03	12.06					
	2.0 i 16V			10.03	12.06					
	2.0 JTD			10.03	12.06					
	1.6 i.e.			11.95	12.06	24.5118-0471.3	330528	2		L=473
	1.9 D			11.95	12.06					
	1.9 TD			11.95	12.06					
	2.0 i 16V			06.00	12.06					
	2.0 JTD			12.99	12.06	24.5111-0462.3	330555	2		L=460
	1.6 i.e.			11.95	12.06	24.5229-0251.3	330535	2		L=250
	1.9 D			11.95	12.06					
	1.9 TD			11.95	12.06					
	2.0 i 16V			06.00	12.06					
	2.0 JTD			12.99	12.06					
	1.6 i.e.			11.95	12.06	24.3219-1704.3	020374			Rz 19,05
	1.9 D			11.95	12.06					
	1.9 TD			11.95	12.06					
	2.0 i 16V			06.00	12.06					
	2.0 JTD			12.99	12.06					
	1.6 i.e.			11.95	12.06	24.3727-0336.2	580336	1	<input type="checkbox"/> - langer Radstand ²⁾	L=500
	1.9 D			11.95	12.06	24.3727-0341.2	580341	1	<input type="checkbox"/> + langer Radstand ³⁾	L=900
	1.9 TD			11.95	12.06	24.3727-0532.2	580532	<input type="checkbox"/>		L=1063
	2.0 i 16V			06.00	12.06	24.3727-0531.2	580531	<input type="checkbox"/>		L=2286
	2.0 JTD			12.99	12.06					

¹⁾ on the brake caliper / sulla pinza freno / sur l'étrier de frein / a la pinza de freno

²⁾ - long wheel base / - passo lungo / - empattement long / - distancia larga entre ejes

³⁾ + long wheel base / + passo lungo / + empattement long / + distancia larga entre ejes



FIAT SCUDO (95-06)

	1.6 i.e.			11.95	12.06	24.3728-0341.2	590341		L=739, + AUT
	1.9 D			11.95	12.06				
	1.9 TD			11.95	12.06	24.3728-0342.2	590342		L=864, + AUT
	2.0 i 16V			06.00	12.06	24.3728-0336.2	590336		L=973, + AUT

FIAT SCUDO (07-)

	1.6 D Multijet	66		01.07		03.2125-0298.3	010818	- ESP	THz 25,40	ATE	
	2.0 D Multijet	88		01.07		03.2125-0293.3	010817	+ ESP	THz 25,40	ATE	
	2.0 D Multijet	94		04.11							
	2.0 D Multijet	100		01.07							
	2.0 D Multijet	120		07.10							
	2.0 D Multijet 4x4	94		04.11							
	1.6 D Multijet	66		01.07	+ HA-Trommelbremse ¹⁾	24.3451-1725.5	240619	<input type="checkbox"/>	D=45/48, - Halter	TRW	
						24.3451-1726.5	240620	<input type="checkbox"/>	D=45/48, - Halter	TRW	
	1.6 D Multijet	66		01.07		24.5144-0455.3	331201	2		L=455	
	2.0 D Multijet	88		01.07							
	2.0 D Multijet	94		04.11							
	2.0 D Multijet	100		01.07							
	2.0 D Multijet	120		07.10							
	2.0 D Multijet 4x4	94		04.11							
	1.6 D Multijet	66		06.07		24.5239-0240.3	331170	2	- langer Radstand ²⁾	L=240	
	2.0 D Multijet	88		06.07		24.5239-0355.3	331243	2	+ langer Radstand ³⁾	L=355	
	2.0 D Multijet	94		04.11							
	2.0 D Multijet	100		06.07							
	2.0 D Multijet	120		07.10							
	2.0 D Multijet 4x4	94		04.11							
	1.6 D Multijet	66		01.07		24.3222-1726.3	020518			Rz 22,20	TRW

FIAT SEDICI (06-)























	1.6 16V	79		06.06		24.5273-0375.3	331147	2		L=375	
	1.6 16V	88		06.06							
	1.6 16V 4x4	79		06.06							
	1.6 16V 4x4	88		06.06							
	1.9 D Multijet	88		06.06							
	1.9 D Multijet 4x4	88		06.06							
	2.0 D Multijet	99		06.06							
	2.0 D Multijet 4x4	99		06.06							
	1.6 16V	79		06.06		24.5279-0300.3	331135	2		L=300	
	1.6 16V	88		06.06							
	1.6 16V 4x4	79		06.06							
	1.6 16V 4x4	88		06.06							
	1.9 D Multijet	88		06.06							
	1.9 D Multijet 4x4	88		06.06							
	2.0 D Multijet	99		06.06							
	2.0 D Multijet 4x4	99		06.06							
	1.6 16V	79		06.06		24.3219-1756.3	020511			Rz 19,05	BOS
	1.6 16V	88		06.06							
	1.6 16V 4x4	79		06.06							
	1.6 16V 4x4	88		06.06							
	1.9 D Multijet	88		06.06							
	1.9 D Multijet 4x4	88		06.06							
	2.0 D Multijet	99		06.06							
	2.0 D Multijet 4x4	99		06.06							
	1.6 16V	79		06.06		24.3727-2007.2	582007	<input type="checkbox"/>	+ HA-Scheibenbremse ⁴⁾	L=1638	
	1.6 16V	88		06.06		24.3727-2006.2	582006	<input type="checkbox"/>	+ HA-Scheibenbremse ⁴⁾	L=1638	
	1.6 16V 4x4	79		06.06							
	1.6 16V 4x4	88		06.06							
	1.9 D Multijet	88		06.06							
	1.9 D Multijet 4x4	88		06.06							
	2.0 D Multijet	99		06.06							
	2.0 D Multijet 4x4	99		06.06							

FIAT SEICENTO (98-08)

	1100 i.e.			04.98	03.08	24.2119-0833.3	010418			THz 19,05
	900 i.e.			04.98	03.08					
	Elektrica			03.00	03.08					
	1100 i.e.			04.98	03.08	24.3481-1743.5	240305	<input type="checkbox"/>	D=48, - Halter	BDX
	900 i.e.			04.98	03.08	24.3481-1744.5	240306	<input type="checkbox"/>	D=48, - Halter	BDX
	1100 i.e.			04.98	03.08	24.5112-0445.3	330564	2		L=445
	900 i.e.			04.98	03.08					
	Elektrica			03.00	03.08	24.5228-0223.3	330530	2		L=223
	1100 i.e.			04.98	03.08	24.5228-0275.3	330035	2		L=275
	900 i.e.			04.98	03.08					
	1100 i.e.			04.98	03.08	24.3219-0803.3	020183			Rz 19,05
	Elektrica			03.00	03.08					

1) + RA drum brake / + P freno a tamburo / + frein à tambour essieu AR / + ET-tambores de freno
2) - long wheel base / - passo lungo / - empattement long / - distancia larga entre ejes
3) + long wheel base / + passo lungo / + empattement long / + distancia larga entre ejes
4) + RA disc brake / + P disco freno / + frein à disque essieu AR / + ET-disco de freno























        											
FIAT SEICENTO (98-08)											
	1100 i.e. 900 i.e.			04.98 04.98	03.08 03.08		24.3727-0544.2	580544	1	↓	L=2670
	900 i.e. 1100 i.e.			04.98 04.98	03.08 03.08		24.3728-0507.2	590507			L=570 L=776
FIAT STILO / STILO Multi Wagon (01-08)											
	1.6 16V 1.9 D Multijet 1.9 JTD 2.4 20V	100 110		04.05 09.05 01.04 10.01	03.08 03.08 03.08 03.08		24.2123-1769.3	010863			THz 23,81 BOS
	1.2 i 16V 1.4 i 16V 1.6 16V 1.8 16V 1.9 D Multijet 1.9 JTD 1.9 JTD	59		02.02 01.04 10.01 10.01 09.05 02.02 10.01	03.08 03.08 03.08 03.08 03.08 03.08 03.08		24.3541-1811.5 24.3541-1812.5	240429 240430	<input type="checkbox"/> <input type="checkbox"/>		D=54, - Halter D=54, - Halter BOS BOS D=54, - Halter D=54, - Halter BOS BOS
	1.2 i 16V 1.4 i 16V 1.6 16V 1.6 16V 1.8 16V 1.9 D Multijet 1.9 D Multijet 1.9 JTD 1.9 JTD 1.9 JTD 2.4 20V	59 100 110		02.02 01.04 10.01 04.05 10.01 09.05 09.05 02.02 10.01 01.04 10.01	03.08 03.08 03.08 03.08 03.08 03.08 03.08 03.08 03.08 03.08 03.08		83.6401-0413.3	330748	2		L=408
	1.2 i 16V 1.4 i 16V 1.6 16V 1.6 16V 1.8 16V 1.9 D Multijet 1.9 D Multijet 1.9 JTD 1.9 JTD 1.9 JTD 2.4 20V	59 100 110		02.02 01.04 10.01 04.05 10.01 09.05 09.05 02.02 10.01 01.04 10.01	03.08 03.08 03.08 03.08 03.08 03.08 03.08 03.08 03.08 03.08 03.08		24.5112-0185.3 83.6501-0282.3	330654 330769	2 2	am Bremsattel ¹⁾	L=185 L=287
	1.2 i 16V 1.4 i 16V 1.6 16V 1.6 16V 1.8 16V 1.9 D Multijet 1.9 D Multijet 1.9 JTD 1.9 JTD 1.9 JTD 2.4 20V	59 100 110		02.02 01.04 10.01 04.05 10.01 09.05 09.05 02.02 10.01 01.04 10.01	03.08 03.08 03.08 03.08 03.08 03.08 03.08 03.08 03.08 03.08 03.08		24.3727-0553.2 24.3727-0554.2	580553 580554	<input type="checkbox"/> <input type="checkbox"/>		L=1786 L=1668
FIAT STRADA / PICK-UP (99-11)											
	1.2 1.3 JTD 1.7 TD 1.9 D 1.9 JTD	62 51 46 59		05.99 05.06 05.99 12.00 04.03	12.11 12.11 12.11 12.11 12.11		20.5522-1093.3	010731		+ ABS	THz 22,20 ATE
	1.2 1.3 JTD 1.7 TD 1.9 D 1.9 JTD	62 51 46 59		05.99 05.06 05.99 12.00 04.03	12.11 12.11 12.11 12.11 12.11		24.5112-0475.3	330698	2		L=475
	1.2 1.3 JTD 1.7 TD 1.9 D 1.9 JTD	62 51 46 59		05.99 05.06 05.99 12.00 04.03	12.11 12.11 12.11 12.11 12.11		24.5228-0375.3	330699	2		L=375
	1.2			05.99	12.11		24.3728-0533.2 24.3728-0535.2	590533 590535			L=684 L=678
FIAT STRADA (11-)											
	1.3 D Multijet	70		01.11			24.5228-0375.3	330699	2		L=375
	1.3 D Multijet	70		01.11			24.3220-1722.3	020458			Rz 20,64

¹⁾ on the brake caliper / sulla pinza freno / sur l'étrier de frein / a la pinza de freno

















FIAT ULYSSE (94-02)										
	1.8 i.e.		06.96	04.99	- ABS	24.2123-1707.3	010492		THz 23,81	
	1.9 TD		01.95	04.99	- ABS					
	2.0	89	06.94	04.99	- ABS					
	1.8 i.e.		05.99	07.02	- ABS	24.2123-1738.3	010658		THz 23,81	
	1.9 TD		05.99	07.02	- ABS					
	2.0	89	05.99	07.02	- ABS					
	1.8 i.e.		05.99	07.02	+ ABS	24.2123-1733.3	010657		THz 23,81	
	1.9 TD		05.99	07.02	+ ABS					
	2.0	89	05.99	07.02	+ ABS					
	2.0 16V		05.99	07.02						
	2.0 JTD		05.99	07.02						
2.0 Turbo	108	05.99	07.02							
2.1 TD		05.99	10.99							
	1.8 i.e.		06.96	07.02		24.3571-1711.5	240159	<input type="checkbox"/>	D=57, - Halter	BDX
	1.9 TD		01.95	07.02						
	2.0	89	06.94	07.02						
	2.0 16V		06.94	07.02						
	2.0 JTD		10.99	07.02						
2.0 Turbo	108	06.94	07.02							
2.1 TD		06.96	10.99							
	1.8 i.e.		06.96	07.02		24.5118-0471.3	330528	2	L=473	
	1.9 TD		01.95	07.02						
	2.0	89	06.94	07.02						
	2.0 16V		06.94	07.02						
	2.0 JTD		10.99	07.02						
2.0 Turbo	108	06.94	07.02							
2.1 TD		06.96	10.99							
	1.8 i.e.		06.96	07.02	+ ABS	11.3361-9975.2	220281	<input type="checkbox"/>	D=36, - Halter	ATE
	1.9 TD		01.95	07.02	+ ABS					
	2.0	89	06.94	07.02	+ ABS					
	2.0 16V		06.94	07.02						
	2.0 JTD		10.99	07.02	+ ABS					
2.0 Turbo	108	06.94	07.02							
2.1 TD		06.96	10.99	+ ABS						
	1.8 i.e.		06.96	07.02		24.5229-0251.3	330535	2	Länge beachten ¹⁾	L=250
	1.9 TD		01.95	07.02						
	2.0	89	06.94	07.02						
	2.0 16V		06.94	07.02						
	2.0 JTD		10.99	07.02						
2.0 Turbo	108	06.94	07.02							
2.1 TD		06.96	10.99							
	1.8 i.e.		06.96	07.02	- ABS	24.3219-1704.3	020374		Rz 19,05	
	1.9 TD		01.95	07.02	- ABS					
	2.0	89	06.94	07.02	- ABS					
	2.0 JTD		10.99	07.02	- ABS					
	2.1 TD		06.96	10.99	- ABS					
	1.8 i.e.		06.96	07.02		24.3727-0336.2	580336	1 <input type="checkbox"/>	L=500	
	2.0	89	06.94	07.02						
	1.9 TD		01.95	07.02						
2.0 16V		06.94	07.02							
2.0 JTD		10.99	07.02							
2.0 Turbo	108	06.94	07.02							
2.1 TD		06.96	10.99							
	1.8 i.e.		06.96	07.02		24.3727-0532.2	580532	1 <input type="checkbox"/>	L=1063	
	2.0	89	06.94	07.02						
	1.9 TD		01.95	07.02						
2.0 16V		06.94	07.02							
2.0 JTD		10.99	07.02							
2.0 Turbo	108	06.94	07.02							
2.1 TD		06.96	10.99							
	1.8 i.e.		06.96	07.02		24.3727-0531.2	580531	1 <input type="checkbox"/>	L=2286	
	2.0	89	06.94	07.02						
	1.9 TD		01.95	07.02						
2.0 16V		06.94	07.02							
2.0 JTD		10.99	07.02							
2.0 Turbo	108	06.94	07.02							
2.1 TD		06.96	10.99							
	1.8 i.e.		06.96	07.02		24.3728-0341.2	590341		L=739, + AUT	
	2.0	89	06.94	07.02						
	1.9 TD		01.95	07.02						
2.0 JTD		10.99	07.02							
2.0 Turbo	108	06.94	07.02							
2.0 16V		06.94	07.02							
2.1 TD		06.96	10.99							
	1.8 i.e.		06.96	07.02		24.3728-0342.2	590342		L=864, + AUT	
	2.0	89	06.94	07.02						
	1.9 TD		01.95	07.02						
2.0 JTD		10.99	07.02							
2.0 Turbo	108	06.94	07.02							
2.0 16V		06.94	07.02							
2.1 TD		06.96	10.99							
	1.8 i.e.		06.96	07.02		24.3728-0336.2	590336		L=973, + AUT	
	2.0	89	06.94	07.02						
	1.9 TD		01.95	07.02						
2.0 JTD		10.99	07.02							
2.0 Turbo	108	06.94	07.02							
2.0 16V		06.94	07.02							
2.1 TD		06.96	10.99							
	1.8 i.e.		06.96	07.02		24.3728-0340.2	590340		L=1088, + AUT	
	2.0	89	06.94	07.02						
	1.9 TD		01.95	07.02						
2.0 JTD		10.99	07.02							
2.0 Turbo	108	06.94	07.02							
2.0 16V		06.94	07.02							
2.1 TD		06.96	10.99							
FIAT ULYSSE (02-11)										
	2.0 D Multijet	88	05.06	01.11		03.2122-2163.3	010800		THz 22,20	ATE
	2.0 D Multijet	100	05.06	01.11						
	2.0 i 16V	100	08.02	01.11						
	2.0 JTD	79	05.03	01.11						
	2.0 JTD	80	08.02	01.11						
	2.2 D Multijet	125	03.08	01.11						
	2.2 JTD	94	08.02	01.11						
2.2 JTD	120	03.08	01.11							
	2.0 D Multijet	88	05.06	01.11		24.3601-1711.7	220607	<input type="checkbox"/>	D=60, - Halter	TRW
	2.0 D Multijet	100	05.06	01.11						
	2.0 i 16V	100	08.02	01.11						
	2.0 JTD	79	05.03	01.11						
	2.0 JTD	80	08.02	01.11						
	2.2 JTD	94	08.02	01.11						
	2.2 JTD	120	03.08	01.11						
	2.2 D Multijet	125	03.08	01.11		24.3451-1855.5	240659	<input type="checkbox"/>	D=40/45, - Halter	TRW

¹⁾ notice length / attenzione lunghezza / faire attention longueur / atención largo

								
FIAT ULYSSE (02-11)								
	2.0 D Multijet	88	05.06	01.11	24.5111-0462.3	330555	2	L=460
	2.0 D Multijet	100	05.06	01.11				
	2.0 i 16V	100	08.02	01.11				
	2.0 JTD	79	05.03	01.11				
	2.0 JTD	80	08.02	01.11				
	2.2 JTD	94	08.02	01.11				
	2.2 JTD	120	03.08	01.11				
3.0 i V6	150	08.02	01.11					
	2.0 D Multijet	88	05.06	01.11	24.3384-1761.7	220671	<input type="checkbox"/>	D=38, - Halter
	2.0 D Multijet	100	05.06	01.11				
	2.0 i 16V	100	08.02	01.11				
	2.0 JTD	79	05.03	01.11				
	2.0 JTD	80	08.02	01.11				
	2.2 D Multijet	125	03.08	01.11				
	2.2 JTD	94	08.02	01.11				
2.2 JTD	120	03.08	01.11					
3.0 i V6	150	08.02	01.11					
	2.0 D Multijet	88	05.06	01.11	24.5229-0251.3	330535	2	L=250
	2.0 D Multijet	100	05.06	01.11				
	2.0 i 16V	100	08.02	01.11				
	2.0 JTD	79	05.03	01.11				
	2.0 JTD	80	08.02	01.11				
	2.2 D Multijet	125	03.08	01.11				
	2.2 JTD	94	08.02	01.11				
2.2 JTD	120	03.08	01.11					
3.0 i V6	150	08.02	01.11					
	2.0 i 16V	100	08.02	01.11	24.3727-0847.2	580847	<input type="checkbox"/>	L=1068
	2.0 JTD	79	05.03	01.11				
	2.0 JTD	80	08.02	01.11				
	2.2 JTD	94	08.02	01.11				
	2.2 JTD	120	03.08	01.11				
	2.2 JTD	120	03.08	01.11				
	3.0 i V6	150	08.02	01.11				
	2.0 D Multijet	88	05.06	01.11	24.3727-0569.2	580569	2	L=1255
	2.0 D Multijet	100	05.06	01.11				
	2.2 D Multijet	125	03.08	01.11				
FORD B-MAX (12-)								
	1.0 EcoBoost	74	10.12		83.7827-0263.3	331193	2	L=260
	1.0 EcoBoost	88	10.12					
	1.0 EcoBoost	92	10.12		24.5204-0260.3	331423	2	L=260
	1.0 EcoBoost	103	02.16					
	1.4 Duratec	66	10.12					
	1.4 LPG	63	08.13					
	1.5 TDCi	55	10.12					
	1.5 TDCi	70	04.15					
	1.6 TDCi	70	10.12					
1.6 Ti-VCT	77	10.12						
FORD C-MAX I (07-10)								
	1.6 i 16V	74	03.07	04.07	03.7863-0332.4	300203		10"
	1.6 TDCi		03.07	04.07				
	1.6 TDCi	66	03.07	04.07				
	1.8 i 16V		03.07	04.07				
	1.8 TDCi	85	03.07	04.07				
	2.0 i 16V	107	03.07	04.07				
	2.0 TDCi		03.07	04.07				
	1.6 i 16V	74	05.07	10.10	03.7863-3932.4	300288		10"
	1.6 TDCi		05.07	10.10				
	1.6 TDCi	66	05.07	10.10				
	1.8 i 16V		05.07	10.10				
	1.8 TDCi	85	05.07	10.10				
	2.0 i 16V	107	05.07	10.10				
	2.0 TDCi		05.07	10.10				
2.0 TDCi	81	02.08	10.10					
	1.6 i 16V	74	03.07	05.07	03.2123-3103.3	010781		Thz 23,81
	1.6 TDCi		03.07	05.07				
	1.6 TDCi	66	03.07	05.07				
	1.8 i 16V		03.07	05.07				
	1.8 TDCi	85	03.07	05.07				
	2.0 i 16V	107	03.07	05.07				
	2.0 TDCi		03.07	05.07				
	1.6 i 16V	74	06.07	10.08	03.2125-0483.3	010783		Thz 25,40
	1.6 TDCi		06.07	10.08				
	1.6 TDCi	66	06.07	10.08				
	1.8 i 16V		06.07	10.08				
	1.8 TDCi	85	06.07	10.08				
	2.0 i 16V	107	06.07	10.08				
	2.0 TDCi		06.07	10.08				
2.0 TDCi	81	02.08	10.08					
	1.6 i 16V	74	11.08	10.10	03.2125-0661.3	010917		Thz 25,40
	1.6 TDCi		11.08	10.10				
	1.6 TDCi	66	11.08	10.10				
	1.8 i 16V		11.08	10.10				
	1.8 TDCi	85	11.08	10.10				
	2.0 i 16V	107	11.08	10.10				
	2.0 TDCi		11.08	10.10				
2.0 TDCi	81	11.08	10.10					

FORD GRAND C-MAX (10-)											
	1.0 EcoBoost	74		09.12		24.3571-9813.5	240557	2		D=57, - Halter D=57, - Halter Haltefeder	ATE ATE ATE
	1.0 EcoBoost	92		09.12		24.3571-9814.5	240558				
	1.5 EcoBoost	110		03.15		11.8116-0356.1	390586				
	1.5 EcoBoost	134		03.15							
	1.5 TDCi	70		03.15							
	1.5 TDCi	88		03.15							
	1.6 EcoBoost	110		12.10							
	1.6 EcoBoost	134		12.10							
	1.6 Flexifuel	88		02.11							
	1.6 LPG	86		02.12							
	1.6 TDCi	70		12.10							
	1.6 TDCi	85		12.10							
	1.6 Ti-VCT	77		12.10							
	1.6 Ti-VCT	92		12.10							
	2.0 TDCi	85		12.10							
	2.0 TDCi	100		12.10							
2.0 TDCi	103		12.10								
2.0 TDCi	110		03.15								
2.0 TDCi	120		12.10								
2.0 TDCi	125		03.15								
	1.0 EcoBoost	74		09.12		11.9387-7083.2	220959	2		D=38, - Halter D=38, - Halter	ATE ATE
	1.0 EcoBoost	92		09.12		11.9387-7084.2	220960				
	1.5 EcoBoost	110		03.15							
	1.5 EcoBoost	134		03.15							
	1.5 TDCi	70		03.15							
	1.5 TDCi	88		03.15							
	1.6 EcoBoost	110		12.10							
	1.6 EcoBoost	134		12.10							
	1.6 Flexifuel	88		02.11							
	1.6 LPG	86		02.12							
	1.6 TDCi	70		12.10							
	1.6 TDCi	85		12.10							
	1.6 Ti-VCT	77		12.10							
	1.6 Ti-VCT	92		12.10							
	2.0 TDCi	85		12.10							
	2.0 TDCi	100		12.10							
2.0 TDCi	103		12.10								
2.0 TDCi	110		03.15								
2.0 TDCi	120		12.10								
2.0 TDCi	125		03.15								
	1.0 EcoBoost	74		09.12		24.3727-0678.2	580678	1	↑ - Mittelkonsole ¹⁾	L=341	
	1.0 EcoBoost	92		09.12							
	1.5 EcoBoost	110		03.15							
	1.5 EcoBoost	134		03.15							
	1.5 TDCi	70		03.15							
	1.5 TDCi	88		03.15							
	1.6 EcoBoost	110		12.10							
	1.6 EcoBoost	134		12.10							
	1.6 Flexifuel	88		02.11							
	1.6 LPG	86		02.12							
	1.6 TDCi	70		12.10							
	1.6 TDCi	85		12.10							
	1.6 Ti-VCT	77		12.10							
	1.6 Ti-VCT	92		12.10							
	2.0 TDCi	85		12.10							
	2.0 TDCi	100		12.10							
2.0 TDCi	103		12.10								
2.0 TDCi	110		03.15								
2.0 TDCi	120		12.10								
2.0 TDCi	125		03.15								
FORD COUGAR (98-01)											
	2.0 i 16V			09.98	12.01	24.2125-1709.3	010499			Thz 25,40	
	2.5 i V6			09.98	12.01						
	2.5 ST 200			01.00	12.01						
	2.0 i 16V			09.98	12.01	24.3601-8527.5	240503	2		D=60, - Halter D=60, - Halter Dichtungssatz Hülsensatz Führungsbolzen Haltefeder	ATE ATE ATE ATE ATE
						24.3601-8528.5	240504				
						11.0441-6007.2	250146				
	2.5 i V6			09.98	12.01	24.3601-8527.5	240503	2		D=60, - Halter D=60, - Halter Dichtungssatz Hülsensatz Führungsbolzen Haltefeder	ATE ATE ATE ATE ATE
						24.3601-8528.5	240504				
						11.0441-6007.2	250146				
2.5 ST 200			01.00	12.01	11.0101-5407.2	260011					
					11.8171-0008.1	990049					
					11.8116-0301.1	390610					
	2.0 i 16V			09.98	12.01	83.7114-0376.3	330373	2		L=370	
	2.5 i V6			09.98	12.01						
	2.5 ST 200			01.00	12.01						
	2.0 i 16V			09.98	12.01	24.3364-1703.5	240309	2		D=36, - Halter D=36, - Halter	BOS BOS
	2.5 i V6			09.98	12.01	24.3364-1704.5	240310				
	2.0 i 16V			09.98	12.01	24.5309-0540.3	331368	2		L=540	
	2.5 i V6			09.98	12.01						
	2.5 ST 200			01.00	12.01						

¹⁾ - centre console / - consolle centrale / - consola central

									
FORD COUGAR (98-01)									
	2.0 i 16V 2.5 i V6 2.5 ST 200			09.98 09.98 01.00	12.01 12.01 12.01	24.3727-0638.2 24.3727-0644.2	580638 580644	1 ↑ 2 ↓	L=270 L=1462
	2.0 i 16V 2.5 i V6 2.5 ST 200			09.98 09.98 01.00	12.01 12.01 12.01	24.2419-1723.3	030112		Gz 19,05
FORD ESCORT VII (95-00)									
	1.3 i 1.4 i 1.6 i 16V 1.8 D 1.8 i 16V 1.8 i 16V 1.8 TD	77 85		02.95 02.95 02.95 02.95 02.95 02.95 02.95	02.99 02.99 02.99 02.99 02.99 02.99 02.99	24.2123-1732.3	010625	- ABS	Thz 23,81 - Behälter
	1.3 i 1.4 i 1.6 i 16V 1.8 D 1.8 i 16V 1.8 TD			08.95 08.95 08.95 08.95 08.95 08.95	02.99 02.99 07.00 02.99 02.99 07.00	03.2123-1581.3	010487	+ ABS	Thz 23,81 (MKIV) ATE
	1.3 i 1.4 i 1.6 i 16V 1.8 D 1.8 i 16V 1.8 i 16V 1.8 TD	77 85		02.95 02.95 02.95 02.95 02.95 02.95 02.95	02.99 02.99 07.00 02.99 02.99 02.99 07.00	24.3541-1707.5 24.3541-1708.5 24.0101-5401.2	240067 240068 260059	 	D=54, - Halter BDX D=54, - Halter BDX Bremsattel-Zubehör BDX
	1.8 i 16V RS 2000	96		02.95 02.95	02.99 02.99	11.0441-6007.2 11.0101-5407.2 11.8171-0008.1	250146 260011 990049		Dichtungssatz ATE Hülensatz ATE Führungsbolzen ATE
	2.0 i 16V Cosworth			02.95	12.95	11.0441-6007.2 11.0101-5407.2 11.8171-0008.1 11.8116-0073.1	250146 260011 990049 390498		Dichtungssatz ATE Hülensatz ATE Führungsbolzen ATE Haltefeder ATE
	1.3 i 1.4 i Cabrio 1.4 i Lim. 1.6 i 16V Cabrio 1.6 i 16V Lim. 1.8 D Cabrio 1.8 D Lim. 1.8 i 16V Cabrio 1.8 i 16V Lim. 1.8 TD Cabrio 1.8 TD Lim.			02.95 02.95 02.95 02.95 02.95 02.95 02.95 02.95 02.95 02.95 02.95	02.99 02.99 02.99 02.99 02.99 02.99 02.99 02.99 02.99 02.99 02.99	24.5305-0300.3	330658	2	L=300
	1.3 i 1.4 i Cabrio 1.4 i Lim. 1.6 i 16V Cabrio 1.6 i 16V Lim. 1.8 D Cabrio 1.8 D Lim. 1.8 i 16V Cabrio 1.8 i 16V Lim. 1.8 TD Cabrio 1.8 TD Lim. 2.0 i 16V Cosworth			02.95 02.95 02.95 02.95 02.95 02.95 02.95 02.95 02.95 02.95 02.95	02.99 02.99 02.99 02.99 02.99 02.99 02.99 02.99 02.99 02.99 12.95	24.5305-0420.3	330661	2	L=420
	1.4 i Kombi 1.6 i 16V Kombi 1.8 D Kombi 1.8 i 16V Kombi 1.8 TD Kombi			08.95 08.95 08.95 08.95 08.95	02.99 02.99 02.99 02.99 02.99	24.5305-0320.3	330764	2	L=322
	1.3 i Kombi 1.4 i Cabrio 1.4 i Kombi 1.6 i 16V Cabrio 1.8 D 1.8 i 16V Cabrio 1.8 TD			02.95 02.95 02.95 02.95 02.95 02.95 02.95	07.95 02.99 07.95 07.95 07.95 07.95 07.95	24.3219-1107.3	020338		Rz 19,05 TRW
	1.3 i Lim. 1.4 i Cabrio 1.4 i Lim. 1.6 i 16V Kombi 1.6 i 16V Kombi 1.6 i 16V Lim. 1.8 D 1.8 i 16V 1.8 i 16V 1.8 i 16V Cabrio 1.8 TD			02.95 02.95 02.95 08.95 02.95 02.95 08.95 08.95 02.95 08.95 08.95	02.99 02.99 02.99 07.00 07.95 07.95 07.00 07.00 07.95 07.00 07.00	24.3220-1112.3	020223		Rz 20,64
	1.3 i Kombi 1.3 i Kombi 1.3 i Lim. 1.4 i Cabrio 1.4 i Kastenw.			08.95 02.95 02.95 02.95 02.95	02.99 02.99 02.99 02.99 02.99	24.3222-1117.3	020272		Rz 22,20



FORD ESCORT VII (95-00)































	1.4 i Kombi 1.4 i Kombi 1.4 i Lim. 1.6 i 16V Cabrio 1.6 i 16V Kombi 1.6 i 16V Lim. 1.6 i 16V Lim. 1.8 D 1.8 D Kastenw. 1.8 i 16V 1.8 i 16V Cabrio 1.8 TD 2.0 i 16V Cosworth RS 2000		08.95 02.95 02.95 08.95 02.95 08.95 02.95 02.95 02.95 02.95 02.95 02.95 02.95 02.95	02.99 02.99 02.99 07.00 07.95 07.00 07.95 07.95 07.00 07.95 07.00 07.95 02.99 02.99	- ABS + ABS + ABS + ABS + ABS + ABS + ABS + ABS + ABS + ABS	24.3222-1117.3	020272			Rz 22,20
	1.3 i 1.4 i 1.6 i 16V 1.8 D 1.8 i 16V 1.8 TD 2.0 i 16V Cosworth	◀	02.95 02.95 02.95 02.95 02.95 02.95 02.95	02.99 02.99 07.00 02.99 02.99 07.00 12.95		24.3727-0661.2 24.3727-0657.2	580661 580657	1 ↑ 1 ↓		L=281 L=1670/1705
	1.3 i 1.4 i 1.6 i 16V 1.8 D 1.8 i 16V 1.8 TD 2.0 i 16V Cosworth	▶	02.95 02.95 02.95 02.95 02.95 02.95 02.95	02.99 02.99 07.00 02.99 02.99 07.00 12.95		24.3727-0661.2	580661	1 ↑		L=281
	1.3 i 1.4 i 1.6 i 16V 1.8 D 1.8 i 16V 1.8 TD 2.0 i 16V Cosworth	◀	02.95 02.95 02.95 02.95 02.95 02.95 02.95	04.98 04.98 04.98 04.98 04.98 04.98 04.98	+ Lieferwagen ¹⁾ + Lieferwagen ¹⁾ + Lieferwagen ¹⁾ + Lieferwagen ¹⁾ + Lieferwagen ¹⁾ + Lieferwagen ¹⁾ + Lieferwagen ¹⁾	24.3727-0661.2	580661	1 ↑		L=281
	1.3 i 1.4 i 1.6 i 16V 1.8 D 1.8 i 16V 1.8 TD 2.0 i 16V Cosworth	◀	05.98 05.98 05.98 05.98 05.98 05.98 05.98	02.99 02.99 02.99 02.99 02.99 02.99 02.99	+ Lieferwagen ¹⁾ + Lieferwagen ¹⁾ + Lieferwagen ¹⁾ + Lieferwagen ¹⁾ + Lieferwagen ¹⁾ + Lieferwagen ¹⁾ + Lieferwagen ¹⁾	24.3727-0661.2	580661	1 ↑		L=281
	1.3 i 1.4 i 1.6 i 16V 1.8 D 1.8 i 16V 1.8 TD 2.0 i 16V Cosworth	▶	02.95 02.95 02.95 02.95 02.95 02.95 02.95	04.98 04.98 04.98 04.98 04.98 04.98 04.98	+ Lieferwagen ¹⁾ + Lieferwagen ¹⁾ + Lieferwagen ¹⁾ + Lieferwagen ¹⁾ + Lieferwagen ¹⁾ + Lieferwagen ¹⁾ + Lieferwagen ¹⁾	24.3727-0661.2	580661	1 ↑		L=281
	1.3 i 1.4 i 1.6 i 16V 1.8 D 1.8 i 16V 1.8 TD 2.0 i 16V Cosworth	▶	05.98 05.98 05.98 05.98 05.98 05.98 05.98	02.99 02.99 02.99 02.99 02.99 02.99 02.99	+ Lieferwagen ¹⁾ + Lieferwagen ¹⁾ + Lieferwagen ¹⁾ + Lieferwagen ¹⁾ + Lieferwagen ¹⁾ + Lieferwagen ¹⁾ + Lieferwagen ¹⁾	24.3727-0661.2	580661	1 ↑		L=281

FORD FIESTA IV (96-02)



















	1.0 i 1.25 i 16V 1.3 i 1.4 i 16V 1.6 1.6 i 16V 1.8 D 1.8 DI	55 66 65 76 44 55	02.00 02.00 02.00 02.00 02.00 02.00 03.00	03.02 03.02 03.02 03.02 03.02 03.02 03.02	- ABS - ABS - ABS - ABS - ABS - ABS - ABS	03.7750-2332.4	300113		9"	ATE
	1.0 i 1.25 i 16V 1.3 i Lim. 1.8 D Lim. 1.8 DI	55	02.97 01.96 01.96 01.96 03.00	01.00 01.00 03.02 03.02 03.02	- ABS - ABS/ + Schaltgetriebe ²⁾ - ABS - ABS - ABS	24.2122-1775.3	010981		THz 22,20 - Behälter	TRW
	1.25 i 16V 1.4 i 16V 1.6 1.6 i 16V	55 66 65 76	01.96 02.96 02.00 10.99	01.00 03.02 03.02 03.02	- ABS/ + Automatikgetriebe ³⁾ - ABS - ABS - ABS	24.2123-1735.3	010652		THz 23,81	
	1.3 i Kastenw. 1.8 D Kastenw.	44	01.96 01.96	01.00 01.00	- ABS - ABS	24.2123-1737.3	010654		THz 23,81	
	1.0 i 1.25 i 16V 1.3 i Kastenw. 1.8 D Kastenw.	55 44	02.00 02.00 02.00 02.00	03.02 03.02 03.02 03.02	- ABS - ABS - ABS - ABS	03.2122-1588.3	010733		THz 22,20	ATE
	1.0 i 1.25 i 16V 1.3 i Lim. 1.4 i 16V 1.6	55 66 65	02.00 02.00 02.00 02.00	03.02 03.02 03.02 03.02	+ ABS + ABS + ABS + ABS	03.2123-2243.3	010748		THz 23,81	ATE

¹⁾ + delivery van / + furgone / + voiture de livraison / + furgoneta
²⁾ - ABS/ + manual transmission / - ABS/+ scatola camb.velocità / - ABS/ + transmission mécanique / - ABS/ + cambio de velocidad
³⁾ - ABS/ + autom.transmission / - ABS/+ scatola cambio autom. / - ABS/ + transmission automatique / - ABS/ + cambio automático



								
FORD FIESTA IV (96-02)								
	1.6 i 16V 1.8 D Lim. 1.8 DI	76 55	02.00 02.00 03.00	03.02 + ABS 03.02 + ABS 03.02 + ABS	03.2123-2243.3	010748		Thz 23,81 ATE
	1.3 i Kastenw. 1.8 D Kastenw.	44	02.00 02.00	03.02 + ABS 03.02 + ABS	03.2122-1564.3	010594		Thz 22,20 ATE
	1.0 i 1.25 i 16V 1.3 i Lim. 1.8 D Lim.	55	02.97 01.96 01.96 01.96	01.00 + Schaltgetriebe ¹⁾ 01.00 01.00	11.3481-8513.2 11.3481-8514.2 11.0441-4805.2 11.0230-0687.1 11.0101-5407.2 11.8171-0008.1 11.8116-0264.1	220335 220336 250020 260106 260011 990049 390594	  2 2	D=48, - Halter D=48, - Halter Dichtungssatz Halter Hülzensatz Führungsbolzen Haltefeder ATE ATE ATE ATE ATE ATE
	1.0 i 1.25 i 16V 1.3 i Kastenw. 1.4 i 16V 1.6 i 16V 1.8 D Kastenw.	55 44 66 76	02.97 01.96 01.96 02.96 10.99 01.96	01.00 + Automatikgetriebe ²⁾ 01.00 01.00 01.00 01.00	11.3541-8529.2 11.3541-8530.2 24.3541-8529.5 24.3541-8530.5 11.0441-5402.2 11.0101-5407.2 11.8171-0008.1 11.8116-0264.1	220341 220342 240553 240554 250028 260011 990049 390594	    2	D=54, - Halter D=54, - Halter D=54, - Halter D=54, - Halter Dichtungssatz Hülzensatz Führungsbolzen Haltefeder ATE ATE ATE ATE ATE ATE
	1.0 i 1.25 i 16V 1.3 i 1.4 i 16V 1.6 1.6 i 16V 1.8 D 1.8 DI	55 66 65 76 44 55	02.00 02.00 02.00 02.00 02.00 02.00 03.00	03.02 - ABS 03.02 - ABS 03.02 - ABS 03.02 - ABS 03.02 - ABS 03.02 - ABS	11.3481-8515.2 11.3481-8516.2 24.3481-8515.5 24.3481-8516.5 11.0101-5407.2 11.8171-0008.1 11.8116-0264.1	220365 220366 240477 240478 260011 990049 390594	    2	D=48, - Halter D=48, - Halter D=48, - Halter D=48, - Halter Hülzensatz Führungsbolzen Haltefeder ATE ATE ATE ATE ATE
	1.0 i 1.25 i 16V 1.3 i 1.4 i 16V 1.6 1.6 i 16V 1.8 D 1.8 DI	55 66 65 76 44 55	02.00 02.00 02.00 02.00 02.00 02.00 03.00	03.02 + ABS 03.02 + ABS 03.02 + ABS 03.02 + ABS 03.02 + ABS 03.02 + ABS	11.3541-8531.2 11.3541-8532.2 11.0101-5407.2 11.8171-0008.1 11.8116-0264.1	220367 220368 260011 990049 390594	  2	D=54, - Halter D=54, - Halter Hülzensatz Führungsbolzen Haltefeder ATE ATE ATE ATE
	1.0 i 1.25 i 16V 1.3 i Lim. 1.4 i 16V 1.6 i 16V 1.8 D Lim.	55 66 76	02.97 01.96 01.96 02.96 10.99 01.96	02.00 02.00 02.00 02.00 02.00	24.5305-0295.3	330657	2	L=297
	1.0 i 1.25 i 16V 1.3 i Lim. 1.4 i 16V 1.6 1.6 i 16V 1.8 D Lim. 1.8 DI	55 66 65 76 55	03.00 03.00 03.00 02.00 03.00 03.00 03.00	03.02 03.02 03.02 03.02 03.02 03.02	24.5305-0310.3	331326	2	L=310
	1.3 i Kastenw. 1.8 D Kastenw.	44	01.96 01.96	03.02 03.02	24.5304-0280.3	330589	2	L=280
	1.0 i 1.25 i 16V 1.3 i Lim. 1.8 D Lim.	55	02.97 01.96 01.96 01.96	01.00 + Schaltgetriebe ¹⁾ 01.00 01.00	24.3217-1715.3	020463	nur paarweise austauschen ³⁾	Rz 17,78 TRW
	1.0 i 1.25 i 16V 1.3 i Lim. 1.8 D Lim. 1.8 DI Lim.	55	02.00 02.00 02.00 03.00	03.02 + Schaltgetriebe ¹⁾ 03.02 03.02	24.3219-1735.3	020464		Rz 19,05
	1.0 i 1.25 i 16V 1.4 i 16V 1.6 1.6 i 16V	55 66 65 76	02.97 01.96 02.96 02.00 10.99	03.02 + Automatikgetriebe ²⁾ 03.02 03.02 03.02	24.3219-1107.3	020338	nur paarweise austauschen ³⁾	Rz 19,05 TRW
	1.3 i Kastenw. 1.8 D Kastenw. 1.8 DI Kastenw.	44 55	01.96 01.96 03.00	03.02 03.02 03.02	24.3222-1117.3	020272		Rz 22,20
	1.0 i 1.25 i 16V 1.3 i Lim. 1.4 i 16V 1.6 1.6 i 16V 1.8 D Lim. 1.8 DI Lim.	55 66 65 76	02.97 01.96 01.96 02.96 10.99 01.96 03.00	03.02 03.02 03.02 03.02 03.02 03.02	24.3727-1800.2 24.3727-0660.2	581800 580660	1  1 	L=312 L=1575/1627
	1.3 i Kastenw. 1.8 D Kastenw. 1.8 DI Kastenw.	44 55	01.96 01.96 03.00	03.02 03.02 03.02	24.3727-0634.2	580634	1 	L=1875/1930
	1.0 i 1.25 i 16V 1.3 i 1.4 i 16V 1.8 D	55 66 44	02.97 01.96 01.96 02.96 01.96	08.98 08.98 08.98 08.98	24.2419-1734.3	030126		Gz 19,05

1) + manual transmission / + scatola cambio velocità / + transmission mécanique / + cambio de velocidad
2) + autom.transmission / + scatola cambio automatico / + transmission automatique / + cambio automático
3) to change only by pairs / sostituire solo a coppie / à changer seulement par paires / cambiar solamente por parejas

										
FORD FIESTA IV (96-02)										
	1.0 i 1.25 i 16V 1.3 i 1.4 i 16V 1.6 1.6 i 16V 1.8 D 1.8 DI	55 66 65 76 44 55		09.98 09.98 09.98 09.98 02.00 10.99 09.98 03.00	03.02 03.02 03.02 03.02 03.02 03.02 03.02 03.02	24.2419-1736.3	030128	Gz 19,05		
FORD FIESTA V (02-08)										
	1.25 i 16V 1.25 i 16V 1.3 i 1.3 i 1.4 i 16V 1.4 TDCi 1.6 i 16V 1.6 TDCi	51 55 44 51 59 50 74 66		03.03 05.02 04.02 04.02 04.02 04.02 04.02 10.04	08.08 08.08 08.08 08.08 08.08 08.08 08.08 08.08	03.7750-8732.4 03.7853-2102.4	300199 300201	- Bremsassistent 1) + Bremsassistent 2)		
	1.25 i 16V 1.25 i 16V 1.3 i 1.3 i 1.4 i 16V 1.4 TDCi 1.6 i 16V 1.6 TDCi	51 55 44 51 59 50 74 66	◀	03.03 05.02 04.02 04.02 04.02 04.02 04.02 10.04	08.08 08.08 08.08 08.08 08.08 08.08 08.08 08.08	03.4153-0015.3 03.4153-5287.4	011005 010953	- ABS + ABS		
	1.25 i 16V 1.25 i 16V 1.3 i 1.3 i 1.4 i 16V 1.4 TDCi 1.6 i 16V 1.6 TDCi	51 55 44 51 59 50 74 66		03.03 05.02 04.02 04.02 04.02 04.02 04.02 10.04	08.08 08.08 08.08 08.08 08.08 08.08 08.08 08.08	11.3541-8531.2 11.3541-8532.2 11.0101-5407.2 11.8171-0008.1 11.8116-0264.1	220367 220368 260011 990049 390594	☐ ☐ 2		
	ST 150	110		11.04	04.08	11.8116-0301.1	390610	2	Haltefeder	ATE
	ST 150	110		05.08	08.08	11.8116-0301.1	390610	2	Haltefeder	ATE
	1.25 i 16V 1.25 i 16V 1.3 i 1.3 i 1.4 i 16V 1.4 TDCi 1.6 i 16V 1.6 TDCi ST 150	51 55 44 51 59 50 74 66 110		03.03 05.02 04.02 04.02 04.02 04.02 04.02 10.04 11.04	08.08 08.08 08.08 08.08 08.08 08.08 08.08 08.08 08.08	24.5141-0473.3	331303	2	L=473	
	1.25 i 16V 1.25 i 16V 1.3 i 1.3 i 1.4 i 16V 1.4 TDCi 1.6 i 16V 1.6 TDCi	51 55 44 51 59 50 74 66		03.03 05.02 04.02 04.02 04.02 04.02 04.02 10.04	08.08 08.08 08.08 08.08 08.08 08.08 08.08 08.08	83.7827-0300.3	330902	2	L=300	
	1.25 i 16V 1.25 i 16V 1.3 i 1.3 i 1.4 i 16V 1.4 TDCi 1.6 i 16V 1.6 TDCi	51 55 44 51 59 50 74 66		03.03 05.02 04.02 04.02 04.02 04.02 04.02 10.04	08.08 08.08 08.08 08.08 08.08 08.08 08.08 08.08	24.3219-1735.3	020464		Rz 19,05	
	1.25 i 16V 1.25 i 16V 1.3 i 1.3 i 1.4 i 16V 1.4 TDCi 1.6 i 16V 1.6 TDCi	51 55 44 51 59 50 74 66		03.03 05.02 04.02 04.02 04.02 04.02 04.02 10.04	08.08 08.08 08.08 08.08 08.08 08.08 08.08 08.08	24.3727-0658.2 24.3727-0653.2	580658 580653	1 ↑ 1 ↓	L=306 L=1305/1445	
	1.25 i 16V 1.25 i 16V 1.3 i 1.3 i 1.4 i 16V 1.4 TDCi 1.6 i 16V 1.6 TDCi ST 150	51 55 44 51 59 50 74 66 110		03.03 05.02 04.02 04.02 04.02 04.02 04.02 10.04 11.04	08.08 08.08 08.08 08.08 08.08 08.08 08.08 08.08 08.08	24.2419-1735.3	030127		Gz 19,05	
FORD FIESTA VI (08-)										
	1.0 1.0 1.0 EcoBoost 1.0 EcoBoost 1.0 Sport EcoBoost 1.25 i 16V	48 59 74 92 103 44		10.12 10.12 10.12 10.12 05.14 09.08		24.3541-1857.5 24.3541-1858.5	240733 240734	☐ ☐	D=54, - Halter D=54, - Halter	TRW TRW

1) - emergency brake assist / - assistenza alla frenata / - assistance de freinage / - asistente de freno
2) + emergency brake assist / + assistenza alla frenata / + assistance de freinage / + asistente de freno































FORD FIESTA VI (08-)

	1.25 i 16V 1.4 Duratec LPG 1.4 i 16V 1.4 TDCi 1.4 TDCi 1.5 TDCi 1.5 TDCi 1.6 TDCi 1.6 TDCi 1.6 TDCi 1.6 TDCi 1.6 Ti-VCT 1.6 Ti-VCT	60 71 50 51 55 70 55 66 70 77 88 99		09.08 06.09 09.08 01.09 07.10 10.12 05.15 09.08 09.08 02.10 10.12 09.08 12.10		24.3541-1857.5 24.3541-1858.5	240733 240734	 	D=54, - Halter D=54, - Halter	TRW TRW
	1.25 i 16V 1.25 i 16V 1.4 Duratec LPG 1.4 i 16V 1.4 TDCi 1.4 TDCi 1.6 TDCi 1.6 TDCi 1.6 TDCi 1.6 TDCi 1.6 Ti-VCT 1.6 Ti-VCT	44 60 71 50 51 55 66 70 88 99		09.08 09.08 06.09 09.08 01.09 07.10 09.08 09.08 09.08 02.10 09.08 12.10		83.7838-0371.3 83.7838-0370.3	331123 331122	 	L=366 L=366	
	1.0 1.0 1.0 EcoBoost 1.0 EcoBoost 1.0 Sport EcoBoost 1.25 i 16V 1.25 i 16V 1.4 Duratec LPG 1.4 i 16V 1.4 TDCi 1.4 TDCi 1.5 TDCi 1.5 TDCi 1.6 TDCi 1.6 TDCi 1.6 TDCi 1.6 TDCi 1.6 Ti-VCT 1.6 Ti-VCT 1.6 Ti-VCT	48 59 74 92 103 44 60 71 50 51 55 70 55 66 70 77 88 99		10.12 10.12 10.12 10.12 05.14 09.08 09.08 06.09 09.08 01.09 07.10 10.12 05.15 09.08 09.08 02.10 10.12 09.08 12.10		83.7827-0263.3 24.5204-0260.3	331193 331423	2 2	L=260 L=260	
	1.0 1.0 1.0 EcoBoost 1.0 EcoBoost 1.0 Sport EcoBoost 1.25 i 16V 1.25 i 16V 1.4 Duratec LPG 1.4 i 16V 1.4 TDCi 1.4 TDCi 1.5 TDCi 1.5 TDCi 1.6 TDCi 1.6 TDCi 1.6 TDCi 1.6 TDCi 1.6 Ti-VCT 1.6 Ti-VCT 1.6 Ti-VCT	48 59 74 92 103 44 60 71 50 51 55 70 55 66 70 77 88 99		10.12 10.12 10.12 10.12 05.14 09.08 09.08 06.09 09.08 01.09 07.10 10.12 05.15 09.08 09.08 02.10 10.12 09.08 12.10		24.3219-1760.3	020529		Rz 19,05	

FORD FOCUS I (98-04)

	1.4 i 16V 1.6 i 16V 1.8 BiFuel 1.8 i 16V 1.8 TDCi 1.8 Turbo DI 2.0 i 16V		10.98 10.98 02.03 10.98 03.01 10.98 10.98	09.04 09.04 01.05 09.04 09.04 09.04 09.04		24.4123-1713.3	010905	+ ABS	THz 23,81 - Behälter	BOS
	1.4 i 16V 1.6 i 16V 1.8 i 16V 1.8 TDCi 1.8 Turbo DI 2.0 i 16V		06.99 06.99 06.99 03.01 06.99 06.99	10.01 10.01 10.01 10.01 10.01 10.01		03.4123-0019.3	010584	+ ESP	THz 23,81	ATE
	1.4 i 16V 1.6 i 16V 1.8 BiFuel 1.8 i 16V 1.8 TDCi 1.8 Turbo DI 2.0 i 16V		11.01 11.01 02.03 11.01 11.01 11.01 11.01	09.04 09.04 01.05 09.04 09.04 09.04 09.04		03.4123-0153.3	010659	+ ESP	THz 23,81	ATE

								
FORD FOCUS I (98-04)								
	1.4 i 16V 1.6 i 16V 1.8 BiFuel 1.8 i 16V 1.8 TDCi 1.8 Turbo DI 2.0 i 16V		10.98 09.04 10.98 09.04 02.03 01.05 10.98 09.04 03.01 09.04 10.98 09.04 10.98 09.04		24.3541-8105.5 240485 24.3541-8106.5 240486 11.0101-5407.2 260011 11.8171-0008.1 990049	 		D=54, - Halter D=54, - Halter Hülsensatz Führungsbolzen ATE ATE ATE ATE
	1.4 i 16V 1.6 i 16V 1.8 BiFuel 1.8 i 16V 1.8 TDCi 1.8 Turbo DI 2.0 i 16V ST 170		10.98 09.04 10.98 09.04 02.03 01.05 10.98 09.04 03.01 09.04 10.98 09.04 10.98 09.04 03.02 09.04		24.5112-0341.3 330655	2		L=340
	1.4 i 16V 1.6 i 16V 1.8 BiFuel 1.8 i 16V 1.8 TDCi 1.8 Turbo DI 2.0 i 16V RS 2.0 ST 170		10.98 09.04 10.98 09.04 02.03 01.05 10.98 09.04 03.01 09.04 10.98 09.04 10.98 09.04 10.02 09.04 03.02 09.04		24.3344-1705.5 240273 24.3344-1706.5 240274	 		D=34, - Halter D=34, - Halter TRW TRW
	1.4 i 16V 1.6 i 16V 1.8 i 16V 1.8 Turbo DI 2.0 i 16V		10.98 08.00 10.98 08.00 10.98 08.00 10.98 08.00 10.98 08.00		24.5228-0196.3 330656	2		L=195
	1.4 i 16V 1.6 i 16V 1.8 i 16V 1.8 Turbo DI 2.0 i 16V		09.00 04.01 09.00 04.01 09.00 04.01 09.00 04.01 09.00 04.01		24.5124-0410.3 330760	2		L=410
	1.4 i 16V 1.6 i 16V 1.8 BiFuel 1.8 i 16V 1.8 TDCi 1.8 Turbo DI 2.0 i 16V RS 2.0 ST 170		05.01 09.04 05.01 09.04 02.03 01.05 05.01 09.04 03.01 09.04 05.01 09.04 05.01 09.04 10.02 09.04 03.02 09.04		24.5124-0411.3 330774	2		L=410
	1.4 i 16V Lim. 1.6 i 16V Lim. 1.8 i 16V Lim. 1.8 Turbo DI Kombi		10.98 09.04 10.98 09.04 10.98 09.04 10.98 09.04		24.3220-1112.3 020223			Rz 20,64
	1.4 i 16V Kombi 1.6 i 16V Kombi 1.8 BiFuel 1.8 i 16V Kombi		10.98 09.04 10.98 09.04 02.03 01.05 10.98 09.04		24.3222-1117.3 020272			Rz 22,20
	1.8 Turbo DI Lim.		10.98 09.04		24.3219-1107.3 020338		nur paarweise austauschen ¹⁾	Rz 19,05 TRW
	1.4 i 16V 1.6 i 16V 1.8 i 16V 1.8 TDCi 1.8 Turbo DI 2.0 i 16V		10.98 08.01 10.98 08.01 10.98 08.01 03.01 08.01 10.98 08.01 10.98 08.01		24.3727-0650.2 580650 24.3727-0649.2 580649 24.3727-0656.2 580656 24.3727-0663.2 580663	1  1  1  2 	+ HA-Trommelbremse ²⁾ + HA-Scheibenbremse ³⁾ Verlängerung ⁴⁾	L=326 L=1483/1483 L=1770/1770 L=175
	1.4 i 16V 1.6 i 16V 1.8 BiFuel 1.8 i 16V 1.8 TDCi 1.8 Turbo DI 2.0 i 16V RS 2.0 ST 170		09.01 09.04 09.01 09.04 02.03 01.05 09.01 09.04 09.01 09.04 09.01 09.04 09.01 09.04 10.02 09.04 03.02 09.04		24.3727-0654.2 580654 24.3727-0651.2 580651 24.3727-0655.2 580655 24.3727-0663.2 580663	1  1  1  2 	+ HA-Trommelbremse ²⁾ + HA-Scheibenbremse ³⁾ Verlängerung ⁴⁾	L=330 L=1483/1483 L=1770/1770 L=175
	1.4 i 16V 1.6 i 16V 1.8 BiFuel 1.8 i 16V 1.8 TDCi 1.8 Turbo DI 2.0 i 16V ST 170		10.98 09.04 10.98 09.04 02.03 01.05 10.98 09.04 03.01 09.04 10.98 09.04 10.98 09.04 03.02 09.04		24.2419-1733.3 030125			Gz 19,05
FORD FOCUS II (05-11)								
	1.4 i 16V 1.6 i 16V 1.6 TDCi 1.6 TDCi 1.6 Ti VCT 1.8 i 16V 1.8 TDCi 2.0 i 16V 2.0 TDCi	59 74 66 85 92 85 107	10.04 02.11 10.04 02.11 10.04 02.11 01.05 02.11 10.04 02.11 01.06 02.11 01.05 02.11 10.04 02.11 10.04 02.11	- ABS - ABS - ABS - ABS - ABS - ABS - ABS - ABS - ABS	03.7760-2332.4 300267		- Bremsassistent ⁵⁾	10" ATE













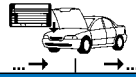





¹⁾ to change only by pairs / sostituire solo a coppie / à changer seulement par paires / cambiar solamente por parejas

²⁾ + RA drum brake / + P freno a tamburo / + frein à tambour essieu AR / + ET-tambores de freno

³⁾ + RA disc brake / + P disco freno / + frein à disque essieu AR / + ET-disco de freno

⁴⁾ extension only / solo prolunga / rallonge seulement / solamente prolongador

⁵⁾ - emergency brake assist / - assistenza alla frenata / - assistance de freinage / - asistente de freno

											
FORD FOCUS II (05-11)											
	2.0 TDCi	81		02.08	02.11	- ABS	03.7760-2332.4	300267	- Bremsassistent 1)	10"	ATE
	1.4 i 16V	59		10.04	04.07	+ ABS	03.7760-8103.4	300240	- Bremsassistent 1)	10"	ATE
	1.6 i 16V	74		10.04	04.07	+ ABS	03.7863-0332.4	300203	+ Bremsassistent 2)	10"	ATE
	1.6 TDCi			10.04	04.07	+ ABS					
	1.6 TDCi	66		01.05	04.07	+ ABS					
	1.6 Ti VCT	85		10.04	04.07	+ ABS					
	1.8 i 16V	92		01.06	04.07	+ ABS					
	1.8 TDCi	85		01.05	04.07	+ ABS					
	2.0 i 16V	107		10.04	04.07	+ ABS					
	2.0 TDCi			10.04	04.07	+ ABS					
	1.4 i 16V	59		05.07	02.11	+ ABS	03.7760-2232.4	300266	- Bremsassistent 1)	10"	ATE
	1.6 i 16V	74		05.07	02.11	+ ABS	03.7863-3932.4	300288	+ Bremsassistent 2)	10"	ATE
	1.6 TDCi			05.07	02.11	+ ABS					
	1.6 TDCi	66		05.07	02.11	+ ABS					
1.6 Ti VCT	85		05.07	02.11	+ ABS						
1.8 i 16V	92		05.07	02.11	+ ABS						
1.8 TDCi	85		05.07	02.11	+ ABS						
2.0 i 16V	107		05.07	02.11	+ ABS						
2.0 TDCi			05.07	02.11	+ ABS						
2.0 TDCi	81		02.08	02.11	+ ABS						
2.5 RS	↙224		01.09	02.11		03.7755-7703.4	300247			9/8" Tandem	ATE
2.5 RS 500	↙257		05.10	02.11		03.7755-3532.4	300290			9/8" Tandem	ATE
	1.4 i 16V	59		10.04	02.11		03.2123-3041.3	010887	- ABS	Thz 23,81	ATE
	1.6 i 16V	74		10.04	02.11						
	1.6 TDCi			10.04	02.11						
	1.6 TDCi	66		01.05	02.11						
	1.6 Ti VCT	85		10.04	02.11						
	1.8 i 16V	92		01.06	02.11						
	1.8 TDCi	85		01.05	02.11						
	2.0 i 16V	107		10.04	02.11						
	2.0 TDCi			10.04	02.11						
	2.0 TDCi	81		02.08	02.11						
	2.5 ST	166		10.05	02.11						
	1.4 i 16V	59		10.04	04.07		03.2123-3103.3	010781	+ ABS	Thz 23,81	ATE
	1.6 i 16V	74		10.04	04.07						
	1.6 TDCi			10.04	04.07						
1.6 TDCi	66		01.05	04.07							
1.6 Ti VCT	85		10.04	04.07							
1.8 i 16V	92		01.06	04.07							
1.8 TDCi	85		01.05	04.07							
2.0 i 16V	107		10.04	04.07							
2.0 TDCi			10.04	04.07							
2.5 ST	166		10.05	04.07							
1.4 i 16V	59		05.07	10.08		03.2125-0483.3	010783	+ ABS	Thz 25,40	ATE	
1.6 i 16V	74		05.07	10.08							
1.6 TDCi			05.07	10.08							
1.6 TDCi	66		05.07	10.08							
1.6 Ti VCT	85		05.07	10.08							
1.8 i 16V	92		05.07	10.08							
1.8 TDCi	85		05.07	10.08							
2.0 i 16V	107		05.07	10.08							
2.0 TDCi			05.07	10.08							
2.0 TDCi	81		02.08	10.08							
2.5 ST	166		05.07	10.08							
1.4 i 16V	59		11.08	02.11		03.2125-0661.3	010917	+ ABS	Thz 25,40	ATE	
1.6 i 16V	74		11.08	02.11							
1.6 TDCi			11.08	02.11							
1.6 TDCi	66		11.08	02.11							
1.6 Ti VCT	85		11.08	02.11							
1.8 i 16V	92		11.08	02.11							
1.8 TDCi	85		11.08	02.11							
2.0 i 16V	107		11.08	02.11							
2.0 TDCi			11.08	02.11							
2.0 TDCi	81		11.08	02.11							
2.5 ST	166		11.08	02.11							
2.5 RS	↙224		01.09	02.11		03.2125-0651.3	010935			Thz 25,40	ATE
2.5 RS 500	↙257		05.10	02.11							
	1.4 i 16V	59		10.04	02.11		24.3571-9813.5	240557		D=57, - Halter	ATE
	1.6 i 16V	74		10.04	02.11		24.3571-9814.5	240558		D=57, - Halter	ATE
	1.6 TDCi			10.04	02.11		11.0230-0736.1	260132		Halter	ATE
	1.6 TDCi	66		01.05	02.11		11.0101-5407.2	260011		Hülzensatz	ATE
	1.6 Ti VCT	85		10.04	02.11		11.8171-0008.1	990049		Führungsbolzen	ATE
	1.8 i 16V	92		01.06	02.11		11.8116-0356.1	390586	2	Haltefeder	ATE
	1.8 TDCi	85		01.05	02.11		24.3571-9813.5	240557		D=57, - Halter	ATE
	2.0 i 16V	107		10.04	02.11		24.3571-9814.5	240558		D=57, - Halter	ATE
	2.0 TDCi			10.04	02.11		11.0230-0818.1	260135		Halter	ATE
	2.0 TDCi	81		02.08	02.11		11.0101-5407.2	260011		Hülzensatz	ATE
							11.8171-0008.1	990049		Führungsbolzen	ATE
							11.8116-0356.1	390586	2	Haltefeder	ATE
	2.5 ST	166		10.05	02.11		11.9576-9975.2	220649		D=57, - Halter	ATE
							11.9576-9976.2	220650		D=57, - Halter	ATE
						11.8116-0345.2	390596	2	Haltefeder	ATE	
						11.8171-0008.1	990049		Führungsbolzen	ATE	
						11.0101-5407.2	260011		Hülzensatz	ATE	
	1.4 i 16V	59		10.04	02.11		83.7716-0397.3	330790	2	L=395	
	1.6 i 16V	74		10.04	02.11						

1) - emergency brake assist / - assistenza alla frenata / - assistance de freinage / - asistente de freno
2) + emergency brake assist / + assistenza alla frenata / + assistance de freinage / + asistente de freno

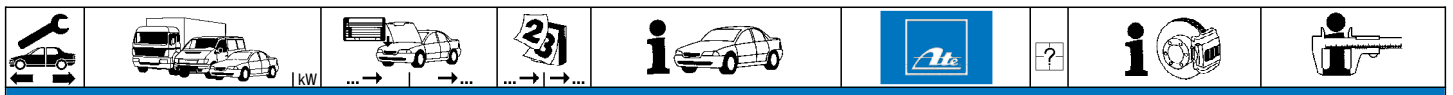

FORD FOCUS II (05-11)

	1.6 TDCi 1.6 TDCi 1.6 Ti VCT 1.8 i 16V 1.8 TDCi 2.0 i 16V 2.0 TDCi 2.0 TDCi	66 85 92 85 107 81	10.04 01.05 10.04 01.06 01.05 10.04 10.04 02.08	02.11 02.11 02.11 02.11 02.11 02.11 02.11	83.7716-0397.3	330790	2		L=395	
	1.4 i 16V 1.6 i 16V 1.6 TDCi 1.6 TDCi 1.6 Ti VCT 1.8 i 16V	59 74 66 85 92	10.04 10.04 10.04 01.05 10.04 01.06	02.11 02.11 02.11 02.11 02.11 02.11	11.9387-7015.2 11.9387-7016.2 11.0101-5407.2 11.8171-0008.1 11.8116-0340.1	220627 220628 260011 990049 390595	2		D=38, - Halter D=38, - Halter Hülsensatz Führungsbolzen Haltefeder	ATE ATE ATE ATE
	1.8 TDCi 2.0 i 16V 2.0 TDCi 2.0 TDCi 2.5 ST	85 107 81 166	01.05 10.04 10.04 02.08 10.05	02.11 02.11 02.11 02.11 02.11	11.9387-7015.2 11.9387-7016.2 11.0230-0698.2 11.0101-5407.2 11.8171-0008.1 11.8116-0340.1	220627 220628 260091 260011 990049 390595	2		D=38, - Halter D=38, - Halter Halter Hülsensatz Führungsbolzen Haltefeder	ATE ATE ATE ATE ATE
	1.4 i 16V	59	10.04	02.11	+ HA-Trommelbremse ¹⁾	83.7788-0382.3	330971	2		L=380
	1.4 i 16V 1.6 i 16V 1.6 TDCi 1.6 TDCi 1.6 Ti VCT 1.8 i 16V 1.8 TDCi 2.0 i 16V 2.0 TDCi 2.0 TDCi 2.5 ST	59 74 66 85 92 85 107 81 166	10.04 10.04 10.04 01.05 10.04 01.05 10.04 10.04 02.08 10.05	02.11 02.11 02.11 02.11 02.11 02.11 02.11 02.11 02.11 02.11	+ HA-Scheibenbremse ²⁾	24.5124-0420.3 83.7714-0391.3 83.7788-0409.3	331276 330980 330981	2 2 2	+ mechanische Feststellbremse ³⁾ + elektrische Feststellbremse ⁴⁾ + Turnier ⁵⁾	L=420 L=390 L=410
	1.4 i 16V	59	10.04	02.11		24.3220-1721.3	020467			Rz 20,64
	1.4 i 16V	59	10.04	02.11	+ HA-Trommelbremse ¹⁾	24.3727-0664.2	580664	1		L=1440/1490
	1.4 i 16V 1.6 i 16V 1.6 TDCi 1.6 TDCi 1.6 Ti VCT 1.8 i 16V 1.8 TDCi 2.0 i 16V 2.0 TDCi 2.0 TDCi 2.5 ST	59 74 66 85 92 85 107 81 166	10.04 10.04 10.04 01.05 10.04 01.06 01.05 10.04 10.04 02.08 10.05	02.11 02.11 02.11 02.11 02.11 02.11 02.11 02.11 02.11 02.11	+ HA-Scheibenbremse ²⁾	24.3727-0678.2 24.3727-0659.2	580678 580659	1 1	+ mechanische Feststellbremse ³⁾ + mechanische Feststellbremse ³⁾	L=341 L=1816/1860
	2.5 RS 2.5 RS 500	224 257	01.09 05.10	02.11 02.11		24.3727-0672.2	580672	1		L=1848/1933

FORD FOCUS III (11-)

	1.0 EcoBoost 1.0 EcoBoost 1.5 EcoBoost 1.5 EcoBoost 1.5 TDCi 1.5 TDCi 1.5 TDCi ECOnetic 1.6 EcoBoost 1.6 EcoBoost 1.6 Flexifuel 1.6 LPG 1.6 TDCi 1.6 TDCi 1.6 TDCi 1.6 TDCi ECOnetic 1.6 Ti-VCT 1.6 Ti-VCT 1.6 Ti-VCT 1.6 Ti-VCT 1.6 Ti-VCT Flexifuel 2.0 EcoBoost ST 2.0 TDCi 2.0 TDCi 2.0 TDCi 2.0 TDCi 2.0 TDCi 2.0 TDCi 2.0 TDCi 2.3 RS	74 92 110 134 70 88 77 110 134 110 88 70 85 77 63 77 88 92 88 184 85 100 103 110 120 136 257	02.12 02.12 09.14 09.14 09.14 09.14 09.14 03.11 03.11 07.13 02.12 03.11 03.11 04.12 08.11 03.11 02.12 03.11 03.11 06.12 03.11 03.11 03.11 11.14 03.11 11.14 07.15		03.4155-5451.3	010995			THz 25,40	ATE
	1.6 EcoBoost 1.6 EcoBoost 2.0 2.0 TDCi 2.0 TDCi 2.0 TDCi 2.0 TDCi	110 134 110 85 100 103 120	03.11 03.11 10.13 03.11 03.11 03.11 03.11		24.3571-9813.5 24.3571-9814.5 11.8116-0356.1	240557 240558 390586	2		D=57, - Halter D=57, - Halter Haltefeder	ATE ATE ATE

¹⁾ + RA drum brake / + P freno a tamburo / + frein à tambour essieu AR / + ET-tambores de freno
²⁾ + RA disc brake / + P disco freno / + frein à disque essieu AR / + ET-disco de freno
³⁾ + mechanical parking brake / + fr. stazionamento meccanico / + frein à main mécanique / + freno de mano mecánica
⁴⁾ + electric parking brake / + freno a mano elettrico / + frein à main électrique / + freno de mano eléctrico
⁵⁾ + Estate / + Station Wagon / + Break / + Break



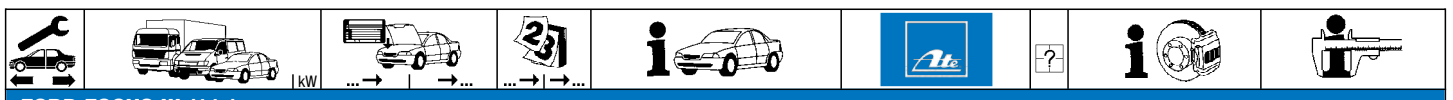



























FORD FOCUS III (11-)

	1.6 LPG	88		02.12		24.3571-9813.5	240557	2	-	D=57, - Halter D=57, - Halter Haltefeder	ATE
	1.6 TDCi	70		03.11		24.3571-9814.5	240558				ATE
	1.6 TDCi	85		03.11		11.8116-0356.1	390586				ATE
	1.6 Ti-VCT	63		08.11							
	1.6 Ti-VCT	77		03.11							
	1.6 Ti-VCT	88		02.12							
	1.6 Ti-VCT	92		03.11							
	1.6 Ti-VCT Flexifuel	88		03.11							
	1.0 EcoBoost	74		02.12		24.3571-9813.5	240557	2	-	D=57, - Halter D=57, - Halter Haltefeder	ATE
	1.0 EcoBoost	92		02.12		24.3571-9814.5	240558				ATE
	1.5 EcoBoost	110		09.14		11.8116-0356.1	390586				ATE
	1.5 EcoBoost	134		09.14							
	1.5 TDCi	70		09.14							
	1.5 TDCi	88		09.14							
	1.5 TDCi ECOnetic	77		09.14							
	1.6 Flexifuel	110		07.13							
	1.6 TDCi ECOnetic	77		04.12							
	2.0 TDCi	110		11.14							
	2.0 TDCi	136		11.14							
	Electric	107		07.13		24.3571-9813.5	240557	2	-	D=57, - Halter D=57, - Halter Haltefeder	ATE
						24.3571-9814.5	240558				ATE
	1.0 EcoBoost	74		02.12		11.9387-7083.2	220959	2	-	D=38, - Halter D=38, - Halter Haltefeder	ATE
	1.0 EcoBoost	92		02.12		11.9387-7084.2	220960				ATE
	1.5 EcoBoost	110		09.14		11.8116-0340.1	390595				ATE
	1.5 EcoBoost	134		09.14							
	1.5 TDCi	70		09.14							
	1.5 TDCi	88		09.14							
	1.5 TDCi ECOnetic	77		09.14							
	1.6 EcoBoost	110		03.11							
	1.6 EcoBoost	134		03.11							
	1.6 Flexifuel	110		07.13							
	1.6 LPG	88		02.12							
	1.6 TDCi	70		03.11							
	1.6 TDCi	85		03.11							
	1.6 TDCi ECOnetic	77		04.12							
	1.6 Ti-VCT	63		08.11							
	1.6 Ti-VCT	77		03.11							
	1.6 Ti-VCT	88		02.12							
	1.6 Ti-VCT	92		03.11							
	1.6 Ti-VCT Flexifuel	88		03.11							
	2.0	110		10.13							
	2.0 EcoBoost ST	184		06.12							
	2.0 TDCi	85		03.11							
	2.0 TDCi	100		03.11							
	2.0 TDCi	103		03.11							
2.0 TDCi	110		11.14								
2.0 TDCi	120		03.11								
2.0 TDCi	136		11.14								
2.3 RS	257		07.15								
Electric	107		07.13								

FORD FOCUS C-MAX (03-07)

	1.6 i 16V	74		08.03	08.06	03.7863-0332.4	300203		+	10"	ATE		
	1.6 TDCi	66		01.05	08.06	03.7760-8103.4	300240				-	10"	ATE
	1.6 TDCi	80		08.03	08.06								
	1.6 Ti VCT	85		08.04	08.06								
	1.8 i 16V	88		08.03	08.06								
	1.8 i 16V	92		04.04	08.06								
	1.8 TDCi	85		01.05	08.06								
	2.0 i 16V	107		04.04	08.06								
	2.0 TDCi	100		08.03	08.06								
		1.6 i 16V	74		09.06	03.07	03.7863-3932.4				300288		+
1.6 TDCi		66		09.06	03.07	03.7760-2232.4	300266	-	10"	ATE			
1.6 TDCi		80		09.06	03.07								
1.6 Ti VCT		85		09.06	03.07								
1.8 i 16V		88		09.06	03.07								
1.8 i 16V		92		09.06	03.07								
1.8 TDCi		85		09.06	03.07								
2.0 i 16V		107		09.06	03.07								
2.0 TDCi		100		09.06	03.07								
		1.6 i 16V	74		08.03	03.07	03.2123-3103.3	010781			Thz 23,81 Thz 25,40		
	1.6 TDCi	66		01.05	03.07	03.2125-0483.3	010783	ATE					
	1.6 TDCi	80		08.03	03.07								
	1.6 Ti VCT	85		08.04	03.07								
	1.8 i 16V	88		08.03	03.07								
	1.8 i 16V	92		04.04	03.07								
	1.8 TDCi	85		01.05	03.07								
	2.0 i 16V	107		04.04	03.07								
2.0 TDCi	100		08.03	03.07									
	1.6 i 16V	74		08.03	03.07	24.3571-9813.5	240557	2	-	D=57, - Halter D=57, - Halter Haltefeder	ATE		
	1.6 TDCi	66		01.05	03.07	24.3571-9814.5	240558				ATE		
	1.6 TDCi	80		08.03	03.07	11.0230-0736.1	260132				ATE		
	1.6 Ti VCT	85		08.04	03.07	11.0101-5407.2	260011				ATE		
	1.8 i 16V	88		08.03	03.07	11.8171-0008.1	990049				ATE		
	1.8 i 16V	92		04.04	03.07	11.8116-0356.1	390586				ATE		

1) - brake caliper, painted / - pinza freno, verniciata / - étrier de frein, verni / - pinza de freno, pintada
 2) + emergency brake assist / + assistenza alla frenata / + assistance de freinage / + asistente de freno
 3) - emergency brake assist / - assistenza alla frenata / - assistance de freinage / - asistente de freno















										
FORD FOCUS C-MAX (03-07)										
	1.8 TDCi 2.0 i 16V 2.0 TDCi	85 107 100		01.05 03.07 04.04 03.07 08.03 03.07	24.3571-9813.5 24.3571-9814.5 11.0230-0818.1 11.0101-5407.2 11.8171-0008.1 11.8116-0356.1	240557 240558 260135 260011 990049 390586		D=57, - Halter D=57, - Halter Halter Hülzensatz Führungsbolzen Haltefeder	ATE ATE ATE ATE ATE ATE	
	1.6 i 16V 1.6 TDCi 1.6 TDCi 1.6 Ti VCT 1.8 i 16V 1.8 i 16V 1.8 TDCi 2.0 i 16V 2.0 TDCi	74 66 80 85 88 92 85 107 100		08.03 03.07 01.05 03.07 08.03 03.07 08.04 03.07 08.03 03.07 04.04 03.07 01.05 03.07 04.04 03.07 08.03 03.07	83.7716-0397.3	330790	2	L=395		
	1.6 i 16V 1.6 Ti VCT 1.8 i 16V 1.8 i 16V	74 85 88 92		08.03 03.07 08.04 03.07 08.03 03.07 04.04 03.07	11.9387-7015.2 11.9387-7016.2 11.0101-5407.2 11.8171-0008.1 11.8116-0340.1	220627 220628 260011 990049 390595		D=38, - Halter D=38, - Halter Hülzensatz Führungsbolzen Haltefeder	ATE ATE ATE ATE ATE	
	1.6 TDCi 1.6 TDCi 1.8 TDCi 2.0 i 16V 2.0 TDCi	66 80 85 107 100		01.05 03.07 08.03 03.07 01.05 03.07 04.04 03.07 08.03 03.07	11.9387-7015.2 11.9387-7016.2 11.0230-0698.2 11.0101-5407.2 11.8171-0008.1 11.8116-0340.1	220627 220628 260091 260011 990049 390595		D=38, - Halter D=38, - Halter Halter Hülzensatz Führungsbolzen Haltefeder	ATE ATE ATE ATE ATE ATE	
	1.6 i 16V 1.6 TDCi 1.6 TDCi 1.6 Ti VCT 1.8 i 16V 1.8 i 16V 1.8 TDCi 2.0 i 16V 2.0 TDCi	74 66 80 85 88 92 85 107 100		08.03 03.07 01.05 03.07 08.03 03.07 08.04 03.07 08.03 03.07 04.04 03.07 01.05 03.07 04.04 03.07 08.03 03.07	24.5124-0420.3 24.5167-0420.3 83.7714-0391.3	331276 331278 330980	2 2 2	+ elektrische Feststellbremse 1) + elektrische Feststellbremse 1)	L=420 L=400 L=390	
	1.6 i 16V 1.6 TDCi 1.6 TDCi 1.6 Ti VCT 1.8 i 16V 1.8 i 16V 1.8 TDCi 2.0 i 16V 2.0 TDCi	74 66 80 85 88 92 85 107 100		08.03 03.07 01.05 03.07 08.03 03.07 08.04 03.07 08.03 03.07 04.04 03.07 01.05 03.07 04.04 03.07 08.03 03.07	24.3727-0678.2 24.3727-0659.2	580678 580659	1 1	+ mechanische Feststellbremse 2) + mechanische Feststellbremse 2)	L=341 L=1816/1860	
FORD FUSION (02-12)										
	1.25 i 16V 1.4 i 16V 1.4 TDCi 1.6 i 16V 1.6 TDCi	55 59 50 74 66		08.04 09.12 07.02 09.12 07.02 09.12 07.02 09.12 10.04 09.12	03.7750-8732.4 03.7853-2102.4	300199 300201		- Bremsassistent 3) + Bremsassistent 4)	9" 9"	ATE ATE
	1.25 i 16V 1.4 i 16V 1.4 TDCi 1.6 i 16V 1.6 TDCi	55 59 50 74 66		08.04 09.12 07.02 09.12 07.02 09.12 07.02 09.12 10.04 09.12	03.4153-0015.3 03.4153-5287.4	011005 010953		- ABS + ABS	ThZ 23,81 - Behälter ThZ 23,81 + Behälter	ATE ATE
	1.25 i 16V 1.4 i 16V 1.4 TDCi 1.6 i 16V 1.6 TDCi	55 59 50 74 66		08.04 09.12 07.02 09.12 07.02 09.12 07.02 09.12 10.04 09.12	11.3541-8531.2 11.3541-8532.2 11.0101-5407.2 11.8171-0008.1 11.8116-0264.1	220367 220368 260011 990049 390594		D=54, - Halter D=54, - Halter Hülzensatz Führungsbolzen Haltefeder	ATE ATE ATE ATE ATE	
	1.25 i 16V 1.4 i 16V 1.4 TDCi 1.6 i 16V 1.6 TDCi	55 59 50 74 66		08.04 09.12 07.02 09.12 07.02 09.12 07.02 09.12 10.04 09.12	83.7769-0493.3	330861	2		L=491	
	1.25 i 16V 1.4 i 16V 1.4 TDCi 1.6 i 16V 1.6 TDCi	55 59 50 74 66		08.04 09.12 07.02 09.12 07.02 09.12 07.02 09.12 10.04 09.12	83.7827-0321.3	330862	2		L=320	
	1.25 i 16V 1.4 i 16V 1.4 TDCi 1.6 i 16V 1.6 TDCi	55 59 50 74 66		08.04 09.12 07.02 09.12 07.02 09.12 07.02 09.12 10.04 09.12	24.3219-1735.3	020464			Rz 19,05	
	1.25 i 16V 1.4 i 16V 1.4 TDCi 1.6 i 16V 1.6 TDCi	55 59 50 74 66		08.04 09.12 07.02 09.12 07.02 09.12 07.02 09.12 10.04 09.12	24.3727-0658.2 24.3727-0653.2	580658 580653	1 1		L=306 L=1305/1445	
	1.25 i 16V 1.4 i 16V 1.4 TDCi 1.6 i 16V 1.6 TDCi	55 59 50 74 66		08.04 09.12 07.02 09.12 07.02 09.12 07.02 09.12 10.04 09.12	24.2419-1735.3	030127			Gz 19,05	

1) + electric parking brake / + freno a mano elettrico / + frein à main électrique / + freno de mano eléctrico

















2) + mechanical parking brake / + fr. stazionamento meccanico / + frein à main mécanique / + freno de mano mecánica

3) - emergency brake assist / - assistenza alla frenata / - assistance de freinage / - asistente de freno

4) + emergency brake assist / + assistenza alla frenata / + assistance de freinage / + asistente de freno

									
FORD GALAXY I (95-06)									
	1.9 TDI	66	01.96	08.97	03.7760-3002.4	300120		10"	ATE
	2.0 i		09.95	08.97					
	2.3 i 16V		01.97	08.97					
	2.8 i V6	128	09.95	08.97					
	1.9 TDI	66	09.97	03.00	03.7755-1902.4	300138		9/8" Tandem	ATE
	1.9 TDI	81	10.97	03.00					
	2.0 i		09.97	03.00					
	2.3 i 16V		09.97	03.00					
	2.8 i V6	128	09.97	03.00					
	1.9 TDI	66	04.00	10.02	03.7755-6302.4	300221	- ESP	9/8" Tandem	ATE
	1.9 TDI	85	04.00	10.02	03.7858-3302.4	300122	+ ESP	9/8" Tandem	ATE
	2.0 i		04.00	10.02					
2.3 i 16V		04.00	10.02						
2.8 i V6	150	04.00	10.02						
1.9 TDI	66	04.00	04.06	03.7755-6302.4	300221	- ESP	9/8" Tandem	ATE	
1.9 TDI	85	04.00	04.06						
1.9 TDI	96	02.03	04.06						
2.0 i		04.00	04.06						
2.3 i 16V		04.00	04.06						
2.8 i V6	150	04.00	04.06						
	1.9 TDI	66	01.96	08.97	03.2123-1548.3	010478	- ABS	THz 23,81	ATE
	2.0 i		09.95	08.97	03.2123-1526.3	010477	+ ABS	THz 23,81	ATE
	2.3 i 16V		01.97	08.97	03.3517-5100.1	390326	- ABS	Verschlußschraube	ATE
	2.8 i V6	128	09.95	08.97					
	1.9 TDI	66	09.97	03.00	03.2125-8404.3	010583	- ABS	THz 25,40	ATE
	1.9 TDI	81	10.97	03.00	03.2125-0332.3	010952	+ ABS	THz 25,40	ATE
	2.0 i		09.97	03.00					
	2.3 i 16V		09.97	03.00					
	2.8 i V6	128	09.97	03.00					
	1.9 TDI	66	04.00	04.06	03.2125-0332.3	010952	- ESP	THz 25,40	ATE
	1.9 TDI	85	04.00	04.06	03.2125-9604.3	010581	+ ESP	THz 25,40	ATE
	1.9 TDI	96	02.03	04.06					
1.9 TDI	110	05.05	04.06						
2.0 i		04.00	04.06						
2.3 i 16V		04.00	04.06						
2.8 i V6	150	04.00	04.06						
	1.9 TDI	66	01.96	04.01	11.0441-5704.2	250034		Dichtungssatz	ATE
	1.9 TDI	81	10.97	04.01	11.0101-5407.2	260011		Hülensatz	ATE
	1.9 TDI	85	04.00	04.01	11.8171-0008.1	990049		Führungsbolzen	ATE
	2.0 i		09.95	04.01	11.8116-0143.1	390513	2	Haltefeder	ATE
	2.3 i 16V		01.97	04.01					
	2.8 i V6	128	09.95	04.01					
	1.9 TDI	66	05.01	04.06	11.9571-9811.2	220485	☐	D=57, - Halter	ATE
	1.9 TDI	85	05.01	04.06	11.9571-9812.2	220486	☐	D=57, - Halter	ATE
	1.9 TDI	96	02.03	04.06	11.0441-5704.2	250034		Dichtungssatz	ATE
	2.0 i		05.01	04.06	11.0101-5407.2	260011		Hülensatz	ATE
	2.3 i 16V		05.01	04.06	11.8171-0008.1	990049		Führungsbolzen	ATE
	2.8 i V6	150	05.01	04.06	11.8116-0326.1	390471	2	Haltefeder	ATE
1.9 TDI	110	05.05	04.06	11.9571-9819.2	220469	☐	D=57, - Halter	ATE	
2.8 i V6	150	04.00	04.06	11.9571-9820.2	220470	☐	D=57, - Halter	ATE	
				11.0441-5704.2	250034		Dichtungssatz	ATE	
	1.9 TDI	66	01.96	04.01	24.5166-0454.3	331306	2	L=454	
	1.9 TDI	81	10.97	03.00					
	2.0 i		09.95	04.01					
	2.3 i 16V		01.97	04.01					
	2.8 i V6	128	09.95	04.01					
	1.9 TDI	66	05.01	04.06	83.6219-0455.3	330592	2	L=455	
	1.9 TDI	85	05.01	04.06					
	1.9 TDI	96	05.01	04.06					
	1.9 TDI	110	05.05	04.06					
	2.0 i		05.01	04.06					
	2.3 i 16V		05.01	04.06					
	2.8 i V6	150	05.01	04.06					
	1.9 TDI	66	01.96	04.06	24.3384-1707.5	240171	☐	D=38, - Halter	TRW
	1.9 TDI	81	10.97	03.00	24.3384-1708.5	240172	☐	D=38, - Halter	TRW
	1.9 TDI	85	04.00	04.06					
	1.9 TDI	96	02.03	04.06					
	2.0 i		09.95	04.06					
	2.3 i 16V		01.97	04.06					
	2.8 i V6	128	09.95	04.06					
	1.9 TDI	110	05.05	04.06	24.3384-1715.5	240265	☐	D=38, - Halter	TRW
	2.8 i V6	150	04.00	04.06	24.3384-1716.5	240266	☐	D=38, - Halter	TRW
	1.9 TDI	66	01.96	04.06	24.5225-0370.3	331379	2	L=373	
	1.9 TDI	81	10.97	03.00	83.6113-0140.3	330482	2	L=140	
	1.9 TDI	85	04.00	04.06					
1.9 TDI	96	02.03	04.06						
1.9 TDI	110	05.05	04.06						
2.0 i		09.95	04.06						
2.3 i 16V		01.97	04.06						
2.8 i V6	128	09.95	03.00						
2.8 i V6	150	04.00	04.06						
	1.9 TDI	66	01.96	04.06	24.3727-0163.2	580163	2	L=1293	
	1.9 TDI	81	10.97	03.00					
	1.9 TDI	85	04.00	04.06					
	1.9 TDI	96	02.03	04.06					

1) on the brake caliper / sulla pinza freno / sur l'étrier de frein / a la pinza de freno

									
FORD GALAXY I (95-06)									
	1.9 TDI 2.0 i 2.3 i 16V 2.8 i V6 2.8 i V6	110 128 150	 	05.05 09.95 01.97 09.95 04.00	04.06 04.06 04.06 03.00 04.06	24.3727-0163.2	580163	2 ↓	L=1293
	1.9 TDI 1.9 TDI 1.9 TDI 1.9 TDI 1.9 TDI 2.0 i 2.3 i 16V 2.8 i V6	66 81 85 96 110 128	 	01.96 10.97 04.00 02.03 05.05 09.95 01.97 09.95	04.06 03.00 04.06 04.06 04.06 04.06 04.06 03.00	24.2419-1722.3	030111		Gz 19,05
FORD GALAXY II (06-)									
	1.6 EcoBoost 1.6 TDCi 1.8 TDCi 1.8 TDCi 2.0 Flexifuel 2.0 i 16V 2.0 SCTi EcoBoost 2.0 TDCi 2.0 TDCi 2.0 TDCi 2.0 TDCi 2.0 TDCi 2.2 TDCi 2.2 TDCi 2.3 i 16V	118 85 74 92 107 107 149 85 96 100 103 120 129 147 118	 	02.11 02.11 04.06 04.06 05.06 04.06 03.10 10.07 04.06 05.06 04.06 03.10 04.08 07.10 07.07		03.7755-1432.4	300300		9/8" Tandem ATE
	1.6 EcoBoost 1.6 TDCi 1.8 TDCi 1.8 TDCi 2.0 Flexifuel 2.0 i 16V 2.0 TDCi 2.0 TDCi 2.0 TDCi 2.0 TDCi 2.0 TDCi 2.2 TDCi 2.2 TDCi 2.3 i 16V	118 85 74 92 107 107 85 96 100 103 120 129 147 118	 	02.11 02.11 04.06 04.06 05.06 04.06 10.07 04.06 05.06 04.06 03.10 11.08 07.10 07.07		11.9601-9711.2 11.9601-9712.2 11.0230-0934.1 11.8116-0206.1 11.0101-5407.2 11.8171-0008.1 11.0441-6008.2	220873 220874 260128 390593 260011 990049 250038	2 	D=60, - Halter D=60, - Halter Halter Haltefeder Hülensatz Führungsbolzen Dichtungssatz ATE ATE ATE ATE ATE ATE
	2.0 SCTi EcoBoost 2.2 TDCi	149 129	 	03.10 04.08	10.08	11.9606-9949.2 11.9606-9950.2 11.0101-5704.2 11.8171-0008.1 11.8116-0388.2	220879 220880 260095 990049 390588	2 	D=60, - Halter D=60, - Halter Hülensatz Führungsbolzen Haltefeder ATE ATE ATE ATE
	1.6 EcoBoost 1.6 TDCi 1.8 TDCi 1.8 TDCi 2.0 Flexifuel 2.0 i 16V 2.0 SCTi EcoBoost 2.0 TDCi 2.0 TDCi 2.0 TDCi 2.0 TDCi 2.2 TDCi 2.2 TDCi 2.3 i 16V	118 85 74 92 107 107 149 85 96 100 103 120 129 147 118	 	02.11 02.11 04.06 04.06 05.06 04.06 11.11 10.07 04.06 05.06 04.06 03.10 10.08 07.10 07.07		24.5162-0390.3	331199	2	L=390
	1.6 EcoBoost 1.6 TDCi 1.8 TDCi 1.8 TDCi 2.0 Flexifuel 2.0 i 16V 2.0 SCTi EcoBoost 2.0 TDCi 2.0 TDCi 2.0 TDCi 2.0 TDCi 2.2 TDCi 2.2 TDCi 2.3 i 16V	118 85 74 92 107 107 149 85 96 100 103 120 129 147 118	 	02.11 02.11 04.06 04.06 05.06 04.06 03.10 10.07 04.06 05.06 04.06 03.10 04.08 07.10 07.07		24.6238-1709.7 24.6238-1710.7	221017 221018	2 	D=38, - Halter D=38, - Halter TRW TRW
	1.6 EcoBoost 1.6 TDCi 1.8 TDCi 1.8 TDCi 2.0 Flexifuel 2.0 i 16V 2.0 SCTi EcoBoost 2.0 TDCi	118 85 74 92 107 107 149 85	 	02.11 02.11 12.06 12.06 12.06 12.06 03.10 10.07		24.5163-0155.3	331204	2	- elektrische Feststellbremse ²⁾ L=155























1) + electric parking brake / + freno a mano elettrico / + frein à main électrique / + freno de mano eléctrico

2) - electric parking brake / - freno a mano elettrico / - frein à main électrique / - freno de mano eléctrico



































FORD GALAXY II (06-)											
	2.0 TDCi	96		12.06		24.5163-0155.3	331204	2	- elektrische Feststellbremse ¹⁾	L=155	
	2.0 TDCi	100		12.06							
	2.0 TDCi	103		12.06							
	2.0 TDCi	120		03.10							
	2.2 TDCi	129		04.08							
	2.2 TDCi	147		07.10							
	2.3 i 16V	118		07.07							
	1.6 EcoBoost	118		02.11		24.5133-0310.3	331197	2	+ elektrische Feststellbremse ²⁾	L=310	
	1.6 TDCi	85		02.11							
	1.8 TDCi	74		04.06							
	1.8 TDCi	92		04.06							
	2.0 Flexifuel	107		05.06							
	2.0 i 16V	107		04.06							
	2.0 SCTi EcoBoost	149		03.10							
	2.0 TDCi	85		10.07							
2.0 TDCi	96		04.06								
2.0 TDCi	100		05.06								
2.0 TDCi	103		04.06								
2.0 TDCi	120		03.10								
2.2 TDCi	129		04.08								
2.2 TDCi	147		07.10								
2.3 i 16V	118		07.07								
1.8 TDCi	74		04.06	06.09	24.5133-0311.3	331198	2	+ elektrische Feststellbremse ²⁾	L=310		
1.8 TDCi	92		04.06	06.09							
2.0 Flexifuel	107		05.06	06.09							
2.0 i 16V	107		04.06	06.09							
2.0 TDCi	85		10.07	06.09							
2.0 TDCi	96		04.06	06.09							
2.0 TDCi	100		05.06	06.09							
2.0 TDCi	103		04.06	06.09							
2.2 TDCi	129		04.08	06.09							
2.3 i 16V	118		07.07	06.09							
	1.6 EcoBoost	118		02.11		24.3727-0676.2	580676	<input type="checkbox"/>	+ mechanische Feststellbremse ³⁾	L=2078	
	1.6 TDCi	85		02.11		24.3727-0677.2	580677	<input type="checkbox"/>	+ mechanische Feststellbremse ³⁾	L=2071	
	1.8 TDCi	74		02.07							
	1.8 TDCi	92		02.07							
	2.0 Flexifuel	107		02.07							
	2.0 i 16V	107		02.07							
	2.0 SCTi EcoBoost	149		03.10							
	2.0 TDCi	85		10.07							
	2.0 TDCi	96		02.07							
	2.0 TDCi	100		02.07							
	2.0 TDCi	103		02.07							
	2.0 TDCi	120		03.10							
	2.2 TDCi	129		04.08							
	2.2 TDCi	147		07.10							
	2.3 i 16V	118		07.07							
FORD GALAXY III (15-)											
	1.5 EcoBoost	118		04.15		11.8171-0096.1	250155		+ 17" Rad ⁴⁾	Führungsbolzen	ATE
	2.0 EcoBoost	176		04.15							
	2.0 TDCi	88		04.15							
	2.0 TDCi	110		04.15							
	2.0 TDCi	132		04.15							
	2.0 TDCi 4x4	110		05.15							
	2.0 TDCi 4x4	132		05.15							
	2.0 TDCi Bi-Turbo	154		04.15							
FORD KA I (96-08)											
	1.6	70		09.00	12.08	03.7750-5432.4	300248			9"	ATE
	1.6 i			08.03	12.08						
	1.0 i			11.96	01.00	11.3481-8513.2	220335	<input type="checkbox"/>		D=48, - Halter	ATE
	1.3 i			11.96	01.00	11.3481-8514.2	220336	<input type="checkbox"/>		D=48, - Halter	ATE
						11.0230-0687.1	260106	2		Halter	ATE
						11.0441-4805.2	250020			Dichtungssatz	ATE
						11.0101-5407.2	260011			Hülzensatz	ATE
						11.8171-0008.1	990049			Führungsbolzen	ATE
						11.8116-0264.1	390594	2		Haltefeder	ATE
1.0 i			02.00	12.08	11.3481-8515.2	220365	<input type="checkbox"/>		D=48, - Halter	ATE	
1.3 i			02.00	12.08	11.3481-8516.2	220366	<input type="checkbox"/>		D=48, - Halter	ATE	
					24.3481-8515.5	240477	<input type="checkbox"/>		D=48, - Halter	ATE	
					24.3481-8516.5	240478	<input type="checkbox"/>		D=48, - Halter	ATE	
					11.0101-5407.2	260011			Hülzensatz	ATE	
					11.8171-0008.1	990049			Führungsbolzen	ATE	
					11.8116-0264.1	390594	2		Haltefeder	ATE	
1.6	70		09.00	12.08	11.3541-8531.2	220367	<input type="checkbox"/>		D=54, - Halter	ATE	
1.6 i			08.03	12.08	11.3541-8532.2	220368	<input type="checkbox"/>		D=54, - Halter	ATE	
					11.0101-5407.2	260011			Hülzensatz	ATE	
					11.8171-0008.1	990049			Führungsbolzen	ATE	
					11.8116-0264.1	390594	2		Haltefeder	ATE	
	1.0 i			11.96	01.01	24.5308-0488.3	330776	<input type="checkbox"/>		L=488	
	1.3 i			11.96	01.01	24.5308-0489.3	330777	<input type="checkbox"/>		L=488	
	1.0 i			11.96	09.98	24.5305-0350.3	330660	2		L=352	
	1.3 i			11.96	09.98						

1) - electric parking brake / - freno a mano elettrico / - frein à main électrique / - freno de mano eléctrico
2) + electric parking brake / + freno a mano elettrico / + frein à main électrique / + freno de mano eléctrico
3) + mechanical parking brake / + fr. stazionamento meccanico / + frein à main mécanique / + freno de mano mecánica
4) + 17" wheel / + ruota 17" / + roue 17" / + rueda 17"

									
FORD KA I (96-08)									
	1.0 i 1.3 i			10.98 10.98	01.00 01.00	24.5305-0340.3	330659	2	L=340
	1.0 i 1.3 i			02.00 02.00	12.08 12.08	24.5305-0351.3	330687	2	L=350
	1.0 i 1.3 i			11.96 11.96	01.00 01.00	24.3219-1107.3	020338	nur paarweise austauschen ¹⁾	Rz 19,05 TRW
	1.0 i 1.3 i 1.6 1.6 i	70		02.00 02.00 09.00 08.03	12.08 12.08 12.08 12.08	24.3219-1735.3	020464		Rz 19,05
	1.0 i 1.3 i			11.96 11.96	11.06 11.06	24.3727-1800.2 24.3727-0660.2	581800 580660	1 ↑ 1 ↓	L=312 L=1575/1627
	1.0 i 1.3 i			12.06 12.06	12.08 12.08	24.3727-0668.2 24.3727-0666.2	580668 580666	1 ↑ 1 ↓	L=333 L=1575/1627
	1.6 1.6 i	70		09.00 08.03	12.08 12.08	24.3727-0668.2 24.3727-0665.2	580668 580665	1 ↑ 1 ↓	L=333 L=1575/1627
	1.0 i 1.3 i			11.96 11.96	08.98 08.98	24.2419-1737.3	030129		Gz 19,05
	1.0 i 1.3 i			09.98 09.98	12.08 12.08	24.2419-1736.3	030128		Gz 19,05
FORD KA II (08-)									
	1.2 i 16V 1.3 TDCi	51 55		10.08 10.08		24.5112-0356.3	331129	2	L=355
	1.2 i 16V 1.3 TDCi	51 55		10.08 10.08		24.5228-0165.3	330879	2	L=165
	1.2 i 16V 1.3 TDCi	51 55		10.08 10.08	05.10 05.10	24.3220-1108.3	020219		Rz 20,64 BDX
	1.2 i 16V 1.3 TDCi	51 55		06.10 06.10		24.3220-1738.3	020545		Rz 20,64
	1.2 i 16V 1.3 TDCi	51 55		10.08 10.08		24.3727-0670.2 24.3727-0671.2	580670 580671	<input type="checkbox"/> <input type="checkbox"/>	L=1402 L=1450
	1.2 i 16V 1.3 TDCi	51 55		10.08 10.08	12.09 12.09	24.3728-0532.2 24.3728-0628.2	590532 590628		L=995 L=1028
FORD KUGA I (08-12)									
	2.0 TDCi 2.0 TDCi 2.0 TDCi 4x4 2.0 TDCi 4x4 2.0 TDCi 4x4 2.5 i 2.5 i 4x4	◀100 ◀103 ◀100 ◀103 ◀120 ◀147 ◀147		04.08 03.10 04.08 03.10 03.10 03.09 11.08	12.12 12.12 12.12 12.12 12.12 12.12 12.12	03.7755-7703.4 03.7755-3532.4	300247 300290		9/8" Tandem 9/8" Tandem ATE
	2.0 TDCi 2.0 TDCi 2.0 TDCi 4x4 2.0 TDCi 4x4 2.0 TDCi 4x4	▶100 ▶103 ▶100 ▶103 ▶120		04.08 03.10 04.08 03.10 03.10	12.12 12.12 12.12 12.12 12.12	03.7760-2232.4	300266		10" ATE
	2.0 TDCi 2.0 TDCi 2.0 TDCi 4x4 2.0 TDCi 4x4 2.0 TDCi 4x4 2.5 i 2.5 i 4x4	◀100 ◀103 ◀100 ◀103 ◀120 ◀147 ◀147		11.08 03.10 11.08 03.10 03.10 03.09 11.08	12.12 12.12 12.12 12.12 12.12 12.12 12.12	03.2125-0651.3	010935		THz 25,40 ATE
	2.0 TDCi 2.0 TDCi 4x4	▶100 ▶100		04.08 04.08	10.08 10.08	03.2125-0483.3	010783		THz 25,40 ATE
	2.0 TDCi 2.0 TDCi 4x4	▶100 ▶100		11.08 11.08	12.12 12.12	03.2125-0661.3	010917		THz 25,40 ATE
	2.0 TDCi 2.0 TDCi 2.0 TDCi 4x4 2.0 TDCi 4x4 2.0 TDCi 4x4 2.5 i 2.5 i 4x4	100 103 100 103 120 147 147		04.08 03.10 04.08 03.10 03.10 03.09 11.08	12.12 12.12 12.12 12.12 12.12 12.12 12.12	24.3571-9813.5 24.3571-9814.5 11.0230-0818.1 11.0101-5407.2 11.8171-0008.1 11.8116-0356.1	240557 240558 260135 260011 990049 390586	<input type="checkbox"/> <input type="checkbox"/> 2	D=57, - Halter ATE D=57, - Halter ATE Halter ATE Hülzensatz ATE Führungsbolzen ATE Haltefeder ATE
	2.0 TDCi 2.0 TDCi 2.0 TDCi 4x4 2.0 TDCi 4x4 2.0 TDCi 4x4 2.5 i 2.5 i 4x4	100 103 100 103 120 147 147		04.08 03.10 04.08 03.10 03.10 03.09 11.08	12.12 12.12 12.12 12.12 12.12 12.12 12.12	83.7788-0435.3	331119	2	L=435
	2.0 TDCi 2.0 TDCi 2.0 TDCi 4x4 2.0 TDCi 4x4 2.0 TDCi 4x4 2.5 i 2.5 i 4x4	100 103 100 103 120 147 147		04.08 03.10 04.08 03.10 03.10 03.09 11.08	12.12 12.12 12.12 12.12 12.12 12.12 12.12	83.7788-0472.3	331120	2	L=472

¹⁾ to change only by pairs / sostituire solo a coppie / à changer seulement par paires / cambiar solamente por parejas

										
FORD KUGA I (08-12)										
	2.0 TDCi	100		04.08	12.12	24.3727-0667.2	580667	1 	L=360 L=1848/1933	
	2.0 TDCi	103		03.10	12.12	24.3727-0672.2	580672	1 		
	2.0 TDCi 4x4	100		04.08	12.12					
	2.0 TDCi 4x4	103		03.10	12.12					
	2.0 TDCi 4x4	120		03.10	12.12					
	2.5 i	147		03.09	12.12					
	2.5 i 4x4	147		11.08	12.12					
FORD KUGA II (13-)										
	1.5 EcoBoost	88		01.16		03.4155-5456.3	010996		THz 25,40	ATE
	1.5 EcoBoost	110		09.14						
	1.5 EcoBoost 4x4	134		09.14						
	1.6 EcoBoost	110		01.13						
	1.6 EcoBoost 4x4	110		01.13						
	1.6 EcoBoost 4x4	134		01.13						
	2.0 TDCi	85		03.13						
	2.0 TDCi	88		09.14						
	2.0 TDCi	103		01.13						
	2.0 TDCi	110		09.14						
	2.0 TDCi 4x4	103		03.13						
	2.0 TDCi 4x4	110		09.14						
	2.0 TDCi 4x4	120		01.13						
	2.0 TDCi 4x4	132		09.14						
	2.5	110		01.14						
	1.5 EcoBoost	88		01.16		24.3571-9813.5	240557		D=57, - Halter	ATE
	1.5 EcoBoost	110		09.14		24.3571-9814.5	240558		D=57, - Halter	ATE
	1.6 EcoBoost	110		01.13						
	1.6 EcoBoost 4x4	110		01.13						
	2.5	110		01.14						
	1.5 EcoBoost	88		01.16		11.9387-7083.2	220959		D=38, - Halter	ATE
	1.5 EcoBoost	110		09.14		11.9387-7084.2	220960		D=38, - Halter	ATE
	1.5 EcoBoost 4x4	134		09.14		11.8116-0340.1	390595	2 	Haltefeder	ATE
	1.6 EcoBoost	110		01.13						
	1.6 EcoBoost 4x4	110		01.13						
	1.6 EcoBoost 4x4	134		01.13						
	2.0 TDCi	85		03.13						
	2.0 TDCi	88		09.14						
	2.0 TDCi	103		01.13						
	2.0 TDCi	110		09.14						
	2.0 TDCi 4x4	103		03.13						
	2.0 TDCi 4x4	110		09.14						
	2.0 TDCi 4x4	120		01.13						
	2.0 TDCi 4x4	132		09.14						
	2.5	110		01.14						
FORD MAVERICK (97-98)										
	2.4 i			10.96	03.98	24.2125-1738.3	010931		THz 25,40	TRW
	2.7 TD			10.96	03.98					
	2.4 i			10.96	03.98 + 2 türig ¹⁾	24.3223-1709.3	020444		Rz 23,81	
	2.7 TD			10.96	03.98 + 2 türig ¹⁾					
FORD MAVERICK (01-07)										
	2.0 i 16V	91		02.01	06.07	24.3727-0673.2	580673	1 	+ Ganzbodenkonsole ²⁾	L=819
	2.3 i 16V	110		03.04	06.07	24.3727-0674.2	580674	1 	- Ganzbodenkonsole ³⁾	L=988
	3.0 i V6	145		02.01	06.07					
	3.0 i 24V	149		03.04	04.06	24.3727-0675.2	580675	1 		L=1081
	3.0 i 24V	149		05.06	06.07	24.3727-0675.2	580675	1 		L=1081
FORD MONDEO II (96-00)										
	1.6 i 16V			10.96	09.00 - ABS	24.2125-1706.3	010496		THz 25,40	
	1.8 i 16V			10.96	09.00 - ABS					
	1.8 TD			10.96	09.00 - ABS					
	2.0 i 16V			10.96	09.00 - ABS					
	2.5 i 24V			10.96	09.00 - ABS					
	2.5 ST 200			05.99	09.00 - ABS					
	1.6 i 16V			10.96	09.00 + ABS	24.2125-1709.3	010499		THz 25,40	
	1.8 i 16V			10.96	09.00 + ABS					
	1.8 TD			10.96	09.00 + ABS					
	2.0 i 16V			10.96	09.00 + ABS					
	2.5 i 24V			10.96	09.00 + ABS					
	2.5 ST 200			05.99	09.00 + ABS					
	1.6 i 16V			10.96	09.00	24.3601-8527.5	240503		D=60, - Halter	ATE
	1.8 i 16V			10.96	09.00	24.3601-8528.5	240504		D=60, - Halter	ATE
	1.8 TD			10.96	09.00	11.0441-6007.2	250146		Dichtungssatz	ATE
	2.0 i 16V			10.96	09.00	11.0101-5407.2	260011		Hülzensatz	ATE
	2.5 i 24V			12.97	09.00	11.8171-0008.1	990049		Führungsbolzen	ATE
	2.5 ST 200			05.99	09.00	11.8116-0301.1	390610	2	Haltefeder	ATE
	2.5 i 24V			10.96	11.97	11.0441-6007.2	250146		Dichtungssatz	ATE
						11.0101-5407.2	260011		Hülzensatz	ATE
						11.8171-0008.1	990049		Führungsbolzen	ATE
						11.8116-0143.1	390513	2	Haltefeder	ATE
	1.6 i 16V			10.96	09.00	83.7114-0376.3	330373	2	L=370	
	1.8 i 16V			10.96	09.00					
	1.8 TD			10.96	09.00					

¹⁾ + 2 door / + 2 porte / + 2 portes / + 2 puertas

²⁾ + center console / + mensola per pianale, sull'intera lunghezza / + console de plancher sur toute la longueur / + consola total de suelo

³⁾ - center console / - mensola per pianale, sull'intera lunghezza / - console de plancher sur toute la longueur / - consola total de suelo

FORD MONDEO II (96-00)										
	2.0 i 16V 2.5 i 24V		10.96 10.96	09.00 09.00	83.7114-0376.3	330373	2	L=370		
	1.6 i 16V Lim. 1.8 i 16V Lim. 1.8 TD Lim. 2.0 i 16V Lim. 2.5 i 24V Lim. 2.5 ST 200		10.96 10.96 10.96 10.96 10.96 05.99	09.00 09.00 09.00 09.00 09.00 09.00 + Limousine 1)	24.3364-1703.5 24.3364-1704.5	240309 240310	 	D=36, - Halter D=36, - Halter	BOS BOS	
	1.6 i 16V Kombi 1.8 i 16V Kombi 1.8 TD Kombi 2.0 i 16V Kombi 2.5 i 24V Kombi 2.5 ST 200		10.96 10.96 10.96 10.96 10.96 05.99	09.00 09.00 09.00 09.00 09.00 09.00 + Kombi 2)	24.3364-1705.5 24.3364-1706.5	240311 240312	 	D=36, - Halter D=36, - Halter	BOS BOS	
	1.6 i 16V Lim. 1.8 i 16V Lim. 1.8 TD Lim. 2.0 i 16V Lim. 2.5 i 24V Lim. 2.5 ST 200		10.96 10.96 10.96 10.96 10.96 05.99	09.00 09.00 09.00 09.00 09.00 09.00 + Limousine 1)	83.6118-0281.3 24.5309-0540.3	330483 331368	2 2	+ HA-Trommelbremse 3) + HA-Scheibenbremse 4)	L=280 L=540	
	1.6 i 16V Kombi 1.8 i 16V Kombi 1.8 TD Kombi 2.0 i 16V Kombi 2.5 i 24V Kombi		10.96 10.96 10.96 10.96 10.96	04.97 04.97 04.97 04.97 04.97	83.6114-0300.3 24.5164-0315.3	330258 331209	2 2	+ HA-Trommelbremse 3) + HA-Scheibenbremse 4)	L=300 L=315	
	1.6 i 16V Kombi 1.8 i 16V Kombi 1.8 TD Kombi 2.0 i 16V Kombi 2.5 i 24V Kombi 2.5 ST 200		05.97 05.97 05.97 05.97 05.97 05.99	09.00 09.00 09.00 09.00 09.00 09.00 + Kombiwagen 5)	83.6114-0300.3 24.5164-0316.3 24.5164-0317.3	330258 331210 331211	2 	+ HA-Trommelbremse 3) + HA-Scheibenbremse 4) + HA-Scheibenbremse 4)	L=300 L=315 L=315	
	1.6 i 16V Lim. 1.8 i 16V Lim. 1.8 TD Lim.		10.96 10.96 10.96	09.00 09.00 09.00	24.3222-1114.3	020269			Rz 22,20	
	2.0 i 16V Lim. 1.6 i 16V Kombi 1.8 i 16V Kombi		10.96 10.96 10.96	09.00 09.00 09.00	24.3220-1111.3 24.3222-1116.3	020222 020271			Rz 20,64 Rz 22,20	
	1.6 i 16V Lim. 1.8 i 16V Lim. 1.8 TD Lim. 2.0 i 16V Lim. 2.5 i 24V Lim. 2.5 ST 200		10.96 10.96 10.96 10.96 10.96 05.99	09.00 09.00 09.00 09.00 09.00 09.00 + Limousine 1)	24.3727-0638.2 24.3727-0639.2 24.3727-0644.2	580638 580639 580644	1 2 2	+ HA-Trommelbremse 3) + HA-Scheibenbremse 4)	L=270 L=1611 L=1462	
	1.6 i 16V Kombi 1.8 i 16V Kombi 1.8 TD Kombi 2.0 i 16V Kombi 2.5 i 24V Kombi 2.5 ST 200		10.96 10.96 10.96 10.96 10.96 05.99	09.00 09.00 09.00 09.00 09.00 09.00 + Kombi 2)	24.3727-0638.2 24.3727-0639.2 24.3727-0641.2	580638 580639 580641	1 2 2	+ HA-Trommelbremse 3) + HA-Scheibenbremse 4)	L=270 L=1611 L=1647	
	1.6 i 16V Lim. 1.8 i 16V Lim. 1.8 TD Lim. 2.0 i 16V Lim.		10.96 10.96 10.96 10.96	09.00 - ABS 09.00 - ABS 09.00 - ABS 09.00 - ABS	03.6043-1954.3 03.6583-0165.3	320226 320285		+ HA-Scheibenbremse 4) + HA-Trommelbremse 3)	BRE 3/30 BRL 8/3 (4) schwarz	ATE ATE
	1.6 i 16V Kombi 1.8 i 16V Kombi 1.8 TD Kombi 2.0 i 16V Kombi		10.96 10.96 10.96 10.96	09.00 - ABS 09.00 - ABS 09.00 - ABS 09.00 - ABS	03.6043-1953.3	320201	2		BRE 3/45	ATE
	1.8 i 16V 1.8 TD 2.0 i 16V 2.5 i 24V 2.5 ST 200		10.96 10.96 10.96 10.96 05.99	09.00 + ABS/ASR 09.00 + ABS 09.00 + ABS/ASR 09.00 09.00	03.6043-1956.3	320202	2		BRE 3/40	ATE
	1.6 i 16V 1.8 i 16V 1.8 TD 2.0 i 16V 2.5 i 24V 2.5 ST 200		10.96 10.96 10.96 10.96 10.96 05.99	09.00 09.00 09.00 09.00 09.00 09.00	24.2419-1723.3	030112			Gz 19,05	
FORD MONDEO III (00-07)										
	1.8 i 16V 1.8 SCi 2.0 DI 2.0 i 16V 2.0 TDCi 2.2 TDCi 2.5 i V6 3.0 i V6 ST 220		10.00 06.03 10.00 10.00 10.01 09.04 10.00 09.04 04.02	03.07 03.07 03.07 03.07 03.07 03.07 03.07 03.07 03.07	24.3571-1735.5 24.3571-1736.5	240385 240386	 	D=57, - Halter D=57, - Halter	BOS BOS	
	1.8 i 16V 1.8 SCi 2.0 DI 2.0 i 16V 2.0 TDCi		10.00 06.03 10.00 10.00 10.01	03.07 03.07 03.07 03.07 03.07	83.7188-0446.3	330664	2		L=470	

1) + Saloon / + Berlina / + Berline / + Berlina
2) + Estate / + Station Wagon / + Break / + Break
3) + RA drum brake / + P freno a tamburo / + frein à tambour essieu AR / + ET-tambores de freno
4) + RA disc brake / + P disco freno / + frein à disque essieu AR / + ET-disco de freno
5) + Estate / + Station Wagon / + Break / + Break



















FORD MONDEO III (00-07)

	2.2 TDCi 2.5 i V6 3.0 i V6 ST 220		09.04 10.00 09.04 04.02	03.07 03.07 03.07 03.07	83.7188-0446.3	330664	2		L=470	
	1.8 i 16V Lim. 1.8 SCi Lim. 2.0 DI Lim. 2.0 i 16V Lim. 2.0 TDCi Lim. 2.5 i V6 Lim. ST 220 Lim.		10.00 06.03 10.00 10.00 10.01 10.00 04.02	08.04 08.04 08.04 08.04 08.04 08.04 08.04	24.3384-1713.5 24.3384-1714.5	240431 240432			D=38, - Halter D=38, - Halter	BOS BOS
	1.8 i 16V Kombi 1.8 SCi Kombi 2.0 DI Kombi 2.0 i 16V Kombi 2.0 TDCi Kombi 2.5 i V6 Kombi ST 220 Kombi		10.00 06.03 10.00 10.00 10.01 10.00 04.02	08.04 08.04 08.04 08.04 08.04 08.04 08.04	24.3384-1757.5 24.3384-1758.5	240473 240474			D=38, - Halter D=38, - Halter	BOS BOS
	1.8 i 16V 1.8 SCi 2.0 DI 2.0 i 16V 2.0 TDCi 2.2 TDCi 2.5 i V6 3.0 i V6 ST 220		10.00 06.03 10.00 10.00 10.01 09.04 10.00 09.04 04.02	03.07 03.07 03.07 03.07 03.07 03.07 03.07 03.07 03.07	83.7788-0280.3	330836	2		L=280	
	1.8 i 16V Lim. 1.8 SCi Lim. 2.0 DI Lim. 2.0 i 16V Lim. 2.0 TDCi Lim. 2.2 TDCi Lim. 2.5 i V6 Lim. 3.0 i V6 Lim. ST 220 Lim.		10.00 06.03 10.00 10.00 10.01 09.04 10.00 09.04 04.02	03.07 03.07 03.07 03.07 03.07 03.07 03.07 03.07 03.07	24.3727-0647.2	580647	2		L=1735	
	1.8 i 16V Kombi 1.8 SCi Kombi 2.0 DI Kombi 2.0 i 16V Kombi 2.0 TDCi Kombi 2.2 TDCi Kombi 2.5 i V6 Kombi 3.0 i V6 Kombi ST 220 Kombi		10.00 06.03 10.00 10.00 10.01 09.04 10.00 09.04 04.02	03.07 03.07 03.07 03.07 03.07 03.07 03.07 03.07 03.07	24.3727-0648.2	580648	2		L=1722	









































FORD MONDEO IV (07-14)

	1.6 EcoBoost 1.6 TDCi 1.6 Ti VCT 1.6 Ti VCT 1.6 Ti VCT 1.8 TDCi 1.8 TDCi 2.0 EcoBoost 2.0 Flexifuel 2.0 i 16V 2.0 LPG 2.0 SCTi 2.0 TDCi 2.0 TDCi 2.0 TDCi 2.0 TDCi 2.0 TDCi 2.2 TDCi 2.2 TDCi 2.3 i 16V 2.5 i 20V	118 85 81 88 92 74 92 176 107 107 107 149 85 96 100 103 120 129 147 118 162		02.11 02.11 04.07 07.10 04.07 04.07 06.07 07.10 03.07 04.07 07.09 03.10 10.07 04.07 03.07 04.07 03.10 04.08 11.10 07.07 04.07	09.14 09.14	03.7755-1432.4	300300			9/8" Tandem	ATE
	1.6 EcoBoost 1.6 TDCi 1.6 Ti VCT 1.6 Ti VCT 1.6 Ti VCT 1.8 TDCi 1.8 TDCi 2.0 EcoBoost 2.0 Flexifuel 2.0 i 16V 2.0 LPG 2.0 SCTi 2.0 TDCi 2.0 TDCi 2.0 TDCi 2.0 TDCi 2.0 TDCi 2.2 TDCi 2.2 TDCi 2.3 i 16V 2.5 i 20V	118 85 81 88 92 74 92 176 107 107 107 149 85 96 100 103 120 129 147 118 162		02.11 02.11 04.07 07.10 04.07 04.07 06.07 07.10 03.07 04.07 07.09 03.10 10.07 04.07 03.07 04.07 03.10 04.08 11.10 07.07 04.07	09.14 09.14	11.9601-9711.2 11.9601-9712.2 11.0230-0934.1 11.0101-5407.2 11.8171-0008.1 11.8116-0206.1 11.0441-6008.2	220873 220874 260128 260011 990049 390593 250038	2		D=60, - Halter D=60, - Halter Halter Hülsensatz Führungsbolzen Haltefeder Dichtungssatz	ATE ATE ATE ATE ATE ATE ATE

									
FORD MONDEO IV (07-14)									
	2.3 i 16V 2.5 i 20V	118 162		07.07 04.07	09.14 09.14		11.9601-9711.2 220873 11.9601-9712.2 220874 11.0230-0934.1 260128 11.0101-5407.2 260011 11.8171-0008.1 990049 11.8116-0206.1 390593 11.0441-6008.2 250038	D=60, - Halter D=60, - Halter Halter Hülzensatz Führungsbolzen Haltefeder Dichtungssatz	ATE ATE ATE ATE ATE ATE ATE
	1.6 EcoBoost 1.6 TDCi 1.6 Ti VCT 1.6 Ti VCT 1.6 Ti VCT 1.8 TDCi 1.8 TDCi 2.0 EcoBoost 2.0 Flexifuel 2.0 i 16V 2.0 LPG 2.0 SCTi 2.0 TDCi 2.0 TDCi 2.0 TDCi 2.0 TDCi 2.0 TDCi 2.2 TDCi 2.2 TDCi 2.3 i 16V 2.5 i 20V	118 85 81 88 92 74 92 176 107 107 107 149 85 96 100 103 120 129 147 118 162		02.11 02.11 04.07 07.10 04.07 04.07 06.07 07.10 03.07 04.07 07.09 03.10 10.07 04.07 03.07 04.07 03.10 04.08 11.10 07.07 04.07	09.14 09.14		24.5162-0390.3 331199	L=390	
	1.6 EcoBoost 1.6 TDCi 1.6 Ti VCT 1.6 Ti VCT 1.6 Ti VCT 1.8 TDCi 1.8 TDCi 2.0 EcoBoost 2.0 Flexifuel 2.0 i 16V 2.0 LPG 2.0 SCTi 2.0 TDCi 2.0 TDCi 2.0 TDCi 2.0 TDCi 2.0 TDCi 2.2 TDCi 2.2 TDCi 2.3 i 16V 2.5 i 20V	118 85 81 88 92 74 92 176 107 107 107 149 85 96 100 103 120 129 147 118 162		02.11 02.11 04.07 07.10 04.07 04.07 06.07 07.10 03.07 04.07 07.09 03.10 10.07 04.07 03.07 04.07 03.10 04.08 11.10 07.07 04.07	09.14 09.14		24.5163-0155.3 331204	+ mechanische Feststellbremse ¹⁾	L=155
	1.6 EcoBoost 1.6 TDCi 1.6 Ti VCT 1.6 Ti VCT 1.6 Ti VCT 1.8 TDCi 1.8 TDCi 2.0 EcoBoost 2.0 Flexifuel 2.0 i 16V 2.0 LPG 2.0 SCTi 2.0 TDCi 2.0 TDCi 2.0 TDCi 2.0 TDCi 2.0 TDCi 2.2 TDCi 2.2 TDCi 2.3 i 16V 2.5 i 20V	118 85 81 88 92 74 92 176 107 107 107 149 85 96 100 103 120 129 147 118 162		02.11 02.11 04.07 07.10 04.07 04.07 06.07 07.10 03.07 04.07 07.09 03.10 10.07 04.07 03.07 04.07 03.10 04.08 11.10 07.07 04.07	09.14 09.14		24.3727-0676.2 580676 24.3727-0677.2 580677	+ mechanische Feststellbremse ¹⁾ + mechanische Feststellbremse ¹⁾	L=2078 L=2071
FORD PUMA (97-01)									
	1.4 i 16V 1.7 i 16V			02.98 01.98	01.00 01.00	- ABS - ABS	24.2123-1735.3 010652	Thz 23,81	
	1.4 i 16V 1.6 i 16V 1.7 i 16V			02.00 08.00 02.00	10.00 12.01 12.01	+ ABS + ABS + ABS	03.2123-2243.3 010748	Thz 23,81	ATE
	1.4 i 16V 1.7 i 16V ST 160			02.98 06.97 06.99	01.00 01.00 01.00		11.3541-8529.2 220341 11.3541-8530.2 220342 24.3541-8529.5 240553 24.3541-8530.5 240554 11.0441-5402.2 250028 11.0101-5407.2 260011 11.8171-0008.1 990049 11.8116-0264.1 390594	D=54, - Halter D=54, - Halter D=54, - Halter D=54, - Halter Dichtungssatz Hülzensatz Führungsbolzen Haltefeder	ATE ATE ATE ATE ATE ATE ATE ATE







¹⁾ + mechanical parking brake / + fr. stazionamento meccanico / + frein à main mécanique / + freno de mano mecánica



											
FORD PUMA (97-01)											
	1.4 i 16V 1.6 i 16V 1.7 i 16V ST 160			02.00 08.00 02.00 02.00	10.00 12.01 12.01 12.01	11.3541-8531.2 11.3541-8532.2 11.0101-5407.2 11.8171-0008.1 11.8116-0264.1	220367 220368 260011 990049 390594	 	D=54, - Halter D=54, - Halter Hülensatz Führungsbolzen Haltefeder	ATE ATE ATE ATE ATE	
	1.7 i 16V 1.4 i 16V 1.7 i 16V			06.97 02.98 02.98	01.98 12.99 12.99	24.5305-0350.3 24.5305-0295.3	330660 330657	2 2	L=352 L=297		
	1.4 i 16V 1.6 i 16V 1.7 i 16V			01.00 08.00 01.00	10.00 12.01 12.01	24.5305-0355.3	330688	2	L=355		
	1.4 i 16V 1.7 i 16V ST 160			02.98 06.97 06.99	01.00 01.00 01.00	24.3217-1715.3	020463		nur paarweise austauschen ¹⁾	Rz 17,78	TRW
	1.4 i 16V 1.4 i 16V 1.6 i 16V 1.7 i 16V ST 160			02.00 08.00 02.00 02.00	10.00 12.01 12.01 12.01	24.3219-1735.3	020464			Rz 19,05	
	1.4 i 16V 1.7 i 16V			02.98 06.97	11.98 11.98	24.3727-1800.2 24.3727-0660.2	581800 580660	1  1 		L=312 L=1575/1627	
	1.4 i 16V 1.6 i 16V 1.7 i 16V			12.98 08.00 12.98	10.00 12.01 12.01	24.3727-1800.2 24.3727-0660.2	581800 580660	1  1 		L=312 L=1575/1627	
	1.4 i 16V 1.7 i 16V			02.98 06.97	08.98 08.98	24.2419-1734.3	030126			Gz 19,05	
	1.4 i 16V 1.6 i 16V 1.7 i 16V			09.98 08.00 09.98	10.00 12.01 12.01	24.2419-1736.3	030128			Gz 19,05	
FORD RANGER II (10-11)											
	2.5 TDCi 2.5 TDCi 4x4 3.0 TDCi 3.0 TDCi 4x4	105 105 115 115		04.10 04.10 04.10 04.10	10.11 10.11 10.11 10.11	24.3223-1711.3	020570			Rz 23,81	
FORD RANGER (11-)											
	2.2 TDCi 2.2 TDCi 2.2 TDCi 2.2 TDCi 4x4 2.2 TDCi 4x4 2.2 TDCi 4x4 2.2 TDCi 4x4 3.2 TDCi 4x4	96 118 92 96 110 118 147		11.11 05.15 05.15 11.11 05.15 11.11 05.15 11.11		24.3223-1711.3	020570		- ABS	Rz 23,81	
	2.2 TDCi 2.2 TDCi 4x4 2.2 TDCi 4x4 3.2 TDCi 4x4	92 110 147		11.11 11.11 11.11 11.11		24.2520-1706.3	040094			Nz 20,40	
FORD SCORPIO / GRANADA (GB) (95-98)											
	2.0 i 2.3 i 16V 2.5 TD 2.9 i			10.94 05.96 10.94 01.95	08.98 08.98 08.98 08.98	24.3601-8527.5 24.3601-8528.5 11.0441-6007.2 11.0101-5407.2 11.8171-0008.1 11.8116-0301.1	240503 240504 250146 260011 990049 390610	 	D=60, - Halter D=60, - Halter Dichtungssatz Hülensatz Führungsbolzen Haltefeder	ATE ATE ATE ATE ATE ATE	
	2.9 i 24V			10.94	08.98	11.0441-6007.2 11.0101-5407.2 11.8171-0008.1 11.8116-0143.1	250146 260011 990049 390513	2		Dichtungssatz Hülensatz Führungsbolzen Haltefeder	ATE ATE ATE ATE
	2.0 i 2.3 i 16V 2.5 TD 2.9 i 2.9 i 24V			10.94 05.96 10.94 01.95 10.94	08.98 08.98 08.98 08.98 08.98	83.6188-0311.3	330291	2		L=310	
	2.0 i Lim. 2.3 i 16V Lim. 2.5 TD Lim. 2.9 i Lim.			10.94 05.96 10.94 01.95	08.98 08.98 08.98 08.98	24.3434-1601.5 24.3434-1602.5 24.0101-4301.2	240019 240020 260047	 	D=43, - Halter D=43, - Halter Bremsattel-Zubehör	TRW TRW TRW	
	2.0 i 2.3 i 16V 2.5 TD 2.9 i 2.9 i 24V			10.94 05.96 10.94 01.95 10.94	08.98 08.98 08.98 08.98 08.98	83.6327-0180.3	330740	2	am Bremsattel ²⁾	L=180	
	2.0 i 2.5 TD 2.9 i 2.9 i 24V			10.94 10.94 01.95 10.94	12.95 12.95 12.95 12.95	24.3727-0642.2	580642	1 		L=3760	
	2.0 i 2.3 i 16V 2.5 TD 2.9 i 2.9 i 24V			01.96 05.96 01.96 01.96 01.96	08.98 08.98 08.98 08.98 08.98	24.3727-0643.2	580643	1 		L=3800	























¹⁾ to change only by pairs / sostituire solo a coppie / à changer seulement par paires / cambiar solamente por parejas

²⁾ on the brake caliper / sulla pinza freno / sur l'étrier de frein / a la pinza de freno

FORD S-MAX (06-)									
	1.6 EcoBoost 1.6 TDCi 1.8 TDCi 1.8 TDCi 2.0 EcoBoost 2.0 i 16V 2.0 SCTi EcoBoost 2.0 TDCi 2.0 TDCi 2.0 TDCi 2.0 TDCi 2.0 TDCi 2.2 TDCi 2.2 TDCi 2.3 i 16V 2.5 ST	118 85 74 92 176 107 149 85 96 100 103 120 129 147 118 162		02.11 02.11 01.07 04.06 07.10 04.06 03.10 10.07 04.06 05.06 04.06 03.10 04.08 07.10 07.07 04.06			03.7755-1432.4 300300		9/8" Tandem ATE
	1.6 EcoBoost 1.6 TDCi 1.8 TDCi 1.8 TDCi 2.0 i 16V 2.0 TDCi 2.0 TDCi 2.0 TDCi 2.0 TDCi 2.0 TDCi 2.2 TDCi 2.2 TDCi 2.3 i 16V	118 85 74 92 107 85 96 100 103 120 129 147 118		02.11 02.11 01.07 04.06 04.06 10.07 04.06 05.06 04.06 03.10 11.08 07.10 07.07			11.9601-9711.2 220873 11.9601-9712.2 220874 11.0230-0934.1 260128 11.0101-5407.2 260011 11.8171-0008.1 990049 11.8116-0206.1 390593 11.0441-6008.2 250038	2	D=60, - Halter D=60, - Halter Halter Hülzensatz Führungsbolzen Haltefeder Dichtungssatz ATE ATE ATE ATE ATE ATE
	2.0 EcoBoost 2.0 SCTi EcoBoost 2.2 TDCi 2.5 ST	176 149 129 162		07.10 03.10 04.08 04.06	10.08		11.9606-9949.2 220879 11.9606-9950.2 220880 11.8116-0388.2 390588	2	D=60, - Halter D=60, - Halter Haltefeder ATE ATE ATE
	1.6 EcoBoost 1.6 TDCi 1.8 TDCi 1.8 TDCi 2.0 i 16V 2.0 TDCi 2.0 TDCi 2.0 TDCi 2.0 TDCi 2.0 TDCi 2.2 TDCi 2.2 TDCi 2.3 i 16V	118 85 74 92 107 85 96 100 103 120 129 147 118		02.11 02.11 01.07 04.06 04.06 10.07 04.06 05.06 04.06 03.10 04.08 07.10 07.07			24.5162-0390.3 331199	2	L=390
	1.6 EcoBoost 1.6 TDCi 1.8 TDCi 1.8 TDCi 2.0 EcoBoost 2.0 i 16V 2.0 SCTi EcoBoost 2.0 TDCi 2.0 TDCi 2.0 TDCi 2.0 TDCi 2.0 TDCi 2.2 TDCi 2.2 TDCi 2.3 i 16V 2.5 ST	118 85 74 92 176 107 149 85 96 100 103 120 129 147 118 162		02.11 02.11 01.07 04.06 07.10 04.06 03.10 10.07 04.06 05.06 04.06 03.10 04.08 07.10 07.07 04.06			24.6238-1709.7 221017 24.6238-1710.7 221018	2	+ elektrische Feststellbremse ¹⁾ + elektrische Feststellbremse ¹⁾ D=38, - Halter D=38, - Halter TRW TRW
	1.6 EcoBoost 1.6 TDCi 1.8 TDCi 1.8 TDCi 2.0 EcoBoost 2.0 i 16V 2.0 SCTi EcoBoost 2.0 TDCi 2.0 TDCi 2.0 TDCi 2.0 TDCi 2.0 TDCi 2.2 TDCi 2.2 TDCi 2.3 i 16V 2.5 ST	118 85 74 92 176 107 149 85 96 100 103 120 129 147 118 162		02.11 02.11 01.07 12.06 07.10 12.06 03.10 10.07 12.06 12.06 12.06 03.10 04.08 07.10 07.07 12.06			24.5163-0155.3 331204	2	+ mechanische Feststellbremse ²⁾ L=155
	1.6 EcoBoost 1.6 TDCi 1.8 TDCi 1.8 TDCi 2.0 EcoBoost 2.0 i 16V 2.0 SCTi EcoBoost 2.0 TDCi 2.0 TDCi	118 85 74 92 176 107 149 85 96		02.11 02.11 01.07 04.06 07.10 04.06 03.10 10.07 04.06			24.5133-0310.3 331197	2	+ elektrische Feststellbremse ¹⁾ L=310

¹⁾ + electric parking brake / + freno a mano elettrico / + frein à main électrique / + freno de mano eléctrico

²⁾ + mechanical parking brake / + fr. stazionamento meccanico / + frein à main mécanique / + freno de mano mecánica

										
FORD S-MAX (06-)										
	2.0 TDCi	100		05.06		24.5133-0310.3	331197	2	+ elektrische Feststellbremse ¹⁾	L=310
	2.0 TDCi	103		04.06						
	2.0 TDCi	120		03.10						
	2.2 TDCi	129		04.08						
	2.2 TDCi	147		07.10						
	2.3 i 16V	118		07.07						
	2.5 ST	162		04.06						
	1.8 TDCi	74		01.07	06.09	24.5133-0311.3	331198	2	+ elektrische Feststellbremse ¹⁾	L=310
	1.8 TDCi	92		04.06	06.09					
	2.0 i 16V	107		04.06	06.09					
2.0 TDCi	85		10.07	06.09						
2.0 TDCi	96		04.06	06.09						
2.0 TDCi	100		05.06	06.09						
2.0 TDCi	103		04.06	06.09						
2.2 TDCi	129		04.08	06.09						
2.3 i 16V	118		07.07	06.09						
2.5 ST	162		04.06	06.09						
	1.6 EcoBoost	118		02.11		24.3727-0676.2	580676		<input type="checkbox"/> + mechanische Feststellbremse ²⁾	L=2078
	1.6 TDCi	85		02.11		24.3727-0677.2	580677		<input type="checkbox"/> + mechanische Feststellbremse ²⁾	L=2071
	1.8 TDCi	74		02.07						
	1.8 TDCi	92		02.07						
	2.0 EcoBoost	176		07.10						
	2.0 i 16V	107		02.07						
	2.0 SCTi EcoBoost	149		03.10						
	2.0 TDCi	85		10.07						
	2.0 TDCi	96		02.07						
	2.0 TDCi	100		02.07						
	2.0 TDCi	103		02.07						
	2.0 TDCi	120		03.10						
	2.2 TDCi	129		04.08						
	2.2 TDCi	147		07.10						
	2.3 i 16V	118		07.07						
2.5 ST	162		02.07							
FORD S-MAX II (15-)										
	1.5 EcoBoost	118		02.15		11.8171-0096.1	250155		+ 17" Rad ³⁾	Führungsbolzen ATE
	2.0 EcoBoost	176		02.15						
	2.0 TDCi	88		02.15						
	2.0 TDCi	110		02.15						
	2.0 TDCi	132		02.15						
	2.0 TDCi 4x4	110		02.15						
	2.0 TDCi 4x4	132		02.15						
	2.0 TDCi Bi-Turbo	154		02.15						
FORD STREET KA (03-06)										
	1.6 i	70		02.03	02.06	03.7750-5432.4	300248			9" ATE
	1.6 i	70		02.03	02.06	11.3541-8531.2	220367	<input type="checkbox"/>		D=54, - Halter ATE
						11.3541-8532.2	220368	<input type="checkbox"/>		D=54, - Halter ATE
						11.0101-5407.2	260011			Hülzensatz ATE
					11.8171-0008.1	990049			Führungsbolzen ATE	
	1.6 i	70		02.03	02.06	24.3219-1735.3	020464			Rz 19,05
	1.6 i	70		02.03	02.06	24.3727-1800.2	581800	1 		L=312
						24.3727-0660.2	580660	1 		L=1575/1627
FORD TOURNEO (94-00)										
	2.0			07.94	03.97	24.2123-1724.3	010566		- ABS	THz 23,81 BDX
	2.4 D	55		07.94	03.97	10.6123-0154.3	010578		+ ABS	THz 23,81 ATE
	2.5 D			07.94	03.97					
	2.5 TD			07.94	03.97					
	2.0			04.97	03.00	24.2123-1749.3	010713		- ABS	THz 23,81
	2.4 D	55		04.97	03.00	24.2123-1742.3	010671		+ ABS	THz 23,81
	2.5 D			04.97	03.00					
	2.5 TD			04.97	03.00					
	2.0			07.94	03.00	24.3421-1709.5	240697	<input type="checkbox"/>		D=42, - Halter TRW
	2.4 D	55		07.94	03.00	24.3421-1710.5	240698	<input type="checkbox"/>		D=42, - Halter TRW
	2.5 D			07.94	03.00					
	2.5 TD			07.94	03.00					
	2.0			07.94	03.00	24.3222-1124.3	020344			Rz 22,20
	2.4 D	55		07.94	03.00	24.3220-1121.3	020343			Rz 20,64
	2.5 D			07.94	03.00					
	2.5 TD			07.94	03.00					
	2.0			07.94	03.00	24.3727-0636.2	580636	1 	+ Einfachbereifung ⁵⁾	L=2823
	2.4 D	55		07.94	03.00	24.3727-0637.2	580637	1 	+ Doppelbereifung ⁶⁾	L=2730
	2.5 D			07.94	03.00					
	2.5 TD			07.94	03.00					

¹⁾ + electric parking brake / + freno a mano elettrico / + frein à main électrique / + freno de mano eléctrico













²⁾ + mechanical parking brake / + fr. stazionamento meccanico / + frein à main mécanique / + freno de mano mecánica

³⁾ + 17" wheel / + ruota 17" / + roue 17" / + rueda 17"

⁴⁾ + 15" wheel / + ruota 15" / + roue 15" / + rueda 15"

⁵⁾ + single tyre / + ruota singola / + roue simple / + cubierta simple

⁶⁾ + twin tyres / + ruote gemellate / + roue jumelée / + cubierta doble

									
FORD TRANSIT (95-00)									
	2.0 Bus	84	09.95	03.97	10.6360-1302.4	300286	+ ABS	10"	ATE
	2.0 CNG Bus	84	06.94	03.97					
	2.0 Kasten	84	06.94	03.97					
	2.0 Pritsche/Fahrg.	84	08.94	03.97					
	2.5 DI Bus	51	08.94	03.97					
	2.5 DI Bus	56	07.94	03.97					
	2.5 DI Kasten	51	06.94	03.97					
	2.5 DI Kasten	56	06.94	03.97					
	2.5 DI Prits./Fahrg.	51	08.94	03.97					
	2.5 DI Prits./Fahrg.	56	08.94	03.97					
	2.5 TD Bus	55	08.94	03.97					
	2.5 TD Bus	63	01.95	03.97					
	2.5 TD Bus	74	07.94	03.97					
	2.5 TD Kasten	63	06.94	03.97					
	2.5 TD Kasten	74	06.94	03.97					
	2.5 TD Prits./Fahrg.	63	08.94	03.97					
	2.5 TD Prits./Fahrg.	74	08.94	03.97					
	2.0 Bus	84	09.95	03.97	24.2123-1724.3	010566	- ABS	THz 23,81	BDX
	2.0 CNG Bus	84	06.94	03.97	10.6123-0154.3	010578	+ ABS	THz 23,81	ATE
	2.0 Kasten	84	06.94	03.97					
	2.0 Pritsche/Fahrg.	84	08.94	03.97					
	2.5 DI Bus	51	08.94	03.97					
	2.5 DI Bus	56	07.94	03.97					
	2.5 DI Kasten	51	06.94	03.97					
	2.5 DI Kasten	56	06.94	03.97					
	2.5 DI Prits./Fahrg.	51	08.94	03.97					
	2.5 DI Prits./Fahrg.	56	08.94	03.97					
	2.5 TD Bus	55	08.94	03.97					
	2.5 TD Bus	63	01.95	03.97					
	2.5 TD Bus	74	07.94	03.97					
	2.5 TD Kasten	63	06.94	03.97					
	2.5 TD Kasten	74	06.94	03.97					
	2.5 TD Prits./Fahrg.	63	08.94	03.97					
	2.5 TD Prits./Fahrg.	74	08.94	03.97					
	2.0 Bus	84	04.97	03.00	24.2123-1749.3	010713	- ABS	THz 23,81	
	2.0 CNG Bus	84	04.97	03.00	24.2123-1742.3	010671	+ ABS	THz 23,81	
	2.0 Kasten	84	04.97	03.00					
	2.0 Pritsche/Fahrg.	84	04.97	03.00					
	2.5 DI Bus	51	04.97	03.00					
	2.5 DI Bus	56	04.97	03.00					
	2.5 DI Bus	85	08.97	03.00					
	2.5 DI Kasten	51	04.97	03.00					
	2.5 DI Kasten	56	04.97	03.00					
	2.5 DI Kasten	85	05.99	03.00					
	2.5 DI Prits./Fahrg.	51	04.97	03.00					
	2.5 DI Prits./Fahrg.	56	04.97	03.00					
	2.5 DI Prits./Fahrg.	85	05.99	03.00					
	2.5 TD Bus	55	04.97	03.00					
	2.5 TD Bus	63	04.97	03.00					
	2.5 TD Bus	74	04.97	03.00					
	2.5 TD Kasten	55	10.98	03.00					
	2.5 TD Kasten	63	04.97	03.00					
	2.5 TD Kasten	74	04.97	03.00					
	2.5 TD Prits./Fahrg.	55	10.98	03.00					
	2.5 TD Prits./Fahrg.	63	04.97	03.00					
	2.5 TD Prits./Fahrg.	74	04.97	03.00					
	2.0 Bus	84	09.95	03.00	24.3421-1709.5	240697	+ 15" Rad ¹⁾	D=42, - Halter	TRW
	2.0 CNG Bus	84	06.94	03.00	24.3421-1710.5	240698	+ 15" Rad ¹⁾	D=42, - Halter	TRW
	2.0 Kasten	84	06.94	03.00					
	2.0 Pritsche/Fahrg.	84	08.94	03.00					
	2.5 DI Bus	51	08.94	03.00					
	2.5 DI Bus	56	07.94	03.00					
	2.5 DI Bus	85	08.97	03.00					
	2.5 DI Kasten	51	06.94	03.00					
	2.5 DI Kasten	56	06.94	03.00					
	2.5 DI Kasten	85	05.99	03.00					
	2.5 DI Prits./Fahrg.	51	08.94	03.00					
	2.5 DI Prits./Fahrg.	56	08.94	03.00					
	2.5 DI Prits./Fahrg.	85	05.99	03.00					
	2.5 TD Bus	55	08.94	03.00					
	2.5 TD Bus	63	01.95	03.00					
	2.5 TD Bus	74	07.94	03.00					
	2.5 TD Kasten	55	10.98	03.00					
	2.5 TD Kasten	63	06.94	03.00					
	2.5 TD Kasten	74	06.94	03.00					
	2.5 TD Prits./Fahrg.	55	10.98	03.00					
	2.5 TD Prits./Fahrg.	63	08.94	03.00					
	2.5 TD Prits./Fahrg.	74	08.94	03.00					
	2.0 Bus	84	09.95	03.00	24.5236-0430.3	330587		L=429	
	2.0 CNG Bus	84	06.94	03.00	24.5236-0429.3	330586		L=429	
	2.0 Kasten	84	06.94	03.00					
	2.0 Pritsche/Fahrg.	84	08.94	03.00					
	2.5 DI Bus	51	08.94	03.00					
	2.5 DI Bus	56	07.94	03.00					
	2.5 DI Bus	85	08.97	03.00					
	2.5 DI Kasten	51	06.94	03.00					
	2.5 DI Kasten	56	06.94	03.00					

1) + 15" wheel / + ruota 15" / + roue 15" / + rueda 15"

FORD TRANSIT (95-00)																	
	2.5 DI Kasten	85	05.99	03.00		24.5236-0430.3	330587										L=429
	2.5 DI Prits./Fahrg.	51	08.94	03.00		24.5236-0429.3	330586										L=429
	2.5 DI Prits./Fahrg.	56	08.94	03.00													
	2.5 DI Prits./Fahrg.	85	05.99	03.00													
	2.5 TD Bus	55	08.94	03.00													
	2.5 TD Bus	63	01.95	03.00													
	2.5 TD Bus	74	07.94	03.00													
	2.5 TD Kasten	55	10.98	03.00													
	2.5 TD Kasten	63	06.94	03.00													
	2.5 TD Kasten	74	06.94	03.00													
2.5 TD Prits./Fahrg.	55	10.98	03.00														
2.5 TD Prits./Fahrg.	63	08.94	03.00														
2.5 TD Prits./Fahrg.	74	08.94	03.00														
	2.0 Bus	84	09.95	03.00		24.5245-0405.3	330686	2	vertikal Bremssystem ¹⁾								L=405
	2.0 CNG Bus	84	06.94	03.00		24.5245-0398.3	331188	2	diagonal Bremssystem ²⁾								L=398
	2.0 Kasten	84	06.94	03.00													
	2.0 Pritsche/Fahrg.	84	08.94	03.00													
	2.5 DI Bus	51	08.94	03.00													
	2.5 DI Bus	56	07.94	03.00													
	2.5 DI Bus	85	08.97	03.00													
	2.5 DI Kasten	51	06.94	03.00													
	2.5 DI Kasten	56	06.94	03.00													
	2.5 DI Kasten	85	05.99	03.00													
	2.5 DI Prits./Fahrg.	51	08.94	03.00													
	2.5 DI Prits./Fahrg.	56	08.94	03.00													
	2.5 DI Prits./Fahrg.	85	05.99	03.00													
	2.5 TD Bus	55	08.94	03.00													
	2.5 TD Bus	63	01.95	03.00													
	2.5 TD Bus	74	07.94	03.00													
	2.5 TD Kasten	55	10.98	03.00													
2.5 TD Kasten	63	06.94	03.00														
2.5 TD Kasten	74	06.94	03.00														
2.5 TD Prits./Fahrg.	55	10.98	03.00														
2.5 TD Prits./Fahrg.	63	08.94	03.00														
2.5 TD Prits./Fahrg.	74	08.94	03.00														
	2.0 Bus	84	09.95	03.00	FT80/100S/100L/115/120	24.3222-1124.3	020344										Rz 22,20
	2.0 CNG Bus	84	06.94	03.00	FT80/100S/100L/115/120												
	2.0 Kasten	84	06.94	03.00	FT80/100S/100L/115/120												
	2.0 Pritsche/Fahrg.	84	08.94	03.00	FT80/100S/100L/115/120												
	2.5 DI Bus	51	08.94	03.00	FT80/100S/100L/115/120/130/150S/150L	24.3220-1121.3	020343										Rz 20,64
	2.5 DI Bus	56	07.94	03.00	FT80/100S/100L/115/120/130/150S/150L												
	2.5 DI Bus	85	08.97	03.00	FT80/100S/100L/115/120/130/150S/150L												
	2.5 DI Kasten	51	06.94	03.00	FT80/100S/100L/115/120/130/150S/150L												
	2.5 DI Kasten	56	06.94	03.00	FT80/100S/100L/115/120/130/150S/150L												
	2.5 DI Kasten	85	05.99	03.00	FT80/100S/100L/115/120/130/150S/150L												
	2.5 DI Prits./Fahrg.	51	08.94	03.00	FT80/100S/100L/115/120/130/150S/150L												
	2.5 DI Prits./Fahrg.	56	08.94	03.00	FT80/100S/100L/115/120/130/150S/150L												
	2.5 DI Prits./Fahrg.	85	05.99	03.00	FT80/100S/100L/115/120/130/150S/150L												
	2.5 TD Bus	55	08.94	03.00	FT80/100S/100L/115/120/130/150S/150L												
	2.5 TD Bus	63	01.95	03.00	FT80/100S/100L/115/120/130/150S/150L												
	2.5 TD Bus	74	07.94	03.00	FT80/100S/100L/115/120/130/150S/150L												
	2.5 TD Kasten	55	10.98	03.00	FT80/100S/100L/115/120/130/150S/150L												
	2.5 TD Kasten	63	06.94	03.00	FT80/100S/100L/115/120/130/150S/150L												
2.5 TD Kasten	74	06.94	03.00	FT80/100S/100L/115/120/130/150S/150L													
2.5 TD Prits./Fahrg.	55	10.98	03.00	FT80/100S/100L/115/120/130/150S/150L													
2.5 TD Prits./Fahrg.	63	08.94	03.00	FT80/100S/100L/115/120/130/150S/150L													
2.5 TD Prits./Fahrg.	74	08.94	03.00	FT80/100S/100L/115/120/130/150S/150L													
	2.0 Bus	84	09.95	03.00	FT190/190A/190EF	24.3225-1103.3	020346										Rz 25,40
	2.0 CNG Bus	84	06.94	03.00	FT190/190A/190EF												
	2.0 Kasten	84	06.94	03.00	FT190/190A/190EF												
	2.0 Pritsche/Fahrg.	84	08.94	03.00	FT190/190A/190EF												
	2.5 DI Bus	51	08.94	03.00	FT190/190A/190EF												
	2.5 DI Bus	56	07.94	03.00	FT190/190A/190EF												
	2.5 DI Bus	85	08.97	03.00	FT190/190A/190EF												
	2.5 DI Kasten	51	06.94	03.00	FT190/190A/190EF												
	2.5 DI Kasten	56	06.94	03.00	FT190/190A/190EF												
	2.5 DI Kasten	85	05.99	03.00	FT190/190A/190EF												
	2.5 DI Prits./Fahrg.	51	08.94	03.00	FT190/190A/190EF												
	2.5 DI Prits./Fahrg.	56	08.94	03.00	FT190/190A/190EF												
	2.5 DI Prits./Fahrg.	85	05.99	03.00	FT190/190A/190EF												
	2.5 TD Bus	55	08.94	03.00	FT190/190A/190EF												
	2.5 TD Bus	63	01.95	03.00	FT190/190A/190EF												
	2.5 TD Bus	74	07.94	03.00	FT190/190A/190EF												
	2.5 TD Kasten	55	10.98	03.00	FT190/190A/190EF												
2.5 TD Kasten	63	06.94	03.00	FT190/190A/190EF													
2.5 TD Kasten	74	06.94	03.00	FT190/190A/190EF													
2.5 TD Prits./Fahrg.	55	10.98	03.00	FT190/190A/190EF													
2.5 TD Prits./Fahrg.	63	08.94	03.00	FT190/190A/190EF													
2.5 TD Prits./Fahrg.	74	08.94	03.00	FT190/190A/190EF													
	2.0 Bus	84	09.95	03.00		24.3727-0636.2	580636	1	+ Einfachbereifung ³⁾								L=2823
	2.0 CNG Bus	84	06.94	03.00		24.3727-0637.2	580637	1	+ Doppelbereifung ⁴⁾								L=2730
	2.0 Kasten	84	06.94	03.00													
	2.0 Pritsche/Fahrg.	84	08.94	03.00													
	2.5 DI Bus	51	08.94	03.00													
	2.5 DI Bus	56	07.94	03.00													
2.5 DI Bus	85	08.97	03.00														
2.5 DI Kasten	51	06.94	03.00														

¹⁾ vertical brake system / sistema del freno verticale / système de freinage vertical / sistema de freno vertical









































²⁾ diagonal brake system / sistema freno diagonalmente / système de freinage en diagonal / sistema de freno en diagonal























































³⁾ + single tyre / + ruota singola / + roue simple / + cubierta simple















































































⁴⁾ + twin tyres / + ruote gemellate / + roue jumelée / + cubierta doble







































































Wrench		Truck		Car		23		i		ATE		?		i		Key	
FORD TRANSIT (06-14)																	
	2.2 TDCi 4x4			10.11	04.14			24.5141-0320.3	330949	2							L=320
	2.2 TDCi FWD			05.06	04.14												
	2.2 TDCi RWD			10.11	04.14												
	2.3 16V RWD			05.06	04.14												
	2.4 TDCi 4x4			05.06	04.14												
	2.4 TDCi RWD			05.06	04.14												
	3.2 TDCi RWD			09.07	04.14												
	2.2 TDCi 4x4			10.11	04.14			24.5124-0252.3	331218	2	+ Einfachbereifung ¹⁾						L=252
	2.2 TDCi FWD			05.06	04.14												
	2.2 TDCi RWD			10.11	04.14												
	2.3 16V RWD			05.06	04.14												
	2.4 TDCi 4x4			05.06	04.14												
	2.4 TDCi RWD			05.06	04.14												
	3.2 TDCi RWD			09.07	04.14												
	2.2 TDCi FWD			05.06	04.14			24.3225-1103.3	020346								Rz 25,40
	2.2 TDCi FWD			05.06	09.11			24.2419-1738.3	030133								Gz 19,05
	2.3 16V RWD			05.06	04.14												
	2.4 TDCi 4x4			05.06	04.14												
	2.4 TDCi RWD			05.06	04.14												
	3.2 TDCi RWD			09.07	04.14												
	2.2 TDCi 4x4			10.11	04.14			24.2520-1706.3	040094								Nz 20,40
	2.2 TDCi FWD			05.06	04.14												
	2.2 TDCi RWD			10.11	04.14												
	2.3 16V RWD			05.06	04.14												
	2.4 TDCi 4x4			05.06	04.14												
	2.4 TDCi RWD			05.06	04.14												
	3.2 TDCi RWD			09.07	04.14												
FORD TRANSIT CONNECT / TOURNEO CONNECT (03-13)																	
	1.8 16V	85		06.02	08.13			11.9367-7001.2	220733								D=36, - Halter
	1.8 Di	55		06.02	08.13			11.9367-7002.2	220734								D=36, - Halter
	1.8 TDCi	66		06.02	08.13			11.0101-5407.2	260011								Hülzensatz
	1.8 TDCi	81		08.06	08.13			11.8171-0008.1	990049								Führungsbolzen
								11.8116-0340.1	390595	2							Haltefeder
	1.8 16V	85		06.02	08.13			24.5148-0354.3	330992	2	+ Trommelbremse ³⁾						L=354
	1.8 Di	55		06.02	08.13												
	1.8 TDCi	66		06.02	08.13												
	1.8 TDCi	81		08.06	08.13												
	1.8 16V	85		06.02	08.13			24.5148-0319.3	331421	2	+ Scheibenbremse ⁴⁾						L=319
	1.8 Di	55		06.02	08.13												
	1.8 TDCi	66		06.02	08.13												
	1.8 TDCi	81		08.06	08.13												
	1.8 16V	85		06.02	08.13			24.3220-1740.3	020553								Rz 20,64
	1.8 Di	55		06.02	08.13												
	1.8 TDCi	66		06.02	08.13												
	1.8 TDCi	81		08.06	08.13												
	1.8 16V	85		06.02	08.13			03.6582-0118.3	320281								BRL 8/1,5 (4)
	1.8 Di	55		06.02	08.13												
	1.8 TDCi	66		06.02	08.13												
	1.8 TDCi	81		08.06	08.13												
	1.8 16V	85		06.02	08.13			24.2419-1733.3	030125								Gz 19,05
	1.8 Di	55		06.02	08.13												
	1.8 TDCi	66		06.02	08.13												
	1.8 TDCi	81		08.06	08.13												
FORD TRANSIT CONNECT / TOURNEO CONNECT (13-)																	
	1.0 EcoBoost	74		09.13				03.4155-5451.3	010995		+ kurzer Radstand ⁵⁾						THz 25,40
	1.6 EcoBoost	110		09.13				03.4155-5456.3	010996		+ langer Radstand ⁶⁾						THz 25,40
	1.6 TDCi	55		09.13													
	1.6 TDCi	70		09.13													
	1.6 TDCi	85		09.13													
	1.0 EcoBoost	74		09.13				24.3571-9814.5	240558								D=57, - Halter
	1.5 TDCi	55		05.15				24.3571-9813.5	240557								D=57, - Halter
	1.5 TDCi	74		05.15				11.8116-0356.1	390586	2							Haltefeder
	1.5 TDCi	88		05.15													
	1.6 EcoBoost	110		09.13													
	1.6 TDCi	55		09.13													
	1.6 TDCi	70		09.13													
	1.6 TDCi	85		09.13													
	1.0 EcoBoost	74		09.13				11.9387-7083.2	220959								D=38, - Halter
	1.5 TDCi	55		05.15				11.9387-7084.2	220960								D=38, - Halter
	1.5 TDCi	74		05.15				11.0230-0698.2	260091								Halter
	1.5 TDCi	88		05.15				11.8116-0340.1	390595	2							Haltefeder
	1.6 EcoBoost	110		09.13													
	1.6 TDCi	55		09.13													
	1.6 TDCi	70		09.13													
	1.6 TDCi	85		09.13													
HONDA ACCORD (98-02)																	
	1.6 i 16V (CG7)	85		10.98	12.02			24.5287-0452.3	331011								L=451
	1.6 i 16V (CH5)	85		10.98	12.02			24.5287-0451.3	331010								L=451
	1.8 VTEC (CG8)	100		10.98	12.02												
	1.8 VTEC (CH6)	100		10.98	12.02												
	2.0 TDiC (CH2)	77		02.99	10.00												

1) + single tyre / + ruota singola / + roue simple / + cubierta simple
2) - rear axle C / - asse posteriore C / - essieu arrière C / - eje trasero C
3) + drum brake / + freno a tamburo / + freins à tambour / + tambores de freno
4) + disc brake / + disco freno / + disques de frein / + disco de freno
5) + short wheel base / + passo lungo / + empattement court / + distancia corta entre ejes
6) + long wheel base / + passo lungo / + empattement long / + distancia larga entre ejes
7) - increased payload / - carico utile maggiorato / - charge utile augmentée / - incremento de carga

										
HONDA ACCORD (98-02)										
	2.0 TDIC (CH8)	77		02.99	10.00	24.5287-0452.3	331011		L=451	
	2.0 VTEC (CG9)	108		10.98	01.01	24.5287-0451.3	331010		L=451	
	2.0 VTEC (CH7)	108		10.98	01.01					
	2.2 Type R (CH1)	156		02.99	12.02					
	2.3 VTEC (CL3)	113		01.01	12.02					
	2.3 VTEC (CL4)	113		01.01	12.02					
	1.8 VTEC (CG8)	100		10.98	12.02	24.3384-1749.5	240345		D=38, - Halter	TRW
	1.8 VTEC (CH6)	100		10.98	12.02	24.3384-1750.5	240346		D=38, - Halter	TRW
	2.0 TDIC (CH2)	77		02.99	10.00					
	2.0 TDIC (CH8)	77		02.99	10.00					
	2.0 VTEC (CG9)	108		10.98	01.01					
	2.0 VTEC (CH7)	108		10.98	01.01					
	2.2 Type R (CH1)	156		02.99	12.02					
	2.3 VTEC (CL3)	113		01.01	12.02					
	2.3 VTEC (CL4)	113		01.01	12.02					
HONDA ACCORD Limousine (03-08)										
	2.0 16V (CL7)	114		01.06	05.08	24.2120-1752.3	010928		Thz 20,64 + Behälter	TRW
	2.0 16V (CL8) Allrad	114		01.06	05.08					
	2.2 i-CTDi (CN1)	103		01.06	05.08					
	2.4 16V (CL9)	140		01.06	05.08					
	2.4 16V (CM5)	113		09.06	05.08					
	2.4 VTEC (CM5)	122		04.06	07.08					
	2.0 16V (CL7)	114		02.03	05.08	11.0101-5407.2	260011	2	Hülensatz	ATE
	2.0 16V (CL8) Allrad	114		02.03	05.08	11.8171-0008.1	990049		Führungsbolzen	ATE
	2.4 16V (CL9)	140		02.03	05.08	11.8116-0356.1	390586		Haltefeder	ATE
	2.4 16V (CM5)	113		09.06	05.08					
	2.4 16V (CM5)	113		01.04	05.08					
	2.4 VTEC (CM5)	122		04.06	07.08					
	2.4 VTEC E (CM5)	118		02.03	09.05					
	2.0 16V (CL7)	114		02.03	05.08	24.5270-0457.3	330997		L=456	
	2.0 16V (CL8) Allrad	114		02.03	05.08	24.5270-0456.3	330996		L=456	
	2.2 i-CTDi (CN1)	103		01.04	05.08					
	2.4 16V (CL9)	140		02.03	05.08					
	2.4 16V (CM5)	113		09.06	05.08					
	2.4 VTEC (CM5)	122		04.06	07.08					
	2.4 VTEC E (CM5)	118		02.03	09.05					
	2.0 16V (CL7)	114		02.03	05.08	24.3384-1749.5	240345		D=38, - Halter	TRW
	2.0 16V (CL8) Allrad	114		02.03	05.08	24.3384-1750.5	240346		D=38, - Halter	TRW
	2.2 i-CTDi (CN1)	103		01.04	05.08					
	2.4 16V (CL9)	140		02.03	05.08					
	2.4 16V (CM5)	113		09.06	05.08					
	2.4 VTEC (CM5)	122		04.06	07.08					
	2.4 VTEC E (CM5)	118		02.03	09.05					
	2.0 16V (CL7)	114		02.03	05.08	24.5270-0461.3	330998		L=461	
	2.0 16V (CL8) Allrad	114		02.03	05.08	24.5270-0462.3	330999		L=461	
	2.2 i-CTDi (CN1)	103		01.04	05.08					
	2.4 16V (CL9)	140		02.03	05.08					
	2.4 16V (CM5)	113		09.06	05.08					
	2.4 VTEC (CM5)	122		04.06	07.08					
	2.4 VTEC E (CM5)	118		02.03	09.05					
HONDA ACCORD Kombi (03-08)										
	2.0 i 16V (CM1)	114		01.06	05.08	24.2120-1752.3	010928		Thz 20,64 + Behälter	TRW
	2.2 CTDi (CM2)	103		01.06	05.08					
	2.4 i 16V (CM2)	140		01.06	05.08					
	2.4 VTEC T	147		01.06	05.08					
	2.0 i 16V (CM1)	114		04.03	05.08	11.0101-5407.2	260011	2	Hülensatz	ATE
	2.2 CTDi (CM2)	103		01.04	05.08	11.8171-0008.1	990049		Führungsbolzen	ATE
	2.4 i 16V (CM2)	140		04.03	05.08	11.8116-0356.1	390586		Haltefeder	ATE
	2.4 VTEC E	118		09.03	09.05					
	2.4 VTEC T	147		09.03	05.08					
	2.0 i 16V (CM1)	114		04.03	05.08	24.5270-0457.3	330997		L=456	
	2.2 CTDi (CM2)	103		01.04	05.08	24.5270-0456.3	330996		L=456	
	2.4 i 16V (CM2)	140		04.03	05.08					
	2.4 VTEC E	118		09.03	09.05					
	2.4 VTEC T	147		09.03	05.08					
	2.0 i 16V (CM1)	114		04.03	05.08	24.3384-1749.5	240345		D=38, - Halter	TRW
	2.2 CTDi (CM2)	103		01.04	05.08	24.3384-1750.5	240346		D=38, - Halter	TRW
	2.4 i 16V (CM2)	140		04.03	05.08					
	2.4 VTEC E	118		09.03	09.05					
	2.4 VTEC T	147		09.03	05.08					
	2.0 i 16V (CM1)	114		04.03	05.08	24.5270-0461.3	330998		L=461	
	2.2 CTDi (CM2)	103		01.04	05.08	24.5270-0462.3	330999		L=461	
	2.4 i 16V (CM2)	140		04.03	05.08					
	2.4 VTEC E	118		09.03	09.05					
	2.4 VTEC T	147		09.03	05.08					
HONDA ACCORD VIII Limousine (08-)										
	2.0 VTEC (CU1)	110		07.08		24.5270-0496.3	331469		L=496, + Zub	
	2.0 VTEC (CU1)	115		07.08		24.5270-0497.3	331470		L=496, + Zub	
	2.2 i-DTEC (CU3)	110		07.08						
	2.2 i-DTEC (CU3)	132		07.08						
	2.4 VTEC (CU2)	133		07.08						
	2.4 VTEC (CU2)	148		07.08						

									
HONDA ACCORD VIII Limousine (08-)									
	2.0 VTEC (CU1)	110		07.08		24.5270-0476.3	331468		L=476, + Zub
	2.0 VTEC (CU1)	115		07.08		24.5270-0475.3	331467		L=476, + Zub
	2.2 i-DTEC (CU3)	110		07.08					
	2.2 i-DTEC (CU3)	132		07.08					
	2.4 VTEC (CU2)	133		07.08					
	2.4 VTEC (CU2)	148		07.08					
HONDA ACCORD VIII Kombi (08-)									
	2.0 VTEC (CW1)	110		07.08		24.5270-0496.3	331469		L=496, + Zub
	2.0 VTEC (CW1)	115		07.08		24.5270-0497.3	331470		L=496, + Zub
	2.2 i-DTEC (CW3)	110		07.08					
	2.2 i-DTEC (CW3)	132		07.08					
	2.4 VTEC (CW2)	148		07.08					
	2.0 VTEC (CW1)	110		07.08		24.5270-0476.3	331468		L=476, + Zub
	2.0 VTEC (CW1)	115		07.08		24.5270-0475.3	331467		L=476, + Zub
	2.2 i-DTEC (CW3)	110		07.08					
	2.2 i-DTEC (CW3)	132		07.08					
	2.4 VTEC (CW2)	148		07.08					
HONDA CITY (08-)									
	1.4 VTEC	73		09.08		24.2122-1771.3	010901		THz 22,20 + Behälter TRW
	1.4 VTEC	73		09.08		24.3511-1717.7	220887		D=51, - Halter
						24.3511-1718.7	220888		D=51, - Halter
	1.4 VTEC	73		09.08		24.5268-0495.3	330933		L=495
						24.5268-0496.3	330934		L=495
	1.4 VTEC	73		09.08		24.3304-1713.7	220885		D=30, - Halter
						24.3304-1714.7	220886		D=30, - Halter
	1.4 VTEC	73		09.08		24.5297-0332.3	331037		L=332
						24.5297-0272.3	331036		L=272
HONDA CIVIC (3/4-tuerig) (95-01)									
	1.4 i (EJ9)	55		11.95	01.01 - ABS	24.2120-1751.3	010909		THz 20,64
	1.4 i (EJ9)	66		11.95	01.01 - ABS				
	1.4 i (EJ9)	55		11.95	01.01 - ABS	24.3511-1709.5	240333		D=51, - Halter
	1.4 i (EJ9)	66		11.95	01.01 - ABS	24.3511-1710.5	240334		D=51, - Halter
	1.4 i (EJ9)	55		11.95	01.01 + ABS	24.3541-1805.5	240323		D=54, - Halter
	1.4 i (EJ9)	66		11.95	01.01 + ABS	24.3541-1806.5	240324		D=54, - Halter
	1.5 VTEC (EK3)	84		11.95	01.01				
	1.6 VTEC (EK1)	84		11.95	01.01				
	1.6 VTEC (EK4)	118		11.95	01.01				
	1.5 VTEC (EK3)	84		11.95	01.01	24.3304-1711.5	240395		D=30, - Halter
	1.6 VTEC (EK4)	118		11.95	01.01	24.3304-1712.5	240396		D=30, - Halter
	1.4 i (EJ9)	55		11.95	01.01	24.3219-1723.3	020427		Rz 19,05
	1.4 i (EJ9)	66		11.95	01.01	24.3219-1724.3	020428		Rz 19,05
	1.5 VTEC (EK3)	84		11.95	01.01				
	1.6 VTEC (EK1)	84		11.95	01.01				
HONDA CIVIC (3-tuerig) (01-05)									
	1.4 i 16V	66		02.01	12.05	24.3541-1825.7	220721		D=54, - Halter TRW
	1.6 i 16V	81		02.01	12.05	24.3541-1826.7	220722		D=54, - Halter TRW
	1.7 CTDi	74		01.02	12.05				
	1.4 i 16V	66		02.01	12.05	24.5289-0277.3	331013	2	L=277
	1.6 i 16V	81		02.01	12.05				
HONDA CIVIC (4-tuerig) (01-05)									
	1.3 IMA	61		01.04	12.05	24.3541-1733.7	220705		D=54, - Halter NIS
	1.4 i 16V	66		02.01	12.05	24.3541-1734.7	220706		D=54, - Halter NIS
	1.6 i 16V	81		02.01	12.05				
	1.4 i 16V	66		02.01	12.05	24.5289-0277.3	331013	2	L=277
	1.6 i 16V	81		02.01	12.05				
HONDA CIVIC (5-tuerig) (97-01)									
	1.4 i 16V (MB2)			01.97	02.01	24.3541-1813.5	240381		D=54, - Halter TRW
	1.5 i 16V (MB3)			01.97	02.01	24.3541-1814.5	240382		D=54, - Halter TRW
	1.6 i 16V (MB4)			01.97	02.01				
	1.6 VTi			01.97	02.01				
	2.0 i TD (MB7)			01.97	02.01				
	1.4 i 16V (MB2)			01.97	02.01 - ABS	24.3219-1743.3	020485		Rz 19,05
	1.5 i 16V (MB3)			01.97	02.01 - ABS				

										
HONDA CIVIC (5-tuerig) (01-05)										
	1.4 i 16V (EU7) 1.6 VTEC (EU8) 1.7 CTDi (EU9)	66 81 74		02.01 02.01 01.02	12.05 12.05 12.05	24.3541-1733.7 24.3541-1734.7	220705 220706	  	D=54, - Halter D=54, - Halter	NIS NIS
	1.4 i 16V (EU7) 1.6 VTEC (EU8)	66 81		02.01 02.01	12.05 12.05	24.5289-0277.3	331013	2	L=277	
	1.4 i 16V (EU7) 1.6 VTEC (EU8) 1.7 CTDi (EU9) 2.0 i Sport (EV1)	66 81 74 118		02.01 02.01 01.02 01.04	12.05 12.05 12.05 12.05	24.3727-1605.2	581605		L=1963	
HONDA CIVIC Hatchback (FK/FN) (05-12)										
	1.4 i-VTEC (FK1/FN4) 1.6 i 16V (FK4)	73 84		10.08 09.05	12.12 12.12	24.2119-1709.3	010876		THz 19,05 + Behälter	TRW
	1.4 i-VTEC (FK1/FN4) 1.6 i 16V (FK4)	73 84		10.08 09.05	12.12 12.12	24.5270-0515.3 24.5270-0516.3	331145 331146	 	L=515 L=515	
	1.4 i-VTEC (FK1) 1.8 i-VTEC (FK2/FN1)	61 103		01.06 01.06	01.12 12.12	24.5268-0510.3 24.5268-0511.3	331143 331144	 	L=510 L=510	
	2.0 i-VTEC (FN2) 2.0 Type R (FN2) 2.2 CTDi (FK3/FN3)	110 148 103		12.06 09.06 01.06	12.10 12.12 12.12	24.5268-0560.3 24.5268-0561.3	331345 331346	  	L=560 L=560	
	1.4 i-VTEC (FK1) 1.8 i-VTEC (FK2/FN1) 2.0 i-VTEC (FN2) 2.0 Type R (FN2) 2.2 CTDi (FK3/FN3)	61 103 110 148 103		01.06 01.06 12.06 09.06 01.06	01.12 12.12 12.10 12.12 12.12	24.5270-0200.3 24.5270-0201.3	331247 331248	    	L=200/290, (Satz) L=200/230, (Satz)	
HONDA CIVIC Stufenheck (FD) (05-12)										
	1.6 16V (FD4) 1.6 16V (FD4/FD6) 1.8 16V (FD1) 1.8 16V (FD1) 1.8 FlexFuel (FD1) 1.8 i-VTEC (FD1/FD7)	92 84 97 103 103 103		09.05 01.06 01.06 02.06 11.06 09.05	12.12 12.12 12.12 12.12 12.12 02.12	24.2119-1709.3	010876		THz 19,05 + Behälter	TRW
	1.3 (FD3) 1.3 Hybrid (FD3)	85 70		02.06 01.06	02.12 02.12	24.3541-1733.7 24.3541-1734.7	220705 220706	 	D=54, - Halter D=54, - Halter	NIS NIS
	1.3 Hybrid (FD3) 1.6 16V (FD4) 1.6 16V (FD4/FD6) 1.8 16V (FD1) 1.8 16V (FD1) 1.8 FlexFuel (FD1) 1.8 i-VTEC (FD1/FD7) 2.0 16V (FD2)	85 92 84 97 103 103 103 114		01.10 09.05 09.05 01.06 02.06 11.06 09.05 02.06	02.12 12.12 12.12 12.12 12.12 12.12 02.12 02.12	24.5270-0515.3 24.5270-0516.3	331145 331146	       	L=515 L=515	
	1.3 (FD3) 1.3 Hybrid (FD3) 2.0 16V (FD2)	85 70 114		02.06 01.06 02.06	02.12 02.12 02.12	24.5268-0560.3 24.5268-0561.3 24.5289-0277.3	331345 331346 331013	  2	L=560 L=560 L=277	
	1.3 (FD3) 1.3 Hybrid (FD3) 1.3 Hybrid (FD3)	85 70 85		01.08 01.08 01.10	02.12 02.12 02.12	24.3727-1606.2 24.3727-1607.2	581606 581607	  	L=2148 L=2100	
HONDA CIVIC AERODECK (98-01)										
	1.4 i 16V (MB8) 1.4 i 16V (MB8) 1.5 VTEC (MB9) 1.6 i 16V (MC1) 2.0 TDIC (MC3)	55 66 84 85 77		02.98 02.98 02.98 02.98 02.98	02.01 02.01 02.01 02.01 02.01	24.3541-1813.5 24.3541-1814.5	240381 240382	    	D=54, - Halter D=54, - Halter	TRW TRW
	1.4 i 16V (MB8) 1.4 i 16V (MB8) 1.5 VTEC (MB9)	55 66 84		02.98 02.98 02.98	02.01 02.01 02.01	24.3219-1743.3	020485	  	Rz 19,05	
HONDA CIVIC COUPE (96-01)										
	1.6 i (EJ6)	77		01.96	12.98	24.2120-1751.3	010909		THz 20,64	
	1.6 i (EJ6)	77		01.96	01.01	24.3511-1709.5 24.3511-1710.5	240333 240334	 	D=51, - Halter D=51, - Halter	
	1.6 VTEC (EJ8) 1.6 VTEC (EM1)	92 118		01.96 04.99	01.01 01.01	24.3541-1805.5 24.3541-1806.5	240323 240324	 	D=54, - Halter D=54, - Halter	
	1.6 VTEC (EM1)	118		04.99	01.01	24.3304-1711.5 24.3304-1712.5	240395 240396	 	D=30, - Halter D=30, - Halter	
	1.6 i (EJ6) 1.6 VTEC (EJ8)	77 92		01.96 01.96	01.01 01.01	24.3219-1723.3 24.3219-1724.3	020427 020428	 	Rz 19,05 Rz 19,05	

											
HONDA CIVIC COUPE (01-04)											
	1.6 i 16V (EM6) 1.7 i 16V (EM2) 1.7 VTEC (EM2)	81 88 92		02.01 02.01 02.01	10.04 10.04 10.04	24.3541-1733.7 24.3541-1734.7	220705 220706	  	D=54, - Halter D=54, - Halter	NIS NIS	
HONDA CR-V I (97-02)											
	2.0 i 16V (RD1) 2.0 i 16V (RD1) 2.0 i 16V (RD1)	94 98 108		01.98 04.99 04.99	04.99 12.01 12.01	- ABS - ABS - ABS	24.2123-1774.3 010877	  	Thz 23,81 + Behälter	TRW	
	2.0 i 16V (RD1) 2.0 i 16V (RD1) 2.0 i 16V (RD1)	94 98 108		01.97 04.99 04.99	04.99 02.02 02.02		24.5287-0442.3 24.5287-0441.3	331009 331008	  	L=441 L=441	
	2.0 i 16V (RD1) 2.0 i 16V (RD1) 2.0 i 16V (RD1)	94 98 108		01.97 04.99 04.99	04.99 02.02 02.02		24.3220-1733.3 24.3220-1734.3	020515 020516	  	Rz 20,64 Rz 20,64	
HONDA CR-V II (02-06)											
	2.0 16V 2.0 16V 2.2 CTDi 2.4 VTEC Allrad	110 112 103 118		07.02 03.02 02.05 03.02	09.06 09.06 09.06 09.06		24.5270-0582.3 24.5270-0581.3	331001 331000	   	L=581 L=581	
	2.0 16V 2.0 16V 2.4 VTEC Allrad	110 112 118		07.02 03.02 03.02	12.04 09.06 12.04		24.3381-1707.7 24.3381-1708.7	220831 220832	  	D=38, + Halter D=38, + Halter	TRW TRW
	2.0 16V 2.0 16V 2.4 VTEC Allrad	110 112 118		07.02 03.02 03.02	12.04 09.06 12.04		24.5270-0435.3	331134	2	L=435	
	2.0 16V 2.2 CTDi 2.4 VTEC Allrad	110 103 118		01.05 02.05 01.05	09.06 09.06 09.06		24.5270-0490.3 24.5270-0450.3	331079 331183	2 2	L=490 L=450	
HONDA CR-V III (07-12)											
	2.0 i-VTEC 2.0 i-VTEC 2.0 i-VTEC 4WD 2.2 CTDi 4WD 2.2 i-DTEC 4WD 2.4 i-VTEC 2.4 i-VTEC 2.4 i-VTEC 4WD 2.4 i-VTEC 4WD 2.4 i-VTEC 4WD 2.4 i-VTEC 4WD	105 110 110 103 110 118 125 134 118 122 124 125		11.09 01.07 01.07 01.07 01.07 01.07 04.07 01.07 01.07 09.09 09.07 04.07	09.12 09.12 09.12 09.12 09.12 09.12 09.12 09.12 09.12 09.12 09.12 09.12		24.5270-0410.3 24.5270-0411.3	331181 331182	           	L=410 L=410	
	2.0 i-VTEC 2.0 i-VTEC 2.0 i-VTEC 4WD 2.2 CTDi 4WD 2.2 i-DTEC 4WD 2.4 i-VTEC 2.4 i-VTEC 2.4 i-VTEC 4WD 2.4 i-VTEC 4WD 2.4 i-VTEC 4WD 2.4 i-VTEC 4WD	105 110 110 103 110 118 125 134 118 122 124 125		11.09 01.07 01.07 01.07 01.07 01.07 04.07 01.07 01.07 09.09 09.07 04.07	09.12 09.12 09.12 09.12 09.12 09.12 09.12 09.12 09.12 09.12 09.12 09.12		24.5270-0450.3	331183	2	L=450	
HONDA CRX (92-98)											
	1.6 i 16V VTEC (EG2) 1.6 i 16V VTEC (EH6)	118 92		01.92 01.92	12.98 12.98		24.3541-1805.5 24.3541-1806.5	240323 240324	 	D=54, - Halter D=54, - Halter	
	1.6 i 16V VTEC (EG2) 1.6 i 16V VTEC (EH6)	118 92		01.92 01.92	12.98 12.98	+ ABS	24.3304-1711.5 24.3304-1712.5	240395 240396	 	D=30, - Halter D=30, - Halter	
	1.6 i 16V VTEC (EH6)	92		01.92	12.98	- ABS	24.3219-1723.3 24.3219-1724.3	020427 020428	 	Rz 19,05 Rz 19,05	
HONDA HR-V (99-05)											
	1.6 i 16V 1.6 i 16V 4WD 1.6 i 16V 4WD	77 77 91		02.99 02.99 10.99	09.05 09.05 09.05	+ 3 türig ¹⁾ + 3 türig ¹⁾ + 3 türig ¹⁾	24.3219-1723.3 24.3219-1724.3	020427 020428	  	Rz 19,05 Rz 19,05	
	1.6 i 16V 1.6 i 16V 4WD 1.6 i 16V 4WD	77 77 91		02.99 02.99 10.99	09.05 09.05 09.05	+ 5 türig ²⁾ + 5 türig ²⁾ + 5 türig ²⁾	24.3220-1733.3 24.3220-1734.3	020515 020516	  	Rz 20,64 Rz 20,64	
HONDA INSIGHT (09-13)											
	1.3 Hybrid 1.3 Hybrid	65 73		04.09 04.09	09.13 09.13		24.5175-0527.3 24.5175-0528.3	331390 331391	 	L=535 L=535	

¹⁾ + 3 door / + 3 porte / + 3 portes / + 3 puertas

²⁾ + 5 door / + 5 porte / + 5 portes / + 5 puertas

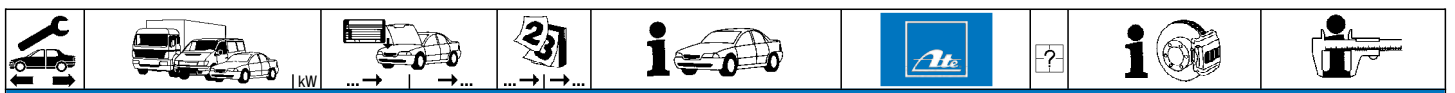









































HONDA JAZZ (02-08)













	1.2 (GD5)	57		01.04	10.08	- ESP	24.2122-1771.3	010901		THz 22,20 + Behälter	TRW
	1.2 (GE2)	59		10.05	10.08	- ESP					
	1.4 (GD1)	61		01.04	10.08	- ESP					
	1.4 (GE3)	65		04.05	10.08	- ESP					
	1.4 (GE3)	67		09.05	10.08	- ESP					
	1.7 (GD3)	92		01.04	10.08	- ESP					
	1.2 (GD5)	57		01.04	10.08	+ ESP	24.2122-1772.3	010902		THz 22,20 + Behälter	TRW
	1.2 (GE2)	59		10.05	10.08	+ ESP					
	1.4 (GD1)	61		01.04	10.08	+ ESP					
	1.4 (GE3)	65		04.05	10.08	+ ESP					
	1.4 (GE3)	67		09.05	10.08	+ ESP					
	1.7 (GD3)	92		01.04	10.08	+ ESP					
	1.2 (GD5)	57		03.02	12.03		24.3511-1719.7	220937		D=51, - Halter	TRW
	1.4 (GD1)	61		03.02	12.03		24.3511-1720.7	220938		D=51, - Halter	TRW
	1.2 (GD5)	57		01.04	10.08		24.3511-1717.7	220887		D=51, - Halter	
	1.2 (GE2)	59		10.05	10.08		24.3511-1718.7	220888		D=51, - Halter	
	1.4 (GD1)	61		01.04	10.08						
	1.4 (GE3)	65		04.05	10.08						
	1.2 (GD5)	57		03.02	10.08		24.5268-0495.3	330933		L=495	
	1.2 (GE2)	59		10.05	10.08		24.5268-0496.3	330934		L=495	
	1.4 (GD1)	61		03.02	10.08						
	1.4 (GE3)	65		04.05	10.08						
	1.4 (GE3)	67		09.05	10.08						
	1.7 (GD3)	92		01.04	10.08						
	1.2 (GD5)	57		01.04	10.08	+ ABS	24.3304-1713.7	220885		D=30, - Halter	
	1.2 (GE2)	59		10.05	10.08		24.3304-1714.7	220886		D=30, - Halter	
	1.4 (GD1)	61		01.04	10.08	+ ABS					
	1.4 (GE3)	65		04.05	10.08						
	1.4 (GE3)	67		09.05	10.08						
	1.7 (GD3)	92		01.04	10.08						
	1.2 (GD5)	57		03.02	10.08		24.5297-0332.3	331037		L=332	
	1.2 (GE2)	59		10.05	10.08		24.5297-0272.3	331036		L=272	
	1.4 (GD1)	61		03.02	10.08						
	1.4 (GE3)	65		04.05	10.08						
	1.4 (GE3)	67		09.05	10.08						
	1.7 (GD3)	92		01.04	10.08						
	1.2 (GD5)	57		03.02	12.03	- ABS	24.3217-1717.3	020477		Rz 17,46	
	1.4 (GD1)	61		03.02	12.03	- ABS					
	1.2 (GD5)	57		03.02	12.03	- ABS	24.3727-1610.2	581610		L=1593	
	1.4 (GD1)	61		03.02	12.03	- ABS	24.3727-1611.2	581611		L=1653	
	1.2 (GD5)	57		01.04	10.08	+ ABS	24.3727-1608.2	581608		L=1634	
	1.2 (GE2)	59		10.05	10.08		24.3727-1609.2	581609		L=1695	

HONDA JAZZ (08-15)

	1.2 i-VTEC	66		07.08	12.08	- ESP	24.2122-1771.3	010901		THz 22,20 + Behälter	TRW
	1.4 i 16V	73		07.08	12.08	- ESP					
	1.5 Flexfuel	88		07.08	12.08	- ESP					
	1.5 i 16V	88		07.08	12.08	- ESP					
	1.2 i-VTEC	66		07.08	12.08	+ ESP	24.2122-1772.3	010902		THz 22,20 + Behälter	TRW
	1.4 i 16V	73		07.08	12.08	+ ESP					
	1.5 Flexfuel	88		07.08	12.08	+ ESP					
	1.5 i 16V	88		07.08	12.08	+ ESP					
	1.2 i-VTEC	66		07.08	12.08		24.5268-0495.3	330933		L=495	
	1.4 i 16V	73		07.08	12.08		24.5268-0496.3	330934		L=495	
	1.2 i-VTEC	66		01.09			24.5175-0527.3	331390		L=535	
	1.3 Hybrid	65		04.11			24.5175-0528.3	331391		L=535	
	1.4 Flexfuel	74		11.08							
	1.4 i 16V	73		01.09							
	1.4 i 16V	74		11.08							
	1.5 Flexfuel	88		01.09							
	1.5 i 16V	88		01.09							
	1.2 i-VTEC	66		07.08	12.08		24.3304-1713.7	220885		D=30, - Halter	
	1.5 Flexfuel	88		07.08	12.08		24.3304-1714.7	220886		D=30, - Halter	
	1.5 i 16V	88		07.08	12.08						
	1.2 i-VTEC	66		07.08	12.08		24.5297-0332.3	331037		L=332	
	1.4 i 16V	73		07.08	12.08		24.5297-0272.3	331036		L=272	
	1.5 Flexfuel	88		07.08	12.08						
	1.5 i 16V	88		07.08	12.08						









										
HONDA JAZZ (08-15)										
	1.2 i-VTEC 1.5 Flexfuel 1.5 i 16V	66 88 88		07.08 07.08 07.08	12.08 12.08 12.08	24.3727-1608.2 24.3727-1609.2	581608 581609	<input type="checkbox"/> <input type="checkbox"/> <input type="checkbox"/>	L=1634 L=1695	
HONDA LOGO (99-02)										
	1.3 i	48		02.99	03.02	24.3511-1709.5 24.3511-1710.5	240333 240334	<input type="checkbox"/> <input type="checkbox"/>	D=51, - Halter D=51, - Halter	
	1.3 i	48		02.99	03.02	24.3217-1736.3 24.3217-1735.3	020568 020567	<input type="checkbox"/> <input type="checkbox"/>	Rz 17,46 Rz 17,46	
HYUNDAI ACCENT I (94-99)										
	1.3 i 12V 1.3 i 12V 1.3 i 12V 1.3 i 12V 1.5 16V 1.5 i 12V 1.5 i 16V	40 44 55 62 76 65 73		09.95 10.94 10.94 10.94 10.94 10.94 10.95	05.98 12.99 12.99 12.99 12.99 12.99 12.99	24.3219-1747.3 24.3219-1748.3	020498 020499	<input type="checkbox"/> <input type="checkbox"/>	Rz 19,05 Rz 19,05	
	1.3 i 12V 1.3 i 12V 1.3 i 12V 1.3 i 12V 1.5 12V	40 44 55 62 65		09.95 10.94 10.94 10.94 10.94	05.98 12.99 12.99 12.99 12.99	24.3727-3103.2 24.3727-3102.2	583103 583102	<input type="checkbox"/> <input type="checkbox"/>	L=1485 L=1485	
HYUNDAI ACCENT II (00-05)										
	1.3 i 12V 1.3 i 12V 1.3 i 12V 1.3 i 12V 1.5 CRDi 1.5 i 12V 1.5 i 16V 1.6 i 16V	55 61 62 63 60 66 75 77		01.00 01.00 08.02 01.00 04.02 01.00 09.00 10.02	09.05 09.05 09.05 09.05 09.05 09.05 09.05 09.05	24.3541-1807.5 24.3541-1808.5	240335 240336	<input type="checkbox"/> <input type="checkbox"/>	D=54, - Halter D=54, - Halter	AKE AKE
	1.3 i 12V 1.3 i 12V 1.3 i 12V 1.3 i 12V 1.5 CRDi 1.5 i 12V 1.5 i 16V 1.6 i 16V	55 61 62 63 60 66 75 77		01.00 01.00 08.02 01.00 04.02 01.00 09.00 10.02	09.05 09.05 09.05 09.05 09.05 09.05 09.05 09.05	24.5261-0256.3	331246	2	L=255	
	1.3 i 12V 1.3 i 12V 1.3 i 12V 1.5 CRDi 1.5 i 12V 1.5 i 16V	55 61 63 60 66 75		01.00 01.00 01.00 04.02 01.00 09.00	07.02 07.02 09.05 07.02 07.02 07.02	24.3219-1743.3	020485		Rz 19,05	
	1.3 i 12V 1.3 i 12V 1.3 i 12V 1.5 CRDi 1.5 i 12V 1.5 i 16V 1.6 i 16V	55 61 62 60 66 75 77		08.02 08.02 08.02 08.02 08.02 08.02 10.02	09.05 09.05 09.05 09.05 09.05 09.05 09.05	24.3217-1723.3	020502		Rz 17,78	
	1.3 i 12V 1.3 i 12V 1.3 i 12V 1.5 CRDi 1.5 i 12V 1.5 i 16V 1.6 i 16V	55 61 62 60 66 75 77		08.02 08.02 08.02 08.02 08.02 08.02 10.02	09.05 09.05 09.05 09.05 09.05 09.05 09.05	24.3727-3105.2 24.3727-3104.2	583105 583104	<input type="checkbox"/> <input type="checkbox"/>	L=1493 L=1493	
HYUNDAI ACCENT IV (10-)										
	1.4 16V 1.4 CRDi 1.6 16V 1.6 16V 1.6 CCVT-I 1.6 CRDi 1.6 CRDi	79 66 90 91 92 94 100		11.10 11.10 11.10 11.10 11.10 10.11 04.11	- ABS - ABS - ABS - ABS - ABS - ABS - ABS	24.3217-1731.3	020551		Rz 17,46	
HYUNDAI ATOS (98-08)										
	1.1 i 12V 1.1 i 12V	43 46		08.03 03.04	05.05 + ABS 02.08 + ABS	24.2120-1767.3	011004		THz 20,64 - Behälter	
	0.8 1.0 i 12V 1.0 i 12V	38 40 43		04.99 02.98 03.01	07.03 03.02 07.03	24.5286-0340.3 24.5286-0341.3	330977 330989	<input type="checkbox"/> <input type="checkbox"/>	L=340 L=340	
	0.8 1.0 i 12V 1.0 i 12V 1.1 i 12V 1.1 i 12V	38 40 43 43 46		04.99 02.98 03.01 08.03 03.04	07.03 03.02 07.03 05.05 + ABS 01.06 + ABS	24.3217-1723.3	020502		Rz 17,78	

								
HYUNDAI ATOS (98-08)								
	0.8 1.0 i 12V 1.0 i 12V 1.1 i 12V 1.1 i 12V	38 40 43 43 46		04.99 07.03 02.98 03.02 03.01 07.03 08.03 05.05 03.04 02.08		24.3727-3101.2 583101 24.3727-3100.2 583100	<input type="checkbox"/>	L=1504 L=1520
	0.8 1.0 i 12V 1.0 i 12V 1.1 i 12V 1.1 i 12V	38 40 43 43 46		04.99 07.03 02.98 03.02 03.01 07.03 08.03 05.05 03.04 02.08		24.3728-3100.2 593100		L=795
HYUNDAI ATOS PRIME (99-08)								
	1.1 i 12V 1.1 i 12V	43 46		06.03 01.07 + ABS 09.05 08.08 + ABS		24.2120-1767.3 011004		Thz 20,64 - Behälter
	1.0 i 12V	40		08.99 02.01		24.5286-0340.3 330977 24.5286-0341.3 330989	<input type="checkbox"/> <input type="checkbox"/>	L=340 L=340
	1.0 i 12V 1.0 i 12V 1.1 i 12V 1.1 i 12V	40 43 43 46		08.99 02.01 03.01 12.05 06.03 01.07 + ABS 09.05 02.06 + ABS		24.3217-1723.3 020502		Rz 17,78
	1.0 i 12V 1.0 i 12V 1.1 i 12V 1.1 i 12V	40 43 43 46		08.99 02.01 03.01 12.05 06.03 01.07 09.05 08.08		24.3727-3101.2 583101 24.3727-3100.2 583100	<input type="checkbox"/>	L=1504 L=1520
	1.0 i 12V 1.0 i 12V 1.1 i 12V 1.1 i 12V	40 43 43 46		08.99 02.01 03.01 12.05 06.03 01.07 09.05 08.08		24.3728-3100.2 593100		L=795
HYUNDAI ELANTRA (00-06)								
	1.5 16V 1.5 D 1.6 i 16V 1.6 i 16V 1.6 i 16V 1.6 i 16V 1.8 i 16V 1.8 i 16V 1.8 i 16V 2.0 CRDi 2.0 i 16V 2.0 i 16V 2.0 i 16V	75 82 66 77 79 82 79 93 97 83 102 104 105		11.01 07.06 11.01 05.06 11.01 05.06 08.03 05.06 11.01 05.06 11.01 07.03 09.04 05.06 11.01 05.06 11.01 05.06 11.01 05.06 11.01 05.06 10.03 05.06		24.3219-1743.3 020485	- ABS	Rz 19,05
	1.5 16V 1.5 D 1.6 i 16V 1.6 i 16V 1.6 i 16V 1.6 i 16V 1.8 i 16V 1.8 i 16V 1.8 i 16V 2.0 CRDi 2.0 i 16V 2.0 i 16V 2.0 i 16V	75 82 66 77 79 82 79 93 97 83 102 104 105		09.00 07.06 06.00 07.06 06.00 05.06 08.03 05.06 06.00 05.06 08.03 05.06 06.00 07.03 06.04 05.06 06.00 05.06 04.01 05.06 06.00 05.06 06.00 05.06 10.03 05.06		24.3727-3118.2 583118 24.3727-3119.2 583119	<input type="checkbox"/> - ABS <input type="checkbox"/> - ABS	L=1718 L=1705
	1.5 16V 1.5 D 1.6 i 16V 1.6 i 16V 1.6 i 16V 1.8 i 16V 1.8 i 16V 2.0 CRDi 2.0 i 16V 2.0 i 16V	75 82 66 77 79 97 83 102 104		06.00 10.03 06.00 07.03 06.00 10.03 08.03 10.03 06.00 10.03 06.00 07.03 06.00 10.03 04.01 10.03 06.00 10.03 06.00 10.03		24.3727-3110.2 583110 24.3727-3111.2 583111	<input type="checkbox"/> + ABS <input type="checkbox"/> + ABS	L=1593 L=1578
	1.5 16V 1.5 D 1.6 i 16V 1.6 i 16V 1.6 i 16V 1.8 i 16V 1.8 i 16V 2.0 CRDi 2.0 i 16V 2.0 i 16V 2.0 i 16V	75 82 66 77 79 82 93 97 83 102 104 105		11.03 07.06 11.03 07.06 11.03 05.06 11.03 05.06 08.03 05.06 06.04 05.06 11.03 05.06 11.03 05.06 11.03 05.06 11.03 05.06 10.03 05.06		24.3727-3112.2 583112 24.3727-3113.2 583113	<input type="checkbox"/> + ABS <input type="checkbox"/> + ABS	L=1578 L=1562

HYUNDAI ELANTRA (06-11)		HYUNDAI GALLOPER (98-03)		HYUNDAI GETZ (02-09)						
	1.6 CRDi 1.6 CVVT 1.6 D 2.0 CVVT	85 90 85 105	11.05 06.06 05.06 06.06	12.11 12.11 12.11 12.11	+ ABS + ABS + ABS + ABS	24.3727-3115.2 24.3727-3114.2	583115 583114	<input type="checkbox"/> <input type="checkbox"/>	L=1672 L=1674	
	2.5 Tci D 2.5 TD 2.5 TD Intercooler 3.0 i V6	77 65 73 104	08.98 08.98 08.98 08.98	12.03 12.03 12.03 12.03		24.3431-1705.5 24.3431-1706.5	240365 240366	<input type="checkbox"/> <input type="checkbox"/>	D=43/43, - Halter D=43/43, - Halter	
	2.5 Tci D 2.5 TD 2.5 TD Intercooler 3.0 i V6	77 65 73 104	08.98 08.98 08.98 08.98	12.03 12.03 12.03 12.03		24.5290-0439.3 24.5290-0440.3	331176 331177	<input type="checkbox"/> <input type="checkbox"/>	L=439 L=439	
	2.6 TD Allrad	63	08.98	06.03		24.5260-0155.3	331156	2 am Bremssattel ¹⁾	L=155	
	1.1 i 12V 1.3 i 12V 1.3 i 12V 1.5 i GL 1.6 i 16V	46 60 63 73 77	09.02 09.02 09.03 08.02 09.02	07.05 04.05 04.05 07.05 07.05		24.2122-1761.3 24.2122-1765.3	010822 010839	- ABS + ABS	THz 22,20 THz 22,20	
	1.1 i 12V 1.4 i 16V 1.5 CRDi 1.5 CRDi 1.5 CRDi GLS 1.5 CRDi GLS 1.6 i 16V	49 71 60 65 75 81 78	08.05 08.05 03.03 08.05 07.04 08.05 08.05	02.09 02.09 04.05 02.09 07.05 02.09 02.09		24.2122-1765.3	010839	- ESP	THz 22,20	
	1.1 i 12V 1.1 i 12V 1.3 i 12V 1.3 i 12V 1.4 i 16V 1.5 CRDi 1.5 CRDi 1.5 CRDi GLS 1.5 CRDi GLS 1.5 i GL 1.6 i 16V 1.6 i 16V	46 49 60 63 71 60 65 75 81 73 77 78	09.02 08.05 09.02 09.03 08.05 03.03 08.05 07.04 08.05 08.02 09.02 08.05	07.05 02.09 04.05 04.05 02.09 04.05 02.09 07.05 02.09 07.05 07.05 02.09		24.3541-1807.5 24.3541-1808.5	240335 240336	<input type="checkbox"/> <input type="checkbox"/>	D=54, - Halter D=54, - Halter	AKE AKE
	1.1 i 12V 1.1 i 12V 1.3 i 12V 1.3 i 12V 1.4 i 16V 1.5 CRDi 1.5 CRDi 1.5 CRDi GLS 1.5 CRDi GLS 1.5 i GL 1.6 i 16V 1.6 i 16V	46 49 60 63 71 60 65 75 81 73 77 78	09.02 08.05 09.02 09.03 08.05 03.03 08.05 07.04 08.05 08.02 09.02 08.05	07.05 02.09 04.05 04.05 02.09 04.05 02.09 07.05 02.09 07.05 07.05 02.09		24.5248-0466.3 24.5248-0467.3	330920 330921	<input type="checkbox"/> <input type="checkbox"/>	L=466 L=466	
	1.1 i 12V 1.1 i 12V 1.4 i 16V 1.5 CRDi 1.5 CRDi 1.5 CRDi GLS 1.5 CRDi GLS 1.5 i GL 1.6 i 16V 1.6 i 16V	46 49 71 65 65 75 81 73 77 78	09.02 08.05 08.05 08.05 08.05 07.04 08.05 08.02 09.02 08.05	07.05 02.09 02.09 04.05 02.09 04.05 02.09 07.05 07.05 02.09		24.5272-0258.3 24.5272-0205.3	330939 330975	<input type="checkbox"/> <input type="checkbox"/>	L=258 L=205	
	1.3 i 12V 1.3 i 12V 1.4 i 16V 1.5 CRDi 1.5 CRDi 1.5 CRDi GLS 1.5 CRDi GLS 1.5 i GL 1.6 i 16V 1.6 i 16V	60 63 71 60 65 75 81 73 77 78	09.02 09.03 08.05 03.03 08.05 07.04 08.05 08.02 09.02 08.05	04.05 04.05 02.09 04.05 02.09 07.05 02.09 07.05 07.05 02.09		24.5298-0469.3 24.5298-0470.3	331191 331192	<input type="checkbox"/> <input type="checkbox"/>	L=469 L=469	
	1.1 i 12V 1.1 i 12V 1.3 i 12V 1.3 i 12V 1.4 i 16V 1.5 CRDi 1.5 CRDi 1.5 CRDi GLS 1.5 CRDi GLS 1.5 i GL 1.6 i 16V 1.6 i 16V	46 49 60 63 71 60 65 75 81 73 77 78	09.02 08.05 09.02 09.03 08.05 03.03 08.05 07.04 08.05 08.02 09.02 08.05	07.05 02.09 04.05 04.05 02.09 04.05 02.09 07.05 02.09 07.05 07.05 02.09		24.3217-1723.3	020502		Rz 17,78	
	1.1 i 12V 1.3 i 12V 1.3 i 12V 1.4 i 16V 1.5 CRDi	46 60 63 71 60	09.02 09.02 09.03 08.05 03.03	07.05 04.05 04.05 02.09 04.05	- ABS/ + HA-Trommelbremse ²⁾ - ABS/ + HA-Trommelbremse ²⁾ - ABS/ + HA-Trommelbremse ²⁾ - ABS/ + HA-Trommelbremse ²⁾ - ABS/ + HA-Trommelbremse ²⁾	24.3727-3124.2 24.3727-3125.2	583124 583125	<input type="checkbox"/> <input type="checkbox"/>	L=1598 L=1607	

¹⁾ on the brake caliper / sulla pinza freno / sur l'étrier de frein / a la pinza de freno



















²⁾ - ABS/ + RA drum brake / - ABS/ + P freno a tamburo / - ABS/ + fr. à tambour essieu AR / - ABS/ + ET tambores de freno

W		KW		23		i		Atc		?		i		K	
HYUNDAI GETZ (02-09)															
	1.5 i GL	73	08.02	07.05	- ABS/ + HA-Trommelbremse ¹⁾	24.3727-3124.2	583124	<input type="checkbox"/>							L=1598
	1.6 i 16V	77	09.02	07.05	- ABS/ + HA-Trommelbremse ¹⁾	24.3727-3125.2	583125	<input type="checkbox"/>							L=1607
	1.6 i 16V	78	08.05	02.09	- ABS/ + HA-Trommelbremse ¹⁾			<input type="checkbox"/>							
	1.1 i 12V	46	09.02	07.05	+ ABS/ + HA-Trommelbremse ²⁾	24.3727-3120.2	583120	<input type="checkbox"/>							L=1610
	1.1 i 12V	49	08.05	02.09	+ ABS/ + HA-Trommelbremse ²⁾	24.3727-3121.2	583121	<input type="checkbox"/>							L=1620
	1.3 i 12V	60	09.02	04.05	+ ABS/ + HA-Trommelbremse ²⁾										
	1.3 i 12V	63	09.03	04.05	+ ABS/ + HA-Trommelbremse ²⁾										
	1.4 i 16V	71	08.05	02.09	+ ABS/ + HA-Trommelbremse ²⁾										
	1.6 i 16V	77	09.02	07.05	+ ABS/ + HA-Trommelbremse ²⁾										
	1.6 i 16V	78	08.05	02.09	+ ABS/ + HA-Trommelbremse ²⁾										
	1.4 i 16V	71	08.05	02.09	+ HA-Scheibenbremse ³⁾	24.3727-3122.2	583122	<input type="checkbox"/>							L=1597
	1.5 CRDi	60	03.03	04.05	+ HA-Scheibenbremse ³⁾	24.3727-3123.2	583123	<input type="checkbox"/>							L=1610
	1.5 CRDi	65	08.05	02.09	+ HA-Scheibenbremse ³⁾										
	1.5 CRDi GLS	75	07.04	07.05	+ HA-Scheibenbremse ³⁾										
1.5 CRDi GLS	81	08.05	02.09	+ HA-Scheibenbremse ³⁾											
1.6 i 16V	77	09.02	07.05	+ HA-Scheibenbremse ³⁾											
1.6 i 16V	78	08.05	02.09	+ HA-Scheibenbremse ³⁾											
HYUNDAI H-1 KASTEN (00-07)															
	2.4	82	03.00	04.04		24.3222-1744.3	020581								Rz 22,20
	2.4	107	11.01	04.04	- ABS										
	2.5 CRDi	103	08.03	04.04	- ABS										
	2.5 TDiC	59	03.00	09.00											
	2.5 TDiC	73	03.00	10.02											
HYUNDAI H-1 STAREX (97-07)															
	2.4	82	06.97	04.04		24.3222-1744.3	020581								Rz 22,20
	2.4	101	02.03	04.04											
	2.4 4WD	82	02.98	04.04											
	2.4 4WD	99	06.01	04.04											
	2.5 Tci	73	06.00	04.04											
	2.5 TDiC	59	06.97	04.04											
	2.5 TDiC	74	05.04	12.07											
	2.5 TDiC 4WD	59	02.98	04.04											
	2.6 TDiC	63	10.97	04.04											
HYUNDAI HIGHWAY VAN (00-04)															
	2.0 CRDi	83	03.01	03.04		24.3431-1710.5	240730	<input type="checkbox"/>							D=43/43, - Halter
	2.0 CVVT	104	11.03	03.04											
	2.0 i 16V	100	03.00	03.04											
	2.7 i V6	125	03.00	03.04											
HYUNDAI i10 (08-13)															
	1.0 12V	51	01.11	11.13		24.5286-0265.3	331046	2							L=265
	1.1 12V	48	01.08	11.13											
	1.1 12V	49	01.08	11.13											
	1.1 12V	51	04.11	11.13											
	1.1 CRDi	55	01.08	11.13											
	1.1 LPG	51	04.11	11.13											
	1.2 12V	57	11.08	11.13											
	1.2 16V	59	01.08	11.13											
	1.2 16V	63	04.11	11.13											
	1.1 12V	48	01.08	11.13		24.5286-0400.3	331375	<input type="checkbox"/>							L=410
1.1 12V	49	01.08	11.13		24.5286-0401.3	331376	<input type="checkbox"/>							L=410	
1.1 12V	51	04.11	11.13												
1.1 CRDi	55	01.08	11.13												
1.1 LPG	51	04.11	11.13												
1.2 12V	57	11.08	11.13												
1.2 16V	59	01.08	11.13												
1.2 16V	63	04.11	11.13												
HYUNDAI i20 (08-14)															
	1.1 CRDi	55	03.12	12.14	- ESP	24.3217-1731.3	020551								Rz 17,46
	1.2 16V	57	09.08	12.14	- ESP										
	1.2 16V	59	09.08	12.14	- ESP										
	1.2 16V	63	03.12	12.14	- ESP										
HYUNDAI i20 / i20 COUPE (GB) (14-)															
	1.0 T-GDI	74	01.16			24.3217-1731.3	020551								Rz 17,46
	1.0 T-GDI	88	01.16												
	1.1 blue CRDi	55	12.14												
	1.1 CRDi	55	12.14												
	1.2	55	12.14												
	1.2	62	12.14												
	1.2 LPGi	61	11.14												
	1.4	74	12.14												
1.4 CRDi	66	12.14													
HYUNDAI i30 (07-11)															
	1.4 16V	77	10.07	10.11		24.5286-0524.3	331223	<input type="checkbox"/>							L=535
	1.4 16V	80	10.07	10.11		24.5286-0525.3	331224	<input type="checkbox"/>							L=535
	1.6 16V	85	10.07	10.11											
	1.6 16V	90	10.07	10.11											
	1.6 16V	93	02.08	10.11											
	1.6 CRDi	66	10.07	10.11											
	1.6 CRDi	85	10.07	10.11											
	1.6 CRDi	94	02.08	10.11											



















¹⁾ - ABS/ + RA drum brake / - ABS/ + P freno a tamburo / - ABS/ + fr. à tambour essieu AR / - ABS/ + ET tambores de freno

²⁾ + ABS/ + RA drum brake / + ABS/ + P freno a tamburo / + ABS/ + fr. à tambour essieu AR / + ABS/ + ET tambores de freno

³⁾ + RA disc brake / + P disco freno / + frein à disque essieu AR / + ET-disco de freno

									
HYUNDAI i30 (07-11)									
	2.0 16V 2.0 CRDi 2.0 CRDi	105 100 103		10.07 02.08 10.07	10.11 10.11 10.11	24.5286-0524.3 24.5286-0525.3	331223 331224	<input type="checkbox"/> <input type="checkbox"/> <input type="checkbox"/>	L=535 L=535
	1.4 16V 1.4 16V 1.6 16V 1.6 16V 1.6 16V 1.6 CRDi 1.6 CRDi 1.6 CRDi 2.0 16V 2.0 CRDi 2.0 CRDi	77 80 85 90 93 66 85 94 105 100 103		10.07 10.07 10.07 10.07 02.08 10.07 10.07 02.08 10.07 02.08 10.07	10.11 10.11 10.11 10.11 10.11 10.11 10.11 10.11 10.11 10.11 10.11	24.3727-3115.2 24.3727-3114.2	583115 583114	<input type="checkbox"/> <input type="checkbox"/>	L=1672 L=1674
HYUNDAI i30 (GD) (11-)									
	1.4 16V 1.4 16V 1.4 CRDi 1.6 1.6 16V 1.6 CRDi 1.6 CRDi 1.6 CRDi 1.6 GDI 1.6 GDI 1.6 T-GDI	73 74 66 137 88 81 94 100 95 99 137		11.11 12.14 11.11 12.14 01.12 06.12 11.11 11.11 11.11 11.11 01.15		24.3727-3126.2	583126	<input type="checkbox"/> - elektrische Feststellbremse ¹⁾	L=1746
HYUNDAI i30 CW Kombi (08-12)									
	1.4 16V 1.4 16V 1.6 16V 1.6 16V 1.6 16V 1.6 16V 1.6 CRDi 1.6 CRDi 1.6 CRDi 2.0 16V 2.0 CRDi 2.0 CRDi	77 80 85 88 90 93 66 85 94 105 100 103		02.08 11.09 02.08 01.10 02.08 02.08 02.08 02.08 02.08 02.08 01.10 02.08	06.12 06.12 06.12 06.12 06.12 06.12 06.12 06.12 06.12 06.12 06.12 06.12	24.5286-0524.3 24.5286-0525.3	331223 331224	<input type="checkbox"/> <input type="checkbox"/>	L=535 L=535
	1.4 16V 1.4 16V 1.6 16V 1.6 16V 1.6 16V 1.6 16V 1.6 CRDi 1.6 CRDi 1.6 CRDi 2.0 16V 2.0 CRDi 2.0 CRDi	77 80 85 88 90 93 66 85 94 105 100 103		02.08 11.09 02.08 01.10 02.08 02.08 02.08 02.08 02.08 02.08 01.10 02.08	06.12 06.12 06.12 06.12 06.12 06.12 06.12 06.12 06.12 06.12 06.12 06.12	24.3727-3116.2 24.3727-3117.2	583116 583117	<input type="checkbox"/> <input type="checkbox"/>	L=1715 L=1705
HYUNDAI i30 CW Kombi (12-)									
	1.4 1.4 16V 1.4 CRDi 1.6 CRDi 1.6 CRDi 1.6 CRDi 1.6 GDI 1.6 GDI 1.6 GDI	74 73 66 81 94 100 88 95 99		06.12 06.12 06.12 06.12 06.12 06.12 06.12 06.12 06.12		24.3727-3126.2	583126	<input type="checkbox"/> - elektrische Feststellbremse ¹⁾	L=1746
HYUNDAI LANTRA/ELANTRA (95-00)									
	1.5 12V 1.5 16V 1.6 16V 1.6 16V 1.8 16V 1.9 D 2.0 16V	65 76 76 94 50 102		05.95 11.95 05.95 11.95 05.95 03.98 05.95	05.00 + ABS 10.00 05.00 10.00 05.00 09.00 05.00	24.3727-3107.2 24.3727-3106.2	583107 583106	<input type="checkbox"/> <input type="checkbox"/>	L=1436 L=1428
HYUNDAI MATRIX (01-10)									
	1.5 16V 1.5 CRDi 1.6 i 16V 1.6 i 16V 1.8 i 16V	75 60 66 76 90		06.01 10.01 01.02 06.01 06.01	07.03 - ABS 07.03 - ABS 07.03 - ABS 07.03 - ABS 07.03	24.2123-1762.3	010823		Thz 23,81
	1.5 16V 1.5 CRDi 1.5 CRDi 1.5 CRDi VGT 1.6 i 16V 1.6 i 16V 1.8 i 16V	75 60 75 81 66 76 90		06.01 10.01 12.04 08.05 01.02 06.01 06.01	08.10 08.10 08.10 08.10 12.05 08.10 08.10	24.5298-0514.3 24.5298-0515.3	331088 331166	<input type="checkbox"/> <input type="checkbox"/>	L=514 L=514

¹⁾ - electric parking brake / - freno a mano elettrico / - frein à main électrique / - freno de mano eléctrico

								
HYUNDAI MATRIX (01-10)								
	1.5 16V	75	06.01	08.10	+ ABS	24.3341-1701.5	240435	D=34, - Halter D=34, - Halter
	1.5 CRDi	60	10.01	08.10	+ ABS	24.3341-1702.5	240436	
	1.5 CRDi	75	12.04	08.10	+ ABS			
	1.5 CRDi VGT	81	08.05	08.10	+ ABS			
	1.6 i 16V	66	01.02	12.05	+ ABS			
	1.6 i 16V	76	06.01	08.10	+ ABS			
1.8 i 16V	90	06.01	08.10					
	1.5 16V	75	06.01	08.10	- ABS	24.3219-1743.3	020485	Rz 19,05
	1.5 CRDi	60	10.01	08.10	- ABS			
	1.5 CRDi	75	12.04	08.10	- ABS			
	1.5 CRDi VGT	81	08.05	08.10	- ABS			
	1.6 i 16V	66	01.02	12.05	- ABS			
	1.6 i 16V	76	06.01	08.10	- ABS			
HYUNDAI SANTA FE I (SM) (01-06)								
	2.0 CRDi	83	08.01	02.06	+ ABS	24.3727-3109.2	583109	L=1741 L=1775
	2.0 CRDi 4x4	83	04.01	02.06	+ ABS	24.3727-3108.2	583108	
	2.0 CRDi 4x4	92	08.03	02.06	+ ABS			
	2.0 CRDi 4x4	107	11.03	02.06	+ ABS			
	2.0 i 16V	99	08.01	02.06	+ ABS			
	2.2 CRDi	110	10.05	02.06	+ ABS			
	2.2 CRDi 4x4	110	10.05	02.06	+ ABS			
	2.4 i 16V	100	02.01	02.06	+ ABS			
	2.4 i 16V	107	02.01	02.06	+ ABS			
	2.4 i 16V 4x4	100	02.01	02.06	+ ABS			
	2.4 i 16V 4x4	107	02.01	02.06	+ ABS			
	2.7 i V6	139	10.05	02.06	+ ABS			
	2.7 i V6 4x4	127	02.01	02.06	+ ABS			
	2.7 i V6 4x4	129	09.02	02.06	+ ABS			
2.7 i V6 4x4	132	02.01	02.06	+ ABS				
2.7 i V6 4x4	139	10.05	02.06	+ ABS				
HYUNDAI TRAJET (00-08)								
	2.0 CRDi	83	04.01	07.08		24.3431-1710.5	240730	D=43/43, - Halter
	2.0 CRDi	92	08.05	07.08				
	2.0 CVVT	104	11.03	07.08				
	2.0 i 16V	100	03.00	10.03				
	2.0 i 16V	103	01.04	07.08				
	2.7 i V6	127	09.00	07.08				
HYUNDAI TUCSON (04-10)								
	2.0 CRDi	83	08.04	03.10		24.5286-0405.3	331061	L=405
	2.0 CRDi	88	01.07	03.10				
	2.0 CRDi	100	01.06	03.10				
	2.0 CRDi	103	01.06	03.10				
	2.0 CRDi	110	01.09	03.10				
	2.0 CRDi Allrad	83	08.04	03.10				
	2.0 CRDi Allrad	88	01.07	03.10				
	2.0 CRDi Allrad	100	01.06	03.10				
	2.0 CRDi Allrad	103	01.06	03.10				
	2.0 CRDi Allrad	110	01.09	03.10				
	2.0 i 16V	104	08.04	03.10				
	2.0 i 16V Allrad	104	08.04	03.10				
	2.7 i 24V Allrad	129	08.04	03.10				
ISUZU D-MAX (8DH) (02-12)								
	2.5 D	74	10.02	05.03		24.3601-1715.5	240389	D=60, - Halter D=60, - Halter
	2.5 D 4x4	74	05.02	05.03		24.3601-1716.5	240390	
	3.0 DiTD	96	10.02	05.03				
	3.0 DiTD 4x4	96	05.02	05.03				
	2.5 D	74	10.02	05.03		24.3225-1702.3	020425	Rz 25,40
	2.5 D 4x4	74	05.02	05.03				
	3.0 DiTD	96	10.02	05.03				
	3.0 DiTD 4x4	96	05.02	05.03				
	2.5 DiTD	100	10.07	05.12		24.3223-1710.3	020557	
	2.5 DiTD 4x4	100	01.07	05.12				
	3.0 D	120	10.07	05.12				
	3.0 D 4x4	120	01.07	05.12				
3.0 DiTD	96	06.03	05.12					
3.0 DiTD 4x4	96	06.03	05.12					
ISUZU D-MAX (TFR / TFS) (12-)								
	2.5 Ddi	120	06.12			24.3223-1710.3	020557	Rz 23,81
	2.5 Ddi 4WD	120	06.12					
IVECO DAILY I / GRINTA (78-99)								
	35 F 8		01.78	05.81		24.3217-1113.3	020176	Rz 17,46
	35.8		06.81	04.99				
	40 F 8		01.78	05.81				
	40.8		06.81	04.99				
	45.10		06.86	04.99		24.3220-1106.3	020217	
	49.10		06.86	04.99				























JAGUAR S-Type (CCX) (99-08)											
	2.5 V6	◀147		02.03	10.07		03.0655-0007.2	370007		Wegsensor	ATE
	2.7 D	◀152		06.04	10.07						
	3.0 V6	◀175		05.03	10.07						
	4.2 V8	◀219		02.03	10.07						
	4.2 V8 Supercharged	◀298		08.03	12.08		03.0655-0007.2	370007		Wegsensor	ATE
	R 4.2 V8	◀291		08.03	10.07						
	2.5 V6	▶147		02.03	10.07		03.0655-0007.2	370007		Wegsensor	ATE
	2.7 D	▶152		06.04	10.07						
	3.0 V6	▶175		05.03	10.07						
	4.2 V8	▶219		02.03	10.07						
4.2 V8 Supercharged	▶298		08.03	12.08		03.0655-0007.2	370007		Wegsensor	ATE	
R 4.2 V8	▶291		08.03	10.07							
	2.5 V6	◀147		06.02	10.07		03.4125-0032.3	010955		THz 25,40	ATE
	2.7 D	◀152		06.04	10.07						
	3.0 V6	◀175		06.02	10.07						
	4.2 V8	◀219		06.02	10.07						
	4.2 V8 Supercharged	◀298		06.02	12.08						
	R 4.2 V8	◀291		06.02	10.07						

JAGUAR X-Type (CF1) Limousine (01-09)											
	2.0 D	96	J04730	07.03			24.3571-1735.5	240385	☐	D=57, - Halter	BOS
	2.0 V6	115		03.02	10.05		24.3571-1736.5	240386	☐	D=57, - Halter	BOS
	2.2 D	107	J04730	01.07							
	2.2 D	110	J04730	10.05							
	2.2 D	114	J04730	10.05							
	2.5 V6	144		06.01	11.09						
	3.0 V6	169		06.01	11.07						
	2.0 D	96	J04731		11.09		24.3571-1735.5	240385	☐	D=57, - Halter	BOS
	2.2 D	107	J04731		11.09		24.3571-1736.5	240386	☐	D=57, - Halter	BOS
	2.2 D	110	J04731		11.09						
2.2 D	114	J04731		11.09							
	2.0 D	96		07.03	11.09		83.7188-0446.3	330664	2	L=470	
	2.0 V6	115		03.02	10.05						
	2.2 D	107		01.07	11.09						
	2.2 D	110		10.05	11.09						
	2.2 D	114		10.05	11.09						
	2.5 V6	144		06.01	11.09						
	3.0 V6	169		06.01	11.07						
	2.0 D	96		07.03	11.09		83.7856-0369.3	331237	2	L=368	
	2.0 V6	115		03.02	10.05						
	2.2 D	107		01.07	11.09						
	2.2 D	110		10.05	11.09						
	2.2 D	114		10.05	11.09						
	2.5 V6	144		06.01	11.09						
	3.0 V6	169		06.01	11.07						





























JAGUAR X-Type (CF1) Kombi (03-09)											
	2.0 D	96	J04730	02.04			24.3571-1735.5	240385	☐	D=57, - Halter	BOS
	2.0 V6	115		11.03	03.09		24.3571-1736.5	240386	☐	D=57, - Halter	BOS
	2.2 D	107	J04730	01.07							
	2.2 D	110	J04730	10.05							
	2.2 D	114	J04730	10.05							
	2.5 V6	144		02.04	12.09						
	3.0 V6	169		02.04	12.09						
	2.0 D	96	J04731		12.09		24.3571-1735.5	240385	☐	D=57, - Halter	BOS
	2.2 D	107	J04731		12.09		24.3571-1736.5	240386	☐	D=57, - Halter	BOS
	2.2 D	110	J04731		12.09						
2.2 D	114	J04731		12.09							
	2.0 D	96		02.04	12.09		83.7188-0446.3	330664	2	L=470	
	2.0 V6	115		11.03	03.09						
	2.2 D	107		01.07	12.09						
	2.2 D	110		10.05	12.09						
	2.2 D	114		10.05	12.09						
	2.5 V6	144		02.04	12.09						
	3.0 V6	169		02.04	12.09						
	2.0 D	96		02.04	12.09		83.7856-0369.3	331237	2	L=368	
	2.0 V6	115		11.03	03.09						
	2.2 D	107		01.07	12.09						
	2.2 D	110		10.05	12.09						
	2.2 D	114		10.05	12.09						
	2.5 V6	144		02.04	12.09						
	3.0 V6	169		02.04	12.09						

JAGUAR XE (X760) (15-)											
	2.0	147		03.15			11.8171-0096.1	250155	+ 17"/18" Rad ¹⁾	Führungsbolzen	ATE
	2.0	177		03.15							
	2.0 D	120		03.15							
	2.0 D	132		03.15							
	2.0 D AWD	132		10.15							
	2.0 D AWD	132		10.15		+ Sportpaket ²⁾	11.8171-0096.1	250155	+ 18" Rad ³⁾	Führungsbolzen	ATE
	3.0 S	250		03.15							

1) + 17"/18" wheel / + ruota 17"/18" / + roue 17"/18" / + rueda 17"/18"
2) + sports package / + pacchetto sportivo / + version sport / + kit deportivo
3) + 18" wheel / + ruota 18" / + roue 18" / + rueda 18"

								
JAGUAR XF (CC9) (08-)								
	2.0 16V 2.2 D 2.2 D 2.2 D 2.7 D 3.0 D 3.0 D 3.0 D 3.0 V6 3.0 V6 AWD 4.2 V8 4.2 V8 4.2 V8 Kompressor 5.0 V8	177 120 140 147 152 155 177 202 250 250 219 313 306 283	06.12 04.11 05.11 03.12 03.08 03.09 03.09 03.12 10.12 03.08 07.09 03.08 03.09		03.7745-6502.4 300296			8" ATE
	2.0 16V 2.2 D 2.2 D 2.2 D 2.7 D 3.0 D 3.0 D 3.0 D 3.0 V6 3.0 V6 3.0 V6 3.0 V6 AWD 4.2 V8 4.2 V8 4.2 V8 Kompressor 5.0 V8 5.0 V8 Kompressor 5.0 V8 Kompressor 5.0 XFR-S	177 120 140 147 152 155 177 202 175 175 179 250 250 219 313 306 283 346 375 405	06.12 04.11 05.11 03.12 03.08 03.09 03.09 03.09 03.08 03.08 03.12 10.12 03.08 07.09 03.08 03.09 01.09 03.09 10.12		03.4156-0016.3 010970			THz 26,99 ATE
	2.0 16V 2.2 D 2.2 D 2.2 D 2.7 D 3.0 D 3.0 D 3.0 D 3.0 V6 3.0 V6 3.0 V6 3.0 V6 AWD 4.2 V8 4.2 V8 4.2 V8 Kompressor 5.0 V8 5.0 V8 Kompressor 5.0 V8 Kompressor 5.0 XFR-S	177 120 140 147 152 155 177 202 175 179 250 250 219	06.12 04.11 05.11 03.12 03.08 03.09 03.09 03.08 03.08 03.12 10.12 03.08	+ Bremsscheibendurchm. 326 mm ¹⁾ + Bremsscheibendurchm. 326 mm ¹⁾ + Bremsscheibendurchm. 326 mm ¹⁾	11.9601-9747.2 11.9601-9748.2	220965 220966	 	D=60, - Halter D=60, - Halter ATE ATE
	3.0 D 3.0 D 3.0 D 3.0 V6 3.0 V6 AWD 5.0 V8	155 177 202 250 250 283	03.09 03.09 03.09 03.12 10.12 03.09	+ Bremsscheibendurchm. 355 mm ²⁾ + Bremsscheibendurchm. 355 mm ²⁾ + Bremsscheibendurchm. 355 mm ²⁾	11.9606-9001.2 11.9606-9002.2	220961 220962	 	D=60, - Halter D=60, - Halter ATE ATE
	2.0 16V 2.2 D 2.2 D 2.2 D 2.7 D 3.0 D 3.0 D 3.0 D 3.0 V6 3.0 V6 3.0 V6 3.0 V6 AWD 4.2 V8	177 120 140 147 152 155 177 202 175 179 250 250 219	06.12 04.11 05.11 03.12 03.08 03.09 03.09 03.09 03.08 03.08 03.12 10.12 03.08		11.9457-7021.2 11.9457-7022.2 11.0230-0840.1	221051 221052 260136	  	+ silberner Sattel ³⁾ + silberner Sattel ³⁾ D=45, - Halter D=45, - Halter Halter ATE ATE ATE
JAGUAR XF (15-)								
	2.0 2.0 D 2.0 D 2.0 D AWD 3.0 3.0 3.0 AWD 3.0 AWD 3.0 D	177 120 132 132 250 280 250 280 221	05.15 05.15 05.15 03.16 05.15 05.15 07.15 07.15 05.15	- Sportpaket ⁴⁾ - Sportpaket ⁴⁾ - Sportpaket ⁴⁾ - Sportpaket ⁴⁾ - Sportpaket ⁴⁾ - Sportpaket ⁴⁾ - Sportpaket ⁴⁾ - Sportpaket ⁴⁾ - Sportpaket ⁴⁾	11.8171-0096.1	250155		Führungsbolzen ATE
	2.0 2.0 D 2.0 D 2.0 D AWD 3.0 3.0 3.0 AWD 3.0 AWD 3.0 D	177 120 132 132 250 280 250 280 221	05.15 05.15 05.15 03.16 05.15 05.15 07.15 07.15 05.15	+ Sportpaket ⁵⁾ + Sportpaket ⁵⁾ + Sportpaket ⁵⁾ + Sportpaket ⁵⁾ + Sportpaket ⁵⁾ + Sportpaket ⁵⁾ + Sportpaket ⁵⁾ + Sportpaket ⁵⁾ + Sportpaket ⁵⁾	11.8171-0096.1	250155		Führungsbolzen ATE

1) + brake disc diameter 326mm / + diametro dischi freno 326mm / + diamètre disques frein 326mm / + diámetro disco freno 326mm
2) + brake disc diameter 355mm / + diametro dischi freno 355mm / + diamètre disques frein 355mm / + diámetro disco freno 355mm
3) + silver caliper / + pinza argento / + étrier argent / + pinza argenteria
4) - sport package / - pacchetto sportivo / - version sport / - kit deportivo
5) + sports package / + pacchetto sportivo / + version sport / + kit deportivo





















										
JAGUAR XF Sportbrake (CC9) (12-)										
	2.2 D 2.2 D	120 147		09.12 09.12		03.7745-6502.4	300296	8"	ATE	
	2.2 D 2.2 D 3.0 D 3.0 D 5.0 XFR-S	120 147 177 202 405		09.12 09.12 09.12 09.12 02.14		03.4156-0016.3	010970	THz 26,99	ATE	
	2.2 D 2.2 D 3.0 D 3.0 D	120 147 177 202		09.12 09.12 09.12 09.12	+ Bremsscheibendurchm. 326 mm ¹⁾ + Bremsscheibendurchm. 326 mm ¹⁾	11.9601-9747.2 11.9601-9748.2	220965 220966	D=60, - Halter D=60, - Halter	ATE ATE	
	3.0 D 3.0 D	177 202		09.12 09.12	+ Bremsscheibendurchm. 355 mm ²⁾ + Bremsscheibendurchm. 355 mm ²⁾	11.9606-9001.2 11.9606-9002.2	220961 220962	D=60, - Halter D=60, - Halter	ATE ATE	
	2.2 D 2.2 D 3.0 D 3.0 D	120 147 177 202		09.12 09.12 09.12 09.12		11.9457-7021.2 11.9457-7022.2 11.0230-0840.1	221051 221052 260136	+ silberner Sattel ³⁾ + silberner Sattel ³⁾	ATE ATE ATE ATE	
JAGUAR XJ (X300) (94-97)										
	12 6.0 6 3.2 6 Sovereign 4.0 R Super Charged 4.0	229 155 177 235		11.94 07.97 11.94 07.97 11.94 07.97 11.94 07.97		11.0441-6003.2 11.8116-0073.1 11.8171-0008.1 11.0101-5407.2	250037 390498 990049 260011	2	Dichtungssatz Haltefeder Führungsbolzen Hülssensatz	ATE ATE ATE ATE
	6 3.2 6 Sovereign 4.0 R Super Charged 4.0	155 177 235		11.94 07.97 11.94 07.97 11.94 07.97		83.6314-0375.3 83.7835-0412.3	330558 331275	2 1	L=375 L=410	ATE ATE
	12 6.0 6 3.2 6 Sovereign 4.0 R Super Charged 4.0	229 155 177 235		11.94 07.97 11.94 07.97 11.94 07.97 11.94 07.97		11.9481-9871.2 11.9481-9872.2	220681 220682		D=48, - Halter D=48, - Halter	ATE ATE
JAGUAR XJ (X350,X358) (03-09)										
	XJ8 3.5 XJ8 4.2	190 219		05.03 03.09 05.03 03.09		03.0655-0007.2	370007		Wegsensor	ATE
	XJ6 3.0 XJ6 3.0 XJ8 3.5 XJ8 4.2	175 179 190 219		05.03 03.09 04.04 01.07 05.03 03.09 05.03 03.09		03.0655-0007.2	370007		Wegsensor	ATE
	XJR 4.2 Kompressor XJR 4.2 Kompressor	291 291		05.03 03.09 05.03 03.09		03.0655-0007.2	370007		Wegsensor	ATE
	XJ6 2.7 D XJ6 3.0 XJ6 3.0 XJ8 3.5 XJ8 4.2 XJR 4.2 Kompressor	152 175 179 190 219 291	G49700	10.05 05.03 03.09 04.04 01.07 05.03 03.09 05.03 03.09		03.4125-0032.3	010955		THz 25,40	ATE
	XJ6 2.7 D	152	H32732	10.05		11.9601-9747.2 11.9601-9748.2	220965 220966		D=60, - Halter D=60, - Halter	ATE ATE
	XJ6 2.7 D	152	G49701		03.09	11.9457-7021.2 11.9457-7022.2 11.0230-0840.1	221051 221052 260136	+ silberner Sattel ³⁾ + silberner Sattel ³⁾	D=45, - Halter D=45, - Halter Halter	ATE ATE ATE
JAGUAR XJ (X351) (09-)										
	2.0 16V 3.0 V6 3.0 V6 3.0 V6 AWD 3.0 V6 D 5.0 V8	177 175 250 250 202 283		05.12 01.11 03.12 10.12 10.09 10.09		11.9606-9001.2 11.9606-9002.2	220961 220962		D=60, - Halter D=60, - Halter	ATE ATE
	2.0 16V 3.0 V6 3.0 V6 3.0 V6 AWD 3.0 V6 D 5.0 V8	177 175 250 250 202 283		05.12 01.11 03.12 10.12 10.09 10.09		11.9457-7021.2 11.9457-7022.2 11.0230-0840.1	221051 221052 260136	+ silberner Sattel ³⁾ + silberner Sattel ³⁾	D=45, - Halter D=45, - Halter Halter	ATE ATE ATE
JAGUAR XK8 Coupe (QEV) (96-05)										
	4.2 V8 R 4.2 V8	219 291		08.02 07.05 08.02 07.05		03.0655-0007.2	370007		Wegsensor	ATE
	4.0 V8 4.0 V8 4.0 V8 4.0 XKR V8 4.2 V8 R 4.2 V8	209 216 267 276 219 291		03.96 07.05 05.96 07.99 08.99 07.05 05.98 07.05 08.02 07.05 08.02 07.05	- Sportpaket ⁴⁾	83.7835-0412.3	331275	1	L=410	ATE
JAGUAR XK8 Convertible (QDV) (96-05)										
	4.2 V8 R 4.2 V8	219 291		08.02 07.05 08.02 07.05		03.0655-0007.2	370007		Wegsensor	ATE

¹⁾ + brake disc diameter 326mm / + diametro dischi freno 326mm / + diamètre disques frein 326mm / + diámetro disco freno 326mm

























²⁾ + brake disc diameter 355mm / + diametro dischi freno 355mm / + diamètre disques frein 355mm / + diámetro disco freno 355mm

























³⁾ + silver caliper / + pinza argento / + étrier argent / + pinza argenteria

⁴⁾ - sport package / - pacchetto sportivo / - version sport / - kit deportivo

								
JAGUAR XK8 Convertible (QDV) (96-05)								
	4.0 V8	209	03.96	07.05	83.7835-0412.3	331275	1	L=410
	4.0 V8	216	05.96	07.99				
	4.0 V8	267	08.99	07.05				
	4.0 XKR V8	276	05.98	07.05				
	4.2 V8	219	08.02	07.05				
	R 4.2 V8	291	08.02	07.05				
JEEP RENEGADE (BU) (14-)								
	1.6 CRD	88	07.14		11.9571-9969.2	220955	<input type="checkbox"/>	D=57, - Halter
	2.0 CRD	88	07.14		11.9571-9970.2	220956	<input type="checkbox"/>	D=57, - Halter
					11.8171-0008.1	990049		Führungsbolzen
								ATE
								ATE
	1.4	103	07.14		24.5112-0406.3	331496	2	L=405
	1.4 4x4	125	07.14					
	1.6	81	07.14					
	1.6 CRD	88	07.14					
	2.0 CRD	88	07.14					
	2.0 CRD 4x4	103	07.14					
	2.0 CRD 4x4	125	07.14					
KIA CARENS I (00-02)								
	1.8 i 16V	81	11.00	06.02	24.5285-0240.3	330976	2	L=240
KIA CARENS II (02-06)								
	1.6 i 16V	77	07.02	04.06 - ABS	24.5285-0240.3	330976	2	L=240
	1.8 i 16V	93	07.02	04.06 - ABS				
	2.0 CRDi	83	07.02	04.06 - ABS				
	2.0 CRDi	103	11.05	04.06 - ABS				
	2.0 CVVT	102	08.04	04.06 - ABS				
KIA CARNIVAL I (99-01)								
	2.5 i	132	10.00	10.01 + ABS	24.3222-1731.3	020531		Rz 22,20
	2.5 V6	121	06.00	10.01 + ABS				
	2.9 TDi	93	06.00	10.01 + ABS				
KIA CARNIVAL II (01-06)								
	2.5 V6	110	10.01	08.06 + ABS	24.3222-1731.3	020531		Rz 22,20
	2.5 V6	132	10.01	08.06 + ABS				
	2.9 CRDi	106	10.01	08.06 + ABS				
	2.9 TD	93	10.01	08.06 + ABS				
KIA CEE'D Limousine (06-12)								
	1.4 16V	66	06.10	09.12	24.5286-0524.3	331223	<input type="checkbox"/>	L=535
	1.4 16V	77	12.06	09.12	24.5286-0525.3	331224	<input type="checkbox"/>	L=535
	1.4 16V	80	12.06	09.12				
	1.6 16V	85	09.07	09.12				
	1.6 16V	90	12.06	09.12				
	1.6 16V	92	10.10	09.12				
	1.6 16V	93	02.08	09.12				
	1.6 CRDi 115	85	12.06	09.12				
	1.6 CRDi 128	94	10.10	09.12				
	1.6 CRDi 90	66	12.06	09.12				
	2.0 16V	105	12.06	09.12				
	2.0 CRDi	103	09.07	09.12				
	1.4 16V	66	06.10	09.12	24.5298-0270.3	331086	<input type="checkbox"/>	L=270
	1.4 16V	77	12.06	09.12	24.5298-0271.3	331087	<input type="checkbox"/>	L=270
	1.4 16V	80	12.06	09.12				
	1.6 16V	85	09.07	09.12				
	1.6 16V	90	12.06	09.12				
	1.6 16V	92	10.10	09.12				
	1.6 16V	93	02.08	09.12				
	1.6 CRDi 115	85	12.06	09.12				
	1.6 CRDi 128	94	10.10	09.12				
	1.6 CRDi 90	66	12.06	09.12				
	2.0 16V	105	12.06	09.12				
	2.0 CRDi	103	09.07	09.12				
	1.6 CRDi 128	94	10.10	09.12	24.3727-3204.2	583204	<input type="checkbox"/>	L=1673
					24.3727-3205.2	583205	<input type="checkbox"/>	L=1673
KIA CEE'D Kombi (07-13)								
	1.4 16V	66	10.10	03.13	24.5286-0524.3	331223	<input type="checkbox"/>	L=535
	1.4 16V	77	10.10	03.13	24.5286-0525.3	331224	<input type="checkbox"/>	L=535
	1.4 16V	80	09.07	03.13				
	1.6 16V	85	09.07	03.13				
	1.6 16V	90	09.07	03.13				
	1.6 16V	92	06.09	03.13				
	1.6 16V	93	09.07	03.13				
	1.6 CRDi 115	85	09.07	03.13				
	1.6 CRDi 128	94	10.10	03.13				
	1.6 CRDi 90	66	09.07	03.13				
	2.0 16V	105	09.07	03.13				
	2.0 CRDi	103	09.07	03.13				

























1) - sport package / - pacchetto sportivo / - version sport / - kit deportivo













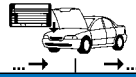









									
KIA CEE'D Kombi (07-13)									
	1.4 16V 1.4 16V 1.4 16V 1.6 16V 1.6 16V 1.6 16V 1.6 16V 1.6 CRDi 115 1.6 CRDi 128 1.6 CRDi 90 2.0 16V 2.0 CRDi	66 77 80 85 90 92 93 85 94 66 105 103		10.10 10.10 09.07 09.07 09.07 06.09 09.07 09.07 10.10 09.07 09.07 09.07	03.13 03.13 03.13 03.13 03.13 03.13 03.13 03.13 03.13 03.13 03.13 03.13		24.5298-0270.3 24.5298-0271.3	331086 331087	L=270 L=270
	1.6 CRDi 128	94		10.10	03.13		24.3727-3204.2 24.3727-3205.2	583204 583205	L=1673 L=1673
KIA MENTOR II (GB) (01-04)									
	1.6 i 16V	75		05.01	08.04		24.5285-0240.3	330976	L=240
	1.6 i 16V	75		05.01	08.04	- ABS	24.3217-1120.3	020360	Rz 17,46
KIA PICANTO (BA) (04-11)									
	1.0 1.0 1.1 1.1 CRDi	45 46 48 55		09.05 11.09 04.04 11.05	04.11 04.11 04.11 04.11		24.3511-1715.5 24.3511-1716.5	240599 240600	D=51, - Halter D=51, - Halter
	1.0 1.0 1.1 1.1 CRDi	45 46 48 55		09.05 11.09 04.04 11.05	04.11 04.11 04.11 04.11		24.5286-0265.3	331046	L=265
	1.0 1.0 1.1 1.1 CRDi	45 46 48 55		09.05 11.09 04.04 11.05	04.11 04.11 04.11 04.11	+ ABS + ABS + ABS + ABS	24.5298-0464.3 24.5298-0465.3	331358 331359	L=464 L=464
	1.0 1.1 1.1 CRDi	45 48 55		09.05 04.04 11.05	09.06 09.06 09.06		24.3215-1703.3	020530	- ABS Rz 15,87
	1.0 1.0 1.1 1.1 CRDi	45 46 48 55		10.06 11.09 10.06 10.06	04.11 04.11 04.11 04.11		24.3215-1703.3	020530	- ABS Rz 15,87
	1.0 1.0 1.1 1.1 CRDi	45 46 48 55		09.05 11.09 04.04 11.05	04.11 04.11 04.11 04.11	- ABS - ABS - ABS - ABS	24.3727-3202.2 24.3727-3203.2	583202 583203	L=1487 L=1487
	1.0 1.0 1.1 1.1 CRDi	45 46 48 55		09.05 11.09 04.04 11.05	04.11 04.11 04.11 04.11	+ ABS + ABS + ABS + ABS	24.3727-3206.2 24.3727-3207.2	583206 583207	L=1515 L=1515
	1.0 1.0 1.1 1.1 CRDi	45 46 48 55		09.05 11.09 09.05 11.05	04.11 04.11 04.11 04.11		24.3728-3201.2	593201	L=840
KIA PRO CEE'D (08-13)									
	1.4 16V 1.4 16V 1.4 16V 1.6 16V 1.6 16V 1.6 16V 1.6 CRDi 115 1.6 CRDi 128 1.6 CRDi 90 2.0 16V 2.0 CRDi 140	66 77 80 90 92 93 85 94 66 105 103		06.10 02.08 02.08 02.08 10.10 02.08 02.08 10.10 02.08 02.08 02.08	03.13 03.13 03.13 03.13 03.13 03.13 03.13 03.13 03.13 03.13 03.13		24.5286-0524.3 24.5286-0525.3	331223 331224	L=535 L=535
	1.4 16V 1.4 16V 1.4 16V 1.6 16V 1.6 16V 1.6 16V 1.6 CRDi 115 1.6 CRDi 128 1.6 CRDi 90 2.0 16V 2.0 CRDi 140	66 77 80 90 92 93 85 94 66 105 103		06.10 02.08 02.08 02.08 10.10 02.08 02.08 10.10 02.08 02.08 02.08	03.13 03.13 03.13 03.13 03.13 03.13 03.13 03.13 03.13 03.13 03.13		24.5298-0270.3 24.5298-0271.3	331086 331087	L=270 L=270
	1.6 CRDi 128	94		10.10	03.13		24.3727-3204.2 24.3727-3205.2	583204 583205	L=1673 L=1673

								
KIA RIO I (DC) (00-05)								
	1.3 i 1.3 i 1.5 i 16V	55 60 72		08.00 08.00 08.00	06.02 06.02 06.02	24.3217-1120.3	020360	Rz 17,46
	1.3 i 1.3 i 1.5 i 16V 1.5 i 16V 1.5 i 16V	55 60 70 71 72		07.02 07.02 09.02 09.02 07.02	02.05 02.05 02.05 02.05 02.05	24.3217-1729.3	020535	Rz 17,46
	1.3 i 1.3 i 1.5 i 16V 1.5 i 16V 1.5 i 16V	55 60 70 71 72		08.00 08.00 09.02 09.02 08.00	02.05 02.05 02.05 02.05 02.05	24.3727-3200.2 24.3727-3201.2	583200 583201	L=1584 L=1584
	1.3 i 1.3 i 1.5 i 16V 1.5 i 16V 1.5 i 16V	55 60 70 71 72		08.00 08.00 09.02 09.02 08.00	02.05 02.05 02.05 02.05 02.05	24.3728-3200.2	593200	L=733
KIA RIO III (UB) (11-)								
	1.1 CRDi 1.2 CVVT 1.25 CVVT 1.25 CVVT 1.4 CRDi 1.4 CVVT 1.4 CVVT 1.6 CVVT	55 62 63 65 66 79 80 90		09.11 11.14 09.11 09.11 09.11 09.11 09.11 06.12		24.3217-1731.3	020551	+ HA-Trommelbremse ¹⁾ Rz 17,46
KIA SEDONA I (GB) (99-01)								
	2.5 i V6 2.9 TDi	121 93		06.00 06.00	09.01 + ABS 09.01 + ABS	24.3222-1731.3	020531	Rz 22,20
KIA SEDONA II (GB) (01-06)								
	2.5 i V6 2.9 CRDi	110 106		10.01 10.01	10.06 + ABS 10.06 + ABS	24.3222-1731.3	020531	Rz 22,20
KIA SEPHIA I (93-98)								
	1.5 16V 1.6 i 1.8 16V			02.96 10.93 01.95	12.98 06.96 12.98	11.0101-5407.2 11.8171-0008.1	260011 990049	Hülsensatz Führungsbolzen ATE ATE
	1.6 i			10.93	03.95	03.0101-0014.2	320004	BRES 3/25 ATE
KIA SEPHIA II (01-04)								
	1.6 i 16V	75		05.01	08.04	24.5285-0240.3	330976	2 L=240
	1.6 i 16V	75		05.01	08.04 - ABS	24.3217-1120.3	020360	Rz 17,46
KIA SHUMA I (97-01)								
	1.5 i 16V 1.8 i 16V	65 81		10.97 10.97	04.01 - ABS 04.01 - ABS	24.5285-0240.3	330976	2 L=240
KIA SHUMA II (01-04)								
	1.6 i 16V 1.8 i 16V	75 84		05.01 04.03	08.04 08.04	24.5285-0240.3	330976	2 L=240
	1.6 i 16V 1.8 i 16V	75 84		05.01 04.03	08.04 - ABS 08.04 - ABS	24.3217-1120.3	020360	Rz 17,46
KIA SORENTO (JC) (02-09)								
	2.5 CRDi 3.5 i V6	103 143		08.02 08.02	11.06 + ABS 11.06 + ABS/ + Automatikgetriebe ²⁾	24.2126-1702.3	010950	THz 26,99
KIA SPORTAGE (94-03)								
	2.0 i 16V 4WD 2.0 i 4WD	94 70		04.94 04.94	09.99 08.99	24.3220-1746.3	020580	Rz 20,64
KIA SPORTAGE (04-10)								
	2.0 CRDi 2.0 CRDi 2.0 CRDi 2.0 CRDi 2.0 CRDi 4WD 2.0 CRDi 4WD	83 100 103 110 83 100		02.05 01.06 01.06 09.08 09.04 01.06	05.10 05.10 05.10 05.10 05.10 05.10	24.5286-0405.3	331061	L=405























¹⁾ + RA drum brake / + P freno a tamburo / + frein à tambour essieu AR / + ET-tambores de freno

²⁾ + ABS/ + autom.transmission / + ABS/ + scatola cambio autom. / + ABS/ + transmission automatique / + ABS/ + cambio automático













































									
KIA SPORTAGE (04-10)									
	2.0 CRDi 4WD 2.0 CRDi 4WD 2.0 i 16V 2.0 i 16V 4WD 2.7 i V6 4WD	103 110 104 104 129		01.06 09.08 09.04 09.04 09.04	05.10 05.10 05.10 05.10 05.10	24.5286-0405.3	331061		L=405
KIA VENGA (10-)									
	1.4 CRDi 75 1.4 CRDi 75 1.4 CRDi 90 1.4 CVVT 1.6 CRDi 115 1.6 CRDi 128 1.6 CVVT	55 57 66 66 85 94 92		02.10 02.10 02.10 02.10 02.10 02.10 02.10		24.4122-1716.3	010983	- ESP	THz 22,20 - Behälter TRW
	1.4 CRDi 75 1.4 CRDi 75 1.4 CRDi 90 1.4 CVVT 1.6 CRDi 115 1.6 CRDi 128 1.6 CVVT	55 57 66 66 85 94 92		02.10 02.10 02.10 02.10 02.10 02.10 02.10		24.4122-1715.3	010982	+ ESP	THz 22,20 - Behälter TRW
LADA 110 Stufenheck (2110) (95-07)									
	1.5 1.5 1.5 i 16V 1.6 1.6 2.0 i Wankel	54 57 70 60 66 110 88		01.95 01.95 01.95 01.00 01.00 08.96 06.97	08.07 08.07 08.07 08.07 08.07 08.07 08.07	24.2120-0803.3	010415		THz 20,64
	1.5 1.5 1.5 i 16V 1.6 1.6 2.0 i Wankel	54 57 70 60 66 110 88		01.95 01.95 01.95 01.00 01.00 08.96 06.97	08.07 08.07 08.07 08.07 08.07 08.07 08.07	24.3220-1103.3	020214		Rz 20,64
LADA 111 Kombi (2111) (95-08)									
	1.5 1.5 i 16V 1.6 1.6	57 70 60 66		01.95 01.95 01.05 03.06	12.08 12.08 12.08 12.08	24.2120-0803.3	010415		THz 20,64
	1.5 1.5 i 16V 1.6 1.6	57 70 60 66		01.95 01.95 01.05 03.06	12.08 12.08 12.08 12.08	24.3220-1103.3	020214		Rz 20,64
LADA 112 Fließheck (2112) (95-08)									
	1.5 1.5 1.5 i 16V 1.6 1.6	54 57 70 60 66		01.95 01.95 01.95 01.05 03.06	12.08 12.08 12.08 12.08 12.08	24.2120-0803.3	010415		THz 20,64
	1.5 1.5 1.5 i 16V 1.6 1.6	54 57 70 60 66		01.95 01.95 01.95 01.05 03.06	12.08 12.08 12.08 12.08 12.08	24.3220-1103.3	020214		Rz 20,64
LADA KALINA (1117/1118/1119) (04-)									
	1.4 16V 1.4 16V LPG 1.6 16V 1.6 16V 1.6 16V	66 65 60 62 66		11.08 11.08 10.04 01.10 10.04		24.3220-1103.3	020214		Rz 20,64
LADA PRIORA (2170/2172) (08-)									
	1.6 i 16V 1.6 i 16V 1.6 LPG	60 72 71		12.08 12.08 12.08		24.3220-1103.3	020214		Rz 20,64
LADA SAMARA (2108/2109) (86-99)									
	1100 1300 1500			09.88 07.86 07.87	12.99 12.99 12.99	24.2120-0803.3	010415		THz 20,64
	1100 1300 1500			09.88 07.86 07.87	12.99 12.99 12.99	24.5127-0305.3	330578	2	L=305
	1100 1300 1500			09.88 07.86 07.87	12.99 12.99 12.99	24.3220-1103.3	020214		Rz 20,64
	1100 1300 1500			09.88 07.86 07.87	12.99 12.99 12.99	24.3727-2403.2	582403	2 	L=1617



















LADA NIVA II (2123) (02-)		LANCIA DEDRA (94-99)		LANCIA DELTA (94-99)		LANCIA DELTA / Chrysler Delta (08-)			
									
	1.7 i 4x4 1.7 i 4x4 1.7 LPG	59 61 57	09.02 08.04 09.02		24.3220-1103.3	020214		Rz 20,64	
	1.8 GT 16V 1.8 i.e. 1.9 TD 2.0 i.e. 2.0 i.e. 16V		03.96 08.99 11.93 08.99 11.93 08.99		24.3344-1703.5 24.3344-1704.5 24.0101-3601.2	240117 240118 260044	<input type="checkbox"/> <input type="checkbox"/>	D=34, - Halter D=34, - Halter Bremsattel-Zubehör	TRW TRW TRW
	1.6		11.93 08.99		24.3222-1701.3	020376		Rz 22,20	
	1.6 1.6 1.8 i.e. 1.9 TD 2.0 i.e. 2.0 i.e. 16V		11.93 08.99 11.93 08.99 11.93 08.99	- Klimaanlage ¹⁾ + Klimaanlage ²⁾	24.3727-0511.2 24.3727-0510.2 24.3727-0521.2 24.3727-0006.2	580511 580510 580521 580006	<input type="checkbox"/> <input type="checkbox"/> <input type="checkbox"/> <input type="checkbox"/>	L=1415 L=1375 L=1517 L=1460	
	1.4 i.e. 1.6 i.e. 1.8 1.8 i.e. 2.0 HF Turbo 2.0 i.e. 16V	66	11.93 08.99 02.96 09.99 11.93 08.99 11.93 08.99		24.2122-1716.3	010485		THz 22,20	
	1.8 1.8 i.e. 2.0 HF Turbo 2.0 i.e. 16V 2.0 TD	66	02.96 09.99 11.93 08.99 11.93 08.99 07.94 08.99		24.3344-1703.5 24.3344-1704.5 24.0101-3601.2	240117 240118 260044	<input type="checkbox"/> <input type="checkbox"/>	D=34, - Halter D=34, - Halter Bremsattel-Zubehör	TRW TRW TRW
	1.4 i.e. 1.6 i.e. 1.8 1.8 i.e. 2.0 HF Integrale 2.0 HF Turbo 2.0 i.e. 16V 2.0 i.e. 16V Integrale 2.0 TD	66	11.93 08.99 02.96 09.99 11.93 08.99 11.93 08.99 11.93 08.99 07.94 08.99		83.6401-0159.3	330746	2	L=160	
	1.4 i.e. 1.6 i.e.		11.93 08.99 11.93 08.99		24.3222-1701.3	020376		Rz 22,20	
	1.4 i.e. 1.6 i.e. 1.8 1.8 i.e. 2.0 HF Turbo 2.0 i.e. 16V 2.0 TD	66	11.93 08.99 02.96 09.99 11.93 08.99 11.93 08.99 07.94 08.99		24.3727-0511.2 24.3727-0510.2 24.3727-0521.2 24.3727-0006.2	580511 580510 580521 580006	<input type="checkbox"/> <input type="checkbox"/> <input type="checkbox"/> <input type="checkbox"/>	L=1415 L=1375 L=1517 L=1460	
	1.4 16V 1.4 16V 1.4 16V Turbo 1.4 Bifuel 1.6 D Multijet 1.6 D Multijet 1.8 Di 16V 1.9 D Multijet 2.0 D Multijet	88 103 110 88 77 88 147 140 121	08.08 07.10 08.08 07.11 04.11 08.08 01.09 08.08 08.08		24.4123-1710.3	010866		THz 23,81 - Behälter	BOS
	1.4 16V 1.4 Bifuel 1.6 D Multijet 1.6 D Multijet 1.8 Di 16V 1.9 D Multijet 2.0 D Multijet	88 88 77 88 147 140 121	08.08 07.11 04.11 08.08 01.09 08.08 08.08		24.3541-1809.5 24.3541-1810.5 11.9571-9953.2 11.9571-9954.2 11.8171-0008.1	240593 240594 220871 220872 990049	<input type="checkbox"/> <input type="checkbox"/> <input type="checkbox"/> <input type="checkbox"/>	D=54, - Halter D=54, - Halter D=57, - Halter D=57, - Halter Führungsbolzen	BOS BOS ATE ATE ATE
	1.4 16V 1.4 16V 1.4 16V Turbo 1.4 Bifuel 1.6 D Multijet 1.6 D Multijet 1.8 Di 16V 1.9 D Multijet 2.0 D Multijet	88 103 110 88 77 88 147 140 121	08.08 07.10 08.08 07.11 04.11 08.08 01.09 08.08 08.08		83.6401-0413.3	330748	2	L=408	
	1.4 16V 1.4 16V 1.4 16V Turbo 1.4 Bifuel 1.6 D Multijet 1.6 D Multijet	88 103 110 88 77 88	08.08 07.10 08.08 07.11 04.11 08.08		24.5112-0187.3	331150	2	L=187	

¹⁾ - air conditioning / - aria condizionata / - air conditionné / - aire acondicionado
²⁾ + air conditioning / + aria condizionata / + air conditionné / + aire acondicionado

									
LANCIA DELTA / Chrysler Delta (08-)									
	1.8 Di 16V 1.9 D Multijet 2.0 D Multijet	147 140 121	01.09 08.08 08.08		24.5112-0187.3	331150	2	L=187	
	1.4 16V 1.4 16V Turbo 1.4 Bifuel 1.6 D Multijet 1.6 D Multijet 1.8 Di 16V 1.9 D Multijet 2.0 D Multijet	88 103 110 88 77 88 147 140 121	08.08 07.10 08.08 07.11 04.11 08.08 01.09 08.08 08.08		24.3727-3001.2 24.3727-3002.2	583001 583002	<input type="checkbox"/> <input type="checkbox"/>	L=1902 L=1760	
LANCIA KAPPA (95-01)									
	2.0 i.e. 2.0 i.e. 16V Turbo 2.0 i.e. 20V Turbo 2.4 i.e. 2.4 JTD 2.4 TD 3.0 i.e. V6		01.95 07.95 06.98 01.95 06.98 01.95 01.95	10.01 10.01 10.01 10.01 10.01 10.01	24.2123-1718.3	010507		THz 23,81	
LANCIA LYBRA (99-05)									
	1.6 1.6 i 16V 1.8 i 16V 1.9 JTD 2.0 i 20V 2.4 20V 2.4 JTD		10.00 10.99 10.99 10.99 10.99 10.01 10.99	10.05 12.05 12.05 12.05 12.05 12.05 12.05	83.6401-0413.3	330748	2	L=408	
	1.6 1.6 i 16V 1.8 i 16V 1.9 JTD 2.0 i 20V 2.4 20V 2.4 JTD		10.00 10.99 10.99 10.99 10.99 10.01 10.99	10.05 12.05 12.05 12.05 12.05 12.05 12.05	24.3384-1741.7 24.3384-1742.7	220599 220600	<input type="checkbox"/> <input type="checkbox"/>	D=38, - Halter D=38, - Halter	TRW TRW
LANCIA MUSA (04-13)									
	1.3 D Multijet 1.3 D Multijet 1.4 1.4 1.9 D Multijet	51 66 57 70 74	10.04 09.06 07.05 10.04 10.04	11.06 11.06 11.06 11.06 11.06	24.2123-1763.3 24.2123-1769.3	010842 010863	- Dynamic Control ¹⁾ + Dynamic Control ²⁾	THz 23,81 THz 23,81	BOS
	1.3 D Multijet 1.3 D Multijet 1.3 D Multijet 1.4 1.4 1.4 1.4 1.4 LPG 1.6 D Multijet 1.6 D Multijet 1.9 D Multijet	51 66 70 57 66 70 57 85 88 74	12.06 12.06 08.09 12.06 10.07 12.06 11.10 07.08 06.08 12.06	12.13 12.13 12.13 12.13 12.13 12.13 12.13 12.13 12.13 12.13	24.4123-1708.3	010859		THz 23,81	BOS
	1.4 1.4 1.4 1.4 LPG	57 66 70 57	07.05 10.07 10.04 11.10	12.13 12.13 12.13 12.13	24.3541-1811.5 24.3541-1812.5	240429 240430	<input type="checkbox"/> <input type="checkbox"/>	D=54, - Halter D=54, - Halter	BOS BOS
	1.3 D Multijet 1.3 D Multijet 1.3 D Multijet 1.4 1.4 1.4 1.4 LPG 1.6 D Multijet 1.6 D Multijet 1.9 D Multijet	51 66 70 57 66 70 57 85 88 74	10.04 09.06 08.09 07.05 10.07 10.04 11.10 07.08 06.08 10.04	12.13 12.13 12.13 12.13 12.13 12.13 12.13 12.13 12.13 12.13	24.5112-0456.3	330875	2	L=455	
	1.6 D Multijet 1.6 D Multijet	85 88	07.08 06.08	12.13 12.13	24.3347-1715.5 24.3347-1716.5	240719 240720	<input type="checkbox"/> <input type="checkbox"/>	D=34, - Halter D=34, - Halter	TRW TRW
	1.3 D Multijet 1.3 D Multijet 1.3 D Multijet 1.4 1.4 1.4 1.4 1.4 LPG 1.6 D Multijet 1.6 D Multijet 1.9 D Multijet	51 66 70 57 66 70 57 85 88 74	10.04 09.06 08.09 07.05 10.07 10.04 11.10 07.08 06.08 10.04	12.13 12.13 12.13 12.13 12.13 12.13 12.13 12.13 12.13 12.13	83.7201-9173.3	330868	2	L=173	
	1.3 D Multijet 1.4	51 70	10.04 10.04	06.05 06.05	24.3222-1724.3	020466		Rz 22,20	
	1.4 1.4 1.4	57 66 70	07.05 10.07 07.05	12.13 12.13 12.13	24.3222-1725.3	020510		Rz 22,00	AP

¹⁾ - dynamic control / - dynamic control / - dynamic control / - Control dinámico
²⁾ + dynamic control / + dynamic control / + dynamic control / + Control dinámico

										
LANCIA MUSA (04-13)										
	1.4 LPG	57		11.10	12.13	24.3222-1725.3	020510		Rz 22,00	AP
	1.9 D Multijet	74		10.04	06.05	24.3220-1107.3	020218		Rz 20,64	AP
	1.3 D Multijet	51		07.05	12.13	24.3220-1728.3	020509		Rz 20,64	
	1.3 D Multijet	66		09.06	12.13					
	1.3 D Multijet	70		08.09	12.13					
1.9 D Multijet	74		07.05	12.13						
	1.4	57		07.05	12.13	24.2520-1705.3	040093		Nz 20,64	
	1.4	66		10.07	12.13					
	1.4	70		10.04	12.13					
	1.4 LPG	57		11.10	12.13					
LANCIA PHEDRA (02-10)										
	2.0 D Multijet	100		07.06	09.10	03.2122-2163.3	010800		Thz 22,20	ATE
	2.0 i 16V	100		08.02	09.10					
	2.0 JTD	80		08.02	09.10					
	2.2 D Multijet	125		03.08	09.10					
	2.2 JTD	94		08.02	09.10					
2.2 JTD	120		04.06	09.10						
	2.0 D Multijet	100		07.06	09.10	24.3601-1711.7	220607		D=60, - Halter	TRW
	2.0 i 16V	100		08.02	09.10	24.3601-1712.7	220608		D=60, - Halter	TRW
	2.0 JTD	80		08.02	09.10					
	2.2 JTD	94		08.02	09.10					
	2.2 D Multijet	125		03.08	09.10	24.3451-1855.5	240659		D=40/45, - Halter	TRW
2.2 JTD	120		04.06	09.10	24.3451-1856.5	240660		D=40/45, - Halter	TRW	
	2.0 D Multijet	100		07.06	09.10	24.5111-0462.3	330555	2	L=460	
	2.0 i 16V	100		08.02	09.10					
	2.0 JTD	80		08.02	09.10					
	2.2 JTD	94		08.02	09.10					
	3.0 i V6	150		08.02	09.10					
	2.0 D Multijet	100		07.06	09.10	24.3384-1761.7	220671		D=38, - Halter	TRW
	2.0 i 16V	100		08.02	09.10	24.3384-1762.7	220672		D=38, - Halter	TRW
	2.0 JTD	80		08.02	09.10					
	2.2 D Multijet	125		03.08	09.10					
	2.2 JTD	94		08.02	09.10					
2.2 JTD	120		04.06	09.10						
3.0 i V6	150		08.02	09.10						
	2.0 D Multijet	100		07.06	09.10	24.5229-0251.3	330535	2	L=250	
	2.0 i 16V	100		08.02	09.10					
	2.0 JTD	80		08.02	09.10					
	2.2 D Multijet	125		03.08	09.10					
	2.2 JTD	94		08.02	09.10					
2.2 JTD	120		04.06	09.10						
3.0 i V6	150		08.02	09.10						
	2.0 i 16V	100		08.02	09.10	24.3727-0847.2	580847		L=1068	
	2.0 JTD	80		08.02	09.10	24.3727-0848.2	580848		L=2360	
	2.2 D Multijet	125		03.08	09.10					
	2.2 JTD	94		08.02	09.10					
	2.2 JTD	120		04.06	09.10					
3.0 i V6	150		08.02	09.10						
2.0 D Multijet	100		07.06	09.10	24.3727-0569.2	580569	2 	L=1255		
LANCIA Y (96-03)										
	1.1 i			05.97	12.98	24.2120-1710.3	010468		Thz 20,64	
	1.2 i	44		01.96	07.03					
	1.2 i 16V	59		10.00	07.03					
	1.2 i 16V	63		05.97	09.00					
	1.4 i			01.96	12.98					
	1.1 i			05.97	12.98	24.3481-1743.5	240305		D=48, - Halter	BDX
	1.2 i	44		10.00	07.03	24.3481-1744.5	240306		D=48, - Halter	BDX
	1.2 i	44		01.96	09.00					
	1.2 i	44		10.00	07.03	24.3481-1751.5	240285		D=48, - Halter	BDX
	1.2 i 16V	59		10.00	07.03	24.3481-1752.5	240286		D=48, - Halter	BDX
1.2 i 16V	63		05.97	09.00						
1.4 i			01.99	07.03						
	1.4 i			01.96	12.98	24.3481-1703.5	240051		D=48, - Halter	TRW
						24.3481-1704.5	240052		D=48, - Halter	TRW
						24.0101-4301.2	260047		Bremssattel-Zubehör	TRW
	1.1 i			05.97	12.98	24.5112-0376.3	330514		L=362	
	1.2 i	44		10.00	07.03	24.5112-0370.3	330515		L=372	
	1.2 i	44		01.96	09.00					
	1.2 i	44		10.00	07.03	24.5112-0395.3	330521		L=395	
	1.2 i 16V	59		10.00	07.03	24.5112-0396.3	330520		L=397	
	1.2 i 16V	63		05.97	09.00					
	1.4 i			01.96	12.98					
	1.1 i			05.97	12.98	24.3220-1108.3	020219		Rz 20,64	BDX
	1.2 i	44		01.96	07.03	24.3220-1107.3	020218		Rz 20,64	AP
	1.2 i 16V	59		10.00	07.03					
	1.2 i 16V	63		05.97	09.00					
	1.4 i			01.96	12.98					
	1.1 i			05.97	12.98	24.3727-0534.2	580534		L=1392	
	1.2 i	44		01.96	07.03	24.3727-0533.2	580533		L=1414	
	1.2 i 16V	59		10.00	07.03					
	1.2 i 16V	63		05.97	09.00					
	1.4 i			01.96	12.98					

											
LANCIA Y (96-03)											
	1.1 i 1.2 i 1.2 i 16V 1.2 i 16V 1.4 i	44 59 63		05.97 01.96 10.00 05.97 01.96	12.98 07.03 07.03 09.00 12.98	- ABS - ABS - ABS - ABS	24.6513-1705.3	320237	←	BRL (2)	
	1.1 i 1.2 i 1.2 i 16V 1.2 i 16V 1.4 i	44 59 63		05.97 01.96 10.00 05.97 01.96	12.98 07.03 07.03 09.00 12.98		24.3728-0516.2	590516		L=856	
LANCIA YPSILON (03-11)											
	1.2 i 1.2 1.2 i 16V 1.3 JTD 1.3 JTD 1.3 JTD 1.3 JTD 1.4 i 1.4 i 16V 1.4 LPG	44 51 59 51 55 66 77 57 70 57		06.03 08.10 06.03 06.03 10.06 10.06 07.07 02.06 06.03 11.10	06.11 06.11 06.11 06.11 06.11 06.11 06.11 06.11 06.11 06.11		24.2120-1745.3 24.2122-1762.3 24.2122-1768.3	010834 010837 010853		THz 20,64 - Dynamic Control ¹⁾ + Dynamic Control ²⁾ THz 22,20 THz 22,20	
	1.2 i 1.4 i 1.4 LPG 1.2 1.2 i 16V 1.3 JTD 1.3 JTD 1.3 JTD 1.3 JTD 1.4 i 16V	44 57 57 51 59 51 55 66 77 70		06.03 02.06 11.10 08.10 06.03 06.03 10.06 10.06 07.07 06.03	06.11 06.11 06.11 06.11 06.11 06.11 06.11 06.11 06.11 06.11		24.3481-1805.7 24.3481-1806.7 24.0101-3802.2 24.3541-1833.5 24.3541-1834.5	220765 220766 260100 240403 240404	<input type="checkbox"/> <input type="checkbox"/> <input type="checkbox"/> <input type="checkbox"/>	D=48, - Halter D=48, - Halter Bremsattel-Zubehör D=54, - Halter D=54, - Halter	TRW TRW TRW TRW
	1.2 1.2 i 1.2 i 16V 1.3 JTD 1.3 JTD 1.3 JTD 1.3 JTD 1.4 i 1.4 i 16V 1.4 LPG	51 44 59 51 55 66 77 57 70 57		08.10 06.03 06.03 06.03 10.06 10.06 07.07 02.06 06.03 11.10	06.11 06.11 06.11 06.11 06.11 06.11 06.11 06.11 06.11 06.11		24.5119-0447.3	330990	2	L=447	
	1.2 1.2 i 1.2 i 16V 1.3 JTD 1.3 JTD 1.3 JTD 1.3 JTD 1.4 i 1.4 i 16V 1.4 LPG	51 44 59 51 55 66 77 57 70 57		08.10 06.03 06.03 06.03 10.06 10.06 07.07 02.06 06.03 11.10	06.11 06.11 06.11 06.11 06.11 06.11 06.11 06.11 06.11 06.11		83.7201-9173.3	330868	2	L=173	
	1.2 i 1.4 i 1.4 LPG 1.2 1.2 i 16V 1.3 JTD 1.3 JTD 1.3 JTD 1.3 JTD 1.4 i 16V	44 57 57 51 59 51 55 66 77 70		06.03 02.06 11.10 08.10 06.03 06.03 10.06 10.06 07.07 06.03	06.11 06.11 06.11 06.11 06.11 06.11 06.11 06.11 06.11 06.11		24.3219-1756.3 24.3220-1727.3	020511 020480		Rz 19,05 Rz 20,64	BOS
	1.2 1.2 i 1.2 i 16V 1.3 JTD 1.3 JTD 1.3 JTD 1.3 JTD 1.4 i 1.4 i 16V 1.4 LPG	51 44 59 51 55 66 77 57 70 57		08.10 06.03 06.03 06.03 10.06 10.06 07.07 02.06 06.03 11.10	06.11 06.11 06.11 06.11 06.11 06.11 06.11 06.11 06.11 06.11		24.3727-3000.2	583000	2 ↕	L=1430	
	1.2 i 1.4 i 1.4 LPG	44 57 57		06.03 02.06 11.10	06.11 06.11 06.11		24.2520-1705.3	040093		Nz 20,64	
LANCIA YPSILON / Chrysler Ypsilon (11-)											
	0.9 0.9 Twinair 1.3 D Multijet 1.2 1.2 Bifuel 1.2 Bifuel	59 63 70 51 49 51		12.13 05.11 05.11 05.11 05.11 04.15			11.8171-0008.1 11.9541-9831.2 11.9541-9832.2 11.8116-0264.1 11.8171-0008.1	990049 220953 220954 390594 990049	<input type="checkbox"/> <input type="checkbox"/> <input type="checkbox"/> 2	Führungsbolzen D=54, - Halter D=54, - Halter Haltefeder Führungsbolzen	ATE ATE ATE ATE

¹⁾ - dynamic control / - dynamic control / - dynamic control / - Control dinámico
²⁾ + dynamic control / + dynamic control / + dynamic control / + Control dinámico







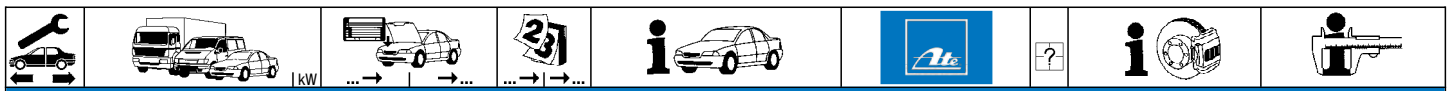

















LANCIA YPSILON / Chrysler Ypsilon (11-)												
	0.9 0.9 Twinair 1.2 1.2 Bifuel 1.2 Bifuel 1.3 D Multijet	59 63 51 49 51 70		12.13 05.11 05.11 05.11 04.15 05.11		24.5112-0356.3	331129	2			L=355	
	0.9 0.9 Twinair 1.2 1.2 Bifuel 1.2 Bifuel 1.3 D Multijet	59 63 51 49 51 70		12.13 05.11 05.11 05.11 04.15 05.11		24.3220-1728.3	020509				Rz 20,64	
LANCIA ZETA (94-02)												
	2.0 i.e. 16V 2.0 i.e. Turbo 2.0 JTD 2.1 TD			05.99 09.02 05.99 09.02 05.99 09.02 05.99 09.99		24.2123-1733.3	010657				THz 23,81	
	2.0 i.e. 16V 2.0 i.e. Turbo 2.0 JTD 2.1 TD			05.98 09.02 06.94 09.02 09.99 09.02 06.96 09.99		24.3571-1709.5 24.3571-1710.5	240153 240154	<input type="checkbox"/> <input type="checkbox"/>			D=57, - Halter D=57, - Halter	TRW TRW
	2.0 i.e. 16V 2.0 i.e. Turbo 2.0 JTD 2.1 TD			05.98 09.02 06.94 09.02 09.99 09.02 06.96 09.99		24.5118-0471.3	330528	2			L=473	
	2.0 i.e. 16V 2.0 i.e. Turbo 2.0 JTD 2.1 TD			05.98 09.02 + ABS 06.94 09.02 09.99 09.02 + ABS 06.96 09.99		11.3361-9975.2 11.3361-9976.2 11.0441-3602.2 11.0101-5407.2 11.8171-0008.1 11.8116-0073.1 24.3361-9975.5 24.3361-9976.5	220281 220282 250008 260011 990049 390498 240541 240542	<input type="checkbox"/> <input type="checkbox"/> <input type="checkbox"/> <input type="checkbox"/> <input type="checkbox"/> <input type="checkbox"/> <input type="checkbox"/> <input type="checkbox"/>	2		D=36, - Halter D=36, - Halter Dichtungssatz Hülzensatz Führungsbolzen Haltefeder D=36, - Halter D=36, - Halter	ATE ATE ATE ATE ATE ATE ATE
	2.0 i.e. 16V 2.0 i.e. Turbo 2.0 JTD 2.1 TD			05.98 09.02 06.94 09.02 09.99 09.02 06.96 09.99		24.5229-0251.3 24.5111-0301.3	330535 330499	2 2	Länge beachten ¹⁾ Länge beachten ¹⁾		L=250 L=300	
	2.0 i.e. 16V 2.0 JTD			05.98 09.02 - ABS 09.99 09.02 - ABS		24.3219-1704.3	020374				Rz 19,05	
	2.0 i.e. 16V 2.0 i.e. Turbo 2.0 JTD 2.1 TD			05.98 09.02 06.94 09.02 09.99 09.02 06.96 09.99		24.3727-0336.2 24.3727-0530.2 24.3727-0529.2	580336 580530 580529	1 <input type="checkbox"/> <input type="checkbox"/>			L=500 L=1255 L=2205	
	2.0 i.e. Turbo 2.0 JTD			06.94 09.02 09.99 09.02		24.3728-0342.2	590342				L=864, + AUT	
	2.0 i.e. 16V 2.1 TD			05.98 09.02 06.96 09.99		24.3728-0336.2 24.3728-0340.2	590336 590340				L=973, + AUT L=1088, + AUT	
LAND ROVER DISCOVERY I (89-98)												
	2.0 16V 4x4 2.5 D 4x4 2.5 TDI 4x4 3.5 V8 4x4 3.9 V8 4x4 3.9 V8 4x4	99 90 83 113 134 136	LA061991 LA061991 LA061991 LA061991 LA061991 LA061991	09.93 07.94 09.89 09.89 09.93 07.94		24.2125-1710.3	010559		- ABS		THz 25,40	
	2.0 16V 4x4 2.5 D 4x4 2.5 TDI 4x4 3.5 V8 4x4 3.9 V8 4x4 3.9 V8 4x4	99 KA034314 90 KA034314 83 KA034314 113 KA034314 134 136		10.98 10.98 10.98 06.94		24.5297-0385.3	331047	2			L=385	
	3.9 V8 4x4 3.9 V8 4x4	134 136		09.93 10.98 07.94 10.98		24.5226-0489.3 24.5226-0485.3	331049 331048	<input type="checkbox"/> <input type="checkbox"/>			L=489 L=485	
LAND ROVER DISCOVERY II (94-04)												
	2.0 16V 4x4	99	LA061991	01.94		24.2125-1710.3	010559		- ABS		THz 25,40	
	2.0 16V 4x4 2.5 Td5 4x4 4.0 V8 4x4	99 KA034314 102 136		11.98 01.99 06.04 11.98 06.04		24.5297-0385.3 24.5226-0485.3 24.5226-0489.3	331047 331048 331049	2 <input type="checkbox"/> <input type="checkbox"/>			L=385 L=485 L=489	
LAND ROVER DISCOVERY III (04-09)												
	2.7 TD 4x4 4.0 4x4 4.0 4x4 4.0 V6 4x4 4.0 V6 4x4 4.4 4x4	140 160 161 156 160 220		07.04 08.09 02.05 08.09 02.05 08.09 10.04 08.09 10.04 08.09 07.04 08.09	- gepanzerte Fahrzeuge ²⁾ - gepanzerte Fahrzeuge ²⁾ - gepanzerte Fahrzeuge ²⁾ - gepanzerte Fahrzeuge ²⁾ - gepanzerte Fahrzeuge ²⁾ - gepanzerte Fahrzeuge ²⁾	24.3481-1787.5 24.3481-1788.5	240621 240622	<input type="checkbox"/> <input type="checkbox"/>			D=48/48, - Halter D=48/48, - Halter	TRW TRW
LAND ROVER DISCOVERY IV (09-)												
	2.7 TD 4x4 3.0 4x4 3.0 SDV6 4x4 3.0 TD 4x4	140 250 188 155		09.09 08.13 11.09 05.10		24.2026-1704.3	010989				THz 26,99/20,64	TRW

¹⁾ notice length / attenzione lunghezza / faire attention longueur / atención largo

²⁾ - armoured vehicles / - veicoli blindati / - véhicule blindé / - vehículo blindado



LAND ROVER DISCOVERY IV (09-)												
	3.0 TD 4x4	180		09.09			24.2026-1704.3	010989			Thz 26,99/20,64	TRW
	3.0 TD 4x4	183		07.12								
	3.0 TD 4x4	200		09.09								
	4.0 4x4	160		09.09								
	5.0 V8 4x4	276		09.09								
	2.7 TD 4x4	140		09.09			24.3481-1787.5	240621	<input type="checkbox"/>		D=48/48, - Halter	TRW
							24.3481-1788.5	240622	<input type="checkbox"/>		D=48/48, - Halter	TRW
LAND ROVER DISCOVERY SPORT (14-)												
	2.0 4WD	177		09.14			11.8171-0096.1	250155			Führungsbolzen	ATE
	2.0 D 4WD	132		06.15								
	2.2 D 4WD	110		09.14								
	2.2 D 4WD	140		09.14								
	2.0 D 2WD	110		09.14			11.9601-9711.2	220873	<input type="checkbox"/>		D=60, - Halter	ATE
							11.9601-9712.2	220874	<input type="checkbox"/>		D=60, - Halter	ATE
							11.0441-6008.2	250038	<input type="checkbox"/>		Dichtungssatz	ATE
LAND ROVER FREELANDER (LN) (98-06)												
	1.8 16V 4x4	86		02.01	10.06		24.4125-1707.3	010986			Thz 25,40	TRW
	2.0 Td4 4x4	80		11.01	10.06							
	2.0 Td4 4x4	82		02.01	10.06							
	2.5 V6 4x4	130		02.01	10.06							
	1.8 16V 4x4	86	1A000001		10.06		24.3571-1753.7	220789	<input type="checkbox"/>		D=57, - Halter	TRW
	2.0 Td4 4x4	80	1A000001		10.06		24.3571-1754.7	220790	<input type="checkbox"/>		D=57, - Halter	TRW
	2.0 Td4 4x4	82	1A000001		10.06							
	2.5 V6 4x4	130	1A000001		10.06							
	1.8 16V 4x4	86	2A393451		10.06		24.5149-0431.3	330993	2		L=431	
	1.8 16V 4x4	88		02.98	11.00							
	2.0 DI 4x4	72		02.98	11.00							
	2.0 Td4 4x4	80	2A393451		10.06							
	2.0 Td4 4x4	82	2A393451		10.06							
	2.5 V6 4x4	130	2A393451		10.06							
	1.8 16V 4x4	86	YA999999	11.00			24.3220-1112.3	020223			Rz 20,64	
	1.8 16V 4x4	88		02.98	11.00							
	2.0 DI 4x4	72		02.98	11.00							
	2.0 Td4 4x4	80	YA999999	11.01								
	2.0 Td4 4x4	82	YA999999	11.00								
	2.5 V6 4x4	130	YA999999	11.00								
	1.8 16V 4x4	86	1A000001		10.06		24.3219-1746.3	020497			Rz 19,05	
	2.0 Td4 4x4	80	1A000001		10.06							
	2.0 Td4 4x4	82	1A000001		10.06							
	2.5 V6 4x4	130	1A000001		10.06							
	1.8 16V 4x4	86	YA999999	11.00			24.3727-3300.2	583300	<input type="checkbox"/>		L=1568	
	1.8 16V 4x4	88		02.98	11.00		24.3727-3301.2	583301	<input type="checkbox"/>		L=1568	
	2.0 DI 4x4	72		02.98	11.00							
	2.0 Td4 4x4	80	YA999999	11.01								
	2.0 Td4 4x4	82	YA999999	11.00								
	2.5 V6 4x4	130	YA999999	11.00								
LAND ROVER FREELANDER 2 (FA) (06-)												
	2.0 4x4	177		10.11			03.7755-1232.4	300260			9/8" Tandem	ATE
	2.2 SD4 4x4	140		08.10								
	2.2 TD4	110		08.10								
	2.2 TD4 4x4	110		10.06								
	2.2 TD4 4x4	112		01.07								
	2.2 TD4 4x4	115		10.06								
	2.2 TD4 4x4	118		10.06								
	3.2 4x4	171		10.06								
	2.0 4x4	177		10.11			11.9601-9711.2	220873	<input type="checkbox"/>		D=60, - Halter	ATE
	2.2 SD4 4x4	140		08.10			11.9601-9712.2	220874	<input type="checkbox"/>		D=60, - Halter	ATE
	2.2 TD4	110		08.10			11.0230-0934.1	260128			Halter	ATE
	2.2 TD4 4x4	110		10.06			11.8116-0206.1	390593	2		Haltefeder	ATE
	2.2 TD4 4x4	112		01.07			11.0101-5407.2	260011			Hülssensatz	ATE
	2.2 TD4 4x4	115		10.06			11.8171-0008.1	990049			Führungsbolzen	ATE
	2.2 TD4 4x4	118		10.06			11.0441-6008.2	250038			Dichtungssatz	ATE
	3.2 4x4	171		10.06			11.9601-9711.2	220873	<input type="checkbox"/>		D=60, - Halter	ATE
							11.9601-9712.2	220874	<input type="checkbox"/>		D=60, - Halter	ATE
							11.8116-0206.1	390593	2		Haltefeder	ATE
							11.0101-5407.2	260011			Hülssensatz	ATE
							11.8171-0008.1	990049			Führungsbolzen	ATE
							11.0441-6008.2	250038			Dichtungssatz	ATE
	2.0 4x4	177	9H123593	10.11			24.3727-3303.2	583303	<input type="checkbox"/>		L=1578	
	2.2 SD4 4x4	140		08.10			24.3727-3302.2	583302	<input type="checkbox"/>		L=1573	
	2.2 TD4	110		08.10								
	2.2 TD4 4x4	110		10.06								
	2.2 TD4 4x4	112		01.07								
	2.2 TD4 4x4	115		10.06								
	2.2 TD4 4x4	118		10.06								
	3.2 4x4	171		10.06								

KW		
LAND ROVER RANGE ROVER II (LP) (94-02)															
	2.5 D 4x4	83		07.94	03.02			24.2125-1710.3	010559					THz 25,40	
	2.5 TD 4x4	100		07.94	03.02										
	3.9 4x4	140		07.94	03.02										
	4.0 4x4	136		06.98	03.02										
	4.6 4x4	160		06.98	03.02										
	4.6 4x4	165		07.94	03.02										
LAND ROVER RANGE ROVER III (LM) (02-12)															
	3.0 TD 6 4x4	130	5A999999	03.02				24.2026-1705.3	010992					THz 26,99/20,64	TRW
	3.6 TD 8 4x4	200	5A999999	04.06											
	4.2 4x4	291	5A999999	05.05											
	4.4 4x4	210	5A999999	03.02											
	4.4 4x4	220	5A999999	08.04											
	4.4 4x4	225	5A999999	05.05											
	3.0 TD 6 4x4	130	5A999999	03.02				11.8116-0283.2	390609	2				Haltefeder	ATE
	3.6 TD 8 4x4	200	5A999999	04.06											
	4.2 4x4	291	5A999999	05.05											
	4.4 4x4	210	5A999999	03.02											
	4.4 4x4	220	5A999999	08.04											
	4.4 4x4	225	5A999999	05.05											
	4.4 4x4	210		03.02	08.12			83.7750-0482.3	331270	2				L=480	
	3.0 TD 6 4x4	130	5A999999	03.02				83.1094-0070.3	331228	2				L=765, + Rohrleitung	
	3.6 TD 8 4x4	200	5A999999	04.06											
	4.2 4x4	291	5A999999	05.05											
	4.4 4x4	210		03.02	08.12										
	4.4 4x4	220	5A999999	08.04											
	4.4 4x4	225	5A999999	05.05											
LAND ROVER RANGE ROVER EVOQUE (SAL) (11-)															
	2.0 16V 4x4	177		06.11				11.9601-9711.2	220873					D=60, - Halter	ATE
	2.0 eD4	110		06.15				11.9601-9712.2	220874					D=60, - Halter	ATE
	2.0 TD4 4x4	110		06.15				11.0441-6008.2	250038					Dichtungssatz	ATE
	2.0 TD4 4x4	132		05.15											
	2.2 eD4	110		06.11											
	2.2 SD4 4x4	140		06.11											
	2.2 TD4 4x4	110		06.11											
	2.0 eD4	110		06.15				11.8171-0096.1	250155					Führungsbolzen	ATE
	2.0 TD4 4x4	110		06.15											
	2.0 TD4 4x4	132		05.15											
LAND ROVER RANGE ROVER EVOQUE Cabriolet (16-)															
	2.0 16V 4x4	177		02.16				11.9601-9711.2	220873					D=60, - Halter	ATE
	2.0 TD4 4x4	110		02.16				11.9601-9712.2	220874					D=60, - Halter	ATE
	2.0 TD4 4x4	132		02.16											
LAND ROVER RANGE ROVER SPORT (LS) (05-13)															
	3.0 TD V6 4x4	155		05.10	06.13			24.2026-1704.3	010989					THz 26,99/20,64	TRW
	3.0 TD V6 4x4	180		09.09	06.13										
	3.0 TD V6 4x4	183		08.12	06.13										
	3.0 TD V6 4x4	188		06.11	06.13										
	3.6 TD V8 4x4	200 AA000001			06.13										
	5.0 V8 4x4	276		07.09	06.13										
	5.0 V8 4x4	372		04.09	06.13										
	5.0 V8 4x4	375		09.09	06.13										
LEXUS ES 350 (06-12)															
	3.5 V6	204		01.07	06.12			24.5296-0563.3	331483					L=562	
MAZDA 121 (96-03)															
	1.25 i 16V	55		03.96	01.00			11.3481-8513.2	220335					D=48, - Halter	ATE
	1.3 i	37		03.96	01.00			11.3481-8514.2	220336					D=48, - Halter	ATE
	1.3 i	44		03.96	01.00			11.0230-0687.1	260106	2				Halter	ATE
	1.8 D	44		03.96	01.00			11.0441-4805.2	250020					Dichtungssatz	ATE
								11.0101-5407.2	260011					Hülssensatz	ATE
								11.8171-0008.1	990049					Führungsbolzen	ATE
								11.8116-0264.1	390594	2				Haltefeder	ATE
	1.25 i 16V	55		03.96	01.00			11.3541-8529.2	220341					D=54, - Halter	ATE
								11.3541-8530.2	220342					D=54, - Halter	ATE
								11.0441-5402.2	250028					Dichtungssatz	ATE
								11.0101-5407.2	260011					Hülssensatz	ATE
								11.8171-0008.1	990049					Führungsbolzen	ATE
								11.8116-0264.1	390594	2				Haltefeder	ATE
	1.25 i 16V	55		02.00	03.03			11.3481-8515.2	220365					D=48, - Halter	ATE
	1.3 i	37		02.00	03.03			11.3481-8516.2	220366					D=48, - Halter	ATE
	1.3 i	44		02.00	03.03			24.3481-8515.5	240477					D=48, - Halter	ATE
	1.8 D	44		02.00	03.03			24.3481-8516.5	240478					D=48, - Halter	ATE
								11.0101-5407.2	260011					Hülssensatz	ATE
								11.8171-0008.1	990049					Führungsbolzen	ATE
								11.8116-0264.1	390594	2				Haltefeder	ATE

1) - armoured vehicles / - veicoli blindati / - véhicules blindés / - vehículo blindado

2) + 16" wheel / + ruota 16" / + roue 16" / + rueda 16"

3) + 17" wheel / + ruota 17" / + roue 17" / + rueda 17"

4) + brake disc diameter 300mm / + diametro dischi freno 300mm / + diamètre disques frein 300mm / + diametro disco freno 300mm

5) + manual transmission / + scatola cambio velocità / + transmission mécanique / + cambio de velocidad



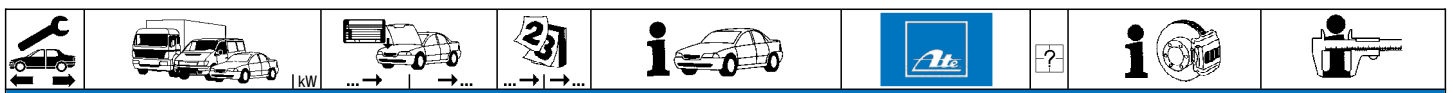

















6) + autom. transmission / + scatola cambio automatico / + transmission automatique / + cambio automático

































MAZDA 121 (96-03)												
	1.25 i 16V	55		02.00	03.03	+ ABS	11.3541-8531.2	220367	2	D=54, - Halter D=54, - Halter Hülzensatz Führungsbolzen Haltefeder	ATE ATE ATE ATE ATE	
	1.3 i	37		02.00	03.03	+ ABS	11.3541-8532.2	220368				
	1.3 i	44		02.00	03.03	+ ABS	11.0101-5407.2	260011				
	1.8 D	44		02.00	03.03	+ ABS	11.8171-0008.1	990049				
	1.25 i 16V	55		03.96	01.00	+ Schaltgetriebe ¹⁾	24.3217-1715.3	020463	2	nur paarweise austauschen ²⁾	Rz 17,78	TRW
	1.3 i	37		03.96	01.00							
	1.3 i	44		03.96	01.00							
	1.8 D	44		03.96	01.00							
	1.25 i 16V	55		02.00	03.03	+ Schaltgetriebe ¹⁾	24.3219-1735.3	020464	2	Rz 19,05		
	1.3 i	37		02.00	03.03							
	1.3 i	44		02.00	03.03							
	1.8 D	44		02.00	03.03							
	1.25 i 16V	55		03.96	03.03	+ Automatikgetriebe ³⁾	24.3219-1107.3	020338	2	nur paarweise austauschen ²⁾	Rz 19,05	TRW
	1.3 i	37		03.96	03.03							
	1.3 i	44		03.96	03.03							
	1.8 D	44		03.96	03.03							
	1.25 i 16V	55		03.96	11.98		24.3727-1800.2	581800	1	L=312 L=1575/1627		
	1.3 i	37		03.96	11.98		24.3727-0660.2	580660				
	1.3 i	44		03.96	11.98							
	1.8 D	44		03.96	11.98							
	1.25 i 16V	55		12.98	03.03		24.3727-0660.2	580660	1	L=1575/1627		
	1.3 i	37		12.98	03.03							
	1.3 i	44		12.98	03.03							
	1.8 D	44		12.98	03.03							
	1.25 i 16V	55		03.96	08.98		24.2419-1734.3	030126	2	Gz 19,05		
	1.3 i	37		03.96	08.98							
	1.3 i	44		03.96	08.98							
	1.8 D	44		03.96	08.98							
	1.25 i 16V	55		09.98	03.03		24.2419-1736.3	030128	2	Gz 19,05		
	1.3 i	37		09.98	03.03							
	1.3 i	44		09.98	03.03							
	1.8 D	44		09.98	03.03							























MAZDA 2 (DY) (03-07)											
	1.2 16V	55		02.03	09.07	- ABS	03.4153-0015.3	011005	2	THz 23,81 - Behälter	ATE
	1.25 16V	55		04.03	09.07	- ABS					
	1.3 16V	67		04.03	09.07	- ABS					
	1.4 16V	59		02.03	09.07	- ABS					
	1.4 CD	50		04.03	09.07	- ABS					
	1.5 16V	82		04.03	09.07	- ABS					
	1.2 16V	55		02.03	09.07	+ ABS	03.4153-5287.4	010953	2	THz 23,81 + Behälter	ATE
	1.25 16V	55		04.03	09.07	+ ABS					
	1.3 16V	67		04.03	09.07	+ ABS					
	1.4 16V	59		02.03	09.07	+ ABS					
	1.4 CD	50		04.03	09.07	+ ABS					
	1.5 16V	82		04.03	09.07	+ ABS					
	1.2 16V	55		02.03	09.07		11.3541-8531.2	220367	2	D=54, - Halter D=54, - Halter Hülzensatz Führungsbolzen Haltefeder	ATE ATE ATE ATE ATE
	1.25 16V	55		04.03	09.07		11.3541-8532.2	220368			
	1.3 16V	67		04.03	09.07		11.0101-5407.2	260011			
	1.4 16V	59		02.03	09.07		11.8171-0008.1	990049			
	1.4 CD	50		04.03	09.07		11.8116-0356.1	390586			
	1.5 16V	82		04.03	09.07						
	1.2 16V	55		02.03	09.07		24.5141-0473.3	331303	2	L=473	
	1.25 16V	55		04.03	09.07						
	1.3 16V	67		04.03	09.07						
	1.4 16V	59		02.03	09.07						
	1.4 CD	50		04.03	09.07						
	1.5 16V	82		04.03	09.07						
	1.2 16V	55		02.03	09.07		83.7827-0300.3	330902	2	L=300	
	1.25 16V	55		04.03	09.07						
	1.3 16V	67		04.03	09.07						
	1.4 16V	59		02.03	09.07						
	1.4 CD	50		04.03	09.07						
	1.5 16V	82		04.03	09.07						
	1.2 16V	55		02.03	09.07		24.3219-1735.3	020464	2	Rz 19,05	
	1.25 16V	55		04.03	09.07						
	1.3 16V	67		04.03	09.07						
	1.4 16V	59		02.03	09.07						
	1.4 CD	50		04.03	09.07						
	1.5 16V	82		04.03	09.07						
	1.2 16V	55		02.03	09.07		24.3727-0658.2	580658	2	L=306 L=1305/1445 L=175	
	1.25 16V	55		04.03	09.07		24.3727-0653.2	580653			
	1.3 16V	67		04.03	09.07		24.3727-0663.2	580663			
	1.4 16V	59		02.03	09.07						
	1.4 CD	50		04.03	09.07						
	1.5 16V	82		04.03	09.07						
	1.2 16V	55		02.03	09.07		24.2419-1735.3	030127	2	Gz 19,05	
	1.25 16V	55		04.03	09.07						
	1.3 16V	67		04.03	09.07						
	1.4 16V	59		02.03	09.07						

1) + manual transmission / + scatola cambio velocità / + transmission mécanique / + cambio de velocidad
2) to change only by pairs / sostituire solo a coppie / à changer seulement par paires / cambiar solamente por parejas
3) + autom.transmission / + scatola cambio automatico / + transmission automatique / + cambio automático
4) extension only / solo prolunga / rallonge seulement / solamente prolongador

																		
MAZDA 2 (DY) (03-07)																		
	1.4 CD 1.5 16V 1.6 16V	50 82 74		04.03 04.03 02.03	09.07 09.07 09.07			24.2419-1735.3	030127									Gz 19,05
MAZDA 2 (DE) (07-14)																		
	1.3 16V 1.3 16V 1.3 BiFuel 1.3 BiFuel 1.3 MZR 1.4 MZR-CD 1.5 16V 1.5 MZR 1.6 MZ-CD 1.6 MZ-CD	55 63 55 62 62 50 76 75 66 70		10.07 10.07 05.11 05.11 01.10 01.08 10.07 06.11 10.08 06.11	12.14 12.14 12.14 12.14 12.14 12.14 12.14 12.14 12.14 12.14			24.5265-0365.3 24.5265-0366.3	331159 331160									L=365 L=365
	1.3 16V 1.3 16V 1.3 BiFuel 1.3 BiFuel 1.3 MZR 1.4 MZR-CD 1.5 16V 1.5 MZR 1.6 MZ-CD 1.6 MZ-CD	55 63 55 62 62 50 76 75 66 70		10.07 10.07 05.11 05.11 01.10 01.08 10.07 06.11 10.08 06.11	12.14 12.14 12.14 12.14 12.14 12.14 12.14 12.14 12.14 12.14			24.5285-0265.3	331184	2								L=265
	1.3 16V 1.3 16V 1.3 BiFuel 1.3 BiFuel 1.3 MZR 1.4 MZR-CD 1.5 16V 1.5 MZR 1.6 MZ-CD 1.6 MZ-CD	55 63 55 62 62 50 76 75 66 70		10.07 10.07 05.11 05.11 01.10 01.08 10.07 06.11 10.08 06.11	12.14 12.14 12.14 12.14 12.14 12.14 12.14 12.14 12.14 12.14			24.3219-1752.3	020505									Rz 19,05
	1.3 16V 1.3 16V 1.3 BiFuel 1.3 BiFuel 1.3 MZR 1.4 MZR-CD 1.5 16V 1.5 MZR 1.6 MZ-CD 1.6 MZ-CD	55 63 55 62 62 50 76 75 66 70		10.07 10.07 05.11 05.11 01.10 01.08 10.07 06.11 10.08 06.11	12.14 12.14 12.14 12.14 12.14 12.14 12.14 12.14 12.14 12.14			24.3727-1826.2 24.3727-1829.2	581826 581829	2	↑ ↓							L=408 L=1328/1360
MAZDA 2 (DJ) (14-)																		
	1.5 D 105 1.5 G 115 1.5 G 75 1.5 G 90	77 85 55 66		11.14 11.14 11.14 11.14				24.3219-1752.3	020505									Rz 19,05
MAZDA 3 (BK) (03-09)																		
	1.4 i 16V 1.4 i 16V 1.6 CiTD 1.6 i 16V	59 62 80 77		10.03 10.03 06.04 10.03	05.09 03.06 05.09 05.09			11.9571-9785.2 11.9571-9786.2 11.0101-5407.2 11.8171-0008.1 11.8116-0356.1	220595 220596 260011 990049 390586	2								D=57, - Halter D=57, - Halter Hülsensatz Führungsbolzen Haltefeder ATE ATE ATE ATE
	2.0 i 16V 2.0 i 16V 2.0 MZR-CD 2.3 DiSi Turbo MPS 2.3 i 16V 2.3 i 16V Sport 2.3 MPS 2.3 MPS 2.3 MZR	104 110 105 184 118 126 191 196 115		04.04 10.03 12.06 06.06 10.03 10.03 12.06 01.07 03.04	06.06 05.09 05.09 06.09 09.04 05.09 05.09 05.09 05.09			11.9571-9785.2 11.9571-9786.2 11.0101-5407.2 11.8171-0008.1 11.8116-0356.1	220595 220596 260011 990049 390586	2								D=57, - Halter D=57, - Halter Hülsensatz Führungsbolzen Haltefeder ATE ATE ATE ATE
	1.4 i 16V 1.4 i 16V 1.6 CiTD 1.6 i 16V	59 62 80 77		10.03 10.03 06.04 10.03	05.09 03.06 05.09 05.09			11.9387-7015.2 11.9387-7016.2 11.0101-5407.2 11.8171-0008.1 11.8116-0340.1	220627 220628 260011 990049 390595	2								D=38, - Halter D=38, - Halter Hülsensatz Führungsbolzen Haltefeder ATE ATE ATE ATE
	2.0 i 16V 2.0 i 16V 2.0 MZR-CD 2.3 DiSi Turbo MPS 2.3 i 16V 2.3 i 16V Sport 2.3 MPS 2.3 MPS 2.3 MZR	104 110 105 184 118 126 191 196 115		04.04 10.03 12.06 06.06 10.03 10.03 12.06 01.07 03.04	06.06 05.09 05.09 06.09 09.04 05.09 05.09 05.09 05.09			11.9387-7015.2 11.9387-7016.2 11.0230-0698.2 11.0101-5407.2 11.8171-0008.1 11.8116-0340.1	220627 220628 260091 260011 990049 390595	2								D=38, - Halter D=38, - Halter Halter Hülsensatz Führungsbolzen Haltefeder ATE ATE ATE ATE
	1.4 i 16V 1.4 i 16V 1.6 CiTD 1.6 i 16V 2.0 i 16V 2.0 i 16V	59 62 80 77 104 110		10.03 10.03 06.04 10.03 04.04 10.03	05.09 03.06 05.09 05.09 06.06 05.09			83.7788-0383.3	330972	2								L=382









										
MAZDA 3 (BK) (03-09)										
	2.0 MZR-CD 2.3 DiSi Turbo MPS 2.3 i 16V 2.3 i 16V Sport 2.3 MPS 2.3 MPS 2.3 MZR	105 184 118 126 191 196 115		12.06 05.09 06.06 06.09 10.03 09.04 10.03 05.09 12.06 05.09 01.07 05.09 03.04 05.09		83.7788-0383.3	330972	2	L=382	
	1.4 i 16V 1.4 i 16V 1.6 CiTD 1.6 i 16V 2.0 i 16V 2.0 i 16V 2.0 MZR-CD 2.3 DiSi Turbo MPS 2.3 i 16V 2.3 i 16V Sport 2.3 MPS 2.3 MPS 2.3 MZR	59 62 80 77 104 110 105 184 118 126 191 196 115		10.03 05.09 10.03 03.06 06.04 05.09 10.03 05.09 04.04 06.06 10.03 05.09 12.06 05.09 06.06 06.09 10.03 09.04 10.03 05.09 12.06 05.09 01.07 05.09 03.04 05.09		24.3727-1813.2 24.3727-1815.2 24.3727-1814.2	581813 581815 581814	  	L=345 L=1831 L=1875	
MAZDA 3 (BL) (09-13)										
	1.6 MZR 1.6 MZR 1.6 MZR-CD 1.6 MZR-CD 2.0 MZR 2.0 MZR 2.0 MZR DISI 2.2 MZR-CD 2.2 MZR-CD 2.3 MPS Turbo	77 79 80 85 108 110 111 110 136 191		06.09 11.13 01.10 11.13 06.09 11.13 11.10 11.13 06.10 11.13 06.09 11.13 06.09 11.13 06.09 11.13 06.09 11.13 06.09 11.13		11.9571-9785.2 11.9571-9786.2	220595 220596	 	D=57, - Halter D=57, - Halter	ATE ATE
	1.6 MZR 1.6 MZR 1.6 MZR-CD 1.6 MZR-CD 2.0 MZR 2.0 MZR 2.0 MZR DISI 2.2 MZR-CD 2.2 MZR-CD 2.3 MPS Turbo	77 79 80 85 108 110 111 110 136 191		06.09 11.13 01.10 11.13 06.09 11.13 11.10 11.13 06.10 11.13 06.09 11.13 06.09 11.13 06.09 11.13 06.09 11.13 06.09 11.13		11.9576-9975.2 11.9576-9976.2	220649 220650	 	D=57, - Halter D=57, - Halter	ATE ATE
	1.6 MZR 1.6 MZR 1.6 MZR-CD 1.6 MZR-CD 2.0 MZR 2.0 MZR 2.0 MZR DISI 2.2 MZR-CD 2.2 MZR-CD 2.3 MPS Turbo	77 79 80 85 108 110 111 110 136 191		06.09 11.13 01.10 11.13 06.09 11.13 11.10 11.13 06.10 11.13 06.09 11.13 06.09 11.13 06.09 11.13 06.09 11.13 06.09 11.13		83.7788-0383.3	330972	2	L=382	
	1.6 MZR 1.6 MZR 1.6 MZR-CD 1.6 MZR-CD 2.0 MZR 2.0 MZR 2.0 MZR DISI 2.2 MZR-CD 2.2 MZR-CD 2.3 MPS Turbo	77 79 80 85 108 110 111 110 136 191		06.09 11.13 01.10 11.13 06.09 11.13 11.10 11.13 06.10 11.13 06.09 11.13 06.09 11.13 06.09 11.13 06.09 11.13 06.09 11.13		24.3727-1825.2	581825	2 	L=1910/1840/342	
MAZDA 323 Limousine/323 C/323 F/323 S (94-98)										
	1.3 i 16V (BA1)			05.94 08.98		24.0101-5102.2	260056		Bremssattel-Zubehör	SUM
	1.3 i 16V (BA1) 1.5 i 16V (BA1) 1.8 i (BA1) 2.0 D			05.94 08.98 05.94 08.98 05.94 08.98 10.96 08.98		24.3219-1725.3	020429		Rz 19,05	TRW
	1.3 i 16V (BA1) 1.5 i 16V (BA1) 1.8 i (BA1)			05.94 08.98 + 3 türig ¹⁾ 05.94 08.98 + 3 türig ¹⁾ 05.94 08.98 + 3 türig ¹⁾		24.3727-1819.2 24.3727-1818.2	581819 581818	 	L=1553 L=1553	
	1.3 i 16V (BA1) 1.5 i 16V (BA1) 1.5 i 16V (BA1) 1.8 i (BA1) 1.8 i (BA1) 2.0 D			05.94 08.98 + 4 türig ²⁾ 05.94 08.98 + 5 türig ³⁾ 05.94 08.98 + 4 türig ²⁾ 05.94 08.98 + 5 türig ³⁾ 05.94 08.98 + 4 türig ²⁾ 10.96 08.98		24.3727-1817.2 24.3727-1816.2	581817 581816	 	L=1653 L=1653	

1) + 3 door / + 3 porte / + 3 portes / + 3 puertas
2) + 4 door / + 4 porte / + 4 portes / + 4 puertas
3) + 5 door / + 5 porte / + 5 portes / + 5 puertas





















										
MAZDA 323 Limousine/323 F/323 P/323 S (98-03)										
	1.6 i 16V (BJ)	70		01.01	10.03	24.3571-1703.5	240099	<input type="checkbox"/>	D=57, - Halter	AKE
	1.6 i 16V (BJ)	72		01.01	10.03	24.3571-1704.5	240100	<input type="checkbox"/>	D=57, - Halter	AKE
	1.8 i 16V (BJ)	84		08.98	12.00					
	2.0 D (BJ)	52		08.98	12.00					
	2.0 DiTD (BJ)	74		01.01	10.03					
	2.0 i 16V (BJ)	96		01.01	10.03					
	2.0 TD (BJ)	66		08.98	12.00					
	1.3 i 16V (BJ)	53		01.01	10.03	24.5288-0375.3	331012	2	L=375	
	1.3 i 16V (BJ)	54		08.98	12.00					
	1.5 i 16V (BJ)	65		08.98	12.00					
	1.6 i 16V (BJ)	70		01.01	10.03					
	1.6 i 16V (BJ)	72		01.01	10.03					
	1.8 i 16V (BJ)	84		08.98	12.00					
	2.0 D (BJ)	52		08.98	12.00					
	2.0 DiTD (BJ)	74		01.01	10.03					
	2.0 i 16V (BJ)	96		01.01	10.03					
	2.0 TD (BJ)	66		08.98	12.00					
	1.6 i 16V (BJ)	70		01.01	10.03	24.3354-1701.5	240347	<input type="checkbox"/>	D=35, - Halter	AKE
	1.6 i 16V (BJ)	72		01.01	10.03	24.3354-1702.5	240348	<input type="checkbox"/>	D=35, - Halter	AKE
	1.8 i 16V (BJ)	84		08.98	12.00					
	2.0 D (BJ)	52		08.98	12.00					
	2.0 DiTD (BJ)	74		01.01	10.03					
	2.0 i 16V (BJ)	96		01.01	10.03					
	2.0 TD (BJ)	66		08.98	12.00					
	1.3 i 16V (BJ)	53		01.01	10.03	24.3217-1716.3	020474		Rz 17,46	
	1.3 i 16V (BJ)	54		08.98	12.00					
	1.5 i 16V (BJ)	65		08.98	12.00					
	2.0 TD (BJ)	66		08.98	12.00					
	1.3 i 16V (BJ)	53		01.01	10.03	24.3727-1812.2	581812	<input type="checkbox"/>	L=252	
	1.3 i 16V (BJ)	54		08.98	12.00	24.3727-1827.2	581827	<input type="checkbox"/>	L=1640	
	1.5 i 16V (BJ)	65		08.98	12.00	24.3727-1828.2	581828	<input type="checkbox"/>	L=1660	
	1.6 i 16V (BJ)	70		01.01	10.03	24.3727-1812.2	581812	<input type="checkbox"/>	L=252	
	1.6 i 16V (BJ)	72		01.01	10.03	24.3727-1823.2	581823	<input type="checkbox"/>	L=1693	
	1.8 i 16V (BJ)	84		08.98	12.00	24.3727-1824.2	581824	<input type="checkbox"/>	L=1715	
	2.0 D (BJ)	52		08.98	12.00					
	2.0 DiTD (BJ)	74		01.01	10.03					
	2.0 i 16V (BJ)	96		01.01	10.03					
	2.0 TD (BJ)	66		08.98	12.00					
MAZDA 5 (CR) (05-10)										
	1.8 16V	85		03.05	11.06	11.9571-9785.2	220595	<input type="checkbox"/>	D=57, - Halter	ATE
	2.0 16V	107		03.05	11.06	11.9571-9786.2	220596	<input type="checkbox"/>	D=57, - Halter	ATE
	2.0 CiTD	81		03.05	11.06	11.0101-5407.2	260011		Hülsensatz	ATE
	2.0 CiTD	105		06.05	11.06	11.8171-0008.1	990049		Führungsbolzen	ATE
						11.8116-0356.1	390586	2	Haltefeder	ATE
	1.8 16V	85		12.06	05.10	11.9571-9785.2	220595	<input type="checkbox"/>	D=57, - Halter	ATE
	2.0 16V	107		12.06	05.10	11.9571-9786.2	220596	<input type="checkbox"/>	D=57, - Halter	ATE
	2.0 CiTD	81		12.06	05.10	11.0101-5407.2	260011		Hülsensatz	ATE
	2.0 CiTD	105		12.06	05.10	11.8171-0008.1	990049		Führungsbolzen	ATE
						11.8116-0356.1	390586	2	Haltefeder	ATE
	1.8 16V	85		03.05	05.10	83.7788-0383.3	330972	2	L=382	
	2.0 16V	107		03.05	05.10					
	2.0 CiTD	81		03.05	05.10					
	2.0 CiTD	105		06.05	05.10					
	1.8 16V	85		03.05	05.10	11.0230-0698.2	260091	2	+ 15" Rad ¹⁾	ATE
	2.0 16V	107		03.05	05.10	11.0101-5407.2	260011		Halter	ATE
	2.0 CiTD	81		03.05	05.10	11.8171-0008.1	990049		Hülsensatz	ATE
	2.0 CiTD	105		06.05	05.10	11.8116-0340.1	390595	2	Führungsbolzen	ATE
									Haltefeder	ATE
	1.8 16V	85		03.05	05.10	83.7788-0383.3	330972	2	L=382	
	2.0 16V	107		03.05	05.10					
	2.0 CiTD	81		03.05	05.10					
	2.0 CiTD	105		06.05	05.10					
	1.8 16V	85		03.05	05.10	24.3727-1812.2	581812	<input type="checkbox"/>	L=252	
	2.0 16V	107		03.05	05.10	24.3727-1822.2	581822	<input type="checkbox"/>	L=1828	
	2.0 CiTD	81		03.05	05.10	24.3727-1820.2	581820	<input type="checkbox"/>	L=1815	
	2.0 CiTD	105		06.05	05.10					
MAZDA 5 (CW) (10-)										
	1.6 CD	85		09.10		11.9571-9785.2	220595	<input type="checkbox"/>	D=57, - Halter	ATE
	1.8 16V	85		09.10		11.9571-9786.2	220596	<input type="checkbox"/>	D=57, - Halter	ATE
	2.0 16V	106		01.11		11.0101-5407.2	260011		Hülsensatz	ATE
	2.0 16V	108		01.11		11.8171-0008.1	990049		Führungsbolzen	ATE
	2.0 16V	110		09.10		11.8116-0356.1	390586	2	Haltefeder	ATE
	2.0 i	111		08.14						
	1.6 CD	85		09.10		83.7788-0383.3	330972	2	L=382	
	1.8 16V	85		09.10						
	2.0 16V	106		01.11						
	2.0 16V	108		01.11						
	2.0 16V	110		09.10						
	2.0 i	111		08.14						
	1.6 CD	85		09.10		24.3727-1812.2	581812	<input type="checkbox"/>	L=252	
	1.8 16V	85		09.10						
	2.0 16V	106		01.11						
	2.0 16V	108		01.11						
	2.0 16V	110		09.10						
	2.0 i	111		08.14						





























¹⁾ + 15" wheel / + ruota 15" / + roue 15" / + rueda 15"







































MAZDA 6 Limousine (GG) (02-07)																																																							
	<table border="1"> <tr><td>1.8 16V</td><td>88</td><td>08.02</td><td>07.07</td><td>+ ESP</td><td rowspan="9">24.2120-1756.3</td><td rowspan="9">010975</td><td rowspan="9">+ Schaltgetriebe ¹⁾</td><td rowspan="9">THz 20,64 - Behälter</td></tr> <tr><td>2.0 16V</td><td>104</td><td>06.02</td><td>07.07</td><td>+ ESP</td></tr> <tr><td>2.0 16V</td><td>108</td><td>03.05</td><td>07.07</td><td>+ ESP</td></tr> <tr><td>2.0 DI</td><td>89</td><td>08.02</td><td>07.07</td><td>+ ESP</td></tr> <tr><td>2.0 DI</td><td>100</td><td>06.02</td><td>07.07</td><td>+ ESP</td></tr> <tr><td>2.0 DI</td><td>105</td><td>06.05</td><td>07.07</td><td>+ ESP</td></tr> <tr><td>2.3 16V</td><td>119</td><td>07.03</td><td>02.05</td><td>+ ESP</td></tr> <tr><td>2.3 16V</td><td>120</td><td>03.05</td><td>07.07</td><td>+ ESP</td></tr> <tr><td>2.3 16V</td><td>122</td><td>06.02</td><td>07.07</td><td>+ ESP</td></tr> <tr><td>2.3 MPS Turbo</td><td>191</td><td>12.05</td><td>07.07</td><td>+ ESP</td></tr> </table>	1.8 16V	88	08.02	07.07	+ ESP	24.2120-1756.3	010975	+ Schaltgetriebe ¹⁾	THz 20,64 - Behälter	2.0 16V	104	06.02	07.07	+ ESP	2.0 16V	108	03.05	07.07	+ ESP	2.0 DI	89	08.02	07.07	+ ESP	2.0 DI	100	06.02	07.07	+ ESP	2.0 DI	105	06.05	07.07	+ ESP	2.3 16V	119	07.03	02.05	+ ESP	2.3 16V	120	03.05	07.07	+ ESP	2.3 16V	122	06.02	07.07	+ ESP	2.3 MPS Turbo	191	12.05	07.07	+ ESP
1.8 16V	88	08.02	07.07	+ ESP	24.2120-1756.3	010975					+ Schaltgetriebe ¹⁾	THz 20,64 - Behälter																																											
2.0 16V	104	06.02	07.07	+ ESP																																																			
2.0 16V	108	03.05	07.07	+ ESP																																																			
2.0 DI	89	08.02	07.07	+ ESP																																																			
2.0 DI	100	06.02	07.07	+ ESP																																																			
2.0 DI	105	06.05	07.07	+ ESP																																																			
2.3 16V	119	07.03	02.05	+ ESP																																																			
2.3 16V	120	03.05	07.07	+ ESP																																																			
2.3 16V	122	06.02	07.07	+ ESP																																																			
2.3 MPS Turbo	191	12.05	07.07	+ ESP																																																			
	<table border="1"> <tr><td>1.8 16V</td><td>88</td><td>08.02</td><td>07.07</td><td></td><td rowspan="9">24.5288-0270.3</td><td rowspan="9">331227</td><td rowspan="9">2</td><td rowspan="9">L=270</td></tr> <tr><td>2.0 16V</td><td>104</td><td>06.02</td><td>07.07</td><td></td></tr> <tr><td>2.0 16V</td><td>108</td><td>03.05</td><td>07.07</td><td></td></tr> <tr><td>2.0 DI</td><td>89</td><td>08.02</td><td>07.07</td><td></td></tr> <tr><td>2.0 DI</td><td>100</td><td>06.02</td><td>07.07</td><td></td></tr> <tr><td>2.0 DI</td><td>105</td><td>06.05</td><td>07.07</td><td></td></tr> <tr><td>2.3 16V</td><td>119</td><td>07.03</td><td>02.05</td><td></td></tr> <tr><td>2.3 16V</td><td>120</td><td>03.05</td><td>07.07</td><td></td></tr> <tr><td>2.3 16V</td><td>122</td><td>06.02</td><td>07.07</td><td></td></tr> <tr><td>2.3 MPS Turbo</td><td>191</td><td>12.05</td><td>07.07</td><td></td></tr> </table>	1.8 16V	88	08.02	07.07		24.5288-0270.3	331227	2	L=270	2.0 16V	104	06.02	07.07		2.0 16V	108	03.05	07.07		2.0 DI	89	08.02	07.07		2.0 DI	100	06.02	07.07		2.0 DI	105	06.05	07.07		2.3 16V	119	07.03	02.05		2.3 16V	120	03.05	07.07		2.3 16V	122	06.02	07.07		2.3 MPS Turbo	191	12.05	07.07	
1.8 16V	88	08.02	07.07		24.5288-0270.3	331227					2	L=270																																											
2.0 16V	104	06.02	07.07																																																				
2.0 16V	108	03.05	07.07																																																				
2.0 DI	89	08.02	07.07																																																				
2.0 DI	100	06.02	07.07																																																				
2.0 DI	105	06.05	07.07																																																				
2.3 16V	119	07.03	02.05																																																				
2.3 16V	120	03.05	07.07																																																				
2.3 16V	122	06.02	07.07																																																				
2.3 MPS Turbo	191	12.05	07.07																																																				
	<table border="1"> <tr><td>1.8 16V</td><td>88</td><td>08.02</td><td>07.07</td><td></td><td rowspan="9">24.3727-1821.2</td><td rowspan="9">581821</td><td rowspan="9">↓</td><td rowspan="9">L=1635/1640</td></tr> <tr><td>2.0 16V</td><td>104</td><td>06.02</td><td>07.07</td><td></td></tr> <tr><td>2.0 16V</td><td>108</td><td>03.05</td><td>07.07</td><td></td></tr> <tr><td>2.0 DI</td><td>89</td><td>08.02</td><td>07.07</td><td></td></tr> <tr><td>2.0 DI</td><td>100</td><td>06.02</td><td>07.07</td><td></td></tr> <tr><td>2.0 DI</td><td>105</td><td>06.05</td><td>07.07</td><td></td></tr> <tr><td>2.3 16V</td><td>119</td><td>07.03</td><td>02.05</td><td></td></tr> <tr><td>2.3 16V</td><td>120</td><td>03.05</td><td>07.07</td><td></td></tr> <tr><td>2.3 16V</td><td>122</td><td>06.02</td><td>07.07</td><td></td></tr> </table>	1.8 16V	88	08.02	07.07		24.3727-1821.2	581821	↓	L=1635/1640	2.0 16V	104	06.02	07.07		2.0 16V	108	03.05	07.07		2.0 DI	89	08.02	07.07		2.0 DI	100	06.02	07.07		2.0 DI	105	06.05	07.07		2.3 16V	119	07.03	02.05		2.3 16V	120	03.05	07.07		2.3 16V	122	06.02	07.07						
1.8 16V	88	08.02	07.07		24.3727-1821.2	581821					↓	L=1635/1640																																											
2.0 16V	104	06.02	07.07																																																				
2.0 16V	108	03.05	07.07																																																				
2.0 DI	89	08.02	07.07																																																				
2.0 DI	100	06.02	07.07																																																				
2.0 DI	105	06.05	07.07																																																				
2.3 16V	119	07.03	02.05																																																				
2.3 16V	120	03.05	07.07																																																				
2.3 16V	122	06.02	07.07																																																				
MAZDA 6 Kombi (GY) (02-07)																																																							
	<table border="1"> <tr><td>1.8 16V</td><td>88</td><td>08.02</td><td>07.07</td><td>+ ESP</td><td rowspan="9">24.2120-1756.3</td><td rowspan="9">010975</td><td rowspan="9">+ Schaltgetriebe ¹⁾</td><td rowspan="9">THz 20,64 - Behälter</td></tr> <tr><td>2.0 16V</td><td>104</td><td>08.02</td><td>07.07</td><td>+ ESP</td></tr> <tr><td>2.0 16V</td><td>108</td><td>03.05</td><td>07.07</td><td>+ ESP</td></tr> <tr><td>2.0 CITD 4x4</td><td>89</td><td>10.02</td><td>02.05</td><td>+ ESP</td></tr> <tr><td>2.0 CITD 4x4</td><td>100</td><td>10.02</td><td>02.05</td><td>+ ESP</td></tr> <tr><td>2.0 DI</td><td>89</td><td>08.02</td><td>07.07</td><td>+ ESP</td></tr> <tr><td>2.0 DI</td><td>100</td><td>08.02</td><td>07.07</td><td>+ ESP</td></tr> <tr><td>2.0 DI</td><td>105</td><td>06.05</td><td>07.07</td><td>+ ESP</td></tr> <tr><td>2.3 16V</td><td>122</td><td>08.02</td><td>07.07</td><td>+ ESP</td></tr> <tr><td>2.3 16V AWD</td><td>119</td><td>11.02</td><td>07.07</td><td>+ ESP</td></tr> </table>	1.8 16V	88	08.02	07.07	+ ESP	24.2120-1756.3	010975	+ Schaltgetriebe ¹⁾	THz 20,64 - Behälter	2.0 16V	104	08.02	07.07	+ ESP	2.0 16V	108	03.05	07.07	+ ESP	2.0 CITD 4x4	89	10.02	02.05	+ ESP	2.0 CITD 4x4	100	10.02	02.05	+ ESP	2.0 DI	89	08.02	07.07	+ ESP	2.0 DI	100	08.02	07.07	+ ESP	2.0 DI	105	06.05	07.07	+ ESP	2.3 16V	122	08.02	07.07	+ ESP	2.3 16V AWD	119	11.02	07.07	+ ESP
1.8 16V	88	08.02	07.07	+ ESP	24.2120-1756.3	010975					+ Schaltgetriebe ¹⁾	THz 20,64 - Behälter																																											
2.0 16V	104	08.02	07.07	+ ESP																																																			
2.0 16V	108	03.05	07.07	+ ESP																																																			
2.0 CITD 4x4	89	10.02	02.05	+ ESP																																																			
2.0 CITD 4x4	100	10.02	02.05	+ ESP																																																			
2.0 DI	89	08.02	07.07	+ ESP																																																			
2.0 DI	100	08.02	07.07	+ ESP																																																			
2.0 DI	105	06.05	07.07	+ ESP																																																			
2.3 16V	122	08.02	07.07	+ ESP																																																			
2.3 16V AWD	119	11.02	07.07	+ ESP																																																			
	<table border="1"> <tr><td>1.8 16V</td><td>88</td><td>08.02</td><td>07.07</td><td></td><td rowspan="9">24.5288-0270.3</td><td rowspan="9">331227</td><td rowspan="9">2</td><td rowspan="9">L=270</td></tr> <tr><td>2.0 16V</td><td>104</td><td>08.02</td><td>07.07</td><td></td></tr> <tr><td>2.0 16V</td><td>108</td><td>03.05</td><td>07.07</td><td></td></tr> <tr><td>2.0 CITD 4x4</td><td>89</td><td>10.02</td><td>02.05</td><td></td></tr> <tr><td>2.0 CITD 4x4</td><td>100</td><td>10.02</td><td>02.05</td><td></td></tr> <tr><td>2.0 DI</td><td>89</td><td>08.02</td><td>07.07</td><td></td></tr> <tr><td>2.0 DI</td><td>100</td><td>08.02</td><td>07.07</td><td></td></tr> <tr><td>2.0 DI</td><td>105</td><td>06.05</td><td>07.07</td><td></td></tr> <tr><td>2.3 16V</td><td>122</td><td>08.02</td><td>07.07</td><td></td></tr> <tr><td>2.3 16V AWD</td><td>119</td><td>11.02</td><td>07.07</td><td></td></tr> </table>	1.8 16V	88	08.02	07.07		24.5288-0270.3	331227	2	L=270	2.0 16V	104	08.02	07.07		2.0 16V	108	03.05	07.07		2.0 CITD 4x4	89	10.02	02.05		2.0 CITD 4x4	100	10.02	02.05		2.0 DI	89	08.02	07.07		2.0 DI	100	08.02	07.07		2.0 DI	105	06.05	07.07		2.3 16V	122	08.02	07.07		2.3 16V AWD	119	11.02	07.07	
1.8 16V	88	08.02	07.07		24.5288-0270.3	331227					2	L=270																																											
2.0 16V	104	08.02	07.07																																																				
2.0 16V	108	03.05	07.07																																																				
2.0 CITD 4x4	89	10.02	02.05																																																				
2.0 CITD 4x4	100	10.02	02.05																																																				
2.0 DI	89	08.02	07.07																																																				
2.0 DI	100	08.02	07.07																																																				
2.0 DI	105	06.05	07.07																																																				
2.3 16V	122	08.02	07.07																																																				
2.3 16V AWD	119	11.02	07.07																																																				
	<table border="1"> <tr><td>1.8 16V</td><td>88</td><td>08.02</td><td>07.07</td><td></td><td rowspan="9">24.3727-1821.2</td><td rowspan="9">581821</td><td rowspan="9">↓</td><td rowspan="9">L=1635/1640</td></tr> <tr><td>2.0 16V</td><td>104</td><td>08.02</td><td>07.07</td><td></td></tr> <tr><td>2.0 16V</td><td>108</td><td>03.05</td><td>07.07</td><td></td></tr> <tr><td>2.0 CITD 4x4</td><td>89</td><td>10.02</td><td>02.05</td><td></td></tr> <tr><td>2.0 CITD 4x4</td><td>100</td><td>10.02</td><td>02.05</td><td></td></tr> <tr><td>2.0 DI</td><td>89</td><td>08.02</td><td>07.07</td><td></td></tr> <tr><td>2.0 DI</td><td>100</td><td>08.02</td><td>07.07</td><td></td></tr> <tr><td>2.0 DI</td><td>105</td><td>06.05</td><td>07.07</td><td></td></tr> <tr><td>2.3 16V</td><td>122</td><td>08.02</td><td>07.07</td><td></td></tr> <tr><td>2.3 16V AWD</td><td>119</td><td>11.02</td><td>07.07</td><td></td></tr> </table>	1.8 16V	88	08.02	07.07		24.3727-1821.2	581821	↓	L=1635/1640	2.0 16V	104	08.02	07.07		2.0 16V	108	03.05	07.07		2.0 CITD 4x4	89	10.02	02.05		2.0 CITD 4x4	100	10.02	02.05		2.0 DI	89	08.02	07.07		2.0 DI	100	08.02	07.07		2.0 DI	105	06.05	07.07		2.3 16V	122	08.02	07.07		2.3 16V AWD	119	11.02	07.07	
1.8 16V	88	08.02	07.07		24.3727-1821.2	581821					↓	L=1635/1640																																											
2.0 16V	104	08.02	07.07																																																				
2.0 16V	108	03.05	07.07																																																				
2.0 CITD 4x4	89	10.02	02.05																																																				
2.0 CITD 4x4	100	10.02	02.05																																																				
2.0 DI	89	08.02	07.07																																																				
2.0 DI	100	08.02	07.07																																																				
2.0 DI	105	06.05	07.07																																																				
2.3 16V	122	08.02	07.07																																																				
2.3 16V AWD	119	11.02	07.07																																																				
MAZDA 6 (GH) (07-12)																																																							
	<table border="1"> <tr><td>1.8 MZR</td><td>88</td><td>08.07</td><td>12.12</td><td></td><td rowspan="9">24.5288-0295.3</td><td rowspan="9">331185</td><td rowspan="9">2</td><td rowspan="9">L=295</td></tr> <tr><td>2.0 MZR</td><td>108</td><td>08.07</td><td>12.12</td><td></td></tr> <tr><td>2.0 MZR</td><td>114</td><td>01.10</td><td>12.12</td><td></td></tr> <tr><td>2.0 MZR-CD</td><td>103</td><td>08.07</td><td>12.12</td><td></td></tr> <tr><td>2.2 MZR-CD</td><td>92</td><td>01.09</td><td>12.12</td><td></td></tr> <tr><td>2.2 MZR-CD</td><td>95</td><td>01.10</td><td>12.12</td><td></td></tr> <tr><td>2.2 MZR-CD</td><td>120</td><td>01.09</td><td>12.12</td><td></td></tr> <tr><td>2.2 MZR-CD</td><td>132</td><td>01.10</td><td>12.12</td><td></td></tr> <tr><td>2.2 MZR-CD</td><td>136</td><td>01.09</td><td>12.12</td><td></td></tr> <tr><td>2.5 MZR</td><td>125</td><td>08.07</td><td>12.12</td><td></td></tr> </table>	1.8 MZR	88	08.07	12.12		24.5288-0295.3	331185	2	L=295	2.0 MZR	108	08.07	12.12		2.0 MZR	114	01.10	12.12		2.0 MZR-CD	103	08.07	12.12		2.2 MZR-CD	92	01.09	12.12		2.2 MZR-CD	95	01.10	12.12		2.2 MZR-CD	120	01.09	12.12		2.2 MZR-CD	132	01.10	12.12		2.2 MZR-CD	136	01.09	12.12		2.5 MZR	125	08.07	12.12	
1.8 MZR	88	08.07	12.12		24.5288-0295.3	331185					2	L=295																																											
2.0 MZR	108	08.07	12.12																																																				
2.0 MZR	114	01.10	12.12																																																				
2.0 MZR-CD	103	08.07	12.12																																																				
2.2 MZR-CD	92	01.09	12.12																																																				
2.2 MZR-CD	95	01.10	12.12																																																				
2.2 MZR-CD	120	01.09	12.12																																																				
2.2 MZR-CD	132	01.10	12.12																																																				
2.2 MZR-CD	136	01.09	12.12																																																				
2.5 MZR	125	08.07	12.12																																																				
MAZDA 626 (GE) (91-97)																																																							
	<table border="1"> <tr><td>1.8 i</td><td>77</td><td>08.91</td><td>04.94</td><td></td><td rowspan="4">24.3571-1703.5</td><td rowspan="4">240099</td><td rowspan="4">☐</td><td rowspan="4">D=57, - Halter</td><td rowspan="4">AKE</td></tr> <tr><td>2.0 D GLX</td><td>55</td><td>01.92</td><td>04.94</td><td></td></tr> <tr><td>2.0 i</td><td>85</td><td>08.91</td><td>04.94</td><td></td></tr> <tr><td>2.0 i 4WD</td><td>85</td><td>04.92</td><td>04.94</td><td></td></tr> <tr><td>2.5 i V6</td><td>121</td><td>09.91</td><td>04.94</td><td></td><td rowspan="4">24.0101-5701.2</td><td rowspan="4">260065</td><td rowspan="4">☐</td><td rowspan="4">Bremsattel-Zubehör</td><td rowspan="4">AKE</td></tr> </table>	1.8 i	77	08.91	04.94		24.3571-1703.5	240099	☐	D=57, - Halter	AKE	2.0 D GLX	55	01.92	04.94		2.0 i	85	08.91	04.94		2.0 i 4WD	85	04.92	04.94		2.5 i V6	121	09.91	04.94		24.0101-5701.2	260065	☐	Bremsattel-Zubehör	AKE																			
1.8 i	77	08.91	04.94		24.3571-1703.5	240099						☐	D=57, - Halter	AKE																																									
2.0 D GLX	55	01.92	04.94																																																				
2.0 i	85	08.91	04.94																																																				
2.0 i 4WD	85	04.92	04.94																																																				
2.5 i V6	121	09.91	04.94		24.0101-5701.2	260065	☐	Bremsattel-Zubehör	AKE																																														
	<table border="1"> <tr><td>1.8 i</td><td>77</td><td>08.91</td><td>04.94</td><td></td><td rowspan="4">24.0101-3001.2</td><td rowspan="4">260039</td><td rowspan="4"></td><td rowspan="4">Bremsattel-Zubehör</td><td rowspan="4">AKE</td></tr> <tr><td>2.0 D GLX</td><td>55</td><td>10.92</td><td>04.94</td><td></td></tr> <tr><td>2.0 i</td><td>85</td><td>08.91</td><td>04.94</td><td></td></tr> <tr><td>2.5 i V6</td><td>121</td><td>01.92</td><td>04.94</td><td></td></tr> </table>	1.8 i	77	08.91						04.94		24.0101-3001.2	260039		Bremsattel-Zubehör	AKE	2.0 D GLX	55	10.92	04.94		2.0 i	85	08.91	04.94		2.5 i V6	121	01.92	04.94																									
1.8 i	77	08.91	04.94							24.0101-3001.2	260039							Bremsattel-Zubehör	AKE																																				
2.0 D GLX	55	10.92	04.94																																																				
2.0 i	85	08.91	04.94																																																				
2.5 i V6	121	01.92	04.94																																																				

1) + manual transmission / + scatoala cambio velocità / + transmission mécanique / + cambio de velocidad

									
MAZDA 626 (GE) (91-97)									
	1.8 i	66		08.94	04.97	24.3727-1812.2	581812	↑	L=252
	1.8 i	77		08.91	04.97	24.3727-1809.2	581809	☐	L=1657
	1.8 i	78		05.94	06.97	24.3727-1808.2	581808	☐	L=1657
	2.0 D	56		05.94	06.97				
	2.0 D GLX	55		10.92	04.97				
	2.0 i	85		08.91	04.97				
	2.5 i V6	121		01.92	04.97				
MAZDA 626 (GF) (97-02)									
	1.8 i 16V	66		05.97	11.99	24.3571-1703.5	240099	☐	D=57, - Halter
	1.8 i 16V	74		12.99	10.02	24.3571-1704.5	240100	☐	D=57, - Halter
	2.0 DiTD	66		04.98	10.02				
	2.0 i 16V	85		05.97	10.02				
	2.0 i 16V	93		01.98	10.02				
	2.0 i 16V	100		02.98	10.02				
	2.0 TD	81		10.00	10.02				
	2.0 Turbo DI	74		04.98	10.02				
	1.8 i 16V	66		05.97	11.99	24.3220-1737.3	020540		Rz 20,64
	1.8 i 16V	74		12.99	10.02				
	1.8 i 16V	66	115108			24.3727-1812.2	581812	↑	L=252
	2.0 DiTD	66	115108	419982					
	2.0 Turbo DI	74	115108	419982					
	1.8 i 16V	66	419983		11.99	24.3727-1812.2	581812	↑	L=252
	1.8 i 16V	74		12.99	10.02				
	2.0 DiTD	66	419983		10.02				
	2.0 TD	81		10.00	10.02				
	2.0 Turbo DI	74	419983		10.02				
	2.0 i 16V	85		05.97	10.02	24.3727-1812.2	581812	↑	L=252
	2.0 i 16V	93		01.98	10.02	24.3727-1823.2	581823	☐	L=1693
	2.0 i 16V	100		02.98	10.02	24.3727-1824.2	581824	☐	L=1715
MAZDA 626 Kombi (GV) (92-98)									
	2.0 D	55		04.92	01.98	24.3727-1812.2	581812	↑	L=252
	2.0 D	60		11.94	04.96				
	2.0 GLX	86		04.92	02.95				
	2.0 i	66		04.92	01.98				
	2.2 i 12V	85		04.92	01.98				
MAZDA 626 Kombi (GW) (98-02)									
	1.8 i 16V	66		02.98	12.99	24.3354-1701.5	240347	☐	D=35, - Halter
	2.0 DiTD	66		09.99	10.02	24.3354-1702.5	240348	☐	D=35, - Halter
	2.0 i 16V	85		02.98	09.99				
	2.0 i 16V	93		01.98	09.99				
	2.0 i 16V	100		02.98	09.99				
	2.0 TD	81		10.00	10.02				
	2.0 Turbo DI	74		04.98	10.02				
	1.8 i 16V	66		02.98	12.99	24.3727-1812.2	581812	↑	L=252
	1.8 i 16V	74		01.00	10.02				
	2.0 DiTD	66		09.99	10.02				
	2.0 i 16V	85		02.98	10.02				
	2.0 i 16V	93		01.98	10.02				
	2.0 i 16V	100		02.98	10.02				
	2.0 TD	81		10.00	10.02				
	2.0 Turbo DI	74		04.98	10.02				
MAZDA B2200/B2500/B2600 (99-02)									
	2.2	68		11.99	08.02	24.3223-1711.3	020570		Rz 23,81
	2.2 4WD	60		02.99	10.99				
	2.2 4WD	68		06.99	08.02				
	2.5 D	57		02.99	10.99				
	2.5 D	62		11.99	08.02				
	2.5 D 4WD	57		02.99	10.99				
	2.5 D 4WD	62		11.99	08.02				
	2.5 TD 4WD	80		02.99	08.02				
	2.6 12V 4WD	90		02.99	08.02				
MAZDA B2500 (02-06)									
	2.5 D	57		08.02	05.04	24.3223-1711.3	020570		Rz 23,81
	2.5 D	62		08.02	07.06				
	2.5 D 4WD	62		08.02	07.06				
	2.5 TDic 4WD	80		08.02	07.06				
MAZDA BT-50 (06-12)									
	2.5 CD	105		12.06	07.12	24.3223-1711.3	020570		Rz 23,81
	2.5 CD 4x4	105		12.06	07.12				
	3.0 CDVi	115		12.06	07.12				
	3.0 CDVi 4x4	115		12.06	07.12				
MAZDA DEMIO (98-02)									
	1.3 i 16V	46		08.98	10.02	24.5285-0269.3	331137	☐	L=269
	1.3 i 16V	53		08.98	03.00				
	1.5 i 16V	55		04.00	10.02				

								
MAZDA DEMIO (98-02)								
	1.3 i 16V 1.3 i 16V 1.5 i 16V	46 53 55		08.98 08.98 04.00	10.02 03.00 10.02	24.3217-1718.3	020478	Rz 17,46
MAZDA MX-3 (91-98)								
	1.6 i (EC)			07.91	12.98 - ABS	24.3217-1120.3	020360	Rz 17,46
MAZDA MX-5 (NB) (98-05)								
	1.6 16V (NB18) 1.8 16V (NB1) 1.8 16V (NB18) 1.8 16V (NB18)	81 103 102 107		05.98 05.98 08.00 08.00	07.00 07.00 - ABS - ABS	24.5265-0335.3	331070	L=335
	1.6 Sport (NB18) 1.8 16V (NB18) 1.8 16V (NB18)	81 102 107		08.00 08.00 08.00	10.05 + ABS + ABS	24.5265-0345.3 24.5265-0346.3	331091 331092	L=345 L=345
	1.6 16V (NB18) 1.6 Sport (NB18) 1.8 16V (NB1) 1.8 16V (NB18) 1.8 16V (NB18)	81 81 103 102 107		05.98 08.02 05.98 08.00 08.00	10.05 10.05 07.00 10.05 10.05	24.5265-0275.3 24.5268-0270.3	331069 331072	L=275 L=270
MAZDA MX-6 (91-97)								
	2.0 (GE1) 2.5 V6 (GE1/GE7) 2.5 V6 (GE1/GE7) 2.5 V6 (GE1/GE7)	85 120 121 123		07.91 08.94 07.91 02.93	08.97 08.97 08.97 08.97	24.3571-1703.5 24.3571-1704.5 24.0101-5701.2	240099 240100 260065	D=57, - Halter D=57, - Halter Bremsattel-Zubehör AKE AKE AKE
	2.0 (GE1) 2.5 V6 (GE1/GE7) 2.5 V6 (GE1/GE7) 2.5 V6 (GE1/GE7)	85 120 121 123		07.91 08.94 07.91 02.93	08.97 08.97 08.97 08.97	24.0101-3001.2	260039	Bremsattel-Zubehör AKE
	2.0 (GE1) 2.5 V6 (GE1/GE7) 2.5 V6 (GE1/GE7) 2.5 V6 (GE1/GE7)	85 120 121 123		07.91 08.94 07.91 02.93	08.97 08.97 08.97 08.97	24.3727-1812.2 24.3727-1809.2 24.3727-1808.2	581812 581809 581808	L=252 L=1657 L=1657
MAZDA PREMACY (CP) (99-05)								
	1.8 i 16V 1.9 i 16V 2.0 DiTD 2.0 DiTD 2.0 i 16V	74 84 66 74 96		07.99 07.99 10.99 07.00 11.01	03.05 03.05 06.00 03.05 03.05	24.5288-0375.3	331012	L=375
	1.8 i 16V 1.9 i 16V 2.0 DiTD 2.0 DiTD 2.0 i 16V	74 84 66 74 96		07.99 07.99 10.99 07.00 11.01	03.05 + ABS 03.05 06.00 + ABS 03.05 + ABS 03.05	24.3354-1701.5 24.3354-1702.5	240347 240348	D=35, - Halter D=35, - Halter AKE AKE
	1.8 i 16V 1.9 i 16V 2.0 DiTD 2.0 DiTD	74 84 66 74		07.99 07.99 10.99 07.00	07.01 07.01 06.00 07.01	24.3220-1737.3	020540	- ABS Rz 20,64
	1.8 i 16V 1.9 i 16V 2.0 DiTD 2.0 DiTD	74 84 66 74	131754 131754 131754 131754	07.99 07.99 10.99 07.00	- ABS - ABS - ABS	24.3727-1812.2	581812	L=252
	1.8 i 16V 1.9 i 16V 2.0 DiTD 2.0 DiTD	74 84 66 74	131755 131755 131755 131755	03.05 03.05 06.00 03.05	+ ABS + ABS - ABS	24.3727-1812.2	581812	L=252
	1.8 i 16V 2.0 DiTD 2.0 i 16V	74 74 96		07.99 07.00 11.01	03.05 + ABS 03.05 + ABS 03.05	24.3727-1812.2	581812	L=252
MAZDA PREMACY (CR) (05-10)								
	2.0 i 16V	107		03.05	11.06 + ⊕	11.9571-9785.2 11.9571-9786.2 11.0101-5407.2 11.8171-0008.1 11.8116-0356.1	220595 220596 260011 990049 390586	D=57, - Halter D=57, - Halter Hülzensatz Führungsbolzen Haltefeder ATE ATE ATE ATE ATE
	2.0 i 16V	107		12.06	05.10 + ⊕	11.9571-9785.2 11.9571-9786.2 11.0101-5407.2 11.8171-0008.1 11.8116-0356.1	220595 220596 260011 990049 390586	D=57, - Halter D=57, - Halter Hülzensatz Führungsbolzen Haltefeder ATE ATE ATE ATE ATE
	2.0 i 16V	107		03.05	05.10 + ⊕	11.0230-0698.2 11.0101-5407.2 11.8171-0008.1 11.8116-0340.1	260091 260011 990049 390595	Halter Hülzensatz Führungsbolzen Haltefeder ATE ATE ATE ATE
	2.0 i 16V	107		03.05	05.10	83.7788-0383.3	330972	L=382
	2.0 i 16V	107		03.05	05.10 + ⊕	24.3727-1812.2 24.3727-1822.2 24.3727-1820.2	581812 581822 581820	L=252 L=1828 L=1815

1) + 15" wheel / + ruota 15" / + roue 15" / + rueda 15"

										
MAZDA XEDOS 6 (92-00)										
	1.6 i 16V (CA1) 2.0 i V6 (CA1)		06.92 06.92	09.99 10.00	24.3571-1703.5 24.3571-1704.5 24.0101-5701.2	240099 240100 260065		D=57, - Halter D=57, - Halter Bremsattel-Zubehör	AKE AKE AKE	
	1.6 i 16V (CA1) 2.0 i V6 (CA1)		06.92 06.92	09.99 10.00	24.0101-3001.2	260039		Bremsattel-Zubehör	AKE	
	1.6 i 16V (CA1) 2.0 i V6 (CA1)		06.92 06.92	09.99 10.00	24.3727-1812.2 24.3727-1809.2 24.3727-1808.2	581812 581809 581808		L=252 L=1657 L=1657		
MERCEDES BENZ A-Klasse (W168) (97-04)										
	A 140 A 160 A 160 CDI A 160 CDI A 170 CDI A 170 CDI A 190 A 210 Evolution	60 75 44 55 66 70 92 103	09.97 09.97 08.98 02.01 03.98 02.01 05.99 03.02	08.04 08.04 01.01 08.04 01.01 08.04 08.04 08.04		010533		THz 22,20		
	A 140 A 160 CDI A 160 CDI	60 44 55	09.97 08.98 02.01	08.04 01.01 08.04	+ kurzer Radstand ¹⁾ 24.3541-1759.7 24.3541-1760.7	220491 220492		D=54, - Halter D=54, - Halter	TRW TRW	
	A 140 A 160 A 170 CDI A 170 CDI	60 75 66 70	09.97 09.97 03.98 02.01	08.04 08.04 01.01 08.04	+ langer Radstand ²⁾ - (BR) 24.3541-1753.7 24.3541-1754.7	220479 220480		D=54, - Halter D=54, - Halter	TRW TRW	
	A 140 A 160 A 160 CDI A 160 CDI A 170 CDI A 170 CDI A 190 A 210 Evolution	60 75 44 55 66 70 92 103	09.97 09.97 08.98 02.01 03.98 02.01 05.99 03.02	08.04 08.04 01.01 08.04 01.01 08.04 08.04 08.04		330877	2	L=280		
	A 160 A 170 CDI A 190	75 70 92	09.97 02.01 05.99	08.04 08.04 08.04	+ langer Radstand ²⁾ + langer Radstand ²⁾ - (BR)	24.3281-1701.5 24.3281-1702.5	240433 240434		D=28, - Halter D=28, - Halter	TRW TRW
	A 140 A 160 A 160 CDI A 160 CDI A 170 CDI A 170 CDI A 190	60 75 44 55 66 70 92	09.97 09.97 08.98 02.01 03.98 02.01 05.99	08.04 08.04 01.01 08.04 01.01 08.04 08.04	+ Trommelbremse ³⁾ + Trommelbremse ³⁾ + (BR)	24.5237-0342.3	331404	2	L=342	
	A 160 A 170 CDI A 190 A 210 Evolution	75 70 92 103	09.97 02.01 05.99 03.02	08.04 08.04 08.04 08.04	+ Scheibenbremse ⁴⁾ + Scheibenbremse ⁴⁾ - (BR)	24.5237-0342.3 24.5238-0230.3	331404 330673	2 2	am Bremsattel ⁵⁾ L=342 L=230	
	A 140 A 160 A 170 CDI	60 75 66	09.97 09.97 03.98	08.04 08.04 08.04	+ kurzer Radstand/ - (BR) ⁶⁾	24.3219-1718.3	020421		Rz 19,05	TRW
	A 140 A 160 A 160 CDI A 160 CDI A 170 CDI A 170 CDI	60 75 44 55 66 70	08.04 08.04 08.98 02.01 01.01 02.01	08.04 08.04 01.01 08.04 01.01 08.04	+ kurzer Radstand/ - (BR) ⁶⁾ + kurzer Radstand ¹⁾	24.3217-1709.3	020419		Rz 17,78	TRW
	A 140 A 160 A 160 CDI A 160 CDI A 170 CDI A 170 CDI A 190	60 75 44 55 66 70 92	09.97 09.97 08.98 02.01 03.98 02.01 05.99	08.04 08.04 01.01 08.04 01.01 08.04 08.04	+ kurzer Radstand ¹⁾ + kurzer Radstand ¹⁾ + kurzer Radstand/ + (BR) ⁷⁾	24.3727-0440.2 24.3727-0421.2 24.3727-0422.2	580440 580421 580422	1 	L=987 L=1062 L=739	
	A 140 A 160 A 160 CDI A 160 CDI A 170 CDI A 170 CDI A 190	60 75 44 55 66 70 92	08.04 08.04 01.01 08.04 01.01 08.04 05.99	08.04 08.04 01.01 08.04 01.01 08.04 - (BR)	+ kurzer Radstand ¹⁾ + kurzer Radstand ¹⁾ + kurzer Radstand/ + (BR) ⁷⁾	24.3727-0400.2 24.3727-0439.2 24.3727-0422.2	580400 580439 580422	1 	L=987 L=1056 L=739	
	A 140 A 160 A 160 CDI A 160 CDI A 170 CDI A 170 CDI A 190	60 75 44 55 66 70 92	08.04 08.04 01.01 08.04 01.01 08.04 05.99	08.04 08.04 01.01 08.04 01.01 08.04 - (BR)	+ kurzer Radstand ¹⁾ + kurzer Radstand ¹⁾ - (BR)	24.3727-0400.2 24.3727-0428.2 24.3727-0427.2	580400 580428 580427	1 	L=987 L=685	
	A 190 A 210 Evolution	92 103	03.02	08.04 08.04	- (BR) + kurzer Radstand ¹⁾	24.3727-0400.2 24.3727-0428.2 24.3727-0427.2	580400 580428 580427	1 	L=987 L=1038 L=685	
	A 160 A 170 CDI A 190 A 210 Evolution	75 70 92 103	09.97 02.01 05.99 03.02	08.04 08.04 08.04 08.04	+ langer Radstand ²⁾ + langer Radstand ²⁾ + langer Radstand ²⁾ + langer Radstand ²⁾	24.3727-0431.2 24.3727-0428.2 24.3727-0427.2	580431 580428 580427	1 	L=1170 L=1038 L=685	
	A 140 A 160 A 160 CDI A 170 CDI	60 75 44 66	09.97 09.97 08.98 03.98	08.04 08.04 08.04 08.04		24.2415-1707.3	030110		Gz 15,87	

¹⁾ + short wheel base / + passo lungo / + empattement court / + distancia corta entre ejes

²⁾ + long wheel base / + passo lungo / + empattement long / + distancia larga entre ejes













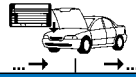











³⁾ + drum brake / + freno a tamburo / + freins à tambour / + tambores de freno

⁴⁾ + disc brake / + disco freno / + disques de frein / + disco de freno

















⁵⁾ on the brake caliper / sulla pinza freno / sur l'étrier de frein / a la pinza de freno

⁶⁾ + short wheel base/ - (BR) / + passo corto/ - (BR) / + empattement court/ - (BR) / + distanc.corta entre ejes/ - (BR)











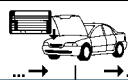

⁷⁾ + short wheel base/ + (BR) / + passo corto/ + (BR) / + empattement court/ + (BR) / + dist.corta entre ejes/ + (BR)

MERCEDES BENZ A-Klasse (W169) (04-12)														
														
	A 150 / A 160 A 160 CDI A 170 A 180 A 180 CDI A 200 A 200 CDI A 200 Turbo E-Cell	70 60 85 85 80 100 142 50		08.04 08.04 08.04 04.09 08.04 08.04 08.04 03.05 12.10	05.12 05.12 05.12 05.12 05.12 05.12 05.12 05.12 05.12	24.2123-1776.3	010926					THz 23,81	TRW	
	A 150 / A 160 A 160 CDI	70 60	J 215300 J 215300	08.04 08.04		24.3571-1751.7 24.3571-1752.7 24.0101-3802.2	220709 220710 260100					D=57, - Halter D=57, - Halter Bremsattel-Zubehör	TRW TRW TRW	
	A 150 / A 160 A 160 CDI A 170 A 180 A 180 CDI A 200	70 60 85 85 80 100	J 215301 J 215301 J 474115 J 474115 J 474115 J 474115	05.12 05.12 05.12 05.12 05.12 05.12	- erhöhte Zuladung ¹⁾	24.3571-1749.5 24.3571-1750.5 24.0101-3802.2	240609 240610 260100					D=57, - Halter D=57, - Halter Bremsattel-Zubehör	TRW TRW TRW	
	A 160 CDI A 170 A 180 A 180 CDI A 200	60 85 85 80 100	J 474114 J 474114 J 474114 J 474114 J 474114	08.04 08.04 04.09 08.04 08.04	+ erhöhte Zuladung ²⁾	24.3571-1749.5 24.3571-1750.5 24.0101-3802.2	240609 240610 260100					D=57, - Halter D=57, - Halter Bremsattel-Zubehör	TRW TRW TRW	
	A 200 CDI A 200 Turbo	142	J 474114 J 474114	08.04 03.05		24.3571-1747.7 24.3571-1748.7 24.0101-3802.2	220691 220692 260100					D=57, - Halter D=57, - Halter Bremsattel-Zubehör	TRW TRW TRW	
	A 150 / A 160 A 160 CDI A 170 A 180 A 180 CDI A 200 A 200 CDI A 200 Turbo E-Cell	70 60 85 85 80 100 142 50		08.04 08.04 08.04 04.09 08.04 08.04 08.04 03.05 12.10	05.12 05.12 05.12 05.12 05.12 05.12 05.12 05.12 05.12	24.5126-0474.3	331017	2				L=474		
	A 150 / A 160 A 160 CDI A 170 A 180 A 180 CDI A 200 A 200 CDI A 200 Turbo	70 60 85 85 80 100 142		08.04 08.04 08.04 04.09 08.04 08.04 08.04 03.05	05.12 05.12 05.12 05.12 05.12 05.12 05.12 05.12	24.3301-1703.7 24.3301-1704.7 24.0101-3802.2	220683 220684 260100					D=30, - Halter D=30, - Halter Bremsattel-Zubehör	TRW TRW TRW	
	A 150 / A 160 A 160 CDI A 170 A 180 A 180 CDI A 200 A 200 CDI A 200 Turbo E-Cell	70 60 85 85 80 100 142 50		08.04 08.04 08.04 04.09 08.04 08.04 08.04 03.05 12.10	05.12 05.12 05.12 05.12 05.12 05.12 05.12 05.12 05.12	24.5238-0230.3	330673	2				L=230		
	A 150 / A 160 A 160 CDI A 170 A 180 A 180 CDI A 200 A 200 CDI A 200 Turbo E-Cell	70 60 85 85 80 100 142 50		08.04 08.04 08.04 04.09 08.04 08.04 08.04 03.05 12.10	05.12 05.12 05.12 05.12 05.12 05.12 05.12 05.12 05.12	24.3727-0485.2 24.3727-0452.2 24.3727-0451.2	580485 580452 580451	1 				L=1130 L=587 L=1215		
MERCEDES BENZ B-Klasse (W245) (05-11)														
	B 150 / B 160 B 160 BlueEfficiency B 170 / B 180 B 170 NGT B 180 BlueEfficiency B 180 CDI B 180 NGT B 200 B 200 CDI B 200 Turbo	70 85 85 85 80 85 100 103 142		03.05 04.09 03.05 04.08 04.09 03.05 04.09 03.05 03.05 03.05	04.11 04.11 04.11 04.09 04.11 04.11 04.11 04.11 04.11 04.11	24.2123-1776.3	010926					THz 23,81	TRW	
	B 150 / B 160 B 160 BlueEfficiency B 170 / B 180 B 180 BlueEfficiency	70 85 85		03.05 04.09 03.05 04.09	04.11 04.11 04.11 04.11	24.3571-1749.5 24.3571-1750.5 24.0101-3802.2	240609 240610 260100					D=57, - Halter D=57, - Halter Bremsattel-Zubehör	TRW TRW TRW	
	B 170 NGT B 180 CDI B 180 NGT B 200 B 200 CDI B 200 Turbo	85 80 85 100 103 142		04.08 03.05 04.09 03.05 03.05 03.05	04.09 04.11 04.11 04.11 04.11 04.11	24.3571-1747.7 24.3571-1748.7 24.0101-3802.2	220691 220692 260100					D=57, - Halter D=57, - Halter Bremsattel-Zubehör	TRW TRW TRW	

¹⁾ - increased payload / - carico utile maggiorato / - charge utile augmentée / - incremento de carga
²⁾ + increased payload / + carico utile maggiorato / + charge utile augmentée / + incremento de carga

									
MERCEDES BENZ B-Klasse (W245) (05-11)									
	B 150 / B 160 B 160 BlueEfficiency B 170 / B 180 B 170 NGT B 180 BlueEfficiency B 180 CDI B 180 NGT B 200 B 200 CDI B 200 Turbo	70 85 85 80 85 100 103 142		03.05 04.11 04.09 04.11 03.05 04.11 04.08 04.09 04.09 04.11 03.05 04.11 04.09 04.11 03.05 04.11 03.05 04.11 03.05 04.11	24.5126-0474.3	331017	2	L=474	
	B 150 / B 160 B 160 BlueEfficiency B 170 / B 180 B 170 NGT B 180 BlueEfficiency B 180 CDI B 180 NGT B 200 B 200 CDI B 200 Turbo	70 85 85 80 85 100 103 142		03.05 04.11 04.09 04.11 03.05 04.11 04.08 04.09 04.09 04.11 03.05 04.11 04.09 04.11 03.05 04.11 03.05 04.11 03.05 04.11	24.3301-1703.7 24.3301-1704.7 24.0101-3802.2	220683 220684 260100	<input type="checkbox"/> <input type="checkbox"/>	D=30, - Halter D=30, - Halter Bremsattel-Zubehör	TRW TRW TRW
	B 150 / B 160 B 160 BlueEfficiency B 170 / B 180 B 170 NGT B 180 BlueEfficiency B 180 CDI B 180 NGT B 200 B 200 CDI B 200 Turbo	70 85 85 80 85 100 103 142		03.05 04.11 04.09 04.11 03.05 04.11 04.08 04.09 04.09 04.11 03.05 04.11 04.09 04.11 03.05 04.11 03.05 04.11 03.05 04.11	24.5238-0230.3	330673	2	L=230	
	B 150 / B 160 B 160 BlueEfficiency B 170 / B 180 B 170 NGT B 180 BlueEfficiency B 180 CDI B 180 NGT B 200 B 200 CDI B 200 Turbo	70 85 85 80 85 100 103 142		03.05 04.11 04.09 04.11 03.05 04.11 04.08 04.09 04.09 04.11 03.05 04.11 04.09 04.11 03.05 04.11 03.05 04.11 03.05 04.11	24.3727-0452.2 24.3727-0451.2	580452 580451	<input type="checkbox"/> <input type="checkbox"/>	L=587 L=1215	
MERCEDES BENZ CITAN (W415) (12-)									
	108 CDI 108 CDI BE 109 CDI 109 CDI BE 111 CDI 111 CDI BE 112 BE	55 55 66 66 81 81 84		09.12 09.12 09.12 09.12 06.13 06.13 06.13	24.3222-1729.3	020526	+ 14" Rad ¹⁾	Rz 22,20	
MERCEDES BENZ C-Klasse (W202) Limousine (93-00)									
	C 180 C 200 C 200 D C 200 Kompressor C 220 C 220 D C 230 C 230 Kompressor C 250 D C 250 TD C 280 C 36 AMG	A021677 / F011180 A519673 / F619720 A072908 / F060570 A519673 / F619720 A072908 / F060570 A519673 / F619720 A072908 / F060570 A519673 / F619720 A072908 / F060570 A519673 / F619720 A072908 / F060570 A519673 / F619720 A072908 / F060570	A519673 / F619720 A519673 / F619720 A519673 / F619720 A519673 / F619720 A519673 / F619720 A519673 / F619720 A519673 / F619720 A519673 / F619720 A519673 / F619720 A519673 / F619720 A519673 / F619720 A519673 / F619720 A519673 / F619720	01.94 10.95 03.93 07.96 09.95 09.95 06.93 05.97 05.94 08.97	03.7760-2702.4	300090		10" ATE	
	C 180 C 200 D C 220 D C 250 D	A021676 / F011179 A072907 / F060569 A072907 / F060569 A072907 / F060569	A519673 / F619720 A519673 / F619720 A519673 / F619720 A519673 / F619720	03.93 03.93 06.93 06.93	24.2022-1601.3	010340		Thz 22,20/17,46	
	C 180 C 180 C 200 C 200 D C 220 C 220 D C 250 D C 280 C 36 AMG	A021677 F011180 A072908 / F060570 A072908 / F060570 A072908 / F060570 A072908 / F060570 A072908 / F060570 A136773 / F110261 A136773 / F110261	A136773 / F619720 A136773 / F110261 A136773 / F110261 A136773 / F110261 A136773 / F110261 A136773 / F110261 A136773 / F110261 A136773 / F110261 A136773 / F110261	05.00 01.94 05.00 06.93 08.95 06.93 05.94	03.2023-0825.3	010028		Thz 23,81/19,05 ATE	
	C 180 C 200 C 200 Kompressor C 220 C 220 D C 230 C 230 Kompressor C 250 TD C 280 C 36 AMG	A136774 A136774 / F110262 A136774 / F110262 A136774 / F110262 A136774 / F110262 A519673 / F619720 A519673 / F619720 A519673 / F619720 A136774 / F110262 A136774 / F110262	A519673 / F619720 A519673 / F619720 A519673 / F619720 A519673 / F619720 A519673 / F619720 A519673 / F619720 A519673 / F619720 A519673 / F619720 A519673 / F619720 A519673 / F619720	05.00 05.00 10.95 08.96 07.96 09.95 09.95 05.97 08.97	24.2023-1701.3	010514		Thz 23,81/19,05 TRW	

¹⁾ + 14" wheel / + ruota 14" / + roue 14" / + rueda 14"



































































































								
MERCEDES BENZ C-Klasse (W202) Limousine (93-00)								
	C 200 CDI C 200 Kompressor C 220 CDI C 220 D C 230 Kompressor C 240 C 250 TD C 280	A519674 / F619721 A519674 / F619721 A519674 / F619721 A519674 / F619721	03.98 09.97 06.97 06.97	05.00 05.00 05.00 05.00 05.00 05.00 05.00	24.2023-1702.3	010534		ThZ 23,81/19,05 TRW
	C 240 C 280 C 43 AMG		06.97 06.97 09.97	05.00 05.00 05.00	24.2023-1704.3	010635		ThZ 23,81 TRW
	C 180 C 220 D C 230 C 250 D	A344661 / F331441 A344661 / F331441 A54906 / F647651 A344661 / F331441		05.00 05.00 06.97 08.95	24.3541-1755.7 24.3541-1756.7	220481 220482	<input type="checkbox"/> <input type="checkbox"/>	D=54, - Halter D=54, - Halter TRW TRW
	C 200 C 200 CDI C 220 C 220 CDI C 230	A344661 / F331441 A344661 / F331441 A344661 / F331441 A545905 / F647650		05.00 03.98 08.96 09.97 07.96	24.3541-1751.7 24.3541-1752.7	220477 220478	<input type="checkbox"/> <input type="checkbox"/>	D=54, - Halter D=54, - Halter TRW TRW
	C 200 Kompressor C 230 Kompressor C 240 C 250 TD C 280	A344661 / F331441	10.95 09.95 06.97 09.95 05.00	05.00 05.00 05.00 05.00 05.00	11.3571-8512.2 24.3571-8511.5 24.3571-8512.5 11.0441-5703.2 11.8170-0401.1 11.0101-5407.2 11.8171-0008.1 11.8116-0253.1	220316 240491 240492 250145 260103 260011 990049 390512	<input type="checkbox"/> <input type="checkbox"/> <input type="checkbox"/> <input type="checkbox"/> <input type="checkbox"/> <input type="checkbox"/> <input type="checkbox"/> <input type="checkbox"/> 2 2	D=57, - Halter D=57, - Halter D=57, - Halter Dichtungssatz Halter Hülzensatz Führungsbolzen Haltefeder ATE ATE ATE ATE ATE
	C 36 AMG C 36 AMG C 43 AMG	A344660 / F331440 A344661 / F331441	05.94 08.97 09.97	05.00 05.00 05.00	13.0441-4214.2 13.4421-8010.2 13.0441-4214.2	250091 210229 250091	<input type="checkbox"/> <input type="checkbox"/>	Dichtungssatz D=42/38 Dichtungssatz ATE ATE
	C 180 C 200 C 200 D C 220 C 220 D C 250 D C 280 C 36 AMG	A344660 / F331440 A344660 / F331440 A344660 / F331440 A344660 / F331440 A344660 / F331440 A344660 / F331440 A344660 / F331440 A344660 / F331440	03.93 01.94 03.93 03.93 06.93 06.93 06.93 05.94		24.5113-0483.3	331397	2	L=483
	C 180 C 200 C 200 CDI C 200 D C 200 Kompressor C 220 C 220 CDI C 220 D C 230 C 230 Kompressor C 240 C 250 D C 250 TD C 280 C 36 AMG C 43 AMG	A344661 / F331441 A344661 / F331441 A344661 / F331441 A344661 / F331441 A344661 / F331441 A344661 / F331441 A344661 / F331441 A344661 / F331441 A344661 / F331441 A344661 / F331441 A344661 / F331441 A344661 / F331441 A344661 / F331441 A344661 / F331441 A344661 / F331441	05.00 05.00 03.98 10.95 08.96 09.97 05.00 07.96 06.97 09.95 05.00 06.97 05.00 09.95 05.00 08.97 09.97 05.00		83.7705-0386.3	330828	2	L=385
	C 180 C 200 C 200 D C 220 C 220 D C 250 D	A419828 / F443892 A419828 / F443892 A419828 / F443892 A419828 / F443892 A419828 / F443892 A419828 / F443892	03.93 01.94 03.93 03.93 06.93 06.93		13.2351-8005.2 24.9235-8005.5 24.9235-8006.5 13.0441-3505.2	210014 230023 230024 250051	<input type="checkbox"/> <input type="checkbox"/> <input type="checkbox"/> <input type="checkbox"/>	D=35 D=35 D=35 Dichtungssatz ATE ATE ATE ATE
	C 180 C 200 C 200 CDI C 200 D C 220 C 220 CDI C 220 D C 230 C 250 D C 280	A419829 / F443893 A419829 / F443893 A419829 / F443893 A419829 / F443893 A419829 / F443893 A419829 / F443893 A419829 / F443893 A419829 / F443893 A419829 / F443893 A344660 / F331440	05.00 05.00 03.98 05.00 08.96 09.97 05.00 07.96 08.95 06.93	- ASR	13.2351-8019.2 13.2351-8020.2 13.0441-3507.2	210139 210140 250053	<input type="checkbox"/> <input type="checkbox"/> <input type="checkbox"/>	D=35 D=35 Dichtungssatz ATE ATE ATE
	C 200 Kompressor C 230 Kompressor C 240 C 250 TD C 280 C 280	A487047 / F576240 A487047 / F576240 A487047 / F576240 A487047 / F576240 A344661 / F331441 A487047 / F576240	10.95 09.95 06.97 09.95 05.97 06.97	- ASR	13.2381-8035.2 24.9238-8035.5 24.9238-8036.5 13.0441-3817.2	210037 230025 230026 250071	<input type="checkbox"/> <input type="checkbox"/> <input type="checkbox"/> <input type="checkbox"/>	D=38 D=38 D=38 Dichtungssatz ATE ATE ATE ATE
	C 200 Kompressor C 230 Kompressor C 240 C 250 TD C 280 C 280	A487048 / F576241 A487048 / F576241 A487048 / F576241 A487048 / F576241 A487048 / F576241	05.00 05.00 05.00 05.00 05.00		13.2361-8003.2 13.2361-8004.2 13.0441-3609.2	210220 210221 250057	<input type="checkbox"/> <input type="checkbox"/>	D=36 D=36 Dichtungssatz ATE ATE ATE
	C 280		06.93	05.97	+ ASR	13.0441-3817.2	250071	Dichtungssatz ATE

MERCEDES BENZ C-Klasse (W202) Limousine (93-00)

	C 36 AMG	A344660 / F331440	05.94				13.2381-8034.2 24.9238-8033.5 24.9238-8034.5 13.0441-3817.2	210223 230015 230016 250071	<input type="checkbox"/> <input type="checkbox"/> <input type="checkbox"/>	D=38 D=38 D=38 Dichtungssatz	ATE ATE ATE ATE
	C 36 AMG	A344661 / F331441		08.97			13.2361-8001.2 13.2361-8002.2 24.9236-8001.5 24.9236-8002.5 13.0441-3606.2	210214 210215 230007 230008 250147	<input type="checkbox"/> <input type="checkbox"/> <input type="checkbox"/> <input type="checkbox"/> <input type="checkbox"/>	D=36 D=36 D=36 D=36 Dichtungssatz	ATE ATE ATE ATE ATE
	C 43 AMG		09.97	05.00			13.2421-8025.2 13.2421-8026.2 13.0441-3606.2	210061 210062 250147	<input type="checkbox"/> <input type="checkbox"/>	D=42 D=42 Dichtungssatz	ATE ATE ATE
	C 180 C 200 C 200 D C 220 C 220 D C 250 D C 280		03.93 01.94 03.93 03.93 06.93 06.93 06.93	08.95 08.95 08.95 08.95 08.95 08.95 08.95			83.7704-0281.3	330804	2		L=280
	C 180 C 200 C 200 CDI C 200 D C 200 Kompressor C 220 C 220 CDI C 220 D C 230 C 230 Kompressor C 240 C 250 TD C 280 C 36 AMG C 43 AMG		09.95 09.95 03.98 09.95 10.95 09.95 09.97 09.95 07.96 09.95 06.97 09.95 09.95 05.94 09.97	05.00 05.00 05.00 05.00 05.00 08.96 05.00 05.00 06.97 05.00 05.00 05.00 05.00 08.97 05.00			24.5123-0281.3	330877	2		L=280
	C 180 C 200 C 200 CDI C 200 D C 200 Kompressor C 220 C 220 CDI C 220 D C 230 C 230 Kompressor C 240 C 250 D C 250 TD C 280 C 36 AMG C 43 AMG		03.93 01.94 03.98 03.93 10.95 03.93 09.97 06.93 07.96 09.95 06.97 06.93 09.95 06.93 09.97	05.00 05.00 05.00 05.00 05.00 08.96 05.00 05.00 06.97 05.00 05.00 08.95 05.00 05.00 08.97 05.00			24.3727-0423.2 24.3727-0418.2 24.3727-0419.2	580423 580418 580419	1 <input type="checkbox"/> <input type="checkbox"/>		L=2554 L=960 L=925
	C 180 C 200 C 200 CDI C 200 D C 200 Kompressor C 220 C 220 CDI C 220 D C 230 C 230 Kompressor C 240 C 250 D C 250 TD C 280 C 36 AMG C 43 AMG		03.93 01.94 03.98 03.93 10.95 03.93 09.97 06.93 07.96 09.95 06.97 06.93 09.95 06.93 05.94 09.97	05.00 05.00 05.00 05.00 05.00 08.96 05.00 05.00 06.97 05.00 05.00 08.95 05.00 05.00 08.97 05.00			24.3727-0418.2 24.3727-0419.2	580418 580419	<input type="checkbox"/> <input type="checkbox"/>		L=960 L=925
	C 180 C 200 C 200 CDI C 200 D C 220 C 220 CDI C 220 D C 230 C 240 C 250 D C 250 TD C 280 C 36 AMG		03.93 01.94 03.98 03.93 03.93 09.97 06.93 07.96 06.97 06.93 09.95 06.93 05.94	05.00 05.00 05.00 05.00 08.96 05.00 05.00 06.97 05.00 08.95 05.00 05.00 08.97			24.2419-0915.3 24.2419-1703.3	030045 030097		+ GG ¹⁾ + ALU ²⁾	Gz 19,05 Gz 19,05
	C 180 C 200 C 200 D C 220 C 220 D C 250 D C 250 TD		03.93 01.94 03.93 03.93 06.93 06.93 09.95	05.00 05.00 05.00 08.96 05.00 08.95 05.00			03.2523-1310.3	040022			Nz 23,81

¹⁾ + cast iron / + ghisa / + fonte grise / + fundición de gris

²⁾ + aluminium / + alluminio / + aluminium / + aluminio

									
MERCEDES BENZ C-Klasse (W202) Limousine (93-00)									
	C 280 C 36 AMG		06.93 05.94	05.00 08.97		03.2523-1310.3 040022		Nz 23,81	
MERCEDES BENZ C-Klasse (S202) Kombi (96-01)									
	C 180 C 200 C 200 D C 200 Kompressor C 220 D C 230 C 250 TD	F619720 F619720 F619720 F619720 F619720 F619720 F619720	06.96 06.96 07.96 11.96 06.96 06.96 06.96			03.7760-2702.4 300090		10" ATE	
	C 180 C 200 C 200 D C 200 Kompressor C 220 D C 230 C 250 TD	F619720 F619720 F619720 F619720 F619720 F619720 F619720	06.96 06.96 07.96 11.96 06.96 06.96 06.96			24.2023-1701.3 010514		Thz 23,81/19,05 TRW	
	C 180 C 200 C 200 CDI C 200 D C 200 Kompressor C 220 CDI C 220 D C 230 C 230 Kompressor C 240 C 250 TD C 280	F619721 F619721 F619721 F619621 F619721 F619721 F619721 F619721	04.01 04.01 03.98 04.01 04.01 09.97 04.01 06.97 06.97 04.01 04.01 06.97 04.01	04.01 04.01 04.01 04.01 04.01 04.01 04.01 04.01 - ESP - ESP		24.2023-1702.3 010534		Thz 23,81/19,05 TRW	
	C 240 C 280 C 43 AMG		06.97 06.97 09.97	04.01 04.01 04.01	+ ESP + ESP	24.2023-1704.3 010635		Thz 23,81 TRW	
	C 180 C 200 C 200 CDI C 200 D C 220 CDI C 220 D C 230 C 200 Kompressor C 230 Kompressor C 240 C 250 TD C 280		06.96 06.96 03.98 07.96 09.97 06.96 06.96 11.96 06.97 06.97 06.96 06.97 04.01	04.01 04.01 04.01 04.01 04.01 04.01 04.01 04.01 04.01 04.01 04.01 04.01 04.01		24.3541-1751.7 24.3541-1752.7 220477 220478	 	D=54, - Halter D=54, - Halter D=57, - Halter D=57, - Halter D=57, - Halter Dichtungssatz Halter Hülsensatz Führungsbolzen Haltefeder	
	C 200 Kompressor C 230 Kompressor C 240 C 250 TD C 280		11.96 06.97 06.97 06.96 06.97	04.01 04.01 04.01 04.01 04.01		11.3571-8512.2 220316 24.3571-8511.5 240491 24.3571-8512.5 240492 11.0441-5703.2 250145 11.8170-0401.1 260103 11.0101-5407.2 260011 11.8171-0008.1 990049 11.8116-0253.1 390512	                          		D=57, - Halter D=57, - Halter D=57, - Halter Dichtungssatz Halter Hülsensatz Führungsbolzen Haltefeder
	C 43 AMG		09.97	04.01		11.8116-0133.1 390511	 	Haltefeder ATE	
	C 180 C 200 C 200 CDI C 200 D C 200 Kompressor C 220 CDI C 220 D C 230 C 230 Kompressor C 240 C 250 TD C 280 C 43 AMG		06.96 06.96 03.98 07.96 11.96 09.97 06.96 06.96 06.97 06.97 06.97 06.96 06.97 09.97 06.96 06.96	04.01 04.01 04.01 04.01 04.01 04.01 04.01 04.01 04.01 04.01 04.01 04.01 04.01 04.01 04.01 04.01		83.7705-0386.3 330828	                      		L=385
	C 180 C 200 C 200 CDI C 200 D C 200 Kompressor C 220 CDI C 220 D C 230 C 250 TD	F576240 F576240 F576240 F576240 F576240 F576240 F576240 F576240 F576240	06.96 06.96 03.98 07.96 11.96 09.97 06.96 06.96 06.96	04.01 04.01 04.01 04.01 04.01 04.01 04.01 04.01 04.01		13.2381-8035.2 210037 24.9238-8035.5 230025 24.9238-8036.5 230026 13.0441-3817.2 250071	                		D=38 D=38 D=38 Dichtungssatz
	C 180 C 200 C 200 CDI C 200 D C 200 Kompressor C 220 CDI C 220 D C 230 C 230 Kompressor C 240 C 250 TD C 280	F576241 F576241 F576241 F576241 F576241 F576241 F576241 F576241 F576241 F576241 F576241	04.01 04.01 04.01 04.01 04.01 04.01 04.01 06.97 06.97 04.01 04.01 04.01			13.2361-8003.2 210220 13.2361-8004.2 210221 13.0441-3609.2 250057	            		D=36 D=36 Dichtungssatz



MERCEDES BENZ C-Klasse (S202) Kombi (96-01)

	C 43 AMG		09.97	04.01		13.2421-8025.2	210061	<input type="checkbox"/>		D=42	ATE
						13.2421-8026.2	210062	<input type="checkbox"/>		D=42	ATE
						13.0441-3606.2	250147	<input type="checkbox"/>		Dichtungssatz	ATE
	C 180		06.96	04.01		24.5123-0281.3	330877	2		L=280	
	C 200		06.96	04.01							
	C 200 CDI		03.98	04.01							
	C 200 D		07.96	04.01							
	C 200 Kompressor		11.96	04.01							
	C 220 CDI		09.97	04.01							
	C 220 D		06.96	04.01							
	C 230		06.96	06.97							
	C 230 Kompressor		06.97	04.01							
	C 240		06.97	04.01							
	C 250 TD		06.96	04.01							
	C 280		06.97	04.01							
	C 43 AMG		09.97	04.01							
	C 180	◀	06.96	04.01		24.3727-0423.2	580423	1	<input type="checkbox"/>	L=2554	
	C 200	◀	06.96	04.01		24.3727-0418.2	580418		<input type="checkbox"/>	L=960	
	C 200 CDI	◀	03.98	04.01		24.3727-0419.2	580419		<input type="checkbox"/>	L=925	
	C 200 D	◀	07.96	04.01							
	C 200 Kompressor	◀	11.96	04.01							
	C 220 CDI	◀	09.97	04.01							
	C 220 D	◀	06.96	04.01							
	C 230	◀	06.96	06.97							
	C 230 Kompressor	◀	06.97	04.01							
	C 240	◀	06.97	04.01							
	C 250 TD	◀	06.96	04.01							
	C 280	◀	06.97	04.01							
	C 43 AMG	◀	09.97	04.01							
	C 180	▶	06.96	04.01		24.3727-0418.2	580418		<input type="checkbox"/>	L=960	
	C 200	▶	06.96	04.01		24.3727-0419.2	580419		<input type="checkbox"/>	L=925	
	C 200 CDI	▶	03.98	04.01							
	C 200 D	▶	07.96	04.01							
	C 200 Kompressor	▶	11.96	04.01							
	C 220 CDI	▶	09.97	04.01							
	C 220 D	▶	06.96	04.01							
	C 230	▶	06.96	06.97							
	C 230 Kompressor	▶	06.97	04.01							
	C 240	▶	06.97	04.01							
	C 250 TD	▶	06.96	04.01							
	C 280	▶	06.97	04.01							
	C 43 AMG	▶	09.97	04.01		24.3727-0418.2	580418		<input type="checkbox"/>	L=960	
						24.3727-0419.2	580419		<input type="checkbox"/>	L=925	
	C 180		06.96	04.01		24.2419-0915.3	030045		+ GG ¹⁾	Gz 19,05	
	C 200		06.96	04.01		24.2419-1703.3	030097		+ ALU ²⁾	Gz 19,05	
	C 200 CDI		03.98	04.01							
	C 200 D		07.96	04.01							
	C 200 Kompressor		11.96	04.01							
	C 220 CDI		09.97	04.01							
	C 220 D		06.96	04.01							
	C 230		06.96	06.97							
	C 230 Kompressor		06.97	04.01							
	C 240		06.97	04.01							
	C 250 TD		06.96	04.01							
	C 280		06.97	04.01							
	C 43 AMG		09.97	04.01							
	C 180		06.96	04.01		03.2523-1310.3	040022			Nz 23,81	
	C 200		06.96	04.01							
	C 200 CDI		03.98	04.01							
	C 200 D		07.96	04.01							
	C 200 Kompressor		11.96	04.01							
	C 220 CDI		09.97	04.01							
	C 220 D		06.96	04.01							
	C 230		06.96	06.97							
	C 230 Kompressor		06.97	04.01							
	C 240		06.97	04.01							
	C 250 TD		06.96	04.01							
	C 280		06.97	04.01							

MERCEDES BENZ C-Klasse (W203) Limousine (00-07)

	C 180	◀	04.00	04.07		03.7848-2002.4	300166			7/8" Tandem	ATE
	C 180 Kompressor	◀	05.02	04.07		03.0655-0007.2	370007			Wegsensor	ATE
	C 200 CDI		04.00	04.07							
	C 200 CDI	◀ 90	04.03	04.07							
	C 200 CGI Kompressor	◀	07.03	04.07							
	C 200 Kompressor	◀	04.00	04.07							
	C 200 Kompressor	◀ 120	05.00	05.02							
	C 220 CDI	◀	04.00	04.07							
	C 220 CDI	◀ 110	02.04	04.07							
	C 230	◀	06.05	04.07							
	C 230 Kompressor	◀	02.04	04.07							
	C 240	◀	04.00	04.07							
	C 240 4-matic	◀	07.02	04.07							
	C 270 CDI	◀	08.00	04.07							
	C 280	◀	06.05	04.07							
	C 280 4-matic	◀	06.05	04.07							
	C 30 CDI AMG	◀	01.03	04.07							

1) + cast iron / + ghisa / + fonte grise / + fundición de gris
 2) + aluminium / + alluminio / + aluminium / + aluminio





MERCEDES BENZ C-Klasse (W203) Limousine (00-07)

	C 32 AMG Kompressor		03.01	04.07	03.7848-2002.4	300166		7/8" Tandem Wegsensor	ATE																																																			
	C 320		04.00	04.07						03.0655-0007.2	370007																																																	
	C 320 4-matic		07.02	04.07																																																								
	C 320 CDI		02.05	04.07																																																								
	C 350		06.05	04.07																																																								
	C 350 4-matic		06.05	04.07																																																								
	C 55 AMG		02.04	04.07																																																								
	C 180		04.00	04.07	03.0655-0007.2	370007		Wegsensor	ATE																																																			
	C 180 Kompressor		05.02	04.07																																																								
	C 200 CDI		04.00	04.07																																																								
	C 200 CDI	90	04.03	04.07																																																								
	C 200 CGI Kompressor		07.03	04.07																																																								
	C 200 Kompressor		04.00	04.07																																																								
	C 200 Kompressor	120	05.00	05.02																																																								
	C 220 CDI		04.00	04.07																																																								
C 220 CDI	110	02.04	04.07																																																									
C 230		06.05	04.07																																																									
C 230 Kompressor		02.04	04.07																																																									
C 240		04.00	04.07																																																									
C 240 4-matic		07.02	04.07																																																									
C 270 CDI		08.00	04.07																																																									
C 280		06.05	04.07																																																									
C 30 CDI AMG		01.03	04.07																																																									
C 32 AMG Kompressor		03.01	04.07																																																									
C 320		04.00	04.07																																																									
C 320 4-matic		07.02	04.07																																																									
C 320 CDI		02.05	04.07																																																									
C 350		06.05	04.07																																																									
C 350 4-matic		06.05	04.07																																																									
C 55 AMG		02.04	04.07																																																									
	C 180		04.00	04.07	03.2023-1741.3	010703		Thz 23,81/20,64																																																				
	C 180 Kompressor		05.02	04.07																																																								
	C 200 CDI		04.00	04.07																																																								
	C 200 CDI	90	04.03	04.07																																																								
	C 200 CGI Kompressor		07.03	04.07																																																								
	C 200 Kompressor		04.00	04.07																																																								
	C 200 Kompressor	120	05.00	05.02																																																								
	C 220 CDI		04.00	04.07																																																								
	C 220 CDI	110	02.04	04.07																																																								
	C 230 Kompressor		02.04	04.07																																																								
	C 240		04.00	04.07																																																								
	C 230		06.05	04.07	03.2025-1741.3	010705		Thz 25,40/20,64	ATE																																																			
	C 240 4-matic		07.02	04.07																																																								
	C 270 CDI		08.00	04.07																																																								
	C 280		06.05	04.07																																																								
C 280 4-matic		06.05	04.07																																																									
C 30 CDI AMG		01.03	04.07																																																									
C 32 AMG Kompressor		03.01	04.07																																																									
C 320		04.00	04.07																																																									
C 320 4-matic		07.02	04.07																																																									
C 320 CDI		02.05	04.07																																																									
C 350		06.05	04.07																																																									
C 350 4-matic		06.05	04.07																																																									
C 55 AMG		02.04	04.07																																																									
C 180		04.00	04.07																																																									
C 180 Kompressor		05.02	04.07																																																									
C 200 CDI		04.00	04.07																																																									
C 200 CDI	90	04.03	04.07																																																									
C 200 CGI Kompressor		07.03	04.07																																																									
C 200 Kompressor		04.00	04.07																																																									
C 200 Kompressor	120	05.00	05.02																																																									
C 220 CDI		04.00	04.07																																																									
C 220 CDI	110	02.04	04.07																																																									
C 180 Kompressor		05.02	04.07	24.3571-1739.7	220667		D=57, - Halter	TRW																																																				
C 200 CDI		04.00	04.07						24.3571-1740.7	220668		D=57, - Halter																																																
C 200 CDI	90	04.03	04.07										24.0101-3803.2	260101		Bremsattel-Zubehör																																												
C 200 CGI Kompressor		07.03	04.07																																																									
C 200 Kompressor		04.00	04.07																																																									
C 200 Kompressor	120	05.00	05.02																																																									
C 220 CDI		04.00	04.07																																																									
C 220 CDI	110	02.04	04.07																																																									
C 180 Kompressor		05.02	04.07																																																									
C 200 CDI	90	04.03	04.07																																																									
C 200 CGI Kompressor		07.03	04.07																																																									
C 200 Kompressor		04.00	04.07																																																									
C 220 CDI	110	04.00	04.07																																																									
C 220 CDI		02.04	04.07																																																									
C 230 Kompressor		02.04	04.07																																																									
C 240		04.00	04.07																																																									
C 270 CDI		08.00	04.07																																																									
C 320		04.00	04.07																																																									
C 180 Kompressor		04.07	04.07	24.0101-3803.2	260101		Bremsattel-Zubehör	TRW																																																				
C 200 CDI	90	04.07	04.07																																																									
C 200 CGI Kompressor		04.07	04.07																																																									
C 200 Kompressor		04.07	04.07																																																									
C 220 CDI	110	04.07	04.07																																																									
C 230		06.05	04.07																																																									
C 230 Kompressor		04.07	04.07																																																									
C 240		04.07	04.07																																																									
C 270 CDI		04.07	04.07																																																									
C 280		06.05	04.07																																																									
C 280 4-matic		06.05	04.07																																																									
C 320		04.07	04.07																																																									
C 320 CDI		02.05	04.07																																																									

1) - sport package/- sport package AMG / - pacchetto sportivo/- pacchetto sport.AMG / - version sport/- version sport AMG / - kit deportivo/- kit deportivo AMG
 2) + sports package/+ sports package AMG / + pacchetto sportivo/+ pacchetto sport.AMG / + version sport/+ version sport AMG / + kit deportivo/+ kit deportivo AMG

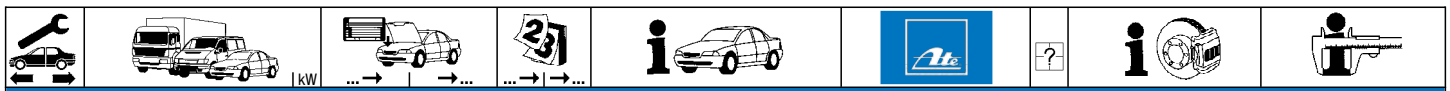

MERCEDES BENZ C-Klasse (W203) Limousine (00-07)

	C 350		06.05	04.07	- Sportpaket / - Sportpaket AMG ¹⁾	24.0101-3803.2	260101		Bremssattel-Zubehör	TRW
	C 230		06.05	04.07	- Sportpaket / - Sportpaket AMG ¹⁾	24.3571-1721.7	220555		D=57, - Halter	TRW
	C 230 Kompressor		02.04	04.07	- Sportpaket / - Sportpaket AMG ¹⁾	24.3571-1722.7	220556		D=57, - Halter	TRW
	C 240		04.00	04.07	- Sportpaket / - Sportpaket AMG ¹⁾	24.0101-3803.2	260101		Bremssattel-Zubehör	TRW
	C 270 CDI		08.00	04.07	- Sportpaket / - Sportpaket AMG ¹⁾					
	C 280		06.05	04.07	- Sportpaket / - Sportpaket AMG ¹⁾					
	C 320		04.00	04.07	- Sportpaket / - Sportpaket AMG ¹⁾					
	C 240 4-matic		07.02	04.07		24.0101-3803.2	260101		Bremssattel-Zubehör	TRW
	C 280 4-matic		06.05	04.07	- Sportpaket / - Sportpaket AMG ¹⁾	13.8190-0330.1	990134	2	Halterschraube	
	C 320 4-matic		07.02	04.07						
	C 350 4-matic		06.05	04.07	- Sportpaket / - Sportpaket AMG ¹⁾	13.8190-0330.1	990134	2	Halterschraube	
	C 180		04.00	04.07		83.7705-0386.3	330828	2	L=385	
	C 180 Kompressor		05.02	04.07						
	C 200 CDI		04.00	04.07						
	C 200 CDI	90	04.03	04.07						
	C 200 CGI Kompressor		07.03	04.07						
	C 200 Kompressor		04.00	04.07						
	C 200 Kompressor	120	05.00	05.02						
	C 220 CDI		04.00	04.07						
	C 220 CDI	110	02.04	04.07						
	C 230		06.05	04.07						
	C 230 Kompressor		02.04	04.07						
	C 240		04.00	04.07						
	C 270 CDI		08.00	04.07						
	C 280		06.05	04.07						
	C 30 CDI AMG		01.03	04.07						
	C 32 AMG Kompressor		03.01	04.07						
	C 320		04.00	04.07						
	C 320 CDI		02.05	04.07						
	C 350		06.05	04.07						
	C 55 AMG		02.04	04.07						
	C 180		04.00	04.07		13.9361-0023.2	210241		D=36	ATE
	C 180 Kompressor		05.02	04.07	- Sportpaket / - Sportpaket AMG ¹⁾	13.9361-0024.2	210242		D=36	ATE
	C 200 CDI		04.00	04.07	- Sportpaket / - Sportpaket AMG ¹⁾	13.0441-3609.2	250057		Dichtungssatz	ATE
	C 200 CDI	90	04.03	04.07	- Sportpaket / - Sportpaket AMG ¹⁾					
	C 200 CGI Kompressor		07.03	04.07	- Sportpaket / - Sportpaket AMG ¹⁾					
	C 200 Kompressor		04.00	04.07	- Sportpaket / - Sportpaket AMG ¹⁾					
	C 200 Kompressor	120	05.00	05.02						
	C 220 CDI		04.00	04.07	- Sportpaket / - Sportpaket AMG ¹⁾					
	C 220 CDI	110	02.04	04.07	- Sportpaket / - Sportpaket AMG ¹⁾					
	C 180 Kompressor		05.02	04.07	+ Sportpaket / + Sportpaket AMG ²⁾	13.9361-0035.2	210253		D=36	ATE
	C 200 CDI		04.00	04.07	+ Sportpaket / + Sportpaket AMG ²⁾	13.9361-0036.2	210254		D=36	ATE
	C 200 CDI	90	04.03	04.07	+ Sportpaket / + Sportpaket AMG ²⁾	13.0441-3609.2	250057		Dichtungssatz	ATE
	C 200 CGI Kompressor		07.03	04.07	+ Sportpaket / + Sportpaket AMG ²⁾					
	C 200 Kompressor		04.00	04.07	+ Sportpaket / + Sportpaket AMG ²⁾					
	C 220 CDI		04.00	04.07	+ Sportpaket / + Sportpaket AMG ²⁾					
	C 220 CDI	110	02.04	04.07	+ Sportpaket / + Sportpaket AMG ²⁾					
	C 230		06.05	04.07						
	C 230 Kompressor		02.04	04.07						
	C 240		04.00	04.07						
	C 240 4-matic		07.02	04.07						
	C 270 CDI		08.00	04.07						
	C 280		06.05	04.07						
	C 280 4-matic		06.05	04.07						
	C 320		04.00	04.07						
	C 320 4-matic		07.02	04.07						
	C 320 CDI		02.05	04.07						
	C 350		06.05	04.07						
	C 350 4-matic		06.05	04.07						
	C 30 CDI AMG		01.03	04.07		13.0441-4216.2	250093		Dichtungssatz	ATE
	C 32 AMG Kompressor		03.01	04.07						
	C 55 AMG		02.04	04.07						
	C 180		04.00	04.07		24.5123-0281.3	330877	2	L=280	
	C 180 Kompressor		05.02	04.07						
	C 200 CDI		04.00	04.07						
	C 200 CDI	90	04.03	04.07						
	C 200 CGI Kompressor		07.03	04.07						
	C 200 Kompressor		04.00	04.07						
	C 200 Kompressor	120	05.00	05.02						
	C 220 CDI		04.00	04.07						
	C 220 CDI	110	02.04	04.07						
	C 230		06.05	04.07						
	C 230 Kompressor		02.04	04.07						
	C 240		04.00	04.07						
	C 240 4-matic		07.02	04.07						
	C 270 CDI		08.00	04.07						
	C 280		06.05	04.07						
	C 280 4-matic		06.05	04.07						
	C 30 CDI AMG		01.03	04.07						
	C 32 AMG Kompressor		03.01	04.07						
	C 320		04.00	04.07						
	C 320 4-matic		07.02	04.07						
	C 320 CDI		02.05	04.07						
	C 350		06.05	04.07						
	C 350 4-matic		06.05	04.07						
	C 55 AMG		02.04	04.07						

¹⁾ - sport package/- sport package AMG / - pacchetto sportivo/- pacchetto sport.AMG / - version sport/- version sport AMG / - kit sportivo/- kit sportivo AMG
²⁾ + sports package/+ sports package AMG / + pacchetto sportivo/+ pacchetto sport.AMG / + version sport/+ version sport AMG / + kit sportivo/+ kit sportivo AMG



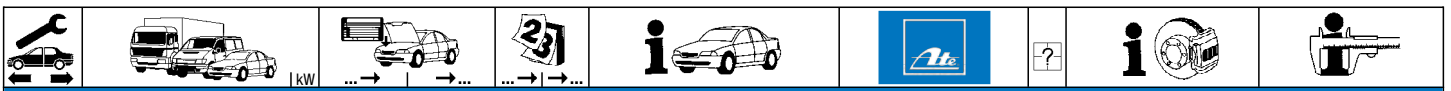

MERCEDES BENZ C-Klasse (W203) Limousine (00-07)

	C 180		04.00	04.07	24.3727-0429.2	580429	1	L=2735 L=925 L=900	
	C 180 Kompressor		05.02	04.07	24.3727-0430.2	580430	<input type="checkbox"/>		
	C 200 CDI		04.00	04.07	24.3727-0436.2	580436	<input type="checkbox"/>		
	C 200 CDI	90	04.03	04.07					
	C 200 CGI Kompressor		07.03	04.07					
	C 200 Kompressor		04.00	04.07					
	C 200 Kompressor	120	05.00	05.02					
	C 220 CDI		04.00	04.07					
	C 220 CDI	110	02.04	04.07					
	C 230		06.05	04.07					
	C 230 Kompressor		02.04	04.07					
	C 240		04.00	04.07					
	C 240 4-matic		07.02	04.07					
	C 270 CDI		08.00	04.07					
	C 280		06.05	04.07					
	C 280 4-matic		06.05	04.07					
	C 30 CDI AMG		01.03	04.07					
	C 32 AMG Kompressor		03.01	04.07					
	C 320		04.00	04.07					
	C 320 4-matic		07.02	04.07					
	C 320 CDI		02.05	04.07					
	C 350		06.05	04.07					
	C 350 4-matic		06.05	04.07					
	C 55 AMG		02.04	04.07					
	C 180		04.00	04.07	24.3727-0430.2	580430	<input type="checkbox"/>		L=925
	C 180 Kompressor		05.02	04.07	24.3727-0436.2	580436	<input type="checkbox"/>		L=900
	C 200 CDI		04.00	04.07					
	C 200 CDI	90	04.03	04.07					
	C 200 CGI Kompressor		07.03	04.07					
C 200 Kompressor		04.00	04.07						
C 200 Kompressor	120	05.00	05.02						
C 220 CDI		04.00	04.07						
C 220 CDI	110	02.04	04.07						
C 230		06.05	04.07						
C 230 Kompressor		02.04	04.07						
C 240		04.00	04.07						
C 240 4-matic		07.02	04.07						
C 270 CDI		08.00	04.07						
C 280		06.05	04.07						
C 30 CDI AMG		01.03	04.07						
C 32 AMG Kompressor		03.01	04.07						
C 320		04.00	04.07						
C 320 4-matic		07.02	04.07						
C 320 CDI		02.05	04.07						
C 350		06.05	04.07						
C 350 4-matic		06.05	04.07						
C 55 AMG		02.04	04.07						

MERCEDES BENZ C-Klasse (S203) Kombi (01-07)

	C 180		03.01	09.07	03.7848-2002.4	300166		7/8" Tandem Wegsensor	ATE ATE		
	C 180 Kompressor		05.02	09.07	03.0655-0007.2	370007					
	C 200 CDI		03.01	09.07							
	C 200 CDI	90	04.03	09.07							
	C 200 CGI Kompressor		07.03	09.07							
	C 200 Kompressor		05.02	09.07							
	C 200 Kompressor	120	03.01	04.02							
	C 220 CDI		03.01	09.07							
	C 220 CDI	110	02.04	09.07							
	C 230		06.05	09.07							
	C 230 Kompressor		02.04	09.07							
	C 240		03.01	09.07							
	C 240 4-matic		07.02	09.07							
	C 270 CDI		03.01	09.07							
	C 280		06.05	09.07							
	C 280 4-matic		06.05	09.07							
	C 30 CDI AMG		01.03	09.07							
	C 32 Kompressor AMG		03.01	09.07							
	C 320		03.01	09.07							
	C 320 4-matic		07.02	09.07							
	C 320 CDI		02.05	09.07							
	C 350		06.05	09.07							
	C 350 4-matic		06.05	09.07							
	C 55 AMG		02.04	09.07							
	C 180		03.01	09.07	03.0655-0007.2	370007				Wegsensor	ATE
	C 180 Kompressor		05.02	09.07							
	C 200 CDI		03.01	09.07							
	C 200 CDI	90	04.03	09.07							
	C 200 CGI Kompressor		07.03	09.07							
C 200 Kompressor		05.02	09.07								
C 200 Kompressor	120	03.01	04.02								
C 220 CDI		03.01	09.07								
C 220 CDI	110	02.04	09.07								
C 230		06.05	09.07								
C 230 Kompressor		02.04	09.07								
C 240		03.01	09.07								
C 240 4-matic		07.02	09.07								
C 270 CDI		03.01	09.07								



MERCEDES BENZ C-Klasse (S203) Kombi (01-07)

	C 280 C 30 CDI AMG C 32 Kompressor AMG C 320 C 320 4-matic C 320 CDI C 350 C 350 4-matic C 55 AMG		06.05 09.07 01.03 09.07 03.01 09.07 03.01 09.07 07.02 09.07 02.05 09.07 06.05 09.07 06.05 09.07 02.04 09.07		03.0655-0007.2 370007		Wegsensor	ATE
	C 180 C 180 Kompressor C 200 CDI C 200 CDI C 200 CGI Kompressor C 200 Kompressor C 200 Kompressor C 220 CDI C 220 CDI C 230 Kompressor C 240		03.01 09.07 05.02 09.07 03.01 09.07 04.03 09.07 07.03 09.07 05.02 09.07 03.01 04.02 03.01 09.07 02.04 09.07 02.04 09.07 03.01 09.07		03.2023-1741.3 010703		THz 23,81/20,64	ATE
	C 230 C 240 4-matic C 270 CDI C 280 C 280 4-matic C 30 CDI AMG C 32 Kompressor AMG C 320 C 320 4-matic C 320 CDI C 350 C 350 4-matic C 55 AMG		06.05 09.07 07.02 09.07 03.01 09.07 06.05 09.07 06.05 09.07 01.03 09.07 03.01 09.07 03.01 09.07 07.02 09.07 02.05 09.07 06.05 09.07 06.05 09.07 02.04 09.07		03.2025-1741.3 010705		THz 25,40/20,64	ATE
	C 180 C 180 Kompressor C 200 CDI C 200 CDI C 200 CGI Kompressor C 200 Kompressor C 200 Kompressor C 220 CDI C 220 CDI	90 120 110	03.01 09.07 05.02 09.07 03.01 09.07 04.03 09.07 07.03 09.07 05.02 09.07 03.01 04.02 03.01 09.07 02.04 09.07	- Sportpaket / - Sportpaket AMG ¹⁾ - Sportpaket / - Sportpaket AMG ¹⁾ - Sportpaket / - Sportpaket AMG ¹⁾ - Sportpaket / - Sportpaket AMG ¹⁾ - Sportpaket / - Sportpaket AMG ¹⁾ - Sportpaket / - Sportpaket AMG ¹⁾	24.3571-1739.7 220667 24.3571-1740.7 220668 24.0101-3803.2 260101		D=57, - Halter D=57, - Halter Bremsattel-Zubehör	TRW TRW TRW
	C 180 Kompressor C 200 CDI C 200 CDI C 200 CGI Kompressor C 200 Kompressor C 220 CDI C 220 CDI C 230 Kompressor C 240 C 270 CDI C 320	90 110	05.02 03.01 09.07 04.03 07.03 05.02 03.01 09.07 02.04 02.04 03.01 03.01	+ Sportpaket / + Sportpaket AMG ²⁾ + Sportpaket / + Sportpaket AMG ²⁾ + Sportpaket / + Sportpaket AMG ²⁾ + Sportpaket / + Sportpaket AMG ²⁾ + Sportpaket / + Sportpaket AMG ²⁾ + Sportpaket / + Sportpaket AMG ²⁾ + Sportpaket / + Sportpaket AMG ²⁾ + Sportpaket / + Sportpaket AMG ²⁾ + Sportpaket / + Sportpaket AMG ²⁾ + Sportpaket / + Sportpaket AMG ²⁾	24.0101-3803.2 260101		Bremsattel-Zubehör	TRW
	C 180 Kompressor C 200 CDI C 200 CGI Kompressor C 200 Kompressor C 220 CDI C 230 C 230 Kompressor C 240 C 270 CDI C 280 C 280 4-matic C 320 C 320 CDI C 350	90 110	09.07 09.07 09.07 09.07 09.07 06.05 09.07 09.07 09.07 09.07 09.07 06.05 09.07 06.05 09.07 02.05 09.07 06.05 09.07	+ Sportpaket / + Sportpaket AMG ²⁾ + Sportpaket / + Sportpaket AMG ²⁾ + Sportpaket / + Sportpaket AMG ²⁾ + Sportpaket / + Sportpaket AMG ²⁾ + Sportpaket / + Sportpaket AMG ²⁾ + Sportpaket / + Sportpaket AMG ²⁾ + Sportpaket / + Sportpaket AMG ²⁾ + Sportpaket / + Sportpaket AMG ²⁾ + Sportpaket / + Sportpaket AMG ²⁾ + Sportpaket / + Sportpaket AMG ²⁾ + Sportpaket / + Sportpaket AMG ²⁾ - Sportpaket / - Sportpaket AMG ¹⁾ - Sportpaket / - Sportpaket AMG ¹⁾	24.0101-3803.2 260101		Bremsattel-Zubehör	TRW
	C 230 C 230 Kompressor C 240 C 270 CDI C 280 C 320		06.05 09.07 02.04 09.07 03.01 09.07 03.01 09.07 06.05 09.07 03.01 09.07	- Sportpaket / - Sportpaket AMG ¹⁾ - Sportpaket / - Sportpaket AMG ¹⁾ - Sportpaket / - Sportpaket AMG ¹⁾ - Sportpaket / - Sportpaket AMG ¹⁾ - Sportpaket / - Sportpaket AMG ¹⁾ - Sportpaket / - Sportpaket AMG ¹⁾	24.3571-1721.7 220555 24.3571-1722.7 220556 24.0101-3803.2 260101		D=57, - Halter D=57, - Halter Bremsattel-Zubehör	TRW TRW TRW
	C 240 4-matic C 280 4-matic C 320 4-matic		07.02 09.07 06.05 09.07 07.02 09.07	- Sportpaket / - Sportpaket AMG ¹⁾	24.0101-3803.2 260101 13.8190-0330.1 990134	2	Bremsattel-Zubehör Halterschraube	TRW
	C 180 C 180 Kompressor C 200 CDI C 200 CDI C 200 CGI Kompressor C 200 Kompressor C 200 Kompressor C 220 CDI C 220 CDI C 230	90 120 110	03.01 09.07 05.02 09.07 03.01 09.07 04.03 09.07 07.03 09.07 05.02 09.07 03.01 04.02 03.01 09.07 02.04 09.07 06.05 09.07		83.7705-0386.3 330828	2	L=385	

¹⁾ - sport package/- sport package AMG / - pacchetto sportivo/- pacchetto sport.AMG / - version sport/- version sport AMG / - kit deportivo/- kit deportivo AMG
²⁾ + sports package/+ sports package AMG / + pacchetto sportivo/+ pacchetto sport.AMG / + version sport/+ version sport AMG / + kit deportivo/+ kit deportivo AMG



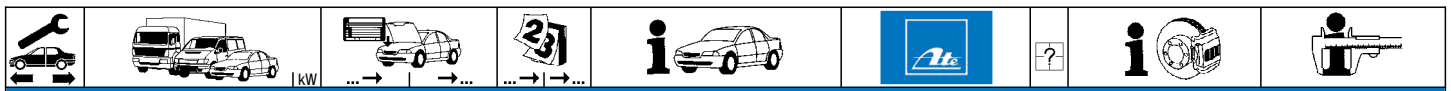

MERCEDES BENZ C-Klasse (S203) Kombi (01-07)

	C 230 Kompressor C 240 C 270 CDI C 280 C 30 CDI AMG C 32 Kompressor AMG C 320 C 320 CDI C 350 C 55 AMG			02.04 09.07 03.01 09.07 03.01 09.07 06.05 09.07 01.03 09.07 03.01 09.07 03.01 09.07 02.05 09.07 06.05 09.07 02.04 09.07		83.7705-0386.3	330828	2		L=385	
	C 180 C 180 Kompressor C 200 CDI C 200 CDI C 200 CGI Kompressor C 200 Kompressor C 200 Kompressor C 220 CDI C 220 CDI C 230 C 230 Kompressor C 240 C 240 4-matic C 270 CDI C 280 C 280 4-matic C 320 C 320 4-matic C 320 CDI C 350 C 350 4-matic	90 120 110		03.01 09.07 05.02 09.07 03.01 09.07 04.03 09.07 07.03 09.07 05.02 09.07 03.01 04.02 03.01 09.07 02.04 09.07 06.05 09.07 02.04 09.07 03.01 09.07 07.02 09.07 03.01 09.07 06.05 09.07 06.05 09.07 03.01 09.07 07.02 09.07 02.05 09.07 06.05 09.07 06.05 09.07		13.9361-0035.2 13.9361-0036.2 13.0441-3609.2	210253 210254 250057	<input type="checkbox"/> <input type="checkbox"/>		D=36 D=36 Dichtungssatz	ATE ATE ATE
	C 30 CDI AMG C 32 Kompressor AMG C 55 AMG			01.03 09.07 03.01 09.07 02.04 09.07		13.0441-4216.2	250093			Dichtungssatz	ATE
	C 350 4-matic			06.05 09.07	- Sportpaket / - Sportpaket AMG ²⁾	13.2421-8025.2 13.2421-8026.2 13.0441-4216.2	210061 210062 250093	<input type="checkbox"/> <input type="checkbox"/>		D=42 D=42 Dichtungssatz	ATE ATE ATE
	C 180 C 180 Kompressor C 200 CDI C 200 CDI C 200 CGI Kompressor C 200 Kompressor C 200 Kompressor C 220 CDI C 220 CDI C 230 C 230 Kompressor C 240 C 240 4-matic C 270 CDI C 280 C 280 4-matic C 30 CDI AMG C 32 Kompressor AMG C 320 C 320 4-matic C 320 CDI C 350 C 350 4-matic C 55 AMG	90 120 110		03.01 09.07 05.02 09.07 03.01 09.07 04.03 09.07 07.03 09.07 05.02 09.07 03.01 04.02 03.01 09.07 02.04 09.07 06.05 09.07 02.04 09.07 03.01 09.07 07.02 09.07 03.01 09.07 06.05 09.07 06.05 09.07 01.03 09.07 03.01 09.07 03.01 09.07 07.02 09.07 02.05 09.07 06.05 09.07 06.05 09.07 02.04 09.07		24.5123-0281.3	330877	2		L=280	
	C 180 C 180 Kompressor C 200 CDI C 200 CDI C 200 CGI Kompressor C 200 Kompressor C 200 Kompressor C 220 CDI C 220 CDI C 230 C 230 Kompressor C 240 C 240 4-matic C 270 CDI C 280 C 280 4-matic C 30 CDI AMG C 32 Kompressor AMG C 320 C 320 4-matic C 320 CDI C 350 C 350 4-matic C 55 AMG	90 120 110		03.01 09.07 05.02 09.07 03.01 09.07 04.03 09.07 07.03 09.07 05.02 09.07 03.01 04.02 03.01 09.07 02.04 09.07 06.05 09.07 02.04 09.07 03.01 09.07 07.02 09.07 03.01 09.07 06.05 09.07 06.05 09.07 01.03 09.07 03.01 09.07 03.01 09.07 07.02 09.07 02.05 09.07 06.05 09.07 06.05 09.07 02.04 09.07		24.3727-0429.2 24.3727-0430.2 24.3727-0436.2	580429 580430 580436	1		L=2735 L=925 L=900	
	C 180 C 180 Kompressor			03.01 09.07 05.02 09.07		24.3727-0430.2 24.3727-0436.2	580430 580436	<input type="checkbox"/> <input type="checkbox"/>		L=925 L=900	

¹⁾ + sports package/+ sports package AMG / + pacchetto sportivo/+ pacchetto sport.AMG / + version sport/+ version sport AMG / + kit deportivo/+ kit deportivo AMG















²⁾ - sport package/- sport package AMG / - pacchetto sportivo/- pacchetto sport.AMG / - version sport/- version sport AMG / - kit deportivo/- kit deportivo AMG

MERCEDES BENZ C-Klasse (S203) Kombi (01-07)

	C 200 CDI ▶		03.01	09.07		24.3727-0430.2	580430				L=925
	C 200 CDI ▶	90	04.03	09.07		24.3727-0436.2	580436	<input type="checkbox"/>			L=900
	C 200 CGI Kompressor ▶		07.03	09.07							
	C 200 Kompressor ▶		05.02	09.07							
	C 200 Kompressor ▶	120	03.01	04.02							
	C 220 CDI ▶		03.01	09.07							
	C 220 CDI ▶	110	02.04	09.07							
	C 230 ▶		06.05	09.07							
	C 230 Kompressor ▶		02.04	09.07							
	C 240 ▶		03.01	09.07							
	C 240 4-matic ▶		07.02	09.07							
	C 270 CDI ▶		03.01	09.07							
	C 280 ▶		06.05	09.07							
	C 30 CDI AMG ▶		01.03	09.07							
	C 32 Kompressor AMG ▶		03.01	09.07							
	C 320 ▶		03.01	09.07							
	C 320 4-matic ▶		07.02	09.07							
	C 320 CDI ▶		02.05	09.07							
	C 350 ▶		06.05	09.07							
	C 350 4-matic ▶		06.05	09.07							
	C 55 AMG ▶		02.04	09.07							

MERCEDES BENZ C-Klasse (CL203) Sportcoupe (01-08)

	C 160 Kompressor ▶		04.05	05.08		03.7848-2002.4	300166			7/8" Tandem	ATE
	C 180 ▶		03.01	05.08		03.0655-0007.2	370007			Wegsensor	ATE
	C 180 Kompressor ▶		05.02	05.08							
	C 200 CDI ▶		07.03	05.08							
	C 200 CGI Kompressor ▶		07.03	05.08							
	C 200 Kompressor ▶		03.01	05.08							
	C 220 ▶		05.02	05.08							
	C 220 CDI ▶		03.01	05.08							
	C 230 ▶		06.05	05.08							
	C 230 Kompressor ▶		03.01	05.08							
	C 30 CDI AMG ▶		09.02	05.08							
	C 320 ▶		09.02	05.08							
	C 350 ▶		06.05	05.08							
	C 160 Kompressor ▶		04.05	05.08		03.0655-0007.2	370007			Wegsensor	ATE
	C 180 ▶		03.01	05.08							
	C 180 Kompressor ▶		05.02	05.08							
	C 200 CDI ▶		07.03	05.08							
	C 200 CGI Kompressor ▶		07.03	05.08							
	C 200 Kompressor ▶		03.01	05.08							
	C 220 ▶		05.02	05.08							
	C 220 CDI ▶		03.01	05.08							
	C 230 ▶		06.05	05.08							
	C 230 Kompressor ▶		03.01	05.08							
	C 30 CDI AMG ▶		09.02	05.08							
	C 320 ▶		09.02	05.08							
	C 350 ▶		06.05	05.08							
	C 160 Kompressor ▶		04.05	05.08		03.2023-1741.3	010703			THz 23,81/20,64	ATE
	C 180 ▶		03.01	05.08							
	C 180 Kompressor ▶		05.02	05.08							
	C 200 CDI ▶		07.03	05.08							
	C 200 CGI Kompressor ▶		07.03	05.08							
	C 200 Kompressor ▶		03.01	05.08							
	C 220 ▶		05.02	05.08							
	C 220 CDI ▶		03.01	05.08							
	C 230 Kompressor ▶		03.01	05.08							
	C 230 ▶		06.05	05.08		03.2025-1741.3	010705			THz 25,40/20,64	ATE
	C 30 CDI AMG ▶		09.02	05.08							
	C 320 ▶		09.02	05.08							
	C 350 ▶		06.05	05.08							
	C 160 Kompressor ▶		04.05	05.08		24.3571-1739.7	220667	<input type="checkbox"/>		D=57, - Halter	TRW
	C 180 ▶		03.01	05.08		24.3571-1740.7	220668	<input type="checkbox"/>		D=57, - Halter	TRW
	C 180 Kompressor ▶		05.02	05.08		24.0101-3803.2	260101			Bremssattel-Zubehör	TRW
	C 200 CDI ▶		07.03	05.08							
	C 200 CGI Kompressor ▶		07.03	05.08							
	C 200 Kompressor ▶		03.01	05.08							
	C 220 ▶		05.02	05.08							
	C 220 CDI ▶		03.01	05.08							
	C 230 Kompressor ▶		03.01	05.08		24.3571-1721.7	220555	<input type="checkbox"/>		D=57, - Halter	TRW
						24.3571-1722.7	220556	<input type="checkbox"/>		D=57, - Halter	TRW
						24.3571-1739.7	220667	<input type="checkbox"/>		D=57, - Halter	TRW
						24.3571-1740.7	220668	<input type="checkbox"/>		D=57, - Halter	TRW
						24.0101-3803.2	260101	<input type="checkbox"/>		Bremssattel-Zubehör	TRW
	C 230 ▶		06.05	05.08		24.3571-1721.7	220555	<input type="checkbox"/>		D=57, - Halter	TRW
	C 320 ▶		09.02	05.08		24.3571-1722.7	220556	<input type="checkbox"/>		D=57, - Halter	TRW
						24.0101-3803.2	260101	<input type="checkbox"/>		Bremssattel-Zubehör	TRW
	C 160 Kompressor ▶		04.05	05.08		83.7705-0386.3	330828	2		L=385	
	C 180 ▶		03.01	05.08							
	C 180 Kompressor ▶		05.02	05.08							
	C 200 CDI ▶		07.03	05.08							
	C 200 CGI Kompressor ▶		07.03	05.08							
	C 200 Kompressor ▶		03.01	05.08							
	C 220 ▶		05.02	05.08							
	C 220 CDI ▶		03.01	05.08							
	C 230 ▶		06.05	05.08							

									
MERCEDES BENZ C-Klasse (CL203) Sportcoupe (01-08)									
	C 230 Kompressor C 30 CDI AMG C 320 C 350		03.01 09.02 09.02 06.05	05.08 05.08 05.08 05.08	83.7705-0386.3	330828	2	L=385	
	C 160 Kompressor C 180 C 180 Kompressor C 200 CDI C 200 CGI Kompressor C 200 Kompressor C 220 C 220 CDI C 230 Kompressor		04.05 03.01 05.02 07.03 07.03 03.01 05.02 03.01	05.08 05.08 05.08 05.08 05.08 05.08 05.08 05.08	13.9361-0023.2 13.9361-0024.2 13.0441-3609.2	210241 210242 250057	<input type="checkbox"/> <input type="checkbox"/> <input type="checkbox"/> <input type="checkbox"/> <input type="checkbox"/> <input type="checkbox"/> <input type="checkbox"/> <input type="checkbox"/>	D=36 D=36 Dichtungssatz	ATE ATE ATE
	C 230 Kompressor		03.01	05.08	13.9361-0035.2 13.9361-0036.2 13.9361-0023.2 13.9361-0024.2 13.0441-3609.2	210253 210254 210241 210242 250057	<input type="checkbox"/> <input type="checkbox"/> <input type="checkbox"/> + AUS <input type="checkbox"/> J <input type="checkbox"/> USA <input type="checkbox"/> + AUS <input type="checkbox"/> J <input type="checkbox"/> USA	D=36 D=36 D=36 D=36 Dichtungssatz	ATE ATE ATE ATE ATE
	C 230 C 320 C 350		06.05 09.02 06.05	05.08 05.08 05.08	13.9361-0035.2 13.9361-0036.2 13.0441-3609.2	210253 210254 250057	<input type="checkbox"/> <input type="checkbox"/> <input type="checkbox"/>	D=36 D=36 Dichtungssatz	ATE ATE ATE
	C 30 CDI AMG	A 556572	09.02		13.9361-0035.2 13.9361-0036.2 13.0441-3609.2	210253 210254 250057	<input type="checkbox"/> <input type="checkbox"/> <input type="checkbox"/>	D=36 D=36 Dichtungssatz	ATE ATE ATE
	C 30 CDI AMG	A 556573		05.08	13.0441-4216.2	250093		Dichtungssatz	ATE
	C 160 Kompressor C 180 C 180 Kompressor C 200 CDI C 200 CGI Kompressor C 200 Kompressor C 220 C 220 CDI C 230 C 230 Kompressor C 30 CDI AMG C 320 C 350		04.05 03.01 05.02 07.03 07.03 03.01 05.02 03.01 06.05 03.01 09.02 09.02 06.05	05.08 05.08 05.08 05.08 05.08 05.08 05.08 05.08 05.08 05.08 05.08 05.08 05.08	24.5123-0281.3	330877	2	L=280	
	C 160 Kompressor C 180 C 180 Kompressor C 200 CDI C 200 CGI Kompressor C 200 Kompressor C 220 C 220 CDI C 230 C 230 Kompressor C 30 CDI AMG C 320 C 350		04.05 03.01 05.02 07.03 07.03 03.01 05.02 03.01 06.05 03.01 09.02 09.02 06.05	05.08 05.08 05.08 05.08 05.08 05.08 05.08 05.08 05.08 05.08 05.08 05.08 05.08	24.3727-0429.2 24.3727-0430.2 24.3727-0436.2	580429 580430 580436	1 <input type="checkbox"/> <input type="checkbox"/> <input type="checkbox"/>	L=2735 L=925 L=900	
	C 160 Kompressor C 180 C 180 Kompressor C 200 CDI C 200 CGI Kompressor C 200 Kompressor C 220 C 220 CDI C 230 C 230 Kompressor C 30 CDI AMG C 320 C 350		04.05 03.01 05.02 07.03 07.03 03.01 05.02 03.01 06.05 03.01 09.02 09.02 06.05	05.08 05.08 05.08 05.08 05.08 05.08 05.08 05.08 05.08 05.08 05.08 05.08 05.08	24.3727-0430.2 24.3727-0436.2	580430 580436	<input type="checkbox"/> <input type="checkbox"/>	L=925 L=900	
MERCEDES BENZ C-Klasse (CLC203) Coupe (08-10)									
	CLC 160 CLC 180 Kompressor CLC 200 CDI CLC 200 Kompressor CLC 220 CDI CLC 230 CLC 350		01.09 05.08 05.08 05.08 05.08 05.08 05.08	10.10 10.10 10.10 10.10 10.10 10.10 10.10	03.7848-2002.4 03.0655-0007.2	300166 370007		7/8" Tandem Wegsensor	ATE ATE
	CLC 160 CLC 180 Kompressor CLC 200 CDI CLC 200 Kompressor CLC 220 CDI CLC 230 CLC 350		01.09 05.08 05.08 05.08 05.08 05.08 05.08	10.10 10.10 10.10 10.10 10.10 10.10 10.10	03.0655-0007.2	370007		Wegsensor	ATE
	CLC 160 CLC 180 Kompressor CLC 200 CDI CLC 200 Kompressor CLC 220 CDI		01.09 05.08 05.08 05.08 05.08	10.10 10.10 10.10 10.10 10.10	03.2023-1741.3	010703		Thz 23,81/20,64	ATE
	CLC 230 CLC 350		05.08 05.08	10.10 10.10	03.2025-1741.3	010705		Thz 25,40/20,64	ATE



MERCEDES BENZ C-Klasse (CLC203) Coupe (08-10)

	CLC 160		01.09	10.10		24.0101-3803.2	260101			Bremssattel-Zubehör	TRW
	CLC 180 Kompressor		05.08	10.10		24.3571-1739.7	220667	<input type="checkbox"/>		D=57, - Halter	TRW
	CLC 200 CDI		05.08	10.10		24.3571-1740.7	220668	<input type="checkbox"/>		D=57, - Halter	TRW
	CLC 220 CDI		05.08	10.10		24.0101-3803.2	260101			Bremssattel-Zubehör	TRW
	CLC 200 Kompressor		05.08	10.10		24.0101-3803.2	260101			Bremssattel-Zubehör	TRW
	CLC 230		05.08	10.10		24.3571-1721.7	220555	<input type="checkbox"/>		D=57, - Halter	TRW
						24.3571-1722.7	220556	<input type="checkbox"/>		D=57, - Halter	TRW
						24.0101-3803.2	260101			Bremssattel-Zubehör	TRW
	CLC 160		01.09	10.10					2		
	CLC 180 Kompressor		05.08	10.10							
	CLC 200 CDI		05.08	10.10							
	CLC 200 Kompressor		05.08	10.10							
	CLC 220 CDI		05.08	10.10							
	CLC 230		05.08	10.10							
	CLC 350		05.08	10.10							
	CLC 160		01.09	10.10		13.9361-0023.2	210241	<input type="checkbox"/>		D=36	ATE
	CLC 180 Kompressor		05.08	10.10		13.9361-0024.2	210242	<input type="checkbox"/>		D=36	ATE
	CLC 200 CDI		05.08	10.10		13.0441-3609.2	250057			Dichtungssatz	ATE
	CLC 220 CDI		05.08	10.10							
	CLC 200 Kompressor		05.08	10.10		13.9361-0035.2	210253	<input type="checkbox"/>		D=36	ATE
	CLC 230		05.08	10.10		13.9361-0036.2	210254	<input type="checkbox"/>		D=36	ATE
	CLC 350		05.08	10.10		13.0441-3609.2	250057			Dichtungssatz	ATE
	CLC 160		01.09	10.10		24.5123-0281.3	330877		2		L=280
	CLC 180 Kompressor		05.08	10.10							
	CLC 200 CDI		05.08	10.10							
	CLC 200 Kompressor		05.08	10.10							
	CLC 220 CDI		05.08	10.10							
	CLC 230		05.08	10.10							
	CLC 350		05.08	10.10							
	CLC 160	◀	01.09	10.10		24.3727-0429.2	580429	1	<input type="checkbox"/>		L=2735
	CLC 180 Kompressor	◀	05.08	10.10		24.3727-0430.2	580430		<input type="checkbox"/>		L=925
	CLC 200 CDI	◀	05.08	10.10		24.3727-0436.2	580436		<input type="checkbox"/>		L=900
	CLC 200 Kompressor	◀	05.08	10.10							
	CLC 220 CDI	◀	05.08	10.10							
	CLC 230	◀	05.08	10.10							
	CLC 350	◀	05.08	10.10							
	CLC 160	▶	01.09	10.10		24.3727-0430.2	580430		<input type="checkbox"/>		L=925
	CLC 180 Kompressor	▶	05.08	10.10		24.3727-0436.2	580436		<input type="checkbox"/>		L=900
	CLC 200 CDI	▶	05.08	10.10							
	CLC 200 Kompressor	▶	05.08	10.10							
	CLC 220 CDI	▶	05.08	10.10							
	CLC 230	▶	05.08	10.10							
	CLC 350	▶	05.08	10.10							

MERCEDES BENZ C-Klasse (W204) Limousine (07-14)

	C 180 CDI	◀ 88	01.11	01.14		03.7745-6302.4	300261			- Start/Stop-Anlage ¹⁾	8"	ATE
	C 180 CGI	◀115	04.09	01.14		03.7745-8902.4	300297			+ Start/Stop-Anlage ²⁾	8"	ATE
	C 180 Kompressor	◀115	01.08	01.14								
	C 180 Kompressor	◀115	03.07	01.14								
	C 200	◀137	05.11	01.14								
	C 200 CDI	◀100	01.11	01.14								
	C 200 CDI	◀100	03.07	01.14								
	C 200 CGI	◀135	04.09	01.14								
	C 200 Kompressor	◀135 A 017628 / F 015295		01.14								
	C 220 CDI	◀120	03.07	01.14								
	C 220 CDI	◀125 A 017628 / F 015295		01.14								
	C 220 CDI	◀125	12.08	01.14								
	C 220 CDI 4-matic	◀125	02.13	01.14								
	C 230	◀150	03.07	01.14								
	C 230 4-matic	◀150	07.07	01.14								
	C 250 CDI	◀150	08.08	01.14								
	C 250 CDI 4-matic	◀150	01.11	01.14								
	C 250 CGI	◀150	04.09	01.14								
	C 280	◀170 A 017628 / F 015295		01.14								
	C 280 4-matic	◀170	07.07	01.14								
	C 300	◀170 A 017628 / F 015295		01.14								
	C 300 4-matic	◀170	04.09	01.14								
	C 300 CDI 4-matic	◀170	01.11	01.14								
	C 300 CGI	◀185	02.11	01.14								
	C 300 CGI 4-matic	◀185	02.11	01.14								
	C 320 CDI	◀165 A 017628 / F 015295		01.14								
	C 320 CDI 4-matic	◀165	07.07	01.14								
	C 350	◀200 A 017628 / F 015295		01.14								
	C 350	◀225	01.11	01.14								
	C 350 4-matic	◀200	07.07	01.14								
	C 350 4-matic	◀225	01.11	01.14								
	C 350 CDI	◀165 A 017628 / F 015295		01.14								
	C 350 CDI	◀170	10.09	01.14								
	C 350 CDI	◀195	06.11	01.14								
	C 350 CDI 4-matic	◀165	07.09	01.14								
	C 350 CDI 4-matic	◀170	10.09	01.14								
	C 350 CGI	◀215	09.08	01.14								
	C 63 AMG	◀ A 017628 / F 015295		01.14								

¹⁾ - idling stop system / - dispositivo start/stop / - unité marche/arrêt / - unidad arranque/paro
²⁾ + idling stop system / + dispositivo start/stop / + unité marche/arrêt / + unidad arranque/paro



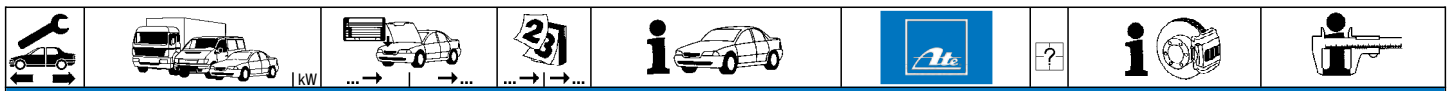















MERCEDES BENZ C-Klasse (W204) Limousine (07-14)

	C 180 CDI	88	01.11	01.14	03.2025-2301.3	010895			ThZ 25,40/22,20	ATE
	C 180 CGI	115	04.09	01.14						
	C 180 Kompressor	115	01.08	01.14						
	C 180 Kompressor	115	03.07	01.14						
	C 180 Kompressor Eco	115	01.09	01.14						
	C 200	137	05.11	01.14						
	C 200 CDI	100	01.11	01.14						
	C 200 CDI	100	03.07	01.14						
	C 200 CGI	135	04.09	01.14						
	C 200 Kompressor	135	03.07	01.14						
	C 220 CDI	120	03.07	01.14						
	C 220 CDI	125	03.07	01.14						
	C 220 CDI	125	12.08	01.14						
	C 220 CDI 4-matic	125	02.13	01.14						
	C 230	150	03.07	01.14						
	C 230 4-matic	150	07.07	01.14						
	C 250 CDI	150	10.08	01.14						
	C 250 CDI 4-matic	150	01.11	01.14						
	C 250 CGI	150	04.09	01.14						
	C 280	170	03.07	01.14						
	C 280 4-matic	170	07.07	01.14						
	C 300	170	07.09	01.14						
	C 300 4-matic	170	04.09	01.14						
	C 300 CDI 4-matic	170	01.11	01.14						
	C 300 CGI	185	02.11	01.14						
	C 300 CGI 4-matic	185	02.11	01.14						
	C 320 CDI	165	03.07	01.14						
	C 320 CDI 4-matic	165	07.07	01.14						
	C 350	200	03.07	01.14						
	C 350	225	01.11	01.14						
	C 350 4-matic	200	07.07	01.14						
	C 350 4-matic	225	01.11	01.14						
	C 350 CDI	165	04.09	01.14						
	C 350 CDI	170	10.09	01.14						
	C 350 CDI	195	06.11	01.14						
	C 350 CDI 4-matic	165	07.09	01.14						
	C 350 CDI 4-matic	170	10.09	01.14						
	C 350 CGI	215	09.08	01.14						
	C 63 AMG	1	09.07	01.14						
	C 180 CDI	88	01.11	01.14	24.3606-1705.7	220993	<input type="checkbox"/>		D=60, - Halter	TRW
	C 180 CGI	115	04.09	01.14	24.3606-1706.7	220994	<input type="checkbox"/>		D=60, - Halter	TRW
	C 180 Kompressor	115	01.08	01.14						
	C 180 Kompressor	115	03.07	01.14						
	C 200 CDI	100	01.11	01.14						
	C 200 CDI	100	03.07	01.14						
	C 180 CDI	88	01.11	01.14	24.3606-1703.5	240587	<input type="checkbox"/>		D=60, - Halter	TRW
	C 180 CGI	115	04.09	01.14	24.3606-1704.5	240588	<input type="checkbox"/>		D=60, - Halter	TRW
	C 180 Kompressor	115	01.08	01.14						
	C 180 Kompressor	115	03.07	01.14						
	C 200	137	05.11	01.14						
	C 200 CDI	100	01.11	01.14						
	C 200 CDI	100	03.07	01.14						
	C 200 CGI	135	04.09	01.14						
	C 200 Kompressor	135	03.07	01.14						
	C 220 CDI	120	03.07	01.14						
	C 220 CDI	125	03.07	01.14						
	C 220 CDI	125	12.08	01.14						
	C 230	150	03.07	01.14						
	C 250 CDI	150	08.08	01.14						
	C 250 CGI	150	04.09	01.14						
	C 200	137	05.11	01.14	24.3606-1707.7	221011	<input type="checkbox"/>		D=60, - Halter	TRW
	C 200 CGI	135	04.09	01.14	24.3606-1708.7	221012	<input type="checkbox"/>		D=60, - Halter	TRW
	C 200 Kompressor	135	03.07	01.14						
	C 220 CDI	120	03.07	01.14						
	C 220 CDI	125	03.07	01.14						
	C 220 CDI	125	12.08	01.14						
	C 230	150	03.07	01.14						
	C 250 CDI	150	08.08	01.14						
	C 250 CGI	150	04.09	01.14						
	C 280	170	03.07	01.14						
	C 300	170	07.09	01.14						
	C 220 CDI 4-matic	125	02.13	01.14	24.3606-1709.7	221045	<input type="checkbox"/>		D=60, - Halter	TRW
	C 230 4-matic	150	07.07	01.14	24.3606-1710.7	221046	<input type="checkbox"/>		D=60, - Halter	TRW
	C 250 CDI 4-matic	150	01.11	01.14						
	C 280 4-matic	170	07.07	01.14						
	C 300 4-matic	170	04.09	01.14						
	C 250 CDI 4-matic	150	01.11	01.14	24.3601-1721.5	240629	<input type="checkbox"/>		D=60, - Halter	TRW
	C 280 4-matic	170	07.07	01.14	24.3601-1722.5	240630	<input type="checkbox"/>		D=60, - Halter	TRW
	C 300 4-matic	170	04.09	01.14						
	C 300 CDI 4-matic	170	01.11	01.14						
	C 300 CGI 4-matic	185	02.11	01.14						
	C 320 CDI 4-matic	165	07.07	01.14						
	C 350 4-matic	200	07.07	01.14						
	C 350 4-matic	225	01.11	01.14						
	C 350 CDI 4-matic	165	07.09	01.14						
	C 350 CDI 4-matic	170	10.09	01.14						

1) - sport package/- sport package AMG / - pacchetto sportivo/- pacchetto sport.AMG / - version sport/- version sport AMG / - kit deportivo/- kit deportivo AMG
 2) + sports package/+ sports package AMG / + pacchetto sportivo/+ pacchetto sport.AMG / + version sport/+ version sport AMG / + kit deportivo/+ kit deportivo AMG

        											
MERCEDES BENZ C-Klasse (W204) Limousine (07-14)											
	C 280	170	03.07	01.14	+ Sportpaket / + Sportpaket AMG ¹⁾	24.3606-1711.5	240780	<input type="checkbox"/> <input type="checkbox"/>	2	D=60, - Halter D=60, - Halter	TRW TRW
	C 300	170	07.09	01.14	+ Sportpaket / + Sportpaket AMG ¹⁾	24.3606-1712.5	240781				
	C 300 CGI	185	02.11	01.14	+ Sportpaket / + Sportpaket AMG ¹⁾						
	C 320 CDI	165	03.07	01.14	+ Sportpaket / + Sportpaket AMG ¹⁾						
	C 350	200	03.07	01.14	+ Sportpaket / + Sportpaket AMG ¹⁾						
	C 350	225	01.11	01.14	+ Sportpaket / + Sportpaket AMG ¹⁾						
	C 350 CDI	170	10.09	01.14	+ Sportpaket / + Sportpaket AMG ¹⁾						
	C 350 CGI	215	09.08	01.14	+ Sportpaket / + Sportpaket AMG ¹⁾						
	C 300 CDI 4-matic	170	01.11	01.14	- Sportpaket / - Sportpaket AMG ²⁾	24.3601-1723.5	240631				
	C 300 CGI 4-matic	185	02.11	01.14	- Sportpaket / - Sportpaket AMG ²⁾	24.3601-1724.5	240632				
C 320 CDI 4-matic	165	07.07	01.14	- Sportpaket / - Sportpaket AMG ²⁾							
C 350 4-matic	200	07.07	01.14	- Sportpaket / - Sportpaket AMG ²⁾							
C 350 4-matic	225	01.11	01.14	- Sportpaket / - Sportpaket AMG ²⁾							
C 350 CDI 4-matic	165	07.09	01.14	- Sportpaket / - Sportpaket AMG ²⁾							
C 350 CDI 4-matic	170	10.09	01.14	- Sportpaket / - Sportpaket AMG ²⁾							
	C 180 CDI	88	01.11	01.14		83.7705-0386.3	330828	<input type="checkbox"/> <input type="checkbox"/>	2	L=385	
	C 180 CGI	115	04.09	01.14							
	C 180 Kompressor	115	01.08	01.14							
	C 180 Kompressor	115	03.07	01.14							
	C 180 Kompressor Eco	115	01.09	01.14							
	C 200	137	05.11	01.14							
	C 200 CDI	100	01.11	01.14							
	C 200 CDI	100	03.07	01.14							
	C 200 CGI	135	04.09	01.14							
	C 200 Kompressor	135	03.07	01.14							
	C 220 CDI	120	03.07	01.14							
	C 220 CDI	125	03.07	01.14							
	C 220 CDI	125	12.08	01.14							
	C 230	150	03.07	01.14							
	C 250 CDI	150	10.08	01.14							
	C 250 CGI	150	04.09	01.14							
	C 280	170	03.07	01.14							
	C 300	170	07.09	01.14							
	C 300 CGI	185	02.11	01.14							
	C 320 CDI	165	03.07	01.14							
	C 350	200	03.07	01.14							
	C 350	225	01.11	01.14							
	C 350 CDI	165	04.09	01.14							
	C 350 CDI	170	10.09	01.14							
	C 350 CDI	195	06.11	01.14							
	C 350 CGI	215	09.08	01.14							
		C 180 CDI	88	01.11	01.14	- Sportpaket / - Sportpaket AMG ²⁾	11.9386-9991.2				
C 180 CGI		115	04.09	01.14		11.9386-9992.2	220950				
C 180 Kompressor		115	01.08	01.14		11.0101-5407.2	260011				
C 180 Kompressor		115	03.07	01.14		11.8171-0008.1	990049				
C 200 CDI		100	01.11	01.14	- Sportpaket / - Sportpaket AMG ²⁾	11.8116-0340.1	390595				
C 200 CDI		100	03.07	01.14							
C 200		137	05.11	01.14		11.9386-9991.2	220949				
C 200 CGI		135	04.09	01.14		11.9386-9992.2	220950				
C 200 Kompressor		135	03.07	01.14		11.0101-5407.2	260011				
C 220 CDI		120	03.07	01.14		11.8171-0008.1	990049				
C 220 CDI		125	03.07	01.14		11.8116-0340.1	390595				
C 220 CDI		125	12.08	01.14							
C 220 CDI 4-matic		125	02.13	01.14							
C 230		150	03.07	01.14							
C 230 4-matic		150	07.07	01.14							
C 250 CDI 4-matic		150	01.11	01.14	+ Sportpaket / + Sportpaket AMG ¹⁾						
C 250 CGI		150	04.09	01.14							
C 280		170	03.07	01.14							
C 280 4-matic	170	07.07	01.14								
C 300	170	07.09	01.14								
C 300 4-matic	170	04.09	01.14								
	C 180 CDI	88	01.11	01.14	+ Sportpaket / + Sportpaket AMG ¹⁾	11.9386-9991.2	220949	<input type="checkbox"/> <input type="checkbox"/>	2	D=38, - Halter D=38, - Halter Hülzensatz Führungsbolzen Haltefeder	ATE ATE ATE ATE ATE
	C 200 CDI	100	01.11	01.14	+ Sportpaket / + Sportpaket AMG ¹⁾	11.9386-9992.2	220950				
						11.0101-5407.2	260011				
						11.8171-0008.1	990049				
						11.8116-0340.1	390595				
	C 250 CDI	150	08.08	01.14		11.9406-9961.2	220951	<input type="checkbox"/> + ALU-Sättel ³⁾ <input type="checkbox"/> + ALU-Sättel ³⁾	2	D=40, - Halter D=40, - Halter Hülzensatz Führungsbolzen Haltefeder	ATE ATE ATE ATE ATE
	C 250 CDI 4-matic	150	01.11	01.14	- Sportpaket / - Sportpaket AMG ²⁾	11.9406-9962.2	220952				
	C 300 CDI 4-matic	170	01.11	01.14		11.0101-5407.2	260011				
	C 320 CDI	165	03.07	01.14		11.8171-0008.1	990049				
	C 320 CDI 4-matic	165	07.07	01.14		11.8116-0340.1	390595				
	C 350	200	03.07	01.14							
	C 350 4-matic	200	07.07	01.14							
	C 350 CDI	165	04.09	01.14							
	C 350 CDI	170	10.09	01.14							
	C 350 CDI	195	06.11	01.14							
	C 350 CDI 4-matic	165	07.09	01.14							
	C 350 CDI 4-matic	170	10.09	01.14							
C 350 CGI	215	09.08	01.14								
	C 300 CGI	185	02.11	01.14		11.9406-9961.2	220951	<input type="checkbox"/> <input type="checkbox"/>	2	D=40, - Halter D=40, - Halter Hülzensatz Führungsbolzen Haltefeder	ATE ATE ATE ATE ATE
	C 300 CGI 4-matic	185	02.11	01.14		11.9406-9962.2	220952				
	C 350	225	01.11	01.14		11.0101-5407.2	260011				
	C 350 4-matic	225	01.11	01.14		11.8171-0008.1	990049				
					11.8116-0340.1	390595					

¹⁾ + sports package/+ sports package AMG / + pacchetto sportivo/+ pacchetto sport.AMG / + version sport/+ version sport AMG / + kit deportivo/+ kit deportivo AMG

²⁾ - sport package/- sport package AMG / - pacchetto sportivo/- pacchetto sport.AMG / - version sport/- version sport AMG / - kit deportivo/- kit deportivo AMG

³⁾ + aluminium calipers / + pinze in alluminio / + étriers en aluminium / + pinzas de aluminio

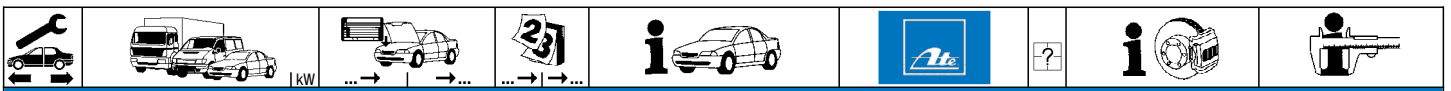

MERCEDES BENZ C-Klasse (W204) Limousine (07-14)

	<ul style="list-style-type: none"> C 180 CDI 88 C 180 CGI 115 C 180 Kompressor 115 C 180 Kompressor 115 C 180 Kompressor Eco 115 C 200 137 C 200 CDI 100 C 200 CDI 100 C 200 CGI 135 C 200 Kompressor 135 C 220 CDI 120 C 220 CDI 125 C 220 CDI 125 C 220 CDI 4-matic 125 C 230 150 C 230 4-matic 150 C 250 CDI 150 C 250 CDI 4-matic 150 C 250 CGI 150 C 280 170 C 280 4-matic 170 C 300 170 C 300 4-matic 170 C 300 CDI 4-matic 170 C 300 CGI 185 C 300 CGI 4-matic 185 C 320 CDI 165 C 320 CDI 4-matic 165 C 350 200 C 350 225 C 350 4-matic 200 C 350 4-matic 225 C 350 CDI 165 C 350 CDI 170 C 350 CDI 195 C 350 CDI 4-matic 165 C 350 CDI 4-matic 170 C 350 CGI 215 C 63 AMG 	<ul style="list-style-type: none"> 01.11 01.14 04.09 01.14 01.08 01.14 03.07 01.14 01.09 01.14 05.11 01.14 01.11 01.14 03.07 01.14 04.09 01.14 03.07 01.14 03.07 01.14 12.08 01.14 02.13 01.14 03.07 01.14 07.07 01.14 10.08 01.14 01.11 01.14 04.09 01.14 03.07 01.14 07.07 01.14 07.09 01.14 04.09 01.14 01.11 01.14 02.11 01.14 02.11 01.14 03.07 01.14 07.07 01.14 03.07 01.14 01.11 01.14 07.07 01.14 01.11 01.14 04.09 01.14 10.09 01.14 06.11 01.14 07.09 01.14 10.09 01.14 09.08 01.14 09.07 01.14 	<ul style="list-style-type: none"> 24.5172-0305.3 	<ul style="list-style-type: none"> 331312 	<ul style="list-style-type: none"> 2 	<ul style="list-style-type: none"> L=305
	<ul style="list-style-type: none"> C 180 CDI ◀ 88 C 180 CGI ◀ 115 C 180 Kompressor ◀ 115 C 180 Kompressor ◀ 115 C 180 Kompressor Eco ◀ C 200 ◀ 137 C 200 CDI ◀ 100 C 200 CDI ◀ 100 C 200 CGI ◀ 135 C 200 Kompressor ◀ 135 C 220 CDI ◀ 120 C 220 CDI ◀ 125 C 220 CDI ◀ 125 C 220 CDI 4-matic ◀ 125 C 230 ◀ 150 C 230 4-matic ◀ 150 C 250 CDI ◀ 150 C 250 CDI 4-matic ◀ 150 C 250 CGI ◀ 150 C 280 ◀ 170 C 280 4-matic ◀ 170 C 300 ◀ 170 C 300 4-matic ◀ 170 C 300 CDI 4-matic ◀ 170 C 300 CGI ◀ 185 C 300 CGI 4-matic ◀ 185 C 320 CDI ◀ 165 C 320 CDI 4-matic ◀ 165 C 350 ◀ 200 C 350 ◀ 225 C 350 4-matic ◀ 200 C 350 4-matic ◀ 225 C 350 CDI ◀ 165 C 350 CDI ◀ 170 C 350 CDI ◀ 195 C 350 CDI 4-matic ◀ 165 C 350 CDI 4-matic ◀ 170 C 350 CGI ◀ 215 C 63 AMG ◀ 	<ul style="list-style-type: none"> 01.11 01.14 04.09 01.14 01.08 01.14 03.07 01.14 01.09 01.14 05.11 01.14 01.11 01.14 03.07 01.14 04.09 01.14 03.07 01.14 03.07 01.14 12.08 01.14 02.13 01.14 03.07 01.14 07.07 01.14 10.08 01.14 01.11 01.14 04.09 01.14 03.07 01.14 07.07 01.14 07.09 01.14 04.09 01.14 01.11 01.14 02.11 01.14 02.11 01.14 03.07 01.14 07.07 01.14 03.07 01.14 01.11 01.14 07.07 01.14 01.11 01.14 04.09 01.14 10.09 01.14 06.11 01.14 07.09 01.14 10.09 01.14 09.08 01.14 09.07 01.14 	<ul style="list-style-type: none"> 24.3727-0465.2 24.3727-0470.2 24.3727-0467.2 	<ul style="list-style-type: none"> 580465 580470 580467 	<ul style="list-style-type: none"> 1 ↑ 1 ↓ 2 ↓ 	<ul style="list-style-type: none"> L=2057 L=1152 L=728
	<ul style="list-style-type: none"> C 180 CDI ▶ 88 C 180 CGI ▶ 115 C 180 Kompressor ▶ 115 C 180 Kompressor ▶ 115 C 180 Kompressor Eco ▶ C 200 ▶ 137 C 200 CDI ▶ 100 C 200 CDI ▶ 100 C 200 CGI ▶ 135 C 200 Kompressor ▶ 135 C 220 CDI ▶ 120 C 220 CDI ▶ 125 C 220 CDI ▶ 125 C 220 CDI 4-matic ▶ 125 C 230 ▶ 150 C 230 4-matic ▶ 150 C 250 CDI ▶ 150 C 250 CDI 4-matic ▶ 150 C 250 CGI ▶ 150 C 280 ▶ 170 C 280 4-matic ▶ 170 C 300 ▶ 170 C 300 4-matic ▶ 170 C 300 CDI 4-matic ▶ 170 C 300 CGI ▶ 185 C 300 CGI 4-matic ▶ 185 C 320 CDI ▶ 165 C 320 CDI 4-matic ▶ 165 C 350 ▶ 200 C 350 ▶ 225 C 350 4-matic ▶ 200 C 350 4-matic ▶ 225 C 350 CDI ▶ 165 C 350 CDI ▶ 170 C 350 CDI ▶ 195 C 350 CDI 4-matic ▶ 165 C 350 CDI 4-matic ▶ 170 C 350 CGI ▶ 215 C 63 AMG ▶ 	<ul style="list-style-type: none"> 01.11 01.14 04.09 01.14 01.08 01.14 03.07 01.14 01.09 01.14 05.11 01.14 01.11 01.14 03.07 01.14 04.09 01.14 03.07 01.14 03.07 01.14 12.08 01.14 02.13 01.14 03.07 01.14 07.07 01.14 10.08 01.14 01.11 01.14 04.09 01.14 03.07 01.14 07.07 01.14 07.09 01.14 04.09 01.14 01.11 01.14 02.11 01.14 02.11 01.14 03.07 01.14 07.07 01.14 03.07 01.14 01.11 01.14 07.07 01.14 01.11 01.14 04.09 01.14 10.09 01.14 06.11 01.14 07.09 01.14 10.09 01.14 09.08 01.14 09.07 01.14 	<ul style="list-style-type: none"> 24.3727-0470.2 24.3727-0467.2 	<ul style="list-style-type: none"> 580470 580467 	<ul style="list-style-type: none"> 1 ↓ 2 ↓ 	<ul style="list-style-type: none"> L=1152 L=728

MERCEDES BENZ C-Klasse (W204) Limousine (07-14)

	C 200 Kompressor ▶135		03.07	01.14		24.3727-0470.2	580470	1		
	C 220 CDI ▶120		03.07	01.14		24.3727-0467.2	580467	2	↓	L=1152
	C 220 CDI ▶125		03.07	01.14						L=728
	C 220 CDI ▶125		12.08	01.14						
	C 220 CDI 4-matic ▶125		02.13	01.14						
	C 230 ▶150		03.07	01.14						
	C 230 4-matic ▶150		07.07	01.14						
	C 250 CDI ▶150		10.08	01.14						
	C 250 CDI 4-matic ▶150		01.11	01.14						
	C 250 CGI ▶150		04.09	01.14						
	C 280 ▶170		03.07	01.14						
	C 280 4-matic ▶170		07.07	01.14						
	C 300 ▶170		07.09	01.14						
	C 300 4-matic ▶170		04.09	01.14						
	C 300 CDI 4-matic ▶170		01.11	01.14						
	C 300 CGI ▶185		02.11	01.14						
	C 300 CGI 4-matic ▶185		02.11	01.14						
	C 320 CDI ▶165		03.07	01.14						
	C 320 CDI 4-matic ▶165		07.07	01.14						
	C 350 ▶200		03.07	01.14						
	C 350 ▶225		01.11	01.14						
	C 350 4-matic ▶200		07.07	01.14						
	C 350 4-matic ▶225		01.11	01.14						
	C 350 CDI ▶165		04.09	01.14						
	C 350 CDI ▶170		10.09	01.14						
	C 350 CDI ▶195		06.11	01.14						
	C 350 CDI 4-matic ▶165		07.09	01.14						
	C 350 CDI 4-matic ▶170		10.09	01.14						
	C 350 CGI ▶215		09.08	01.14						
	C 63 AMG ▶		09.07	01.14						

MERCEDES BENZ C-Klasse (S204) Kombi (07-14)

	C 180 CDI BE ◀ 88		01.11	08.14		03.7745-6302.4	300261			- Start/Stop-Anlage ¹⁾	8"	ATE
	C 180 CGI ◀115		04.09	08.14		03.7745-8902.4	300297			+ Start/Stop-Anlage ²⁾	8"	ATE
	C 180 Kompressor ◀115		09.07	08.14								
	C 180 Kompressor ◀115		01.08	08.14								
	C 200 CDI ◀100		09.07	08.14								
	C 200 CDI ◀100		08.10	08.14								
	C 200 CGI ◀135		04.09	08.14								
	C 200 Kompressor ◀135		09.07	08.14								
	C 220 CDI ◀120		01.07	08.14								
	C 220 CDI ◀125		09.07	08.14								
	C 220 CDI ◀125		12.08	08.14								
	C 220 CDI 4-matic ◀125		02.13	08.14								
	C 230 ◀150		09.07	08.14								
	C 250 CDI ◀150		04.09	08.14								
	C 250 CDI 4matic ◀150		04.09	08.14								
	C 250 CGI ◀150		04.09	08.14								
	C 280 ◀170		09.07	08.14								
	C 300 ◀170		08.07	08.14								
	C 320 CDI ◀165		09.07	08.14								
	C 320 CDI 4-matic ◀165		09.07	08.14								
	C 350 ◀200		09.07	08.14								
	C 350 CDI ◀165		08.07	08.14								
	C 350 CDI ◀195		06.11	08.14								
	C 350 CDI 4-matic ◀170		10.09	08.14								
	C 350 CDI BlueEff. ◀170		04.09	08.14								
	C 350 CGI ◀225		06.11	08.14								
	C 63 AMG ◀		09.07	08.14								

	C 180 CDI BE ◀ 88		01.11	08.14		03.2025-2301.3	010895			Thz 25,40/22,20	ATE
	C 180 CGI ◀115		04.09	08.14							
	C 180 Kompressor ◀115		09.07	08.14							
	C 180 Kompressor ◀115		01.08	08.14							
	C 200 CDI ◀100		09.07	08.14							
	C 200 CDI ◀100		08.10	08.14							
	C 200 CGI ◀135		04.09	08.14							
	C 200 Kompressor ◀135		09.07	08.14							
	C 220 CDI ◀120		01.07	08.14							
	C 220 CDI ◀125		09.07	08.14							
	C 220 CDI ◀125		12.08	08.14							
	C 220 CDI 4-matic ◀125		02.13	08.14							
	C 230 ◀150		09.07	08.14							
	C 230 ◀150		09.07	08.14							
	C 250 CDI ◀150		04.09	08.14							
	C 250 CDI 4matic ◀150		04.09	08.14							
	C 250 CGI ◀150		04.09	08.14							
	C 280 ◀170		09.07	08.14							
	C 300 ◀170		08.07	08.14							
	C 320 CDI ◀165		09.07	08.14							
	C 320 CDI 4-matic ◀165		09.07	08.14							
	C 350 ◀200		09.07	08.14							
	C 350 CDI ◀165		08.07	08.14							
	C 350 CDI ◀195		06.11	08.14							
	C 350 CDI 4-matic ◀170		10.09	08.14							
	C 350 CDI BlueEff. ◀170		04.09	08.14							
	C 350 CGI ◀225		06.11	08.14							
	C 63 AMG ◀		09.07	08.14							

¹⁾ - idling stop system / - dispositivo start/stop / - unité marche/arrêt / - unidad arranque/paro
²⁾ + idling stop system / + dispositivo start/stop / + unité marche/arrêt / + unidad arranque/paro





MERCEDES BENZ C-Klasse (S204) Kombi (07-14)

	C 180 CDI BE	88	01.11	08.14	- Sportpaket / - Sportpaket AMG ¹⁾	24.3606-1705.7	220993			D=60, - Halter	TRW
	C 180 CGI	115	04.09	08.14	+ Sportpaket / - Sportpaket AMG ¹⁾	24.3606-1706.7	220994			D=60, - Halter	TRW
	C 180 Kompressor	115	09.07	08.14	- Sportpaket / - Sportpaket AMG ¹⁾						
	C 180 Kompressor	115	01.08	08.14	- Sportpaket / - Sportpaket AMG ¹⁾						
	C 200 CDI	100	09.07	08.14	- Sportpaket / - Sportpaket AMG ¹⁾						
	C 200 CDI	100	08.10	08.14	- Sportpaket / - Sportpaket AMG ¹⁾						
	C 180 CDI BE	88	01.11	08.14	+ Sportpaket / + Sportpaket AMG ²⁾	24.3606-1703.5	240587			D=60, - Halter	TRW
	C 180 CGI	115	04.09	08.14	+ Sportpaket / + Sportpaket AMG ²⁾	24.3606-1704.5	240588			D=60, - Halter	TRW
	C 180 Kompressor	115	09.07	08.14	+ Sportpaket / + Sportpaket AMG ²⁾						
	C 180 Kompressor	115	01.08	08.14	+ Sportpaket / + Sportpaket AMG ²⁾						
	C 200 CDI	100	09.07	08.14	+ Sportpaket / + Sportpaket AMG ²⁾						
	C 200 CDI	100	08.10	08.14	+ Sportpaket / + Sportpaket AMG ²⁾						
	C 200 CGI	135	04.09	08.14	+ Sportpaket / + Sportpaket AMG ²⁾						
	C 200 Kompressor	135	09.07	08.14	+ Sportpaket / + Sportpaket AMG ²⁾						
	C 220 CDI	120	01.07	08.14	+ Sportpaket / + Sportpaket AMG ²⁾						
C 220 CDI	125	09.07	08.14	+ Sportpaket / + Sportpaket AMG ²⁾							
C 220 CDI	125	12.08	08.14	+ Sportpaket / + Sportpaket AMG ²⁾							
C 230	150	09.07	08.14	+ Sportpaket / + Sportpaket AMG ²⁾							
C 250 CDI	150	04.09	08.14	+ Sportpaket / + Sportpaket AMG ²⁾							
C 250 CGI	150	04.09	08.14	+ Sportpaket / + Sportpaket AMG ²⁾							
C 200 CGI	135	04.09	08.14	- Sportpaket / - Sportpaket AMG ¹⁾	24.3606-1707.7	221011			D=60, - Halter	TRW	
C 200 Kompressor	135	09.07	08.14	- Sportpaket / - Sportpaket AMG ¹⁾	24.3606-1708.7	221012			D=60, - Halter	TRW	
C 220 CDI	120	01.07	08.14	- Sportpaket / - Sportpaket AMG ¹⁾							
C 220 CDI	125	09.07	08.14	- Sportpaket / - Sportpaket AMG ¹⁾							
C 220 CDI	125	12.08	08.14	- Sportpaket / - Sportpaket AMG ¹⁾							
C 230	150	09.07	08.14	- Sportpaket / - Sportpaket AMG ¹⁾							
C 250 CDI	150	04.09	08.14	- Sportpaket / - Sportpaket AMG ¹⁾							
C 250 CGI	150	04.09	08.14	- Sportpaket / - Sportpaket AMG ¹⁾							
C 280	170	09.07	08.14	- Sportpaket / - Sportpaket AMG ¹⁾							
C 300	170	08.07	08.14	- Sportpaket / - Sportpaket AMG ¹⁾							
C 220 CDI 4-matic	125	02.13	08.14	- Sportpaket / - Sportpaket AMG ¹⁾	24.3606-1709.7	221045			D=60, - Halter	TRW	
C 250 CDI 4matic	150	04.09	08.14	- Sportpaket / - Sportpaket AMG ¹⁾	24.3606-1710.7	221046			D=60, - Halter	TRW	
C 280	170	09.07	08.14	+ Sportpaket / + Sportpaket AMG ²⁾	24.3606-1711.5	240780			D=60, - Halter	TRW	
C 300	170	08.07	08.14	+ Sportpaket / + Sportpaket AMG ²⁾	24.3606-1712.5	240781			D=60, - Halter	TRW	
C 320 CDI	165	09.07	08.14	+ Sportpaket / + Sportpaket AMG ²⁾							
C 350	200	09.07	08.14	+ Sportpaket / + Sportpaket AMG ²⁾							
C 350 CDI	165	08.07	08.14	+ Sportpaket / + Sportpaket AMG ²⁾							
C 350 CDI	195	06.11	08.14	+ Sportpaket / + Sportpaket AMG ²⁾							
C 350 CDI BlueEff.	170	04.09	08.14	+ Sportpaket / + Sportpaket AMG ²⁾							
C 350 CGI	225	06.11	08.14	+ Sportpaket / + Sportpaket AMG ²⁾							
C 320 CDI 4-matic	165	09.07	08.14		24.3601-1723.5	240631		- Sportpaket / - Sportpaket AMG ¹⁾	D=60, - Halter	TRW	
C 350 CDI 4-matic	170	10.09	08.14		24.3601-1724.5	240632		- Sportpaket / - Sportpaket AMG ¹⁾	D=60, - Halter	TRW	
					24.3601-1721.5	240629		+ Sportpaket / + Sportpaket AMG ²⁾	D=60, - Halter	TRW	
					24.3601-1722.5	240630		+ Sportpaket / + Sportpaket AMG ²⁾	D=60, - Halter	TRW	
	C 180 CDI BE	88	01.11	08.14		83.7705-0386.3	330828	2		L=385	
	C 180 CGI	115	04.09	08.14							
	C 180 Kompressor	115	09.07	08.14							
	C 180 Kompressor	115	01.08	08.14							
	C 200 CDI	100	09.07	08.14							
	C 200 CDI	100	08.10	08.14							
	C 200 CGI	135	04.09	08.14							
	C 200 Kompressor	135	09.07	08.14							
	C 220 CDI	120	01.07	08.14							
	C 220 CDI	125	09.07	08.14							
	C 220 CDI	125	12.08	08.14							
	C 230	150	09.07	08.14							
	C 250 CDI	150	04.09	08.14							
	C 250 CGI	150	04.09	08.14							
	C 280	170	09.07	08.14							
	C 300	170	08.07	08.14							
	C 320 CDI	165	09.07	08.14							
	C 350	200	09.07	08.14							
	C 350 CDI	165	08.07	08.14							
	C 350 CDI	195	06.11	08.14							
C 350 CDI BlueEff.	170	04.09	08.14								
C 350 CGI	225	06.11	08.14								
	C 180 CDI BE	88	01.11	08.14	- Sportpaket / - Sportpaket AMG ¹⁾	11.0101-5407.2	260011			Hülsensatz	ATE
	C 180 CGI	115	04.09	08.14	- Sportpaket / - Sportpaket AMG ¹⁾	11.8171-0008.1	990049			Führungsbolzen	ATE
	C 180 Kompressor	115	09.07	08.14	- Sportpaket / - Sportpaket AMG ¹⁾	11.8116-0340.1	390595	2		Haltefeder	ATE
	C 180 Kompressor	115	01.08	08.14	- Sportpaket / - Sportpaket AMG ¹⁾						
	C 200 CDI	100	09.07	08.14	- Sportpaket / - Sportpaket AMG ¹⁾						
	C 200 CDI	100	08.10	08.14	- Sportpaket / - Sportpaket AMG ¹⁾						
	C 180 CDI BE	88	01.11	08.14	+ Sportpaket / + Sportpaket AMG ²⁾	11.9386-9991.2	220949			D=38, - Halter	ATE
	C 180 CGI	115	04.09	08.14	+ Sportpaket / + Sportpaket AMG ²⁾	11.9386-9992.2	220950			D=38, - Halter	ATE
	C 180 Kompressor	115	09.07	08.14	+ Sportpaket / + Sportpaket AMG ²⁾	11.0101-5407.2	260011			Hülsensatz	ATE
	C 180 Kompressor	115	01.08	08.14	+ Sportpaket / + Sportpaket AMG ²⁾	11.8171-0008.1	990049			Führungsbolzen	ATE
C 200 CDI	100	09.07	08.14	+ Sportpaket / + Sportpaket AMG ²⁾	11.8116-0340.1	390595	2		Haltefeder	ATE	
C 200 CDI	100	08.10	08.14	+ Sportpaket / + Sportpaket AMG ²⁾							
C 200 CGI	135	04.09	08.14		11.9386-9991.2	220949		+ ALU-Sättel ³⁾	D=38, - Halter	ATE	
C 200 Kompressor	135	09.07	08.14		11.9386-9992.2	220950		+ ALU-Sättel ³⁾	D=38, - Halter	ATE	
C 220 CDI	120	01.07	08.14		11.0101-5407.2	260011			Hülsensatz	ATE	
C 220 CDI	125	09.07	08.14		11.8171-0008.1	990049			Führungsbolzen	ATE	
C 220 CDI	125	12.08	08.14		11.8116-0340.1	390595	2		Haltefeder	ATE	
C 220 CDI 4-matic	125	02.13	08.14								
C 230	150	09.07	08.14								
C 250 CDI 4matic	150	04.09	08.14	+ Sportpaket / + Sportpaket AMG ²⁾							

¹⁾ - sport package/- sport package AMG / - pacchetto sportivo/- pacchetto sport.AMG / - version sport/- version sport AMG / - kit deportivo/- kit deportivo AMG
²⁾ + sports package/+ sports package AMG / + pacchetto sportivo/+ pacchetto sport.AMG / + version sport/+ version sport AMG / + kit deportivo/+ kit deportivo AMG
³⁾ + aluminium calipers / + pinze in alluminio / + étriers en aluminium / + pinzas de aluminio

MERCEDES BENZ C-Klasse (S204) Kombi (07-14)													
	C 250 CGI	150	04.09	08.14		11.9386-9991.2	220949	+ ALU-Sättel ¹⁾ + ALU-Sättel ¹⁾	D=38, - Halter D=38, - Halter Hülzensatz Führungsbolzen Haltefeder	ATE ATE ATE ATE ATE			
	C 280	170	09.07	08.14		11.9386-9992.2	220950						
	C 300	170	08.07	08.14		11.0101-5407.2	260011						
						11.8171-0008.1	990049						
						11.8116-0340.1	390595						
	C 250 CDI	150	04.09	08.14		11.9406-9961.2	220951				+ ALU-Sättel ¹⁾ + ALU-Sättel ¹⁾	D=40, - Halter D=40, - Halter Hülzensatz Führungsbolzen Haltefeder	ATE ATE ATE ATE ATE
	C 250 CDI 4matic	150	04.09	08.14		11.9406-9962.2	220952						
	C 320 CDI	165	09.07	08.14		11.0101-5407.2	260011						
	C 320 CDI 4-matic	165	09.07	08.14		11.8171-0008.1	990049						
	C 350	200	09.07	08.14		11.8116-0340.1	390595						
C 350 CDI	165	08.07	08.14										
C 350 CDI	195	06.11	08.14										
C 350 CDI 4-matic	170	10.09	08.14										
C 350 CDI BlueEff.	170	04.09	08.14										
C 350 CGI	225	06.11	08.14	11.9406-9961.2	220951	+ ALU-Sättel ¹⁾ + ALU-Sättel ¹⁾	D=40, - Halter D=40, - Halter Hülzensatz Führungsbolzen Haltefeder	ATE ATE ATE ATE ATE					
				11.9406-9962.2	220952								
				11.0101-5407.2	260011								
				11.8171-0008.1	990049								
				11.8116-0340.1	390595								
	C 180 CDI BE	88	01.11	08.14		24.5172-0305.3	331312	2	L=305				
	C 180 CGI	115	04.09	08.14									
	C 180 Kompressor	115	09.07	08.14									
	C 180 Kompressor	115	01.08	08.14									
	C 200 CDI	100	09.07	08.14									
	C 200 CDI	100	08.10	08.14									
	C 200 CGI	135	04.09	08.14									
	C 200 Kompressor	135	09.07	08.14									
	C 220 CDI	120	01.07	08.14									
	C 220 CDI	125	09.07	08.14									
	C 220 CDI	125	12.08	08.14									
	C 220 CDI 4-matic	125	02.13	08.14									
	C 230	150	09.07	08.14									
	C 250 CDI	150	04.09	08.14									
	C 250 CDI 4matic	150	04.09	08.14									
	C 250 CGI	150	04.09	08.14									
	C 280	170	09.07	08.14									
	C 300	170	08.07	08.14									
	C 320 CDI	165	09.07	08.14									
	C 320 CDI 4-matic	165	09.07	08.14									
	C 350	200	09.07	08.14									
	C 350 CDI	165	08.07	08.14									
	C 350 CDI	195	06.11	08.14									
C 350 CDI 4-matic	170	10.09	08.14										
C 350 CDI BlueEff.	170	04.09	08.14										
C 350 CGI	225	06.11	08.14										
C 63 AMG		09.07	08.14										
	C 180 CDI BE	◀ 88	01.11	08.14		24.3727-0465.2	580465	1 ↑	L=2057 L=1152 L=728				
	C 180 CGI	◀ 115	04.09	08.14									
	C 180 Kompressor	◀ 115	09.07	08.14									
	C 180 Kompressor	◀ 115	01.08	08.14									
	C 200 CDI	◀ 100	09.07	08.14									
	C 200 CDI	◀ 100	08.10	08.14									
	C 200 CGI	◀ 135	04.09	08.14									
	C 200 Kompressor	◀ 135	09.07	08.14									
	C 220 CDI	◀ 120	01.07	08.14									
	C 220 CDI	◀ 125	09.07	08.14									
	C 220 CDI	◀ 125	12.08	08.14									
	C 220 CDI 4-matic	◀ 125	02.13	08.14									
	C 230	◀ 150	09.07	08.14									
	C 250 CDI	◀ 150	04.09	08.14									
	C 250 CDI 4matic	◀ 150	04.09	08.14									
	C 250 CGI	◀ 150	04.09	08.14									
	C 280	◀ 170	09.07	08.14									
	C 300	◀ 170	08.07	08.14									
	C 320 CDI	◀ 165	09.07	08.14									
	C 320 CDI 4-matic	◀ 165	09.07	08.14									
	C 350	◀ 200	09.07	08.14									
	C 350 CDI	◀ 165	08.07	08.14									
	C 350 CDI	◀ 195	06.11	08.14									
C 350 CDI 4-matic	◀ 170	10.09	08.14										
C 350 CDI BlueEff.	◀ 170	04.09	08.14										
C 350 CGI	◀ 225	06.11	08.14										
C 63 AMG	◀	09.07	08.14										
	C 180 CGI	▶ 115	04.09	08.14		24.3727-0470.2	580470	1 ↓	L=1152 L=728				
	C 180 Kompressor	▶ 115	09.07	08.14									
	C 180 Kompressor	▶ 115	01.08	08.14									
	C 200 CDI	▶ 100	09.07	08.14									
	C 200 CDI	▶ 100	08.10	08.14									
	C 200 CGI	▶ 135	04.09	08.14									
	C 200 Kompressor	▶ 135	09.07	08.14									
	C 220 CDI	▶ 120	01.07	08.14									
	C 220 CDI	▶ 125	09.07	08.14									
	C 220 CDI	▶ 125	12.08	08.14									
	C 220 CDI 4-matic	▶ 125	02.13	08.14									
	C 230	▶ 150	09.07	08.14									
	C 250 CDI	▶ 150	04.09	08.14									
	C 250 CDI 4matic	▶ 150	04.09	08.14									

¹⁾ + aluminium calipers / + pinze in alluminio / + étriers en aluminium / + pinzas de aluminio

²⁾ - sport package/- sport package AMG / - pacchetto sportivo/- pacchetto sport.AMG / - version sport/- version sport AMG / - kit deportivo/- kit deportivo AMG



MERCEDES BENZ C-Klasse (S204) Kombi (07-14)

	C 250 CGI ▶150	04.09	08.14	24.3727-0470.2	580470	1	↓	L=1152
	C 280 ▶170	09.07	08.14	24.3727-0467.2	580467	2	↓	L=728
	C 300 ▶170	08.07	08.14					
	C 320 CDI ▶165	09.07	08.14					
	C 320 CDI 4-matic ▶165	09.07	08.14					
	C 350 ▶200	09.07	08.14					
	C 350 CDI ▶165	08.07	08.14					
	C 350 CDI ▶195	06.11	08.14					
	C 350 CDI 4-matic ▶170	10.09	08.14					
	C 350 CDI BlueEff. ▶170	04.09	08.14					
	C 350 CGI ▶225	06.11	08.14					
	C 63 AMG ▶	09.07	08.14					

MERCEDES BENZ C-Klasse (C204) Coupe (11-)

	C 180 ◀115	01.13		03.7745-6302.4	300261		- Start/Stop-Anlage 1)	8"	ATE
	C 180 CGI ◀115	06.11		03.7745-8902.4	300297		+ Start/Stop-Anlage 2)	8"	ATE
	C 200 CGI ◀135	06.11							
	C 220 CDI ◀125	06.11							
	C 250 CDI ◀150	06.11							
	C 250 CGI ◀150	06.11							
	C 350 ◀225	06.11							
	C 350 4-matic ◀225	09.13							
	C 63 AMG ◀336	06.11							
	C 63 AMG ◀373	11.12							
	C 63 AMG Black Series ◀380	01.12							
	C 180 ◀115	01.13		03.2025-2301.3	010895			THz 25,40/22,20	ATE
	C 180 CGI ◀115	06.11							
	C 200 CGI ◀135	06.11							
	C 220 CDI ◀125	06.11							
	C 250 CDI ◀150	06.11							
	C 250 CGI ◀150	06.11							
	C 350 ◀225	06.11							
	C 350 4-matic ◀225	09.13							
	C 63 AMG ◀336	06.11							
	C 63 AMG ◀373	11.12							
	C 63 AMG Black Series ◀380	01.12							
	C 180 115	01.13		24.3606-1705.7	220993			D=60, - Halter	TRW
	C 180 CGI 115	06.11		24.3606-1706.7	220994			D=60, - Halter	TRW
	C 180 115	01.13		24.3606-1703.5	240587			D=60, - Halter	TRW
	C 180 CGI 115	06.11		24.3606-1704.5	240588			D=60, - Halter	TRW
	C 200 CGI 135	06.11							
	C 220 CDI 125	06.11							
	C 250 CDI 150	06.11							
	C 250 CGI 150	06.11							
	C 200 CGI 135	06.11		24.3606-1707.7	221011			D=60, - Halter	TRW
	C 220 CDI 125	06.11		24.3606-1708.7	221012			D=60, - Halter	TRW
	C 250 CDI 150	06.11							
	C 250 CGI 150	06.11							
	C 350 4-matic 225	09.13		24.3601-1723.5	240631			D=60, - Halter	TRW
				24.3601-1724.5	240632			D=60, - Halter	TRW
				24.3601-1721.5	240629			D=60, - Halter	TRW
				24.3601-1722.5	240630			D=60, - Halter	TRW
	C 350 225	06.11		24.3606-1711.5	240780			D=60, - Halter	TRW
				24.3606-1712.5	240781			D=60, - Halter	TRW
	C 180 115	01.13		83.7705-0386.3	330828	2		L=385	
	C 180 CGI 115	06.11							
	C 200 CGI 135	06.11							
	C 220 CDI 125	06.11							
	C 250 CDI 150	06.11							
	C 250 CGI 150	06.11							
	C 350 225	06.11							
	C 180 115	01.13		11.9386-9991.2	220949			D=38, - Halter	ATE
	C 180 CGI 115	06.11		11.9386-9992.2	220950			D=38, - Halter	ATE
				11.0101-5407.2	260011			Hülzensatz	ATE
				11.8171-0008.1	990049			Führungsbolzen	ATE
				11.8116-0340.1	390595	2		Haltefeder	ATE
	C 180 115	01.13		11.9386-9991.2	220949			D=38, - Halter	ATE
	C 180 CGI 115	06.11		11.9386-9992.2	220950			D=38, - Halter	ATE
	C 200 CGI 135	06.11		11.0101-5407.2	260011			Hülzensatz	ATE
	C 220 CDI 125	06.11		11.8171-0008.1	990049			Führungsbolzen	ATE
	C 250 CGI 150	06.11		11.8116-0340.1	390595	2		Haltefeder	ATE
	C 250 CDI 150	06.11		11.9406-9961.2	220951			D=40, - Halter	ATE
	C 350 225	06.11		11.9406-9962.2	220952			D=40, - Halter	ATE
	C 350 4-matic 225	09.13		11.0101-5407.2	260011			Hülzensatz	ATE
				11.8171-0008.1	990049			Führungsbolzen	ATE
				11.8116-0340.1	390595	2		Haltefeder	ATE
	C 180 115	01.13		24.5172-0305.3	331312	2		L=305	
	C 180 CGI 115	06.11							
	C 200 CGI 135	06.11							
	C 220 CDI 125	06.11							
	C 250 CDI 150	06.11							
	C 250 CGI 150	06.11							
	C 350 225	06.11							
	C 350 4-matic 225	09.13							
	C 63 AMG 336	06.11							
	C 63 AMG 373	11.12							

1) - idling stop system / - dispositivo start/stop / - unité marche/arrêt / - unidad arranque/paro
 2) + idling stop system / + dispositivo start/stop / + unité marche/arrêt / + unidad arranque/paro
 3) - sport package/- sport package AMG / - pacchetto sportivo/- pacchetto sport.AMG / - version sport/- version sport AMG / - kit deportivo/- kit deportivo AMG
 4) + sports package/+ sports package AMG / + pacchetto sportivo/+ pacchetto sport.AMG / + version sport/+ version sport AMG / + kit deportivo/+ kit deportivo AMG

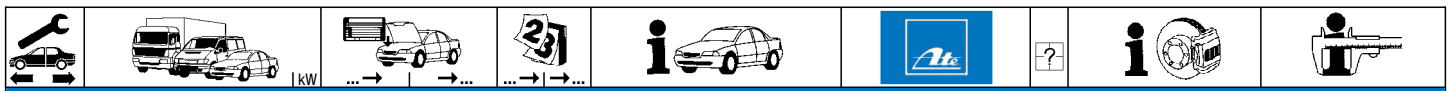

MERCEDES BENZ C-Klasse (C204) Coupe (11-)

	C 180	◀115		01.13		24.3727-0465.2	580465	1	⬆	L=2057 L=1152 L=728
	C 180 CGI	◀115		06.11		24.3727-0470.2	580470	1	□	
	C 200 CGI	◀135		06.11		24.3727-0467.2	580467	2	⬇	
	C 220 CDI	◀125		06.11						
	C 250 CDI	◀150		06.11						
	C 250 CGI	◀150		06.11						
	C 350	◀225		06.11						
	C 350 4-matic	◀225		09.13						
	C 63 AMG	◀336		06.11						
	C 63 AMG	◀373		11.12						
	C 180	▶115		01.13		24.3727-0470.2	580470	1	□	
	C 180 CGI	▶115		06.11		24.3727-0467.2	580467	2	⬇	
	C 200 CGI	▶135		06.11						
	C 220 CDI	▶125		06.11						
C 250 CDI	▶150		06.11							
C 250 CGI	▶150		06.11							
C 350	▶225		06.11							
C 350 4-matic	▶225		09.13							
C 63 AMG	▶336		06.11							
C 63 AMG	▶373		11.12							
C 63 AMG Black Series	◀380		01.12		24.3727-0465.2	580465	1	⬆	L=2057 L=1152 L=743	
					24.3727-0470.2	580470	1	□		
					24.3727-0478.2	580478	2	⬇		
C 63 AMG Black Series	▶380		01.12		24.3727-0470.2	580470	1	□	L=1152 L=743	
					24.3727-0478.2	580478	2	⬇		

MERCEDES BENZ CL-Klasse (C140) Coupe (96-99)

	CL 420	◀		06.96	02.99	03.2026-0462.3	010728			Thz 26,99/25,40	ATE
	CL 500	◀		06.96	02.99						
	CL 600	◀		06.96	02.99						
	CL 420	▶		06.96	02.99	03.2026-0562.3	010729			Thz 26,99/25,40	ATE
	CL 500	▶		06.96	02.99						
	CL 600	▶		06.96	02.99						
	CL 420			06.96	02.99	24.5113-0483.3	331397	2		L=483	
	CL 500			06.96	02.99						
	CL 600			06.96	02.99						
	CL 420			06.96	02.99	13.2461-8001.2	210226		☐	D=46	ATE
	CL 500			06.96	02.99	24.9246-8001.5	230021		☐	D=46	ATE
	CL 600			06.96	02.99	24.9246-8002.5	230022		☐	D=46	ATE
					06.96	02.99	13.0441-4601.2	250099		☐	Dichtungssatz
	CL 420			06.96	02.99	24.5123-0281.3	330877	2		L=280	
	CL 500			06.96	02.99						
	CL 600			06.96	02.99						
	CL 420	◀		06.96	02.99	24.3727-0462.2	580462	1	⬆	L=2622	
	CL 500	◀		06.96	02.99	24.3727-0456.2	580456	1	□	L=1134	
	CL 600	◀		06.96	02.99	24.3727-0455.2	580455	1	□	L=1109	
					06.96	02.99					
	CL 420	▶		06.96	02.99	24.3727-0456.2	580456		☐	L=1134	
	CL 500	▶		06.96	02.99	24.3727-0455.2	580455		☐	L=1109	
	CL 600	▶		06.96	02.99						

MERCEDES BENZ CL-Klasse (C215) Coupe (99-06)

	CL 500			03.99	08.06	24.4025-1701.3	010719			Thz 25,40	
	CL 55 AMG			10.99	08.06						
	CL 55 Kompressor AMG			06.02	08.06						
	CL 600			03.99	08.06						
	CL 65 AMG			09.03	08.06						
	CL 500			03.99	08.06	83.6105-0360.3	330635	2		L=360	
	CL 55 AMG			10.99	08.06						
	CL 55 Kompressor AMG			06.02	08.06						
	CL 600			03.99	08.06						
	CL 65 AMG			09.03	08.06						
	CL 500			03.99	08.06	13.9426-7005.2	210273		☐	D=42	ATE
						13.9426-7006.2	210274		☐	D=42	ATE
						11.0101-4202.2	260094			Hülsensatz	
	CL 55 AMG			10.99	08.06	13.9426-7003.2	210271		☐	D=42	ATE
	CL 600			03.99	08.06	13.9426-7004.2	210272		☐	D=42	ATE
	CL 500			03.99	08.06	24.5123-0240.3	330759	2		L=240	
	CL 55 AMG			10.99	08.06						
	CL 55 Kompressor AMG			06.02	08.06						
	CL 600			03.99	08.06						
	CL 65 AMG			09.03	08.06	24.5172-0305.3	331312	2		L=305	
	CL 500	◀		03.99	08.06	24.3727-0461.2	580461	1	⬆	L=2742	
	CL 55 AMG	◀		10.99	08.06	24.3727-0458.2	580458		☐	L=990	
	CL 600	◀		03.99	08.06	24.3727-0457.2	580457		☐	L=980	
	CL 55 Kompressor AMG	◀		06.02	08.06	24.3727-0461.2	580461	1	⬆	L=2742	
	CL 65 AMG	◀		09.03	08.06	24.3727-0461.2	580461	1	⬆	L=2742	
	CL 500	▶		03.99	08.06	24.3727-0458.2	580458		☐	L=990	
	CL 55 AMG	▶		10.99	08.06	24.3727-0457.2	580457		☐	L=980	
	CL 600	▶		03.99	08.06						















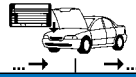























MERCEDES BENZ CL-Klasse (C216) Coupe (06-14)

	CL 500	285	A 024306	07.06		03.7858-1932.4	300263		9/8" Tandem Wegsensor	ATE
	CL 500	320	A 024306	02.11		03.0655-0007.2	370007			ATE
	CL 500 4-matic	285	A 024306	03.08						
	CL 500 4-matic	320	A 024306	02.11						
	CL 500 BlueEfficiency		A 024306	10.10						
	CL 600	380	A 024306	07.06						
	CL 63 AMG	386	A 024306	01.07						
	CL 63 AMG	400	A 024306	02.11						
	CL 63 AMG	420	A 024306	01.10						
	CL 65 AMG	450	A 024306	01.07						
CL 65 AMG	463	A 024306	02.11							
	CL 500	285	A 024307	03.14		03.0655-0007.2	370007		Wegsensor	ATE
	CL 500	320	A 024307	03.14						
	CL 500 4-matic	285	A 024307	03.14						
	CL 500 4-matic	320	A 024307	03.14						
	CL 500 BlueEfficiency		A 024307	03.14						
	CL 600	380	A 024307	03.14						
	CL 63 AMG	386	A 024307	03.14						
	CL 63 AMG	400	A 024307	03.14						
	CL 63 AMG	420	A 024307	03.14						
	CL 65 AMG	450	A 024307	03.14						
CL 65 AMG	463	A 024307	03.14							
	CL 500	285	A 024016	07.06		03.4055-0013.3	010793		THz 25,40	ATE
	CL 500 4-matic	285	A 024016	03.08						
	CL 500 BlueEfficiency		A 024016	10.10						
	CL 600	380	A 024016	07.06						
	CL 63 AMG	386	A 024016	01.07						
	CL 65 AMG	450	A 024016	01.07						
	CL 65 AMG	463	A 024016	02.11						
	CL 500	285	A 024017	03.14		03.4156-0073.3	010942		THz 26,99	ATE
	CL 500	320		02.11	03.14					
	CL 500 4-matic	285	A 024017	03.14						
CL 500 4-matic	320		02.11	03.14						
CL 500 BlueEfficiency		A 024017	03.14							
CL 600	380	A 024017	03.14							
CL 63 AMG	386	A 024017	03.14							
CL 63 AMG	400		02.11	03.14						
CL 63 AMG	420		01.10	03.14						
CL 65 AMG	450	A 024017	03.14							
CL 65 AMG	463	A 024017	03.14							
	CL 500	285		07.06	03.14	11.9426-9959.2	220801	☐	D=42, - Halter	ATE
	CL 500	320		02.11	03.14	11.9426-9960.2	220802	☐	D=42, - Halter	ATE
	CL 500 4-matic	285		03.08	03.14	11.8116-0086.2	390606	2	Haltefeder	ATE
	CL 500 BlueEfficiency			10.10	03.14	11.8171-0008.1	990049	2	Führungsbolzen	ATE
						11.0101-5407.2	260011		Hülzensatz	ATE
	CL 500	285		02.11	03.14	11.9426-9959.2	220801	☐	D=42, - Halter	ATE
	CL 500 4-matic	320		02.11	03.14	11.9426-9960.2	220802	☐	D=42, - Halter	ATE
						11.8171-0008.1	990049		Führungsbolzen	ATE
						11.0101-5407.2	260011		Hülzensatz	ATE
						11.8116-0086.2	390606	2	Haltefeder	ATE
	CL 500	285		07.06	03.14	24.5123-0350.3	330963	2	L=350	
	CL 500	320		02.11	03.14					
	CL 500 4-matic	285		03.08	03.14					
	CL 500 4-matic	320		02.11	03.14					
	CL 500 BlueEfficiency			10.10	03.14					
	CL 600	380		07.06	03.14					
	CL 63 AMG	386		01.07	03.14					
	CL 63 AMG	400		02.11	03.14					
	CL 63 AMG	420		01.10	03.14					
	CL 65 AMG	450		01.07	03.14					
CL 65 AMG	463		02.11	03.14						

















MERCEDES BENZ CLK-Klasse (C208) Coupe (97-02)





























	CLK 200	100	F 129679		06.02	03.7863-0903.4	300244		10" Wegsensor	ATE
	CLK 200 Kompressor	120		06.00	06.02	03.0655-0007.2	370007			ATE
	CLK 200 Kompressor	141	F 129679		06.02					
	CLK 230 Kompressor	142	F 129679		06.02					
	CLK 230 Kompressor	145		06.00	06.02					
	CLK 200	100	F 129678	06.97		- ESP	24.2023-1702.3	010534	THz 23,81/19,05	TRW
	CLK 200 Kompressor	141	F 129678	06.97		- ESP				
	CLK 230 Kompressor	142	F 129678	06.97		- ESP				
	CLK 320	160	F 129678	06.97		- ESP				
	CLK 200	100	F 129679		06.02		03.2023-2004.3	010788	THz 23,81/19,05	ATE
	CLK 200 Kompressor	120		06.00	06.02					
	CLK 200 Kompressor	141	F 129679		06.02					
	CLK 230 Kompressor	142	F 129679		06.02					
	CLK 230 Kompressor	145		06.00	06.02					
	CLK 320	160	F 129678	06.97		+ ESP	24.2023-1704.3	010635	THz 23,81	TRW
CLK 320	160	F 129679		06.02						
CLK 430	205			03.98	06.02	24.2025-1709.3	010693	THz 25,40		
CLK 55 AMG	255			08.99	06.02					

												
MERCEDES BENZ CLK-Klasse (C208) Coupe (97-02)												
	CLK 200 CLK 200 Kompressor CLK 200 Kompressor CLK 230 Kompressor CLK 230 Kompressor	100 120 141 142 145		06.97 06.00 06.97 06.97 06.00	06.02 06.02 06.02 06.02 06.02		11.3571-8512.2 24.3571-8511.5 24.3571-8512.5 11.0441-5703.2 11.8170-0401.1 11.0101-5407.2 11.8171-0008.1 11.8116-0253.1	220316 240491 240492 250145 260103 260011 990049 390512	2 2		D=57, - Halter D=57, - Halter D=57, - Halter Dichtungssatz Halter Hülsensatz Führungsbolzen Haltefeder	ATE ATE ATE ATE ATE ATE ATE ATE
	CLK 320 CLK 430	160 205		06.97 03.98	06.02 06.02 + 		11.3571-8509.2 11.3571-8510.2 11.0441-5703.2 11.0101-5407.2 11.8171-0008.1 11.8116-0253.1	220313 220314 250145 260011 990049 390512	2		D=57, - Halter D=57, - Halter Dichtungssatz Hülsensatz Führungsbolzen Haltefeder	ATE ATE ATE ATE ATE ATE
	CLK 430	205	F129678	03.98	- 		13.4421-8010.2 13.0441-4214.2 11.8171-0096.1	210229 250091 250155			D=42/38 Dichtungssatz Führungsbolzen	ATE ATE ATE
	CLK 430	205	F129679		06.02	- 	11.9441-9971.2 11.9441-9972.2 11.8171-0096.1 11.0101-7003.2 11.8116-0133.1	220839 220840 250155 260124 390511	2		D=44, - Halter D=44, - Halter Führungsbolzen Hülsensatz Haltefeder	ATE ATE ATE ATE ATE
	CLK 55 AMG	255		08.99	06.02		11.8116-0133.1	390511	2		Haltefeder	ATE
	CLK 200 CLK 200 Kompressor CLK 200 Kompressor CLK 230 Kompressor CLK 230 Kompressor CLK 320 CLK 430 CLK 55 AMG	100 120 141 142 145 160 205 255		06.97 06.00 06.97 06.00 06.97 03.98 08.99	06.02 06.02 06.02 06.02 06.02 06.02 06.02		83.7705-0386.3	330828	2		L=385	
	CLK 200 CLK 200 Kompressor CLK 200 Kompressor CLK 230 Kompressor CLK 230 Kompressor	100 120 141 142 145	F 000850 F 000850 F 000850 F 000850 F 000850	06.97 06.00 06.97 06.97 06.00			13.2381-8035.2 24.9238-8035.5 24.9238-8036.5 13.0441-3817.2	210037 230025 230026 250071			D=38 D=38 D=38 Dichtungssatz	ATE ATE ATE ATE
	CLK 200 CLK 200 Kompressor CLK 200 Kompressor CLK 230 Kompressor CLK 230 Kompressor	100 120 141 142 145	F 000851 / T 000001 F 000851 / T 000001 F 000851 / T 000001 F 000851 / T 000001 F 000851 / T 000001		06.02 06.02 06.02 06.02 06.02		13.2361-8003.2 13.2361-8004.2 13.0441-3609.2	210220 210221 250057			D=36 D=36 Dichtungssatz	ATE ATE ATE
	CLK 320 CLK 430	160 205	F 196683 / T 098095 F 129678	06.97 03.98			13.2361-8001.2 13.2361-8002.2 24.9236-8001.5 24.9236-8002.5 13.0441-3606.2	210214 210215 230007 230008 250147			D=36 D=36 D=36 D=36 Dichtungssatz	ATE ATE ATE ATE ATE
	CLK 430 CLK 55 AMG	205 255	F126679		06.02 08.99	06.02	13.2421-8025.2 13.2421-8026.2 13.0441-4216.2	210061 210062 250093			D=42 D=42 Dichtungssatz	ATE ATE ATE
	CLK 320	160	F 196684 / T 098096		06.02		13.9361-0035.2 13.9361-0036.2 13.0441-3609.2	210253 210254 250057			D=36 D=36 Dichtungssatz	ATE ATE ATE
	CLK 200 CLK 200 Kompressor CLK 200 Kompressor CLK 230 Kompressor CLK 230 Kompressor CLK 320 CLK 430 CLK 55 AMG	100 120 141 142 145 160 205 255		06.97 06.00 06.97 06.97 06.00 06.97 03.98 08.99	06.02 06.02 06.02 06.02 06.02 06.02 06.02 06.02		24.5123-0281.3	330877	2		L=280	
	CLK 200 CLK 200 Kompressor CLK 200 Kompressor CLK 230 Kompressor CLK 230 Kompressor CLK 320 CLK 430 CLK 55 AMG	100 120 141 142 145 160 205 255		06.97 06.00 06.97 06.97 06.00 06.97 03.98 08.99	06.02 06.02 06.02 06.02 06.02 06.02 06.02 06.02		24.3727-0423.2 24.3727-0418.2 24.3727-0419.2	580423 580418 580419	1		L=2554 L=960 L=925	
	CLK 200 CLK 230 Kompressor CLK 230 Kompressor CLK 320 CLK 430 CLK 55 AMG	100 142 145 160 205 255		06.97 06.97 06.00 06.97 03.98 08.99	06.02 06.02 06.02 06.02 06.02 06.02		24.3727-0418.2 24.3727-0419.2	580418 580419			L=960 L=925	
	CLK 200 CLK 200 Kompressor CLK 200 Kompressor CLK 230 Kompressor CLK 230 Kompressor	100 120 141 142 145		06.97 06.00 06.97 06.97 06.00	06.02 06.02 06.02 06.02 06.02		24.2419-0915.3 24.2419-1703.3	030045 030097			+ GG ¹⁾ + ALU ²⁾	Gz 19,05 Gz 19,05
	CLK 200 CLK 200 Kompressor CLK 230 Kompressor	100 141 142		06.97 06.97 06.97	06.02 06.02 06.02		03.2523-1310.3	040022			Nz 23,81	

¹⁾ + cast iron / + ghisa / + fonte grise / + fundición de gris

²⁾ + aluminium / + alluminio / + aluminium / + aluminio

									
MERCEDES BENZ CLK-Klasse (A208) Cabrio (98-03)									
	CLK 200 CLK 200 Kompressor CLK 200 Kompressor CLK 230 Kompressor CLK 230 Kompressor	100 T 028296 120 141 T 028296 142 T 028296 145		06.03 06.03 06.03 06.03 06.03	03.7863-0903.4 03.0655-0007.2	300244 370007		10" Wegsensor ATE ATE	
	CLK 200 CLK 200 Kompressor CLK 230 Kompressor CLK 320	100 141 142 160	T 028295 T 028295 T 028295 T 028295	06.98 06.98 06.98 06.98	- ESP - ESP - ESP - ESP	24.2023-1702.3	010534	Thz 23,81/19,05 TRW	
	CLK 200 CLK 200 Kompressor CLK 200 Kompressor CLK 230 Kompressor CLK 230 Kompressor	100 T 028296 120 141 T 028296 142 T 028296 145		06.03 06.03 06.03 06.03 06.03		03.2023-2004.3	010788	Thz 23,81/19,05 ATE	
	CLK 320 CLK 320	160 160 T 028296	T 028295	06.98 06.03	+ ESP	24.2023-1704.3	010635	Thz 23,81 TRW	
	CLK 430 CLK 55 AMG	205 255		06.99 01.00	06.03 06.03	24.2025-1709.3	010693	Thz 25,40	
	CLK 200	100		06.98 06.03	06.03	11.3571-8512.2 24.3571-8511.5 24.3571-8512.5 11.0441-5703.2 11.8170-0401.1 11.0101-5407.2 11.8171-0008.1 11.8116-0253.1	220316 240491 240492 250145 260103 260011 990049 390512	<input type="checkbox"/> <input type="checkbox"/> <input type="checkbox"/> <input type="checkbox"/> 2 <input type="checkbox"/> 2	D=57, - Halter D=57, - Halter D=57, - Halter Dichtungssatz Halter Hülsensatz Führungsbolzen Haltefeder ATE ATE ATE ATE ATE ATE ATE
	CLK 200 Kompressor CLK 200 Kompressor CLK 230 Kompressor CLK 230 Kompressor CLK 320	120 141 142 145 160		06.00 06.98 06.98 06.00 06.98	06.03 06.03 06.03 06.03 06.03	11.3571-8509.2 11.3571-8510.2 11.0441-5703.2 11.0101-5407.2 11.8171-0008.1 11.8116-0253.1	220313 220314 250145 260011 990049 390512	<input type="checkbox"/> <input type="checkbox"/> <input type="checkbox"/> <input type="checkbox"/> 2	D=57, - Halter D=57, - Halter Dichtungssatz Hülsensatz Führungsbolzen Haltefeder ATE ATE ATE ATE ATE
	CLK 430	205		06.99	06.03	11.9441-9971.2 11.9441-9972.2 11.0101-7003.2 11.8171-0008.1 11.8116-0133.1	220839 220840 260124 990049 390511	<input type="checkbox"/> <input type="checkbox"/> 2	D=44, - Halter D=44, - Halter Hülsensatz Führungsbolzen Haltefeder ATE ATE ATE ATE
	CLK 55 AMG	255		01.00	06.03	11.8116-0133.1	390511	2 Haltefeder ATE	
	CLK 200 CLK 200 Kompressor CLK 200 Kompressor CLK 230 Kompressor CLK 230 Kompressor CLK 320 CLK 430 CLK 55 AMG	100 120 141 142 145 160 205 255		06.98 06.00 06.98 06.98 06.00 06.98 06.99 01.00	06.03 06.03 06.03 06.03 06.03 06.03 06.03 06.03	83.7705-0386.3	330828	2 L=385	
	CLK 200 CLK 200 Kompressor CLK 200 Kompressor CLK 230 Kompressor CLK 230 Kompressor CLK 320	100 120 141 142 145 160		06.98 06.00 06.98 06.98 06.00 06.98	06.03 06.03 06.03 06.03 06.03 06.03	13.2361-8003.2 13.2361-8004.2 13.0441-3609.2	210220 210221 250057	<input type="checkbox"/> <input type="checkbox"/> <input type="checkbox"/> <input type="checkbox"/> <input type="checkbox"/> <input type="checkbox"/>	D=36 D=36 Dichtungssatz ATE ATE ATE ATE ATE
	CLK 200 Kompressor CLK 200 Kompressor CLK 230 Kompressor CLK 230 Kompressor CLK 320	120 141 142 145 160	F 196683 / T 098095 F 196683 / T 098095 F 196683 / T 098095 F 196683 / T 098095 F 196683 / T 098095	06.00 06.98 06.98 06.00 06.98	06.03 06.03 06.03 06.03 06.03	13.2361-8001.2 13.2361-8002.2 24.9236-8001.5 24.9236-8002.5 13.0441-3606.2	210214 210215 230007 230008 250147	<input type="checkbox"/> <input type="checkbox"/> <input type="checkbox"/> <input type="checkbox"/> <input type="checkbox"/>	D=36 D=36 D=36 D=36 Dichtungssatz ATE ATE ATE ATE
	CLK 200 Kompressor CLK 200 Kompressor CLK 230 Kompressor CLK 230 Kompressor CLK 320	120 F 196684 / T 098096 141 F 196684 / T 098096 142 F 196684 / T 098096 145 F 196684 / T 098096 160 F 196684 / T 098096		06.03 06.03 06.03 06.03 06.03	06.03 06.03 06.03 06.03 06.03	13.9361-0035.2 13.9361-0036.2 13.0441-3609.2	210253 210254 250057	<input type="checkbox"/> <input type="checkbox"/> <input type="checkbox"/>	D=36 D=36 Dichtungssatz ATE ATE ATE
	CLK 430 CLK 55 AMG	205 255		06.99 01.00	06.03 06.03	13.2421-8025.2 13.2421-8026.2 13.0441-4216.2	210061 210062 250093	<input type="checkbox"/> <input type="checkbox"/> <input type="checkbox"/>	D=42 D=42 Dichtungssatz ATE ATE ATE
	CLK 200 CLK 200 Kompressor CLK 200 Kompressor CLK 230 Kompressor CLK 230 Kompressor CLK 320 CLK 430 CLK 55 AMG	100 120 141 142 145 160 205 255		06.98 06.00 06.98 06.98 06.00 06.98 06.99 01.00	06.03 06.03 06.03 06.03 06.03 06.03 06.03 06.03	24.5123-0281.3	330877	2 L=280	
	CLK 200 CLK 200 Kompressor CLK 200 Kompressor CLK 230 Kompressor CLK 230 Kompressor CLK 320 CLK 430 CLK 55 AMG	100 120 141 142 145 160 205 255		06.98 06.00 06.98 06.98 06.00 06.98 06.99 01.00	06.03 06.03 06.03 06.03 06.03 06.03 06.03 06.03	24.3727-0423.2 24.3727-0418.2 24.3727-0419.2	580423 580418 580419	1 <input type="checkbox"/> <input type="checkbox"/> <input type="checkbox"/>	L=2554 L=960 L=925
	CLK 200 CLK 200 Kompressor CLK 230 Kompressor CLK 230 Kompressor CLK 320	100 120 142 145 160		06.98 06.00 06.98 06.00 06.98	06.03 06.03 06.03 06.03 06.03	24.3727-0418.2 24.3727-0419.2	580418 580419	<input type="checkbox"/> <input type="checkbox"/> <input type="checkbox"/>	L=960 L=925

								
MERCEDES BENZ CLK-Klasse (A208) Cabrio (98-03)								
	CLK 200	100	06.98	06.03	24.2419-0915.3	030045	+ GG 1)	Gz 19,05
	CLK 200 Kompressor	120	06.00	06.03	24.2419-1703.3	030097	+ ALU 2)	Gz 19,05
	CLK 200 Kompressor	141	06.98	06.03				
	CLK 230 Kompressor	142	06.98	06.03				
	CLK 230 Kompressor	145	06.00	06.03				
	CLK 200	100	06.98	06.03	03.2523-1310.3	040022		Nz 23,81
	CLK 200 Kompressor	141	06.98	06.03				
	CLK 230 Kompressor	142	06.98	06.03				
MERCEDES BENZ CLK-Klasse (C209) Coupe (02-09)								
	CLK 200 CGI	125	09.02	04.09	03.7848-2002.4	300166		7/8" Tandem
	CLK 200 Kompressor	120	09.02	04.09	03.0655-0007.2	370007		Wegsensor
	CLK 200 Kompressor	135	10.06	04.09				ATE
	CLK 220 CDI	125	05.05	04.09				
	CLK 240	125	05.02	04.09				
	CLK 270 CDI	125	10.02	04.09				
	CLK 280	170	05.05	04.09				
	CLK 320	160	05.02	04.09				
	CLK 320 CDI	165	05.05	04.09				
	CLK 350	200	05.05	04.09				
	CLK 500	225	05.02	04.09				
	CLK 500	285	06.06	04.09				
	CLK 55 AMG	270	09.02	04.09				
	CLK 63 AMG	270	04.06	04.09				
	CLK 200 CGI	125	09.02	04.09	03.0655-0007.2	370007		Wegsensor
	CLK 200 Kompressor	120	09.02	04.09				ATE
	CLK 200 Kompressor	135	10.06	04.09				
	CLK 220 CDI	125	05.05	04.09				
	CLK 240	125	05.02	04.09				
	CLK 270 CDI	125	10.02	04.09				
	CLK 280	170	05.05	04.09				
	CLK 320	160	05.02	04.09				
	CLK 320 CDI	165	05.05	04.09				
	CLK 350	200	05.05	04.09				
	CLK 500	225	05.02	04.09				
	CLK 500	285	06.06	04.09				
	CLK 55 AMG	270	09.02	04.09				
	CLK 63 AMG	270	04.06	04.09				
	CLK 200 CGI	125	09.02	04.09	03.2023-1741.3	010703		THz 23,81/20,64
	CLK 200 Kompressor	120	09.02	04.09				ATE
	CLK 200 Kompressor	135	10.06	04.09				
	CLK 270 CDI	125	10.02	04.09				
	CLK 200 CGI	125	09.02	04.09	03.2025-1741.3	010705		THz 25,40/20,64
	CLK 200 Kompressor	120	09.02	04.09				ATE
	CLK 200 Kompressor	135	10.06	04.09				
	CLK 220 CDI	125	05.05	04.09				
	CLK 240	125	05.02	04.09				
	CLK 270 CDI	125	10.02	04.09				
	CLK 280	170	05.05	04.09				
	CLK 320	160	05.02	04.09				
	CLK 320 CDI	165	05.05	04.09				
	CLK 350	200	05.05	04.09				
	CLK 500	225	05.02	04.09				
	CLK 500	285	06.06	04.09				
	CLK 55 AMG	270	09.02	04.09				
	CLK 63 AMG	270	04.06	04.09				
	CLK 200 CGI	125	09.02	04.09	24.3571-1739.7	220667	 - Sportpaket / - Sportpaket AMG 3)	D=57, - Halter
	CLK 200 Kompressor	120	09.02	04.09	24.3571-1740.7	220668	 - Sportpaket / - Sportpaket AMG 3)	D=57, - Halter
	CLK 220 CDI	125	05.05	04.09	24.0101-3803.2	260101		Bremssattel-Zubehör
	CLK 240	125	05.02	04.09	24.3571-1721.7	220555	 - Sportpaket / - Sportpaket AMG 3)	D=57, - Halter
	CLK 320	160	05.02	04.09	24.3571-1722.7	220556	 - Sportpaket / - Sportpaket AMG 3)	D=57, - Halter
	CLK 200 Kompressor	135	10.06	04.09	24.3571-1721.7	220555	 - Sportpaket / - Sportpaket AMG 3)	D=57, - Halter
	CLK 270 CDI	125	10.02	04.09	24.3571-1722.7	220556	 - Sportpaket / - Sportpaket AMG 3)	D=57, - Halter
	CLK 280	170	05.05	04.09				
	CLK 200 CGI	125	09.02	04.09	83.7705-0386.3	330828	2	L=385
	CLK 200 Kompressor	120	09.02	04.09				
	CLK 200 Kompressor	135	10.06	04.09				
	CLK 220 CDI	125	05.05	04.09				
	CLK 240	125	05.02	04.09				
	CLK 270 CDI	125	10.02	04.09				
	CLK 280	170	05.05	04.09				
	CLK 320	160	05.02	04.09				
	CLK 320 CDI	165	05.05	04.09				
	CLK 350	200	05.05	04.09				
	CLK 500	225	05.02	04.09				
	CLK 500	285	06.06	04.09				
	CLK 55 AMG	270	09.02	04.09				
	CLK 63 AMG	270	04.06	04.09				
	CLK 200 CGI	125	09.02	04.09	13.9361-0023.2	210241	 - Sportpaket / - Sportpaket AMG 3)	D=36
	CLK 200 Kompressor	120	09.02	04.09	13.9361-0024.2	210242	 - Sportpaket / - Sportpaket AMG 3)	D=36
	CLK 220 CDI	125	05.05	04.09	13.9361-0035.2	210253	 + Sportpaket / + Sportpaket AMG 4)	D=36
					13.9361-0036.2	210254	 + Sportpaket / + Sportpaket AMG 4)	D=36
					13.0441-3609.2	250057		Dichtungssatz
	CLK 200 Kompressor	135	10.06	04.09	13.9361-0035.2	210253	 - Sportpaket / - Sportpaket AMG 3)	D=36
	CLK 240	125	05.02	04.09	13.9361-0036.2	210254	 - Sportpaket / - Sportpaket AMG 3)	D=36
	CLK 270 CDI	125	10.02	04.09	13.0441-3609.2	250057		Dichtungssatz

1) + cast iron / + ghisa / + fonte grise / + fundición de gris

2) + aluminium / + alluminio / + aluminium / + aluminio

3) - sport package/- sport package AMG / - pacchetto sportivo/- pacchetto sport.AMG / - version sport/- version sport AMG / - kit deportivo/- kit deportivo AMG































4) + sports package/+ sports package AMG / + pacchetto sportivo/+ pacchetto sport.AMG / + version sport/+ version sport AMG / + kit deportivo/+ kit deportivo AMG

MERCEDES BENZ CLK-Klasse (C209) Coupe (02-09)

	CLK 280	170		05.05	04.09	13.9361-0035.2	210253	<input type="checkbox"/>		D=36 D=36 Dichtungssatz	ATE
	CLK 320	160		05.02	04.09	13.9361-0036.2	210254				ATE
	CLK 320 CDI	165		05.05	04.09	13.0441-3609.2	250057				ATE
	CLK 350	200		05.05	04.09						
	CLK 500	225		05.02	04.09	13.0441-4216.2	250093			Dichtungssatz	ATE
	CLK 500	285		06.06	04.09						
	CLK 55 AMG	270	F 123374	09.02							
	CLK 200 CGI	125		09.02	04.09	24.5123-0281.3	330877	2		L=280	
	CLK 200 Kompressor	120		09.02	04.09						
	CLK 200 Kompressor	135		10.06	04.09						
	CLK 220 CDI			05.05	04.09						
	CLK 240			05.02	04.09						
	CLK 270 CDI			10.02	04.09						
	CLK 280	170		05.05	04.09						
	CLK 320	160		05.02	04.09						
	CLK 320 CDI	165		05.05	04.09						
	CLK 350	200		05.05	04.09						
	CLK 500	225		05.02	04.09						
	CLK 500	285		06.06	04.09						
	CLK 55 AMG	270		09.02	04.09						
	CLK 63 AMG			04.06	04.09						
		CLK 200 CGI	125		09.02	04.09	24.3727-0429.2				580429
CLK 200 Kompressor		120		09.02	04.09	24.3727-0430.2	580430				
CLK 200 Kompressor		135		10.06	04.09	24.3727-0436.2	580436				
CLK 220 CDI				05.05	04.09						
CLK 240				05.02	04.09						
CLK 270 CDI				10.02	04.09						
CLK 280		170		05.05	04.09						
CLK 320		160		05.02	04.09						
CLK 320 CDI		165		05.05	04.09						
CLK 350		200		05.05	04.09						
CLK 500		225		05.02	04.09						
CLK 500		285		06.06	04.09						
CLK 55 AMG		270		09.02	04.09						
CLK 63 AMG				04.06	04.09						
		CLK 200 CGI	125		09.02	04.09	24.3727-0430.2	580430	<input type="checkbox"/>		L=925 L=900
	CLK 200 Kompressor	120		09.02	04.09	24.3727-0436.2	580436				
	CLK 200 Kompressor	135		10.06	04.09						
	CLK 220 CDI			05.05	04.09						
	CLK 240			05.02	04.09						
	CLK 270 CDI			10.02	04.09						
	CLK 280	170		05.05	04.09						
	CLK 320	160		05.02	04.09						
	CLK 320 CDI	165		05.05	04.09						
	CLK 350	200		05.05	04.09						
	CLK 500	225		05.02	04.09						
	CLK 500	285		06.06	04.09						
	CLK 55 AMG	270		09.02	04.09						
	CLK 63 AMG			04.06	04.09						
		CLK 200 CGI	125		09.02	04.09	24.3727-0429.2	580429			
CLK 200 Kompressor		120		09.02	04.09						
CLK 200 Kompressor		135		10.06	04.09						
CLK 220 CDI				05.05	04.09						
CLK 240				05.02	04.09						
CLK 270 CDI				10.02	04.09						
CLK 280		170		05.05	04.09						
CLK 320		160		05.02	04.09						
CLK 320 CDI		165		05.05	04.09						
CLK 350		200		05.05	04.09						
CLK 500		225		05.02	04.09						
CLK 500		285		06.06	04.09						
CLK 55 AMG		270		09.02	04.09						
CLK 63 AMG				04.06	04.09						















MERCEDES BENZ CLK-Klasse (A209) Cabrio (03-09)





































	CLK 200 CGI	125		05.03	12.09	03.7848-2002.4	300166	<input type="checkbox"/>		7/8" Tandem Wegsensor	ATE				
	CLK 200 Kompressor	120		05.03	12.09	03.0655-0007.2	370007				ATE				
	CLK 200 Kompressor	135		10.06	12.09										
	CLK 240	125		05.03	12.09										
	CLK 280	170		05.05	12.09										
	CLK 320	160		05.03	12.09										
	CLK 320 CDI	165		05.05	12.09										
	CLK 350	200		05.05	12.09										
	CLK 500	225		05.03	12.09										
	CLK 500	285		06.06	12.09										
	CLK 55 AMG	270		05.03	12.09										
	CLK 63 AMG	354		04.06	12.09										
		CLK 200 CGI	125		05.03	12.09	03.0655-0007.2				370007	<input type="checkbox"/>		Wegsensor	ATE
		CLK 200 Kompressor	120		05.03	12.09									
		CLK 200 Kompressor	135		10.06	12.09									
CLK 240		125		05.03	12.09										
CLK 280		170		05.05	12.09										
CLK 320		160		05.03	12.09										
CLK 320 CDI		165		05.05	12.09										
CLK 350		200		05.05	12.09										
CLK 500		225		05.03	12.09										
CLK 500		285		06.06	12.09										
CLK 55 AMG		270		05.03	12.09										
CLK 63 AMG		354		04.06	12.09										
		CLK 200 CGI	125		05.03	12.09	03.2023-1741.3	010703	<input type="checkbox"/>		THz 23,81/20,64				ATE
		CLK 200 Kompressor	120		05.03	12.09	03.2025-1741.3	010705							ATE
		CLK 200 Kompressor	135		10.06	12.09									
	CLK 240	125		05.03	12.09										
	CLK 280	170		05.05	12.09										
	CLK 320	160		05.03	12.09										
	CLK 320 CDI	165		05.05	12.09										
	CLK 350	200		05.05	12.09										
	CLK 500	225		05.03	12.09										
	CLK 500	285		06.06	12.09										
	CLK 55 AMG	270		05.03	12.09										
	CLK 63 AMG	354		04.06	12.09										















										
MERCEDES BENZ CLK-Klasse (A209) Cabrio (03-09)										
	CLK 200 CGI	125	05.03	12.09	24.3571-1739.7	220667		D=57, - Halter D=57, - Halter Bremsattel-Zubehör	TRW TRW TRW	
	CLK 240	125	05.03	12.09	24.3571-1721.7	220555		D=57, - Halter	TRW	
	CLK 320	160	05.03	12.09	24.3571-1722.7	220556		D=57, - Halter	TRW	
	CLK 200 Kompressor	120	05.03	12.09	24.3571-1721.7	220555	 - Sportpaket / - Sportpaket AMG 1)	D=57, - Halter	TRW	
	CLK 200 Kompressor	135	10.06	12.09	24.3571-1722.7	220556	 - Sportpaket / - Sportpaket AMG 1)	D=57, - Halter	TRW	
	CLK 280	170	05.05	12.09						
	CLK 200 CGI	125	05.03	12.09	83.7705-0386.3	330828	2	L=385		
	CLK 200 Kompressor	120	05.03	12.09						
	CLK 200 Kompressor	135	10.06	12.09						
	CLK 240	125	05.03	12.09						
	CLK 280	170	05.05	12.09						
	CLK 320	160	05.03	12.09						
	CLK 320 CDI	165	05.05	12.09						
	CLK 350	200	05.05	12.09						
	CLK 500	225	05.03	12.09						
	CLK 500	285	06.06	12.09						
	CLK 55 AMG	270	05.03	12.09						
	CLK 63 AMG	354	04.06	12.09						
		CLK 200 CGI	125	05.03	12.09	13.9361-0023.2	210241		D=36	ATE
					13.9361-0024.2	210242		D=36	ATE	
					13.0441-3609.2	250057		Dichtungssatz	ATE	
CLK 200 Kompressor		120	05.03	12.09	13.9361-0035.2	210253		D=36	ATE	
CLK 200 Kompressor		135	10.06	12.09	13.9361-0036.2	210254		D=36	ATE	
CLK 240		125	05.03	12.09	13.0441-3609.2	250057		Dichtungssatz	ATE	
CLK 280		170	05.05	12.09						
CLK 320		160	05.03	12.09						
CLK 320 CDI		165	05.05	12.09						
CLK 350		200	05.05	12.09						
	CLK 500	225	05.03	12.09	13.0441-4216.2	250093		Dichtungssatz	ATE	
	CLK 500	285	06.06	12.09						
	CLK 55 AMG	270	05.03	12.09						
					T 033979 / F 123374					
	CLK 200 CGI	125	05.03	12.09	24.5123-0281.3	330877	2	L=280		
	CLK 200 Kompressor	120	05.03	12.09						
	CLK 200 Kompressor	135	10.06	12.09						
	CLK 240	125	05.03	12.09						
	CLK 280	170	05.05	12.09						
	CLK 320	160	05.03	12.09						
	CLK 320 CDI	165	05.05	12.09						
	CLK 350	200	05.05	12.09						
	CLK 500	225	05.03	12.09						
	CLK 500	285	06.06	12.09						
	CLK 55 AMG	270	05.03	12.09						
	CLK 63 AMG	354	04.06	12.09						
		CLK 200 CGI	125	05.03	12.09	24.3727-0429.2	580429	1 	L=2735	
CLK 200 Kompressor		120	05.03	12.09	24.3727-0430.2	580430		L=925		
CLK 200 Kompressor		135	10.06	12.09	24.3727-0436.2	580436		L=900		
CLK 240		125	05.03	12.09						
CLK 280		170	05.05	12.09						
CLK 320		160	05.03	12.09						
CLK 320 CDI		165	05.05	12.09						
CLK 350		200	05.05	12.09						
CLK 500		225	05.03	12.09						
CLK 500		285	06.06	12.09						
CLK 55 AMG		270	05.03	12.09						
		CLK 200 CGI	125	05.03	12.09	24.3727-0430.2	580430		L=925	
		CLK 200 Kompressor	120	05.03	12.09	24.3727-0436.2	580436		L=900	
		CLK 200 Kompressor	135	10.06	12.09					
		CLK 240	125	05.03	12.09					
		CLK 280	170	05.05	12.09					
		CLK 320	160	05.03	12.09					
	CLK 320 CDI	165	05.05	12.09						
	CLK 350	200	05.05	12.09						
	CLK 500	225	05.03	12.09						
	CLK 500	285	06.06	12.09						
	CLK 55 AMG	270	05.03	12.09						
	CLK 63 AMG	354	04.06	12.09	24.3727-0429.2	580429	1 	L=2735		
MERCEDES BENZ CLS-Klasse (C219) Coupe (04-10)										
	CLS 280 / CLS 300	170	10.07	10.10	24.2125-1745.3	010998		Thz 25,40	TRW	
	CLS 320 CDI	155	05.05	10.10						
	CLS 320 CDI	165	05.05	10.10						
	CLS 350	200	08.04	10.10						
	CLS 350 CDI	165	04.09	10.10						
	CLS 350 CDI	200	04.09	10.10						
	CLS 350 CGI	215	04.09	10.10						
	CLS 350 CGI	215	04.06	10.10						
	CLS 500	225	08.04	10.10						
	CLS 500 / CLS 550	285	04.06	10.10						
	CLS 55 AMG	350	01.05	10.10						
	CLS 63 AMG	378	04.06	10.10						

1) - sport package/- sport package AMG / - pacchetto sportivo/- pacchetto sport.AMG / - version sport/- version sport AMG / - kit sportivo/- kit sportivo AMG



													
MERCEDES BENZ CLS-Klasse (C219) Coupe (04-10)													
	CLS 280 / CLS 300	170	10.07	10.10	24.5123-0380.3	331256	2	L=380					
	CLS 320 CDI	155	05.05	10.10									
	CLS 320 CDI	165	05.05	10.10									
	CLS 350	200	08.04	10.10									
	CLS 350 CDI	165	04.09	10.10									
	CLS 350 CDI	200	04.09	10.10									
	CLS 350 CGI	215	04.09	10.10									
	CLS 350 CGI	215	04.06	10.10									
	CLS 500	225	08.04	10.10									
	CLS 500 / CLS 550	285	04.06	10.10									
	CLS 55 AMG	350	01.05	10.10									
	CLS 63 AMG	378	04.06	10.10									
		CLS 280 / CLS 300	170	10.07					10.10	11.9426-9991.2	220641	2	D=42, - Halter ATE D=42, - Halter ATE Halter ATE Hülensatz ATE Dichtungssatz ATE Haltefeder ATE
		CLS 320 CDI	155	05.05					10.10				
CLS 320 CDI		165	05.05	10.10	11.8170-0611.1	260116							
CLS 350 CDI		165	04.09	10.10	11.0101-4202.2	260094							
CLS 350 CDI		200	04.09	10.10	11.0441-4203.2	250013							
CLS 350		200	08.04	10.10	11.9426-9991.2	220641							
		215	04.09	10.10	11.9426-9992.2	220642							
		215	04.06	10.10	11.8170-0611.1	260116							
		215	04.06	10.10	11.0101-5407.2	260011							
		225	08.04	10.10	11.8171-0008.1	990049							
CLS 500 / CLS 550		285	04.06	10.10	11.8116-0323.1	390459							
		CLS 500 / CLS 550	285	04.06	10.10	11.9426-9959.2	220801	2	D=42, - Halter ATE D=42, - Halter ATE Führungsbolzen ATE Haltefeder ATE				
11.8171-0008.1		990049											
	CLS 280 / CLS 300	170	10.07	10.10	24.5238-0255.3	330674	2	L=255					
	CLS 320 CDI	155	05.05	10.10									
	CLS 320 CDI	165	05.05	10.10									
	CLS 350	200	08.04	10.10									
	CLS 350 CDI	165	04.09	10.10									
	CLS 350 CDI	200	04.09	10.10									
	CLS 350 CGI	215	04.09	10.10									
	CLS 350 CGI	215	04.06	10.10									
	CLS 500	225	08.04	10.10									
	CLS 500 / CLS 550	285	04.06	10.10									
	CLS 55 AMG	350	01.05	10.10									
	CLS 63 AMG	378	04.06	10.10									
		CLS 280 / CLS 300	170	10.07					10.10	24.3727-0447.2	580447	1	L=1952 L=1742 L=1726
		CLS 350	200	08.04					10.10				
CLS 350 CGI		215	04.09	10.10	24.3727-0448.2	580448							
CLS 350 CGI		215	04.06	10.10	24.3727-0449.2	580449							
CLS 500		225	08.04	10.10									
CLS 500 / CLS 550		285	04.06	10.10									
CLS 55 AMG		350	01.05	10.10									
CLS 63 AMG		378	04.06	10.10									
CLS 280 / CLS 300		170	10.07	10.10			24.3727-0448.2	580448					
CLS 350		200	08.04	10.10			24.3727-0449.2	580449					
CLS 350 CGI	215	04.09	10.10										
CLS 350 CGI	215	04.06	10.10										
CLS 500 / CLS 550	285	04.06	10.10										
CLS 55 AMG	350	01.05	10.10	24.3727-0448.2	580448								
CLS 63 AMG	378	04.06	10.10										
MERCEDES BENZ CLS-Klasse (C218) Coupe (10-)													
	CLS 250 CDI	150	11.10		03.7755-8202.4	300301		9/8" Tandem ATE					
	CLS 350 CDI	195	11.10										
	CLS 350 CDI 4-matic	195	09.11										
	CLS 350 CGI	225	11.10										
	CLS 350 d 4-matic	190	04.15										
	CLS 500	300	11.10										
	CLS 500 4-matic	300	11.10										
	CLS 63 AMG	386	03.11										
	CLS 63 AMG	412	01.11										
		CLS 220 BlueTec	150	05.14						03.2126-3196.3	010968		Thz 26,99 ATE
CLS 250 BT 4-matic		150	05.14										
CLS 250 CDI		150	11.10										
CLS 350 BlueTec		185	01.13										
CLS 350 BT 4-matic		185	01.13										
CLS 350 CDI		195	11.10										
CLS 350 CDI 4-matic		195	09.11										
CLS 350 CGI		225	11.10										
CLS 350 d 4-matic		190	04.15										
CLS 400		245	05.14										
CLS 400 4-matic		245	05.14										
CLS 500		300	11.10										
CLS 500 4-matic		300	11.10										
CLS 63 AMG		386	03.11										
CLS 63 AMG		412	01.11										
CLS 63 AMG 4-matic		410	01.13										
CLS 63 AMG S		430	01.13										
CLS 63 AMG S 4-matic		430	01.13										

									
MERCEDES BENZ CLS-Klasse (C218) Coupe (10-)									
	CLS 220 BlueTec CLS 250 CDI CLS 350 BlueTec CLS 350 CDI CLS 350 CGI	150 185 185 195 225	05.14 11.10 01.13 11.10 11.10		24.3606-1711.5 24.3606-1712.5	240780 240781	 	D=60, - Halter D=60, - Halter	TRW TRW
	CLS 250 BT 4-matic CLS 350 BT 4-matic CLS 350 CDI 4-matic CLS 350 d 4-matic	150 185 195 190	05.14 01.13 09.11 04.15		24.3601-1721.5 24.3601-1722.5	240629 240630	 	D=60, - Halter D=60, - Halter	TRW TRW
	CLS 220 BlueTec CLS 250 CDI CLS 350 BlueTec CLS 350 CDI CLS 350 CGI CLS 400 CLS 500 CLS 500 4-matic	150 185 185 195 225 245 300 300	05.14 11.10 01.13 11.10 11.10 05.14 11.10 11.10		24.5148-0406.3	331478	2	L=402	
	CLS 250 BT 4-matic CLS 350 BT 4-matic CLS 350 CDI 4-matic CLS 350 d 4-matic CLS 400 4-matic	150 185 195 190 245	05.14 01.13 09.11 04.15 05.14		83.7713-0487.3	331342	2	L=488	
	CLS 220 BlueTec CLS 250 BT 4-matic CLS 250 CDI CLS 350 BlueTec CLS 350 BT 4-matic CLS 350 CDI CLS 350 CDI 4-matic CLS 350 CGI CLS 350 d 4-matic CLS 400 CLS 400 4-matic CLS 500 CLS 500 4-matic	150 150 150 185 185 195 195 225 190 245 245 300 300	05.14 05.14 11.10 01.13 01.13 11.10 09.11 11.10 04.15 05.14 05.14 11.10 11.10		24.3426-9990.5 24.3426-9989.5 11.8116-0087.2 11.9426-9992.2 11.9426-9991.2 11.0101-5407.2 11.8171-0008.1 11.8116-0087.2 11.9426-9959.2 11.9426-9960.2 11.0101-5407.2 11.8171-0008.1 11.8116-0087.2	240648 240647 390607 220642 220641 260011 990049 390607 220801 220802 260011 990049 390607	  2   2   2	D=42, - Halter D=42, - Halter Haltefeder D=42, - Halter D=42, - Halter Hülzensatz Führungsbolzen Haltefeder D=42, - Halter D=42, - Halter Hülzensatz Führungsbolzen Haltefeder	ATE ATE ATE ATE ATE ATE ATE ATE ATE ATE ATE ATE ATE
	CLS 250 CDI CLS 350 BlueTec CLS 350 BT 4-matic CLS 350 CDI CLS 350 CDI 4-matic CLS 350 CGI CLS 350 d 4-matic CLS 500 CLS 500 4-matic CLS 63 AMG CLS 63 AMG CLS 63 AMG S CLS 250 CDI CLS 350 BlueTec CLS 350 BT 4-matic CLS 350 CDI CLS 350 CGI CLS 500 CLS 500 4-matic CLS 63 AMG CLS 63 AMG CLS 63 AMG S CLS 350 CDI 4-matic	150 185 185 195 195 225 190 300 300 386 412 430 150 185 185 195 225 300 300 386 412 430 195	11.10 01.13 01.13 11.10 09.11 11.10 04.15 11.10 11.10 03.11 01.11 01.13 11.10 01.13 01.13 11.10 11.10 11.10 03.11 01.11 01.13 09.11		24.3727-0484.2 24.3727-0483.2 24.3727-0478.2 24.3727-0483.2 24.3727-0483.2 24.3727-0483.2 24.3727-0483.2 24.3727-0483.2 24.3727-0483.2 24.3727-0483.2	580484 580483 580478 580483 580478 580484 580483 580483 580483 580483	1  1  2  1  1  2  1  2  1  1  1 	L=2040 L=1250 L=743 L=1660 L=1250 L=743 L=2040 L=1250	
MERCEDES BENZ CLS-Klasse (X218) Shooting Brake (12-)									
	CLS 250 CDI CLS 350 CLS 350 CDI CLS 350 CDI 4-matic	150 225 195 195	09.12 09.12 09.12 09.12	A 26541 A 26541 A 26541 A 26541	03.7858-1932.4	300263		9/8" Tandem	ATE
	CLS 220 BlueTec CLS 250 BT 4-matic CLS 250 CDI CLS 350 CLS 350 BlueTec CLS 350 BT 4-matic CLS 350 CDI CLS 350 CDI 4-matic CLS 350 d 4-matic CLS 400 CLS 400 4-matic CLS 500	150 150 150 225 190 185 195 195 190 245 245 300	05.14 05.14 09.12 09.12 05.14 05.14 09.12 09.12 04.15 05.14 05.14 09.12		03.2126-3196.3	010968		Thz 26,99	ATE

	 kW							
MERCEDES BENZ CLS-Klasse (X218) Shooting Brake (12-)								
	CLS 500 4-matic ◀300 CLS 63 AMG ◀386 CLS 63 AMG ◀410 CLS 63 AMG 4-matic ◀410 CLS 63 AMG S ◀430 CLS 63 AMG S 4-matic ◀430		09.12 09.12 01.13 01.13 01.13 01.13		03.2126-3196.3 010968			ThZ 26,99 ATE
	CLS 220 BlueTec 150 CLS 250 CDI 150 CLS 250 BT 4-matic 150		05.14 09.12 05.14		24.3606-1711.5 240780 24.3606-1712.5 240781 24.3601-1721.5 240629 24.3601-1722.5 240630	<input type="checkbox"/> <input type="checkbox"/> <input type="checkbox"/> <input type="checkbox"/>		D=60, - Halter D=60, - Halter D=60, - Halter D=60, - Halter TRW TRW TRW TRW
	CLS 350 225 CLS 350 BlueTec 190 CLS 350 CDI 195		09.12 05.14 09.12		24.3606-1711.5 240780 24.3606-1712.5 240781	<input type="checkbox"/> <input type="checkbox"/> <input type="checkbox"/>		- Sportpaket 1) - Sportpaket 1) D=60, - Halter D=60, - Halter TRW TRW
	CLS 350 BT 4-matic 185 CLS 350 CDI 4-matic 195 CLS 350 d 4-matic 190		05.14 09.12 04.15		24.3601-1721.5 240629 24.3601-1722.5 240630	<input type="checkbox"/> <input type="checkbox"/> <input type="checkbox"/>		- Sportpaket 1) - Sportpaket 1) D=60, - Halter D=60, - Halter TRW TRW
	CLS 220 BlueTec 150 CLS 250 CDI 150 CLS 350 225 CLS 350 BlueTec 190 CLS 350 CDI 195 CLS 400 245 CLS 500 300		05.14 09.12 09.12 05.14 09.12 05.14 09.12		24.5148-0406.3 331478	2		L=402
	CLS 250 BT 4-matic 150 CLS 350 BT 4-matic 185 CLS 350 CDI 4-matic 195 CLS 350 d 4-matic 190 CLS 400 4-matic 245 CLS 500 4-matic 300		05.14 05.14 09.12 04.15 05.14 09.12		83.7713-0487.3 331342	2		L=488
	CLS 220 BlueTec 150 CLS 250 BT 4-matic 150 CLS 250 CDI 150		05.14 05.14 09.12		24.3426-9990.5 240648 24.3426-9989.5 240647 11.0101-5407.2 260011 11.8171-0008.1 990049 11.8116-0087.2 390607	<input type="checkbox"/> <input type="checkbox"/> <input type="checkbox"/> <input type="checkbox"/> <input type="checkbox"/>		D=42, - Halter D=42, - Halter Hülzensatz Führungsbolzen Haltefeder ATE ATE ATE ATE ATE
	CLS 350 225 CLS 350 BlueTec 190 CLS 350 BT 4-matic 185 CLS 350 CDI 195 CLS 350 CDI 4-matic 195 CLS 350 d 4-matic 190 CLS 400 245 CLS 400 4-matic 245		09.12 05.14 05.14 09.12 09.12 04.15 05.14 05.14		11.9426-9992.2 220642 11.9426-9991.2 220641 11.0101-5407.2 260011 11.8171-0008.1 990049 11.8116-0087.2 390607	<input type="checkbox"/> <input type="checkbox"/> <input type="checkbox"/> <input type="checkbox"/> <input type="checkbox"/>		D=42, - Halter D=42, - Halter Hülzensatz Führungsbolzen Haltefeder ATE ATE ATE ATE ATE
	CLS 500 300 CLS 500 4-matic 300		09.12 09.12		11.9426-9959.2 220801 11.9426-9960.2 220802 11.0101-5407.2 260011 11.8171-0008.1 990049 11.8116-0087.2 390607	<input type="checkbox"/> <input type="checkbox"/> <input type="checkbox"/> <input type="checkbox"/> <input type="checkbox"/>		D=42, - Halter D=42, - Halter Hülzensatz Führungsbolzen Haltefeder ATE ATE ATE ATE ATE
	CLS 250 CDI ◀150 CLS 350 ◀225 CLS 350 CDI ◀195 CLS 350 CDI 4-matic ◀195 CLS 350 d 4-matic ◀190 CLS 500 ◀300 CLS 500 4-matic ◀300 CLS 63 AMG ◀386		09.12 09.12 09.12 09.12 04.15 09.12 09.12 09.12		24.3727-0484.2 580484 24.3727-0483.2 580483 24.3727-0478.2 580478	1 <input type="checkbox"/> 1 <input type="checkbox"/> 2 <input type="checkbox"/>		L=2040 L=1250 L=743
	CLS 250 CDI ▶150 CLS 350 ▶225 CLS 350 CDI ▶195 CLS 350 CDI 4-matic ▶195 CLS 350 d 4-matic ▶190 CLS 500 ▶300 CLS 500 4-matic ▶300 CLS 63 AMG ▶386		09.12 09.12 09.12 09.12 04.15 09.12 09.12 09.12		24.3727-0479.2 580479 24.3727-0483.2 580483 24.3727-0478.2 580478	1 <input type="checkbox"/> 1 <input type="checkbox"/> 2 <input type="checkbox"/>		L=1660 L=1250 L=743
	CLS 220 BlueTec ◀ CLS 250 BT 4-matic ◀150 CLS 350 BlueTec ◀190 CLS 350 BT 4-matic ◀185 CLS 400 ◀245 CLS 400 4-matic ◀245 CLS 63 AMG ◀410 CLS 63 AMG 4-matic ◀410 CLS 63 AMG S ◀430 CLS 63 AMG S 4-matic ◀430		05.14 05.14 05.14 05.14 05.14 05.14 01.13 01.13 01.13 01.13		24.3727-0484.2 580484 24.3727-0483.2 580483	1 <input type="checkbox"/> 1 <input type="checkbox"/>		L=2040 L=1250
	CLS 220 BlueTec ▶ CLS 250 BT 4-matic ▶150 CLS 350 BlueTec ▶190 CLS 350 BT 4-matic ▶185 CLS 400 ▶245 CLS 400 4-matic ▶245 CLS 63 AMG ▶410 CLS 63 AMG S ▶430		05.14 05.14 05.14 05.14 05.14 05.14 01.13 01.13		24.3727-0479.2 580479 24.3727-0483.2 580483	1 <input type="checkbox"/> 1 <input type="checkbox"/>		L=1660 L=1250

1) - sport package / - pacchetto sportivo / - version sport / - kit deportivo

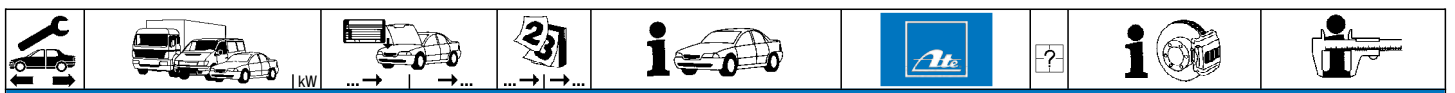

MERCEDES BENZ E-Klasse (C124) Coupe (93-97)

	E 200 E 220 E 320 E 36 AMG E 36 AMG	100 110 162 195 200		06.93 06.93 06.93 06.93 05.94	06.97 06.97 06.97 04.95 06.97	03.7760-2702.4	300090			10"	ATE
	E 200 E 220 E 320 E 36 AMG E 36 AMG	100 110 162 195 200	C 164263 C 164263 C 164263 C 164263 C 164263	06.93 06.93 06.93 06.93 05.94		03.2023-0825.3	010028			Thz 23,81/19,05	ATE
	E 200 E 220	100 110		06.93 06.93	06.97 06.97	24.3541-1603.5 24.3541-1604.5 24.0101-3601.2	240037 240038 260044			D=54, - Halter D=54, - Halter Bremsattel-Zubehör	TRW TRW TRW
	E 320	162	B 862121	06.93		13.0441-4214.2	250091			Dichtungssatz	ATE
	E 320	162	B 862122		06.97	13.0441-4214.2	250091			Dichtungssatz	ATE
	E 200 E 220 E 320 E 36 AMG E 36 AMG	100 110 162 195 200		06.93 06.93 06.93 06.93 05.94	06.97 06.97 06.97 04.95 06.97	24.5101-0346.3	331406	2		L=346	
	E 200 E 220	100 110		06.93 06.93	06.97 06.97	13.2351-8005.2 24.9235-8005.5 24.9235-8006.5 13.0441-3505.2	210014 230023 230024 250051			D=35 D=35 D=35 Dichtungssatz	ATE ATE ATE ATE
	E 320 E 36 AMG E 36 AMG	162 195 200		06.93 06.93 05.94	06.97 04.95 06.97	13.2381-8035.2 24.9238-8035.5 24.9238-8036.5 13.0441-3817.2	210037 230025 230026 250071			D=38 D=38 D=38 Dichtungssatz	ATE ATE ATE ATE
	E 200 E 220 E 320 E 36 AMG E 36 AMG	100 110 162 195 200		06.93 06.93 06.93 06.93 05.94	06.97 06.97 06.97 04.95 06.97	83.7704-0281.3	330804	2		L=280	
	E 200 E 220 E 320 E 36 AMG E 36 AMG	100 110 162 195 200		06.93 06.93 06.93 06.93 05.94	06.97 06.97 06.97 04.95 06.97	24.3727-0409.2	580409	2		L=1060	
	E 200 E 220 E 320 E 36 AMG E 36 AMG	100 110 162 195 200		06.93 06.93 06.93 06.93 05.94	06.97 06.97 06.97 04.95 06.97	24.2419-0915.3 24.2419-1703.3	030045 030097		+ GG ¹⁾ + ALU ²⁾	Gz 19,05 Gz 19,05	
	E 200	100		06.93	06.97	03.2523-1210.3 03.2523-1310.3	040021 040022			Nz 23,81 Nz 23,81	
	E 220 E 320 E 36 AMG E 36 AMG	110 162 195 200		06.93 06.93 06.93 05.94	06.97 06.97 04.95 06.97	03.2523-1310.3	040022			Nz 23,81	

MERCEDES BENZ E-Klasse (A124) Cabrio (93-98)

	E 200 E 220 E 320 E 36 AMG	100 110 162 200		06.93 06.93 06.93 05.94	03.98 03.98 03.98 03.98	03.7760-2702.4	300090			10"	ATE
	E 200 E 220 E 320 E 36 AMG	100 110 162 200	C 164263 C 164263 C 164263 C 164263	06.93 06.93 06.93 05.94		03.2023-0825.3	010028			Thz 23,81/19,05	ATE
	E 200 E 220	100 110		06.93 06.93	03.98 03.98	24.3541-1603.5 24.3541-1604.5 24.0101-3601.2	240037 240038 260044			D=54, - Halter D=54, - Halter Bremsattel-Zubehör	TRW TRW TRW
	E 320	162	B 862121	06.93		13.0441-4214.2	250091			Dichtungssatz	ATE
	E 320	162	B 862122		03.98	13.0441-4214.2	250091			Dichtungssatz	ATE
	E 36 AMG	200		05.94	03.98	13.0441-4214.2	250091			Dichtungssatz	ATE
	E 200 E 220 E 320 E 36 AMG	100 110 162 200		06.93 06.93 06.93 05.94	03.98 03.98 03.98 03.98	24.5101-0346.3	331406	2		L=346	
	E 200 E 220 E 320 E 36 AMG	100 110 162 200		06.93 06.93 06.93 05.94	03.98 03.98 03.98 03.98	13.2381-8035.2 24.9238-8035.5 24.9238-8036.5 13.0441-3817.2	210037 230025 230026 250071			D=38 D=38 D=38 Dichtungssatz	ATE ATE ATE ATE
	E 200 E 220 E 320 E 36 AMG	100 110 162 200		06.93 06.93 06.93 05.94	03.98 03.98 03.98 03.98	83.7704-0281.3	330804	2		L=280	
	E 200 E 220 E 320 E 36 AMG	100 110 162 200		06.93 06.93 06.93 05.94	03.98 03.98 03.98 03.98	24.3727-0409.2	580409	2		L=1060	

¹⁾ + cast iron / + ghisa / + fonte grise / + fundición de gris

²⁾ + aluminium / + alluminio / + aluminium / + aluminio





MERCEDES BENZ E-Klasse (A124) Cabrio (93-98)											
	E 200	100		06.93	03.98		24.2419-0915.3	030045	+ GG ¹⁾ + ALU ²⁾	Gz 19,05	
	E 220	110		06.93	03.98		24.2419-1703.3	030097		Gz 19,05	
	E 320	162		06.93	03.98						
	E 36 AMG	200		05.94	03.98						
	E 200	100		06.93	03.98		03.2523-1210.3	040021		Nz 23,81	
							03.2523-1310.3	040022		Nz 23,81	
	E 220	110		06.93	03.98		03.2523-1310.3	040022		Nz 23,81	
	E 320	162		06.93	03.98						
	E 36 AMG	200		05.94	03.98						

MERCEDES BENZ E-Klasse (W210) Limousine (95-02)

	E 200		A394035	06.95			03.7760-4102.4	300091		10"	ATE	
	E 200 D		A394035	10.96	+ P							
	E 220 D		A394035	06.95								
	E 230		A394035	06.95								
	E 250 D		A394035	06.95								
	E 250 D		A394035	06.95	+ I							
	E 290 TD		A394035	01.96								
	E 300 D		A394035	06.95								
	E 200		A394035	06.95			03.2023-1066.3	010032		Thz 23,81/19,05	ATE	
	E 200 D		A394035	10.96	+ P							
	E 220 D		A394035	06.95								
	E 230		A394035	06.95								
	E 250 D		A394035	06.95								
	E 250 D		A394035	06.95	+ I							
	E 290 TD		A394035	01.96								
	E 300 D		A394035	06.95								
	E 280			01.96	09.96		24.2025-1702.3	010515		Thz 25,40/19,05	TRW	
	E 320			06.95	09.96							
	E 420			01.96	08.97							
	E 50 AMG			01.96	08.97							
	E 200		A394036	07.98	04.02		03.2023-1812.3	010570		Thz 23,81/19,05	ATE	
	E 200 CDI			07.98	04.02	+ P						
	E 200 D		A394036	07.98	04.02							
	E 220 CDI			07.98	04.02							
	E 220 D		A394036	06.98	04.02							
	E 240			09.97	04.02	- ESP						
	E 250 D		A394036	04.02	04.02							
	E 250 D		A394036	04.02	04.02	+ I						
	E 250 TD			09.97	04.02							
	E 290 TD		A394036	04.02	04.02							
	E 300 D		A394036	04.02	04.02							
	E 200 Kompressor	120		08.00	04.02		24.2025-1703.3	010516		Thz 25,40/19,05	TRW	
	E 200 Kompressor	137		09.97	04.02							
	E 240			09.97	04.02	+ ESP						
	E 270 CDI			07.99	04.02							
	E 280			10.96	04.02							
	E 280 4-matic			10.96	04.02							
	E 300 TD			10.96	04.02							
	E 320			10.96	04.02							
	E 320 4-matic			06.97	04.02							
	E 320 CDI			07.99	04.02							
	E 430			09.97	04.02							
	E 430 4-matic			05.99	04.02							
	E 55 AMG			09.97	04.02							
		E 200			06.95	04.02		11.3571-8512.2	220316	 	D=57, - Halter	ATE
		E 200 CDI			07.98	04.02		24.3571-8511.5	240491		D=57, - Halter	ATE
E 200 D				10.96	04.02	+ P	24.3571-8512.5	240492	D=57, - Halter		ATE	
E 200 Kompressor		120		08.00	04.02		11.0441-5703.2	250145	Dichtungssatz		ATE	
E 220 CDI				07.98	04.02		11.8170-0401.1	260103	Halter		ATE	
E 220 D				06.95	06.98		11.0101-5407.2	260011	Hülssensatz		ATE	
E 230				06.95	08.97		11.8171-0008.1	990049	Führungsbolzen		ATE	
E 240				09.97	04.02		11.8116-0253.1	390512	Haltefeder		ATE	
E 250 D				06.95	04.02							
E 250 D				06.95	04.02	+ I						
E 250 TD				09.97	04.02							
E 290 TD				01.96	04.02							
E 300 D				06.95	04.02							
E 200 Kompressor		137		09.97	04.02		11.3571-8509.2	220313	D=57, - Halter		ATE	
E 270 CDI				07.99	04.02		11.3571-8510.2	220314	D=57, - Halter		ATE	
E 280			01.96	04.02		11.0441-5703.2	250145	Dichtungssatz	ATE			
E 280 4-matic			10.96	04.02		11.0101-5407.2	260011	Hülssensatz	ATE			
E 300 TD			10.96	04.02		11.8171-0008.1	990049	Führungsbolzen	ATE			
E 320			06.95	04.02		11.8116-0253.1	390512	Haltefeder	ATE			
E 320 4-matic			06.97	04.02								
E 320 CDI			07.99	04.02								
	E 420		A 962231 / X 027613	01.96			13.4421-8010.2	210229	D=42/38	ATE		
	E 430		A 962231 / X 027613	09.97			13.0441-4214.2	250091	Dichtungssatz	ATE		
	E 420		A 962232 / X 027614		04.02		11.9441-9971.2	220839	D=44, - Halter	ATE		
	E 430		A 962232 / X 027614		04.02		11.9441-9972.2	220840	D=44, - Halter	ATE		
	E 430 4-matic			05.99	04.02		11.8171-0096.1	250155	Führungsbolzen	ATE		
	E 50 AMG			01.96	08.97		11.0101-7003.2	260124	Hülssensatz	ATE		
	E 55 AMG			09.97	04.02		11.8116-0133.1	390511	Haltefeder	ATE		

¹⁾ + cast iron / + ghisa / + fonte grise / + fundición de gris

²⁾ + aluminium / + alluminio / + aluminium / + aluminio

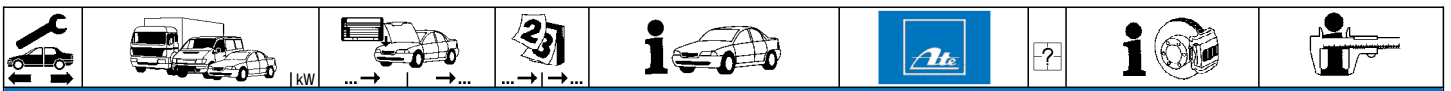

MERCEDES BENZ E-Klasse (W210) Limousine (95-02)

	E 200			06.95	04.02	83.7705-0386.3	330828	2		L=385											
	E 200 CDI			07.98	04.02																
	E 200 D			10.96	04.02						+ P										
	E 200 Kompressor	120		08.00	04.02																
	E 200 Kompressor	137		09.97	04.02																
	E 220 CDI			07.98	04.02																
	E 220 D			06.95	06.98																
	E 230			06.95	08.97																
	E 240			09.97	04.02																
	E 250 D	▶		06.95	04.02																
	E 250 D			06.95	04.02						+ I										
	E 250 TD			09.97	04.02																
	E 270 CDI			07.99	04.02																
	E 280			01.96	04.02																
	E 290 TD			01.96	04.02																
	E 300 D			06.95	04.02																
	E 300 TD			10.96	04.02																
	E 320			06.95	04.02																
	E 320 CDI			07.99	04.02																
	E 420			01.96	08.97																
E 430			09.97	04.02																	
E 50 AMG			01.96	08.97																	
E 55 AMG			09.97	04.02																	
E 280 4-matic			10.96	04.02																	
E 320 4-matic			06.97	04.02																	
E 430 4-matic			05.99	04.02																	
	E 200		A379346	06.95		13.2381-8035.2	210037	<input type="checkbox"/> <input type="checkbox"/> <input type="checkbox"/>	D=38	ATE											
	E 200 D		A379346	10.96	+ P						24.9238-8035.5	230025									
	E 220 D		A379346	06.95							24.9238-8036.5	230026									
	E 230		A379346	06.95							13.0441-3817.2	250071									
	E 240		A379346	09.97																	
	E 250 D	▶	A379346	06.95																	
	E 250 D		A379346	06.95	+ I																
	E 290 TD		A379346	01.96																	
	E 300 D		A379346	06.95																	
		E 200	A379347		04.02							13.2361-8003.2	210220	<input type="checkbox"/> <input type="checkbox"/>	D=36	ATE					
E 200 CDI				07.98	04.02	13.2361-8004.2	210221														
E 200 D		A379347		04.02	+ P	13.0441-3609.2	250057														
E 200 Kompressor		120		08.00	04.02																
E 220 CDI				07.98	04.02																
E 220 D		A379347			06.98																
E 230		A379347			08.97																
E 240		A379347			04.02																
E 250 D		▶	A379347		04.02																
E 250 D		A379347			04.02	+ I															
E 250 TD			09.97	04.02																	
E 290 TD	A379347			04.02																	
E 300 D	A379347			04.02																	
	E 280		A379346	01.96		13.2361-8001.2	210214	<input type="checkbox"/> <input type="checkbox"/>	D=36	ATE											
	E 280 4-matic		A379346	10.96							13.2361-8002.2	210215									
	E 300 TD		A379346	10.96							24.9236-8001.5	230007									
	E 320		A379346	06.95							24.9236-8002.5	230008									
	E 320 4-matic		A379346	06.97							13.0441-3606.2	250147									
	E 420		A379346	01.96																	
	E 430		A379346	09.97																	
		E 200 Kompressor	137		09.97						04.02	13.2361-8005.2	210237	<input type="checkbox"/> <input type="checkbox"/>	D=36	ATE					
		E 270 CDI			07.99						04.02						13.2361-8006.2	210238			
		E 280	A379347								04.02						13.0441-3609.2	250057			
E 280 4-matic		A379347			04.02																
E 300 TD		A379347			04.02																
E 320		A379347			04.02																
E 320 4-matic		A379347			04.02																
E 320 CDI				07.99	04.02																
E 420		A379347			08.97																
E 430		A379347			04.02																
	E 430 4-matic			05.99	04.02	13.2421-8025.2	210061	<input type="checkbox"/> <input type="checkbox"/>	D=42	ATE											
	E 50 AMG			01.96	08.97						13.2421-8026.2	210062									
	E 55 AMG			09.97	04.02						13.0441-4216.2	250093									
		E 270 CDI			07.99						04.02	13.9421-7009.2	210269	<input type="checkbox"/> <input type="checkbox"/>	D=42	ATE					
		E 280			01.96						04.02						13.9421-7010.2	210270			
		E 320			06.95						04.02						13.0441-4216.2	250093			
		E 420			01.96						04.02										
		E 430			09.97						04.02										
			E 200								06.95						04.02	24.5123-0281.3	330877	2	L=280
			E 200 CDI								07.98						04.02				
E 200 D				10.96	04.02	+ P															
E 200 Kompressor	120			08.00	04.02																
E 200 Kompressor	137			09.97	04.02																
E 220 CDI				07.98	04.02																
E 220 D				06.95	06.98																
E 230				06.95	08.97																
E 240				09.97	04.02																
E 250 D	▶			06.95	04.02																
E 250 D			06.95	04.02	+ I																
E 250 TD			09.97	04.02																	
E 270 CDI			07.99	04.02																	



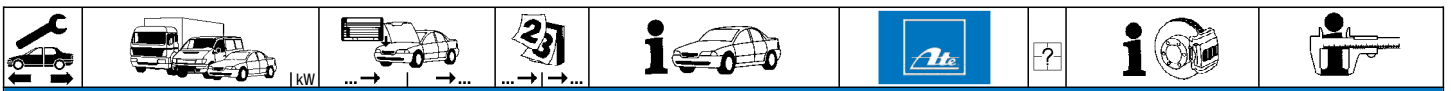





MERCEDES BENZ E-Klasse (W210) Limousine (95-02)

	E 280		01.96	04.02	24.5123-0281.3	330877	2		L=280
	E 290 TD		01.96	04.02					
	E 300 D		06.95	04.02					
	E 300 TD		10.96	04.02					
	E 320		06.95	04.02					
	E 320 CDI		07.99	04.02					
	E 420		01.96	08.97					
	E 430		09.97	04.02					
	E 50 AMG		01.96	08.97					
	E 55 AMG		09.97	04.02					
	E 280 4-matic		10.96	04.02					
	E 320 4-matic		06.97	04.02					
	E 430 4-matic		05.99	04.02					
		E 200	◀	06.95					
E 200 CDI		◀	07.98	04.02					
E 200 D		◀	10.96	04.02 + (P)					
E 200 Kompressor		◀120	08.00	04.02					
E 200 Kompressor		◀137	09.97	04.02					
E 220 CDI		◀	07.98	04.02					
E 220 D		◀	06.95	06.98					
E 230		◀	06.95	08.97					
E 240		◀	09.97	04.02					
E 250 D		◀	06.95	04.02 + (I)					
E 250 TD		◀	09.97	04.02					
E 270 CDI		◀	07.99	04.02					
E 280		◀	01.96	04.02					
E 280 4-matic		◀	10.96	04.02					
E 290 TD		◀	01.96	04.02					
E 300 D		◀	06.95	04.02					
E 300 TD		◀	10.96	04.02					
E 320		◀	06.95	04.02					
E 320 4-matic		◀	06.97	04.02					
E 320 CDI		◀	07.99	04.02					
E 420		◀	01.96	08.97					
E 430		◀	09.97	04.02					
E 430 4-matic		◀	05.99	04.02					
E 50 AMG		◀	01.96	08.97					
E 55 AMG		◀	09.97	04.02					
E 200		▶	06.95	04.02					
E 220 D		▶	06.95	06.98					
E 230		▶	06.95	08.97					
E 250 D		▶	06.95	04.02					
E 280		▶	01.96	09.96					
E 290 TD		▶	01.96	04.02					
E 300 D		▶	06.95	04.02					
E 320		▶	06.95	09.96					
E 420		▶	01.96	08.97					
E 50 AMG		▶	01.96	08.97					
E 200 CDI		▶	07.98	04.02					
E 220 CDI		▶	07.98	04.02					
E 240		▶	09.97	04.02					
E 270 CDI		▶	07.99	04.02					
E 280		▶	10.96	04.02					
E 300 TD		▶	10.96	04.02					
E 320		▶	10.96	04.02					
E 320 CDI	▶	07.99	04.02						
E 430	▶	09.97	04.02						
E 430 4-matic	▶	05.99	04.02						
E 55 AMG	▶	09.97	04.02						
	E 200		06.95	04.02	24.2419-0915.3	030045		+ GG ¹⁾ + ALU ²⁾	Gz 19,05 Gz 19,05
	E 200 CDI		07.98	04.02					
	E 200 D		10.96	04.02 + (P)					
	E 200 Kompressor	120	08.00	04.02					
	E 200 Kompressor	137	09.97	04.02					
	E 220 CDI		07.98	04.02					
	E 220 D		06.95	06.98					
	E 230		06.95	08.97					
	E 240		09.97	04.02					
	E 250 D	▶	06.95	04.02					
	E 250 D		06.95	04.02 + (I)					
	E 250 TD		09.97	04.02					
	E 270 CDI		07.99	04.02					
	E 280		01.96	04.02					
E 290 TD		01.96	04.02						
E 300 D		06.95	04.02						
E 320 CDI		07.99	04.02						
	E 200		06.95	04.02	03.2523-1210.3	040021			Nz 23,81 Nz 23,81
	E 200 CDI		07.98	04.02					
	E 200 D		10.96	04.02 + (P)					
	E 200 Kompressor	120	08.00	04.02					
	E 200 Kompressor	137	09.97	04.02					
	E 220 CDI		07.98	04.02					
	E 220 D		06.95	06.98					
	E 230		06.95	08.97					
	E 240		09.97	04.02					
	E 250 D	▶	06.95	04.02					
	E 250 D		06.95	04.02 + (I)					

1) + cast iron / + ghisa / + fonte grise / + fundición de gris

2) + aluminium / + alluminio / + aluminium / + aluminio

MERCEDES BENZ E-Klasse (W210) Limousine (95-02)									
	E 250 TD E 270 CDI E 280 E 290 TD E 300 D E 320 CDI			09.97 07.99 01.96 01.96 06.95 07.99	04.02 04.02 04.02 04.02 04.02 04.02		03.2523-1210.3 03.2523-1310.3	040021 040022	Nz 23,81 Nz 23,81
MERCEDES BENZ E-Klasse (S210) Kombi (96-03)									
	E 200 E 230 E 250 D E 250 D E 290 TD		A394035 A394035 A394035 A394035 A394035	05.96 05.96 05.96 05.96 05.96			03.7760-4102.4	300091	10" ATE
	E 200 E 230 E 250 D E 250 D E 290 TD		A394035 A394035 A394035 A394035 A394035	05.96 05.96 05.96 05.96 05.96		+ Radstand 2833mm ¹⁾ + Ⓞ / + Radstand 2833mm ²⁾ + Radstand 2833mm ¹⁾	03.2023-1066.3	010032	THz 23,81/19,05 ATE
	E 250 D E 290 TD E 420		A394035 A394035	05.96 05.96 08.97		+ Radstand 3570mm ³⁾ + Radstand 3570mm ³⁾	24.2025-1702.3	010515	THz 25,40/19,05 TRW
	E 200 E 220 CDI E 230 E 240	A394036 A394036		07.98 08.97 09.97	04.03 04.03 04.03	+ Radstand 2833mm ¹⁾ - ESP	03.2023-1812.3	010570	THz 23,81/19,05 ATE
	E 200 Kompressor E 220 CDI E 240 E 250 D E 250 D E 250 D E 250 TD E 270 CDI E 280 E 280 4-matic E 290 TD E 300 TD E 320 E 320 4-matic E 320 CDI E 430 E 430 4-matic E 55 AMG	A394036 A394036 A394036		09.97 07.98 09.97 09.97 09.97 07.99 10.96 10.96 10.96 06.97 07.99 09.97 05.99 09.97	04.03 04.03 04.03 04.03 04.03 04.03 04.03 04.03 04.03 04.03 04.03 04.03 04.03 04.03 04.03 04.03 04.03	+ Radstand 3570mm ³⁾ + ESP + Radstand 3570mm ³⁾ + Radstand 2833mm ¹⁾ + Ⓞ / + Radstand 2833mm ²⁾ + Radstand 3570mm ³⁾	24.2025-1703.3	010516	THz 25,40/19,05 TRW
	E 200 E 200 Kompressor E 220 CDI E 230 E 240 E 250 D E 250 D E 250 TD E 290 TD	120		05.96 08.00 07.98 05.96 09.97 05.96 05.96 09.97 05.96	04.03 04.03 04.03 08.97 04.03 04.03 04.03 04.03 04.03	+ Radstand 2833mm ¹⁾ + Radstand 2833mm ¹⁾ + Ⓞ / + Radstand 2833mm ²⁾ + Radstand 2833mm ¹⁾	11.3571-8512.2 24.3571-8511.5 24.3571-8512.5 11.0441-5703.2 11.8170-0401.1 11.0101-5407.2 11.8171-0008.1 11.8116-0253.1	220316 240491 240492 250145 260103 260011 990049 390512	D=57, - Halter ATE D=57, - Halter ATE D=57, - Halter ATE Dichtungssatz ATE Halter ATE Hülssensatz ATE Führungsbolzen ATE Halterfeder ATE
	E 200 Kompressor E 220 CDI E 250 D E 270 CDI E 280 E 280 4-matic E 290 TD E 300 TD E 320 E 320 4-matic E 320 CDI	137		09.97 07.98 05.96 07.99 10.96 10.96 05.96 10.96 10.96 06.97 07.99	04.03 04.03 04.03 04.03 04.03 04.03 04.03 04.03 04.03 04.03 04.03	+ Radstand 3570mm ³⁾ + Radstand 3570mm ³⁾ + Radstand 3570mm ³⁾ + Radstand 3570mm ³⁾	11.3571-8509.2 11.3571-8510.2 11.0441-5703.2 11.0101-5407.2 11.8171-0008.1 11.8116-0253.1	220313 220314 250145 260011 990049 390512	D=57, - Halter ATE D=57, - Halter ATE Dichtungssatz ATE Hülssensatz ATE Führungsbolzen ATE Halterfeder ATE
	E 420 E 430		A 962231 / X 027613 A 962231 / X 027613	05.96 09.97			13.4421-8010.2 13.0441-4214.2	210229 250091	D=42/38 ATE Dichtungssatz ATE
	E 420 E 430 E 430 4-matic	A 962232 / X 027614 A 962232 / X 027614			04.03 04.03 05.99		11.9441-9971.2 11.9441-9972.2 11.8171-0096.1 11.0101-7003.2	220839 220840 250155 260124	D=44, - Halter ATE D=44, - Halter ATE Führungsbolzen ATE Hülssensatz ATE
	E 55 AMG			09.97	04.03		11.8116-0133.1	390511	2 Halterfeder ATE
	E 200 E 200 Kompressor E 220 CDI E 230 E 240 E 250 D E 250 D E 250 D E 250 TD E 270 CDI E 280 E 290 TD E 300 TD E 320 E 320 CDI E 420			05.96 09.97 07.98 05.96 09.97 05.96 05.96 05.96 09.97 07.99 10.96 05.96 10.96 10.96 07.99 05.96	04.03 04.03 04.03 08.97 04.03 04.03 04.03 04.03 04.03 04.03 04.03 04.03 04.03 04.03 04.03 08.97	+ Radstand 3570mm ³⁾ + Radstand 2833mm ¹⁾ + Ⓞ / + Radstand 2833mm ²⁾ + Radstand 3570mm ³⁾	83.7705-0386.3	330828	2 L=385

1) + wheel base 2833 mm / + passo 2833 mm / + empattement 2833 mm / + distancia entre ejes 2833 mm
2) + Ⓞ / + wheel base 2833mm / + Ⓞ / + passo 2833mm / + Ⓞ / + empattement 2833mm / + Ⓞ / + dist.entre ejes 2833mm
3) + wheel base 3570 mm / + passo 3570 mm / + empattement 3570 mm / + distancia entre ejes 3570 mm





MERCEDES BENZ E-Klasse (S210) Kombi (96-03)

	E 430 E 55 AMG		09.97 04.03 09.97 04.03		83.7705-0386.3	330828	2		L=385	
	E 280 4-matic E 320 4-matic E 430 4-matic		10.96 04.03 06.97 04.03 05.99 04.03		24.5123-0281.3	330877	2		L=280	
	E 200 E 200 Kompressor E 220 CDI E 230 E 240 E 250 D E 250 D E 250 D E 250 TD E 270 CDI E 280 E 280 4-matic E 290 TD E 300 TD E 320 E 320 4-matic E 320 CDI E 420 E 430		05.96 04.03 09.97 04.03 07.98 04.03 05.96 08.97 09.97 04.03 05.96 04.03 + Radstand 3570mm ¹⁾ 05.96 04.03 + Radstand 2833mm ²⁾ 05.96 04.03 + ☉ / + Radstand 2833mm ³⁾ 09.97 04.03 07.99 04.03 10.96 04.03 + Radstand 3570mm ¹⁾ 10.96 04.03 05.96 04.03 10.96 04.03 10.96 04.03 06.97 04.03 07.99 04.03 05.96 08.97 09.97 04.03		13.2401-8013.2 13.2401-8014.2 24.9240-8013.5 24.9240-8014.5 13.0441-4020.2	210051 210052 230019 230020 250084	<input type="checkbox"/> <input type="checkbox"/> <input type="checkbox"/> <input type="checkbox"/> <input type="checkbox"/>		D=40 D=40 D=40 D=40 Dichtungssatz	ATE ATE ATE ATE ATE
	E 430 4-matic E 55 AMG		05.99 04.03 09.97 04.03		13.2461-8001.2 24.9246-8001.5 24.9246-8002.5 13.0441-4601.2	210226 230021 230022 250099	<input type="checkbox"/> <input type="checkbox"/> <input type="checkbox"/> <input type="checkbox"/>		D=46 D=46 D=46 Dichtungssatz	ATE ATE ATE ATE
	E 270 CDI E 280 E 430 E 430 4-matic		07.99 04.03 10.96 04.03 05.99 04.03 09.97 04.03		13.9421-7009.2 13.9421-7010.2 13.0441-4216.2	210269 210270 250093	<input type="checkbox"/> <input type="checkbox"/> <input type="checkbox"/> <input type="checkbox"/>		D=42 D=42 Dichtungssatz	ATE ATE ATE
	E 200 E 200 Kompressor E 220 CDI E 230 E 240 E 250 D E 250 D E 250 D E 250 TD E 270 CDI E 280 E 290 TD E 300 TD E 320 E 320 CDI E 420 E 430 E 55 AMG		05.96 04.03 09.97 04.03 07.98 04.03 05.96 08.97 09.97 04.03 05.96 04.03 + Radstand 3570mm ¹⁾ 05.96 04.03 + Radstand 2833mm ²⁾ 05.96 04.03 + ☉ / + Radstand 2833mm ³⁾ 09.97 04.03 07.99 04.03 10.96 04.03 + Radstand 3570mm ¹⁾ 05.96 04.03 10.96 04.03 10.96 04.03 07.99 04.03 05.96 08.97 09.97 04.03 09.97 04.03		24.5123-0281.3	330877	2		L=280	
	E 280 4-matic E 320 4-matic E 430 4-matic		10.96 04.03 06.97 04.03 05.99 04.03		24.5123-0281.3	330877	2		L=280	
	E 200 E 200 Kompressor E 220 CDI E 230 E 240 E 250 D E 250 TD E 270 CDI E 280 4-matic E 290 TD E 300 TD E 320 E 320 4-matic E 320 CDI E 420 E 430 E 430 4-matic E 55 AMG	◀	05.96 04.03 09.97 04.03 07.98 04.03 05.96 08.97 09.97 04.03 05.96 04.03 + ☉ / + Radstand 2833mm ³⁾ 09.97 04.03 07.99 04.03 10.96 04.03 05.96 04.03 + Radstand 2833mm ²⁾ 10.96 04.03 06.97 04.03 07.99 04.03 05.96 08.97 09.97 04.03 05.99 04.03 09.97 04.03		24.3727-0426.2 24.3727-0424.2 24.3727-0425.2	580426 580424 580425	1 <input type="checkbox"/> <input type="checkbox"/> <input type="checkbox"/>		L=2613 L=1058 L=1031	
	E 250 D E 280 E 290 TD	◀	05.96 04.03 + Radstand 3570mm ¹⁾ 10.96 04.03 + Radstand 3570mm ¹⁾ 05.96 04.03 + Radstand 3570mm ¹⁾		24.3727-0424.2 24.3727-0425.2	580424 580425	<input type="checkbox"/> <input type="checkbox"/> <input type="checkbox"/>		L=1058 L=1031	
	E 200 E 230 E 250 D E 290 TD E 420	▶	05.96 04.03 05.96 08.97 05.96 04.03 05.96 04.03 05.96 08.97		24.3727-0424.2 24.3727-0425.2	580424 580425	<input type="checkbox"/> <input type="checkbox"/> <input type="checkbox"/> <input type="checkbox"/> <input type="checkbox"/>		L=1058 L=1031	
	E 240 E 270 CDI E 300 TD E 320 E 320 CDI E 430 E 430 4-matic	▶	09.97 04.03 07.99 04.03 10.96 04.03 10.96 04.03 07.99 04.03 09.97 04.03 05.99 04.03		24.3727-0424.2 24.3727-0425.2	580424 580425	<input type="checkbox"/> <input type="checkbox"/> <input type="checkbox"/> <input type="checkbox"/> <input type="checkbox"/> <input type="checkbox"/> <input type="checkbox"/>		L=1058 L=1031	

1) + wheel base 3570 mm / + passo 3570 mm / + empattement 3570 mm / + distancia entre ejes 3570 mm
 2) + wheel base 2833 mm / + passo 2833 mm / + empattement 2833 mm / + distancia entre ejes 2833 mm
 3) + ☉ / + wheel base 2833mm / + ☉ / + passo 2833mm / + ☉ / + empattement 2833mm / + ☉ / + dist.entre ejes 2833mm



MERCEDES BENZ E-Klasse (S210) Kombi (96-03)

	E 55 AMG		09.97	04.03		24.3727-0424.2	580424	<input type="checkbox"/>		L=1058 L=1031
	E 200		05.96	04.03		24.2419-0915.3	030045	<input type="checkbox"/>	+ GG ¹⁾	Gz 19,05
	E 200 Kompressor		09.97	04.03		24.2419-1703.3	030097	<input type="checkbox"/>	+ ALU ²⁾	Gz 19,05
	E 220 CDI		07.98	04.03	+ Radstand 2833mm ³⁾					
	E 230		05.96	08.97						
	E 240		09.97	04.03						
	E 250 D		05.96	04.03	+ Radstand 3570mm ⁴⁾					
	E 250 D		05.96	04.03	+ Radstand 2833mm ³⁾					
	E 250 D		05.96	04.03	+ / + Radstand 2833mm ⁵⁾					
	E 250 TD		09.97	04.03						
	E 270 CDI		07.99	04.03						
	E 280		10.96	04.03	+ Radstand 3570mm ⁴⁾					
	E 290 TD		05.96	04.03						
	E 320 CDI		07.99	04.03						

MERCEDES BENZ E-Klasse (W211) Limousine (02-09)

	E 200 CDI	75	05.02	02.09		24.2125-1745.3	010998			Thz 25,40	TRW
	E 200 CDI	90	05.02	02.09							
	E 200 CDI	100	04.06	02.09							
	E 200 Kompressor	120	05.02	02.09							
	E 200 Kompressor	135	04.06	02.09							
	E 200 NGT	120	03.04	02.09							
	E 220 CDI	100	03.02	02.09							
	E 220 CDI	110	03.02	02.09							
	E 220 CDI	120	03.03	02.09							
	E 220 CDI	125	04.06	02.09							
	E 230	150	04.06	02.09							
	E 240	130	03.02	02.09							
	E 240 4-matic	130	03.03	02.09							
	E 250 CDI	150	08.08	02.09							
	E 270 CDI	120	03.02	02.09							
	E 270 CDI	130	03.02	02.09							
	E 280	170	05.05	02.09							
	E 280 4-matic	170	05.05	02.09							
	E 280 CDI	130	05.04	02.09							
	E 280 CDI	140	03.05	02.09							
	E 280 CDI 4-matic	140	03.05	02.09							
	E 300 Bluetec	155	09.07	02.09							
	E 320	165	03.02	02.09							
	E 320 4-matic	165	03.03	02.09							
	E 320 CDI	150	11.02	02.09							
	E 320 CDI	165	03.05	02.09							
	E 320 CDI 4-matic	165	03.05	02.09							
	E 350	200	12.04	02.09							
	E 350 4-matic	200	12.04	02.09							
	E 350 CGI	215	09.07	02.09							
	E 400 CDI	191	03.03	02.09							
	E 420 CDI	231	01.06	02.09							
	E 500	225	03.02	02.09							
	E 500	285	04.06	02.09							
	E 500 4-matic	225	10.03	02.09							
	E 500 4-matic	285	04.06	02.09							
	E 55 Kompressor AMG	350	10.02	02.09							
	E 63 AMG	378	03.06	02.09							
	E 240 4-matic	130	03.03	02.09		11.9601-9770.2	220878	<input type="checkbox"/>		D=60, - Halter	ATE
	E 280 4-matic	170	05.05	02.09	- Sportpaket / - Sportpaket AMG ⁶⁾	11.9601-9769.2	220877	<input type="checkbox"/>		D=60, - Halter	ATE
	E 280 CDI 4-matic	140	03.05	02.09	- Sportpaket / - Sportpaket AMG ⁶⁾	11.0101-5704.2	260095	<input type="checkbox"/>		Hülsensatz	ATE
	E 320 4-matic	165	03.03	02.09		11.8171-0008.1	990049	<input type="checkbox"/>		Führungsbolzen	ATE
	E 320 CDI 4-matic	165	03.05	02.09	- Sportpaket / - Sportpaket AMG ⁶⁾	11.8116-0253.1	390512	2	<input type="checkbox"/>	Haltefeder	ATE
	E 350 4-matic	200	12.04	02.09	- Sportpaket / - Sportpaket AMG ⁶⁾						
	E 280 4-matic	170	A 870950	05.05	+ Sportpaket / + Sportpaket AMG ⁷⁾	11.9441-9972.2	220840	<input type="checkbox"/>		D=44, - Halter	ATE
	E 280 CDI 4-matic	140	A 870950	03.05	+ Sportpaket / + Sportpaket AMG ⁷⁾	11.9441-9971.2	220839	<input type="checkbox"/>		D=44, - Halter	ATE
	E 320 CDI 4-matic	165	A 870950	03.05	+ Sportpaket / + Sportpaket AMG ⁷⁾	11.0101-5704.2	260095	<input type="checkbox"/>		Hülsensatz	ATE
	E 350 4-matic	200	A 870950	12.04	+ Sportpaket / + Sportpaket AMG ⁷⁾	11.8116-0133.1	390511	2	<input type="checkbox"/>	Haltefeder	ATE
	E 500 4-matic	225	A 870950	10.03							
	E 280 4-matic	170 A 870951		02.09	+ Sportpaket / + Sportpaket AMG ⁷⁾	11.9441-9955.2	220805	<input type="checkbox"/>		D=44, - Halter	ATE
	E 280 CDI 4-matic	140 A 870951		02.09	+ Sportpaket / + Sportpaket AMG ⁷⁾	11.9441-9956.2	220806	<input type="checkbox"/>		D=44, - Halter	ATE
	E 320 CDI 4-matic	165 A 870951		02.09	+ Sportpaket / + Sportpaket AMG ⁷⁾	11.0101-7003.2	260124	<input type="checkbox"/>		Hülsensatz	ATE
	E 350 4-matic	200 A 870951		02.09	+ Sportpaket / + Sportpaket AMG ⁷⁾	11.8171-0096.1	250155	<input type="checkbox"/>		Führungsbolzen	ATE
	E 500 4-matic	225 A 870951		02.09		11.8116-0133.1	390511	2	<input type="checkbox"/>	Haltefeder	ATE
	E 500 4-matic	285	04.06	02.09							
	E 200 CDI	75	05.02	02.09		24.5123-0380.3	331256	2		L=380	
	E 200 CDI	90	05.02	02.09							
	E 200 CDI	100	04.06	02.09							
	E 200 Kompressor	120	05.02	02.09							
	E 200 Kompressor	135	04.06	02.09							
	E 200 NGT	120	03.04	02.09							
	E 220 CDI	100	03.02	02.09							
	E 220 CDI	110	03.02	02.09							
	E 220 CDI	120	03.03	02.09							
	E 220 CDI	125	04.06	02.09							
	E 230	150	04.06	02.09							
	E 240	130	03.02	02.09							
	E 250 CDI	150	08.08	02.09							
	E 270 CDI	120	03.02	02.09							

¹⁾ + cast iron / + ghisa / + fonte grise / + fundición de gris

²⁾ + aluminium / + alluminio / + aluminium / + aluminio

³⁾ + wheel base 2833 mm / + passo 2833 mm / + empattement 2833 mm / + distancia entre ejes 2833 mm

⁴⁾ + wheel base 3570 mm / + passo 3570 mm / + empattement 3570 mm / + distancia entre ejes 3570 mm

⁵⁾ + / + wheel base 2833mm / + / + passo 2833mm / + / + empattement 2833mm / + / + dist.entre ejes 2833mm

⁶⁾ - sport package/- sport package AMG / - pacchetto sportivo/- pacchetto sport.AMG / - version sport/- version sport AMG / - kit deportivo/- kit deportivo AMG

⁷⁾ + sports package/+ sports package AMG / + pacchetto sportivo/+ pacchetto sport.AMG / + version sport/+ version sport AMG / + kit deportivo/+ kit deportivo AMG



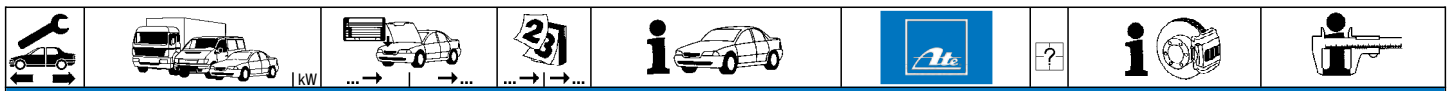

MERCEDES BENZ E-Klasse (W211) Limousine (02-09)

	E 270 CDI	130		03.02	02.09		24.5123-0380.3	331256	2			L=380	
	E 280	170		05.05	02.09								
	E 280 CDI	130		05.04	02.09								
	E 280 CDI	140		03.05	02.09								
	E 300 Bluetec	155		09.07	02.09								
	E 320	165		03.02	02.09								
	E 320 CDI	150		11.02	02.09								
	E 320 CDI	165		03.05	02.09								
	E 350	200		12.04	02.09								
	E 350 CGI	215		09.07	02.09								
	E 400 CDI	191		03.03	02.09								
	E 420 CDI	231		01.06	02.09								
	E 500	225		03.02	02.09								
	E 500	285		04.06	02.09								
	E 55 Kompressor AMG	350		10.02	02.09								
	E 63 AMG	378		03.06	02.09								
	E 200 CDI	75		05.02	02.09	- Taxi / - Sportpaket / - Sportpaket AMG ¹⁾	24.3426-9989.5	240647				D=42, - Halter	ATE
	E 200 CDI	90		05.02	02.09	- Taxi / - Sportpaket / - Sportpaket AMG ¹⁾	24.3426-9990.5	240648				D=42, - Halter	ATE
	E 200 CDI	100		04.06	02.09	- Taxi / - Sportpaket / - Sportpaket AMG ¹⁾	11.0441-4203.2	250013				Dichtungssatz	ATE
	E 200 Kompressor	120		05.02	02.09	- Taxi / - Sportpaket / - Sportpaket AMG ¹⁾	11.0101-4202.2	260094				Hülsensatz	
	E 200 Kompressor	135		04.06	02.09	- Taxi / - Sportpaket / - Sportpaket AMG ¹⁾	11.8171-0072.1	250154				Führungsbolzen	ATE
	E 200 NGT	120		03.04	02.09	- Taxi / - Sportpaket / - Sportpaket AMG ¹⁾	11.8116-0323.1	390459	2			Haltefeder	ATE
	E 220 CDI	100		03.02	02.09	- Taxi / - Sportpaket / - Sportpaket AMG ¹⁾	13.8190-0330.1	990134	4			Haltschraube	
	E 220 CDI	110		03.02	02.09	- Taxi / - Sportpaket / - Sportpaket AMG ¹⁾							
	E 220 CDI	120		03.03	02.09	- Taxi / - Sportpaket / - Sportpaket AMG ¹⁾							
	E 220 CDI	125		04.06	02.09	- Taxi / - Sportpaket / - Sportpaket AMG ¹⁾							
	E 230	150		04.06	02.09	- Sportpaket / - Sportpaket AMG ²⁾							
	E 240	130		03.02	02.09	- Taxi							
	E 240 4-matic	130		03.03	02.09								
	E 250 CDI	150		08.08	02.09	- Taxi							
	E 270 CDI	120		03.02	02.09	- Taxi							
	E 270 CDI	130		03.02	02.09	- Taxi							
	E 280 4-matic	170		05.05	02.09	- Sportpaket / - Sportpaket AMG ²⁾							
	E 280 CDI	140		03.05	02.09	- Sportpaket / - Sportpaket AMG ²⁾							
	E 280 CDI 4-matic	140		03.05	02.09	- Sportpaket / - Sportpaket AMG ²⁾							
	E 320	165	A 400547	03.02	02.09	- Taxi							
	E 320 4-matic	165 X 122526		02.09									
	E 320 CDI	150	A 400547	11.02									
	E 200 CDI	75		05.02	02.09	+ Taxi	11.9426-9991.2	220641				D=42, - Halter	ATE
	E 200 CDI	75		05.02	02.09	- Taxi / + Sportpaket / + Sportpaket AMG ³⁾	11.9426-9992.2	220642				D=42, - Halter	ATE
	E 200 CDI	90		05.02	02.09	- Taxi / + Sportpaket / + Sportpaket AMG ³⁾	11.8170-0611.1	260116				Halter	ATE
	E 200 CDI	90		05.02	02.09	+ Taxi	11.0441-4203.2	250013				Dichtungssatz	ATE
	E 200 CDI	100		04.06	02.09	+ Taxi	11.0101-4202.2	260094				Hülsensatz	
	E 200 CDI	100		04.06	02.09	- Taxi / + Sportpaket / + Sportpaket AMG ³⁾	11.8171-0072.1	250154				Führungsbolzen	ATE
	E 200 Kompressor	120		05.02	02.09	+ Taxi	11.8116-0323.1	390459	2			Haltefeder	ATE
	E 200 Kompressor	120		05.02	02.09	- Taxi / + Sportpaket / + Sportpaket AMG ³⁾	13.8190-0330.1	990134	4			Haltschraube	
	E 200 Kompressor	135		04.06	02.09	+ Taxi							
	E 200 Kompressor	135		04.06	02.09	- Taxi / + Sportpaket / + Sportpaket AMG ³⁾							
	E 200 NGT	120		03.04	02.09	+ Taxi							
	E 200 NGT	120		03.04	02.09	- Taxi / + Sportpaket / + Sportpaket AMG ³⁾							
	E 220 CDI	100		03.02	02.09	+ Taxi							
	E 220 CDI	100		03.02	02.09	- Taxi / + Sportpaket / + Sportpaket AMG ³⁾							
	E 220 CDI	110		03.02	02.09	+ Taxi							
	E 220 CDI	110		03.02	02.09	- Taxi / + Sportpaket / + Sportpaket AMG ³⁾							
	E 220 CDI	120		03.03	02.09	+ Taxi							
	E 220 CDI	120		03.03	02.09	- Taxi / + Sportpaket / + Sportpaket AMG ³⁾							
	E 220 CDI	125		04.06	02.09	+ Taxi							
	E 220 CDI	125		04.06	02.09	- Taxi / + Sportpaket / + Sportpaket AMG ³⁾							
	E 230	150		04.06	02.09	+ Sportpaket / + Sportpaket AMG ⁴⁾							
	E 240	130		03.02	02.09	+ Taxi							
	E 250 CDI	150		08.08	02.09	+ Taxi							
	E 270 CDI	120		03.02	02.09	+ Taxi							
	E 270 CDI	130		03.02	02.09	+ Taxi							
	E 280	170		05.05	02.09								
	E 280 4-matic	170		05.05	02.09	+ Sportpaket / + Sportpaket AMG ⁴⁾							
	E 280 CDI	130		05.04	02.09								
	E 280 CDI	140		03.05	02.09	+ Sportpaket / + Sportpaket AMG ⁴⁾							
	E 280 CDI 4-matic	140		03.05	02.09	+ Sportpaket / + Sportpaket AMG ⁴⁾							
	E 300 Bluetec	155		09.07	02.09								
	E 320	165		03.02	02.09	+ Taxi							
	E 320	165 A 500548		02.09		- Taxi							
	E 320 4-matic	165		03.03									
	E 320 CDI	150	X 122525	11.02	02.09	+ Taxi							
	E 320 CDI	150 A 400548		02.09		- Taxi							
	E 320 CDI	165		03.05	02.09								
	E 320 CDI 4-matic	165		03.05	02.09								
	E 350	200		12.04	02.09								
	E 350 4-matic	200		12.04	02.09								
	E 350 CGI	215		09.07	02.09								
	E 400 CDI	191		03.03	02.09								
	E 420 CDI	231		01.06	02.09	+ Sportpaket / + Sportpaket AMG ⁴⁾							
	E 500	225		03.02	02.09								
	E 500 4-matic	225		10.03	02.09								
	E 500 4-matic	285		04.06	02.09								

¹⁾ -Taxi/-sports pack./-sports pack.AMG / -Taxi/-pacch.sport./-pacch.sport AMG / -Taxi/-vers.sport/-vers.sport AMG / -Taxi/-kit deport./-kit deport. AMG
²⁾ - sport package/- sport package AMG / - pacchetto sportivo/- pacchetto sport.AMG / - version sport/- version sport AMG / - kit deportivo/- kit deportivo AMG
³⁾ -Taxi/+sports pack./+sports pack.AMG / -Taxi/+pacch.sport./+pacch.sport AMG / -Taxi/+vers.sport./+vers.sport AMG / -Taxi/+kit deport./+kit deport. AMG
⁴⁾ + sports package/+ sports package AMG / + pacchetto sportivo/+ pacchetto sport.AMG / + version sport/+ version sport AMG / + kit deportivo/+ kit deportivo AMG



MERCEDES BENZ E-Klasse (W211) Limousine (02-09)

	E 420 CDI	231	01.06	02.09	- Sportpaket / - Sportpaket AMG ¹⁾	11.9426-9959.2	220801	<input type="checkbox"/> <input type="checkbox"/>	D=42, - Halter D=42, - Halter Dichtungssatz Führungsbolzen Hülsensatz Haltefeder	ATE							
	E 500	285	04.06	02.09		11.9426-9960.2	220802			ATE							
						11.0441-4203.2	250013			ATE							
						11.8171-0008.1	990049			ATE							
						11.0101-5407.2	260011			ATE							
						11.8116-0086.2	390606			ATE							
	E 200 CDI	75	05.02	02.09		24.5238-0255.3	330674	2		L=255							
	E 200 CDI	90	05.02	02.09													
	E 200 CDI	100	04.06	02.09													
	E 200 Kompressor	120	05.02	02.09													
	E 200 Kompressor	135	04.06	02.09													
	E 200 NGT	120	03.04	02.09													
	E 220 CDI	100	03.02	02.09													
	E 220 CDI	110	03.02	02.09													
	E 220 CDI	120	03.03	02.09													
	E 220 CDI	125	04.06	02.09													
	E 230	150	04.06	02.09													
	E 240	130	03.02	02.09													
	E 240 4-matic	130	03.03	02.09													
	E 250 CDI	150	08.08	02.09													
	E 270 CDI	120	03.02	02.09													
	E 270 CDI	130	03.02	02.09													
	E 280	170	05.05	02.09													
	E 280 4-matic	170	05.05	02.09													
	E 280 CDI	130	05.04	02.09													
	E 280 CDI	140	03.05	02.09													
	E 280 CDI 4-matic	140	03.05	02.09													
	E 300 Bluetec	155	09.07	02.09													
	E 320	165	03.02	02.09													
	E 320 4-matic	165	03.03	02.09													
	E 320 CDI	150	11.02	02.09													
	E 320 CDI	165	03.05	02.09													
	E 320 CDI 4-matic	165	03.05	02.09													
	E 350	200	12.04	02.09													
	E 350 4-matic	200	12.04	02.09													
	E 350 CGI	215	09.07	02.09													
	E 400 CDI	191	03.03	02.09													
	E 420 CDI	231	01.06	02.09													
	E 500	225	03.02	02.09													
	E 500	285	04.06	02.09													
	E 500 4-matic	225	10.03	02.09													
	E 500 4-matic	285	04.06	02.09													
	E 55 Kompressor AMG	350	10.02	02.09													
	E 63 AMG	378	03.06	02.09													
		E 200 CDI	◀75	05.02							02.09		24.3727-0447.2	580447	1	<input type="checkbox"/> <input type="checkbox"/> <input type="checkbox"/>	L=1952 L=1742 L=1726
		E 200 CDI	◀90	05.02							02.09						
		E 200 CDI	◀100	04.06							02.09						
		E 200 Kompressor	◀120	05.02							02.09						
		E 200 Kompressor	◀135	04.06							02.09						
		E 200 NGT	◀120	03.04							02.09						
E 220 CDI		◀100	03.02	02.09													
E 220 CDI		◀110	03.02	02.09													
E 220 CDI		◀120	03.03	02.09													
E 220 CDI		◀125	04.06	02.09													
E 230		◀150	04.06	02.09													
E 240		◀130	03.02	02.09													
E 240 4-matic		◀130	03.03	02.09													
E 250 CDI		◀150	08.08	02.09													
E 270 CDI		◀120	03.02	02.09													
E 270 CDI		◀130	03.02	02.09													
E 280		◀170	05.05	02.09													
E 280 4-matic		◀170	05.05	02.09													
E 280 CDI		◀130	05.04	02.09													
E 320		◀165	03.02	02.09													
E 320 4-matic		◀165	03.03	02.09													
E 320 CDI		◀150	11.02	02.09													
E 350		◀200	12.04	02.09													
E 350 4-matic		◀200	12.04	02.09													
E 350 CGI		◀215	09.07	02.09													
E 400 CDI		◀191	03.03	02.09													
E 420 CDI		◀231	01.06	02.09													
E 500		◀225	03.02	02.09													
E 500		◀285	04.06	02.09													
E 500 4-matic		◀225	10.03	02.09													
E 500 4-matic		◀285	04.06	02.09													
E 55 Kompressor AMG		◀350	10.02	02.09													
E 63 AMG		◀378	03.06	02.09													
		E 200 CDI	▶75	05.02	02.09		24.3727-0449.2	580449	<input type="checkbox"/> <input type="checkbox"/>		L=1742 L=1726						
		E 200 CDI	▶90	05.02	02.09												
		E 200 CDI	▶100	04.06	02.09												
		E 200 Kompressor	▶120	05.02	02.09												
		E 200 Kompressor	▶135	04.06	02.09												
		E 200 NGT	▶120	03.04	02.09												
		E 220 CDI	▶100	03.02	02.09												
		E 220 CDI	▶110	03.02	02.09												
		E 220 CDI	▶120	03.03	02.09												
		E 220 CDI	▶125	04.06	02.09												

1) - sport package/- sport package AMG / - pacchetto sportivo/- pacchetto sport.AMG / - version sport/- version sport AMG / - kit sportivo/- kit sportivo AMG



MERCEDES BENZ E-Klasse (W211) Limousine (02-09)

	E 230	▶150		04.06	02.09	24.3727-0449.2	580449	<input type="checkbox"/>		L=1742
	E 240	▶130		03.02	02.09	24.3727-0448.2	580448	<input type="checkbox"/>		L=1726
	E 240 4-matic	▶130		03.03	02.09					
	E 250 CDI	▶150		08.08	02.09					
	E 270 CDI	▶120		03.02	02.09					
	E 270 CDI	▶130		03.02	02.09					
	E 280	▶170		05.05	02.09					
	E 280 4-matic	▶170		05.05	02.09					
	E 280 CDI	▶130		05.04	02.09					
	E 320	▶165		03.02	02.09					
	E 320 4-matic	▶165		03.03	02.09					
	E 320 CDI	▶150		11.02	02.09					
	E 350	▶200		12.04	02.09					
	E 350 4-matic	▶200		12.04	02.09					
	E 350 CGI	▶215		09.07	02.09					
	E 400 CDI	▶191		03.03	02.09					
	E 420 CDI	▶231		01.06	02.09					
	E 500	▶225		03.02	02.09					
E 500	▶285		04.06	02.09						
E 500 4-matic	▶225		10.03	02.09						
E 500 4-matic	▶285		04.06	02.09						
E 55 Kompressor AMG	▶350		10.02	02.09						
E 63 AMG	▶378		03.06	02.09						

MERCEDES BENZ E-Klasse (S211) Kombi (03-09)

	E 200 CDI	◀100		04.06	10.09	24.2125-1745.3	010998			Thz 25,40	TRW
	E 200 Kompressor	◀120		03.03	10.09						
	E 200 Kompressor	◀135		04.06	10.09						
	E 220 CDI	◀		03.03	10.09						
	E 220 CDI	◀125		04.06	10.09						
	E 230	◀150		05.07	10.09						
	E 240	◀130		03.03	10.09						
	E 240 4-matic	◀130		07.03	10.09						
	E 270 CDI	◀120		03.03	10.09						
	E 270 CDI	◀130		03.03	10.09						
	E 280	◀170		05.05	10.09						
	E 280 4-matic	◀170		05.05	10.09						
	E 280 CDI	◀130		05.04	10.09						
	E 280 CDI	◀140		03.05	10.09						
	E 280 CDI 4-matic	◀140		05.05	10.09						
	E 320	◀165		03.03	10.09						
	E 320 4-matic	◀165		07.03	10.09						
	E 320 CDI	◀150		03.03	10.09						
	E 320 CDI	◀165		03.05	10.09						
	E 320 CDI 4-matic	◀165		05.05	10.09						
	E 350	◀200		12.04	10.09						
	E 350 4-matic	◀200		12.04	10.09						
	E 350 CGI	◀215		05.06	10.09						
	E 500	◀225		10.03	10.09						
	E 500	◀285		04.06	10.09						
	E 500 4-matic	◀225		10.03	10.09						
	E 500 4-matic	◀285		04.06	10.09						
	E 55 Kompressor AMG	◀350		07.03	10.09						
E 63 AMG	◀378		03.06	10.09							
	E 240 4-matic	130		07.03	10.09	11.9601-9770.2	220878	<input type="checkbox"/>		D=60, - Halter	ATE
	E 280 4-matic	170		05.05	10.09	11.9601-9769.2	220877	<input type="checkbox"/>		D=60, - Halter	ATE
	E 280 CDI 4-matic	140		05.05	10.09	11.0441-6007.2	250146			Dichtungssatz	ATE
	E 320 4-matic	165		07.03	10.09	11.0101-5704.2	260095			Hülsensatz	ATE
	E 320 CDI 4-matic	165		05.05	10.09	11.8171-0008.1	990049			Führungsbolzen	ATE
	E 350 4-matic	200		12.04	10.09	11.8116-0253.1	390512	2		Haltefeder	ATE
	E 280 4-matic	170	A 870950	05.05		11.9441-9972.2	220840	<input type="checkbox"/>		D=44, - Halter	ATE
	E 280 CDI 4-matic	140	A 870950	05.05		11.9441-9971.2	220839	<input type="checkbox"/>		D=44, - Halter	ATE
	E 320 CDI 4-matic	165	A 870950	05.05		11.0101-5704.2	260095			Hülsensatz	ATE
	E 350 4-matic	200	A 870950	12.04							
	E 500 4-matic	225	A 870950	10.03							
	E 280 4-matic	170	A 870951		10.09	11.9441-9955.2	220805	<input type="checkbox"/>		D=44, - Halter	ATE
	E 280 CDI 4-matic	140	A 870951		10.09	11.9441-9956.2	220806	<input type="checkbox"/>		D=44, - Halter	ATE
	E 320 CDI 4-matic	165	A 870951		10.09	11.0101-7003.2	260124			Hülsensatz	ATE
	E 350 4-matic	200	A 870951		10.09						
	E 200 CDI	100		04.06	10.09	24.5123-0380.3	331256	2		L=380	
	E 200 Kompressor	120		03.03	10.09						
	E 200 Kompressor	135		04.06	10.09						
	E 220 CDI	125		03.03	10.09						
	E 220 CDI	150		04.06	10.09						
	E 230	150		05.07	10.09						
	E 240	130		03.03	10.09						
	E 270 CDI	120		03.03	10.09						
	E 270 CDI	130		03.03	10.09						
	E 280	170		05.05	10.09						
	E 280 CDI	130		05.04	10.09						
	E 280 CDI	140		03.05	10.09						
E 320	165		03.03	10.09							
E 320 CDI	150		03.03	10.09							
E 320 CDI	165		03.05	10.09							
E 350	200		12.04	10.09							

1) - sport package/- sport package AMG / - pacchetto sportivo/- pacchetto sport.AMG / - version sport/- version sport AMG / - kit sportivo/- kit sportivo AMG
 2) + sports package/+ sports package AMG / + pacchetto sportivo/+ pacchetto sport.AMG / + version sport/+ version sport AMG / + kit sportivo/+ kit sportivo AMG





MERCEDES BENZ E-Klasse (S211) Kombi (03-09)

	E 280	◀170	05.05	10.09	24.3727-0447.2	580447	1	L=1952 L=1742 L=1726	
	E 280 4-matic	◀170	05.05	10.09	24.3727-0449.2	580449	<input type="checkbox"/>		
	E 280 CDI	◀130	05.04	10.09	24.3727-0448.2	580448	<input type="checkbox"/>		
	E 320	◀165	03.03	10.09					
	E 320 4-matic	◀165	07.03	10.09					
	E 320 CDI	◀150	03.03	10.09					
	E 320 CDI 4-matic	◀165	05.05	10.09					
	E 350	◀200	12.04	10.09					
	E 350 4-matic	◀200	12.04	10.09					
	E 350 CGI	◀215	05.06	10.09					
	E 500	◀225	10.03	10.09					
	E 500	◀285	04.06	10.09					
	E 500 4-matic	◀225	10.03	10.09					
	E 500 4-matic	◀285	04.06	10.09					
	E 55 Kompressor AMG	◀350	07.03	10.09					
	E 63 AMG	◀378	03.06	10.09					
	E 200 CDI	▶100	04.06	10.09	24.3727-0449.2	580449	<input type="checkbox"/>		L=1742 L=1726
	E 200 Kompressor	▶120	03.03	10.09	24.3727-0448.2	580448	<input type="checkbox"/>		
	E 200 Kompressor	▶135	04.06	10.09					
	E 220 CDI	▶	03.03	10.09					
E 220 CDI	▶125	04.06	10.09						
E 230	▶150	05.07	10.09						
E 240	▶130	03.03	10.09						
E 240 4-matic	▶130	07.03	10.09						
E 270 CDI	▶120	03.03	10.09						
E 270 CDI	▶130	03.03	10.09						
E 280	▶170	05.05	10.09						
E 280 4-matic	▶170	05.05	10.09						
E 280 CDI	▶130	05.04	10.09						
E 320	▶165	03.03	10.09						
E 320 4-matic	▶165	07.03	10.09						
E 320 CDI	▶150	03.03	10.09						
E 320 CDI 4-matic	▶165	05.05	10.09						
E 350	▶200	12.04	10.09						
E 350 4-matic	▶200	12.04	10.09						
E 350 CGI	▶215	05.06	10.09						
E 500	▶225	10.03	10.09						
E 500	▶285	04.06	10.09						
E 500 4-matic	▶225	10.03	10.09						
E 500 4-matic	▶285	04.06	10.09						
E 55 Kompressor AMG	▶350	07.03	10.09						
E 63 AMG	▶378	03.06	10.09						

MERCEDES BENZ E-Klasse (W212) Limousine (09-)

	E 200	◀135	01.13		03.7755-8202.4	300301		9/8" Tandem ATE
	E 200 CDI	◀100	03.09					
	E 200 CGI	◀135	08.09					
	E 200 NGT	◀115	07.13					
	E 200 NGT	◀120	03.09					
	E 220 BlueTec	◀130	05.14					
	E 220 BlueTec 4-matic	◀125	01.15					
	E 220 CDI	◀	03.09					
	E 250	◀	03.09					
	E 250	◀155	01.13					
	E 250 CDI	◀150	03.09					
	E 250 CDI 4-matic	◀150	03.09					
	E 250 CGI	◀150	03.09					
	E 300	◀170	03.09					
	E 300 BE 4-matic	◀185	07.11					
	E 300 BlueEfficiency	◀185	07.11					
	E 300 CDI	◀	04.11					
	E 350	◀200	03.09					
	E 350	◀225	09.11					
	E 350 4-matic	◀200	03.09					
	E 350 4-matic	◀225	09.11					
	E 350 Bluetec	◀155	03.09					
	E 350 BlueTec	◀185	01.13					
	E 350 BlueTec	◀190	05.14					
	E 350 BlueTec 4-matic	◀185	01.13					
	E 350 BT 4-matic	◀190	05.14					
	E 350 CDI	◀170	03.09					
	E 350 CDI	◀195	09.14					
	E 350 CDI	◀195	03.11					
	E 350 CDI 4-matic	◀170	03.09					
	E 350 CDI 4-matic	◀195	03.11					
	E 350 CGI	◀215	03.09					
	E 400	◀245	07.14					
	E 400	◀245	01.13					
	E 400 4-matic	◀245	07.14					
	E 400 4-matic	◀245	01.13					
	E 500	◀285	03.09					
	E 500	◀300	09.11					
	E 500 4-matic	◀285	03.09					
	E 500 4-matic	◀300	09.11					
E 63 AMG	◀386	03.09						
E 63 AMG	◀386	02.11						
E 63 AMG	◀410	02.11						



MERCEDES BENZ E-Klasse (W212) Limousine (09-)

	E 63 AMG 4-matic	410		02.11		03.7755-8202.4	300301		9/8" Tandem	ATE
	E 63 AMG S	430		04.13						
	E 63 AMG S 4-matic	430		04.13						
	E 200	135		01.13		03.2126-3196.3	010968		THz 26,99	ATE
	E 200 CDI	100		03.09		03.4156-5106.3	010997		THz 26,99	ATE
	E 200 CGI	135		08.09						
	E 200 NGT	115		07.13						
	E 200 NGT	120		03.09						
	E 220 BlueTec	130		05.14						
	E 220 BlueTec 4-matic	125		01.15						
	E 220 CDI	100		03.09						
	E 250	155		03.09						
	E 250	155		01.13						
	E 250 CDI	150		03.09						
	E 250 CDI 4-matic	150		03.09						
	E 250 CGI	150		01.09						
	E 300	170		03.09						
	E 300 BE 4-matic	185		07.11						
	E 300 BlueEfficiency	185		07.11						
	E 300 CDI	150		04.11						
	E 350	200		03.09						
	E 350	225		09.11						
	E 350 4-matic	200		03.09						
	E 350 4-matic	225		09.11						
	E 350 Bluetec	155		03.09						
	E 350 BlueTec	185		01.13						
	E 350 BlueTec	190		05.14						
	E 350 BlueTec 4-matic	185		01.13						
	E 350 BT 4-matic	190		05.14						
	E 350 CDI	170		03.09						
	E 350 CDI	195		09.14						
	E 350 CDI	195		03.11						
	E 350 CDI 4-matic	170		03.09						
	E 350 CDI 4-matic	195		03.11						
	E 350 CGI	215		03.09						
	E 400	245		07.14						
	E 400	245		01.13						
	E 400 4-matic	245		07.14						
	E 400 4-matic	245		01.13						
	E 500	285		03.09						
	E 500	300		09.11						
	E 500 4-matic	285		03.09						
	E 500 4-matic	300		09.11						
	E 63 AMG	386		03.09						
	E 63 AMG	386		02.11						
	E 63 AMG	410		02.11						
	E 63 AMG 4-matic	410		02.11						
	E 63 AMG S	430		04.13						
	E 63 AMG S 4-matic	430		04.13						
	E 200	135		01.13	- Sportpaket / - Sportpaket AMG ¹⁾	24.3606-1707.7	221011	<input type="checkbox"/>	D=60, - Halter	TRW
	E 200 CDI	100		03.09	- Sportpaket / - Sportpaket AMG ¹⁾	24.3606-1708.7	221012	<input type="checkbox"/>	D=60, - Halter	TRW
	E 200 CGI	135		08.09	- Sportpaket / - Sportpaket AMG ¹⁾					
	E 200 NGT	115		07.13	- Sportpaket / - Sportpaket AMG ¹⁾					
	E 200 NGT	120		03.09	- Sportpaket / - Sportpaket AMG ¹⁾					
	E 220 BlueTec	130		05.14	- Sportpaket / - Sportpaket AMG ¹⁾					
	E 220 CDI	100		03.09	- Sportpaket / - Sportpaket AMG ¹⁾					
	E 250	155		03.09	- Sportpaket / - Sportpaket AMG ¹⁾					
	E 250 CDI	150	A 001284	03.09	- Sportpaket / - Sportpaket AMG ¹⁾					
	E 200	135		01.13	+ Sportpaket / + Sportpaket AMG ²⁾	24.3606-1711.5	240780	<input type="checkbox"/>	D=60, - Halter	TRW
	E 200 CDI	100		03.09	+ Sportpaket / + Sportpaket AMG ²⁾	24.3606-1712.5	240781	<input type="checkbox"/>	D=60, - Halter	TRW
	E 200 CGI	135		08.09	+ Sportpaket / + Sportpaket AMG ²⁾					
	E 200 NGT	115		07.13	+ Sportpaket / + Sportpaket AMG ²⁾					
	E 200 NGT	120		03.09	+ Sportpaket / + Sportpaket AMG ²⁾					
	E 220 BlueTec	130		05.14	+ Sportpaket / + Sportpaket AMG ²⁾					
	E 220 CDI	100		03.09	+ Sportpaket / + Sportpaket AMG ²⁾					
	E 250	155		03.09	+ Sportpaket / + Sportpaket AMG ²⁾					
	E 250	155		01.13	+ Sportpaket / + Sportpaket AMG ²⁾					
	E 250 CDI	150		03.09	+ Sportpaket / + Sportpaket AMG ²⁾					
	E 250 CGI	150		01.09	+ Sportpaket / + Sportpaket AMG ²⁾					
	E 300	170		03.09	+ Sportpaket / + Sportpaket AMG ²⁾					
	E 300 BlueEfficiency	185		07.11	+ Sportpaket / + Sportpaket AMG ²⁾					
	E 300 BlueTec Hybrid	150		06.12	+ Sportpaket / + Sportpaket AMG ²⁾					
	E 300 CDI	150		04.11	+ Sportpaket / + Sportpaket AMG ²⁾					
	E 350	200		03.09	+ Sportpaket / + Sportpaket AMG ²⁾					
	E 350	225		09.11	+ Sportpaket / + Sportpaket AMG ²⁾					
	E 350 Bluetec	155		03.09	+ Sportpaket / + Sportpaket AMG ²⁾					
	E 350 BlueTec	185		01.13	+ Sportpaket / + Sportpaket AMG ²⁾					
	E 350 BlueTec	190		05.14	+ Sportpaket / + Sportpaket AMG ²⁾					
	E 350 CDI	170		03.09	+ Sportpaket / + Sportpaket AMG ²⁾					
	E 350 CDI	195		09.14	+ Sportpaket / + Sportpaket AMG ²⁾					
	E 350 CDI	195		03.11	+ Sportpaket / + Sportpaket AMG ²⁾					
	E 350 CGI	215		03.09	+ Sportpaket / + Sportpaket AMG ²⁾					
	E 220 BlueTec 4-matic	125		01.15	- Sportpaket / - Sportpaket AMG ¹⁾	24.3601-1723.5	240631	<input type="checkbox"/>	D=60, - Halter	TRW
	E 250 CDI 4-matic	150		03.09	- Sportpaket / - Sportpaket AMG ¹⁾	24.3601-1724.5	240632	<input type="checkbox"/>	D=60, - Halter	TRW
	E 300 BE 4-matic	185		07.11	- Sportpaket / - Sportpaket AMG ¹⁾					
	E 350 4-matic	200		03.09	- Sportpaket / - Sportpaket AMG ¹⁾					
	E 350 4-matic	225		09.11	- Sportpaket / - Sportpaket AMG ¹⁾					

¹⁾ - sport package/- sport package AMG / - pacchetto sportivo/- pacchetto sport.AMG / - version sport/- version sport AMG / - kit deportivo/- kit deportivo AMG

²⁾ + sports package/+ sports package AMG / + pacchetto sportivo/+ pacchetto sport.AMG / + version sport/+ version sport AMG / + kit deportivo/+ kit deportivo AMG





MERCEDES BENZ E-Klasse (W212) Limousine (09-)

	E 350 BlueTec 4-matic	185		01.13	- Sportpaket / - Sportpaket AMG 1)	24.3601-1723.5	240631		D=60, - Halter D=60, - Halter	TRW TRW			
	E 350 BT 4-matic	190		05.14	- Sportpaket / - Sportpaket AMG 1)	24.3601-1724.5	240632						
	E 350 CDI 4-matic	170		03.09	- Sportpaket / - Sportpaket AMG 1)								
	E 350 CDI 4-matic	195		03.11	- Sportpaket / - Sportpaket AMG 1)								
	E 220 BlueTec 4-matic	125		01.15	+ Sportpaket / + Sportpaket AMG 2)	24.3601-1721.5	240629						
	E 250 CDI 4-matic	150		03.09	+ Sportpaket / + Sportpaket AMG 2)	24.3601-1722.5	240630						
	E 300 BE 4-matic	185		07.11	+ Sportpaket / + Sportpaket AMG 2)								
	E 350 4-matic	200		03.09	+ Sportpaket / + Sportpaket AMG 2)								
	E 350 4-matic	225		09.11	+ Sportpaket / + Sportpaket AMG 2)								
E 350 CDI 4-matic	170		03.09	+ Sportpaket / + Sportpaket AMG 2)									
E 350 CDI 4-matic	195		03.11	+ Sportpaket / + Sportpaket AMG 2)									
	E 200	135		01.13		24.5148-0406.3	331478	2	L=402				
	E 200 CDI	100		03.09									
	E 200 CGI	135		08.09									
	E 200 NGT	115		07.13									
	E 200 NGT	120		03.09									
	E 220 BlueTec	130		05.14									
	E 220 CDI			03.09									
	E 250			03.09									
	E 250	155		01.13									
	E 250 CDI	150		03.09									
	E 250 CGI	150		01.09									
	E 300	170		03.09									
	E 300 BlueEfficiency	185		07.11									
	E 300 BlueTec Hybrid	150		06.12									
	E 300 CDI			04.11									
	E 350	200		03.09									
	E 350	225		09.11									
	E 350 Bluetec	155		03.09									
	E 350 BlueTec	185		01.13									
	E 350 BlueTec	190		05.14									
	E 350 CDI	170		03.09									
	E 350 CDI	195		09.14									
	E 350 CDI	195		03.11									
	E 350 CGI	215		03.09									
	E 400	245		07.14									
	E 400	245		01.13									
	E 400 Hybrid			06.12									
	E 500	285		03.09									
	E 500	300		09.11									
	E 220 BlueTec 4-matic	125		01.15		83.7713-0487.3	331342				2	L=488	
	E 250 CDI 4-matic	150		03.09									
	E 300 BE 4-matic	185		07.11									
	E 350 4-matic	200		03.09									
E 350 4-matic	225		09.11										
E 350 BlueTec 4-matic	185		01.13										
E 350 BT 4-matic	190		05.14										
E 350 CDI 4-matic	170		03.09										
E 350 CDI 4-matic	195		03.11										
E 400 4-matic	245		07.14										
E 400 4-matic	245		01.13										
E 500 4-matic	285		03.09										
E 500 4-matic	300		09.11										
	E 200	135		01.13		24.3426-9989.5	240647	2	D=42, - Halter D=42, - Halter Hülsensatz Führungsbolzen Haltefeder	ATE ATE ATE ATE			
	E 200 CDI	100		03.09		24.3426-9990.5	240648						
	E 200 CGI	135		08.09		11.0101-5407.2	260011						
	E 200 NGT	115		07.13		11.8171-0008.1	990049						
	E 200 NGT	120		03.09		11.8116-0087.2	390607						
	E 220 BlueTec	130		05.14									
	E 220 BlueTec 4-matic	125		01.15									
	E 220 CDI		A 007599										
	E 220 CDI			03.09									
	E 250			03.09									
	E 250	155		01.13									
	E 250 CDI 4-matic	150		03.09									
	E 250 CGI	150		01.09									
	E 250 CDI	150		03.09		11.9426-9992.2	220642						
	E 300	170	A 007598	03.09		11.9426-9991.2	220641						
	E 300 BE 4-matic	185		07.11		11.0101-5407.2	260011						
	E 300 BlueEfficiency	185		07.11		11.8171-0008.1	990049						
	E 300 BlueTec Hybrid	150		06.12		11.8116-0087.2	390607						
E 300 CDI			04.11										
E 350	200		03.09										
E 350	225		09.11										
E 350 4-matic	200		03.09										
E 350 4-matic	225		09.11										
E 350 Bluetec	155		03.09										
E 350 BlueTec	185		01.13										
E 350 BlueTec	190		05.14										
E 350 BlueTec 4-matic	185		01.13										
E 350 BT 4-matic	190		05.14										
E 350 CDI	170		03.09										
E 350 CDI	195		09.14										
E 350 CDI	195		03.11										
E 350 CDI 4-matic	170		03.09										
E 350 CDI 4-matic	195		03.11										
E 350 CGI	215		03.09										

1) - sport package/- sport package AMG / - pacchetto sportivo/- pacchetto sport.AMG / - version sport/- version sport AMG / - kit sportivo/- kit sportivo AMG
 2) + sports package/+ sports package AMG / + pacchetto sportivo/+ pacchetto sport.AMG / + version sport/+ version sport AMG / + kit sportivo/+ kit sportivo AMG

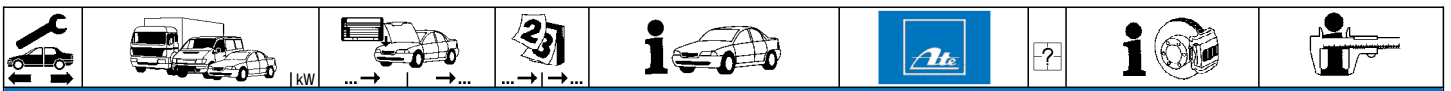

MERCEDES BENZ E-Klasse (W212) Limousine (09-)

	E 400	245	07.14	11.9426-9992.2	220642	2	D=42, - Halter	ATE
	E 400	245	01.13	11.9426-9991.2	220641			ATE
	E 400 4-matic	245	07.14	11.0101-5407.2	260011			ATE
	E 400 4-matic	245	01.13	11.8171-0008.1	990049			ATE
	E 400 Hybrid		06.12	11.8116-0087.2	390607			ATE
	E 500	285	03.09	11.9426-9959.2	220801	2	D=42, - Halter	ATE
	E 500	300	09.11	11.9426-9960.2	220802			ATE
	E 500 4-matic	285	03.09	11.8171-0008.1	990049			ATE
	E 500 4-matic	300	09.11	11.0101-5407.2	260011			ATE
				11.8116-0087.2	390607			ATE
	E 200	135	01.13	24.3727-0484.2	580484	1	L=2040 L=1250 L=743	ATE
	E 200 CDI	100	03.09	24.3727-0483.2	580483			ATE
	E 200 CGI	135	08.09	24.3727-0478.2	580478			ATE
	E 200 NGT	115	07.13					ATE
	E 200 NGT	120	03.09					ATE
	E 220 BlueTec	130	05.14					ATE
	E 220 BlueTec 4-matic	125	01.15					ATE
	E 220 CDI		03.09					ATE
	E 250		03.09					ATE
	E 250	155	01.13					ATE
	E 250 CDI	150	03.09					ATE
	E 250 CDI 4-matic	150	03.09					ATE
	E 250 CGI	150	01.09					ATE
	E 300	170	03.09					ATE
	E 300 BE 4-matic	185	07.11					ATE
	E 300 BlueEfficiency	185	07.11					ATE
	E 300 BlueTec Hybrid	150	06.12					ATE
	E 300 CDI		04.11					ATE
	E 350	200	03.09					ATE
	E 350	225	09.11					ATE
	E 350 4-matic	200	03.09					ATE
	E 350 4-matic	225	09.11					ATE
	E 350 Bluetec	155	03.09					ATE
	E 350 BlueTec	185	01.13					ATE
	E 350 BlueTec	190	05.14					ATE
	E 350 BlueTec 4-matic	185	01.13					ATE
	E 350 BT 4-matic	190	05.14					ATE
	E 350 CDI	170	03.09					ATE
	E 350 CDI	195	09.14					ATE
	E 350 CDI	195	03.11					ATE
	E 350 CDI 4-matic	170	03.09					ATE
	E 350 CDI 4-matic	195	03.11					ATE
	E 350 CGI	215	03.09					ATE
	E 400	245	07.14					ATE
	E 400	245	01.13					ATE
	E 400 4-matic	245	07.14					ATE
	E 400 4-matic	245	01.13					ATE
	E 400 Hybrid		06.12					ATE
	E 500	285	03.09					ATE
	E 500	300	09.11					ATE
	E 500 4-matic	285	03.09					ATE
	E 500 4-matic	300	09.11					ATE
	E 63 AMG	386	03.09					ATE
E 63 AMG	386	02.11			ATE			
E 63 AMG	410	02.11			ATE			
E 63 AMG 4-matic	410	02.11			ATE			
E 63 AMG S	430	04.13			ATE			
E 63 AMG S 4-matic	430	04.13			ATE			
	E 200	135	01.13	24.3727-0479.2	580479	1	L=1660 L=1250 L=743	ATE
	E 200 CDI	100	03.09	24.3727-0483.2	580483			ATE
	E 200 CGI	135	08.09	24.3727-0478.2	580478			ATE
	E 200 NGT	115	07.13					ATE
	E 200 NGT	120	03.09					ATE
	E 220 BlueTec	130	05.14					ATE
	E 220 BlueTec 4-matic	125	01.15					ATE
	E 220 CDI		03.09					ATE
	E 250		03.09					ATE
	E 250	155	01.13					ATE
	E 250 CDI	150	03.09					ATE
	E 250 CDI 4-matic	150	03.09					ATE
	E 250 CGI	150	01.09					ATE
	E 300	170	03.09					ATE
	E 300 BE 4-matic	185	07.11					ATE
	E 300 BlueEfficiency	185	07.11					ATE
	E 300 BlueTec Hybrid	150	06.12					ATE
	E 300 CDI		04.11					ATE
	E 350	200	03.09					ATE
	E 350	225	09.11					ATE
	E 350 4-matic	200	03.09					ATE
	E 350 4-matic	225	09.11					ATE
	E 350 Bluetec	155	03.09					ATE
	E 350 BlueTec	185	01.13					ATE
	E 350 BlueTec	190	05.14					ATE
	E 350 BlueTec 4-matic	185	01.13					ATE
	E 350 BT 4-matic	190	05.14					ATE
	E 350 CDI	170	03.09					ATE
	E 350 CDI	195	09.14					ATE



MERCEDES BENZ E-Klasse (W212) Limousine (09-)

	E 350 CDI	▶195	03.11	24.3727-0479.2	580479	1	↑	L=1660
	E 350 CDI	▶195	03.11	24.3727-0483.2	580483	1	□	L=1250
	E 350 CDI 4-matic	▶170	03.09	24.3727-0478.2	580478	2	↓	L=743
	E 350 CGI	▶215	03.09					
	E 400	▶245	07.14					
	E 400	▶245	01.13					
	E 400 4-matic	▶245	07.14					
	E 400 4-matic	▶245	01.13					
	E 400 Hybrid	▶	06.12					
	E 500	▶285	03.09					
	E 500	▶300	09.11					
	E 500 4-matic	▶285	03.09					
	E 500 4-matic	▶300	09.11					
	E 63 AMG	▶386	03.09					
	E 63 AMG	▶386	02.11					
	E 63 AMG	▶410	02.11					
	E 63 AMG 4-matic	▶410	02.11					
	E 63 AMG S	▶430	04.13					
	E 63 AMG S 4-matic	▶430	04.13					

MERCEDES BENZ E-Klasse (S212) Kombi (09-)

	E 200	◀135	03.13	03.7755-8202.4	300301			9/8" Tandem	ATE
	E 200 CDI	◀100	11.09						
	E 200 CGI	◀135	11.09						
	E 220 BlueTec	◀130	05.15						
	E 220 BlueTec 4-matic	◀125	12.14						
	E 220 CDI	◀125	11.09						
	E 250	◀155	03.13						
	E 250 CDI	◀150	11.09						
	E 250 CDI 4-matic	◀150	07.10						
	E 250 CGI	◀150	11.09						
	E 300	◀170	11.09						
	E 300	◀185	07.11						
	E 300 4-matic	◀185	07.11						
	E 300 CDI	◀150	03.11						
	E 300 CDI	◀170	11.09						
	E 350	◀200	11.09						
	E 350	◀225	09.11						
	E 350 4-matic	◀200	11.09						
	E 350 4-matic	◀225	09.11						
	E 350 BlueTec	◀155	11.09						
	E 350 BlueTec	◀185	01.13						
	E 350 BlueTec	◀190	07.14						
	E 350 BlueTec 4-matic	◀185	01.13						
	E 350 BlueTec 4-matic	◀190	07.14						
	E 350 CDI	◀170	11.09						
	E 350 CDI	◀195	07.11						
	E 350 CDI 4-matic	◀170	11.09						
	E 350 CDI 4-matic	◀195	07.11						
	E 350 CGI	◀215	11.09						
	E 400	◀245	01.13						
	E 400	◀245	07.14						
	E 400 4-matic	◀245	01.13						
	E 400 4-matic	◀245	07.14						
	E 500	◀285	11.09						
	E 500	◀300	09.11						
	E 500 4-matic	◀300	09.11						
	E 63 AMG	◀386	02.11						
	E 63 AMG	◀386	11.09						
	E 63 AMG	◀410	02.11						
	E 63 AMG 4-matic	◀410	02.11						
	E 63 AMG S	◀430	04.13						
	E 63 AMG S 4-matic	◀430	04.13						
	E 200	◀135	03.13	03.2126-3196.3	010968			THz 26,99	ATE
	E 200 CDI	◀100	11.09	03.4156-5106.3	010997			THz 26,99	ATE
	E 200 CGI	◀135	11.09						
	E 220 BlueTec	◀130	05.15						
	E 220 BlueTec 4-matic	◀125	12.14						
	E 220 CDI	◀125	11.09						
	E 250	◀155	03.13						
	E 250 CDI	◀150	11.09						
	E 250 CDI 4-matic	◀150	07.10						
	E 250 CGI	◀150	11.09						
	E 300	◀170	11.09						
	E 300	◀185	07.11						
	E 300 4-matic	◀185	07.11						
	E 300 CDI	◀150	03.11						
	E 300 CDI	◀170	11.09						
	E 350	◀200	11.09						
	E 350	◀225	09.11						
	E 350 4-matic	◀200	11.09						
	E 350 4-matic	◀225	09.11						
	E 350 BlueTec	◀155	11.09						
	E 350 BlueTec	◀185	01.13						
	E 350 BlueTec	◀190	07.14						
	E 350 BlueTec 4-matic	◀185	01.13						
	E 350 BlueTec 4-matic	◀190	07.14						



MERCEDES BENZ E-Klasse (S212) Kombi (09-)

	E 350 CDI E 350 CDI E 350 CDI 4-matic E 350 CDI 4-matic E 350 CGI E 400 E 400 E 400 4-matic E 400 4-matic E 500 E 500 E 500 4-matic E 63 AMG E 63 AMG E 63 AMG E 63 AMG 4-matic E 63 AMG S E 63 AMG S 4-matic	170 195 170 195 215 245 245 245 245 285 300 300 386 386 410 410 430 430	11.09 07.11 11.09 07.11 11.09 01.13 07.14 01.13 07.14 11.09 09.11 09.11 02.11 11.09 02.11 02.11 04.13 04.13		03.2126-3196.3 03.4156-5106.3	010968 010997			THz 26,99 THz 26,99	ATE ATE
	E 200 E 200 CDI E 200 CGI E 220 BlueTec E 220 CDI	135 100 135 130 125	03.13 11.09 11.09 05.15 11.09	- Sportpaket / - Sportpaket AMG ¹⁾ - Sportpaket / - Sportpaket AMG ¹⁾ - Sportpaket / - Sportpaket AMG ¹⁾ - Sportpaket / - Sportpaket AMG ¹⁾ - Sportpaket / - Sportpaket AMG ¹⁾	24.3606-1707.7 24.3606-1708.7	221011 221012	<input type="checkbox"/> <input type="checkbox"/>		D=60, - Halter D=60, - Halter	TRW TRW
	E 200 E 200 CDI E 200 CGI E 220 BlueTec E 220 CDI E 250 E 250 CDI E 250 CGI E 300 E 300 E 300 BlueTec Hybrid E 300 CDI E 300 CDI E 350 E 350 E 350 BlueTec E 350 BlueTec E 350 BlueTec E 350 CDI E 350 CDI E 350 CGI	135 100 135 130 125 155 150 150 170 185 150 150 170 200 225 155 185 190 170 195 215	03.13 11.09 11.09 05.15 11.09 03.13 11.09 11.09 11.09 07.11 06.12 03.11 11.09 11.09 09.11 11.09 07.14 07.14 11.09 07.11 11.09	+ Sportpaket / + Sportpaket AMG ²⁾ + Sportpaket / + Sportpaket AMG ²⁾	24.3606-1711.5 24.3606-1712.5	240780 240781	<input type="checkbox"/> <input type="checkbox"/>		D=60, - Halter D=60, - Halter	TRW TRW
	E 220 BlueTec 4-matic E 250 CDI 4-matic E 300 4-matic E 350 4-matic E 350 4-matic E 350 BlueTec 4-matic E 350 BlueTec 4-matic E 350 CDI 4-matic E 350 CDI 4-matic	125 150 185 200 225 185 190 170 195	12.14 07.10 07.11 11.09 09.11 01.13 07.14 11.09 07.11	- Sportpaket / - Sportpaket AMG ¹⁾ - Sportpaket / - Sportpaket AMG ¹⁾ - Sportpaket / - Sportpaket AMG ¹⁾ - Sportpaket / - Sportpaket AMG ¹⁾ - Sportpaket / - Sportpaket AMG ¹⁾ - Sportpaket / - Sportpaket AMG ¹⁾ - Sportpaket / - Sportpaket AMG ¹⁾ - Sportpaket / - Sportpaket AMG ¹⁾ - Sportpaket / - Sportpaket AMG ¹⁾	24.3601-1723.5 24.3601-1724.5	240631 240632	<input type="checkbox"/> <input type="checkbox"/>		D=60, - Halter D=60, - Halter	TRW TRW
	E 220 BlueTec 4-matic E 250 CDI 4-matic E 300 4-matic E 350 4-matic E 350 4-matic E 350 CDI 4-matic E 350 CDI 4-matic	125 150 185 200 225 170 195	12.14 07.10 07.11 11.09 09.11 11.09 07.11	+ Sportpaket / + Sportpaket AMG ²⁾ + Sportpaket / + Sportpaket AMG ²⁾ + Sportpaket / + Sportpaket AMG ²⁾ + Sportpaket / + Sportpaket AMG ²⁾ + Sportpaket / + Sportpaket AMG ²⁾ + Sportpaket / + Sportpaket AMG ²⁾ + Sportpaket / + Sportpaket AMG ²⁾	24.3601-1721.5 24.3601-1722.5	240629 240630	<input type="checkbox"/> <input type="checkbox"/>		D=60, - Halter D=60, - Halter	TRW TRW
	E 200 E 200 CDI E 200 CGI E 220 BlueTec E 220 CDI E 250 E 250 CDI E 250 CGI E 300 E 300 E 300 BlueTec Hybrid E 300 CDI E 300 CDI E 350 E 350 E 350 BlueTec E 350 BlueTec E 350 BlueTec E 350 CDI E 350 CDI E 350 CDI E 350 CGI E 400 E 400 E 400 E 500 E 500	135 100 135 130 125 155 150 150 170 185 150 150 170 200 225 155 185 190 170 195 215 245 245 245 285 300	03.13 11.09 11.09 05.15 11.09 03.13 11.09 11.09 11.09 07.11 06.12 03.11 11.09 11.09 09.11 11.09 01.13 07.14 11.09 07.11 11.09 11.09 01.13 07.14 11.09 09.11		24.5148-0406.3	331478	2		L=402	
	E 220 BlueTec 4-matic E 250 CDI 4-matic	125 150	12.14 07.10		83.7713-0487.3	331342	2		L=488	

¹⁾ - sport package/- sport package AMG / - pacchetto sportivo/- pacchetto sport.AMG / - version sport/- version sport AMG / - kit deportivo/- kit deportivo AMG
²⁾ + sports package/+ sports package AMG / + pacchetto sportivo/+ pacchetto sport.AMG / + version sport/+ version sport AMG / + kit deportivo/+ kit deportivo AMG





MERCEDES BENZ E-Klasse (S212) Kombi (09-)

	E 300 4-matic E 350 4-matic E 350 4-matic E 350 BlueTec 4-matic E 350 BlueTec 4-matic E 350 CDI 4-matic E 350 CDI 4-matic E 400 4-matic E 400 4-matic E 500 4-matic	185 200 225 185 190 170 195 245 245 300		07.11 11.09 09.11 01.13 07.14 11.09 07.11 01.13 07.14 09.11		83.7713-0487.3	331342	2		L=488	
	E 200 E 200 CDI E 200 CGI E 220 BlueTec E 220 BlueTec 4-matic E 220 CDI E 250 E 250 CDI E 250 CDI 4-matic E 250 CGI	135 100 135 130 125 125 155 150 150 150		03.13 11.09 11.09 05.15 12.14 11.09 03.13 11.09 07.10 11.09		24.3426-9989.5 24.3426-9990.5 11.0101-5407.2 11.8116-0087.2	240647 240648 260011 390607	2		D=42, - Halter D=42, - Halter Hülzensatz Haltefeder	ATE ATE ATE ATE
	E 300 E 300 E 300 4-matic E 300 BlueTec Hybrid E 300 CDI E 300 CDI E 350 E 350 E 350 4-matic E 350 4-matic E 350 BlueTec E 350 BlueTec E 350 BlueTec E 350 BlueTec 4-matic E 350 BlueTec 4-matic E 350 CDI E 350 CDI E 350 CDI 4-matic E 350 CDI 4-matic E 350 CGI E 400 E 400 E 400 4-matic E 400 4-matic	170 185 185 150 150 170 200 225 200 225 155 185 190 185 190 170 195 170 195 215 245 245 245 245		11.09 07.11 07.11 06.12 03.11 11.09 11.09 09.11 11.09 09.11 11.09 01.13 07.14 01.13 07.14 11.09 07.11 11.09 07.11 11.09 01.13 07.14 01.13 07.14		11.9426-9992.2 11.9426-9991.2 11.8171-0008.1 11.0101-5407.2 11.8116-0087.2	220642 220641 990049 260011 390607	2		D=42, - Halter D=42, - Halter Führungsbolzen Hülzensatz Haltefeder	ATE ATE ATE ATE ATE
	E 500 E 500 E 500 4-matic	285 300 300		11.09 09.11 09.11		11.9426-9959.2 11.9426-9960.2 11.8116-0087.2 11.0101-5407.2	220801 220802 390607 990049	2		D=42, - Halter D=42, - Halter Haltefeder Führungsbolzen Hülzensatz	ATE ATE ATE ATE ATE
	E 200 E 200 CDI E 200 CGI E 220 BlueTec E 220 BlueTec 4-matic E 220 CDI E 250 E 250 CDI E 250 CDI 4-matic E 250 CGI E 300 E 300 E 300 4-matic E 300 BlueTec Hybrid E 300 CDI E 300 CDI E 350 E 350 E 350 4-matic E 350 4-matic E 350 BlueTec E 350 BlueTec E 350 BlueTec E 350 BlueTec 4-matic E 350 BlueTec 4-matic E 350 CDI E 350 CDI E 350 CDI 4-matic E 350 CDI 4-matic E 350 CGI E 400 E 400 E 400 4-matic E 400 4-matic E 500 E 500 E 500 4-matic E 63 AMG	135 100 135 130 125 125 155 150 150 150 170 185 185 150 150 170 195 170 195 215 245 245 245 245 135 100 135 130 125 125 155 150 150 150 170 185 185 150 150 170 195 170 195 215 245 245 245 245 285 300 300		03.13 11.09 11.09 05.15 12.14 11.09 03.13 11.09 07.10 11.09 11.09 07.11 07.11 06.12 03.11 11.09 11.09 09.11 11.09 09.11 09.11 11.09 01.13 07.14 01.13 07.14 11.09 07.11 11.09 07.11 11.09 01.13 07.14 01.13 07.14 11.09 07.11 11.09 07.11 11.09 01.13 07.14 01.13 07.14 11.09 09.11 09.11 02.11		24.3727-0484.2 24.3727-0483.2 24.3727-0478.2	580484 580483 580478	1 1 2	 	L=2040 L=1250 L=743	



MERCEDES BENZ E-Klasse (S212) Kombi (09-)

	E 63 AMG	↖386	11.09	24.3727-0484.2	580484	1 ↑	L=2040 L=1250 L=743
	E 63 AMG	↖410	02.11	24.3727-0483.2	580483	1 □	
	E 63 AMG 4-matic	↖410	02.11	24.3727-0478.2	580478	2 ↓	
	E 63 AMG S	↖430	04.13				
	E 63 AMG S 4-matic	↖430	04.13				
	E 200	↗135	03.13	24.3727-0479.2	580479	1 ↑	L=1660
	E 200 CDI	↗100	11.09	24.3727-0483.2	580483	1 □	L=1250
	E 200 CGI	↗135	11.09	24.3727-0478.2	580478	2 ↓	L=743
	E 220 BlueTec	↗130	05.15				
	E 220 BlueTec 4-matic	↗125	12.14				
	E 220 CDI	↗125	11.09				
	E 250	↗155	03.13				
	E 250 CDI	↗150	11.09				
	E 250 CDI 4-matic	↗150	07.10				
	E 250 CGI	↗150	11.09				
	E 300	↗170	11.09				
	E 300	↗185	07.11				
	E 300 4-matic	↗185	07.11				
	E 300 BlueTec Hybrid	↗150	06.12				
	E 300 CDI	↗150	03.11				
	E 300 CDI	↗170	11.09				
	E 350	↗200	11.09				
	E 350	↗225	09.11				
	E 350 4-matic	↗200	11.09				
	E 350 4-matic	↗225	09.11				
	E 350 BlueTec	↗155	11.09				
	E 350 BlueTec	↗185	01.13				
	E 350 BlueTec	↗190	07.14				
	E 350 BlueTec 4-matic	↗185	01.13				
	E 350 BlueTec 4-matic	↗190	07.14				
	E 350 CDI	↗170	11.09				
	E 350 CDI	↗195	07.11				
	E 350 CDI 4-matic	↗170	11.09				
	E 350 CDI 4-matic	↗195	07.11				
	E 350 CGI	↗215	11.09				
	E 400	↗245	01.13				
	E 400	↗245	07.14				
	E 400 4-matic	↗245	01.13				
	E 400 4-matic	↗245	07.14				
	E 500	↗285	11.09				
	E 500	↗300	09.11				
	E 500 4-matic	↗300	09.11				
	E 63 AMG	↗386	02.11				
	E 63 AMG	↗386	11.09				
	E 63 AMG	↗410	02.11				
	E 63 AMG 4-matic	↗410	02.11				
	E 63 AMG S	↗430	04.13				
	E 63 AMG S 4-matic	↗430	04.13				

MERCEDES BENZ E-Klasse (C207) Coupe (09-)

	E 200	↖135	03.13	03.7745-6302.4	300261	- Start/Stop-Anlage ¹⁾ + Start/Stop-Anlage ²⁾	8" 8"	ATE ATE
	E 200 CGI	↖135	09.09	03.7745-8902.4	300297			
	E 220 BlueTec	↖130	05.14					
	E 220 CDI	↖120	07.14					
	E 220 CDI	↖125	05.09					
	E 250	↖155	03.13					
	E 250 CDI	↖150	05.09					
	E 250 CGI	↖150	05.09					
	E 300 CGI	↖185	04.11					
	E 320	↖200	07.14					
	E 350	↖225	09.09					
	E 350 4-matic BE	↖225	02.13					
	E 350 BlueTec	↖185	01.13					
	E 350 BlueTec	↖190	05.14					
	E 350 CDI	↖170	05.09					
	E 350 CDI	↖195	04.11					
	E 350 CGI	↖215	05.09					
	E 400	↖245	07.14					
	E 400	↖245	03.13					
	E 500	↖285	05.09					
	E 500	↖300	06.13					
	E 550 CGI	↖300	09.11					
	E 200	↖135	03.13	03.2025-2301.3	010895		THz 25,40/22,20	ATE
	E 200 CGI	↖135	09.09					
	E 220 BlueTec	↖130	05.14					
	E 220 CDI	↖120	07.14					
	E 220 CDI	↖125	05.09					
	E 250	↖155	03.13					
	E 250 CDI	↖150	05.09					
	E 250 CGI	↖150	05.09					
	E 300 CGI	↖185	04.11					
	E 320	↖200	07.14					
	E 350	↖225	09.09					
	E 350 4-matic BE	↖225	02.13					
	E 350 BlueTec	↖185	01.13					
	E 350 BlueTec	↖190	05.14					
E 350 CDI	↖170	05.09						

¹⁾ - idling stop system / - dispositivo start/stop / - unité marche/arrêt / - unidad arranque/paro

²⁾ + idling stop system / + dispositivo start/stop / + unité marche/arrêt / + unidad arranque/paro





MERCEDES BENZ E-Klasse (C207) Coupe (09-)

	E 350 CDI E 350 CGI E 400 E 400 E 500 E 500 E 550 CGI	◀195 ◀215 ◀245 ◀245 ◀285 ◀300 ◀300	04.11 05.09 07.14 03.13 05.09 06.13 09.11		03.2025-2301.3 010895			THz 25,40/22,20	ATE
	E 200 E 200 CGI E 220 BlueTec E 220 CDI E 220 CDI E 250 CGI	135 135 130 120 125 150	03.13 09.09 05.14 07.14 05.09 05.09	- Sportpaket / - Sportpaket AMG ¹⁾ - Sportpaket / - Sportpaket AMG ¹⁾ - Sportpaket / - Sportpaket AMG ¹⁾ - Sportpaket / - Sportpaket AMG ¹⁾ - Sportpaket / - Sportpaket AMG ¹⁾	24.3606-1707.7 24.3606-1708.7	221011 221012	 	D=60, - Halter D=60, - Halter	TRW TRW
	E 200 E 200 CGI E 220 CDI E 220 CDI E 250 E 250 CDI E 250 CGI E 300 CGI E 320 E 350 E 350 E 350 BlueTec E 350 BlueTec E 350 CDI E 350 CDI E 350 CGI	135 135 120 125 155 150 150 185 200 200 225 185 190 170 195 215	03.13 09.09 07.14 05.09 03.13 05.09 05.09 04.11 07.14 05.11 09.09 01.13 05.14 05.09 04.11 05.09	+ Sportpaket / + Sportpaket AMG ²⁾ + Sportpaket / + Sportpaket AMG ²⁾ + Sportpaket / + Sportpaket AMG ²⁾ + Sportpaket / + Sportpaket AMG ²⁾ + Sportpaket / + Sportpaket AMG ²⁾ + Sportpaket / + Sportpaket AMG ²⁾ + Sportpaket / + Sportpaket AMG ²⁾ + Sportpaket / + Sportpaket AMG ²⁾ + Sportpaket / + Sportpaket AMG ²⁾ + Sportpaket / + Sportpaket AMG ²⁾ + Sportpaket / + Sportpaket AMG ²⁾ + Sportpaket / + Sportpaket AMG ²⁾ + Sportpaket / + Sportpaket AMG ²⁾ + Sportpaket / + Sportpaket AMG ²⁾ + Sportpaket / + Sportpaket AMG ²⁾	24.3606-1711.5 24.3606-1712.5	240780 240781	 	D=60, - Halter D=60, - Halter	TRW TRW
	E 350 4-matic BE E 350 4-matic BE	225 225	02.13 02.13	- Sportpaket / - Sportpaket AMG ¹⁾ + Sportpaket / + Sportpaket AMG ²⁾	24.3601-1723.5 24.3601-1724.5	240631 240632	 	D=60, - Halter D=60, - Halter	TRW TRW
	E 550 CGI	300	09.11		11.8171-0096.1	250155		Führungsbolzen	ATE
	E 200 E 200 CGI E 220 BlueTec E 220 CDI E 220 CDI E 250 E 250 CDI E 250 CGI E 300 CGI E 320 E 350 E 350 BlueTec E 350 BlueTec E 350 CDI E 350 CDI E 350 CGI E 400 E 400 E 500 E 500 E 550 CGI	135 135 130 120 125 155 150 150 185 200 225 185 190 170 195 215 245 245 285 300 300	03.13 09.09 05.14 07.14 05.09 03.13 05.09 05.09 04.11 07.14 09.09 01.13 05.14 05.09 04.11 05.09 07.14 03.13 05.09 06.13 09.11		83.7705-0386.3	330828	2	L=385	
	E 300 CGI E 350 E 350 BlueTec E 350 BlueTec E 350 CDI E 350 CDI E 350 CGI E 500 E 500 E 550 CGI	185 225 185 190 170 195 215 285 300 300	04.11 09.09 01.13 05.14 05.09 04.11 05.09 05.09 06.13 09.11		11.9406-9961.2 11.9406-9962.2 11.8116-0340.1 11.0101-5407.2 11.8171-0008.1	220951 220952 390595 260011 990049	 2 	D=40, - Halter D=40, - Halter Haltefeder Hülzensatz Führungsbolzen	ATE ATE ATE ATE ATE
	E 200 CGI E 220 BlueTec E 220 CDI E 220 CDI E 250 CDI E 250 CGI	135 130 120 125 150 150	09.09 05.14 07.14 05.09 05.09 05.09		11.9386-9991.2 11.9386-9992.2 11.8116-0340.1	220949 220950 390595	 2	D=38, - Halter D=38, - Halter Haltefeder	ATE ATE ATE
	E 200 E 250	135 155	03.13 03.13		11.9386-9991.2 11.9386-9992.2 11.0101-5407.2 11.8116-0340.1	220949 220950 260011 390595	 2	D=38, - Halter D=38, - Halter Hülzensatz Haltefeder	ATE ATE ATE ATE
	E 320 E 350 E 350 4-matic BE E 400 E 400	200 200 225 245 245	07.14 05.11 02.13 07.14 03.13		11.9406-9961.2 11.9406-9962.2 11.0101-5407.2 11.8171-0008.1 11.8116-0340.1	220951 220952 260011 990049 390595	 2	D=40, - Halter D=40, - Halter Hülzensatz Führungsbolzen Haltefeder	ATE ATE ATE ATE ATE
	E 200 E 200 CGI E 220 BlueTec E 220 CDI E 220 CDI E 250	135 135 130 120 125 155	03.13 09.09 05.14 07.14 05.09 03.13		24.5172-0305.3	331312	2	L=305	

¹⁾ - sport package/- sport package AMG / - pacchetto sportivo/- pacchetto sport.AMG / - version sport/- version sport AMG / - kit deportivo/- kit deportivo AMG
²⁾ + sports package/+ sports package AMG / + pacchetto sportivo/+ pacchetto sport.AMG / + version sport/+ version sport AMG / + kit deportivo/+ kit deportivo AMG
³⁾ + aluminium calipers / + pinze in alluminio / + étriers en aluminium / + pinzas de aluminio

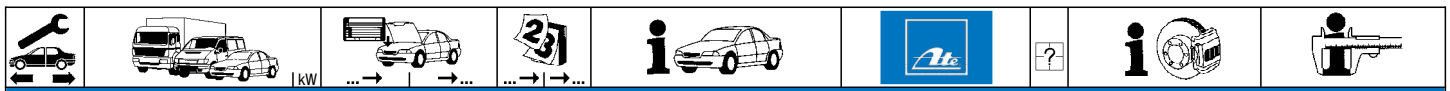

MERCEDES BENZ E-Klasse (C207) Coupe (09-)













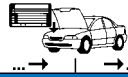













	E 250 CDI	150	05.09	24.5172-0305.3	331312	2		L=305
	E 250 CGI	150	05.09					
	E 300 CGI	185	04.11					
	E 320	200	07.14					
	E 350	225	09.09					
	E 350 4-matic BE	225	02.13					
	E 350 BlueTec	185	01.13					
	E 350 BlueTec	190	05.14					
	E 350 CDI	170	05.09					
	E 350 CDI	195	04.11					
	E 350 CGI	215	05.09					
	E 400	245	07.14					
	E 400	245	03.13					
	E 500	285	05.09					
	E 500	300	06.13					
	E 550 CGI	300	09.11					
	E 200	1135	03.13	24.3727-0465.2	580465	1	↑	L=2057
	E 200 CGI	1135	09.09	24.3727-0470.2	580470	1	□	L=1152
	E 220 BlueTec	1130	05.14	24.3727-0467.2	580467	2	↓	L=728
	E 220 CDI	1120	07.14					
	E 220 CDI	1125	05.09					
	E 250	1155	03.13					
	E 250 CDI	1150	05.09					
	E 250 CGI	1150	05.09					
	E 300 CGI	1185	04.11					
	E 320	1200	07.14					
	E 350	1225	09.09					
	E 350 4-matic BE	1225	02.13					
	E 350 BlueTec	1185	01.13					
	E 350 BlueTec	1190	05.14					
	E 350 CDI	1170	05.09					
	E 350 CDI	1195	04.11					
	E 350 CGI	1215	05.09					
	E 400	1245	07.14					
	E 400	1245	03.13					
	E 500	1285	05.09					
	E 500	1300	06.13					
	E 550 CGI	1300	09.11					
	E 200	1135	03.13	24.3727-0470.2	580470	1	□	L=1152
	E 200 CGI	1135	09.09	24.3727-0467.2	580467	2	↓	L=728
	E 220 BlueTec	1130	05.14					
	E 220 CDI	1120	07.14					
	E 220 CDI	1125	05.09					
	E 250	1155	03.13					
	E 250 CDI	1150	05.09					
	E 250 CGI	1150	05.09					
	E 300 CGI	1185	04.11					
	E 320	1200	07.14					
	E 350	1225	09.09					
	E 350 4-matic BE	1225	02.13					
	E 350 BlueTec	1185	01.13					
	E 350 BlueTec	1190	05.14					
	E 350 CDI	1170	05.09					
	E 350 CDI	1195	04.11					
	E 350 CGI	1215	05.09					
	E 400	1245	07.14					
	E 400	1245	03.13					
	E 500	1285	05.09					
	E 500	1300	06.13					
	E 550 CGI	1300	09.11					

MERCEDES BENZ E-Klasse (A207) Cabrio (10-)

	E 200	1135	03.13	03.7745-6302.4	300261		- Start/Stop-Anlage 1)	8"	ATE
	E 200 CGI	1135	03.10	03.7745-8902.4	300297		+ Start/Stop-Anlage 2)	8"	ATE
	E 220 BlueTec	1130	05.14						
	E 220 CDI	1125	03.10						
	E 250	1155	03.13						
	E 250 CDI	1150	03.10						
	E 250 CGI	1150	03.10						
	E 300 CGI	1185	03.10						
	E 320	1200	07.14						
	E 350	1225	04.11						
	E 350 BlueTec	1185	01.13						
	E 350 BlueTec	1190	05.14						
	E 350 CDI	1170	03.10						
	E 350 CDI	1195	04.11						
	E 350 CGI	1215	03.10						
	E 400	1245	07.14						
	E 400	1245	03.13						
	E 500	1285	03.10						
	E 500	1300	06.13						
	E 550 CGI	1300	09.11						
	E 200	1135	03.13	03.2025-2301.3	010895			THz 25,40/22,20	ATE
	E 200 CGI	1135	03.10						
	E 220 BlueTec	1130	05.14						
	E 220 CDI	1125	03.10						
	E 250	1155	03.13						

1) - idling stop system / - dispositivo start/stop / - unité marche/arrêt / - unidad arranque/paro
 2) + idling stop system / + dispositivo start/stop / + unité marche/arrêt / + unidad arranque/paro



								
MERCEDES BENZ E-Klasse (A207) Cabrio (10-)								
	E 250 CDI E 250 CGI E 300 CGI E 320 E 350 E 350 BlueTec E 350 BlueTec E 350 CDI E 350 CDI E 350 CGI E 400 E 400 E 500 E 500 E 550 CGI	150 150 185 200 225 185 190 170 195 215 245 245 285 300 300	03.10 03.10 03.10 07.14 04.11 01.13 05.14 03.10 04.11 03.10 07.14 03.13 03.10 06.13 09.11		03.2025-2301.3 010895			ThZ 25,40/22,20 ATE
	E 200 E 200 CGI E 220 BlueTec E 220 CDI E 250 CDI	135 135 130 125 150	03.13 03.10 05.14 03.10 03.10	- Sportpaket / - Sportpaket AMG ¹⁾ - Sportpaket / - Sportpaket AMG ¹⁾ - Sportpaket / - Sportpaket AMG ¹⁾ - Sportpaket / - Sportpaket AMG ¹⁾ - Sportpaket / - Sportpaket AMG ¹⁾	24.3606-1707.7 221011 24.3606-1708.7 221012	 		D=60, - Halter D=60, - Halter TRW TRW
	E 200 E 200 CGI E 220 BlueTec E 220 CDI E 250 E 250 CDI E 250 CGI E 300 CGI E 320 E 350 E 350 BlueTec E 350 BlueTec E 350 CDI E 350 CDI E 350 CGI E 550 CGI	135 135 130 125 155 150 150 185 200 225 185 190 170 195 215 300	03.13 03.10 05.14 03.10 03.13 03.10 03.10 03.10 07.14 04.11 01.13 05.14 03.10 04.11 03.10 09.11	+ Sportpaket / + Sportpaket AMG ²⁾ + Sportpaket / + Sportpaket AMG ²⁾ + Sportpaket / + Sportpaket AMG ²⁾ + Sportpaket / + Sportpaket AMG ²⁾ + Sportpaket / + Sportpaket AMG ²⁾ + Sportpaket / + Sportpaket AMG ²⁾ + Sportpaket / + Sportpaket AMG ²⁾ + Sportpaket / + Sportpaket AMG ²⁾ + Sportpaket / + Sportpaket AMG ²⁾ + Sportpaket / + Sportpaket AMG ²⁾ + Sportpaket / + Sportpaket AMG ²⁾ + Sportpaket / + Sportpaket AMG ²⁾ + Sportpaket / + Sportpaket AMG ²⁾ + Sportpaket / + Sportpaket AMG ²⁾ + Sportpaket / + Sportpaket AMG ²⁾	24.3606-1711.5 240780 24.3606-1712.5 240781	 		D=60, - Halter D=60, - Halter TRW TRW
	E 200 E 200 CGI E 220 BlueTec E 220 CDI E 250 E 250 CDI E 250 CGI E 300 CGI E 320 E 350 E 350 BlueTec E 350 BlueTec E 350 CDI E 350 CDI E 350 CGI E 550 CGI	135 135 130 125 155 150 150 185 200 225 185 190 170 195 215 300	03.13 03.10 05.14 03.10 03.13 03.10 03.10 03.10 07.14 04.11 01.13 05.14 03.10 04.11 03.10 09.11		11.8171-0096.1 250155 83.7705-0386.3 330828	2		Führungsbolzen L=385 ATE
	E 200 E 200 CGI E 220 BlueTec E 220 CDI E 250 E 250 CDI E 250 CGI E 300 CGI E 320 E 350 E 350 BlueTec E 350 BlueTec E 350 CDI E 350 CDI E 350 CGI E 400 E 400 E 500 E 500 E 550 CGI	135 135 130 125 155 150 150 185 200 225 185 190 170 195 215 245 245 285 300 300	03.13 03.10 05.14 03.10 03.13 03.10 03.10 03.10 07.14 04.11 01.13 05.14 03.10 04.11 03.10 07.14 03.13 03.10 06.13 09.11		11.9386-9991.2 220949 11.9386-9992.2 220950	 	+ ALU-Sättel ³⁾ + ALU-Sättel ³⁾	D=38, - Halter D=38, - Halter ATE ATE
	E 200 E 250	135 155	03.13 03.13		11.9386-9991.2 220949 11.9386-9992.2 220950 11.0101-5407.2 260011 11.8116-0340.1 390595	 		D=38, - Halter D=38, - Halter Hülensatz Haltefeder ATE ATE ATE
	E 300 CGI E 350 E 350 BlueTec E 350 BlueTec E 350 CDI E 350 CDI E 350 CGI E 500 E 500 E 550 CGI	185 225 185 190 170 195 215 285 300 300	03.10 04.11 01.13 05.14 03.10 04.11 03.10 03.10 06.13 09.11		11.9406-9961.2 220951 11.9406-9962.2 220952 11.0101-5407.2 260011 11.8171-0008.1 990049 11.8116-0340.1 390595	 	+ ALU-Sättel ³⁾ + ALU-Sättel ³⁾	D=40, - Halter D=40, - Halter Hülensatz Führungsbolzen Haltefeder ATE ATE ATE ATE
	E 320 E 400 E 400	200 245 245	07.14 07.14 03.13		11.9406-9961.2 220951 11.9406-9962.2 220952 11.0101-5407.2 260011 11.8171-0008.1 990049 11.8116-0340.1 390595	 		D=40, - Halter D=40, - Halter Hülensatz Führungsbolzen Haltefeder ATE ATE ATE ATE
	E 200 E 200 CGI E 220 BlueTec E 220 CDI E 250 E 250 CDI	135 135 130 125 155 150	03.13 03.10 05.14 03.10 03.13 03.10		24.5172-0305.3 331312	2		L=305

¹⁾ - sport package/- sport package AMG / - pacchetto sportivo/- pacchetto sport.AMG / - version sport/- version sport AMG / - kit deportivo/- kit deportivo AMG
²⁾ + sports package/+ sports package AMG / + pacchetto sportivo/+ pacchetto sport.AMG / + version sport/+ version sport AMG / + kit deportivo/+ kit deportivo AMG
³⁾ + aluminium calipers / + pinze in alluminio / + étriers en aluminium / + pinzas de aluminio

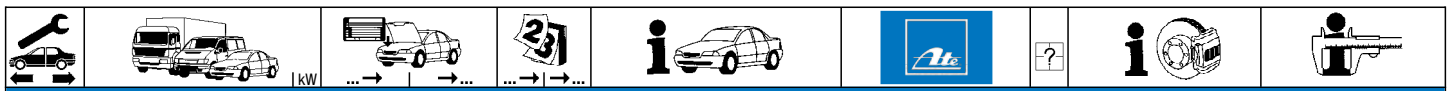

















MERCEDES BENZ E-Klasse (A207) Cabrio (10-)

	E 250 CGI	150	03.10	24.5172-0305.3	331312	2		L=305
	E 300 CGI	185	03.10					
	E 320	200	07.14					
	E 350	225	04.11					
	E 350 BlueTec	185	01.13					
	E 350 BlueTec	190	05.14					
	E 350 CDI	170	03.10					
	E 350 CDI	195	04.11					
	E 350 CGI	215	03.10					
	E 400	245	07.14					
	E 400	245	03.13					
	E 500	285	03.10					
	E 500	300	06.13					
	E 550 CGI	300	09.11					
	E 200	◀135	03.13	24.3727-0465.2	580465	1	↑	L=2057
	E 200 CGI	◀135	03.10	24.3727-0470.2	580470	1	□	L=1152
	E 220 BlueTec	◀130	05.14	24.3727-0467.2	580467	2	↓	L=728
	E 220 CDI	◀125	03.10					
	E 250	◀155	03.13					
	E 250 CDI	◀150	03.10					
	E 250 CGI	◀150	03.10					
	E 300 CGI	◀185	03.10					
	E 320	◀200	07.14					
	E 350	◀225	04.11					
	E 350 BlueTec	◀185	01.13					
	E 350 BlueTec	◀190	05.14					
	E 350 CDI	◀170	03.10					
	E 350 CDI	◀195	04.11					
	E 350 CGI	◀215	03.10					
	E 400	◀245	07.14					
	E 400	◀245	03.13					
	E 500	◀285	03.10					
	E 500	◀300	06.13					
	E 550 CGI	◀300	09.11					
	E 200	▶135	03.13	24.3727-0470.2	580470	1	□	L=1152
	E 200 CGI	▶135	03.10	24.3727-0467.2	580467	2	↓	L=728
	E 220 BlueTec	▶130	05.14					
	E 220 CDI	▶125	03.10					
	E 250	▶155	03.13					
	E 250 CDI	▶150	03.10					
	E 250 CGI	▶150	03.10					
	E 300 CGI	▶185	03.10					
	E 320	▶200	07.14					
	E 350	▶225	04.11					
	E 350 BlueTec	▶185	01.13					
	E 350 BlueTec	▶190	05.14					
	E 350 CDI	▶170	03.10					
	E 350 CDI	▶195	04.11					
	E 350 CGI	▶215	03.10					
	E 400	▶245	07.14					
	E 400	▶245	03.13					
	E 500	▶285	03.10					
	E 500	▶300	06.13					
	E 550 CGI	▶300	09.11					









MERCEDES BENZ G-Klasse (W463) (90-)

	200 GE	◀ 85	01.90	03.6855-1402.4	300057			9" Tandem	ATE
	230 GE	◀	06.90						
	250 GD	◀	06.90						
	300 GD	◀	09.89						
	300 GE	◀	06.90						
	350 G Turbo	◀	09.91						
	G 270 CDI	◀	10.01						
	G 300 TD	◀	08.96						
	G 320	◀	09.94						
	G 36 AMG	◀	01.95						
	G 400 CDI	◀	12.00						
	G 500	◀	04.98						
	G 500 E	◀	09.93						
	G 55 AMG	◀	04.99						
	200 GE	▶ 85	01.90	03.6855-1902.4	300059			9" Tandem	ATE
	230 GE	▶	06.90						
	250 GD	▶	06.90						
	300 GD	▶	09.89						
	300 GE	▶	06.90						
	350 G Turbo	▶	09.91						
	G 270 CDI	▶	10.01						
	G 300 TD	▶	08.96						
	G 320	▶	09.94						
	G 36 AMG	▶	01.95						
	G 400 CDI	▶	12.00						
	G 500	▶	04.98						
	G 500 E	▶	09.93						
	G 55 AMG	▶	04.99						



MERCEDES BENZ G-Klasse (W463) (90-)										
										
	200 GE 230 GE 250 GD 300 GD 300 GE 350 G Turbo G 270 CDI G 300 TD G 320 G 36 AMG G 400 CDI G 500 G 500 E G 55 AMG	85	01.90 06.90 06.90 09.89 06.90 09.91 10.01 08.96 09.94 01.95 12.00 04.98 09.93 04.99		03.2125-2102.3	010207	- ABS	THz 25,40	ATE	
	G 320 CDI G 350 CDI BlueTec G 500		09.06 06.10 05.08	12.11	24.2125-1745.3	010998		THz 25,40	TRW	
	200 GE 230 GE 250 GD 300 GD 300 GE 350 G Turbo G 270 CDI G 300 TD G 320 G 350 CDI BlueTec G 36 AMG G 400 CDI G 500 G 500 E G 55 AMG	85	01.90 06.90 06.90 09.89 06.90 09.91 10.01 08.96 09.94 06.10 01.95 12.00 04.98 09.93 04.99		13.9441-0041.2 13.9441-0042.2 13.0441-4408.2	210279 210280 250096	<input type="checkbox"/> - belüftete Scheiben ¹⁾ <input type="checkbox"/> - belüftete Scheiben ¹⁾ <input type="checkbox"/> - belüftete Scheiben ¹⁾	D=44 D=44 Dichtungssatz	ATE ATE ATE	
	200 GE 230 GE 250 GD 300 GD 300 GE 350 G Turbo G 270 CDI G 300 TD G 320 G 36 AMG G 400 CDI G 500 G 500 E	85	01.90 06.90 06.90 09.89 06.90 09.91 10.01 08.96 09.94 01.95 12.00 04.98 09.93		24.5224-0460.3	331264	2	L=460		
	230 GE 250 GD 300 GD 300 GE 350 G Turbo G 270 CDI G 300 TD G 320 G 36 AMG G 400 CDI G 500 G 500 E		06.90 06.90 09.89 06.90 09.91 10.01 08.96 09.94 01.95 12.00 04.98 09.93		24.5165-0450.3	331259	2	L=450		
	G 320 CDI G 350 CDI BlueTec G 350 d G 500	180 285	09.06 06.10 06.15 05.08		83.6104-0220.3	330474	2	L=220		
	200 GE 230 GE 250 GD 300 GD 300 GE 350 G Turbo G 270 CDI G 300 TD G 320 G 36 AMG G 400 CDI G 500 G 500 E G 55 AMG	85	01.90 06.90 06.90 09.89 06.90 09.91 10.01 08.96 09.94 01.95 12.00 04.98 09.93 04.99		24.3217-1109.3	020173		Rz 17,46		
	G 320 CDI G 350 CDI BlueTec G 500 G 63 AMG G 65 AMG G 350 d	285 400 450 180	09.06 06.10 05.08 06.12 06.12 06.15		24.3727-0476.2 24.3727-0477.2	580476 580477	<input type="checkbox"/> <input type="checkbox"/>	L=2230 L=2374		
	G 320 CDI G 350 CDI BlueTec G 500 G 63 AMG G 65 AMG G 350 d	285 400 450 180	09.06 06.10 05.08 06.12 06.12 06.15		24.3727-0476.2 24.3727-0477.2	580476 580477	<input type="checkbox"/> Komponentennummer: 504028/02 <input type="checkbox"/> Komponentennummer: 504028/02	L=2230 L=2374		
	200 GE 230 GE 250 GD 300 GD	85	01.90 06.90 06.90 09.89		03.6513-0340.3	320084		BRL 1/3 (2)	ATE	

¹⁾ - ventilated discs / - dischi ventilati / - disques ventilés / - disco ventilado

MERCEDES BENZ G-Klasse (W463) (90-)										
	300 GE 350 G Turbo G 270 CDI G 300 TD G 320 G 36 AMG G 400 CDI G 500 G 500 E G 55 AMG			06.90 09.91 10.01 08.96 09.94 01.95 12.00 04.98 09.93 04.99			03.6513-0340.3	320084		BRL 1/3 (2) ATE
	200 GE 230 GE 250 GD 300 GD 300 GE 350 G Turbo G 270 CDI G 300 TD G 320 G 36 AMG G 400 CDI G 500 G 500 E G 55 AMG	85		01.90 06.90 06.90 09.89 06.90 09.91 10.01 08.96 09.94 01.95 12.00 04.98 09.93 04.99			24.2419-0942.3	030068		Gz 19,05
	200 GE 230 GE 250 GD 300 GD 300 GE 350 G Turbo	85		01.90 06.90 06.90 09.89 06.90 09.91			03.2523-1310.3 03.2523-0812.3 03.0450-2311.2	040022 040020 082311		Nz 23,81 Nz 23,81 Nz Reparatursatz Nz 23,81
MERCEDES BENZ G-Klasse (W463) Cabrio (90-)										
	200 GE 230 GE 300 GD 300 GE 320 GE 350 G Turbo G 300 TD G 320 G 400 CDI G 500			01.90 06.90 12.90 09.89 09.94 09.91 09.96 11.97 12.00 04.98			03.6855-1402.4	300057		9" Tandem ATE
	200 GE 230 GE 300 GD 300 GE 320 GE 350 G Turbo G 300 TD G 320 G 400 CDI G 500			01.90 06.90 12.90 09.89 09.94 09.91 09.96 11.97 12.00 04.98			03.6855-1902.4	300059		9" Tandem ATE
	200 GE 230 GE 300 GD 300 GE 320 GE 350 G Turbo G 300 TD G 320 G 400 CDI G 500			01.90 06.90 12.90 09.89 09.94 09.91 09.96 11.97 12.00 04.98			03.2125-2102.3	010207	- ABS	THz 25,40 ATE
	G 320 CDI G 350 CDI BlueTec			09.06 06.10			24.2125-1745.3	010998		THz 25,40 TRW
	200 GE 230 GE 300 GD 300 GE 320 GE 350 G Turbo G 300 TD G 320 G 400 CDI G 500			01.90 06.90 12.90 09.89 09.94 09.91 09.96 11.97 12.00 04.98			13.9441-0041.2 13.9441-0042.2 13.0441-4408.2	210279 210280 250096	<input type="checkbox"/> - belüftete Scheiben ¹⁾ <input type="checkbox"/> - belüftete Scheiben ¹⁾ <input type="checkbox"/> - belüftete Scheiben ¹⁾	D=44 D=44 Dichtungssatz ATE ATE ATE
	200 GE 230 GE 300 GD 300 GE 320 GE 350 G Turbo G 300 TD G 320 G 400 CDI G 500			01.90 06.90 12.90 09.89 09.94 09.91 09.96 11.97 12.00 04.98			24.5224-0460.3	331264	2	L=460

¹⁾ - ventilated discs / - dischi ventilati / - disques ventilés / - disco ventilado

















MERCEDES BENZ G-Klasse (W463) Cabrio (90-)

	230 GE		06.90		24.5165-0450.3	331259	2		L=450	
	300 GD		12.90							
	300 GE		09.89							
	320 GE		09.94							
	350 G Turbo		09.91							
	G 300 TD		09.96							
	G 320		11.97							
	G 400 CDI		12.00							
	G 500		04.98							
	G 320 CDI		09.06		83.6104-0220.3	330474	2		L=220	
	G 350 CDI BlueTec		06.10							
	200 GE		01.90		24.3217-1109.3	020173			Rz 17,46	
	230 GE		06.90							
	300 GD		12.90							
	300 GE		09.89							
	320 GE		09.94							
	350 G Turbo		09.91							
	G 300 TD		09.96							
	G 320		11.97							
	G 400 CDI		12.00							
	G 500		04.98							
	200 GE		01.90		03.6513-0340.3	320084			BRL 1/3 (2)	ATE
	230 GE		06.90							
	300 GD		12.90							
	300 GE		09.89							
	320 GE		09.94							
	350 G Turbo		09.91							
	G 300 TD		09.96							
	G 320		11.97							
	G 400 CDI		12.00							
	G 500		04.98							
	200 GE		01.90		24.2419-0942.3	030068			Gz 19,05	
	230 GE		06.90							
	300 GD		12.90							
	300 GE		09.89							
	320 GE		09.94							
	350 G Turbo		09.91							
	G 300 TD		09.96							
	G 320		11.97							
	G 320 CDI		09.06							
	G 400 CDI		12.00							
	G 500		04.98							
	200 GE		01.90		03.2523-1310.3	040022			Nz 23,81	
	230 GE		06.90		03.2523-0812.3	040020			Nz 23,81	
					03.0450-2311.2	082311			Nz Reparatursatz	
	300 GD		12.90		03.2523-1210.3	040021			Nz 23,81	
	300 GE		09.89							

MERCEDES BENZ GL-Klasse (X164) (06-12)

	GL 320 CDI 4-matic		03.06	06.12	03.0655-0007.2	370007			Wegsensor	ATE
	GL 350 BT 4-matic		05.09	06.12						
	GL 350 CDI 4-matic		05.09	06.12						
	GL 420 CDI 4-matic		03.06	06.12						
	GL 450 4-matic		03.06	06.12						
	GL 450 CDI 4-matic		05.09	06.12						
	GL 500 4-matic		03.06	06.12						
	GL 350 BT 4-matic		05.09	06.12	03.4156-0014.3	010930			Thz 26,99 - Behälter	ATE
	GL 320 CDI 4-matic		03.06	06.12	11.8171-0096.1	250155			Führungsbolzen	ATE
	GL 350 BT 4-matic		05.09	06.12	11.8116-0133.1	390511	2		Haltefeder	ATE
	GL 350 CDI 4-matic		05.09	06.12	11.0101-7003.2	260124			Hülzensatz	ATE
	GL 420 CDI 4-matic		03.06	06.12	11.8171-0096.1	250155			Führungsbolzen	ATE
	GL 450 4-matic		03.06	06.12	11.8116-0133.1	390511	2		Haltefeder	ATE
	GL 450 CDI 4-matic		05.09	06.12	11.0101-7003.2	260124			Hülzensatz	ATE
	GL 500 4-matic		03.06	06.12						
	GL 320 CDI 4-matic		03.06	06.12	24.5123-0545.3	331240	2		L=545	
	GL 350 BT 4-matic		05.09	06.12						
	GL 350 CDI 4-matic		05.09	06.12						
	GL 420 CDI 4-matic		03.06	06.12						
	GL 450 4-matic		03.06	06.12						
	GL 450 CDI 4-matic		05.09	06.12						
	GL 500 4-matic		03.06	06.12						
	GL 320 CDI 4-matic		03.06	06.12	24.3421-9965.5	240645			D=42, - Halter	ATE
	GL 350 BT 4-matic		05.09	06.12	24.3421-9966.5	240646			D=42, - Halter	ATE
	GL 350 CDI 4-matic		05.09	06.12	11.8116-0323.1	390459	2		Haltefeder	ATE
	GL 420 CDI 4-matic		03.06	06.12	11.8171-0008.1	990049			Führungsbolzen	ATE
	GL 450 4-matic		03.06	06.12	11.0101-5407.2	260011			Hülzensatz	ATE
	GL 450 CDI 4-matic		05.09	06.12						
	GL 500 4-matic		03.06	06.12						

								
MERCEDES BENZ GL-Klasse (X164) (06-12)								
	GL 320 CDI 4-matic		03.06	06.12	24.5123-0610.3	331241	2	L=610
	GL 350 BT 4-matic		05.09	06.12				
	GL 350 CDI 4-matic		05.09	06.12				
	GL 420 CDI 4-matic		03.06	06.12				
	GL 450 4-matic		03.06	06.12				
	GL 450 CDI 4-matic		05.09	06.12				
	GL 500 4-matic		03.06	06.12				
MERCEDES BENZ GL-Klasse / GLS-Klasse (X166) (12-)								
	GL 350 BT 4-matic	190	07.12		24.5140-0256.3	331445	2	L=660
	GL 400 4-matic	245	08.13					
	GL 500 4-matic	320	07.12					
	GL 63 AMG		07.12					
	GLS 350 d 4-matic	190	11.15					
	GLS 400 4-matic	245	11.15					
	GLS 500 4-matic	335	11.15					
	GLS 63 AMG 4-matic	430	11.15					
MERCEDES BENZ GLE-Klasse (C292) Coupe (15-)								
	GLE 350 d 4-matic	190	03.15		24.5140-0256.3	331445	2	L=660
	GLE 400 4-matic	245	03.15					
	GLE 450 AMG 4-matic	270	03.15					
	GLE 500 4-matic	335	10.15					
	GLE 63 AMG 4-matic	410	03.15					
	GLE 63 AMG S 4-matic	430	03.15					
MERCEDES BENZ GLK-Klasse (X204) (08-15)								
	GLK 200	135	08.13		03.7745-6302.4	300261	- Start/Stop-Anlage ¹⁾	8" ATE
	GLK 200 CDI	105	07.10		03.7745-8902.4	300297	+ Start/Stop-Anlage ²⁾	8" ATE
	GLK 220 BT 4-matic		03.12					
	GLK 220 CDI		04.09					
	GLK 220 CDI 4-matic		04.09					
	GLK 250	155	08.13					
	GLK 250 4-matic	155	08.13					
	GLK 250 BT 4-matic		03.12					
	GLK 250 CDI 4-matic	150	09.08					
	GLK 280 4-matic	170	09.08					
	GLK 300 4-matic	170	04.09					
	GLK 300 4-matic	185	09.09					
	GLK 320 CDI 4-matic	165	09.08					
	GLK 350	200	09.08					
	GLK 350 4-matic	200	09.08					
	GLK 350 4-matic	225	09.08					
	GLK 350 CDI 4-matic	165	04.09					
	GLK 350 CDI 4-matic	170	02.10					
	GLK 350 CDI 4-matic	195	07.12					
	GLK 200	135	08.13		03.2025-2301.3	010895		Thz 25,40/22,20 ATE
	GLK 200 CDI	105	07.10					
	GLK 220 BT 4-matic		03.12					
	GLK 220 CDI		04.09					
	GLK 220 CDI 4-matic		04.09					
	GLK 250	155	08.13					
	GLK 250 4-matic	155	08.13					
	GLK 250 BT 4-matic		03.12					
	GLK 250 CDI 4-matic	150	09.08					
	GLK 280 4-matic	170	09.08					
	GLK 300 4-matic	170	04.09					
	GLK 300 4-matic	185	09.09					
	GLK 320 CDI 4-matic	165	09.08					
	GLK 350	200	09.08					
	GLK 350 4-matic	200	09.08					
	GLK 350 4-matic	225	09.08					
	GLK 350 CDI 4-matic	165	04.09					
	GLK 350 CDI 4-matic	170	02.10					
	GLK 350 CDI 4-matic	195	07.12					
	GLK 200	135	08.13		24.5172-0305.3	331312	2	L=305
	GLK 200 CDI	105	07.10					
	GLK 220 BT 4-matic		03.12					
	GLK 220 CDI		04.09					
	GLK 220 CDI 4-matic		04.09					
	GLK 250	155	08.13					
	GLK 250 4-matic	155	08.13					
	GLK 250 BT 4-matic		03.12					
	GLK 250 CDI 4-matic	150	09.08					
	GLK 280 4-matic	170	09.08					
	GLK 300 4-matic	170	04.09					
	GLK 300 4-matic	185	09.09					
	GLK 320 CDI 4-matic	165	09.08					
	GLK 350	200	09.08					
	GLK 350 4-matic	200	09.08					
	GLK 350 4-matic	225	09.08					
	GLK 350 CDI 4-matic	165	04.09					
	GLK 350 CDI 4-matic	170	02.10					
	GLK 350 CDI 4-matic	195	07.12					

¹⁾ - idling stop system / - dispositivo start/stop / - unité marche/arrêt / - unidad arranque/paro
²⁾ + idling stop system / + dispositivo start/stop / + unité marche/arrêt / + unidad arranque/paro





MERCEDES BENZ GLK-Klasse (X204) (08-15)

	GLK 200 CDI	◀105		07.10		24.3727-0480.2	580480	1	⬆	L=2057 L=1140 L=744
	GLK 220 BT 4-matic	◀		03.12		24.3727-0481.2	580481	1	◻	
	GLK 220 CDI	◀		04.09		24.3727-0482.2	580482	2	⬇	
	GLK 220 CDI 4-matic	◀		04.09						
	GLK 250 4-matic	◀155		08.13						
	GLK 250 BT 4-matic	◀		03.12						
	GLK 250 CDI 4-matic	◀150		09.08						
	GLK 280 4-matic	◀170		09.08						
	GLK 300 4-matic	◀170		04.09						
	GLK 300 4-matic	◀185		09.09						
	GLK 320 CDI 4-matic	◀165		09.08						
	GLK 350 4-matic	◀200		09.08						
	GLK 350 4-matic	◀225		09.08						
	GLK 350 CDI 4-matic	◀165		04.09						
	GLK 350 CDI 4-matic	◀170		02.10						
	GLK 350 CDI 4-matic	◀195		07.12						
	GLK 200	◀135		08.13		24.3727-0480.2	580480	1	⬆	
GLK 250	◀155		08.13		24.3727-0481.2	580481	1	◻		
GLK 350	◀200		09.08		24.3727-0482.2	580482	2	⬇		

















MERCEDES BENZ M-Klasse (W163) (98-05)

	ML 270 CDI			09.99	06.05	03.0655-0007.2	370007			Wegsensor	ATE							
	ML 320			03.98	08.02 + ESP													
	ML 430			09.98	06.05													
	ML 55 AMG			09.99	06.05													
	ML 350			09.02	06.05	03.0655-0007.2	370007			Wegsensor	ATE							
	ML 400 CDI			07.01	06.05													
	ML 500			07.01	06.05													
	ML 230			03.98	06.05							03.2125-7310.3	010743			THz 25,40	ATE	
ML 270 CDI			09.99	06.05														
ML 320			03.98	08.02														
ML 350			09.02	06.05														
ML 400 CDI			07.01	06.05														
ML 430			09.98	06.05														
ML 500			07.01	06.05														
ML 55 AMG			09.99	06.05														
	ML 230			03.98	08.00	83.6211-0532.3	330552			L=525								
	ML 270 CDI			09.99	08.00													
	ML 320			03.98	08.00													
	ML 430			09.98	08.00													
	ML 55 AMG			09.99	08.00													
	ML 230			09.00	06.05	83.6211-0536.3	330628			L=525								
	ML 270 CDI			09.00	06.05													
	ML 320			09.00	08.02													
	ML 350			09.02	06.05													
	ML 400 CDI			07.01	06.05													
	ML 430			09.00	06.05													
	ML 500			07.01	06.05													
	ML 55 AMG			09.00	06.05													
		ML 230			03.98							06.05	83.6105-0300.3	330537			L=300	
		ML 270 CDI			09.99							06.05						
ML 320				03.98	08.02													
ML 350				09.02	06.05													
ML 400 CDI				07.01	06.05													
ML 430				09.98	06.05													
ML 500				07.01	06.05													
ML 55 AMG				09.99	06.05													
		ML 230	▶		03.98	06.05	24.3727-0432.2	580432			L=2025							
		ML 270 CDI	▶		09.99	06.05												
	ML 320	▶		03.98	08.02													
	ML 350	▶		09.02	06.05													
	ML 400 CDI	▶		07.01	06.05													
	ML 430	▶		09.98	06.05													
	ML 500	▶		07.01	06.05													
	ML 55 AMG	▶		09.99	06.05													
		ML 230	▶		03.98	06.05							24.3727-0432.2	580432			L=2025	
		ML 270 CDI	▶		09.99	06.05												
ML 320		▶		03.98	08.02													
ML 350		▶		09.02	06.05													
ML 400 CDI		▶		07.01	06.05													
ML 430		▶		09.98	06.05													
ML 500		▶		07.01	06.05													
ML 55 AMG		▶		09.99	06.05													
		ML 230			03.98	06.05	24.2419-0915.3	030045			Gz 19,05							
	ML 230			03.98	06.05	03.2523-1310.3	040022			Nz 23,81								

















MERCEDES BENZ M-Klasse (W164) (05-11)

	ML 280 CDI			07.05	05.11	03.0655-0007.2	370007			Wegsensor	ATE
	ML 300			05.09	05.11						
	ML 300 CDI 4-matic			07.09	05.11						
	ML 320 CDI			07.05	05.11						
	ML 350			07.05	05.11						

1) + cast iron / + ghisa / + fonte grise / + fundición de gris
2) + aluminium / + alluminio / + aluminium / + aluminio

								
MERCEDES BENZ M-Klasse (W164) (05-11)								
	ML 350 BT 4-matic ML 350 CDI 4-matic ML 420 CDI 4-matic ML 450 CDI 4-matic ML 500 ML 63 AMG			05.09 05.11 07.09 05.11 04.06 05.11 09.09 05.11 07.05 05.11 09.05 05.11		03.0655-0007.2 370007		Wegsensor ATE
	ML 350 CDI 4-matic ML 450 Hybrid 4-matic	A 168878 A 209847		08.09 05.11		03.0655-0007.2 370007		Wegsensor ATE
	ML 300 ML 300 CDI 4-matic ML 350 BT 4-matic ML 350 CDI 4-matic ML 450 CDI 4-matic ML 450 Hybrid 4-matic	A 209848		05.09 05.11 07.09 05.11 05.09 05.11 05.09 05.11 09.09 05.11 08.09 05.11		03.4156-0014.3 010930		THz 26,99 - Behälter ATE
	ML 280 CDI ML 300 ML 300 CDI 4-matic ML 320 CDI ML 350 ML 350 BT 4-matic ML 350 CDI 4-matic ML 420 CDI 4-matic ML 450 CDI 4-matic ML 450 Hybrid 4-matic ML 500 ML 63 AMG			07.05 05.11 05.09 05.11 07.09 05.11 07.05 05.11 07.05 05.11 05.09 05.11 07.09 05.11 04.06 05.11 09.09 05.11 08.09 05.11 07.05 05.11		11.8171-0096.1 250155 11.8116-0133.1 390511 11.0101-7003.2 260124	2	Führungsbolzen ATE Haltefeder ATE Hülzensatz ATE
	ML 280 CDI ML 300 ML 300 CDI 4-matic ML 320 CDI ML 350 ML 350 BT 4-matic ML 350 CDI 4-matic ML 420 CDI 4-matic ML 450 CDI 4-matic ML 450 Hybrid 4-matic ML 500 ML 63 AMG			07.05 05.11 05.09 05.11 07.09 05.11 07.05 05.11 07.05 05.11 05.09 05.11 07.09 05.11 04.06 05.11 09.09 05.11 08.09 05.11 07.05 05.11 09.05 05.11		11.8171-0067.1 250153 11.0101-5706.2 260097 11.8116-0353.2 390585	2	Führungsbolzen ATE Hülzensatz ATE Haltefeder ATE
	ML 280 CDI ML 300 ML 300 CDI 4-matic ML 320 CDI ML 350 ML 350 BT 4-matic ML 350 CDI 4-matic ML 420 CDI 4-matic ML 450 CDI 4-matic ML 450 Hybrid 4-matic ML 500 ML 63 AMG			07.05 05.11 05.09 05.11 07.09 05.11 07.05 05.11 07.05 05.11 05.09 05.11 07.09 05.11 04.06 05.11 09.09 05.11 08.09 05.11 07.05 05.11 09.05 05.11		24.5123-0545.3 331240	2	L=545
	ML 280 CDI ML 300 ML 300 CDI 4-matic ML 320 CDI ML 350 ML 350 BT 4-matic ML 350 CDI 4-matic ML 450 Hybrid 4-matic ML 500			07.05 05.11 05.09 05.11 07.09 05.11 07.05 05.11 07.05 05.11 05.09 05.11 07.09 05.11 08.09 05.11 07.05 05.11		24.3421-9965.5 240645 24.3421-9966.5 240646 11.8116-0323.1 390459 11.8171-0008.1 990049 11.0101-5407.2 260011	2	+ 18" Rad ¹⁾ + 18" Rad ¹⁾ D=42, - Halter ATE D=42, - Halter ATE Haltefeder ATE Führungsbolzen ATE Hülzensatz ATE
	ML 420 CDI 4-matic ML 450 CDI 4-matic			04.06 05.11 09.09 05.11		24.3421-9965.5 240645 24.3421-9966.5 240646 11.8116-0323.1 390459 11.8171-0008.1 990049 11.0101-5407.2 260011	2	D=42, - Halter ATE D=42, - Halter ATE Haltefeder ATE Führungsbolzen ATE Hülzensatz ATE
	ML 280 CDI ML 300 ML 300 CDI 4-matic ML 320 CDI ML 350 ML 350 BT 4-matic ML 350 CDI 4-matic ML 420 CDI 4-matic ML 450 CDI 4-matic ML 450 Hybrid 4-matic ML 500 ML 63 AMG			07.05 05.11 05.09 05.11 07.09 05.11 07.05 05.11 07.05 05.11 05.09 05.11 07.09 05.11 04.06 05.11 09.09 05.11 08.09 05.11 07.05 05.11 09.05 05.11		24.5123-0610.3 331241	2	L=610
MERCEDES BENZ M-Klasse/GLE-Klasse (W166) (11-)								
	GLE 250 d 150 GLE 250 d 4-matic 150 GLE 320 4-matic 200 GLE 350 d 4-matic 190 GLE 400 4-matic 245 GLE 450 AMG 4-matic 270 GLE 500 4-matic 320 GLE 500 e 4-matic 245 GLE 500 e Hybrid 325 GLE AMG 63 4-matic 430 GLE AMG 63 S 4-matic 150 ML 250 CDI BT 4-matic 185 ML 300 4-matic 185 ML 350 BE 4-matic 225 ML 350 BT 4-matic 190 ML 350 CDI 4-matic 170 ML 400 4-matic 245			04.15 04.15 10.15 04.15 04.15 10.15 04.15 04.15 04.15 04.15 04.15 06.11 04.14 06.11 06.11 06.11 08.13		24.5140-0256.3 331445	2	L=660













¹⁾ + 18" wheel / + ruota 18" / + roue 18" / + rueda 18"

									
MERCEDES BENZ M-Klasse/GLE-Klasse (W166) (11-)									
	ML 400 Hybrid 4-matic ML 500 BE 4-matic ML 63 AMG 4-matic	300	02.12 02.12 04.12		24.5140-0256.3	331445	2	L=660	
MERCEDES BENZ R-Klasse (W251,V251) (06-12)									
	R 280 R 280 CDI R 280 CDI 4-matic R 300 R 300 CDI R 300 CDI 4-matic R 320 CDI 4-matic R 350 R 350 4-matic R 350 BT 4-matic R 350 CDI 4-matic R 500 4-matic R 63 AMG		01.07 05.06 11.05 01.07 07.09 07.09 11.05 11.05 01.06 05.09 05.09 11.05 11.05	10.12 10.12 10.12 10.12 10.12 10.12 10.12 10.12 10.12 10.12 10.12 10.12 10.12	03.0655-0007.2	370007		Wegsensor ATE	
	R 280 CDI R 350 4-matic R 350 BT 4-matic		05.06 01.06 05.09	10.12 10.12 10.12	03.4156-0014.3	010930		Thz 26,99 - Behälter ATE	
	R 280 R 280 4-matic R 280 CDI R 280 CDI 4-matic R 300 R 300 CDI R 300 CDI 4-matic R 320 CDI 4-matic R 350 R 350 4-matic R 350 BT 4-matic R 350 CDI 4-matic R 500 4-matic R 63 AMG		01.07 05.07 05.06 11.05 07.09 07.09 07.09 11.05 11.05 01.06 05.09 05.09 11.05 11.05	10.12 10.12 10.12 10.12 10.12 10.12 10.12 10.12 10.12 10.12 10.12 10.12 10.12 10.12	11.8171-0096.1 11.0101-7003.2	250155 260124		Führungsbolzen Hülsensatz ATE ATE	
	R 280 R 280 CDI 4-matic R 300 R 300 CDI R 300 CDI 4-matic R 320 CDI 4-matic R 350 R 350 4-matic R 350 BT 4-matic R 350 CDI 4-matic R 500 4-matic R 280 4-matic R 280 CDI R 350 4-matic		01.07 11.05 07.09 07.09 07.09 11.05 11.05 05.09 05.09 11.05 05.07 05.06 01.06	10.12 10.12 10.12 10.12 10.12 10.12 10.12 10.12 10.12 10.12 10.12 10.12 10.12 10.12	24.3421-9965.5 24.3421-9966.5 11.8116-0323.1 11.8171-0008.1 11.0101-5407.2 24.3421-9965.5 24.3421-9966.5 11.8116-0323.1 11.8171-0008.1 11.0101-5407.2	240645 240646 390459 990049 260011 240645 240646 390459 990049 260011	2 2	<input type="checkbox"/> + 18" Rad 1) <input type="checkbox"/> + 18" Rad 1) <input type="checkbox"/> + 3. Sitzreihe 2) <input type="checkbox"/> + 3. Sitzreihe 2)	D=42, - Halter D=42, - Halter Haltefeder Führungsbolzen Hülsensatz ATE ATE ATE ATE ATE ATE ATE ATE
MERCEDES BENZ S-Klasse (W140) (93-98)									
	S 280 / 300 SE 2.8 S 300 TD S 320 S 350 TD	A 358833 A 358833 A 358833 A 358833		10.98 10.98 10.98 06.96	03.7858-0102.4	300262	+ Linkslenker 3)	9/8" Tandem ATE	
	S 280 / 300 SE 2.8 S 320 S 350 TD		A212244 A212244 A212244	07.93 07.93 07.93	03.2025-0211.3	010034		Thz 25,40/19,05 ATE	
	S 280 / 300 SE 2.8 S 300 TD S 320 S 350 TD	A212245		10.98 10.98 10.98 06.96	24.2025-1702.3	010515		Thz 25,40/19,05 TRW	
	S 420 S 420 C S 500 S 500 C S 600 S 600 C		A358832 A358832 A358832 A358832 A358832 A358832	07.93 04.94 07.93 07.93 07.93 07.93	03.2026-0462.3	010728		Thz 26,99/25,40 ATE	
	S 420 S 500 S 500 C S 600 S 600 C	A358833 A358833 A358833 A358833 A358833		10.98 10.98 05.96 10.98 05.96	03.2026-0712.3	010730		Thz 26,99/25,40 ATE	
	S 420 S 500 S 500 C S 600 S 600 C		A212244 A212244 A212244 A212244	07.93 07.93 07.93 07.93	03.2026-0512.3	010038		Thz 26,99/25,40 ATE	
	S 420 S 420 C S 500 S 500 C S 600	A212245 A212245 A212245 A212245 A212245	A358832 A358832 A358832 A358832 A358832	04.94 05.96	03.2026-0562.3	010729		Thz 26,99/25,40 ATE	

1) + 18" wheel / + ruota 18" / + roue 18" / + rueda 18"

2) + 3rd seat row / + 3a fila di sedili / + 3ème rangée de sièges / + 3a fila de asientos

3) + left hand drive / + guida a sinistra / + conduite à gauche / + volante a la izquierda

MERCEDES BENZ S-Klasse (W140) (93-98)												
	S 600 C	A212245	A358832				03.2026-0562.3	010729		ThZ 26,99/25,40	ATE	
	S 280 / 300 SE 2.8 S 320 S 350 TD S 420 S 420 C S 500 S 500 C S 600 S 600 C		A290166 A290166 A290166 A290166 A290166 A290166 A290166 A290166	07.93 07.93 07.93 07.93 04.94 07.93 07.93 07.93 07.93	10.98 10.98 10.98 10.98 08.95 08.95 08.95 08.95		24.5113-0540.3	331301	2		L=540	
	S 280 / 300 SE 2.8 S 300 TD S 320 S 350 TD S 420 S 420 C S 500 S 500 C S 600 S 600 C	A290167 A290167 A290167 A290167 A290167 A290167		04.96 10.98 10.98 06.96 10.98 09.95 05.96 10.98 09.95 10.98 09.95 05.96	10.98 10.98 10.98 06.96 10.98 05.96 10.98 05.96 10.98 05.96		24.5113-0483.3	331397	2		L=483	
	S 280 / 300 SE 2.8 S 300 TD S 320 S 350 TD			07.93 04.96 07.93 07.93	10.98 10.98 10.98 06.96		13.2401-8013.2 13.2401-8014.2 24.9240-8013.5 24.9240-8014.5 13.0441-4020.2	210051 210052 230019 230020 250084	<input type="checkbox"/> <input type="checkbox"/> <input type="checkbox"/> <input type="checkbox"/>		D=40 D=40 D=40 D=40 Dichtungssatz	ATE ATE ATE ATE ATE
	S 420 S 420 C S 500 S 500 C S 600 S 600 C			07.93 04.94 07.93 07.93 07.93 07.93	10.98 05.96 10.98 05.96 10.98 05.96		13.2461-8001.2 24.9246-8001.5 24.9246-8002.5 13.0441-4601.2	210226 230021 230022 250099	<input type="checkbox"/> <input type="checkbox"/> <input type="checkbox"/> <input type="checkbox"/>		D=46 D=46 D=46 Dichtungssatz	ATE ATE ATE ATE
	S 280 / 300 SE 2.8 S 300 TD S 320 S 350 TD S 420 S 420 C S 500 S 500 C S 600 S 600 C			07.93 04.96 07.93 07.93 07.93 04.94 07.93 07.93 07.93 07.93	10.98 10.98 10.98 06.96 10.98 05.96 10.98 05.96 10.98 05.96		83.7704-0281.3	330804	2		L=280	
	S 280 / 300 SE 2.8 S 300 TD S 320 S 350 TD S 420 S 420 C S 500 S 500 C S 600 S 600 C			07.93 04.96 07.93 07.93 07.93 04.94 07.93 07.93 07.93 07.93	10.98 10.98 10.98 + Radstand 3040mm ¹⁾ 06.96 10.98 + Radstand 3040mm ¹⁾ 05.96 10.98 + Radstand 3040mm ¹⁾ 05.96 10.98 + Radstand 3040mm ¹⁾ 05.96		24.3727-0462.2 24.3727-0456.2 24.3727-0455.2	580462 580456 580455	1 <input type="checkbox"/> <input type="checkbox"/> <input type="checkbox"/>		L=2622 L=1134 L=1109	
	S 320 S 420 S 500 S 600			07.93 07.93 07.93 07.93	10.98 + Radstand 3140mm ²⁾ 10.98 + Radstand 3140mm ²⁾ 10.98 + Radstand 3140mm ²⁾ 10.98 + Radstand 3140mm ²⁾		24.3727-0456.2 24.3727-0455.2	580456 580455	<input type="checkbox"/> <input type="checkbox"/>		L=1134 L=1109	
	S 280 / 300 SE 2.8 S 300 TD S 320 S 350 TD S 420 S 420 C S 500 S 500 C S 600 S 600 C			07.93 04.96 07.93 07.93 07.93 04.94 07.93 07.93 07.93 07.93	10.98 10.98 10.98 + Radstand 3040mm ¹⁾ 06.96 10.98 + Radstand 3040mm ¹⁾ 05.96 10.98 + Radstand 3040mm ¹⁾ 05.96 10.98 + Radstand 3040mm ¹⁾ 05.96		24.3727-0456.2 24.3727-0455.2	580456 580455	<input type="checkbox"/> <input type="checkbox"/>		L=1134 L=1109	
	S 320 S 420 S 500 S 600			07.93 07.93 07.93 07.93	10.98 + Radstand 3140mm ²⁾ 10.98 + Radstand 3140mm ²⁾ 10.98 + Radstand 3140mm ²⁾ 10.98 + Radstand 3140mm ²⁾		24.3727-0456.2 24.3727-0455.2	580456 580455	<input type="checkbox"/> <input type="checkbox"/>		L=1134 L=1109	
	S 280 / 300 SE 2.8 S 320			07.93 07.93	10.98 10.98		24.2419-0915.3 24.2419-1703.3	030045 030097	<input type="checkbox"/> <input type="checkbox"/>	+ GG ³⁾ + ALU ⁴⁾	Gz 19,05 Gz 19,05	
	S 280 / 300 SE 2.8 S 320			07.93 07.93	10.98 10.98		03.2523-1310.3	040022			Nz 23,81	

MERCEDES BENZ S-Klasse (W220) (98-06)













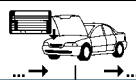

	S 280 S 320 S 320 CDI S 320 CDI S 350 S 350 4-matic S 370	145 150		11.98 11.98 08.99 09.02 09.02 06.03 08.04	03.06 03.06 03.06 03.06 03.06 03.06 03.06		24.4025-1701.3	010719			ThZ 25,40
--	---	------------	--	---	---	--	----------------	--------	--	--	-----------

¹⁾ + wheel base 3040 mm / + passo 3040 mm / + empattement 3040 mm / + distancia entre ejes 3040 mm

²⁾ + wheel base 3140 mm / + passo 3140 mm / + empattement 3140 mm / + distancia entre ejes 3140 mm

³⁾ + cast iron / + ghisa / + fonte grise / + fundición de gris

⁴⁾ + aluminium / + alluminio / + aluminium / + aluminio

								
MERCEDES BENZ S-Klasse (W220) (98-06)								
	S 400 CDI S 430 S 430 4-matic S 500 S 500 4-matic S 55 AMG S 55 Kompressor AMG S 600 S 63 AMG S 65 AMG			08.00 11.98 09.02 11.98 09.02 04.99 06.02 08.99 09.01 03.04	03.06 03.06 03.06 03.06 03.06 03.06 03.06 03.06 03.06 03.06	24.4025-1701.3 010719		Thz 25,40
	S 350 4-matic S 430 4-matic S 500 4-matic			06.03 09.02 09.02	03.06 03.06 03.06	11.9601-9770.2 11.9601-9769.2 11.0441-6007.2 11.0101-5704.2 11.8171-0008.1 11.8116-0253.1 220878 220877 250146 260095 990049 390512	2	D=60, - Halter D=60, - Halter Dichtungssatz Hülsensatz Führungsbolzen Haltefeder ATE ATE ATE ATE ATE ATE
	S 280 S 320 S 320 CDI S 320 CDI S 350 S 370 S 400 CDI S 430 S 430 4-matic S 500 S 500 4-matic S 55 AMG S 55 Kompressor AMG S 600 S 63 AMG S 65 AMG	145 150		11.98 11.98 08.99 09.02 09.02 08.04 08.00 11.98 09.02 11.98 09.02 04.99 06.02 08.99 09.01 03.04	03.06 03.06 03.06 03.06 03.06 03.06 03.06 03.06 03.06 03.06 03.06 03.06 03.06 03.06 03.06 03.06	24.5123-0380.3 331256	2	L=380
	S 280 S 320 S 320 CDI S 320 CDI S 370 S 350 S 350 4-matic S 400 CDI S 430 S 430 4-matic S 500 S 500 4-matic S 55 AMG S 55 Kompressor AMG S 600 S 63 AMG S 65 AMG	145 150		11.98 11.98 08.99 09.02 08.04 09.02 06.03 08.00 11.98 09.02 11.98 09.02	03.06 03.06 03.06 03.06 03.06 03.06 03.06 03.06 03.06 03.06 03.06 03.06 03.06 03.06 03.06	13.9426-7001.2 13.9426-7002.2 11.0101-4202.2 210255 210256 260094 24.3426-9979.5 24.3426-9980.5 11.8171-0072.1 11.0441-4203.2 11.0101-4202.2 11.8116-0323.1 240579 240580 250154 250013 260094 390459	2	D=42 D=42 Hülsensatz D=42, - Halter D=42, - Halter Führungsbolzen Dichtungssatz Hülsensatz Haltefeder ATE ATE ATE ATE
	S 280 S 320 S 430 S 500 S 280 S 320 S 320 CDI S 400 CDI S 430 S 500 S 55 AMG S 55 Kompressor AMG S 600 S 280 S 320 S 320 CDI S 320 CDI S 350 S 370 S 400 CDI S 430 S 430 4-matic S 500		A043586 A043586 A043586 A043586 A043587 A043587 145 A043587 A043587 A043587 A297723 A297723 04.99 06.02 08.99 A297724 A297724 145 150 A297724 A297724 A297724	11.98 11.98 11.98 11.98 08.99 08.00 08.99 08.00 04.99 06.02 08.99 09.02 09.02 09.02 09.02 09.02	03.06 03.06 03.06 03.06 03.06 03.06 03.06 03.06 03.06 03.06 03.06 03.06 03.06 03.06 03.06 03.06 03.06 03.06 03.06 03.06	24.5123-0281.3 330877 24.5123-0240.3 330759 24.5238-0255.3 330674	2	L=280 L=240 L=255

1) - armoured vehicles / - veicoli blindati / - véhicule blindé / - vehículo blindado
2) + armoured vehicles / + veicoli blindati / + véhicule blindé / + vehículo blindado

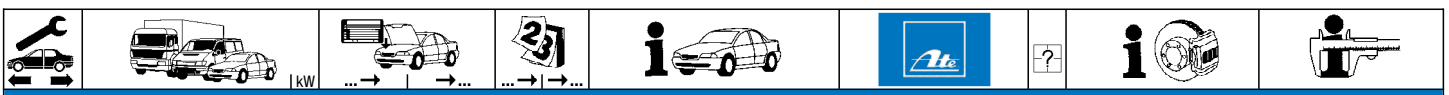

MERCEDES BENZ S-Klasse (W220) (98-06)

	S 500 4-matic S 55 AMG	A297724	09.02 03.06	03.06 03.06	24.5238-0255.3	330674	2		L=255
	S 63 AMG S 65 AMG		09.01 03.04	03.06 03.06	24.5172-0305.3	331312	2		L=305
	S 280 S 320 S 320 CDI S 320 CDI S 350 4-matic S 370 S 400 CDI S 430 S 430 4-matic S 500 S 500 4-matic S 55 AMG	◀145 ◀150	11.98 11.98 08.99 09.02 06.03 08.04 08.00 11.98 09.02 11.98 09.02 04.99	03.06 03.06 03.06 03.06 03.06 03.06 03.06 03.06 03.06 03.06 03.06 03.06	+ Radstand 2965mm 1) + Radstand 2965mm 1) + Radstand 2965mm 1) + Radstand 2965mm 1) + Radstand 2965mm 1) + Radstand 2965mm 1) + Radstand 2965mm 1) + Radstand 2965mm 1) + Radstand 2965mm 1) + Radstand 2965mm 1) + Radstand 2965mm 1) + Radstand 2965mm 1)	24.3727-0458.2 24.3727-0457.2	580458 580457	<input type="checkbox"/> <input checked="" type="checkbox"/>	L=990 L=980
	S 320 CDI L S 320 L S 350 L S 350 L 4-matic S 400 CDI L S 430 L S 430 L 4-matic S 500 L S 500 L 4-matic S 55 AMG L S 600	◀	08.00 11.98 09.02 06.03 08.00 11.98 09.02 11.98 09.02 04.99 08.99	03.06 03.06 03.06 03.06 03.06 03.06 03.06 03.06 03.06 03.06 03.06	+ Radstand 3085mm 2) + Radstand 3085mm 2) + Radstand 3085mm 2) + Radstand 3085mm 2) + Radstand 3085mm 2) + Radstand 3085mm 2) + Radstand 3085mm 2) + Radstand 3085mm 2) + Radstand 3085mm 2) + Radstand 3085mm 2) + Radstand 3085mm 2)	24.3727-0466.2 24.3727-0458.2 24.3727-0457.2	580466 580458 580457	1 <input checked="" type="checkbox"/> <input type="checkbox"/> <input type="checkbox"/>	L=2937 L=990 L=980
	S 55 L Kompressor AMG	◀	06.02	03.06	+ Radstand 3085mm 2)	24.3727-0466.2	580466	1 <input checked="" type="checkbox"/>	L=2937
	S 63 AMG S 65 AMG	◀	09.01 03.04	03.06 03.06		24.3727-0466.2	580466	1 <input checked="" type="checkbox"/>	L=2937
	S 280 S 320 S 320 CDI S 350 4-matic S 370 S 400 CDI S 430 S 430 4-matic S 500 S 500 4-matic S 55 AMG	▶145	11.98 11.98 08.99 06.03 08.04 08.00 11.98 09.02 11.98 09.02 04.99	03.06 03.06 03.06 03.06 03.06 03.06 03.06 03.06 03.06 03.06 03.06	+ Radstand 2965mm 1) + Radstand 2965mm 1) + Radstand 2965mm 1) + Radstand 2965mm 1) + Radstand 2965mm 1) + Radstand 2965mm 1) + Radstand 2965mm 1) + Radstand 2965mm 1) + Radstand 2965mm 1) + Radstand 2965mm 1) + Radstand 2965mm 1)	24.3727-0458.2 24.3727-0457.2	580458 580457	<input type="checkbox"/> <input type="checkbox"/>	L=990 L=980
	S 320 CDI L S 320 L S 350 L S 350 L 4-matic S 400 CDI L S 430 L S 430 L 4-matic S 500 L S 500 L 4-matic S 55 AMG L S 600	▶	08.00 11.98 09.02 06.03 08.00 11.98 09.02 11.98 09.02 04.99 08.99	03.06 03.06 03.06 03.06 03.06 03.06 03.06 03.06 03.06 03.06 03.06	+ Radstand 3085mm 2) + Radstand 3085mm 2) + Radstand 3085mm 2) + Radstand 3085mm 2) + Radstand 3085mm 2) + Radstand 3085mm 2) + Radstand 3085mm 2) + Radstand 3085mm 2) + Radstand 3085mm 2) + Radstand 3085mm 2) + Radstand 3085mm 2)	24.3727-0458.2 24.3727-0457.2	580458 580457	<input type="checkbox"/> <input checked="" type="checkbox"/>	L=990 L=980

MERCEDES BENZ S-Klasse (W221) (06-13)

	S 250 CDI S 280 / S 300 S 320 CDI S 320 CDI / S 350 CDI S 320 CDI 4-matic S 320 CDI 4-matic S 350 S 350 4-matic S 350 BlueTec S 350 BlueTec 4-matic S 350 CGI S 350 CGI 4-matic S 420 CDI / S 450 CDI S 450 S 450 4-matic S 500 S 500 4-matic S 500 CGI S 500 CGI 4-matic S 63 AMG	150 170 A 265575 155 A 265575 173 A 265575 155 A 265575 173 A 265575 200 A 265575 200 A 265575 190 190 225 225 235 A 265575 250 A 265575 250 A 265575 285 A 265575 285 A 265575 320 320 A 265575	01.11 05.13 05.13 05.13 05.13 05.13 05.13 05.13 04.11 04.11 04.11 04.11 05.13 05.13 05.13 05.13 05.13 05.13 04.11 03.11 05.13	05.13 05.13	03.0655-0007.2	370007		+ Distronic Plus	Wegsensor	ATE
	S 400 Hybrid	205	06.09	05.13	03.0655-0007.2	370007			Wegsensor	ATE
	S 280 / S 300 S 320 CDI S 320 CDI / S 350 CDI S 320 CDI 4-matic S 320 CDI 4-matic S 350 S 350 4-matic S 420 CDI / S 450 CDI S 450 S 450 4-matic S 500	170 155 173 155 173 200 200 235 250 250 285	A 265574 A 265574 A 265574 A 265574 A 265574 A 265574 A 265574 A 265574 A 265574 A 265574 A 265574	04.06 12.05 12.05 12.05 05.06 12.05 02.07 04.06 04.06 04.06 12.05	03.7858-1932.4 03.0655-0007.2	300263 370007			9/8" Tandem Wegsensor	ATE ATE

1) + wheel base 2965 mm / + passo 2965 mm / + empattement 2965 mm / + distancia entre ejes 2965 mm

2) + wheel base 3085 mm / + passo 3085 mm / + empattement 3085 mm / + distancia entre ejes 3085 mm



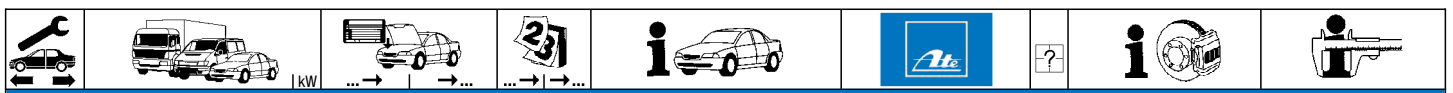

MERCEDES BENZ S-Klasse (W221) (06-13)

	S 500 4-matic	285	A 265574	04.06			03.7858-1932.4	300263		9/8" Tandem	ATE	
	S 63 AMG		A 265574	01.07			03.0655-0007.2	370007		Wegsensor	ATE	
	S 600	380		12.05	05.13	- Start/Stop-Anlage ¹⁾	03.0655-0007.2	370007		Wegsensor	ATE	
	S 63 AMG			01.07	05.13							
	S 65 AMG			04.06	05.13							
	S 600	380	A 060620	12.05		- Start/Stop-Anlage ¹⁾	03.0655-0007.2	370007		Wegsensor	ATE	
	S 65 AMG		A 060620	04.06								
	S 600	380	A 060621		05.13	- Start/Stop-Anlage ¹⁾	03.0655-0007.2	370007		Wegsensor	ATE	
	S 65 AMG		A 060621		05.13							
	S 250 CDI	150		01.11	05.13		03.4156-0073.3	010942		THz 26,99	ATE	
	S 350 BlueTec	190		04.11	05.13							
	S 350 BlueTec 4-matic	190		04.11	05.13							
	S 350 CGI	225		04.11	05.13							
	S 350 CGI 4-matic	225		04.11	05.13							
	S 500 CGI	320		04.11	05.13							
	S 500 CGI 4-matic	320		03.11	05.13							
	S 280 / S 300	170	A 293047	04.06			03.4055-0013.3	010793		- gepanzerte Fahrzeuge ²⁾	THz 25,40	ATE
	S 320 CDI	155	A 293047	12.05								
	S 320 CDI / S 350 CDI	173	A 293047	12.05								
	S 320 CDI 4-matic	155	A 293047	12.05								
	S 320 CDI 4-matic	173	A 293047	05.06								
	S 350	200	A 293047	12.05								
	S 350 4-matic	200	A 293047	02.07								
	S 420 CDI / S 450 CDI	235	A 293047	04.06								
	S 450	250	A 293047	04.06								
	S 450 4-matic	250	A 293047	04.06								
	S 500	285	A 293047	12.05								
	S 500 4-matic	285	A 293047	04.06								
	S 600	380	A 293047	12.05								
	S 63 AMG		A 293047	01.07								
S 65 AMG		A 293047	04.06									
S 280 / S 300	170	A 293048		05.13		03.4156-0073.3	010942		- gepanzerte Fahrzeuge ²⁾	THz 26,99	ATE	
S 320 CDI	155	A 293048		05.13								
S 320 CDI / S 350 CDI	173	A 293048		05.13								
S 320 CDI 4-matic	155	A 293048		05.13								
S 320 CDI 4-matic	173	A 293048		05.13								
S 350	200	A 293048		05.13								
S 350 4-matic	200	A 293048		05.13								
S 420 CDI / S 450 CDI	235	A 293048		05.13								
S 450	250	A 293048		05.13								
S 450 4-matic	250	A 293048		05.13								
S 500	285	A 293048		05.13								
S 500 4-matic	285	A 293048		05.13								
S 600	380	A 293048		05.13								
S 63 AMG		A 293048		05.13								
S 65 AMG		A 293048		05.13								
S 400 Hybrid	205		06.09	05.13		03.4155-5141.3	010969			THz 25,40	ATE	
	S 250 CDI	150		01.11	05.13		24.3426-9990.5	240648	<input type="checkbox"/> - AMG Sportpaket ³⁾ <input type="checkbox"/> - AMG Sportpaket ³⁾ <input checked="" type="checkbox"/> + AMG Sportpaket ⁴⁾ <input checked="" type="checkbox"/> + AMG Sportpaket ⁴⁾	D=42, - Halter	ATE	
							24.3426-9989.5	240647		D=42, - Halter	ATE	
							11.9426-9959.2	220801		D=42, - Halter	ATE	
							11.9426-9960.2	220802		D=42, - Halter	ATE	
							11.8116-0086.2	390606		2	Haltefeder	ATE
							11.8171-0008.1	990049		Führungsbolzen	ATE	
							11.0101-5407.2	260011		Hülsensatz	ATE	
	S 280 / S 300	170	A 265575	04.06			24.3426-9990.5	240648	<input type="checkbox"/> - Sportpaket ⁵⁾ <input type="checkbox"/> - Sportpaket ⁵⁾ <input type="checkbox"/> - Sportpaket ⁵⁾ <input checked="" type="checkbox"/> + Sportpaket ⁶⁾ <input checked="" type="checkbox"/> + Sportpaket ⁶⁾	D=42, - Halter	ATE	
	S 320 CDI	155	A 265575	12.05			24.3426-9989.5	240647		D=42, - Halter	ATE	
	S 320 CDI / S 350 CDI	173	A 265575	12.05			11.8170-0611.1	260116		Halter	ATE	
	S 320 CDI 4-matic	155	A 265575	12.05			11.9426-9959.2	220801		D=42, - Halter	ATE	
	S 320 CDI 4-matic	173	A 265575	05.06			11.9426-9960.2	220802		D=42, - Halter	ATE	
	S 350	200	A 265575	12.05			11.8116-0086.2	390606	2	Haltefeder	ATE	
	S 350 4-matic	200	A 265575	02.07			11.8171-0008.1	990049		Führungsbolzen	ATE	
	S 400 Hybrid	205	A 265575	06.09			11.0101-5407.2	260011		Hülsensatz	ATE	
	S 420 CDI / S 450 CDI	235		04.06	05.13							
	S 450 4-matic	250		04.06	05.13							
	S 450	250		04.06	05.13		11.9426-9959.2	220801	<input type="checkbox"/> <input type="checkbox"/>	D=42, - Halter	ATE	
	S 450 4-matic	250		04.06	05.13		11.9426-9960.2	220802		D=42, - Halter	ATE	
	S 500	285		12.05	05.13		11.8171-0008.1	990049		Führungsbolzen	ATE	
S 500 4-matic	285		04.06	05.13		11.0101-5407.2	260011	Hülsensatz		ATE		
S 500 CGI	320		04.11	05.13		11.8116-0086.2	390606	2		Haltefeder	ATE	
S 500 CGI 4-matic	320		03.11	05.13								
S 280 / S 300	170	A 265576		05.13		11.9426-9992.2	220642	<input type="checkbox"/> - Sportpaket ⁵⁾ <input type="checkbox"/> - Sportpaket ⁵⁾ <input type="checkbox"/> - Sportpaket ⁵⁾ <input checked="" type="checkbox"/> + Sportpaket ⁶⁾ <input checked="" type="checkbox"/> + Sportpaket ⁶⁾	D=42, - Halter	ATE		
S 320 CDI	155	A 265576		05.13		11.9426-9991.2	220641		D=42, - Halter	ATE		
S 320 CDI / S 350 CDI	173	A 265576		05.13		11.8170-0611.1	260116		Halter	ATE		
S 320 CDI 4-matic	155	A 265576		05.13		11.9426-9959.2	220801		D=42, - Halter	ATE		
S 320 CDI 4-matic	173	A 265576		05.13		11.9426-9960.2	220802		D=42, - Halter	ATE		
S 350	200	A 265576		05.13		11.8116-0086.2	390606	2	Haltefeder	ATE		
S 350 4-matic	200	A 265576		05.13		11.8171-0008.1	990049		Führungsbolzen	ATE		
S 350 BlueTec	190		04.11	05.13		11.0101-5407.2	260011		Hülsensatz	ATE		
S 350 BlueTec 4-matic	190		04.11	05.13								
S 350 CGI	225		04.11	05.13								
S 350 CGI 4-matic	225		04.11	05.13								
S 400 Hybrid	205	A 265576		05.13								

¹⁾ - idling stop system / - dispositivo start/stop / - unité marche/arrêt / - unidad arranque/paro
²⁾ - armoured vehicles / - veicoli blindati / - véhicule blindé / - vehículo blindado
³⁾ - AMG sports package / - kit sportivo AMG / - version sport AMG / - paquete deportivo AMG
⁴⁾ + AMG sports package / + pacchetto sportivo AMG / + version Sport AMG / + kit deportivo AMG
⁵⁾ - sport package / - pacchetto sportivo / - version sport / - kit deportivo
⁶⁾ + sports package / + pacchetto sportivo / + version sport / + kit deportivo



MERCEDES BENZ S-Klasse (W221) (06-13)

	S 250 CDI	150		01.11	05.13		24.5123-0350.3	330963	2		L=350
	S 280 / S 300	170		04.06	05.13						
	S 320 CDI	155		12.05	05.13						
	S 320 CDI / S 350 CDI	173		12.05	05.13						
	S 320 CDI 4-matic	155		12.05	05.13						
	S 320 CDI 4-matic	173		05.06	05.13						
	S 350	200		12.05	05.13						
	S 350 4-matic	200		02.07	05.13						
	S 350 BlueTec	190		04.11	05.13						
	S 350 BlueTec 4-matic	190		04.11	05.13						
	S 350 CGI	225		04.11	05.13						
	S 350 CGI 4-matic	225		04.11	05.13						
	S 400 Hybrid	205		06.09	05.13						
	S 420 CDI / S 450 CDI	235		04.06	05.13						
	S 450	250		04.06	05.13						
	S 450 4-matic	250		04.06	05.13						
	S 500	285		12.05	05.13						
	S 500 4-matic	285		04.06	05.13						
	S 500 CGI	320		04.11	05.13						
	S 500 CGI 4-matic	320		03.11	05.13						
	S 600	380		12.05	05.13						
	S 63 AMG			01.07	05.13						
	S 65 AMG			04.06	05.13						

MERCEDES BENZ S-Klasse (W222) (13-)

	S 300 BT Hybrid	150		02.14			24.5123-0350.3	330963	2		L=350
	S 300 BT Hybrid	170		02.14							
	S 320	200		05.14							
	S 350 BT	190		03.13							
	S 350 BT 4-matic	185		02.14							
	S 350 BT 4-matic	190		02.14							
	S 400	245		03.14							
	S 400 4-matic	245		11.14							
	S 400 Hybrid	225		03.13							
	S 500	335		03.13							
	S 500 4-matic	335		09.13							
	S 500 Hybrid	245		07.14							
	S 500 Maybach	335		12.14		- gepanzerte Fahrzeuge 1)					
	S 600	390		04.14							
	S 600 Maybach	390		12.14		- gepanzerte Fahrzeuge 1)					
	S 63 AMG	430		09.13							
	S 63 AMG 4-matic	430		09.13							
	S 65 AMG	463		03.14							

MERCEDES BENZ S-Klasse (C217) Coupe (14-)

	S 500	335		11.14			24.5123-0350.3	330963	2		L=350
	S 500 4-Matic	335		04.14							
	S 63 AMG	430		07.14							
	S 63 AMG 4-Matic	430		04.14							
	S 65 AMG	463		07.14							

MERCEDES BENZ S-Klasse (A217) Cabrio (15-)

	S 500	335		12.15			24.5123-0350.3	330963	2		L=350
	S 63 AMG 4-matic	430		12.15							
	S 65 AMG	463		04.16							

MERCEDES BENZ SL-Klasse (R129) (93-01)

	SL 280	142	F102744	08.93			03.2025-0211.3	010034			THz 25,40/19,05	ATE
	SL 320	170	F102744	08.93								
	SL 500	235	F102744	08.93		- ESP						
	SL 60 AMG	280	F102744	05.94		- ESP						
	SL 280	142	F102745		F148143		24.2025-1702.3	010515			THz 25,40/19,05	TRW
	SL 320	170	F102745		F148143							
	SL 500	235	F102745		F148143							
	SL 60 AMG	280	F102745		F148143							
	SL 280	142	F155734	08.93			13.0441-4214.2	250091			Dichtungssatz	ATE
	SL 500	235		08.93		+ AMG Technikpaket 2)						
	SL 500	235	F103937			- AMG Technikpaket 3)						
	SL 280	142	F155735				24.9442-8003.5	230053			D=42/38	ATE
	SL 500	235	F103936	08.93		- AMG Technikpaket 3)	24.9442-8004.5	230054			D=42/38	ATE
	SL 60 AMG	280	F103936	05.94			13.0441-4214.2	250091			Dichtungssatz	ATE
	SL 280	150	F187941	08.93			24.9442-8003.5	230053			D=42/38	ATE
	SL 320	165	F187941	05.98			24.9442-8004.5	230054			D=42/38	ATE
	SL 320	170	F187941	08.93			13.0441-4214.2	250091			Dichtungssatz	ATE
	SL 500	235	F103937				13.0441-4214.2	250091			Dichtungssatz	ATE
	SL 60 AMG	280	F103937									
	SL 600			08.93								
	SL 280	142	F125157	08.93			24.5101-0346.3	331406	2		L=346	
	SL 320	170	F125157	08.93								
	SL 500	235	F125157	08.93								
	SL 60 AMG	280	F125157	05.94								
	SL 600		F125157	08.93								
	SL 280	142	F125158				83.7705-0342.3	331273	2		L=340	
	SL 280	150		08.93								
	SL 320	165		05.98								
	SL 320	170	F125158									

1) - armoured vehicles / - veicoli blindati / - véhicules blindés / - vehículo blindado

2) + AMG Performance package / + Performance package AMG / + Performance package AMG / + Performance package AMG

















3) - AMG Performance package / - Performance package AMG / - Performance package AMG / - Performance package AMG



MERCEDES BENZ SL-Klasse (R129) (93-01)										
	SL 500	225		05.98	09.01	83.7705-0342.3	331273	2		L=340
	SL 500	235 F125158			09.01					
	SL 55 AMG	260		03.00	09.01					
	SL 60 AMG	280 F125158			09.01					
	SL 600	F125158			09.01					
	SL 280	142	F 125157	08.93		13.2381-8035.2	210037	<input type="checkbox"/>		D=38
	SL 320	170	F 125157	08.93		24.9238-8035.5	230025	<input type="checkbox"/>		D=38
	SL 500	235	F 103936	08.93		24.9238-8036.5	230026	<input type="checkbox"/>		D=38
	SL 60 AMG	280	F 103936	05.94		13.0441-3817.2	250071	<input type="checkbox"/>		Dichtungssatz
	SL 500	235 F 103937	F 125157			13.2381-8034.2	210223	<input type="checkbox"/>		D=38
	SL 60 AMG	280 F 103937	F 125157			24.9238-8033.5	230015	<input type="checkbox"/>		D=38
						24.9238-8034.5	230016	<input type="checkbox"/>		D=38
						13.0441-3817.2	250071	<input type="checkbox"/>		Dichtungssatz
	SL 280	142 F 125158			09.01	13.2361-8001.2	210214	<input type="checkbox"/>		D=36
	SL 280	150 F 187941			09.01	13.2361-8002.2	210215	<input type="checkbox"/>		D=36
	SL 320	165	F 187941	05.98	- ESP	24.9236-8001.5	230007	<input type="checkbox"/>		D=36
	SL 320	170 F 125158			09.01	24.9236-8002.5	230008	<input type="checkbox"/>		D=36
	SL 500	235 F 125158			09.01	13.0441-3606.2	250147	<input type="checkbox"/>		Dichtungssatz
	SL 60 AMG	280 F 125158			09.01			<input type="checkbox"/>		ATE
	SL 280	150	F 187941	08.93	+ ESP	13.2421-8025.2	210061	<input type="checkbox"/>		D=42
	SL 320	165	F 187941	05.98	+ ESP	13.2421-8026.2	210062	<input type="checkbox"/>		D=42
	SL 500	235 F 125158			09.01	13.0441-4216.2	250093	<input type="checkbox"/>		Dichtungssatz
	SL 60 AMG	280 F 125158			09.01			<input type="checkbox"/>		ATE
	SL 600			08.93	+ ESP			<input type="checkbox"/>		ATE
	SL 280	150 F 187942			09.01	13.2381-8035.2	210037	<input type="checkbox"/>	+ SL Edition	D=38
	SL 320	165 F 187942			09.01	24.9238-8035.5	230025	<input type="checkbox"/>	+ SL Edition	D=38
	SL 500	225		05.98	09.01	24.9238-8036.5	230026	<input type="checkbox"/>	+ SL Edition	D=38
	SL 55 AMG	260		03.00	09.01	13.2421-8025.2	210061	<input type="checkbox"/>	- SL Edition	D=42
						13.2421-8026.2	210062	<input type="checkbox"/>	- SL Edition	D=42
						13.0441-4216.2	250093	<input type="checkbox"/>		Dichtungssatz
								<input type="checkbox"/>		ATE
	SL 280	142	F 125157	08.93		83.7704-0281.3	330804	2		L=280
	SL 320	170	F 125157	08.93						
	SL 500	235	F 125157	08.93						
	SL 60 AMG	280	F 125157	05.94						
	SL 600		F 125157	08.93						
	SL 280	142 F 125158			09.01	24.5123-0281.3	330877	2		L=280
	SL 280	150		08.93	09.01					
	SL 320	165		05.98	09.01					
	SL 320	170 F 125158			09.01					
	SL 500	225		05.98	09.01					
	SL 500	235 F 125158			09.01					
	SL 55 AMG	260		03.00	09.01					
	SL 60 AMG	280 F 125158			09.01					
	SL 600	F 125158			09.01					
	SL 280	142		08.93	09.01	24.3727-0464.2	580464	1	<input type="checkbox"/>	L=2297
	SL 280	150		08.93	09.01	24.3727-0468.2	580468	<input type="checkbox"/>		L=1044
	SL 320	165		05.98	09.01	24.3727-0469.2	580469	<input type="checkbox"/>		L=1014
	SL 320	170		08.93	09.01					
	SL 500	225		05.98	09.01					
	SL 500	235		08.93	09.01					
	SL 55 AMG	260		03.00	09.01					
	SL 60 AMG	280		05.94	09.01					
	SL 600			08.93	09.01					
	SL 280	142		08.93	09.01	24.3727-0468.2	580468	<input type="checkbox"/>		L=1044
	SL 280	150		08.93	09.01	24.3727-0469.2	580469	<input type="checkbox"/>		L=1014
	SL 320	165		05.98	09.01					
	SL 320	170		08.93	09.01					
	SL 500	225		05.98	09.01					
	SL 500	235		08.93	09.01					
	SL 55 AMG	260		03.00	09.01					
	SL 60 AMG	280		05.94	09.01					
	SL 600			08.93	09.01					
	SL 280	142		08.93	09.01	24.2419-0915.3	030045		+ GG ¹⁾	Gz 19,05
	SL 280	150		08.93	09.01	24.2419-1703.3	030097		+ ALU ²⁾	Gz 19,05
	SL 280	142		08.93	09.01	03.2523-1310.3	040022			Nz 23,81
	SL 280	150		08.93	09.01					
MERCEDES BENZ SL-Klasse (R230) (01-11)										
	SL 65 AMG BlackSeries	493		07.08	11.11	03.7848-2002.4	300166			7/8" Tandem
						03.0655-0007.2	370007			Wegsensor
	SL 280	170		11.07	11.11	83.7715-0380.3	331269	2		L=380
	SL 300	170		04.09	11.11					
	SL 350	180		02.03	11.11					
	SL 350	200		03.06	11.11					
	SL 350	232		04.08	11.11					
	SL 500	225		09.01	11.11					
	SL 500	285		03.06	11.11					
	SL 55 AMG	350		09.01	11.11					
	SL 55 AMG	368		06.02	11.11					
	SL 55 AMG	380		03.06	11.11					
	SL 600	368		04.03	11.11					
	SL 600	380		03.06	11.11					
	SL 63 AMG	386		11.07	11.11					

1) + cast iron / + ghisa / + fonte grise / + fundición de gris

2) + aluminium / + alluminio / + aluminium / + aluminio

											
MERCEDES BENZ SL-Klasse (R230) (01-11)											
	SL 65 AMG	450		03.04	11.11	83.7715-0380.3	331269	2	L=380		
	SL 280	170		11.07	11.11	11.9426-9960.2	220802	2	D=42, - Halter	ATE	
	SL 300	170		04.09	11.11	11.9426-9959.2	220801			ATE	
	SL 350	200		03.06	11.11	11.8116-0086.2	390606	2	Haltefeder	ATE	
	SL 350	232		04.08	11.11	11.8171-0008.1	990049			ATE	
	SL 500	285		03.06	11.11	11.0101-5407.2	260011	2	Führungsbolzen Hülsensatz	ATE	
	SL 280	170		11.07	11.11	24.3426-9989.5	240647			ATE	
	SL 300	170		04.09	11.11	24.3426-9990.5	240648	2	D=42, - Halter	ATE	
	SL 350	200		03.06	11.11	11.8116-0086.2	390606			ATE	
							11.8171-0008.1	990049	2	Haltefeder	ATE
							11.0101-5407.2	260011			ATE
	SL 350	180		02.03	11.11	24.3426-9989.5	240647	2	D=42, - Halter	ATE	
						24.3426-9990.5	240648			ATE	
						11.0441-4203.2	250013	2	D=42, - Halter	ATE	
						11.8116-0323.1	390459			ATE	
						11.8171-0072.1	250154	2	Haltefeder	ATE	
						11.0101-5407.2	260011			ATE	
	SL 350	232		04.08	11.11	11.9426-9991.2	220641	2	D=42, - Halter	ATE	
	SL 500	225		09.01	11.11	11.9426-9992.2	220642			ATE	
						11.8170-0611.1	260116	2	Halter	ATE	
						11.0441-4203.2	250013			ATE	
						11.0101-5407.2	260011	2	Dichtungssatz	ATE	
						11.8171-0008.1	990049			ATE	
						11.8116-0323.1	390459	2	Hülsensatz	ATE	
						11.8171-0008.1	990049			ATE	
						11.8116-0323.1	390459	2	Haltefeder	ATE	
										ATE	
	SL 280	170		11.07	11.11	24.5172-0305.3	331312	2	L=305		
	SL 300	170		04.09	11.11						
	SL 350	180		02.03	11.11						
	SL 350	200		03.06	11.11						
	SL 350	232		04.08	11.11						
	SL 500	225		09.01	11.11						
	SL 500	285		03.06	11.11						
	SL 55 AMG	350		09.01	11.11						
	SL 55 AMG	368		06.02	11.11						
	SL 55 AMG	380		03.06	11.11						
	SL 600	368		04.03	11.11						
	SL 600	380		03.06	11.11						
	SL 63 AMG	386		11.07	11.11						
	SL 65 AMG	450		03.04	11.11						
	SL 65 AMG BlackSeries	493		07.08	11.11	24.5238-0255.3	330674	2	L=255		
MERCEDES BENZ SL-Klasse (R231) (12-)											
	SL 350	225		03.12		03.2126-3196.3	010968		Thz 26,99	ATE	
	SL 400	245		04.14							
	SL 400	270		04.14							
	SL 500	320		03.12							
	SL 500	335		04.15							
	SL 63 AMG			03.12							
	SL 65 AMG	463		03.12							
MERCEDES BENZ SLK-Klasse (R170) (96-04)											
	SLK 200 Kompressor	◀120		03.00	03.04	03.0655-0007.2	370007		Wegsensor	ATE	
	SLK 230 Kompressor	◀145		03.00	03.04						
	SLK 32 AMG	◀260		03.01	03.04						
	SLK 320	◀160		04.00	03.04						
	SLK 200 Kompressor	▶120		03.00	03.04	03.0655-0007.2	370007		Wegsensor	ATE	
	SLK 230 Kompressor	▶145		03.00	03.04						
	SLK 32 AMG	▶260		03.01	03.04						
	SLK 320	▶160		04.00	03.04						
	SLK 200	100	F025730	09.96		24.2023-1701.3	010514		Thz 23,81/19,05	TRW	
	SLK 200 Kompressor	141	F025730	09.96							
	SLK 230 Kompressor	142	F025730	09.96							
	SLK 200	100	F025731	03.04		24.2023-1702.3	010534		Thz 23,81/19,05	TRW	
	SLK 200 Kompressor	141	F025731	03.04							
	SLK 230 Kompressor	142	F025731	03.04							
	SLK 200 Kompressor	▶120		03.00	03.04	03.2025-1741.3	010705		Thz 25,40/20,64	ATE	
	SLK 230 Kompressor	▶145		03.00	03.04						
	SLK 32 AMG	▶260		03.01	03.04						
	SLK 320	▶160		04.00	03.04						
	SLK 200	100		09.96	03.04	11.3571-8512.2	220316	2	D=57, - Halter	ATE	
	SLK 200 Kompressor	120		03.00	03.04	24.3571-8511.5	240491			ATE	
	SLK 200 Kompressor	141		09.96	03.04	24.3571-8512.5	240492	2	D=57, - Halter	ATE	
	SLK 230 Kompressor	142		09.96	03.04	11.0441-5703.2	250145			ATE	
	SLK 230 Kompressor	145		03.00	03.04	11.8170-0401.1	260103	2	Dichtungssatz	ATE	
						11.0101-5407.2	260011			ATE	
						11.8171-0008.1	990049	2	Halter	ATE	
						11.8116-0253.1	390512			ATE	
								2	Hülsensatz	ATE	
										ATE	
								2	Führungsbolzen	ATE	
										ATE	
								2	Haltefeder	ATE	
										ATE	
	SLK 320	160		04.00	03.04	11.3571-8509.2	220313	2	D=57, - Halter	ATE	
						11.3571-8510.2	220314			ATE	
						11.0441-5703.2	250145	2	Dichtungssatz	ATE	
						11.0101-5407.2	260011			ATE	
						11.8171-0008.1	990049	2	Hülsensatz	ATE	
						11.8116-0253.1	390512			ATE	
								2	Führungsbolzen	ATE	
										ATE	
								2	Haltefeder	ATE	
										ATE	

1) + sports package / + pacchetto sportivo / + version sport / + kit deportivo

2) - sport package / - pacchetto sportivo / - version sport / - kit deportivo





MERCEDES BENZ SLK-Klasse (R170) (96-04)























	SLK 32 AMG	260			03.01	03.04			11.9441-9971.2	220839			D=44, - Halter	ATE
									11.9441-9972.2	220840			D=44, - Halter	ATE
									11.8171-0096.1	250155			Führungsbolzen	ATE
									11.0101-5704.2	260095			Hülzensatz	ATE
									11.8116-0133.1	390511	2		Haltefeder	ATE
	SLK 200	100			09.96	03.04			83.7705-0386.3	330828	2		L=385	
	SLK 200 Kompressor	120			03.00	03.04								
	SLK 200 Kompressor	141			09.96	03.04								
	SLK 230 Kompressor	142			09.96	03.04								
	SLK 230 Kompressor	145			03.00	03.04								
	SLK 32 AMG	260			03.01	03.04								
	SLK 320	160			04.00	03.04								
	SLK 200	100		F017687	09.96				13.2381-8035.2	210037			D=38	ATE
	SLK 200 Kompressor	141		F017687	09.96				24.9238-8035.5	230025			D=38	ATE
	SLK 230 Kompressor	142		F017687	09.96				24.9238-8036.5	230026			D=38	ATE
									13.0441-3817.2	250071			Dichtungssatz	ATE
	SLK 200	100	F017688			03.04			13.2361-8003.2	210220			D=36	ATE
	SLK 200 Kompressor	120			03.00	03.04			13.2361-8004.2	210221			D=36	ATE
	SLK 200 Kompressor	141	F017688			03.04			13.0441-3609.2	250057			Dichtungssatz	ATE
	SLK 230 Kompressor	142	F017688			03.04								
	SLK 230 Kompressor	145			03.00	03.04								
	SLK 320	160			04.00	03.04								
	SLK 32 AMG	260			03.01	03.04			13.2421-8025.2	210061			D=42	ATE
									13.2421-8026.2	210062			D=42	ATE
									13.0441-4216.2	250093			Dichtungssatz	ATE
	SLK 200	100			09.96	03.04			24.5123-0281.3	330877	2		L=280	
	SLK 200 Kompressor	120			03.00	03.04								
	SLK 200 Kompressor	141			09.96	03.04								
	SLK 230 Kompressor	142			09.96	03.04								
	SLK 230 Kompressor	145			03.00	03.04								
	SLK 32 AMG	260			03.01	03.04								
	SLK 320	160			04.00	03.04								
	SLK 200	100			09.96	03.04			24.3727-0433.2	580433			L=1005	
	SLK 200 Kompressor	120			03.00	03.04								
	SLK 200 Kompressor	141			09.96	03.04								
	SLK 230 Kompressor	142			09.96	03.04								
	SLK 230 Kompressor	145			03.00	03.04								
	SLK 32 AMG	260			03.01	03.04								
	SLK 320	160			04.00	03.04								
	SLK 200	100			09.96	03.04			24.2419-0915.3	030045		+ GG ¹⁾	Gz 19,05	
	SLK 200 Kompressor	120			03.00	03.04			24.2419-1703.3	030097		+ ALU ²⁾	Gz 19,05	
	SLK 200 Kompressor	141			09.96	03.04								
	SLK 230 Kompressor	142			09.96	03.04								
	SLK 230 Kompressor	145			03.00	03.04								
	SLK 32 AMG	260			03.01	03.04								
	SLK 320	160			04.00	03.04								

MERCEDES BENZ SLK-Klasse (R171) (04-11)

	SLK 200 Kompressor	◀120	F 196638	03.04					03.7848-9402.4	300227			7/8" Tandem	ATE
	SLK 200 Kompressor	◀135	F 196638	01.08					03.0655-0007.2	370007			Wegsensor	ATE
	SLK 280	◀170	F 196638	04.05										
	SLK 300	◀170	F 196638	03.09										
	SLK 350	◀200	F 196638	03.04										
	SLK 350	◀224	F 196638	01.08										
	SLK 55 AMG	◀	F 196638	03.04										
	SLK 200 Kompressor	◀120 F 196639			01.11				03.0655-0007.2	370007			Wegsensor	ATE
	SLK 200 Kompressor	◀135 F 196639			01.11									
	SLK 280	◀170 F 196639			01.11									
	SLK 300	◀170 F 196639			01.11									
	SLK 350	◀200 F 196639			01.11									
	SLK 350	◀224 F 196639			01.11									
	SLK 55 AMG	◀ F 196639			01.11									
	SLK 200 Kompressor	▶120	F 196638	03.04					03.0655-0007.2	370007			Wegsensor	ATE
	SLK 200 Kompressor	▶135	F 196638	01.08										
	SLK 280	▶170	F 196638	04.05										
	SLK 300	▶170	F 196638	03.09										
	SLK 350	▶200	F 196638	03.04										
	SLK 350	▶224	F 196638	01.08										
	SLK 55 AMG	▶	F 196638	03.04										
	SLK 200 Kompressor	▶120 F 196639			01.11				03.0655-0007.2	370007			Wegsensor	ATE
	SLK 200 Kompressor	▶135 F 196639			01.11									
	SLK 280	▶170 F 196639			01.11									
	SLK 300	▶170 F 196639			01.11									
	SLK 350	▶200 F 196639			01.11									
	SLK 350	▶224 F 196639			01.11									
	SLK 55 AMG	▶ F 196639			01.11									
	SLK 200 Kompressor	◀120		03.04	01.11				03.2025-1741.3	010705			THz 25,40/20,64	ATE
	SLK 200 Kompressor	◀135		01.08	01.11									
	SLK 280	◀170		04.05	01.11									
	SLK 300	◀170		03.09	01.11									
	SLK 350	◀200		03.04	01.11									
	SLK 350	◀224		01.08	01.11									
	SLK 55 AMG	◀		03.04	01.11									





































¹⁾ + cast iron / + ghisa / + fonte grise / + fundición de gris





















²⁾ + aluminium / + alluminio / + aluminium / + aluminio

											
MERCEDES BENZ SLK-Klasse (R171) (04-11)											
	SLK 200 Kompressor	120	F 197201	03.04		- Sportpaket ¹⁾	24.3571-1739.7	220667	D=57, - Halter	TRW	
	SLK 200 Kompressor	135	F 197201	01.08		- Sportpaket ¹⁾	24.3571-1740.7	220668	D=57, - Halter	TRW	
							24.0101-3803.2	260101	Bremssattel-Zubehör	TRW	
	SLK 280	170		04.05	01.11	- Sportpaket ¹⁾	24.3571-1721.7	220555	D=57, - Halter	TRW	
	SLK 300	170		03.09	01.11	- Sportpaket ¹⁾	24.3571-1722.7	220556	D=57, - Halter	TRW	
	SLK 200 Kompressor	120		03.04	01.11		83.7705-0386.3	330828	2	L=385	
	SLK 200 Kompressor	135		01.08	01.11						
	SLK 280	170		04.05	01.11						
	SLK 300	170		03.09	01.11						
	SLK 350	200		03.04	01.11						
	SLK 350	224		01.08	01.11						
	SLK 55 AMG			03.04	01.11						
	SLK 200 Kompressor	120		03.04	01.11	- Sportpaket ¹⁾	13.9361-0023.2	210241	D=36	ATE	
	SLK 200 Kompressor	135		01.08	01.11	- Sportpaket ¹⁾	13.9361-0024.2	210242	D=36	ATE	
	SLK 280	170		04.05	01.11	- Sportpaket ¹⁾	13.0441-3609.2	250057	Dichtungssatz	ATE	
	SLK 300	170		03.09	01.11	- Sportpaket ¹⁾					
	SLK 200 Kompressor	135		01.08	01.11	+ Sportpaket ²⁾	13.9361-0035.2	210253	D=36	ATE	
	SLK 200 Kompressor	135		01.08	01.11	+ Sportpaket ²⁾	13.9361-0036.2	210254	D=36	ATE	
	SLK 280	170		04.05	01.11	+ Sportpaket ²⁾	13.0441-3609.2	250057	Dichtungssatz	ATE	
	SLK 300	170		03.09	01.11	+ Sportpaket ²⁾					
	SLK 350	200		03.04	01.11						
	SLK 350	224		01.08	01.11						
	SLK 200 Kompressor	120		03.04	01.11		24.5123-0281.3	330877	2	L=280	
	SLK 200 Kompressor	135		01.08	01.11						
	SLK 280	170		04.05	01.11						
	SLK 300	170		03.09	01.11						
	SLK 350	200		03.04	01.11						
	SLK 350	224		01.08	01.11						
	SLK 55 AMG			03.04	01.11						
MERCEDES BENZ SLK-Klasse / SLC-Klasse (R172) (11-)											
	SLC 180	115		01.16			03.7745-1632.4	300293	- Start/Stop-Anlage ³⁾	8/7" Tandem	ATE
	SLC 200	135		01.16							
	SLC 250 d	150		01.16							
	SLC 300	180		01.16							
	SLC 43 AMG	270		01.16							
	SLK 200	135		04.15							
	SLK 200	135		02.11							
	SLK 250	150		02.11							
	SLK 250 CDI	150		01.12							
	SLK 300	180		07.15							
	SLK 350	225		02.11							
	SLK 55 AMG	310		01.12							
		SLC 180	115		01.16			24.3606-1707.7	221011	- Sportpaket ¹⁾	D=60, - Halter
SLK 200		135		02.11			24.3606-1708.7	221012	- Sportpaket ¹⁾	D=60, - Halter	TRW
	SLC 180	115		01.16			83.7705-0386.3	330828	2	L=385	
	SLC 200	135		01.16							
	SLC 250 d	150		01.16							
	SLC 300	180		01.16							
	SLC 43 AMG	270		01.16							
	SLK 200	135		04.15							
	SLK 200	135		02.11							
	SLK 250	150		02.11							
	SLK 250 CDI	150		01.12							
	SLK 300	180		07.15							
	SLK 350	225		02.11							
	SLK 55 AMG	310		01.12							
	MERCEDES BENZ Vaneo (BM414) (02-05)										
	1.4	60		06.02	12.05		24.4123-1703.3	010831		Thz 23,81	TRW
	1.6	60		02.02	12.05						
	1.6	75		02.02	12.05						
	1.7 CDI	55		02.02	12.05						
	1.7 CDI	67		02.02	12.05						
1.9	92		02.02	12.05							
	1.4	60		06.02	12.05		24.3571-1743.7	220687	- Sportpaket ¹⁾	D=57, - Halter	TRW
	1.6	60		02.02	12.05						
	1.6	75		02.02	12.05						
	1.7 CDI	55		02.02	12.05						
	1.7 CDI	67		02.02	12.05						
1.9	92		02.02	12.05		24.0101-3803.2	260101		Bremssattel-Zubehör	TRW	
	1.4	60		06.02	12.05		24.5123-0295.3	330820	2	L=295	
	1.6	60		02.02	12.05						
	1.6	75		02.02	12.05						
	1.7 CDI	55		02.02	12.05						
	1.7 CDI	67		02.02	12.05						
1.9	92		02.02	12.05							
	1.4	60		06.02	12.05		24.3301-1701.7	220697	- Sportpaket ¹⁾	D=30, - Halter	TRW
	1.6	60		02.02	12.05						
	1.6	75		02.02	12.05						
	1.7 CDI	55		02.02	12.05						
	1.7 CDI	67		02.02	12.05						
1.9	92		02.02	12.05		24.3301-1702.7	220698		D=30, - Halter	TRW	

1) - sport package / - pacchetto sportivo / - version sport / - kit deportivo
2) + sports package / + pacchetto sportivo / + version sport / + kit deportivo
3) - idling stop system / - dispositivo start/stop / - unité marche/arrêt / - unidad arranque/paro
4) + idling stop system / + dispositivo start/stop / + unité marche/arrêt / + unidad arranque/paro



									
MERCEDES BENZ Vaneo (BM414) (02-05)									
	1.4 1.6 1.6 1.7 CDI 1.7 CDI 1.9	60 60 75 55 67 92		06.02 02.02 02.02 02.02 02.02 02.02	12.05 12.05 12.05 12.05 12.05 12.05	24.5238-0230.3	330673	2	L=230
	1.4 1.6 1.6 1.7 CDI 1.7 CDI 1.9	60 60 75 55 67 92		06.02 02.02 02.02 02.02 02.02 02.02	12.05 12.05 12.05 12.05 12.05 12.05	24.3727-0450.2 24.3727-0428.2 24.3727-0427.2	580450 580428 580427	1   	L=1463 L=1038 L=685
MERCEDES BENZ V-Klasse (BM638) (96-03)									
	V 200 V 200 CDI V 220 CDI V 230 V 230 TD V 280			09.96 03.99 03.99 09.96 09.96 09.97	08.03 08.03 08.03 08.03 08.03 08.03	24.2123-1712.3 24.2123-1729.3	010519 010567	- ABS + ABS	THz 23,81 THz 23,81
	V 200 V 200 CDI V 220 CDI V 230 V 230 TD V 280			09.96 03.99 03.99 09.96 09.96 09.97	08.03 08.03 08.03 08.03 08.03 08.03	11.3601-8514.2 11.3601-8513.2 11.0441-6007.2 11.0101-5704.2 11.8171-0008.1 11.8116-0200.1	220394 220393 250146 260095 990049 390505	     2	D=60, - Halter D=60, - Halter Dichtungssatz Hülssensatz Führungsbolzen Haltefeder ATE ATE ATE ATE ATE ATE
	V 200 V 200 CDI V 220 CDI V 230 V 230 TD V 280			09.96 03.99 03.99 09.96 09.96 09.97	08.03 08.03 08.03 08.03 08.03 08.03	24.5131-0495.3	330677	2	L=495
	V 200 V 200 CDI V 220 CDI V 230 V 230 TD V 280			09.96 03.99 03.99 09.96 09.96 09.97	08.03 08.03 08.03 08.03 08.03 08.03	11.3331-0039.2 11.3331-0040.2 24.3331-1701.5 24.3331-1702.5 11.0441-3305.2	220387 220388 240543 240544 250006	    	D=33, - Halter D=33, - Halter D=33, - Halter D=33, - Halter Dichtungssatz ATE ATE BOS BOS ATE
	V 200 V 200 CDI V 220 CDI V 230 V 230 TD V 280			09.96 03.99 03.99 09.96 09.96 09.97	08.03 08.03 08.03 08.03 08.03 08.03	24.5113-0515.3	330668	2	L=515
	V 200 V 200 CDI V 220 CDI V 230 V 230 TD V 280			09.96 03.99 03.99 09.96 09.96 09.97	08.03 08.03 08.03 08.03 08.03 08.03	24.3727-0435.2	580435	2 	L=1167
	V 200 V 200 CDI V 220 CDI V 230 V 230 TD V 280			09.96 03.99 03.99 09.96 09.96 09.97	08.03 08.03 08.03 08.03 08.03 08.03	24.2419-1712.3	030105		Gz 19,05
	V 200 V 200 CDI V 220 CDI V 230 V 230 TD V 280			09.96 03.99 03.99 09.96 09.96 09.97	08.03 08.03 08.03 08.03 08.03 08.03	24.2522-1704.3	040078		Nz 22,20
MERCEDES BENZ VIANO (BM639) (03-14)									
	2.0 CDI 2.0 CDI 4-matic 2.2 CDI 2.2 CDI 4-matic 3.0 3.0 CDI 3.2 3.5 3.7	140 160 190 170		08.03 07.10 08.03 07.10 08.03 03.06 08.03 09.07 06.04	02.14 02.14 02.14 02.14 02.14 02.14 02.14 02.14 02.14	24.2123-1772.3	010858		THz 23,81 BOS
	2.0 CDI 2.0 CDI 4-matic 2.2 CDI 2.2 CDI 4-matic 3.0 3.0 CDI 3.2 3.5 3.7	140 160 190 170	342257 407625 342257 407625 342257 342257 342257 342257 342257	08.03 07.10 08.03 07.10 08.03 03.06 08.03 09.07 06.04		24.3481-1803.7	220703		D=48/48, - Halter BOS

								
MERCEDES BENZ VIANO (BM639) (03-14)								
	2.0 CDI 2.0 CDI 4-matic 2.2 CDI 2.2 CDI 4-matic 3.0 3.0 CDI 3.2 3.5 3.7	140 160 190 170	08.03 07.10 08.03 07.10 08.03 03.06 08.03 09.07 06.04	02.14 02.14 02.14 02.14 02.14 02.14 02.14 02.14 02.14	24.5140-0498.3	330912	2	L=498
	2.0 CDI 2.0 CDI 4-matic 2.2 CDI 2.2 CDI 4-matic 3.0 3.0 CDI 3.2 3.5 3.7	140 160 190 170	08.03 07.10 08.03 07.10 08.03 03.06 08.03 09.07 06.04	02.14 02.14 02.14 02.14 02.14 02.14 02.14 02.14 02.14	24.5123-0328.3	330910	2	L=328
	2.0 CDI 2.0 CDI 4-matic 2.2 CDI 2.2 CDI 4-matic 3.0 3.0 CDI 3.2 3.5 3.7	140 160 190 170	08.03 07.10 08.03 07.10 08.03 03.06 08.03 09.07 06.04	02.14 02.14 02.14 02.14 02.14 02.14 02.14 02.14 02.14	24.3727-0453.2 24.3727-0454.2	580453 580454	<input type="checkbox"/> <input type="checkbox"/>	L=1285 L=1152
MERCEDES BENZ VITO (BM638) (96-03)								
	108 CDI 108 D 110 CDI 110 D 112 CDI 113 114		03.99 03.96 03.99 03.96 03.99 03.96 12.96	08.03 08.03 08.03 08.03 08.03 08.03 08.03	24.2123-1712.3 24.2123-1729.3	010519 010567	- ABS + ABS	THz 23,81 THz 23,81
	108 CDI 108 D 110 CDI 110 D 112 CDI 113 114		03.99 03.96 03.99 03.96 03.99 03.96 12.96	08.03 08.03 08.03 08.03 08.03 08.03 08.03	11.3601-8514.2 11.3601-8513.2 11.0441-6007.2 11.0101-5704.2 11.8171-0008.1 11.8116-0200.1	220394 220393 250146 260095 990049 390505	<input type="checkbox"/> <input type="checkbox"/> <input type="checkbox"/> <input type="checkbox"/> <input type="checkbox"/> 2	D=60, - Halter D=60, - Halter Dichtungssatz Hülensatz Führungsbolzen Haltefeder ATE ATE ATE ATE ATE
	108 CDI 108 D 110 CDI 110 D 112 CDI 113 114		03.99 03.96 03.99 03.96 03.99 03.96 12.96	08.03 08.03 08.03 08.03 08.03 08.03 08.03	24.5131-0495.3	330677	2	L=495
	108 CDI 108 D 110 CDI 110 D 112 CDI 113 114		03.99 03.96 03.99 03.96 03.99 03.96 12.96	08.03 08.03 08.03 08.03 08.03 08.03 08.03	11.3331-0039.2 11.3331-0040.2 24.3331-1701.5 24.3331-1702.5 11.0441-3305.2	220387 220388 240543 240544 250006	<input type="checkbox"/> <input type="checkbox"/> <input type="checkbox"/> <input type="checkbox"/> <input type="checkbox"/>	D=33, - Halter D=33, - Halter D=33, - Halter D=33, - Halter Dichtungssatz ATE ATE BOS BOS ATE
	108 CDI 108 D 110 CDI 110 D 112 CDI 113 114		03.99 03.96 03.99 03.96 03.99 03.96 12.96	08.03 08.03 08.03 08.03 08.03 08.03 08.03	24.5113-0515.3	330668	2	L=515
	108 CDI 108 D 110 CDI 110 D 112 CDI 113 114		03.99 03.96 03.99 03.96 03.99 03.96 12.96	08.03 08.03 08.03 08.03 08.03 08.03 08.03	24.3727-0435.2	580435	2 ↓	L=1167
	108 CDI 108 D 110 CDI 110 D 112 CDI 113 114		03.99 03.96 03.99 03.96 03.99 03.96 12.96	08.03 08.03 08.03 08.03 08.03 08.03 08.03	24.2419-1712.3	030105		Gz 19,05
	108 CDI 108 D 110 CDI 110 D 112 CDI 113 114		03.99 03.96 03.99 03.96 03.99 03.96 12.96	08.03 08.03 08.03 08.03 08.03 08.03 08.03	24.2522-1704.3	040078		Nz 22,20

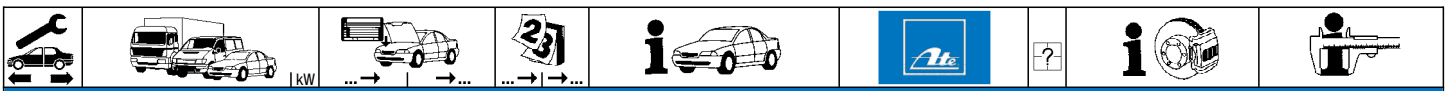

MERCEDES BENZ VITO (BM639) (03-14)

	109 CDI		3558104	08.03	24.2123-1772.3	010858		THz 23,81	BOS
	109 CDI 4-matic	70	3558104	09.07					
	110 CDI	70	3558104	09.10					
	111 CDI		3558104	08.03					
	111 CDI 4-matic	80	3558104	09.07					
	113 CDI	100	3558104	09.10					
	113 CDI 4-matic	100	3558104	09.10					
	115 CDI	110	3558104	08.03					
	115 CDI 4-matic	110	3558104	09.07					
	116 CDI	120	3558104	09.10					
	116 CDI 4-matic	120	3558104	09.10					
	119	140	3558104	08.03					
	120 CDI	150	3558104	09.07					
	122	160	3558104	08.03					
	122 CDI	165	3558104	09.10					
	123	170	3558104	06.04					
123	190	3558104	09.07						
126	190	3558104	09.07						
	109 CDI		3558105	02.14	24.2123-1778.3	010947		THz 23,81	TRW
	109 CDI 4-matic	70	3558105	02.14					
	110 CDI	70	3558105	02.14					
	111 CDI		3558105	02.14					
	111 CDI 4-matic	80	3558105	02.14					
	113 CDI	100	3558105	02.14					
	113 CDI 4-matic	100	3558105	02.14					
	115 CDI	110	3558105	02.14					
	115 CDI 4-matic	110	3558105	02.14					
	116 CDI	120	3558105	02.14					
	116 CDI 4-matic	120	3558105	02.14					
	119	140	3558105	02.14					
	120 CDI	150	3558105	02.14					
	122	160	3558105	02.14					
	122 CDI	165	3558105	02.14					
	123	170	3558105	02.14					
123	190	3558105	02.14						
126	190	3558105	02.14						
	109 CDI		342257	08.03	24.3481-1803.7	220703		D=48/48, - Halter	BOS
	109 CDI 4-matic	70	407625	09.07					
	110 CDI	70	342257	09.10					
	111 CDI		342257	08.03					
	111 CDI 4-matic	80	407625	09.07					
	113 CDI	100	342257	09.10					
	113 CDI 4-matic	100	407625	09.10					
	115 CDI	110	342257	08.03					
	115 CDI 4-matic	110	407625	09.07					
	116 CDI	120	342257	09.10					
	116 CDI 4-matic	120	407625	09.10					
	119	140	342257	08.03					
	120 CDI	150	342257	09.07					
	122	160	342257	08.03					
	122 CDI	165	342257	09.10					
	123	170	342257	06.04					
123	190	342257	09.07						
126	190	342257	09.07						
E-Cell	60		03.12	02.14					
	109 CDI			08.03	24.5140-0498.3	330912	2	L=498	
	109 CDI 4-matic	70		09.07					
	110 CDI	70		09.10					
	111 CDI			08.03					
	111 CDI 4-matic	80		09.07					
	113 CDI	100		09.10					
	113 CDI 4-matic	100		09.10					
	115 CDI	110		08.03					
	115 CDI 4-matic	110		09.07					
	116 CDI	120		09.10					
	116 CDI 4-matic	120		09.10					
	119	140		08.03					
	120 CDI	150		09.07					
	122	160		08.03					
	122 CDI	165		09.10					
	123	170		06.04					
123	190		09.07						
126	190		09.07						
E-Cell	60		03.12	02.14					
	109 CDI			08.03	24.5123-0328.3	330910	2	L=328	
	109 CDI 4-matic	70		09.07					
	110 CDI	70		09.10					
	111 CDI			08.03					
	111 CDI 4-matic	80		09.07					
	113 CDI	100		09.10					
	113 CDI 4-matic	100		09.10					
	115 CDI	110		08.03					
	115 CDI 4-matic	110		09.07					
	116 CDI	120		09.10					
	116 CDI 4-matic	120		09.10					
	119	140		08.03					
	120 CDI	150		09.07					
	123	170		06.04					
	123	190		09.07					
	126	190		09.07					
E-Cell	60		03.12	02.14					

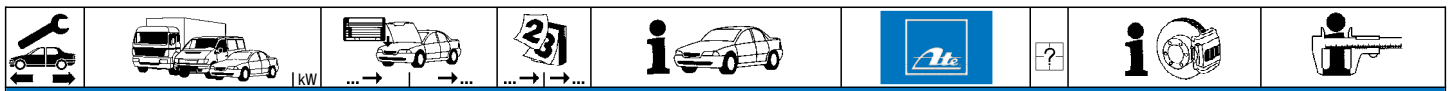

MERCEDES BENZ VITO (BM639) (03-14)

	122	160		08.03	02.14		24.5123-0328.3	330910	2		L=328
	122 CDI	165		09.10	02.14						
	123	170		06.04	02.14						
	123	190		09.07	02.14						
	126	190		09.07	02.14						
	E-Cell	60		03.12	02.14						
	109 CDI			08.03	02.14		24.3727-0453.2	580453	<input type="checkbox"/>		L=1285
	109 CDI 4-matic	70		09.07	02.14		24.3727-0454.2	580454	<input type="checkbox"/>		L=1152
	110 CDI	70		09.10	02.14						
	111 CDI			08.03	02.14						
	111 CDI 4-matic	80		09.07	02.14						
	113 CDI	100		09.10	02.14						
	113 CDI 4-matic	100		09.10	02.14						
	115 CDI	110		08.03	02.14						
	115 CDI 4-matic	110		09.07	02.14						
	116 CDI	120		09.10	02.14						
	116 CDI 4-matic	120		09.10	02.14						
	119	140		08.03	02.14						
	120 CDI	150		09.07	02.14						
	122	160		08.03	02.14						
	122 CDI	165		09.10	02.14						
	123	170		06.04	02.14						
	123	190		09.07	02.14						
	126	190		09.07	02.14						

MERCEDES BENZ Transporter (BM 901/902) SPRINTER (95-06)

	208 CDI		A906425	04.00			24.2123-1711.3	010518			Thz 23,81	
	208 D		A906425	02.95								
	210 D		A906425	01.97								
	211 CDI		A906425	04.00								
	212 D		A906425	02.95								
	213 CDI		A906425	04.00								
	214	92	A906425	04.00								
	214	105	A906425	02.95								
	216 CDI		A906425	04.00								
	208 CDI		A906426		05.06		24.2123-1754.3	010741			Thz 23,81	
	208 D		A906426		05.06							
	210 D		A906426		05.06							
	211 CDI		A906426		05.06							
	212 D		A906426		05.06							
	213 CDI		A906426		05.06							
	214	92	A906426		05.06							
	214	105	A906426		05.06							
	216 CDI		A906426		05.06							
	208 CDI			04.00	05.06		11.3601-8513.2	220393	<input type="checkbox"/>		D=60, - Halter	ATE
	208 D			02.95	05.06		11.3601-8514.2	220394	<input type="checkbox"/>		D=60, - Halter	ATE
	210 D			01.97	05.06		11.0441-6007.2	250146			Dichtungssatz	ATE
	211 CDI			04.00	05.06		11.0101-5704.2	260095			Hülsensatz	ATE
	212 D			02.95	05.06		11.8171-0008.1	990049			Führungsbolzen	ATE
	213 CDI			04.00	05.06		11.8116-0200.1	390505	2		Haltefeder	ATE
	214	92		04.00	05.06							
	214	105		02.95	05.06							
	216 CDI			04.00	05.06							
	208 CDI			04.00	05.06		24.3441-1701.5	240331	<input type="checkbox"/>		D=44, - Halter	PER
	208 D			02.95	05.06		24.3441-1702.5	240332	<input type="checkbox"/>		D=44, - Halter	PER
	210 D			01.97	05.06							
	211 CDI			04.00	05.06							
	212 D			02.95	05.06							
	213 CDI			04.00	05.06							
	214	92		04.00	05.06							
	214	105		02.95	05.06							
	216 CDI			04.00	05.06							
	208 CDI			04.00	05.06		83.7716-0363.3	330829	2		L=363	
	208 D			02.95	05.06							
	210 D			01.97	05.06							
	211 CDI			04.00	05.06							
	212 D			02.95	05.06							
	213 CDI			04.00	05.06							
	214	92		04.00	05.06							
	214	105		02.95	05.06							
	216 CDI			04.00	05.06							
	208 CDI (BM 901)			04.00	05.06		11.3451-8501.2	220389	<input type="checkbox"/>		D=45, - Halter	ATE
	208 D (BM 901)			02.95	05.06		11.3451-8502.2	220390	<input type="checkbox"/>		D=45, - Halter	ATE
	210 D (BM 901)			01.97	05.06		11.0441-4502.2	250143			Dichtungssatz	ATE
	211 CDI (BM 901)			04.00	05.06		11.0101-5407.2	260011			Hülsensatz	ATE
	212 D (BM 901)			02.95	05.06		11.8171-0008.1	990049			Führungsbolzen	ATE
	213 CDI (BM 901)			04.00	05.06		11.8116-0172.1	390500	2		Haltefeder	ATE
	214 (BM 901)	92		04.00	05.06							
	214 (BM 901)	105		02.95	05.06							
	216 CDI (BM 901)			04.00	05.06							





MERCEDES BENZ Transporter (BM 901/902) SPRINTER (95-06)















	208 CDI (BM 902) 208 D (BM 902) 210 D (BM 902) 211 CDI (BM 902) 212 D (BM 902) 213 CDI (BM 902) 214 (BM 902) 214 (BM 902) 216 CDI (BM 902)	92 105	04.00 02.95 01.97 04.00 02.95 04.00 04.00 02.95 04.00	05.06 05.06 05.06 05.06 05.06 05.06 05.06 05.06 05.06	11.3521-8501.2 11.3521-8502.2 24.3521-1707.5 24.3521-1708.5 11.8170-0407.1 11.0441-5203.2 11.0101-5407.2 11.8171-0008.1 11.8116-0191.1	220391 220392 240471 240472 260114 250144 260011 990049 390522	2	 	D=52, - Halter D=52, - Halter D=52, - Halter Halter Dichtungssatz Hülensatz Führungsbolzen Haltefeder	ATE ATE BOS BOS ATE ATE ATE ATE
	208 CDI 208 D 210 D 211 CDI 212 D 213 CDI 214 214 216 CDI	92 105	04.00 02.95 01.97 04.00 02.95 04.00 04.00 02.95 04.00	05.06 05.06 05.06 05.06 05.06 05.06 05.06 05.06 05.06	83.7716-0363.3	330829	2		L=363	
	208 CDI 208 D 210 D 211 CDI 212 D 213 CDI 214 214 216 CDI	92 105	04.00 02.95 01.97 04.00 02.95 04.00 04.00 02.95 04.00	05.06 05.06 05.06 05.06 05.06 05.06 05.06 05.06 05.06	24.3727-0442.2 24.3727-0445.2 24.3727-0443.2 24.3727-0444.2 24.3727-0441.2 24.3727-0438.2 24.3727-0463.2	580442 580445 580443 580444 580441 580438 580463	1 1 1 1 1 2 2	 	L=1435 L=1415 L=1990 L=1970 L=2460 L=1513 L=1545	
	208 CDI 208 D 210 D 211 CDI 212 D 213 CDI 214 214 216 CDI	92 105	04.00 02.95 01.97 04.00 02.95 04.00 04.00 02.95 04.00	05.06 05.06 05.06 05.06 05.06 05.06 05.06 05.06 05.06	24.2419-1712.3	030105			Gz 19,05	
	208 CDI 208 D 210 D 211 CDI 212 D 213 CDI 214 214 216 CDI	92 105	04.00 02.95 01.97 04.00 02.95 04.00 04.00 02.95 04.00	05.06 05.06 05.06 05.06 05.06 05.06 05.06 05.06 05.06	24.2522-1703.3	040077			Nz 22,20	

MERCEDES BENZ Transporter (BM 903/904) SPRINTER (95-06)



















	308 CDI 308 D 310 D 311 CDI 312 D 313 CDI 314 314 316 CDI	92 105	A905511 / R400726 A905511 / R400726 A905511 / R400726 A905511 / R400726 A905511 / R400726 A905511 / R400726 A905511 / R400726 A905511 / R400726 A905511 / R400726	04.00 02.95 02.95 04.00 02.95 04.00 04.00 02.95 04.00		24.2123-1711.3	010518		THz 23,81	
	308 CDI 308 D 310 D 311 CDI 312 D 313 CDI 314 314 316 CDI	92 105	A905512 / R400727 A905512 / R400727 A905512 / R400727 A905512 / R400727 A905512 / R400727 A905512 / R400727 A905512 / R400727 A905512 / R400727 A905512 / R400727	05.06 05.06 05.06 05.06 05.06 05.06 05.06 05.06 05.06		24.2123-1754.3	010741		THz 23,81	
	408 CDI 408 D 410 D 411 CDI 412 D 413 CDI 414 414 416 CDI	92 105	A906425 / R400726 A906425 / R400726 A906425 / R400726 A906425 / R400726 A906425 / R400726 A906425 / R400726 A906425 / R400726 A906425 / R400726 A906425 / R400726	04.00 06.95 09.96 04.00 06.95 04.00 04.00 06.95 04.00		24.2125-1727.3	010723		THz 25,40	
	408 CDI 408 D 410 D 411 CDI 412 D 413 CDI 414 414 416 CDI	92 105	A906426 / R400727 A906426 / R400727 A906426 / R400727 A906426 / R400727 A906426 / R400727 A906426 / R400727 A906426 / R400727 A906426 / R400727 A906426 / R400727	05.06 05.06 05.06 05.06 05.06 05.06 05.06 05.06 05.06		24.2125-1728.3	010751		THz 25,40	

1) +wheel bas.3000mm/-swivel seat / +passo 3000mm/-sedile girevole / +empatt.3000mm/-siège pivotant / +dist.rueda 3000mm/-asiento giratorio
 2) +wheel bas.3000mm/+swivel seat / +passo 3000mm/+sedile girevole / +empatt.3000mm/+siège pivotant / +dist.rueda 3000mm/+asiento giratorio
 3) +wheel bas.3550mm/-swivel seat / +passo 3550mm/-sedile girevole / +empatt.3550mm/-siège pivotant / +dist.rueda 3550mm/-asiento giratorio
 4) +wheel bas.3550mm/+swivel seat / +passo 3550mm/+sedile girevole / +empatt.3550mm/+siège pivotant / +dist.rueda 3550mm/+asiento giratorio
 5) + wheel base 4025 mm / + passo 4025 mm / + empattement 4025 mm / + distancia entre rueda 4025mm
 6) component no.: 504013/01 / no. componente: 504013/01 / no. de composant: 504013/01 / no. componente: 504013/01
 7) component no.: 504013/04 / no. componente: 504013/04 / no. de composant: 504013/04 / no. componente: 504013/04



										
MERCEDES BENZ Transporter (BM 903/904) SPRINTER (95-06)										
	308 CDI			04.00	05.06	11.3601-8513.2	220393	2	D=60, - Halter D=60, - Halter Dichtungssatz Hülzensatz Führungsbolzen Haltefeder	ATE ATE ATE ATE ATE ATE
	308 D			02.95	05.06	11.3601-8514.2	220394			
	310 D			02.95	05.06	11.0441-6007.2	250146			
	311 CDI			04.00	05.06	11.0101-5704.2	260095			
	312 D			02.95	05.06	11.8171-0008.1	990049			
	313 CDI			04.00	05.06	11.8116-0200.1	390505			
	314			04.00	05.06					
	314	92		02.95	05.06					
	316 CDI	105		04.00	05.06					
	408 CDI			04.00	05.06					
	408 D			06.95	05.06					
	410 D			09.96	05.06					
	411 CDI			04.00	05.06					
	412 D			06.95	05.06					
	413 CDI			04.00	05.06					
414	92		04.00	05.06						
414	105		06.95	05.06						
416 CDI			04.00	05.06						
	308 CDI			04.00	05.06	24.3441-1701.5	240331	2	D=44, - Halter D=44, - Halter	PER PER
	308 D			02.95	05.06	24.3441-1702.5	240332			
	310 D			02.95	05.06					
	311 CDI			04.00	05.06					
	312 D			02.95	05.06					
	313 CDI			04.00	05.06					
	314			04.00	05.06					
	314	92		02.95	05.06					
	316 CDI	105		04.00	05.06					
	408 CDI			04.00	05.06					
	408 D			06.95	05.06					
	410 D			09.96	05.06					
	411 CDI			04.00	05.06					
	412 D			06.95	05.06					
	413 CDI			04.00	05.06					
414	92		04.00	05.06						
414	105		06.95	05.06						
416 CDI			04.00	05.06						
	308 CDI			04.00	05.06	83.7716-0363.3	330829	2	L=363 L=490	
	308 D			02.95	05.06	24.5237-0490.3	330672			
	310 D			02.95	05.06					
	311 CDI			04.00	05.06					
	312 D			02.95	05.06					
	313 CDI			04.00	05.06					
	314			04.00	05.06					
	314	92		02.95	05.06					
	316 CDI	105		04.00	05.06					
	408 CDI			04.00	05.06					
	408 D			06.95	05.06					
	410 D			09.96	05.06					
	411 CDI			04.00	05.06					
	412 D			06.95	05.06					
	413 CDI			04.00	05.06					
414	92		04.00	05.06						
414	105		06.95	05.06						
416 CDI			04.00	05.06						
	308 CDI			04.00	05.06	11.3521-8501.2	220391	2	D=52, - Halter D=52, - Halter D=52, - Halter D=52, - Halter Halter Dichtungssatz Hülzensatz Führungsbolzen Haltefeder	ATE ATE BOS BOS ATE ATE ATE ATE
	308 D			02.95	05.06	11.3521-8502.2	220392			
	310 D			02.95	05.06	24.3521-1707.5	240471			
	311 CDI			04.00	05.06	24.3521-1708.5	240472			
	312 D			02.95	05.06	11.8170-0407.1	260114			
	313 CDI			04.00	05.06	11.0441-5203.2	250144			
	314			04.00	05.06	11.0101-5407.2	260011			
	314	92		02.95	05.06	11.8171-0008.1	990049			
	316 CDI	105		04.00	05.06	11.8116-0191.1	390522			
	408 CDI			04.00	05.06	24.3441-1701.5	240331			
	408 D			06.95	05.06	24.3441-1702.5	240332			
	410 D			09.96	05.06					
	411 CDI			04.00	05.06					
	412 D			06.95	05.06					
	413 CDI			04.00	05.06					
414	92		04.00	05.06						
414	105		06.95	05.06						
416 CDI			04.00	05.06						
	308 CDI			04.00	05.06	83.7716-0363.3	330829	2	am Bremssattel ¹⁾	L=363 L=510 L=235
	308 D			02.95	05.06	83.6105-0510.3	330622			
	310 D			02.95	05.06	24.5237-0235.3	330781			
	311 CDI			04.00	05.06					
	312 D			02.95	05.06					
	313 CDI			04.00	05.06					
	314			04.00	05.06					
	314	92		02.95	05.06					
	316 CDI	105		04.00	05.06					
	408 CDI			04.00	05.06					
	408 D			06.95	05.06					
	410 D			09.96	05.06					
	411 CDI			04.00	05.06					
	412 D			06.95	05.06					
	413 CDI			04.00	05.06					

¹⁾ on the brake caliper / sulla pinza freno / sur l'étrier de frein / a la pinza de freno

										
MERCEDES BENZ Transporter (BM 903/904) SPRINTER (95-06)										
	414 414 416 CDI	92 105	04.00 06.95 04.00	05.06 05.06 05.06	83.7716-0363.3 83.6105-0510.3 24.5237-0235.3	330829 330622 330781	2 2 2	am Bremsattel 1)	L=363 L=510 L=235	
	308 CDI 308 D 310 D 311 CDI 312 D 313 CDI 314 314 316 CDI	92 105	04.00 02.95 02.95 04.00 02.95 04.00 04.00 02.95 04.00	05.06 05.06 05.06 05.06 05.06 05.06 05.06 05.06 05.06	24.3727-0442.2 24.3727-0445.2 24.3727-0443.2 24.3727-0444.2 24.3727-0441.2 24.3727-0438.2 24.3727-0463.2	580442 580445 580443 580444 580441 580438 580463	1 1 1 1 1 2 2	+ Radstand 3000mm / - Fzg. mit Drehsitz 2) + Radstand 3000mm / + Fzg. mit Drehsitz 3) + Radstand 3550mm / - Fzg. mit Drehsitz 4) + Radstand 3550mm / + Fzg. mit Drehsitz 5) + Radstand 4025mm 6) Komponentennummer: 504013/01 7) Komponentennummer: 504013/04 8)	L=1435 L=1415 L=1990 L=1970 L=2460 L=1513 L=1545	
	408 CDI 408 D 410 D 411 CDI 412 D 413 CDI 414 414 416 CDI	92 105	04.00 06.95 09.96 04.00 06.95 04.00 04.00 06.95 04.00	05.06 05.06 05.06 05.06 05.06 05.06 05.06 05.06 05.06	24.3727-0443.2 24.3727-0444.2 24.3727-0441.2 24.3727-0181.2 24.3727-0179.2 24.3727-0180.2	580443 580444 580441 580181 580179 580180	1 1 1 1 1 1	+ Radstand 3550mm / - Fzg. mit Drehsitz 4) + Radstand 3550mm / + Fzg. mit Drehsitz 5) <input type="checkbox"/> <input type="checkbox"/>	L=1990 L=1970 L=2460 L=2440 L=1525 L=1526	
	308 CDI 308 D 310 D 311 CDI 312 D 313 CDI 314 314 316 CDI 408 CDI 408 D 410 D 411 CDI 412 D 413 CDI 414 414 416 CDI	92 105	04.00 02.95 02.95 04.00 02.95 04.00 02.95 04.00 04.00 04.00 06.95 09.96 04.00 06.95 04.00 04.00 06.95	05.06 05.06 05.06 05.06 05.06 05.06 05.06 05.06 05.06 05.06 05.06 05.06 05.06 05.06 05.06 05.06 05.06	24.2419-1712.3	030105			Gz 19,05	
	308 CDI 308 D 310 D 311 CDI 312 D 313 CDI 314 314 316 CDI 408 CDI 408 D 410 D 411 CDI 412 D 413 CDI 414 414 416 CDI	92 105	04.00 02.95 02.95 04.00 02.95 04.00 02.95 04.00 04.00 04.00 06.95 09.96 04.00 06.95 04.00 04.00 06.95	05.06 05.06 05.06 05.06 05.06 05.06 05.06 05.06 05.06 05.06 05.06 05.06 05.06 05.06 05.06 05.06 05.06	24.2522-1703.3	040077			Nz 22,20	
MERCEDES BENZ Transporter (BM 905) SPRINTER (01-06)										
	616 CDI		04.01	05.06	24.3441-1701.5 24.3441-1702.5	240331 240332	<input type="checkbox"/> <input type="checkbox"/>	D=44, - Halter D=44, - Halter	PER PER	
	616 CDI		04.01	05.06	24.5137-0365.3	331130	2		L=355	
	616 CDI		04.01	05.06	24.5237-0235.3	330781	2	am Bremsattel 1)	L=235	
	616 CDI		04.01	05.06	24.2419-1712.3	030105			Gz 19,05	
MERCEDES BENZ Transporter (BM 906) SPRINTER (06-)										
	209 CDI 210 CDI 211 CDI 213 CDI 214 CDI 215 CDI 216 216 CDI 218 CDI 219 CDI 224 309 CDI 310 CDI		10.09 10.09 10.09 10.09 04.16 10.09 10.09 10.09 10.09 10.09 10.09 10.09 10.09		24.2126-1704.3	010990			Thz 26,99	TRW

1) on the brake caliper / sulla pinza freno / sur l'étrier de frein / a la pinza de freno

2) +wheel bas.3000mm/-swivel seat / +passo 3000mm/-sedile girevole / +empatt.3000mm/-siège pivotant / +dist.rueda 3000mm/-asiento giratorio

3) +wheel bas.3000mm/+swivel seat / +passo 3000mm/+sedile girevole / +empatt.3000mm/+siège pivotant / +dist.rueda 3000mm/+asiento giratorio

4) +wheel bas.3550mm/-swivel seat / +passo 3550mm/-sedile girevole / +empatt.3550mm/-siège pivotant / +dist.rueda 3550mm/-asiento giratorio

5) +wheel bas.3550mm/+swivel seat / +passo 3550mm/+sedile girevole / +empatt.3550mm/+siège pivotant / +dist.rueda 3550mm/+asiento giratorio

6) + wheel base 4025 mm / + passo 4025 mm / + empattement 4025 mm / + distancia entre rueda 4025mm

7) component no.: 504013/01 / no. componente: 504013/01 / no. de composant: 504013/01 / no. componente: 504013/01

8) component no.: 504013/04 / no. componente: 504013/04 / no. de composant: 504013/04 / no. componente: 504013/04

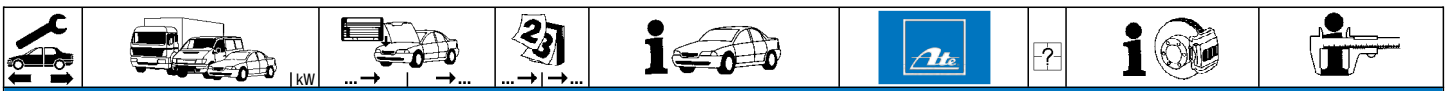

MERCEDES BENZ Transporter (BM 906) SPRINTER (06-)

	311 CDI		10.09	24.2126-1704.3	010990		THz 26,99	TRW
	311 CDI 4x4		10.09					
	313 CDI		10.09					
	313 CDI 4x4		10.09					
	314 CDI		05.16					
	314 CDI 4x4		05.16					
	315 CDI		10.09					
	315 CDI 4x4		10.09					
	316		10.09					
	316 CDI		10.09					
	316 CDI 4x4		10.09					
	316 LGT	115	10.09					
	316 NGT		10.09					
	318 CDI		10.09					
	318 CDI 4x4		10.09					
	319 CDI		10.09					
	319 CDI 4x4		10.09					
	324		10.09					
	411 CDI	80	10.09					
	413 CDI		10.09					
	415 CDI		10.09					
	416 CDI	120	10.09					
	418 CDI		10.09					
	419 CDI	140	10.09					
	424		10.09					
	509 CDI		10.09					
	510 CDI	70	10.09					
	511 CDI		10.09					
	511 CDI 4x4	80	10.09					
	513 CDI		10.09					
	513 CDI 4x4	95	10.09					
	514 CDI		05.16					
	514 CDI 4x4		05.16					
	515 CDI		10.09					
	515 CDI 4x4	110	10.09					
	516	115	10.09					
	516 CDI		10.09					
	516 CDI 4x4	120	10.09					
	516 NGT	115	10.09					
	518 CDI		10.09					
	518 CDI 4x4	135	10.09					
	519 CDI		10.09					
	519 CDI 4x4	140	10.09					
	524		10.09					
	209 CDI		04.06	24.5137-0385.3	331089	2	L=385	
	210 CDI		03.09					
	211 CDI		04.06					
	213 CDI		04.06					
	214 CDI		04.16					
	215 CDI		04.06					
	216		09.08					
	216 CDI		03.09					
	218 CDI		04.06					
	219 CDI		03.09					
	224		04.06					
	309 CDI		04.06					
	310 CDI		03.09					
	311 CDI		04.06					
	313 CDI		04.06					
	314 CDI		05.16					
	315 CDI		04.06					
	316		09.08					
	316 CDI		03.09					
	316 LGT	115	09.08					
	316 NGT		09.08					
	318 CDI		04.06					
	319 CDI		03.09					
	324		04.06					
	411 CDI	80	06.09					
	413 CDI		04.06					
	415 CDI		04.06					
	416 CDI	120	03.09					
	418 CDI		04.06					
	419 CDI	140	03.09					
	424		04.06					
	509 CDI		04.06					
	510 CDI	70	03.09					
	511 CDI		04.06					
	513 CDI		03.09					
	514 CDI		05.16					
	515 CDI		04.06					
	516	115	09.08					
	516 CDI		03.09					
	516 NGT	115	09.08					
	518 CDI		04.06					
	519 CDI		03.09					
	524		04.06					



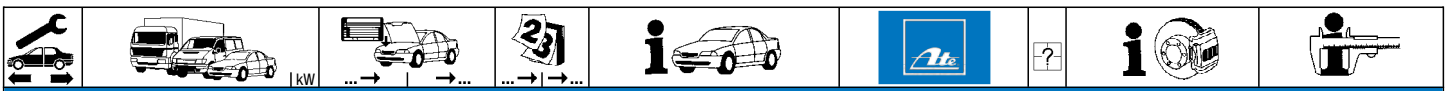

MERCEDES BENZ Transporter (BM 906) SPRINTER (06-)

	311 CDI 4x4		02.08	24.5137-0455.3	331131	2		L=455
	313 CDI 4x4		06.06					
	314 CDI 4x4		05.16					
	315 CDI 4x4		02.08					
	316 CDI 4x4		03.09					
	318 CDI 4x4		02.08					
	319 CDI 4x4		03.09					
	511 CDI 4x4	80	06.06					
	513 CDI 4x4	95	06.06					
	514 CDI 4x4		05.16					
	515 CDI 4x4	110	06.06					
	516 CDI 4x4	120	06.06					
518 CDI 4x4	135	06.06						
519 CDI 4x4	140	03.09						
	209 CDI		04.06	24.5137-0490.3	330964	2		L=490
	210 CDI		03.09					
	211 CDI		04.06					
	213 CDI		04.06					
	214 CDI		04.16					
	215 CDI		04.06					
	216		09.08					
	216 CDI		03.09					
	218 CDI		04.06					
	219 CDI		03.09					
	224		04.06					
	309 CDI		04.06					
	310 CDI		03.09					
	311 CDI		04.06					
	313 CDI		04.06					
	314 CDI		05.16					
	315 CDI		04.06					
	316		09.08					
	316 CDI		03.09					
	316 LGT	115	09.08					
	316 NGT		09.08					
	318 CDI		04.06					
319 CDI		03.09						
324		04.06						
	311 CDI 4x4		02.08	24.5137-0495.3	331132	2		L=495
	313 CDI 4x4		06.06					
	314 CDI 4x4		05.16					
	315 CDI 4x4		02.08					
	316 CDI 4x4		03.09					
	318 CDI 4x4		02.08					
	319 CDI 4x4		03.09					
		411 CDI	80					
413 CDI			04.06					
415 CDI			04.06					
416 CDI		120	03.09					
418 CDI			04.06					
419 CDI		140	03.09					
424			04.06					
509 CDI			04.06					
510 CDI		70	03.09					
511 CDI			04.06					
511 CDI 4x4		80	06.06					
513 CDI			03.09					
513 CDI 4x4		95	06.06					
514 CDI			05.16					
514 CDI 4x4			05.16					
515 CDI			04.06					
515 CDI 4x4		110	06.06					
516		115	09.08					
516 CDI			03.09					
516 CDI 4x4		120	06.06					
516 NGT		115	09.08					
518 CDI			04.06					
518 CDI 4x4		135	06.06					
519 CDI			03.09					
519 CDI 4x4	140	03.09						
524		04.06						
	209 CDI		04.06	24.3727-0472.2	580472	1 ↑		L=1468
	210 CDI		03.09					
	211 CDI		04.06					
	213 CDI		04.06					
	214 CDI		04.16					
	215 CDI		04.06					
	216		09.08					
	216 CDI		03.09					
	218 CDI		04.06					
	219 CDI		03.09					
	224		04.06					
	309 CDI		04.06					
	310 CDI		03.09					
311 CDI		04.06						
311 CDI 4x4		02.08						
313 CDI		04.06						
				24.3727-0473.2	580473	2 ↓		L=1706

¹⁾ - tyre 285/65 / - cerchio 285/65 / - pneu 285/65 / - cerco 285/65
²⁾ + tyre 285/65 / + cerchio 285/65 / + pneu 285/65 / + cerco 285/65

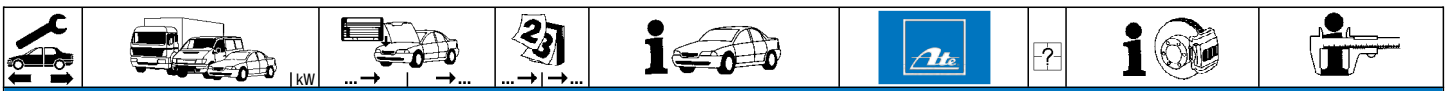

MERCEDES BENZ Transporter (BM 906) SPRINTER (06-)

	313 CDI 4x4			06.06	24.3727-0472.2	580472	1 ↑	L=1468 L=1706
	314 CDI			05.16	24.3727-0473.2	580473	2 ↓	
	314 CDI 4x4			05.16				
	315 CDI			04.06				
	315 CDI 4x4			02.08				
	316			09.08				
	316 CDI			03.09				
	316 CDI 4x4			03.09				
	316 LGT	115		09.08				
	316 NGT			09.08				
	318 CDI			04.06				
	318 CDI 4x4			02.08				
	319 CDI			03.09				
	319 CDI 4x4			03.09				
	324			04.06				
	411 CDI	80		06.09				
	413 CDI			04.06				
	415 CDI			04.06				
	416 CDI	120		03.09				
	418 CDI			04.06				
419 CDI	140		03.09					
424			04.06					
509 CDI		S 544979	04.06	24.3727-0474.2	580474	1 ↑	L=1867	
510 CDI	70	S 544979	03.09					
511 CDI		S 544979	04.06					
511 CDI 4x4	80	S 544979	06.06					
513 CDI		S 544979	03.09					
513 CDI 4x4	95	S 544979	06.06					
514 CDI		S 544979	05.16					
514 CDI 4x4		S 544979	05.16					
515 CDI		S 544979	04.06					
515 CDI 4x4	110	S 544979	06.06					
516	115	S 544979	09.08					
516 CDI		S 544979	03.09					
516 CDI 4x4	120	S 544979	06.06					
516 NGT	115	S 544979	09.08					
518 CDI		S 544979	04.06					
518 CDI 4x4	135	S 544979	06.06					
519 CDI		S 544979	03.09					
519 CDI 4x4	140	S 544979	03.09					
524		S 544979	04.06					
509 CDI		S 544980		24.3727-0474.2	580474	1 ↑		L=1867 L=1399
510 CDI	70	S 544980		24.3727-0475.2	580475	2 ↓		
511 CDI		S 544980						
511 CDI 4x4	80	S 544980						
513 CDI		S 544980						
513 CDI 4x4	95	S 544980						
514 CDI		S 544980						
514 CDI 4x4		S 544980						
515 CDI		S 544980						
515 CDI 4x4	110	S 544980						
516	115	S 544980						
516 CDI		S 544980						
516 CDI 4x4	120	S 544980						
516 NGT	115	S 544980						
518 CDI		S 544980						
518 CDI 4x4	135	S 544980						
519 CDI		S 544980						
519 CDI 4x4	140	S 544980						
524		S 544980						
509 CDI			04.06	24.3727-0474.2	580474	1 ↑	L=1867 L=1430	
510 CDI	70		03.09	24.3727-0471.2	580471	2 ↓		
511 CDI			04.06					
511 CDI 4x4	80		06.06					
513 CDI			03.09					
513 CDI 4x4	95		06.06					
514 CDI			05.16					
514 CDI 4x4			05.16					
515 CDI			04.06					
515 CDI 4x4	110		06.06					
516	115		09.08					
516 CDI			03.09					
516 CDI 4x4	120		06.06					
516 NGT	115		09.08					
518 CDI			04.06					
518 CDI 4x4	135		06.06					
519 CDI			03.09					
519 CDI 4x4	140		03.09					
524			04.06					

MERCEDES BENZ Transporter VARIO (96-13)

	VARIO 512 D		09.96	12.13	03.2128-1203.3	010922		Thz 28,57	ATE
	VARIO 612 D		09.96	12.13					
	VARIO 613 D / 614 D		09.96	12.13					
	VARIO 615 D / 616 D		09.98	12.13					
	VARIO 618 D		09.96	12.13					
	VARIO 810 D		09.96	12.13					

¹⁾ for 285/65 R 16 C / per 285/65 R 16 C / pour 285/65 R 16 C / para 285/65 R 16 C



MERCEDES BENZ Transporter VARIO (96-13)										
	VARIO 812 D VARIO 813 D / 814 D VARIO 813 DA / 814 DA VARIO 815 D / 816 D VARIO 815 DA / 816 DA VARIO 818 D VARIO 818 DA			09.96 09.96 09.96 09.96 09.96 09.96 09.06	12.13 12.13 12.13 12.13 12.13 12.13 12.13		03.2128-1203.3	010922	THz 28,57 ATE	
MERCEDES NFZ. UNIMOG 20 (BM 405.050) (07-)										
	U 20 (BM 405.050)			12.07			13.2601-0145.2 13.2601-0146.2	210247 210248	2 <input type="checkbox"/> li. vor + re. hinter der Achse ¹⁾ 2 <input type="checkbox"/> re. vor + li. hinter der Achse ²⁾	D=60 D=60 ATE ATE
	U 20 (BM 405.050)			12.07			83.6203-0250.3	330299	1 <input type="checkbox"/>	L=250
	U 20 (BM 405.050)			12.07			13.2544-0019.2 13.2601-0146.2 13.2544-0020.2 13.2601-0145.2 13.8158-0020.1 13.8158-0021.1 13.0471-5409.2 13.0471-5405.2	210251 210248 210252 210247 990113 990114 250139 250136	<input type="checkbox"/> vor der Achse ³⁾ <input type="checkbox"/> hinter der Achse ⁴⁾ <input type="checkbox"/> vor der Achse ³⁾ <input type="checkbox"/> hinter der Achse ⁴⁾ <input type="checkbox"/> <input type="checkbox"/> <input type="checkbox"/>	D=54 D=60 D=54 D=60 Handbremshebel Handbremshebel Rep.Satz Bremshebel Rep.Satz Nachstellung ATE ATE ATE ATE
MERCEDES NFZ. UNIMOG 300-400 (BM 405.1) (00-)										
	U 300 (BM 405.100) U 300 (BM 405.101) U 300 (BM 405.120) U 300 (BM 405.121)			03.00 03.00 03.00 03.00	VA 737.570 ⁵⁾ VA 737.570 ⁵⁾ VA 737.570 ⁵⁾ VA 737.570 ⁵⁾		13.2601-0145.2 13.2601-0146.2	210247 210248	2 <input type="checkbox"/> li. vor + re. hinter der Achse ¹⁾ 2 <input type="checkbox"/> re. vor + li. hinter der Achse ²⁾	D=60 D=60 ATE ATE
	U 300 (BM 405.100) U 300 (BM 405.101) U 300 (BM 405.120) U 300 (BM 405.121)			03.00 03.00 03.00 03.00	VA 737.571 ⁶⁾ VA 737.571 ⁶⁾ VA 737.571 ⁶⁾ VA 737.571 ⁶⁾		13.2601-0146.2 13.2601-0145.2	210248 210247	2 <input type="checkbox"/> li. vor + re. hinter der Achse ¹⁾ 2 <input type="checkbox"/> re. vor + li. hinter der Achse ²⁾	D=60 D=60 ATE ATE
	U 300 (BM 405.100) U 300 (BM 405.101) U 300 (BM 405.120) U 300 (BM 405.121)			03.00 03.00 03.00 03.00			83.6203-0250.3	330299	1 <input type="checkbox"/>	L=250
	U 300 (BM 405.100) U 300 (BM 405.101) U 300 (BM 405.120) U 300 (BM 405.121)			03.00 03.00 03.00 03.00			13.2544-0019.2 13.2601-0146.2 13.2544-0020.2 13.2601-0145.2 13.8158-0020.1 13.8158-0021.1 13.0471-5409.2 13.0471-5405.2	210251 210248 210252 210247 990113 990114 250139 250136	<input type="checkbox"/> vor der Achse ³⁾ <input type="checkbox"/> hinter der Achse ⁴⁾ <input type="checkbox"/> vor der Achse ³⁾ <input type="checkbox"/> hinter der Achse ⁴⁾ <input type="checkbox"/> <input type="checkbox"/> <input type="checkbox"/>	D=54 D=60 D=54 D=60 Handbremshebel Handbremshebel Rep.Satz Bremshebel Rep.Satz Nachstellung ATE ATE ATE ATE
MERCEDES NFZ. UNIMOG 3000-5000 (BM 437.4) (02-)										
	U 3000 (BM 437.420) U 3000 (BM 437.421) U 3000 (BM 437.425) U 3000 (BM 437.426) U 4000 (BM 437.420) U 4000 (BM 437.421) U 4000 (BM 437.425) U 4000 (BM 437.426)			09.02 09.02 09.02 09.02 09.02 09.02 09.02 09.02			13.2601-0145.2 13.2601-0146.2	210247 210248	2 <input type="checkbox"/> li. vor + re. hinter der Achse ¹⁾ 2 <input type="checkbox"/> re. vor + li. hinter der Achse ²⁾	D=60 D=60 ATE ATE
	U 5000 (BM 437.430) U 5000 (BM 437.431) U 5000 (BM 437.435) U 5000 (BM 437.436)			09.02 09.02 09.02 09.02			13.9571-0003.2 13.9571-0004.2 13.0441-5721.2	210277 210278 250123	<input type="checkbox"/> <input type="checkbox"/> <input type="checkbox"/>	D=57/48 D=57/48 Dichtungssatz ATE ATE ATE
	U 3000 (BM 437.420) U 3000 (BM 437.421) U 3000 (BM 437.425) U 3000 (BM 437.426) U 4000 (BM 437.420) U 4000 (BM 437.421) U 4000 (BM 437.425) U 4000 (BM 437.426)			09.02 09.02 09.02 09.02 09.02 09.02 09.02 09.02			13.2544-0019.2 13.2601-0146.2 13.2544-0020.2 13.2601-0145.2 13.8158-0020.1 13.8158-0021.1 13.0471-5409.2	210251 210248 210252 210247 990113 990114 250139	<input type="checkbox"/> vor der Achse ³⁾ <input type="checkbox"/> hinter der Achse ⁴⁾ <input type="checkbox"/> vor der Achse ³⁾ <input type="checkbox"/> hinter der Achse ⁴⁾ <input type="checkbox"/> <input type="checkbox"/> <input type="checkbox"/>	D=54 D=60 D=54 D=60 Handbremshebel Handbremshebel Rep.Satz Bremshebel ATE ATE ATE ATE
	U 5000 (BM 437.430) U 5000 (BM 437.431) U 5000 (BM 437.435) U 5000 (BM 437.436)			09.02 09.02 09.02 09.02	HA 747.221 ⁸⁾		13.9574-7005.2 13.9574-7006.2 13.9571-0003.2 13.9571-0004.2 13.0441-5721.2 24.8190-0029.2 24.8190-0030.2	210275 210276 210277 210278 250123 990156 990157	<input type="checkbox"/> vor der Achse ³⁾ <input type="checkbox"/> vor der Achse ³⁾ <input type="checkbox"/> hinter der Achse ⁴⁾ <input type="checkbox"/> hinter der Achse ⁴⁾ <input type="checkbox"/> vor der Achse ³⁾ <input type="checkbox"/> <input type="checkbox"/>	D=57/48 D=57/48 D=57/48 D=57/48 Dichtungssatz Handbremsbetätigung Handbremsbetätigung ATE ATE ATE ATE ATE ATE
	U 5000 (BM 437.436)			09.02	HA 747.480 ⁹⁾		13.9574-7005.2 13.9574-7006.2 13.0441-5721.2 24.8190-0029.2 24.8190-0030.2	210275 210276 250123 990156 990157	<input type="checkbox"/> <input type="checkbox"/> <input type="checkbox"/> <input type="checkbox"/> <input type="checkbox"/>	D=57/48 D=57/48 Dichtungssatz Handbremsbetätigung Handbremsbetätigung ATE ATE ATE ATE
	U 3000 (BM 437.420) U 3000 (BM 437.421)			09.02 09.02			83.6203-0250.3 24.5201-0220.3	330299 331272	1 <input type="checkbox"/> - ABS 1 <input type="checkbox"/> + ABS	L=250 L=220

¹⁾ left i. front + right beh.axle / sinist.davant.+destr.diet.ass. / gauche dev. + droite derr.ess. / izqu.adel.+ derech.detrás

²⁾ right in front+left beh.axle / destr.davant.+sinist.diet.ass. / droite dev. + gauche derr.ess. / derech.adel.+ izqu.detrás

³⁾ forward of axle / davanti l'assale / devant l'essieu / antes del eje

⁴⁾ aft of axle / a destra dell'assale / derrière l'essieu / atrás de eje

⁵⁾ FA 737.570 / A 737.570 / essieu AV 737.570 / ED 737.570

⁶⁾ FA 737.571 / A 737.571 / essieu AV 737.571 / ED 737.571

⁷⁾ FA 737.221 / A 737.221 / essieu AV 737.221 / ED 737.221

⁸⁾ RA 747.221 / P 747.221 / ess. AR 747.221 / ET 747.221

⁹⁾ RA 747.480 / P 747.480 / ess. AR 747.480 / ET 747.480

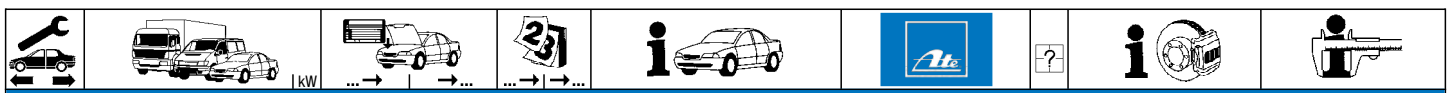

MG ZT Limousine (01-05)											
	1.8 16V (160)	118		06.01	12.05	+ Bremsscheibe 284 X 22 ¹⁾	11.9571-9871.2	220425		D=57, - Halter	ATE
	1.8 T 16V (160)	118		01.03	12.05	+ Bremsscheibe 284 X 22 ¹⁾	11.9571-9872.2	220426		D=57, - Halter	ATE
	2.0 CDTi	85		06.02	09.03	+ Bremsscheibe 284 X 22 ¹⁾					
	2.0 CDTi	96		11.02	12.05	+ Bremsscheibe 284 X 22 ¹⁾					
	2.5 V6 (180)	130		01.03	12.05	+ Bremsscheibe 284 X 22 ¹⁾					
	2.5 V6 (190)	140		06.01	12.05	+ Bremsscheibe 325 X 25 ²⁾	24.3571-1733.5	240349		D=57, - Halter	ATE
	4.6 V8 (260X)	191		10.03	12.05	+ Bremsscheibe 325 X 25 ²⁾	24.3571-1734.5	240350		D=57, - Halter	ATE
	1.8 16V (160)	118		06.01	12.05	+ Bremsscheibe 280 X 10 ³⁾	11.9361-9961.2	220855		D=36, - Halter	ATE
	1.8 T 16V (160)	118		01.03	12.05	+ Bremsscheibe 280 X 10 ³⁾	11.9361-9962.2	220856		D=36, - Halter	ATE
	2.0 CDTi	85		06.02	09.03	+ Bremsscheibe 280 X 10 ³⁾					
	2.0 CDTi	96		11.02	12.05	+ Bremsscheibe 280 X 10 ³⁾					
	2.5 V6 (180)	130		01.03	12.05	+ Bremsscheibe 280 X 10 ³⁾					
	2.5 V6 (190)	140		06.01	12.05	+ Bremsscheibe 280 X 10 ³⁾					
	1.8 16V (160)	118		06.01	12.05	+ Bremsscheibe 276 X 19 ⁴⁾	24.3401-1703.5	240351		D=40, - Halter	ATE
	1.8 T 16V (160)	118		01.03	12.05	+ Bremsscheibe 276 X 19 ⁴⁾	24.3401-1704.5	240352		D=40, - Halter	ATE
	2.0 CDTi	85		06.02	09.03	+ Bremsscheibe 276 X 19 ⁴⁾					
	2.0 CDTi	96		11.02	12.05	+ Bremsscheibe 276 X 19 ⁴⁾					
	2.5 V6 (180)	130		01.03	12.05	+ Bremsscheibe 276 X 19 ⁴⁾					
	2.5 V6 (190)	140		06.01	12.05	+ Bremsscheibe 276 X 19 ⁴⁾					

MG ZT-T Kombi (01-05)											
	1.8 16V (160)	118		10.01	12.05	+ Bremsscheibe 284 X 22 ¹⁾	11.9571-9871.2	220425		D=57, - Halter	ATE
	1.8 T 16V (160)	118		01.03	12.05	+ Bremsscheibe 284 X 22 ¹⁾	11.9571-9872.2	220426		D=57, - Halter	ATE
	2.0 CDTi	85		06.02	09.03	+ Bremsscheibe 284 X 22 ¹⁾					
	2.0 CDTi	96		11.02	12.05	+ Bremsscheibe 284 X 22 ¹⁾					
	2.5 V6 (180)	130		01.03	12.05	+ Bremsscheibe 284 X 22 ¹⁾					
	2.5 V6 (190)	140		10.01	12.05	+ Bremsscheibe 325 X 25 ²⁾	24.3571-1733.5	240349		D=57, - Halter	ATE
	4.6 V8 (260X)	191		10.03	12.05	+ Bremsscheibe 325 X 25 ²⁾	24.3571-1734.5	240350		D=57, - Halter	ATE
	1.8 16V (160)	118		10.01	12.05	+ Bremsscheibe 280 X 10 ³⁾	11.9361-9961.2	220855		D=36, - Halter	ATE
	1.8 T 16V (160)	118		01.03	12.05	+ Bremsscheibe 280 X 10 ³⁾	11.9361-9962.2	220856		D=36, - Halter	ATE
	2.0 CDTi	85		06.02	09.03	+ Bremsscheibe 280 X 10 ³⁾					
	2.0 CDTi	96		11.02	12.05	+ Bremsscheibe 280 X 10 ³⁾					
	2.5 V6 (180)	130		01.03	12.05	+ Bremsscheibe 280 X 10 ³⁾					
	2.5 V6 (190)	140		10.01	12.05	+ Bremsscheibe 280 X 10 ³⁾					
	1.8 16V (160)	118		10.01	12.05	+ Bremsscheibe 276 X 19 ⁴⁾	24.3401-1703.5	240351		D=40, - Halter	ATE
	1.8 T 16V (160)	118		01.03	12.05	+ Bremsscheibe 276 X 19 ⁴⁾	24.3401-1704.5	240352		D=40, - Halter	ATE
	2.0 CDTi	85		06.02	09.03	+ Bremsscheibe 276 X 19 ⁴⁾					
	2.0 CDTi	96		11.02	12.05	+ Bremsscheibe 276 X 19 ⁴⁾					
	2.5 V6 (180)	130		01.03	12.05	+ Bremsscheibe 276 X 19 ⁴⁾					
	2.5 V6 (190)	140		10.01	12.05	+ Bremsscheibe 276 X 19 ⁴⁾					

MINI R50 / R53 (00-06)											
	Cooper	85		06.00	11.06		03.7860-1402.4	300228		10"	ATE
	Cooper JCW	155		11.03	11.06						
	Cooper JCW S	147		11.03	11.06						
	Cooper S			07.02	11.06						
	One	66		06.00	11.06						
	One 1.4			06.00	11.06						
	Cooper	85		06.00	11.06		03.2122-1853.3	010893	- DSC	Thz 22,20	ATE
	Cooper JCW	155		11.03	11.06		03.2122-1824.3	010892	+ DSC	Thz 22,20	ATE
	Cooper JCW S	147		11.03	11.06						
	Cooper S			07.02	11.06						
	One	66		06.00	11.06						
	One 1.4			06.00	11.06						
	Cooper	85		06.00	11.06		11.9481-9811.2	220445		D=48, - Halter	ATE
	Cooper S			07.02	11.06		11.9481-9812.2	220446		D=48, - Halter	ATE
	One	66		06.00	11.06		11.0101-5402.2	260009		Hülsensatz	ATE
	One 1.4			06.00	11.06		11.8171-0008.1	990049		Führungsbolzen	ATE
	One D			03.03	11.06		11.8116-0274.1	390516	2	Haltefeder	ATE
	Cooper	85		06.00	11.06		24.5173-0570.3	331364	2		L=570
	Cooper	85		06.00	03.03		11.9347-7001.2	220473		D=34, - Halter	ATE
	Cooper S			07.02	03.03		11.9347-7002.2	220474		D=34, - Halter	ATE
	One	66		06.00	03.03		11.8170-0584.1	260105	2	Halter	ATE
	One 1.4			06.00	03.03		11.0101-5407.2	260011		Hülsensatz	ATE
	One D			03.03	03.03		11.8171-0008.1	990049		Führungsbolzen	ATE
	Cooper	85		04.03	11.06		11.9347-7003.2	220565		D=34, - Halter	ATE
	Cooper JCW	155		11.03	11.06		11.9347-7004.2	220566		D=34, - Halter	ATE
	Cooper JCW S	147		11.03	11.06		11.8170-0584.1	260105	2	Halter	ATE
	Cooper S			04.03	11.06		11.0101-5407.2	260011		Hülsensatz	ATE
	One	66		04.03	11.06		11.8171-0008.1	990049		Führungsbolzen	ATE
	One 1.4			04.03	11.06		11.8116-0340.1	390595	2	Haltefeder	ATE
	One D			04.03	11.06						
	Cooper	85		06.00	03.03		24.5173-0435.3	331363	2		L=435
	Cooper S			07.02	03.03						
	One	66		06.00	03.03						
	One 1.4			06.00	03.03						
	One D			03.03	03.03						

1) + brake disc 284 X 22 / + dischi freno 284 X 22 / + disque de frein 284 X 22 / + disco de freno 284 X 22
2) + brake disc 325 X 25 / + dischi freno 325 X 25 / + disque de frein 325 X 25 / + disco de freno 325 X 25
3) + brake disc 280 X 10 / + dischi freno 280 X 10 / + disque de frein 280 X 10 / + disco de freno 280 X 10
4) + brake disc 276 X 19 / + dischi freno 276 X 19 / + disque de frein 276 X 19 / + disco de freno 276 X 19



























MINI R50 / R53 (00-06)										
	Cooper	85		04.03	11.06		83.7751-0425.3	331271	2	L=425
	Cooper JCW	155		11.03	11.06					
	Cooper JCW S	147		11.03	11.06					
	Cooper S			04.03	11.06					
	One	66		04.03	11.06					
	One 1.4			04.03	11.06					
	One D			04.03	11.06					
	Cooper	85		06.00	11.06		24.3727-0245.2	580245	<input type="checkbox"/>	L=1433
	Cooper JCW	155		11.03	11.06		24.3727-0244.2	580244	<input type="checkbox"/>	L=1435
	Cooper JCW S	147		11.03	11.06					
	Cooper S			07.02	11.06					
	One	66		06.00	11.06					
	One 1.4			06.00	11.06					
	One D			03.03	11.06					

MINI R52 Cabrio (04-08)										
	Cooper	85		04.04	08.08		03.7860-1402.4	300228		10" ATE
	Cooper S	125		04.04	08.08					
	Cooper S JCW	155		11.03	08.08					
	One	66		04.04	08.08					
	Cooper	85		04.04	08.08		03.2122-1853.3	010893	- DSC	THz 22,20 ATE
	Cooper S	125		04.04	08.08		03.2122-1824.3	010892	+ DSC	THz 22,20 ATE
	Cooper S JCW	155		11.03	08.08					
	One	66		04.04	08.08					
	Cooper	85		04.04	08.08		11.9481-9811.2	220445	<input type="checkbox"/>	D=48, - Halter ATE
	Cooper S	125		04.04	08.08		11.9481-9812.2	220446	<input type="checkbox"/>	D=48, - Halter ATE
	Cooper S JCW	155		11.03	08.08		11.0101-5407.2	260011		Hülzensatz ATE
	One	66		04.04	08.08		11.8171-0008.1	990049		Führungsbolzen ATE
							11.8116-0274.1	390516	2	Haltefeder ATE
	Cooper	85		04.04	08.08		24.5173-0570.3	331364	2	L=570
	Cooper S	125		04.04	08.08					
	Cooper S JCW	155		11.03	08.08					
	One	66		04.04	08.08					
	Cooper	85		04.04	08.08		11.9347-7003.2	220565	<input type="checkbox"/>	D=34, - Halter ATE
	Cooper S	125		04.04	08.08		11.9347-7004.2	220566	<input type="checkbox"/>	D=34, - Halter ATE
	Cooper S JCW	155		11.03	08.08		11.8170-0584.1	260105	2	Halter ATE
	One	66		04.04	08.08		11.0101-5407.2	260011		Hülzensatz ATE
							11.8171-0008.1	990049		Führungsbolzen ATE
							11.8116-0340.1	390595	2	Haltefeder ATE
	Cooper	85		04.04	08.08		83.7751-0425.3	331271	2	L=425
	Cooper S	125		04.04	08.08					
	Cooper S JCW	155		11.03	08.08					
	One	66		04.04	08.08					
	Cooper	85		04.04	08.08		24.3727-0245.2	580245	<input type="checkbox"/>	L=1433
	Cooper S	125		04.04	08.08		24.3727-0244.2	580244	<input type="checkbox"/>	L=1435
	Cooper S JCW	155		11.03	08.08					
	One	66		04.04	08.08					

MINI R55 Clubman (07-14)										
	Cooper			09.07	06.14		24.4123-1712.3	010897		THz 23,81 TRW
	Cooper D			09.07	06.14					
	Cooper S			09.07	06.14					
	Cooper SD	105		02.11	06.14					
	John Cooper Works	155		03.08	06.14					
	One			03.10	06.14					
	One D	66		03.10	06.14					
	Cooper			09.07	06.14		24.3541-1843.5	240585	<input type="checkbox"/>	D=54, - Halter TRW
	Cooper D			09.07	06.14		24.3541-1844.5	240586	<input type="checkbox"/>	D=54, - Halter TRW
	One			03.10	06.14					
	One D	66		03.10	06.14					
	Cooper S			09.07	06.14		24.3541-1843.5	240585	<input type="checkbox"/>	D=54, - Halter TRW
	Cooper SD	105		02.11	06.14		24.3541-1844.5	240586	<input type="checkbox"/>	D=54, - Halter TRW
	Cooper			09.07	06.14		83.7750-0524.3	331230	2	L=523
	Cooper D			09.07	06.14					
	Cooper S			09.07	06.14					
	Cooper SD	105		02.11	06.14					
	John Cooper Works	155		03.08	06.14					
	One			03.10	06.14					
	One D	66		03.10	06.14					
	Cooper			09.07	06.14		24.3367-1711.7	220753	<input type="checkbox"/>	D=36, - Halter TRW
	Cooper D			09.07	06.14		24.3367-1712.7	220754	<input type="checkbox"/>	D=36, - Halter TRW
	Cooper S			09.07	06.14		24.0101-3803.2	260101		Bremssattel-Zubehör TRW
	Cooper SD	105		02.11	06.14					
	One			03.10	06.14					
	One D	66		03.10	06.14					
	Cooper			09.07	06.14		83.7751-0417.3	331102	2	L=418
	Cooper D			09.07	06.14					
	Cooper S			09.07	06.14					
	Cooper SD	105		02.11	06.14					
	John Cooper Works	155		03.08	06.14					
	One			03.10	06.14					
	One D	66		03.10	06.14					
	Cooper			09.07	06.14		24.3727-0240.2	580240	<input type="checkbox"/>	L=1474
	Cooper D			09.07	06.14		24.3727-0243.2	580243	<input type="checkbox"/>	L=1483
	Cooper S			09.07	06.14					
	Cooper SD	105		02.11	06.14					







































								
MINI R55 Clubman (07-14)								
	John Cooper Works One One D	155 66	03.08 03.10 03.10	06.14 06.14 06.14	24.3727-0240.2 24.3727-0243.2	580240 580243	<input type="checkbox"/> <input type="checkbox"/>	L=1474 L=1483
MINI R55 Clubvan (12-)								
	Cooper Cooper D One	90 82 72	12.12 12.12 12.12		24.4123-1712.3	010897		Thz 23,81 TRW
	Cooper Cooper D One	90 82 72	12.12 12.12 12.12		24.3541-1843.5 24.3541-1844.5	240585 240586	<input type="checkbox"/> <input type="checkbox"/>	D=54, - Halter TRW D=54, - Halter TRW
	Cooper Cooper D One	90 82 72	12.12 12.12 12.12		83.7750-0524.3	331230	2	L=523
	Cooper Cooper D One	90 82 72	12.12 12.12 12.12		24.3367-1711.7 24.3367-1712.7	220753 220754	<input type="checkbox"/> <input type="checkbox"/>	D=36, - Halter TRW D=36, - Halter TRW
	Cooper Cooper D One	90 82 72	12.12 12.12 12.12		83.7751-0417.3	331102	2	L=418
	Cooper Cooper D One	90 82 72	12.12 12.12 12.12		24.3727-0240.2 24.3727-0243.2	580240 580243	<input type="checkbox"/> <input type="checkbox"/>	L=1474 L=1483
MINI R56 (06-14)								
	Cooper Cooper Cooper Cooper D Cooper S Cooper S Cooper S Cooper SD John Cooper Works John Cooper Works One One One One D	85 88 90 128 147 155 160 55 70 72 66	03.10 11.06 03.10 04.07 03.10 11.06 01.12 02.11 03.08 07.07 03.09 04.07 03.10 03.10	06.14 06.14 06.14 06.14 06.14 06.14 06.14 06.14 06.14 06.14 06.14 06.14 06.14 06.14	24.4123-1712.3	010897		Thz 23,81 TRW
	Cooper Cooper Cooper Cooper D Cooper SD One One One One D	85 88 90 55 70 72 66	03.10 11.06 03.10 04.07 02.11 03.09 04.07 03.10 03.10	06.14 06.14 06.14 06.14 06.14 06.14 06.14 06.14 06.14	24.3541-1843.5 24.3541-1844.5	240585 240586	<input type="checkbox"/> <input type="checkbox"/>	D=54, - Halter TRW D=54, - Halter TRW
	Cooper S Cooper S Cooper S	128 147	03.10 11.06 01.12	06.14 06.14 06.14	24.3541-1843.5 24.3541-1844.5	240585 240586	<input type="checkbox"/> <input type="checkbox"/>	D=54, - Halter TRW D=54, - Halter TRW
	Cooper Cooper Cooper Cooper D Cooper S Cooper S Cooper S Cooper SD John Cooper Works John Cooper Works John Cooper Works GP One One One One D	85 88 90 128 147 155 160 160 55 70 72 66	03.10 11.06 03.10 04.07 03.10 11.06 01.12 02.11 03.08 07.07 09.12 03.09 04.07 03.10 03.10	06.14 06.14 06.14 06.14 06.14 06.14 06.14 06.14 06.14 06.14 06.14 06.14 06.14 06.14 06.14	83.7750-0524.3	331230	2	L=523
	Cooper Cooper Cooper Cooper D Cooper S Cooper S Cooper S Cooper SD One One One One D	85 88 90 128 147 55 70 72 66	03.10 11.06 03.10 04.07 03.10 11.06 01.12 02.11 03.09 04.07 03.10 03.10	06.14 06.14 06.14 06.14 06.14 06.14 06.14 06.14 06.14 06.14 06.14 06.14	24.3367-1711.7 24.3367-1712.7 24.0101-3803.2	220753 220754 260101	<input type="checkbox"/> <input type="checkbox"/>	D=36, - Halter TRW D=36, - Halter TRW Bremsattel-Zubehör TRW
	Cooper Cooper Cooper Cooper D Cooper S Cooper S Cooper S	85 88 90 128 147	03.10 11.06 03.10 04.07 03.10 11.06 01.12	06.14 06.14 06.14 06.14 06.14 06.14 06.14	83.7751-0417.3	331102	2	L=418
	Cooper Cooper Cooper Cooper D Cooper S Cooper S Cooper S	85 88 90 128 147	03.10 11.06 03.10 04.07 03.10 11.06 01.12	06.14 06.14 06.14 06.14 06.14 06.14 06.14				







































MINI R56 (06-14)										
	Cooper SD			02.11	06.14		83.7751-0417.3	331102	2	L=418
	John Cooper Works	155		03.08	06.14					
	John Cooper Works	160		07.07	06.14					
	John Cooper Works GP	160		09.12	06.14					
	One	55		03.09	06.14					
	One	70		04.07	06.14					
	One	72		03.10	06.14					
	One D	66		03.10	06.14					
	Cooper	85		03.10	06.14		24.3727-0241.2	580241	<input type="checkbox"/>	L=1393
	Cooper	88		11.06	06.14		24.3727-0242.2	580242	<input type="checkbox"/>	L=1402
	Cooper	90		03.10	06.14					
	Cooper D			04.07	06.14					
	Cooper S			03.10	06.14					
	Cooper S	128		11.06	06.14					
	Cooper S	147		01.12	06.14					
	Cooper SD			02.11	06.14					
	John Cooper Works	155		03.08	06.14					
	John Cooper Works	160		07.07	06.14					
	John Cooper Works GP	160		09.12	06.14					
	One	55		03.09	06.14					
	One	70		04.07	06.14					
	One	72		03.10	06.14					
	One D	66		03.10	06.14					

























MINI R57 Cabrio (09-14)										
	Cooper			01.09	06.14		24.4123-1712.3	010897		THz 23,81
	Cooper	90		03.10	06.14					
	Cooper D	82		06.10	06.14					
	Cooper S			03.10	06.14					
	Cooper S	128		01.09	06.14					
	Cooper SD	105		02.11	06.14					
	John Cooper Works	155		03.09	06.14					
	One	72		03.10	06.14					
	Cooper			01.09	06.14		24.3541-1843.5	240585	<input type="checkbox"/>	D=54, - Halter
	Cooper	90		03.10	06.14		24.3541-1844.5	240586	<input type="checkbox"/>	D=54, - Halter
	Cooper D	82		06.10	06.14		24.3541-1843.5	240585	<input type="checkbox"/>	D=54, - Halter
	Cooper S			03.10	06.14		24.3541-1844.5	240586	<input type="checkbox"/>	D=54, - Halter
	Cooper S	128		01.09	06.14					
	Cooper SD	105		02.11	06.14					
	One	72		03.10	06.14					
	Cooper			01.09	06.14		83.7750-0524.3	331230	2	L=523
	Cooper	90		03.10	06.14					
	Cooper D	82		06.10	06.14					
	Cooper S			03.10	06.14					
	Cooper S	128		01.09	06.14					
	Cooper SD	105		02.11	06.14					
	John Cooper Works	155		03.09	06.14					
	One	72		03.10	06.14					
	Cooper			01.09	06.14		24.3367-1711.7	220753	<input type="checkbox"/>	D=36, - Halter
	Cooper	90		03.10	06.14		24.3367-1712.7	220754	<input type="checkbox"/>	D=36, - Halter
	Cooper D	82		06.10	06.14		24.0101-3803.2	260101		Bremssattel-Zubehör
	Cooper S			03.10	06.14					
	Cooper S	128		01.09	06.14					
	Cooper SD	105		02.11	06.14					
	One	72		03.10	06.14					
	Cooper			01.09	06.14		83.7751-0417.3	331102	2	L=418
	Cooper	90		03.10	06.14					
	Cooper D	82		06.10	06.14					
	Cooper S			03.10	06.14					
	Cooper S	128		01.09	06.14					
	Cooper SD	105		02.11	06.14					
	John Cooper Works	155		03.09	06.14					
	One	72		03.10	06.14					
	Cooper			01.09	06.14		24.3727-0241.2	580241	<input type="checkbox"/>	L=1393
	Cooper	90		03.10	06.14		24.3727-0242.2	580242	<input type="checkbox"/>	L=1402
	Cooper D	82		06.10	06.14					
	Cooper S			03.10	06.14					
	Cooper S	128		01.09	06.14					
	Cooper SD	105		02.11	06.14					
	John Cooper Works	155		03.09	06.14					
	One	72		03.10	06.14					

MINI R58 Coupe (11-)										
	Cooper			10.11			24.4123-1712.3	010897		THz 23,81
	Cooper S			10.11						
	Cooper S JCW	155		10.11						
	Cooper SD			10.11						
	Cooper			10.11			24.3541-1843.5	240585	<input type="checkbox"/>	D=54, - Halter
	Cooper SD			10.11			24.3541-1844.5	240586	<input type="checkbox"/>	D=54, - Halter
	Cooper S			10.11			24.3541-1843.5	240585	<input type="checkbox"/>	D=54, - Halter
							24.3541-1844.5	240586	<input type="checkbox"/>	D=54, - Halter
	Cooper			10.11			83.7750-0524.3	331230	2	L=523
	Cooper S			10.11						
	Cooper S JCW	155		10.11						
	Cooper SD			10.11						

									
MINI R58 Coupe (11-)									
	Cooper Cooper S Cooper SD		10.11 10.11 10.11		24.3367-1711.7 24.3367-1712.7	220753 220754	 	D=36, - Halter D=36, - Halter	TRW TRW
	Cooper Cooper S Cooper S JCW Cooper SD	155	10.11 10.11 10.11 10.11		83.7751-0417.3	331102	2	L=418	
	Cooper Cooper S Cooper S JCW Cooper SD	155	10.11 10.11 10.11 10.11		24.3727-0241.2 24.3727-0242.2	580241 580242	 	L=1393 L=1402	
MINI R59 Roadster (12-)									
	Cooper Cooper S Cooper S JCW Cooper SD	155	02.12 02.12 02.12 02.12		24.4123-1712.3	010897		Thz 23,81	TRW
	Cooper Cooper S Cooper SD		02.12 02.12 02.12		24.3541-1843.5 24.3541-1844.5	240585 240586	 	D=54, - Halter D=54, - Halter	TRW TRW
	Cooper Cooper S Cooper S JCW Cooper SD	155	02.12 02.12 02.12 02.12		83.7750-0524.3	331230	2	L=523	
	Cooper Cooper S Cooper SD		02.12 02.12 02.12		24.3367-1711.7 24.3367-1712.7	220753 220754	 	D=36, - Halter D=36, - Halter	TRW TRW
	Cooper Cooper S Cooper S JCW Cooper SD	155	02.12 02.12 02.12 02.12		83.7751-0417.3	331102	2	L=418	
	Cooper Cooper S Cooper S JCW Cooper SD	155	02.12 02.12 02.12 02.12		24.3727-0241.2 24.3727-0242.2	580241 580242	 	L=1393 L=1402	
MINI R60 Countryman (10-)									
	Cooper Cooper All4 Cooper D Cooper S Cooper S All4 Cooper S JCW Cooper SD Cooper SD All4 Cooper D All4 One One D	90 90 82 147 160 105 105 82 72 66	09.10 11.14 09.10 09.10 02.12 09.10 02.11 02.11 09.10 09.10 09.10		24.4123-1712.3	010897		Thz 23,81	TRW
	Cooper Cooper All4 Cooper D Cooper SD Cooper SD All4 Cooper D All4 One One D	90 90 82 105 82 72 66	09.10 11.14 09.10 02.11 02.11 09.10 09.10 09.10		24.3541-1853.5 24.3541-1854.5	240623 240624	 	D=54, - Halter D=54, - Halter	TRW TRW
MINI R61 Paceman (12-)									
	Cooper Cooper All4 Cooper D Cooper D All4 Cooper S Cooper S All4 Cooper S JCW Cooper SD Cooper SD All4	90 90 82 82 135 135 160 105 105	11.12 07.14 11.12 11.12 11.12 11.12 11.12 11.12 11.12		24.4123-1712.3	010897		Thz 23,81	TRW
	Cooper Cooper All4 Cooper D Cooper D All4 Cooper SD Cooper SD All4	90 90 82 82 105 105	11.12 07.14 11.12 11.12 11.12 11.12		24.3541-1853.5 24.3541-1854.5	240623 240624	 	D=54, - Halter D=54, - Halter	TRW TRW
MITSUBISHI ASX (10-)									
	1.6 i 16V 1.6 i 16V 1.8 DI-D 1.8 DI-D 1.8 DI-D 4WD 1.8 DI-D 4WD 1.8 i 16V 1.8 i 16V 4WD 2.0 i 16V 2.0 i 16V	85 86 85 110 85 110 102 102 110 118	06.10 06.10 06.10 06.10 06.10 06.10 02.10 02.10 06.10 06.10	06.12 06.12 06.12 06.12 06.12 06.12 06.12 06.12 06.12 06.12	24.5286-0615.3	331493		L=615	























										
MITSUBISHI ASX (10-)										
	2.0 i 16V 4WD 2.0 i 16V 4WD	110 118		06.10 06.10	06.12 06.12	24.5286-0615.3	331493	<input type="checkbox"/>	L=615	
	1.6 i 16V 1.6 i 16V 1.8 DI-D 1.8 DI-D 1.8 DI-D 4WD 1.8 DI-D 4WD 1.8 i 16V 1.8 i 16V 4WD 2.0 i 16V 2.0 i 16V 2.0 i 16V 4WD 2.0 i 16V 4WD	85 86 85 110 85 110 102 102 110 118 110 118		06.10 06.10 06.10 06.10 06.10 06.10 02.10 02.10 06.10 06.10 06.10 06.10	06.12 06.12 06.12 06.12 06.12 06.12 06.12 06.12 06.12 06.12 06.12 06.12	24.5247-0237.3 24.5247-0236.3	331418 331417	<input type="checkbox"/> <input type="checkbox"/>	L=235 L=235	
MITSUBISHI CARISMA (95-06)										
	1.6 i (DA1A) 1.8 i (DA2A) 1.8 i 16V (DA2A)	66 85 103		07.95 07.95 07.95	06.06 - ABS 06.06 - ABS 06.06 - ABS	24.2122-1718.3	010517	<input type="checkbox"/>	Thz 22,20	
	1.6 i (DA1A) 1.6 i 16V (DA1A) 1.6 i 16V (DA1A) 1.8 i (DA2A) 1.8 i 16V (DA2A) 1.8 i 16V GDI (DA2A) 1.9 TD (DA4A)	66 70 73 85 103 92 66		03.99 03.99 03.99 07.95 07.95 09.97 03.99	06.00 06.06 06.06 02.99 02.99 08.00 09.00	24.3541-1783.5 24.3541-1784.5	240269 240270	<input type="checkbox"/> <input type="checkbox"/>	D=54, - Halter D=54, - Halter	TRW TRW
	1.3 i (DA6A) 1.6 i (DA1A) 1.6 i 16V (DA1A) 1.8 i (DA2A) 1.8 i 16V (DA2A) 1.8 i 16V GDI (DA2A) 1.9 DI-D (DA5A) 1.9 DI-D (DA5A)	55 66 76 85 103 92 75 85		09.00 07.00 06.99 03.99 03.99 09.00 09.00 09.00	10.04 06.06 06.06 06.06 06.06 06.06 06.06 06.06	24.3541-1785.5 24.3541-1786.5	240271 240272	<input type="checkbox"/> <input type="checkbox"/>	D=54, - Halter D=54, - Halter	TRW TRW
	1.3 i (DA6A) 1.6 i (DA1A) 1.6 i 16V (DA1A) 1.6 i 16V (DA1A) 1.6 i 16V (DA1A) 1.8 i (DA2A) 1.8 i 16V (DA2A) 1.8 i 16V GDI (DA2A) 1.8 i 16V GDI (DA2A) 1.9 DI-D (DA5A) 1.9 DI-D (DA5A) 1.9 TD (DA4A)	55 66 70 73 76 85 103 90 92 75 85 66		09.00 07.95 12.98 05.97 06.99 07.95 07.95 10.00 09.97 09.00 09.00 10.96	10.04 06.06 06.06 06.06 06.06 06.06 06.06 06.06 06.06 06.06 06.06 09.00	24.5248-0461.3	330707	2	L=460	
	1.3 i (DA6A) 1.6 i (DA1A) 1.6 i 16V (DA1A) 1.8 i (DA2A) 1.8 i 16V (DA2A) 1.8 i 16V GDI (DA2A) 1.8 i 16V GDI (DA2A) 1.9 DI-D (DA5A) 1.9 DI-D (DA5A)	55 66 76 85 103 90 92 75 85		09.00 06.99 06.99 11.97 11.97 10.00 06.99 09.00 09.00	10.04 + ABS + ABS + ABS + ABS + ABS + ABS + ABS + ABS	24.3384-1743.5 24.3384-1744.5	240319 240320	<input type="checkbox"/> <input type="checkbox"/>	D=38, - Halter D=38, - Halter	TRW TRW
	1.3 i (DA6A) 1.6 i (DA1A) 1.6 i 16V (DA1A) 1.6 i 16V (DA1A) 1.6 i 16V (DA1A) 1.8 i (DA2A) 1.8 i 16V (DA2A) 1.8 i 16V GDI (DA2A) 1.8 i 16V GDI (DA2A) 1.9 DI-D (DA5A) 1.9 DI-D (DA5A) 1.9 TD (DA4A)	55 66 70 73 76 85 103 90 92 75 85 66		09.00 07.95 12.98 05.97 06.99 07.95 07.95 10.00 09.97 09.00 09.00 10.96	10.04 06.06 06.06 06.06 06.06 06.06 06.06 06.06 06.06 06.06 06.06 09.00	24.5249-0416.3	330708	2	L=416	
	1.6 i (DA1A) 1.6 i 16V (DA1A) 1.8 i (DA2A) 1.8 i 16V (DA2A) 1.8 i 16V GDI (DA2A) 1.9 TD (DA4A)	66 73 85 103 92 66		07.95 05.97 07.95 07.95 09.97 10.96	09.98 - ABS 09.98 - ABS 06.06 - ABS 06.06 - ABS 09.98 - ABS 09.98 - ABS	24.3219-1753.3	020506	<input type="checkbox"/>	Rz 19,05	
	1.6 i (DA1A) 1.6 i 16V (DA1A) 1.6 i 16V (DA1A) 1.6 i 16V (DA1A) 1.8 i 16V GDI (DA2A) 1.8 i 16V GDI (DA2A) 1.9 TD (DA4A)	66 70 73 76 90 92 66		10.98 12.98 10.98 06.99 10.00 10.98 10.98	06.06 - ABS 06.06 - ABS 06.06 - ABS 06.06 - ABS 06.06 - ABS 06.06 - ABS 09.00 - ABS	24.3219-1745.3	020496	<input type="checkbox"/>	Rz 19,05	
	1.3 i (DA6A) 1.6 i 16V (DA1A) 1.8 i (DA2A) 1.8 i 16V (DA2A) 1.8 i 16V GDI (DA2A)	55 76 85 103 90		09.00 09.00 07.00 10.00	10.04 06.06 06.06 06.06 06.06	24.3727-2109.2 24.3727-2108.2	582109 582108	<input type="checkbox"/> <input type="checkbox"/>	L=1588 L=1588	

									
MITSUBISHI CARISMA (95-06)									
	1.8 i 16V GDI (DA2A)	92		07.00	06.06	24.3727-2109.2	582109	<input type="checkbox"/>	L=1588
	1.9 DI-D (DA5A)	75		09.00	06.06	24.3727-2108.2	582108	<input type="checkbox"/>	L=1588
	1.9 DI-D (DA5A)	85		09.00	06.06				
MITSUBISHI COLT/LANCER Limousine (96-03)									
	1.3 i 12V (CJ1A)	55		05.96	08.00	24.5205-0205.3	330780	2	L=205
	1.3 i 12V (CK1A)	55		05.96	07.01				
	1.3 i 16V (CJ1A)	60		09.00	06.03				
	1.6 i 16V (CJ4A)	66		05.96	08.00				
	1.6 i 16V (CJ4A)	76		09.00	06.03				
	1.6 i 16V (CK4A)	66		05.96	07.01				
	1.3 i 12V (CJ1A)	55		05.96	08.00	24.3219-1752.3	020505	- ABS	Rz 19,05
	1.3 i 12V (CK1A)	55		05.96	07.01				
	1.3 i 16V (CJ1A)	60		09.00	06.03				
	1.6 i 16V (CJ4A)	66		05.96	08.00				
	1.6 i 16V (CJ4A)	76		09.00	06.03				
	1.6 i 16V (CK4A)	66		05.96	07.01				
MITSUBISHI COLT (04-12)									
	1.1 Bifuel	55		10.04	09.08	24.2122-1770.3	010898		Thz 22,20 TRW
	1.1 i 12V (Z32A)	55		10.04	09.08				
	1.3 Bifuel	70		06.04	09.08				
	1.3 i 16V	68		10.04	09.08				
	1.3 i 16V (Z34A)	70		06.04	09.08				
	1.5 CZT (Z37A)	110		03.05	09.08				
	1.5 DI-D (Z38A)	50		08.04	06.12				
	1.5 DI-D (Z39A)	70		08.04	06.12				
	1.5 i 16V (Z27A)	72		09.04	02.06				
	1.5 i 16V (Z36A)	80		06.04	09.08				
	1.5 i 16V (Z37A)	132		05.07	09.08				
	1.1 Bifuel	55		10.08	06.12	24.4122-1717.3	010993		Thz 22,20 - Behälter TRW
	1.1 i 12V (Z32A)	55		10.08	06.12				
	1.3 Bifuel	70		10.08	06.12				
	1.3 i 16V	68		10.08	06.12				
	1.3 i 16V (Z34A)	70		10.08	06.12				
	1.5 CZT (Z37A)	110		10.08	06.12				
	1.5 i 16V (Z36A)	80		10.08	06.12				
	1.5 i 16V (Z37A)	132		10.08	06.12				
	1.1 Bifuel	55		10.04	06.12	24.3541-1819.7	220767	<input type="checkbox"/>	D=54, - Halter TRW
	1.1 i 12V (Z32A)	55		10.04	06.12	24.3541-1820.7	220768	<input type="checkbox"/>	D=54, - Halter TRW
	1.3 Bifuel	70		06.04	06.12				
	1.3 i 16V	68		10.04	06.12				
	1.3 i 16V (Z34A)	70		06.04	06.12				
	1.5 DI-D (Z38A)	50		08.04	06.12				
	1.5 DI-D (Z39A)	70		08.04	06.12				
	1.5 i 16V (Z27A)	72		09.04	02.06				
	1.5 i 16V (Z36A)	80		06.04	06.12				
	1.5 i 16V (Z37A)	132		05.07	09.08				
	1.1 Bifuel	55		05.07	06.12	24.5298-0475.3	331255	2	L=474
	1.1 i 12V (Z32A)	55		05.07	06.12				
	1.3 Bifuel	70		05.07	06.12				
	1.3 i 16V	68		05.07	06.12				
	1.3 i 16V (Z34A)	70		05.07	06.12				
	1.5 CZT (Z37A)	110		05.07	06.12				
	1.5 DI-D (Z38A)	50		05.07	06.12				
	1.5 DI-D (Z39A)	70		05.07	06.12				
	1.5 i 16V (Z36A)	80		05.07	06.12				
	1.5 i 16V (Z37A)	132		05.07	06.12				
	1.1 Bifuel	55		10.04	06.12	24.3344-1725.7	220771	<input type="checkbox"/>	D=34, - Halter TRW
	1.1 i 12V (Z32A)	55		10.04	06.12	24.3344-1726.7	220772	<input type="checkbox"/>	D=34, - Halter TRW
	1.3 Bifuel	70		06.04	06.12				
	1.3 i 16V	68		10.04	06.12				
	1.3 i 16V (Z34A)	70		06.04	06.12				
	1.5 CZT (Z37A)	110		03.05	06.12				
	1.5 DI-D (Z38A)	50		08.04	06.12				
	1.5 DI-D (Z39A)	70		08.04	06.12				
	1.5 i 16V (Z27A)	72		09.04	02.06				
	1.5 i 16V (Z36A)	80		06.04	06.12				
	1.5 i 16V (Z37A)	132		05.07	06.12				
	1.1 Bifuel	55		10.04	01.09	24.5150-0459.3	331018	2	L=459
	1.1 i 12V (Z32A)	55		10.04	01.09				
	1.3 Bifuel	70		06.04	01.09				
	1.3 i 16V	68		10.04	01.09				
	1.3 i 16V (Z34A)	70		06.04	01.09				
	1.5 DI-D (Z38A)	50		08.04	06.12				
	1.5 DI-D (Z39A)	70		08.04	06.12				
	1.1 Bifuel	55		10.04	01.09	24.5150-0459.3	331018	2	L=459
	1.1 i 12V (Z32A)	55		10.04	01.09				
	1.3 Bifuel	70		06.04	01.09				
	1.3 i 16V	68		10.04	01.09				
	1.3 i 16V (Z34A)	70		06.04	01.09				
	1.5 CZT (Z37A)	110		03.05	01.09				
	1.5 DI-D (Z38A)	50		08.04	06.12				
	1.5 DI-D (Z39A)	70		08.04	06.12				
	1.5 i 16V (Z27A)	72		09.04	02.06				
	1.5 i 16V (Z36A)	80		06.04	01.09				
	1.5 i 16V (Z37A)	132		05.07	01.09				















									
MITSUBISHI COLT (04-12)									
	1.1 Bifuel 1.1 i 12V (Z32A) 1.3 Bifuel 1.3 i 16V 1.3 i 16V (Z34A) 1.5 CZT (Z37A) 1.5 i 16V (Z36A) 1.5 i 16V (Z37A)	55 55 70 68 70 110 80 132		02.09 02.09 02.09 02.09 02.09 02.09 02.09	06.12 06.12 06.12 06.12 06.12 06.12 06.12	24.5150-0459.3	331018	2	L=459
	1.1 Bifuel 1.1 i 12V (Z32A) 1.3 Bifuel 1.3 i 16V 1.3 i 16V (Z34A) 1.5 DI-D (Z38A) 1.5 DI-D (Z39A)	55 55 70 68 70 50 70		10.04 10.04 06.04 10.04 06.04 08.04 08.04	06.12 06.12 06.12 06.12 06.12 06.12 06.12	24.3219-1757.3	020517		Rz 19,05 TRW
	1.1 Bifuel 1.1 i 12V (Z32A) 1.3 Bifuel 1.3 i 16V 1.3 i 16V (Z34A) 1.5 DI-D (Z38A) 1.5 DI-D (Z39A)	55 55 70 68 70 50 70		10.04 10.04 06.04 10.04 06.04 08.04 08.04	06.12 06.12 06.12 06.12 06.12 06.12 06.12	24.3727-2112.2 24.3727-2113.2	582112 582113	<input type="checkbox"/> + Trommelbremse ¹⁾ <input type="checkbox"/> + Trommelbremse ¹⁾	L=1525 L=1560
	1.1 Bifuel 1.1 i 12V (Z32A) 1.3 Bifuel 1.3 i 16V 1.3 i 16V (Z34A) 1.5 CZT (Z37A) 1.5 DI-D (Z38A) 1.5 DI-D (Z39A) 1.5 i 16V (Z27A) 1.5 i 16V (Z36A) 1.5 i 16V (Z37A)	55 55 70 68 70 110 50 70 72 80 132		10.04 10.04 06.04 10.04 06.04 03.05 08.04 08.04 09.04 06.04 07.05	06.12 06.12 06.12 06.12 06.12 06.12 06.12 06.12 02.06 06.12 06.12	24.3727-2110.2 24.3727-2111.2	582110 582111	<input type="checkbox"/> + Scheibenbremse ²⁾ <input type="checkbox"/> + Scheibenbremse ²⁾	L=1540 L=1570
MITSUBISHI COLT CZC Cabriolet (06-09)									
	1.5 16V (Z36A) 1.5 Turbo (Z37A)	80 110		05.06 05.06	07.09 07.09	24.2122-1770.3	010898		THz 22,20 TRW
	1.5 16V (Z36A)	80		05.06	07.09	24.3541-1819.7 24.3541-1820.7	220767 220768	<input type="checkbox"/> <input type="checkbox"/>	D=54, - Halter D=54, - Halter TRW TRW
	1.5 16V (Z36A) 1.5 Turbo (Z37A)	80 110		05.07 05.07	07.09 07.09	24.5298-0475.3	331255	2	L=474
	1.5 16V (Z36A) 1.5 Turbo (Z37A)	80 110		05.06 05.06	07.09 07.09	24.3344-1725.7 24.3344-1726.7	220771 220772	<input type="checkbox"/> <input type="checkbox"/>	D=34, - Halter D=34, - Halter TRW TRW
	1.5 16V (Z36A) 1.5 Turbo (Z37A)	80 110		05.06 05.06	07.09 07.09	24.5150-0459.3	331018	2	L=459
	1.5 16V (Z36A) 1.5 Turbo (Z37A)	80 110		05.06 05.06	07.09 07.09	24.3727-2110.2 24.3727-2111.2	582110 582111	<input type="checkbox"/> <input type="checkbox"/>	L=1540 L=1570
MITSUBISHI GALANT (96-03)									
	2.4 GDi (EA3) 2.5 i V6 (EA5)	110 120		03.99 12.97	03.00 03.00	24.3431-1701.5 24.3431-1702.5	240437 240438	<input type="checkbox"/> <input type="checkbox"/>	D=43/43, - Halter D=43/43, - Halter
	2.0 i 16V (EA2) 2.0 i 16V (EA2) 2.0 i 16V (EA2W) 2.0 i 16V (EA2W) 2.0 TDi (EA6) 2.4 GDi (EA3) 2.4 GDi (EA3) 2.5 i V6 (EA5) 2.5 i V6 (EA5)	98 100 98 100 66 106 110 118 120		04.00 10.96 04.00 10.96 10.96 04.00 03.99 04.00 10.96	10.03 10.03 10.03 10.03 07.01 10.03 10.03 10.03 10.03	24.5290-0545.3	331063	2	L=545
	2.0 TDi (EA6)	66		10.96	07.01	24.5230-0243.3	331155	2	L=243
MITSUBISHI GALLOPER (99-03)									
	2.5 TD 2.5 TD Intercooler 3.0 V6	65 73 104		01.99 01.99 01.99	12.03 12.03 12.03	24.3431-1705.5 24.3431-1706.5	240365 240366	<input type="checkbox"/> <input type="checkbox"/>	D=43/43, - Halter D=43/43, - Halter
MITSUBISHI i-MiEV (09-14)									
	i-MiEV i-MiEV	35 49		07.09 02.11	04.14	24.3219-1753.3	020506		Rz 19,05













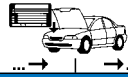





¹⁾ + drum brake / + freno a tamburo / + freins à tambour / + tambores de freno

²⁾ + disc brake / + disco freno / + disques de frein / + disco de freno























								
MITSUBISHI L 200 (96-06)								
	2.5 TD 4WD (K74T)	73		06.96	07.01	24.3431-1705.5	240365	D=43/43, - Halter D=43/43, - Halter
	2.5 TD 4WD (K74T)	85		08.01	04.06	24.3431-1706.5	240366	
	2.5 TDi 4WD (K74T)	98		08.01	04.06			
	2.5 TD 4WD (K74T)	73		06.96	07.01	24.5260-0155.3	331156	2 am Bremsattel ¹⁾ L=155
	2.5 TD 4WD (K74T)	85		08.01	04.06			
	2.5 TDi 4WD (K74T)	98		08.01	04.06			
	2.4 i 4WD (K75T)	97		06.96	07.01	24.5284-0400.3	331060	
MITSUBISHI L 200 (06-15)								
	2.5 DI-D	103		04.10		24.5241-0721.3	331416	L=720 L=720
	2.5 DI-D	123		10.07		24.5241-0720.3	331415	
	2.5 DI-D 4x4	100		01.06				
	2.5 DI-D 4x4	103		04.10				
	2.5 DI-D 4x4	131		04.10				
	2.5 DI-D RWD	94		04.10				
	2.5 DI-D RWD	100		01.06				
	2.5 DI-D RWD	123		08.07				
	2.5 DI-D	103		04.10		24.3222-1736.3	020562	Rz 22,20 Rz 22,20
	2.5 DI-D	123		10.07		24.3222-1737.3	020563	
	2.5 DI-D 4x4	100		01.06				
	2.5 DI-D 4x4	103		04.10				
	2.5 DI-D 4x4	131		04.10				
	2.5 DI-D RWD	94		04.10				
	2.5 DI-D RWD	100		01.06				
	2.5 DI-D RWD	123		08.07				
MITSUBISHI L 200 (15-)								
	2.4 DI-D (KJOT)	113		09.15		24.3222-1737.3	020563	Rz 22,20
MITSUBISHI L 300 (94-00) (Kabine und Chassis)								
	2.0 (P13T)	85		06.94	04.00	24.3571-1737.5	240387	D=57, - Halter D=57, - Halter
	2.5 TD (P15T)	64		06.94	05.99	24.3571-1738.5	240388	
MITSUBISHI L 400 (96-05)								
	2.4	97		06.96	06.05	24.3431-1705.5	240365	D=43/43, - Halter D=43/43, - Halter
	2.4 4x4	94		06.96	06.05	24.3431-1706.5	240366	
MITSUBISHI LANCER Evolution (04-07)								
	2.0 i 16V 4WD (CT9A)	195		03.04	12.05	24.3431-1701.5	240437	D=43/43, - Halter D=43/43, - Halter
						24.3431-1702.5	240438	
	2.0 i 16V (CT9A)	206		01.06	08.07	24.5286-0545.3	331250	L=545
MITSUBISHI LANCER Limousine (03-07)								
	1.3 i 16V (CS1A)	60		09.03	03.07	24.5286-0545.3	331250	L=545
	1.6 i 16V (CS3A)	72		09.03	03.07			
	2.0 i 16V (CS9A)	99		12.03	03.07			
MITSUBISHI LANCER Kombi (03-07)								
	1.6 i 16V (CS3W)	72		09.03	03.07	24.5286-0545.3	331250	L=545
	2.0 i 16V (CS9W)	99		09.03	03.07			
	2.4 i 16V (CS9W)	98		09.03	03.07			
MITSUBISHI LANCER Stufenheck/Sportlimousine (CY_A) (07-)								
	1.5 16V (CY2A)	80		06.08		24.5286-0615.3	331493	L=615
	1.6 16V ((CY1A)	86		05.10				
	1.8 16V (CY3A)	103		05.10				
	1.8 16V (CY3A)	105		02.08				
	1.8 16V Flex (CY3A)	103		03.09				
	1.8 DI-D (CY9A)	85		05.10				
	1.8 DI-D (CY9A)	110		06.10				
	2.0 16V (CY4A)	108		01.09				
	2.0 16V (CY4A)	113		10.07				
	2.0 16V Turbo (CY4A)	177		10.08				
	2.0 DI-D (CY8A)	103		01.08				
	1.5 16V (CY2A)	80		06.08		24.5247-0237.3	331418	L=235 L=235
	1.6 16V ((CY1A)	86		05.10		24.5247-0236.3	331417	
	1.8 16V (CY3A)	103		05.10				
	1.8 16V (CY3A)	105		02.08				
	1.8 16V Flex (CY3A)	103		03.09				
	1.8 DI-D (CY9A)	85		05.10				
	1.8 DI-D (CY9A)	110		06.10				
	2.0 16V (CY4A)	108		01.09				
	2.0 16V (CY4A)	113		10.07				
	2.0 16V Turbo (CY4A)	177		10.08				
	2.0 DI-D (CY8A)	103		01.08				

¹⁾ on the brake caliper / sulla pinza freno / sur l'étrier de frein / a la pinza de freno

										
MITSUBISHI LANCER Sportback (CX_A) (08-)										
	2.0 Ralliart (CX4A)	177		10.08		24.3431-1701.5	240437	D=43/43, - Halter D=43/43, - Halter		
	2.0 Ralliart (CX4A)	184		08.11		24.3431-1702.5	240438			
	1.5 16V (CX2A)	80		06.08		24.5286-0615.3	331493	L=615		
	1.5 Bifuel (CX2A)	80		03.10						
	1.6 16V (CX1A)	86		05.10						
	1.8 16V (CX3A)	103		03.09						
	1.8 16V (CX3A)	105		06.08						
	1.8 16V Flex (CX3A)	103		03.09						
	1.8 Bifuel (CX3A)	105		02.10						
	1.8 DI-D (CX9A)	85		05.10						
	1.8 DI-D (CX9A)	110		06.10						
	2.0 DI-D (CX8A)	103		06.08						
2.0 Ralliart (CX4A)	177		10.08		24.5286-0600.3	331173	L=600 L=600			
2.0 Ralliart (CX4A)	184		08.11		24.5286-0601.3	331174				
	1.5 16V (CX2A)	80		06.08		24.5247-0237.3	331418	L=235 L=235		
	1.5 Bifuel (CX2A)	80		03.10		24.5247-0236.3	331417			
	1.6 16V (CX1A)	86		05.10						
	1.8 16V (CX3A)	103		03.09						
	1.8 16V (CX3A)	105		06.08						
	1.8 16V Flex (CX3A)	103		03.09						
	1.8 Bifuel (CX3A)	105		02.10						
	1.8 DI-D (CX9A)	85		05.10						
	1.8 DI-D (CX9A)	110		06.10						
	2.0 DI-D (CX8A)	103		06.08						
2.0 Ralliart (CX4A)	177		10.08		24.5247-0275.3	331244	L=275			
2.0 Ralliart (CX4A)	184		08.11							
MITSUBISHI OUTLANDER I (03-06)										
	2.0 i 16V	100		05.03	10.06	24.3431-1701.5	240437	D=43/43, - Halter D=43/43, - Halter		
	2.0 i 16V 4WD	93		05.03	10.06	24.3431-1702.5	240438			
	2.0 i 16V 4WD	100		05.03	10.06					
	2.0 i 16V 4WD	177		05.03	10.06					
	2.0 i 16V Turbo 4WD	148		04.04	10.06					
	2.4 GDI 4WD	121		01.05	10.06					
	2.4 i 16V 4WD	102		05.03	10.06					
	2.4 i 16V 4WD	118		11.03	10.06					
	2.4 i 16V 4WD	119		05.03	10.06					
	2.4 i 16V 4WD	121		10.05	10.06					
	2.4 Mivec	118		07.03	10.06					
	MITSUBISHI OUTLANDER II (06-12)									
		2.0 DI-D	103		01.07	11.12	24.3431-1701.5		240437	D=43/43, - Halter D=43/43, - Halter
2.0 i 16V		108		11.06	11.12	24.3431-1702.5	240438			
2.0 i 16V 4x4		108		11.06	11.12					
2.2 DI-D		130		11.06	11.12					
2.2 DI-D 4x4		103		09.10	11.12					
2.2 DI-D 4x4		115		08.07	11.12					
2.2 DI-D 4x4		130		11.06	11.12					
2.4 Flex 4x4		125		09.07	11.12					
2.4 i 16V		125		11.06	11.12					
2.4 Mivec 4x4		125		09.07	11.12					
3.0 V6 4x4		162		11.06	11.12					
3.0 V6 4x4		177		10.09	11.12					
3.0 V6 FWD		162		11.06	11.12					
2.0 DI-D		103		01.07	11.12	24.5286-0600.3	331173	L=600 L=600		
2.0 i 16V	108		11.06	03.10	24.5286-0601.3	331174				
2.0 i 16V 4x4	108		11.06	03.10						
2.2 DI-D	130		11.06	11.12						
2.2 DI-D 4x4	103		09.10	11.12						
2.2 DI-D 4x4	115		08.07	11.12						
2.2 DI-D 4x4	130		11.06	11.12						
3.0 V6 4x4	162		11.06	11.12						
3.0 V6 4x4	177		10.09	11.12						
3.0 V6 FWD	162		11.06	11.12						
2.0 DI-D	103		01.07	11.12	24.5247-0275.3	331244	L=275			
2.2 DI-D 4x4	115		08.07	11.12						
2.4 Flex 4x4	125		09.07	11.12						
3.0 V6 4x4	162		11.06	11.12						
3.0 V6 4x4	177		10.09	11.12						
3.0 V6 FWD	162		11.06	11.12						
2.0 i 16V	108		11.06	03.10	24.5247-0237.3	331418	L=235 L=235			
2.0 i 16V 4x4	108		11.06	03.10	24.5247-0236.3	331417				
MITSUBISHI OUTLANDER III (12-)										
	2.0 16V	107		10.12		24.3431-1701.5	240437	D=43/43, - Halter D=43/43, - Halter		
	2.0 16V	110		08.12		24.3431-1702.5	240438			
	2.0 16V 4WD	107		10.12						
	2.0 16V 4WD	110		08.12						
	2.0 16V Hybrid 4WD	89		12.12						
	2.2 DI-D	110		08.12						
	2.2 DI-D 4WD	110		08.12						

























										
MITSUBISHI PAJERO (90-00)										
	2.4 (V21C/V21W)	82		12.90	03.00		24.3431-1705.5	240365	D=43/43, - Halter D=43/43, - Halter	
	2.4 (V41W)	82		12.90	03.00		24.3431-1706.5	240366		
	2.5 TD (V24C/V24W)	73		12.90	03.00					
	2.5 TD (V44W)	73		12.90	03.00					
	2.8 D 4x4 (V26W)	71		11.93	03.00					
	2.8 TD (V46W)	92		11.93	03.00					
	3.0 V6 (V23C/V23W)			12.90	03.00					
	3.0 V6 (V43W)	130		12.90	03.00					
	2.4 (V21C/V21W)	82		06.96	03.00		24.5284-0400.3	331060	2	L=400
	2.4 (V41W)	82		06.96	03.00					
	2.5 TD (V24C/V24W)	73		06.96	03.00					
	2.5 TD (V44W)	73		06.96	03.00					
	2.8 D 4x4 (V26W)	71		06.96	03.00					
	2.8 TD (V46W)	92		06.96	03.00					
	3.0 V6 (V23C/V23W)			06.96	03.00					
	3.0 V6 (V43W)	130		06.96	03.00					
	3.5 V6 (V25W)	153		06.96	03.00					
	3.5 V6 (V45W)	143		06.96	03.00					
	2.4 (V21C/V21W)	82		12.90	03.00		24.3431-1703.5	240363	D=43, - Halter D=43, - Halter	
	2.4 (V41W)	82		12.90	03.00		24.3431-1704.5	240364		
	2.5 TD (V24C/V24W)	73		12.90	03.00					
	2.5 TD (V44W)	73		12.90	03.00					
	2.8 D 4x4 (V26W)	71		11.93	03.00					
	2.8 TD (V46W)	92		11.93	03.00					
	3.0 V6 (V23C/V23W)			12.90	03.00					
	3.0 V6 (V43W)	130		12.90	03.00					
	3.5 V6 (V25W)	153		11.93	03.00					
	3.5 V6 (V45W)	143		11.93	03.00					
	2.4 (V21C/V21W)	82		12.90	03.00		24.5159-0195.3	331153	2	L=195
	2.4 (V41W)	82		12.90	03.00					
	2.5 TD (V24C/V24W)	73		12.90	03.00					
	2.5 TD (V44W)	73		12.90	03.00					
	2.8 D 4x4 (V26W)	71		11.93	03.00					
	2.8 TD (V46W)	92		11.93	03.00					
	3.0 V6 (V23C/V23W)			12.90	03.00					
	3.0 V6 (V43W)	130		12.90	03.00					
	3.5 V6 (V25W)	153		11.93	03.00					
	3.5 V6 (V45W)	143		11.93	03.00					
MITSUBISHI PAJERO (00-07)										
	2.5 TDiC (V64W)	73		04.00	01.07		24.5286-0660.3	331252	2	L=660
	2.5 TDiC (V64W)	85		04.00	01.07					
	3.2 DiD (V68W)	118		10.01	08.06					
	3.2 DiD (V68W)	121		04.00	09.01					
	3.5 i V6 GDI (V65W)	149		04.00	08.06					
	2.5 TDiC (V64W)	73		04.00	01.07		24.5286-0540.3	331249	2	L=540
	2.5 TDiC (V64W)	85		04.00	01.07					
	3.2 DiD (V68W)	118		10.01	08.06					
	3.2 DiD (V68W)	121		04.00	09.01					
	3.5 i V6 GDI (V65W)	149		04.00	08.06					
MITSUBISHI PAJERO (07-)										
	3.0 i V6 (V93W)	131		02.07			24.5286-0660.3	331252	2	L=660
	3.2 DI-D (V88W)	118		02.07						
	3.2 DI-D (V88W)	125		02.07						
	3.2 DI-D (V98W)	118		02.07						
	3.2 DI-D (V98W)	125		02.07						
	3.2 DI-D 4x4 (V88W)	140		02.07						
	3.2 TD 4x4 (V88W)	147		01.09						
	3.2 TD 4x4 (V98W)	147		01.09						
	3.8 i V6 (V87W)	182		02.10						
	3.8 i V6 (V87W)	184		02.07						
	3.8 i V6 (V97W)	182		02.10						
	3.8 i V6 (V97W)	184		02.07						
	3.2 DI-D (V88W)	118		02.07			24.5286-0540.3	331249	2	L=540
	3.2 DI-D (V88W)	125		02.07						
	3.2 DI-D 4x4 (V88W)	140		02.07						
	3.2 TD 4x4 (V88W)	147		01.09						
	3.8 i V6 (V87W)	182		02.10						
	3.8 i V6 (V87W)	184		02.07						
	3.0 i V6 (V93W)	131		02.07			24.5286-0556.3	331251	2	L=555
	3.2 DI-D (V98W)	118		02.07						
	3.2 DI-D (V98W)	125		02.07						
	3.2 TD 4x4 (V98W)	147		01.09						
	3.8 i V6 (V97W)	182		02.10						
	3.8 i V6 (V97W)	184		02.07						
MITSUBISHI PAJERO PININ / SHOGUN PININ (GB) (99-05)										
	1.8 i 16V (H67W)	84		11.01	02.05		24.5286-0485.3	331172	2	L=495
	1.8 i 16V GDi (H66W)	88		10.99	10.01					
	2.0 16V GDi (H77W)	95		09.00	02.05					
	1.8 i 16V (H67W)	84		11.01	02.05		24.5279-0225.3	331163	2	L=225
	1.8 i 16V GDi (H66W)	88		10.99	10.01		24.5160-0215.3	331154	2	L=215
	2.0 16V GDi (H77W)	95		09.00	02.05					am Bremssattel ¹⁾

¹⁾ on the brake caliper / sulla pinza freno / sur l'étrier de frein / a la pinza de freno

































									
MITSUBISHI PAJERO SPORT / MONTERO (USA) (98-09)									
	2.5 TDCi (K94W) 73 2.5 TDCi (K94W) 85 2.5 TDCi (K94W) 98 2.8 TDI 87		11.98 02.09 07.02 02.09 08.03 02.09 11.98 02.09		24.3431-1705.5 240365 24.3431-1706.5 240366	<input type="checkbox"/> <input type="checkbox"/>		D=43/43, - Halter D=43/43, - Halter	
	2.5 TDCi (K94W) 73 2.5 TDCi (K94W) 85 2.5 TDCi (K94W) 98 2.8 TDI 87 3.0 i V6 (K96W) 125 3.0 i V6 (K96W) 130		11.98 02.09 07.02 02.09 08.03 02.09 11.98 02.09 06.00 02.09 11.98 09.01		24.5158-0164.3 331152 24.5284-0400.3 331060	2 2	am Bremssattel ¹⁾	L=165 L=400	
	2.5 TDCi (K94W) 73 2.5 TDCi (K94W) 85 2.5 TDCi (K94W) 98 2.8 TDI 87 3.0 i V6 (K96W) 125 3.0 i V6 (K96W) 130		11.98 02.09 07.02 02.09 08.03 02.09 11.98 02.09 06.00 02.09 11.98 09.01		24.5159-0195.3 331153	2		L=195	
MITSUBISHI PAJERO SPORT (KH_) (09-)									
	2.4 94 2.5 DI-D 131 2.5 DI-D 4WD 131 3.0 V6 4WD 162 3.2 DI-D 121		11.09 11.09 11.09 11.09 11.09	- Europa ²⁾ - Europa ²⁾ - Europa ²⁾ - Europa ²⁾ - Europa ²⁾	24.5241-0721.3 331416 24.5241-0720.3 331415	<input type="checkbox"/> <input type="checkbox"/>		L=720 L=720	
MITSUBISHI SANTAMO (99-04)									
	2.0 i 16V 102 2.0 i 16V 4WD 102		05.99 12.04 05.99 12.04		24.3541-1815.5 240383 24.3541-1816.5 240384	<input type="checkbox"/> <input type="checkbox"/>		D=54, - Halter D=54, - Halter	SUM SUM
MITSUBISHI SPACE GEAR (95-02)									
	2.4 i 4x4 97 2.5 TDiC 4x4 73		05.95 05.00 05.95 05.00		24.3431-1705.5 240365 24.3431-1706.5 240366	<input type="checkbox"/> <input type="checkbox"/>		D=43/43, - Halter D=43/43, - Halter	
MITSUBISHI SPACE RUNNER (91-99)									
	1.8 (N11W) 85 1.8 4x4 (N21W) 90 2.0 TD (N18W) 60		06.91 08.99 06.91 08.99 06.92 08.99		24.3541-1815.5 240383 24.3541-1816.5 240384	<input type="checkbox"/> <input type="checkbox"/>		D=54, - Halter D=54, - Halter	SUM SUM
	1.8 (N11W) 85 2.0 TD (N18W) 60 1.8 4x4 (N21W) 90		06.91 08.99 06.92 08.99 06.91 08.99		24.3219-1752.3 020505 24.3219-1716.3 020071			Rz 19,05 Rz 19,05	
MITSUBISHI SPACE RUNNER (99-03)									
	2.0 16V (N63W) 100 2.4 16V GDI (N64W) 110		09.99 04.00 09.99 04.00		24.3431-1701.5 240437 24.3431-1702.5 240438	<input type="checkbox"/> <input type="checkbox"/>		D=43/43, - Halter D=43/43, - Halter	
MITSUBISHI SPACE STAR (98-06)									
	1.3 i (DG1A) 60 1.3 i (DG1A) 61 1.3 i (DG1A) 63 1.6 i 16V (DG3A) 72 1.8 GDI (DG5A) 82 1.8 GDI (DG5A) 90 1.9 DI-D (DG4A) 75 1.9 DI-D (DG4A) 85		08.00 03.06 12.98 03.06 06.98 07.00 09.01 03.06 10.02 03.06 06.98 03.06 02.01 03.06 10.02 03.06		24.3541-1783.5 240269 24.3541-1784.5 240270	<input type="checkbox"/> <input type="checkbox"/>		D=54, - Halter D=54, - Halter	TRW TRW
	1.3 i (DG1A) 60 1.3 i (DG1A) 61 1.3 i (DG1A) 63 1.6 i 16V (DG3A) 72 1.8 GDI (DG5A) 82 1.8 GDI (DG5A) 90 1.9 DI-D (DG4A) 75 1.9 DI-D (DG4A) 85		08.00 03.06 12.98 03.06 06.98 07.00 09.01 03.06 10.02 03.06 06.98 03.06 02.01 03.06 10.02 03.06		24.5248-0461.3 330707	2		L=460	
	1.3 i (DG1A) 60 1.6 i 16V (DG3A) 72 1.8 GDI (DG5A) 82 1.8 GDI (DG5A) 90 1.9 DI-D (DG4A) 75 1.9 DI-D (DG4A) 85		08.00 03.06 09.01 03.06 10.02 03.06 08.00 03.06 02.01 03.06 10.02 03.06	+ ABS + ABS + ABS	24.3384-1743.5 240319 24.3384-1744.5 240320	<input type="checkbox"/> <input type="checkbox"/>		D=38, - Halter D=38, - Halter	TRW TRW
	1.3 i (DG1A) 60 1.3 i (DG1A) 61 1.3 i (DG1A) 63 1.6 i 16V (DG3A) 72 1.8 GDI (DG5A) 82 1.8 GDI (DG5A) 90 1.9 DI-D (DG4A) 75 1.9 DI-D (DG4A) 85		08.00 03.06 12.98 03.06 06.98 07.00 09.01 03.06 10.02 03.06 06.98 03.06 02.01 03.06 10.02 03.06		24.5249-0416.3 330708	2		L=416	
	1.3 i (DG1A) 63 1.3 i (DG1A) 60 1.3 i (DG1A) 61 1.3 i (DG1A) 63 1.8 GDI (DG5A) 82 1.8 GDI (DG5A) 90		06.98 09.98 08.00 03.06 12.98 03.06 10.98 07.00 10.02 03.06 06.98 03.06	- ABS - ABS - ABS - ABS - ABS	24.3219-1753.3 020506 24.3219-1745.3 020496			Rz 19,05 Rz 19,05	

¹⁾ on the brake caliper / sulla pinza freno / sur l'étrier de frein / a la pinza de freno

²⁾ - Europe / - Europa / - Europe / - Europa

















								
MITSUBISHI SPACE STAR (98-06)								
	1.3 i (DG1A)	60	08.00	03.06	24.3727-2114.2	582114	<input type="checkbox"/>	L=1490
	1.3 i (DG1A)	61	12.98	03.06	24.3727-2115.2	582115	<input type="checkbox"/>	L=1473
	1.3 i (DG1A)	63	06.98	07.00				
	1.8 GDI (DG5A)	82	10.02	03.06				
	1.8 GDI (DG5A)	90	06.98	03.06				
	1.6 i 16V (DG3A)	72	09.01	03.06	24.3727-2116.2	582116	<input type="checkbox"/>	L=1573
	1.9 DI-D (DG4A)	75	02.01	03.06	24.3727-2117.2	582117	<input type="checkbox"/>	L=1551
	1.9 DI-D (DG4A)	85	10.02	03.06				
MITSUBISHI SPACE STAR (A05A) (12-)								
	1.0 12V	52	05.12		24.3219-1753.3	020506		Rz 19,05
	1.2 12V	57	05.12					
	1.2 12V	59	10.12					
MITSUBISHI SPACE WAGON (91-98)								
	1.8 (N31W)		05.91	05.92 - (N)	24.3541-1815.5	240383	<input type="checkbox"/>	D=54, - Halter
	1.8 4x4 (N41W)		05.91	05.92 - (N)	24.3541-1816.5	240384	<input type="checkbox"/>	D=54, - Halter
	1.8 TD (N35W)		05.91	05.92				
	2.0 (N33W)		06.92	10.98 - (N)				
	2.0 4x4 (N43W)		06.92	10.98				
	2.0 TD (N38W)		06.92	10.98				
	2.4 (N34W)		06.92	05.96				
	1.8 (N31W)		05.91	05.92	24.3219-1716.3	020071		Rz 19,05
	1.8 4x4 (N41W)		05.91	05.92				
	1.8 TD (N35W)		05.91	05.92				
	2.0 (N33W)		06.92	10.98				
	2.0 4x4 (N43W)		06.92	10.98				
MITSUBISHI SPACE WAGON (98-05)								
	2.0 GDi (N83W)	98	05.02	08.05	24.3431-1701.5	240437	<input type="checkbox"/>	D=43/43, - Halter
	2.0 GLX (N83W)	80	10.98	04.02	24.3431-1702.5	240438	<input type="checkbox"/>	D=43/43, - Halter
	2.4 GDi (N84W)	108	09.00	08.03				
	2.4 GDi (N84W)	110	10.98	08.03				
	2.4 GDi 4x4 (N94W)	108	09.00	08.03				
	2.4 GDi 4x4 (N94W)	110	10.98	08.03				
NISSAN ALMERA (N15) (95-00)								
	1.4 i		02.98	04.00 + ABS	24.2123-1761.3	010780		Thz 23,81 + Behälter
	1.6 i		01.98	04.00 + ABS				
	2.0 D		01.98	04.00 + ABS				
	2.0 i		01.98	04.00 + ABS				
	1.4 i		07.95	04.00	24.5283-0471.3	330960	<input type="checkbox"/>	L=470
	1.6 i		07.95	04.00	24.5283-0470.3	330959	<input type="checkbox"/>	L=470
	2.0 D		07.95	04.00				
	2.0 i		04.96	04.00				
	1.4 i		01.98	04.00 + ABS	24.3344-1719.5	240343	<input type="checkbox"/>	D=34, - Halter
	1.6 i		01.98	04.00 + ABS	24.3344-1720.5	240344	<input type="checkbox"/>	D=34, - Halter
	2.0 D		01.98	04.00 + ABS				
	2.0 i		01.98	04.00 + ABS				
	1.4 i		07.95	04.00	24.5281-0556.3	330955	2	L=555
	1.6 i		07.95	04.00				
	2.0 D		07.95	04.00				
	2.0 i		04.96	04.00				
	1.4 i		07.95	04.00 - ABS	24.3215-1107.3	020352		Rz 15,87
	1.6 i		07.95	04.00 - ABS				
	2.0 D		07.95	04.00 - ABS				
	2.0 i		07.95	04.00 - ABS				
	1.4 i		07.95	03.96 - ABS	24.3727-1701.2	581701	<input type="checkbox"/>	L=250
	1.6 i		07.95	03.96 - ABS				
	2.0 D		07.95	03.96 - ABS				
	1.4 i		04.96	04.00 - ABS	24.3727-1701.2	581701	<input type="checkbox"/>	L=250
	1.6 i		04.96	04.00 - ABS	24.3727-1742.2	581742	<input type="checkbox"/>	L=1660
	2.0 D		04.96	04.00 - ABS	24.3727-1743.2	581743	<input type="checkbox"/>	L=1662
	1.4 i		07.95	03.96 + ABS	24.3727-1701.2	581701	<input type="checkbox"/>	L=250
	1.6 i		07.95	03.96 + ABS	24.3727-1746.2	581746	<input type="checkbox"/>	L=1680
	2.0 D		07.95	03.96 + ABS	24.3727-1747.2	581747	<input type="checkbox"/>	L=1682
	1.4 i		04.96	12.97 + ABS	24.3727-1701.2	581701	<input type="checkbox"/>	L=250
	1.6 i		04.96	12.97 + ABS	24.3727-1746.2	581746	<input type="checkbox"/>	L=1680
	2.0 D		04.96	12.97 + ABS	24.3727-1747.2	581747	<input type="checkbox"/>	L=1682
	1.4 i		01.98	04.00 + ABS	24.3727-1701.2	581701	<input type="checkbox"/>	L=250
	1.6 i		01.98	04.00 + ABS	24.3727-1746.2	581746	<input type="checkbox"/>	L=1680
	2.0 D		01.98	04.00 + ABS	24.3727-1747.2	581747	<input type="checkbox"/>	L=1682
	2.0 i		04.96	04.00				
	1.4 i		07.95	04.00	24.3728-1707.2	591707		L=725
	1.6 i		07.95	04.00				
NISSAN ALMERA (N16) (00-06)								
	1.5 i	66	03.00	03.01 + ASR/ + ETS	24.2123-1761.3	010780		Thz 23,81 + Behälter
	1.8 i	84	03.00	03.01 + ABS				
	2.2 Di	81	03.00	03.01				

NISSAN ALMERA (N16) (00-06)																			
	1.5 dCi	60		01.03	11.06	+ ABS		24.3571-1731.5	240321										
	1.5 i	66		03.00	03.01	+ ABS/ Produktionsland	⬇	24.3571-1732.5	240322									D=57, - Halter D=57, - Halter	
	1.5 i	66		02.00	11.06	+ ABS													
	1.5 i	72		10.02	11.06	+ ABS													
	1.8 i	84		03.00	03.01	Produktionsland	⬇												
	1.8 i	84		02.00	11.06														
	1.8 i	85		10.02	11.06														
	2.2 dCi	82		09.03	11.06														
	2.2 dCi	100		09.03	11.06														
	2.2 Di	81		02.00	11.06														
2.2 Di	81		03.00	03.01	Produktionsland	⬇													
	1.5 dCi	60		01.03	11.06			24.5266-0453.3	330931									L=452	
	1.5 i	66		02.00	11.06			24.5266-0452.3	330930									L=452	
	1.5 i	72		10.02	11.06														
	1.8 i	84		02.00	11.06														
	1.8 i	85		10.02	11.06														
	2.2 dCi	82		09.03	11.06														
	2.2 dCi	100		09.03	11.06														
	2.2 Di	81		02.00	11.06														
	1.5 i	66		03.00	03.01	Produktionsland	⬇	24.5266-0475.3	331139										L=475
	1.8 i	84		03.00	03.01	Produktionsland	⬇	24.5266-0476.3	331140										L=475
2.2 Di	81		03.00	03.01	Produktionsland	⬇													
	1.5 i	66		02.00	03.01	- ABS		24.3344-1717.5	240341									D=34, - Halter	
	1.8 i	84		02.00	03.01	- ABS		24.3344-1718.5	240342									D=34, - Halter	
	2.2 Di	81		02.00	03.01	- ABS													
	1.5 i	66		03.00	03.01	+ ABS/ Produktionsland	⬇	24.3344-1719.5	240343									D=34, - Halter	
	1.8 i	84		03.00	03.01	Produktionsland	⬇	24.3344-1720.5	240344									D=34, - Halter	
	2.2 Di	81		03.00	03.01	Produktionsland	⬇												
	1.5 dCi	60		01.03	11.06	- ABS		24.5247-0310.3	330951									L=310	
	1.5 i	66		02.00	11.06	- ABS													
	1.5 i	72		10.02	11.06	- ABS													
	1.5 dCi	60		01.03	11.06	+ ABS		24.5281-0554.3	331005									L=555	
	1.5 i	66		02.00	11.06	+ ABS		24.5281-0553.3	331004									L=555	
	1.5 i	72		10.02	11.06	+ ABS													
	1.8 i	84		02.00	11.06														
	1.8 i	85		10.02	11.06														
	2.2 dCi	82		09.03	11.06														
	2.2 dCi	100		09.03	11.06														
2.2 Di	81		02.00	11.06															
	1.5 i	66		03.00	03.01	+ ABS/ Produktionsland	⬇	24.5281-0557.3	330956									L=555	
	1.8 i	84		03.00	03.01	Produktionsland	⬇												
	2.2 Di	81		03.00	03.01	Produktionsland	⬇												
	1.5 dCi	60		01.03	11.06	- ABS		24.3727-1736.2	581736									L=1634	
	1.5 i	66		02.00	11.06	- ABS		24.3727-1737.2	581737									L=1642	
	1.5 i	72		10.02	11.06	- ABS													
	1.5 dCi	60		01.03	11.06	+ ABS		24.3727-1724.2	581724									L=1650	
	1.5 i	66		02.00	11.06	+ ABS		24.3727-1725.2	581725									L=1661	
	1.5 i	72		10.02	11.06	+ ABS													
	1.8 i	84		02.00	11.06														
	1.8 i	85		10.02	11.06														
	2.2 dCi	82		09.03	11.06														
	2.2 dCi	100		09.03	11.06														
2.2 Di	81		02.00	11.06															
	1.5 i	66		03.00	03.01	- ABS/ Produktionsland	⬇	24.3727-1723.2	581723									L=236	
	1.5 i	66		03.00	03.01	+ ABS/ Produktionsland	⬇	24.3727-1723.2	581723									L=236	
	1.8 i	84		03.00	03.01	Produktionsland	⬇												
2.2 Di	81		03.00	03.01	Produktionsland	⬇													
	1.5 dCi	60		01.03	11.06			24.2519-1703.3	040091									Nz 19,05	
	1.5 i	66		03.00	03.01	Produktionsland	⬇												
	1.5 i	66		02.00	11.06														
	1.5 i	72		10.02	11.06														
	1.8 i	84		03.00	03.01	Produktionsland	⬇												
	1.8 i	85		10.02	11.06														
2.2 dCi	82		09.03	11.06			24.2519-1704.3	040092									Nz 19,05		
2.2 dCi	100		09.03	11.06															
2.2 Di	81		09.01	11.06															
NISSAN ALMERA (B10RS) (06-)																			
	1.6 i	79		01.06		- Ⓞ		24.3727-1723.2	581723									L=236	
NISSAN ALMERA TINO (V10M) (00-05)																			
	1.8 i 16V	84		08.00	11.05			24.3571-1781.5	240745									D=57, - Halter	
	1.8 i 16V	85		12.02	11.05			24.3571-1782.5	240746									D=57, - Halter	
	2.0 i 16V	100		08.00	08.03														
	2.2 dCi	82		09.03	11.05														
	2.2 dCi	100		09.03	11.05														
	2.2 Di	84		08.00	08.03														
	1.8 i 16V	84		08.00	11.05			24.3727-1733.2	581733									L=221	
	1.8 i 16V	85		12.02	11.05			24.3727-1734.2	581734									L=1660	
	2.0 i 16V	100		08.00	08.03			24.3727-1735.2	581735									L=1670	
	2.2 dCi	82		09.03	11.05														
2.2 dCi	100		09.03	11.05															

									
NISSAN ALMERA TINO (V10M) (00-05)									
	2.2 Di	84		08.00	08.03	24.3727-1733.2	581733	L=221 L=1660 L=1670	
						24.3727-1734.2	581734		
						24.3727-1735.2	581735		
	1.8 i 16V	84		08.00	11.05	24.2519-1703.3	040091	Nz 19,05	
	1.8 i 16V	85		12.02	11.05				
	2.2 dCi	82		09.03	11.05	24.2519-1704.3	040092	Nz 19,05	
	2.2 dCi	100		09.03	11.05				
	2.2 Di	84		07.01	08.03				
NISSAN INTERSTAR (X70) (02-10)									
	1.9 dCi	60		07.02	08.06	- ABS	24.2025-1708.3	010692	THz 25,40
	2.2 dCi	66		07.02	08.06	- ABS			
	2.5 dCi	73		11.03	06.10	- ABS			
	2.5 dCi	74		04.06	06.10	- ABS			
	2.5 dCi	84		07.02	08.06	- ABS			
	2.5 dCi	88		09.06	06.10	- ABS			
	2.5 dCi	107		09.06	06.10	- ABS			
	3.0 dCi	100		11.03	08.06	- ABS			
	1.9 dCi	60		07.02	12.02	+ ABS	24.2025-1706.3	010676	THz 25,40
	2.2 dCi	66		07.02	12.02	+ ABS			
	2.5 dCi	84		07.02	12.02	+ ABS			
	1.9 dCi	60		01.03	08.06	+ ABS	24.2123-1759.3	010768	THz 23,81
	2.2 dCi	66		01.03	08.06	+ ABS			
	2.5 dCi	73		11.03	06.10	+ ABS			
	2.5 dCi	74		04.06	06.10	+ ABS			
	2.5 dCi	84		01.03	08.06	+ ABS			
	2.5 dCi	88		09.06	06.10	+ ABS			
	2.5 dCi	107		09.06	06.10	+ ABS			
	3.0 dCi	100		11.03	08.06	+ ABS			
	1.9 dCi	60		07.02	08.06	- ABS	24.5134-0457.3	330752	2  L=457
	2.2 dCi	66		07.02	08.06	- ABS	24.5134-0468.3	330704	2  L=468
	2.5 dCi	73		11.03	06.10	- ABS			
	2.5 dCi	74		04.06	06.10	- ABS			
	2.5 dCi	84		07.02	08.06	- ABS			
	2.5 dCi	88		09.06	06.10	- ABS			
	2.5 dCi	107		09.06	06.10	- ABS			
	3.0 dCi	100		11.03	08.06	- ABS			
	1.9 dCi	60		07.02	10.03	+ ABS	24.5134-0457.3	330752	2  L=457
	2.2 dCi	66		07.02	10.03	+ ABS	24.5134-0468.3	330704	2  L=468
	2.5 dCi	84		07.02	10.03	+ ABS			
	1.9 dCi	60		11.03	08.06	+ ABS	24.5111-0510.3	330819	2 L=510
	2.2 dCi	66		11.03	08.06	+ ABS			
	2.5 dCi	73		11.03	06.10	+ ABS			
	2.5 dCi	74		04.06	06.10	+ ABS			
	2.5 dCi	84		11.03	08.06	+ ABS			
	2.5 dCi	88		09.06	06.10	+ ABS			
	2.5 dCi	107		09.06	06.10	+ ABS			
	3.0 dCi	100		11.03	08.06	+ ABS			
	1.9 dCi	60		07.02	08.06		24.3424-1701.5	240561	 D=42, - Halter
	2.2 dCi	66		07.02	08.06		24.3424-1702.5	240562	 D=42, - Halter
	2.5 dCi	73		11.03	06.10				
	2.5 dCi	74		04.06	06.10				
	2.5 dCi	84		07.02	08.06				
	2.5 dCi	88		09.06	06.10				
	2.5 dCi	107		09.06	06.10				
	3.0 dCi	100		11.03	08.06				
	1.9 dCi	60		07.02	10.03		24.5111-0326.3	330766	2  am Bremssattel ¹⁾ L=326
	2.2 dCi	66		07.02	10.03				
	2.5 dCi	84		07.02	10.03				
	1.9 dCi	60		11.03	08.06		24.5258-0450.3	330824	 L=450
	2.2 dCi	66		11.03	08.06		24.5251-0465.3	330822	 L=465
	2.5 dCi	73		11.03	06.10				
	2.5 dCi	74		04.06	06.10				
	2.5 dCi	84		11.03	08.06				
	2.5 dCi	88		09.06	06.10				
	2.5 dCi	107		09.06	06.10				
	3.0 dCi	100		11.03	08.06				
	1.9 dCi	60		07.02	08.06		24.3727-0762.2	580762	1  L=1175
	2.2 dCi	66		07.02	08.06		24.3727-1072.2	581072	2  - langer Radstand ²⁾ L=1420
	2.5 dCi	73		11.03	06.10				
	2.5 dCi	74		04.06	06.10				
	2.5 dCi	84		07.02	08.06				
	2.5 dCi	88		09.06	06.10				
	2.5 dCi	107		09.06	06.10				
	3.0 dCi	100		11.03	08.06				
	1.9 dCi	60		07.02	12.02		24.2415-1710.3	030124	Gz 15,87
	2.2 dCi	66		07.02	12.02				
	2.5 dCi	84		07.02	12.02				
NISSAN JUKE (F15) (10-)									
	1.2 DIG-T	85		05.14			24.5293-0636.3	331441	 L=635
	1.5 dCi	81		06.10			24.5293-0635.3	331440	 L=635
	1.6 16V	69		01.13					
	1.6 16V	86		06.10					
	1.6 DIG-T	140		06.10					
									

¹⁾ on the brake caliper / sulla pinza freno / sur l'étrier de frein / a la pinza de freno

²⁾ - long wheel base / - passo lungo / - empattement long / - distancia larga entre ejes

NISSAN JUKE (F15) (10-)									
									
	1.6 DIG-T	147		11.12		24.5293-0636.3	331441	<input type="checkbox"/>	L=635
	1.6 DIG-T	160		08.14		24.5293-0635.3	331440	<input type="checkbox"/>	L=635
	1.6 DIG-T 4x4	140		06.10	Produktionsland [®]				
	1.6 DIG-T Nismo 4x4	147		02.13					
	1.6 DIG-T NismoRS 4x4	157		08.14					
NISSAN KUBISTAR (X76) Kombi (03-09)									
	1.2	44		08.03	08.05 - ABS	24.2122-1727.3	010586		THz 22,20 BDX
	1.2	55		08.03	10.09 - ABS				
	1.4	55		08.03	10.09 - ABS				
	1.5 dCi	42		08.03	08.05 - ABS				
	1.5 dCi	44		09.05	10.09 - ABS				
	1.5 dCi	48		08.03	08.05 - ABS				
	1.5 dCi	51		09.05	10.09 - ABS				
	1.5 dCi	60		08.03	08.05 - ABS				
	1.5 dCi	66		09.05	10.09 - ABS				
	1.6 i 16V	70		08.03	10.09 - ABS				
	1.2	44		08.03	08.05	24.3541-1765.5	240235	<input type="checkbox"/>	D=54, - Halter BOS
	1.2	55		08.03	10.09	24.3541-1766.5	240236	<input type="checkbox"/>	D=54, - Halter BOS
	1.4	55		08.03	10.09				
	1.5 dCi	42		08.03	08.05				
	1.5 dCi	44		09.05	10.09				
	1.5 dCi	48		08.03	08.05				
	1.5 dCi	51		09.05	10.09				
	1.5 dCi	60		08.03	08.05				
	1.5 dCi	66		09.05	10.09				
	1.6 i 16V	70		08.03	10.09				
	1.2	44		08.03	08.05	24.5111-0336.3	330570	2	L=335
	1.2	55		08.03	10.09				
	1.4	55		08.03	10.09				
	1.5 dCi	42		08.03	08.05				
	1.5 dCi	44		09.05	10.09				
	1.5 dCi	48		08.03	08.05				
	1.5 dCi	51		09.05	10.09				
	1.5 dCi	60		08.03	08.05				
	1.5 dCi	66		09.05	10.09				
	1.6 i 16V	70		08.03	10.09				
	1.2	44		08.03	08.05	24.5229-0193.3	330571	<input type="checkbox"/>	L=193
	1.2	55		08.03	03.08				
	1.4	55		08.03	03.08				
	1.5 dCi	42		08.03	08.05				
	1.5 dCi	44		09.05	03.08				
	1.5 dCi	48		08.03	08.05				
	1.5 dCi	51		09.05	03.08				
	1.5 dCi	60		08.03	08.05				
	1.5 dCi	66		09.05	03.08				
	1.6 i 16V	70		08.03	03.08				
	1.2	44		08.03	08.05	24.3222-1716.3	020434	- erhöhte Zuladung ¹⁾	Rz 22,00 BDX
	1.2	55		08.03	10.09				
	1.4	55		08.03	10.09				
	1.5 dCi	42		08.03	08.05				
	1.5 dCi	44		09.05	10.09				
	1.5 dCi	48		08.03	08.05				
	1.5 dCi	51		09.05	10.09				
	1.5 dCi	60		08.03	08.05				
	1.5 dCi	66		09.05	10.09				
	1.6 i 16V	70		08.03	10.09				
	1.2	44		08.03	08.05	24.3222-1715.3	020433	+ erhöhte Zuladung ²⁾	Rz 22,00 BDX
	1.2	55		08.03	10.09				
	1.4	55		08.03	10.09				
	1.5 dCi	42		08.03	08.05				
	1.5 dCi	44		09.05	10.09				
	1.5 dCi	48		08.03	08.05				
	1.5 dCi	51		09.05	10.09				
	1.5 dCi	60		08.03	08.05				
	1.5 dCi	66		09.05	10.09				
	1.6 i 16V	70		08.03	10.09				
	1.2	44		08.03	08.05	24.3727-1041.2	581041	<input type="checkbox"/>	L=1423
	1.2	55		08.03	10.09	24.3727-1042.2	581042	<input type="checkbox"/>	L=1421
	1.4	55		08.03	10.09				
	1.5 dCi	42		08.03	08.05				
	1.5 dCi	44		09.05	10.09				
	1.5 dCi	48		08.03	08.05				
	1.5 dCi	51		09.05	10.09				
	1.5 dCi	60		08.03	08.05				
	1.5 dCi	66		09.05	10.09				
	1.6 i 16V	70		08.03	10.09				
	1.2	44		08.03	08.05	24.3728-1016.2	591016		L=969
	1.2	55		08.03	10.09				
	1.6 i 16V	70		08.03	10.09				
	1.5 dCi	42		08.03	08.05	24.3728-1023.2	591023		L=960
	1.5 dCi	44		09.05	10.09				
	1.5 dCi	48		08.03	08.05				
	1.5 dCi	51		09.05	10.09				
	1.5 dCi	51		09.05	10.09				
	1.5 dCi	60		08.03	08.05				





































1) - increased payload / - carico utile maggiorato / - charge utile augmentée / - incremento de carga























2) + increased payload / + carico utile maggiorato / + charge utile augmentée / + incremento de carga

NISSAN MICRA (K11E) (92-02)												
	1.0 i 16V	40		08.92	07.00	- ABS	24.3481-1763.5	240367			D=48, - Halter	AKE
	1.0 i 16V	44		08.00	12.02	- ABS	24.3481-1764.5	240368			D=48, - Halter	AKE
	1.3 i 16V	55		08.92	07.00	- ABS						
	1.4 i 16V	60		08.00	12.02	- ABS						
	1.5 D	42		02.98	12.02	- ABS						
	1.0 i 16V	40		08.92	08.00	- ABS	24.5269-0462.3	331027		2	L=462	
	1.0 i 16V	44		09.00	12.02	- ABS						
	1.3 i 16V	55		08.92	08.00	- ABS						
	1.4 i 16V	60		09.00	12.02	- ABS						
	1.5 D	42		02.98	12.02	- ABS						
	1.0 i 16V	40		08.92	08.00	+ ABS	24.5269-0460.3	331026		2	L=460	
	1.0 i 16V	44		09.00	12.02	+ ABS						
	1.3 i 16V	55		08.92	08.00	+ ABS						
	1.4 i 16V	60		09.00	12.02	+ ABS						
	1.5 D	42		02.98	12.02	+ ABS						
	1.0 i 16V	40		08.92	08.00	+ ABS	24.3304-1709.5	240359			D=30, - Halter	AKE
	1.0 i 16V	44		09.00	12.02	+ ABS	24.3304-1710.5	240360			D=30, - Halter	AKE
	1.3 i 16V	55		08.92	08.00	+ ABS						
	1.4 i 16V	60		09.00	12.02	+ ABS						
	1.0 i 16V	40		08.92	01.98	- ABS	24.5247-0210.3	331023		2	L=210	
	1.3 i 16V	55		08.92	01.98	- ABS						
	1.0 i 16V	40		08.92	01.98	+ ABS	24.5269-0195.3	330935		2	L=195	
	1.3 i 16V	55		08.92	01.98	+ ABS						
	1.0 i 16V	40		02.98	08.00		24.5247-0195.3	330919		2	L=195	
	1.0 i 16V	44		09.00	12.02							
	1.3 i 16V	55		02.98	08.00							
	1.4 i 16V	60		09.00	12.02							
	1.5 D	42		02.98	12.02							
	1.0 i 16V	40		08.92	08.00	- ABS	24.3217-1708.3	020414			Rz 17,78	
	1.0 i 16V	44		09.00	12.02	- ABS						
	1.3 i 16V	55		08.92	08.00	- ABS						
	1.4 i 16V	60		09.00	12.02	- ABS						
	1.5 D	42		02.98	12.02	- ABS						
	1.0 i 16V	40		08.92	08.00	- ABS	24.3727-1701.2	581701			L=250	
	1.3 i 16V	55		08.92	08.00	- ABS	24.3727-1705.2	581705			L=1410	
	1.5 D	42		02.98	08.00		24.3727-1704.2	581704			L=1433	
	1.0 i 16V	44		09.00	12.02	- ABS	24.3727-1701.2	581701			L=250	
	1.4 i 16V	60		09.00	12.02	- ABS						
	1.0 i 16V	40		09.00	12.02							
	1.0 i 16V	44		08.92	08.00	+ ABS	24.3727-1701.2	581701			L=250	
	1.0 i 16V	44		09.00	12.02	+ ABS	24.3727-1715.2	581715			L=1287	
	1.3 i 16V	55		08.92	08.00	+ ABS	24.3727-1714.2	581714			L=1310	
	1.4 i 16V	60		09.00	12.02	+ ABS						
	1.0 i 16V	40		08.92	01.98		24.3728-1708.2	591708			L=623	
	1.3 i 16V	55		08.92	01.98							
	1.0 i 16V	40		02.98	08.00		24.3728-1709.2	591709			L=655	
	1.0 i 16V	44		09.00	12.02							
	1.3 i 16V	55		02.98	08.00							
	1.4 i 16V	60		09.00	12.02							

NISSAN MICRA (K12E) (03-10)												
	1.0 i 16V	48		01.03	06.10		03.7863-3002.4	300223			10"	ATE
	1.2 i 16V	48		01.03	06.10							
	1.2 i 16V	59		01.03	06.10							
	1.4 i 16V	65		01.03	06.10							
	1.5 dCi	48		01.03	06.10							
	1.5 dCi	50		06.05	06.10							
	1.5 dCi	60		09.03	06.10							
	1.5 dCi	63		01.03	06.10							
	1.6 i 16V	81		05.05	06.10							
		1.0 i 16V	48		01.03	06.10		03.2123-2863.3	010790	- ESP		Thz 23,81
1.2 i 16V		48		01.03	06.10		03.2123-2923.3	010791	+ ESP		Thz 23,81	ATE
1.2 i 16V		59		01.03	06.10							
1.4 i 16V		65		01.03	06.10							
1.5 dCi		48		01.03	06.10							
1.5 dCi		50		06.05	06.10							
1.5 dCi		60		09.03	06.10							
1.5 dCi		63		01.03	06.10							
1.6 i 16V		81		05.05	06.10							
		1.0 i 16V	48		01.03	06.10		24.3541-1851.5	240709			D=54, - Halter
	1.2 i 16V	48		01.03	06.10		24.3541-1852.5	240710			D=54, - Halter	TRW
	1.2 i 16V	59		01.03	06.10							
	1.4 i 16V	65		01.03	06.10							
	1.5 dCi	48		01.03	06.10							
	1.5 dCi	50		06.05	06.10							
	1.5 dCi	60		09.03	06.10							
	1.5 dCi	63		01.03	06.10							
	1.6 i 16V	81		05.05	06.10							
		1.0 i 16V	48		01.03	06.10		24.5292-0605.3	331030			L=605
1.2 i 16V		48		01.03	06.10		24.5293-0605.3	331031			L=605	
1.2 i 16V		59		01.03	06.10							
1.4 i 16V		65		01.03	06.10							
1.5 dCi		48		01.03	06.10							
1.5 dCi		50		06.05	06.10							
	1.5 dCi	60		09.03	06.10							





















											
NISSAN MICRA (K12E) (03-10)											
	1.5 dCi 1.6 i 16V	63 81		01.03 05.05	06.10 06.10		24.5292-0605.3 24.5293-0605.3	331030 331031			L=605 L=605
	1.0 i 16V 1.2 i 16V 1.2 i 16V 1.4 i 16V 1.5 dCi 1.5 dCi 1.5 dCi 1.5 dCi 1.6 i 16V	48 48 59 65 48 50 60 63 81		01.03 01.03 01.03 01.03 01.03 06.05 09.03 01.03 05.05	06.10 06.10 06.10 06.10 06.10 06.10 06.10 06.10 06.10		24.5247-0281.3	330967	2		L=280
	1.0 i 16V 1.2 i 16V 1.2 i 16V 1.4 i 16V 1.5 dCi 1.5 dCi 1.5 dCi 1.5 dCi 1.6 i 16V	48 48 59 65 48 50 60 63 81		01.03 01.03 01.03 01.03 01.03 06.05 09.03 01.03 05.05	06.10 06.10 06.10 06.10 06.10 06.10 06.10 06.10 06.10		24.3219-1755.3	020508			Rz 19,05
	1.0 i 16V 1.2 i 16V 1.2 i 16V 1.4 i 16V 1.5 dCi 1.5 dCi 1.5 dCi 1.5 dCi 1.6 i 16V	48 48 59 65 48 50 60 63 81		01.03 01.03 01.03 01.03 01.03 06.05 09.03 01.03 05.05	06.10 06.10 06.10 06.10 06.10 06.10 06.10 06.10 06.10		24.3727-1722.2 24.3727-1718.2 24.3727-1719.2	581722 581718 581719	  		L=200 L=1540 L=1604
NISSAN MICRA C+C (CK12E) (05-10)											
	1.4 i 16V 1.6 i 16V	65 81		08.05 08.05	12.10 12.10		03.7863-3002.4	300223			10" ATE
	1.4 i 16V 1.6 i 16V	65 81		08.05 08.05	12.10 12.10		03.2123-2863.3 03.2123-2923.3	010790 010791	- ESP + ESP		THz 23,81 THz 23,81 ATE
	1.4 i 16V 1.6 i 16V	65 81		08.05 08.05	12.10 12.10		24.3541-1851.5 24.3541-1852.5	240709 240710	 		D=54, - Halter D=54, - Halter TRW
	1.4 i 16V 1.6 i 16V	65 81		08.05 08.05	12.10 12.10		24.5292-0605.3 24.5293-0605.3	331030 331031	 		L=605 L=605
	1.4 i 16V 1.6 i 16V	65 81		08.05 08.05	12.10 12.10		24.5247-0281.3	330967	2		L=280
	1.4 i 16V 1.6 i 16V	65 81		08.05 08.05	12.10 12.10		24.3219-1755.3	020508			Rz 19,05
	1.4 i 16V 1.6 i 16V	65 81		08.05 08.05	12.10 12.10		24.3727-1722.2 24.3727-1718.2 24.3727-1719.2	581722 581718 581719	  		L=200 L=1540 L=1604
NISSAN MICRA (K13K) (10-)											
	1.2 DIG 1.2 i 1.2 i	72 56 59		04.11 05.10 05.10			24.5293-0567.3	331438			L=568
	1.2 DIG 1.2 i 1.2 i	72 56 59		04.11 05.10 05.10			24.3219-1768.3	020561			Rz 19,05
NISSAN NAVARA (D40M) (05-)											
	2.5 dCi 2.5 dCi 2.5 dCi 4WD	106 128 128		07.05 12.05 07.05	09.06 09.06 09.06		03.2125-0161.3	010920			THz 25,40 ATE
	2.5 dCi 2.5 dCi 2.5 dCi 2.5 dCi 4WD 2.5 dCi 4WD 2.5 dCi 4WD 2.5 dCi 4WD 3.0 dCi 4WD	106 120 128 106 126 128 140 170		07.05 10.06 12.05 10.08 10.06 07.05 12.09 02.10			24.3222-1702.3	020525			Rz 22,20
NISSAN NOTE (E11E) (06-13)											
	1.4 1.5 dCi 1.5 dCi 1.5 dCi 1.5 dCi 1.6	65 50 63 66 76 81		03.06 03.06 03.06 09.10 07.08 03.06	05.13 05.13 05.13 05.13 05.13 05.13		03.7863-3002.4	300223			10" ATE

										
NISSAN NOTE (E11E) (06-13)										
	1.4 1.5 dCi 1.5 dCi 1.5 dCi 1.5 dCi 1.6	65 50 63 66 76 81		03.06 03.06 03.06 09.10 07.08 03.06	05.13 05.13 05.13 05.13 05.13 05.13	03.2123-2863.3 03.2123-2923.3	010790 010791	- ESP + ESP	THz 23,81 THz 23,81	ATE ATE
	1.4 1.5 dCi 1.5 dCi 1.5 dCi 1.5 dCi 1.6	65 50 63 66 76 81		03.06 03.06 03.06 09.10 07.08 03.06	05.13 05.13 05.13 05.13 05.13 05.13	24.3541-1851.5 24.3541-1852.5	240709 240710	<input type="checkbox"/> <input type="checkbox"/>	D=54, - Halter D=54, - Halter	TRW TRW
	1.4 1.5 dCi 1.5 dCi 1.5 dCi 1.5 dCi 1.6	65 50 63 66 76 81		03.06 03.06 03.06 09.10 07.08 03.06	05.13 05.13 05.13 05.13 05.13 05.13	24.5292-0605.3 24.5293-0605.3	331030 331031	<input type="checkbox"/> <input type="checkbox"/>	L=605 L=605	
	1.4 1.5 dCi 1.5 dCi 1.5 dCi 1.5 dCi 1.6	65 50 63 66 76 81		03.06 03.06 03.06 09.10 07.08 03.06	05.13 05.13 05.13 05.13 05.13 05.13	24.5247-0281.3	330967	2		L=280
	1.4 1.5 dCi 1.5 dCi 1.5 dCi 1.5 dCi 1.6	65 50 63 66 76 81		03.06 03.06 03.06 09.10 07.08 03.06	05.13 05.13 05.13 05.13 05.13 05.13	24.3219-1755.3	020508			Rz 19,05
	1.4 1.5 dCi 1.5 dCi 1.5 dCi 1.5 dCi 1.6	65 50 63 66 76 81		03.06 03.06 03.06 09.10 07.08 03.06	05.13 05.13 05.13 05.13 05.13 05.13	24.3727-1722.2 24.3727-1744.2 24.3727-1745.2	581722 581744 581745	<input type="checkbox"/> <input type="checkbox"/> <input type="checkbox"/>	L=200 L=1706 L=1770	
NISSAN NOTE (E12E) (13-)										
	1.2 1.2 DIG 1.2 LPG 1.5 dCi	59 72 59 66		06.13 06.13 06.13 06.13		24.3219-1768.3	020561			Rz 19,05
NISSAN NP 300 (D40M) (08-)										
	2.5 dCi 2.5 dCi 4x4	98 98		04.08 04.08		03.2125-0161.3	010920			THz 25,40 ATE
	2.5 dCi 2.5 dCi 4x4	98 98		04.08 04.08		24.3222-1702.3	020525			Rz 22,20
NISSAN NV 200 (M20) Kasten (10-)										
	1.5 dCi 1.5 dCi 1.5 dCi 1.6 i 16V	63 66 81 81		02.10 04.11 04.11 02.10		24.3222-1735.3	020554			Rz 22,20
NISSAN NV 200 EVALIA (M20) Bus (10-)										
	1.5 dCi 1.5 dCi 1.5 dCi 1.6 i 16V	63 66 81 81		07.10 04.11 04.11 07.10		24.3222-1735.3	020554			Rz 22,20
NISSAN PATHFINDER (R50) (97-04)										
	3.3 i V6 4WD 3.3 i V6 4WD 3.5 i V6 4WD 3.5 i V6 4WD	110 125 162 162		03.98 09.97 11.00 06.01	10.00 12.04 05.01 12.04	24.3222-1747.3	020576			Rz 22,20
						24.3222-1743.3	020575			Rz 22,20
NISSAN PATHFINDER (R51M) (05-)										
	2.5 dCi 2.5 dCi 4WD 2.5 dCi 4WD 4.0 4.0 4WD	128 126 128 198 198		10.06 10.06 10.06 10.06 10.06	+ Automatikgetriebe ¹⁾ + Automatikgetriebe ¹⁾ + Automatikgetriebe ¹⁾	03.7858-7602.4	300277			9/8" Tandem ATE
	2.5 dCi 2.5 dCi 4WD 2.5 dCi 4WD 2.5 dCi 4WD	128 126 128 140		01.05 10.06 03.05 08.10	- Spezialausrüstung ²⁾ - Spezialausrüstung ²⁾ - Spezialausrüstung ²⁾	03.2125-0161.3	010920			THz 25,40 ATE
	2.5 dCi 2.5 dCi 4WD 2.5 dCi 4WD 2.5 dCi 4WD 4.0 4.0 4WD	128 120 126 128 198 198		01.05 01.05 10.06 03.05 01.05 09.05	+ Spezialausrüstung ³⁾ + Spezialausrüstung ³⁾ + Spezialausrüstung ³⁾ + Spezialausrüstung ³⁾	03.2125-0531.3	010945			THz 25,40 ATE

















¹⁾ + autom.transmission / + scatola cambio automatico / + transmission automatique / + cambio automático

²⁾ - special equipment / - dotazione speciale / - équipement spécial / - equipamiento especial

³⁾ + special equipment / + dotazione speciale / + équipement spécial / + equipamiento especial

									
NISSAN PICK-UP (D22) (98-07)									
	2.4 i 4WD	88		02.98	10.01		24.3222-1747.3	020576	Rz 22,20
	2.4 i 4WD	110		11.01	04.05				
	2.5 TD 4WD	76		05.98	10.01				
	3.2 TD 4WD	76		10.98	12.07				
	2.4 i 4WD	98		11.01	04.05		24.3222-1743.3	020575	Rz 22,20
	2.4 i 4WD	110		11.01	04.05				
	2.5 TDi 4WD	98		11.01	04.05				
	3.2 TD 4WD	76		10.98	12.07				
NISSAN PICK-UP (D22S) (06-)									
	2.5 DDTi 4WD			01.06			24.3222-1743.3	020575	Rz 22,20
NISSAN PIXO (K10B) (09-13)									
	1.0 i 12V	50		06.09	04.13		24.3219-1765.3	020547	Rz 19,05
NISSAN PRIMASTAR (X83) Bus (01-)									
	1.9 dCi (100)	74		03.01	01.03	- ABS	24.2120-1738.3	010759	THz 20,64 TRW
	1.9 dCi (80)	60		03.01	01.03	- ABS			
	2.0 i 16V	88		03.01	01.03	- ABS			
	1.9 dCi (100)	74		02.03	08.06	- ABS	24.2120-1740.3	010764	THz 20,64 TRW
	1.9 dCi (80)	60		02.03	08.06	- ABS			
	2.0 dCi (115)	84		09.08		- ABS			
	2.0 dCi (120)	84		09.06		- ABS			
	2.0 dCi (90)	66		09.06		- ABS			
	2.0 i 16V	88		02.03		- ABS			
	2.5 dCi (140)	99		07.03	08.06	- ABS			
2.5 dCi (150)	107		09.06		- ABS				
	1.9 dCi (100)	74		02.03	08.06	+ ABS	24.2125-1731.3	010826	THz 25,40 TRW
	1.9 dCi (80)	60		02.03	08.06	+ ABS			
	2.0 dCi (115)	84		09.08		+ ABS			
	2.0 dCi (120)	84		09.06		+ ABS			
	2.0 dCi (90)	66		09.06		+ ABS			
	2.0 i 16V	88		02.03		+ ABS			
	2.5 dCi (140)	99		07.03	08.06	+ ABS			
	2.5 dCi (150)	107		09.06		+ ABS			
	1.9 dCi (100)	74		04.06		+ ESP	24.2125-1734.3	010878	THz 25,40 TRW
	1.9 dCi (80)	60		04.06		+ ESP			
2.0 dCi (115)	84		09.08		+ ESP				
2.0 dCi (120)	84		09.06		+ ESP				
2.0 dCi (90)	66		09.06		+ ESP				
2.0 i 16V	88		02.03		+ ESP				
2.5 dCi (140)	99		07.03		+ ESP				
2.5 dCi (150)	107		09.06		+ ESP				
	1.9 dCi (100)	74		03.01	08.06		24.3451-1713.7	220737	D=40/45, - Halter TRW
	1.9 dCi (80)	60		03.01	08.06		24.3451-1714.7	220738	D=40/45, - Halter TRW
	2.0 dCi (115)	84		09.08					
	2.0 dCi (120)	84		09.06					
	2.0 dCi (90)	66		09.06					
	2.0 i 16V	88		03.01					
	2.5 dCi (140)	99		07.03	08.06				
2.5 dCi (150)	107		09.06						
	1.9 dCi (100)	74		03.01	08.06		24.5111-0386.3	330503	2
	1.9 dCi (80)	60		03.01	08.06				
	2.0 dCi (115)	84		09.08					
	2.0 dCi (120)	84		09.06					
	2.0 dCi (90)	66		09.06					
	2.0 i 16V	88		03.01					
	2.5 dCi (140)	99		07.03	08.06				
2.5 dCi (150)	107		09.06						
	1.9 dCi (100)	74		03.01	08.06		24.3414-1707.5	240337	D=41, - Halter TRW
	1.9 dCi (80)	60		03.01	08.06		24.3414-1708.5	240338	D=41, - Halter TRW
	2.0 dCi (115)	84		09.08					
	2.0 dCi (120)	84		09.06					
	2.0 dCi (90)	66		09.06					
	2.0 i 16V	88		03.01					
	2.5 dCi (140)	99		09.03	08.06				
2.5 dCi (150)	107		09.06						
	1.9 dCi (100)	74		03.01	08.06		24.5229-0200.3	330572	2
	1.9 dCi (80)	60		03.01	08.06		24.5111-0221.3	330818	2
	2.0 dCi (115)	84		09.08					am Bremsattel 1)
	2.0 dCi (120)	84		09.06					
	2.0 dCi (90)	66		09.06					
	2.0 i 16V	88		03.01					
	2.5 dCi (140)	99		07.03	08.06				
2.5 dCi (150)	107		09.06						
	1.9 dCi (100)	74		03.01	08.06		24.3727-0796.2	580796	+ kurzer Radstand 2)
	1.9 dCi (80)	60		03.01	08.06		24.3727-0797.2	580797	+ langer Radstand 3)
	2.0 dCi (115)	84		09.08			24.3727-1068.2	581068	
	2.0 dCi (120)	84		09.06			24.3727-1071.2	581071	
	2.0 dCi (90)	66		09.06					
	2.0 i 16V	88		03.01					
	2.5 dCi (140)	99		07.03	08.06				

1) on the brake caliper / sulla pinza freno / sur l'étrier de frein / a la pinza de freno
2) + short wheel base / + passo lungo / + empattement court / + distancia corta entre ejes
3) + long wheel base / + passo lungo / + empattement long / + distancia larga entre ejes

NISSAN PRIMASTAR (X83) Bus (01-)											
											
	2.5 dCi (150)	107		09.06					24.3727-0796.2 580796 24.3727-0797.2 580797 24.3727-1068.2 581068 24.3727-1071.2 581071	+ kurzer Radstand ¹⁾ + langer Radstand ²⁾	L=1245/498 L=1643/498 L=1503 L=1603
NISSAN PRIMASTAR (X83) Kasten/Pritsche (02-)											
	1.9 dCi (100)	74		07.02	01.03	- ABS			24.2120-1738.3 010759		THz 20,64 TRW
	1.9 dCi (80)	60		07.02	01.03	- ABS					
	2.0 i 16V	88		07.02	01.03	- ABS					
	1.9 dCi (100)	74		02.03	08.06	- ABS			24.2120-1740.3 010764		THz 20,64 TRW
	1.9 dCi (80)	60		02.03	08.06	- ABS					
	2.0 dCi (115)	84		09.08		- ABS					
	2.0 dCi (120)	84		09.06		- ABS					
	2.0 dCi (90)	66		09.06		- ABS					
	2.0 i 16V	88		02.03		- ABS					
	2.5 dCi (140)	99		07.03	08.06	- ABS					
	2.5 dCi (150)	107		09.06		- ABS					
	1.9 dCi (100)	74		02.03	08.06	+ ABS			24.2125-1731.3 010826		THz 25,40 TRW
	1.9 dCi (80)	60		02.03	08.06	+ ABS					
	2.0 dCi (115)	84		09.08		+ ABS					
	2.0 dCi (120)	84		09.06		+ ABS					
	2.0 dCi (90)	66		09.06		+ ABS					
	2.0 i 16V	88		02.03		+ ABS					
	2.5 dCi (140)	99		07.03	08.06	+ ABS					
	2.5 dCi (150)	107		09.06		+ ABS					
	1.9 dCi (100)	74		04.06		+ ESP			24.2125-1734.3 010878		THz 25,40 TRW
	1.9 dCi (80)	60		04.06		+ ESP					
	2.0 dCi (120)	84		09.06		+ ESP					
	2.0 dCi (90)	66		09.06		+ ESP					
	2.0 i 16V	88		02.03		+ ESP					
	2.5 dCi (140)	99		07.03		+ ESP					
	2.5 dCi (150)	107		09.06		+ ESP					
	1.9 dCi (100)	74		07.02	08.06				24.3451-1713.7 220737	<input type="checkbox"/>	D=40/45, - Halter TRW
	1.9 dCi (80)	60		07.02	08.06				24.3451-1714.7 220738	<input type="checkbox"/>	D=40/45, - Halter TRW
	2.0 dCi (115)	84		09.08							
	2.0 dCi (120)	84		09.06							
	2.0 dCi (90)	66		09.06							
	2.0 i 16V	88		07.02							
	2.5 dCi (140)	99		07.03	08.06						
	2.5 dCi (150)	107		09.06							
	1.9 dCi (100)	74		07.02	08.06				24.5111-0386.3 330503	2	L=385
	1.9 dCi (80)	60		07.02	08.06						
	2.0 dCi (115)	84		09.08							
	2.0 dCi (120)	84		09.06							
	2.0 dCi (90)	66		09.06							
	2.0 i 16V	88		07.02							
	2.5 dCi (140)	99		07.03	08.06						
	2.5 dCi (150)	107		09.06							
	1.9 dCi (100)	74		07.02	08.06				24.3414-1707.5 240337	<input type="checkbox"/>	D=41, - Halter TRW
	1.9 dCi (80)	60		07.02	08.06				24.3414-1708.5 240338	<input type="checkbox"/>	D=41, - Halter TRW
	2.0 dCi (115)	84		09.08							
	2.0 dCi (120)	84		09.06							
	2.0 dCi (90)	66		09.06							
	2.0 i 16V	88		07.02							
	2.5 dCi (140)	99		07.03	08.06						
	2.5 dCi (150)	107		09.06							
	1.9 dCi (100)	74		07.02	08.06				24.5229-0200.3 330572	2	L=200
	1.9 dCi (80)	60		07.02	08.06				24.5111-0221.3 330818	2	L=220
	2.0 dCi (115)	84		09.08							
	2.0 dCi (120)	84		09.06							
	2.0 dCi (90)	66		09.06							
	2.0 i 16V	88		07.02							
	2.5 dCi (140)	99		07.03	08.06						
	2.5 dCi (150)	107		09.06							
	1.9 dCi (100)	74		07.02	08.06	- Pritsche/Fahrgestell ⁴⁾			24.3727-0796.2 580796 24.3727-0797.2 580797 24.3727-1068.2 581068 24.3727-1071.2 581071	+ kurzer Radstand ¹⁾ + langer Radstand ²⁾	L=1245/498 L=1643/498 L=1503 L=1603
	1.9 dCi (80)	60		07.02	08.06						
	2.0 dCi (115)	84		09.08							
	2.0 dCi (120)	84		09.06							
	2.0 dCi (90)	66		09.06							
	2.0 i 16V	88		07.02							
	2.5 dCi (140)	99		07.03	08.06						
	2.5 dCi (150)	107		09.06							
	1.9 dCi (100)	74		07.02	08.06	+ Pritsche/Fahrgestell ⁵⁾			24.3727-1068.2 581068 24.3727-1071.2 581071	<input type="checkbox"/>	L=1503 L=1603
NISSAN PRIMERA (P11E) Limousine (96-02)											
	1.6 i 16V			06.96	02.02	+ ABS			24.3571-1731.5 240321	<input type="checkbox"/>	D=57, - Halter TRW
	1.8 i 16V	84		06.99	02.02	+ ABS			24.3571-1732.5 240322	<input type="checkbox"/>	D=57, - Halter TRW
	2.0 i 16V	85		06.96	02.02	+ ABS					
	2.0 i 16V	96		04.98	02.02	+ ABS					
	2.0 i 16V	103		06.99	02.02	+ ABS					
	2.0 i 16V	110		04.98	02.02	+ ABS					
	2.0 TD	66		06.96	02.02	+ ABS					

¹⁾ + short wheel base / + passo lungo / + empattement court / + distancia corta entre ejes

²⁾ + long wheel base / + passo lungo / + empattement long / + distancia larga entre ejes

³⁾ on the brake caliper / sulla pinza freno / sur l'étrier de frein / a la pinza de freno

⁴⁾ - Pickup/Chassis / - Autocarro a cassone/Telaio / - Camion plateau/Châssis / - Camión plataforma/Chasis

⁵⁾ + Pickup/Chassis / + Autocarro a cassone/Telaio / + Camion plateau/Châssis / + Camión plataforma/Chasis

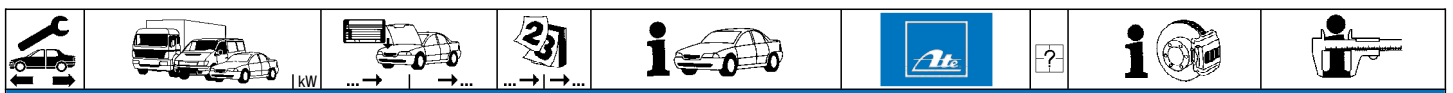











































NISSAN PRIMERA (P11E) Limousine (96-02)

	1.6 i 16V		06.96	02.02	24.5267-0391.3	330974			L=390 L=390
	1.8 i 16V	84	06.99	02.02	24.5267-0390.3	330932			
	2.0 i 16V	85	06.96	02.02					
	2.0 i 16V	96	06.96	02.02					
	2.0 i 16V	103	06.99	02.02					
	2.0 i 16V	110	06.96	02.02					
	2.0 TD	66	06.96	02.02					
	1.8 i 16V	84	06.99	03.01	24.3344-1717.5	240341		D=34, - Halter D=34, - Halter	TRW TRW
	2.0 i 16V	85	06.96	03.01	24.3344-1718.5	240342			
	2.0 i 16V	96	06.96	03.01					
	2.0 i 16V	103	06.99	03.01					
	2.0 i 16V	110	06.96	03.01					
	1.6 i 16V		06.96	02.02	24.5281-0585.3	331007			L=585 L=580
	1.8 i 16V	84	06.99	02.02	24.5281-0580.3	331006			
	2.0 i 16V	85	06.96	02.02					
	2.0 i 16V	96	06.96	02.02					
	2.0 i 16V	103	06.99	02.02					
	2.0 i 16V	110	06.96	02.02					
	2.0 TD	66	06.96	02.02					
	1.6 i 16V		06.96	02.02	24.3220-1718.3	020438			Rz 20,64
	2.0 TD	66	06.96	02.02					
	1.6 i 16V		06.96	02.02	24.3727-1713.2	581713			L=1620 L=1640
	2.0 TD	66	06.96	02.02	24.3727-1712.2	581712			
	1.8 i 16V	84	06.99	02.02	24.3727-1731.2	581731			
	2.0 i 16V	85	06.96	02.02	24.3727-1730.2	581730			
	2.0 i 16V	96	06.96	02.02					
	2.0 i 16V	103	06.99	02.02					L=1632 L=1657
	2.0 i 16V	110	06.96	02.02					
	2.0 TD	66	06.96	02.02					
	1.6 i 16V		02.00	02.02	24.2519-1703.3	040091			Nz 19,05
	1.8 i 16V	84	02.00	02.02					
	2.0 i 16V	103	02.00	02.02					

NISSAN PRIMERA (P12E) Limousine (02-08)

	1.6	78	06.04	10.08	24.2122-1774.3	010987			Thz 22,20 - Behälter
	1.6	80	06.04	04.06					
	1.8	85	06.04	10.08					
	1.9 dCi	88	06.04	10.07					
	2.0	103	06.04	10.08					
	2.2 dCi	102	06.04	10.07					
	2.5	125	06.04	04.06					
	1.6	78	03.02	10.08	24.3571-1781.5	240745		D=57, - Halter D=57, - Halter	
	1.6	80	03.02	04.06	24.3571-1782.5	240746			
	1.8	85	03.02	10.08					
	1.9 dCi	88	04.03	10.07					
	2.0	103	03.02	10.08					
	2.2 dCi	102	04.03	10.07					
	2.2 Di	93	03.02	04.03					
2.5	125	03.02	04.06						
	1.6	78	03.02	10.08	24.5278-0661.3	331190		L=661 L=652	
	1.6	80	03.02	04.06	24.5278-0652.3	331189			
	1.8	85	03.02	10.08					
	1.9 dCi	88	04.03	10.07					
	2.0	103	03.02	10.08					
	2.2 dCi	102	04.03	10.07					
	2.2 Di	93	03.02	04.03					
2.5	125	03.02	04.06						
	1.6	78	03.02	10.08	11.9387-7021.2	220629		D=38, - Halter D=38, - Halter Hülzensatz Führungsbolzen Haltefeder	ATE ATE ATE ATE ATE
	1.6	80	03.02	04.06	11.9387-7022.2	220630			
	1.8	85	03.02	10.08	11.0101-5407.2	260011			
	1.9 dCi	88	04.03	10.07	11.8171-0008.1	990049			
	2.0	103	03.02	10.08	11.8116-0340.1	390595			
	2.2 dCi	102	04.03	10.07					
	2.2 Di	93	03.02	04.03					
2.5	125	03.02	04.06						
	1.6	78	03.02	10.08	24.5281-0641.3	330969		L=640 L=640	
	1.6	80	03.02	04.06	24.5281-0640.3	330968			
	1.8	85	03.02	10.08					
	1.9 dCi	88	04.03	10.07					
	2.0	103	03.02	10.08					
	2.2 dCi	102	04.03	10.07					
	2.2 Di	93	03.02	04.03					
2.5	125	03.02	04.06						
	1.6	78	03.02	10.08	24.3727-1723.2	581723		L=236 L=1778 L=1778	
	1.6	80	03.02	04.06	24.3727-1729.2	581729			
	1.8	85	03.02	10.08	24.3727-1728.2	581728			
	1.9 dCi	88	04.03	10.07					
	2.0	103	03.02	10.08					
	2.2 dCi	102	04.03	10.07					
	2.2 Di	93	03.02	04.03					
	2.5	125	03.02	04.06					
	1.6	78	03.02	10.08	24.2519-1703.3	040091			
	1.6	80	03.02	04.06					
1.8	85	03.02	10.08				Nz 19,05		
1.9 dCi	88	04.03	10.07						











								
NISSAN PRIMERA (P12E) Limousine (02-08)								
	2.2 dCi 2.2 Di	102 93	04.03 03.02	10.07 04.03	24.2519-1704.3	040092		Nz 19,05
NISSAN PRIMERA (W10) Kombi (90-98)								
	1.6 2.0 D		07.90 07.90	03.98 12.95	24.3220-1703.3	020391		Rz 20,64
	1.6 2.0 D		07.90 07.90	03.98 12.95	24.3727-1701.2	581701	↑	L=250
	1.6 2.0 D 2.0 i		07.90 07.90 07.90	03.98 12.95 12.95	24.3727-1701.2	581701	↑	L=250
NISSAN PRIMERA (W11) Kombi (98-02)								
	1.6 i 16V 1.6 i 16V 1.6 i 16V 1.8 i 16V 2.0 i 16V 2.0 i 16V 2.0 TD	66 73 81 84 85 96 66	04.98 04.98 04.98 08.99 04.98 04.98 04.98	02.02 02.02 02.02 02.02 06.99 06.99 02.02	24.3571-1731.5 24.3571-1732.5	240321 240322	☐ ☐	D=57, - Halter D=57, - Halter
	2.0 i 16V 2.0 i 16V 2.0 i 16V	85 96 103	07.99 07.99 08.99	02.02 02.02 02.02	11.0101-5407.2 11.8171-0008.1 11.8116-0274.1	260011 990049 390516	2	Hülzensatz Führungsbolzen Haltefeder
	1.6 i 16V 1.6 i 16V 1.6 i 16V 1.8 i 16V 2.0 i 16V 2.0 i 16V 2.0 TD	66 73 81 84 85 96 103 66	04.98 04.98 04.98 08.99 04.98 04.98 08.99	02.02 02.02 02.02 02.02 02.02 02.02 02.02	24.5267-0391.3 24.5267-0390.3	330974 330932	☐ ☐	L=390 L=390
	1.6 i 16V 1.6 i 16V 1.6 i 16V 1.8 i 16V 2.0 i 16V 2.0 i 16V 2.0 TD	66 73 81 84 85 96 103 66	04.98 04.98 04.98 08.99 04.98 04.98 08.99	03.01 03.01 03.01 03.01 03.01 03.01 03.01	24.3344-1717.5 24.3344-1718.5	240341 240342	☐ ☐	D=34, - Halter D=34, - Halter
	1.6 i 16V 1.6 i 16V 1.6 i 16V 1.8 i 16V 2.0 i 16V 2.0 i 16V 2.0 TD	66 73 81 84 85 96 103 66	04.98 04.98 04.98 08.99 04.98 04.98 08.99	02.02 02.02 02.02 02.02 02.02 02.02 02.02	24.5281-0585.3 24.5281-0580.3	331007 331006	☐ ☐	L=585 L=580
	1.6 i 16V 1.6 i 16V 1.6 i 16V 1.8 i 16V 2.0 i 16V 2.0 i 16V 2.0 TD	66 73 81 84 85 96 103 66	04.98 04.98 04.98 08.99 04.98 04.98 08.99	03.01 03.01 03.01 03.01 03.01 03.01 03.01	24.3727-1716.2 24.3727-1717.2	581716 581717	☐ ☐	L=1642 L=1668
	1.6 i 16V 1.6 i 16V 1.6 i 16V 1.8 i 16V 2.0 i 16V 2.0 i 16V 2.0 TD	66 73 81 84 85 96 103 66	04.01 04.01 04.01 04.01 04.01 04.01 04.01	02.02 02.02 02.02 02.02 02.02 02.02 02.02	24.3727-1720.2 24.3727-1721.2	581720 581721	☐ ☐	L=1635 L=1660
	1.8 i 16V 2.0 i 16V	84 103	08.99 08.99	02.02 02.02	24.2519-1703.3	040091		Nz 19,05
NISSAN PRIMERA (W12) Kombi (02-08)								
	1.6 1.8 1.9 dCi 2.0 2.2 dCi 2.5	80 85 88 103 102 125	06.04 06.04 06.04 06.04 06.04 06.04	04.06 10.08 10.07 10.08 10.07 04.06	24.2122-1774.3	010987		ThZ 22,20 - Behälter
	1.6 1.8 1.9 dCi 2.0 2.2 dCi 2.2 Di 2.5	80 85 88 103 102 93 125	03.02 03.02 04.03 03.02 04.03 03.02 03.02	04.06 10.08 10.07 10.08 10.07 04.03 04.06	24.3571-1781.5 24.3571-1782.5	240745 240746	☐ ☐	D=57, - Halter D=57, - Halter

										
NISSAN PRIMERA (W12) Kombi (02-08)										
	1.6 1.8 1.9 dCi 2.0 2.2 dCi 2.2 Di 2.5	80 85 88 103 102 93 125		03.02 03.02 04.03 03.02 04.03 03.02 03.02	04.06 10.08 10.07 10.08 10.07 04.03 04.06	24.5278-0661.3 24.5278-0652.3	331190 331189	<input type="checkbox"/> <input type="checkbox"/>	L=661 L=652	
	1.6 1.8 1.9 dCi 2.0 2.2 dCi 2.2 Di 2.5	80 85 88 103 102 93 125		03.02 03.02 04.03 03.02 04.03 03.02 03.02	04.06 10.08 10.07 10.08 10.07 04.03 04.06	11.9387-7021.2 11.9387-7022.2 11.0101-5407.2 11.8171-0008.1 11.8116-0340.1	220629 220630 260011 990049 390595	<input type="checkbox"/> <input type="checkbox"/> <input type="checkbox"/> <input type="checkbox"/> <input type="checkbox"/> <input type="checkbox"/> <input type="checkbox"/>	D=38, - Halter D=38, - Halter Hülzensatz Führungsbolzen Haltefeder	ATE ATE ATE ATE ATE
	1.6 1.8 1.9 dCi 2.0 2.2 dCi 2.2 Di 2.5	80 85 88 103 102 93 125		03.02 03.02 04.03 03.02 04.03 03.02 03.02	04.06 10.08 10.07 10.08 10.07 04.03 04.06	24.5281-0641.3 24.5281-0640.3	330969 330968	<input type="checkbox"/> <input type="checkbox"/>	L=640 L=640	
	1.6 1.8 1.9 dCi 2.0 2.2 dCi 2.2 Di 2.5	80 85 88 103 102 93 125		03.02 03.02 04.03 03.02 04.03 03.02 03.02	04.06 10.08 10.07 10.08 10.07 04.03 04.06	24.3727-1723.2 24.3727-1729.2 24.3727-1728.2	581723 581729 581728	<input type="checkbox"/> <input type="checkbox"/> <input type="checkbox"/>	L=236 L=1778 L=1778	
	1.6 1.8 1.9 dCi 2.2 dCi 2.2 Di	80 85 88 102 93		03.02 03.02 04.03 04.03 03.02	04.06 10.08 10.07 10.07 04.03	24.2519-1703.3	040091	<input type="checkbox"/>	Nz 19,05	
	2.2 dCi 2.2 Di	102 93		04.03 03.02	10.07 04.03	24.2519-1704.3	040092	<input type="checkbox"/>	Nz 19,05	
NISSAN QASHQAI / QASHQAI +2 (J10, JJ10) (07-14)										
	1.5 dCi 1.5 dCi 1.5 dCi 1.6 dCi 1.6 dCi Allrad 1.6 i 16V 1.6 i 16V 2.0 dCi 2.0 dCi Allrad 2.0 i 16V 2.0 i 16V 2.0 i 16V Allrad 2.0 i 16V Allrad	76 78 81 96 96 84 86 110 110 102 104 102 104		07.08 02.07 11.10 10.11 10.11 02.07 11.10 02.07 02.07 11.10 02.07 11.10	01.14 01.14 01.14 01.14 01.14 01.14 01.14 01.14 01.14 01.14 01.14 01.14 01.14	24.5266-0600.3 24.5266-0601.3	331161 331162	<input type="checkbox"/> <input type="checkbox"/>	L=600 L=600	
	1.5 dCi 1.5 dCi 1.5 dCi 1.6 dCi 1.6 dCi Allrad 1.6 i 16V 1.6 i 16V 2.0 dCi 2.0 dCi Allrad 2.0 i 16V 2.0 i 16V 2.0 i 16V Allrad 2.0 i 16V Allrad	76 78 81 96 96 84 86 110 110 102 104 102 104		07.08 02.07 11.10 10.11 10.11 02.07 11.10 02.07 02.07 11.10 02.07 11.10	01.14 01.14 01.14 01.14 01.14 01.14 01.14 01.14 01.14 01.14 01.14 01.14 01.14	24.5247-0190.3 24.5292-0240.3 24.5292-0241.3	331385 331225 331226	2 <input type="checkbox"/> am Bremssattel 1) <input type="checkbox"/> am Bremssattel 1)	L=190 L=240 L=240	
	1.5 dCi 1.5 dCi 1.5 dCi 1.6 dCi 1.6 dCi Allrad 1.6 i 16V 1.6 i 16V 2.0 dCi 2.0 dCi Allrad 2.0 i 16V 2.0 i 16V 2.0 i 16V Allrad 2.0 i 16V Allrad	76 78 81 96 96 84 86 110 110 102 104 102 104		07.08 02.07 11.10 10.11 10.11 02.07 11.10 02.07 02.07 11.10 02.07 11.10	01.14 01.14 01.14 01.14 01.14 01.14 01.14 01.14 01.14 01.14 01.14 01.14 01.14	24.3727-1732.2 24.3727-1738.2 24.3727-1739.2	581732 581738 581739	<input type="checkbox"/> kurze Ausführung 2) <input type="checkbox"/> kurze Ausführung 2)	L=262 L=1703 L=1705	
	1.5 dCi 1.5 dCi 1.5 dCi 1.6 dCi 1.6 dCi Allrad 1.6 i 16V 1.6 i 16V 2.0 dCi 2.0 dCi Allrad 2.0 i 16V 2.0 i 16V 2.0 i 16V Allrad 2.0 i 16V Allrad	76 78 81 96 96 84 86 110 110 102 104 102 104		08.08 08.08 02.10 07.11 07.11 08.08 02.10 08.08 08.08 08.08 08.08 08.08	01.14 01.14 01.14 01.14 01.14 01.14 01.14 01.14 01.14 01.14 01.14 01.14 01.14	24.3727-1732.2 24.3727-1740.2 24.3727-1741.2	581732 581740 581741	<input type="checkbox"/> lange Ausführung 3) <input type="checkbox"/> lange Ausführung 3)	L=262 L=1833 L=1835	

1) on the brake caliper / sulla pinza freno / sur l'étrier de frein / a la pinza de freno

2) short version / versione corto / version court / versión corta

3) long version / versione lunga / version longue / versión larga

NISSAN SERENA/VANETTE CARGO (C23M/963) (92-01)					
	1.6 i 16V 71 2.0 D 49 2.0 i 16V 93 2.3 D 55	07.92 11.01 07.92 08.94 07.92 11.01 09.94 11.01	24.3223-1709.3 020444		Rz 23,81
	1.6 i 16V 71 2.0 D 49 2.3 D 55	06.94 11.01 06.94 08.94 09.94 11.01	24.3727-1727.2 581727 24.3727-1726.2 581726	<input type="checkbox"/> <input type="checkbox"/>	L=1234 L=1608
NISSAN SUNNY (Y10) Kombi (90-00)					
	1.6 16V 2.0 D 1.6 16V 4x4 1.7 D	11.90 03.00 11.90 03.00 11.90 03.00 11.90 03.00	24.3727-1701.2 581701 24.3727-1701.2 581701 24.3727-1701.2 581701	<input type="checkbox"/> <input type="checkbox"/> <input type="checkbox"/> <input type="checkbox"/>	L=250 L=250 L=250 L=728
	1.6 16V 1.6 16V 4x4	11.90 03.00 11.90 03.00	24.3728-1703.2 591703		L=728
NISSAN TERRANO II (R20) (93-06)					
	2.4 i 4WD 91 2.7 TD 4WD 74 2.4 i 4WD 87 2.7 TD 4WD 74 2.7 TDi 4WD 92 3.0 Di 4WD 113	02.93 04.96 - ABS 02.93 04.96 - ABS 05.96 11.05 - ABS 05.96 01.02 - ABS 05.96 11.05 - ABS 05.02 04.06 - ABS	24.2123-1726.3 010557 24.2125-1738.3 010931		THz 23,81 - Behälter THz 25,40 TRW
	2.4 i 4WD 87 2.7 TD 4WD 74 2.7 TDi 4WD 92 3.0 Di 4WD 113	09.00 11.05 + ABS 09.00 01.02 + ABS 09.00 11.05 + ABS 05.02 04.06 + ABS	24.5290-0414.3 331175 24.5290-0410.3 331081	<input type="checkbox"/> <input type="checkbox"/>	L=414 L=410
	2.4 i 4WD 87 2.4 i 4WD 91 2.7 TD 4WD 74 2.7 TDi 4WD 92 3.0 Di 4WD 113	05.96 11.05 02.93 04.96 02.93 01.02 05.96 11.05 05.02 04.06	24.5278-0467.3 331073	2	L=467
	2.4 i 4WD 91 2.7 TD 4WD 74 2.4 i 4WD 87 2.4 i 4WD 91 2.7 TD 4WD 74 2.7 TD 4WD 74 2.7 TDi 4WD 92	02.93 04.96 + 2 türig ¹⁾ 02.93 04.96 + 2 türig ¹⁾ 05.96 09.99 + 2 türig ¹⁾ 02.93 04.96 + 4 türig ²⁾ 05.96 09.99 + 2 türig ¹⁾ 05.96 09.99 + 2 türig ¹⁾	24.3222-1717.3 020443 24.3223-1709.3 020444		Rz 22,20 Rz 23,81
	2.4 i 4WD 87 2.7 TD 4WD 74 2.7 TDi 4WD 92	05.96 09.99 + 4 türig ²⁾ 05.96 09.99 + 4 türig ²⁾ 05.96 09.99 + 4 türig ²⁾	24.3225-1703.3 020481		Rz 25,40
	2.4 i 4WD 87 2.4 i 4WD 87 2.7 TD 4WD 74 2.7 TD 4WD 74 2.7 TDi 4WD 92 2.7 TDi 4WD 92 2.7 TDi 4WD 92 3.0 Di 4WD 113	10.99 01.02 + ABS/ + 4 türig ³⁾ 10.99 01.02 - ABS/ + 2 türig ⁴⁾ 10.99 01.02 + ABS/ + 4 türig ³⁾ 10.99 01.02 - ABS/ + 2 türig ⁴⁾ 02.02 11.05 + 2 türig ¹⁾ 10.99 01.02 - ABS/+ Automatikgetriebe/+ 4 türig ⁵⁾ 10.99 01.02 + ABS/ + Schaltgetriebe/ + 4 türig ⁶⁾ 10.99 01.02 - ABS/ + Schaltgetriebe/ + 2 türig ⁷⁾ 05.02 04.06 + 2 türig ¹⁾	24.3222-1124.3 020344		Rz 22,20
	2.4 i 4WD 87 2.7 TD 4WD 74 2.7 TDi 4WD 92 2.7 TDi 4WD 92	10.99 01.02 + ABS/ + 2 türig ⁸⁾ 10.99 01.02 + ABS/ + 2 türig ⁸⁾ 10.99 01.02 + Automatikgetriebe/ + 2 türig ⁹⁾ 10.99 01.02 + ABS/ + Schaltgetriebe/ + 2 türig ¹⁰⁾	24.3220-1121.3 020343		Rz 20,64
	2.4 i 4WD 87 2.4 i 4WD 87 2.7 TD 4WD 74 2.7 TDi 4WD 92 2.7 TDi 4WD 92 3.0 Di 4WD 113	02.02 11.05 + 4 türig ²⁾ 10.99 01.02 - ABS/ + 4 türig ¹¹⁾ 10.99 01.02 - ABS/ + 4 türig ¹¹⁾ 02.02 11.05 + 4 türig ²⁾ 10.99 01.02 - ABS/ + Schaltgetriebe/ + 4 türig ¹²⁾ 05.02 04.06 + 4 türig ²⁾	24.3223-1706.3 020479		Rz 23,81
NISSAN X-TRAIL (T30) (01-07)					
	2.0 i 16V 103 2.0 i 16V 110 2.0 i 16V 4x4 103 2.0 i 16V 4x4 110 2.0 i 16V 4x4 206 2.2 DCi FWD 84 2.2 Di 4x4 84 2.5 i 16V 4x4 121 2.5 i 16V 4x4 132 2.5 i 16V 4x4 134 2.5 i 16V FWD 131	07.01 08.03 - ESP/ + Schaltgetriebe ¹³⁾ 09.01 08.03 - ESP/ + Schaltgetriebe ¹³⁾ 07.01 08.03 - ESP/ + Schaltgetriebe ¹³⁾ 09.01 08.03 - ESP/ + Schaltgetriebe ¹³⁾ 06.01 08.03 - ESP/ + Schaltgetriebe ¹³⁾ 07.01 09.03 - ESP/ + Schaltgetriebe ¹³⁾ 07.01 09.03 - ESP/ + Schaltgetriebe ¹³⁾ 01.03 08.03 - ESP/ + Schaltgetriebe ¹³⁾ 11.02 08.03 - ESP/ + Schaltgetriebe ¹³⁾ 09.01 08.03 - ESP/ + Schaltgetriebe ¹³⁾ 11.02 08.03 - ESP/ + Schaltgetriebe ¹³⁾	24.2125-1741.3 010988		THz 25,40 - Behälter
	2.0 i 16V 103 2.0 i 16V 110 2.0 i 16V 4x4 103 2.0 i 16V 4x4 110 2.0 i 16V 4x4 206 2.2 DCi 84 2.2 dCi 100 2.2 dCi 4x4 100 2.2 DCi FWD 84 2.2 Di 4x4 84	07.01 02.07 09.01 02.07 07.01 02.07 09.01 02.07 06.01 02.07 10.04 02.07 12.03 02.07 12.03 02.07 07.01 09.03 07.01 09.03	24.5290-0505.3 331083 24.5290-0502.3 331164	<input type="checkbox"/> <input type="checkbox"/>	L=505 L=502

1) + 2 door / + 2 porte / + 2 portes / + 2 puertas

2) + 4 door / + 4 porte / + 4 portes / + 4 puertas

3) + ABS/ + 4 door / + ABS/ + 4 porte / + ABS/ + 4 portes / + ABS/ + 4 puertas

4) - ABS/ + 2 door / - ABS/ + 2 porte / - ABS/ + 2 portes / - ABS/ + 2 puertas

5) - ABS/+ autom.transm./ + 4 door / - ABS/+ scatola camb. velocità/ + 4 porte / - ABS/ + transmission autom./

+ 4 portes / - ABS/ + cambio autom./ + 4 puertas

6) + ABS/ + manual transm./ + 4 door / + ABS/+ scatola camb. velocità/ + 4 porte / + ABS/ + transmiss.mécanique/

+ 4 portes / + ABS/ + cambio velocidad/ + 4 puertas







































7) -ABS/ + manual transm./ + 2 door / - ABS/+ sc.camb.velocità/ + 2 porte / - ABS/ + transmiss.mécanique/ + 2 portes / - ABS/ + cambio velocidad/ + 2 puertas

8) + ABS/ + 2 door / + ABS/ + 2 porte / + ABS/ + 2 portes / + ABS/ + 2 puertas

9) + autom.transm./ + 2 door / + scatola camb.autom./ + 2 porte / + transmission automatique/ + 2 portes / + cambio automático/ + 2 puertas

10) + ABS/ + manual transm./ + 2 door / + ABS/+ scatola camb. velocità/ + 2 porte / + ABS/ + transmiss.mécanique/ + 2 portes / + ABS/ + cambio velocidad/ + 2 puertas

11) - ABS/ + 4 door / - ABS/ + 4 porte / - ABS/ + 4 portes / - ABS/ + 4 puertas



















































									
NISSAN X-TRAIL (T30) (01-07)									
	2.5 i 16V 4x4 2.5 i 16V 4x4 2.5 i 16V 4x4 2.5 i 16V FWD	121 132 134 131		01.03 02.07 11.02 02.07 09.01 02.07 11.02 02.07		24.5290-0505.3 331083 24.5290-0502.3 331164	 	L=505 L=502	
	2.0 i 16V 2.0 i 16V 2.0 i 16V 4x4 2.0 i 16V 4x4 2.0 i 16V 4x4 2.2 DCi 2.2 dCi 2.2 dCi 4x4 2.2 DCi FWD 2.2 Di 4x4 2.5 i 16V 4x4 2.5 i 16V 4x4 2.5 i 16V 4x4 2.5 i 16V FWD	103 110 103 110 206 84 100 100 84 84 121 132 134 131		07.01 02.07 09.01 02.07 07.01 02.07 09.01 02.07 06.01 02.07 10.04 02.07 12.03 02.07 12.03 02.07 07.01 09.03 07.01 09.03 01.03 02.07 11.02 02.07 09.01 02.07 11.02 02.07		24.5290-0486.3 331178 24.5290-0485.3 331082	 	L=485 L=485	
	2.0 i 16V 2.0 i 16V 2.0 i 16V 4x4 2.0 i 16V 4x4 2.0 i 16V 4x4 2.2 DCi 2.2 dCi 2.2 dCi 4x4 2.2 DCi FWD 2.2 Di 4x4 2.5 i 16V 4x4 2.5 i 16V 4x4 2.5 i 16V 4x4 2.5 i 16V FWD	103 110 103 110 206 84 100 100 84 84 121 132 134 131		07.01 02.07 09.01 02.07 07.01 02.07 09.01 02.07 06.01 02.07 10.04 02.07 12.03 02.07 12.03 02.07 07.01 09.03 07.01 09.03 01.03 02.07 11.02 02.07 09.01 02.07 11.02 02.07		24.3727-1723.2 581723 24.3727-1748.2 581748 24.3727-1749.2 581749	  	L=236 L=1745 L=1733	
	2.2 dCi 2.2 dCi 4x4 2.2 DCi FWD 2.2 Di 4x4	100 100 84 84		12.03 02.07 12.03 02.07 07.01 09.03 07.01 09.03		24.2519-1704.3 040092		Nz 19,05	
NISSAN X-TRAIL (T31) (07-14)									
	2.0 2.0 2.0 4x4 2.0 dCi 2.0 dCi 2.0 dCi 4x4 2.0 dCi FWD 2.0 FWD 2.0 FWD 2.5 2.5 4x4	103 104 101 110 127 130 110 103 104 124 122		06.08 05.14 06.07 05.14 06.07 05.14 06.07 05.14 06.07 05.14 10.09 05.14 06.07 05.14 06.08 05.14 03.07 05.14 06.07 05.14 01.12 05.14		24.5267-0625.3 331332 24.5267-0626.3 331333	 	L=625 L=625	
	2.0 2.0 2.0 4x4 2.0 dCi 2.0 dCi 2.0 dCi 4x4 2.0 dCi FWD 2.0 FWD 2.0 FWD 2.5 2.5 4x4	103 104 101 110 127 130 110 103 104 124 122		06.08 05.14 06.07 05.14 06.07 05.14 06.07 05.14 10.09 05.14 06.07 05.14 06.08 05.14 03.07 05.14 06.07 05.14 01.12 05.14		24.5247-0191.3 331386 24.5290-0240.3 331334 24.5290-0241.3 331335	2  am Bremssattel 1)  am Bremssattel 1)	L=190 L=240 L=240	
OPEL ADAM / Vauxhall Adam (13-)									
	1.0 1.0 ECOTEC DIT 1.0 ECOTEC DIT 1.2 1.2 ecoFLEX 1.4 ecoFLEX 1.4 ecoFLEX 1.4 LPG 1.4 T ecoFlex	50 66 85 69 51 64 74 64 110		07.13 07.14 07.14 07.13 01.13 01.13 01.13 07.13 11.14	+ Bremsscheibendurchm. 257 mm 2) + Bremsscheibendurchm. 257 mm 2) + Bremsscheibendurchm. 257 mm 2) + Bremsscheibendurchm. 257 mm 2) + Bremsscheibendurchm. 257 mm 2) + Bremsscheibendurchm. 257 mm 2) + Bremsscheibendurchm. 257 mm 2) + Bremsscheibendurchm. 257 mm 2) + Bremsscheibendurchm. 257 mm 2)	24.3541-1769.5 240601 24.3541-1770.5 240602	 	D=54, - Halter D=54, - Halter	BOS BOS
	1.0 1.0 ECOTEC DIT 1.0 ECOTEC DIT 1.2 1.2 ecoFLEX 1.4 ecoFLEX 1.4 ecoFLEX 1.4 LPG 1.4 T ecoFlex	50 66 85 69 51 64 74 64 110		07.13 07.14 07.14 07.13 01.13 01.13 01.13 07.13 11.14	+ Bremsscheibendurchm. 308 mm 3) + Bremsscheibendurchm. 308 mm 3) + Bremsscheibendurchm. 308 mm 3) + Bremsscheibendurchm. 308 mm 3) + Bremsscheibendurchm. 308 mm 3) + Bremsscheibendurchm. 308 mm 3) + Bremsscheibendurchm. 308 mm 3) + Bremsscheibendurchm. 308 mm 3) + Bremsscheibendurchm. 308 mm 3)	11.9571-9823.2 220471 24.3571-9823.5 240499 11.9571-9824.2 220472 24.3571-9824.5 240500	       	D=57, - Halter D=57, - Halter D=57, - Halter D=57, - Halter	ATE ATE ATE ATE
	1.0 1.0 ECOTEC DIT 1.0 ECOTEC DIT 1.2 1.2 ecoFLEX 1.4 ecoFLEX 1.4 ecoFLEX	50 66 85 69 51 64 74		07.13 07.14 07.14 07.13 01.13 01.13 01.13		24.3219-1755.3 020508		Rz 19,05	

1) on the brake caliper / sulla pinza freno / sur l'étrier de frein / a la pinza de freno

2) + brake disc diameter 257mm / + diametro dischi freno 257mm / + diamètre disques frein 257mm / + diámetro disco freno 257mm

3) + brake disc diameter 308mm / + diametro dischi freno 308mm / + diamètre disques frein 308mm / + diámetro disco freno 308mm

4) - sport package / - pacchetto sportivo / - version sport / - kit deportivo

											
OPEL ADAM / Vauxhall Adam (13-)											
	1.4 LPG 1.4 T ecoFlex	64 110		07.13 11.14		24.3219-1755.3 020508		Rz 19,05			
	1.0 1.0 ECOTEC DIT 1.0 ECOTEC DIT 1.2 1.2 ecoFLEX 1.4 ecoFLEX 1.4 ecoFLEX 1.4 LPG 1.4 T ecoFlex	50 66 85 69 51 64 74 64 110		07.13 07.14 07.14 07.13 01.13 01.13 01.13 07.13 11.14		24.3727-0799.2 580799	1  für Trommeldurchmesser 203 mm ¹⁾	L=1335/1335			
OPEL AGILA / Vauxhall Agila Mk I (00-07)											
	1.0 1.0 12V 1.2 16V 1.3 CDTI	44 43 55 51		08.03 09.00 09.00 08.03	07.07 + ABS 07.07 + ABS 07.07 + ABS 07.07 + ABS	24.2120-1730.3 010678		Thz 20,64			
	1.0 1.0 12V 1.2 16V 1.2 16V Twinport 1.3 CDTI	44 43 55 59 51	3G002367 3G002367 3G002367 3G002367 3G002367	08.03 09.00 09.00 07.04 08.03		24.3481-1757.5 24.3481-1758.5	240325 240326	 	D=48, - Halter D=48, - Halter	BOS BOS	
	1.0 1.0 12V 1.2 16V 1.2 16V Twinport 1.3 CDTI	44 43 55 59 51	3G002368 3G002368 3G002368 3G002368 3G002368	07.07 07.07 07.07 07.07 07.07		24.3481-1777.5 24.3481-1778.5	240451 240452	 	D=48, - Halter D=48, - Halter		
	1.0 1.0 12V 1.2 16V 1.2 16V Twinport 1.3 CDTI	44 43 55 59 51		08.03 09.00 09.00 07.04 08.03	07.07 07.07 07.07 07.07 07.07	24.5247-0280.3	330700	2		L=280	
	1.0 1.0 12V 1.2 16V 1.2 16V Twinport 1.3 CDTI	44 43 55 59 51		08.03 09.00 09.00 07.04 08.03	07.07 07.07 07.07 07.07 07.07	24.3215-1701.3	020493			Rz 15,87	
	1.0 12V 1.2 16V	43 55	1G075421 1G075421	09.00 09.00		24.3727-0771.2 24.3727-0774.2	580771 580774	 	L=1516, + Zub L=1507, + Zub		
	1.0 12V 1.2 16V	43 55	1G075422 1G075422	2G999999 2G999999		24.3727-0771.2 24.3727-0772.2	580771 580772	 	L=1516, + Zub L=1498, + Zub		
	1.0 1.0 12V 1.2 16V 1.2 16V Twinport 1.3 CDTI	44 43 55 59 51	3G000001 3G000001	08.03 07.07 07.07 07.07 08.03	07.07 07.07 07.07 07.07 07.07	24.3727-0777.2 24.3727-0778.2	580777 580778	 	L=1536, + Zub L=1530, + Zub		
	1.0 12V	43	YG057598	09.00		24.3728-0727.2	590727			L=690	
	1.0 1.0 12V	44 43	YG057599	08.03	07.07 07.07	24.3728-0727.2	590727			L=690	
	1.2 16V 1.3 CDTI	55 51	YG057523	08.03	07.07 07.07	24.3728-0725.2	590725			L=675	
OPEL AGILA / Vauxhall Agila Mk II (08-)											
	1.0 1.0 1.2 1.2 1.3 CDTI	48 50 63 69 55		01.08 07.11 01.08 11.10 01.08		24.3541-1821.7 24.3541-1822.7	220695 220696	 	D=54, - Halter D=54, - Halter	TRW TRW	
	1.0 1.0 1.2 1.2 1.3 CDTI	48 50 63 69 55		01.08 07.11 01.08 11.10 01.08		24.3219-1756.3	020511			Rz 19,05	BOS
	1.0 1.0 1.2 1.2 1.3 CDTI	48 50 63 69 55		01.08 07.11 01.08 11.10 01.08		24.3727-0793.2 24.3727-0792.2	580793 580792	 	L=1600 L=1600		
	1.0 1.0 1.2 1.2	48 50 63 69	AM999999 AM999999 AM999999 AM999999	01.08 07.11 01.08 11.10		24.3728-0728.2	590728			L=716	
OPEL AMPERA / Vauxhall Ampera (11-)											
	EV 150	111		11.11		11.9601-2601.2 11.9601-2602.2 11.0103-0002.2	220913 220914 250157	  	D=60, - Halter D=60, - Halter Bremsattel-Zubehör	ATE ATE ATE	
	EV 150	111		11.11		24.5176-0400.3	331492	2		L=400	
	EV 150	111		11.11		11.9382-7001.2 11.9382-7002.2 11.0103-0001.2	220889 220890 250156	  	D=38, - Halter D=38, - Halter Bremsattel-Zubehör	ATE ATE ATE	

¹⁾ for drum diameter 203mm / per tamburi diametro 203mm / pour tambour diamètre 203mm / para tambores diámetro 203mm

²⁾ from production date 08.2012 / da data die produzione 08.2012 / à partir de la date de production 08.2012 / desde fecha de producción 08.2012

³⁾ electric parking brake / fr.di stazionamento elettrico / frein à main électrique / freno de mano eléctrico

OPEL ARENA / Vauxhall Arena (97-01)																	
	1.9 D			03.98	09.01	- ABS		24.3223-1106.3	020317				Rz 23,81	BDX			
	1.9 D			03.98	09.01	+ ABS		24.3225-1601.3	020359				Rz 25,40	TRW			
	2.5 D			03.98	09.01												
OPEL ASTRA F / Vauxhall Astra MKIII (91-01)																	
	1.4 N			10.91	09.98	- ABS		24.2120-0702.3	010361			Kennzeichen: EB/nicht für Delco BKV ¹⁾	THz 20,64				
	1.4 S			10.91	09.98	- ABS/ - verstärkte Bremse ²⁾											
	1.6	52		10.91	09.98	- ABS											
	1.6 i Caravan	52		05.93	09.98	- ABS											
	1.7 D			10.91	09.98	- ABS/ - verstärkte Bremse ²⁾											
	1.7 TD			10.91	09.98	- ABS											
	1.8	66		10.91	09.98	- ABS											
	1.4 S			10.91	09.98	- ABS/ + verstärkte Bremse ³⁾		03.2122-0264.3	010129				THz 22,20	ATE			
	1.6 16V			02.93	09.98	- ABS											
	1.6 S			10.91	09.98	- ABS											
	1.7 D			10.91	09.98	- ABS/ + verstärkte Bremse ³⁾											
	1.8 16V			10.91	09.98	- ABS											
	2.0	85		10.91	09.98	- ABS											
	1.4			10.91	09.98	+ ABS		03.2122-0282.3	010130				THz 22,20	ATE			
	1.6			10.91	09.98	+ ABS											
1.6 16V			02.93	09.98	+ ABS												
1.6 i Caravan	52		05.93	09.98	+ ABS												
1.6 S			10.91	09.98	+ ABS												
1.7 D			10.91	09.98	+ ABS												
1.7 TD			10.91	09.98	+ ABS												
1.8			10.91	09.98	+ ABS												
1.8 16V			10.91	09.98	+ ABS												
2.0			10.91	09.98	+ ABS												
2.0 GSi			10.91	09.98	+ ABS												
2.0 GSi 16V			10.91	09.98	+ ABS												
	1.4 i	44		10.91	09.98			24.3481-1733.5	240213			D=48, - Halter	ATE				
	1.4 N			10.91	09.98			24.3481-1734.5	240214			D=48, - Halter	ATE				
	1.4 S			10.91	09.98	- verstärkte Br./+ Schaltgetr. ⁴⁾		11.0441-4811.2	250024			Dichtungssatz	ATE				
	1.4 S	55		10.91	09.98			11.0101-5407.2	260011			Hülssensatz	ATE				
	1.4 Si	60		10.91	07.95			11.8171-0008.1	990049			Führungsbolzen	ATE				
	1.6 N Limousine			10.91	09.98	+ Schaltgetriebe ⁵⁾		11.8116-0129.1	390591	2		Haltefeder	ATE				
	1.4 16V	66		10.91	09.98	- verstärkte Bremse ⁶⁾		11.9481-9871.2	220681			D=48, - Halter	ATE				
	1.4 Cabrio			10.91	03.01			11.9481-9872.2	220682			D=48, - Halter	ATE				
	1.4 S			10.91	09.98	- verstärkte Br./+ Automatikg. ⁷⁾		11.0441-4811.2	250024			Dichtungssatz	ATE				
	1.4 Si	60		08.95	09.98			11.0101-5407.2	260011			Hülssensatz	ATE				
	1.6 Cabrio			10.91	03.01			11.8171-0008.1	990049			Führungsbolzen	ATE				
	1.6 N Caravan			10.91	09.98			11.8116-0129.1	390591	2		Haltefeder	ATE				
	1.6 N Limousine			10.91	09.98	+ Automatikgetriebe ⁸⁾											
	1.6 S			10.91	09.98												
	1.6 Si			03.92	12.94												
1.7 D			10.91	09.98	- verstärkte Bremse ⁶⁾												
1.7 TD			10.91	09.98	- verstärkte Bremse ⁶⁾												
1.7 TD Caravan			10.91	09.98	- verstärkte Bremse ⁶⁾												
1.8	66		10.91	09.98													
1.4 16V	66		10.91	09.98	+ verstärkte Bremse ⁹⁾		24.3521-1701.5	240001			D=52, - Halter	ATE					
1.4 S			10.91	09.98	+ verstärkte Bremse ⁹⁾		24.3521-1702.5	240002			D=52, - Halter	ATE					
1.6			10.91	09.98			11.0441-5202.2	250026			Dichtungssatz	ATE					
1.6 16V			02.93	09.98			11.0101-5407.2	260011			Hülssensatz	ATE					
1.7 D			10.91	09.98	+ verstärkte Bremse ⁹⁾		11.8171-0008.1	990049			Führungsbolzen	ATE					
1.7 TD			10.91	09.98	+ verstärkte Bremse ⁹⁾		11.8116-0097.1	390590	2		Haltefeder	ATE					
1.7 TD Caravan			10.91	09.98	+ verstärkte Bremse ⁹⁾												
1.8			10.91	09.98													
1.8 16V			10.91	09.98													
1.8 Cabrio			10.91	03.01													
2.0			10.91	09.98													
2.0 16V			10.91	09.98													
2.0 Cabrio			10.91	10.94													
2.0 GSi			10.91	09.98													
2.0 GSi 16V			10.91	09.98													
	1.4			10.91	09.98			24.5298-0322.3	331314	2		L=322					
	1.6			10.91	09.98												
	1.6 16V			02.93	09.98												
	1.6 S			10.91	09.98												
	1.7 D			10.91	09.98												
	1.7 TD			10.91	09.98												
	1.8			10.91	09.98												
	1.8 16V			10.91	09.98												
	2.0			10.91	09.98												
	2.0 GSi			10.91	09.98												
2.0 GSi 16V			10.91	09.98													
	1.8 16V			10.91	09.98			13.2351-0013.2	210010			D=35	ATE				
	2.0 GSi			10.91	09.98			13.2351-0014.2	210011			D=35	ATE				
	2.0 GSi 16V			10.91	09.98			24.9235-0013.5	230001			D=35	ATE				
								24.9235-0014.5	230002			D=35	ATE				
							13.0441-3506.2	250052			Dichtungssatz	ATE					
	1.4 Limousine			10.91	09.98			24.5117-0195.3	330565	2		L=198					
	1.6 16V Limousine			02.93	09.98												
	1.6 Limousine			10.91	09.98												
	1.6 S Limousine			10.91	09.98												
	1.7 D Limousine			10.91	09.98												
1.7 TD Limousine			10.91	09.98													

1) registration no.: EB/not for Delco BKV / targa: EB/non per Delco BKV / indice: EB/sans pour Delco BKV / distiutivo: EB/ no para Delco BKV
2) - ABS/ - heavy duty brake / - ABS/ - freno rinforzato / - ABS/ - frein renforcé / - ABS/ - freno reforzado
3) - ABS/ + heavy duty brake / - ABS/ + freno rinforzato / - ABS/ + frein renforcé / - ABS/ + freno reforzado
4) - heavy duty br./+ manual trans. / - fr.rinforzato/+ scatola camb.velocità / - frein renforcé/+ transm.mécanique / - freno reforzado/+ camb.velocidad
5) + manual transmission / + scatola cambio velocità / + transmission mécanique / + cambio de velocidad
6) - heavy duty brake / - freno rinforzato / - frein renforcé / - freno reforzado

7) - heavy duty br./+ autom.trans. / - fr.rinforzato/+ scatola cambio autom. / - frein renforcé/ + transm.automatique / - freno reforzado/+ camb.automático
8) + autom.transmission / + scatola cambio automatico / + transmission automatique / + cambio automático
9) + heavy duty brake / + freno rinforzato / + frein renforcé / + freno reforzado

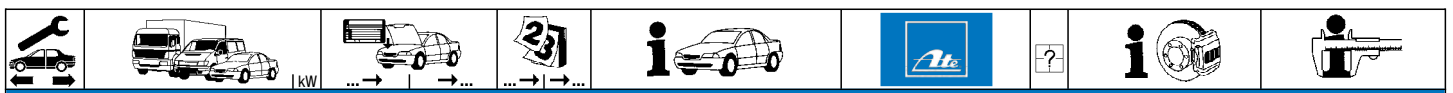













OPEL ASTRA F / Vauxhall Astra MKIII (91-01)

















	1.8 16V 1.8 Limousine 2.0 GSi 2.0 GSi 16V 2.0 Limousine			10.91 10.91 10.91 10.91 10.91	09.98 09.98 09.98 09.98 09.98	24.5117-0195.3	330565	2		L=198	
	1.4 Caravan 1.6 Caravan 1.6 S Caravan 1.7 D Caravan 1.7 TD Caravan 1.8 Caravan 2.0 Caravan			10.91 10.91 03.92 10.91 10.91 10.91 10.91	09.98 09.98 09.98 09.98 09.98 09.98 09.98	24.5233-0200.3	330425	2		L=198	
	1.4 Cabrio 1.4 N Limousine 1.4 S Limousine 1.6 1.6 16V Limousine 1.6 Cabrio 1.6 Limousine 1.6 Si 1.7 D Limousine 1.7 TD Limousine 1.8 Cabrio 1.8 Limousine 2.0 Cabrio 2.0 Limousine	52 74 66 85	R2500000 R2500000 R2500000 R2500000 R2500000 R2500000 R2500000 R2500000 R2500000 R2500000 R2500000 R2500000 R2500000 R2500000	10.91 10.91 10.91 05.93 02.93 10.91 10.91 03.92 10.91 10.91 10.91 10.91 10.91 10.91		- verstärkte Bremse ¹⁾	03.3217-3512.3	020032		Rz 17,46	TRW
	1.4 Cabrio 1.4 Caravan 1.4 N Limousine 1.4 S Limousine 1.4 S Limousine 1.6 1.6 16V Limousine 1.6 Cabrio 1.6 Caravan 1.6 Limousine 1.6 Si 1.7 D Caravan 1.7 D Limousine 1.7 TD Caravan 1.7 TD Limousine 1.8 16V Cabrio 1.8 16V Caravan 1.8 16V Limousine 1.8 Cabrio 1.8 Caravan 1.8 Limousine 2.0 Cabrio 2.0 Caravan 2.0 Limousine	R2500001 R2500001 R2500001 52 R2500001 R2500001 74 R2500001 R2500001 R2500001 74 R2500001 R2500001 R2500001 R2500001 85 85 85 R2500001 66 R2500001 R2500001 85 R2500001		10.91 10.91 10.91 10.91 10.91 10.91 10.91 10.91 10.91 10.91 10.91 10.91 10.91 10.91 10.91 11.94 07.94 11.94 10.91 10.91 10.91 10.91 10.91 10.91	03.01 09.98 09.98 09.98 09.98 07.96 09.98 03.01 09.98 09.98 09.98 09.98 09.98 09.98 09.98 03.01 01.98 09.98 03.01 09.98 09.98 10.94 09.98 09.98	+ verstärkte Bremse ⁴⁾ - verstärkte Bremse ¹⁾	24.3219-1767.3 24.3219-1715.3	020552 020122	+ GG ²⁾ + ALU ³⁾	Rz 19,05 Rz 19,05 (ALU)	
	1.4 Limousine 1.6 16V Limousine 1.6 Limousine 1.6 S Limousine 1.7 D Limousine 1.7 TD Limousine 1.8 Limousine 2.0 Limousine			10.91 02.93 10.91 10.91 10.91 10.91 10.91 10.91	09.98 09.98 09.98 09.98 09.98 09.98 09.98 09.98	24.3727-0735.2	580735	1	L=1273/1690, + Zub		
	1.4 Caravan 1.6 Caravan 1.6 S Caravan 1.7 D Caravan 1.7 TD Caravan 1.8 Caravan 2.0 Caravan		R8999999	10.91 10.91 03.92 10.91 10.91 10.91 10.91	09.98 09.98 09.98 09.98 09.98 09.98 09.98	24.3727-0732.2	580732	1	L=1288/1398, + Zub		
	1.8 16V 2.0 GSi 2.0 GSi 16V			10.91 10.91 10.91	09.98 09.98 09.98	24.3727-0742.2 24.3727-0732.2	580742 580732	1 1	+ Scheibenbremse ⁵⁾ + Trommelbremse ⁶⁾	L=1175/1575, + Zub L=1288/1398, + Zub	
	1.4 N Limousine 1.4 S Limousine 1.6 Cabrio 1.6 N Limousine 1.8 Limousine 2.0 Limousine	66 85	R2500000 R2500000	10.91 10.91 10.91 10.91 10.91 10.91	09.98 09.98 09.98 09.98 07.93 07.93	03.0101-0027.2	320022		+ Schaltgetriebe ⁷⁾	BRES 3/45	ATE
	1.6 S Limousine 1.7 D Limousine			10.91 10.91	07.93 07.93	03.0101-0026.2	320230			BRES 3/40	ATE
	1.6 Cabrio 1.6 N Limousine 1.7 D Limousine	T2526384 T2526384		03.01 09.98 08.93	03.01 09.98 09.98	03.0101-0031.2	320211			BRES 3/30	ATE
	1.6 16V Limousine 1.6 S Limousine 1.8 Limousine 2.0 GSi 16V 2.0 Limousine	85		02.93 08.93 08.93 08.92 08.93	09.98 09.98 09.98 09.98 09.98	03.6583-0054.3	320146		- RC	BRL 8/3 (4)	ATE
	1.6 16V Limousine			02.93	09.98	03.6585-0018.3	320114		+ RC	BRL 8/5 (4)	ATE

1) - heavy duty brake / - freno reforzado / - frein renforcé / - freno reforzado
2) + cast iron / + ghisa / + fonte grise / + fundición de gris
3) + aluminium / + alluminio / + aluminium / + aluminio
4) + heavy duty brake / + freno reforzado / + frein renforcé / + freno reforzado
5) + disc brake / + disco freno / + disques de frein / + disco de freno
6) + drum brake / + freno a tamburo / + freins à tambour / + tambores de freno
7) + manual transmission / + scatola cambio velocità / + transmission mécanique / + cambio de velocidad



OPEL ASTRA F / Vauxhall Astra MKIII (91-01)											
	1.6 Cabrio 1.6 N Limousine 1.7 TD Limousine	R2500001 R2500001	T2526383 T2526383			03.0101-0025.2	320014			BRES 3/35	ATE
	1.7 TD Limousine			10.91	07.93						
	1.7 TD Limousine			08.93	09.98	- verstärkte Bremse ¹⁾	03.0101-0032.2	320231		BRES 3/25	ATE
	1.7 TD Limousine			08.93	09.98	+ verstärkte Bremse ²⁾	03.0101-0025.2	320014		BRES 3/35	ATE
	1.4 Caravan 1.6 Caravan 1.7 D Caravan 1.7 TD Caravan 1.8 Caravan 2.0 Caravan			10.91 10.91 10.91 10.91 10.91 10.91	09.98 09.98 09.98 09.98 09.98 09.98		03.6565-0130.3	320098		BRL 6/5 (4)	ATE
	1.4 1.6 1.6 16V 1.6 S 1.7 D 1.7 TD 1.8 1.8 16V 2.0 2.0 16V		S8999999 S8999999 S8999999 S8999999 S8999999 S8999999 S8999999 S8999999 S8999999 S8999999	10.91 10.91 02.93 10.91 10.91 10.91 10.91 10.91 10.91 10.91							L=815
	1.4 1.6 1.6 16V 1.6 S 1.7 D 1.7 TD 1.8	T2500001 T2500001 T2500001 T2500001 T2500001 T2500001 T2500001		09.98 09.98 09.98 09.98 09.98 09.98	- Klimaanlage ³⁾ - Klimaanlage ³⁾ - Klimaanlage ³⁾ - Klimaanlage ³⁾	24.3728-0723.2	590723				L=882
	1.4 1.6 1.6 16V 1.6 S 1.8 16V 2.0 2.0 16V 2.0 GSi	T2500001 T2500001 T2500001 T2500001 T2500001 T2500001 T2500001 T2500001		09.98 09.98 09.98 09.98 09.98 09.98 09.98 09.98	+ Klimaanlage ⁴⁾ + Klimaanlage ⁴⁾ + Klimaanlage ⁴⁾ + Klimaanlage ⁴⁾	24.3728-0722.2	590722				L=923
OPEL ASTRA F CLASSIC (98-02)											
	1.4 i 1.6 i 1.6 i 16V	44 55 74		01.98 01.98 01.98	12.02 12.02 12.02	24.2120-0702.3 03.2122-0282.3 03.2122-0282.3	010361 010130 010130		- ABS + ABS + ABS	THz 20,64 THz 22,20 THz 22,20	ATE ATE ATE
	1.4 i 1.6 i 1.6 i 16V	44 55 74		01.98 01.98 01.98	12.02 12.02 12.02	24.3481-1733.5 24.3481-1734.5 11.0441-4811.2 11.0101-5407.2 11.8171-0008.1 11.8116-0129.1	240213 240214 250024 260011 990049 390591	2 2		D=48, - Halter D=48, - Halter Dichtungssatz Hülssensatz Führungsbolzen Haltefeder	ATE ATE ATE ATE ATE ATE
	1.4 i 1.6 i 1.6 i 16V	44 55 74		01.98 01.98 01.98	12.02 12.02 12.02	24.3521-1701.5 24.3521-1702.5 11.0441-5202.2 11.0101-5407.2 11.8171-0008.1 11.8116-0097.1	240001 240002 250026 260011 990049 390590	2 2		D=52, - Halter D=52, - Halter Dichtungssatz Hülssensatz Führungsbolzen Haltefeder	ATE ATE ATE ATE ATE ATE
	1.4 i 1.6 i 1.6 i 16V	44 55 74		01.98 01.98 01.98	12.02 12.02 12.02	24.5298-0322.3	331314	2			L=322
	1.4 i 1.6 i 1.6 i 16V	44 55 74		01.98 01.98 01.98	12.02 12.02 12.02	24.5117-0195.3	330565	2			L=198
	1.4 i 1.6 i 1.6 i 16V	44 55 74		01.98 01.98 01.98	12.02 12.02 12.02	24.3219-1715.3	020122				Rz 19,05 (ALU)
	1.4 i 1.6 i 1.6 i 16V	44 55 74		01.98 01.98 01.98	12.02 12.02 12.02	24.3727-0735.2	580735	1	↓		L=1273/1690, + Zub
	1.4 i 1.6 i 1.6 i 16V	44 55 74		01.98 01.98 01.98	12.02 12.02 12.02	03.0101-0031.2	320211			BRES 3/30	ATE
	1.4 i 1.6 i 1.6 i 16V	44 55 74		01.98 01.98 01.98	12.02 12.02 12.02	03.6583-0054.3	320146			BRL 8/3 (4)	ATE
	1.4 i 1.6 i 1.6 i 16V	44 55 74		01.98 01.98 01.98	12.02 12.02 12.02	24.3728-0723.2	590723				L=882
OPEL ASTRA F CLASSIC Caravan (98-05)											
	1.4 i 1.4 i 16V 1.6 i	44 66 55		01.98 09.03 01.98	01.05 01.05 01.05	24.2120-0702.3	010361			THz 20,64	

1) - heavy duty brake / - freno rinforzato / - frein renforcé / - freno reforzado
2) + heavy duty brake / + freno rinforzato / + frein renforcé / + freno reforzado
3) - air conditioning / - aria condizionata / - air conditionné / - aire acondicionado
4) + air conditioning / + aria condizionata / + air conditionné / + aire acondicionado

									
OPEL ASTRA F CLASSIC Caravan (98-05)									
	1.4 i	44		01.98	01.05	24.3481-1733.5	240213	2	D=48, - Halter ATE D=48, - Halter ATE Dichtungssatz ATE Hülzensatz ATE Führungsbolzen ATE Haltefeder ATE
	1.4 i 16V	66		09.03	01.05	24.3481-1734.5	240214		
						11.0441-4811.2	250024		
	1.6 i	55		01.98	01.05	11.0101-5407.2	260011	2	D=48, - Halter ATE D=48, - Halter ATE Dichtungssatz ATE Hülzensatz ATE Führungsbolzen ATE Haltefeder ATE
					11.8171-0008.1	990049			
					11.8116-0129.1	390591			
	1.6 i 16V	74		01.98	01.05	24.3521-1701.5	240001	2	D=52, - Halter ATE D=52, - Halter ATE Dichtungssatz ATE Hülzensatz ATE Führungsbolzen ATE Haltefeder ATE
					24.3521-1702.5	240002			
					11.0441-5202.2	250026			
	1.4 i	44		01.98	01.05	24.5298-0322.3	331314	2	L=322
	1.4 i 16V	66		09.03	01.05				
	1.6 i	55		01.98	01.05				
	1.6 i 16V	74		01.98	01.05				
	1.4 i	44		01.98	01.05	24.5233-0200.3	330425	2	L=198
	1.4 i 16V	66		09.03	01.05				
	1.6 i	55		01.98	01.05				
	1.6 i 16V	74		01.98	01.05				
	1.4 i	44		01.98	01.05	24.3219-1715.3	020122		Rz 19,05 (ALU)
	1.4 i 16V	66		09.03	01.05				
	1.6 i	55		01.98	01.05				
	1.6 i 16V	74		01.98	01.05				
	1.4 i	44		01.98	01.05	24.3727-0732.2	580732	1	L=1288/1398, + Zub
	1.4 i 16V	66		09.03	01.05				
	1.6 i	55		01.98	01.05				
	1.6 i 16V	74		01.98	01.05				
	1.4 i	44		01.98	01.05	03.6565-0130.3	320098		BRL 6/5 (4) ATE
	1.4 i 16V	66		09.03	01.05				
	1.6 i	55		01.98	01.05				
	1.6 i 16V	74		01.98	01.05				
	1.4 i	44		01.98	01.05	24.3728-0723.2	590723		L=882
	1.4 i 16V	66		09.03	01.05				
	1.6 i	55		01.98	01.05				
	1.6 i 16V	74		01.98	01.05				
OPEL ASTRA G / Vauxhall Astra MKIV (98-05)									
	1.2 16V			04.98		24.2123-1734.3	010640		Thz 23,81 TRW
	1.2 16V	22000001							
	1.4 16V			04.98					
	1.4 16V	22000001							
	1.4 Caravan	66		09.07					
	1.4 Limousine	66		09.07					
	1.6			04.98					
	1.6	22000001							
	1.6 16V			04.98					
	1.6 16V	22000001							
	1.6 16V Cabrio			03.01					
	1.6 CNG			03.03					
	1.7 CDTI			04.03					
	1.7 DTI			02.00					
	1.7 DTI	22000001							
	1.7 TD			04.98					
	1.8 16V			04.98					
	1.8 16V Cabrio			03.01					
	1.8 16V Caravan			04.98					
	1.8 16V Coupe			03.00					
	2.0 16V			04.98					
	2.0 16V OPC			10.99					
	2.0 16V OPC Cabrio			03.02					
	2.0 DI			04.98					
	2.0 DTI 16V			08.99					
	2.0 Turbo			03.00					
	2.2 16V			09.00					
	2.2 16V Cabrio			03.01					
	2.2 16V Coupe			09.00					
	2.2 DTI 16V			09.02					
2.2 DTI 16V Cabrio			09.02						
2.2 DTI 16V Coupe			09.02						
1.2 16V			04.98						
1.4 16V			04.98						
1.4 Caravan	66		09.07						
1.4 Limousine	66		09.07						
1.6			04.98						
1.6 16V			04.98						
1.6 16V Cabrio			03.01						
1.6 CNG			03.03						
1.7 DTI			02.00						
1.7 TD			04.98						
1.8 16V			04.98						

1) - ESP/ + RA disc brake / - ESP/ + P disco freno / - ESP/ + fr.à disque essieu AR / - ESP/ + ET disco de freno
2) - ESP/ + RA drum brake / - ESP/ + P freno a tamburo / - ESP/ + fr.à tambour essieu AR / - ESP/ + ET tambores de freno

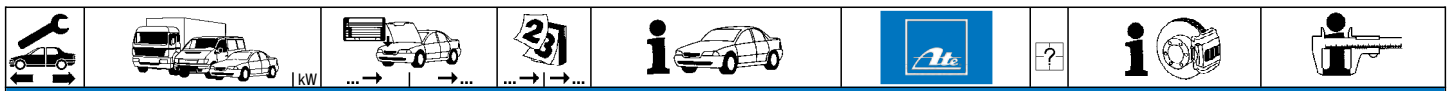

OPEL ASTRA G / Vauxhall Astra MKIV (98-05)

	1.6 LPG	74		06.02	07.03	24.3344-1713.7	220559			D=34, - Halter	TRW
	1.7 CDTI			04.03	07.03	24.3344-1714.7	220560			D=34, - Halter	TRW
	1.7 DTI			07.01	07.03						
	1.8 16V			07.01	07.03						
	2.0 DI			07.01	07.03						
	1.2 16V			08.03		24.3347-1711.5	240699			D=34, - Halter	TRW
	1.4 16V			08.03		24.3347-1712.5	240700			D=34, - Halter	TRW
	1.4 Caravan	66		09.07							
	1.4 Limousine	66		09.07							
	1.6			08.03							
1.6 16V			08.03								
1.6 CNG			08.03								
1.6 LPG	74		06.02								
1.7 CDTI			08.03								
1.7 DTI			08.03								
1.8 16V			08.03								
2.0 DI			08.03								
1.6			08.03		24.3367-1707.7	220669			D=36, - Halter	TRW	
1.6 LPG	74		08.03		24.3367-1708.7	220670			D=36, - Halter	TRW	
1.6 16V Cabrio			07.01		24.3367-1713.7	220779			D=36, - Halter	TRW	
2.0 DTI 16V			07.01		24.3367-1714.7	220780			D=36, - Halter	TRW	
2.2 16V			07.01								
2.2 DTI 16V			09.02								
1.6 CNG			03.03		24.3384-1753.7	220633			D=38, - Halter	TRW	
1.8 16V Cabrio			07.01		24.3384-1754.7	220634			D=38, - Halter	TRW	
1.8 16V Coupe			07.01								
2.0 16V OPC			07.01								
2.0 16V OPC Cabrio			03.02								
2.0 Turbo			07.01								
2.2 16V Cabrio			07.01								
2.2 16V Coupe			07.01								
2.2 DTI 16V Cabrio			09.02								
2.2 DTI 16V Coupe			09.02								
	1.2 16V			04.98		24.5240-0220.3	330619	2	+ HA-Trommelbremse ³⁾	L=220	
	1.4 16V			04.98							
	1.4 Caravan	66		09.07							
	1.4 Limousine	66		09.07							
	1.6			04.98							
	1.6 16V			04.98							
	1.6 CNG			03.03							
	1.7 DTI			02.00							
	1.7 TD			04.98							
	1.2 16V			22999999	04.98	24.5241-0200.3	330620	2	+ HA-Scheibenbremse ⁴⁾	L=200	
1.4 16V			22999999	04.98							
1.6			22999999	04.98							
1.6 16V			22999999	04.98							
1.6 16V Cabrio			22999999	03.01							
1.6 CNG			22999999	03.03							
1.7 CDTI			22999999	04.03							
1.7 DTI			22999999	02.00							
1.7 TD			22999999	04.98							
1.8 16V			22999999	04.98							
1.8 16V Cabrio			22999999	03.01							
1.8 16V Caravan			22999999	04.98							
1.8 16V Coupe			22999999	03.00							
2.0 16V			22999999	04.98							
2.0 16V OPC			22999999	10.99							
2.0 16V OPC Cabrio			22999999	03.02							
2.0 DI			22999999	04.98							
2.0 DTI 16V			22999999	08.99							
2.0 Turbo			22999999	03.00							
2.2 16V			22999999	09.00							
2.2 16V Cabrio			22999999	03.01							
2.2 16V Coupe			22999999	09.00							
2.2 DTI 16V			22999999	09.02							
2.2 DTI 16V Cabrio			22999999	09.02							
2.2 DTI 16V Coupe			22999999	09.02							
1.2 16V		32000001				24.5157-0218.3	331095			L=219/185, + Rohrleitung	
1.4 16V		32000001				24.5157-0219.3	331096			L=219/185, + Rohrleitung	
1.4 Caravan	66		09.07								
1.4 Limousine	66		09.07								
1.6		32000001									
1.6 16V		32000001									
1.6 16V Cabrio		32000001									
1.6 CNG		32000001									
1.7 CDTI		32000001									
1.7 DTI		32000001									
1.8 16V		32000001									
1.8 16V Cabrio		32000001									
1.8 16V Caravan		32000001									
1.8 16V Coupe		32000001									
2.0 16V		32000001									
2.0 16V OPC		32000001									
2.0 16V OPC Cabrio		32000001									
2.0 DI		32000001									
2.0 DTI 16V		32000001									

1) - sports suspension / - sospensione sportiva / - châssis de sport / - suspensión deportiva
 2) + sports suspension / + sospensione sportiva / + châssis de sport / + suspensión deportiva
 3) + RA drum brake / + P freno a tamburo / + frein à tambour essieu AR / + ET-tambores de freno
 4) + RA disc brake / + P disco freno / + frein à disque essieu AR / + ET-disco de freno



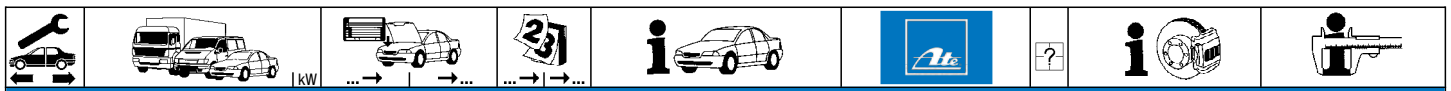

OPEL ASTRA G / Vauxhall Astra MKIV (98-05)

	2.2 16V 2.2 16V Cabrio 2.2 16V Coupe 2.2 DTI 16V 2.2 DTI 16V Cabrio 2.2 DTI 16V Coupe	42000001 42000001 42000001 42000001 42000001 42000001				24.3727-0748.2 24.3727-0783.2	580748 580783	1 ↑ 1 ↓	L=279, + Zub L=1587/1587, + Zub
	1.2 16V 1.4 16V Caravan 1.4 Caravan 1.6 16V Caravan 1.6 Caravan 1.6 CNG 1.7 CDTI Caravan 1.7 DTI Caravan 1.7 TD Caravan 1.8 16V Caravan 2.0 16V Caravan	66	04.98 04.98 09.07 04.98 04.98 03.03 04.03 02.00 04.98 04.98 04.98	- ABS - ABS - ABS - ABS - ABS - ABS - ABS - ABS - ABS - ABS - ABS		03.6583-0073.3	320234		BRL 8/3 (4) ATE
	1.4 16V Limousine 1.4 Limousine 1.6 16V Limousine 1.6 Limousine 1.7 CDTI Limousine 1.7 DTI Limousine 1.7 TD Limousine 1.8 16V Limousine 2.0 16V Limousine 2.0 DI 2.0 DTI 16V	66	04.98 09.07 04.98 04.98 04.03 02.00 04.98 04.98 04.98 04.98 08.99	- ABS - ABS - ABS - ABS - ABS - ABS - ABS - ABS - ABS - ABS - ABS		03.6583-0074.3	320235		BRL 8/3 (4) ATE
	1.2 16V 1.4 16V 1.4 Caravan 1.4 Limousine 1.6 1.6 16V 1.6 16V Cabrio 1.6 CNG 1.7 CDTI 1.7 DTI 1.7 TD 1.8 16V 1.8 16V Cabrio 1.8 16V Caravan 1.8 16V Coupe 2.0 16V 2.0 16V OPC 2.0 16V OPC Cabrio 2.0 DI 2.0 DTI 16V 2.0 Turbo 2.2 16V 2.2 16V Cabrio 2.2 16V Coupe 2.2 DTI 16V 2.2 DTI 16V Cabrio 2.2 DTI 16V Coupe	66 66	04.98 04.98 09.07 09.07 04.98 04.98 03.01 03.03 04.03 02.00 04.98 04.98 03.01 04.98 03.00 04.98 10.99 03.02 04.98 08.99 03.00 09.00 03.01 09.00 09.02 09.02 09.02			24.2415-1704.3	030087		Gz 15,87

OPEL ASTRA H / GTC / Vauxhall Astra Mk V (04-10)

	1.9 CDTI 1.9 CDTI 1.9 CDTI	74 88 110	09.05 09.04 09.04	11.10 11.10 11.10		03.7863-7803.4	300237		10" ATE
	1.2 1.3 CDTI 1.4 1.6 1.6 1.6 Turbo 1.7 CDTI 1.7 CDTI 1.7 CDTI 1.7 CDTI 1.8 1.8 2.0 Turbo 2.0 Turbo 2.0 Turbo OPC	66 77 85 132 59 74 81 92 92 103 125 147 177	68999999 68999999 68999999 68999999 68999999 68999999 68999999 68999999 68999999 68999999 68999999 68999999 68999999 68999999 68999999	08.05 08.05 01.04 01.04 01.07 01.07 01.04 01.04 04.07 04.07 01.04 01.06 01.04 09.04 03.05		24.2125-1737.3 24.2125-1736.3	010906 010904	- ESP + ESP	THz 25,40 TRW TRW
	1.2 1.3 CDTI 1.4 1.6 1.6 1.6 Turbo 1.7 CDTI 1.7 CDTI 1.7 CDTI 1.7 CDTI 1.8 1.8	72000001 66 72000001 72000001 77 72000001 85 72000001 132 72000001 59 72000001 74 72000001 81 72000001 92 72000001 92 72000001 103 72000001		11.10 11.10 11.10 11.10 11.10 11.10 11.10 11.10 11.10 11.10 11.10 11.10		24.4125-1704.3 24.4125-1703.3	010908 010907	- ESP + ESP	THz 25,40 TRW TRW



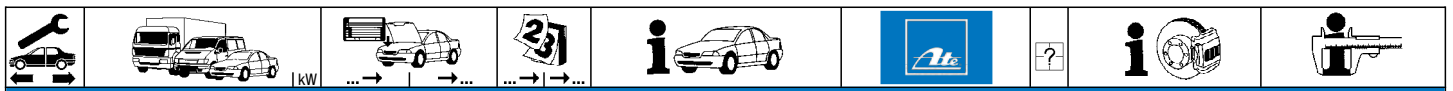

OPEL ASTRA H / GTC / Vauxhall Astra Mk V (04-10)

	2.0 Turbo	125 72000001		11.10	24.4125-1704.3	010908		- ESP	THz 25,40	TRW
	2.0 Turbo	147 72000001		11.10	24.4125-1703.3	010907		+ ESP	THz 25,40	TRW
	2.0 Turbo OPC	177 72000001		11.10						
	1.2		68999999	08.05	24.2125-1736.3	010904			THz 25,40	TRW
	1.3 CDTI	66	68999999	08.05						
	1.4		68999999	01.04						
	1.6	77	68999999	01.04						
	1.6	85	68999999	01.07						
	1.6 Turbo	132	68999999	01.07						
	1.7 CDTI	59	68999999	01.04						
	1.7 CDTI	74	68999999	01.04						
	1.7 CDTI	81	68999999	04.07						
	1.7 CDTI	92	68999999	04.07						
	1.8	92	68999999	01.04						
	1.8	103	68999999	01.06						
	2.0 Turbo	125	68999999	01.04						
	2.0 Turbo	147	68999999	09.04						
	2.0 Turbo OPC	177	68999999	03.05						
	1.2		72000001	11.10	24.4125-1703.3	010907			THz 25,40	TRW
	1.3 CDTI	66	72000001	11.10						
	1.4		72000001	11.10						
	1.6	77	72000001	11.10						
	1.6	85	72000001	11.10						
	1.6 Turbo	132	72000001	11.10						
	1.7 CDTI	59	72000001	11.10						
	1.7 CDTI	74	72000001	11.10						
	1.7 CDTI	81	72000001	11.10						
	1.7 CDTI	92	72000001	11.10						
	1.8	92	72000001	11.10						
	1.8	103	72000001	11.10						
	2.0 Turbo	125	72000001	11.10						
	2.0 Turbo	147	72000001	11.10						
	2.0 Turbo OPC	177	72000001	11.10						
	1.9 CDTI	74		09.05	03.4155-0156.3	010862			THz 25,40	ATE
	1.9 CDTI	88		09.04						
	1.9 CDTI	110		09.04						
	1.2			08.05	11.9571-9823.2	220471			D=57, - Halter	ATE
	1.3 CDTI	66		08.05	11.9571-9824.2	220472			D=57, - Halter	ATE
	1.4			01.04	24.3571-9823.5	240499			D=57, - Halter	ATE
	1.6	77		01.04	24.3571-9824.5	240500			D=57, - Halter	ATE
	1.6	85		01.07	11.0441-5704.2	250034			Dichtungssatz	ATE
	1.7 CDTI	59		01.04	11.0101-5407.2	260011			Hülssensatz	ATE
	1.7 CDTI	74		01.04	11.8171-0008.1	990049			Führungsbolzen	ATE
	1.7 CDTI	81		04.07	11.8116-0292.1	390521	2		Haltefeder	ATE
	1.8	92		01.04						
	1.8	103		01.06						
	1.6 Turbo	132		01.07	11.9571-9823.2	220471			D=57, - Halter	ATE
	1.7 CDTI	92		04.07	11.9571-9824.2	220472			D=57, - Halter	ATE
	1.9 CDTI	74		09.05	24.3571-9823.5	240499			D=57, - Halter	ATE
	1.9 CDTI	88		09.04	24.3571-9824.5	240500			D=57, - Halter	ATE
	1.9 CDTI	110		09.04	11.8170-0758.1	260120			Halter	ATE
	2.0 Turbo	125		01.04	11.0441-5704.2	250034			Dichtungssatz	ATE
	2.0 Turbo	147		09.04	11.0101-5407.2	260011			Hülssensatz	ATE
					11.8171-0008.1	990049			Führungsbolzen	ATE
					11.8116-0292.1	390521	2		Haltefeder	ATE
	2.0 Turbo OPC	177		03.05	11.0101-5407.2	260011			Hülssensatz	ATE
					11.8171-0008.1	990049			Führungsbolzen	ATE
					11.8116-0356.1	390586	2		Haltefeder	ATE
	1.2			08.05	24.5241-0429.3	331381	2		L=429	
	1.3 CDTI	66		08.05						
	1.4			01.04						
	1.6	77		01.04						
	1.6	85		01.07						
	1.6 Turbo	132		01.07						
	1.7 CDTI	59		01.04						
	1.7 CDTI	74		01.04						
	1.7 CDTI	81		04.07						
	1.7 CDTI	92		04.07						
	1.8	92		01.04						
	1.8	103		01.06						
	1.9 CDTI	74		09.05						
	1.9 CDTI	88		09.04						
	1.9 CDTI	110		09.04						
	2.0 Turbo	125		01.04						
	2.0 Turbo	147		09.04						
	1.2			08.05	24.3367-1707.7	220669		für 4-Loch-Felge 1)	D=36, - Halter	TRW
	1.3 CDTI	66		08.05	24.3367-1708.7	220670		für 4-Loch-Felge 1)	D=36, - Halter	TRW
	1.4			01.04	24.3387-1701.7	220673		für 5-Loch-Felge 2)	D=38, - Halter	TRW
	1.6	77		01.04	24.3387-1702.7	220674		für 5-Loch-Felge 2)	D=38, - Halter	TRW
	1.6	85		01.07						
	1.6 Turbo	132		01.07						
	1.7 CDTI	59		01.04						
	1.7 CDTI	74		01.04						
	1.7 CDTI	81		04.07						
	1.7 CDTI	92		04.07						
	1.8	92		01.04						
	1.8	103		01.06						

1) for 4 bore wheel rim / per cerchione a 4 fori / pour jante à 4 trous / para Liantas de 4 taladros

2) for 5 bore wheel rim / per cerchione a 5 fori / pour jante à 5 trous / para Liantas de 5 taladros

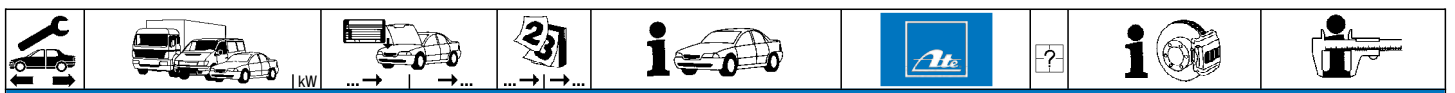

OPEL ASTRA H / GTC / Vauxhall Astra Mk V (04-10)

	1.9 CDTI	74	09.05	11.10	24.3367-1707.7	220669	<input type="checkbox"/> für 4-Loch-Felge ¹⁾ <input type="checkbox"/> für 4-Loch-Felge ¹⁾ <input type="checkbox"/> für 5-Loch-Felge ²⁾ <input type="checkbox"/> für 5-Loch-Felge ²⁾	D=36, - Halter D=36, - Halter D=38, - Halter D=38, - Halter	TRW TRW TRW TRW
	1.9 CDTI	88	09.04	11.10	24.3367-1708.7	220670			
	1.9 CDTI	110	09.04	11.10	24.3387-1701.7	220673			
	2.0 Turbo	125	01.04	11.10	24.3387-1702.7	220674			
	2.0 Turbo	147	09.04	11.10					
	1.2		08.05	11.10	24.5157-0218.3	331095	<input type="checkbox"/> + HA-Scheibenbremse ³⁾ <input type="checkbox"/> + HA-Scheibenbremse ³⁾	L=219/185, + Rohrleitung L=219/185, + Rohrleitung	
	1.3 CDTI	66	08.05	11.10	24.5157-0219.3	331096			
	1.4		01.04	11.10					
	1.6		01.04	11.10					
	1.6	77	01.04	11.10					
	1.6	85	01.07	11.10					
	1.6 Turbo	132	01.07	11.10					
	1.7 CDTI	59	01.04	11.10					
	1.7 CDTI	74	01.04	11.10					
	1.7 CDTI	81	04.07	11.10					
	1.7 CDTI	92	04.07	11.10					
	1.8	92	01.04	11.10					
	1.8	103	01.06	11.10					
	1.9 CDTI	74	09.05	11.10					
	1.9 CDTI	88	09.04	11.10					
	1.9 CDTI	110	09.04	11.10					
	2.0 Turbo	125	01.04	11.10					
	2.0 Turbo	147	09.04	11.10					
	2.0 Turbo OPC	177	03.05	11.10					
		1.2		08.05	11.10	24.5152-0218.3			
1.3 CDTI		66	08.05	11.10	24.5152-0219.3	331043			
1.4			01.04	11.10					
1.6			01.04	11.10					
1.6		77	01.04	11.10					
1.6		85	01.07	11.10					
1.7 CDTI		59	01.04	11.10					
1.7 CDTI		74	01.04	11.10					
1.8		92	01.04	11.10					
1.8		103	01.06	11.10					
	1.2		08.05	07.06	24.3220-1719.3	020448		Rz 20,64	
	1.4		01.04	07.06					
	1.6	77	01.04	07.06					
	1.7 CDTI	59	01.04	07.06					
	1.7 CDTI	74	01.04	07.06					
	1.2		08.06	11.10	24.3219-1755.3	020508		Rz 19,05	
	1.4		08.06	11.10					
	1.6	77	08.06	11.10					
	1.7 CDTI	59	08.06	11.10					
	1.7 CDTI	74	08.06	11.10					
	1.2		08.05	11.10	24.3727-0775.2	580775	<input checked="" type="checkbox"/> + HA-Scheibenbremse ³⁾	L=1647/1665, + Zub	
	1.3 CDTI	66	08.05	11.10					
	1.4		01.04	11.10					
	1.6	77	01.04	11.10					
	1.6	85	01.07	11.10					
	1.6 Turbo	132	01.07	11.10					
	1.7 CDTI	59	01.04	11.10					
	1.7 CDTI	74	01.04	11.10					
	1.7 CDTI	81	04.07	11.10					
	1.7 CDTI	92	04.07	11.10					
	1.8	92	01.04	11.10					
	1.8	103	01.06	11.10					
	1.9 CDTI	74	09.05	11.10					
	1.9 CDTI	88	09.04	11.10					
	1.9 CDTI	110	09.04	11.10					
2.0 Turbo	125	01.04	11.10						
2.0 Turbo	147	09.04	11.10						
2.0 Turbo OPC	177	03.05	11.10						
	1.2		08.05	07.06	24.3727-0770.2	580770	<input checked="" type="checkbox"/> + HA-Trommelbremse ⁴⁾ <input checked="" type="checkbox"/> Verlängerung/+HA-Trommelbr. ⁵⁾	L=1295/1328, + Zub L=182, + Zub	
	1.4		01.04	07.06	24.3727-0746.2	580746			
	1.6	77	01.04	07.06					
	1.7 CDTI	59	01.04	07.06					
	1.7 CDTI	74	01.04	07.06					
	1.2		08.06	11.10	24.3727-0770.2	580770	<input checked="" type="checkbox"/> + HA-Trommelbremse ⁴⁾	L=1295/1328, + Zub	
	1.4		08.06	11.10					
	1.6	77	08.06	11.10					
	1.7 CDTI	59	08.06	11.10					
	1.7 CDTI	74	08.06	11.10					
	1.2		08.05	11.10	24.2415-1704.3	030087		Gz 15,87	
	1.3 CDTI	66	08.05	11.10					
	1.4		01.04	11.10					
	1.6	77	01.04	11.10					
	1.6	85	01.07	11.10					
	1.6 Turbo	132	01.07	11.10					
	1.7 CDTI	59	01.04	11.10					
	1.7 CDTI	74	01.04	11.10					
	1.7 CDTI	81	04.07	11.10					
	1.7 CDTI	92	04.07	11.10					

¹⁾ for 4 bore wheel rim / per cerchione a 4 fori / pour jante à 4 trous / para Llantas de 4 taladros
²⁾ for 5 bore wheel rim / per cerchione a 5 fori / pour jante à 5 trous / para Llantas de 5 taladros
³⁾ + RA disc brake / + P disco freno / + frein à disque essieu AR / + ET-disco de freno
⁴⁾ + RA drum brake / + P freno a tamburo / + frein à tambour essieu AR / + ET-tambores de freno
⁵⁾ extension only / + RA drum br. / solo prolonga./+ P fra tamburo / rallonge seulem.+ tamb.ess.AR / solam.prolongad./+ tambores ET



















OPEL ASTRA H / GTC / Vauxhall Astra Mk V (04-10)

	1.8	◀ 92		01.04	11.10	24.2415-1704.3	030087			Gz 15,87
	1.8	◀103		01.06	11.10					
	1.9 CDTI	◀ 74		09.05	11.10					
	1.9 CDTI	◀ 88		09.04	11.10					
	1.9 CDTI	◀110		09.04	11.10					
	2.0 Turbo	◀125		01.04	11.10					
	2.0 Turbo	◀147		09.04	11.10					
	2.0 Turbo OPC	◀177		03.05	11.10					

OPEL ASTRA H Caravan/Vau. Astra MKV Estate (04-10)

	1.9 CDTI	◀ 74		09.05	11.10	03.7863-7803.4	300237			10"	ATE
	1.9 CDTI	◀ 88		08.04	11.10						
	1.9 CDTI	◀110		09.04	11.10						
	1.2	◀ 59	68999999	08.05		24.2125-1737.3	010906		- ESP	THz 25,40	TRW
	1.3 CDTI	◀ 66	68999999	08.05		24.2125-1736.3	010904		+ ESP	THz 25,40	TRW
	1.4	◀	68999999	08.04							
	1.6	◀ 77	68999999	08.04							
	1.6	◀ 85	68999999	01.07							
	1.6 LPG	◀ 85	68999999	08.09							
	1.6 Turbo	◀132	68999999	01.07							
	1.7 CDTI	◀ 59	68999999	08.04							
	1.7 CDTI	◀ 74	68999999	08.04							
	1.7 CDTI	◀ 81	68999999	04.07							
	1.7 CDTI	◀ 92	68999999	04.07							
	1.7 TD	◀ 79	68999999	08.04							
	1.8	◀ 92	68999999	08.04							
	1.8	◀103	68999999	08.05							
	2.0 Turbo	◀125	68999999	08.04							
	2.0 Turbo	◀147	68999999	09.04							
	1.2	◀ 59 72000001			11.10	24.2125-1704.3	010446		- ESP	THz 25,40	TRW
	1.3 CDTI	◀ 66 72000001			11.10	24.2125-1703.3	010483		+ ESP	THz 25,40	
	1.4	◀ 72000001			11.10						
	1.6	◀ 77 72000001			11.10						
	1.6	◀ 85 72000001			11.10						
	1.6 LPG	◀ 85 72000001			11.10						
	1.6 Turbo	◀132 72000001			11.10						
	1.7 CDTI	◀ 59 72000001			11.10						
	1.7 CDTI	◀ 74 72000001			11.10						
	1.7 CDTI	◀ 81 72000001			11.10						
	1.7 CDTI	◀ 92 72000001			11.10						
	1.7 TD	◀ 79 72000001			11.10						
	1.8	◀ 92 72000001			11.10						
	1.8	◀103 72000001			11.10						
	2.0 Turbo	◀125 72000001			11.10						
	2.0 Turbo	◀147 72000001			11.10						
	1.2	▶ 59	62999999	08.05		24.2125-1736.3	010904			THz 25,40	TRW
	1.3 CDTI	▶ 66	62999999	08.05							
	1.4	▶	62999999	08.04							
	1.6	▶ 77	62999999	08.04							
	1.6	▶ 85	62999999	01.07							
	1.6 LPG	▶ 85	62999999	08.09							
	1.6 Turbo	▶132	62999999	01.07							
	1.7 CDTI	▶ 59	62999999	08.04							
	1.7 CDTI	▶ 74	62999999	08.04							
	1.7 CDTI	▶ 81	62999999	04.07							
	1.7 CDTI	▶ 92	62999999	04.07							
	1.7 TD	▶ 79	62999999	08.04							
	1.8	▶ 92	62999999	08.04							
	1.8	▶103	62999999	08.05							
	2.0 Turbo	▶125	62999999	08.04							
	2.0 Turbo	▶147	62999999	09.04							
	1.2	▶ 59 72000001			11.10	24.4125-1703.3	010907			THz 25,40	TRW
	1.3 CDTI	▶ 66 72000001			11.10						
	1.4	▶ 72000001			11.10						
	1.6	▶ 77 72000001			11.10						
	1.6	▶ 85 72000001			11.10						
	1.6 LPG	▶ 85 72000001			11.10						
	1.6 Turbo	▶132 72000001			11.10						
	1.7 CDTI	▶ 59 72000001			11.10						
	1.7 CDTI	▶ 74 72000001			11.10						
	1.7 CDTI	▶ 81 72000001			11.10						
	1.7 CDTI	▶ 92 72000001			11.10						
	1.7 TD	▶ 79 72000001			11.10						
	1.8	▶ 92 72000001			11.10						
	1.8	▶103 72000001			11.10						
	2.0 Turbo	▶125 72000001			11.10						
	2.0 Turbo	▶147 72000001			11.10						
	1.9 CDTI	74		09.05	11.10	03.4155-0156.3	010862			THz 25,40	ATE
	1.9 CDTI	88		08.04	11.10						
	1.9 CDTI	110		09.04	11.10						

								
OPEL ASTRA H Caravan/Vau. Astra MKV Estate (04-10)								
	1.2	59	08.05	11.10	11.9571-9823.2	220471	<input type="checkbox"/> <input type="checkbox"/> <input type="checkbox"/> <input type="checkbox"/>	D=57, - Halter ATE D=57, - Halter ATE D=57, - Halter ATE Dichtungssatz ATE Hülzensatz ATE Führungsbolzen ATE Haltefeder ATE
	1.3 CDTI	66	08.05	11.10	11.9571-9824.2	220472		
	1.4		08.04	11.10	24.3571-9823.5	240499		
	1.6	77	08.04	11.10	24.3571-9824.5	240500		
	1.6	85	01.07	11.10	11.0441-5704.2	250034		
	1.6 LPG	85	08.09	11.10	11.0101-5407.2	260011		
	1.7 CDTI	59	08.04	11.10	11.8171-0008.1	990049		
	1.7 CDTI	74	08.04	11.10	11.8116-0292.1	390521		
	1.7 CDTI	81	04.07	11.10				
	1.7 TD	79	08.04	11.10				
	1.8	92	09.04	11.10				
	1.8	103	08.05	11.10				
	1.6 Turbo	132	01.07	11.10	11.9571-9823.2	220471		
	1.7 CDTI	92	04.07	11.10	11.9571-9824.2	220472		
	1.9 CDTI	74	09.05	11.10	24.3571-9823.5	240499		
	1.9 CDTI	88	08.04	11.10	24.3571-9824.5	240500		
	1.9 CDTI	110	09.04	11.10	11.8170-0758.1	260120		
	2.0 Turbo	125	08.04	11.10	11.0441-5704.2	250034		
2.0 Turbo	147	09.04	11.10	11.0101-5407.2	260011			
				11.8171-0008.1	990049			
				11.8116-0292.1	390521			
	1.2	59	08.05	11.10	24.5241-0429.3	331381	2	L=429
	1.3 CDTI	66	08.05	11.10				
	1.4		08.04	11.10				
	1.6	77	08.04	11.10				
	1.6	85	01.07	11.10				
	1.6 LPG	85	08.09	11.10				
	1.6 Turbo	132	01.07	11.10				
	1.7 CDTI	59	08.04	11.10				
	1.7 CDTI	74	08.04	11.10				
	1.7 CDTI	81	04.07	11.10				
	1.7 CDTI	92	04.07	11.10				
	1.7 TD	79	08.04	11.10				
	1.8	92	09.04	11.10				
	1.8	103	08.05	11.10				
	1.9 CDTI	74	09.05	11.10				
	1.9 CDTI	88	08.04	11.10				
	1.9 CDTI	110	09.04	11.10				
	2.0 Turbo	125	08.04	11.10				
2.0 Turbo	147	09.04	11.10					
	1.2	59	08.05	11.10	24.3367-1707.7	220669	<input type="checkbox"/> für 4-Loch-Felge ¹⁾ <input type="checkbox"/> für 4-Loch-Felge ¹⁾ <input type="checkbox"/> für 5-Loch-Felge ²⁾ <input type="checkbox"/> für 5-Loch-Felge ²⁾	D=36, - Halter TRW D=36, - Halter TRW D=38, - Halter TRW D=38, - Halter TRW
	1.3 CDTI	66	08.05	11.10	24.3367-1708.7	220670		
	1.4		08.04	11.10	24.3387-1701.7	220673		
	1.6	77	08.04	11.10	24.3387-1702.7	220674		
	1.6	85	01.07	11.10				
	1.6 LPG	85	08.09	11.10				
	1.6 Turbo	132	01.07	11.10				
	1.7 CDTI	59	08.04	11.10				
	1.7 CDTI	74	08.04	11.10				
	1.7 CDTI	81	04.07	11.10				
	1.7 CDTI	92	04.07	11.10				
	1.7 TD	79	08.04	11.10				
	1.8	92	09.04	11.10				
	1.8	103	08.05	11.10				
	1.9 CDTI	74	09.05	11.10				
	1.9 CDTI	88	08.04	11.10				
	1.9 CDTI	110	09.04	11.10				
	2.0 Turbo	125	08.04	11.10				
2.0 Turbo	147	09.04	11.10					
	1.2	59	08.08	11.10	24.5157-0218.3	331095	<input type="checkbox"/> <input type="checkbox"/>	L=219/185, + Rohrleitung L=219/185, + Rohrleitung
	1.3 CDTI	66	08.05	11.10	24.5157-0219.3	331096		
	1.4		08.04	11.10				
	1.6	77	08.04	11.10				
	1.6	85	01.07	11.10				
	1.6 LPG	85	08.09	11.10				
	1.6 Turbo	132	01.07	11.10				
	1.7 CDTI	59	08.04	11.10				
	1.7 CDTI	74	08.04	11.10				
	1.7 CDTI	81	04.07	11.10				
	1.7 CDTI	92	04.07	11.10				
	1.7 TD	79	08.04	11.10				
	1.8	92	09.04	11.10				
	1.8	103	08.05	11.10				
	1.9 CDTI	74	09.05	11.10				
	1.9 CDTI	88	08.04	11.10				
	1.9 CDTI	110	09.04	11.10				
	2.0 Turbo	125	08.04	11.10				
2.0 Turbo	147	09.04	11.10					
	1.4		08.04	07.06	24.3220-1719.3	020448		Rz 20,64
	1.6	77	08.04	07.06				
	1.7 CDTI	59	08.04	07.06				
	1.7 CDTI	74	08.04	07.06				
	1.4		08.06	11.10	24.3219-1755.3	020508		
	1.6	77	08.06	11.10				
1.7 CDTI	59	08.06	11.10					
1.7 CDTI	74	08.06	11.10					

¹⁾ for 4 bore wheel rim / per cerchione a 4 fori / pour jante à 4 trous / para Llantas de 4 taladros

²⁾ for 5 bore wheel rim / per cerchione a 5 fori / pour jante à 5 trous / para Llantas de 5 taladros

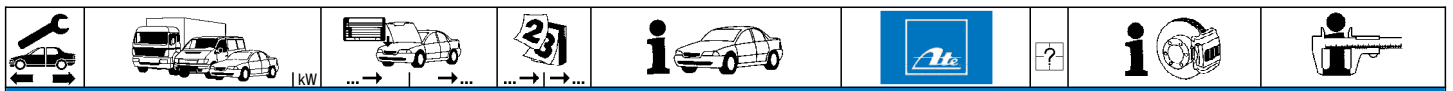

OPEL ASTRA H Caravan/Vau. Astra MKV Estate (04-10)

	1.2	59		08.05	11.10	24.3727-0785.2	580785	1	HA-Scheibenbremse ¹⁾	L=1735/1760, + Zub	
	1.3 CDTI	66		08.05	11.10						
	1.4			08.04	11.10						
	1.6	77		08.04	11.10						
	1.6	85		01.07	11.10						
	1.6 LPG	85		08.09	11.10						
	1.6 Turbo	132		01.07	11.10						
	1.7 CDTI	59		08.04	11.10						
	1.7 CDTI	74		08.04	11.10						
	1.7 CDTI	81		04.07	11.10						
	1.7 CDTI	92		04.07	11.10						
	1.7 TD	79		08.05	11.10						
	1.8	92		09.04	11.10						
	1.8	103		08.05	11.10						
	1.9 CDTI	74		09.05	11.10						
	1.9 CDTI	88		08.04	11.10						
	1.9 CDTI	110		09.04	11.10						
	2.0 Turbo	125		08.04	11.10						
	2.0 Turbo	147		09.04	11.10						
		1.2	59		08.05	11.10	24.3727-0770.2	580770	1	HA-Trommelbremse ²⁾	L=1295/1328, + Zub
1.4				08.04	11.10	24.3727-0746.2	580746	2	Verlängerung/+HA-Trommelbr. ³⁾	L=182, + Zub	
1.6		77		08.04	11.10						
1.7 CDTI		59		08.04	11.10						
1.7 CDTI		74		08.04	11.10						
1.7 TD		79		08.04	11.10						
		1.2	59		08.05	11.10	24.2415-1704.3	030087			Gz 15,87
		1.3 CDTI	66		08.05	11.10					
		1.4			08.04	11.10					
		1.6	77		08.04	11.10					
	1.6	85		01.07	11.10						
	1.6 LPG	85		08.09	11.10						
	1.6 Turbo	132		01.07	11.10						
	1.7 CDTI	59		08.04	11.10						
	1.7 CDTI	74		08.04	11.10						
	1.7 CDTI	81		04.07	11.10						
	1.7 CDTI	92		04.07	11.10						
	1.7 TD	79		08.04	11.10						
	1.8	92		09.04	11.10						
	1.8	103		08.05	11.10						
	1.9 CDTI	74		09.05	11.10						
	1.9 CDTI	88		08.04	11.10						
	1.9 CDTI	110		09.04	11.10						
	2.0 Turbo	125		08.04	11.10						
2.0 Turbo	147		09.04	11.10							



















OPEL ASTRA H TwinTop (06-10)

	1.9 CDTI	110		03.06	11.10	03.7863-7803.4	300237			10"	ATE
	1.6	77	68999999	03.06		24.2125-1737.3	010906		- ESP	Thz 25,40	TRW
	1.6	85	68999999	12.06		24.2125-1736.3	010904		+ ESP	Thz 25,40	TRW
	1.6 Turbo	132	68999999	02.07							
	1.8		68999999	03.06							
	2.0 Turbo	125	68999999	03.06							
	2.0 Turbo	147	68999999	03.06							
	1.6	77	72000001		11.10	24.4125-1704.3	010908		- ESP	Thz 25,40	TRW
	1.6	85	72000001		11.10	24.4125-1703.3	010907		+ ESP	Thz 25,40	TRW
	1.6 Turbo	132	72000001		11.10						
	1.8		72000001		11.10						
	2.0 Turbo	125	72000001		11.10						
	2.0 Turbo	147	72000001		11.10						
	1.9 CDTI	110		03.06	11.10	03.4155-0156.3	010862		+ ESP	Thz 25,40	ATE
	1.6	77	68999999	03.06		24.2125-1736.3	010904			Thz 25,40	TRW
1.6	85	68999999	12.06								
1.6 Turbo	132	68999999	02.07								
1.8		68999999	03.06								
2.0 Turbo	125	68999999	03.06								
2.0 Turbo	147	68999999	03.06								
1.6	77		03.06	11.10	24.4125-1703.3	010907			Thz 25,40	TRW	
1.6	85		12.06	11.10							
1.6 Turbo	132		02.07	11.10							
1.8			03.06	11.10							
2.0 Turbo	125		03.06	11.10							
2.0 Turbo	147		03.06	11.10							
1.9 CDTI	110		03.06	11.10	03.4155-0156.3	010862			Thz 25,40	ATE	
	1.6	77		03.06	11.10	11.9571-9823.2	220471		☐	D=57, - Halter	ATE
	1.6	85		12.06	11.10	11.9571-9824.2	220472		☐	D=57, - Halter	ATE
	1.8			03.06	11.10	24.3571-9823.5	240499		☐	D=57, - Halter	ATE
						24.3571-9824.5	240500		☐	D=57, - Halter	ATE
						11.0441-5704.2	250034			Dichtungssatz	ATE
						11.0101-5407.2	260011			Hülzensatz	ATE
						11.8171-0008.1	990049			Führungsbolzen	ATE
					11.8116-0292.1	390521	2		Haltefeder	ATE	

¹⁾ + RA disc brake / + P disco freno / + frein à disque essieu AR / + ET-disco de freno

²⁾ + RA drum brake / + P freno a tamburo / + frein à tambour essieu AR / + ET-tambores de freno

³⁾ extension only / + RA drum br. / solo prolonga/+ P fra tamburo / rallonge seulem.+ tamb.ess.AR / solam.prolongad./+ tambores ET

										
OPEL ASTRA H TwinTop (06-10)										
	1.6 Turbo 1.9 CDTI 2.0 Turbo 2.0 Turbo	132 110 125 147		02.07 03.06 03.06 03.06	11.10 11.10 11.10 11.10	11.9571-9823.2 11.9571-9824.2 24.3571-9823.5 24.3571-9824.5 11.8170-0758.1 11.0441-5704.2 11.0101-5407.2 11.8171-0008.1 11.8116-0292.1	220471 220472 240499 240500 260120 250034 260011 990049 390521	2 2	D=57, - Halter D=57, - Halter D=57, - Halter D=57, - Halter Halter Dichtungssatz Hülensatz Führungsbolzen Haltefeder	ATE ATE ATE ATE ATE ATE ATE ATE
	1.6 1.6 1.6 Turbo 1.8 1.9 CDTI 2.0 Turbo 2.0 Turbo	77 85 132 110 125 147		03.06 12.06 02.07 03.06 03.06 03.06 03.06	11.10 11.10 11.10 11.10 11.10 11.10 11.10	24.5241-0429.3	331381	2	L=429	
	1.6 1.6 1.6 Turbo 1.8 1.9 CDTI 2.0 Turbo 2.0 Turbo	77 85 132 110 125 147		03.06 12.06 02.07 03.06 03.06 03.06 03.06	11.10 11.10 11.10 11.10 11.10 11.10 11.10	24.3367-1707.7 24.3367-1708.7 24.3387-1701.7 24.3387-1702.7	220669 220670 220673 220674	<input type="checkbox"/> für 4-Loch-Felge 1) <input type="checkbox"/> für 4-Loch-Felge 2) <input type="checkbox"/> für 5-Loch-Felge 1) <input type="checkbox"/> für 5-Loch-Felge 2)	D=36, - Halter D=36, - Halter D=38, - Halter D=38, - Halter	TRW TRW TRW TRW
	1.6 1.6 1.6 Turbo 1.8 1.9 CDTI 2.0 Turbo 2.0 Turbo	77 85 132 110 125 147		03.06 12.06 02.07 03.06 03.06 03.06 03.06	11.10 11.10 11.10 11.10 11.10 11.10 11.10	24.5157-0218.3 24.5157-0219.3	331095 331096	<input type="checkbox"/> + HA-Scheibenbremse 3) <input type="checkbox"/> + HA-Scheibenbremse 3)	L=219/185, + Rohrleitung L=219/185, + Rohrleitung	
	1.6 1.6 1.6 Turbo 1.8 1.9 CDTI 2.0 Turbo 2.0 Turbo	77 85 132 110 125 147		03.06 12.06 02.07 03.06 03.06 03.06 03.06	11.10 11.10 11.10 11.10 11.10 11.10 11.10	24.3727-0775.2	580775	1  + HA-Scheibenbremse 3)	L=1647/1665, + Zub	
	1.6 1.6 1.6 Turbo 1.8 1.9 CDTI 2.0 Turbo 2.0 Turbo	77 85 132 110 125 147		03.06 12.06 02.07 03.06 03.06 03.06 03.06	11.10 11.10 11.10 11.10 11.10 11.10 11.10	24.2415-1704.3	030087		Gz 15,87	
OPEL ASTRA J / GTC / Vauxhall Astra MK VI (09-)										
	1.3 CDTI ECOTEC 1.4 ecoFLEX 1.4 ecoFLEX 1.4 LPG Turbo ecoFLEX 1.4 Turbo ECOTEC 1.4 Turbo ECOTEC 1.6 CDTi 1.6 CDTi 1.6 SIDI 1.6 SIDI 1.6 Turbo ECOTEC 1.6 Turbo ECOTEC 1.7 CDTI ECOTEC 1.7 CDTI ECOTEC 1.8 2.0 CDTi BiTurbo 2.0 CDTI ECOTEC	70 64 74 103 88 103 81 100 125 147 85 132 81 96 103 143 70		12.09 12.09 12.09 01.12 11.10 12.09 02.14 01.14 12.12 07.13 12.09 12.09 12.09 12.09 10.11 12.12 12.09		03.7858-0732.4	300272		9/8" Tandem	ATE
	1.3 CDTI ECOTEC 1.4 ecoFLEX 1.4 ecoFLEX 1.4 LPG Turbo ecoFLEX 1.4 Turbo ECOTEC 1.4 Turbo ECOTEC 1.6 CDTi 1.6 CDTi 1.6 SIDI 1.6 SIDI 1.6 Turbo ECOTEC 1.6 Turbo ECOTEC 1.7 CDTI ECOTEC 1.7 CDTI ECOTEC 1.8 2.0 CDTi BiTurbo 2.0 CDTI ECOTEC	70 64 74 103 88 103 81 100 125 147 85 132 81 96 103 143 70		12.09 12.09 12.09 01.12 11.10 12.09 02.14 01.14 12.12 07.13 12.09 12.09 12.09 12.09 10.11 12.12 12.09		03.2125-0421.3	010934		Thz 25,40	ATE
	1.3 CDTI ECOTEC 1.4 ecoFLEX 1.4 ecoFLEX 1.4 LPG Turbo ecoFLEX 1.4 Turbo ECOTEC 1.4 Turbo ECOTEC 1.6 CDTi	70 64 74 103 88 103 81		12.09 12.09 12.09 01.12 11.10 12.09 02.14		11.9601-2603.2 11.9601-2604.2 11.0103-0002.2	220915 220916 250157	<input type="checkbox"/> <input type="checkbox"/> <input type="checkbox"/> <input type="checkbox"/> <input type="checkbox"/> <input type="checkbox"/> <input type="checkbox"/> ab Produktionsdatum 08.2012 5)	D=60, - Halter D=60, - Halter Bremsattel-Zubehör	ATE ATE ATE

1) for 4 bore wheel rim / per cerchione a 4 fori / pour jante à 4 trous / para Llantas de 4 taladros

2) for 5 bore wheel rim / per cerchione a 5 fori / pour jante à 5 trous / para Llantas de 5 taladros

3) + RA disc brake / + P disco freno / + frein à disque essieu AR / + ET-disco de freno

4) + brake disc diameter 276 mm / + disco fr.diam. 276mm / + disques fr.diam. 276mm / + disco fr.diam. 276mm

5) from production date 08.2012 / da data die produzione 08.2012 / à partir de la date de production 08.2012 / desde fecha de producción 08.2012

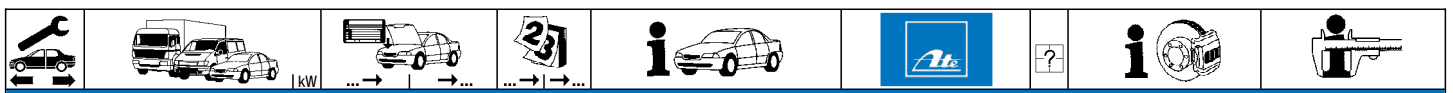





















OPEL ASTRA J / GTC / Vauxhall Astra MK VI (09-)

	1.6 CDTi	100		01.14	+ Bremsscheibendurchm. 276 mm ¹⁾	11.9601-2603.2	220915	<input type="checkbox"/> ab Produktionsdatum 08.2012 ²⁾	D=60, - Halter	ATE		
	1.6 SIDI	125		12.12	+ Bremsscheibendurchm. 276 mm ¹⁾	11.9601-2604.2	220916		D=60, - Halter	ATE		
	1.6 SIDI	147		07.13	+ Bremsscheibendurchm. 276 mm ¹⁾	11.0103-0002.2	250157		Bremssattel-Zubehör	ATE		
	1.6 Turbo ECOTEC	85		12.09	+ Bremsscheibendurchm. 276 mm ¹⁾							
	1.6 Turbo ECOTEC	132		12.09	+ Bremsscheibendurchm. 276 mm ¹⁾							
	1.7 CDTi ECOTEC	81		12.09	+ Bremsscheibendurchm. 276 mm ¹⁾							
	1.7 CDTi ECOTEC	96		12.09	+ Bremsscheibendurchm. 276 mm ¹⁾							
	1.8	103		10.11	+ Bremsscheibendurchm. 276 mm ¹⁾							
	2.0 CDTi BiTurbo	143		12.12	+ Bremsscheibendurchm. 276 mm ¹⁾							
	2.0 CDTi ECOTEC			12.09	+ Bremsscheibendurchm. 276 mm ¹⁾							
	1.3 CDTi ECOTEC	70		12.09	+ Bremsscheibendurchm. 300 mm ³⁾	11.9601-2601.2	220913		<input type="checkbox"/> ab Produktionsdatum 08.2012 ²⁾	D=60, - Halter	ATE	
	1.4 ecoFLEX	64		12.09	+ Bremsscheibendurchm. 300 mm ³⁾	11.9601-2602.2	220914			D=60, - Halter	ATE	
	1.4 ecoFLEX	74		12.09	+ Bremsscheibendurchm. 300 mm ³⁾	11.0103-0002.2	250157			Bremssattel-Zubehör	ATE	
	1.4 LPG Turbo ecoFLEX	103		01.12	+ Bremsscheibendurchm. 300 mm ³⁾							
	1.4 Turbo ECOTEC	88		11.10	+ Bremsscheibendurchm. 300 mm ³⁾							
	1.4 Turbo ECOTEC	103		12.09	+ Bremsscheibendurchm. 300 mm ³⁾							
	1.6 CDTi	81		02.14	+ Bremsscheibendurchm. 300 mm ³⁾							
	1.6 CDTi	100		01.14	+ Bremsscheibendurchm. 300 mm ³⁾							
	1.6 SIDI	125		12.12	+ Bremsscheibendurchm. 300 mm ³⁾							
1.6 SIDI	147		07.13	+ Bremsscheibendurchm. 300 mm ³⁾								
1.6 Turbo ECOTEC	85		12.09	+ Bremsscheibendurchm. 300 mm ³⁾								
1.6 Turbo ECOTEC	132		12.09	+ Bremsscheibendurchm. 300 mm ³⁾								
1.7 CDTi ECOTEC	81		12.09	+ Bremsscheibendurchm. 300 mm ³⁾								
1.7 CDTi ECOTEC	96		12.09	+ Bremsscheibendurchm. 300 mm ³⁾								
1.8	103		10.11	+ Bremsscheibendurchm. 300 mm ³⁾								
2.0 CDTi BiTurbo	143		12.12	+ Bremsscheibendurchm. 300 mm ³⁾								
2.0 CDTi ECOTEC			12.09	+ Bremsscheibendurchm. 300 mm ³⁾								
	1.3 CDTi ECOTEC	70	A8068771	12.09		24.5176-0400.3	331492	2		L=400		
	1.4 ecoFLEX	64	A8068771	12.09								
	1.4 ecoFLEX	74	A8068771	12.09								
	1.4 LPG Turbo ecoFLEX	103	A8068771	01.12								
	1.4 Turbo ECOTEC	88	A8068771	11.10								
	1.4 Turbo ECOTEC	103	A8068771	12.09								
	1.6 SIDI	125	A8068771	12.12								
	1.6 Turbo ECOTEC	85	A8068771	12.09								
	1.6 Turbo ECOTEC	132	A8068771	12.09								
	1.7 CDTi ECOTEC	81	A8068771	12.09								
	1.7 CDTi ECOTEC	96	A8068771	12.09								
	2.0 CDTi BiTurbo	143	A8068771	12.12								
	2.0 CDTi ECOTEC		A8068771	12.09								
		1.3 CDTi ECOTEC	70		12.09		11.9382-7001.2	220889	<input type="checkbox"/> - elektrische Feststellbremse ⁴⁾ <input type="checkbox"/> - elektrische Feststellbremse ⁴⁾ <input checked="" type="checkbox"/> + elektrische Feststellbremse ⁵⁾ <input type="checkbox"/> + elektrische Feststellbremse ⁵⁾	D=38, - Halter	ATE	
		1.4 ecoFLEX	64		12.09		11.9382-7002.2	220890		D=38, - Halter	ATE	
		1.4 ecoFLEX	74		12.09		11.9382-7003.2	220891		D=38, - Halter	ATE	
		1.4 LPG Turbo ecoFLEX	103		01.12		11.9382-7004.2	220892		D=38, - Halter	ATE	
		1.4 Turbo ECOTEC	88		11.10							
		1.4 Turbo ECOTEC	103		12.09							
1.6 CDTi		81		02.14								
1.6 CDTi		100		01.14								
1.6 SIDI		125		12.12								
1.6 SIDI		147		07.13								
1.6 Turbo ECOTEC		85		12.09								
1.6 Turbo ECOTEC		132		12.09								
1.7 CDTi ECOTEC		81		12.09								
1.7 CDTi ECOTEC		96		12.09								
1.8		103		10.11								
2.0 CDTi BiTurbo		143		12.12								
2.0 CDTi ECOTEC				12.09								
		1.3 CDTi ECOTEC	70		12.09		24.3727-0798.2	580798		<input checked="" type="checkbox"/> - elektrische Feststellbremse ⁴⁾ <input type="checkbox"/> - elektrische Feststellbremse ⁴⁾ <input type="checkbox"/> - elektrische Feststellbremse ⁴⁾	L=1798	
		1.4 ecoFLEX	64		12.09		24.3727-0794.2	580794			L=1812	
	1.4 ecoFLEX	74		12.09		24.3727-0795.2	580795	L=1814				
	1.4 LPG Turbo ecoFLEX	103		01.12								
	1.4 Turbo ECOTEC	88		11.10								
	1.4 Turbo ECOTEC	103		12.09								
	1.6 CDTi	81		02.14								
	1.6 CDTi	100		01.14								
	1.6 SIDI	125		12.12								
	1.6 SIDI	147		07.13								
	1.6 Turbo ECOTEC	85		12.09								
	1.6 Turbo ECOTEC	132		12.09								
	1.7 CDTi ECOTEC	81		12.09								
	1.7 CDTi ECOTEC	96		12.09								
	1.8	103		10.11								
	2.0 CDTi BiTurbo	143		12.12								
	2.0 CDTi ECOTEC			12.09								

OPEL ASTRA J Sports Tourer/Vau.Astra Sports Tourer (10-)

	1.3 CDTi ECOTEC	70		11.10		03.7858-0732.4	300272		9/8" Tandem	ATE
	1.4 ecoFLEX	64		11.10						
	1.4 ecoFLEX	74		11.10						
	1.4 LPG Turbo ecoFLEX	103		01.12						
	1.4 Turbo ECOTEC	88		11.10						
	1.4 Turbo ECOTEC	103		11.10						
	1.6 CDTi	81		02.14						
	1.6 CDTi	100		01.14						
	1.6 ECOTEC	85		11.10						
	1.6 LPG	84		10.12						
	1.6 SIDI	125		12.12						

¹⁾ + brake disc diameter 276 mm / + disco fr.diam. 276mm / + disques fr.diam. 276mm / + disco fr.diam. 276mm
²⁾ from production date 08.2012 / da data die produzione 08.2012 / à partir de la date de production 08.2012 / desde fecha de producción 08.2012
³⁾ + brake disc diameter 300mm / + diametro dischi freno 300mm / + diamètre disques frein 300mm / + diámetro disco freno 300mm
⁴⁾ - electric parking brake / - freno a mano elettrico / - frein à main électrique / - freno de mano eléctrico
⁵⁾ + electric parking brake / + freno a mano elettrico / + frein à main électrique / + freno de mano eléctrico

									
OPEL ASTRA J Sports Tourer/Vau.Astra Sports Tourer (10-)									
	1.6 Turbo ECOTEC	132		11.10	03.7858-0732.4	300272		9/8" Tandem	ATE
	1.7 CDTi ECOTEC			11.10					
	1.7 CDTi ECOTEC	92		11.10					
	2.0 CDTi BiTurbo	143		12.12					
	2.0 CDTi ECOTEC			11.10					
	1.3 CDTi ECOTEC	70		11.10	03.2125-0421.3	010934		Thz 25,40	ATE
	1.4 ecoFLEX	64		11.10					
	1.4 ecoFLEX	74		11.10					
	1.4 LPG Turbo ecoFLEX	103		01.12					
	1.4 Turbo ECOTEC	88		11.10					
	1.4 Turbo ECOTEC	103		11.10					
	1.6 CDTi	81		02.14					
	1.6 CDTi	100		01.14					
	1.6 ECOTEC	85		11.10					
	1.6 LPG	84		10.12					
	1.6 SIDI	125		12.12					
	1.6 Turbo ECOTEC	132		11.10					
	1.7 CDTi ECOTEC			11.10					
	1.7 CDTi ECOTEC	92		11.10					
	2.0 CDTi BiTurbo	143		12.12					
	2.0 CDTi ECOTEC			11.10					
	1.3 CDTi ECOTEC	70		11.10	11.9601-2603.2	220915	 ab Produktionsdatum 08.2012 ²⁾	D=60, - Halter	ATE
	1.4 ecoFLEX	64		11.10	11.9601-2604.2	220916		D=60, - Halter	ATE
	1.4 ecoFLEX	74		11.10	11.0103-0002.2	250157		Bremssattel-Zubehör	ATE
	1.4 LPG Turbo ecoFLEX	103		01.12					
	1.4 Turbo ECOTEC	88		11.10					
	1.4 Turbo ECOTEC	103		11.10					
	1.6 CDTi	81		02.14					
	1.6 CDTi	100		01.14					
	1.6 ECOTEC	85		11.10					
	1.6 LPG	84		10.12					
	1.6 SIDI	125		12.12					
	1.6 Turbo ECOTEC	132		11.10					
	1.7 CDTi ECOTEC			11.10					
	1.7 CDTi ECOTEC	92		11.10					
	2.0 CDTi BiTurbo	143		12.12					
	2.0 CDTi ECOTEC			11.10					
	1.3 CDTi ECOTEC	70		11.10	11.9601-2601.2	220913	 ab Produktionsdatum 08.2012 ²⁾	D=60, - Halter	ATE
	1.4 ecoFLEX	64		11.10	11.9601-2602.2	220914		D=60, - Halter	ATE
	1.4 ecoFLEX	74		11.10	11.0103-0002.2	250157		Bremssattel-Zubehör	ATE
	1.4 LPG Turbo ecoFLEX	103		01.12					
	1.4 Turbo ECOTEC	88		11.10					
	1.4 Turbo ECOTEC	103		11.10					
	1.6 CDTi	81		02.14					
	1.6 CDTi	100		01.14					
	1.6 ECOTEC	85		11.10					
	1.6 LPG	84		10.12					
	1.6 SIDI	125		12.12					
	1.6 Turbo ECOTEC	132		11.10					
	1.7 CDTi ECOTEC			11.10					
	1.7 CDTi ECOTEC	92		11.10					
	2.0 CDTi BiTurbo	143		12.12					
	2.0 CDTi ECOTEC			11.10					
	1.3 CDTi ECOTEC	70	A8068771	11.10	24.5176-0400.3	331492	2	L=400	
	1.4 ecoFLEX	64	A8068771	11.10					
	1.4 ecoFLEX	74	A8068771	11.10					
	1.4 LPG Turbo ecoFLEX	103	A8068771	01.12					
	1.4 Turbo ECOTEC	88	A8068771	11.10					
	1.4 Turbo ECOTEC	103	A8068771	11.10					
	1.6 ECOTEC	85	A8068771	11.10					
	1.6 LPG	84	A8068771	10.12					
	1.6 SIDI	125	A8068771	12.12					
	1.6 Turbo ECOTEC	132	A8068771	11.10					
	1.7 CDTi ECOTEC		A8068771	11.10					
	1.7 CDTi ECOTEC	92	A8068771	11.10					
	2.0 CDTi BiTurbo	143	A8068771	12.12					
	2.0 CDTi ECOTEC		A8068771	11.10					
	1.3 CDTi ECOTEC	70		11.10	11.9382-7001.2	220889	 - elektrische Feststellbremse ⁴⁾	D=38, - Halter	ATE
	1.4 ecoFLEX	64		11.10	11.9382-7002.2	220890	 - elektrische Feststellbremse ⁴⁾	D=38, - Halter	ATE
	1.4 ecoFLEX	74		11.10	11.9382-7003.2	220891	 + elektrische Feststellbremse ⁵⁾	D=38, - Halter	ATE
	1.4 LPG Turbo ecoFLEX	103		01.12	11.9382-7004.2	220892	 + elektrische Feststellbremse ⁵⁾	D=38, - Halter	ATE
	1.4 Turbo ECOTEC	88		11.10					
	1.4 Turbo ECOTEC	103		11.10					
	1.6 CDTi	81		02.14					
	1.6 CDTi	100		01.14					
	1.6 ECOTEC	85		11.10					
	1.6 LPG	84		10.12					
	1.6 SIDI	125		12.12					
	1.6 Turbo ECOTEC	132		11.10					
	1.7 CDTi ECOTEC			11.10					
	1.7 CDTi ECOTEC	92		11.10					
	2.0 CDTi BiTurbo	143		12.12					
	2.0 CDTi ECOTEC			11.10					

















































¹⁾ + brake disc diameter 276 mm / + disco fr.diam. 276mm / + disques fr.diam. 276mm / + disco fr.diam. 276mm

²⁾ from production date 08.2012 / da data die produzione 08.2012 / à partir de la date de production 08.2012 / desde fecha de producción 08.2012













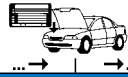



³⁾ + brake disc diameter 300mm / + diametro dischi freno 300mm / + diamètre disques frein 300mm / + diámetro disco freno 300mm

⁴⁾ - electric parking brake / - freno a mano elettrico / - frein à main électrique / - freno de mano eléctrico

⁵⁾ + electric parking brake / + freno a mano elettrico / + frein à main électrique / + freno de mano eléctrico

























										
OPEL ASTRA J Sports Tourer/Vau.Astra Sports Tourer (10-)										
	1.3 CDTi ECOTEC 1.4 ecoFLEX 1.4 ecoFLEX 1.4 LPG Turbo ecoFLEX 1.4 Turbo ECOTEC 1.4 Turbo ECOTEC 1.6 CDTi 1.6 CDTi 1.6 ECOTEC 1.6 LPG 1.6 SIDI 1.6 Turbo ECOTEC 1.7 CDTi ECOTEC 1.7 CDTi ECOTEC 2.0 CDTi BiTurbo 2.0 CDTi ECOTEC	70 64 74 103 88 103 81 100 85 84 125 132 92 143		11.10 11.10 11.10 01.12 11.10 11.10 02.14 01.14 11.10 10.12 12.12 11.10 11.10 11.10 12.12		24.3727-0798.2 24.3727-0794.2 24.3727-0795.2	580798 580794 580795	1 - elektrische Feststellbremse 1) - elektrische Feststellbremse 1) - elektrische Feststellbremse 1)	L=1798 L=1812 L=1814	
OPEL CALIBRA / Vauxhall Calibra (89-97)										
	2.0 2.0 16V 2.0 16V 4x4 2.0 4x4 2.0 Turbo 2.5			09.89 07.97 09.89 07.97 09.89 07.97 09.89 07.97 03.92 07.97 02.93 07.97		03.2122-0282.3	010130		Thz 22,20 ATE	
	2.0 2.0 16V 2.0 16V 4x4 2.0 4x4 2.0 Turbo 2.5			09.89 07.97 09.89 07.97 09.89 07.97 09.89 07.97 03.92 07.97 02.93 07.97		24.3521-1701.5 24.3521-1702.5 11.0441-5202.2 11.0101-5407.2 11.8171-0008.1	240001 240002 250026 260011 990049	     	D=52, - Halter D=52, - Halter Dichtungssatz Hülssensatz Führungsbolzen	ATE ATE ATE ATE ATE ATE
	2.0 2.0 16V 2.0 16V 4x4 2.0 4x4 2.0 Turbo 2.5			09.89 07.97 09.89 07.97 09.89 07.97 09.89 07.97 03.92 07.97 02.93 07.97		11.0441-5402.2 11.0101-5407.2 11.8171-0008.1 11.8116-0097.1	250028 260011 990049 390590	2    	Dichtungssatz Hülssensatz Führungsbolzen Haltefeder	ATE ATE ATE ATE ATE ATE
	2.0 2.0 16V 2.0 16V 4x4 2.0 4x4 2.0 Turbo 2.5			09.89 07.97 09.89 07.97 09.89 07.97 09.89 07.97 03.92 07.97 02.93 07.97		11.3541-8085.2 24.3541-8086.5 24.3541-8085.5 11.0101-5407.2 11.8171-0008.1 11.8116-0292.1	220287 240526 240525 260011 990049 390521	2      	D=54, + Halter D=54, - Halter D=54, - Halter Hülssensatz Führungsbolzen Haltefeder	ATE ATE ATE ATE ATE ATE
	2.0 2.0 16V 2.0 16V 4x4 2.0 4x4 2.0 Turbo 2.5			09.89 07.97 09.89 07.97 09.89 07.97 09.89 07.97 03.92 07.97 02.93 07.97		24.5298-0322.3	331314	2	L=322	
	2.0 2.0 16V 2.0 16V 4x4 2.0 4x4 2.0 Turbo 2.5			09.89 07.97 09.89 07.97 09.89 07.97 09.89 07.97 03.92 07.97 02.93 07.97		13.2351-0013.2 13.2351-0014.2 24.9235-0013.5 24.9235-0014.5 13.0441-3506.2	210010 210011 230001 230002 250052	    	D=35 D=35 D=35 D=35 Dichtungssatz	ATE ATE ATE ATE ATE
	2.0 2.0 16V 2.0 16V 4x4 2.0 4x4 2.0 Turbo 2.5			09.89 07.97 09.89 07.97 09.89 07.97 09.89 07.97 03.92 07.97 02.93 07.97		13.0441-3506.2	250052		Dichtungssatz	ATE
	2.0 2.0 16V 2.0 16V 4x4 2.0 4x4 2.0 Turbo 2.5			09.89 07.97 09.89 07.97 09.89 07.97 09.89 07.97 03.92 07.97 02.93 07.97		13.2351-0013.2 13.2351-0014.2 24.9235-0013.5 24.9235-0014.5 13.0441-3506.2	210010 210011 230001 230002 250052	    	D=35 D=35 D=35 D=35 Dichtungssatz	ATE ATE ATE ATE ATE
	2.0 2.0 16V 2.0 16V 4x4 2.0 4x4 2.0 Turbo 2.5			09.89 07.97 09.89 07.97 09.89 07.97 09.89 07.97 03.92 07.97 02.93 07.97		24.5233-0200.3	330425	2	L=198	
	2.0 2.0 16V 2.0 16V 4x4 2.0 4x4 2.0 Turbo 2.5			09.89 07.97 09.89 07.97 09.89 07.97 09.89 07.97 03.92 07.97 02.93 07.97		24.5117-0195.3	330565	2	L=198	
	2.0 2.0 16V 2.0 16V 4x4 2.0 4x4 2.0 Turbo 2.5			09.89 07.97 09.89 07.97 09.89 07.97 09.89 07.97 03.92 07.97 02.93 07.97		24.3727-0736.2	580736	1 	L=1365/1498, + Zub	
	2.0 2.0 16V 2.0 16V 4x4 2.0 4x4 2.0 Turbo 2.5			09.89 07.97 09.89 07.97 09.89 07.97 09.89 07.97 03.92 07.97 02.93 07.97		03.0101-0038.2	320245		BRES 4/5 ATE	
	2.0 2.0 16V 2.0 16V 4x4 2.0 4x4 2.0 Turbo 2.5			09.89 07.97 09.89 07.97 09.89 07.97 09.89 07.97 03.92 07.97 02.93 07.97		03.0101-0038.2	320245		BRES 4/5 ATE	

1) - electric parking brake / - freno a mano elettrico / - frein à main électrique / - freno de mano eléctrico

									
OPEL CALIBRA / Vauxhall Calibra (89-97)									
	2.0 2.0 16V 2.0 16V 4x4 2.0 4x4 2.5		S9999999 S9999999 S9999999 S9999999 S9999999	09.89 09.89 09.89 09.89 02.93		24.3728-0715.2	590715	L=835	
DIV	2.0 16V 4x4 2.0 4x4 2.0 Turbo			09.89 07.97 09.89 07.97 03.92 07.97		10.0515-0515.3	340024	+ Verteilergetriebe ¹⁾ Hydraulikspeicher ATE	
OPEL CAMPO (97-01)									
	2.5 DTI 2.5 DTI 4x4 3.1 TD 3.1 TD 4x4			09.96 09.96 09.96 09.96		24.3225-1702.3	020425	Rz 25,40	
OPEL CASCADA / Vauxhall Cascada (13-)									
	1.4 Turbo ECOTEC 1.4 Turbo ECOTEC 1.6 DI Turbo 1.6 SIDI Turbo 2.0 CDTi 2.0 CDTi BiTurbo 2.0 CDTi ECOTEC	88 103 147 125 125 143 121		01.13 01.13 11.13 01.13 07.15 01.13 01.13		03.7858-0732.4	300272	9/8" Tandem ATE	
	1.4 Turbo ECOTEC 1.4 Turbo ECOTEC 1.6 DI Turbo 1.6 SIDI Turbo 2.0 CDTi 2.0 CDTi BiTurbo 2.0 CDTi ECOTEC	88 103 147 125 125 143 121		01.13 01.13 11.13 01.13 07.15 01.13 01.13		03.2125-0421.3	010934	THz 25,40 ATE	
	1.4 Turbo ECOTEC 1.4 Turbo ECOTEC 1.6 DI Turbo 1.6 SIDI Turbo 2.0 CDTi 2.0 CDTi BiTurbo 2.0 CDTi ECOTEC	88 103 147 125 125 143 121		01.13 01.13 11.13 01.13 07.15 01.13 01.13		11.9382-7001.2 11.9382-7002.2 11.9382-7003.2 11.9382-7004.2 11.0103-0001.2	220889 220890 220891 220892 250156	<input type="checkbox"/> - elektrische Feststellbremse ²⁾ <input type="checkbox"/> - elektrische Feststellbremse ²⁾ <input checked="" type="checkbox"/> + elektrische Feststellbremse ³⁾ <input checked="" type="checkbox"/> + elektrische Feststellbremse ³⁾ D=38, - Halter D=38, - Halter D=38, - Halter D=38, - Halter Bremsattel-Zubehör ATE ATE ATE ATE ATE	
OPEL COMBO / Vauxhall Combo (01-11)									
	1.3 CDTi 1.4 16V 1.6 1.7 DI 16V 1.7 DTI 16V		33999999 33999999 33999999 33999999 33999999	06.03 10.01 10.01 10.01 10.01		24.2122-1740.3	010711	THz 22,20 DEL	
	1.3 CDTi 1.4 16V 1.6 1.6 CNG 1.7 CDTi 16V 1.7 DI 16V 1.7 DTI 16V	43000001 43000001 43000001 43000001 43000001 43000001 43000001		10.11 10.11 10.11 04.05 06.04 10.11 10.11	- ESP - ESP - ESP - ESP - ESP - ESP - ESP	24.2123-1767.3	010844	+ HA-Scheibenbremse ⁴⁾ THz 23,81 BOS	
	1.3 CDTi 1.4 16V 1.6 1.6 CNG 1.7 CDTi 16V 1.7 DI 16V 1.7 DTI 16V	43000001 43000001 43000001 43000001 43000001 43000001 43000001		10.11 10.11 10.11 04.05 06.04 10.11 10.11	+ ESP + ESP + ESP + ESP + ESP + ESP + ESP	24.2122-1757.3	010769	+ HA-Trommelbremse ⁵⁾ THz 22,20 BOS	
	1.3 CDTi 1.4 16V 1.6 1.6 CNG 1.7 CDTi 16V 1.7 DI 16V 1.7 DTI 16V	43000001 43000001 43000001 43000001 43000001 43000001 43000001		10.11 10.11 10.11 04.05 06.04 10.11 10.11	+ ESP + ESP + ESP + ESP + ESP + ESP + ESP	24.2123-1768.3	010845	+ HA-Scheibenbremse ⁴⁾ THz 23,81 BOS	
	1.3 CDTi 1.4 16V 1.6 1.7 DI 16V 1.7 DTI 16V			06.03 10.01 10.01 10.01 10.01	10.11 10.11 10.11 10.11 10.11	+ erhöhte Zuladung ⁶⁾ + erhöhte Zuladung ⁶⁾ + erhöhte Zuladung ⁶⁾ + erhöhte Zuladung ⁶⁾ + erhöhte Zuladung ⁶⁾	24.3541-1795.7 24.3541-1796.7	220551 220552	<input checked="" type="checkbox"/> <input checked="" type="checkbox"/> <input checked="" type="checkbox"/> <input checked="" type="checkbox"/> <input checked="" type="checkbox"/> D=54, - Halter D=54, - Halter TRW TRW
	1.3 CDTi 1.4 16V 1.6 1.7 DI 16V 1.7 DTI 16V	43033898, 53000000 43033898, 53000000 43033898, 53000000 43033898, 53000000 43033898, 53000000		06.03 10.01 10.01 10.01 10.01		+ erhöhte Zuladung ⁷⁾ + erhöhte Zuladung ⁷⁾ + erhöhte Zuladung ⁷⁾ + erhöhte Zuladung ⁷⁾ + erhöhte Zuladung ⁷⁾	24.3541-1795.7 24.3541-1796.7	220551 220552	<input checked="" type="checkbox"/> <input checked="" type="checkbox"/> <input checked="" type="checkbox"/> <input checked="" type="checkbox"/> <input checked="" type="checkbox"/> D=54, - Halter D=54, - Halter TRW TRW
	1.3 CDTi 1.4 16V 1.6 1.6 CNG 1.7 CDTi 16V 1.7 DI 16V 1.7 DTI 16V	43033899, 53000001 43033899, 53000001 43033899, 53000001 43033899, 53000001 43033899, 53000001 43033899, 53000001 43033899, 53000001		06.03 10.01 10.01 04.05 06.04 10.11 10.11	10.11 10.11 10.11 10.11 10.11 10.11 10.11	+ erhöhte Zuladung ⁷⁾ + erhöhte Zuladung ⁷⁾ + erhöhte Zuladung ⁷⁾ + erhöhte Zuladung ⁷⁾ + erhöhte Zuladung ⁷⁾ + erhöhte Zuladung ⁷⁾ + erhöhte Zuladung ⁷⁾	11.9571-9823.2 11.9571-9824.2 24.3571-9823.5 24.3571-9824.5 11.0441-5704.2 11.0101-5407.2 11.8171-0008.1 11.8116-0292.1	220471 220472 240499 240500 250034 260011 990049 390521	<input checked="" type="checkbox"/> <input checked="" type="checkbox"/> <input checked="" type="checkbox"/> <input checked="" type="checkbox"/> <input checked="" type="checkbox"/> <input checked="" type="checkbox"/> <input checked="" type="checkbox"/> <input checked="" type="checkbox"/> <input checked="" type="checkbox"/> <input checked="" type="checkbox"/> D=57, - Halter D=57, - Halter D=57, - Halter D=57, - Halter Dichtungssatz Hülzensatz Führungsbolzen Haltefeder ATE ATE ATE ATE ATE ATE ATE ATE ATE ATE

1) + distribution transmission / + differenziale centrale / + transmission 4x4 / + engranaje de distribución
2) - electric parking brake / - freno a mano elettrico / - frein à main électrique / - freno de mano eléctrico
3) + electric parking brake / + freno a mano elettrico / + frein à main électrique / + freno de mano eléctrico
4) + RA disc brake / + P disco freno / + frein à disque essieu AR / + ET-disco de freno
5) + RA drum brake / + P freno a tamburo / + frein à tambour essieu AR / + ET-tambores de freno
6) - increased payload / - carico utile maggiorato / - charge utile augmentée / - incremento de carga
7) + increased payload / + carico utile maggiorato / + charge utile augmentée / + incremento de carga



									
OPEL COMBO / Vauxhall Combo (01-11)									
	1.3 CDTi 1.4 16V 1.6 1.6 CNG 1.7 CDTi 16V 1.7 DI 16V 1.7 DTI 16V		06.03 10.01 10.01 04.05 06.04 10.01 10.01	10.11 10.11 10.11 10.11 10.11 10.11 10.11	24.5256-0298.3	330756	2	L=298	
	1.3 CDTi 1.4 16V 1.6 1.6 CNG 1.7 CDTi 16V 1.7 DI 16V 1.7 DTI 16V		06.03 10.01 10.01 04.05 06.04 10.01 10.01	10.11 10.11 10.11 10.11 10.11 10.11 10.11	24.3387-1701.7 24.3387-1702.7	220673 220674	 	D=38, - Halter D=38, - Halter	TRW TRW
	1.3 CDTi 1.4 16V 1.6 1.6 CNG 1.7 CDTi 16V 1.7 DI 16V 1.7 DTI 16V		06.03 10.01 10.01 04.05 06.04 10.01 10.01	10.11 10.11 10.11 10.11 10.11 10.11 10.11	24.5240-0220.3	330619	2	L=220	
	1.3 CDTi 1.4 16V 1.6 1.6 CNG 1.7 CDTi 16V 1.7 DI 16V 1.7 DTI 16V		06.03 10.01 10.01 04.05 06.04 10.01 10.01	10.11 10.11 10.11 10.11 10.11 10.11 10.11	24.3219-1715.3	020122		Rz 19,05 (ALU)	
	1.3 CDTi 1.4 16V 1.6 1.6 CNG 1.7 CDTi 16V 1.7 DI 16V 1.7 DTI 16V		06.03 10.01 10.01 04.05 06.04 10.01 10.01	10.11 10.11 10.11 10.11 10.11 10.11 10.11	24.3727-0767.2 24.3727-0761.2 24.3727-0746.2	580767 580761 580746	1  1  + Trommelbremse ¹⁾ 2  Verlängerung ²⁾	L=445, + Zub L=1235/1235, + Zub L=182, + Zub	
	1.3 CDTi 1.4 16V 1.6 1.6 CNG 1.7 CDTi 16V 1.7 DI 16V 1.7 DTI 16V		06.03 10.01 10.01 04.05 06.04 10.01 10.01	10.11 - ABS 10.11 - ABS 10.11 - ABS 10.11 - ABS 10.11 - ABS 10.11 - ABS 10.11 - ABS	03.6583-0196.3	320246		BRL 8/3 (4)	ATE
OPEL COMBO D / Vauxhall Combo D (11-)									
	1.3 CDTi 1.3 CDTi 1.3 CDTi 1.4 1.4 CNG 1.6 CDTi 1.6 CDTi 1.6 CDTi 1.6 CDTi 1.6 CDTi 2.0 CDTi	55 66 70 70 88 66 70 74 77 88 99	03.15 11.11 03.16 11.11 11.11 11.11 03.15 11.11 11.11 03.15 11.11		24.5112-0406.3	331496	2	L=405	
	1.3 CDTi 1.3 CDTi 1.3 CDTi 1.4 1.4 CNG 1.6 CDTi 1.6 CDTi 1.6 CDTi 1.6 CDTi 1.6 CDTi 2.0 CDTi	55 66 70 70 88 66 70 74 77 88 99	03.15 11.11 03.16 11.11 11.11 11.11 03.15 11.11 11.11 03.15 11.11		24.5204-0200.3	331499	2	L=200	
	1.4 1.4 CNG 2.0 CDTi	70 88 99	11.11 11.11 11.11	+ 10" Bremse ³⁾ + 10" Bremse ³⁾ + 10" Bremse ³⁾	24.3225-1704.3	020541		Rz 25,40	
	1.3 CDTi 1.3 CDTi 1.3 CDTi 1.6 CDTi 1.6 CDTi 1.6 CDTi 1.6 CDTi 1.6 CDTi	55 66 70 66 70 74 77 88	03.15 11.11 03.16 11.11 03.15 11.11 11.11 03.15	+ 9" Bremse ⁴⁾ + 9" Bremse ⁴⁾ + 9" Bremse ⁴⁾ + 9" Bremse ⁴⁾ + 9" Bremse ⁴⁾ + 9" Bremse ⁴⁾ + 9" Bremse ⁴⁾ + 9" Bremse ⁴⁾	24.3220-1728.3	020509	+ kurzer Radstand ⁵⁾	Rz 20,64	
	1.3 CDTi 1.3 CDTi 1.3 CDTi 1.6 CDTi 1.6 CDTi 1.6 CDTi 1.6 CDTi 1.6 CDTi	55 66 70 66 70 74 77 88	03.15 11.11 03.16 11.11 03.15 11.11 11.11 03.15	+ 10" Bremse ³⁾ + 10" Bremse ³⁾ + 10" Bremse ³⁾ + 10" Bremse ³⁾ + 10" Bremse ³⁾ + 10" Bremse ³⁾ + 10" Bremse ³⁾ + 10" Bremse ³⁾	24.3225-1704.3 24.3222-1725.3	020541 020510	+ erhöhte Zuladung ⁶⁾ - erhöhte Zuladung ⁷⁾	Rz 25,40 Rz 22,00	AP

¹⁾ + drum brake / + freno a tamburo / + freins à tambour / + tambores de freno

²⁾ extension only / solo prolunga / rallonge seulement / solamente prolungador

















³⁾ + 10" brake / + freno 10" / + frein de 10" / + freno de 10"

⁴⁾ + 9" brake / + servofreno da 9" / + frein de 9" / + freno de 9"

⁵⁾ + short wheel base / + passo lungo / + empattement court / + distancia corta entre ejes

⁶⁾ + increased payload / + carico utile maggiorato / + charge utile augmentée / + incremento de carga

⁷⁾ - increased payload / - carico utile maggiorato / - charge utile augmentée / - incremento de carga

										
OPEL CORSA B / Vauxhall Corsa (93-00)										
	1.0 12V 1.2 1.2 16V 1.4 1.4 i 16V 1.4 Si 1.5 D 1.5 TD 1.6 GSI 16V 1.6 i 16V 1.7 D Combo			11.96 09.00 03.93 09.00 04.98 09.00 03.93 09.00 03.93 09.00 03.93 09.00 03.93 09.00 03.93 09.00 09.93 09.00 09.93 09.00 09.93 09.00 09.93 09.00		24.2120-0702.3 010361 24.2120-1714.3 010455		- ABS/Kennzeichen:EB/nicht für Delco BKV ¹⁾ + ABS/ Kennzeichen: EL ²⁾	THz 20,64 THz 20,64	
	1.0 12V 1.2 1.2 1.2 16V 1.2 16V 1.4 1.4 1.5 D 1.5 TD 1.7 D 1.2 1.2 16V 1.2 16V 1.4 1.4 1.4 i 16V 1.4 Si 1.6 GSI 16V 1.6 i 16V Combo			11.96 09.00 03.93 09.00 03.93 09.00 04.98 09.00 04.98 09.00 03.93 09.00 03.93 09.00 03.93 09.00 03.93 09.00 09.93 09.00 03.93 09.00 04.98 09.00 04.98 09.00 03.93 09.00 03.93 09.00 09.93 09.00 09.93 09.00 09.93 09.00 09.93 09.00		24.3481-1733.5 240213 24.3481-1734.5 240214 11.0441-4811.2 250024 11.0101-5407.2 260011 11.8171-0008.1 990049 11.8116-0129.1 390591		- Sport/ + Automatikgetr./ - Klimaanlage ³⁾ - Sport/ + Schaltgetriebe ⁴⁾ - Sport/ + Automatikgetr./ - Klimaanlage ³⁾ - Sport/ + Schaltgetriebe ⁴⁾ - Sport/ + Automatikgetr./ - Klimaanlage ³⁾ - Sport/ + Schaltgetriebe ⁴⁾ - Sport/ + Automatikgetr./ + Klimaanlage ⁵⁾ + Sport ⁶⁾ - Sport/ + Automatikgetr./ + Klimaanlage ⁵⁾ + Sport ⁶⁾ - Sport/ + Automatikgetr./ + Klimaanlage ⁵⁾	D=48, - Halter D=48, - Halter Dichtungssatz Hülzensatz Führungsbolzen Haltefeder	ATE ATE ATE ATE ATE ATE ATE ATE ATE ATE ATE ATE ATE ATE ATE ATE ATE ATE ATE ATE
	1.0 12V 1.2 1.2 16V 1.4 1.4 i 16V 1.4 Si 1.5 D 1.5 TD 1.6 GSI 16V 1.6 i 16V 1.7 D Combo			11.96 09.00 03.93 09.00 04.98 09.00 03.93 09.00 03.93 09.00 03.93 09.00 03.93 09.00 03.93 09.00 09.93 09.00 09.93 09.00 09.93 09.00 09.93 09.00		24.5231-0320.3 330496			L=320	
	1.0 12V 1.2 1.2 16V 1.4 1.4 i 16V 1.4 Si 1.5 D 1.5 TD 1.6 GSI 16V 1.6 i 16V 1.7 D Combo			11.96 09.00 03.93 09.00 04.98 09.00 03.93 09.00 03.93 09.00 03.93 09.00 03.93 09.00 03.93 09.00 09.93 09.00 09.93 09.00 09.93 09.00 09.93 09.00		24.5233-0200.3 330425			L=198	
	1.0 12V 1.2 1.2 16V 1.4 1.4 i 16V 1.4 Si 1.5 D 1.5 TD 1.6 GSI 16V 1.6 i 16V 1.7 D Combo			11.96 09.00 03.93 09.00 04.98 09.00 03.93 09.00 03.93 09.00 03.93 09.00 03.93 09.00 03.93 09.00 09.93 09.00 09.93 09.00 09.93 09.00 09.93 09.00		24.3219-1767.3 020552 24.3219-1715.3 020122		+ GG ⁷⁾ + ALU ⁸⁾	Rz 19,05 Rz 19,05 (ALU)	
	1.0 12V 1.2 1.2 16V 1.4 1.4 i 16V 1.4 Si 1.5 D 1.5 TD 1.6 GSI 16V 1.6 i 16V 1.7 D Combo			11.96 09.00 03.93 09.00 04.98 09.00 03.93 09.00 03.93 09.00 03.93 09.00 03.93 09.00 03.93 09.00 09.93 09.00 09.93 09.00 09.93 09.00 09.93 09.00		24.3219-1111.3 020194 24.3727-0743.2 580743 24.3727-0744.2 580744			Rz 19,05 L=1373, + Zub L=1078, + Zub	TRW
	1.0 12V 1.2 1.2 16V 1.4 1.4 i 16V 1.4 Si 1.5 D 1.5 TD 1.6 GSI 16V 1.6 i 16V 1.7 D Combo			11.96 09.00 03.93 09.00 04.98 09.00 03.93 09.00 03.93 09.00 03.93 09.00 03.93 09.00 03.93 09.00 09.93 09.00 09.93 09.00 09.93 09.00 09.93 09.00		03.0101-0031.2 320211 03.6585-0018.3 320114			BRES 3/30 BRL 8/5 (4)	ATE ATE

1) - ABS/marking:EB/not for Delco BKV / - ABS/marcatura:EB/non per Delco BKV / - ABS/marquage:EB/pas pour Delco BKV / - ABS/marcaje:EB/no para Delco BKV

2) + ABS/ registration number: EL / + ABS/ sigla: EL / + ABS/ indice: EL / + ABS/ distintivo: EL

3) - Sport/+ auto.transm./- air condit. / - Sport/+ scatola.auto./- aria condiz. / - Sport/+ transm.auto./- air condit. / - Sport/+ cambio auto./- aire acond.













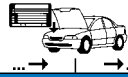































4) - Sport/+ manual transm./- Sport/+ cambio velocidad / - Sport/+ transm. mécanique / - Sport/+ cambio velocidad

5) - Sport/+ auto.transm./+ air condit. / - Sport/+ scatola.auto./+ aria condiz. / - Sport/+ transm.auto./+ air condit. / - Sport/+ cambio auto./+ aire acond.













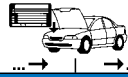









6) + Sport / + Sportivo / + Sport / + Deportivo

7) + cast iron / + ghisa / + fonte grise / + fundición de gris

8) + aluminium / + aluminio / + aluminium / + aluminio

								
OPEL CORSA C / Vauxhall Corsa MK II (00-06)								
	1.0 12V		09.00	09.06	24.3219-1715.3	020122		Rz 19,05 (ALU)
	1.2 16V		09.00	09.06				
	1.3 CDTi		06.03	09.06				
	1.4 16V		09.00	09.06				
	1.6		09.01	09.06				
	1.7 DI 16V		09.00	09.06				
	1.7 DTI 16V		09.00	09.06				
	1.7 CDTi		06.03	09.06	24.3220-1719.3	020448		Rz 20,64
	1.0 12V		09.00	09.06	24.3727-0755.2	580755	1 	L=330, + Zub
	1.2 16V		09.00	09.06	24.3727-0750.2	580750		L=1095, + Zub
	1.6		09.01	09.06	24.3727-0749.2	580749		L=832, + Zub
	1.7 DI 16V		09.00	09.06	24.3727-0787.2	580787	2 	L=217, + Zub
					24.3727-0786.2	580786	2 	L=217, + Zub
	1.3 CDTi		06.03	09.06	24.3727-0755.2	580755	1 	L=330, + Zub
	1.7 CDTi		06.03	09.06	24.3727-0769.2	580769		L=1106
	1.7 DTI 16V		09.00	09.06	24.3727-0749.2	580749		L=832, + Zub
					24.3727-0787.2	580787	2 	L=217, + Zub
					24.3727-0786.2	580786	2 	L=217, + Zub
	1.4 16V		09.00	09.06	24.3727-0755.2	580755	1 	L=330, + Zub
	1.8 16V		09.00	09.06	24.3727-0769.2	580769		L=1106
					24.3727-0749.2	580749	2 	L=832, + Zub
					24.3727-0787.2	580787	2 	L=217, + Zub
					24.3727-0786.2	580786	2 	L=217, + Zub
					24.3727-0762.2	580762		L=1426, + Zub
					24.3727-0766.2	580766		L=1143, + Zub
	1.0 12V		09.00	09.06	03.6043-0964.3	320268	+ M10	BRE 3/30
	1.2 16V		09.00	09.06	03.6043-0974.3	320244	+ M12	BRE 3/30
OPEL CORSA D / Vauxhall Corsa MK III (06-)								
	1.0 i		10.06		24.4122-1709.3	010871	- ESP	THz 22,20 - Behälter
	1.2	51	06.10		24.4122-1705.3	010852	+ ESP	THz 22,20 + Behälter
	1.2	63	06.10					
	1.2 i 16V	59	10.06					
	1.2 LPG		09.09					
	1.3 CDTi	55	10.06					
	1.3 CDTi	66	10.06					
	1.3 CDTi	70	06.10					
	1.4	64	09.09					
	1.4	74	06.10					
	1.4 i 16V	66	10.06					
	1.0 i		10.06		24.3541-1769.5	240601	 + belüftete Scheiben ⁵⁾	D=54, - Halter
	1.2	51	06.10		24.3541-1770.5	240602	 + belüftete Scheiben ⁵⁾	D=54, - Halter
	1.2	63	06.10					
	1.2 i 16V	59	10.06					
	1.2 LPG		09.09					
	1.3 CDTi	55	10.06					
	1.3 CDTi	70	06.10					
	1.4	64	09.09					
	1.4	74	06.10					
	1.4 i 16V	66	10.06					
								+ Bremsscheibe 257mm ⁶⁾
	1.3 CDTi	55	10.06		24.3541-1829.5	240721		D=54, - Halter
	1.3 CDTi	66	10.06		24.3541-1830.5	240722		D=54, - Halter
	1.3 CDTi	70	06.10					
	1.6 Turbo GSI	110	06.07		11.9571-9823.2	220471		D=57, - Halter
					11.9571-9824.2	220472		D=57, - Halter
					24.3571-9823.5	240499		D=57, - Halter
					24.3571-9824.5	240500		D=57, - Halter
					11.0441-5704.2	250034		Dichtungssatz
					11.8171-0008.1	990049		Führungsbolzen
					11.8116-0292.1	390521	2	Haltefeder
	1.6 Turbo OPC		03.07		11.0441-5704.2	250034		Dichtungssatz
					11.8171-0008.1	990049		Führungsbolzen
					11.8116-0292.1	390521	2	Haltefeder
					24.5112-0402.3	331297	2	L=402
	1.0 i		10.06		24.5112-0402.3	331297	2	L=402
	1.2	51	06.10					
	1.2	63	06.10					
	1.2 i 16V	59	10.06					
	1.2 LPG		09.09					
	1.3 CDTi	55	10.06					
	1.3 CDTi	66	10.06					
	1.3 CDTi	70	06.10					
	1.4	64	09.09					
	1.4	74	06.10					
	1.4 i 16V	66	10.06					
	1.7 CDTi	92	10.06					
	1.7 CDTi	96	06.10					
	1.0 i		10.06		24.5112-0142.3	331016	2	+ Scheibenbremse ⁸⁾
	1.2	51	06.10					
	1.2	63	06.10					
	1.2 i 16V	59	10.06					
	1.2 LPG		09.09					
	1.3 CDTi	55	10.06					
	1.3 CDTi	66	10.06					
	1.3 CDTi	70	06.10					
	1.4	64	09.09					
	1.4	74	06.10					
		1.4	74	06.10				

1) extens.only/+ RA-drum br./-ABS / solo prol./+P fra tambu./-ABS / rallong.seul./-tamb.es.AR/+ABS / solam.prolo./+tambores ET/-ABS
2) extens.only/+ RA-drum br./+ABS / solo prol./+P fra tambu./+ABS / rallong.seul./+tamb.es.AR/+ABS / solam.prolo./+tambores ET/+ABS
3) + RA drum brake / + P freno a tamburo / + frein à tambour essieu AR / + ET-tambores de freno
4) + RA disc brake / + P disco freno / + frein à disque essieu AR / + ET-disco de freno
5) + ventilated discs / + dischi ventilati / + disques ventilés / + disco ventilado
6) + brake disc 257mm / + dischi freno 257mm / + disque de frein 257mm / + disco de freno 257mm
7) + brake disc 284mm / + dischi freno 284mm / + disque de frein 284mm / + disco de freno 284mm
8) + disc brake / + disco freno / + disques de frein / + disco de freno

									
OPEL CORSA D / Vauxhall Corsa MK III (06-)									
	1.4 i 16V 1.4 Turbo ecoFLEX 1.6 Turbo GSI 1.6 Turbo OPC 1.7 CDTi 1.7 CDTi	66 88 110 92 96		10.06 06.12 06.07 03.07 10.06 06.10		24.5112-0142.3	331016	2 + Scheibenbremse ¹⁾	L=142
	1.0 i 1.2 1.2 1.2 i 16V 1.2 LPG 1.2 LPG 1.3 CDTi 1.3 CDTi 1.3 CDTi 1.4 1.4 1.4 i 16V	51 63 59 55 66 70 64 74 66		10.06 06.10 06.10 10.06 09.09 09.09 10.06 10.06 06.10 09.09 06.10 10.06		24.3219-1755.3	020508		Rz 19,05
	1.0 i 1.2 1.2 1.2 i 16V 1.2 LPG	51 63 59	76064268 76064268 76064268 76064268	10.06 06.10 06.10 10.06 09.09		24.3727-0781.2	580781	1 ↘ + 3 türig ²⁾	L=1477/1462, + Zub
	1.0 i 1.2 1.2 1.2 i 16V 1.2 LPG	51 63 59		10.06 06.10 06.10 10.06 09.09		24.3727-0782.2	580782	1 ↘ + 5 türig ³⁾	L=1477/1492, + Zub
	1.3 CDTi 1.3 CDTi 1.3 CDTi 1.4 1.4 1.4 i 16V	55 66 70 64 74 66		10.06 10.06 06.10 09.09 06.10 10.06		24.3727-0782.2	580782	1 ↘	L=1477/1492, + Zub
OPEL CORSA E / Vauxhall Corsa Mk IV (14-)									
	1.0 1.0 1.2 1.3 CDTi 1.3 CDTi 1.4 1.4 1.4 LPG 1.4 Turbo 1.4 Turbo	66 85 51 55 70 55 66 66 74 110		11.14 11.14 11.14 11.14 11.14 11.14 11.14 03.15 11.14 03.15		11.8116-0264.1	390594	2 + Bremsscheibendurchm. 257 mm ⁴⁾	Haltefeder ATE
	1.0 1.0 1.2 1.3 CDTi 1.3 CDTi 1.4 1.4 1.4 LPG 1.4 Turbo 1.4 Turbo	66 85 51 55 70 55 66 66 74 110		11.14 11.14 11.14 11.14 11.14 11.14 11.14 03.15 11.14 03.15		11.9571-9823.2 24.3571-9823.5 11.9571-9824.2 24.3571-9824.5 11.0441-5704.2 11.8171-0008.1 11.0101-5407.2 11.8116-0292.1	220471 240499 220472 240500 250034 990049 260011 390521	2    	D=57, - Halter D=57, - Halter D=57, - Halter Dichtungssatz Führungsbolzen Hülzensatz Haltefeder ATE ATE ATE ATE ATE ATE
	1.0 1.0 1.2 1.3 CDTi 1.3 CDTi 1.4 1.4 1.4 LPG 1.4 Turbo 1.4 Turbo	66 85 51 55 70 55 66 66 74 110		11.14 11.14 11.14 11.14 11.14 11.14 11.14 03.15 11.14 03.15		24.3219-1755.3	020508	+ 9" Bremse ⁶⁾	Rz 19,05
OPEL FRONTERA A (92-98)									
	2.0 2.2 16V 2.3 TD 2.4 2.5 TDS 2.8 TD		PV561270 PV561270 PV561398 PV560157 PV560157 PV560157	03.92 03.95 03.92 03.92 09.96 03.95		03.2120-1981.3	010105		THz 20,64 DEL
	2.0 2.2 16V 2.3 TD 2.4 2.5 TDS 2.8 TD		PV561117 PV561117 PV563935 PV567152 PV567152 PV567152	03.92 03.95 03.92 03.92 09.96 03.95		03.2120-1981.3	010105		THz 20,64 DEL
	2.0 2.2 16V 2.3 TD 2.4 2.5 TDS 2.8 TD	SV720103 SV720103 SV720103 SV720103 SV720103 SV720103		10.98 10.98 10.98 10.98 10.98 10.98		24.3601-1717.5 24.3601-1718.5	240391 240392	 	D=60, - Halter D=60, - Halter AKE AKE

¹⁾ + disc brake / + disco freno / + disques de frein / + disco de freno

























²⁾ + 3 door / + 3 porte / + 3 portes / + 3 puertas

³⁾ + 5 door / + 5 porte / + 5 portes / + 5 puertas

⁴⁾ + brake disc diameter 257mm / + diametro dischi freno 257mm / + diamètre disques frein 257mm / + diámetro disco freno 257mm

⁵⁾ + brake disc diameter 308mm / + diametro dischi freno 308mm / + diamètre disques frein 308mm / + diámetro disco freno 308mm

⁶⁾ + 9" brake / + servofreno da 9" / + frein de 9" / + freno de 9"

										
OPEL FRONTERA A (92-98)										
	2.0 2.2 16V 2.3 TD 2.4 2.5 TDS 2.8 TD	SV720103 SV720103 SV720103 SV720103 SV720103 SV720103		10.98 10.98 10.98 10.98 10.98 10.98		24.3411-1701.5 24.3411-1702.5	240361 240362	 	D=41, - Halter D=41, - Halter	AKE AKE
	2.0 2.2 16V 2.3 TD 2.4 2.5 TDS 2.8 TD		SV720102 SV720102 SV720102 SV720102 SV720102 SV720102	03.92 03.95 03.92 03.92 09.96 03.95		24.3225-1702.3	020425		Rz 25,40	
OPEL FRONTERA B (98-04)										
	2.2 DTI 2.2 i 3.2 i			10.98 02.04 10.98 02.04 10.98 02.04		24.3601-1717.5 24.3601-1718.5	240391 240392	 	D=60, - Halter D=60, - Halter	AKE AKE
	2.2 DTI 2.2 i 3.2 i			10.98 02.04 10.98 02.04 10.98 02.04		24.5277-0420.3	330944	2	L=420	
	2.2 DTI 2.2 i 3.2 i			10.98 02.04 10.98 02.04 10.98 02.04		24.3411-1701.5 24.3411-1702.5	240361 240362	 	D=41, - Halter D=41, - Halter	AKE AKE
	2.2 DTI 2.2 i 3.2 i			10.98 02.04 10.98 02.04 10.98 02.04		24.5278-0335.3 24.5290-0180.3	330945 331028	1 2	am Bremssattel ¹⁾	L=335 L=180
OPEL INSIGNIA / Vauxhall Insignia (08-)										
	1.4 Turbo ecoFLEX 1.4 Turbo LPG ecoFLEX 1.6 1.6 CDTi 1.6 CDTi 1.6 SIDI 1.6 Turbo 1.8 2.0 BiTurbo CDTi 2.0 BiTurbo CDTi 4x4 2.0 CDTi 2.0 CDTi 2.0 CDTi 2.0 CDTi 2.0 CDTi 2.0 CDTi 2.0 CDTi 2.0 CDTi 4x4 2.0 CDTi 4x4 2.0 Turbo 2.0 Turbo 2.0 Turbo 4x4 2.0 Turbo 4x4	◀103 ◀103 ◀85 ◀88 ◀100 ◀125 ◀132 ◀103 ◀ ◀ ◀81 ◀88 ◀96 ◀103 ◀118 ◀120 ◀118 ◀120 ◀162 ◀184 ◀162 ◀184		06.11 07.12 07.08 07.15 07.15 03.13 10.08 07.08 07.08 07.08 03.13 07.08 07.13 07.08 07.13 06.10 07.13 07.13 07.08 04.14 07.08 09.11		03.7858-0732.4	300272		9/8" Tandem	ATE
	1.4 Turbo ecoFLEX 1.4 Turbo LPG ecoFLEX 1.6 1.6 CDTi 1.6 CDTi 1.6 SIDI 1.6 Turbo 1.8 2.0 BiTurbo CDTi 2.0 BiTurbo CDTi 4x4 2.0 CDTi 2.0 CDTi 2.0 CDTi 2.0 CDTi 2.0 CDTi 2.0 CDTi 2.0 CDTi 2.0 CDTi 4x4 2.0 CDTi 4x4 2.0 Turbo 2.0 Turbo 2.0 Turbo 4x4 2.0 Turbo 4x4 2.8 V6 T 4x4 OPC 2.8 V6 Turbo 4x4	◀103 ◀103 ◀85 ◀88 ◀100 ◀125 ◀132 ◀103 ◀ ◀ ◀81 ◀88 ◀96 ◀103 ◀118 ◀120 ◀118 ◀120 ◀162 ◀184 ◀162 ◀184 ◀239 ◀191		06.11 07.12 07.08 07.15 07.15 03.13 10.08 07.08 07.08 07.08 03.13 07.08 07.13 07.08 07.13 06.10 07.13 07.13 07.08 04.14 07.08 09.11 07.09 07.08		03.2125-0421.3	010934		Thz 25,40	ATE
	1.4 Turbo ecoFLEX 1.4 Turbo LPG ecoFLEX 1.6 1.6 CDTi 1.6 CDTi 1.6 SIDI 1.6 Turbo 1.8 2.0 BiTurbo CDTi 2.0 BiTurbo CDTi 4x4 2.0 CDTi 2.0 CDTi	103 103 85 88 100 125 132 103 81 88		06.11 07.12 07.08 07.15 07.15 03.13 10.08 07.08 07.08 07.08 03.13		24.5176-0494.3	331447	2	+ 16"/17" Rad ²⁾	L=494

¹⁾ on the brake caliper / sulla pinza freno / sur l'étrier de frein / a la pinza de freno

²⁾ + 16"/17" wheel / + ruota 16"/17" / + roue 16"/17" / + ruedas 16"/17"

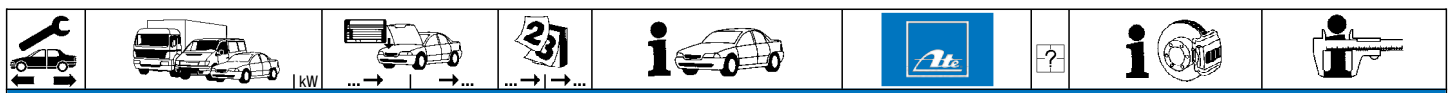

OPEL INSIGNIA / Vauxhall Insignia (08-)

	2.0 CDTi	96		07.08	24.5176-0494.3	331447	2	+ 16"/17" Rad ¹⁾	L=494
	2.0 CDTi	103		07.13					
	2.0 CDTi	118		07.08					
	2.0 CDTi	120		07.13					
	2.0 CDTi 4x4	118		06.10					
	2.0 CDTi 4x4	120		07.13					
	2.0 Turbo	162		07.08					
	2.0 Turbo	184		04.14					
	2.0 Turbo 4x4	162		07.08					
	2.0 Turbo 4x4	184		09.11					
	2.8 V6 Turbo 4x4	191		07.08					
	1.4 Turbo ecoFLEX	103		06.11	24.5176-0384.3	331373	2		L=384
	1.4 Turbo LPG ecoFLEX	103		07.12					
	1.6	85		07.08					
	1.6 CDTi	88		07.15					
	1.6 CDTi	100		07.15					
	1.6 SIDI	125		03.13					
	1.6 Turbo	132		10.08					
	1.8	103		07.08					
	2.0 BiTurbo CDTi			07.08					
	2.0 BiTurbo CDTi 4x4			07.08					
	2.0 CDTi	81		07.08					
	2.0 CDTi	88		03.13					
	2.0 CDTi	96		07.08					
	2.0 CDTi	103		07.13					
	2.0 CDTi	118		07.08					
	2.0 CDTi	120		07.13					
	2.0 CDTi 4x4	118		06.10					
	2.0 CDTi 4x4	120		07.13					
	2.0 Turbo	162		07.08					
	2.0 Turbo	184		04.14					
	2.0 Turbo 4x4	162		07.08					
	2.0 Turbo 4x4	184		09.11					
	2.8 V6 T 4x4 OPC	239		07.09					
	2.8 V6 Turbo 4x4	191		07.08					
	1.4 Turbo ecoFLEX	103	B1182367	06.11	24.3727-0791.2	580791	2	↓	L=1937, + Zub
	1.6	85	B1182367	07.08					
	1.6 Turbo	132	B1182367	10.08					
	1.8	103	B1182367	07.08					
	2.0 BiTurbo CDTi		B1182367	07.08					
	2.0 CDTi	81	B1182367	07.08					
	2.0 CDTi	96	B1182367	07.08					
	2.0 CDTi	118	B1182367	07.08					
	2.0 Turbo	162	B1182367	07.08					
	2.0 BiTurbo CDTi 4x4		A1006683	07.08	24.3727-0789.2	580789	2	↓	L=2005, + Zub
	2.0 CDTi 4x4	118	A1006683	06.10					
	2.0 Turbo 4x4	162	A1006683	07.08					
	2.0 Turbo 4x4	184	A1006683	09.11					
	2.8 V6 T 4x4 OPC	239	A1006683	07.09					
	2.8 V6 Turbo 4x4	191	A1006683	07.08					















OPEL INSIGNIA Country Tourer (13-)

	2.0 CDTi 4x4	◀120		09.13	03.7858-0732.4	300272			9/8" Tandem	ATE
	2.0 SIDI Turbo 4x4	◀184		09.13						
	2.0 SIDI Turbo 4x4	◀184		09.13						
	2.0 CDTi 4x4	◀120		09.13	03.2125-0421.3	010934			Thz 25,40	ATE
	2.0 SIDI Turbo 4x4	◀184		09.13						
	2.0 SIDI Turbo 4x4	◀184		09.13						
	2.0 CDTi 4x4	120	D1999999	09.13	24.5176-0494.3	331447	2	+ 16"/17" Rad ¹⁾	L=494	
	2.0 SIDI Turbo 4x4	184	D1999999	09.13						
	2.0 SIDI Turbo 4x4	184	D1999999	09.13						
	2.0 CDTi 4x4	120	E1000001		24.5176-0494.3	331447	2	+ 16"/17" Rad ¹⁾	L=494	
	2.0 SIDI Turbo 4x4	184	E1000001							
	2.0 SIDI Turbo 4x4	184	E1000001							
	2.0 CDTi 4x4	120		09.13	24.5176-0384.3	331373	2		L=384	
	2.0 SIDI Turbo 4x4	184		09.13						
	2.0 SIDI Turbo 4x4	184		09.13						

OPEL INSIGNIA Sports Tourer / Vauxh. Insignia SportsTourer (08-)



























	1.4 Turbo ecoFLEX	◀103		06.11	03.7858-0732.4	300272			9/8" Tandem	ATE
	1.4 Turbo LPG ecoFLEX	◀103		07.12						
	1.6	◀85		07.08						
	1.6 CDTi	◀88		07.15						
	1.6 CDTi	◀100		07.15						
	1.6 SIDI	◀125		03.13						
	1.6 Turbo	◀132		10.08						
	1.8	◀103		07.08						
	2.0 BiTurbo CDTi	◀		07.08						
	2.0 BiTurbo CDTi 4x4	◀		07.08						
	2.0 CDTi	◀81		07.08						
	2.0 CDTi	◀88		03.13						
	2.0 CDTi	◀96		07.08						
	2.0 CDTi	◀103		07.13						
	2.0 CDTi	◀118		07.08						
	2.0 CDTi	◀120		07.13						
	2.0 CDTi 4x4	◀118		06.10						





















¹⁾ + 16"/17" wheel / + ruota 16"/17" / + roue 16"/17" / + ruedas 16"/17"

										
OPEL INSIGNIA Sports Tourer / Vauxh. Insignia SportsTourer (08-)										
	2.0 Turbo 4x4 2.8 V6 T 4x4 OPC 2.8 V6 Turbo 4x4	184 239 191	A1006683 A1006683 A1006683	09.11 07.09 07.08	24.3727-0789.2	580789	2 ↓	L=2005, + Zub		
OPEL KARL / Vauxhall Viva (15-)										
	1.0 1.0 LPG	55 54		01.15 02.15	24.3225-1704.3	020541		Rz 25,40		
OPEL MERIVA A / Vauxhall Meriva Mk I (03-10)										
	1.3 CDTI 1.3 CDTI 1.4 16V 1.4 LPG 1.6 1.6 1.6 16V 1.6 Turbo OPC 1.7 CDTI 1.7 CDTI 1.7 DTI 1.7 DTI 16V 1.8 16V	51 55 66 66 64 77 74 132 74 92 48 55 92	44999999 44999999 44999999 44999999 44999999 44999999 44999999 44999999 44999999 44999999 44999999 44999999 44999999	04.05 09.03 07.04 07.04 05.03 01.06 05.03 09.05 09.03 09.06 05.03 09.02 09.02	24.2123-1764.3	010824	- ESP	THz 23,81 TRW		
	1.4 16V 1.4 LPG 1.6 1.3 CDTI 1.3 CDTI 1.4 16V 1.4 LPG 1.6 1.6 16V 1.7 CDTI 1.7 CDTI 1.7 DTI 1.7 DTI 16V 1.8 16V	66 66 64 51 55 66 66 77 74 74 92 48 55 92	74237192 74237192 74237192 74237192 74237192 74237192 74237192 74237192 74237192 74237192 74237192 74237192 74237192 74237192	07.04 07.04 05.03 04.05 09.03 07.04 07.04 01.06 05.03 09.03 09.06 05.03 05.03 05.03	05.10 + 4-Loch Felge ¹⁾ 05.10 + 4-Loch Felge ¹⁾ 05.10 05.10 05.10 + 5-Loch Felge ²⁾ 05.10 + 5-Loch Felge ²⁾ 05.10 05.10 05.10 05.10 05.10 05.10 05.10 05.10	24.3541-1795.7 24.3541-1796.7 11.9571-9823.2 11.9571-9824.2 24.3571-9823.5 24.3571-9824.5 11.0441-5704.2 11.0101-5407.2 11.8171-0008.1 11.8116-0292.1	220551 220552 220471 220472 240499 240500 250034 260011 990049 390521	2 2 2 2 2 2 2 2 2 2 2 2 2 2	D=54, - Halter D=54, - Halter D=57, - Halter D=57, - Halter D=57, - Halter D=57, - Halter Dichtungssatz Hülensatz Führungsbolzen Haltefeder	TRW TRW ATE ATE ATE ATE ATE ATE ATE ATE
	1.3 CDTI 1.3 CDTI 1.4 16V 1.4 LPG 1.6 1.6 1.6 16V 1.7 CDTI 1.7 CDTI 1.7 DTI 1.7 DTI 16V 1.8 16V	51 55 66 66 64 77 74 74 92 48 55 92		04.05 09.03 07.04 07.04 05.03 01.06 05.03 09.03 09.06 05.03 05.03 05.03	05.10 05.10 05.10 05.10 05.10 05.10 05.10 05.10 05.10 05.10 05.10 05.10	24.5256-0318.3	331426	2	L=329	
	1.6 1.4 16V 1.4 LPG 1.6 1.6 16V 1.7 CDTI 1.7 DTI 1.7 DTI 16V 1.8 16V 1.3 CDTI 1.3 CDTI 1.4 16V 1.4 LPG 1.6 1.6 16V 1.7 CDTI 1.7 DTI 1.7 DTI 16V 1.8 16V	64 66 66 64 74 74 48 55 92 51 55 66 66 77 74 48 48 55 92	34999999 44000001 34999999 34999999 34999999 34999999 34999999 34999999 34999999 44000001 44000001 44000001 44000001 44000001 44000001 44000001 44000001 44000001 44000001	05.03 07.04 07.04 05.03 05.03 09.03 05.03 05.03 05.03 04.05 09.03 07.04 07.04 01.06 05.10 09.06 05.10 05.10 05.10	05.10 + 4-Loch Felge ¹⁾ 05.10 + 4-Loch Felge ¹⁾ 05.10 05.10 05.10 05.10 05.10 05.10 05.10 05.10 05.10 + 5-Loch Felge ²⁾ 05.10 + 5-Loch Felge ²⁾ 05.10 05.10 05.10 05.10 05.10 05.10 05.10 05.10	24.3367-1713.7 24.3367-1714.7 24.3367-1707.7 24.3367-1708.7 24.3384-1753.7 24.3384-1754.7 24.3387-1701.7 24.3387-1702.7	220779 220780 220669 220670 220633 220634 220673 220674	2 2 2 2 2 2 2 2	D=36, - Halter D=36, - Halter D=36, - Halter D=36, - Halter D=38, - Halter D=38, - Halter D=38, - Halter D=38, - Halter	TRW TRW TRW TRW TRW TRW TRW TRW

































¹⁾ + 4 bore wheel rim / + cerchione a 4 fori / + jante à 4 trous / + Llantas de 4 taladros

²⁾ + 5 bore wheel rim / + cerchione a 5 fori / + jante à 5 trous / + Llantas de 5 taladros

									
OPEL MERIVA A / Vauxhall Meriva Mk I (03-10)									
	1.3 CDTI	51		04.05	05.10	24.5157-0218.3	331095		L=219/185, + Rohrleitung
	1.3 CDTI	55		09.03	05.10	24.5157-0219.3	331096		L=219/185, + Rohrleitung
	1.4 16V	66		07.04	05.10				
	1.4 LPG	66		07.04	05.10				
	1.6	64		05.03	05.10				
	1.6	77		01.06	05.10				
	1.6 16V	74		05.03	05.10				
	1.6 Turbo OPC	132		09.05	05.10				
	1.7 CDTI	74		09.03	05.10				
	1.7 CDTI	92		09.06	05.10				
	1.7 DTI	48		05.03	05.10				
	1.7 DTI 16V	55		05.03	05.10				
	1.8 16V	92		05.03	05.10				
	1.3 CDTI	51	34999999	04.05		24.3727-0780.2	580780	1 	L=1610/1610, + Zub
	1.3 CDTI	55	34999999	09.03					
	1.4 16V	66	34999999	07.04					
	1.4 LPG	66	34999999	07.04					
	1.6	64	34999999	05.03					
	1.6	77	34999999	01.06					
	1.6 16V	74	34999999	05.03					
	1.6 Turbo OPC	132	34999999	09.05					
	1.7 CDTI	74	34999999	09.03					
	1.7 CDTI	92	34999999	09.06					
	1.7 DTI	48	34999999	05.03					
	1.7 DTI 16V	55	34999999	05.03					
	1.8 16V	92	34999999	05.03					
	1.3 CDTI	51	44000001	05.03		24.3727-0779.2	580779	1 	L=1615/1615, + Zub
	1.3 CDTI	55	44000001	05.10					
	1.4 16V	66	44000001	05.10					
	1.4 LPG	66	44000001	05.10					
	1.6	64	44000001	05.10					
	1.6	77	44000001	05.10					
	1.6 16V	74	44000001	05.10					
	1.6 Turbo OPC	132	44000001	05.10					
	1.7 CDTI	74	44000001	05.10					
	1.7 CDTI	92	44000001	05.10					
	1.7 DTI	48	44000001	05.10					
	1.7 DTI 16V	55	44000001	05.10					
	1.8 16V	92	44000001	05.10					
	1.3 CDTI	51		04.05	05.10	03.6583-0102.3	320280	- ABS	BRL 8/3 (4) ATE
	1.3 CDTI	55		09.03	05.10				
	1.4 16V	66		07.04	05.10				
	1.4 LPG	66		07.04	05.10				
	1.6	64		05.03	05.10				
	1.6	77		01.06	05.10				
	1.6 16V	74		05.03	05.10				
	1.7 CDTI	74		09.03	05.10				
	1.7 CDTI	92		09.06	05.10				
	1.7 DTI	48		05.03	05.03				
	1.7 DTI 16V	55		05.03	05.10				
	1.8 16V	92		05.03	05.10				
OPEL MERIVA B / Vauxhall Meriva Mk II (10-)									
	1.3 CDTI	55		06.10		24.4125-1705.3	010972	- ESP	THz 25,40 TRW
	1.3 CDTI	70		06.10		24.4125-1706.3	010973	+ ESP	THz 25,40 TRW
	1.4	74		06.10					
	1.4	103		06.10					
	1.4 ecoFLEX	88		06.10					
	1.7 CDTi	74		06.10					
	1.7 CDTi	81		06.10					
	1.7 CDTi	96		06.10					
	1.6 CDTi	70		03.14		24.4125-1705.3	010972	- ESP	THz 25,40 TRW
	1.6 CDTi	81		03.14					
	1.6 CDTi	100		08.13					
	1.3 CDTI	55		06.10		11.9571-9823.2	220471		D=57, - Halter ATE
	1.3 CDTI	70		06.10		11.9571-9824.2	220472		D=57, - Halter ATE
	1.4	74		06.10		24.3571-9823.5	240499		D=57, - Halter ATE
	1.4 ecoFLEX	88		06.10		24.3571-9824.5	240500		D=57, - Halter ATE
	1.7 CDTi	74		06.10		11.0441-5704.2	250034		Dichtungssatz ATE
	1.7 CDTi	81		06.10		11.0101-5407.2	260011		Hülsensatz ATE
	1.7 CDTi	96		06.10		11.8171-0008.1	990049		Führungsbolzen ATE
						11.8116-0292.1	390521	2	Haltefeder ATE
	1.4	103		06.10		11.9571-9823.2	220471		D=57, - Halter ATE
	1.6 CDTi	70		03.14		11.9571-9824.2	220472		D=57, - Halter ATE
	1.6 CDTi	81		03.14		24.3571-9823.5	240499		D=57, - Halter ATE
	1.6 CDTi	100		08.13		24.3571-9824.5	240500		D=57, - Halter ATE
	1.7 CDTi	74		06.10		11.8170-0758.1	260120		Halter ATE
	1.7 CDTi	81		06.10		11.0441-5704.2	250034		Dichtungssatz ATE
	1.7 CDTi	81		06.10		11.0101-5407.2	260011		Hülsensatz ATE
	1.7 CDTi	96		06.10		11.8171-0008.1	990049		Führungsbolzen ATE
						11.8116-0292.1	390521	2	Haltefeder ATE
	1.3 CDTI	55		06.10		24.5241-0429.3	331381	2	L=429
	1.3 CDTI	70		06.10					
	1.4	74		06.10					
	1.4	103		06.10					
	1.4 ecoFLEX	88		06.10					
	1.6 CDTi	70		03.14					

        											
OPEL MERIVA B / Vauxhall Meriva Mk II (10-)											
	1.6 CDTi	81		03.14		24.5241-0429.3	331381	2			L=429
	1.6 CDTi	100		08.13							
	1.7 CDTi	74		06.10							
	1.7 CDTi	81		06.10							
	1.7 CDTi	96		06.10							
	1.3 CDTi	55		06.10		24.3384-1775.5	240711	<input type="checkbox"/>			D=38, - Halter TRW
	1.3 CDTi	70		06.10		24.3384-1776.5	240712	<input type="checkbox"/>			D=38, - Halter TRW
	1.4	74		06.10							
	1.4	103		06.10							
	1.4 ecoFLEX	88		06.10							
	1.6 CDTi	70		03.14							
	1.6 CDTi	81		03.14							
	1.6 CDTi	100		08.13							
	1.7 CDTi	74		06.10							
	1.7 CDTi	81		06.10							
1.7 CDTi	96		06.10								
	1.3 CDTi	55		06.10		24.5157-0219.3	331096	<input type="checkbox"/>			L=219/185, + Rohrleitung
	1.3 CDTi	70		06.10		24.5157-0218.3	331095	<input type="checkbox"/>			L=219/185, + Rohrleitung
	1.4	74		06.10							
	1.4	103		06.10							
	1.4 ecoFLEX	88		06.10							
	1.6 CDTi	70		03.14							
	1.6 CDTi	81		03.14							
	1.6 CDTi	100		08.13							
	1.7 CDTi	74		06.10							
	1.7 CDTi	81		06.10							
1.7 CDTi	96		06.10								
OPEL MOKKA / Vauxhall Mokka (12-)											
	1.4	103		04.13		11.9601-2601.2	220913	<input type="checkbox"/>			D=60, - Halter ATE
	1.4 4x4	103		06.12		11.9601-2602.2	220914	<input type="checkbox"/>			D=60, - Halter ATE
	1.4 4x4	112		06.16		11.0103-0002.2	250157	<input type="checkbox"/>			Bremssattel-Zubehör ATE
	1.6	85		06.12							
	1.6 CDTi	81		06.15							
	1.6 CDTi	100		01.15							
	1.6 CDTi 4x4	100		01.15							
	1.7 CDTi	96		06.12							
	1.7 CDTi 4x4	96		06.12							
	1.8	103		01.13							
1.8 4x4	103		01.13								
	1.4	103		04.13		11.9382-7003.2	220891	<input type="checkbox"/>			D=38, - Halter ATE
	1.4 4x4	103		06.12		11.9382-7004.2	220892	<input type="checkbox"/>			D=38, - Halter ATE
	1.4 4x4	112		06.16		11.0103-0001.2	250156	<input type="checkbox"/>			Bremssattel-Zubehör ATE
	1.6	85		06.12							
	1.6 CDTi	81		06.15							
	1.6 CDTi	100		01.15							
	1.6 CDTi 4x4	100		01.15							
	1.7 CDTi	96		06.12							
	1.7 CDTi 4x4	96		06.12							
	1.8	103		01.13							
1.8 4x4	103		01.13								
OPEL MONTEREY (92-98)											
	3.1 TD			09.91	07.98	24.3601-1717.5	240391	<input type="checkbox"/>			D=60, - Halter AKE
	3.2			05.92	07.98	24.3601-1718.5	240392	<input type="checkbox"/>			D=60, - Halter AKE
	3.1 TD			09.91	07.98	24.3411-1701.5	240361	<input type="checkbox"/>			D=41, - Halter AKE
	3.2			05.92	07.98	24.3411-1702.5	240362	<input type="checkbox"/>			D=41, - Halter AKE
OPEL MONTEREY (98-99)											
	3.0 DTI			07.98	08.99	24.3601-1717.5	240391	<input type="checkbox"/>			D=60, - Halter AKE
	3.5 V6			07.98	08.99	24.3601-1718.5	240392	<input type="checkbox"/>			D=60, - Halter AKE
	3.0 DTI			07.98	08.99	24.3411-1701.5	240361	<input type="checkbox"/>			D=41, - Halter AKE
	3.5 V6			07.98	08.99	24.3411-1702.5	240362	<input type="checkbox"/>			D=41, - Halter AKE
OPEL MOVANO A (98-10)											
	1.9 DTI			09.00	01.10	24.2025-1708.3	010692				Thz 25,40
	2.2 DTI 16V			09.00	01.10						
	2.5 D	66		07.98	09.00						
	2.5 DTI	59		10.01	01.10						
	2.8 DTI			07.98	10.01						
	3.0 DTI	100		10.03	01.10						
	1.9 DTI			09.00	08.03	24.2025-1706.3	010676				Thz 25,40
	2.2 DTI 16V	66		09.00	08.03						
	2.5 D	59		07.98	09.00						
	2.5 DTI			10.01	08.03						
	2.8 DTI			07.98	10.01						
	3.0 DTI	100		10.03	08.06						
	1.9 DTI			09.03	08.06	24.2123-1759.3	010768				Thz 23,81 BOS
	2.2 DTI 16V	66		09.03	08.06						
	2.5 DTI			09.03	08.06						
	3.0 DTI	100		10.03	08.06						

¹⁾ from production date 08.2012 / da data die produzone 08.2012 / à partir de la date de production 08.2012 / desde fecha de producción 08.2012

									
OPEL MOVANO A (98-10)									
	1.9 DTI			09.00	08.03	24.5134-0518.3	330705	2  + HA-Trommelbremse ¹⁾	L=518
	2.2 DTI 16V	66		09.00	08.03	24.5134-0562.3	330706	2  + HA-Trommelbremse ¹⁾	L=568
	2.5 D	59		07.98	09.00				
	2.5 DTI			10.01	08.03				
	2.8 DTI			07.98	10.01				
	1.9 DTI			09.00	08.03	24.5134-0457.3	330752	2  + HA-Scheibenbremse ²⁾	L=457
2.2 DTI 16V	66		09.00	08.03	24.5134-0468.3	330704	2  + HA-Scheibenbremse ²⁾	L=468	
2.5 D	59		07.98	09.00					
2.5 DTI			10.01	08.03					
2.8 DTI			07.98	10.01					
	1.9 DTI			09.03	08.06	24.5111-0510.3	330819	2	L=510
	2.2 DTI 16V	66		09.03	08.06				
	2.5 DTI			09.03	08.06				
	3.0 DTI	100		10.03	08.06				
	1.9 DTI			09.00	01.10	24.3424-1701.5	240561		D=42, - Halter
	2.2 DTI 16V	66		09.00	01.10	24.3424-1702.5	240562		D=42, - Halter
	2.5 CDTI	74		09.06	01.10				
	2.5 CDTI	88		09.06	01.10				
	2.5 CDTI	107		09.06	01.10				
	2.5 D	59		07.98	09.00				
	2.5 DTI			10.01	01.10				
	2.8 DTI			07.98	10.01				
	3.0 DTI	100		10.03	01.10				
	2.5 D	59		07.98	09.00	24.5111-0326.3	330766	2 am Bremsattel ³⁾	L=326
	2.8 DTI			07.98	10.01				
	1.9 DTI			09.00	08.03	24.5111-0326.3	330766	2 am Bremsattel ³⁾	L=326
	2.2 DTI 16V	66		09.00	08.03				
	2.5 DTI			10.01	08.03				
	1.9 DTI			09.03	01.10	24.5258-0450.3	330824		L=450
	2.2 DTI 16V	66		09.03	01.10	24.5251-0465.3	330822		L=465
	2.5 CDTI	74		09.06	01.10				
	2.5 CDTI	88		09.06	01.10				
	2.5 CDTI	107		09.06	01.10				
	2.5 DTI			09.03	01.10				
	3.0 DTI	100		10.03	01.10				
	1.9 DTI			09.00	01.10	24.3223-1707.3	020435		Rz 23,81
	2.2 DTI 16V	66		09.00	01.10	24.3223-1708.3	020436		Rz 23,81
	2.5 D	59		07.98	09.00				
	2.5 DTI			10.01	01.10				
	2.8 DTI			07.98	10.01				
	1.9 DTI			09.00	01.10	24.3727-0762.2	580762	1 	L=1175
	2.2 DTI 16V	66		09.00	01.10	24.3727-1072.2	581072	2 	L=1420
	2.5 CDTI	74		09.06	01.10	24.3727-1000.2	581000	2 	L=1737
	2.5 CDTI	88		09.06	01.10				
	2.5 CDTI	107		09.06	01.10				
	2.5 D	59		07.98	09.00				
	2.5 DTI			10.01	01.10				
2.8 DTI			07.98	10.01					
3.0 DTI	100		10.03	01.10					
	1.9 DTI			09.00	01.10	24.2415-1710.3	030124		Gz 15,87
	2.2 DTI 16V	66		09.00	01.10				
	2.5 D	59		07.98	09.00				
	2.5 DTI			10.01	01.10				
	2.8 DTI			07.98	10.01				
3.0 DTI	100		10.03	01.10					
OPEL OMEGA B / Vauxhall Omega (94-03)									
	2.0		V1999999	03.94		24.2123-1740.3	010662		Thz 23,81
	2.0 16V		V1999999	03.94					
	2.0	W1000001		09.99		24.2125-1724.3	010690	- ESP	Thz 25,40
	2.0 16V	W1000001		09.99		24.2125-1740.3	010971	+ ESP	Thz 25,40
	2.0 DTI 16V			09.97	08.00				
	2.2 16V			10.99	08.03				
	2.2 DTI 16V			09.00	08.03				
	2.5 DTI			09.01	08.03				
	2.5 TD	W1000001			08.03				
	2.5 V6	W1000001		09.00	08.03			- Sonderfahrzeuge ⁵⁾	
	2.6 V6			09.00	08.03			- Sonderfahrzeuge ⁵⁾	
3.0 V6	W1000001			01.01			- Sonderfahrzeuge ⁵⁾		
3.2 V6			02.01	08.03			- Sonderfahrzeuge ⁵⁾		
	2.0		V1999999	03.94		11.0101-5407.2	260011		Hülsensatz
	2.0 16V		V1999999	03.94		11.8171-0008.1	990049		Führungsbolzen
						11.8116-0292.1	390521	2	Haltefeder
	2.0	W1000001		09.99		24.3571-1705.5	240069		D=57, - Halter
	2.0 16V	W1000001		09.99		24.3571-1706.5	240070		D=57, - Halter
	2.0 DTI 16V			09.97	08.00	24.0101-3401.2	260043		Bremsattel-Zubehör
	2.2 16V			10.99	08.03				
	2.2 DTI 16V			09.00	08.03				
	2.5 DTI			09.01	08.03				
	2.5 TD			04.94	08.03				
	2.5 V6			03.94	09.00				
2.6 V6			09.00	08.03					
3.0 V6			04.94	01.01					
3.2 V6			02.01	08.03					

¹⁾ + RA drum brake / + P freno a tamburo / + frein à tambour essieu AR / + ET-tambores de freno

²⁾ + RA disc brake / + P disco freno / + frein à disque essieu AR / + ET-disco de freno

³⁾ on the brake caliper / sulla pinza freno / sur l'étrier de frein / a la pinza de freno

⁴⁾ - Police / - Polizia / - voiture de police / - Police

⁵⁾ - special vehicles / - veicoli speciali / - véhicules spéciaux / - vehículo especial

⁶⁾ - special vehicles / - Police / - veicoli speciali / - Polizia / - véhicules spéciaux / - Police / - vehículo especial / - Police



OPEL OMEGA B / Vauxhall Omega (94-03)

	2.0 2.0 16V 2.0 DTI 16V 2.2 16V 2.2 DTI 16V 2.5 DTI 2.5 TD 2.5 V6 2.6 V6 3.0 V6 3.2 V6			03.94 09.99 03.94 09.99 09.97 08.00 10.99 08.03 09.00 08.03 09.01 08.03 04.94 08.03 03.94 09.00 09.00 08.03 04.94 01.01 02.01 08.03		83.7216-0404.3	330374	2		L=400	
	2.0 2.0 16V 2.0 DTI 16V 2.2 16V 2.2 DTI 16V 2.5 DTI 2.5 TD 2.5 V6 2.6 V6 3.0 V6 3.2 V6			03.94 09.99 03.94 09.99 09.97 08.00 10.99 08.03 09.00 08.03 09.01 08.03 04.94 08.03 03.94 09.00 09.00 08.03 04.94 01.01 02.01 08.03		13.2401-0039.2 13.2401-0040.2 24.9240-0039.5 24.9240-0040.5 13.0441-4022.2 13.2421-0043.2 13.2421-0044.2 13.0441-4216.2	210153 210154 230055 230056 250149 210193 210194 250093		<input type="checkbox"/> - belüftete Scheiben ¹⁾ <input type="checkbox"/> - belüftete Scheiben ¹⁾ <input type="checkbox"/> - belüftete Scheiben ¹⁾ <input type="checkbox"/> - belüftete Scheiben ¹⁾ <input type="checkbox"/> - belüftete Scheiben ¹⁾ <input type="checkbox"/> + belüftete Scheiben ²⁾ <input type="checkbox"/> + belüftete Scheiben ²⁾ <input type="checkbox"/> + belüftete Scheiben ²⁾	D=40 D=40 D=40 D=40 Dichtungssatz D=42 D=42 Dichtungssatz	ATE ATE ATE ATE ATE ATE ATE ATE
	2.0 2.0 16V 2.0 DTI 16V 2.2 16V 2.2 DTI 16V 2.5 DTI 2.5 TD 2.5 V6 2.6 V6 3.0 V6 3.2 V6			03.94 09.99 03.94 09.99 09.97 08.00 10.99 08.03 09.00 08.03 09.01 08.03 04.94 08.03 03.94 09.00 09.00 08.03 04.94 01.01 02.01 08.03		24.5233-0200.3	330425	2		L=198	
	2.0 2.0 16V 2.0 DTI 16V 2.2 16V 2.2 DTI 16V 2.5 DTI 2.5 TD 2.5 V6 2.6 V6 3.0 V6 3.2 V6			03.94 09.99 03.94 09.99 09.97 08.00 10.99 08.03 09.00 08.03 09.01 08.03 04.94 08.03 03.94 09.00 09.00 08.03 04.94 01.01 02.01 08.03		24.3727-0725.2	580725	1	↓	L=1550/1550, + Zub	
	2.0 2.0 16V 2.0 DTI 16V 2.2 16V 2.2 DTI 16V 2.5 DTI 2.5 TD 2.5 V6 2.6 V6 3.0 V6 3.2 V6			03.94 09.99 03.94 09.99 09.97 08.00 10.99 08.03 09.00 08.03 09.01 08.03 04.94 08.03 03.94 09.00 09.00 08.03 04.94 01.01 02.01 08.03		24.2419-1709.3	030103			Gz 19,05	

OPEL SIGNUM / Vauxhall Signum (03-08)

	1.8 1.8 1.9 CDTI 1.9 CDTI 1.9 CDTI 2.0 DTI 2.0 Turbo 2.2 2.2 DTI 3.0 V6 CDTI 3.0 V6 CDTI 3.2 V6	◀ 90 ◀103 ◀ 74 ◀ 88 ◀110 ◀ ◀ ◀ ◀ ◀130 ◀135 ◀		05.03 05.08 09.05 05.08 08.05 05.08 04.04 05.08 04.04 05.08 05.03 05.08 05.03 05.08 03.03 05.08 05.03 05.08 05.03 05.08 09.05 05.08 05.03 05.08		24.2125-1732.3	010827		+ ESP	Thz 25,40	TRW
	1.8 1.8 1.9 CDTI 1.9 CDTI 1.9 CDTI 2.0 DTI 2.2 2.2 DTI	90 103 74 88 110		05.03 05.08 09.05 05.08 08.05 05.08 04.04 05.08 04.04 05.08 05.03 05.08 03.03 05.08 05.03 05.08	- Sportfahrwerk ³⁾ - Polizei ⁷⁾ - Polizei ⁷⁾ - Sportfahrwerk ³⁾ - Sportfahrwerk ³⁾ - Sportfahrwerk ³⁾ - Sportfahrwerk ³⁾ - Sportfahrwerk ³⁾	11.9571-9781.2 11.9571-9782.2 11.0101-5407.2 11.8171-0008.1 11.8116-0295.2 11.8116-0356.1	220659 220660 260011 990049 390524 390586		<input type="checkbox"/> GG / nur paarweise austauschen ⁴⁾ <input type="checkbox"/> GG / nur paarweise austauschen ⁴⁾ + ALU-Sättel ⁵⁾ + GG-Sättel ⁶⁾	D=57, - Halter D=57, - Halter Hülssensatz Führungsbolzen Haltefeder Haltefeder	ATE ATE ATE ATE ATE ATE
	1.8 1.9 CDTI 1.9 CDTI 2.0 Turbo 2.2 2.2 DTI 3.0 V6 CDTI 3.2 V6	90 88 110 130	51066206 51066206 51066206 51066206 51066206 31068238 31068238	05.03 04.04 04.04 05.03 03.03 05.03 05.03	+ Sportfahrwerk ⁸⁾ + Sportfahrwerk ⁸⁾ + Sportfahrwerk ⁸⁾ + Sportfahrwerk ⁸⁾ + Sportfahrwerk ⁸⁾ + Sportfahrwerk ⁸⁾	11.0530-0004.2 11.0101-5407.2 11.8171-0008.1 11.8116-0325.2	220933 260011 990049 390461	2 2	<input type="checkbox"/> <input type="checkbox"/>	D=57, - Halter Hülssensatz Führungsbolzen Haltefeder	ATE ATE ATE ATE

1) - ventilated discs / - dischi ventilati / - disques ventilés / - disco ventilado
 2) + ventilated discs / + dischi ventilati / + disques ventilés / + disco ventilado
 3) - sports suspension / - sospensione sportiva / - châssis de sport / - suspensión deportiva
 4) GG/ replace only in pairs / GG/ sostituire solo a coppie / GG/ ne remplacer que par paires / GG/ reemplazar sólo por pares
 5) + aluminium calipers / + pinze in alluminio / + étriers en aluminium / + pinzas de aluminio
 6) + cast iron caliper / + pinza in ghisa / + étriers en fonte grise / + fundición gris-pinza
 7) - Police / - Polizia / - voiture de police / - Police
 8) + sports suspension / + sospensione sportiva / + châssis de sport / + suspensión deportiva

OPEL SIGNUM / Vauxhall Signum (03-08)													
	1.8	90	51066207			05.08	+ Sportfahrwerk ¹⁾	11.9571-9779.2	220657	2	☐ ☐	D=57, - Halter D=57, - Halter Hülsensatz Führungsbolzen Haltefeder	ATE ATE ATE ATE ATE
	1.8	103			09.05	05.08	+ Polizei ²⁾	11.9571-9780.2	220658				
	1.9 CDTI	74			08.05	05.08	+ Polizei ²⁾	11.0101-5407.2	260011				
	1.9 CDTI	88	51066207			05.08	+ Sportfahrwerk ¹⁾	11.8171-0008.1	990049				
	1.9 CDTI	110	51066207			05.08	+ Sportfahrwerk ¹⁾	11.8116-0356.1	390586				
	2.0 Turbo		51066207			05.08							
	2.2		51066207			05.08	+ Sportfahrwerk ¹⁾						
	2.2 DTI		51066207			05.08	+ Sportfahrwerk ¹⁾						
	3.0 V6 CDTI	130	31068239	51999999		09.05	05.08	11.9606-9971.2	220589				
	3.0 V6 CDTI	135						11.9606-9972.2	220590				
3.2 V6		31068239	51999999				11.0441-6008.2	250038					
							11.0101-5407.2	260011					
							11.8171-0008.1	990049					
							11.8116-0345.2	390596					
2.8 V6 Turbo				03.06	05.08		11.9606-9971.2	220589					
2.8 V6 Turbo	169			09.05	05.08		11.9606-9972.2	220590					
							11.0441-6008.2	250038					
							11.0101-5407.2	260011					
							11.8171-0008.1	990049					
							11.8116-0345.2	390596					
	1.8	90				05.03	05.08	83.7807-0412.3	331098	2		L=412	
	1.8	103			09.05	05.08							
	1.9 CDTI	74			08.05	05.08							
	1.9 CDTI	88			04.04	05.08							
	1.9 CDTI	110			04.04	05.08							
	2.0 DTI				05.03	05.08							
	2.0 Turbo				05.03	05.08							
	2.2				03.03	05.08							
	2.2 DTI				05.03	05.08							
	2.8 V6 Turbo				03.06	05.08							
2.8 V6 Turbo	169			09.05	05.08								
3.0 V6 CDTI	130			05.03	05.08								
3.0 V6 CDTI	135			09.05	05.08								
3.2 V6				05.03	05.08								
	1.8	90	41085480			05.03		11.9407-7001.2	220573	2	☐ - belüftete Scheiben ³⁾ ☐ - belüftete Scheiben ³⁾	D=40, - Halter D=40, - Halter Halter Hülsensatz Führungsbolzen Haltefeder	ATE ATE ATE ATE ATE ATE
	1.9 CDTI	88	41085480			04.04		11.9407-7002.2	220574				
	1.9 CDTI	110	41085480			04.04		11.8170-0633.1	260117				
	2.0 DTI		41085480			05.03		11.0101-5407.2	260011				
	2.2		41085480			03.03		11.8171-0008.1	990049				
	2.2 DTI		41085480			05.03		11.8116-0340.1	390595				
	1.8	90	41085481			09.05	05.08	11.9407-7005.2	220637				
	1.8	103			08.05	05.08		11.9407-7006.2	220638				
	1.9 CDTI	74				05.08		11.8170-0633.1	260117				
	1.9 CDTI	88	41085481			05.08		11.0101-5407.2	260011				
1.9 CDTI	110	41085481			05.08		11.8171-0008.1	990049					
2.0 DTI		41085481			05.08		11.8116-0340.1	390595					
2.2		41085481			05.08								
2.2 DTI		41085481			05.08								
1.8	90	41085480			05.03		11.9407-7003.2	220835					
1.9 CDTI	88	41085480			04.04		11.9407-7004.2	220836					
1.9 CDTI	110	41085480			04.04		11.0101-5407.2	260011					
2.0 DTI		41085480			05.03		11.8171-0008.1	990049					
2.0 Turbo		41085480			05.03		11.8116-0340.1	390595					
2.2		41085480			03.03								
2.2 DTI		41085480			05.03								
3.0 V6 CDTI	130	41085480			05.03								
3.2 V6		41085480			05.03								
1.8	90	41085481				05.08	11.9407-7007.2	220867					
1.9 CDTI	88	41085481				05.08	11.9407-7008.2	220868					
1.9 CDTI	110	41085481				05.08	11.0101-5407.2	260011					
2.0 DTI		41085481				05.08	11.8171-0008.1	990049					
2.0 Turbo		41085481				05.08	11.8116-0340.1	390595					
2.2		41085481				05.08							
2.2 DTI		41085481				05.08							
2.8 V6 Turbo				03.06	05.08								
2.8 V6 Turbo	169			09.05	05.08								
3.0 V6 CDTI	130	41085481				05.08							
3.0 V6 CDTI	135			09.05	05.08								
3.2 V6		41085481				05.08							
	1.8	90				05.03	05.08	24.5259-0315.3	330882	2		L=315	
	1.8	103			09.05	05.08							
	1.9 CDTI	74			08.05	05.08							
	1.9 CDTI	88			04.04	05.08							
	1.9 CDTI	110			04.04	05.08							
	2.0 DTI				05.03	05.08							
	2.0 Turbo				05.03	05.08							
	2.2				03.03	05.08							
	2.2 DTI				05.03	05.08							
	2.8 V6 Turbo				03.06	05.08							
2.8 V6 Turbo	169			09.05	05.08								
3.0 V6 CDTI	130			05.03	05.08								
3.0 V6 CDTI	135			09.05	05.08								
3.2 V6				05.03	05.08								

¹⁾ + sports suspension / + sospensione sportiva / + châssis de sport / + suspensión deportiva

²⁾ + Police / + Polizia / + voiture de police / + Police

³⁾ - ventilated discs / - dischi ventilati / - disques ventilés / - disco ventilado

⁴⁾ + ventilated discs / + dischi ventilati / + disques ventilés / + disco ventilado

OPEL SIGNUM / Vauxhall Signum (03-08)																				
	1.9 CDTI	88			04.04	05.08	- Schlechtwegeausführung ¹⁾	24.3727-0788.2	580788	1								L=1800/1800, + Zub		
	1.9 CDTI	110			04.04	05.08	- Schlechtwegeausführung ¹⁾													
	2.0 DTI				05.03	05.08	- Schlechtwegeausführung ¹⁾													
	2.2 DTI				05.03	05.08	- Schlechtwegeausführung ¹⁾													
	3.0 V6 CDTI	130			05.03	05.08	- Schlechtwegeausführung ¹⁾													
OPEL TIGRA / Vauxhall Tigra (94-00)																				
	1.4 16V				07.94	12.00		24.2120-0702.3	010361									- ABS/Kennzeichen:EB/nicht für Delco BKV ²⁾ + ABS/ Kennzeichen: EL ³⁾	Thz 20,64	
	1.6 16V				07.94	08.98		24.2120-1714.3	010455										Thz 20,64	
	1.4 16V				07.94	12.00		11.9481-9871.2	220681									D=48, - Halter	ATE	
	1.6 16V				07.94	08.98		11.9481-9872.2	220682									D=48, - Halter	ATE	
								11.0441-4811.2	250024									Dichtungssatz	ATE	
								11.0101-5407.2	260011									Hülensatz	ATE	
								11.8171-0008.1	990049									Führungsbolzen	ATE	
								11.8116-0129.1	390591	2								Haltefeder	ATE	
	1.4 16V				07.94	12.00		24.5231-0320.3	330496	2								L=320		
	1.6 16V				07.94	08.98														
	1.4 16V				07.94	12.00		24.5233-0200.3	330425	2								L=198		
	1.6 16V				07.94	08.98														
	1.4 16V				07.94	12.00		24.3219-1767.3	020552									+ GG ⁴⁾	Rz 19,05	
	1.6 16V				07.94	08.98		24.3219-1715.3	020122									+ ALU ⁵⁾	Rz 19,05 (ALU)	
	1.4 16V				07.94	12.00		24.3727-0743.2	580743										L=1373, + Zub	
	1.6 16V				07.94	08.98		24.3727-0744.2	580744										L=1078, + Zub	
	1.4 16V				07.94	12.00		03.6585-0018.3	320114									BRL 8/5 (4)	ATE	
	1.6 16V				07.94	08.98														
	1.4 16V				07.94	12.00		24.3728-0720.2	590720									S3/S4/S6	L=727	
	1.6 16V				07.94	08.98												S3/S4/S6		
	1.4 16V					12.00		24.3728-0721.2	590721									T3/T4/T6	L=794	
	1.6 16V					08.98												T3/T4/T6		
OPEL TIGRA TWIN TOP / Vau. Tigra Twin Top (04-09)																				
	1.3 CDTI	51			06.04	08.09	- ESP	24.2123-1767.3	010844										Thz 23,81	BOS
	1.4	66			06.04	08.09	- ESP													
	1.8	92			06.04	08.09	- ESP													
	1.3 CDTI	51			06.04	08.09	+ ESP	24.2123-1768.3	010845										Thz 23,81	BOS
	1.4	66			06.04	08.09	+ ESP													
	1.8	92			06.04	08.09	+ ESP													
	1.3 CDTI	51			06.04	08.09		24.3541-1795.7	220551										D=54, - Halter	TRW
	1.4	66			06.04	08.09		24.3541-1796.7	220552										D=54, - Halter	TRW
	1.8	92			06.04	08.09														
	1.3 CDTI	51			06.04	08.09		24.5256-0298.3	330756	2									L=298	
	1.4	66			06.04	08.09														
	1.8	92			06.04	08.09														
	1.3 CDTI	51			06.04	08.09		24.3347-1713.5	240701										D=34, - Halter	TRW
	1.4	66			06.04	08.09		24.3347-1714.5	240702										D=34, - Halter	TRW
	1.8	92			06.04	08.09														
	1.3 CDTI	51			06.04	08.09		24.5240-0195.3	330753	2									L=195	
	1.4	66			06.04	08.09														
	1.8	92			06.04	08.09														
	1.3 CDTI	51			06.04	08.09		24.3219-1715.3	020122										Rz 19,05 (ALU)	
	1.4	66			06.04	08.09														
	1.8	92			06.04	08.09														
	1.3 CDTI	51			06.04	08.09		24.3727-0750.2	580750										+ HA-Trommelbremse ⁶⁾	L=1095, + Zub
	1.4	66			06.04	08.09		24.3727-0749.2	580749										+ HA-Trommelbremse ⁶⁾	L=832, + Zub
	1.8	92			06.04	08.09		24.3727-0786.2	580786										+ HA-Scheibenbremse ⁸⁾	L=217, + Zub
								24.3727-0768.2	580768										+ HA-Scheibenbremse ⁸⁾	L=1426, + Zub
								24.3727-0766.2	580766										+ HA-Scheibenbremse ⁸⁾	L=1143, + Zub
OPEL VECTRA B / Vauxhall Vectra (96-02)																				
	2.0 16V				W1285446	09.95		03.7745-3003.4	300157										8/7" Tandem	ATE
	2.5 V6					09.95	09.00													
	2.6 V6					09.00	04.02													
	1.6				V7999999	09.95		24.2122-1724.3	010561										Thz 22,20	
	1.6				V5999999	09.95														
	1.6				V1999999	09.95														
	1.6 16V				V7999999	09.95														
	1.6 16V				V5999999	09.95														
	1.6 16V				V1999999	09.95														
	1.7 TD					09.95	11.96													
	1.8 i 16V				V7999999	09.95														
	1.8 i 16V				V5999999	09.95														
	1.8 i 16V				V1999999	09.95														
	2.0 DI 16V				V7999999	11.96														
	2.0 DI 16V				V5999999	11.96														
	2.0 DI 16V				V1999999	11.96														
	2.0 DTI 16V				V7999999	06.97														
	2.0 DTI 16V				V5999999	06.97														
	2.0 DTI 16V				V1999999	06.97														
	1.6				W7999999	09.95		24.2122-1724.3	010561										Thz 22,20	

¹⁾ - rough road construction / - versione per percorsi accidentati / - version pour mauvaise route / - versión 4x4

²⁾ - ABS/markin:EB/not for Delco BKV / - ABS/marcatura:EB/non per Delco BKV / - ABS/marquaje:EB/pas pour Delco BKV / - ABS/marcaje:EB/no para Delco BKV

³⁾ + ABS/ registration number: EL / + ABS/ sigla: EL / + ABS/ indice: EL / + ABS/ distintivo: EL

⁴⁾ + cast iron / + ghisa / + fonte grise / + fundición de gris

⁵⁾ + aluminium / + alluminio / + aluminium / + aluminio

⁶⁾ + RA drum brake / + P freno a tamburo / + frein à tambour essieu AR / + ET-tambores de freno

⁷⁾ extension only / + RA drum br. / solo prolunga / + P fr.a tamburo / rallonge seules. + tamb.ess.AR / solam.prolongad./+ tambores ET



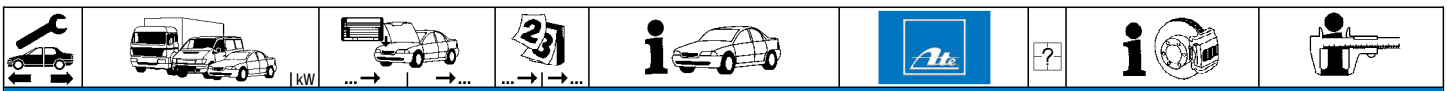

























⁸⁾ + RA disc brake / + P disco freno / + frein à disque essieu AR / + ET-disco de freno



OPEL VECTRA B / Vauxhall Vectra (96-02)

	1.6		W5999999	09.95		24.2122-1724.3	010561			THz 22,20	
	1.6		W1999999	09.95							
	1.6 16V		W7999999	09.95							
	1.6 16V		W5999999	09.95							
	1.6 16V		W1999999	09.95							
	1.8 i 16V		W7999999	09.95							
	1.8 i 16V		W5999999	09.95							
	1.8 i 16V		W1999999	09.95							
	2.0 DI 16V		W7999999	11.96							
	2.0 DI 16V		W5999999	11.96							
	2.0 DI 16V		W1999999	11.96							
	2.0 DTI 16V		W7999999	06.97							
	2.0 DTI 16V		W5999999	06.97							
	2.0 DTI 16V		W1999999	06.97							
	1.6	W7000001	W7999999			24.2123-1777.3	010943			THz 23,81	
	1.6	W5000001	W5999999								
	1.6	W1000001	W1999999								
	1.6 16V	W7000001	W7999999								
	1.6 16V	W5000001	W5999999								
	1.6 16V	W1000001	W1999999								
	1.8 i 16V	W7000001	W7999999								
	1.8 i 16V	W5000001	W5999999								
	1.8 i 16V	W1000001	W1999999								
	2.0 DI 16V	W7000001	W7999999								
	2.0 DI 16V	W5000001	W5999999								
	2.0 DI 16V	W1000001	W1999999								
	2.0 DTI 16V	W7000001	W7999999								
	2.0 DTI 16V	W5000001	W5999999								
	2.0 DTI 16V	W1000001	W1999999								
	1.6	X7000001		04.02		24.2125-1714.3	010641			THz 25,40	TRW
	1.6	X5000001		04.02							
	1.6	X1000001		04.02							
	1.6 16V	X7000001		04.02							
	1.6 16V	X5000001		04.02							
	1.6 16V	X1000001		04.02							
	1.8 i 16V	X7000001		04.02							
	1.8 i 16V	X5000001		04.02							
	1.8 i 16V	X1000001		04.02							
	2.0 DI 16V	X7000001		04.02							
	2.0 DI 16V	X5000001		04.02							
	2.0 DI 16V	X1000001		04.02							
	2.0 DTI 16V	X7000001		04.02							
	2.0 DTI 16V	X5000001		04.02							
	2.0 DTI 16V	X1000001		04.02							
	2.0 16V	W7154258	W7154258	09.95		03.2123-1622.3	010470			THz 23,81	ATE
	2.0 16V	W5276825	W5276825	09.95							
	2.0 16V	W1285446	W1285446	09.95							
	2.5 V6	W7154258	W7154258	09.95							
	2.5 V6	W5276825	W5276825	09.95							
	2.5 V6	W1285446	W1285446	09.95							
	2.0 16V	W7154259		04.02		24.2125-1714.3	010641			THz 25,40	TRW
	2.0 16V	W5276826		04.02							
	2.0 16V	W1285447		04.02							
	2.2 16V			09.00	04.02						
	2.2 DTI 16V			09.00	04.02						
	2.5 V6	W7154259		09.00	04.02	03.2125-7402.3	010541			THz 25,40	ATE
	2.5 V6	W5276826		09.00	04.02						
	2.5 V6	W1285447		09.00	04.02						
	2.6 V6			09.00	04.02						
	2.0 16V		W7154258	09.95		03.2123-1722.3	010471			THz 23,81	ATE
	2.0 16V		W5276825	09.95							
	2.0 16V		W1285446	09.95							
	2.5 V6		W7154258	09.95							
	2.5 V6		W5276825	09.95							
	2.5 V6		W1285446	09.95							
	2.0 16V	W7154259		04.02		03.2125-7502.3	010616			THz 25,40	ATE
	2.0 16V	W5276826		04.02							
	2.0 16V	W1285447		04.02							
	2.2 16V			09.00	04.02						
	2.5 V6	W7154259		09.00	04.02						
	2.5 V6	W5276826		09.00	04.02						
	2.5 V6	W1285447		09.00	04.02						
	2.6 V6			09.00	04.02						
	1.6		W7999999	09.95		24.3521-1701.5	240001			D=52, - Halter	ATE
	1.6 16V		W7999999	09.95	11.96	24.3521-1702.5	240002			D=52, - Halter	ATE
	1.7 TD			09.95	11.96	11.0441-5202.2	250026			Dichtungssatz	ATE
	1.8 i 16V		W7999999	09.95		11.0101-5407.2	260011			Hülssensatz	ATE
	2.0 DI 16V		W7999999	11.96		11.8171-0008.1	990049			Führungsbolzen	ATE
	2.0 DTI 16V		W7999999	06.97		11.8116-0097.1	390590	2		Haltefeder	ATE
	1.6	X1000001		04.02		24.3571-1761.5	240461			D=57, - Halter	ATE
	1.6 16V	X1000001		04.02		24.3571-1762.5	240462			D=57, - Halter	ATE
	1.8 i 16V	X1000001		04.02		11.0441-5704.2	250034			Dichtungssatz	ATE
	2.0 16V			09.95	04.02	11.0101-5407.2	260011			Hülssensatz	ATE
	2.0 DI 16V	X1000001		04.02	04.02	11.8171-0008.1	990049			Führungsbolzen	ATE
	2.0 DTI 16V	X1000001		04.02	04.02	11.8116-0292.1	390521	2		Haltefeder	ATE
	2.2 16V			09.00	04.02						



										
OPEL VECTRA B / Vauxhall Vectra (96-02)										
	2.2 DTI 16V 2.5 V6 2.6 V6 i 500 2.5	143		09.00 09.95 09.00 05.98	04.02 09.00 04.02 09.00	24.3571-1761.5 24.3571-1762.5 11.0441-5704.2 11.0101-5407.2 11.8171-0008.1 11.8116-0292.1	240461 240462 250034 260011 990049 390521	 2	D=57, - Halter D=57, - Halter Dichtungssatz Hülsensatz Führungsbolzen Haltefeder	ATE ATE ATE ATE ATE ATE
	1.6 1.6 16V 1.7 TD 1.8 i 16V 2.0 16V 2.0 DI 16V 2.0 DTI 16V 2.2 16V 2.2 DTI 16V 2.5 V6 2.6 V6 i 500 2.5	143		09.95 09.95 09.95 09.95 09.95 11.96 06.97 09.00 09.00 09.95 09.00 05.98	04.02 04.02 11.96 04.02 04.02 04.02 04.02 04.02 04.02 09.00 04.02		24.5231-0391.3 331424	2	L=391	
	1.6 16V 1.7 TD 1.8 i 16V 2.0 16V 2.0 DI 16V Caravan 2.0 DTI 16V 2.5 V6		V7999999 V7999999 V7999999 V7999999 V7999999 V7999999 V7999999	09.95 09.95 09.95 09.95 11.96 06.97 09.95		13.2351-0025.2 13.2351-0026.2 13.0441-3506.2	210210 210211 250052	 2	D=35 D=35 Dichtungssatz	ATE ATE ATE
	1.6 16V 1.7 TD 1.8 i 16V 2.0 16V 2.0 DI 16V Caravan 2.0 DTI 16V 2.2 16V 2.2 DTI 16V 2.5 V6 2.6 V6 i 500 2.5	W1000001 W1000001 W1000001 W1000001 W1000001 W1000001 W1000001		09.00 09.00 09.00 09.00 09.00 09.00 05.98	04.02 11.96 04.02 04.02 04.02 04.02 04.02 04.02 09.00 04.02	13.2351-0051.2 13.2351-0052.2 24.9235-0051.5 24.9235-0052.5 13.0441-3507.2	210180 210181 230003 230004 250053	 2	D=35 D=35 D=35 D=35 Dichtungssatz	ATE ATE ATE ATE ATE
	1.6 1.6 16V 1.7 TD 1.8 i 16V 2.0 16V 2.0 DI 16V 2.0 DTI 16V 2.2 16V 2.2 DTI 16V 2.5 V6 2.6 V6 i 500 2.5	143		09.95 09.95 09.95 09.95 09.95 11.96 06.97 09.00 09.00 09.95 09.00 05.98	04.02 04.02 11.96 04.02 04.02 04.02 04.02 04.02 04.02 09.00 04.02	24.5233-0200.3	330425	2	L=198	
	1.6 1.6 1.6 2.0 DI 16V Limousine 2.0 DI 16V Limousine 2.0 DI 16V Limousine		W7152258 W5276825 W1238518 W7152258 W5276825 W1238518	09.95 09.95 09.95 11.96 11.96 11.96		24.3219-1767.3 24.3219-1715.3	020552 020122	+ GG ¹⁾ + ALU ²⁾	Rz 19,05 Rz 19,05 (ALU)	
	1.6 1.6 1.6 2.0 DI 16V Limousine 2.0 DI 16V Limousine 2.0 DI 16V Limousine	W7154259 W5276826 W1238519	W7999999 W5999999 W1999999			24.3219-1715.3	020122		Rz 19,05 (ALU)	
	1.6 1.6 1.6 2.0 DI 16V Limousine 2.0 DI 16V Limousine 2.0 DI 16V Limousine	X7000001 X5000001 X1000001		04.02 04.02 04.02		24.3220-1719.3	020448		Rz 20,64	
	1.6 1.6 16V 1.7 TD 1.8 i 16V 2.0 16V 2.0 DI 16V Caravan 2.0 DTI 16V 2.2 16V 2.2 DTI 16V 2.5 V6 2.6 V6 2.0 DI 16V Limousine			09.95 09.95 09.95 09.95 09.95 11.96 06.97 09.00 09.00 09.95 09.00 11.96	04.02 04.02 11.96 04.02 04.02 04.02 04.02 04.02 04.02 09.00 04.02	24.3727-0748.2 24.3727-0751.2 24.3727-0745.2	580748 580751 580745	1  1  2  Verlängerung ³⁾	L=279, + Zub L=1455/1455, + Zub L=210, + Zub	
	1.6 1.6 16V 1.7 TD 1.8 i 16V		W1238518 W1238518 W1238518	09.95 09.95 09.95 09.95	04.02 04.02 11.96	24.3727-0748.2 24.3727-0751.2 24.3727-0760.2	580748 580751 580760	1  1  2  Verlängerung ³⁾	L=279, + Zub L=1455/1455, + Zub L=220, + Zub	
	1.6 1.6 16V 1.7 TD 1.8 i 16V		W1238518 W1238518	09.95 09.95 09.95 09.95	04.02 04.02 11.96	24.2415-1703.3	030102		Gz 15,87	

¹⁾ + cast iron / + ghisa / + fonte grise / + fundición de gris

²⁾ + aluminium / + alluminio / + aluminium / + aluminio

³⁾ extension only / solo prolunga / rallonge seulement / solamente prolongador

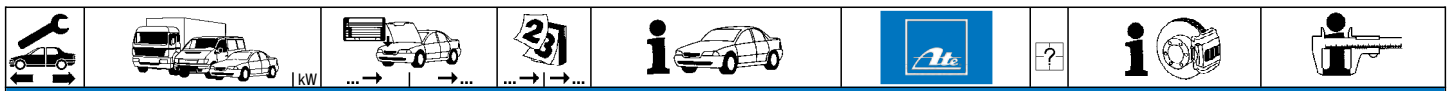

OPEL VECTRA B / Vauxhall Vectra (96-02)

	2.0 16V		W1238518	09.95	10.08		24.2415-1703.3	030102		Gz 15,87
	2.0 DI 16V		W1238518	11.96						
	2.0 DTI 16V		W1238518	06.97						
	2.5 V6		W1238518	09.95						
	1.6		W1238519		04.02		24.2415-1708.3	030119		Gz 15,87
	1.6 16V		W1238519		04.02					
	1.8 i 16V		W1238519		04.02					
	2.0 16V		W1238519		04.02					
	2.0 DI 16V		W1238519		04.02					
	2.0 DTI 16V		W1238519		04.02					
	2.2 16V			09.00	04.02					
	2.2 DTI 16V			09.00	04.02					
	2.5 V6		W1238519		09.00					
	2.6 V6			09.00	04.02					

OPEL VECTRA C (F68,F69)/Vau. Vectra MK II (02-08)

	1.6	74		08.05	10.08	+ ESP	24.2125-1732.3	010827		THz 25,40	TRW
	1.6	77		01.06	10.08	+ ESP					
	1.6 16V			04.02	10.08	+ ESP					
	1.8	81		04.02	10.08	+ ESP					
	1.8	103		01.06	10.08	+ ESP					
	1.8 16V	90		04.02	10.08	+ ESP					
	1.9 CDTI	74		10.05	10.08	+ ESP					
	1.9 CDTI	88		04.04	10.08	+ ESP					
	1.9 CDTI	110		04.04	10.08	+ ESP					
	2.0 DTI 16V			04.02	10.08	+ ESP					
	2.0 Turbo			03.03	10.08	+ ESP					
	2.2 16V	108		04.02	10.08	+ ESP					
	2.2 direct	114		10.03	10.08	+ ESP					
	2.2 DTI 16V			04.02	10.08	+ ESP					
	3.0 CDTI			05.03	10.08	+ ESP					
	3.0 V6 CDTI	135		08.05	10.08	+ ESP					
	3.2 V6			04.02	10.08	+ ESP					
		1.6	74		08.05	10.08		11.9571-9781.2	220659	<input type="checkbox"/> GG / nur paarweise austauschen 1)	D=57, - Halter
1.6		77		01.06	10.08		11.9571-9782.2	220660	<input type="checkbox"/> GG / nur paarweise austauschen 1)	D=57, - Halter	ATE
1.6 16V				04.02	10.08		11.0101-5407.2	260011		Hülzensatz	ATE
1.8		81		04.02	10.08	- Sportfahrwerk 4)	11.8171-0008.1	990049		Führungsbolzen	ATE
1.8		103		01.06	10.08	+ Sportfahrwerk/ - Polizei 5)	11.8116-0295.2	390524	2 + ALU-Sättel 2)	Haltefeder	ATE
1.8 16V		90		04.02	10.08	- Sportfahrwerk 4)	11.8116-0356.1	390586	2 + GG-Sättel 3)	Haltefeder	ATE
1.9 CDTI		74	61000001		10.08	- Polizei 6)					
1.9 CDTI		88		04.04	10.08						
1.9 CDTI		110		04.04	10.08						
2.0 DTI 16V				04.02	10.08						
2.2 16V		108		04.02	10.08	- Sportfahrwerk 4)					
2.2 direct		114		10.03	10.08	- Sportfahrwerk 4)					
2.2 DTI 16V				04.02	10.08	- Sportfahrwerk 4)					
1.8		81		04.02	10.08	+ Sportfahrwerk 7)	11.0530-0004.2	220933	2 <input type="checkbox"/>	D=57, - Halter	ATE
1.8 16V		90		04.02	10.08	+ Sportfahrwerk 7)	11.0101-5407.2	260011		Hülzensatz	ATE
2.0 Turbo				03.03	10.08		11.8171-0008.1	990049		Führungsbolzen	ATE
2.2 16V		108		04.02	10.08	+ Sportfahrwerk 7)	11.8116-0325.2	390461	2	Haltefeder	ATE
2.2 direct		114		10.03	10.08	+ Sportfahrwerk 7)					
2.2 DTI 16V			04.02	10.08	+ Sportfahrwerk 7)						
3.0 CDTI		31070293	05.03	10.08							
3.2 V6		31070293	04.02	10.08							
	1.8	103		01.06	10.08	+ Sportfahrwerk/ + Polizei 9)	11.9571-9779.2	220657	<input type="checkbox"/>	D=57, - Halter	ATE
	1.9 CDTI	74	61000001		10.08	+ Polizei 9)	11.9571-9780.2	220658	<input type="checkbox"/>	D=57, - Halter	ATE
							11.0101-5407.2	260011		Hülzensatz	ATE
							11.8171-0008.1	990049		Führungsbolzen	ATE
							11.8116-0356.1	390586	2	Haltefeder	ATE
	2.8 V6 Turbo	169	61000001		10.08	- OPC / -VXR	11.9606-9971.2	220589	<input type="checkbox"/>	D=60, - Halter	ATE
	2.8 V6 Turbo	184	61000001		10.08	- OPC / -VXR	11.9606-9972.2	220590	<input type="checkbox"/>	D=60, - Halter	ATE
	3.0 CDTI		31070294		10.08		11.0441-6008.2	250038		Dichtungssatz	ATE
	3.0 V6 CDTI	135	61000001		10.08		11.0101-5407.2	260011		Hülzensatz	ATE
	3.2 V6		31070294		10.08		11.8171-0008.1	990049		Führungsbolzen	ATE
							11.8116-0345.2	390596	2	Haltefeder	ATE
	2.8 V6 Turbo	169	61000001		10.08	+ OPC / +VXR	11.9606-9971.2	220589	<input type="checkbox"/>	D=60, - Halter	ATE
	2.8 V6 Turbo	184	61000001		10.08	+ OPC / +VXR	11.9606-9972.2	220590	<input type="checkbox"/>	D=60, - Halter	ATE
							11.0101-5407.2	260011		Hülzensatz	ATE
							11.8171-0008.1	990049		Führungsbolzen	ATE
							11.8116-0345.2	390596	2	Haltefeder	ATE
	2.8 V6 Turbo OPC	188	61000001		10.08		11.9576-9945.2	220931	<input type="checkbox"/>	D=57, - Halter	ATE
	2.8 V6 Turbo OPC	206	61000001		10.08		11.9576-9946.2	220932	<input type="checkbox"/>	D=57, - Halter	ATE
							11.0101-5407.2	260011		Hülzensatz	ATE
							11.8171-0008.1	990049		Führungsbolzen	ATE
						11.8116-0410.2	390589	2	Haltefeder	ATE	
	1.6	74		08.05	10.08		83.7807-0412.3	331098	2	L=412	
	1.6	77		01.06	10.08						
	1.6 16V			04.02	10.08						
	1.8	81		04.02	10.08						
	1.8	103		01.06	10.08						
	1.8 16V	90		04.02	10.08						
	1.9 CDTI	74		10.05	10.08						
	1.9 CDTI	88		04.04	10.08						
	1.9 CDTI	110		04.04	10.08						
	2.0 DTI 16V			04.02	10.08						
	2.0 Turbo			03.03	10.08						
2.2 16V	108		04.02	10.08							

1) GG/ replace only in pairs / GG/ sostituire solo a coppie / GG/ ne remplacer que par paires / GG/ reemplazar sólo por pares

2) + aluminium callipers / + pinze in alluminio / + étriers en aluminium / + pinzas de aluminio

3) + cast iron caliper / + pinza in ghisa / + étriers en fonte grise / + fundición gris-pinza

4) - sports suspension / - sospensione sportiva / - châssis de sport / - suspensión deportiva

5) + sports suspension/ - Police / + sospensione sportiva/ - Polizia / + châssis de sport/ - Police / + suspensión deportiva/ - Police

6) - Police / - Polizia / - voiture de police / - Police

7) + sports suspension / + sospensione sportiva / + châssis de sport / + suspensión deportiva

8) + sports suspension/ + Police / + sospensione sportiva/ + Polizia / + châssis de sport/ + Police / + suspensión deportiva/ + Police

9) + Police / + Polizia / + voiture de police / + Police















OPEL VECTRA C (F68,F69)/Vau. Vectra MK II (02-08)																		
	2.2 direct	114	10.03	10.08		83.7807-0412.3	331098	2									L=412	
	2.2 DTI 16V		04.02	10.08														
	2.8 V6 Turbo	169	08.05	10.08														
	2.8 V6 Turbo	184	08.06	10.08														
	2.8 V6 Turbo OPC	188	08.05	10.08														
	2.8 V6 Turbo OPC	206	08.06	10.08														
	3.0 CDTI		05.03	10.08														
	3.0 V6 CDTI	135	08.05	10.08														
	3.2 V6		04.02	10.08														
	1.6	74	08.05	10.08	- belüftete Scheiben ¹⁾	11.9387-7003.2	220567										D=38, - Halter	
	1.6	77	01.06	10.08	- belüftete Scheiben ¹⁾	11.9387-7004.2	220568											ATE
	1.6 16V		04.02	10.08	- belüftete Scheiben ¹⁾	11.8170-0633.1	260017											ATE
	1.8	81	04.02	10.08	- belüftete Scheiben ¹⁾	11.0101-5407.2	260011											ATE
	1.8	103	01.06	10.08	- belüftete Scheiben ¹⁾	11.8171-0008.1	990049											ATE
	1.8 16V	90	04.02	10.08	- belüftete Scheiben ¹⁾	11.8116-0340.1	390595	2										ATE
	1.9 CDTI	74	10.05	10.08	- belüftete Scheiben ¹⁾													
	1.9 CDTI	88	04.04	10.08	- belüftete Scheiben ¹⁾													
	1.9 CDTI	110	04.04	10.08	- belüftete Scheiben ¹⁾													
	2.0 DTI 16V		04.02	10.08	- belüftete Scheiben ¹⁾													
	2.0 Turbo		03.03	10.08	- belüftete Scheiben ¹⁾													
	2.2 16V	108	04.02	10.08	- belüftete Scheiben ¹⁾													
	2.2 direct	114	10.03	10.08	- belüftete Scheiben ¹⁾													
	2.2 DTI 16V		04.02	10.08	- belüftete Scheiben ¹⁾													
	2.8 V6 Turbo	169	08.05	10.08	- belüftete Scheiben ¹⁾													
	2.8 V6 Turbo	184	08.06	10.08	- belüftete Scheiben ¹⁾													
	3.0 CDTI		05.03	10.08	- belüftete Scheiben ¹⁾													
	3.0 V6 CDTI	135	08.05	10.08	- belüftete Scheiben ¹⁾													
	3.2 V6		04.02	10.08	- belüftete Scheiben ¹⁾													
	1.6	74	08.05	10.08	+ belüftete Scheiben ²⁾	11.9387-7005.2	220569											D=38, - Halter
	1.6	77	01.06	10.08	+ belüftete Scheiben ²⁾	11.9387-7006.2	220570											ATE
	1.6 16V		04.02	10.08	+ belüftete Scheiben ²⁾	11.0101-5407.2	260011											ATE
	1.8	81	04.02	10.08	+ belüftete Scheiben ²⁾	11.8171-0008.1	990049											ATE
	1.8	103	01.06	10.08	+ belüftete Scheiben ²⁾	11.8116-0340.1	390595	2										ATE
	1.8 16V	90	04.02	10.08	+ belüftete Scheiben ²⁾													
	1.9 CDTI	74	10.05	10.08	+ belüftete Scheiben ²⁾													
	1.9 CDTI	88	04.04	10.08	+ belüftete Scheiben ²⁾													
	1.9 CDTI	110	04.04	10.08	+ belüftete Scheiben ²⁾													
	2.0 DTI 16V		04.02	10.08	+ belüftete Scheiben ²⁾													
	2.0 Turbo		03.03	10.08	+ belüftete Scheiben ²⁾													
	2.2 16V	108	04.02	10.08	+ belüftete Scheiben ²⁾													
	2.2 direct	114	10.03	10.08	+ belüftete Scheiben ²⁾													
	2.2 DTI 16V		04.02	10.08	+ belüftete Scheiben ²⁾													
	2.8 V6 Turbo	169	08.05	10.08	+ belüftete Scheiben ²⁾													
	2.8 V6 Turbo	184	08.06	10.08	+ belüftete Scheiben ²⁾													
	3.0 CDTI		05.03	10.08	+ belüftete Scheiben ²⁾													
	3.0 V6 CDTI	135	08.05	10.08	+ belüftete Scheiben ²⁾													
	3.2 V6		04.02	10.08	+ belüftete Scheiben ²⁾													
	2.8 V6 Turbo OPC	188	08.05	10.08		11.0101-5407.2	260011											Hülzensatz
	2.8 V6 Turbo OPC	206	08.06	10.08		11.8171-0008.1	990049											ATE
						11.8116-0340.1	390595	2										ATE
																		ATE
	1.6	74	08.05	10.08		24.5259-0315.3	330882	2										L=315
	1.6	77	01.06	10.08														
	1.6 16V		04.02	10.08														
	1.8	81	04.02	10.08														
	1.8	103	01.06	10.08														
	1.8 16V	90	04.02	10.08														
	1.9 CDTI	74	10.05	10.08														
	1.9 CDTI	88	04.04	10.08														
	1.9 CDTI	110	04.04	10.08														
	2.0 DTI 16V		04.02	10.08														
	2.0 Turbo		03.03	10.08														
	2.2 16V	108	04.02	10.08														
	2.2 direct	114	10.03	10.08														
	2.2 DTI 16V		04.02	10.08														
	2.8 V6 Turbo	169	08.05	10.08														
	2.8 V6 Turbo	184	08.06	10.08														
	2.8 V6 Turbo OPC	188	08.05	10.08														
	2.8 V6 Turbo OPC	206	08.06	10.08														
	3.0 CDTI		05.03	10.08														
	3.0 V6 CDTI	135	08.05	10.08														
	3.2 V6		04.02	10.08														
	1.6	74	08.05	10.08	- Schlechtwegeausführung ³⁾	24.3727-0758.2	580758	1										L=1630/1573, + Zub
	1.6	77	01.06	10.08	- Schlechtwegeausführung ³⁾													
	1.6 16V		04.02	10.08	- Schlechtwegeausführung ³⁾													
	1.8	81	04.02	10.08	- Schlechtwegeausführung ³⁾													
	1.8	103	01.06	10.08	- Schlechtwegeausführung ³⁾													
	1.8 16V	90	04.02	10.08	- Schlechtwegeausführung ³⁾													
	2.0 Turbo		03.03	10.08	- Schlechtwegeausführung ³⁾													
	2.2 16V	108	04.02	10.08	- Schlechtwegeausführung ³⁾													
	2.2 direct	114	10.03	10.08	- Schlechtwegeausführung ³⁾													
	2.8 V6 Turbo	169	08.05	10.08	- Schlechtwegeausführung ³⁾													
	2.8 V6 Turbo	184	08.06	10.08	- Schlechtwegeausführung ³⁾													
	2.8 V6 Turbo OPC	188	08.05	10.08	- Schlechtwegeausführung ³⁾													
	3.2 V6		04.02	10.08	- Schlechtwegeausführung ³⁾													

¹⁾ - ventilated discs / - dischi ventilati / - disques ventilés / - disco ventilado

²⁾ + ventilated discs / + dischi ventilati / + disques ventilés / + disco ventilado

















³⁾ - rough road construction / - versione per percorsi accidentati / - version pour mauvaise route / - versión 4x4

										
OPEL VECTRA C Caravan (F35) / Vau. MK II (03-08)										
	3.2 V6	155	41085480	10.03	- belüftete Scheiben ¹⁾	11.9407-7001.2 220573 11.9407-7002.2 220574 11.8170-0633.1 260117 11.0101-5407.2 260011 11.8171-0008.1 990049 11.8116-0340.1 390595	2	D=40, - Halter D=40, - Halter Halter Hülzensatz Führungsbolzen Haltefeder	ATE ATE ATE ATE ATE ATE	
	1.6	77	41085480	06.06	+ belüftete Scheiben ²⁾	11.9407-7003.2 220835		D=40, - Halter	ATE	
	1.6 16V	74	41085480	10.03	+ belüftete Scheiben ²⁾	11.9407-7004.2 220836		D=40, - Halter	ATE	
	1.8	81	41085480	04.02	+ belüftete Scheiben ²⁾	11.0101-5407.2 260011		Hülzensatz	ATE	
	1.8	103	41085480	01.06	+ belüftete Scheiben ²⁾	11.8171-0008.1 990049		Führungsbolzen	ATE	
	1.8 16V	90	41085480	10.03	+ belüftete Scheiben ²⁾	11.8116-0340.1 390595	2	Haltefeder	ATE	
	1.9 CDTI	74	41085480	10.03	+ belüftete Scheiben ²⁾					
	1.9 CDTI	88	41085480	04.04	+ belüftete Scheiben ²⁾					
	1.9 CDTI	110	41085480	04.04	+ belüftete Scheiben ²⁾					
	2.0 DTI 16V	74	41085480	10.03	+ belüftete Scheiben ²⁾					
	2.0 Turbo	129	41085480	10.03	+ belüftete Scheiben ²⁾					
	2.2 16V	108	41085480	10.03	+ belüftete Scheiben ²⁾					
	2.2 direct	114	41085480	10.03	+ belüftete Scheiben ²⁾					
	2.2 DTI 16V	92	41085480	10.03	+ belüftete Scheiben ²⁾					
	3.0 V6 CDTI	130	41085480	10.03	+ belüftete Scheiben ²⁾					
	3.0 V6 CDTI	135	41085480	08.05	+ belüftete Scheiben ²⁾					
	3.2 V6	155	41085480	10.03	+ belüftete Scheiben ²⁾					
	1.6	77	41085481	10.08		11.9407-7005.2 220637		D=40, - Halter	ATE	
	1.6 16V	74	41085481	10.08		11.9407-7006.2 220638		D=40, - Halter	ATE	
	1.8	81	41085481	10.08		11.8170-0633.1 260117	2	- belüftete Scheiben ¹⁾	ATE	
	1.8	103	41085481	10.08		11.0101-5407.2 260011		Hülzensatz	ATE	
	1.8 16V	90	41085481	10.08		11.8171-0008.1 990049		Führungsbolzen	ATE	
	1.9 CDTI	74	41085481	10.08		11.8116-0340.1 390595	2	Haltefeder	ATE	
	1.9 CDTI	88	41085481	10.08						
	1.9 CDTI	110	41085481	10.08						
	2.0 DTI 16V	74	41085481	10.08						
	2.2 16V	108	41085481	10.08						
	2.2 direct	114	41085481	10.08						
	2.2 DTI 16V	92	41085481	10.08						
	2.0 Turbo	129	41085481	10.08		11.9407-7007.2 220867		D=40, - Halter	ATE	
	2.8 V6 Turbo	169	41085481	10.08		11.9407-7008.2 220868		D=40, - Halter	ATE	
	2.8 V6 Turbo	184	41085481	10.08		11.8170-0633.1 260117	2	- belüftete Scheiben ¹⁾	ATE	
	3.0 V6 CDTI	130	41085481	10.08		11.0101-5407.2 260011		Halter	ATE	
	3.0 V6 CDTI	135	41085481	10.08		11.8171-0008.1 990049		Hülzensatz	ATE	
	3.2 V6	155	41085481	10.08		11.8116-0340.1 390595	2	Führungsbolzen Haltefeder	ATE ATE	
	2.8 V6 Turbo OPC	188		08.05	10.08	11.9407-7007.2 220867		D=40, - Halter	ATE	
	2.8 V6 Turbo OPC	206		06.06	10.08	11.9407-7008.2 220868		D=40, - Halter	ATE	
						11.0101-5407.2 260011		Hülzensatz	ATE	
						11.8171-0008.1 990049		Führungsbolzen	ATE	
	1.6	77		06.06	10.08	24.5259-0315.3 330882	2	L=315		
	1.6 16V	74		10.03	10.08					
	1.8	81		04.02	10.08					
	1.8	103		01.06	10.08					
	1.8 16V	90		10.03	10.08					
	1.9 CDTI	74		10.05	10.08					
	1.9 CDTI	88		04.04	10.08					
	1.9 CDTI	110		04.04	10.08					
	2.0 DTI 16V	74		10.03	10.08					
	2.0 Turbo	129		10.03	10.08					
	2.2 16V	108		10.03	10.08					
	2.2 direct	114		10.03	10.08					
	2.2 DTI 16V	92		10.03	10.08					
	2.8 V6 Turbo	169		08.05	10.08					
	2.8 V6 Turbo	184		11.06	10.08					
	2.8 V6 Turbo OPC	188		08.05	10.08					
	2.8 V6 Turbo OPC	206		06.06	10.08					
	3.0 V6 CDTI	130		10.03	10.08					
	3.0 V6 CDTI	135		08.05	10.08					
	3.2 V6	155		10.03	10.08					
	1.9 CDTI	88		04.04	10.08	24.3727-0788.2 580788	1	L=1800/1800, + Zub		
	1.9 CDTI	110		04.04	10.08					
	2.0 DTI 16V	74		10.03	10.08					
	2.2 DTI 16V	92		10.03	10.08					
	3.0 V6 CDTI	130		10.03	10.08					
OPEL VIVARO (01-14)										
	1.9 CDTI	◀ 60	6V699999	08.01		24.2125-1734.3 010878		+ ASR	ThZ 25,40	TRW
	1.9 CDTI	◀ 74	6V699999	08.01						
	1.9 Di	◀ 60	6V699999	08.06						
	2.0	86	6V699999	08.06						
	2.0 16V	88	6V699999	08.01						
	2.0 CDTI	66	6V699999	08.06						
	2.0 CDTI	84	6V699999	08.06						
	2.5 CDTI	84	6V699999	08.06						
	2.5 CDTI	99	6V699999	05.03						
	2.5 CDTI	107	6V699999	08.06						
	2.5 DTi	99	6V699999	08.06						
	1.9 CDTI	▶ 60	4V602168			24.2125-1731.3 010826		- ASR	ThZ 25,40	TRW
	1.9 CDTI	▶ 74	4V602168							
	1.9 Di	▶ 60	4V602168							
	2.0	86	4V602168							
	2.0 16V	88	4V602168							

¹⁾ - ventilated discs / - dischi ventilati / - disques ventilés / - disco ventilado

²⁾ + ventilated discs / + dischi ventilati / + disques ventilés / + disco ventilado







³⁾ - rough road construction / - versione per percorsi accidentati / - version pour mauvaise route / - versión 4x4

								
OPEL VIVARO (01-14)								
	2.0 CDTI 2.0 CDTI 2.5 CDTI 2.5 CDTI 2.5 CDTI 2.5 DTi	66 4V602168 84 4V602168 84 4V602168 99 4V602168 107 4V602168 99 4V602168	6V699999 6V699999 6V699999 6V699999 6V699999 6V699999			24.2125-1731.3 010826	- ASR	THz 25,40 TRW
	1.9 CDTI 1.9 CDTI 1.9 Di 2.0 2.0 16V 2.0 CDTI 2.0 CDTI 2.5 CDTI 2.5 CDTI 2.5 CDTI 2.5 DTi	60 7V600001 / 7Y000001 74 7V600001 / 7Y000001 60 7V600001 / 7Y000001 86 7V600001 / 7Y000001 88 7V600001 / 7Y000001 66 7V600001 / 7Y000001 84 7V600001 / 7Y000001 84 7V600001 / 7Y000001 99 7V600001 / 7Y000001 107 7V600001 / 7Y000001 99 7V600001 / 7Y000001		06.14 06.14 06.14 06.14 06.14 06.14 06.14 06.14 06.14 06.14 06.14		24.2120-1748.3 24.2120-1753.3 010894 010946	+ ABS + ASR	THz 20,64 THz 20,64 TRW TRW
	1.9 CDTI 1.9 CDTI 1.9 Di 2.0 2.0 16V 2.0 CDTI 2.0 CDTI 2.5 CDTI 2.5 CDTI 2.5 CDTI 2.5 DTi	60 74 60 86 88 66 84 84 99 107 99		08.01 08.01 08.06 08.06 08.01 08.06 08.06 08.06 05.03 08.06 08.06	06.14 06.14 06.14 06.14 06.14 06.14 06.14 06.14 06.14 06.14 06.14	24.3451-1713.7 24.3451-1714.7 220737 220738	<input type="checkbox"/> <input type="checkbox"/>	D=40/45, - Halter D=40/45, - Halter TRW TRW
	1.9 CDTI 1.9 CDTI 1.9 Di 2.0 2.0 16V 2.0 CDTI 2.0 CDTI 2.5 CDTI 2.5 CDTI 2.5 CDTI 2.5 DTi	60 74 60 86 88 66 84 84 99 107 99		08.01 08.01 08.06 08.06 08.01 08.06 08.06 08.06 05.03 08.06 08.06	06.14 06.14 06.14 06.14 06.14 06.14 06.14 06.14 06.14 06.14 06.14	24.5111-0386.3 330503	2	L=385
	1.9 CDTI 1.9 CDTI 1.9 Di 2.0 2.0 16V 2.0 CDTI 2.0 CDTI 2.5 CDTI 2.5 CDTI 2.5 CDTI 2.5 DTi	60 2V607599 74 2V607599 60 2V607599 86 2V607599 88 2V607599 66 2V607599 84 2V607599 84 2V607599 99 2V607599 107 2V607599 99 2V607599		06.14 06.14 06.14 06.14 06.14 06.14 06.14 06.14 06.14 06.14 06.14		24.3414-1707.5 24.3414-1708.5 240337 240338	<input type="checkbox"/> <input type="checkbox"/>	D=41, - Halter D=41, - Halter TRW TRW
	1.9 CDTI 1.9 CDTI 1.9 Di 2.0 2.0 16V 2.0 CDTI 2.0 CDTI 2.5 CDTI 2.5 CDTI 2.5 CDTI 2.5 DTi	60 74 60 86 88 66 84 84 99 107 99		08.01 08.01 08.06 08.06 08.01 08.06 08.06 08.06 05.03 08.06 08.06	06.14 06.14 06.14 06.14 06.14 06.14 06.14 06.14 06.14 06.14 06.14	24.5229-0200.3 24.5111-0221.3 330572 330818	2 2 am Bremssattel ¹⁾	L=200 L=220
	1.9 CDTI 1.9 CDTI 1.9 Di 2.0 2.0 16V 2.0 CDTI 2.0 CDTI 2.5 CDTI 2.5 CDTI 2.5 CDTI 2.5 DTi	60 74 60 86 88 66 84 84 99 107 99	606709 606709 606709 606709 606709 606709 606709 606709 606709 606709 606709	08.01 08.01 08.06 08.06 08.01 08.06 08.06 08.06 05.03 08.06 08.06	- Pritsche/Fahrgestell ²⁾ - Pritsche/Fahrgestell ²⁾ - Pritsche/Fahrgestell ²⁾ - Pritsche/Fahrgestell ²⁾ - Pritsche/Fahrgestell ²⁾ - Pritsche/Fahrgestell ²⁾ - Pritsche/Fahrgestell ²⁾ - Pritsche/Fahrgestell ²⁾ - Pritsche/Fahrgestell ²⁾ - Pritsche/Fahrgestell ²⁾ - Pritsche/Fahrgestell ²⁾	24.3727-0796.2 24.3727-0797.2 580796 580797	1  1 	+ kurzer Radstand ³⁾ + langer Radstand ⁴⁾ L=1245/498 L=1643/498
	1.9 CDTI 1.9 CDTI 1.9 Di 2.0 2.0 16V 2.0 CDTI 2.0 CDTI 2.5 CDTI 2.5 CDTI 2.5 CDTI 2.5 DTi	60 74 60 86 88 66 84 84 99 107 99		08.01 08.01 08.06 08.06 08.01 08.06 08.06 08.06 05.03 08.06 08.06	06.14 06.14 06.14 06.14 06.14 06.14 06.14 06.14 06.14 06.14 06.14	24.3727-1068.2 24.3727-1071.2 581068 581071	<input type="checkbox"/> <input type="checkbox"/>	L=1503 L=1603

1) on the brake caliper / sulla pinza freno / sur l'étrier de frein / a la pinza de freno
2) - Pickup/Chassis / - Autocarro a cassone/Telaio / - Camion plateau/Châssis / - Camión plataforma/Chasis
3) + short wheel base / + passo lungo / + empattement court / + distancia corta entre ejes
4) + long wheel base / + passo lungo / + empattement long / + distancia larga entre ejes

OPEL VIVARO B (14-)											
	1.6 Biturbo CDTI	103		07.14		24.3414-1707.5	240337		D=41, - Halter	TRW	
	1.6 CDTI	66		07.14		24.3414-1708.5	240338		D=41, - Halter	TRW	
	1.6 CDTi	70		04.15							
	1.6 CDTI	85		07.14							
	1.6 CDTI	88		07.14							
	1.6 CDTI	92		04.15							
	1.6 CDTi	107		04.15							
OPEL ZAFIRA I / Vauxhall Zafira I (99-05)											
	1.6 16V			04.99	06.05	- ESP	24.2123-1734.3	010640		THz 23,81	TRW
	1.8 16V			04.99	06.05	- ESP					
	2.0 16V OPC			09.01	06.05	- ESP					
	2.0 DI 16V			10.99	06.05	- ESP					
	2.0 DTI 16V			06.00	06.05	- ESP					
	2.2 16V			09.00	06.05	- ESP					
	2.2 DTI 16V			01.02	06.05	- ESP					
	1.6 16V			04.99	06.05	+ ESP	24.2123-1739.3	010661		THz 23,81	
	1.8 16V			04.99	06.05	+ ESP					
	2.0 16V OPC			09.01	06.05	+ ESP					
	2.0 DI 16V			10.99	06.05	+ ESP					
	2.0 DTI 16V			06.00	06.05	+ ESP					
	2.2 16V			09.00	06.05	+ ESP					
	2.2 DTI 16V			01.02	06.05	+ ESP					
	1.6 16V			04.99	06.05		11.9571-9823.2	220471		D=57, - Halter	ATE
	1.8 16V			04.99	06.05		11.9571-9824.2	220472		D=57, - Halter	ATE
	2.0 16V OPC			09.01	06.05		24.3571-9823.5	240499		D=57, - Halter	ATE
	2.0 DI 16V			10.99	06.05		24.3571-9824.5	240500		D=57, - Halter	ATE
	2.0 DTI 16V			06.00	06.05		11.0441-5704.2	250034		Dichtungssatz	ATE
	2.2 16V			09.00	06.05		11.0101-5407.2	260011		Hülzensatz	ATE
	2.2 DTI 16V			01.02	06.05		11.8171-0008.1	990049		Führungsbolzen	ATE
							11.8116-0292.1	390521	2	Haltefeder	ATE
	1.6 16V			04.99	06.05		24.5241-0396.3	331380	2	L=398	
	1.8 16V			04.99	06.05						
	2.0 16V OPC			09.01	06.05						
	2.0 DI 16V			10.99	06.05						
	2.0 DTI 16V			06.00	06.05						
	2.2 16V			09.00	06.05						
	2.2 DTI 16V			01.02	06.05						
	1.6 16V			04.99	06.05	+ D A CH	24.3384-1753.7	220633		D=38, - Halter	TRW
	1.8 16V			04.99	06.05		24.3384-1754.7	220634		D=38, - Halter	TRW
	2.0 16V OPC			09.01	06.05						
	2.0 DI 16V			10.99	06.05						
	2.0 DTI 16V			06.00	06.05						
	2.2 16V			09.00	06.05						
	2.2 DTI 16V			01.02	06.05						
	1.6 16V			04.99	06.05	- D A CH	24.5240-0220.3	330619	2	L=220	
	1.6 16V	22999999		04.99		+ D A CH	24.5241-0200.3	330620	2	L=200	
	1.8 16V	22999999		04.99							
	2.0 16V OPC	22999999		09.01							
	2.0 DI 16V	22999999		10.99							
	2.0 DTI 16V	22999999		06.00							
	2.2 16V	22999999		09.00							
	2.2 DTI 16V	22999999		01.02							
	1.6 16V	32000001		06.05	+ D A CH		24.5157-0218.3	331095		L=219/185, + Rohrleitung	
	1.8 16V	32000001		06.05			24.5157-0219.3	331096		L=219/185, + Rohrleitung	
	2.0 16V OPC	32000001		06.05							
	2.0 DI 16V	32000001		06.05							
	2.0 DTI 16V	32000001		06.05							
	2.2 16V	32000001		06.05							
	2.2 DTI 16V	32000001		06.05							
	1.6 16V			04.99	06.05	- D A CH	24.3220-1719.3	020448		Rz 20,64	
	1.6 16V			04.99	06.05	- verstärktes Fahrwerk/ - D A CH	24.3727-0748.2	580748	1 ↑	L=279, + Zub	
							24.3727-0746.2	580746	2 ↓	L=182, + Zub	
	1.6 16V			04.99	06.05	+ verstärktes Fahrwerk/ - D A CH	24.3727-0748.2	580748	1 ↑	L=279, + Zub	
							24.3727-0746.2	580746	2 ↓	L=182, + Zub	
	1.6 16V	22006460		04.99		+ D A CH	24.3727-0748.2	580748	1 ↑	L=279, + Zub	
	1.8 16V	22006460		04.99			24.3727-0757.2	580757	1 ↓	L=1680/1680, + Zub	
	2.0 16V OPC	22006460		09.01							
	2.0 DI 16V	22006460		10.99							
	2.0 DTI 16V	22006460		06.00							
	2.2 16V	22006460		09.00							
	2.2 DTI 16V	22006460		01.02							
	1.6 16V	22006461	32999999			+ D A CH	24.3727-0748.2	580748	1 ↑	L=279, + Zub	
	1.8 16V	22006461	32999999				24.3727-0756.2	580756	1 ↓	L=1680/1680, + Zub	
	2.0 16V OPC	22006461	32999999								
	2.0 DI 16V	22006461	32999999								
	2.0 DTI 16V	22006461	32999999								
	2.2 16V	22006461	32999999								
	2.2 DTI 16V	22006461	32999999								
	1.6 16V	1H999999	1H999999	04.99		+ D A CH	24.3727-0748.2	580748	1 ↑	L=279, + Zub	
	1.8 16V	1H999999	1H999999	04.99			24.3727-0757.2	580757	1 ↓	L=1680/1680, + Zub	
	2.0 16V OPC	1H999999	1H999999	09.01							
	2.0 DI 16V	1H999999	1H999999	10.99							
	2.0 DTI 16V	1H999999	1H999999	06.00							

1) - reinforced susp./-D A CH / - sospensione rinforzata/ - D A CH / - châssis renforcé/ - D A CH / - suspensión reforzada/ - D A CH
2) extension only / solo prolunga / rallonge seulement / solamente prolongador
3) + reinforced susp./-D A CH / + sospensione rinforzata/ - D A CH / + châssis renforcé/ - D A CH / + suspensión reforzada/ - D A CH

OPEL ZAFIRA I / Vauxhall Zafira I (99-05)												
	2.2 16V		1H999999	09.00		24.3727-0748.2	580748	1	↑	L=279, + Zub		
	2.2 DTI 16V		1H999999	01.02		24.3727-0757.2	580757	1	↓	L=1680/1680, + Zub		
	1.6 16V	2H000001	32999999		+ D A CH	24.3727-0748.2	580748	1	↑	L=279, + Zub		
	1.8 16V	2H000001	32999999			24.3727-0756.2	580756	1	↓	L=1680/1680, + Zub		
	2.0 16V OPC	2H000001	32999999									
	2.0 DI 16V	2H000001	32999999									
	2.0 DTI 16V	2H000001	32999999									
	2.2 16V	2H000001	32999999									
	2.2 DTI 16V	2H000001	32999999									
	1.6 16V	42000001			06.05	+ D A CH	24.3727-0748.2	580748	1	↑	L=279, + Zub	
1.8 16V	42000001			06.05		24.3727-0784.2	580784	1	↓	L=1677/1677, + Zub		
2.0 16V OPC	42000001			06.05						- Schlechtwegeausführung 1)		
2.0 DI 16V	42000001			06.05								
2.0 DTI 16V	42000001			06.05								
2.2 16V	42000001			06.05								
2.2 DTI 16V	42000001			06.05								
	1.6 16V			04.99	06.05	- ABS	03.6583-0085.3	320238		BRL 8/3 (4)	ATE	
	1.8 16V			04.99	06.05	- ABS						
	2.0 16V OPC			09.01	06.05	- ABS						
	2.0 DI 16V			10.99	06.05	- ABS						
	2.0 DTI 16V			06.00	06.05	- ABS						
	2.2 16V			09.00	06.05	- ABS						
	2.2 DTI 16V			01.02	06.05	- ABS						
OPEL ZAFIRA II / Vauxhall Zafira II (05-)												
	1.6	◀ 77		07.05		03.7863-7803.4	300237		+ ESP	10"	ATE	
	1.6	◀ 85		12.07								
	1.6 CNG	◀ 69		01.06								
	1.6 CNG Turbo	◀ 110		02.09								
	1.7 CDTI	◀ 81		12.07								
	1.7 CDTI	◀ 92		12.07								
	1.8	◀ 88		06.13								
	1.8	◀ 103		07.05								
	1.9 CDTI	◀ 74		07.05								
	1.9 CDTI	◀ 88		07.05								
	1.9 CDTI	◀ 110		07.05								
	2.0	◀ 125		07.05								
	2.0 OPC	◀ 177		09.05								
	2.0 Turbo	◀ 147		07.05								
	2.2	◀ 110		07.05								
		1.6	◀ 77		07.05		03.4155-0153.3	010927		- ESP	THz 25,40	ATE
		1.6	◀ 85		12.07		03.4155-0156.3	010862		+ ESP	THz 25,40	ATE
1.6 CNG		◀ 69		01.06								
1.6 CNG Turbo		◀ 110		02.09								
1.7 CDTI		◀ 81		12.07								
1.7 CDTI		◀ 92		12.07								
1.8		◀ 88		06.13								
1.8		◀ 103		07.05								
1.9 CDTI		◀ 74		07.05								
1.9 CDTI		◀ 88		07.05								
1.9 CDTI		◀ 110		07.05								
2.0		◀ 125		07.05								
2.0 OPC		◀ 177		09.05								
2.0 Turbo		◀ 147		07.05								
2.2		◀ 110		07.05								
		1.6	▶ 77	6G999999	07.05		24.2125-1736.3	010904			THz 25,40	TRW
		1.6 CNG Turbo	▶ 110	6G999999	02.09							
	1.8	▶ 103	6G999999	07.05								
	2.0	▶ 125	6G999999	07.05								
	2.0 OPC	▶ 177	6G999999	09.05								
	2.0 Turbo	▶ 147	6G999999	07.05								
	1.6	▶ 77 72000001				24.4125-1703.3	010907			THz 25,40	TRW	
1.6 CNG Turbo	▶ 110 72000001											
1.8	▶ 88		06.13									
1.8	▶ 103 72000001											
2.0	▶ 125 72000001											
2.0 OPC	▶ 177 72000001											
2.0 Turbo	▶ 147 72000001											
	1.7 CDTI	▶ 81		12.07		03.4155-0156.3	010862			THz 25,40	ATE	
	1.7 CDTI	▶ 92		12.07								
	1.9 CDTI	▶ 74		07.05								
	1.9 CDTI	▶ 88		07.05								
	1.9 CDTI	▶ 110		07.05								
	2.2	▶ 110		07.05								
		1.6	77		07.05		11.9571-9823.2	220471	☐		D=57, - Halter	ATE
1.6		85		12.07		11.9571-9824.2	220472	☐		D=57, - Halter	ATE	
1.8		88		06.13		24.3571-9823.5	240499	☐		D=57, - Halter	ATE	
1.8		103		07.05		24.3571-9824.5	240500	☐		D=57, - Halter	ATE	
						11.0441-5704.2	250034			Dichtungssatz	ATE	
						11.0101-5407.2	260011			Hülssensatz	ATE	
					11.8171-0008.1	990049			Führungsbolzen	ATE		
					11.8116-0292.1	390521	2		Haltefeder	ATE		

1) - rough road construction / - versione per percorsi accidentati / - version pour mauvaise route / - versión 4x4



OPEL ZAFIRA II / Vauxhall Zafira II (05-)										
	1.6 CNG	69	01.06		11.9571-9823.2	220471	2	ATE	D=57, - Halter	ATE
	1.6 CNG Turbo	110	02.09		11.9571-9824.2	220472				
	1.7 CDTI	81	12.07		24.3571-9823.5	240499				
	1.7 CDTI	92	12.07		24.3571-9824.5	240500				
	1.9 CDTI	74	07.05		11.0441-5704.2	250034				
	1.9 CDTI	88	07.05		11.8170-0758.1	260120				
	1.9 CDTI	110	07.05		11.0101-5407.2	260011				
	2.0	125	07.05		11.8171-0008.1	990049				
	2.0 Turbo	147	07.05		11.8116-0292.1	390521				
	2.2	110	07.05							
	2.0 OPC	177	09.05		11.0101-5407.2	260011				
					11.8171-0008.1	990049				
				11.8116-0356.1	390586					
	1.6	77	07.05		24.5241-0429.3	331381	2	ATE	Hülensatz	ATE
	1.6	85	12.07							
	1.6 CNG	69	01.06							
	1.6 CNG Turbo	110	02.09							
	1.7 CDTI	81	12.07							
	1.7 CDTI	92	12.07							
	1.8	88	06.13							
	1.8	103	07.05							
	1.9 CDTI	74	07.05							
	1.9 CDTI	88	07.05							
	1.9 CDTI	110	07.05							
	2.0	125	07.05							
2.0 Turbo	147	07.05								
2.2	110	07.05								
	1.6	77	07.05		24.3417-1703.7	220759	2	TRW	D=41, - Halter	TRW
	1.6	85	12.07		24.3417-1704.7	220760				
	1.6 CNG	69	01.06		24.0101-3803.2	260101				
	1.6 CNG Turbo	110	02.09							
	1.7 CDTI	81	12.07							
	1.7 CDTI	92	12.07							
	1.8	88	06.13							
	1.8	103	07.05							
	1.9 CDTI	74	07.05							
	1.9 CDTI	88	07.05							
	1.9 CDTI	110	07.05							
	2.0	125	07.05							
2.0 Turbo	147	07.05								
2.2	110	07.05								
	1.6	77	07.05		24.5157-0218.3	331095	2	ATE	L=219/185, + Rohrleitung	ATE
	1.6	85	12.07		24.5157-0219.3	331096				
	1.6 CNG	69	01.06							
	1.6 CNG Turbo	110	02.09							
	1.7 CDTI	81	12.07							
	1.7 CDTI	92	12.07							
	1.8	88	06.13							
	1.8	103	07.05							
	1.9 CDTI	74	07.05							
	1.9 CDTI	88	07.05							
	1.9 CDTI	110	07.05							
	2.0	125	07.05							
2.0 OPC	177	09.05								
2.0 Turbo	147	07.05								
2.2	110	07.05								
	1.6	77	07.05		24.3727-0790.2	580790	1	ATE	L=1749/1774, + Zub	ATE
	1.6	85	12.07							
	1.6 CNG	69	01.06							
	1.6 CNG Turbo	110	02.09							
	1.7 CDTI	81	12.07							
	1.7 CDTI	92	12.07							
	1.8	88	06.13							
	1.8	103	07.05							
	1.9 CDTI	74	07.05							
	1.9 CDTI	88	07.05							
	1.9 CDTI	110	07.05							
	2.0	125	07.05							
2.0 OPC	177	09.05								
2.0 Turbo	147	07.05								
2.2	110	07.05								
OPEL ZAFIRA III Tourer / Vauxhall Zafira III Tourer (11-)										
	1.4 T	88	11.11		03.7858-0732.4	300272	ATE	ATE	9/8" Tandem	ATE
	1.4 T	103	11.11							
	1.4 T LPG	103	11.11							
	1.6 CDTi ecoFLEX	88	07.14							
	1.6 CDTi ecoFLEX	100	03.13							
	1.6 SIDI	125	12.12							
	1.6 SIDI	147	07.13							
	1.6 T CNG	110	11.11							
	1.8	103	11.11							
	1.8	101	11.11							
	1.8 LPG	101	11.11							
	2.0 CDTi	81	11.11							
2.0 CDTi	96	11.11								

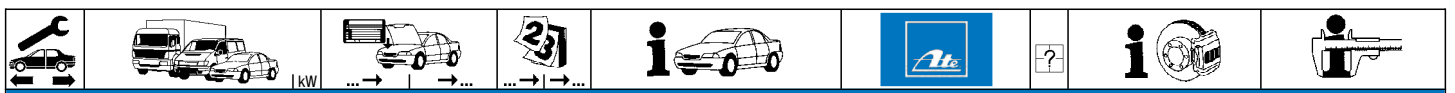

OPEL ZAFIRA III Tourer / Vauxhall Zafira III Tourer (11-)

	2.0 CDTi 2.0 CDTi BiTurbo	125 143		01.15 12.12		03.7858-0732.4	300272		9/8" Tandem	ATE
	1.4 T 1.4 T 1.4 T LPG 1.6 CDTi ecoFLEX 1.6 CDTi ecoFLEX 1.6 SIDI 1.6 SIDI 1.6 T CNG 1.8 1.8 1.8 LPG 2.0 CDTi 2.0 CDTi 2.0 CDTi 2.0 CDTi 2.0 CDTi BiTurbo	88 103 103 88 100 125 147 110 103 101 81 96 125 143		11.11 11.11 11.11 07.14 03.13 12.12 07.13 11.11 11.11 11.11 11.11 11.11 01.15 12.12		03.2125-0421.3	010934		THz 25,40	ATE
	1.4 T 1.4 T 1.4 T LPG 1.6 CDTi ecoFLEX 1.6 CDTi ecoFLEX 1.6 SIDI 1.6 SIDI 1.6 T CNG 1.8 1.8 1.8 LPG 2.0 CDTi 2.0 CDTi 2.0 CDTi 2.0 CDTi 2.0 CDTi BiTurbo	88 103 103 88 100 125 147 110 103 101 81 96 125 143	ORGA 08787	05.96 01.97 09.00 01.97 05.96 05.96 03.04 05.96 03.04 04.96 07.04	- ABS - ABS - ABS - ABS - ABS - ABS - ABS - ABS	11.9601-2601.2 11.9601-2602.2	220913 220914	<input type="checkbox"/> <input type="checkbox"/>	D=60, - Halter D=60, - Halter	ATE ATE

PEUGEOT 106 (96-04)

	1.0 i 1.0 i 1.1 1.1 i 1.1 i 1.6 1.6 1.6 16V Electric	33 37 42 40 44 65 74 87 20	ORGA 08787	05.96 01.97 09.00 01.97 05.96 05.96 03.04 05.96 03.04 04.96 07.04	- ABS - ABS - ABS - ABS - ABS - ABS - ABS - ABS	03.7740-3302.4	300107		8"	ATE
	1.0 i 1.0 i 1.1 i 1.1 i 1.6 1.6 1.6 16V Electric	33 37 40 44 65 74 87 20	ORGA 08787	05.96 01.97 01.97 05.96 05.96 03.04 05.96 03.04 04.96 07.04	- ABS - ABS - ABS - ABS - ABS - ABS - ABS	03.2120-4166.3 24.2120-1722.3	010452 010544		THz 20,64 THz 20,64	ATE BDX
	1.0 i 1.0 i 1.1 i 1.1 i 1.4 i 1.5 D 1.5 D	33 37 40 44 55 40 42	ORGA 08788	03.04 03.04 03.04 03.04 05.96 03.04 05.96 03.04 10.00 03.04	- ABS - ABS - ABS - ABS - ABS - ABS - ABS	24.2119-1708.3	010543		THz 19,05	BDX
	1.0 i 1.0 i 1.1 1.1 i 1.1 i 1.4 i 1.5 D 1.5 D 1.6 1.6	33 37 42 40 44 55 40 42 65 74		05.96 03.04 01.97 03.01 09.00 10.02 01.97 03.04 05.96 03.04 05.96 03.04 10.00 03.04 05.96 03.04 05.96 03.04	+ ABS + ABS + ABS + ABS + ABS + ABS + ABS + ABS	24.2120-1728.3	010626		THz 20,64	
	1.0 i 1.0 i 1.1 1.1 i 1.1 i 1.6 1.6 16V	33 37 42 40 44 74 87		05.96 03.04 01.97 03.04 09.00 10.02 01.97 03.04 05.96 03.04 05.96 03.04 05.96 03.04	- ABS - ABS - ABS - ABS - ABS - ABS	11.0441-4501.2	250015		Dichtungssatz	ATE
	1.0 i 1.0 i 1.0 i	33 33 37	ORGA 07874 ORGA 07664 ORGA 07874	05.96 05.96 01.97	+ ABS - ABS + ABS	11.3481-9833.2 11.3481-9834.2 24.3481-9833.5 24.3481-9834.5 11.0441-4811.2 11.0101-5407.2 11.8171-0008.1 11.8116-0129.1	220561 220562 240479 240480 250024 260011 990049 390591	<input type="checkbox"/> <input type="checkbox"/> <input type="checkbox"/> <input type="checkbox"/>	D=48, - Halter D=48, - Halter D=48, - Halter D=48, - Halter Dichtungssatz Hülzensatz Führungsbolzen Haltefeder	ATE ATE ATE ATE ATE ATE ATE
	1.0 i 1.0 i 1.0 i	33 33 37	ORGA 07874 ORGA 07664 ORGA 07874	05.96 05.96 01.97	+ ABS - ABS + ABS	24.5111-0330.3 24.5111-0301.3	330160 330499	2 2	für 3-Loch-Felge ²⁾ für 4-Loch-Felge ³⁾	L=330 L=300

1) + brake disc diameter 300mm / + diametro dischi freno 300mm / + diamètre disques frein 300mm / + diámetro disco freno 300mm
 2) for 3 bore wheel rim / per cerchione a 3 fori / pour jante à 3 trous / para Liantas de 3 taladros
 3) for 4 bore wheel rim / per cerchione a 4 fori / pour jante à 4 trous / para Liantas de 4 taladros



PEUGEOT 106 (96-04)														
	1.0 i	37	ORGA 07664	01.97	- ABS	24.5111-0330.3	330160	2	für 3-Loch-Felge ¹⁾ für 4-Loch-Felge ²⁾	L=330 L=300				
	1.1	42	ORGA 07664	09.00	- ABS	24.5111-0301.3	330499	2						
	1.1 i	44	ORGA 07664	05.96	- ABS									
	1.0 i	33	ORGA 07875		03.04	+ ABS	24.5111-0290.3	330108	2	L=290				
	1.0 i	33	ORGA 07665		03.04	- ABS								
	1.0 i	37	ORGA 07875		03.12	+ ABS								
	1.0 i	37	ORGA 07665		03.04	- ABS								
	1.1	42	ORGA 07665		10.02	- ABS								
	1.1 i	40	ORGA 07665		03.04	- ABS								
	1.1 i	44	ORGA 07665		03.04	- ABS								
	1.4 i	55	ORGA 07874	05.96		+ ABS	24.5111-0301.3	330499	2	L=300				
	1.4 i	55	ORGA 07664	05.96		- ABS								
	1.5 D	40	ORGA 07874	05.96		+ ABS								
	1.5 D	40	ORGA 07664	05.96		- ABS								
	1.6	65	ORGA 07874	05.96		+ ABS								
1.6	65	ORGA 07664	05.96		- ABS									
1.6	74	ORGA 07874	05.96		+ ABS									
1.6	74	ORGA 07664	05.96		- ABS									
1.6 16V	87	ORGA 07874	05.96		+ ABS									
1.6 16V Electric	20	ORGA 07664	04.96	07.04	- ABS									
1.4 i	55	ORGA 07875		03.04	+ ABS	24.5111-0290.3	330108	2	L=290					
1.4 i	55	ORGA 07665		03.04	- ABS									
1.5 D	40	ORGA 07665		03.04	- ABS									
1.5 D	40	ORGA 07875		03.04	+ ABS									
1.5 D	42		10.00	03.04	+ ABS									
1.5 D	42		10.00	03.04	- ABS									
1.6	65	ORGA 07875		03.04	+ ABS									
1.6	65	ORGA 07665		03.04	- ABS									
1.6	74	ORGA 07875		03.04	+ ABS									
1.6	74	ORGA 07665		03.04	- ABS									
1.6 16V	87	ORGA 07875		03.04	+ ABS									
1.6 16V	87	ORGA 07665		03.04	- ABS									
	1.0 i	33		05.96	03.04					- verstärktes Fahrwerk ³⁾	24.5229-0199.3	330534	2	L=200
	1.0 i	37		01.97	03.04	- verstärktes Fahrwerk ³⁾								
	1.1	42		09.02	10.02	- verstärktes Fahrwerk ³⁾								
	1.1 i	40		01.97	03.04	- verstärktes Fahrwerk ³⁾								
	1.1 i	44		05.96	03.04	- verstärktes Fahrwerk ³⁾								
	1.4 i	55		05.96	03.04	- verstärktes Fahrwerk ³⁾								
	1.5 D	40		05.96	03.04	- verstärktes Fahrwerk ³⁾								
	1.5 D	42		10.00	03.04	- verstärktes Fahrwerk ³⁾								
	1.6	65		05.96	03.04	- verstärktes Fahrwerk ³⁾								
	1.6	74		05.96	03.04	- verstärktes Fahrwerk ³⁾								
	1.6 16V	87		05.96	03.04	- verstärktes Fahrwerk ³⁾								
	1.6 16V Electric	20		04.96	07.04									
	1.0 i	33		05.96	03.04	+ verstärktes Fahrwerk ⁴⁾	24.5229-0199.3	330534	<input type="checkbox"/>	L=200				
	1.0 i	37		01.97	03.04	+ verstärktes Fahrwerk ⁴⁾								
	1.1	42		09.00	10.02	+ verstärktes Fahrwerk ⁴⁾								
1.1 i	40		01.97	03.04	+ verstärktes Fahrwerk ⁴⁾									
1.1 i	44		05.96	03.04	+ verstärktes Fahrwerk ⁴⁾									
1.4 i	55		05.96	03.04	+ verstärktes Fahrwerk ⁴⁾									
1.5 D	40		05.96	03.04	+ verstärktes Fahrwerk ⁴⁾									
1.5 D	42		10.00	03.04	+ verstärktes Fahrwerk ⁴⁾									
1.6	65		05.96	03.04	+ verstärktes Fahrwerk ⁴⁾									
1.6	74		05.96	03.04	+ verstärktes Fahrwerk ⁴⁾									
1.6 16V	87		05.96	03.04	+ verstärktes Fahrwerk ⁴⁾									
1.6 16V Electric	20		04.96	07.04										
	1.0 i	33		05.96	03.04	- ABS					24.3219-1603.3	020200	<input type="checkbox"/>	RzR 19,05
	1.0 i	37		01.97	03.04	- ABS								
	1.1	42		09.00	10.02	- ABS								
	1.1 i	40		01.97	03.04	- ABS								
	1.1 i	44		05.96	03.04	- ABS								
	1.0 i	33	ORGA 08056	05.96		+ ABS	24.3220-1711.3	020409	<input type="checkbox"/>	Rz 20,64	TRW			
	1.0 i	37	ORGA 08056	01.97		+ ABS								
	1.1 i	40	ORGA 08056	01.97		+ ABS								
	1.1 i	44	ORGA 08056	05.96		+ ABS								
	1.0 i	33	ORGA 08057		03.04	+ ABS	24.3220-1717.3	020430	<input type="checkbox"/>	Rz 20,64	TRW			
	1.0 i	37	ORGA 08057		03.04	+ ABS								
	1.1	42		09.00	10.02	+ ABS								
	1.1 i	40	ORGA 08057		03.04	+ ABS								
	1.1 i	44	ORGA 08057		03.04	+ ABS								
	1.4 i	55		05.96	03.04	- ABS	24.3219-1609.3	020319	<input type="checkbox"/>	RzR 19,05				
1.5 D	40		05.96	03.04	- ABS									
1.5 D	42		10.00	03.04	- ABS									
1.6	65		05.96	03.04	- ABS									
1.4 i	55	ORGA 08056	05.96		+ ABS	24.3220-1711.3	020409	<input type="checkbox"/>	Rz 20,64	TRW				
1.5 D	40	ORGA 08056	05.96		+ ABS									
1.6	65	ORGA 08056	05.96		+ ABS									
1.4 i	55	ORGA 08057		03.04	+ ABS	24.3220-1717.3	020430	<input type="checkbox"/>	Rz 20,64	TRW				
1.5 D	40	ORGA 08057		03.04	+ ABS									
1.5 D	42		10.00	03.04	+ ABS									
1.6	65	ORGA 08057		03.04	+ ABS									
1.6 16V	20		04.96	07.04	- ABS	24.3219-1112.3	020311		+ 4-Loch-Felge ⁷⁾	Rz 19,05	BDX			

¹⁾ for 3 bore wheel rim / per cerchione a 3 fori / pour jante à 3 trous / para Llantas de 3 taladros

²⁾ for 4 bore wheel rim / per cerchione a 4 fori / pour jante à 4 trous / para Llantas de 4 taladros

³⁾ - reinforced suspension / - sospensione rinforzata / - châssis renforcé / - suspensión reforzada

⁴⁾ + reinforced suspension / + sospensione rinforzata / + châssis renforcé / + suspensión reforzada

⁵⁾ + cast iron / + ghisa / + fonte grise / + fundición de gris

⁶⁾ + aluminium / + alluminio / + aluminium / + aluminio

⁷⁾ + 4 bore wheel rim / + cerchione a 4 fori / + jante à 4 trous / + Llantas de 4 taladros

PEUGEOT 106 (96-04)		KW		23		i		ATE		?		i		Key	
	1.0 i	33		05.96	03.04			24.3727-0816.2	580816	2	↓			L=1442	
	1.0 i	37		01.97	03.04										
	1.1	42		09.00	10.02										
	1.1 i	40		01.97	03.04										
	1.1 i	44		05.96	03.04										
	1.4 i	55		05.96	03.04										
	1.5 D	40		05.96	03.04										
	1.5 D	42		10.00	03.04										
	1.6	65		05.96	03.04										
	1.6	74		05.96	03.04			24.3727-0817.2	580817	2	↓			L=1505	
1.6 16V	87		05.96	03.04											
	1.0 i	33		05.96	03.04	- Servolenkung ¹⁾		24.3728-0842.2	590842					L=1337, + AUT	
	1.0 i	37		01.97	03.04	- Servolenkung ¹⁾									
	1.1	42		09.00	10.02	- Servolenkung ¹⁾									
	1.1 i	40		01.97	03.04	- Servolenkung ¹⁾									
	1.1 i	44		05.96	03.04	- Servolenkung ¹⁾									
	1.4 i	55		05.96	03.04	- Servolenkung ¹⁾									
	1.5 D	40		05.96	03.04	- Servolenkung ¹⁾									
	1.5 D	42		10.00	03.04	- Servolenkung ¹⁾									
	1.6	65		05.96	03.04	- Servolenkung ¹⁾									
	1.6	74		05.96	03.04	- Servolenkung ¹⁾									
1.6 16V	87		05.96	03.04	- Servolenkung ¹⁾										
1.1	42	ORGA 08940	09.00		- Fahrschule / + Servolenkung ²⁾		24.3728-0844.2	590844					L=1463, + AUT		
1.1 i	40	ORGA 08940	01.97		- Fahrschule / + Servolenkung ²⁾										
1.1 i	44	ORGA 08940	05.96		- Fahrschule / + Servolenkung ²⁾										
1.4 i	55	ORGA 08940	05.96		+ Servolenkung ³⁾										
1.5 D	40	ORGA 08940	05.96		+ Servolenkung ³⁾										
1.5 D	42	ORGA 08940	10.00		+ Servolenkung ³⁾										
1.6	65	ORGA 08940	05.96		+ Servolenkung ³⁾										
1.6	74	ORGA 08940	05.96		+ Servolenkung ³⁾										
1.6 16V	87	ORGA 08940	05.96		+ Servolenkung ³⁾										
1.0 i	33		05.96	03.04	+ Servolenkung ³⁾		24.3728-0315.2	590315					L=673		
1.0 i	37		01.97	03.04	+ Servolenkung ³⁾										
1.1	42	ORGA 08941		10.02	- Fahrschule/ + Servolenkung ⁴⁾										
1.1 i	40	ORGA 08941		03.04	- Fahrschule/ + Servolenkung ⁴⁾										
1.1 i	44	ORGA 08941		03.04	- Fahrschule/ + Servolenkung ⁴⁾										
1.4 i	55	ORGA 08941		03.04	+ Servolenkung ³⁾										
1.5 D	40	ORGA 08941		03.04	+ Servolenkung ³⁾										
1.5 D	42	ORGA 08941		03.04	+ Servolenkung ³⁾										
1.6	65	ORGA 08941		03.04	+ Servolenkung ³⁾										
1.6	74	ORGA 08941		03.04	+ Servolenkung ³⁾										
1.6 16V	87	ORGA 08941		03.04	+ Servolenkung ³⁾										
1.1	42		09.00	10.02	+ Fahrschule/ + Servolenkung ⁵⁾		24.3728-0814.2	590814					L=678		
1.1 i	44		05.96	03.04	+ Fahrschule/ + Servolenkung ⁵⁾										
PEUGEOT 107 (05-14)															
	1.0	50		06.05	05.14			24.4120-1701.3	010846			- DSC	THz 20,64	BOS	
	1.4 HDi	40		06.05	05.14										
	1.0	50		06.05	05.14			24.3481-1791.5	240731				D=48, - Halter		
	1.4 HDi	40		06.05	05.14			24.3481-1792.5	240732				D=48, - Halter		
	1.0	50		06.05	05.14			24.5295-0496.3	331033				L=496		
	1.4 HDi	40		06.05	05.14			24.5262-0501.3	331025				L=501		
	1.0	50		06.05	05.14			24.5261-0225.3	330909	2			L=225		
	1.4 HDi	40		06.05	05.14										
	1.0	50		06.05	05.14			24.3217-1719.3	020482				Rz 17,46	BOS	
	1.4 HDi	40		06.05	05.14										
	1.0	50		06.05	05.14			24.3728-0851.2	590851				L=1596		
	1.4 HDi	40		06.05	05.14			24.3728-0852.2	590852				L=1479		
PEUGEOT 108 (14-)															
	1.0 68 VTi	51		05.14				24.3481-1791.5	240731				D=48, - Halter		
	1.2 82 VTi	60		05.14				24.3481-1792.5	240732				D=48, - Halter		
PEUGEOT 205 (91-98)															
	1.0	33		09.90	09.98			03.2119-3389.3	010057			+ 4 Anschlüsse ⁶⁾	THz 19,05	ATE	
	1.1			09.90	09.98			03.2120-2031.3	010106			+ 4 Anschlüsse ⁶⁾	THz 20,64	ATE	
	1.1 i	44		09.90	09.98			03.3517-5100.1	390326				Verschlußschraube	ATE	
	1.4			09.90	09.98										
	1.4 i	55		09.90	09.98										
	1.6			09.90	09.98										
	1.6 i	66		09.90	09.98	- ABS									
	1.7 D	44		03.94	09.98										
	1.7 TD	57		09.90	09.98										
	1.9 D	47		09.90	09.98										
	1.9 GTI	88		09.90	10.94	- ABS									
	1.9 GTI	94		09.90	09.98	- ABS									
	1.9 GTI/CTI	75		09.90	07.94	- ABS									

¹⁾ - power steering / - servosterzo / - direction assistée / - dirección asistida

²⁾ - driving school/+power steering / - scuola guida/ + servosterzo / - auto école/ + direct.assistée / - autoescuela/ + direcc.asistida

³⁾ + power steering / + servosterzo / + direction assistée / + dirección asistida

⁴⁾ - driving school/+power steering / - scuola guida/ + servosterzo / - auto école/ + direct.assistée / - autoescuela/ + direcc.asistida

⁵⁾ + driving school/+power steering / + scuola guida/ + servosterzo / + auto école/ + direction assistée / + autoescuela/ + direcc.asistida

⁶⁾ + 4 connections / + 4 attacchi / + 4 raccords / + 4 conexiones

PEUGEOT 205 (91-98)											
	1.0	33		09.90	09.98	24.3481-1609.7	220197			D=48, + Halter	TRW
	1.1			09.90	09.98	24.3481-1610.7	220198			D=48, + Halter	TRW
	1.4			09.90	09.98						
	1.6			09.90	09.98						
	1.1 i	44		09.90	09.98	24.3481-1609.7	220197			D=48, + Halter	TRW
	1.4 i	55		09.90	09.98	24.3481-1610.7	220198			D=48, + Halter	TRW
	1.6 i	66		09.90	09.98						
	1.9 GTI/CTI	75		09.90	07.94						
	1.7 TD	57		06.93	09.98	11.3481-9833.2	220561			D=48, - Halter	ATE
						11.3481-9834.2	220562			D=48, - Halter	ATE
					24.3481-9833.5	240479			D=48, - Halter	ATE	
					24.3481-9834.5	240480			D=48, - Halter	ATE	
					11.0441-4811.2	250024			Dichtungssatz	ATE	
					11.0101-5407.2	260011			Hülsensatz	ATE	
					11.8171-0008.1	990049			Führungsbolzen	ATE	
					11.8116-0129.1	390591	2		Haltefeder	ATE	
1.9 D	47		09.90	09.98	24.3481-1609.7	220197			D=48, + Halter	TRW	
					24.3481-1610.7	220198			D=48, + Halter	TRW	
1.9 GTI	88		09.90	10.94	11.3481-9833.2	220561			D=48, - Halter	ATE	
1.9 GTI	94		09.90	09.98	11.3481-9834.2	220562			D=48, - Halter	ATE	
					24.3481-1615.5	240031			D=48, - Halter	TRW	
					24.3481-1616.5	240032			D=48, - Halter	TRW	
					11.0441-4811.2	250024			Dichtungssatz	ATE	
					11.0101-5407.2	260011			Hülsensatz	ATE	
					24.0101-4806.2	260052			Bremssattel-Zubehör	TRW	
					11.8116-0129.1	390591	2		Haltefeder	ATE	
					11.8171-0008.1	990049			Führungsbolzen	ATE	
	1.0	33		09.90	09.98	24.5112-0325.3	330415	2	Länge beachten ¹⁾	L=355	
	1.1			09.90	09.98	24.5112-0405.3	330428	2	Länge beachten ¹⁾	L=405	
	1.1 i	44		09.90	09.98						
	1.4			09.90	09.98						
	1.4 i	55		09.90	09.98						
	1.6			09.90	09.98						
	1.7 D	44		03.94	09.98						
	1.9 D	47		09.90	09.98						
	1.9 GTI/CTI	75		09.90	07.94						
	1.7 TD	57		09.90	09.98	24.5112-0430.3	330615	2		L=430	
1.6 i	66		09.90	09.98	+ ABS	24.5112-0405.3	330428	2		L=405	
1.9 GTI	88		09.90	10.94							
1.9 GTI	94		09.90	09.98							
1.9 GTI/CTI	75		09.90	07.94	+ ABS						
	1.0	33		09.90	09.98	24.5228-0255.3	330409	2		L=255	
	1.1			09.90	09.98						
	1.1 i	44		09.90	09.98						
	1.4			09.90	09.98						
	1.4 i	55		09.90	09.98						
	1.6			09.90	09.98						
	1.7 TD	57		09.90	09.98						
	1.9 D Lim.	47		09.90	09.98						
	1.9 GTI/CTI	75		09.90	07.94						
	1.7 D	44		03.94	09.98	24.5112-0325.3	330415	2		L=355	
1.9 D Kombi	47		09.90	09.98							
1.9 GTI	88		09.90	10.94	- ABS	24.5112-0155.3	330507	2	Länge beachten ¹⁾	L=155	
1.9 GTI	94		09.90	09.98	- ABS	24.5228-0255.3	330409	2	Länge beachten ¹⁾	L=255	
1.6 i	66		09.90	09.98	+ ABS	24.5112-0300.3	330696	2	Länge beachten ¹⁾	L=300	
1.9 GTI	88		09.90	10.94	+ ABS	24.5112-0155.3	330507	2	Länge beachten ¹⁾	L=155	
1.9 GTI	94		09.90	09.98	+ ABS						
1.9 GTI/CTI	75		09.90	07.94	+ ABS						
	1.0	33		09.90	09.98	24.3219-1605.3	020202			RzR 19,05	BDX
	1.1			09.90	09.98	24.3219-1606.3	020203			RzR 19,05	BDX
	1.1 i	44		09.90	09.98	24.3219-1601.3	020198			RzR 19,05	TRW
	1.4			09.90	09.98	24.3219-1602.3	020199			RzR 19,05	TRW
	1.4 i	55		09.90	09.98						
	1.6			09.90	09.98						
	1.6 i	66		09.90	09.98						
	1.7 TD	57		09.90	09.98						
	1.9 D Lim.	47		09.90	09.98						
	1.7 TD	57		09.90	09.98	+ ABS	24.3219-1118.3	020332		Rz 19,05	TRW
1.9 GTI/CTI	75		09.90	07.94							
1.7 D	44		03.94	09.98	24.3220-1619.3	020246			Rz 20,64	TRW	
1.9 D Kombi	47		09.90	09.98							
	1.0	33		09.90	09.98	24.3727-0802.2	580802			L=1372	
	1.1			09.90	09.98	24.3727-0801.2	580801			L=1386	
	1.1 i	44		09.90	09.98						
	1.4			09.90	09.98						
	1.4 i	55		09.90	09.98						
	1.6			09.90	09.98						
	1.6 i	66		09.90	09.98						
	1.7 D	44		03.94	09.98						
	1.7 TD	57		09.90	09.98						
	1.9 D	47		09.90	09.98						
1.9 GTI/CTI	75		09.90	07.94							
1.9 GTI	88		09.90	10.94	24.3727-0810.2	580810			L=1417		
1.9 GTI	94		09.90	09.98	24.3727-0811.2	580811			L=1432		

¹⁾ notice length / attenzione lunghezza / faire attention longueur / atención largo

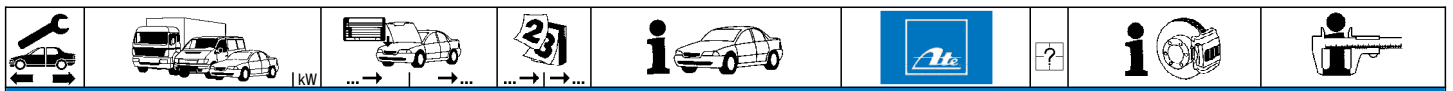

PEUGEOT 206 Limousine (98-09)

	1.4 HDi	50		09.01	02.09		03.2120-4321.3	010525	- ABS	THz 20,64	ATE
	1.4 HDi	51		09.02	02.07		24.2120-1737.3	010757	- ABS	THz 20,64	
	1.4	55		03.07	02.09	+ Automatikgetriebe ¹⁾	03.4122-0031.3	010611	- ABS	THz 22,20	
	1.4	55		09.98	02.09	+ Automatikgetriebe ¹⁾	03.4122-0041.3	010612	+ ABS	THz 22,20	
	1.4 LPG	55		05.06	09.07	+ Automatikgetriebe ¹⁾					
	1.6	65		09.98	12.00	+ Automatikgetriebe ¹⁾					
	1.9 D	51		09.98	02.09	+ (N) (S) (FR)					
	2.0 HDi	66		12.99	02.09	+ (N) (S) (FR)					
	1.4 16V	65		10.03	02.09		03.2122-1356.3	010529	- ABS	THz 22,20	
	1.6 16V	80		12.00	02.09	+ Schaltgetriebe ²⁾					
	2.0 HDi	66		12.99	02.09	- (N) (S) (FR)					
	1.6 16V	80		12.00	02.09	+ Automatikgetriebe ¹⁾	03.4122-0031.3	010611	- ABS	THz 22,20	
	2.0 HDi	66		12.99	02.09	+ (N) (S) (FR)					
	1.4 16V	65		10.03	02.09		03.2122-1351.3	010528	- ESP	THz 22,20	
	1.4 HDi	50		09.01	02.09		03.2122-1942.3	010700	+ ESP	THz 22,20	
	1.4 HDi	51		09.02	02.07						
	1.4 HDi eco 70	50		09.08	02.09						
	1.6 16V	80		12.00	02.09	+ Schaltgetriebe ²⁾					
	1.6 HDi 110	80		05.04	02.09	- (N) (S) (FR)					
2.0 HDi	66		09.98	02.09	- (N) (S) (FR)						
2.0 S16	99		04.99	10.00							
2.0 S16	100		10.00	02.07							
1.6 16V	80		10.00	02.09	+ Automatikgetriebe ¹⁾	03.4122-0041.3	010612	- ESP	THz 22,20		
1.6 HDi 110	80		05.04	02.09	+ (N) (S) (FR)	03.4122-0054.3	010813	+ ESP	THz 22,20		
2.0 HDi	66		12.99	02.09	+ (N) (S) (FR)						
1.6 16V	80		12.00	02.09	+ Schaltgetriebe ²⁾	03.2122-1356.3	010529	- ABS	THz 22,20		
						03.2122-1351.3	010528	+ ABS	THz 22,20		
2.0 RC	130		07.03	02.09		03.2122-1942.3	010700		THz 22,20		
	1.1		ORGA 08882	09.98		+ ABS	24.3481-1741.5	240245		D=48, - Halter	BOS
	1.1		ORGA 08238	09.98		- ABS	24.3481-1742.5	240246		D=48, - Halter	BOS
	1.4	55	ORGA 08882	09.98		- ROL GAR/+Schaltgetriebe ³⁾				D=48, - Halter	BOS
	1.1		ORGA 08610	ORGA 08882		- ABS	24.3481-1741.5	240245		D=48, - Halter	BOS
							24.3481-1742.5	240246		D=48, - Halter	BOS
	1.1		ORGA 08883	ORGA 09974		+ ABS	24.3481-1771.5	240375		D=48, - Halter	BOS
	1.1		ORGA 08883	ORGA 09974		+ /-ABS	24.3481-1772.5	240376		D=48, - Halter	BOS
	1.4	55	ORGA 08883	ORGA 09974		- ROL GAR/+Schaltgetriebe ³⁾				D=48, - Halter	BOS
	1.1		ORGA 09975		02.09		24.3481-1771.5	240375		D=48, - Halter	BOS
	1.4	55		03.07	02.09	- ROL GAR/+Schaltgetriebe ³⁾	24.3481-1772.5	240376		D=48, - Halter	BOS
	1.4	55	ORGA 09975		02.09	- ROL GAR/+Schaltgetriebe ³⁾	24.3481-1769.5	240373		D=48, - Halter	BOS
	1.4 HDi	50		09.01	02.09		24.3481-1770.5	240374		D=48, - Halter	BOS
	1.4 HDi	51		09.02	02.07					D=48, - Halter	BOS
	1.4 HDi eco 70	50		09.08	02.09					D=48, - Halter	BOS
	1.4 LPG	55		05.06	09.07	- ROL GAR/+Schaltgetriebe ³⁾				D=48, - Halter	BOS
	1.4	55		09.98		+ Automatikgetriebe ¹⁾	24.3481-1739.5	240243		D=48, - Halter	BOS
	1.4 Roland Garros	55	ORGA 08749	ORGA 08749	09.98		24.3481-1740.5	240244		D=48, - Halter	BOS
	1.6	65	ORGA 08749	ORGA 08749	09.98					D=48, - Halter	BOS
	1.9 D	51	ORGA 08749	ORGA 08749	09.98					D=48, - Halter	BOS
	1.4	55		03.07	02.09	+ Automatikgetriebe ¹⁾	24.3481-1769.5	240373		D=48, - Halter	BOS
1.4	55	ORGA 08750		02.09	+ Automatikgetriebe ¹⁾	24.3481-1770.5	240374		D=48, - Halter	BOS	
1.4 LPG	55		05.06	09.07	+ Automatikgetriebe ¹⁾				D=48, - Halter	BOS	
1.4 Roland Garros	55	ORGA 08750		02.09					D=48, - Halter	BOS	
1.6	65	ORGA 08750		02.09					D=48, - Halter	BOS	
1.9 D	51	ORGA 08750		02.09					D=48, - Halter	BOS	
1.6 16V	80		ORGA 08777	12.00		24.3541-1767.5	240237		D=54, - Halter	BOS	
2.0 HDi	66		ORGA 08777	12.99		24.3541-1768.5	240238		D=54, - Halter	BOS	
2.0 S16	99			04.99	10.00				D=54, - Halter	BOS	
2.0 S16	100		ORGA 08777	10.00					D=54, - Halter	BOS	
1.4 16V	65			10.03	02.09	24.3541-1771.5	240239		D=54, - Halter	BOS	
1.6 16V	80	ORGA 09079		02.09		24.3541-1772.5	240240		D=54, - Halter	BOS	
1.6 HDi 110	80			05.04	02.09				D=54, - Halter	BOS	
2.0 HDi	66	ORGA 09079	ORGA 10891						D=54, - Halter	BOS	
2.0 S16	100	ORGA 09079		02.09					D=54, - Halter	BOS	
	1.1			09.98	02.09		24.5111-0306.3	330596	2	L=305	
	1.4	55		03.07	02.09						
	1.4	55		09.98	02.09						
	1.4 16V	65		10.03	02.09						
	1.4 HDi	50		09.01	02.09						
	1.4 HDi	51		09.02	02.07						
	1.4 HDi eco 70	50		09.08	02.09						
	1.4 LPG	55		05.06	09.07						
	1.6	65		09.98	12.00						
	1.6 16V	80		12.00	02.09						
	1.6 HDi 110	80		05.04	02.09						
	1.9 D	51		09.98	02.09						
	2.0 HDi	66		12.99	02.09						
	2.0 RC	130		07.03	02.09						
2.0 S16	99		04.99	10.00							
2.0 S16	100		10.00	02.09							
	1.1		ORGA 09155	09.98		- ABS	24.5229-0240.3	330400		L=242	
	1.4	55	ORGA 09155	09.98		- ABS	24.5229-0200.3	330572		L=200	
	1.4 HDi	50	ORGA 09155	09.01		- ABS					
	1.4 HDi	51	ORGA 09155	09.02		- ABS					
	1.4 HDi eco 70	50		09.08	02.09						
1.6	65		09.98	12.00							

1) + autom.transmission / + scatola cambio automatico / + transmission automatique / + cambio automático
 2) + manual transmission / + scatola cambio velocità / + transmission mécanique / + cambio de velocidad
 3) - ROL GAR/ + manuel transmission / - ROL GAR/ + cambio velocità / - ROL GAR/ + transm. mécanique / - ROL GAR/ + cambio velocidad
 4) - ventilated discs / - dischi ventilati / - disques ventilés / - disco ventilado
 5) + ventilated discs / + dischi ventilati / + disques ventilés / + disco ventilado

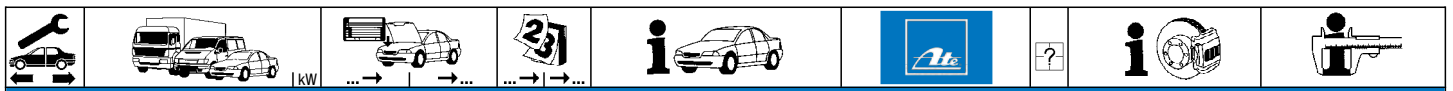

PEUGEOT 206 Limousine (98-09)

























	1.6 16V	80	ORGA 09155	12.00	- ABS	24.5229-0240.3	330400	2	L=242 L=200			
	1.9 D	51	ORGA 09155	09.98	- ABS	24.5229-0200.3	330572					
	2.0 HDi	66	ORGA 09155	12.99	- ABS							
	2.0 S16	99		04.99	10.00							
	2.0 S16	100	ORGA 09155	10.00	- ABS							
	1.1			09.98	02.09	+ ABS	24.5229-0200.3			330572		
	1.1		ORGA 09156		02.09	- ABS						
	1.4	55		03.07	02.09	- ABS						
	1.4	55		09.98	02.09	+ ABS						
	1.4	55	ORGA 09156		02.09	- ABS						
	1.4 16V	65		10.03	02.09							
	1.4 HDi	50		09.01	02.09	+ ABS						
	1.4 HDi	50	ORGA 09156		02.09	- ABS						
	1.4 HDi	51		09.02	02.07	+ ABS						
	1.4 HDi	51	ORGA 09156		02.09	- ABS						
	1.4 LPG	55		05.06	09.07	- ABS						
	1.6 16V	80		12.00	02.09	+ ABS						
	1.6 16V	80	ORGA 09156		02.09	- ABS						
	1.6 HDi 110	80		05.04	02.09							
	1.9 D	51		09.98	02.09	+ ABS						
1.9 D	51	ORGA 09156		02.09	- ABS							
2.0 HDi	66		12.99	02.09	+ ABS							
2.0 HDi	66	ORGA 09156		02.09	- ABS							
2.0 RC	130		07.03	02.09								
2.0 S16	100		10.00	02.09	+ ABS							
2.0 S16	100	ORGA 09156		02.09	- ABS							
	1.1			09.98	02.09	- ABS	24.3219-1112.3	020311	Rz 19,05	BDX		
	1.4	55		03.07	02.09	- ABS						
	1.4	55		09.98	02.09	- ABS						
	1.4 HDi	50		09.01	02.09	- ABS						
	1.4 HDi	51		09.02	02.07	- ABS						
	1.4 HDi eco 70	50		09.08	02.09	- ABS						
	1.4 LPG	55		05.06	09.07	- ABS						
	1.6	65		09.98	12.00	- ABS/ + Schaltgetriebe 1)						
	1.9 D	51		09.98	02.09	- ABS						
	1.1			09.98	02.09	- ABS	24.3220-1617.3	020244	2	RzR 20,64	BDX	
	1.4	55		03.07	02.09	- ABS	24.3220-1618.3	020245		RzR 20,64	BDX	
	1.4	55		09.98	02.09	- ABS						
	1.4 HDi	50		09.01	02.09	- ABS						
	1.4 HDi	51		09.02	02.07	- ABS						
	1.4 HDi eco 70	50		09.08	02.09	- ABS						
	1.4 LPG	55		05.06	09.07	- ABS						
	1.6	65		09.98	12.00	- ABS/ + Schaltgetriebe 1)						
	1.1			09.98	02.09	+ ABS	24.3220-1717.3	020430		+ ALU 2)	Rz 20,64	TRW
	1.4	55		03.07	02.09	+ ABS						
	1.4	55		09.98	02.09	+ ABS						
1.4 16V	65		10.03	02.09								
1.4 HDi	50		09.01	02.09	+ ABS							
1.4 HDi	51		09.02	02.07	+ ABS							
1.4 HDi eco 70	50		09.08	02.09	+ ABS							
1.4 LPG	55		05.06	09.07	+ ABS							
1.6	65		09.98	12.00	+ ABS							
1.6 16V	80		09.98	12.00	- ABS/ + Automatikgetriebe 3)							
1.9 D	51		09.98	02.09	+ ABS							
2.0 HDi	66		12.99	02.09	+ ABS							
	1.1		ORGA 11108	09.98		24.3727-0830.2	580830	2	L=1638			
	1.4	55	ORGA 11108	03.07								
	1.4	55	ORGA 11108	09.98								
	1.4 HDi	50	ORGA 11108	09.01								
	1.4 HDi	51	ORGA 11108	09.02								
	1.4 LPG	55	ORGA 11108	05.06								
	1.6	65		09.98	12.00							
	1.9 D	51	ORGA 11108	09.98								
	2.0 HDi	66	ORGA 11108	12.99								
	1.4 16V	65	ORGA 11108	10.03		24.3727-0833.2	580833					
	1.6 16V	80	ORGA 11108	12.00								
	1.6 HDi 110	80	ORGA 11108	05.04								
	2.0 RC	130	ORGA 11108	07.03								
	2.0 S16	99		04.99	10.00							
2.0 S16	100	ORGA 11108	10.00									
	1.1	◀	ORGA 09456	09.98		24.3728-0845.2	590845	2	L=660, + AUT			
	1.4	◀ 55	ORGA 09456	09.98								
	1.6	◀ 65		09.98	12.00							
	1.6 16V	◀ 80	ORGA 09456	12.00								
	1.1	◀	ORGA 09457	ORGA 09921		24.3728-0832.2	590832					
	1.4	◀ 55	ORGA 09457	ORGA 09921								
	1.4 16V	◀ 65		ORGA 09921	10.03							
	1.6 16V	◀ 80	ORGA 09457	ORGA 09921								
	1.1	◀	ORGA 09922		02.09	24.3728-0848.2	590848					
	1.4	◀ 55		03.07	02.09							
	1.4	◀ 55	ORGA 09922		02.09							
	1.4 16V	◀ 65	ORGA 09922		02.09							
	1.4 LPG	◀ 55		05.06	09.07							
	1.6 16V	◀ 80	ORGA 09922		02.09							
1.4 HDi	◀ 50	ORGA 09456	09.01		24.3728-0827.2	590827						

1) - ABS/ + manual transmission / - ABS/+ scatola camb.velocità / - ABS/ + transmission mécanique / - ABS/ + cambio de velocidad



























2) + aluminium / + alluminio / + aluminium / + aluminio

3) - ABS/ + autom.transmission / - ABS/ + scatola cambio autom. / - ABS/ + transmission automatique / - ABS/ + cambio automático



											
PEUGEOT 206 Limousine (98-09)											
	1.4 HDi	51	ORGA 09456	09.02		24.3728-0827.2	590827		L=920, + AUT		
	2.0 HDi	66	ORGA 09457	12.99							
	2.0 S16	99		04.99	10.00						
	2.0 S16	100	ORGA 09426	10.00							
	1.4 HDi	50 ORGA 09457	ORGA 09921			24.3728-0833.2	590833		L=830, + AUT		
	1.4 HDi	51 ORGA 09457	ORGA 09921								
	2.0 HDi	66 ORGA 09457	ORGA 09921								
	2.0 RC	130	ORGA 09921	07.03							
	2.0 S16	100 ORGA 09583	ORGA 09921								
	1.9 D	51	ORGA 09456	09.98		24.3728-0841.2	590841		L=910, + AUT		
2.0 S16	100 ORGA 09427	ORGA 09456									
1.9 D	51 ORGA 09457			02.09	24.3728-0833.2	590833		L=830, + AUT			
1.4 HDi	50 ORGA 09922			02.09	24.3728-0849.2	590849		L=831, + AUT			
1.4 HDi	51 ORGA 09922			02.09							
2.0 HDi	66 ORGA 09922			02.09							
2.0 RC	130		07.03	02.09							
2.0 S16	100 ORGA 09922			02.09							
PEUGEOT 206 CC (00-07)											
	1.6 16V	80	ORGA 09820	09.00	- ABS/ + Schaltgetriebe ¹⁾	03.7750-1832.4	300111		9"	ATE	
	1.6 16V	80	ORGA 09456	09.00	+ ABS/ + Schaltgetriebe ²⁾						
	1.6 16V	80 ORGA 09821			01.07	03.7750-6232.4	300215		9"	ATE	
	1.6 16V	80 ORGA 09457	ORGA 09740			03.7853-1602.4	300167		9"	ATE	
	1.6 16V	80	ORGA 09820	09.00	- ABS/ + Automatikgetriebe ³⁾	03.7750-2232.4	300112		9"	ATE	
	1.6 16V	80	ORGA 09456	09.00	+ ABS/ + Schaltgetriebe ²⁾						
	1.6 16V	80 ORGA 09821			01.07	03.7750-6332.4	300226		9"	ATE	
	1.6 16V	80 ORGA 09741			01.07	03.7853-2602.4	300196		9"	ATE	
	1.6 HDi 110	80		04.05	01.07	- (N) (S) (RH)					
	1.6 HDi 110	80 ORGA 09741			01.07	+ ABS/ + Automatikgetriebe ⁴⁾	03.7853-2702.4	300269		9"	ATE
1.6 HDi 110	80		04.05	01.07	+ (N) (S) (RH)						
	1.6 16V	80		09.00	01.07	+ Schaltgetriebe ⁵⁾	03.2122-1356.3	010529	- ABS	Thz 22,20	ATE
							03.2122-1351.3	010528	- ESP	Thz 22,20	ATE
							03.2122-1942.3	010700	+ ESP	Thz 22,20	ATE
	1.6 16V	80		09.00	01.07	+ Automatikgetriebe ⁶⁾	03.4122-0031.3	010611	- ABS	Thz 22,20	ATE
						03.4122-0041.3	010612	- ESP	Thz 22,20	ATE	
						03.4122-0054.3	010813	+ ESP	Thz 22,20	ATE	
1.6 HDi 110	80		04.05	01.07	+ (N) (S) (RH)	03.4122-0041.3	010612	- ESP	Thz 22,20	ATE	
						03.4122-0054.3	010813	+ ESP	Thz 22,20	ATE	
1.6 HDi 110	80		04.05	01.07	- (N) (S) (RH)	03.2122-1351.3	010528	- ESP	Thz 22,20	ATE	
2.0 16V	100		09.00	01.07		03.2122-1942.3	010700	+ ESP	Thz 22,20	ATE	
	1.6 16V	80	ORGA 08777	09.00		24.3541-1767.5	240237			D=54, - Halter	BOS
	2.0 16V	100	ORGA 08777	09.00		24.3541-1768.5	240238			D=54, - Halter	BOS
	1.6 16V	80 ORGA 09079	ORGA 10949			24.3541-1771.5	240239			D=54, - Halter	BOS
	1.6 HDi 110	80		04.05	01.07	24.3541-1772.5	240240			D=54, - Halter	BOS
2.0 16V	100 ORGA 09079			01.07							
	1.6 16V	80		09.00	01.07	24.5111-0306.3	330596	2		L=305	
	1.6 HDi 110	80		04.05	01.07						
	2.0 16V	100		09.00	01.07						
	1.6 16V	80	ORGA 09155	09.00		24.5229-0240.3	330400			L=242	
	2.0 16V	100	ORGA 09155	09.00		24.5229-0200.3	330572			L=200	
	1.6 16V	80 ORGA 09156			01.07	24.5229-0200.3	330572	2		L=200	
1.6 HDi 110	80		04.05	01.07							
2.0 16V	100 ORGA 09156			01.07							
	1.6 16V	80	ORGA 11108	09.00		24.3727-0833.2	580833	2		L=1707	
	1.6 HDi 110	80	ORGA 11108	04.05							
	2.0 16V	100	ORGA 11108	09.00							
	1.6 16V	80	ORGA 09456	09.00		24.3728-0845.2	590845			L=660, + AUT	
	1.6 16V	80 ORGA 09457	ORGA 09921			24.3728-0832.2	590832			L=580, + AUT	
	1.6 16V	80 ORGA 09922			01.07	24.3728-0848.2	590848			L=580, + AUT	
	2.0 16V	100	ORGA 09426	09.00		24.3728-0827.2	590827			L=920, + AUT	
	2.0 16V	100 ORGA 09427	ORGA 09456			24.3728-0841.2	590841			L=910, + AUT	
	2.0 16V	100 ORGA 09457	ORGA 09921			24.3728-0833.2	590833			L=830, + AUT	
	2.0 16V	100 ORGA 09922			01.07	24.3728-0849.2	590849			L=831, + AUT	
PEUGEOT 206 SW (02-07)											
	1.4	55	ORGA 09820	07.02	- ABS/ + Schaltgetriebe ¹⁾	03.7750-0532.4	300110		9"	ATE	
	1.4 HDi	50	ORGA 09820	07.02	- ABS						
	1.1	44	ORGA 09456	07.02	+ ABS	03.7750-1832.4	300111		9"	ATE	
	1.4	55	ORGA 09456	07.02	+ ABS/ + Schaltgetriebe ²⁾						
	1.4 HDi	50	ORGA 09456	07.02	+ ABS						
	1.6 16V	80	ORGA 09820	07.02	+ ABS/ + Schaltgetriebe ²⁾						
	1.6 16V	80	ORGA 09456	07.02	+ ABS/ + Schaltgetriebe ²⁾						
	1.6 16V	80 ORGA 09821			05.07	03.7750-6232.4	300215		9"	ATE	
	1.1	44 ORGA 09457	ORGA 09740			03.7853-1602.4	300167		9"	ATE	
	1.4	55 ORGA 09457	ORGA 09740								
1.4 HDi	50 ORGA 09457	ORGA 09820									
1.6 16V	80 ORGA 09457	ORGA 09740									
1.4	55	ORGA 09820	07.02	- ABS/ + Automatikgetriebe ³⁾	03.7750-2232.4	300112		9"	ATE		
1.4	55	ORGA 09456	07.02	+ ABS/ + Automatikgetriebe ⁴⁾							
1.6 16V	80	ORGA 09820	07.02	- ABS/ + Automatikgetriebe ³⁾							
1.6 16V	80	ORGA 09456	07.02	+ ABS/ + Automatikgetriebe ⁴⁾							

¹⁾ - ABS/ + manual transmission / - ABS/+ scatola camb.velocità / - ABS/ + transmission mécanique / - ABS/ + cambio de velocidad
²⁾ + ABS/ + manual transm. / + ABS/+ scatola camb.velocità / + ABS/ + transmission mécanique / + ABS/ + cambio de velocidad
³⁾ - ABS/ + autom.transmission / - ABS/ + scatola cambio autom. / - ABS/ + transmission automatique / - ABS/ + cambio automático
⁴⁾ + ABS/ + autom.transmission / + ABS/ + scatola cambio autom. / + ABS/ + transmission automatique / + ABS/ + cambio automático
⁵⁾ + manual transmission / + scatola cambio velocità / + transmission mécanique / + cambio de velocidad
⁶⁾ + autom.transmission / + scatola cambio automatico / + transmission automatique / + cambio automático

													
PEUGEOT 206 SW (02-07)													
	1.1	44	ORGA 09741		05.07	+ ABS	03.7853-2602.4	300196		9"	ATE		
	1.4	55	ORGA 09741		05.07	+ ABS/ + Schaltgetriebe ¹⁾							
	1.4 16V	65			10.03	05.07	+ ABS						
	1.4 HDi	50	ORGA 09821		05.07	+ ABS							
	1.6 16V	80	ORGA 09741		05.07	+ ABS/ + Schaltgetriebe ¹⁾							
	1.6 HDi 110	80			05.04	05.07	+ ABS/ - (N) (S) (FH)						
	1.4	55	ORGA 09741		05.07	+ ABS/ + Automatikgetriebe ²⁾	03.7853-2702.4	300269		9"	ATE		
	1.6 16V	80	ORGA 09741		05.07	+ ABS/ + Automatikgetriebe ²⁾							
	1.6 HDi 110	80			05.04	05.07	+ ABS/ + (N) (S) (FH)						
	1.4	55	ORGA 09821		05.07	- ABS/ + Automatikgetriebe ³⁾	03.7750-6332.4	300226		9"	ATE		
1.6 16V	80	ORGA 09821		05.07	- ABS/ + Automatikgetriebe ³⁾								
2.0 HDi	66		ORGA 09820	07.02		- ABS	03.7750-1832.4	300111	- (N) (S) (FH)	9"	ATE		
2.0 HDi	66		ORGA 09456	07.02		+ ABS	03.7750-2232.4	300112	+ (N) (S) (FH)	9"	ATE		
2.0 HDi	66	ORGA 09821		05.07		- ABS	03.7750-6232.4	300215	- (N) (S) (FH)	9"	ATE		
2.0 HDi	66	ORGA 09457	ORGA 09820			+ ABS	03.7750-6332.4	300226	+ (N) (S) (FH)	9"	ATE		
2.0 HDi	66	ORGA 09821		05.07		+ ABS	03.7853-1602.4	300167	- (N) (S) (FH)	9"	ATE		
2.0 HDi	66	ORGA 09821		05.07		+ ABS	03.7853-2602.4	300196	- (N) (S) (FH)	9"	ATE		
2.0 HDi	66	ORGA 09821		05.07		+ ABS	03.7853-2702.4	300269	+ (N) (S) (FH)	9"	ATE		
	1.1	44			07.02	05.07	03.2120-4321.3	010525		- ABS	THz 20,64	ATE	
	1.4	55			07.02	05.07	+ Schaltgetriebe ⁴⁾	24.2120-1737.3	010757	- ABS	THz 20,64	ATE	
	1.4 HDi	50			07.02	05.07		03.2122-1351.3	010528	+ ABS	THz 22,20	ATE	
	1.4	55			07.02	05.07	+ Automatikgetriebe ⁵⁾	03.2120-4321.3	010525	- ABS	THz 20,64	ATE	
	1.6 16V	80			07.02	05.07	+ Automatikgetriebe ⁵⁾	24.2120-1737.3	010757	- ABS	THz 20,64	ATE	
	2.0 HDi	66			07.02	05.07	+ (N) (S) (FH)	03.2122-1351.3	010528	- ESP	THz 22,20	ATE	
	1.4 16V	65			10.03	05.07		03.2122-1356.3	010529	- ABS	THz 22,20	ATE	
	1.6 16V	80			07.02	05.07	+ Schaltgetriebe ⁴⁾	03.2122-1351.3	010528	- ESP	THz 22,20	ATE	
	2.0 HDi	66			07.02	05.07	- (N) (S) (FH)	03.2122-1942.3	010700	+ ESP	THz 22,20	ATE	
	1.6 HDi 110	80			05.04	05.07	- (N) (S) (FH)	03.2122-1351.3	010528	- ESP	THz 22,20	ATE	
1.6 HDi 110	80			05.04	05.07	+ (N) (S) (FH)	03.2122-1942.3	010700	+ ESP	THz 22,20	ATE		
1.6 HDi 110	80			05.04	05.07		03.4122-0031.3	010611	- ABS	THz 22,20	ATE		
1.6 16V	80			07.02	05.07	+ Automatikgetriebe ⁵⁾	03.4122-0041.3	010612	- ESP	THz 22,20	ATE		
2.0 HDi	66			07.02	05.07	+ (N) (S) (FH)	03.4122-0054.3	010813	+ ESP	THz 22,20	ATE		
2.0 S16	100			07.02	05.07		03.2122-1351.3	010528	- ESP	THz 22,20	ATE		
2.0 S16	100			07.02	05.07		03.2122-1942.3	010700	+ ESP	THz 22,20	ATE		
	1.1	44			07.02	05.07	24.3481-1771.5	240375			D=48, - Halter	BOS	
	1.4	55			07.02	05.07	24.3481-1772.5	240376			D=48, - Halter	BOS	
	1.4 16V	65			10.03	05.07							
	1.4 HDi	50			07.02	05.07	- belüftete Scheiben ⁶⁾						
	1.4 HDi	50			07.02	05.07	+ belüftete Scheiben ⁷⁾	24.3481-1769.5	240373			D=48, - Halter	BOS
	1.4 HDi	50			07.02	05.07		24.3481-1770.5	240374			D=48, - Halter	BOS
	1.6 16V	80		ORGA 10808	07.02	05.07		24.3541-1771.5	240239			D=54, - Halter	BOS
	1.6 HDi 110	80		ORGA 10808	07.02	05.07		24.3541-1772.5	240240			D=54, - Halter	BOS
	2.0 HDi	66		ORGA 10808	07.02	05.07							
	2.0 S16	100		ORGA 10808	07.02	05.07							
	1.1	44			07.02	05.07	24.5111-0306.3	330596	2		L=305		
	1.4	55			07.02	05.07							
	1.4 16V	65			10.03	05.07							
	1.4 HDi	50			07.02	05.07							
	1.6 16V	80			07.02	05.07							
	1.6 HDi 110	80			05.04	05.07							
	2.0 HDi	66			07.02	05.07							
	2.0 S16	100			07.02	05.07							
		1.1	44		ORGA 09155	07.02		24.5229-0240.3	330400			L=242	
		1.4	55		ORGA 09155	07.02		24.5229-0200.3	330572			L=200	
1.4 HDi		50		ORGA 09155	07.02								
1.6 16V		80		ORGA 09155	07.02								
2.0 HDi		66		ORGA 09155	07.02								
2.0 S16		100		ORGA 09155	07.02								
1.1		44	ORGA 09156		05.07		24.5229-0200.3	330572	2		L=200		
1.4		55	ORGA 09156		05.07								
1.4 16V		65			10.03	05.07							
1.4 HDi		50	ORGA 09156		05.07								
1.6 16V	80	ORGA 09156		05.07									
1.6 HDi 110	80			05.04	05.07								
2.0 HDi	66	ORGA 09156		05.07									
2.0 S16	100	ORGA 09156		05.07									
	1.1	44			07.02	05.07	24.3220-1717.3	020430		+ ALU ⁸⁾	Rz 20,64	TRW	
	1.4	55			07.02	05.07							
	1.4 HDi	50			07.02	05.07							
	2.0 HDi	66			07.02	05.07							
	2.0 HDi	66			07.02	05.07							
	1.1	44		ORGA 11108	07.02		24.3727-0830.2	580830	2		L=1638		
	1.4	55		ORGA 11108	07.02								
	1.4 HDi	50		ORGA 11108	07.02								
	2.0 HDi	66		ORGA 11108	07.02								
	1.4 16V	65		ORGA 11108	10.03		24.3727-0833.2	580833	2		L=1707		
	1.6 16V	80			07.02	05.07							
	1.6 HDi 110	80			05.04	05.07							
	2.0 S16	100			07.02	05.07							

¹⁾ + ABS/ + manual transm. / + ABS/+ scatola camb.velocità / + ABS/ + transmission mécanique / + ABS/ + cambio de velocidad
²⁾ + ABS/ + autom.transmission / + ABS/ + scatola cambio autom. / + ABS/ + transmission automatique / + ABS/ + cambio automático
³⁾ - ABS/ + autom.transmission / - ABS/ + scatola cambio autom. / - ABS/ + transmission automatique / - ABS/ + cambio automático
⁴⁾ + manual transmission / + scatola cambio velocità / + transmission mécanique / + cambio de velocidad
⁵⁾ + autom.transmission / + scatola cambio automatico / + transmission automatique / + cambio automatico
⁶⁾ - ventilated discs / - dischi ventilati / - disques ventilés / - disco ventilado
⁷⁾ + ventilated discs / + dischi ventilati / + disques ventilés / + disco ventilado
⁸⁾ + aluminium / + alluminio / + aluminium / + aluminio



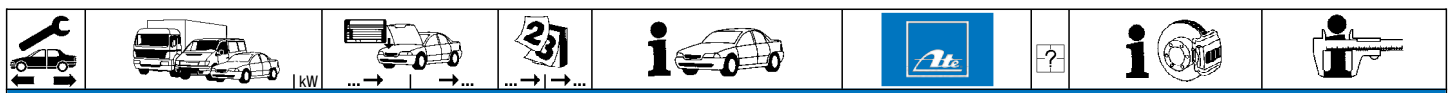

PEUGEOT 206 SW (02-07)

	1.1	44	ORGA 09456	07.02		24.3728-0845.2	590845			L=660, + AUT
	1.4	55	ORGA 09456	07.02						
	1.6 16V	80	ORGA 09456	07.02						
	1.1	44	ORGA 09457	ORGA 09921		24.3728-0832.2	590832			L=580, + AUT
	1.4	55	ORGA 09457	ORGA 09921						
	1.4 16V	65		ORGA 09921	10.03					
	1.6 16V	80	ORGA 09457	ORGA 09921						
	1.1	44	ORGA 09922		05.07	24.3728-0848.2	590848			L=580, + AUT
1.4	55	ORGA 09922		05.07						
1.4 16V	65	ORGA 09922		05.07						
1.6 16V	80	ORGA 09922		05.07						
1.4 HDi	50	ORGA 09456	ORGA 09456	07.02	24.3728-0827.2	590827			L=920, + AUT	
2.0 HDi	66	ORGA 09456	ORGA 09456	07.02						
2.0 S16	100	ORGA 09426	ORGA 09426	07.02						
2.0 S16	100	ORGA 09427	ORGA 09456		24.3728-0841.2	590841			L=910, + AUT	
1.4 HDi	50	ORGA 09457	ORGA 09961		24.3728-0833.2	590833			L=830, + AUT	
2.0 HDi	66	ORGA 09457	ORGA 09961							
2.0 S16	100	ORGA 09457	ORGA 09961							
1.4 HDi	50	ORGA 09962		05.07	24.3728-0849.2	590849			L=831, + AUT	
2.0 HDi	66	ORGA 09962		05.07						
2.0 S16	100	ORGA 09962		05.07						



























PEUGEOT 206 PLUS (09-13)

	1.1	44		01.09	05.13	03.7853-2602.4	300196	+ ABS	9"	ATE
	1.4 HDi eco 70	50		01.09	05.13					
	1.4 i	54		09.10	05.13					
	1.4 i	55		01.09	05.13					
	1.6 16V	80		07.10	05.13	03.7853-2702.4	300269		9"	ATE
	1.1	44		01.09	05.13	03.2120-4321.3	010525	- ABS	THz 20,64	ATE
	1.4 HDi eco 70	50		01.09	05.13	24.2120-1737.3	010757	- ABS	THz 20,64	
	1.4 i	54		09.10	05.13	03.2122-1351.3	010528	+ ABS	THz 22,20	ATE
	1.4 i	55		01.09	05.13	03.2122-1942.3	010700	+ ESP	THz 22,20	ATE
	1.6 16V	80		07.10	05.13	03.4122-0041.3	010612		THz 22,20	ATE
	1.1	44		01.09	05.13	24.3481-1769.5	240373		D=48, - Halter	BOS
	1.4 HDi eco 70	50		01.09	05.13	24.3481-1770.5	240374		D=48, - Halter	BOS
	1.4 i	54		09.10	05.13					
	1.4 i	55		01.09	05.13					
	1.1	44		01.09	05.13	24.3481-1771.5	240375		D=48, - Halter	BOS
	1.4 HDi eco 70	50		01.09	05.13	24.3481-1772.5	240376		D=48, - Halter	BOS
	1.4 i	54		09.10	05.13					
	1.4 i	55		01.09	05.13					
	1.6 16V	80		07.10	05.13	24.3541-1771.5	240239		D=54, - Halter	BOS
						24.3541-1772.5	240240		D=54, - Halter	BOS
	1.1	44		01.09	05.13	24.5111-0306.3	330596	2		L=305
	1.4 HDi eco 70	50		01.09	05.13					
	1.4 i	54		09.10	05.13					
	1.4 i	55		01.09	05.13					
	1.6 16V	80		07.10	05.13					
	1.1	44		01.09	05.13	24.5229-0200.3	330572	2		L=200
	1.4 HDi eco 70	50		01.09	05.13					
	1.4 i	54		09.10	05.13					
	1.4 i	55		01.09	05.13					
	1.6 16V	80		07.10	05.13					
	1.1	44		01.09	05.13	24.3220-1717.3	020430	+ ALU ²⁾	Rz 20,64	TRW
	1.4 HDi eco 70	50		01.09	05.13					
	1.4 i	54		09.10	05.13					
	1.4 i	55		01.09	05.13					
	1.6 16V	80		07.10	05.13					
	1.1	44		01.09	05.13	24.3220-1617.3	020244		RzR 20,64	BDX
	1.4 HDi eco 70	50		01.09	05.13	24.3220-1618.3	020245		RzR 20,64	BDX
	1.4 i	54		09.10	05.13					
	1.4 i	55		01.09	05.13					
	1.6 16V	80		07.12	05.13					
	1.1	44		01.09	05.13	24.3219-1112.3	020311		Rz 19,05	BDX
	1.4 HDi eco 70	50		01.09	05.13					
	1.4 i	54		09.10	05.13					
	1.4 i	55		01.09	05.13					
	1.6 16V	80		07.12	05.13					
	1.1	44		01.09	05.13	24.3727-0830.2	580830	2		L=1638
	1.4 HDi eco 70	50		01.09	05.13					
	1.4 i	54		09.10	05.13					
	1.4 i	55		01.09	05.13					
	1.6 16V	80		07.10	05.13					
	1.4 HDi eco 70	50		01.09	05.13	24.3728-0849.2	590849			L=831, + AUT
	1.1	44		01.09	05.13	24.3728-0848.2	590848			L=580, + AUT
	1.4 i	54		09.10	05.13					
	1.4 i	55		01.09	05.13					
	1.6 16V	80		07.10	05.13					

¹⁾ + ABS/+ electr.br.force distribution / + ABS/+ ripartiz.eletr.di frenata / + ABS/+ répartition élect.de freinage / + ABS/+ distrib.electr.la carga frenado

²⁾ + aluminium / + alluminio / + aluminium / + aluminio

³⁾ - ABS/ + brake press.regulator / - ABS/+ correttore di frenata / - ABS/+ correcteur de freinage / - ABS/+ corrector de frenado

										
PEUGEOT 207 Limousine (06-12)										
	1.4	53		02.06	06.12					
	1.4	55		09.07	06.12	24.4122-1704.3	010847	- ESP	THz 22,20	TRW
	1.4 16V	65		02.06	06.12	24.4122-1703.3	010843	+ ESP	THz 22,20	TRW
	1.4 16V VTi	70		08.07	06.12					
	1.4 HDi	50		02.06	06.12					
	1.6 16V	80		02.06	06.12					
	1.6 HDi	66		02.06	06.12					
	1.6 16V RC	128		10.06	06.12	24.4123-1705.3	010832	- ESP	THz 23,81	TRW
	1.6 16V Turbo	110		02.06	06.12	24.4123-1704.3	010828	+ ESP	THz 23,81	TRW
	1.6 16V Turbo	115		01.10	06.12					
1.6 16V VTi	88		10.06	06.12						
1.6 HDi	68		11.09	06.12						
1.6 HDi	80		02.06	06.12						
1.6 HDi 110	82		08.09	06.12						
	1.4	53		02.06	06.12	24.3541-1771.5	240239		D=54, - Halter	BOS
	1.4	55		09.07	06.12	24.3541-1772.5	240240		D=54, - Halter	BOS
	1.4 16V	65		02.06	06.12					
	1.4 HDi	50		02.06	06.12					
	1.6 HDi	66		02.06	06.12					
	1.6 HDi	68		11.09	06.12					
	1.4 16V VTi	70		08.07	06.12	24.3541-1761.5	240233		D=54, - Halter	BOS
	1.6 16V	80		02.06	06.12	24.3541-1762.5	240234		D=54, - Halter	BOS
	1.6 16V Turbo	110		02.06	06.12					
	1.6 16V Turbo	115		01.10	06.12					
1.6 16V VTi	88		10.06	06.12						
1.6 HDi	66		02.06	06.12						
1.6 HDi	80		02.06	06.12						
1.6 HDi 110	82		08.09	06.12						
	1.6 16V RC	128		10.06	06.12	11.9571-9765.2	220663		D=57, - Halter	ATE
						11.9571-9766.2	220664		D=57, - Halter	ATE
						11.8116-0351.1	390538	2	Haltefeder	ATE
						11.0101-5704.2	260095		Hülzensatz	ATE
						11.8171-0008.1	990049		Führungsbolzen	ATE
	1.4	53		02.06	06.12	24.5144-0480.3	330961	2		L=480
	1.4	55		09.07	06.12					
	1.4 16V	65		02.06	06.12					
	1.4 16V VTi	70		08.07	06.12					
	1.4 HDi	50		02.06	06.12					
	1.6 16V	80		02.06	06.12					
	1.6 16V RC	128		10.06	06.12					
	1.6 16V Turbo	110		02.06	06.12					
	1.6 16V Turbo	115		10.09	06.12					
	1.6 16V VTi	88		10.06	06.12					
	1.6 HDi	66		02.06	06.12					
	1.6 HDi	68		11.09	06.12					
	1.6 HDi	80		02.06	06.12					
1.6 HDi 110	82		08.09	06.12						
	1.6 16V	80	ORGA 11635		06.12	24.3387-1733.5	240655		D=38, - Halter	TRW
	1.6 16V RC	128	ORGA 11628		06.12	24.3387-1734.5	240656		D=38, - Halter	TRW
	1.6 16V Turbo	110	ORGA 11635		06.12					
	1.6 16V Turbo	115	ORGA 11635		06.12					
	1.6 16V VTi	88	ORGA 11628		06.12					
	1.6 HDi	66	ORGA 11635		06.12					
	1.6 HDi	80	ORGA 11635		06.12					
1.6 HDi 110	82	ORGA 11635		06.12						
	1.4	53		02.06	06.12	24.5239-0190.3	330966	2		L=190
	1.4	55		09.07	06.12					
	1.4 16V	65		02.06	06.12					
	1.4 16V VTi	70		08.07	06.12					
	1.4 HDi	50		02.06	06.12					
	1.6 16V	80		02.06	06.12					
	1.6 16V RC	128		10.06	06.12					
	1.6 16V Turbo	110		02.06	06.12					
	1.6 16V Turbo	115		10.09	06.12					
	1.6 16V VTi	88		10.06	06.12					
	1.6 HDi	66		02.06	06.12					
	1.6 HDi	68		11.09	06.12					
	1.6 HDi	80		02.06	06.12					
1.6 HDi 110	82		08.09	06.12						
	1.4	53		02.06	06.12	24.3220-1611.3	020238		RzR 20,64	BDX
	1.4	55		09.07	06.12	24.3220-1612.3	020239		RzR 20,64	BDX
	1.4 HDi	50		02.06	06.12					
	1.4	53		02.06	06.12	24.3220-1732.3	020514		Rz 20,64	BOS
	1.4	55		09.07	06.12					
	1.4 16V	65		02.06	06.12					
	1.4 16V VTi	70		08.07	06.12					
1.4 HDi	50		02.06	06.12						
1.6 HDi	66		02.06	06.12						
1.6 HDi	68		11.09	06.12						
	1.4	53		02.06	06.12	24.3727-0846.2	580846	2		L=1796
	1.4	55		09.07	06.12					
	1.4 16V	65		02.06	06.12					
	1.4 16V VTi	70		08.07	06.12					
	1.4 HDi	50		02.06	06.12					
	1.6 HDi	66		02.06	06.12					
	1.6 HDi	68		11.09	06.12					

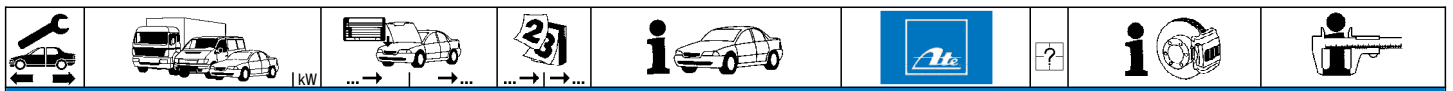

PEUGEOT 207 Limousine (06-12)

	1.6 16V	80	ORGA 11634	02.06		24.3727-0845.2	580845	2 ↓		L=1905
	1.6 16V RC	128	ORGA 11634	10.06						
	1.6 16V Turbo	110	ORGA 11634	02.06						
	1.6 16V Turbo	115	ORGA 11634	10.09						
	1.6 16V VTi	88	ORGA 11634	10.06						
	1.6 HDi	66	ORGA 11634	02.06						
	1.6 HDi	80	ORGA 11634	02.06						
	1.6 HDi 110	82	ORGA 11634	08.09						
	1.6 16V	80	ORGA 11635	06.12						
	1.6 16V RC	128	ORGA 11635	06.12						
	1.6 16V Turbo	110	ORGA 11635	06.12						
	1.6 16V Turbo	115	ORGA 11635	06.12						
1.6 16V VTi	88	ORGA 11635	06.12							
1.6 HDi	66	ORGA 11635	06.12							
1.6 HDi	80	ORGA 11635	06.12							
1.6 HDi 110	82	ORGA 11635	06.12							
	1.4	53	ORGA 11556	02.06		24.2415-1715.3	030137			Gz 15,87
	1.4	55	ORGA 11556	09.07						
	1.4 16V	65	ORGA 11556	02.06						
	1.4 16V VTi	70	ORGA 11556	08.07						
	1.4 HDi	50	ORGA 11556	02.06						
	1.6 16V	80	ORGA 11556	02.06						
	1.6 16V VTi	88	ORGA 11556	02.07						
	1.4	53		02.06						
	1.4	55		08.08						
	1.4 16V	65		02.06						
1.4 16V VTi	70		08.07							
1.4 HDi	50		02.06							
1.6 16V	80		02.06							
1.6 16V VTi	88		08.07							
1.6 16V RC	128	ORGA 11557	06.12							
1.6 16V Turbo	110	ORGA 11557	06.12							
1.6 16V Turbo	115	ORGA 11557	06.12							
1.6 HDi	66	ORGA 11557	06.12							
1.6 HDi	68	ORGA 11557	06.12							
1.6 HDi	80	ORGA 11557	06.12							
1.6 Turbo Le Mans	110	ORGA 11557	06.12							
	1.4	53	ORGA 11647	02.06		24.2519-1707.3	040100			Nz 19,05
	1.4	55	ORGA 11647	09.07						
	1.4 16V	65	ORGA 11647	02.06						
	1.4 16V VTi	70	ORGA 11647	08.07						
	1.4 HDi	50	ORGA 11647	02.06						
	1.6 16V	80	ORGA 11647	02.06						
	1.6 16V VTi	88	ORGA 11437	02.07						
	1.4	53	ORGA 11648	06.12						
	1.4	55	ORGA 11648	06.12						
	1.4 16V	65	ORGA 11648	06.12						
1.4 16V VTi	70	ORGA 11648	06.12							
1.4 HDi	50	ORGA 11648	06.12							
1.6 16V	80	ORGA 11648	06.12							
1.6 16V RC	128	ORGA 11648	06.12							
1.6 16V Turbo	110	ORGA 11648	06.12							
1.6 16V Turbo	115	ORGA 11648	06.12							
1.6 HDi	66	ORGA 11648	06.12							
1.6 HDi	80	ORGA 11648	06.12							
1.6 Turbo Le Mans	110	ORGA 11648	06.12							

PEUGEOT 207 CC (07-15)

	1.6 16V	88		02.07		24.4123-1705.3	010832	- ESP + ESP		THz 23,81 THz 23,81	TRW TRW
	1.6 16V Turbo	110		02.07							
	1.6 16V Turbo	115		10.09							
	1.6 HDi	80		02.07							
	1.6 HDi	82		08.09							
	1.6 16V	88		02.07		24.3541-1761.5	240233			D=54, - Halter D=54, - Halter	BOS BOS
	1.6 16V Turbo	110		02.07							
	1.6 16V Turbo	115		10.09							
	1.6 HDi	80		02.07							
	1.6 HDi	82		08.09							
	1.6 16V	88		02.07		24.5144-0480.3	330961		2	L=480	
	1.6 16V Turbo	110		02.07							
	1.6 16V Turbo	115		10.09							
	1.6 HDi	80		02.07							
	1.6 HDi	82		08.09							
	1.6 16V	88	ORGA 1164282			24.3387-1733.5	240655			D=38, - Halter D=38, - Halter	TRW TRW
	1.6 16V Turbo	110	ORGA 1163582								
	1.6 16V Turbo	115	ORGA 1163582								
	1.6 HDi	80	ORGA 1163582								
	1.6 HDi	82		08.09							
	1.6 16V	88		02.07		24.5239-0190.3	330966		2	L=190	
	1.6 16V Turbo	110		02.07							
	1.6 16V Turbo	115		10.09							
	1.6 HDi	80		02.07							
	1.6 HDi	82		08.09							

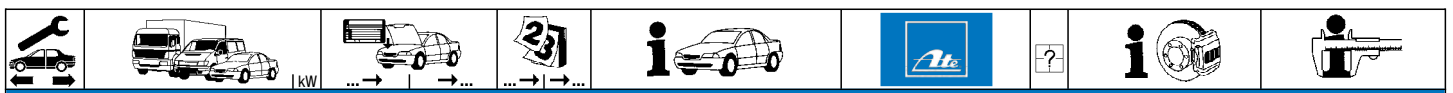

PEUGEOT 207 CC (07-15)

	1.6 16V	88	ORGA 1163482	02.07	24.3727-0845.2	580845	2 ↓		L=1905
	1.6 16V Turbo	110	ORGA 1163482	02.07					
	1.6 16V Turbo	115	ORGA 1163482	10.09					
	1.6 HDi	80	ORGA 1163482	02.07					
	1.6 HDi	82	ORGA 1163482	08.09					
	1.6 16V	88	ORGA 1163582		24.3727-0855.2	580855	2 ↓		L=1910
	1.6 16V Turbo	110	ORGA 1163582						
	1.6 16V Turbo	115	ORGA 1163582						
	1.6 HDi	80	ORGA 1163582						
	1.6 HDi	82	ORGA 1163582						
	1.6 16V Turbo	110	ORGA 11557		24.2415-1717.3	030140			Gz 15,87
	1.6 16V Turbo	115	ORGA 11557						
	1.6 HDi	80	ORGA 11557						
	1.6 16V	88	ORGA 11556	02.07					
	1.6 16V	88		02.07					
	1.6 16V Turbo	110	ORGA 11648		24.2518-1703.3	040101			Nz 18,90
	1.6 16V Turbo	115	ORGA 11648						
	1.6 HDi	80	ORGA 11648						
	1.6 16V	88	ORGA 11437	02.07					

PEUGEOT 207 SW (07-13)

	1.4 i	54		06.07	07.13	24.4122-1704.3	010847	- ESP	THz 22,20	TRW
	1.4 i 16V	70		06.07	07.13	24.4122-1703.3	010843	+ ESP	THz 22,20	TRW
	1.6 HDi FAP 90	66		06.07	07.13					
	1.6 16V RC	128		11.07	07.13	24.4123-1705.3	010832	- ESP	THz 23,81	TRW
	1.6 16V Turbo	110		02.07	07.13	24.4123-1704.3	010828	+ ESP	THz 23,81	TRW
	1.6 HDi	68		11.09	07.13					
	1.6 HDi	82		08.09	07.13					
	1.6 HDi FAP 110	80		06.07	07.13					
1.6 i 16V	88		06.07	07.13						
	1.4 i	54		06.07	07.13	24.3541-1771.5	240239	☐	D=54, - Halter	BOS
						24.3541-1772.5	240240	☐	D=54, - Halter	BOS
	1.4 i 16V	70		06.07	07.13	24.3541-1761.5	240233	☐	D=54, - Halter	BOS
	1.6 16V Turbo	110		02.07	07.13	24.3541-1762.5	240234	☐	D=54, - Halter	BOS
	1.6 HDi	68		11.09	07.13					
	1.6 HDi	82		08.09	07.13					
	1.6 HDi FAP 110	80		06.07	07.13					
	1.6 HDi FAP 90	66		06.07	07.13					
1.6 i 16V	88		06.07	07.13						
	1.6 16V RC	128		11.07	07.13	11.9571-9765.2	220663	☐	D=57, - Halter	ATE
						11.9571-9766.2	220664	☐	D=57, - Halter	ATE
						11.0101-5704.2	260095		Hülzensatz	ATE
						11.8171-0008.1	990049		Führungsbolzen	ATE
						11.8116-0351.1	390538	2	Haltefeder	ATE
	1.4 i	54		06.07	07.13	24.5144-0480.3	330961	2		L=480
	1.4 i 16V	70		06.07	07.13					
	1.6 16V RC	128		11.07	07.13					
	1.6 16V Turbo	110		02.07	07.13					
	1.6 HDi	68		11.09	07.13					
	1.6 HDi	82		08.09	07.13					
	1.6 HDi FAP 110	80		06.07	07.13					
	1.6 HDi FAP 90	66		06.07	07.13					
1.6 i 16V	88		06.07	07.13						
	1.6 16V RC	128	ORGA 11628		07.13	24.3387-1733.5	240655	☐	D=38, - Halter	TRW
	1.6 16V Turbo	110	ORGA 11628		07.13	24.3387-1734.5	240656	☐	D=38, - Halter	TRW
	1.6 HDi	68		11.09	07.13					
	1.6 HDi FAP 110	80	ORGA 11635		07.13					
	1.6 HDi FAP 90	66	ORGA 11635		07.13					
1.6 i 16V	88	ORGA 11628		07.13						
	1.4 i	54		06.07	07.13	24.5239-0190.3	330966	2		L=190
	1.4 i 16V	70		06.07	07.13					
	1.6 16V RC	128		11.07	07.13					
	1.6 16V Turbo	110		02.07	07.13					
	1.6 HDi	68		11.09	07.13					
	1.6 HDi	82		08.09	07.13					
	1.6 HDi FAP 110	80		06.07	07.13					
	1.6 HDi FAP 90	66		06.07	07.13					
1.6 i 16V	88		06.07	07.13						
	1.4 i	54		06.07	07.13	24.3220-1611.3	020238	☐ - ABS	RzR 20,64	BDX
	1.6 HDi FAP 90	66		06.07	07.13	24.3220-1612.3	020239	☐ - ABS	RzR 20,64	BDX
	1.4 i	54		06.07	07.13	24.3220-1611.3	020238	+ ABS	RzR 20,64	BDX
	1.4 i 16V	70		06.07	07.13					
	1.6 HDi	68		11.09	07.13					
1.6 HDi FAP 90	66		06.07	07.13						
	1.6 16V RC	128	ORGA 11634	11.07		24.3727-0845.2	580845	2 ↓		L=1905
	1.6 16V Turbo	110	ORGA 11634	02.07						
	1.6 HDi	68	ORGA 11634	11.09						
	1.6 HDi	82	ORGA 11634	08.09						
	1.6 HDi FAP 110	80	ORGA 11634	06.07						
	1.6 HDi FAP 90	66	ORGA 11634	06.07						
	1.6 i 16V	88	ORGA 11634	06.07						
	1.4 i	54		06.07	07.13	24.3727-0846.2	580846	2 ↓		L=1796
	1.4 i 16V	70		06.07	07.13					
	1.6 16V RC	128	ORGA 11635		07.13	24.3727-0855.2	580855	2 ↓		L=1910



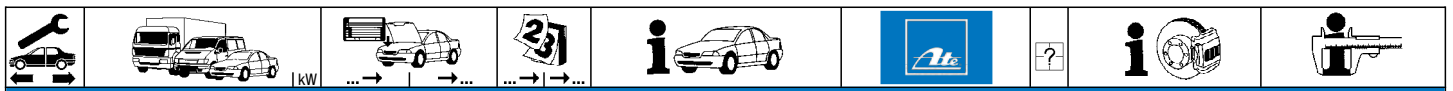

PEUGEOT 207 SW (07-13)















	1.6 16V Turbo 1.6 HDi 1.6 HDi 1.6 HDi FAP 110 1.6 HDi FAP 90 1.6 i 16V	110 ORGA 11635 68 ORGA 11635 82 ORGA 11635 80 ORGA 11635 66 ORGA 11635 88 ORGA 11635		07.13 07.13 07.13 07.13 07.13 07.13	24.3727-0855.2	580855	2 ↓	L=1910
	1.4 i 1.4 i 16V 1.6 i 16V	54 70 88	ORGA 11556 ORGA 11556 ORGA 11556	06.07 06.07 06.07	24.2415-1715.3	030137		Gz 15,87
	1.4 i 1.4 i 16V 1.6 i 16V	54 70 88		06.07 06.07 06.07	24.2415-1714.3	030134		Gz 15,87
	1.6 16V RC 1.6 16V Turbo 1.6 HDi 1.6 HDi FAP 110 1.6 HDi FAP 90	128 ORGA 11557 110 ORGA 11557 68 ORGA 11557 80 ORGA 11557 66 ORGA 11557	ORGA 12775 ORGA 12775	07.13 07.13 07.13 07.13 07.13	24.2415-1717.3	030140		Gz 15,87
	1.4 i 1.4 i 16V 1.6 i 16V	54 70 88	ORGA 11647 ORGA 11647 ORGA 11437	06.07 06.07 06.07	24.2519-1707.3	040100		Nz 19,05
	1.4 i 1.4 i 16V	54 ORGA 11648 70 ORGA 11648		07.13 07.13	24.2518-1702.3	040099		Nz 18,90
	1.6 16V RC 1.6 16V Turbo 1.6 HDi 1.6 HDi 1.6 HDi FAP 110 1.6 HDi FAP 90	128 ORGA 11648 110 ORGA 11648 68 ORGA 11648 82 ORGA 11648 80 ORGA 11648 66 ORGA 11648		07.13 07.13 07.13 07.13 07.13 07.13	24.2518-1703.3	040101		Nz 18,90

PEUGEOT 208 (12-)

	1.0 VTi 1.2 THP 1.2 VTi 1.4 HDi 1.4 VTi 1.4 VTi GPL 1.6 BlueHDi 120 1.6 e-HDi 1.6 e-HDi 1.6 HDi 1.6 HDi 1.6 THP 1.6 VTi	50 ORGA 13342 81 ORGA 13342 60 ORGA 13342 50 70 70 88 68 84 55 85 115 88		+ Trommelbremse 1) + Trommelbremse 1) + Trommelbremse 1) + Trommelbremse 1) + Trommelbremse 1) + Trommelbremse 1) + Trommelbremse 1) + Trommelbremse 1) + Trommelbremse 1) + Trommelbremse 1) + Trommelbremse 1) + Trommelbremse 1) + Trommelbremse 1)	24.4122-1703.3 24.4122-1704.3	010843 010847	+ DSC - DSC	THz 22,20 THz 22,20	TRW TRW
	1.0 VTi 1.2 THP 1.2 VTi 1.4 HDi 1.4 VTi 1.4 VTi GPL 1.6 BlueHDi 100 1.6 BlueHDi 120 1.6 e-HDi 1.6 e-HDi 1.6 GTi 1.6 GTi 30th 1.6 HDi 1.6 HDi 1.6 THP 1.6 THP 163 1.6 VTi	50 81 60 50 70 70 73 88 68 84 147 153 55 85 115 120 88	01.12 01.13 01.12 01.12 10.13 01.15 11.13 01.12 01.12 03.13 10.14 01.13 04.14 01.12 03.15 01.12	+ Scheibenbremse 2) + Scheibenbremse 2) + Scheibenbremse 2) + Scheibenbremse 2) + Scheibenbremse 2) + Scheibenbremse 2) + Scheibenbremse 2) + Scheibenbremse 2) + Scheibenbremse 2) + Scheibenbremse 2) + Scheibenbremse 2) + Scheibenbremse 2) + Scheibenbremse 2) + Scheibenbremse 2) + Scheibenbremse 2) + Scheibenbremse 2)	24.4123-1704.3 24.4123-1705.3	010828 010832	+ DSC - DSC	THz 23,81 THz 23,81	TRW TRW
	1.0 VTi 1.2 THP 1.2 VTi 1.4 HDi 1.4 VTi 1.4 VTi GPL 1.6 BlueHDi 100 1.6 BlueHDi 120 1.6 e-HDi 1.6 e-HDi 1.6 HDi 1.6 HDi 1.6 THP 1.6 THP 163 1.6 VTi	50 81 60 50 70 70 73 88 68 84 55 85 115 120 88	01.12 01.13 01.12 01.12 01.12 10.13 01.15 11.13 01.12 01.12 01.13 04.14 01.12 03.15 01.12	+ Bremsscheibendurchm. 266 mm 3) + Bremsscheibendurchm. 266 mm 3) + Bremsscheibendurchm. 266 mm 3) + Bremsscheibendurchm. 266 mm 3) + Bremsscheibendurchm. 266 mm 3) + Bremsscheibendurchm. 266 mm 3) + Bremsscheibendurchm. 266 mm 3) + Bremsscheibendurchm. 266 mm 3) + Bremsscheibendurchm. 266 mm 3) + Bremsscheibendurchm. 266 mm 3) + Bremsscheibendurchm. 266 mm 3) + Bremsscheibendurchm. 266 mm 3) + Bremsscheibendurchm. 266 mm 3) + Bremsscheibendurchm. 266 mm 3) + Bremsscheibendurchm. 266 mm 3)	24.3541-1771.5 24.3541-1772.5	240239 240240	<input checked="" type="checkbox"/> <input type="checkbox"/>	D=54, - Halter D=54, - Halter	BOS BOS
	1.0 VTi 1.2 THP 1.2 VTi 1.4 HDi 1.4 VTi 1.4 VTi GPL 1.6 BlueHDi 100 1.6 BlueHDi 120 1.6 e-HDi 1.6 e-HDi 1.6 HDi 1.6 HDi 1.6 THP 1.6 THP 163 1.6 VTi	50 81 60 50 70 70 73 88 68 84 55 85 115 120 88	01.12 01.13 01.12 01.12 01.12 10.13 01.15 11.13 01.12 01.12 01.13 04.14 01.12 03.15 01.12	+ Bremsscheibendurchm. 302 mm 4) + Bremsscheibendurchm. 302 mm 4) + Bremsscheibendurchm. 302 mm 4) + Bremsscheibendurchm. 302 mm 4) + Bremsscheibendurchm. 302 mm 4) + Bremsscheibendurchm. 302 mm 4) + Bremsscheibendurchm. 302 mm 4) + Bremsscheibendurchm. 302 mm 4) + Bremsscheibendurchm. 302 mm 4) + Bremsscheibendurchm. 302 mm 4) + Bremsscheibendurchm. 302 mm 4) + Bremsscheibendurchm. 302 mm 4) + Bremsscheibendurchm. 302 mm 4) + Bremsscheibendurchm. 302 mm 4) + Bremsscheibendurchm. 302 mm 4)	11.9571-9939.2 11.9571-9940.2 11.0101-5704.2 11.8171-0008.1 11.8116-0356.1	220923 220924 260095 990049 390586	<input checked="" type="checkbox"/> <input type="checkbox"/>	D=57, - Halter D=57, - Halter Hülzensatz Führungsbolzen Haltefeder	ATE ATE ATE ATE ATE

1) + drum brake / + freno a tamburo / + freins à tambour / + tambores de freno
 2) + disc brake / + disco freno / + disques de frein / + disco de freno
 3) + brake disc diameter 266 mm / + disco fr.diam. 266mm / + disques fr.diam. 266mm / + disco fr.diam. 266mm
 4) + brake disc diameter 302 mm / + disco fr.diam. 302mm / + disques fr.diam. 302mm / + disco fr.diam. 302mm



													
PEUGEOT 208 (12-)													
	1.6 HDi	85	04.14	+ Bremsscheibendurchm. 302 mm ¹⁾	11.9571-9939.2	220923	2	D=57, - Halter ATE D=57, - Halter ATE Hülsensatz ATE Führungsbolzen ATE Haltefeder ATE					
	1.6 THP	115	01.12	+ Bremsscheibendurchm. 302 mm ¹⁾	11.9571-9940.2	220924							
	1.6 THP 163	120	03.15	+ Bremsscheibendurchm. 302 mm ¹⁾	11.0101-5704.2	260095							
	1.6 VTi	88	01.12	+ Bremsscheibendurchm. 302 mm ¹⁾	11.8171-0008.1	990049							
					11.8116-0356.1	390586							
	1.6 GTi	147	03.13	+ Bremsscheibendurchm. 302 mm ¹⁾	11.0101-5704.2	260095	2	Hülsensatz ATE Führungsbolzen ATE Haltefeder ATE					
	1.6 GTi 30th	153 ORGA 14084		+ Bremsscheibendurchm. 302 mm ¹⁾	11.8171-0008.1	990049							
					11.8116-0356.1	390586							
	1.0 VTi	50	01.12	+ Bremsscheibendurchm. 266 mm ²⁾	24.5111-0496.3	331371	2	L=495					
	1.2 THP	81	01.13	+ Bremsscheibendurchm. 266 mm ²⁾									
	1.2 VTi	60	01.12	+ Bremsscheibendurchm. 266 mm ²⁾									
	1.4 HDi	50	01.12	+ Bremsscheibendurchm. 266 mm ²⁾									
	1.4 VTi	70	01.12	+ Bremsscheibendurchm. 266 mm ²⁾									
	1.4 VTi GPL	70	10.13	+ Bremsscheibendurchm. 266 mm ²⁾									
	1.6 BlueHDi 100	73	01.15	+ Bremsscheibendurchm. 266 mm ²⁾									
	1.6 BlueHDi 120	88	11.13	+ Bremsscheibendurchm. 266 mm ²⁾									
	1.6 e-HDi	68	01.12	+ Bremsscheibendurchm. 266 mm ²⁾									
	1.6 e-HDi	84	01.12	+ Bremsscheibendurchm. 266 mm ²⁾									
	1.6 GTi	147	03.13	+ Bremsscheibendurchm. 266 mm ²⁾									
	1.6 HDi	55	01.13	+ Bremsscheibendurchm. 266 mm ²⁾									
	1.6 HDi	85	04.14	+ Bremsscheibendurchm. 266 mm ²⁾									
	1.6 THP	115	01.12	+ Bremsscheibendurchm. 266 mm ²⁾									
	1.6 THP 163	120	03.15	+ Bremsscheibendurchm. 266 mm ²⁾									
	1.6 VTi	88	01.12	+ Bremsscheibendurchm. 266 mm ²⁾									
		1.0 VTi	50	01.12					+ Bremsscheibendurchm. 302 mm ¹⁾	24.5144-0480.3	330961	2	L=480
	1.2 THP	81	01.13	+ Bremsscheibendurchm. 302 mm ¹⁾									
	1.2 VTi	60	01.12	+ Bremsscheibendurchm. 302 mm ¹⁾									
	1.4 HDi	50	01.12	+ Bremsscheibendurchm. 302 mm ¹⁾									
	1.4 VTi	70	01.12	+ Bremsscheibendurchm. 302 mm ¹⁾									
	1.4 VTi GPL	70	10.13	+ Bremsscheibendurchm. 302 mm ¹⁾									
	1.6 BlueHDi 100	73	01.15	+ Bremsscheibendurchm. 302 mm ¹⁾									
	1.6 BlueHDi 120	88	11.13	+ Bremsscheibendurchm. 302 mm ¹⁾									
	1.6 e-HDi	68	01.12	+ Bremsscheibendurchm. 302 mm ¹⁾									
	1.6 e-HDi	84	01.12	+ Bremsscheibendurchm. 302 mm ¹⁾									
	1.6 GTi	147	03.13	+ Bremsscheibendurchm. 302 mm ¹⁾									
	1.6 HDi	55	01.13	+ Bremsscheibendurchm. 302 mm ¹⁾									
	1.6 HDi	85	04.14	+ Bremsscheibendurchm. 302 mm ¹⁾									
	1.6 THP	115	01.12	+ Bremsscheibendurchm. 302 mm ¹⁾									
	1.6 THP 163	120	03.15	+ Bremsscheibendurchm. 302 mm ¹⁾									
	1.6 VTi	88	01.12	+ Bremsscheibendurchm. 302 mm ¹⁾									
	1.0 VTi	50	01.12		24.3387-1733.5	240655	2	D=38, - Halter TRW D=38, - Halter TRW					
	1.2 THP	81	01.13										
	1.2 VTi	60	01.12										
	1.4 HDi	50	01.12										
	1.4 VTi	70	01.12										
	1.4 VTi GPL	70	10.13										
	1.6 BlueHDi 100	73	01.15										
	1.6 BlueHDi 120	88	11.13										
	1.6 e-HDi	68	01.12										
	1.6 e-HDi	84	01.12										
	1.6 HDi	55	01.13										
	1.6 HDi	85	04.14										
	1.6 THP	115	01.12										
	1.6 THP 163	120	03.15										
	1.6 VTi	88	01.12										
		1.0 VTi	50	01.12						24.5239-0190.3	330966	2	L=190
		1.2 THP	81	01.13									
1.2 VTi		60	01.12										
1.4 HDi		50	01.12										
1.4 VTi		70	01.12										
1.4 VTi GPL		70	10.13										
1.6 BlueHDi 100		73	01.15										
1.6 BlueHDi 120		88	11.13										
1.6 e-HDi		68	01.12										
1.6 e-HDi		84	01.12										
1.6 GTi		147	03.13										
1.6 GTi 30th		153	10.14										
1.6 HDi		55	01.13										
1.6 HDi		85	04.14										
1.6 THP		115	01.12										
1.6 THP 163		120	03.15										
1.6 VTi		88	01.12										
	1.0 VTi	50	01.12		24.3220-1743.3	020556		Rz 20,64					
	1.2 THP	81	01.13										
	1.2 VTi	60	01.12										
	1.4 HDi	50	01.12										
	1.4 VTi	70	01.12										
	1.4 VTi GPL	70	10.13										
	1.6 BlueHDi 100	73	01.15										
	1.6 BlueHDi 120	88	11.13										
	1.6 e-HDi	68	01.12										
	1.6 e-HDi	84	01.12										
	1.6 HDi	55	01.13										
	1.6 HDi	85	04.14										
	1.6 THP	115	01.12										
	1.6 THP 163	120	03.15										
	1.6 VTi	88	01.12										

¹⁾ + brake disc diameter 302 mm / + disco fr.diam. 302mm / + disques fr.diam. 302mm / + disco fr.diam. 302mm

²⁾ + brake disc diameter 266 mm / + disco fr.diam. 266mm / + disques fr.diam. 266mm / + disco fr.diam. 266mm

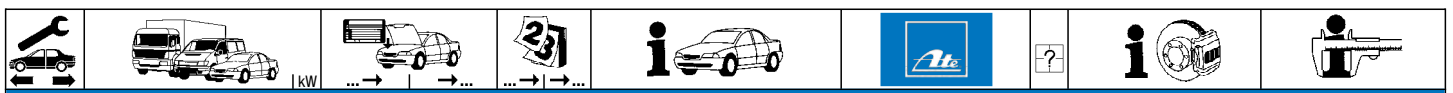

PEUGEOT 208 (12-)									
	1.0 VTi	▶ 50		01.12	+ BVM MA-Getriebe ¹⁾	24.2415-1714.3	030134		Gz 15,87
	1.2 VTi	▶ 60		01.12	+ BVM MA-Getriebe ¹⁾				
	1.4 HDi	▶ 50		01.12	+ BVM MA-Getriebe ¹⁾				
	1.4 VTi	▶ 70		01.12	+ BVM MA-Getriebe ¹⁾				
	1.4 VTi GPL	▶ 70		10.13	+ BVM MA-Getriebe ¹⁾				
	1.6 BlueHDi 100	▶ 73		01.15	+ BVM MA-Getriebe ¹⁾				
	1.6 e-HDi	▶ 68		01.12	+ BVM MA-Getriebe ¹⁾				
	1.6 e-HDi	▶ 84		01.12	+ BVM MA-Getriebe ¹⁾				
	1.6 GTi	▶ 147		03.13	+ BVM MA-Getriebe ¹⁾				
	1.6 THP	▶ 115		01.12	+ BVM MA-Getriebe ¹⁾				
	1.6 THP 163	▶ 120		03.15	+ BVM MA-Getriebe ¹⁾				
	1.6 VTi	▶ 88		01.12	+ BVM MA-Getriebe ¹⁾				
	1.0 VTi	50		01.12	+ BVM MA-Getriebe ¹⁾	24.2518-1702.3	040099		Nz 18,90
	1.2 VTi	60		01.12	+ BVM MA-Getriebe ¹⁾				
	1.4 HDi	50		01.12	+ BVM MA-Getriebe ¹⁾				
	1.4 VTi	70		01.12	+ BVM MA-Getriebe ¹⁾				
	1.4 VTi GPL	70		10.13	+ BVM MA-Getriebe ¹⁾				
	1.6 BlueHDi 100	73		01.15	+ BVM MA-Getriebe ¹⁾				
	1.6 e-HDi	68		01.12	+ BVM MA-Getriebe ¹⁾				
	1.6 e-HDi	84		01.12	+ BVM MA-Getriebe ¹⁾				
	1.6 GTi	147		03.13	+ BVM MA-Getriebe ¹⁾				
	1.6 THP	115		01.12	+ BVM MA-Getriebe ¹⁾				
	1.6 THP 163	120		03.15	+ BVM MA-Getriebe ¹⁾				
	1.6 VTi	◀ 88		01.12	+ BVM MA-Getriebe ¹⁾				
	1.6 VTi	▶ 88		01.12	+ BVM MA-Getriebe ¹⁾	24.2518-1704.3	040102		Nz 18,90
PEUGEOT 301 (12-)									
	1.6 BlueHDi 100	73		04.14		24.4122-1703.3	010843	+ ESP	Thz 22,20 TRW
	1.6 HDi 92	68		11.12					
	1.2 VTi 72	53		11.12		24.3541-1771.5	240239	+ belüftete Scheiben ²⁾	D=54, - Halter BOS
	1.2 VTi 82	60		12.14		24.3541-1772.5	240240	+ belüftete Scheiben ²⁾	D=54, - Halter BOS
	1.6 BlueHDi 100	73		04.14					
	1.6 HDi 92	68		11.12					
	1.6 VTi 115	85		11.12					
	1.2 VTi 72	53		11.12		24.5239-0190.3	330966	2	L=190
	1.2 VTi 82	60							
	1.6 BlueHDi 100	73		04.14					
	1.6 HDi 92	68		11.12					
	1.6 VTi 115	85		11.12					
	1.2 VTi 72	53		11.12		24.3220-1617.3	020244	- ABS	RzR 20,64 BDX
	1.2 VTi 82	60		12.14		24.3220-1618.3	020245	- ABS	RzR 20,64 BDX
	1.6 BlueHDi 100	73		04.14		24.3220-1743.3	020556	+ ABS	Rz 20,64
	1.6 HDi 92	68		11.12					
	1.6 VTi 115	85		11.12					
	1.2 VTi 72	53		11.12	+ BVM MA-Getriebe ¹⁾	24.2518-1702.3	040099		Nz 18,90
	1.2 VTi 82	60		12.14	+ BVM MA-Getriebe ¹⁾				
	1.6 BlueHDi 100	73		04.14	+ BVM MA-Getriebe ¹⁾				
	1.6 HDi 92	68		11.12	+ BVM MA-Getriebe ¹⁾				
	1.6 VTi 115	85		11.12	+ BVM MA-Getriebe ¹⁾				
	1.2 VTi 72	53		11.12	+ BE4R-Getriebe ³⁾	24.2518-1703.3	040101		Nz 18,90
	1.2 VTi 82	60		12.14	+ BE4R-Getriebe ³⁾				
	1.6 BlueHDi 100	73		04.14	+ BE4R-Getriebe ³⁾				
	1.6 HDi 92	68		11.12	+ BE4R-Getriebe ³⁾				
	1.6 VTi 115	85		11.12	+ BE4R-Getriebe ³⁾				
PEUGEOT 306 Limousine (3/5-tuerig) (93-01)									
	1.4	55		05.97	05.01 - ABS	03.7750-9302.4	300116		9" ATE
	1.6	65		05.97	10.00 - ABS				
	1.6	72		10.00	05.01 - ABS				
	1.8	◀ 74		05.97	05.01 - ABS				
	1.8 16V	◀ 81		05.97	05.01 - ABS				
	1.8 D	◀ 43		05.97	05.01 - ABS				
	1.9 D	◀		05.97	05.01 - ABS				
	1.9 TD	◀ 66		05.97	05.01 - ABS				
	2.0	◀ 89		05.97	05.01 - ABS				
	2.0 16V	◀		05.97	05.01 - ABS				
	2.0 HDi	◀ 66		06.99	05.01 - ABS				
	2.0 S16	◀ 110		05.97	05.01 - ABS				
	2.0 S16	◀ 112		05.97	05.01 - ABS				
	1.1	◀ 44		03.94	04.97 + ABS	03.7750-9402.4	300117		9" ATE
	1.4	◀ 55	ORGA 08575	03.93	+ ABS				
	1.6	◀ 65	ORGA 08575	03.93	+ ABS				
	1.8	◀ 74	ORGA 08575	03.93	+ ABS				
	1.8 16V	◀ 81	ORGA 08575	03.97	+ ABS				
	1.8 D	◀ 43		03.93	05.01 + ABS				
	1.9 D	◀ 47		05.93	05.01 + ABS				
	1.9 D	◀ 50		06.94	05.01 + ABS				
	1.9 D	◀ 51	ORGA 08575	09.98	+ ABS				
	1.9 D	◀ 55		03.98	05.01 + ABS				
	1.9 TD	◀ 66	ORGA 08575	10.93	+ ABS				
	2.0	◀ 89	ORGA 08575	03.94	+ ABS				
	2.0 16V	◀	ORGA 08575	03.97	+ ABS				
	2.0 HDi	◀ 66	ORGA 08575	06.99	+ ABS				
	2.0 S16	◀ 110	ORGA 08575	03.94	+ ABS				
	2.0 S16	◀ 112	ORGA 08575	07.94	+ ABS				

¹⁾ + BVM MA transmission / + scatola cambio BVM MA / + boîte de vitesse BVM MA / + cambio BVM MA

²⁾ + ventilated discs / + dischi ventilati / + disques ventilés / + disco ventilado

³⁾ + BE4R transmission / + scatola cambio BE4R / + boîte de vitesse BE4R / + cambio BE4R

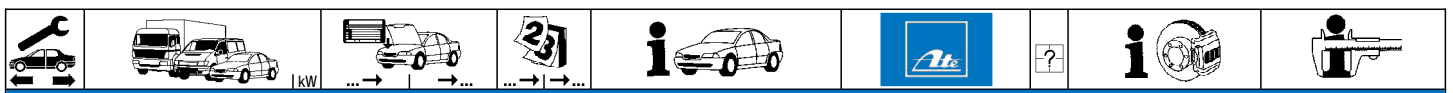

PEUGEOT 306 Limousine (3/5-tuerig) (93-01)

	1.6	▶ 65		03.93	04.97	+ ABS	03.7750-2232.4	300112		9"	ATE
	1.1	44		03.94	04.97	- ABS/ + 3 türig ¹⁾	24.2120-1704.3	010429		THz 20,64	BDX
	1.4	55		03.93	04.97	- ABS/ + Fahrschule/ + 3 türig ²⁾					
	1.1	44		03.94	04.97	- ABS/ + 5 türig ³⁾	03.2119-3391.3	010058		THz 19,05	ATE
	1.4	55		03.93	04.97	- ABS/ - Fahrschule/ + 5 türig ⁴⁾	24.2119-1702.3	010435		THz 19,05	BDX
	1.4	55		05.97	05.01	- ABS	03.2120-4321.3	010525		THz 20,64	ATE
	1.6	65		05.97	10.00	- ABS	24.2120-1726.3	010564		THz 20,64	BDX
	1.6	72		10.00	05.01	- ABS					
	1.8	▶ 74		05.97	05.01	- ABS					
	1.8 D	◀ 43		05.97	05.01	- ABS					
	1.9 D	◀		05.97	05.01	- ABS					
	1.6	65		03.93	04.97	- ABS	03.2120-1897.3	010103		THz 20,64	ATE
	1.8	◀ 74		03.93	04.97	- ABS	24.2120-1704.3	010429		THz 20,64	BDX
	1.8 16V	◀ 81		03.97	04.97	- ABS					
	1.8 D	◀ 43		03.93	04.97	- ABS					
	1.9 D	◀		05.93	04.97	- ABS					
	1.9 TD	◀ 66		10.93	04.97	- ABS					
	2.0	◀ 89		03.94	04.97	- ABS					
	2.0 16V	◀		03.97	04.97	- ABS					
	2.0 S16	◀110		03.94	04.97	- ABS					
	2.0 S16	◀112		07.94	04.97	- ABS					
	1.8 16V	◀ 81		05.97	05.01	- ABS	03.2122-1356.3	010529		THz 22,20	ATE
	1.9 TD	◀ 66		05.97	05.01	- ABS					
	2.0	◀ 89		05.97	05.01	- ABS					
	2.0 16V	◀		05.97	05.01	- ABS					
	2.0 HDi	◀ 66		06.99	05.01	- ABS					
	2.0 S16	◀110		05.97	05.01	- ABS					
	2.0 S16	◀112		05.97	05.01	- ABS					
	1.4	◀ 55	ORGA 08575	05.97		+ ABS	03.2122-1351.3	010528		THz 22,20	ATE
	1.6	◀ 65	ORGA 08575	05.97		+ ABS	24.2122-1733.3	010668		THz 22,20	BOS
	1.8	◀ 74	ORGA 08575	05.97		+ ABS					
	1.8 16V	◀ 81	ORGA 08575	05.97		+ ABS					
	1.8 D	◀ 43	ORGA 08575	05.97		+ ABS					
	1.9 D	◀	ORGA 08575	05.97		+ ABS					
	1.9 TD	◀ 66	ORGA 08575	05.97		+ ABS					
	2.0	◀ 89	ORGA 08575	05.97		+ ABS					
	2.0 16V	◀	ORGA 08575	05.97		+ ABS					
	2.0 HDi	◀ 66	ORGA 08575	06.99		+ ABS					
	2.0 S16	◀110	ORGA 08575	05.97		+ ABS					
	2.0 S16	◀112	ORGA 08575	05.97		+ ABS					
	1.4	◀ 55	ORGA 08576	05.01		+ ABS	24.2123-1715.3	010520		THz 23,81	BDX
	1.6	◀ 65	ORGA 08576	10.00		+ ABS					
	1.6	◀ 72		05.01		+ ABS					
	1.8	◀ 74	ORGA 08576	05.01		+ ABS					
	1.8 16V	◀ 81	ORGA 08576	05.01		+ ABS					
	1.8 D	◀ 43	ORGA 08576	05.01		+ ABS					
	1.9 D	◀	ORGA 08576	05.01		+ ABS					
	1.9 TD	◀ 66	ORGA 08576	05.01		+ ABS					
	2.0	◀ 89	ORGA 08576	05.01		+ ABS					
	2.0 16V	◀	ORGA 08576	05.01		+ ABS					
	2.0 HDi	◀ 66	ORGA 08576	05.01		+ ABS					
	2.0 S16	◀110	ORGA 08576	05.01		+ ABS					
	2.0 S16	◀112	ORGA 08576	05.01		+ ABS					
	2.0 S16	◀120		03.96		+ ABS					
	1.8	▶ 74		03.93	05.01	- ABS	03.2120-4246.3	010614		THz 20,64	ATE
	1.8 D	▶ 43		03.93	05.01	- ABS	24.2120-1722.3	010544		THz 20,64	BDX
	1.9 D	▶ 47		05.93	05.01	- ABS					
	1.9 D	▶ 50		06.94	05.01	- ABS					
	1.9 D	▶ 51		09.98	05.01	- ABS	03.2122-1461.3	010610		THz 22,20	ATE
	1.8 16V	▶ 81		03.97	05.01	- ABS	03.2122-1421.3	010615		THz 22,20	ATE
	1.9 TD	▶ 66		10.93	05.01	- ABS					
	2.0	▶ 89		03.94	05.01	- ABS					
	2.0 16V	▶		03.97	05.01	- ABS					
	2.0 HDi	▶ 66		06.99	05.01	- ABS					
	2.0 S16	▶110		03.94	05.01	- ABS					
	2.0 S16	▶112		07.94	05.01	- ABS					
	1.1	44 S 30209025				+ ABS	24.2122-1705.3	010434		THz 22,20	
	1.4	55 S 30209025				+ ABS					
	1.6	65 S 30209025				+ ABS					
	1.8	74 S 30209025				+ ABS					
	1.8 16V	81		03.97		+ ABS					
	1.8 D	43 S 30209025				+ ABS					
	1.9 D	S 30209025				+ ABS					
	1.9 TD	66		10.93		+ ABS					
	2.0	89		03.94		+ ABS					
	2.0 16V			03.97		+ ABS					
	2.0 S16	110		03.94		+ ABS					
	2.0 S16	112		07.94		+ ABS					
	1.9 D	▶ 51	ORGA 08575	05.97		+ ABS	03.2122-1461.3	010610		THz 22,20	ATE
	2.0 S16	120		03.96		- ABS	24.2123-1714.3	010587		THz 23,81	BDX

1) - ABS/ + 3 door / - ABS/ + 3 porte / - ABS/ + 3 portes / - ABS/ + 3 puertas
 2) - ABS/ + driving school/ + 3 door / - ABS/ + scuola guida/ + 3 porte / - ABS/ + auto école/ + 3 portes / - ABS/ + autoescuela/ + 3 puertas
 3) - ABS/ + 5 door / - ABS/ + 5 porte / - ABS/ + 5 portes / - ABS/ + 5 puertas
 4) - ABS/ - driving school/ + 5 door / - ABS/ - scuola guida/ + 5 porte / - ABS/ - auto école/ + 5 portes / - ABS/ - autoescuela/ + 5 puertas



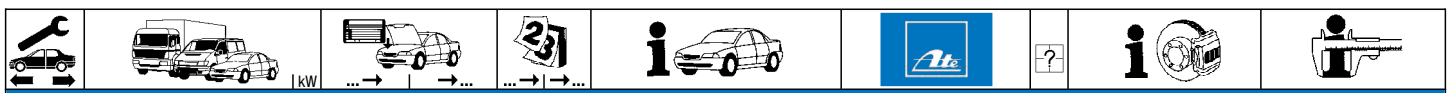

PEUGEOT 306 Limousine (3/5-tuerig) (93-01)

	1.4	55		05.97	05.01	- ABS	24.3481-1741.5	240245			D=48, - Halter	BOS
							24.3481-1742.5	240246			D=48, - Halter	BOS
	1.1	44		03.94	04.97	+ ABS	11.3481-9833.2	220561			D=48, - Halter	ATE
	1.4	55	ORGA 08575	03.93		+ ABS/- Entreprise	11.3481-9834.2	220562			D=48, - Halter	ATE
	1.4 Entreprise	55		03.93	05.01		24.3481-9833.5	240479			D=48, - Halter	ATE
	1.6	65	ORGA 08575	03.93			24.3481-9834.5	240480			D=48, - Halter	ATE
	1.6	65	ORGA 08576		10.00	- ABS	11.0441-4811.2	250024			Dichtungssatz	ATE
	1.6	66	ORGA 08575	07.00			11.0101-5407.2	260011			Hülzensatz	ATE
	1.6	66	ORGA 08576		05.01	- ABS	11.8171-0008.1	990049			Führungsbolzen	ATE
	1.6	72		10.00	05.01	- ABS	11.8116-0129.1	390591	2		Haltefeder	ATE
	1.6	74	ORGA 08575	03.93								
	1.8	74	ORGA 08576		05.01	- ABS						
	1.8 D	43		03.93	05.01							
	1.9 D	47		05.93	05.01							
	1.9 D	50		06.94	05.01							
	1.9 D	51	ORGA 08575	09.98								
	1.9 D	51	ORGA 08576		05.01	- ABS						
	1.9 D	55		03.98	05.01							
	1.9 D Entreprise			09.98	10.00	+ ABS						
	1.9 TD	66		10.93	05.01							
	1.4	55	ORGA 08576		05.01	+ ABS	24.3541-1767.5	240237			D=54, - Halter	BOS
	1.6	65	ORGA 08576		10.00	+ ABS	24.3541-1768.5	240238			D=54, - Halter	BOS
	1.6	66	ORGA 08576		05.01	+ ABS	24.3541-1757.7	220483			D=54, - Halter	TRW
	1.6	72		10.00	05.01	+ ABS	24.3541-1758.7	220484			D=54, - Halter	TRW
	1.8	74	ORGA 08576		05.01	+ ABS						
	1.8 16V	81		03.97	05.01							
	1.9 D	51	ORGA 08576		05.01	+ ABS						
	1.9 D Entreprise			10.00	05.01	+ ABS						
	2.0	89		05.97	05.01							
	2.0 16V			05.97	05.01							
	2.0 HDi	66		06.99	05.01							
	2.0 S16	110		05.97	05.01							
	2.0 S16	112		05.97	05.01							
	2.0	89		03.94	04.97	- Niveauregulierung ¹⁾	24.0101-3601.2	260044				TRW
	2.0 16V			03.97	04.97	- Niveauregulierung ¹⁾						
	1.1	44		03.94	04.97	- ABS	24.5111-0495.3	330505	2		L=495	
	1.4	55		03.93	04.97	- ABS						
	1.1	44		03.94	04.97	+ ABS	24.5111-0495.3	330505	2	Länge beachten ²⁾	L=495	
	1.4	55		05.97	05.01		24.5111-0520.3	330506	2	Länge beachten ²⁾	L=519	
	1.4	55		03.93	04.97	+ ABS						
	1.6	65		03.93	10.00							
	1.6	72		10.00	05.01							
	1.8	74		03.93	05.01							
	1.8 16V	81		03.97	05.01							
	1.8 D	43		03.93	05.01							
	1.9 D			05.93	05.01							
	1.9 TD	66		10.93	05.01							
	2.0	89		03.94	05.01							
	2.0 16V			03.97	05.01							
	2.0 HDi	66		06.99	05.01							
	2.0 S16	110		03.94	05.01							
	2.0 S16	112		07.94	05.01							
	2.0 S16	120		03.96	05.01							
	1.1	44		03.94	04.97	- ABS	24.5228-0195.3	330469	2		L=202	
	1.4	55		03.93	04.97	- ABS						
	1.1	44		03.94	04.97	+ ABS	24.5228-0195.3	330469			L=202	
	1.4	55		05.97	05.01		24.5228-0245.3	330531			L=245	
	1.4	55		03.93	04.97	+ ABS						
	1.6	65		03.93	10.00							
	1.6	72		10.00	05.01							
	1.8	74		03.93	05.01							
	1.8 16V	81		03.97	05.01							
	1.8 D	43		03.93	05.01							
	1.9 D			05.93	05.01							
	1.9 TD	66		10.93	05.01							
	2.0	89		03.94	05.01							
	2.0 16V			03.97	05.01							
	2.0 HDi	66		06.99	05.01							
	2.0 S16	110		03.94	05.01							
	2.0 S16	112		07.94	05.01							
	2.0 S16	120		03.96	05.01							
	1.1	44		03.94	04.97	- ABS	24.3220-1617.3	020244			RzR 20,64	BDX
	1.4	55		05.97	05.01	- ABS	24.3220-1618.3	020245			RzR 20,64	BDX
	1.4	55		03.93	04.97	- ABS/-verst.Fahrw./+ 5 türig ³⁾	24.3220-1615.3	020242			RzR 20,64	TRW
	1.6	65		03.93	10.00	- ABS	24.3220-1616.3	020243			RzR 20,64	TRW
	1.6	72		10.00	05.01	- ABS						
	1.8	74		03.93	05.01	- ABS						
	1.8 D	43		05.97	05.01	- ABS						
	1.8 D	43		03.93	04.97	- ABS/-verst.Fahrw./+ 5 türig ³⁾						
	1.9 D			05.97	05.01	- ABS						
	1.9 D			05.93	04.97	- ABS/-verst.Fahrw./+ 5 türig ³⁾						
	1.9 TD	66		10.93	05.01	- ABS/-verst.Fahrw./+ 5 türig ³⁾						
	1.1	44		03.94	04.97	+ ABS	24.3220-1702.3	020375			Rz 20,64	BDX
	1.4	55		03.93	04.97	+ ABS/- verstärktes Fahrwerk ⁴⁾						
	1.4	55		03.93	04.97	- ABS/+ verst.Fahrw./+ 3 türig ⁵⁾						
	1.4 Entreprise	55		05.97	05.01							















¹⁾ - suspension level control / - correttore assetto / - correcteur d'assiette / - regulación altura suspensión

²⁾ notice length / attenzione lunghezza / faire attention longueur / atención largo

³⁾ -ABS/- reinforced susp./+ 5 door / - ABS/- sospens.rinforzata/+ 5 porte / - ABS/- châssis renforcé/+ 5 portes / - ABS/- suspens.reforzada/+ 5 puertas

⁴⁾ + ABS/- reinforced suspension / + ABS/- sospensione rinforzata / + ABS/- châssis renforcé / + ABS/- suspensión reforzada

⁵⁾ - ABS/+ reinforced susp./+ 3 door / - ABS/+ sospens.rinforzata / + 3 porte / - ABS/+ châssis renforcé / + 3 portes / - ABS/+ suspensión reforzada/+ 3 puertas

											
PEUGEOT 306 Limousine (3/5-tuerig) (93-01)											
	1.8 D	43		03.93	04.97	+ ABS/ - verstärktes Fahrwerk ¹⁾	24.3220-1702.3	020375	Rz 20,64	BDX	
	1.8 D	43		03.93	04.97	- ABS/+ verst.Fahrw./+ 3 türig ²⁾					
	1.8 D Entreprise	43		05.97	05.01						
	1.9 D			05.93	04.97	+ ABS/ - verstärktes Fahrwerk ¹⁾					
	1.9 D			05.93	04.97	- ABS/+ verst.Fahrw./+ 3 türig ²⁾					
	1.9 D Entreprise			05.97	05.01						
	1.9 TD	66		10.93	05.01	+ ABS/ - verstärktes Fahrwerk ¹⁾					
	1.9 TD	66		10.93	05.01	- ABS/+ verst.Fahrw./+ 3 türig ²⁾					
	1.1	44		03.94	08.95	+ ABS	24.3220-1619.3	020246	Rz 20,64		TRW
	1.4	55		03.93	08.95	+ ABS					
	1.6	65		03.93	08.95	+ ABS					
	1.8	74		03.93	08.95	+ ABS					
1.8 D	43		03.93	08.95	+ ABS						
1.9 TD	66		10.93	08.95	+ ABS						
1.1	44	ORGA 08729	09.95		+ ABS	24.3220-1711.3	020409	+ GG ³⁾	Rz 20,64	TRW	
1.4	55	ORGA 08729	09.95		+ ABS						
1.6	65	ORGA 08729	09.95		+ ABS						
1.8	74	ORGA 08729	09.95		+ ABS						
1.8 D	43	ORGA 08729	09.95		+ ABS						
1.9 TD	66	ORGA 08729	09.95		+ ABS						
1.4	55	ORGA 08730	05.01		+ ABS	24.3220-1717.3	020430	+ ALU ⁴⁾	Rz 20,64	TRW	
1.6	72	ORGA 08730	05.01		+ ABS						
1.8	74	ORGA 08730	05.01		+ ABS						
1.8 D	43	ORGA 08730	05.01		+ ABS						
1.9 D		ORGA 08730	05.01		+ ABS						
1.9 TD	66	ORGA 08730	05.01		+ ABS						
	1.1	44		03.94	04.97		24.3727-0818.2	580818	L=1656 L=1561		
	1.4	55		03.93	05.01	- Entreprise	24.3727-0819.2	580819			
	1.6	65		03.93	10.00						
	1.6	72		10.00	05.01						
	1.8	74		03.93	05.01						
	1.8 D	43		03.93	05.01	- Entreprise					
	1.9 D			05.93	05.01	- Entreprise					
	1.9 TD	66		10.93	05.01						
	1.4 Entreprise	55		03.93	05.01		24.3727-0823.2	580823			L=1690
	1.8 D Entreprise	43		03.93	05.01		24.3727-0822.2	580822			L=1608, + Zub
	1.9 D Entreprise			05.93	05.01						
	1.8 16V	81		03.97	05.01		24.3727-0812.2	580812			L=1696
2.0	89		03.94	05.01		24.3727-0813.2	580813	L=1614			
2.0 16V			03.97	05.01							
2.0 HDi	66		06.99	05.01							
2.0 S16	110		03.94	05.01							
2.0 S16	112		07.94	05.01							
2.0 S16	120		03.96	05.01							
	1.1	44		03.94	04.97	+ ABS	24.6042-1701.3	320149	BRE 2/20		
	1.4	55		03.93	04.97	+ ABS					
	1.6	65		03.93	04.97	+ ABS					
	1.8 D	43		03.93	04.97	+ ABS					
	1.9 D	47		05.93	04.97	+ ABS					
	1.9 D	50		06.94	04.97	+ ABS					
	1.1	44		03.94	04.97		24.3728-0822.2	590822	L=676		
	1.4	55		03.93	08.99	+ Fahrschule ⁵⁾					
	1.4	55		03.93	08.99	- Fahrschule ⁶⁾					
	1.6	65		03.93	08.99	+ Fahrschule ⁵⁾					
	1.6	65		03.93	08.99	- Fahrschule ⁶⁾					
	1.4	55		09.99	05.01		24.3728-0834.2	590834		L=620, + AUT	
	1.6	65		09.99	10.00						
	1.6	72		10.00	05.01						
	1.8	74	ORGA 08336	03.93			24.3728-0835.2	590835		L=655, + AUT	
	1.8 16V	81	ORGA 08336	03.97							
	1.8 D	43	ORGA 07972	03.93							
	1.9 D		ORGA 08336	05.93		- Fahrschule ⁶⁾					
2.0	89	ORGA 08336	02.96								
2.0 HDi	66	ORGA 08336	06.99								
1.8	74	ORGA 08337	05.01			24.3728-0823.2	590823	L=625, + AUT			
1.8 16V	81	ORGA 08337	05.01								
1.8 D	43	ORGA 08337	05.01								
1.9 D		ORGA 08337	05.01		- Fahrschule ⁶⁾						
2.0	89	ORGA 08337	05.01								
2.0 HDi	66	ORGA 08337	05.01								
1.9 TD	66	ORGA 08337	05.01			24.3728-0825.2	590825	L=694, + AUT			
2.0 16V		ORGA 08337	05.01								
2.0 S16	110	ORGA 08337	05.01								
2.0 S16	112	ORGA 08337	05.01								
2.0 S16	120	ORGA 08337	05.01								
PEUGEOT 306 Limousine (4-tuerig) (94-01)											
	1.4	55		05.97	05.01	- ABS	03.7750-9302.4	300116	9"	ATE	
	1.6	65		05.97	10.00	- ABS					
	1.6	72		10.00	05.01	- ABS					
	1.8	74		05.97	05.01	- ABS					
	1.8 16V	81		05.97	05.01	- ABS					
	1.9 D			05.97	05.01	- ABS					

1) + ABS/ - reinforced suspension / + ABS/ - sospensione rinforzata / + ABS/ - châssis renforcé / + ABS/ - suspensión reforzada
2) - ABS/+reinforced susp./+3 door / - ABS/+ sospens.rinforzata/ + 3 porte / - ABS/ + châssis renforcé/+ 3 portes / - ABS/+suspensión reforzada/+3 puertas
3) + cast iron / + ghisa / + fonte grise / + fundición de gris
4) + aluminium / + alluminio / + aluminium / + aluminio
5) + driving school / + scuola guida / + auto école / + autoescuela
6) - driving school / - scuola guida / - auto école / - autoescuela

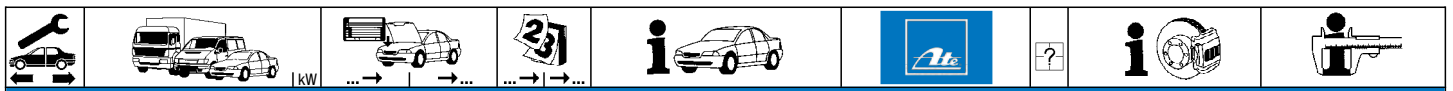

PEUGEOT 306 Limousine (4-tuerig) (94-01)

	1.9 TD	◀ 66		05.97	05.01	- ABS	03.7750-9302.4	300116		9"	ATE					
	2.0	◀ 89		05.97	05.01	- ABS										
	2.0 16V	◀ 97		05.97	05.01	- ABS										
	2.0 HDi	◀ 66		06.99	05.01	- ABS										
	2.0 S16	◀ 110		05.97	05.01	- ABS										
	2.0 S16	◀ 112		05.97	05.01	- ABS										
	1.4	◀ 55	ORGA 08575	10.94		+ ABS						03.7750-9402.4	300117		9"	ATE
	1.6	◀ 65	ORGA 08575	10.94		+ ABS										
	1.8	◀ 74	ORGA 08575	04.94		+ ABS										
	1.8 16V	◀ 81	ORGA 08575	03.97		+ ABS										
1.9 D	◀ 47		10.94	05.01	+ ABS											
1.9 D	◀ 50		10.94	05.01	+ ABS											
1.9 D	◀ 51	ORGA 08575	09.98		+ ABS											
1.9 D	◀ 55		03.98	05.01	+ ABS											
1.9 TD	◀ 66		10.94	05.01	+ ABS											
2.0	◀ 89	ORGA 08575	04.94		+ ABS											
2.0 16V	◀ 97	ORGA 08575	03.97		+ ABS											
2.0 HDi	◀ 66	ORGA 08575	06.99		+ ABS											
2.0 S16	◀ 110	ORGA 08575	06.94		+ ABS											
2.0 S16	◀ 112	ORGA 08575	07.94		+ ABS											
	1.6	▶ 65		10.94	04.97	+ ABS	03.7750-2232.4	300112		9"	ATE					
	1.4	55		10.94	04.97											
	1.6	◀ 65		10.94	04.97	- ABS	03.2119-3391.3	010058		THz 19,05	ATE					
	1.8	◀ 74		10.94	04.97	- ABS										
	1.8 16V	◀ 81		03.97	04.97	- ABS										
	1.9 D	◀		10.94	04.97	- ABS										
	1.9 TD	◀ 66		10.94	04.97	- ABS										
	2.0	◀ 89		10.94	04.97	- ABS										
	2.0 16V	◀ 97		03.97	04.97	- ABS										
	2.0 S16	◀ 110		06.94	04.97	- ABS										
	2.0 S16	◀ 112		07.94	04.97	- ABS										
	1.4	55		05.97	05.01	- ABS						03.2120-4321.3	010525		THz 20,64	ATE
	1.6	65		05.97	10.00	- ABS										
	1.6	72		10.00	05.01	- ABS	24.2120-1726.3	010564		THz 20,64	BDX					
	1.8	◀ 74		05.97	05.01	- ABS										
	1.9 D	◀		05.97	05.01	- ABS										
	1.8 16V	◀ 81		05.97	05.01	- ABS	03.2122-1356.3	010529		THz 22,20	ATE					
	1.9 TD	◀ 66		05.97	05.01	- ABS										
	2.0	◀ 89		05.97	05.01	- ABS										
	2.0 16V	◀ 97		05.97	05.01	- ABS										
	2.0 HDi	◀ 66		06.99	05.01	- ABS										
	2.0 S16	◀ 110		05.97	05.01	- ABS										
	2.0 S16	◀ 112		05.97	05.01	- ABS										
	1.8	▶ 74		10.94	05.01	- ABS						03.2120-4246.3	010614		THz 20,64	ATE
	1.9 D	▶ 47		10.94	05.01	- ABS										
	1.9 D	▶ 50		10.94	05.01	- ABS						24.2120-1722.3	010544		THz 20,64	BDX
	1.9 D	▶ 55		03.98	05.01	- ABS										
	1.9 D	▶ 51		09.98	05.01	- ABS	03.2122-1461.3	010610		THz 22,20	ATE					
	1.8 16V	▶ 81		05.97	05.01	- ABS										
1.9 TD	▶ 66		05.97	05.01	- ABS											
2.0	▶ 89		05.97	05.01	- ABS											
2.0 16V	▶ 97		05.97	05.01	- ABS											
2.0 HDi	▶ 66		06.99	05.01	- ABS											
2.0 S16	▶ 110		05.97	05.01	- ABS											
2.0 S16	▶ 112		05.97	05.01	- ABS											
1.4	55 S 30209025		04.97		+ ABS	24.2122-1705.3						010434		THz 22,20		
1.6	65 S 30209025		04.97		+ ABS											
1.8	74 S 30209025		04.97		+ ABS											
1.8 16V	81		03.97	04.97	+ ABS											
1.9 D	S 30209025		04.97		+ ABS											
1.9 TD	66		10.94	04.97	+ ABS											
2.0	89		04.94	04.97	+ ABS											
2.0 16V	97		03.97	04.97	+ ABS											
2.0 S16	110		06.94	04.97	+ ABS											
2.0 S16	112		07.94	04.97	+ ABS											
1.4	◀ 55	ORGA 08575	05.97		+ ABS	03.2122-1351.3	010528		THz 22,20	ATE						
1.6	◀ 65	ORGA 08575	05.97		+ ABS											
1.8	◀ 74	ORGA 08575	05.97		+ ABS											
1.8 16V	◀ 81	ORGA 08575	05.97		+ ABS											
1.9 D	◀	ORGA 08575	05.97		+ ABS											
1.9 TD	◀ 66	ORGA 08575	05.97		+ ABS											
2.0	◀ 89	ORGA 08575	05.97		+ ABS											
2.0 16V	◀ 97	ORGA 08575	05.97		+ ABS											
2.0 S16	◀ 110	ORGA 08575	05.97		+ ABS											
2.0 S16	◀ 112	ORGA 08575	05.97		+ ABS											
1.4	◀ 55	ORGA 08576		05.01	+ ABS	24.2123-1715.3	010520		THz 23,81	BDX						
1.6	◀ 65	ORGA 08576		10.00	+ ABS											
1.6	◀ 72		10.00	05.01	+ ABS											
1.8	◀ 74	ORGA 08576		05.01	+ ABS											
1.8 16V	◀ 81	ORGA 08576		05.01	+ ABS											
1.9 D	◀	ORGA 08576		05.01	+ ABS											
1.9 TD	◀ 66	ORGA 08576		05.01	+ ABS											
2.0	◀ 89	ORGA 08576		05.01	+ ABS											

1) - ABS/ - driving school / - ABS/ - scuola guida / - ABS/ - auto-école / - ABS/ - autoescuela

2) - ABS/ + driving school / - ABS/ + scuola guida / - ABS/ + auto école / - ABS/ + autoescuela

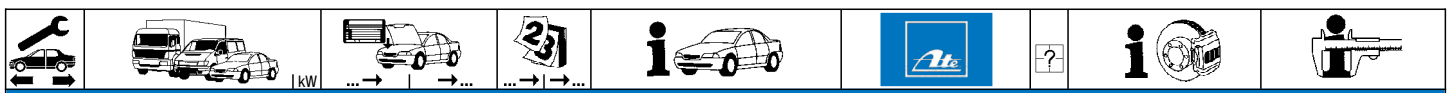

PEUGEOT 306 Limousine (4-tuerig) (94-01)

	1.9 TD	66	ORGA 08730		05.01		24.3220-1717.3	020430		+ ALU ¹⁾	Rz 20,64	TRW
	1.4	55			10.94	05.01	24.3727-0818.2	580818	<input type="checkbox"/>		L=1656	
	1.6	65			10.00	05.01	24.3727-0819.2	580819	<input type="checkbox"/>		L=1561	
	1.6	65			10.94	10.00						
	1.8	74			10.94	05.01						
	1.9 D				10.94	05.01						
	1.9 TD	66			10.94	05.01						
	1.8 16V	81			03.97	05.01	24.3727-0812.2	580812	<input type="checkbox"/>		L=1696	
	2.0	89			10.94	05.01	24.3727-0813.2	580813	<input type="checkbox"/>		L=1614	
	2.0 16V	97			03.97	05.01						
	2.0 HDi	66			06.99	05.01						
	2.0 S16	110			06.94	05.01						
	2.0 S16	112			07.94	05.01						
	1.4	55			10.94	04.97	24.6042-1701.3	320149			BRE 2/20	
	1.6	65			10.94	04.97						
	1.8	74			10.94	04.97						
	1.8 16V	81			03.97	04.97						
	1.9 D	47			10.94	04.97						
	1.9 D	50			10.94	04.97						
	2.0	89			10.94	04.97						
	2.0 16V	97			03.97	04.97						
	1.4	55			10.94	08.99	24.3728-0822.2	590822			L=676	
	1.4	55			10.94	05.01						
	1.6	65			10.94	08.99						
	1.6	65			10.94	10.00						
	1.6	72			10.00	05.01						
	1.4	55			09.99	05.01	24.3728-0834.2	590834			L=620, + AUT	
	1.6	65			09.99	10.00						
	1.6	72			10.00	05.01						
	1.8	74	ORGA 08336	04.94			24.3728-0835.2	590835			L=655, + AUT	
	1.8 16V	81	ORGA 08336	03.97								
	1.9 D		ORGA 08336	10.94								
	2.0	89	ORGA 08336	04.94								
	2.0 HDi	66	ORGA 08336	06.99								
	1.8	74	ORGA 08337	05.01			24.3728-0823.2	590823			L=625, + AUT	
	1.8 16V	81	ORGA 08337	05.01								
	1.9 D		ORGA 08337	05.01								
	2.0	89	ORGA 08337	05.01								
	2.0 HDi	66	ORGA 08337	05.01								
	1.9 TD	66	ORGA 08337	05.01			24.3728-0825.2	590825			L=694, + AUT	
	2.0	89	ORGA 08337	05.01								
	2.0 16V	97	ORGA 08337	05.01								
	2.0 S16	110	ORGA 08337	05.01								
	2.0 S16	112	ORGA 08337	05.01								

PEUGEOT 306 Cabriolet (94-03)

	1.6	65	ORGA 08575	04.96			03.7750-9402.4	300117			9"	ATE
	1.8	74	ORGA 08575	03.94								
	2.0	89	ORGA 08575	03.94								
	2.0 16V	97	ORGA 08575	03.97								
	2.0 16V	99	ORGA 08575	03.97								
	1.6	65		04.96	10.00		03.7750-2232.4	300112			9"	ATE
	1.6	65	ORGA 07737	04.96		- ABS	03.2120-4241.3	010524			Thz 20,64	ATE
							24.2120-1722.3	010544			Thz 20,64	BDX
	1.8	74		03.94	10.00	- ABS	24.2120-1722.3	010544			Thz 20,64	BDX
	2.0	89	ORGA 07744	03.94		- ABS	24.2122-1705.3	010434			Thz 22,20	
	2.0 16V	97	ORGA 07744	03.97		- ABS						
	2.0 16V	99	ORGA 07744	03.97		- ABS						
	1.6	65	ORGA 08575	04.96		+ ABS	03.2122-1351.3	010528			Thz 22,20	ATE
	1.8	74	ORGA 08575	03.94		+ ABS						
	2.0	89		03.94	04.97	+ ABS						
	2.0 16V	97	ORGA 08575	03.97		+ ABS						
	2.0 16V	99	ORGA 08575	03.97		+ ABS						
	1.6	65	ORGA 08576	10.00		+ ABS	24.2123-1715.3	010520			Thz 23,81	BDX
	1.6	72		10.00	07.03	+ ABS						
	1.8	74	ORGA 08576	10.00		+ ABS						
	1.8 16V	81		07.00	07.03	+ ABS						
	2.0 16V	97	ORGA 08576	10.00		+ ABS						
	2.0 16V	99	ORGA 08576	04.02		+ ABS						
	1.6	65	ORGA 08575	04.96			11.3481-9833.2	220561	<input type="checkbox"/>		D=48, - Halter	ATE
	1.6	65		05.00	10.00	- ABS	11.3481-9834.2	220562	<input type="checkbox"/>		D=48, - Halter	ATE
	1.8	74	ORGA 08575	03.94			24.3481-9833.5	240479	<input type="checkbox"/>		D=48, - Halter	ATE
	1.8	74		05.00	10.00	- ABS	24.3481-9834.5	240480	<input type="checkbox"/>		D=48, - Halter	ATE
							11.0441-4811.2	250024			Dichtungssatz	ATE
							11.0101-5407.2	260011			Hülzensatz	ATE
							11.8171-0008.1	990049			Führungsbolzen	ATE
							11.8116-0129.1	390591			Haltefeder	ATE
	1.6	65	ORGA 08576	10.00		+ ABS	24.3541-1767.5	240237	<input type="checkbox"/>		D=54, - Halter	BOS
	1.6	72		10.00	07.03		24.3541-1768.5	240238	<input type="checkbox"/>		D=54, - Halter	BOS
	1.8	74	ORGA 08576	10.00		+ ABS	24.3541-1757.7	220483	<input type="checkbox"/>		D=54, - Halter	TRW
	1.8 16V	81		07.00	07.03		24.3541-1758.7	220484	<input type="checkbox"/>		D=54, - Halter	TRW
	2.0	89		03.94	04.97	- Niveauregulierung ⁶⁾	24.0101-3601.2	260044			Bremssattel-Zubehör	TRW
	2.0 16V	97		03.97	04.97	- Niveauregulierung ⁶⁾						

1) + aluminium / + alluminio / + aluminium / + aluminio
2) + ABS/ - reinforced suspension / + ABS/ - sospensione rinforzata / + ABS/ - châssis renforcé / + ABS/ - suspensión reforzada
3) - reinforced suspension / - sospensione rinforzata / - châssis renforcé / - suspensión reforzada
4) + driving school / + scuola guida / + auto école / + autoescuela
5) - driving school / - scuola guida / - auto école / - autoescuela
6) - suspension level control / - correttore assetto / - correcteur d'assiette / - regulacion altura suspensión

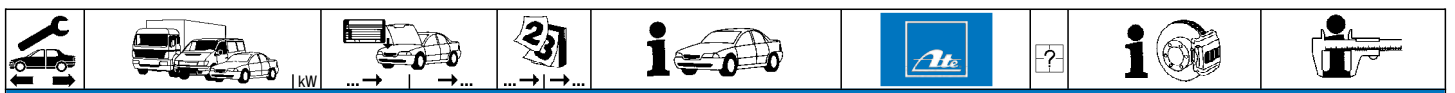

PEUGEOT 306 Cabriolet (94-03)

	2.0 16V	97		05.97	10.00	24.3541-1767.5	240237			D=54, - Halter	BOS
	2.0 16V	99		03.97	04.02	24.3541-1768.5	240238			D=54, - Halter	BOS
	1.6	65		04.96	10.00	24.5111-0495.3	330505	2	Länge beachten ¹⁾	L=495	
	1.6	72		10.00	07.03	24.5111-0520.3	330506	2	Länge beachten ¹⁾	L=519	
	1.8	74		03.94	10.00						
	1.8 16V	81		07.00	07.03						
	2.0	89		03.94	04.97						
	2.0 16V	97		03.97	10.00						
	2.0 16V	99		03.97	04.02						
	1.6	65		04.96	10.00	24.5228-0195.3	330469			L=202	
	1.6	72		10.00	07.03	24.5228-0245.3	330531			L=245	
	1.8	74		03.94	10.00						
	1.8 16V	81		07.00	07.03						
	2.0	89		03.94	04.97						
	2.0 16V	97		03.97	10.00						
	2.0 16V	99		03.97	04.02						
	1.6	65		04.96	10.00	24.3220-1617.3	020244			RzR 20,64	BDX
	1.6	72		10.00	07.03	24.3220-1618.3	020245			RzR 20,64	BDX
	1.8	74		03.94	10.00	24.3220-1615.3	020242			RzR 20,64	TRW
	1.8	74		03.94	10.00	24.3220-1616.3	020243			RzR 20,64	TRW
	1.6	65	ORGA 08575	04.96	10.00	24.3220-1702.3	020375			Rz 20,64	BDX
	1.8	74		03.94	10.00						
	1.8	74		03.94	08.95	24.3220-1619.3	020246			Rz 20,64	TRW
	1.6	65	ORGA 08729	04.96	10.00	24.3220-1711.3	020409		+ GG ²⁾	Rz 20,64	TRW
	1.8	74	ORGA 08729	09.95	10.00						
	1.6	65	ORGA 08730	10.00	10.00	24.3220-1717.3	020430		+ ALU ³⁾	Rz 20,64	TRW
	1.6	72		10.00	07.03						
	1.8	74	ORGA 08730	10.00	10.00						
	1.6	65		04.96	10.00	24.3727-0307.2	580307			L=1585	
	1.6	72		10.00	07.03	24.3727-0306.2	580306			L=1493	
	1.8	74		05.97	10.00						
	1.8	74		03.94	04.97	24.3727-0814.2	580814			L=1621	
	1.8	74		03.94	04.97	24.3727-0815.2	580815			L=1531	
	1.8 16V	81		07.00	07.03	24.3727-0304.2	580304			L=1612	
	2.0	89		03.94	04.97	24.3727-0305.2	580305			L=1533	
	2.0 16V	97		03.97	10.00						
	2.0 16V	99		03.97	04.02						
	1.6	65		04.96	10.00	24.3728-0822.2	590822			L=676	
	1.6	72		10.00	07.03						
	1.8	74	ORGA 08336	03.94	10.00	24.3728-0835.2	590835			L=655, + AUT	
	2.0	89		02.96	04.97						
	1.8	74	ORGA 08337	10.00	10.00	24.3728-0823.2	590823			L=625, + AUT	
	1.8 16V	81		07.00	07.03						
	2.0 16V	97	ORGA 08337	10.00	10.00	24.3728-0825.2	590825			L=694, + AUT	
	2.0 16V	99	ORGA 08337	04.02	04.02						

PEUGEOT 306 Kombi (97-02)















	1.4	55		03.97	03.02	03.7750-9302.4	300116			9"	ATE
	1.6	65		03.97	10.00						
	1.6	72		10.00	03.02						
	1.8 D	66		03.97	03.02						
	1.9 D	51		03.97	03.02						
	1.4	55		03.97	03.02	03.2122-1356.3	010529			Thz 22,20	ATE
	1.6	65		03.97	10.00						
	1.6	72		10.00	03.02						
	1.8 D	66		03.97	03.02						
	1.9 D	51		03.97	03.02						
	1.9 TD	66		03.97	03.02						
	1.8	74		03.97	03.02	24.2123-1714.3	010587			Thz 23,81	BDX
	1.8 16V	81		03.97	03.02						
	1.9 TD	66		03.97	03.02						
	2.0 16V	97		03.97	03.02						
	2.0 HDi	66		06.99	03.02						
	1.4	55		03.97	03.02	24.2123-1715.3	010520			Thz 23,81	BDX
	1.6	65		03.97	10.00						
	1.6	72		10.00	03.02						
	1.8	74		03.97	03.02						
	1.8 16V	81		03.97	03.02						
	1.8 D	66		03.97	03.02						
	1.9 D	51		03.97	03.02						
	1.9 TD	66		03.97	03.02						
	2.0 16V	97		03.97	03.02						
	2.0 HDi	66		06.99	03.02						
	1.8 D	66		03.97	03.02	03.2122-1421.3	010615			Thz 22,20	ATE
	1.9 D	51		03.97	03.02						
	1.9 TD	66		03.97	03.02						

¹⁾ notice length / attenzione lunghezza / faire attention longueur / atención largo

²⁾ + cast iron / + ghisa / + fonte grise / + fundición de gris

³⁾ + aluminium / + alluminio / + aluminium / + aluminio



									
PEUGEOT 306 Kombi (97-02)									
	1.4 1.6 1.6 1.8 D 1.9 D	55 65 72 51	03.97 03.97 10.00 03.97 03.97	03.02 10.00 03.02 03.02 03.02	- ABS - ABS - ABS - ABS - ABS	11.3481-9833.2 11.3481-9834.2 24.3481-9833.5 24.3481-9834.5 11.0441-4811.2 11.0101-5407.2 11.8171-0008.1 11.8116-0129.1	220561 220562 240479 240480 250024 260011 990049 390591	<input type="checkbox"/> <input type="checkbox"/> <input type="checkbox"/> <input type="checkbox"/> <input type="checkbox"/> <input type="checkbox"/> <input type="checkbox"/> <input type="checkbox"/> <input type="checkbox"/>	
	1.4 1.6 1.6 1.8 1.8 16V 1.8 D 1.9 D 1.9 TD 2.0 16V 2.0 HDi	55 65 72 74 81 51 66 97 66	03.97 03.97 10.00 03.97 03.97 03.97 03.97 03.97 03.97 06.99	03.02 10.00 03.02 03.02 03.02 03.02 03.02 03.02 03.02 03.02	+ ABS + ABS + ABS + ABS + ABS + ABS + ABS + ABS + ABS + ABS	24.3541-1767.5 24.3541-1768.5 24.3541-1757.7 24.3541-1758.7	240237 240238 220483 220484	<input type="checkbox"/> <input type="checkbox"/> <input type="checkbox"/> <input type="checkbox"/> <input type="checkbox"/> <input type="checkbox"/> <input type="checkbox"/> <input type="checkbox"/> <input type="checkbox"/> <input type="checkbox"/>	
	1.4 1.6 1.6 1.8 1.8 16V 1.8 D 1.9 D 1.9 TD 2.0 16V 2.0 HDi	55 65 72 74 81 51 66 97 66	03.97 03.97 10.00 03.97 03.97 03.97 03.97 03.97 03.97 06.99	03.02 10.00 03.02 03.02 03.02 03.02 03.02 03.02 03.02 03.02		24.5111-0495.3 24.5111-0520.3	330505 330506	2 2	Länge beachten ¹⁾ Länge beachten ¹⁾
	1.4 1.6 1.6 1.8 1.8 16V 1.8 D 1.9 D 1.9 TD 2.0 16V 2.0 HDi	55 65 72 74 81 51 66 97 66	03.97 03.97 10.00 03.97 03.97 03.97 03.97 03.97 03.97 06.99	03.02 10.00 03.02 03.02 03.02 03.02 03.02 03.02 03.02 03.02		24.5228-0195.3 24.5228-0245.3	330469 330531	<input type="checkbox"/> <input type="checkbox"/>	L=202 L=245
	1.4 1.6 1.6 1.8 D 1.9 D	55 65 72 51	03.97 03.97 10.00 03.97 03.97	03.02 10.00 03.02 03.02 03.02	- ABS - ABS - ABS - ABS - ABS	24.3220-1702.3	020375		Rz 20,64
	1.4 1.6 1.6 1.8 1.8 D 1.9 D 1.9 TD	55 65 72 74 51 66	03.97 03.97 10.00 03.97 03.97 03.97 03.97	03.02 10.00 03.02 03.02 03.02 03.02 03.02	+ ABS + ABS + ABS + ABS + ABS + ABS + ABS	24.3222-1714.3	020432		Rz 22,00
	1.4 1.6 1.6 1.8 1.8 D 1.9 D 1.9 TD	55 65 72 74 51 66	03.97 03.97 10.00 03.97 03.97 03.97 03.97	03.02 10.00 03.02 03.02 03.02 03.02 03.02		24.3727-0823.2 24.3727-0822.2	580823 580822	<input type="checkbox"/> <input type="checkbox"/>	L=1690 L=1608, + Zub
	1.8 16V 2.0 16V 2.0 HDi	81 97 66	03.97 03.97 06.99	03.02 03.02 03.02		24.3727-0812.2 24.3727-0813.2	580812 580813	<input type="checkbox"/> <input type="checkbox"/>	L=1696 L=1614
	1.4 1.4 1.6 1.6 1.6	55 55 65 65 72	03.97 03.97 03.97 03.97 10.00	08.99 03.02 08.99 10.00 03.02	+ Fahrschule ²⁾ - Fahrschule ³⁾ + Fahrschule ²⁾ - Fahrschule ³⁾ - Fahrschule ³⁾	24.3728-0822.2	590822		L=676
	1.4 1.6 1.6	55 65 72	09.99 09.99 10.00	03.02 10.00 03.02	+ Fahrschule ²⁾ + Fahrschule ²⁾ + Fahrschule ²⁾	24.3728-0834.2	590834		L=620, + AUT
	1.8 1.8 16V 1.8 D 1.9 D 2.0 HDi	74 81 51 66	03.97 03.97 03.97 03.97 06.99		ORGA 08336 ORGA 08336 ORGA 08336 ORGA 08336 ORGA 08336	24.3728-0835.2	590835		L=655, + AUT
	1.8 1.8 16V 1.8 D 1.9 D 2.0 HDi	74 81 51 66	03.97 03.97 03.97 03.97 03.97		ORGA 08337 ORGA 08337 ORGA 08337 ORGA 08337 ORGA 08337	24.3728-0823.2	590823		L=625, + AUT
	1.9 TD 2.0 16V	66 97	03.97 03.97	03.02 03.02	ORGA 08337 ORGA 08337	24.3728-0825.2	590825		L=694, + AUT

¹⁾ notice length / attenzione lunghezza / faire attention longueur / atención largo

²⁾ + driving school / + scuola guida / + auto école / + autoescuela

³⁾ - driving school / - scuola guida / - auto école / - autoescuela

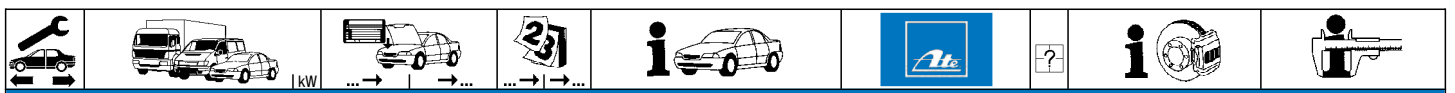

PEUGEOT 307 Limousine (00-07)

























	1.4 16V 1.6 1.6 16V 1.6 BioFlex 1.6 HDi 110 1.6 HDi 90 2.0 16V 2.0 16V 2.0 16V 2.0 HDi 135 2.0 HDi 90	65 81 80 80 80 66 100 103 130 100 66	ORGA 11192 ORGA 11192 ORGA 11192 ORGA 11192 ORGA 11192 ORGA 11192 ORGA 11192 ORGA 11192 ORGA 11192	11.03 07.06 08.00 09.07 02.04 04.05 08.00 03.05 06.05 10.03 08.00	07.07 07.07 07.07 07.07 07.07 07.07 07.07 07.07 07.07 07.07 07.07	24.4123-1706.3 010848	+ ESP	THz 23,81	BOS	
	1.4 1.4 16V 1.4 16V 1.4 HDi 1.6 1.6 16V 1.6 16V 1.6 HDi 90 1.6 HDi 90 2.0 HDi 90	55 65 ORGA 10551 65 50 81 80 ORGA 10551 80 66 ORGA 10551 66 66		08.00 07.07 11.03 10.01 07.06 07.07 08.00 04.05 08.00	07.07 07.07 + ESP 07.07 - ESP 07.07 + ESP/ + Schaltgetriebe 1) 07.07 + ESP/ + Schaltgetriebe 1) 07.07 - ESP/ + Schaltgetriebe 2) 07.07 + ESP 07.07 - ESP 07.07	24.3541-1771.5 24.3541-1772.5	240239 240240	 	D=54, - Halter D=54, - Halter	BOS BOS
	1.4 16V 1.6 1.6 16V 1.6 16V 1.6 BioFlex 1.6 HDi 110 1.6 HDi 90 2.0 16V 2.0 16V 2.0 HDi 110	65 81 80 80 80 80 66 100 103 79	ORGA 10550 ORGA 10550 ORGA 10550 ORGA 10550	11.03 07.06 08.00 08.00 09.07 02.04 04.05 08.00 03.05 08.00	+ ESP + Automatikgetriebe 3) + ESP/ + Schaltgetriebe 1) + Automatikgetriebe 3) + ESP	24.3541-1761.5 24.3541-1762.5	240233 240234	 	D=54, - Halter D=54, - Halter	BOS BOS
	2.0 16V 2.0 HDi 135	130 100	ORGA 10487 ORGA 10487	06.05 10.03		11.9571-9765.2 11.9571-9766.2 11.8116-0351.1 11.0101-5704.2 11.8171-0008.1	220663 220664 390538 260095 990049	 2	D=57, - Halter D=57, - Halter Haltefeder Hülzensatz Führungsbolzen	ATE ATE ATE ATE ATE
	2.0 16V 2.0 HDi 135	130 ORGA 10488 100 ORGA 10488		07.07 07.07		11.9571-9765.2 11.9571-9766.2 11.8116-0351.1 11.0101-5704.2 11.8171-0008.1	220663 220664 390538 260095 990049	 2	D=57, - Halter D=57, - Halter Haltefeder Hülzensatz Führungsbolzen	ATE ATE ATE ATE ATE
	1.4 1.4 16V 1.4 HDi 1.6 1.6 16V 1.6 BioFlex 1.6 HDi 110 1.6 HDi 90 2.0 16V 2.0 16V 2.0 16V 2.0 HDi 110 2.0 HDi 110 2.0 HDi 135 2.0 HDi 90	55 65 50 81 80 80 80 66 100 103 130 79 79 100 66		08.00 11.03 10.01 07.06 08.00 09.07 02.04 04.05 08.00 03.05 06.05 08.00 10.03 08.00	07.07 07.07 07.07 07.07 07.07 07.07 07.07 07.07 07.07 07.07 07.07 07.07 07.07 07.07	24.5111-0420.3 330682	2		L=420	
	1.4 1.4 16V 1.4 HDi 1.6 1.6 16V 1.6 HDi 110 1.6 HDi 90 2.0 16V 2.0 16V 2.0 HDi 110 2.0 HDi 135 2.0 HDi 90	55 65 50 81 80 80 66 100 103 130 79 100 66		03.04 11.03 03.04 07.06 03.04 02.04 04.05 03.04 03.05 06.05 03.04 10.03 03.04	07.07 07.07 07.07 07.07 07.07 07.07 07.07 07.07 07.07 07.07 07.07 07.07 07.07	24.3387-1709.7 24.3387-1710.7	220743 220744	 	D=38, - Halter D=38, - Halter	TRW TRW
	1.4 1.4 16V 1.4 HDi 1.6 1.6 16V 1.6 HDi 110 1.6 HDi 90 2.0 16V 2.0 16V 2.0 16V 2.0 HDi 110 2.0 HDi 135 2.0 HDi 90	55 65 50 81 80 80 66 100 103 130 79 100 66		08.00 11.03 10.01 07.06 08.00 02.04 04.05 08.00 03.05 06.05 08.00 10.03 08.00	07.07 07.07 07.07 07.07 07.07 07.07 07.07 07.07 07.07 07.07 07.07 07.07 07.07	24.5246-0190.3 330697	2		L=190	
	1.4 1.4 16V 1.4 HDi 1.6 1.6 16V 1.6 HDi 110	55 65 50 81 80 80		08.00 11.03 10.01 07.06 08.00 02.04	07.07 07.07 07.07 07.07 07.07 07.07	24.3727-0832.2 580832	2		L=2035	

1) + ESP/ + manual transm. / + ESP/+ scatola cambio velocità / + ESP/ + transmission mécanique / + ESP/ + cambio de velocidad

2) - ESP/ + manual transm. / - ESP/+ scatola cambio velocità / - ESP/ + transmission mécanique / - ESP/ + cambio de velocidad

3) + autom.transmission / + scatola cambio automatico / + transmission automatique / + cambio automático



									
PEUGEOT 307 Limousine (00-07)									
	1.6 HDi 90	66		04.05	07.07	24.3727-0832.2	580832	2 ↓	L=2035
	2.0 16V	100		08.00	07.07				
	2.0 16V	103		03.05	07.07				
	2.0 16V	130		06.05	07.07				
	2.0 HDi 110	79		08.00	07.07				
	2.0 HDi 135	100		10.03	07.07				
	2.0 HDi 90	66		08.00	07.07				
PEUGEOT 307 Break (02-08)									
	1.4	55		04.02	09.03	24.4123-1706.3	010848		Thz 23,81
	1.4 16V	65	ORGA 11192	11.03	+ ESP				BOS
	1.6 16V	80	ORGA 11192	03.02	+ ESP				
	1.6 BioFlex	80	ORGA 11192	09.07	+ ESP				
	1.6 HDi 110	80	ORGA 11192	02.04	+ ESP				
	1.6 HDi 90	66	ORGA 11192	04.05	+ ESP				
	2.0 16V	100		03.02	04.08				
	2.0 16V	103	ORGA 11192	03.05	+ ESP				
	2.0 16V	130	ORGA 11192	06.05					
	2.0 HDi 135	100	ORGA 11192	02.04	+ ESP				
	2.0 HDi 90	66	ORGA 11192	09.05	04.08				
	1.4	55		04.02	09.03	24.3541-1771.5	240239		D=54, - Halter
	1.4 16V	65		11.03	04.08	24.3541-1772.5	240240		D=54, - Halter
	1.4 16V	65	ORGA 10551	04.08	+ ESP				BOS
	1.4 HDi	50		03.02	04.08				
	1.4	55	ORGA 10550	04.02	+ ESP	24.3541-1761.5	240233		D=54, - Halter
	1.4 16V	65	ORGA 10550	11.03	+ ESP	24.3541-1762.5	240234		D=54, - Halter
	1.6 16V	80		03.02	04.08				BOS
	1.6 BioFlex	80		09.07	04.08				
	1.6 HDi 110	80		02.04	04.08				
	1.6 HDi 90	66		04.05	04.08				
	2.0 16V	100		03.02	04.08				
	2.0 16V	103	ORGA 12053	03.05					
	2.0 HDi 110	79	ORGA 12053	03.02					
	2.0 HDi 90	66		03.02	04.08				
	2.0 16V	130	ORGA 10487	06.05		11.9571-9765.2	220663		D=57, - Halter
	2.0 HDi 135	100	ORGA 10487	02.04		11.9571-9766.2	220664		D=57, - Halter
						11.8116-0351.1	390538	2	Haltefeder
						11.0101-5704.2	260095		Hülzensatz
						11.8171-0008.1	990049		Führungsbolzen
	2.0 16V	130	ORGA 10488	04.08		11.9571-9765.2	220663		D=57, - Halter
	2.0 HDi 135	100	ORGA 10488	04.08		11.9571-9766.2	220664		D=57, - Halter
						11.8116-0351.1	390538	2	Haltefeder
						11.0101-5704.2	260095		Hülzensatz
						11.8171-0008.1	990049		Führungsbolzen
	1.4	55		04.02	09.03	24.5111-0420.3	330682	2	L=420
	1.4 16V	65		11.03	04.08				
	1.4 HDi	50		03.02	04.08				
	1.6 16V	80		03.02	04.08				
	1.6 BioFlex	80		09.07	04.08				
	1.6 HDi 110	80		02.04	04.08				
	1.6 HDi 90	66		04.05	04.08				
	2.0 16V	100		03.02	04.08				
	2.0 16V	103		03.05	04.08				
	2.0 16V	130		06.05	04.08				
	2.0 HDi 110	79		03.02	04.08				
	2.0 HDi 135	100		02.04	04.08				
	2.0 HDi 90	66		03.02	04.08				
	1.4	55	ORGA 12056	04.02		24.3387-1709.7	220743		D=38, - Halter
	1.4 16V	65	ORGA 12056	11.03		24.3387-1710.7	220744		D=38, - Halter
	1.4 HDi	50	ORGA 12056	03.02					
	1.6 16V	80	ORGA 12056	03.02					
	1.6 BioFlex	80	ORGA 12056	09.07					
	1.6 HDi 110	80	ORGA 12056	02.04					
	1.6 HDi 90	66	ORGA 12056	04.05					
	2.0 16V	100	ORGA 12056	03.02					
	2.0 16V	103	ORGA 12056	03.05					
	2.0 16V	130	ORGA 12056	06.05					
	2.0 HDi 110	79	ORGA 12056	03.02					
	2.0 HDi 135	100	ORGA 12056	02.04					
	2.0 HDi 90	66	ORGA 12056	03.02					
	1.4	55		04.02	09.03	24.5246-0190.3	330697	2	L=190
	1.4 16V	65		11.03	04.08				
	1.4 HDi	50		03.02	04.08				
	1.6 16V	80		03.02	04.08				
	1.6 BioFlex	80		09.07	04.08				
	1.6 HDi 110	80		02.04	04.08				
	1.6 HDi 90	66		04.05	04.08				
	2.0 16V	100		03.02	04.08				
	2.0 16V	103		03.05	04.08				
	2.0 16V	130		06.05	04.08				
	2.0 HDi 110	79		03.02	04.08				
	2.0 HDi 135	100		02.04	04.08				
	2.0 HDi 90	66		03.02	04.08				

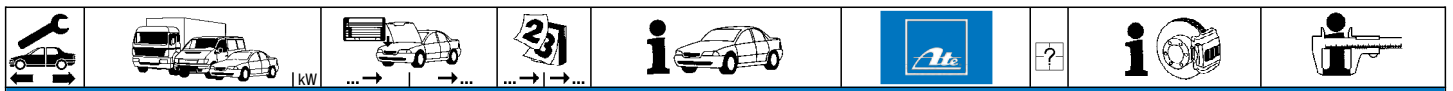

PEUGEOT 307 Break (02-08)

	1.4	55	ORGA 10933	04.02		24.3727-0839.2	580839	2		L=2115
	1.4 16V	65	ORGA 10933	11.03						
	1.4 HDi	50	ORGA 10933	03.02						
	1.6 16V	80	ORGA 10933	03.02						
	1.6 HDi 110	80	ORGA 10933	02.04						
	1.6 HDi 90	66	ORGA 10933	04.05						
	2.0 16V	100	ORGA 10933	03.02						
	2.0 16V	103	ORGA 10933	03.05						
	2.0 16V	130	ORGA 10933	06.05						
	2.0 HDi 110	79	ORGA 10933	03.02						
	2.0 HDi 135	100	ORGA 10933	02.04						
	2.0 HDi 90	66	ORGA 10933	03.02						

PEUGEOT 307 CC (03-09)

	CC 110	80	ORGA 11192	03.05	+ ESP	24.4123-1706.3	010848			THz 23,81	BOS
	CC 135	100		10.03	+ ESP						
	CC 140	103	ORGA 11192	03.05	+ ESP						
	CC 180	130	ORGA 11192	10.03							
	CC HDi 135	100	ORGA 11192	06.05							
	CC 110	80		03.05	02.09	24.3541-1761.5	240233			D=54, - Halter	BOS
	CC 135	100		10.03	02.09	24.3541-1762.5	240234			D=54, - Halter	BOS
	CC 140	103	ORGA 12053	03.05							
	CC 180	130	ORGA 10487	10.03		11.9571-9765.2	220663			D=57, - Halter	ATE
	CC HDi 135	100	ORGA 10487	06.05		11.9571-9766.2	220664			D=57, - Halter	ATE
						11.8116-0351.1	390538	2		Haltefeder	ATE
						11.0101-5704.2	260095			Hülzensatz	ATE
						11.8171-0008.1	990049			Führungsbolzen	ATE
	CC 180	130	ORGA 10488		02.09	11.9571-9765.2	220663			D=57, - Halter	ATE
	CC HDi 135	100	ORGA 10488		02.09	11.9571-9766.2	220664			D=57, - Halter	ATE
						11.8116-0351.1	390538	2		Haltefeder	ATE
						11.0101-5704.2	260095			Hülzensatz	ATE
						11.8171-0008.1	990049			Führungsbolzen	ATE
	CC 110	80		03.05	02.09	24.5111-0420.3	330682	2		L=420	
	CC 135	100		10.03	02.09						
	CC 140	103		03.05	02.09						
	CC 180	130		10.03	02.09						
	CC HDi 135	100		06.05	02.09						
	CC 110	80	ORGA 12056	03.05		24.3387-1709.7	220743			D=38, - Halter	TRW
	CC 135	100	ORGA 12056	10.03		24.3387-1710.7	220744			D=38, - Halter	TRW
	CC 140	103	ORGA 12056	03.05							
	CC 180	130	ORGA 12056	10.03							
	CC HDi 135	100	ORGA 12056	06.05							
	CC 110	80		03.05	02.09	24.5246-0190.3	330697	2		L=190	
	CC 135	100		10.03	02.09						
	CC 140	103		03.05	02.09						
	CC 180	130		10.03	02.09						
	CC HDi 135	100		06.05	02.09						
	CC 110	80		03.05	02.09	24.3727-0832.2	580832	2		L=2035	
	CC 135	100		10.03	02.09						
	CC 140	103		03.05	02.09						
	CC 180	130		10.03	02.09						
	CC HDi 135	100		06.05	02.09						

PEUGEOT 307 SW (02-08)

	1.4	55		04.02	09.03	+ ESP	24.4123-1706.3	010848			THz 23,81	BOS
	1.4 16V	65	ORGA 11192	11.03		+ ESP						
	1.6 16V	80	ORGA 11192	03.02		+ ESP						
	1.6 BioFlex	80	ORGA 11192	09.07		+ ESP						
	1.6 D	66	ORGA 11192	12.06		+ ESP						
	1.6 HDi 110	80	ORGA 11192	02.04		+ ESP						
	2.0 16V	100		03.02	04.08	+ ESP						
	2.0 16V	103	ORGA 11192	03.05		+ ESP						
	2.0 HDi 135	100	ORGA 11192	02.04		+ ESP						
	2.0 HDi 90	66		09.05	04.08	+ ESP						
	1.4	55		04.02	09.03	- ESP	24.3541-1771.5	240239			D=54, - Halter	BOS
	1.4 16V	65	ORGA 10551		04.08	+ ESP	24.3541-1772.5	240240			D=54, - Halter	BOS
	1.4 16V	65		11.03	04.08	- ESP						
	1.4 HDi	50		03.02	01.05							
	1.4	55	ORGA 10550	04.02		+ ESP	24.3541-1761.5	240233			D=54, - Halter	BOS
	1.4 16V	65	ORGA 10550	11.03		+ ESP	24.3541-1762.5	240234			D=54, - Halter	BOS
	1.6 16V	80		03.02	04.08							
	1.6 BioFlex	80		09.07	04.08							
	1.6 D	66		12.06	04.08							
	1.6 HDi 110	80		02.04	04.08							
	2.0 16V	100		03.02	04.08							
	2.0 16V	103	ORGA 12053	03.05								
	2.0 HDi 110	79	ORGA 12053	03.02								
	2.0 HDi 90	66		03.02	04.08							
	2.0 HDi 135	100	ORGA 10487	02.04			11.9571-9765.2	220663			D=57, - Halter	ATE
							11.9571-9766.2	220664			D=57, - Halter	ATE
							11.8116-0351.1	390538	2		Haltefeder	ATE
							11.0101-5704.2	260095			Hülzensatz	ATE
							11.8171-0008.1	990049			Führungsbolzen	ATE



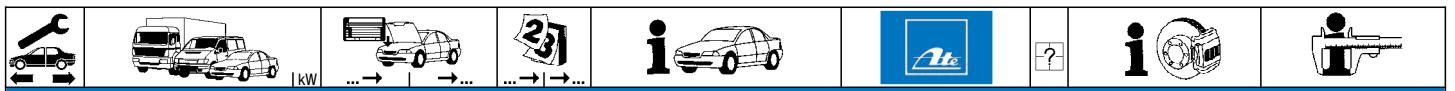

PEUGEOT 307 SW (02-08)

	2.0 HDi 135	100	ORGA 10488		04.08			11.9571-9765.2 220663 11.9571-9766.2 220664 11.8116-0351.1 390538 11.0101-5704.2 260095 11.8171-0008.1 990049	2		D=57, - Halter D=57, - Halter Haltefeder Hülzensatz Führungsbolzen	ATE ATE ATE ATE ATE
	1.4 1.4 16V 1.4 HDi 1.6 16V 1.6 BioFlex 1.6 D 1.6 HDi 110 2.0 16V 2.0 16V 2.0 HDi 110 2.0 HDi 135 2.0 HDi 90	55 65 50 80 80 66 80 100 103 79 100 66			04.02 09.03 11.03 04.08 03.02 01.05 03.02 04.08 09.07 04.08 12.06 04.08 02.04 04.08 03.02 04.08 03.05 04.08 03.02 04.08 02.04 04.08 03.02 04.08			24.5111-0420.3 330682	2		L=420	
	1.4 1.4 16V 1.4 HDi 1.6 16V 1.6 BioFlex 1.6 D 1.6 HDi 110 2.0 16V 2.0 16V 2.0 HDi 110 2.0 HDi 135 2.0 HDi 90	55 65 50 80 80 66 80 100 103 79 100 66	ORGA 12056 ORGA 12056	04.02 11.03	01.05			24.3387-1709.7 220743 24.3387-1710.7 220744			D=38, - Halter D=38, - Halter	TRW TRW
	1.4 1.4 16V 1.4 HDi 1.6 16V 1.6 BioFlex 1.6 D 1.6 HDi 110 2.0 16V 2.0 16V 2.0 HDi 110 2.0 HDi 135 2.0 HDi 90	55 65 50 80 80 66 80 100 103 79 100 66			04.02 09.03 11.03 04.08 03.02 01.05 03.02 04.08 09.07 04.08 12.06 04.08 02.04 04.08 03.02 04.08 03.05 04.08 03.02 04.08 02.04 04.08 03.02 04.08			24.5246-0190.3 330697	2		L=190	
	1.4 1.4 16V 1.4 HDi 1.6 16V 1.6 BioFlex 1.6 D 1.6 HDi 110 2.0 16V 2.0 16V 2.0 HDi 110 2.0 HDi 135 2.0 HDi 90	55 65 50 80 80 66 80 100 103 79 100 66	ORGA 10933 ORGA 10933	04.02 11.03	01.05			24.3727-0839.2 580839	2		L=2115	

PEUGEOT 308 Limousine (07-13)

	1.6 175 THP 2.0 HDi 135	128 100	ORGA 11577 ORGA 11577	03.08 08.07				11.9571-9765.2 220663 11.9571-9766.2 220664 11.8116-0351.1 390538 11.0101-5704.2 260095 11.8171-0008.1 990049	2		D=57, - Halter D=57, - Halter Haltefeder Hülzensatz Führungsbolzen	ATE ATE ATE ATE ATE
	1.6 GTi	147		07.10	07.13			11.9601-9883.2 220917 11.9601-9884.2 220918 11.0101-5407.2 260011 11.8171-0008.1 990049 11.0441-6008.2 250038			D=60, - Halter D=60, - Halter Hülzensatz Führungsbolzen Dichtungssatz	ATE ATE ATE ATE ATE
	1.6 16V 1.6 175 THP 2.0 HDi 135 2.0 HDi 163	115 128 100 120	ORGA 11578 ORGA 11578 ORGA 11678	10.09 07.13 04.12	07.13			11.9571-9939.2 220923 11.9571-9940.2 220924 11.0101-5704.2 260095 11.8116-0356.1 390586	2		D=57, - Halter D=57, - Halter Hülzensatz Haltefeder	ATE ATE ATE ATE
	1.4 16V 1.4 VTi 1.6 1.6 140 THP 1.6 150 THP 1.6 16V 1.6 175 THP 1.6 BioFlex 1.6 HDi 110 1.6 HDi 112 1.6 HDi 115 1.6 HDi 90 1.6 HDi 92 1.6 VTi 2.0 HDi 2.0 HDi 135 2.0 HDi 163 2.0 HDi FAP 140	72 70 120 103 110 115 128 80 80 82 84 66 68 88 110 100 120 103		12.09 08.07 01.12 08.07 08.07 10.09 03.08 04.08 08.07 12.09 03.13 08.07 11.09 08.07 10.11 08.07 04.12 12.08	07.13 07.13 07.13 07.13 07.13 07.13 07.13 07.13 07.13 07.13 07.13 07.13 07.13 07.13 07.13 07.13 07.13 07.13			24.3387-1731.7 221009 24.3387-1732.7 221010			D=38, - Halter D=38, - Halter	TRW TRW

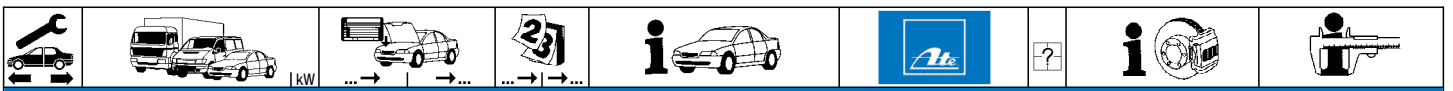

PEUGEOT 308 Limousine (07-13)

	1.4 16V	72		12.09	07.13		24.5246-0190.3	330697	2		L=190
	1.4 VTi	70		08.07	07.13						
	1.6	120		01.12	07.13						
	1.6 140 THP	103		08.07	07.13						
	1.6 150 THP	110		08.07	07.13						
	1.6 16V	115		10.09	07.13						
	1.6 175 THP	128		03.08	07.13						
	1.6 BioFlex	80		04.08	07.13						
	1.6 GTi	147		07.10	07.13						
	1.6 HDi 110	80		08.07	07.13						
	1.6 HDi 112	82		12.09	07.13						
	1.6 HDi 115	84		03.13	07.13						
	1.6 HDi 90	66		08.07	07.13						
	1.6 HDi 92	68		11.09	07.13						
	1.6 VTi	88		08.07	07.13						
	2.0 HDi	110		10.11	07.13						
	2.0 HDi 135	100		08.07	07.13						
	2.0 HDi 163	120		04.12	07.13						
	2.0 HDi FAP 140	103		12.08	07.13						

PEUGEOT 308 SW (08-14)

	1.6 16V	103	ORGA 11577	05.08			11.9571-9765.2	220663		D=57, - Halter	ATE
	1.6 16V	110	ORGA 11577	05.08			11.9571-9766.2	220664		D=57, - Halter	ATE
	1.6 16V	128	ORGA 11577	05.08			11.8116-0351.1	390538	2	Haltefeder	ATE
	2.0 BioFlex	103	ORGA 11577	05.08			11.0101-5704.2	260095		Hülsensatz	ATE
	2.0 HDi 135	100	ORGA 11577	05.08			11.8171-0008.1	990049		Führungsbolzen	ATE
	1.6 16V	103	ORGA 11578		04.14		11.9571-9939.2	220923		D=57, - Halter	ATE
	1.6 16V	110	ORGA 11578		04.14		11.9571-9940.2	220924		D=57, - Halter	ATE
	1.6 16V	115		10.09	04.14		11.0101-5704.2	260095		Hülsensatz	ATE
	1.6 16V	128	ORGA 11578		04.14		11.8171-0008.1	990049		Führungsbolzen	ATE
	2.0 BioFlex	103	ORGA 11578		04.14		11.8116-0356.1	390586	2	Haltefeder	ATE
	2.0 HDi	120	ORGA 11678	06.09	04.14						
	2.0 HDi 135	100	ORGA 11578		04.14						
	2.0 HDi 140	103		12.08	04.14						
	2.0 HDi 150	110		04.11	04.14						
	1.4 16V	70		05.08	04.14	- Break Loisirs	24.3387-1731.7	221009		D=38, - Halter	TRW
	1.4 16V	72		12.09	04.14	- Break Loisirs	24.3387-1732.7	221010		D=38, - Halter	TRW
	1.6 16V	88		05.08	04.14	- Break Loisirs					
	1.6 16V	103		05.08	04.14	- Break Loisirs					
	1.6 16V	110		05.08	04.14	- Break Loisirs					
	1.6 16V	115		10.09	04.14	- Break Loisirs					
	1.6 16V	128		05.08	04.14	- Break Loisirs					
	1.6 Bioflex	82		03.09	04.14	- Break Loisirs					
	1.6 HDi 110	80		05.08	04.14	- Break Loisirs					
	1.6 HDi 112	82		12.09	04.14	- Break Loisirs					
	1.6 HDi 115	84		03.13	04.14	- Break Loisirs					
	1.6 HDi 90	66		05.08	04.14	- Break Loisirs					
	1.6 HDi 92	68		11.09	04.14	- Break Loisirs					
	2.0 BioFlex	103		05.08	04.14	- Break Loisirs					
	2.0 HDi	120		06.09	04.14	- Break Loisirs					
	2.0 HDi 135	100		05.08	04.14	- Break Loisirs					
	2.0 HDi 140	103		12.08	04.14	- Break Loisirs					
	2.0 HDi 150	110		04.11	04.14	- Break Loisirs					
	1.4 16V	70		05.08	04.14	+ Break Loisirs	24.3387-1725.7	221003		D=38, - Halter	TRW
	1.4 16V	72		12.09	04.14	+ Break Loisirs	24.3387-1726.7	221004		D=38, - Halter	TRW
	1.6 16V	88		05.08	04.14	+ Break Loisirs					
	1.6 16V	103		05.08	04.14	+ Break Loisirs					
	1.6 16V	110		05.08	04.14	+ Break Loisirs					
	1.6 16V	115		10.09	04.14	+ Break Loisirs					
	1.6 16V	128		05.08	04.14	+ Break Loisirs					
	1.6 Bioflex	82		03.09	04.14	+ Break Loisirs					
	1.6 HDi 110	80		05.08	04.14	+ Break Loisirs					
	1.6 HDi 112	82		12.09	04.14	+ Break Loisirs					
	1.6 HDi 115	84		03.13	04.14	+ Break Loisirs					
	1.6 HDi 90	66		05.08	04.14	+ Break Loisirs					
	1.6 HDi 92	68		11.09	04.14	+ Break Loisirs					
	2.0 BioFlex	103		05.08	04.14	+ Break Loisirs					
	2.0 HDi	120		06.09	04.14	+ Break Loisirs					
	2.0 HDi 135	100		05.08	04.14	+ Break Loisirs					
	2.0 HDi 140	103		12.08	04.14	+ Break Loisirs					
	2.0 HDi 150	110		04.11	04.14	+ Break Loisirs					
	1.4 16V	70		05.08	04.14		24.5246-0190.3	330697	2		L=190
	1.4 16V	72		12.09	04.14						
	1.6 16V	88		05.08	04.14						
	1.6 16V	103		05.08	04.14						
	1.6 16V	110		05.08	04.14						
	1.6 16V	115		10.09	04.14						
	1.6 16V	128		05.08	04.14						
	1.6 Bioflex	82		03.09	04.14						
	1.6 HDi 110	80		05.08	04.14						
	1.6 HDi 112	82		12.09	04.14						
	1.6 HDi 115	84		03.13	04.14						
	1.6 HDi 90	66		05.08	04.14						
	1.6 HDi 92	68		11.09	04.14						
	2.0 BioFlex	103		05.08	04.14						
	2.0 HDi	120		06.09	04.14						
	2.0 HDi 135	100		05.08	04.14						



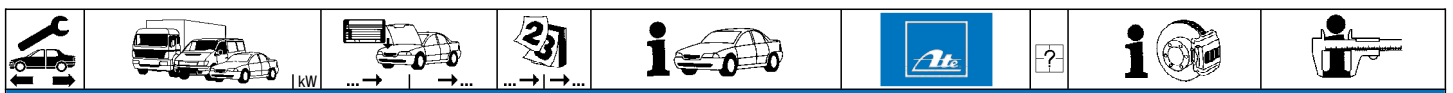

PEUGEOT 308 SW (08-14)										
	2.0 HDi 140	103		12.08	04.14	24.5246-0190.3	330697	2		L=190
	2.0 HDi 150	110		04.11	04.14					
	1.4 16V	70		05.08	04.14	24.3727-0854.2	580854	2	↓	L=2128
	1.4 16V	72		12.09	04.14					
	1.6 16V	88		05.08	04.14					
	1.6 16V	103		05.08	04.14					
	1.6 16V	110		05.08	04.14					
	1.6 16V	115		10.09	04.14					
	1.6 16V	128		05.08	04.14					
	1.6 Bioflex	82		03.09	04.14					
	1.6 HDi 110	80		05.08	04.14					
	1.6 HDi 112	82		12.09	04.14					
	1.6 HDi 115	84		03.13	04.14					
	1.6 HDi 90	66		05.08	04.14					
	1.6 HDi 92	68		11.09	04.14					
	2.0 BioFlex	103		05.08	04.14					
	2.0 HDi	120		06.09	04.14					
	2.0 HDi 135	100		05.08	04.14					
	2.0 HDi 140	103		12.08	04.14					
	2.0 HDi 150	110		04.11	04.14					

PEUGEOT 308 CC (09-15)											
	1.6 16V	103		06.09		11.9571-9939.2	220923			D=57, - Halter	ATE
	1.6 16V	115		09.09		11.9571-9940.2	220924			D=57, - Halter	ATE
	1.6 THP	110		06.09		11.8116-0356.1	390586	2		Haltefeder	ATE
	2.0 HDi	100		04.09		11.0101-5704.2	260095			Hülsensatz	ATE
	2.0 HDi	120		06.09		11.8171-0008.1	990049	2		Führungsbolzen	ATE
	2.0 HDi FAP 140	103		03.09							
	1.6 THP	147		10.10		11.9601-9883.2	220917			D=60, - Halter	ATE
						11.9601-9884.2	220918			D=60, - Halter	ATE
						11.0441-6008.2	250038			Dichtungssatz	ATE
						11.0101-5407.2	260011			Hülsensatz	ATE
						11.8171-0008.1	990049	2		Führungsbolzen	ATE
	1.6 16V	103		06.09		24.3387-1731.7	221009			D=38, - Halter	TRW
	1.6 16V	115		09.09		24.3387-1732.7	221010			D=38, - Halter	TRW
	1.6 HDi	82		03.09							
	1.6 HDi 115	84		03.13							
	1.6 THP	110		06.09							
	1.6 VTi	88		03.09							
	2.0 HDi	100		04.09							
	2.0 HDi	120		06.09							
	2.0 HDi FAP 140	103		03.09							
	1.6 16V	103		06.09		24.5246-0190.3	330697	2		L=190	
	1.6 16V	115		09.09							
	1.6 HDi	82		03.09							
	1.6 HDi 115	84		03.13							
	1.6 THP	110		06.09							
	1.6 THP	147		10.10							
	1.6 VTi	88		03.09							
	2.0 HDi	100		04.09							
	2.0 HDi	120		06.09							
	2.0 HDi FAP 140	103		03.09							

PEUGEOT 308 II (T9) (13-)											
	1.2 THP 110	81		11.13		11.8171-0008.1	990049			Führungsbolzen	ATE
	1.2 THP 130	96		11.13		+ Bremsscheibendurchm. 304 mm ¹⁾	11.0101-5407.2	260011		Hülsensatz	ATE
	1.2 VTi 82	60		09.13		+ Bremsscheibendurchm. 304 mm ¹⁾	11.8116-0326.1	390471	2	Haltefeder	ATE
	1.6 GT 205	151		06.14		+ Bremsscheibendurchm. 304 mm ¹⁾					
	1.6 GTi 250	184		08.15		+ Bremsscheibendurchm. 304 mm ¹⁾					
	1.6 GTi 270	200		06.15		+ Bremsscheibendurchm. 304 mm ¹⁾					
	1.6 HDi 100	73		04.14		+ Bremsscheibendurchm. 304 mm ¹⁾					
	1.6 HDi 115	85		09.13		+ Bremsscheibendurchm. 304 mm ¹⁾					
	1.6 HDi 120	88		11.13		+ Bremsscheibendurchm. 304 mm ¹⁾					
	1.6 HDi 92	68		09.13		+ Bremsscheibendurchm. 304 mm ¹⁾					
	1.6 THP 125	92		09.13		+ Bremsscheibendurchm. 304 mm ¹⁾					
	1.6 THP 150	110		03.14		+ Bremsscheibendurchm. 304 mm ¹⁾					
	1.6 THP 155	115		09.13		+ Bremsscheibendurchm. 304 mm ¹⁾					
	1.6 THP 163	120		06.14		+ Bremsscheibendurchm. 304 mm ¹⁾					
	1.6 VTi	85		03.14		+ Bremsscheibendurchm. 304 mm ¹⁾					
	2.0 GT HDi 180	133		06.14		+ Bremsscheibendurchm. 304 mm ¹⁾					
	2.0 HDi 150	110		11.13		+ Bremsscheibendurchm. 304 mm ¹⁾					
	1.2 THP 110	81		11.13		+ Bremsscheibendurchm. 249 mm ²⁾	11.8171-0008.1	990049		Führungsbolzen	ATE
	1.2 THP 130	96		11.13		+ Bremsscheibendurchm. 249 mm ²⁾	11.8116-0340.1	390595	2	Haltefeder	ATE
	1.2 VTi 82	60		09.13		+ Bremsscheibendurchm. 249 mm ²⁾					
	1.6 GT 205	151		06.14		+ Bremsscheibendurchm. 249 mm ²⁾					
	1.6 GTi 250	184		08.15		+ Bremsscheibendurchm. 249 mm ²⁾					
	1.6 GTi 270	200		06.15		+ Bremsscheibendurchm. 249 mm ²⁾					
	1.6 HDi 100	73		04.14		+ Bremsscheibendurchm. 249 mm ²⁾					
	1.6 HDi 115	85		09.13		+ Bremsscheibendurchm. 249 mm ²⁾					
	1.6 HDi 120	88		11.13		+ Bremsscheibendurchm. 249 mm ²⁾					
	1.6 HDi 92	68		09.13		+ Bremsscheibendurchm. 249 mm ²⁾					
	1.6 THP 125	92		09.13		+ Bremsscheibendurchm. 249 mm ²⁾					
	1.6 THP 150	110		03.14		+ Bremsscheibendurchm. 249 mm ²⁾					
	1.6 THP 155	115		09.13		+ Bremsscheibendurchm. 249 mm ²⁾					
	1.6 THP 163	120		06.14		+ Bremsscheibendurchm. 249 mm ²⁾					
	1.6 VTi	85		03.14		+ Bremsscheibendurchm. 249 mm ²⁾					

1) + brake disc diameter 304 mm / + disco fr.diam. 304mm / + disques fr.diam. 304mm / + disco fr.diam. 304mm
 2) + brake disc diameter 249mm / + diametro dischi freno 249mm / + diamètre disques frein 249mm / + diámetro disco freno 249mm

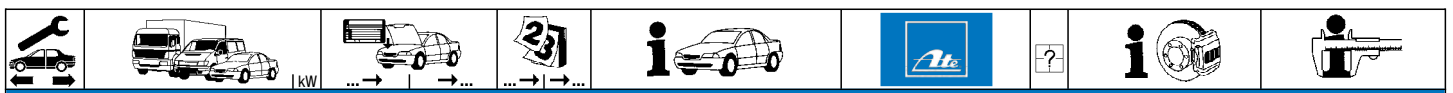

PEUGEOT 308 II (T9) (13-)										
	2.0 GT HDi 180	133		06.14	+ Bremsscheibendurchm. 249 mm ¹⁾	11.8171-0008.1	990049	2	Führungsbolzen Haltefeder	ATE
	2.0 HDi 150	110		11.13	+ Bremsscheibendurchm. 249 mm ¹⁾	11.8116-0340.1	390595			ATE
	1.2 THP 110	81		11.13	+ Bremsscheibendurchm. 268 mm ²⁾	11.8171-0008.1	990049	2	Führungsbolzen Hülzensatz Haltefeder	ATE
	1.2 THP 130	96		11.13	+ Bremsscheibendurchm. 268 mm ²⁾	11.0101-5407.2	260011			ATE
	1.2 VTi 82	60		09.13	+ Bremsscheibendurchm. 268 mm ²⁾	11.8116-0340.1	390595			ATE
	1.6 GT 205	151		06.14	+ Bremsscheibendurchm. 268 mm ²⁾					
	1.6 GTi 250	184		08.15	+ Bremsscheibendurchm. 268 mm ²⁾					
	1.6 GTi 270	200		06.15	+ Bremsscheibendurchm. 268 mm ²⁾					
	1.6 HDi 100	73		04.14	+ Bremsscheibendurchm. 268 mm ²⁾					
	1.6 HDi 115	85		09.13	+ Bremsscheibendurchm. 268 mm ²⁾					
	1.6 HDi 120	88		11.13	+ Bremsscheibendurchm. 268 mm ²⁾					
	1.6 HDi 92	68		09.13	+ Bremsscheibendurchm. 268 mm ²⁾					
	1.6 THP 125	92		09.13	+ Bremsscheibendurchm. 268 mm ²⁾					
	1.6 THP 150	110		03.14	+ Bremsscheibendurchm. 268 mm ²⁾					
	1.6 THP 155	115		09.13	+ Bremsscheibendurchm. 268 mm ²⁾					
	1.6 THP 163	120		06.14	+ Bremsscheibendurchm. 268 mm ²⁾					
	1.6 VTi	85		03.14	+ Bremsscheibendurchm. 268 mm ²⁾					
	2.0 GT HDi 180	133		06.14	+ Bremsscheibendurchm. 268 mm ²⁾					
	2.0 HDi 150	110		11.13	+ Bremsscheibendurchm. 268 mm ²⁾					

PEUGEOT 308 II SW (T9) (14-)													
	1.2 e-THP	81		08.14	+ Bremsscheibendurchm. 304 mm ³⁾	11.0441-6008.2	250038	2	Dichtungssatz Führungsbolzen Haltefeder	ATE			
	1.2 e-THP	96		03.14	+ Bremsscheibendurchm. 304 mm ³⁾	11.8171-0008.1	990049			ATE			
	1.6 BlueHdi	73		03.14	+ Bremsscheibendurchm. 304 mm ³⁾	11.8116-0326.1	390471			ATE			
	1.6 BlueHdi	88		03.14	+ Bremsscheibendurchm. 304 mm ³⁾								
	1.6 e-HDi	85		03.14	+ Bremsscheibendurchm. 304 mm ³⁾								
	1.6 GT 205	151		06.14	+ Bremsscheibendurchm. 304 mm ³⁾								
	1.6 HDi	68		03.14	+ Bremsscheibendurchm. 304 mm ³⁾								
	1.6 THP	115		03.14	+ Bremsscheibendurchm. 304 mm ³⁾								
	1.6 THP 125	92		03.14	+ Bremsscheibendurchm. 304 mm ³⁾								
	1.6 THP 150	110		03.14	+ Bremsscheibendurchm. 304 mm ³⁾								
	1.6 THP 163	120		06.14	+ Bremsscheibendurchm. 304 mm ³⁾								
	1.6 VTi	85		03.14	+ Bremsscheibendurchm. 304 mm ³⁾								
	2.0 BlueHdi	110		03.14	+ Bremsscheibendurchm. 304 mm ³⁾								
	2.0 BlueHdi 180	132		06.14	+ Bremsscheibendurchm. 304 mm ³⁾								
	2.0 GT HDi 180	133		06.14	+ Bremsscheibendurchm. 304 mm ³⁾								
		1.2 e-THP	81		08.14	+ Bremsscheibendurchm. 249 mm ¹⁾	11.8171-0008.1			990049	2	Führungsbolzen Hülzensatz Haltefeder	ATE
		1.2 e-THP	96		03.14	+ Bremsscheibendurchm. 249 mm ¹⁾	11.0101-5407.2			260011			ATE
		1.6 BlueHdi	73		03.14	+ Bremsscheibendurchm. 249 mm ¹⁾	11.8116-0340.1			390595			ATE
1.6 BlueHdi		88		03.14	+ Bremsscheibendurchm. 249 mm ¹⁾								
1.6 e-HDi		85		03.14	+ Bremsscheibendurchm. 249 mm ¹⁾								
1.6 GT 205		151		06.14	+ Bremsscheibendurchm. 249 mm ¹⁾								
1.6 HDi		68		03.14	+ Bremsscheibendurchm. 249 mm ¹⁾								
1.6 THP		115		03.14	+ Bremsscheibendurchm. 249 mm ¹⁾								
1.6 THP 125		92		03.14	+ Bremsscheibendurchm. 249 mm ¹⁾								
1.6 THP 150		110		03.14	+ Bremsscheibendurchm. 249 mm ¹⁾								
1.6 THP 163		120		06.14	+ Bremsscheibendurchm. 249 mm ¹⁾								
1.6 VTi		85		03.14	+ Bremsscheibendurchm. 249 mm ¹⁾								
2.0 BlueHdi		110		03.14	+ Bremsscheibendurchm. 249 mm ¹⁾								
2.0 BlueHdi 180		132		06.14	+ Bremsscheibendurchm. 249 mm ¹⁾								
2.0 GT HDi 180		133		06.14	+ Bremsscheibendurchm. 249 mm ¹⁾								
		1.2 e-THP	81		08.14	+ Bremsscheibendurchm. 268 mm ²⁾	11.8171-0008.1	990049	2	Führungsbolzen Hülzensatz Haltefeder			ATE
		1.2 e-THP	96		03.14	+ Bremsscheibendurchm. 268 mm ²⁾	11.0101-5407.2	260011					ATE
		1.6 BlueHdi	73		03.14	+ Bremsscheibendurchm. 268 mm ²⁾	11.8116-0340.1	390595					ATE
	1.6 BlueHdi	88		03.14	+ Bremsscheibendurchm. 268 mm ²⁾								
	1.6 e-HDi	85		03.14	+ Bremsscheibendurchm. 268 mm ²⁾								
	1.6 GT 205	151		06.14	+ Bremsscheibendurchm. 268 mm ²⁾								
	1.6 HDi	68		03.14	+ Bremsscheibendurchm. 268 mm ²⁾								
	1.6 THP	115		03.14	+ Bremsscheibendurchm. 268 mm ²⁾								
	1.6 THP 125	92		03.14	+ Bremsscheibendurchm. 268 mm ²⁾								
	1.6 THP 150	110		03.14	+ Bremsscheibendurchm. 268 mm ²⁾								
	1.6 THP 163	120		06.14	+ Bremsscheibendurchm. 268 mm ²⁾								
	1.6 VTi	85		03.14	+ Bremsscheibendurchm. 268 mm ²⁾								
	2.0 BlueHdi	110		03.14	+ Bremsscheibendurchm. 268 mm ²⁾								
	2.0 BlueHdi 180	132		06.14	+ Bremsscheibendurchm. 268 mm ²⁾								
	2.0 GT HDi 180	133		06.14	+ Bremsscheibendurchm. 268 mm ²⁾								

PEUGEOT 406 Limousine (95-04)												
	1.6 i	◀ 65 ORGA 08701		04.04		03.7863-2202.4	300127	2	10"	ATE		
	1.8 16V	◀ 81 ORGA 08701		10.00								
	1.8 16V	◀ 85		10.00								
	2.0 16V	◀ 97 ORGA 08701		04.04	- ESP							
	2.0 16V	◀ 100 ORGA 08701		04.04	- ESP							
	2.0 16V Hpi	◀ 103		05.01	04.04 - ESP							
	2.0 HDi 110	◀ 80 ORGA 08701		08.01	04.04 - ESP							
	2.0 HDi 110 FAP	◀ 79		08.01	04.04 - ESP							
	2.0 HDi 90	◀ 66 ORGA 08701		04.04	- ESP							
	2.0 Turbo	◀ ORGA 08701		04.04	- ESP							
	2.2 HDi	◀ 98 ORGA 08701		04.04	- ESP							
	2.2 i	◀ 116 ORGA 08701		04.04	- ESP							
	2.0 16V	◀ 97 ORGA 08701		04.04	+ ESP	03.7863-2802.4	300188				10"	ATE
	2.0 16V	◀ 100 ORGA 08701		04.04	+ ESP							
	2.0 16V Hpi	◀ 103		05.01	04.04 + ESP							
	2.0 HDi 110	◀ 80 ORGA 08701		08.01	04.04 + ESP							
	2.0 HDi 110 FAP	◀ 79		08.01	04.04 + ESP							
	2.0 HDi 90	◀ 66 ORGA 08701		04.04	+ ESP							
2.0 Turbo	◀ ORGA 08701		04.04	+ ESP								





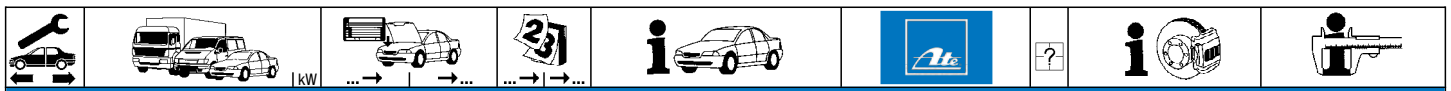











1) + brake disc diameter 249mm / + diametro dischi freno 249mm / + diamètre disques frein 249mm / + diámetro disco freno 249mm
 2) + brake disc diameter 268 mm / + disco fr.diam. 268mm / + disques fr.diam. 268mm / + disco fr.diam. 268mm
 3) + brake disc diameter 304 mm / + disco fr.diam. 304mm / + disques fr.diam. 304mm / + disco fr.diam. 304mm





PEUGEOT 406 Limousine (95-04)

	2.2 HDi 2.2 i	98 ORGA 08701 116 ORGA 08701		04.04 + ESP 04.04 + ESP	03.7863-2802.4 300188		10"	ATE
	1.6 i 1.8 16V 1.8 i 1.9 D 1.9 TD 1.9 TD 2.0 16V 2.0 Turbo 2.1 TD 3.0 24V	65 81 66 55 66 68 97 80 140		10.95 01.99 10.95 01.99 05.97 01.99 10.96 01.99 01.96 01.99 01.96 01.99 10.95 01.99 04.96 01.99 10.95 01.99 10.96 01.99	24.2123-1710.3 010504 24.2123-1713.3 010505	- ABS + ABS	THz 23,81 THz 23,81	BOS BOS
	1.6 i 1.8 16V 1.8 i 1.9 D 1.9 TD 1.9 TD 2.0 16V 2.0 16V 2.0 16V 2.0 HDi 110 2.0 HDi 90 2.0 Turbo 2.1 TD 2.2 HDi 2.2 i 3.0 24V 3.0 V6	65 81 66 55 66 68 97 99 100 80 66 80 98 116 140 152	ORGA 08700 ORGA 08700 ORGA 08700 ORGA 08700 ORGA 08700 ORGA 08700 ORGA 08700 ORGA 08700 ORGA 08700 ORGA 08700 ORGA 08700 ORGA 08700 ORGA 08700 ORGA 08700 ORGA 08700 ORGA 08700	02.99 02.99 02.99 02.99 02.99 02.99 02.99 02.99 08.00 08.00 02.99 02.99 03.00 07.00 02.99 03.00	24.2123-1751.3 010698 24.2123-1741.3 010681	- ABS + ABS	THz 23,81 THz 23,81	
	1.6 i 1.8 16V 1.8 16V 1.8 i 1.9 D 1.9 TD 1.9 TD 2.0 16V 2.0 16V 2.0 16V HPi 2.0 HDi 110 2.0 HDi 110 FAP 2.0 HDi 90 2.2 HDi 2.2 i 3.0 24V 3.0 V6	65 ORGA 08701 81 ORGA 08701 85 66 ORGA 08701 55 ORGA 08701 66 ORGA 08701 68 ORGA 08701 97 ORGA 08701 100 ORGA 08701 103 80 ORGA 08701 79 66 ORGA 08701 98 ORGA 08701 116 ORGA 08701 140 ORGA 08701 152 ORGA 08701		04.04 10.00 10.00 04.04 - ESP 04.04 04.04 04.04 04.04 04.04 - ESP 04.04 - ESP 05.01 04.04 - ESP 08.01 - ESP 08.01 04.04 - ESP 04.04 - ESP 04.04 - ESP 04.04 - ESP 04.04	03.2123-2581.3 010613		THz 23,81	ATE
	1.8 16V 2.0 16V 2.0 16V 2.0 16V HPi 2.0 HDi 110 2.0 HDi 110 FAP 2.0 HDi 90 2.2 HDi 2.2 i	85 97 ORGA 08701 100 ORGA 08701 103 80 ORGA 08701 79 66 ORGA 08701 98 ORGA 08701 116 ORGA 08701		10.00 04.04 + ESP 04.04 + ESP 04.04 + ESP 05.01 04.04 + ESP 08.01 + ESP 08.01 04.04 + ESP 04.04 + ESP 04.04 + ESP 04.04 + ESP	03.2123-2561.3 010629		THz 23,81	ATE
	1.6 i 1.8 16V 1.8 16V 1.8 i 1.9 D	65 81 85 66 55		10.95 04.04 10.95 10.00 10.00 04.04 10.95 04.04 10.96 04.04	24.3571-1717.5 240227 24.3571-1718.5 240228	<input checked="" type="checkbox"/> <input type="checkbox"/>	D=57, - Halter D=57, - Halter	TRW TRW
	1.9 TD 1.9 TD 2.0 16V 2.0 16V 2.0 16V 2.0 16V HPi 2.0 HDi 110 2.0 HDi 110 FAP 2.0 HDi 90 2.0 Turbo 2.1 TD 2.2 HDi 2.2 i 3.0 24V 3.0 V6	66 68 97 99 100 103 80 79 66 80 98 116 140 152		01.96 04.04 01.96 04.04 10.95 04.04 02.99 08.00 08.00 04.04 05.01 04.04 02.99 08.01 08.01 04.04 02.99 04.04 04.96 04.04 10.95 04.04 03.00 04.04 07.00 04.04 10.96 04.04 03.00 04.04	24.3571-1715.5 240225 24.3571-1716.5 240226	<input checked="" type="checkbox"/> <input type="checkbox"/>	D=57, - Halter D=57, - Halter	TRW TRW
	1.6 i 1.8 16V 1.8 16V 1.8 i 1.9 D 1.9 TD 1.9 TD 2.0 16V 2.0 16V 2.0 16V	65 81 85 66 55 66 68 97 99 100		10.95 04.04 10.95 10.00 10.00 04.04 05.97 04.04 10.96 04.04 10.95 04.04 01.96 04.04 10.95 04.04 01.99 08.00 08.00 04.04	24.5130-0527.3 330585 24.5130-0526.3 330584	<input checked="" type="checkbox"/> <input type="checkbox"/>	L=526 L=526	

									
PEUGEOT 406 Limousine (95-04)									
	2.0 16V HPi	103		05.01	04.04	24.5130-0527.3	330585	<input type="checkbox"/>	L=526
	2.0 HDi 110	80		02.99	08.01	24.5130-0526.3	330584	<input type="checkbox"/>	L=526
	2.0 HDi 110 FAP	79		08.01	04.04				
	2.0 HDi 90	66		02.99	04.04				
	2.0 Turbo			04.96	04.04				
	2.1 TD	80		10.95	04.04				
	2.2 HDi	98		03.00	04.04				
	2.2 i	116		07.00	04.04				
	3.0 24V	140		10.96	04.04				
	3.0 V6	152		03.00	04.04				
	2.0 16V	97 ORGA 08638	ORGA 08882			24.5130-0527.3	330585	<input type="checkbox"/>	L=526
	2.0 16V	99 ORGA 08638		08.00	+ ABS	24.5130-0526.3	330584	<input type="checkbox"/>	L=526
	2.0 16V HPi	103		05.01	04.04				
	2.2 HDi	98 ORGA 08338	ORGA 08882						
	3.0 24V	140 ORGA 08338	ORGA 08882						
	3.0 V6	152 ORGA 08338	ORGA 08882						
	2.0 16V	97 ORGA 08883			04.04	24.5111-0535.3	330684	2	L=535
	2.0 16V	100 ORGA 08883			04.04				
	2.0 16V HPi	103		05.01	04.04				
	2.2 HDi	98 ORGA 08883			04.04				
	3.0 24V	140 ORGA 08883			04.04				
	3.0 V6	152 ORGA 08883			04.04				
	1.8 16V	85		10.00	04.04	11.3331-0037.2	220395	<input type="checkbox"/>	D=33, - Halter
	2.0 16V	97		10.95	04.04	11.3331-0038.2	220396	<input type="checkbox"/>	D=33, - Halter
	2.0 16V	99		01.99	08.00	24.3331-0037.5	240547	<input type="checkbox"/>	D=33, - Halter
	2.0 16V	100		08.00	04.04	24.3331-0038.5	240548	<input type="checkbox"/>	D=33, - Halter
	2.0 16V HPi	103		05.01	04.04	11.0441-3305.2	250006	<input type="checkbox"/>	Dichtungssatz
	2.0 HDi 110	80		02.99	08.01				ATE
	2.0 HDi 110 FAP	79		08.01	04.04				ATE
	2.0 HDi 90	66		02.99	04.04				ATE
	2.0 Turbo			04.96	04.04				
	2.1 TD	80		10.95	04.04				
	2.2 HDi	98		03.00	04.04				
	2.2 i	116		07.00	04.04				
	3.0 24V	140		10.96	04.04				
	3.0 V6	152		03.00	04.04				
	1.6 i	65		10.95	04.04	24.5228-0280.3	330532	2	L=280
	1.8 16V	81		10.95	10.00				
	1.8 16V	85		10.00	04.04				
	1.8 i	66		05.97	04.04				
1.9 D	55		10.96	04.04					
	1.9 TD	66		10.95	04.04				
	1.9 TD	68		01.96	04.04				
	2.0 16V	97		10.95	04.04				
	2.0 16V	99		01.99	08.00				
	2.0 16V	100		08.00	04.04				
	2.0 16V HPi	103		05.01	04.04				
	2.0 HDi 110	80		02.99	08.01				
	2.0 HDi 110 FAP	79		08.01	04.04				
	2.0 HDi 90	66		02.99	04.04				
	2.0 Turbo			04.96	04.04				
	2.1 TD	80		10.95	04.04				
	2.2 HDi	98		03.00	04.04				
	2.2 i	116		07.00	04.04				
	3.0 24V	140		10.96	04.04				
	3.0 V6	152		03.00	04.04				
	1.6 i	65		10.95	04.04	24.3220-1707.3	020402	<input type="checkbox"/>	RzR 20,64
	1.8 16V	81		10.95	10.00	24.3220-1708.3	020403	<input type="checkbox"/>	RzR 20,64
	1.8 i	66		05.97	04.04	24.3220-1709.3	020404	<input type="checkbox"/>	Rz 20,64
	1.9 D	55		10.96	04.04	24.3220-1710.3	020405	<input type="checkbox"/>	Rz 20,64
	1.9 TD	66		10.95	04.04				BDX
1.9 TD	68		01.96	04.04				BDX	
	1.6 i	65		10.95	04.04	24.3220-1709.3	020404	<input type="checkbox"/>	Rz 20,64
	1.8 16V	81		10.95	10.00	24.3220-1710.3	020405	<input type="checkbox"/>	Rz 20,64
	1.8 i	66		05.97	04.04				BDX
	1.9 D	55		10.96	04.04				BDX
	1.9 TD	66		10.95	04.04				
	1.9 TD	68		01.96	04.04				
	1.6 i	65	ORGA 08511	10.95		24.3727-0834.2	580834	1 <input type="checkbox"/>	Einstellung nach unten ¹⁾
	1.8 16V	81	ORGA 08511	10.95		24.3727-0851.2	580851	1 <input type="checkbox"/>	Einstellung nach oben/ ORGA -08574 ²⁾
	1.8 i	66	ORGA 08511	05.97		24.3727-0852.2	580852	1 <input type="checkbox"/>	Einstellung nach oben/ ORGA 08575- ³⁾
	1.9 D	55	ORGA 08511	10.96		24.3727-0824.2	580824	<input type="checkbox"/>	L=824
1.9 TD	66	ORGA 08511	10.95		24.3727-0825.2	580825	<input type="checkbox"/>	L=750	
	1.6 i	65	ORGA 08512		04.04	24.3727-0834.2	580834	1 <input type="checkbox"/>	Einstellung nach unten/ ORGA 08575- ⁴⁾
	1.8 16V	81	ORGA 08512		10.00	24.3727-0851.2	580851	1 <input type="checkbox"/>	Einstellung nach oben/ ORGA -08574 ²⁾
	1.8 i	66	ORGA 08512		04.04	24.3727-0852.2	580852	1 <input type="checkbox"/>	Einstellung nach oben/ ORGA 08575- ³⁾
	1.9 D	55	ORGA 08512		04.04	24.3727-0835.2	580835	<input type="checkbox"/>	L=824
	1.9 TD	66	ORGA 08512		04.04	24.3727-0836.2	580836	<input type="checkbox"/>	L=751
	1.8 16V	85		10.00	04.04	24.3727-0834.2	580834	1 <input type="checkbox"/>	Einstellung nach unten ¹⁾
	2.0 16V	97		10.95	04.04	24.3727-0826.2	580826	<input type="checkbox"/>	L=695
	2.0 16V	99		01.99	08.00	24.3727-0827.2	580827	<input type="checkbox"/>	L=642
	2.0 16V	100		08.00	04.04				
	2.0 16V HPi	103		05.01	04.04				
2.0 HDi 110	80		02.99	08.01					
2.0 HDi 110 FAP	79		08.01	04.04					
2.0 HDi 90	66		02.99	04.04					

¹⁾ Adjust down / Regolazione verso il basso / Réglage vers le bas / Ajuste hacia abajo

²⁾ Adjust up/ ORGA -08574 / Regolazione verso l'alto/ ORGA -08574 / Réglage vers le haut/ ORGA -08574 / Ajuste hacia arriba/ ORGA -08574

³⁾ Adjust up/ ORGA 08575- / Regolazione verso l'alto / Réglage vers le haut/ ORGA 08575- / Ajuste hacia arriba/ ORGA 08575-

⁴⁾ Adjust down/ ORGA 08575- / Regolazione verso il basso/ ORGA 08575- / Réglage vers le bas/ ORGA 08575- / Ajuste hacia abajo/ ORGA 08575-





PEUGEOT 406 Limousine (95-04)

	2.0 Turbo			04.96	04.04	24.3727-0834.2	580834	1	Einstellung nach unten ¹⁾ <input type="checkbox"/> <input type="checkbox"/>	L=1700 L=695 L=642				
	2.1 TD	80		10.95	04.04	24.3727-0826.2	580826							
	2.2 HDi	98		03.00	04.04	24.3727-0827.2	580827							
	2.2 i	116		07.00	04.04									
	3.0 24V	140		10.96	04.04									
	3.0 V6	152		03.00	04.04									
	1.8 16V	85	ORGA 08574	10.00		24.3727-0851.2	580851	1	Einstellung nach oben ²⁾ <input type="checkbox"/> <input type="checkbox"/>	L=1756 L=695 L=642				
	2.0 16V	97	ORGA 08574	10.95		24.3727-0826.2	580826							
	2.0 16V	99	ORGA 08574	01.99		24.3727-0827.2	580827							
	2.0 16V	100	ORGA 08574	08.00										
	2.0 16V HPi	103	ORGA 08574	05.01										
	2.0 HDi 110	80	ORGA 08574	02.99										
	2.0 HDi 110 FAP	79	ORGA 08574	08.01										
	2.0 HDi 90	66	ORGA 08574	02.99										
	2.0 Turbo		ORGA 08574	04.96										
	2.1 TD	80	ORGA 08574	10.95										
	2.2 HDi	98	ORGA 08574	03.00										
	2.2 i	116	ORGA 08574	07.00										
	3.0 24V	140	ORGA 08574	10.96										
	3.0 V6	152	ORGA 08574	03.00										
	1.8 16V	85	ORGA 08575		04.04		24.3727-0852.2				580852	1	Einstellung nach oben ²⁾ <input type="checkbox"/> <input type="checkbox"/>	L=1656 L=695 L=642
	2.0 16V	97	ORGA 08575		04.04		24.3727-0826.2				580826			
2.0 16V	99	ORGA 08575		08.00		24.3727-0827.2	580827							
2.0 16V	100	ORGA 08575		04.04										
2.0 16V HPi	103	ORGA 08575		04.04										
2.0 HDi 110	80	ORGA 08575		08.01										
2.0 HDi 110 FAP	79	ORGA 08575		04.04										
2.0 HDi 90	66	ORGA 08575		04.04										
2.0 Turbo		ORGA 08575		04.04										
2.1 TD	80	ORGA 08575		04.04										
2.2 HDi	98	ORGA 08575		04.04										
2.2 i	116	ORGA 08575		04.04										
3.0 24V	140	ORGA 08575		04.04										
3.0 V6	152	ORGA 08575		04.04										
	1.6 i	65		10.95	04.04	24.3728-0846.2	590846			L=805, + AUT				
	1.8 16V	81		10.95	10.00									
	1.8 16V	85		10.00	04.04									
	1.8 i	66		05.97	04.04									
	1.9 D	55		10.96	04.04	24.3728-0840.2	590840			L=800, + AUT				
	1.9 TD	66		10.95	04.04									
2.0 16V	97		10.95	04.04	24.3728-0847.2	590847			L=847, + AUT					

PEUGEOT 406 Kombi (96-04)

	1.8	66	ORGA 08701		04.04	03.7863-2202.4	300127			10"	ATE	
	1.8 16V	81	ORGA 08701		10.00							
	1.8 16V	85		10.00	04.04							
	1.9 D	55	ORGA 08701		04.04							
	1.9 TD	66	ORGA 08701		04.04							
	2.0 16V	97	ORGA 08701		04.04	- ESP						
	2.0 16V	99	ORGA 08701		10.00	- ESP						
	2.0 16V	100		10.00	04.04	- ESP						
	2.0 HDi 110	80	ORGA 08701		08.01	- ESP						
	2.0 HDi 110 FAP	79		08.01	04.04	- ESP						
	2.0 HDi 90	66	ORGA 08701		04.04	- ESP						
	2.0 Turbo		ORGA 08701		04.04	- ESP						
	2.2	116	ORGA 08701		04.04	- ESP						
	2.2 HDi	98	ORGA 08701		04.04	- ESP						
	2.0 16V	97	ORGA 08701		04.04	+ ESP	03.7863-2802.4	300188			10"	ATE
	2.0 16V	99	ORGA 08701		10.00	+ ESP						
	2.0 16V	100		10.00	04.04	+ ESP						
	2.0 16V HPi	103		05.01	04.04	+ ESP						
2.0 HDi 110	80	ORGA 08701		08.01	+ ESP							
2.0 HDi 110 FAP	79		08.01	04.04	+ ESP							
2.0 HDi 90	66	ORGA 08701		04.04	+ ESP							
2.0 Turbo		ORGA 08701		04.04	+ ESP							
2.2	116	ORGA 08701		04.04	+ ESP							
2.2 HDi	98	ORGA 08701		04.04	+ ESP							
	1.8	66		05.97	01.99	24.2123-1710.3	010504		- ABS	THz 23,81	BOS	
	1.8 16V	81		10.95	01.99	24.2123-1713.3	010505		+ ABS	THz 23,81	BOS	
	1.9 D	55		10.96	01.99							
	1.9 TD	66		10.95	01.99							
	2.0 16V	97		10.95	01.99							
	2.0 Turbo			10.96	01.99							
	2.1 TD	80		10.96	01.99							
	3.0 24V	140		10.96	01.99							
	1.8	66	ORGA 08700		02.99		24.2123-1751.3	010698		- ABS	THz 23,81	
	1.8 16V	81	ORGA 08700		02.99		24.2123-1741.3	010681		+ ABS	THz 23,81	
	1.9 D	55	ORGA 08700		02.99							
	1.9 TD	66	ORGA 08700		02.99							
2.0 16V	97	ORGA 08700		02.99								
2.0 16V	99	ORGA 08700		01.99								
2.0 HDi 110	80	ORGA 08700		02.99								
2.0 HDi 90	66	ORGA 08700		02.99								
2.0 Turbo		ORGA 08700		02.99								
2.1 TD	80	ORGA 08700		02.99								
2.2	116	ORGA 08700		07.00								

¹⁾ Adjust down / Regolazione verso il basso / Réglage vers le bas / Ajuste hacia abajo

²⁾ Adjust up / Regolazione verso l'alto / Réglage vers le haut / Ajuste hacia arriba

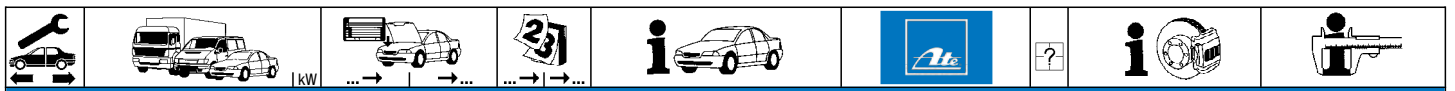















PEUGEOT 406 Coupe (97-05)

	2.2 2.2 HDi	116 98 ORGA 08701		03.02	09.05 + ESP 09.05 + ESP	03.7863-2802.4	300188			10"	ATE
	2.0 16V 3.0 24V	97 140		03.97 03.97	01.99 01.99	24.2123-1710.3 24.2123-1713.3	010504 010505		- ABS + ABS	THz 23,81 THz 23,81	BOS BOS
	2.0 16V 2.0 16V 2.2 HDi 3.0 24V 3.0 V6	97 99 98 140 152	ORGA 08700 ORGA 08700 ORGA 08700 ORGA 08700 ORGA 08700	02.99 01.99 03.00 02.99 03.00		24.2123-1751.3 24.2123-1741.3	010698 010681		- ABS + ABS	THz 23,81 THz 23,81	
	2.0 16V 2.0 16V 2.0 16V 2.2 2.2 HDi 3.0 24V 3.0 V6	97 ORGA 08701 99 ORGA 08701 100 116 98 ORGA 08701 140 ORGA 08701 152 ORGA 08701		09.05 10.00 03.02	- ESP - ESP - ESP - ESP	03.2123-2581.3	010613			THz 23,81	ATE
	2.0 16V 2.0 16V 2.0 16V 2.2 2.2 HDi	97 ORGA 08701 99 ORGA 08701 100 116 98 ORGA 08701		09.05 10.00 03.02	+ ESP + ESP + ESP + ESP	03.2123-2561.3	010629			THz 23,81	ATE
	2.0 16V 2.0 16V 2.0 16V 2.2 2.2 HDi	97 99 100 116 98		03.97 01.99 10.00 03.02 06.02	09.05 10.00 09.05 09.05 09.05	24.3571-1715.5 24.3571-1716.5	240225 240226	<input type="checkbox"/> <input type="checkbox"/>		D=57, - Halter D=57, - Halter	TRW TRW
	2.0 16V 2.0 16V 2.0 16V 2.2 2.2 HDi 3.0 24V 3.0 V6	97 99 100 116 98 140 152		03.97 01.99 10.00 03.02 03.00 03.97 03.00	09.05 10.00 09.05 09.05 09.05 09.05 09.05	11.3331-0037.2 11.3331-0038.2 24.3331-0037.5 24.3331-0038.5 11.0441-3305.2	220395 220396 240547 240548 250006	<input type="checkbox"/> <input type="checkbox"/> <input type="checkbox"/> <input type="checkbox"/> <input type="checkbox"/>		D=33, - Halter D=33, - Halter D=33, - Halter D=33, - Halter Dichtungssatz	ATE ATE ATE ATE ATE
	2.0 16V 2.0 16V 2.0 16V 2.2 2.2 HDi 3.0 24V 3.0 V6	97 99 100 116 98 140 152		03.97 01.99 10.00 03.02 03.00	09.05 10.00 09.05 09.05 09.05	24.5228-0280.3	330532	2		L=280	
	2.0 16V 2.0 16V 2.0 16V 2.2 HDi 3.0 24V 3.0 V6	97 99 100 98 140 152		03.97 01.99 10.00 03.00 03.97 03.00	09.05 10.00 09.05 09.05 09.05 09.05	24.3727-0834.2 24.3727-0828.2 24.3727-0829.2	580834 580828 580829	1 <input type="checkbox"/> <input type="checkbox"/> <input type="checkbox"/>		L=1700 L=706 L=644	
	2.2	116		03.02	09.05	24.3727-0834.2 24.3727-0826.2 24.3727-0827.2	580834 580826 580827	1 <input type="checkbox"/> <input type="checkbox"/> <input type="checkbox"/>		L=1700 L=695 L=642	
	2.0 16V	97		03.97	09.05	24.3728-0847.2	590847			L=847, + AUT	

PEUGEOT 407 Limousine / SW (04-11)

	1.6 HDi 110 1.8 16V 1.8 16V 2.0 16V 2.0 16V 2.0 Bioflex 2.0 HDi 135 2.2 16V 2.2 16V 2.2 HDi 170 2.7 HDi 3.0 V6	80 85 92 100 103 103 100 116 120 125 150 155	ORGA 11192 ORGA 11192 ORGA 11192 ORGA 11192 ORGA 11192 ORGA 11283 ORGA 11192 ORGA 11283 ORGA 11192 ORGA 11073 ORGA 11192	05.04 05.04 09.05 05.04 02.11 09.05 05.04 05.04 09.05 05.06 10.05 05.04		03.7860-3402.4	300217			10"	ATE
	1.6 HDi 110 1.8 16V 2.0 16V 2.0 Bioflex 2.0 HDi 135 2.0 HDi 140 2.2 16V 2.2 16V 2.2 HDi 2.2 HDi 170 2.7 HDi 3.0 V6	80 ORGA 11193 92 ORGA 11193 103 ORGA 11193 103 ORGA 11193 100 ORGA 11193 103 116 ORGA 11284 120 ORGA 11284 120 125 ORGA 11193 150 ORGA 11074 155 ORGA 11193	ORGA 12046 ORGA 12046 ORGA 12046 ORGA 12046 ORGA 12046 ORGA 12046 ORGA 12046 ORGA 12046 ORGA 12046 ORGA 12046 ORGA 12046	08.08 02.11 02.11 06.08 02.11		03.7860-5102.4	300218			10"	ATE
	1.6 HDi 110 1.8 16V 2.0 16V 2.0 Bioflex 2.0 HDi 2.0 HDi	80 ORGA 12047 92 ORGA 12047 103 ORGA 12047 103 ORGA 12047 110 120		02.11 02.11 02.11 02.11 02.10 07.09		03.7860-8002.4	300258			10"	ATE



								
PEUGEOT 407 Limousine / SW (04-11)								
	2.0 HDi 135 2.0 HDi 140 2.2 HDi 2.2 HDi 170 3.0 V6	100 ORGA 12047 103 ORGA 12047 120 ORGA 12047 125 ORGA 12047 155 ORGA 12047		02.11 02.11 02.11 02.11 02.11		03.7860-8002.4	300258	10" ATE
	1.6 HDi 110 1.8 16V 1.8 16V 2.0 16V 2.0 16V 2.0 Bioflex 2.0 HDi 135	80 85 92 100 103 103 100	ORGA 11682	05.04 05.04 09.05 05.04 09.05 09.07 05.04	02.11 02.11 02.11 02.11 02.11 02.11	03.2122-2023.3	010798	Thz 22,20 ATE
	2.0 HDi 2.0 HDi 2.0 HDi 135 2.0 HDi 140 2.2 16V 2.2 16V 2.2 HDi 2.2 HDi 170 2.7 HDi 3.0 V6	110 120 100 ORGA 11683 103 116 120 125 150 155	ORGA 12347 ORGA 12347 ORGA 12347 ORGA 12347 ORGA 12347 ORGA 12347 ORGA 12347	02.10 07.09 08.08 05.04 09.05 06.08 05.06 10.05 05.04	02.11 02.11 02.11 02.11 02.11 02.11 02.11	03.2123-3123.3	010806	Thz 23,81 ATE
	1.6 HDi 110 1.8 16V 1.8 16V 2.0 16V 2.0 16V 2.0 Bioflex 2.0 HDi 135 2.0 HDi 140	80 85 92 100 103 103 100 103	ORGA 11682	05.04 05.04 09.05 05.04 09.05 09.07 05.04 08.08	02.11 02.11 02.11 02.11 02.11 02.11	24.3571-1745.7 24.3571-1746.7 24.0101-3802.2	220689 220690 260100	D=57, - Halter D=57, - Halter Bremsattel-Zubehör TRW TRW TRW
	2.2 16V 2.2 16V 2.2 HDi 2.2 HDi 170 2.7 HDi 3.0 V6	116 120 120 125 150 155	ORGA 12410	05.04 09.05 06.08 05.06 10.05 05.04	02.11 02.11 02.11 02.11 02.11	24.3451-1719.7 24.3451-1720.7 24.0101-3802.2	220763 220764 260100	D=45/45, - Halter D=45/45, - Halter Bremsattel-Zubehör TRW TRW TRW
	2.0 HDi 2.0 HDi 2.0 HDi 135 2.0 HDi 140	110 120 100 ORGA 11683 103		02.10 07.09 02.11 08.08	02.11 02.11 02.11 02.11	11.9601-9731.2 11.9601-9732.2 11.0101-5407.2 11.0441-6008.2	220853 220854 260011 250038	D=60, - Halter D=60, - Halter Hülssensatz Dichtungssatz Haltefeder ATE ATE ATE ATE
	3.0 V6	155 ORGA 12411		02.11	02.11	11.9601-9883.2 11.9601-9884.2 11.0101-5407.2 11.0441-6008.2	220917 220918 260011 250038	D=60, - Halter D=60, - Halter Hülssensatz Dichtungssatz ATE ATE ATE ATE
	1.6 HDi 110 1.8 16V 1.8 16V 2.0 16V 2.0 16V 2.0 HDi 135 2.2 16V 2.2 16V 2.2 HDi 170 2.7 HDi 3.0 V6	80 ORGA 10332 85 ORGA 10332 92 100 ORGA 10332 103 100 ORGA 10332 116 ORGA 10332 120 125 150 155 ORGA 10332	ORGA 11125 ORGA 11125 ORGA 11125 ORGA 11125 ORGA 11125 ORGA 11125 ORGA 11125 ORGA 11125 ORGA 11125 ORGA 11125	09.05 09.05 09.05 05.06 10.05	02.11 02.11 02.11 02.11 02.11	24.5161-0315.3 24.5161-0316.3	331186 331187	L=310/275, + Rohrleitung L=310/275, + Rohrleitung
	1.6 HDi 110 1.8 16V 1.8 16V 2.0 16V 2.0 16V 2.0 Bioflex 2.0 HDi 2.0 HDi 2.0 HDi 135 2.0 HDi 140 2.2 16V 2.2 16V 2.2 HDi 2.2 HDi 170 2.7 HDi 3.0 V6	80 ORGA 11126 85 ORGA 11126 92 ORGA 11126 100 ORGA 11126 103 ORGA 11126 103 110 120 100 ORGA 11126 103 116 ORGA 11126 120 ORGA 11126 120 125 ORGA 11126 150 ORGA 11126 155 ORGA 11126		09.07 02.10 07.09 08.08 06.08	02.11 02.11 02.11 02.11 02.11 02.11 02.11 02.11 02.11 02.11 02.11 02.11 02.11 02.11 02.11	24.5161-0314.3 24.5161-0313.3	331220 331219	L=310/275, + Rohrleitung L=310/275, + Rohrleitung
	1.6 HDi 110 1.8 16V 1.8 16V 2.0 16V 2.0 16V 2.0 Bioflex 2.0 HDi 2.0 HDi 2.0 HDi 135 2.0 HDi 140 2.2 16V 2.2 16V 2.2 HDi 2.2 HDi 170	80 85 92 100 103 103 110 120 100 ORGA 11126 103 116 ORGA 11126 120 ORGA 11126 120 125 ORGA 11126 150 ORGA 11126		05.04 05.04 09.05 05.04 09.05 09.07 02.10 07.09 05.04 08.08 05.04 09.05 06.08 05.06	02.11 02.11 02.11 02.11 02.11 02.11 02.11 02.11 02.11 02.11 02.11 02.11 02.11 02.11	24.3387-1707.7 24.3387-1708.7 24.0101-3803.2	220701 220702 260101	D=38, - Halter D=38, - Halter Bremsattel-Zubehör TRW TRW TRW

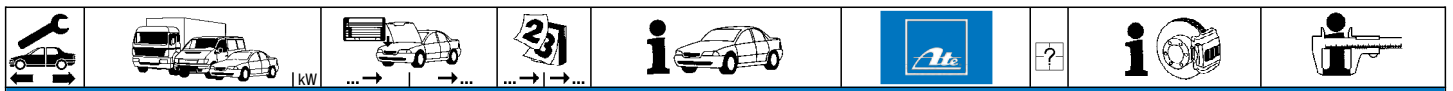

PEUGEOT 407 Limousine / SW (04-11)

	2.7 HDi 3.0 V6	150 155		10.05 05.04	02.11 02.11		24.3387-1707.7 24.3387-1708.7 24.0101-3803.2	220701 220702 260101			D=38, - Halter D=38, - Halter Bremsattel-Zubehör	TRW TRW TRW
	1.6 HDi 110 1.8 16V 1.8 16V 2.0 16V 2.0 16V 2.0 HDi 135 2.0 HDi 140 2.2 16V 2.2 16V 2.2 HDi 2.2 HDi 170 2.7 HDi 3.0 V6	80 85 92 100 103 100 103 116 120 120 125 150 155	ORGA 11710 ORGA 11710 ORGA 11710 ORGA 11710 ORGA 11710 ORGA 11710 ORGA 11710 ORGA 11710 ORGA 11710 ORGA 11710 ORGA 11710 ORGA 11710 ORGA 11710	05.04 05.04 09.05 05.04 09.05 05.04 08.08 05.04 09.05 06.08 05.06 10.05 05.04			24.5151-0583.3 24.5151-0584.3	331019 331020			L=584 L=584	
	1.6 HDi 110 1.8 16V 1.8 16V 2.0 16V 2.0 16V 2.0 Bioflex 2.0 HDi 2.0 HDi 2.0 HDi 135 2.0 HDi 140 2.2 16V 2.2 16V 2.2 HDi 2.2 HDi 170 2.7 HDi 3.0 V6	80 85 92 100 103 103 110 120 100 103 116 120 120 125 150 155	ORGA 11711 ORGA 11711 ORGA 11711 ORGA 11711 ORGA 11711 ORGA 11101 ORGA 11711 ORGA 11711 ORGA 11711 ORGA 11711 ORGA 11711 ORGA 11711 ORGA 11711 ORGA 11711 ORGA 11711 ORGA 11711	09.07 02.10 07.09	02.11 02.11 02.11 02.11 02.11 02.11 02.11 02.11 02.11 02.11 02.11 02.11 02.11 02.11 02.11 02.11		24.5151-0638.3 24.5151-0639.3	331141 331142			L=638 L=638	
	1.6 HDi 110 1.8 16V 1.8 16V 2.0 16V 2.0 16V 2.0 Bioflex 2.0 HDi 2.0 HDi 2.0 HDi 135 2.0 HDi 140 2.2 16V 2.2 16V 2.2 HDi 2.2 HDi 170 2.7 HDi 3.0 V6	80 85 92 100 103 103 110 120 100 103 116 120 120 125 150 155		05.04 05.04 09.05 05.04 09.05 02.10 07.09 05.04 08.08 05.04 09.05 06.08 05.06 10.05 05.04	02.11 02.11 02.11 02.11 02.11 02.11 02.11 02.11 02.11 02.11 02.11 02.11 02.11 02.11 02.11 02.11		24.3727-0844.2	580844	2		L=2155	

PEUGEOT 407 Coupe (05-11)

	2.0 HDi 135 2.2 16V 2.7 HDi 3.0 V6	100 120 150 155	ORGA 11192 ORGA 11283 ORGA 11073 ORGA 11192	07.07 10.05 10.05 10.05			03.7860-3402.4	300217			10"	ATE
	2.0 HDi 135 2.2 16V 2.7 HDi 3.0 V6	100 120 150 155	ORGA 11193 ORGA 11284 ORGA 11074 ORGA 11193		12.11 12.11		03.7860-5102.4	300218			10"	ATE
	2.0 HDi 2.0 HDi 2.0 HDi 135 3.0 HDi 3.0 V6	110 120 100 177 155	ORGA 12046 ORGA 12047 ORGA 12047	02.10 06.09 06.09	12.11 12.11 12.11 12.11 12.11		03.7860-8002.4	300258			10"	ATE
	2.0 HDi 2.0 HDi 135 2.2 16V 2.7 HDi 3.0 HDi 3.0 V6	120 100 120 150 177 155	ORGA 12347 ORGA 12347 ORGA 12347 ORGA 12347 ORGA 12347 ORGA 12347	06.09 07.07 10.05 10.05 06.09 10.05			03.2123-3123.3	010806			Thz 23,81	ATE
	2.0 HDi 135 2.2 16V 2.7 HDi 3.0 V6	100 120 150 155		07.07 10.05 10.05 10.05	12.11 12.11 12.11		24.3451-1719.7 24.3451-1720.7 24.0101-3802.2	220763 220764 260100			D=45/45, - Halter D=45/45, - Halter Bremsattel-Zubehör	TRW TRW TRW
	2.0 HDi 2.0 HDi	110 120		02.10 06.09	12.11 12.11		11.9601-9731.2 11.9601-9732.2 11.0101-5407.2 11.0441-6008.2 11.8116-0356.1	220853 220854 260011 250038 390586		2	D=60, - Halter D=60, - Halter Hülzensatz Dichtungssatz Haltefeder	ATE ATE ATE ATE ATE
	3.0 HDi 3.0 V6	177 155	ORGA 12411	06.09	12.11 12.11		11.9601-9883.2 11.9601-9884.2 11.0101-5407.2 11.0441-6008.2	220917 220918 260011 250038			D=60, - Halter D=60, - Halter Hülzensatz Dichtungssatz	ATE ATE ATE ATE
	2.2 16V 2.7 HDi 3.0 V6	120 150 155	ORGA 11125 ORGA 11125 ORGA 11125	10.05 10.05 10.05			24.5161-0315.3 24.5161-0316.3	331186 331187			L=310/275, + Rohrleitung L=310/275, + Rohrleitung	



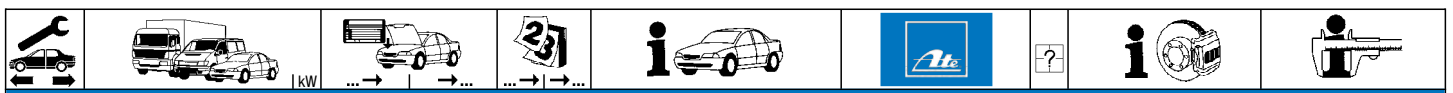

PEUGEOT 407 Coupe (05-11)

	2.0 HDi	110		02.10	02.11	24.5161-0314.3	331220			L=310/275, + Rohrleitung L=310/275, + Rohrleitung				
	2.0 HDi	120		06.09	12.11	24.5161-0313.3	331219							
	2.0 HDi 135	100		07.07	12.11									
	2.2 16V	120	ORGA 11126		12.11									
	2.7 HDi	150	ORGA 11126		12.11									
	3.0 V6	155	ORGA 11126		12.11									
	3.0 HDi	177		06.09	12.11	24.5161-0775.3	331412							
	3.0 V6	155	ORGA 12411		12.11	24.5161-0776.3	331413							
	2.0 HDi	110		02.10	12.11	24.3387-1707.7	220701						D=38, - Halter D=38, - Halter Bremsattel-Zubehör	TRW TRW TRW
	2.0 HDi	120		06.09	12.11	24.3387-1708.7	220702							
	2.0 HDi 135	100		07.07	12.11	24.0101-3803.2	260101							
	2.2 16V	120		10.05	12.11									
2.7 HDi	150		10.05	12.11										
3.0 HDi	177		06.09	12.11										
3.0 V6	155		10.05	12.11										
	2.0 HDi 135	100	ORGA 11710	07.07		24.5151-0583.3	331019			L=584 L=584				
	2.2 16V	120	ORGA 11710	10.05		24.5151-0584.3	331020							
	2.7 HDi	150	ORGA 11710	10.05										
	3.0 V6	155	ORGA 11710	10.05										
	2.0 HDi	110		02.10	12.11	24.5151-0638.3	331141			L=638 L=638				
	2.0 HDi	120		06.09	12.11	24.5151-0639.3	331142							
	2.0 HDi 135	100	ORGA 11711		12.11									
	2.2 16V	120	ORGA 11711		12.11									
	2.7 HDi	150	ORGA 11711		12.11									
	3.0 HDi	177		06.09	12.11									
	3.0 V6	155	ORGA 11711		12.11									
	2.0 HDi	110		02.10	12.11	24.3727-0844.2	580844						L=2155	
2.0 HDi	120		06.09	12.11										
2.0 HDi 135	100		07.07	12.11										
2.2 16V	120		10.05	12.11										
2.7 HDi	150		10.05	12.11										
3.0 HDi	177		06.09	12.11										
3.0 V6	155		10.05	12.11										

PEUGEOT 508 (10-)

	1.6 HDi	82		02.12		03.7860-7802.4	300280		+ DSC/ - Start/Stop-Anlage ¹⁾	10"	ATE
	1.6 HDi	82		11.10							
	1.6 THP	115		11.10		03.7860-7802.4	300280				
	1.6 VTi	110		11.10							
	2.0 HDi	120		11.10							
	2.0 HDi Hybrid4 AWC	120		11.10							
2.2 HDi	150		11.10								
	1.6 BlueHDi 120	88		03.14		03.2123-3641.3	010963		- DSC	THz 23,81	ATE
	1.6 HDi	82		02.12							
	1.6 HDi	82		11.10							
	1.6 THP	115		11.10							
	1.6 THP 150	110		11.10							
	1.6 THP 163			09.11							
	1.6 VTi			11.10							
	2.0 HDi			11.10							
	2.0 HDi	120		11.10							
	2.0 HDi 150	110		04.14							
	2.0 HDi 180	133		04.14							
	2.0 HDi Hybrid4	147		06.12							
	2.0 HDi Hybrid4 AWC	120		11.10							
	2.2 HDi	150		11.10							
	2.2 HDi	150		11.10		24.5161-0775.3	331412			L=775 L=775	
						24.5161-0776.3	331413				
	1.6 BlueHDi 120	88		03.14		11.9601-9883.2	220917		- Bremsattel lackiert ³⁾ - Bremsattel lackiert ³⁾	D=60, - Halter D=60, - Halter Hülzensatz Führungsbolzen Dichtungssatz	ATE ATE ATE ATE ATE
	1.6 HDi	82		02.12		11.9601-9884.2	220918				
	1.6 HDi	82		11.10		11.0101-5407.2	260011				
	1.6 THP	115		11.10		11.8171-0008.1	990049				
	1.6 THP 150	110		11.10		11.0441-6008.2	250038				
	1.6 THP 163			09.11							
	1.6 VTi			11.10							
	2.0 HDi			11.10							
	2.0 HDi	120		11.10							
	2.0 HDi 150	110		04.14							
2.0 HDi 180	133		04.14								
2.0 HDi Hybrid4	147		06.12								
2.0 HDi Hybrid4 AWC	120		11.10								
2.2 HDi	150		11.10								
	1.6 BlueHDi 120	88		03.14		11.9387-7089.2	220997			D=38, - Halter D=38, - Halter	ATE ATE
	1.6 HDi	82		02.12		11.9387-7090.2	220998				
	1.6 HDi	82		11.10							
	1.6 THP	115		11.10							
	1.6 THP 150	110		11.10							
	1.6 THP 163			09.11							
	1.6 VTi			11.10							
	2.0 HDi			11.10							
	2.0 HDi	120		11.10							
	2.0 HDi 150	110		04.14							
2.0 HDi 180	133		04.14								
2.0 HDi Hybrid4	147		06.12								

¹⁾ + DSC/ - start/stop system / + DSC/ - impianto start/stop / + DSC/ - unité marche/arrêt / + DSC/ - instalación de arranque/paro

²⁾ + br.disc diam. 340mm /+ br.disc thickness 30mm / + disco fr.diam. 340mm /+ disco fr.spessore 30mm / + disques fr.diam. 340mm /+ disques fr.épaisseur 30mm / + disco fr.diam. 340mm /+ disco fr.espesor 30mm

³⁾ - brake caliper, painted / - pinza freno, verniciata / - étrier de frein, verni / - pinza de freno, pintada

⁴⁾ - electric parking brake / - freno a mano eléctrico / - frein à main électrique / - freno de mano eléctrico

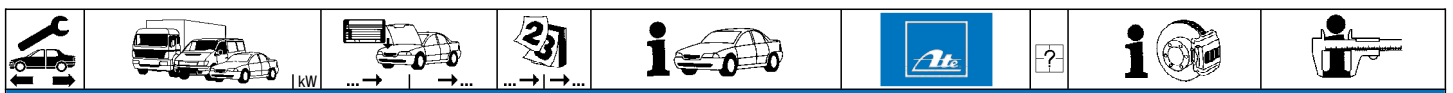

PEUGEOT 605 (90-99)

	3.0 V6	123		04.90	08.94	- ABS	24.2122-1703.3	010422			THz 22,20	
	2.0			04.90	12.99	+ ABS/ - ⊕	24.2122-1708.3	010437			THz 22,20	
	2.0 16V	97	ORGA 07692	09.94		+ ABS						
	2.0 16V	97	ORGA 07693									
	2.0 i	89		04.90	12.99	+ ABS						
	2.1 D	60		04.90	08.94	+ ABS						
	2.1 TD	80		10.90	12.99	+ ABS						
	2.0 Turbo	104		12.92	08.94	+ ABS	03.2123-0921.3	010174			THz 23,81 (MKIV)	ATE
	2.0 Turbo	108		09.94	12.99	+ ABS						
	2.5 TD	95		09.94	12.99	+ ABS						
	3.0 V6	123		04.90	12.99	+ ABS/ - ASR						
	3.0 V6	140		04.97	12.99							
	3.0 V6	147		04.90	12.99	+ ABS/ - ASR						
	3.0 V6	140		04.97	12.99		11.0441-5703.2	250145			Dichtungssatz	ATE
	3.0 V6	147	S 90807684		12.99		11.0101-5407.2	260011			Hülensatz	ATE
							11.8171-0008.1	990049			Führungsbolzen	ATE
							11.8116-0143.1	390513	2		Haltefeder	ATE
	2.0			04.90	12.99	- ⊕	24.5118-0520.3	330600	2		L=520	
	2.0 16V	97		09.94	12.99							
	2.0 i	89		04.90	12.99							
	2.0 Turbo	104		12.92	08.94							
	2.0 Turbo	108		09.94	12.99							
	2.1 D	60		04.90	08.94							
	2.1 TD	80		10.90	12.99							
	2.5 TD	95		09.94	12.99							
	3.0 V6	123		04.90	12.99							
	3.0 V6	140		04.97	12.99							
	3.0 V6	147	S 90807683	04.90	12.99							
	2.0			04.90	12.99	- ⊕	11.0441-3305.2	250006			Dichtungssatz	ATE
	2.0 16V	97		09.94	12.99							
	2.0 i	89		04.90	12.99							
	2.0 Turbo	104		12.92	08.94							
	2.0 Turbo	108		09.94	12.99							
	2.1 D	60		04.90	08.94							
	2.1 TD	80		10.90	12.99							
	2.5 TD	95		09.94	12.99							
	3.0 V6	123		04.90	12.99							
	3.0 V6	140		04.97	12.99							
	3.0 V6	147		04.90	12.99							
	2.0			04.90	12.99	- ⊕	24.5229-0181.3	330533	2	Länge beachten ¹⁾	L=180	
	2.0 16V	97		09.94	12.99		24.5111-0201.3	330498	2	Länge beachten ¹⁾	L=200	
	2.0 i	89		04.90	12.99							
	2.0 Turbo	104		12.92	08.94							
	2.0 Turbo	108		09.94	12.99							
	2.1 D	60		04.90	08.94							
	2.1 TD	80		10.90	12.99							
	2.5 TD	95		09.94	12.99							
	3.0 V6	123		04.90	12.99							
	3.0 V6	140		04.97	12.99							
	3.0 V6	147		04.90	12.99							
	2.0			04.90	12.99	- ⊕	03.6583-0031.3	320106			BRL 8/3 (4)	ATE
	2.0 16V	97		09.94	12.99							
	2.0 i	89		04.90	12.99							
	2.0 Turbo	104		12.92	08.94							
	2.0 Turbo	108		09.94	12.99							
	2.1 D	60		04.90	08.94							
	2.1 TD	80		10.90	12.99							
	2.5 TD	95		09.94	12.99							
	3.0 V6	123		04.90	12.99							
	3.0 V6	140		04.97	12.99							
	3.0 V6	147		04.90	12.99							

PEUGEOT 607 (00-10)

	2.0	100		02.00	11.04		24.3571-1727.7	220601			D=57, - Halter	TRW
	2.0 HDi	79		03.01	07.04							
	2.0 HDi	80		05.00	11.04							
	2.2 16V	116		02.00	11.04							
	2.2 HDi	98		02.00	11.04							
	2.0	100		12.04	12.10		24.3451-1719.7	220763			D=45/45, - Halter	TRW
	2.0 HDi	80		12.04	12.10		24.3451-1720.7	220764			D=45/45, - Halter	TRW
	2.0 HDi	100		09.05	12.10							
	2.2 16V	116		12.04	12.10							
	2.2 16V	120		09.05	12.10							
	2.2 HDi	98		12.04	12.10							
	2.2 HDi	125		05.06	12.10							
	2.7 HDi 24V	150		12.04	12.10							
	3.0 V6 24V	155		03.04	12.10							
	2.0	100		02.00	11.04		11.0441-3305.2	250006			Dichtungssatz	ATE
	2.0 HDi	79		03.01	07.04							
	2.0 HDi	80		05.00	11.04							
	2.2 16V	116		02.00	11.04							
	2.2 HDi	98		02.00	11.04							
	3.0 V6 24V	152		02.00	11.04							
	2.0	100		12.04	12.10		24.3387-1715.7	220755			D=38, - Halter	TRW
	2.0 HDi	80		12.04	12.10		24.3387-1716.7	220756			D=38, - Halter	TRW
	2.0 HDi	100		09.05	12.10							
	2.2 16V	116		12.04	12.10							

¹⁾ notice length / attenzione lunghezza / faire attention longueur / atención largo



PEUGEOT 607 (00-10)										
	2.2 16V 2.2 HDi 2.2 HDi 2.7 HDi 24V 3.0 V6 24V	120 98 125 150 155		09.05 12.04 05.06 12.04 03.04	12.10 12.10 12.10 12.10 12.10	24.3387-1715.7 24.3387-1716.7	220755 220756	<input type="checkbox"/> <input type="checkbox"/>	D=38, - Halter D=38, - Halter	TRW TRW
	2.0 2.0 HDi 2.0 HDi 2.2 16V 2.2 HDi 3.0 V6 24V	100 79 80 116 98 152		02.00 03.01 05.00 02.00 02.00 02.00	11.04 07.04 11.04 11.04 11.04 11.04	24.5111-0201.3	330498	2	L=200	
	2.0 2.0 HDi 2.0 HDi 2.2 16V 2.2 HDi 3.0 V6 24V	100 79 80 116 98 152		02.00 03.01 05.00 02.00 02.00 02.00	11.04 07.04 11.04 11.04 11.04 11.04	24.3727-0837.2 24.3727-0838.2	580837 580838	<input type="checkbox"/> <input type="checkbox"/>	L=724 L=713	
	2.0 2.0 HDi 2.0 HDi 2.2 16V 2.2 16V 2.2 HDi 2.2 HDi 2.7 HDi 24V 3.0 V6 24V	100 80 100 116 120 98 125 150 155		12.04 12.04 09.05 12.04 09.05 12.04 05.06 12.04 03.04	12.10 12.10 12.10 12.10 12.10 12.10 12.10 12.10 12.10	24.3727-0840.2 24.3727-0841.2	580840 580841	<input type="checkbox"/> <input type="checkbox"/>	L=815 L=794	

PEUGEOT 806 (94-02)										
	1.8 i	73	ORGA 08206	10.96		24.2122-1703.3 24.2122-1708.3	010422 010437	- ABS + ABS	THz 22,20 THz 22,20	
	1.8 i	73	ORGA 08207		06.02	24.2122-1741.3 24.2122-1742.3	010695 010696	- ABS + ABS	THz 22,20 THz 22,20	
	1.9 TD 2.0 16V 2.0 i 2.0 Turbo 2.1 TD		ORGA 08206 ORGA 08206 ORGA 08206 ORGA 08206 ORGA 08206	07.95 10.98 08.94 08.94 06.96		24.2123-1707.3	010492	- ABS	THz 23,81	
	1.9 TD 2.0 16V 2.0 HDi 2.0 i 2.0 Turbo 2.1 TD		ORGA 08207 ORGA 08207 ORGA 08207 ORGA 08207 ORGA 08207	06.02 06.02 08.99 06.02 06.02 06.02		24.2123-1738.3 24.2123-1733.3	010658 010657	- ABS + ABS	THz 23,81 THz 23,81	
	1.8 i	73		10.96	06.02	24.3571-1711.5 24.3571-1712.5	240159 240160	<input type="checkbox"/> <input type="checkbox"/>	D=57, - Halter D=57, - Halter	BDX BDX
	1.9 TD 2.0 16V 2.0 HDi 2.0 i 2.0 Turbo 2.1 TD			07.95 10.98 08.99 08.94 08.94 06.96	06.02 06.02 06.02 06.02 06.02 06.02	24.3571-1709.5 24.3571-1710.5	240153 240154	<input type="checkbox"/> <input type="checkbox"/> <input type="checkbox"/>	D=57, - Halter D=57, - Halter D=57, - Halter	TRW TRW
	1.8 i 1.9 TD 2.0 16V 2.0 HDi 2.0 i 2.0 Turbo 2.1 TD	73 80 89 108 80		10.96 07.95 10.98 08.99 08.94 08.94 06.96	06.02 06.02 06.02 06.02 06.02 06.02	24.5118-0471.3	330528	2	L=473	
	1.8 i 1.9 TD 2.0 16V 2.0 HDi 2.0 i 2.0 Turbo 2.1 TD	73 80 89 108 80		10.96 07.95 10.98 08.99 08.94 08.94 06.96	06.02 + ABS 06.02 + ABS 06.02 06.02 + ABS 06.02 + ABS 06.02	11.3361-9975.2 11.3361-9976.2 11.0441-3602.2 11.0101-5407.2 11.8116-0073.1 24.3361-9975.5 24.3361-9976.5	220281 220282 250008 260011 390498 240541 240542	<input type="checkbox"/> <input type="checkbox"/> <input type="checkbox"/> <input type="checkbox"/> <input type="checkbox"/> <input type="checkbox"/> <input type="checkbox"/>	D=36, - Halter D=36, - Halter Dichtungssatz Hülssensatz Haltefeder D=36, - Halter D=36, - Halter	ATE ATE ATE ATE ATE ATE ATE
	1.8 i 1.9 TD 2.0 HDi 2.0 i	73 80 89		10.96 07.95 08.99 08.94	06.02 + HA-Trommelbremse 1) 06.02 + HA-Trommelbremse 1) 06.02 + HA-Trommelbremse 1) 06.02 + HA-Trommelbremse 1)	24.5229-0251.3	330535	2	L=250	
	1.8 i 1.9 TD 2.0 16V 2.0 HDi 2.0 i 2.0 Turbo 2.1 TD	73 80 89 108 80		10.96 07.95 10.98 08.99 08.94 08.94 06.96	06.02 + HA-Scheibenbremse 2) 06.02 + HA-Scheibenbremse 2) 06.02 06.02 + HA-Scheibenbremse 2) 06.02 + HA-Scheibenbremse 2) 06.02	24.5229-0251.3 24.5111-0301.3	330535 330499	2 2	Länge beachten 3) Länge beachten 3)	L=250 L=300
	1.8 i 1.9 TD 2.0 HDi 2.0 i	73 80 89		10.96 07.95 08.99 08.94	06.02 - ABS 06.02 - ABS 06.02 - ABS 06.02 - ABS	24.3219-1704.3	020374		Rz 19,05	
	1.8 i 1.9 TD 2.0 HDi 2.0 i	73 80 89		10.96 07.95 08.99 08.94	06.02 + HA-Trommelbremse 1) 06.02 + HA-Trommelbremse 1) 06.02 + HA-Trommelbremse 1) 06.02 + HA-Trommelbremse 1)	24.3727-0532.2 24.3727-0531.2	580532 580531	<input type="checkbox"/> <input type="checkbox"/>	L=1063 L=2286	
	1.8 i	73		10.96	06.02 + HA-Trommelbremse 1)	24.3727-0532.2	580532	<input type="checkbox"/>	L=1063	

1) + RA drum brake / + P freno a tamburo / + frein à tambour essieu AR / + ET-tambores de freno
 2) + RA disc brake / + P disco freno / + frein à disque essieu AR / + ET-disco de freno
 3) notice length / attenzione lunghezza / faire attention longueur / atención largo









PEUGEOT 806 (94-02)























	1.9 TD			07.95	06.02	+ HA-Trommelbremse ¹⁾	24.3727-0532.2	580532	<input type="checkbox"/>		L=1063
	2.0 HDi	▶ 80		08.99	06.02	+ HA-Trommelbremse ¹⁾					
	2.0 i	▶ 89		08.94	06.02	+ HA-Trommelbremse ¹⁾					
	1.8 i	◀ 73		10.96	06.02	+ HA-Scheibenbremse ²⁾	24.3727-0336.2	580336	1		L=500
	1.9 TD	◀		07.95	06.02	+ HA-Scheibenbremse ²⁾	24.3727-0530.2	580530	<input type="checkbox"/>		L=1255
	2.0 16V	◀		10.98	06.02		24.3727-0529.2	580529	<input type="checkbox"/>		L=2205
	2.0 HDi	◀ 80		08.99	06.02	+ HA-Scheibenbremse ²⁾					
	2.0 i	◀ 89		08.94	06.02	+ HA-Scheibenbremse ²⁾					
	2.0 Turbo	◀108		08.94	06.02						
	2.1 TD	◀ 80		06.96	06.02						
	1.8 i	◀ 73		10.96	06.02		24.3728-0341.2	590341			L=739, + AUT
	2.0 i	◀ 89		08.94	06.02						
	1.9 TD	◀		07.95	06.02	+ ME-Getriebe ³⁾	24.3728-0342.2	590342			L=864, + AUT
2.0 Turbo	◀108		08.94	06.02	+ ME-Getriebe ³⁾						
2.0 16V	◀		10.98	06.02		24.3728-0336.2	590336			L=973, + AUT	
1.9 TD	◀		07.95	06.02	+ ML5-Getriebe ⁴⁾	24.3728-0340.2	590340			L=1088, + AUT	
2.0 Turbo	◀108		08.94	06.02	+ ML5-Getriebe ⁴⁾						
2.1 TD	◀ 80		06.96	06.02	+ ML5-Getriebe ⁴⁾						

PEUGEOT 807 (02-14)

	2.0 16V	◀100 ORGA 10528			06.14		03.7860-2002.4	300216			10"	ATE
	2.0 16V	◀103 ORGA 10528	ORGA 10919									
	2.0 HDi	◀ 79 ORGA 10528	ORGA 10919									
	2.0 HDi	◀ 80 ORGA 10528	ORGA 10919									
	2.0 HDi	◀ 88 ORGA 10528	ORGA 10919									
	2.0 HDi	◀100 ORGA 10528			06.14							
	2.2 16V	◀116 ORGA 10528			06.14							
	2.2 HDi	◀ 94 ORGA 10528	ORGA 10919									
	2.2 HDi	◀100 ORGA 10528	ORGA 10919									
	2.0 16V	◀103 ORGA 10920			06.14		03.7860-4302.4	300231			10"	ATE
2.0 HDi	◀ 79 ORGA 10920			06.14								
2.0 HDi	◀ 80 ORGA 10920			05.06								
2.0 HDi	◀ 88 ORGA 10920			06.14								
2.2 HDi	◀ 94 ORGA 10920			06.14								
2.2 HDi	◀100 ORGA 10920			06.14								
2.0 HDi	◀120			06.09	06.14		03.7870-1602.4	300311			11"	ATE
	2.0 16V	100 ORGA 10528			06.14		03.2122-2163.3	010800			THz 22,20	ATE
	2.0 16V	103		09.05	06.14							
	2.0 HDi	79 ORGA 10528			06.14							
	2.0 HDi	80 ORGA 10528			05.06							
	2.0 HDi	88 ORGA 10528			06.14							
	2.0 HDi	100		06.06	06.14							
	2.2 16V	116 ORGA 10528			06.14							
	2.2 HDi	94 ORGA 10528			06.14							
	2.2 HDi	100 ORGA 10528			06.14							
	2.0 HDi	120		06.09	06.14		03.2123-3421.3	010933			THz 23,81	ATE
2.2 HDi			10.07	06.14								
	2.0 16V	100		06.02	06.14		24.3601-1711.7	220607	<input type="checkbox"/>		D=60, - Halter	TRW
	2.0 16V	103		09.05	06.14		24.3601-1712.7	220608	<input type="checkbox"/>		D=60, - Halter	TRW
	2.0 HDi	79		06.02	06.14							
	2.0 HDi	80		04.04	05.06							
	2.0 HDi	88		11.06	06.14							
	2.0 HDi	100		06.06	06.14							
	2.2 16V	116		06.02	06.14							
	2.2 HDi	94		06.02	06.14							
	2.2 HDi	100		04.04	06.14							
	2.0 HDi	120		06.09	06.14		24.3451-1855.5	240659	<input type="checkbox"/>		D=40/45, - Halter	TRW
2.2 HDi			10.07	06.14		24.3451-1856.5	240660	<input type="checkbox"/>		D=40/45, - Halter	TRW	
	2.0 16V	100		06.02	06.14		24.5111-0462.3	330555	2		L=460	
	2.0 16V	103		09.05	06.14							
	2.0 HDi	79		06.02	06.14							
	2.0 HDi	80		04.04	05.06							
	2.0 HDi	88		11.06	06.14							
	2.0 HDi	100		06.06	06.14							
	2.2 16V	116		06.02	06.14							
	2.2 HDi	94		06.02	06.14							
	2.2 HDi	100		04.04	06.14							
	2.0 HDi	120		06.09	06.14		24.5144-0500.3	331169	2		L=500	
2.2 HDi			10.07	06.14								
	2.0 16V	100		06.02	06.14		24.3384-1761.7	220671	<input type="checkbox"/>		D=38, - Halter	TRW
	2.0 16V	103		09.05	06.14		24.3384-1762.7	220672	<input type="checkbox"/>		D=38, - Halter	TRW
	2.0 HDi	79		06.02	06.14							
	2.0 HDi	80		04.04	05.06							
	2.0 HDi	88		11.06	06.14							
	2.0 HDi	100		06.06	06.14							
	2.0 HDi	120		06.09	06.14							
	2.2 16V	116		06.02	06.14							
	2.2 HDi	94		10.07	06.14							
	2.2 HDi	100		06.02	06.14							
2.2 HDi	100		04.04	06.14								
3.0 V6	150		06.02	06.14								

1) + RA drum brake / + P freno a tamburo / + frein à tambour essieu AR / + ET-tambores de freno
 2) + RA disc brake / + P disco freno / + frein à disque essieu AR / + ET-disco de freno
 3) + ME transmission / + scatola cambio ME / + boîte de vitesse ME / + cambio ME
 4) + ML5 transmission / + scatola cambio ML5 / + boîte de vitesse ML5 / + cambio ML5

PEUGEOT 807 (02-14)											
	2.0 16V	100		06.02	06.14	24.5229-0251.3	330535	2		L=250	
	2.0 16V	103		09.05	06.14						
	2.0 HDi	79		06.02	06.14						
	2.0 HDi	80		04.04	05.06						
	2.0 HDi	88		11.06	06.14						
	2.0 HDi	100		06.06	06.14						
	2.0 HDi	120		06.09	06.14						
	2.2 16V	116		06.02	06.14						
	2.2 HDi			10.07	06.14						
	2.2 HDi	94		06.02	06.14						
	2.2 HDi	100		04.04	06.14						
	3.0 V6	150		06.02	06.14						
	2.0 16V	◀100	ORGA 10284	06.02		24.3727-0847.2	580847	<input type="checkbox"/>		L=1068	
	2.0 16V	◀103	ORGA 10284	09.05		24.3727-0848.2	580848	<input type="checkbox"/>		L=2360	
	2.0 HDi	◀79	ORGA 10284	06.02							
	2.0 HDi	◀80	ORGA 10284	05.06							
	2.0 HDi	◀88	ORGA 10284	11.06							
	2.0 HDi	◀100	ORGA 10284	06.06							
	2.2 16V	◀116	ORGA 10284	06.02							
	2.2 HDi	◀	ORGA 10284	10.07							
	2.2 HDi	◀94	ORGA 10284	06.02							
	2.2 HDi	◀100	ORGA 10284	04.04							
	3.0 V6	◀150	ORGA 10284	06.02							
	2.0 16V	◀100 ORGA 10285			06.14	24.3727-0850.2	580850	<input type="checkbox"/>		L=1041	
	2.0 16V	◀103 ORGA 10285			06.14	24.3727-0849.2	580849	<input type="checkbox"/>		L=2308	
	2.0 HDi	◀79 ORGA 10285			06.14						
	2.0 HDi	◀80 ORGA 10285			05.06						
	2.0 HDi	◀88 ORGA 10285			06.14						
	2.0 HDi	◀100 ORGA 10285			06.14						
	2.0 HDi	◀120		06.09	01.14						
	2.2 16V	◀116 ORGA 10285			06.14						
	2.2 HDi	◀ ORGA 10285			06.14						
	2.2 HDi	◀94 ORGA 10285			06.14						
	2.2 HDi	◀100 ORGA 10285			06.14						
	3.0 V6	◀150 ORGA 10285			06.14						
	2.0 16V	▶100	ORGA 10284	06.02		24.3727-0848.2	580848	<input type="checkbox"/>		L=2360	
	2.0 16V	▶103	ORGA 10284	09.05		24.3727-0847.2	580847	<input type="checkbox"/>		L=1068	
	2.0 HDi	▶79	ORGA 10284	06.02							
	2.0 HDi	▶80	ORGA 10284	04.04							
	2.0 HDi	▶88	ORGA 10284	11.06							
	2.0 HDi	▶100	ORGA 10284	06.06							
	2.2 16V	▶116	ORGA 10284	06.02							
	2.2 HDi	▶	ORGA 10284	10.07							
	2.2 HDi	▶94	ORGA 10284	06.02							
	2.2 HDi	▶100	ORGA 10284	04.04							
	3.0 V6	▶150	ORGA 10284	06.02							
	2.0 16V	▶100 ORGA 10285			06.14	24.3727-0849.2	580849	<input type="checkbox"/>		L=2308	
	2.0 16V	▶103 ORGA 10285			06.14	24.3727-0850.2	580850	<input type="checkbox"/>		L=1041	
	2.0 HDi	▶79 ORGA 10285			06.14						
	2.0 HDi	▶80 ORGA 10285			05.06						
	2.0 HDi	▶88 ORGA 10285			06.14						
	2.0 HDi	▶100 ORGA 10285			06.14						
	2.0 HDi	▶120		06.09	06.14						
	2.2 16V	▶116 ORGA 10285			06.14						
	2.2 HDi	▶ ORGA 10285			06.14						
	2.2 HDi	▶94 ORGA 10285			06.14						
	2.2 HDi	▶100 ORGA 10285			06.14						
	3.0 V6	▶150 ORGA 10285			06.14						
PEUGEOT 1007 (05-11)											
	1.4	54	ORGA 11009	04.05		24.2122-1764.3	010851		- DSC	Thz 22,20	BOS
	1.4 16V	65	ORGA 11009	10.05		24.2122-1766.3	010840		- DSC	Thz 22,20	TRW
	1.4 HDi	50	ORGA 11009	04.05		24.2122-1767.3	010841		+ DSC	Thz 22,20	TRW
	1.6 16V	80	ORGA 11009	04.05							
	1.4	54	ORGA 11010		02.11	24.4122-1704.3	010847		- DSC	Thz 22,20	TRW
	1.4 16V	65	ORGA 11010		02.11	24.4122-1703.3	010843		+ DSC	Thz 22,20	TRW
	1.4 HDi	50	ORGA 11010		02.11						
	1.6 16V	80	ORGA 11010		02.11						
	1.6 HDi 110	80		04.07	02.11						
	1.4	54		04.05	02.11	24.3541-1771.5	240239	<input type="checkbox"/>		D=54, - Halter	BOS
	1.4 16V	65		10.05	02.11	24.3541-1772.5	240240	<input type="checkbox"/>		D=54, - Halter	BOS
	1.4 HDi	50		04.05	02.11						
	1.6 16V	80		04.05	02.11						
	1.6 HDi 110	80		04.07	02.11						
	1.4	54		04.05	02.11	24.3541-1761.5	240233	<input type="checkbox"/>		D=54, - Halter	BOS
	1.4 16V	65		10.05	02.11	24.3541-1762.5	240234	<input type="checkbox"/>		D=54, - Halter	BOS
	1.4 HDi	50		04.05	02.11						
	1.6 16V	80		04.05	02.11						
	1.6 HDi 110	80		04.07	02.11						
	1.4	54		04.05	02.11	24.5111-0446.3	331055	2			L=445
	1.4 16V	65		10.05	02.11						
	1.4 HDi	50		04.05	02.11						
	1.6 16V	80		04.05	02.11						
	1.6 HDi 110	80		04.07	02.11						
	1.6 16V	80		04.05	02.11	24.5111-0460.3	330603	2			L=460
	1.6 HDi 110	80		04.07	02.11	24.3387-1705.7	220675	<input type="checkbox"/>		D=38, - Halter	TRW
	1.6 HDi 110	80		04.07	02.11	24.3387-1706.7	220676	<input type="checkbox"/>		D=38, - Halter	TRW

										
PEUGEOT 1007 (05-11)										
	1.4 1.4 16V 1.4 HDi 1.6 16V	54 65 50 80	ORGA 10583 ORGA 10583 ORGA 10583 ORGA 10583	04.05 10.05 04.05 04.05		24.5246-0185.3	330881	2	L=185	
	1.4 1.4 16V 1.4 HDi 1.6 16V 1.6 HDi 110	54 65 50 80 80	ORGA 10584 ORGA 10584 ORGA 10584 ORGA 10584	02.11 02.11 02.11 02.11 04.07 02.11		24.5246-0190.3	330697	2	L=190	
	1.4 1.4 16V 1.4 HDi	54 65 50		04.05 02.11 10.05 02.11 04.05 02.11		24.3220-1724.3 24.3220-1717.3	020476 020430	+ ALU ¹⁾	Rz 20,64 Rz 20,64	BOS TRW
	1.4 1.4 16V 1.4 HDi	54 65 50		04.05 02.11 10.05 02.11 04.05 02.11		24.3727-0843.2	580843	2 ↓	L=1612	
PEUGEOT 2008 (13-)										
	1.2 THP 110 1.2 THP 130 1.2 VTi 82 1.4 HDi 68 1.6 BlueHDi 100 1.6 BlueHDi 120 1.6 BlueHDi 75 1.6 e-HDi 115 1.6 e-HDi 92 1.6 HDi 115 1.6 VTi 120	81 96 60 50 73 88 55 84 68 85 88	ORGA 13384	01.15 01.15 03.13 01.15 07.14 01.15 03.13 03.13 07.14 03.13		24.4123-1704.3	010828		THz 23,81	TRW
	1.2 THP 110 1.2 THP 130 1.2 VTi 82 1.4 HDi 68 1.6 BlueHDi 100 1.6 BlueHDi 120 1.6 BlueHDi 75 1.6 e-HDi 115 1.6 e-HDi 92 1.6 HDi 115 1.6 VTi 120	81 96 60 50 73 88 55 84 68 85 88		01.15 01.15 03.13 03.13 01.15 07.14 01.15 03.13 03.13 07.14 03.13	+ Bremsscheibendurchm. 266 mm ²⁾ + Bremsscheibendurchm. 266 mm ²⁾ + Bremsscheibendurchm. 266 mm ²⁾ + Bremsscheibendurchm. 266 mm ²⁾ + Bremsscheibendurchm. 266 mm ²⁾ + Bremsscheibendurchm. 266 mm ²⁾ + Bremsscheibendurchm. 266 mm ²⁾ + Bremsscheibendurchm. 266 mm ²⁾ + Bremsscheibendurchm. 266 mm ²⁾ + Bremsscheibendurchm. 266 mm ²⁾ + Bremsscheibendurchm. 266 mm ²⁾	24.3541-1771.5 24.3541-1772.5	240239 240240	 	D=54, - Halter D=54, - Halter	BOS BOS
	1.2 THP 110 1.2 THP 130 1.2 VTi 82 1.4 HDi 68 1.6 BlueHDi 100 1.6 BlueHDi 120 1.6 BlueHDi 75 1.6 e-HDi 115 1.6 e-HDi 92 1.6 HDi 115 1.6 VTi 120	81 96 60 50 73 88 55 84 68 85 88		01.15 01.15 03.13 03.13 01.15 07.14 01.15 03.13 03.13 07.14 03.13		24.5111-0496.3	331371	2	L=495	
	1.2 THP 110 1.2 THP 130 1.2 VTi 82 1.4 HDi 68 1.6 BlueHDi 100 1.6 BlueHDi 120 1.6 BlueHDi 75 1.6 e-HDi 115 1.6 e-HDi 92 1.6 HDi 115 1.6 VTi 120	81 96 60 50 73 88 55 84 68 85 88		01.15 01.15 03.13 03.13 01.15 07.14 01.15 03.13 03.13 07.14 03.13		24.3387-1733.5 24.3387-1734.5	240655 240656	 	D=38, - Halter D=38, - Halter	TRW TRW
	1.2 THP 110 1.2 THP 130 1.2 VTi 82 1.4 HDi 68 1.6 BlueHDi 100 1.6 BlueHDi 120 1.6 BlueHDi 75 1.6 e-HDi 115 1.6 e-HDi 92 1.6 HDi 115 1.6 VTi 120	81 96 60 50 73 88 55 84 68 85 88		01.15 01.15 03.13 03.13 01.15 07.14 01.15 03.13 03.13 07.14 03.13		24.5239-0190.3	330966	2	L=190	
	1.2 THP 110 1.2 THP 130 1.2 VTi 82 1.4 HDi 68 1.6 BlueHDi 100 1.6 BlueHDi 120 1.6 BlueHDi 75 1.6 e-HDi 115 1.6 e-HDi 92 1.6 HDi 115 1.6 VTi 120	▶ 81 ▶ 96 ▶ 60 ▶ 50 ▶ 73 ▶ 88 ▶ 55 ▶ 84 ▶ 68 ▶ 85 ▶ 88		01.15 01.15 03.13 03.13 01.15 07.14 01.15 03.13 03.13 07.14 03.13		24.2415-1714.3	030134	+ BVM MA-Getriebe ³⁾	Gz 15,87	
	1.2 THP 110 1.2 THP 130 1.2 VTi 82	▶ 81 ▶ 96 ▶ 60		01.15 01.15 03.13	+ BE4R-Getriebe ⁴⁾ + BE4R-Getriebe ⁴⁾ + BE4R-Getriebe ⁴⁾	24.2415-1714.3	030134	- Start/Stop-Anlage ⁵⁾	Gz 15,87	

1) + aluminium / + alluminio / + aluminium / + aluminio
2) + brake disc diameter 266 mm / + disco fr.diam. 266mm / + disques fr.diam. 266mm / + disco fr.diam. 266mm
3) + BVM MA transmission / + scatola cambio BVM MA / + boîte de vitesse BVM MA / + cambio BVM MA
4) + BE4R transmission / + scatola cambio BE4R / + boîte de vitesse BE4R / + cambio BE4R
5) - idling stop system / - dispositivo start/stop / - unité marche/arrêt / - unidad arranque/paro



PEUGEOT 2008 (13-)										
	1.4 HDi 68	▶ 50		03.13	+ BE4R-Getriebe ¹⁾	24.2415-1714.3	030134		- Start/Stop-Anlage ²⁾	Gz 15,87
	1.6 BlueHDi 100	▶ 73		01.15	+ BE4R-Getriebe ¹⁾					
	1.6 BlueHDi 120	▶ 88		07.14	+ BE4R-Getriebe ¹⁾					
	1.6 BlueHDi 75	▶ 55		01.15	+ BE4R-Getriebe ¹⁾					
	1.6 e-HDi 115	▶ 84		03.13	+ BE4R-Getriebe ¹⁾					
	1.6 e-HDi 92	▶ 68		03.13	+ BE4R-Getriebe ¹⁾					
	1.6 HDi 115	▶ 85		07.14	+ BE4R-Getriebe ¹⁾					
1.6 VTi 120	▶ 88		03.13	+ BE4R-Getriebe ¹⁾						
	1.2 THP 110	81		01.15		24.2518-1702.3	040099		+ BVM MA-Getriebe ³⁾	Nz 18,90
	1.2 THP 130	96		01.15						
	1.2 VTi 82	60		03.13						
	1.4 HDi 68	50		03.13						
	1.6 BlueHDi 100	73		01.15						
	1.6 BlueHDi 75	55		01.15						
	1.6 e-HDi 115	84		03.13						
1.6 e-HDi 92	68		03.13							
1.6 VTi 120	88		03.13							
	1.2 THP 110	81		01.15	+ BE4R-Getriebe ¹⁾	24.2518-1703.3	040101		- Start/Stop-Anlage ²⁾	Nz 18,90
	1.2 THP 130	96		01.15	+ BE4R-Getriebe ¹⁾					
	1.2 VTi 82	60		03.13	+ BE4R-Getriebe ¹⁾					
	1.4 HDi 68	50		03.13	+ BE4R-Getriebe ¹⁾					
	1.6 BlueHDi 100	73		01.15	+ BE4R-Getriebe ¹⁾					
	1.6 BlueHDi 75	55		01.15	+ BE4R-Getriebe ¹⁾					
	1.6 e-HDi 115	84		03.13	+ BE4R-Getriebe ¹⁾					
1.6 e-HDi 92	68		03.13	+ BE4R-Getriebe ¹⁾						
1.6 VTi 120	88		03.13	+ BE4R-Getriebe ¹⁾						

PEUGEOT 3008 (09-)													
	1.2	96		01.15		03.7860-3732.4	300306			10"	ATE		
	1.6 HDi	80	ORGA 12620	06.09									
	1.6 HDi	82		08.10									
	1.6 HDi 120	88		05.14									
	1.6 THP			06.09									
	1.6 VTi	88		06.09									
	2.0 HDi			06.09									
	2.0 HDi	100		09.11									
	1.6 HDi	82		ORGA 12621									03.7860-3732.4
1.6 HDi 115	84			11.12									
	1.2	96		01.15		03.4153-0173.3	010815			Thz 23,81	ATE		
	1.6 HDi	80		06.09									
	1.6 HDi	82		08.10									
	1.6 HDi 115	84		11.12									
	1.6 HDi 120	88		05.14									
	1.6 THP			06.09									
	1.6 THP 16V 163	121		05.14									
	1.6 VTi	88		06.09									
	2.0 HDi			06.09									
2.0 HDi	100		09.11										
	1.6 THP			06.09		11.9571-9939.2	220923	2		D=57, - Halter	ATE		
	1.6 THP 16V 163	121		05.14								11.9571-9940.2	220924
	2.0 HDi			06.09								11.0101-5704.2	260095
	2.0 HDi	100		09.11								11.8116-0356.1	390586
												11.8171-0008.1	990049
	2.0 HDi Hybrid4			02.11		11.9601-9717.2	220901	2		D=60, - Halter	ATE		
												11.9601-9718.2	220902
												11.8171-0008.1	990049
												11.0101-5704.2	260095
												11.0441-6008.2	250038
												11.8116-0356.1	390586
	1.2	96		01.15		24.5246-0190.3	330697	2		L=190			
	1.6 HDi	80		06.09									
	1.6 HDi	82		08.10									
	1.6 HDi 115	84		11.12									
	1.6 HDi 120	88		05.14									
	1.6 THP			06.09									
	1.6 THP 16V 163	121		05.14									
	1.6 VTi	88		06.09									
	2.0 HDi			06.09									
2.0 HDi	100		09.11										

PEUGEOT 4007 (07-12)													
	2.0	108		11.10	11.12	24.3431-1701.5	240437	2		D=43/43, - Halter			
	2.0 4x4	108		11.10	11.12							24.3431-1702.5	240438
	2.2 HDi 4x4	115		02.07	11.12								
	2.4 16V 4x4	125		07.07	11.12								
	2.0	108		11.10	11.12	24.5286-0600.3	331173	2		L=600			
	2.0 4x4	108		11.10	11.12							24.5286-0601.3	331174
	2.2 HDi 4x4	115		02.07	11.12								
	2.4 16V 4x4	125		07.07	11.12								
	2.2 HDi 4x4	115	ORGA 12718	02.07		24.5112-0280.3	331200	2		L=280			
	2.4 16V 4x4	125	ORGA 12718	07.07								24.5247-0275.3	331244
												24.5247-0276.3	331245
	2.2 HDi 4x4	115	ORGA 12719	11.12		24.5247-0275.3	331244	2		L=275			
	2.4 16V 4x4	125	ORGA 12719	11.12								24.5247-0276.3	331245

¹⁾ + BE4R transmission / + scatola cambio BE4R / + boîte de vitesse BE4R / + cambio BE4R
²⁾ - idling stop system / - dispositivo start/stop / - unité marche/arrêt / - unidad arranque/paño
³⁾ + BVM MA transmission / + scatola cambio BVM MA / + boîte de vitesse BVM MA / + cambio BVM MA
⁴⁾ on the brake caliper / sulla pinza freno / sur l'étrier de frein / a la pinza de freno



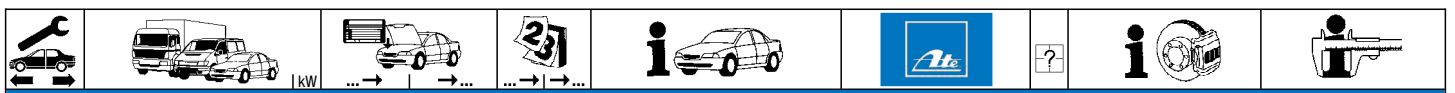

PEUGEOT 5008 (09-)

	1.2	96	ORGA 12655	01.15	03.7860-3732.4	300306		10"	ATE						
	1.6 16V	88		09.09											
	1.6 16V	115		09.09											
	1.6 HDi	80		09.09											
	1.6 HDi	82		08.10											
	1.6 THP 150	110		02.12											
	1.6 THP 163	120		02.12											
	2.0 HDi	100		02.12											
	2.0 HDi	110		09.09											
	2.0 HDi	120		09.09											
	1.6 HDi	82	ORGA 12656		03.7860-3732.4	300306	- Start/Stop-Anlage 1)	10"	ATE						
	1.6 HDi 115	84		11.12											
	1.6 HDi 120	88		05.14											
	1.2	96		01.15	03.4153-0173.3	010815		THz 23,81	ATE						
	1.6 16V	88		09.09											
	1.6 16V	115		09.09											
	1.6 HDi	80		09.09											
	1.6 HDi	82		08.10											
	1.6 HDi 115	84		11.12											
	2.0 HDi	100		02.12											
	2.0 HDi	110		09.09											
	2.0 HDi	110		09.09											
	2.0 HDi	120		09.09											
	1.6 16V	88		09.09	11.9601-9717.2	220901	☐	D=60, - Halter	ATE						
	1.6 HDi	80		09.09						11.9601-9718.2	220902	☐	D=60, - Halter	ATE	
	1.6 HDi	82		08.10						11.0441-6008.2	250038		Dichtungssatz	ATE	
	1.6 HDi 115	84		11.12						11.8171-0008.1	990049		Führungsbolzen	ATE	
										11.8116-0356.1	390586	2	Haltefeder	ATE	
										11.0101-5704.2	260095		Hülzensatz	ATE	
	1.2	96								01.15	11.9601-9717.2	220901	☐	D=60, - Halter	ATE
	1.6 16V	115								09.09	11.9601-9718.2	220902	☐	D=60, - Halter	ATE
	1.6 HDi 120	88								05.14	11.0441-6008.2	250038		Dichtungssatz	ATE
	1.6 THP 150	110								02.12	11.8171-0008.1	990049		Führungsbolzen	ATE
1.6 THP 163	120		02.12	11.8116-0356.1	390586	2	Haltefeder	ATE							
2.0 HDi	100		02.12	11.0101-5704.2	260095		Hülzensatz	ATE							
2.0 HDi	110		09.09												
2.0 HDi	120		09.09												
	1.2	96		01.15	24.5246-0216.3	331022	2	L=216							
	1.6 16V	88		09.09											
	1.6 16V	115		09.09											
	1.6 HDi	80		09.09											
	1.6 HDi	82		08.10											
	1.6 HDi 115	84		11.12											
	1.6 HDi 120	88		05.14											
	1.6 THP 150	110		02.12											
	1.6 THP 163	120		02.12											
	2.0 HDi	100		02.12											
2.0 HDi	110	09.09													
2.0 HDi	120	09.09													

PEUGEOT BIPPER (08-15)

	1.3 HDi 75	55		10.10	24.3541-1769.5	240601	☐	D=54, - Halter	BOS					
	1.4 HDi	50		02.08						24.3541-1770.5	240602	☐	D=54, - Halter	BOS
	1.4 i	54		02.08										
	1.3 HDi 75	55		10.10	24.5112-0402.3	331297	2	L=402						
	1.4 HDi	50		02.08										
	1.4 i	54		02.08										
	1.3 HDi 75	55		10.10	24.5228-0181.3	331279	2	L=180						
	1.4 HDi	50		02.08										
	1.4 i	54		02.08										
	1.3 HDi 75	55		10.10	24.3220-1728.3	020509		Rz 20,64						
	1.4 HDi	50		02.08										
	1.4 i	54		02.08										

PEUGEOT BOXER Bus (94-02)

	1.9 D (10)	◀ 51	S 15064995	02.94	24.2122-1715.3	010481		THz 22,20						
	1.9 TD (10/14)	◀ 66	S 15064995	08.94						- ABS				
	1.9 TD (10/14)	◀ 68	S 15064995	02.94						- ABS				
	2.0 i (10/14)	◀ 80	S 15064995	02.94						- ABS				
	2.5 D (14)	◀ 63	S 15064995	08.94						- ABS				
	2.5 TD (14)	◀ 76	S 15064995	08.94						- ABS				
	2.8 D (14)	◀ 64	S 15064995	01.99						- ABS				
	2.8 HDi 4X4 (10/14)	◀	S 15064995	10.00						- ABS				
	1.9 D (10)	◀ 51	S 15064996	S 16205754						- ABS	24.2125-1703.3	010483	THz 25,40	
	1.9 TD (10/14)	◀ 66	S 15064996	S 16205754						- ABS				
1.9 TD (10/14)	◀ 68	S 15064996	S 16205754	- ABS										
2.0 i (10/14)	◀ 80	S 15064996	S 16205754	- ABS										
2.0 i (18)	◀ 80	S 16205352	02.94	- ABS										
2.5 D (14)	◀ 63	S 15064996	S 16205754	- ABS										
2.5 D (18)	◀ 63	S 16205352	08.94	- ABS										
2.5 TD (14)	◀ 76	S 15064996	S 16205754	- ABS										
2.5 TD (18)	◀ 76	S 16205352	08.94	- ABS										
2.5 TDi (14)	◀ 79	S 15064996	S 16205754	- ABS										
2.5 TDi (18)	◀ 79	S 16205352	01.97	- ABS										
2.8 D (14)	◀ 64	S 15064996	S 16205754	- ABS										
2.8 D (18)	◀ 64	S 16205352	01.99	- ABS										
2.8 HDi (14)	◀ 94	S 16205754	11.00	- ABS										



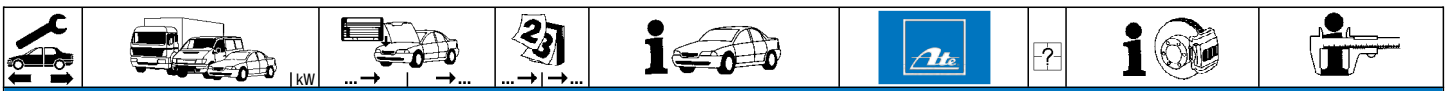

















1) - idling stop system / - dispositivo start/stop / - unité marche/arrêt / - unidad arranque/paro



PEUGEOT BOXER Bus (94-02)

	2.8 HDi (18)	94	S 16205352	11.00	- ABS	24.2125-1703.3	010483		THz 25,40	
	2.8 HDi 4X4 (10/14)		S 15064996		- ABS					
	2.8 HDi 4X4 (18)		S 16205352	10.00	- ABS					
	1.9 D (10)	51	S 16205755		03.02	- ABS	24.2125-1725.3	010717		THz 25,40
	1.9 TD (10/14)	66	S 16205755		03.02	- ABS				
	1.9 TD (10/14)	68	S 16205755		03.02	- ABS				
	2.0 i (10/14)	80	S 16205755		03.02	- ABS				
	2.0 i (18)	80	S 16205353		03.02	- ABS				
	2.5 D (14)	63	S 16205755		03.02	- ABS				
	2.5 D (18)	63	S 16205353		03.02	- ABS				
	2.5 TD (14)	76	S 16205755		03.02	- ABS				
	2.5 TD (18)	76	S 16205353		03.02	- ABS				
	2.5 TDi (14)	79	S 16205755		03.02	- ABS				
	2.5 TDi (18)	79	S 16205353		03.02	- ABS				
	2.8 D (14)	64	S 16205755		02.02	- ABS				
	2.8 D (18)	64	S 16205353		02.02	- ABS				
	2.8 HDi (14)	94	S 16205755		03.02	- ABS				
	2.8 HDi (18)	94	S 16205353		03.02	- ABS				
	2.8 HDi 4X4 (10/14)		S 16205755		03.02	- ABS				
	2.8 HDi 4X4 (18)		S 16205353		03.02	- ABS				
1.9 D (10)	51	S 15064995	S 16206253	02.94	+ ABS	24.2122-1714.3	010480		THz 22,20	
1.9 TD (10/14)	66	S 15064995	S 16206253	08.94	+ ABS					
1.9 TD (10/14)	68	S 15064995	S 16206253	02.94	+ ABS					
2.0 i (10/14)	80	S 15064995	S 16206253	02.94	+ ABS					
2.5 D (14)	63	S 15064995	S 16206253	08.94	+ ABS					
2.5 TD (14)	76	S 15064995	S 16206253	08.94	+ ABS					
2.8 D (14)	64	S 15064995	S 16206253	01.99	+ ABS					
2.8 HDi 4X4 (10/14)		S 15064995	S 16206253	10.00	+ ABS					
1.9 D (10)	51	S 15064996	S 16206253		+ ABS	24.2125-1702.3	010482		THz 25,40	
1.9 TD (10/14)	66	S 15064996	S 16206253		+ ABS					
1.9 TD (10/14)	68	S 15064996	S 16206253		+ ABS					
2.0 i (10/14)	80	S 15064996	S 16206253		+ ABS					
2.0 i (18)	80	S 16194399	S 16194399	02.94	+ ABS					
2.5 D (14)	63	S 15064996	S 16206253		+ ABS					
2.5 D (18)	63	S 16194399	S 16194399	08.94	+ ABS					
2.5 TD (14)	76	S 15064996	S 16206253		+ ABS					
2.5 TD (18)	76	S 16194399	S 16194399	08.94	+ ABS					
2.5 TDi (14)	79	S 16206253	S 16206253	01.97	+ ABS					
2.5 TDi (18)	79	S 16194399	S 16194399	01.97	+ ABS					
2.8 D (14)	64	S 15064995	S 16206253		+ ABS					
2.8 D (18)	64	S 16194399	S 16194399	01.99	+ ABS					
2.8 HDi (14)	94	S 16206253	S 16206253	11.00	+ ABS					
2.8 HDi (18)	94	S 16194399	S 16194399	11.00	+ ABS					
2.8 HDi 4X4 (10/14)		S 15064995	S 16206253		+ ABS					
2.8 HDi 4X4 (18)		S 16194399	S 16194399	10.00	+ ABS					
1.9 D (10)	51	S 16206254			03.02	+ ABS	24.2125-1726.3	010718	THz 25,40	
1.9 TD (10/14)	66	S 16206254			03.02	+ ABS				
1.9 TD (10/14)	68	S 16206254			03.02	+ ABS				
2.0 i (10/14)	80	S 16206254			03.02	+ ABS				
2.0 i (18)	80	S 16194400			03.02	+ ABS				
2.5 D (14)	63	S 16206254			03.02	+ ABS				
2.5 D (18)	63	S 16194400			03.02	+ ABS				
2.5 TD (14)	76	S 16206254			03.02	+ ABS				
2.5 TD (18)	76	S 16194400			03.02	+ ABS				
2.5 TDi (14)	79	S 16206254			03.02	+ ABS				
2.5 TDi (18)	79	S 16194400			03.02	+ ABS				
2.8 D (14)	64	S 16206254			02.02	+ ABS				
2.8 D (18)	64	S 16194400			02.02	+ ABS				
2.8 HDi (14)	94	S 16206254			03.02	+ ABS				
2.8 HDi (18)	94	S 16194400			03.02	+ ABS				
2.8 HDi 4X4 (10/14)		S 16206254			03.02	+ ABS				
2.8 HDi 4X4 (18)		S 16194400			03.02	+ ABS				
	1.9 D (10)	51		02.94	10.01	+ ABS	24.0101-4804.2	260050		Bremssattel-Zubehör TRW
	1.9 TD (10/14)	66		08.94	10.01	+ ABS				
	1.9 TD (10/14)	68		02.94	10.01	+ ABS				
	2.0 i (10/14)	80		02.94	10.01	+ ABS				
	2.5 D (14)	63		08.94	10.01	+ ABS				
	2.8 D (14)	64	S 16206253		01.99	+ ABS				
	2.8 HDi 4X4 (10/14)		S 16206253		10.00	+ ABS				
	1.9 D (10)	51	S 15866409	02.94			24.5112-0466.3	330579	2	L=462
	1.9 TD (10/14)	66	S 15866409	08.94			24.5112-0465.3	330526	2	L=465, + Clip
	1.9 TD (10/14)	68	S 15866409	02.94						
	2.0 i (10/14/18)	80	S 15866409	02.94						
	2.5 D (14/18)	63	S 15866409	08.94						
	2.5 TD (14/18)	76	S 15866409	08.94						
	2.5 TDi (14/18)	79	S 15866409	01.97						
	2.8 D (14/18)	64	S 15866409	01.99						
	2.8 HDi (14/18)		S 15866409	11.00						
	1.9 D (10)	51	S 15866410			10.01		24.5112-0466.3	330579	2
1.9 TD (10/14)	66	S 15866410			10.01		24.5112-0461.3	330616	2	L=460, + Clip
1.9 TD (10/14)	68	S 15866410			10.01					
2.0 i (10/14/18)	80	S 15866410			10.01					
2.5 D (14/18)	63	S 15866410			10.01					
2.5 TD (14/18)	76	S 15866410			10.01					
2.5 TDi (14/18)	79	S 15866410			10.01					
2.8 D (14/18)	64	S 15866410	S 16206244		10.01					



									
PEUGEOT BOXER Bus (94-02)									
	2.8 HDi (14/18)	S 15866410		10.01		24.5112-0466.3 330579 24.5112-0461.3 330616	2 2	L=462 L=460, + Clip	
	1.9 D (10)	51		11.01	03.02	24.5112-0477.3 331299	2	L=477	
	1.9 TD (10/14)	66		11.01	03.02	24.5112-0470.3 331460	2	L=470	
	1.9 TD (10/14)	68		11.01	03.02				
	2.0 i (10/14/18)	80		11.01	03.02				
	2.5 D (14/18)	63		11.01	03.02				
	2.5 TD (14/18)	76		11.01	03.02				
	2.5 TDi (14/18)	79		11.01	03.02				
	2.8 D (14/18)	64 S 16205353			02.02				
2.8 HDi (14/18)			11.01	03.02					
	1.9 D (10)	51		11.01	03.02	24.3461-1701.5 240449		D=46, - Halter	
	1.9 TD (10/14)	66		11.01	03.02	24.3461-1702.5 240450		D=46, - Halter	
	1.9 TD (10/14)	68		11.01	03.02				
	2.0 i (10/14/18)	80		11.01	03.02				
	2.5 D (14/18)	63		11.01	03.02				
	2.5 TD (14/18)	76		11.01	03.02				
	2.5 TDi (14/18)	79		11.01	03.02				
	2.8 D (14/18)	64 S 16194400			02.02				
	2.8 HDi (14/18)			11.01	03.02				
2.8 HDi 4X4 (10/14)	S 16194400			03.02					
2.8 HDi 4X4 (18)	S 16194400			03.02					
	1.9 D (10)	51		02.94	10.01	- ABS	24.5112-0340.3 330511	1	- verstärktes Fahrwerk ¹⁾
	1.9 TD (10/14)	66		08.94	10.01	- ABS	24.5112-0361.3 330649	1	+ verstärktes Fahrwerk ²⁾
	1.9 TD (10/14)	68		02.94	10.01	- ABS			
	2.0 i (10/14/18)	80		02.94	10.01	- ABS			
	2.5 D (14/18)	63		08.94	10.01	- ABS			
	2.5 TD (14/18)	76		08.94	10.01	- ABS			
	2.5 TDi (14/18)	79		01.97	10.01	- ABS			
	2.8 D (14/18)	64	S 16206244		01.99	- ABS			
	2.8 HDi (14/18)			11.00	10.01	- ABS			
	1.9 D (10)	51		11.01	03.02	- ABS	24.5112-0361.3 330649	1	+ HA-Trommelbremse ³⁾
	1.9 TD (10/14)	66		11.01	03.02	- ABS	83.6401-0159.3 330746	2	+ HA-Scheibenbremse ⁴⁾
	1.9 TD (10/14)	68		11.01	03.02	- ABS			
	2.0 i (10/14/18)	80		11.01	03.02	- ABS			
	2.5 D (14/18)	63		11.01	03.02	- ABS			
	2.5 TD (14/18)	76		11.01	03.02	- ABS			
	2.5 TDi (14/18)	79		11.01	03.02	- ABS			
	2.8 D (14/18)	64 S 16205353			02.02	- ABS			
	2.8 HDi (14/18)			11.01	03.02	- ABS			
	1.9 D (10)	51		02.94	10.01	+ ABS	24.5112-0315.3 330509		- verstärktes Fahrwerk ¹⁾
	1.9 TD (10/14)	66		08.94	10.01	+ ABS			
	1.9 TD (10/14)	68		02.94	10.01	+ ABS			
	2.0 i (10/14/18)	80		02.94	10.01	+ ABS			
	2.5 D (14/18)	63		08.94	10.01	+ ABS			
	2.5 TD (14/18)	76		08.94	10.01	+ ABS			
	2.5 TDi (14/18)	79		01.97	10.01	+ ABS			
	2.8 D (14/18)	64	S 16206253		01.99	+ ABS			
	2.8 HDi (14/18)			11.00	10.01	+ ABS			
	1.9 D (10)	51		11.01	03.02	+ ABS	83.6401-0159.3 330746	2	+ HA-Scheibenbremse ⁴⁾
	1.9 TD (10/14)	66		11.01	03.02	+ ABS			
	1.9 TD (10/14)	68		11.01	03.02	+ ABS			
	2.0 i (10/14/18)	80		11.01	03.02	+ ABS			
	2.5 D (14/18)	63		11.01	03.02	+ ABS			
	2.5 TD (14/18)	76		11.01	03.02	+ ABS			
	2.5 TDi (14/18)	79		11.01	03.02	+ ABS			
	2.8 D (14/18)	64 S 16194400			02.02	+ ABS			
	2.8 HDi (14/18)			11.01	03.02	+ ABS			
	1.9 D (10)	51		02.94	10.01		24.3225-1701.3 020399		Rz 25,40
	1.9 TD (10/14)	66		08.94	10.01				
	1.9 TD (10/14)	68		02.94	10.01				
	2.0 i (10/14)	80		02.94	10.01				
	2.5 D (14)	63		08.94	10.01				
	2.8 D (14)	64	S 16206253		01.99				
	2.8 HDi 4X4 (10/14)		S 16206253		10.00				
	2.5 TD (14)	76		08.94	10.01		24.3226-1702.3 020469		Rz 26,99
	2.5 TDi (14)	79		01.97	10.01				
	2.8 D (14)	64	S 16206253		01.99				
	2.8 HDi (14)	94		11.00	10.01				
	2.8 HDi 4X4 (10/14)		S 16206253		10.00				
	1.9 D (10)	51		11.01	03.02		24.3226-1702.3 020469		Rz 26,99
	1.9 TD (10/14)	66		11.01	03.02				
	1.9 TD (10/14)	68		11.01	03.02				
	2.0 i (10/14)	80		11.01	03.02				
	2.5 D (14)	63		11.01	03.02				
	2.5 TD (14)	76		11.01	03.02				
	2.5 TDi (14)	79		11.01	03.02				
	2.8 D (14)	64 S 16204256			02.02				
	2.8 HDi (14)	94		11.01	03.02				
	2.8 HDi 4X4 (10/14)		S 16204256		03.02				
	2.0 i (18)	80		02.94	10.01		24.3228-1701.3 020401		Rz 28,57
	2.5 D (18)	63		08.94	10.01				
	2.5 TD (18)	76		08.94	10.01				
	2.5 TDi (18)	79		01.97	10.01				
	2.8 D (18)	64	S 16209999		01.99				
2.8 HDi (18)	94		11.00	10.01					

1) - reinforced suspension / - sospensione rinforzata / - châssis renforcé / - suspensión reforzada
2) + reinforced suspension / + sospensione rinforzata / + châssis renforcé / + suspensión reforzada
3) + RA drum brake / + P freno a tamburo / + frein à tambour essieu AR / + ET-tambores de freno
4) + RA disc brake / + P disco freno / + frein à disque essieu AR / + ET-disco de freno



PEUGEOT BOXER Bus (94-02)

	2.8 HDi 4X4 (18)		S 16209999	10.00		24.3228-1701.3	020401		Rz 28,57
	1.9 D (10)	51	S 16158427	02.94		24.3727-0345.2	580345	1 ↓	L=3045
	1.9 TD (10/14)	66	S 16158427	08.94					
	1.9 TD (10/14)	68	S 16158427	02.94					
	2.0 i (10/14/18)	80	S 16158427	02.94					
	2.5 D (14/18)	63	S 16158427	08.94					
	2.5 TD (14/18)	76	S 16158427	08.94					
	2.5 TDi (14/18)	79	S 16158427	01.97					
	2.8 D (14/18)	64	S 16158427	01.99					
	2.8 HDi (14/18)		S 16158427	11.00					
	1.9 D (10)	51	S 16158428		03.02	24.3727-0350.2	580350	1 ↓	L=2827
	1.9 TD (10/14)	66	S 16158428		03.02				
	1.9 TD (10/14)	68	S 16158428		03.02				
	2.0 i (10/14/18)	80	S 16158428		03.02				
	2.5 D (14/18)	63	S 16158428		03.02				
	2.5 TD (14/18)	76	S 16158428		03.02				
	2.5 TDi (14/18)	79	S 16158428		03.02				
	2.8 D (14/18)	64	S 16158428		02.02				
	2.8 HDi (14/18)		S 16158428		03.02				
	1.9 TD 4x4 (10/14)	68		07.96	03.02	24.3727-0842.2	580842	1 ↓	L=4100
	2.0 i 4x4 (10/14/18)	80		07.96	03.02				
	2.5 D 4x4 (14/18)	63		07.96	03.02				
	2.5 TD 4X4 (14/18)	76		07.96	03.02				
	2.5 TDi 4x4 (14/18)	79		01.97	03.02				
	2.8 HDi 4X4 (10/14)			10.00	03.02				
	2.8 HDi 4X4 (18)			10.00	03.02				
	1.9 D (10)	51	S 16206244	02.94		24.6512-1701.3	320153	- ABS	BRL (2)
	1.9 TD (10/14)	66	S 16206244	08.94					
	1.9 TD (10/14)	68	S 16206244	02.94					
	2.0 i (10/14/18)	80	S 16206244	02.94					
	2.5 TD (14/18)	76	S 16206244	08.94					
	2.5 TD (14/18)	76	S 16206244	08.94					
	2.5 TDi (14/18)	79	S 16206244	01.97					
	2.8 D (14/18)	64	S 16206244	01.99					
	2.8 HDi (14/18)		S 16206244	11.00					
	1.9 D (10)	51		02.94	03.02 + ML5-Getriebe ¹⁾	24.3728-0300.2	590300		L=1478
	1.9 TD (10/14)	66		08.94	03.02 + ML5-Getriebe ¹⁾				
	1.9 TD (10/14)	68		02.94	03.02 + ML5-Getriebe ¹⁾				
	1.9 TD (10/14)	66		08.94	03.02 + ME-Getriebe ²⁾	24.3728-0337.2	590337		L=1058
	1.9 TD (10/14)	68		02.94	03.02 + ME-Getriebe ²⁾				
	1.9 D (10)	51		02.94	03.02 + ME-Getriebe ²⁾	24.3728-0518.2	590518		L=1034
	2.0 i (10/14/18)	80		08.94	03.02 + ME-Getriebe ²⁾				
	2.5 D (14/18)	63		02.94	03.02 + ME-Getriebe ²⁾				
	2.0 i (10/14/18)	80		02.94	03.02 + ML5-Getriebe ¹⁾	24.3728-0335.2	590335		L=1435
	2.5 D (14/18)	63		08.94	03.02 + ML5-Getriebe ¹⁾				
	2.8 D (14/18)	64		01.99	02.02 + ML5-Getriebe ¹⁾				
	2.8 HDi (14/18)			11.00	03.02 + ML5-Getriebe ¹⁾				
	2.0 i (10/14/18)	80		02.94	03.02 + MG5T-Getriebe ³⁾	24.3728-0519.2	590519		L=1090
	2.5 D (14/18)	63		08.94	03.02 + MG5T-Getriebe ³⁾				
	2.5 TD (14/18)	76		08.94	03.02 + MG5T-Getriebe ³⁾				
	2.5 TDi (14/18)	79		01.97	03.02 + MG5T-Getriebe ³⁾				
	2.8 HDi (14/18)			11.00	03.02 + MG5T-Getriebe ³⁾				

PEUGEOT BOXER Kasten (94-02)

	1.9 D (10)	51	S 15064995	02.94	- ABS	24.2122-1715.3	010481		Thz 22,20
	1.9 TD (10/14)	68	S 15064995	02.94	- ABS				
	2.0 i (10/14)	80	S 15064995	02.94	- ABS				
	2.5 D/DT (14)	63	S 15064995	02.94	- ABS				
	2.5 TD (14)	76	S 15064995	02.94	- ABS				
	2.8 D (14)	64	S 15064995	01.99	- ABS				
	1.9 D (10)	50	S 16205754	07.99	- ABS	24.2125-1703.3	010483		Thz 25,40
	1.9 D (10)	51	S 15064996		- ABS				
	1.9 TD (10/14)	66	S 16205754	07.99	- ABS				
	1.9 TD (10/14)	68	S 15064996		- ABS				
	2.0 i (10/14)	80	S 15064996		- ABS				
	2.0 i (18)	80	S 16205352	02.94	- ABS				
	2.5 D/DT (18)	63	S 16205352	02.94	- ABS				
	2.5 D/DT (14)	63	S 15064996		- ABS				
	2.5 TD (14)	76	S 15064996		- ABS				
	2.5 TD (18)	76	S 16205352	02.94	- ABS				
	2.5 TDi (14)	79	S 16205754	01.97	- ABS				
	2.5 TDi (18)	79	S 16205352	01.97	- ABS				
	2.8 D (14)	64	S 15064996		- ABS				
	2.8 D (18)	64	S 16205352	01.99	- ABS				
	2.8 HDi (14)	94	S 16205754	11.00	- ABS				
	2.8 HDi (18)	94	S 16205352	11.00	- ABS				
	1.9 D (10)	50	S 16205755		03.02 - ABS	24.2125-1725.3	010717		Thz 25,40
	1.9 D (10)	51	S 16205755		03.02 - ABS				
	1.9 TD (10/14)	66	S 16205755		03.02 - ABS				
	1.9 TD (10/14)	68	S 16205755		03.02 - ABS				
	2.0 HDi (10/14/18)	62		08.01	03.02 - ABS				
	2.0 i (10/14)	80	S 16205755		03.02 - ABS				
	2.0 i (18)	80	S 16205353		03.02 - ABS				
	2.5 D/DT (18)	63	S 16205353		03.02 - ABS				

¹⁾ + ML5 transmission / + scatola cambio ML5 / + boîte de vitesse ML5 / + cambio ML5



²⁾ + ME transmission / + scatola cambio ME / + boîte de vitesse ME / + cambio ME

³⁾ + MG5T transmission / + scatola cambio MG5T / + boîte de vitesse MG5T / + cambio MG5T

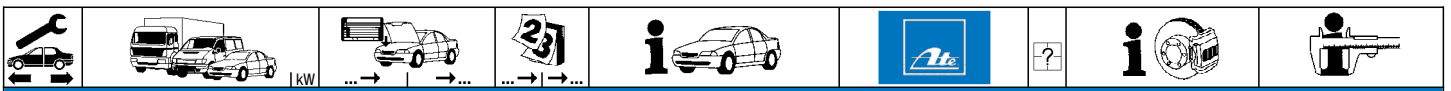



PEUGEOT BOXER Kasten (94-02)

	2.5 D/DT (14) 2.5 TD (14) 2.5 TD (18) 2.5 TDi (14) 2.5 TDi (18) 2.8 D (14) 2.8 D (18) 2.8 HDi (14) 2.8 HDi (18)	63 S 16205755 76 S 16205755 76 S 16205353 79 S 16205755 79 S 16205353 64 S 16205755 64 S 16205353 94 S 16205755 94 S 16205353			03.02 - ABS 03.02 - ABS 03.02 - ABS 03.02 - ABS 03.02 - ABS 02.02 - ABS 02.02 - ABS 03.02 - ABS 03.02 - ABS	24.2125-1725.3	010717		THz 25,40
	1.9 D (10) 1.9 TD (10/14) 2.0 i (10/14) 2.5 D/DT (14) 2.5 TD (14) 2.8 D (14)	51 68 80 63 76 64	S 15064995 S 15064995 S 15064995 S 15064995 S 15064995 S 15064995	02.94 02.94 02.94 02.94 02.94 01.99	+ ABS + ABS + ABS + ABS + ABS + ABS	24.2122-1714.3	010480		THz 22,20
	1.9 D (10) 1.9 D (10) 1.9 TD (10/14) 1.9 TD (10/14) 2.0 i (10/14) 2.0 i (18) 2.5 D/DT (18) 2.5 D/DT (14) 2.5 TD (14) 2.5 TD (18) 2.5 TDi (14) 2.5 TDi (18) 2.8 D (14) 2.8 D (18) 2.8 HDi (14) 2.8 HDi (18)	50 51 S 15064996 66 68 S 15064996 80 S 15064996 80 63 63 S 15064996 76 S 15064996 76 79 79 64 S 15064996 64 94 94	S 16206253 S 16206253 S 16206253 S 16206253 S 16206253 S 16194399 S 16194399 S 16206253 S 16206253 S 16194399 S 16206253 S 16194399 S 16206253 S 16194399 S 16206253 S 16194399	07.99 07.99 07.99 07.99 02.94 02.94 01.97 01.97 01.99 11.00 11.00	+ ABS + ABS + ABS + ABS + ABS + ABS + ABS + ABS + ABS + ABS + ABS + ABS + ABS + ABS + ABS + ABS	24.2125-1702.3	010482		THz 25,40
	1.9 D (10) 1.9 D (10) 1.9 TD (10/14) 1.9 TD (10/14) 2.0 HDi (10/14/18) 2.0 i (10/14) 2.0 i (18) 2.5 D/DT (18) 2.5 D/DT (14) 2.5 TD (14) 2.5 TD (18) 2.5 TDi (14) 2.5 TDi (18) 2.8 D (14) 2.8 D (18) 2.8 HDi (14) 2.8 HDi (18)	50 S 16206254 51 S 16206254 66 S 16206254 68 S 16206254 62 80 S 16206254 80 S 16194400 63 S 16194400 63 S 16206254 76 S 16206254 76 S 16194400 79 S 16206254 79 S 16194400 64 S 16206254 64 S 16194400 94 S 16206254 94 S 16194400		08.01	03.02 + ABS 03.02 + ABS 03.02 + ABS 03.02 + ABS 03.02 + ABS 03.02 + ABS 03.02 + ABS 03.02 + ABS 03.02 + ABS 03.02 + ABS 02.02 + ABS 02.02 + ABS 03.02 + ABS 03.02 + ABS	24.2125-1726.3	010718		THz 25,40
	1.9 D (10) 1.9 D (10) 1.9 DT 4x4 (10/14) 1.9 TD (10/14) 1.9 TD (10/14) 2.0 HDi (10/14) 2.0 i (10/14) 2.0 i 4x4 (10/14) 2.5 D/DT (14) 2.8 D (14)	50 51 66 66 68 62 80 80 63 64	S 16206253	07.99 02.94 03.96 07.99 02.94 08.01 02.94 03.96 02.94 01.99	10.01 + ABS 10.01 + ABS 10.01 + ABS 10.01 + ABS 10.01 + ABS 10.01 + ABS 10.01 + ABS 10.01 + ABS 10.01 + ABS + ABS	24.0101-4804.2	260050		Bremssattel-Zubehör TRW
	1.9 D (10) 1.9 D (10) 1.9 TD (10/14) 1.9 TD (10/14) 2.0 i (10/14/18) 2.5 D/DT (14/18) 2.5 TD (14/18) 2.5 TDi (14/18) 2.8 D (14/18) 2.8 HDi (14/18)	50 51 66 68 80 63 76 79 64 94	S 15866409 S 15866409 S 15866409 S 15866409 S 15866409 S 15866409 S 15866409 S 15866409 S 15866409 S 15866409	07.99 02.94 07.99 02.94 02.94 02.94 01.97 01.99		24.5112-0466.3 24.5112-0465.3	330579 330526	2 2	L=462 L=465, + Clip
	1.9 D (10) 1.9 D (10) 1.9 TD (10/14) 1.9 TD (10/14) 2.0 HDi (10/14/18) 2.0 i (10/14/18) 2.5 D/DT (14/18) 2.5 TD (14/18) 2.5 TDi (14/18) 2.8 D (14/18) 2.8 HDi (14/18)	50 S 15866410 51 S 15866410 66 S 15866410 68 S 15866410 62 80 S 15866410 63 S 15866410 76 S 15866410 79 S 15866410 64 S 15866410 94 S 15866410	S 16206244	08.01	10.01 10.01 10.01 10.01 10.01 10.01 10.01 10.01 10.01	24.5112-0466.3 24.5112-0461.3	330579 330616	2 2	L=462 L=460, + Clip
	1.9 D (10) 1.9 D (10) 1.9 TD (10/14) 1.9 TD (10/14) 2.0 HDi (10/14/18) 2.0 i (10/14/18) 2.5 D/DT (14/18) 2.5 TD (14/18)	50 51 66 68 62 80 63 80		11.01 11.01 11.01 11.01 11.01 11.01 11.01	03.02 03.02 03.02 03.02 03.02 03.02 03.02	24.5112-0477.3 24.5112-0470.3	331299 331460	2 2	L=477 L=470



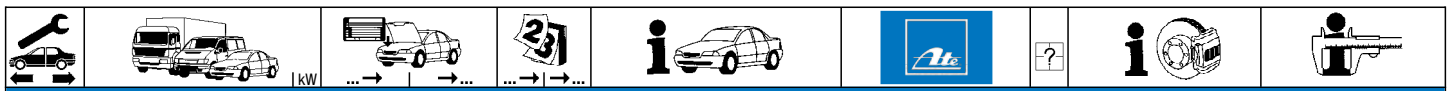

PEUGEOT BOXER Kasten (94-02)

	2.5 TD (14/18)	76		11.01	03.02	24.5112-0477.3	331299	2		L=477
	2.5 TDi (14/18)	79		11.01	03.02	24.5112-0470.3	331460	2		L=470
	2.8 D (14/18)	64 S 16205353			02.02					
	2.8 HDi (14/18)	94		11.01	03.02					
	1.9 D (10)	50		11.01	03.02	24.3461-1701.5	240449			D=46, - Halter
	1.9 D (10)	51		11.01	03.02	24.3461-1702.5	240450			D=46, - Halter
	1.9 DT 4x4 (10/14)	66		11.01	03.02					
	1.9 TD (10/14)	66		11.01	03.02					
	1.9 TD (10/14)	68		11.01	03.02					
	2.0 HDi (10/14/18)	62		11.01	03.02					
	2.0 i (10/14/18)	80		11.01	03.02					
	2.0 i 4x4 (10/14/18)	80		11.01	03.02					
	2.5 D/DT (14/18)	63		11.01	03.02					
	2.5 TDi (14/18)	79		11.01	03.02					
	2.5 TDi (14/18)	79		11.01	03.02					
	2.8 D (14/18)	64 S 16194400			02.02					
	2.8 HDi (14/18)	94		11.01	03.02					
	2.8 HDi 4x4 (14/18)	94		11.01	03.02					
	1.9 D (10)	50		07.99	10.01	24.5112-0340.3	330511	1	- verstärktes Fahrwerk ¹⁾	L=340
	1.9 D (10)	51		02.94	10.01	24.5112-0361.3	330649	1	+ verstärktes Fahrwerk ²⁾	L=360
	1.9 TD (10/14)	66		07.99	10.01					
	1.9 TD (10/14)	68		02.94	10.01					
	2.0 HDi (10/14/18)	62		08.01	10.01					
	2.0 i (10/14/18)	80		02.94	10.01					
	2.5 D/DT (14/18)	63		02.94	10.01					
	2.5 TD (14/18)	76		02.94	10.01					
	2.5 TDi (14/18)	79		01.97	10.01					
	2.5 TDi (14/18)	79		01.99	10.01					
	2.8 D (14/18)	64 S 16206244		01.99	10.01					
	2.8 HDi (14/18)	94		11.00	10.01					
	1.9 D (10)	50		11.01	03.02	24.5112-0361.3	330649	1	+ HA-Trommelbremse ³⁾	L=360
	1.9 D (10)	51		11.01	03.02	83.6401-0159.3	330746	2	+ HA-Scheibenbremse ⁴⁾	L=160
	1.9 TD (10/14)	66		11.01	03.02					
	1.9 TD (10/14)	68		11.01	03.02					
	2.0 HDi (10/14/18)	62		11.01	03.02					
	2.0 i (10/14/18)	80		11.01	03.02					
	2.5 D/DT (14/18)	63		11.01	03.02					
	2.5 TD (14/18)	76		11.01	03.02					
	2.5 TDi (14/18)	79		11.01	03.02					
	2.5 TDi (14/18)	79		11.01	03.02					
	2.8 D (14/18)	64 S 16205353			02.02					
	2.8 HDi (14/18)	94		11.01	03.02					
	1.9 D (10)	50		07.99	10.01	24.5112-0315.3	330509		- verstärktes Fahrwerk ¹⁾	L=315
	1.9 D (10)	51		02.94	10.01					
	1.9 TD (10/14)	66		07.99	10.01					
	1.9 TD (10/14)	68		02.94	10.01					
	2.0 HDi (10/14/18)	62		08.01	10.01					
	2.0 i (10/14/18)	80		02.94	10.01					
	2.5 D/DT (14/18)	63		02.94	10.01					
	2.5 TD (14/18)	76		02.94	10.01					
	2.5 TDi (14/18)	79		01.97	10.01					
	2.5 TDi (14/18)	79		01.99	10.01					
	2.8 D (14/18)	64 S 16206253		01.99	10.01					
	2.8 HDi (14/18)	94		11.00	10.01					
	1.9 D (10)	50		11.01	03.02	83.6401-0159.3	330746	2	+ HA-Scheibenbremse ⁴⁾	L=160
	1.9 D (10)	51		11.01	03.02					
	1.9 TD (10/14)	66		11.01	03.02					
	1.9 TD (10/14)	68		11.01	03.02					
	2.0 HDi (10/14/18)	62		11.01	03.02					
	2.0 i (10/14/18)	80		11.01	03.02					
	2.5 D/DT (14/18)	63		11.01	03.02					
	2.5 TD (14/18)	76		11.01	03.02					
	2.5 TDi (14/18)	79		11.01	03.02					
	2.5 TDi (14/18)	79		11.01	03.02					
	2.8 D (14/18)	64 S 16194400			02.02					
	2.8 HDi (14/18)	94		11.01	03.02					
	1.9 D (10)	50		07.99	10.01	24.3225-1701.3	020399			Rz 25,40
	1.9 D (10)	51		02.94	10.01					
	1.9 DT 4x4 (10/14)	66		03.96	10.01					
	1.9 TD (10/14)	66		07.99	10.01					
	1.9 TD (10/14)	68		02.94	10.01					
	2.0 HDi (10/14)	62		08.01	10.01					
	2.0 i (10/14)	80		02.94	10.01					
	2.0 i 4x4 (10/14)	80		03.96	10.01					
	2.5 D/DT (14)	63		02.94	10.01					
	2.8 D (14)	64	S 16206253	01.99	10.01					
	2.5 TD (14)	76		02.94	10.01	24.3226-1702.3	020469			Rz 26,99
	2.5 TDi (14)	79		01.97	10.01					
	2.8 D (14)	64	S 16206253	01.99	10.01					
	2.8 HDi (14)	94		11.00	10.01					
	2.8 HDi (14)	94		11.00	10.01					
	1.9 D (10)	50		11.01	03.02	24.3226-1702.3	020469			Rz 26,99
	1.9 D (10)	51		11.01	03.02					
	1.9 DT 4x4 (10/14)	66		11.01	03.02					
	1.9 TD (10/14)	66		11.01	03.02					
	1.9 TD (10/14)	68		11.01	03.02					
	2.0 HDi (10/14)	62		11.01	03.02					
	2.0 i (10/14)	80		11.01	03.02					
	2.0 i 4x4 (10/14)	80		11.01	03.02					
	2.5 D/DT (14)	63		11.01	03.02					

1) - reinforced suspension / - sospensione rinforzata / - châssis renforcé / - suspensión reforzada
2) + reinforced suspension / + sospensione rinforzata / + châssis renforcé / + suspensión reforzada
3) + RA drum brake / + P freno a tamburo / + frein à tambour essieu AR / + ET-tambores de freno
4) + RA disc brake / + P disco freno / + frein à disque essieu AR / + ET-disco de freno





PEUGEOT BOXER Kasten (94-02)

	2.5 TD (14)	76		11.01	03.02	24.3226-1702.3	020469		Rz 26,99				
	2.5 TDi (14)	79		11.01	03.02								
	2.8 D (14)	64	S 16204256		02.02	24.3228-1701.3	020401		Rz 28,57				
	2.8 HDi (14)	94		11.01	03.02								
	2.8 HDi 4x4 (14)	94		11.01	03.02								
	2.0 HDi (18)	62		08.01	10.01								
	2.0 i (18)	80		02.94	10.01								
	2.0 i 4x4 (18)	80		03.96	10.01								
	2.5 D/DT (18)	63		02.94	10.01								
	2.5 TD (18)	76		02.94	10.01								
	2.5 TDi (18)	79		01.97	10.01								
	2.8 D (18)	64	S 16209999	01.99	10.01								
2.8 HDi (18)	94		11.00	10.01									
2.8 HDi 4x4 (18)	94		10.00	10.01									
	1.9 D (10)	50	S 16158427	07.99		24.3727-0340.2	580340	1	L=3025				
	1.9 D (10)	51	S 16158427	02.94									
	1.9 TD (10/14)	66	S 16158427	07.99									
	1.9 TD (10/14)	68	S 16158427	02.94									
	2.0 i (10/14/18)	80	S 16158427	02.94									
	2.5 D/DT (14/18)	63	S 16158427	02.94									
	2.5 TD (14/18)	76	S 16158427	02.94									
	2.5 TDi (14/18)	79	S 16158427	01.97									
	2.8 D (14/18)	64	S 16158427	01.99									
	2.8 HDi (14/18)	94	S 16158427	11.00									
	1.9 D (10)	50	S 16158428							24.3727-0344.2	580344	1	L=2806
	1.9 D (10)	51	S 16158428										
	1.9 TD (10/14)	66	S 16158428										
	1.9 TD (10/14)	68	S 16158428										
	2.0 i (10/14/18)	80	S 16158428										
	2.5 D/DT (14/18)	63	S 16158428										
	2.5 TD (14/18)	76	S 16158428										
	2.5 TDi (14/18)	79	S 16158428										
2.8 D (14/18)	64	S 16158428											
2.8 HDi (14/18)	94	S 16158428											
1.9 D (10)	50	S 16194400		03.02	24.3727-0343.2	580343	1	L=2827					
1.9 D (10)	51	S 16194400		03.02									
1.9 TD (10/14)	66	S 16194400		03.02									
1.9 TD (10/14)	68	S 16194400		03.02									
2.0 HDi (10/14/18)	62		08.01	03.02									
2.0 i (10/14/18)	80	S 16194400		03.02									
2.5 D/DT (14/18)	63	S 16194400		03.02									
2.5 TD (14/18)	76	S 16194400		03.02									
2.5 TDi (14/18)	79	S 16194400		03.02									
2.8 D (14/18)	64	S 16194400		02.02									
2.8 HDi (14/18)	94	S 16194400		03.02									
2.5 D 4x4 (14/18)	63		07.99	03.02	24.3727-0842.2	580842	1	L=4100					
2.5 TDi 4x4 (14/18)	79		07.99	03.02									
	1.9 D (10)	50	S 16206244	07.99		24.6512-1701.3	320153		BRL (2)				
	1.9 D (10)	51	S 16206244	02.94									
	1.9 TD (10/14)	66	S 16206244	07.99									
	1.9 TD (10/14)	68	S 16206244	02.94									
	2.0 HDi (10/14/18)	62	S 16206244	08.01									
	2.0 i (10/14/18)	80	S 16206244	02.94									
	2.5 D/DT (14/18)	63	S 16206244	02.94									
	2.5 TD (14/18)	76	S 16206244	02.94									
	2.5 TDi (14/18)	79	S 16206244	01.97									
	2.8 D (14/18)	64	S 16206244	01.99									
2.8 HDi (14/18)	94	S 16206244	11.00										
	1.9 D (10)	50		07.99	03.02	24.3728-0300.2	590300		L=1478				
	1.9 D (10)	51		02.94	03.02								
	1.9 TD (10/14)	66		07.99	03.02								
	1.9 TD (10/14)	68		02.94	03.02								
	1.9 TD (10/14)	66		07.99	03.02								
	1.9 TD (10/14)	68		02.94	03.02								
	1.9 D (10)	50		07.99	03.02								
	1.9 D (10)	51		02.94	03.02								
	2.0 i (10/14/18)	80		02.94	03.02								
	2.5 D/DT (14/18)	63		02.94	03.02								
	2.0 i (10/14/18)	80		02.94	03.02								
	2.5 D/DT (14/18)	63		02.94	03.02								
	2.5 TD (14/18)	76		02.94	03.02								
	2.5 TDi (14/18)	79		01.97	03.02								
	2.8 HDi (14/18)	94		11.00	03.02								
	2.0 i (10/14/18)	80		02.94	03.02								
	2.5 D/DT (14/18)	63		02.94	03.02								
	2.8 D (14/18)	64		01.99	02.02								
2.8 HDi (14/18)	94		11.00	03.02									

PEUGEOT BOXER Pritsche/Fahrgestell (94-02)

	1.9 D (10/14)	51	S 15064995	03.94		24.2122-1715.3	010481		Thz 22,20
	2.0 i (10/14)		S 15064995	06.94					
	2.5 D (14)	63	S 15064995	02.94					
	2.5 TD (14)	76	S 15064995	02.94					
	2.8 D (14)	64	S 15064995	01.99					
↓	1.9 D (10/14)	51	S 15064996			24.2125-1703.3	010483		Thz 25,40

1) + RA drum brake / + P freno a tamburo / + frein à tambour essieu AR / + ET-tambores de freno
 2) + RA disc brake / + P disco freno / + frein à disque essieu AR / + ET-disco de freno
 3) + ML5 transmission / + scatola cambio ML5 / + boîte de vitesse ML5 / + cambio ML5
 4) + ME transmission / + scatola cambio ME / + boîte de vitesse ME / + cambio ME
 5) + MG5T transmission / + scatola cambio MG5T / + boîte de vitesse MG5T / + cambio MG5T

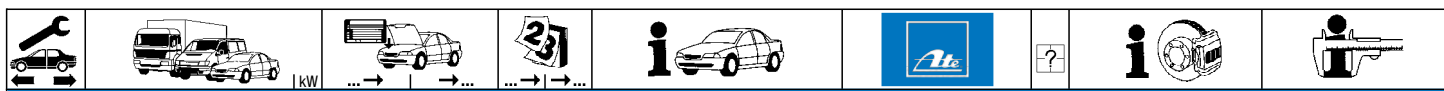

PEUGEOT BOXER Pritsche/Fahrgestell (94-02)

	1.9 TD (10/14) 66 1.9 TD (10/14) 68 2.0 i (10/14) S 15064996 2.0 i (18) 2.5 D (14) 63 S 15064996 2.5 D (18) 63 2.5 TD (14) 76 S 15064996 2.5 TD (18) 76 2.5 TDi (14) 79 2.5 TDi (18) 79 2.8 D (14) 64 S 15064996 2.8 D (18) 64 2.8 HDi (14) 94 2.8 HDi (18) 94	S 16205754 S 16205754 S 16205754 S 16205352 S 16205754 S 16205352 S 16205754 S 16205352 S 16205754 S 16205352 S 16205754 S 16205352 S 16205754 S 16205352 S 16205754 S 16205352	12.98 07.96 06.94 02.94 02.94 01.97 01.97 11.00 11.00	- ABS - ABS - ABS - ABS - ABS - ABS - ABS - ABS - ABS - ABS - ABS - ABS	24.2125-1703.3	010483		Thz 25,40	
	1.9 D (10/14) 51 1.9 TD (10/14) 66 1.9 TD (10/14) 68 2.0 i (10/14) S 16205755 2.0 i (18) S 16205353 2.5 D (14) 63 S 16205755 2.5 D (18) 63 S 16205353 2.5 TD (14) 76 S 16205755 2.5 TD (18) 76 S 16205353 2.5 TDi (14) 79 S 16205755 2.5 TDi (18) 79 S 16205353 2.8 D (14) 64 S 16205755 2.8 D (18) 64 S 16205353 2.8 HDi (14) 94 S 16205755 2.8 HDi (18) 94 S 16205353	S 16205755 S 16205755 S 16205755 S 16205755 S 16205353 S 16205755 S 16205353 S 16205755 S 16205353 S 16205755 S 16205353 S 16205755 S 16205353 S 16205755 S 16205353	04.02 03.02 03.02 03.02 03.02 03.02 03.02 03.02 03.02 02.02 02.02 03.02	- ABS - ABS - ABS - ABS - ABS - ABS - ABS - ABS - ABS - ABS - ABS - ABS - ABS	24.2125-1725.3	010717		Thz 25,40	
	1.9 D (10/14) 51 2.0 i (10/14) 2.5 D (14) 63 2.5 TD (14) 76 2.8 D (14) 64	S 15064995 S 15064995 S 15064995 S 15064995 S 15064995	03.94 06.94 02.94 02.94 01.99	+ ABS + ABS + ABS + ABS + ABS	24.2122-1714.3	010480		Thz 22,20	
	1.9 D (10/14) 51 1.9 TD (10/14) 66 1.9 TD (10/14) 68 2.0 i (10/14) S 15064996 2.0 i (18) S 16194399 2.5 D (14) 63 S 15064996 2.5 D (18) 63 2.5 TD (14) 76 S 15064996 2.5 TD (18) 76 2.5 TDi (14) 79 2.5 TDi (18) 79 2.8 D (14) 64 S 15064995 2.8 D (18) 64 2.8 HDi (14) 94 2.8 HDi (18) 94	S 16206253 S 16206253 S 16206253 S 16206253 S 16194399 S 16206253 S 16194399 S 16194399 S 16206253 S 16194399 S 16206253 S 16194399 S 16206253 S 16194399 S 16206253 S 16194399	12.98 07.96 06.94 02.94 02.94 01.97 01.97 01.99 11.00 11.00	+ ABS + ABS + ABS + ABS + ABS + ABS + ABS + ABS + ABS + ABS + ABS + ABS + ABS + ABS + ABS + ABS	24.2125-1702.3	010482		Thz 25,40	
	1.9 D (10/14) 51 1.9 TD (10/14) 66 1.9 TD (10/14) 68 2.0 i (10/14) S 16206254 2.0 i (18) S 16194400 2.5 D (14) 63 S 16206254 2.5 D (18) 63 S 16194400 2.5 TD (14) 76 S 16206254 2.5 TD (18) 76 S 16194400 2.5 TDi (14) 79 S 16206254 2.5 TDi (18) 79 S 16194400 2.8 D (14) 64 S 16206254 2.8 D (18) 64 S 16194400 2.8 HDi (14) 94 S 16206254 2.8 HDi (18) 94 S 16194400	S 16206254 S 16206254 S 16206254 S 16206254 S 16194400 S 16206254 S 16194400 S 16206254 S 16194400 S 16206254 S 16194400 S 16206254 S 16194400 S 16206254 S 16194400	04.02 03.02 03.02 03.02 03.02 03.02 03.02 03.02 03.02 02.02 02.02 03.02 03.02	+ ABS + ABS + ABS + ABS + ABS + ABS + ABS + ABS + ABS + ABS + ABS + ABS + ABS + ABS	24.2125-1726.3	010718		Thz 25,40	
	1.9 D (10/14) 51 1.9 TD (10/14) 66 1.9 TD (10/14) 68 2.0 i (10/14) 2.5 D (14) 63 2.8 D (14) 64	S 16206253 S 16206253 S 16206253 S 16206253	03.94 12.98 07.96 06.94 02.94 01.99	+ ABS + ABS + ABS + ABS + ABS	24.0101-4804.2	260050		Bremssattel-Zubehör TRW	
	1.9 D (10/14) 51 1.9 TD (10/14) 66 1.9 TD (10/14) 68 2.0 i (10/14/18) 2.5 D (14/18) 63 2.5 TD (14/18) 76 2.5 TDi (14/18) 79 2.8 D (14/18) 64 2.8 HDi (14/18) 94	S 15866409 S 15866409 S 15866409 S 15866409 S 15866409 S 15866409 S 15866409 S 15866409 S 15866409	03.94 12.98 07.96 06.94 02.94 02.94 01.97 01.99 11.00			24.5112-0466.3 24.5112-0465.3	330579 330526	2 2	L=462 L=465, + Clip
	1.9 D (10/14) 51 1.9 TD (10/14) 66 1.9 TD (10/14) 68 2.0 i (10/14/18) S 15866410 2.5 D (14/18) 63 2.5 TD (14/18) 76 2.5 TDi (14/18) 79	S 15866410 S 15866410 S 15866410 S 15866410 S 15866410 S 15866410	10.01 10.01 10.01 10.01 10.01 10.01			24.5112-0466.3 24.5112-0461.3	330579 330616	2 2	L=462 L=460, + Clip





PEUGEOT BOXER Pritsche/Fahrgestell (94-02)

	2.8 D (14/18)	64 S 15866410	S 16206244			24.5112-0466.3	330579	2		L=462
	2.8 HDi (14/18)	94 S 15866410		10.01		24.5112-0461.3	330616	2		L=460, + Clip
	1.9 D (10/14)	51 S 16205353			04.02	24.5112-0477.3	331299	2		L=477
	1.9 TD (10/14)	66		11.01	03.02	24.5112-0470.3	331460	2		L=470
	1.9 TD (10/14)	68		11.01	03.02					
	2.0 i (10/14/18)			11.01	03.02					
	2.5 D (14/18)	63		11.01	03.02					
	2.5 TD (14/18)	76		11.01	03.02					
	2.5 TDi (14/18)	79		11.01	03.02					
2.8 D (14/18)	64 S 16205353									
2.8 HDi (14/18)	94		11.01	03.02						
	1.9 D (10/14)	51 S 16194400			04.02	24.3461-1701.5	240449			D=46, - Halter
	1.9 TD (10/14)	66		11.01	03.02	24.3461-1702.5	240450			D=46, - Halter
	1.9 TD (10/14)	68		11.01	03.02					
	2.0 i (10/14/18)			11.01	03.02					
	2.5 D (14/18)	63		11.01	03.02					
	2.5 TD (14/18)	76		11.01	03.02					
	2.5 TDi (14/18)	79		11.01	03.02					
	2.8 D (14/18)	64 S 16194400								
	2.8 HDi (14/18)	94		11.01	03.02					
2.8 HDi 4X4 (14/18)	93		11.01	11.01						
	1.9 D (10/14)	51	S 16206244	03.94		24.5112-0340.3	330511	1	- verstärktes Fahrwerk ¹⁾	L=340
	1.9 TD (10/14)	66		12.98	10.01	24.5112-0361.3	330649	1	+ verstärktes Fahrwerk ²⁾	L=360
	1.9 TD (10/14)	68		07.96	10.01					
	2.0 i (10/14/18)			06.94	10.01					
	2.5 D (14/18)	63		02.94	10.01					
	2.5 TD (14/18)	76		02.94	10.01					
	2.5 TDi (14/18)	79		01.97	10.01					
	2.8 D (14/18)	64	S 16206244	01.99						
	2.8 HDi (14/18)	94		11.00	10.01					
	1.9 D (10/14)	51 S 16205353			04.02	24.5112-0361.3	330649	1	+ HA-Trommelbremse ³⁾	L=360
	1.9 TD (10/14)	66		11.01	03.02	83.6401-0159.3	330746	2	+ HA-Scheibenbremse ⁴⁾	L=160
	1.9 TD (10/14)	68		11.01	03.02					
	2.0 i (10/14/18)			11.01	03.02					
	2.5 D (14/18)	63		11.01	03.02					
	2.5 TD (14/18)	76		11.01	03.02					
	2.5 TDi (14/18)	79		11.01	03.02					
	2.8 D (14/18)	64 S 16205353								
	2.8 HDi (14/18)	94		11.01	03.02					
	1.9 D (10/14)	51	S 16206253	03.94		24.5112-0315.3	330509		- verstärktes Fahrwerk ¹⁾	L=315
	1.9 TD (10/14)	66		12.98	10.01					
	1.9 TD (10/14)	68		07.96	10.01					
	2.0 i (10/14/18)			06.94	10.01					
	2.5 D (14/18)	63		02.94	10.01					
	2.5 TD (14/18)	76		02.94	10.01					
	2.5 TDi (14/18)	79		01.97	10.01					
	2.8 D (14/18)	64	S 16206253	01.99						
	2.8 HDi (14/18)	94		11.00	10.01					
	1.9 D (10/14)	51 S 16194400			04.02	83.6401-0159.3	330746	2	+ HA-Scheibenbremse ⁴⁾	L=160
	1.9 TD (10/14)	66		11.01	03.02					
	1.9 TD (10/14)	68		11.01	03.02					
	2.0 i (10/14/18)			11.01	03.02					
	2.5 D (14/18)	63		11.01	03.02					
	2.5 TD (14/18)	76		11.01	03.02					
	2.5 TDi (14/18)	79		11.01	03.02					
	2.8 D (14/18)	64 S 16194400								
	2.8 HDi (14/18)	94		11.01	03.02					
	1.9 D (10/14)	51	S 16206253	03.94		24.3225-1701.3	020399			Rz 25,40
	1.9 TD (10/14)	66		12.98	10.01					
	1.9 TD (10/14)	68		07.96	10.01					
	2.0 i (10/14)			06.94	10.01					
	2.5 D (14)	63		02.94	10.01					
	2.8 D (14)	64	S 16206253	01.99						
	2.5 TD (14)	76		02.94	10.01	24.3226-1702.3	020469			Rz 26,99
	2.5 TDi (14)	79		01.97	10.01					
	2.8 D (14)	64	S 16206253	01.99						
2.8 HDi (14)	94		11.00	10.01						
2.8 HDi 4X4 (14)	93		10.00	10.01						
	1.9 D (10/14)	51 S 16204256			04.02	24.3226-1702.3	020469			Rz 26,99
	1.9 TD (10/14)	66		11.01	03.02					
	1.9 TD (10/14)	68		11.01	03.02					
	2.0 i (10/14)			11.01	03.02					
	2.5 D (14)	63		11.01	03.02					
	2.5 TD (14)	76		11.01	03.02					
	2.5 TDi (14)	79		11.01	03.02					
	2.8 D (14)	64 S 16204256								
	2.8 HDi (14)	94		11.01	03.02					
2.8 HDi 4X4 (14)	93		11.01	11.01						
	2.0 i (18)			06.94	10.01	24.3228-1701.3	020401			Rz 28,57
	2.5 D (18)	63		02.94	10.01					
	2.5 TD (18)	76		02.94	10.01					
	2.5 TDi (18)	79		01.97	10.01					
	2.8 D (18)	64	S 16209999	01.99						
	2.8 HDi (18)	94		11.00	10.01					
	2.8 HDi 4X4 (18)	93		10.00	10.01					

1) - reinforced suspension / - sospensione rinforzata / - châssis renforcé / - suspensión reforzada
2) + reinforced suspension / + sospensione rinforzata / + châssis renforcé / + suspensión reforzada
3) + RA drum brake / + P freno a tamburo / + frein à tambour essieu AR / + ET-tambores de freno
4) + RA disc brake / + P disco freno / + frein à disque essieu AR / + ET-disco de freno



PEUGEOT BOXER Pritsche/Fahrgestell (94-02)

	1.9 D (10/14)	51	S 16158427	03.94		24.3727-0340.2	580340	1	↓		L=3025
	1.9 TD (10/14)	66	S 16158427	12.98							
	1.9 TD (10/14)	68	S 16158427	07.96							
	2.0 i (10/14/18)		S 16158427	06.94							
	2.5 D (14/18)	63	S 16158427	02.94							
	2.5 TD (14/18)	76	S 16158427	02.94							
	2.5 TDi (14/18)	79	S 16158427	01.97							
	2.8 D (14/18)	64	S 16158427	01.99							
	2.8 HDi (14/18)	94	S 16158427	11.00							
	1.9 D (10/14)	51	S 16158428	S 16194399			24.3727-0344.2	580344	1	↓	
1.9 TD (10/14)	66	S 16158428	S 16194399								
1.9 TD (10/14)	68	S 16158428	S 16194399								
2.0 i (10/14/18)		S 16158428	S 16194399								
2.5 D (14/18)	63	S 16158428	S 16194399								
2.5 TD (14/18)	76	S 16158428	S 16194399								
2.5 TDi (14/18)	79	S 16158428	S 16194399								
2.8 D (14/18)	64	S 16158428	S 16194399								
2.8 HDi (14/18)	94	S 16158428	S 16194399								
1.9 D (10/14)	51	S 16194400		04.02		24.3727-0343.2	580343	1	↓	+ HA-Trommelbremse 1)	L=2827
1.9 TD (10/14)	66	S 16194400		03.02		24.3727-0348.2	580348	1	↓	+ HA-Scheibenbremse 2)	L=2715
1.9 TD (10/14)	68	S 16194400		03.02							
2.0 i (10/14/18)		S 16194400		03.02							
2.5 D (14/18)	63	S 16194400		03.02							
2.5 TD (14/18)	76	S 16194400		03.02							
2.5 TDi (14/18)	79	S 16194400		03.02							
2.8 D (14/18)	64	S 16194400		02.02							
2.8 HDi (14/18)	94	S 16194400		03.02							
2.5 D 4x4 (14/18)	63			07.99	03.02	24.3727-0842.2	580842	1	↓		L=4100
2.5 TDi 4x4 (14/18)	79			07.99	03.02						
2.8 HDi 4X4 (14/18)	93			10.00	11.01						
	1.9 D (10/14)	51	S 16206244	03.94		24.6512-1701.3	320153			- ABS	BRL (2)
	1.9 TD (10/14)	66	S 16206244	12.98							
	1.9 TD (10/14)	68	S 16206244	07.96							
	2.0 i (10/14/18)		S 16206244	06.94							
	2.5 D (14/18)	63	S 16206244	02.94							
	2.5 TD (14/18)	76	S 16206244	02.94							
	2.5 TDi (14/18)	79	S 16206244	01.97							
	2.8 D (14/18)	64	S 16206244	01.99							
	2.8 HDi (14/18)	94	S 16206244	11.00							
		1.9 D (10/14)	51		03.94	04.02	24.3728-0300.2	590300			+ ML5-Getriebe 3)
1.9 TD (10/14)		66		12.98	03.02					+ ML5-Getriebe 3)	
1.9 TD (10/14)		68		07.96	03.02					+ ML5-Getriebe 3)	
1.9 TD (10/14)		66		12.98	03.02	24.3728-0337.2	590337			+ ME-Getriebe 4)	L=1058
1.9 TD (10/14)		68		07.96	03.02					+ ME-Getriebe 4)	
2.0 i (10/14/18)				06.94	03.02					+ ME-Getriebe 4)	
2.5 D (14/18)		63		02.94	03.02					+ ME-Getriebe 4)	
2.0 i (10/14/18)				06.94	03.02	24.3728-0335.2	590335			+ ML5-Getriebe 3)	L=1435
2.5 D (14/18)		63		02.94	03.02					+ ML5-Getriebe 3)	
2.8 D (14/18)		64		01.99	02.02					+ ML5-Getriebe 3)	
2.8 HDi (14/18)	94		11.00	03.02					+ ML5-Getriebe 3)		
2.0 i (10/14/18)			06.94	03.02	24.3728-0519.2	590519			+ MG5T-Getriebe 5)	L=1090	
2.5 D (14/18)	63		02.94	03.02					+ MG5T-Getriebe 5)		
2.5 TD (14/18)	76		02.94	03.02					+ MG5T-Getriebe 5)		
2.5 TDi (14/18)	79		01.97	03.02					+ MG5T-Getriebe 5)		
2.8 HDi (14/18)	94		11.00	03.02					+ MG5T-Getriebe 5)		

PEUGEOT BOXER (02-06)

	2.0 HDi (10/14/18)	62		04.02	03.06	24.2125-1725.3	010717			- ABS	Thz 25,40
	2.0 i (10/14/18)	81		04.02	03.06	24.2125-1726.3	010718			+ ABS	Thz 25,40
	2.2 HDi (10/14/18)	74		04.02	03.06						
	2.8 HDi (10/14/18)			04.02	03.06						
	2.0 HDi (10/14/18)	62		04.02	03.06	24.5112-0477.3	331299	2			L=477
	2.0 i (10/14/18)	81		04.02	03.06	24.5112-0470.3	331460	2			L=470
	2.2 HDi (10/14/18)	74		04.02	03.06						
	2.8 HDi (10/14/18)			04.02	03.06						
	2.0 HDi (10/14/18)	62		04.02	03.06	24.3461-1701.5	240449				D=46, - Halter
	2.0 i (10/14/18)	81		04.02	03.06	24.3461-1702.5	240450				D=46, - Halter
	2.2 HDi (10/14/18)	74		04.02	03.06						
	2.8 HDi (10/14/18)			04.02	03.06						
	2.0 HDi (10/14/18)	62		04.02	03.06	24.5112-0361.3	330649	1		+ HA-Trommelbremse 1)	L=360
	2.0 i (10/14/18)	81		04.02	03.06	83.6401-0159.3	330746	2		+ HA-Scheibenbremse 2)	L=160
	2.2 HDi (10/14/18)	74		04.02	03.06						
	2.8 HDi (10/14/18)			04.02	03.06						
	2.0 HDi (10/14/18)	62		04.02	03.06	83.6401-0159.3	330746	2		+ HA-Scheibenbremse 2)	L=160
	2.0 i (10/14/18)	81		04.02	03.06						
	2.2 HDi (10/14/18)	74		04.02	03.06						
	2.8 HDi (10/14/18)			04.02	03.06						
	2.0 HDi (10/14)	62		04.02	03.06	24.3226-1702.3	020469				Rz 26,99
	2.0 i (10/14)	81		04.02	03.06						
	2.2 HDi (10/14)	74		04.02	03.06						
	2.8 HDi (10/14)			04.02	03.06						
	2.0 HDi (10/14/18)	62		04.02	03.06	24.3727-0300.2	580300	1	↑		L=1078
	2.0 i (10/14/18)	81		04.02	03.06	24.3727-0343.2	580343	1	↓	+ HA-Trommelbremse 1)	L=2827
	2.2 HDi (10/14/18)	74		04.02	03.06						
	2.8 HDi (10/14/18)			04.02	03.06						

1) + RA drum brake / + P freno a tamburo / + frein à tambour essieu AR / + ET-tambores de freno



























2) + RA disc brake / + P disco freno / + frein à disque essieu AR / + ET-disco de freno

3) + ML5 transmission / + scatola cambio ML5 / + boîte de vitesse ML5 / + cambio ML5

4) + ME transmission / + scatola cambio ME / + boîte de vitesse ME / + cambio ME

5) + MG5T transmission / + scatola cambio MG5T / + boîte de vitesse MG5T / + cambio MG5T



										
PEUGEOT BOXER (02-06)										
	2.0 HDi (10/14/18)	62	S 17103012	04.02		24.3727-0300.2	580300	1 	L=1078 L=2715	
	2.0 i (10/14/18)	81	S 17103012	04.02		24.3727-0348.2	580348	1 		
	2.2 HDi (10/14/18)	74	S 17103012	04.02						
	2.8 HDi (10/14/18)		S 17103012	04.02						
	2.0 HDi (10/14/18)	62	S 17103013		03.06		24.3727-0300.2	580300	1 	L=1078
	2.0 i (10/14/18)	81	S 17103013		03.06					
2.2 HDi (10/14/18)	74	S 17103013		03.06						
2.8 HDi (10/14/18)		S 17103013		03.06						
2.8 HDi 4x4(10/14/18)		S 17103012	04.02			24.3727-0562.2	580562	1 	L=1059	
						24.3727-0348.2	580348	1 	L=2715	
2.8 HDi 4x4(10/14/18)		S 17103013		03.06		24.3727-0562.2	580562	1 	L=1059	
2.8 HDi 4x4(10/14/18)			04.02	03.06		24.6512-1701.3	320153		BRL (2)	
PEUGEOT BOXER (06-)										
	2.2 HDi 100	74		04.06	Nutzlast 120/140 ²⁾	24.4126-1701.3	010868	+ DSC	THz 26,99 + Behälter BOS	
	2.2 HDi 110	81		03.11	Nutzlast 120/140 ²⁾					
	2.2 HDi 120	88		04.06	Nutzlast 120/140 ²⁾					
	2.2 HDi 130	96		03.11	Nutzlast 120/140 ²⁾					
	2.2 HDi 150	110		03.11	Nutzlast 120/140 ²⁾					
	3.0 HDi 145	107		04.10	Nutzlast 120/140 ²⁾					
	3.0 HDi 160	116		04.06	Nutzlast 120/140 ²⁾					
	3.0 HDi 175	130		03.11	Nutzlast 120/140 ²⁾					
	2.2 HDi 100	74		04.06	Nutzlast 160/200 ³⁾	24.4125-1701.3	010867	+ DSC	THz 25,40 + Behälter BOS	
	2.2 HDi 110	81		03.11	Nutzlast 160/200 ³⁾					
	2.2 HDi 120	88		04.06	Nutzlast 160/200 ³⁾					
	2.2 HDi 130	96		03.11	Nutzlast 160/200 ³⁾					
2.2 HDi 150	110		03.11	Nutzlast 160/200 ³⁾						
3.0 HDi 145	107		04.10	Nutzlast 160/200 ³⁾						
3.0 HDi 160	116		04.06	Nutzlast 160/200 ³⁾						
3.0 HDi 175	130		03.11	Nutzlast 160/200 ³⁾						
	2.0 BlueHDi 110	81		07.15		24.5112-0492.3	331217	2	L=492	
	2.0 BlueHDi 130	96		07.15						
	2.0 BlueHDi 160	120		07.15						
	2.2 HDi 100	74		04.06						
	2.2 HDi 110	81		03.11						
	2.2 HDi 120	88		04.06						
	2.2 HDi 130	96		03.11						
	2.2 HDi 150	110		03.11						
	3.0 HDi 145	107		04.10						
	3.0 HDi 160	116		04.06						
3.0 HDi 175	130		03.11							
	2.0 BlueHDi 110	81		07.15		24.5112-0417.3	331298	2	+ kurzer Radstand ⁴⁾	L=417
	2.0 BlueHDi 130	96		07.15		83.7101-9489.3	330906	2	+ langer Radstand ⁵⁾	L=489
	2.0 BlueHDi 160	120		07.15						
	2.2 HDi 100	74		04.06						
	2.2 HDi 110	81		03.11						
	2.2 HDi 120	88		04.06						
	2.2 HDi 130	96		03.11						
	2.2 HDi 150	110		03.11						
	3.0 HDi 145	107		04.10						
	3.0 HDi 160	116		04.06						
3.0 HDi 175	130		03.11							
PEUGEOT EXPERT Kombi (95-06)										
	1.6	58	ORGA 08206	10.95		24.2122-1703.3	010422	- ABS/ + 0,8 t	THz 22,20	
	1.8	74	ORGA 08206	10.96		24.2122-1708.3	010437	+ ABS/ + 0,8 t	THz 22,20	
	1.9 D	51	ORGA 08206	10.95		24.2123-1707.3	010492	- ABS/ + 0,9 t	THz 23,81	
	1.9 TD	66	ORGA 08206	10.95						
	1.9 TD	68	ORGA 08206	04.96						
	1.6	58	ORGA 08207		12.06	24.2122-1741.3	010695	- ABS/ + 0,8 t	THz 22,20	
	1.8	74	ORGA 08207		12.06	24.2122-1742.3	010696	+ ABS/ + 0,8 t	THz 22,20	
	1.9 D	51	ORGA 08207		12.06	24.2123-1738.3	010658	- ABS/ + 0,9 t	THz 23,81	
	1.9 TD	66	ORGA 08207		12.06	24.2123-1733.3	010657	+ ABS/ + 0,9 t	THz 23,81	
	1.9 TD	68	ORGA 08207		12.06					
	2.0 16V	100		07.00	12.06	24.2123-1738.3	010658	- ABS	THz 23,81	
	2.0 HDi	69		07.00	12.06	24.2123-1733.3	010657	+ ABS	THz 23,81	
	2.0 HDi	80		07.00	12.06					
	1.6	58	ORGA 09792	10.95		24.3571-1709.5	240153		D=57, - Halter	
	1.8	74	ORGA 09792	10.96		24.3571-1710.5	240154		D=57, - Halter	
	1.9 D	51	ORGA 09155	10.95						
	1.9 TD	66	ORGA 09792	10.95						
	1.9 TD	68	ORGA 09792	04.96						
	2.0 16V	100	ORGA 09792	07.00						
	2.0 HDi	69	ORGA 09792	07.00						
	2.0 HDi	80	ORGA 09792	07.00						
	1.9 D	51	ORGA 09156		12.06	24.3571-1711.5	240159		D=57, - Halter	
						24.3571-1712.5	240160		D=57, - Halter	
	1.6	58	ORGA 09793		12.06	24.3601-1711.7	220607		D=60, - Halter	
	1.8	74	ORGA 09793		12.06	24.3601-1712.7	220608		D=60, - Halter	
	1.9 TD	66	ORGA 09793		12.06					
	1.9 TD	68	ORGA 09793		12.06					
	2.0 16V	100	ORGA 09793		12.06					
	2.0 HDi	69	ORGA 09793		12.06					

1) + RA disc brake / + P disco freno / + frein à disque essieu AR / + ET-disco de freno
2) payload 120/140 / carico utile 120/140 / charge utile 120/140 / carga útil 120/140
3) payload 160/200 / carico utile 160/200 / charge utile 160/200 / carga útil 160/200
4) + short wheel base / + passo lungo / + empattement court / + distancia corta entre ejes
5) + long wheel base / + passo lungo / + empattement long / + distancia larga entre ejes

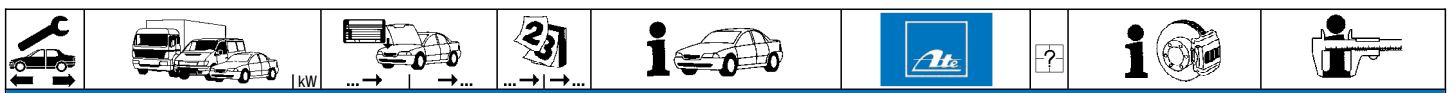

PEUGEOT EXPERT Kombi (95-06)





























	2.0 HDi	80	ORGA 09793		12.06		24.3601-1711.7 24.3601-1712.7	220607 220608			D=60, - Halter D=60, - Halter	TRW TRW
	1.6 1.8 1.9 D 1.9 TD 1.9 TD 2.0 16V 2.0 HDi 2.0 HDi	58 74 51 66 68 100 69 80	ORGA 09792 ORGA 09792 ORGA 09792 ORGA 09792 ORGA 09792 ORGA 09792 ORGA 09792 ORGA 09792	10.95 10.96 10.95 10.95 04.96 07.00 07.00			24.5118-0471.3	330528	2		L=473	
	1.6 1.8 1.9 D 1.9 TD 1.9 TD 2.0 16V 2.0 HDi 2.0 HDi	58 74 51 66 68 100 69 80	ORGA 09793 ORGA 09793 ORGA 09793 ORGA 09793 ORGA 09793 ORGA 09793 ORGA 09793 ORGA 09793	12.06 12.06 12.06 12.06 12.06 12.06 12.06 12.06			24.5111-0462.3	330555	2		L=460	
	1.6 1.8 1.9 D 1.9 TD 1.9 TD 2.0 16V 2.0 HDi 2.0 HDi	58 74 51 66 68 100 69 80		10.95 10.96 10.95 10.95 04.96 07.00 07.00	12.06 12.06 12.06 12.06 12.06 12.06 12.06		24.5229-0251.3	330535	2		L=250	
	1.6 1.8 1.9 D 1.9 TD 1.9 TD 2.0 16V 2.0 HDi 2.0 HDi	58 74 51 66 68 100 69 80		10.95 10.96 10.95 10.95 04.96 07.00 07.00	12.06 12.06 12.06 12.06 12.06 12.06 12.06		24.3219-1704.3	020374			Rz 19,05	
	1.6 1.8 1.9 D 1.9 TD 1.9 TD 2.0 16V 2.0 HDi 2.0 HDi	58 74 51 66 68 100 69 80		10.95 10.96 10.95 10.95 04.96 07.00 07.00	12.06 12.06 12.06 12.06 12.06 12.06 12.06		24.3727-0336.2 24.3727-0341.2 24.3727-0532.2 24.3727-0531.2	580336 580341 580532 580531	1 1	- langer Radstand ¹⁾ + langer Radstand ²⁾	L=500 L=900 L=1063 L=2286	
	1.6 1.8 1.9 D 1.9 TD 1.9 TD 2.0 16V 2.0 HDi 2.0 HDi	58 74 51 66 68 100 69 80		10.95 10.96 10.95 10.95 04.96 07.00 07.00	12.06 12.06 12.06 12.06 12.06 12.06 12.06		24.3727-0336.2 24.3727-0341.2 24.3727-0532.2	580336 580341 580532	1 1	- langer Radstand ¹⁾ + langer Radstand ²⁾	L=500 L=900 L=1063	
	1.6 1.8 1.9 D 1.9 TD 1.9 TD 2.0 HDi 2.0 HDi	58 74 51 66 68 69 80		10.95 10.96 10.95 04.96 07.00 07.00	12.06 12.06 12.06 12.06 12.06 12.06		24.3728-0341.2	590341			L=739, + AUT	
	1.9 D 2.0 16V	51 100		10.95 07.00	12.06 12.06	+ BE4-Getriebe ³⁾	24.3728-0336.2	590336			L=973, + AUT	
	1.9 TD 1.9 TD	66 68		10.95 04.96	12.06 12.06		24.3728-0342.2 24.3728-0340.2	590342 590340		+ MESK-Getriebe ⁴⁾ + ML5T-Getriebe ⁵⁾	L=864, + AUT L=1088, + AUT	
	2.0 HDi 2.0 HDi	69 80		07.00 07.00	12.06 12.06		24.3728-0333.2	590333			L=1003, + AUT	

PEUGEOT EXPERT Kasten (95-06)

	1.6 1.8 1.9 D 1.9 TD 1.9 TD	58 74 51 66 68	ORGA 08206 ORGA 08206 ORGA 08206 ORGA 08206 ORGA 08206	10.95 10.96 10.95 10.95 04.96			24.2122-1703.3 24.2122-1708.3 24.2123-1707.3	010422 010437 010492			- ABS/ + 0,8 t + ABS/ + 0,8 t - ABS/ + 0,9 t	THz 22,20 THz 22,20 THz 23,81	
	1.6 1.8 1.9 D 1.9 TD 1.9 TD	58 74 51 66 68	ORGA 08207 ORGA 08207 ORGA 08207 ORGA 08207 ORGA 08207	10.95 10.96 10.95 04.96 12.06			24.2122-1741.3 24.2122-1742.3 24.2123-1738.3 24.2123-1733.3	010695 010696 010658 010657			- ABS/ + 0,8 t + ABS/ + 0,8 t - ABS/ + 0,9 t + ABS/ + 0,9 t	THz 22,20 THz 22,20 THz 23,81 THz 23,81	
	2.0 16V 2.0 HDi 2.0 HDi	100 69 80		07.00 07.00 07.00	12.06 12.06 12.06		24.2123-1738.3 24.2123-1733.3	010658 010657			- ABS + ABS	THz 23,81 THz 23,81	
	1.6 1.8 1.9 D 1.9 TD 1.9 TD 2.0 16V 2.0 HDi 2.0 HDi	58 74 51 66 68 100 69 80	ORGA 09792 ORGA 09792 ORGA 09155 ORGA 09792 ORGA 09792 ORGA 09792 ORGA 09792 ORGA 09792	10.95 10.96 10.95 10.95 04.96 07.00 07.00		+ 0,8/0,9 t + 0,8/0,9 t + 0,8/0,9 t + 0,8/0,9 t + 0,8/0,9 t + 0,8/0,9 t + 0,8/0,9 t	24.3571-1709.5 24.3571-1710.5	240153 240154	 		D=57, - Halter D=57, - Halter	TRW TRW	
	1.9 D	51	ORGA 09156	12.06	+ 0,8/0,9 t		24.3571-1711.5 24.3571-1712.5	240159 240160	 		D=57, - Halter D=57, - Halter	BDX BDX	

¹⁾ - long wheel base / - passo lungo / - empattement long / - distancia larga entre ejes
²⁾ + long wheel base / + passo lungo / + empattement long / + distancia larga entre ejes
³⁾ + BE4 transmission / + scatola cambio BE4 / + boîte de vitesse BE4 / + cambio BE4
⁴⁾ + MESK transmission / + scatola cambio MESK / + boîte de vitesse MESK / + cambio MESK
⁵⁾ + ML5T transmission / + scatola cambio ML5T / + boîte de vitesse ML5T / + cambio ML5T





























												
PEUGEOT EXPERT Kasten (95-06)												
	1.6 1.8 1.9 TD 1.9 TD 2.0 16V 2.0 HDi 2.0 HDi	58 74 66 68 100 69 80	ORGA 09793 ORGA 09793 ORGA 09793 ORGA 09793 ORGA 09793 ORGA 09793 ORGA 09793		12.06 12.06 12.06 12.06 12.06 12.06 12.06	+ 0,8/0,9 t + 0,8/0,9 t + 0,8/0,9 t + 0,8/0,9 t + 0,8/0,9 t + 0,8/0,9 t + 0,8/0,9 t	24.3601-1711.7 24.3601-1712.7	220607 220608	<input type="checkbox"/> <input type="checkbox"/>	D=60, - Halter D=60, - Halter	TRW TRW	
	1.6 1.8 1.9 D 1.9 TD 1.9 TD 2.0 16V 2.0 HDi 2.0 HDi	58 74 51 66 68 100 69 80	ORGA 09792 ORGA 09792 ORGA 09792 ORGA 09792 ORGA 09792 ORGA 09792 ORGA 09792 ORGA 09792	10.95 10.96 10.95 10.95 04.96 07.00 07.00 07.00	12.06 12.06 12.06 12.06 12.06 12.06 12.06 12.06		24.5118-0471.3	330528	2	L=473		
	1.6 1.8 1.9 D 1.9 TD 1.9 TD 2.0 16V 2.0 HDi 2.0 HDi	58 74 51 66 68 100 69 80	ORGA 09793 ORGA 09793 ORGA 09793 ORGA 09793 ORGA 09793 ORGA 09793 ORGA 09793 ORGA 09793		12.06 12.06 12.06 12.06 12.06 12.06 12.06 12.06		24.5111-0462.3	330555	2	L=460		
	1.6 1.8 1.9 D 1.9 TD 1.9 TD 2.0 16V 2.0 HDi 2.0 HDi	58 74 51 66 68 100 69 80		10.95 10.96 10.95 10.95 04.96 07.00 07.00 07.00	12.06 12.06 12.06 12.06 12.06 12.06 12.06 12.06		24.5229-0251.3	330535	2	L=250		
	1.6 1.8 1.9 D 1.9 TD 1.9 TD 2.0 16V 2.0 HDi 2.0 HDi	58 74 51 66 68 100 69 80		10.95 10.96 10.95 04.96 07.00 07.00 07.00	12.06 12.06 12.06 12.06 12.06 12.06 12.06		24.3219-1704.3	020374		Rz 19,05		
	1.6 1.8 1.9 D 1.9 TD 1.9 TD 2.0 16V 2.0 HDi 2.0 HDi	58 74 51 66 68 100 69 80		10.95 10.96 10.95 10.95 04.96 07.00 07.00 07.00	12.06 12.06 12.06 12.06 12.06 12.06 12.06 12.06		24.3727-0336.2 24.3727-0341.2 24.3727-0532.2 24.3727-0531.2	580336 580341 580532 580531	1  1 	- langer Radstand ¹⁾ + langer Radstand ²⁾	L=500 L=900 L=1063 L=2286	
	1.6 1.8 1.9 D 1.9 TD 1.9 TD 2.0 16V 2.0 HDi 2.0 HDi	58 74 51 66 68 100 69 80		10.95 10.96 10.95 10.95 04.96 07.00 07.00 07.00	12.06 12.06 12.06 12.06 12.06 12.06 12.06 12.06		24.3727-0336.2 24.3727-0341.2 24.3727-0532.2	580336 580341 580532	1  1 	- langer Radstand ¹⁾ + langer Radstand ²⁾	L=500 L=900 L=1063	
	1.6 1.8 1.9 TD 1.9 TD 1.9 D 2.0 16V 2.0 HDi 2.0 HDi	58 74 66 68 51 100 69 80		10.95 10.96 10.95 04.96 10.95 07.00 07.00 07.00	12.06 12.06 12.06 12.06 12.06 12.06 12.06 12.06		24.3728-0341.2	590341			L=739, + AUT	
	1.6 1.8 1.9 TD 1.9 TD	58 74 66 68		10.95 10.96 10.95 04.96	12.06 12.06 12.06 12.06		24.3728-0342.2 24.3728-0340.2	590342 590340		+ ME5K-Getriebe ³⁾ + ML5T-Getriebe ⁴⁾	L=864, + AUT L=1088, + AUT	
	1.6 1.8 1.9 D	58 74 51		10.95 10.96 10.95	12.06 12.06 12.06		24.3728-0333.2	590333			L=1003, + AUT	
	1.6 1.8 1.9 D	58 74 51		10.95 10.96 10.95	12.06 12.06 12.06		24.3728-0341.2	590341			L=739, + AUT	
PEUGEOT EXPERT Pritsche/Fahrgestell (95-06)												
	1.6 1.9 D 1.9 TD 1.9 TD	58 51 66 68	ORGA 08206 ORGA 08206 ORGA 08206 ORGA 08206	10.95 10.95 10.95 04.96	12.06 12.06 12.06 12.06		24.2122-1703.3 24.2122-1708.3 24.2123-1707.3	010422 010437 010492		- ABS/ + 0,8 t + ABS/ + 0,8 t - ABS/ + 0,9 t	THz 22,20 THz 22,20 THz 23,81	
	1.6 1.9 D 1.9 TD 1.9 TD 2.0 HDi	58 51 66 68 80	ORGA 08207 ORGA 08207 ORGA 08207 ORGA 08207 ORGA 08207	10.95 10.95 10.95 10.95 10.00	12.06 12.06 12.06 12.06 12.06		24.2122-1741.3 24.2122-1742.3 24.2123-1738.3 24.2123-1733.3	010695 010696 010658 010657		- ABS/ + 0,8 t + ABS/ + 0,8 t - ABS/ + 0,9 t + ABS/ + 0,9 t	THz 22,20 THz 22,20 THz 23,81 THz 23,81	
	1.6 1.9 D 1.9 TD 1.9 TD 2.0 HDi	58 51 66 68 80	ORGA 09792 ORGA 09792 ORGA 09792 ORGA 09792 ORGA 09792	10.95 10.95 10.95 04.96 10.00	12.06 12.06 12.06 12.06 12.06		24.3571-1709.5 24.3571-1710.5	240153 240154	<input type="checkbox"/> <input type="checkbox"/>		D=57, - Halter D=57, - Halter	TRW TRW
	1.6 1.9 D 1.9 TD	58 51 66	ORGA 09793 ORGA 09793 ORGA 09793	12.06 12.06 12.06	12.06 12.06 12.06		24.3601-1711.7 24.3601-1712.7	220607 220608	<input type="checkbox"/> <input type="checkbox"/>		D=60, - Halter D=60, - Halter	TRW TRW

1) - long wheel base / - passo lungo / - empattement long / - distancia larga entre ejes
2) + long wheel base / + passo lungo / + empattement long / + distancia larga entre ejes
3) + ME5K transmission / + scatola cambio ME5K / + boîte de vitesse ME5K / + cambio ME5K
4) + ML5T transmission / + scatola cambio ML5T / + boîte de vitesse ML5T / + cambio ML5T

PEUGEOT EXPERT Pritsche/Fahrgestell (95-06)									
	1.9 TD 2.0 HDi	68 ORGA 09793 80 ORGA 09793		12.06 12.06	24.3601-1711.7 24.3601-1712.7	220607 220608		D=60, - Halter D=60, - Halter	TRW TRW
	1.6 1.9 D 1.9 TD 1.9 TD 2.0 HDi	58 51 66 68 80	ORGA 09792 ORGA 09792 ORGA 09792 ORGA 09792 ORGA 09792	10.95 10.95 10.95 04.96 10.00	24.5118-0471.3	330528	2	L=473	
	1.6 1.9 D 1.9 TD 1.9 TD 2.0 HDi	58 ORGA 09793 51 ORGA 09793 66 ORGA 09793 68 ORGA 09793 80 ORGA 09793		12.06 12.06 12.06 12.06 12.06	24.5111-0462.3	330555	2	L=460	
	1.6 1.9 D 1.9 TD 1.9 TD 2.0 HDi	58 51 66 68 80		10.95 10.95 10.95 04.96 10.00	24.5229-0251.3	330535	2	L=250	
	1.6 1.9 D 1.9 TD 1.9 TD 2.0 HDi	58 51 66 68 80		10.95 10.95 10.95 04.96 10.00	24.3219-1704.3	020374		Rz 19,05	
	1.6 1.9 D 1.9 TD 1.9 TD 2.0 HDi	58 51 66 68 80		10.95 10.95 10.95 04.96 10.00	24.3727-0336.2 24.3727-0341.2 24.3727-0532.2 24.3727-0531.2	580336 580341 580532 580531	1 1 <input type="checkbox"/> <input type="checkbox"/>	- langer Radstand ¹⁾ + langer Radstand ²⁾	L=500 L=900 L=1063 L=2286
	1.6 1.9 D 1.9 TD 1.9 TD 2.0 HDi	58 51 66 68 80		10.95 10.95 10.95 04.96 10.00	24.3727-0336.2 24.3727-0341.2 24.3727-0532.2	580336 580341 580532	1 1 <input type="checkbox"/>	- langer Radstand ¹⁾ + langer Radstand ²⁾	L=500 L=900 L=1063
	1.9 D 1.9 TD	51 66		10.95 10.95	24.3728-0336.2 24.3728-0342.2 24.3728-0340.2	590336 590342 590340		+ ME5K-Getriebe ³⁾ + ML5T-Getriebe ⁴⁾	L=973, + AUT L=864, + AUT L=1088, + AUT

PEUGEOT EXPERT / Expert Tepee (07-15)									
	1.6 HDi 90 2.0 HDi 100 2.0 HDi 120 2.0 HDi 120 4x4 2.0 HDi 130 2.0 HDi 130 4x4 2.0 HDi 140 2.0 HDi 165 2.0 i 16V	66 72 88 88 94 94 100 120 103		01.07 03.11 01.07 01.07 03.11 03.11 01.07 09.09 01.07	03.2125-0298.3 03.2125-0293.3	010818 010817	- ESP + ESP	THz 25,40 THz 25,40	ATE ATE
	1.6 HDi 90 2.0 HDi 100 2.0 HDi 120 2.0 HDi 120 4x4 2.0 HDi 130 2.0 HDi 130 4x4 2.0 HDi 140 2.0 HDi 165 2.0 i 16V	66 72 88 88 94 94 100 120 103		01.07 03.11 01.07 01.07 03.11 03.11 01.07 09.09 01.07	24.3451-1725.5 24.3451-1726.5	240619 240620	 	D=45/48, - Halter D=45/48, - Halter	TRW TRW
	1.6 HDi 90 2.0 HDi 100 2.0 HDi 120 2.0 HDi 120 4x4 2.0 HDi 130 2.0 HDi 130 4x4 2.0 HDi 140 2.0 HDi 165 2.0 i 16V	66 72 88 88 94 94 100 120 103		01.07 03.11 01.07 01.07 03.11 03.11 01.07 09.09 01.07	24.3481-1785.5 24.3481-1786.5	240595 240596	 	D=48/45, - Halter D=48/45, - Halter	TRW TRW
	1.6 HDi 90 2.0 HDi 100 2.0 HDi 120 2.0 HDi 120 4x4 2.0 HDi 130 2.0 HDi 130 4x4 2.0 HDi 140 2.0 HDi 165 2.0 i 16V	66 72 88 88 94 94 100 120 103		01.07 03.11 01.07 01.07 03.11 03.11 01.07 09.09 01.07	24.5144-0455.3	331201	2	L=455	
	1.6 HDi 90 2.0 HDi 100 2.0 HDi 120 2.0 HDi 120 4x4 2.0 HDi 130 2.0 HDi 130 4x4 2.0 HDi 140 2.0 HDi 165 2.0 i 16V	66 72 88 88 94 94 100 120 103		01.07 03.11 01.07 01.07 03.11 03.11 01.07 09.09 01.07	24.3414-1715.5 24.3414-1716.5	240589 240590	 	D=41, - Halter D=41, - Halter	TRW TRW
	1.6 HDi 90 2.0 HDi 100 2.0 HDi 120 2.0 HDi 120 4x4 2.0 HDi 130 2.0 HDi 130 4x4 2.0 HDi 140 2.0 HDi 165 2.0 i 16V	66 72 88 88 94 94 100 120 103	ORGA 10933 ORGA 10933 ORGA 10933 ORGA 10933 ORGA 10933 ORGA 10933 ORGA 10933 ORGA 10933 ORGA 10933	01.07 03.11 01.07 01.07 03.11 03.11 01.07 09.09 01.07	24.5239-0260.3 24.5239-0365.3	331171 331281	2 2	- langer Radstand ¹⁾ + langer Radstand ²⁾	L=260 L=365

¹⁾ - long wheel base / - passo lungo / - empattement long / - distancia larga entre ejes
²⁾ + long wheel base / + passo lungo / + empattement long / + distancia larga entre ejes
³⁾ + ME5K transmission / + scatola cambio ME5K / + boîte de vitesse ME5K / + cambio ME5K
⁴⁾ + ML5T transmission / + scatola cambio ML5T / + boîte de vitesse ML5T / + cambio ML5T
⁵⁾ + RA drum brake / + P freno a tamburo / + frein à tambour essieu AR / + ET-tambores de freno
⁶⁾ + RA disc brake / + P disco freno / + frein à disque essieu AR / + ET-disco de freno

PEUGEOT EXPERT / Expert Tepee (07-15)												
												
	1.6 HDi 90 2.0 HDi 100 2.0 HDi 120 2.0 HDi 120 4x4 2.0 HDi 130 2.0 HDi 130 4x4 2.0 HDi 140 2.0 HDi 165 2.0 i 16V	66 ORGA 10934 72 ORGA 10934 88 ORGA 10934 88 ORGA 10934 94 ORGA 10934 94 ORGA 10934 100 ORGA 10934 120 ORGA 10934 103 ORGA 10934							24.5239-0240.3 331170 24.5239-0355.3 331243	2 2 - langer Radstand ¹⁾ + langer Radstand ²⁾	L=240 L=355	
	1.6 HDi 90	66		01.07					24.3222-1726.3 020518		Rz 22,20	TRW
PEUGEOT PARTNER Kombi (96-08)												
	1.1 i 1.4 i 1.8 i 1.9 D 1.9 D Electric	44 55 66 50 51 28	ORGA 08609 ORGA 08609 ORGA 08609 ORGA 08609 ORGA 08609 ORGA 08609	07.96 07.96 05.97 07.96 12.98 01.98					24.2123-1710.3 010504		THz 23,81	BOS
	1.1 i 1.4 i 1.8 i 1.9 D 1.9 D Electric	44 55 66 50 51 28	ORGA 08609 ORGA 08609 ORGA 08609 ORGA 08609 ORGA 08609 ORGA 08609	07.96 07.96 05.97 07.96 12.98 01.98					24.2123-1713.3 010505		THz 23,81	BOS
	1.1 i 1.4 i 1.6 16V 1.6 HDi 75 1.6 HDi 90 1.8 i 1.9 D 1.9 D 2.0 HDi 90 Electric	44 ORGA 08610 55 ORGA 08610 80 55 66 66 ORGA 08610 50 ORGA 08610 51 ORGA 08610 66 28 ORGA 08610		07.01 02.06 02.06 03.08 03.08 03.08 03.08 03.08 02.00 03.08	03.08 03.08 - ESP 03.08 03.08 03.08 03.08 03.08 - ESP 03.08			03.2123-2781.3 010631 24.2123-1714.3 010587 24.2123-1715.3 010520		- ABS - ABS + ABS	THz 23,81 THz 23,81 THz 23,81	ATE BDX BDX
	1.1 i 1.4 i 1.6 16V 1.8 i 1.9 D 1.9 D 2.0 HDi 90 Electric	44 55 80 66 50 51 66 28		07.96 07.96 07.01 05.97 07.96 12.98 02.00 01.98	09.02 09.02 03.08 03.08 03.08 03.08 03.08 12.01			24.3541-1777.5 240247 24.3541-1778.5 240248 24.3541-1757.7 220483 24.3541-1758.7 220484		   	D=54, - Halter D=54, - Halter D=54, - Halter D=54, - Halter	TRW TRW TRW TRW
	1.1 i 1.4 1.4 i 1.6 16V 1.6 HDi 75 1.6 HDi 90 1.8 i 1.9 D 1.9 D 1.9 D 4X4 2.0 HDi 90	44 54 55 80 ORGA 09128 55 66 66 ORGA 09128 50 ORGA 09128 51 ORGA 09128 51 66 ORGA 09128		10.02 11.02 10.02 07.01 02.06 02.06 03.08 03.08 04.04 03.08	03.08 03.08 03.08 - ESP - ESP - ESP 03.08 03.08 03.08 - ESP			24.3541-1771.5 240239 24.3541-1772.5 240240		 	D=54, - Halter D=54, - Halter	BOS BOS
	1.6 16V 1.6 HDi 75 1.6 HDi 90 2.0 HDi 90	80 ORGA 09128 55 66 66 ORGA 09128		02.06 02.06 03.08 03.08	+ ESP + ESP + ESP + ESP			24.3541-1761.5 240233 24.3541-1762.5 240234		 	D=54, - Halter D=54, - Halter	BOS BOS
	1.1 i 1.4 i 1.6 16V 1.6 HDi 75 1.6 HDi 90 1.8 i 1.9 D 1.9 D 2.0 HDi 90 Electric	44 55 80 55 66 66 50 51 66 28		07.96 07.96 07.01 02.06 02.06 05.97 07.96 12.98 02.00 01.98	03.08 03.08 - ESP - ESP - ESP 03.08 03.08 03.08 - ESP 12.01			24.5111-0438.3 330568	2		L=445	
	1.6 16V 1.6 HDi 75 1.6 HDi 90 2.0 HDi 90	80 55 66 66		07.01 02.06 02.06 02.00	03.08 03.08 + ESP + ESP			24.5111-0460.3 330603	2		L=460	
	1.6 16V 1.6 HDi 75 1.6 HDi 90 2.0 HDi 90	80 55 66 66		07.01 02.06 02.06 02.00	03.08 03.08 + ESP + ESP			24.3387-1711.7 220747 24.3387-1712.7 220748		 	D=38, - Halter D=38, - Halter	TRW TRW
	1.1 i 1.4 i 1.6 16V 1.8 i 1.9 D 1.9 D 2.0 HDi 90 Electric	44 55 80 66 50 51 66 28	ORGA 09533 ORGA 09533 ORGA 09533 ORGA 09533 ORGA 09533 ORGA 09533 ORGA 09533	07.96 07.96 07.01 05.97 07.96 12.98 02.00 01.98	12.01			24.5229-0255.3 330581	2		L=255	

¹⁾ - long wheel base / - passo lungo / - empattement long / - distancia larga entre ejes

²⁾ + long wheel base / + passo lungo / + empattement long / + distancia larga entre ejes

PEUGEOT PARTNER Kombi (96-08)										
	1.1 i	44	ORGA 09534		03.08		24.5246-0260.3	330782	2	L=260
	1.4 i	55	ORGA 09534		03.08					
	1.6 16V	80	ORGA 09534		03.08					
	1.6 HDi 75	55		02.06	03.08					
	1.6 HDi 90	66		02.06	03.08					
	1.8 i	66	ORGA 09534		03.08					
	1.9 D	50	ORGA 09534		03.08					
	1.9 D	51	ORGA 09534		03.08					
	2.0 HDi 90	66	ORGA 09534		03.08					
	1.1 i	44		07.96	03.08		24.3222-1711.3	020413		Rz 22,20
	1.4 i	55		07.96	03.08		24.3222-1734.3	020539		Rz 22,20
	1.6 16V	80		07.01	03.08	- ESP				
	1.6 HDi 75	55		02.06	03.08	- ESP				
	1.6 HDi 90	66		02.06	03.08	- ESP				
	1.8 i	66		05.97	03.08					
	1.9 D	50		07.96	03.08					
	1.9 D	51		12.98	03.08					
	2.0 HDi 90	66		02.00	03.08	- ESP				
	Electric	28		01.98	12.01					
	1.1 i	44	ORGA 08393	07.96	03.08		24.3727-0314.2	580314	<input type="checkbox"/> + HA-Trommelbremse ¹⁾	L=1745
	1.4 i	55	ORGA 08393	07.96	03.08		24.3727-0315.2	580315	<input type="checkbox"/> + HA-Trommelbremse ¹⁾	L=1818
	1.8 i	66	ORGA 08393	05.97	03.08					
	1.9 D	50	ORGA 08393	07.96	03.08					
	1.9 D	51	ORGA 08393	12.98	03.08					
	1.1 i	44	ORGA 08394		03.08	+ Δ	24.3727-0314.2	580314	<input type="checkbox"/> + HA-Trommelbremse ¹⁾	L=1745
	1.4 i	55	ORGA 08394		03.08		24.3727-0339.2	580339	<input type="checkbox"/> + HA-Trommelbremse ¹⁾	L=1850
	1.6 16V	80		07.01	03.08	- ESP				
	1.6 HDi 75	55		02.06	03.08	- ESP				
	1.6 HDi 90	66		02.06	03.08	- ESP				
	1.8 i	66	ORGA 08394		03.08					
	1.9 D	50	ORGA 08394		03.08					
	1.9 D	51	ORGA 08394		03.08					
	2.0 HDi 90	66		02.00	03.08	- ESP				
	1.6 16V	80		07.01	03.08	+ ESP	24.3727-0349.2	580349	<input type="checkbox"/> + HA-Scheibenbremse ²⁾	L=1820
	1.6 HDi 75	55		02.06	03.08	+ ESP	24.3727-0347.2	580347	<input type="checkbox"/> + HA-Scheibenbremse ²⁾	L=1923
	1.6 HDi 90	66		02.06	03.08	+ ESP				
	2.0 HDi 90	66		02.00	03.08	+ ESP				
	1.1 i	44		07.96	03.08		03.6582-0010.3	320145	- verstärktes Fahrwerk ³⁾	BRL 8/1,5 (4)
	1.4 i	55		07.96	03.08		03.6582-0011.3	320232	+ verstärktes Fahrwerk ⁴⁾	BRL 8/1,5 (4)
	1.6 16V	80		07.01	03.08					
	1.6 HDi 75	55		02.06	03.08					
	1.6 HDi 90	66		02.06	03.08					
	1.8 i	66		05.97	03.08					
	1.9 D	50		07.96	03.08					
	1.9 D	51		12.98	03.08					
	2.0 HDi 90	66		02.00	03.08					
	Electric	28		01.98	12.01		03.6582-0015.3	320227		BRL 8/1,5 (4)
	1.1 i	44		07.96	03.08		24.3728-0328.2	590328		L=617
	1.4 i	55		07.96	03.08					
	1.6 16V	80		07.01	03.08		24.3728-0850.2	590850		L=909, + AUT
	1.6 HDi 75	55		02.06	03.08					
	2.0 HDi 90	66		02.00	03.08					
	1.6 HDi 90	66	ORGA 11129	02.06			24.3728-0850.2	590850	+ BE4-Getriebe ⁵⁾	L=909, + AUT
	1.9 D	50	ORGA 11129	07.96						
	1.9 D	51	ORGA 11129	12.98						
	2.0 HDi 90	66	ORGA 11129	02.00						
	1.6 HDi 90	66	ORGA 11130		03.08		24.3728-0343.2	590343	+ BE4-Getriebe ⁵⁾	L=882, + AUT
	1.9 D	50	ORGA 11130		03.08					
	1.9 D	51	ORGA 11130		03.08					
	2.0 HDi 90	66	ORGA 11130		03.08					
	1.9 D	50		07.96	03.08	+ BE3-Getriebe ⁶⁾	24.3728-0329.2	590329		L=653, + AUT
	1.9 D	51		12.98	03.08	+ BE3-Getriebe ⁶⁾				
	1.8 i	66		05.97	03.08		24.3728-0338.2	590338		L=653, + AUT
PEUGEOT PARTNER Kasten (96-08)										
	1.1 i	44	ORGA 08609	07.96		- ABS	24.2123-1710.3	010504		THz 23,81
	1.4 i	55	ORGA 08609	07.96		- ABS				
	1.8	66	ORGA 08609	03.97		- ABS				
	1.8 D	43	ORGA 08609	07.96		- ABS				
	1.8 D	44	ORGA 08609	11.96		- ABS				
	1.9 D	50	ORGA 08609	05.96		- ABS				
	1.9 D	51	ORGA 08609	07.96		- ABS				
	1.1 i	44	ORGA 08609	07.96		+ ABS	24.2123-1713.3	010505		THz 23,81
	1.4 i	55	ORGA 08609	07.96		+ ABS				
	1.8	66	ORGA 08609	03.97		+ ABS				
	1.8 D	43	ORGA 08609	07.96		+ ABS				
	1.8 D	44	ORGA 08609	11.96		+ ABS				
	1.9 D	50	ORGA 08609	05.96		+ ABS				
	1.9 D	51	ORGA 08609	07.96		+ ABS				
	1.1 i	44	ORGA 08610		03.08		03.2123-2781.3	010631	- ABS	THz 23,81
	1.4 i	55	ORGA 08610		03.08		24.2123-1714.3	010587	- ABS	THz 23,81
	1.6 HDi 75	55		02.06	03.08		24.2123-1715.3	010520	+ ABS	THz 23,81
	1.6 HDi 90	66		02.06	03.08					
	1.8	66	ORGA 08610		08.00					
	1.8 D	43	ORGA 08610		03.08					

¹⁾ + RA drum brake / + P freno a tamburo / + frein à tambour essieu AR / + ET-tambores de freno

















²⁾ + RA disc brake / + P disco freno / + frein à disque essieu AR / + ET-disco de freno







³⁾ - reinforced suspension / - sospensione rinforzata / - châssis renforcé / - suspensión reforzada

⁴⁾ + reinforced suspension / + sospensione rinforzata / + châssis renforcé / + suspensión reforzada























⁵⁾ + BE4 transmission / + scatola cambio BE4 / + boîte de vitesse BE4 / + cambio BE4

⁶⁾ + BE3 transmission / + scatola cambio BE3 / + boîte de vitesse BE3 / + cambio BE3

											
PEUGEOT PARTNER Kasten (96-08)											
	1.8 D 1.9 D 1.9 D 2.0 HDi 90 Electric	44 50 51 66 25	ORGA 08610 ORGA 08610 ORGA 08610		11.96 12.98 03.08 04.00 01.98	03.2123-2781.3 24.2123-1714.3 24.2123-1715.3	010631 010587 010520	- ABS - ABS + ABS	THz 23,81 THz 23,81 THz 23,81	ATE BDX BDX	
	1.1 i 1.4 i 1.8	44 55 66			07.96 07.96 03.97	09.02 09.02 08.00	24.3541-1777.5 24.3541-1778.5	240247 240248	<input type="checkbox"/> <input type="checkbox"/>	D=54, - Halter D=54, - Halter	TRW TRW
	1.6 1.8 1.8 D 1.8 D 1.9 D 1.9 D 2.0 HDi 90	80 66 43 44 50 51 66		ORGA 09127 ORGA 09127 ORGA 09127 ORGA 09127 ORGA 09127	09.00 03.97 07.96 11.96 05.96 07.96 04.00	03.08 08.00	24.3541-1757.7 24.3541-1758.7	220483 220484	<input type="checkbox"/> <input type="checkbox"/>	D=54, - Halter D=54, - Halter	TRW TRW
	1.1 i 1.4 1.4 i 1.6 HDi 75 1.6 HDi 90 1.8 D 1.8 D 1.9 D 1.9 D 2.0 HDi 90 Electric 2.0 HDi 90	44 54 55 55 66 43 44 50 51 66 25 66		ORGA 09128 ORGA 09128 ORGA 09128 ORGA 09128 ORGA 09128	10.02 11.02 10.02 02.06 02.06 03.08 02.98 12.98 03.08 03.08 01.98 03.08	03.08 03.08 03.08 03.08	24.3541-1771.5 24.3541-1772.5	240239 240240	<input type="checkbox"/> <input type="checkbox"/>	D=54, - Halter D=54, - Halter	BOS BOS
	1.1 i 1.4 i 1.6 1.6 HDi 75 1.6 HDi 90 1.8 1.8 D 1.8 D 1.9 D 1.9 D 2.0 HDi 90 Electric 2.0 HDi 90	44 55 80 55 66 66 43 44 50 51 66 25 66			07.96 07.96 09.00 02.06 02.06 03.97 07.96 11.96 05.96 07.96 04.00 01.98 04.00	03.08 03.08 03.08 03.08 03.08 08.00 03.08 02.98 12.98 03.08 - ESP 03.08 03.08 + ESP	24.5111-0438.3 24.5111-0460.3	330568 330603	2 2	L=445 L=460	
	2.0 HDi 90	66			04.00	03.08 + ESP	24.3387-1711.7 24.3387-1712.7	220747 220748	<input type="checkbox"/> <input type="checkbox"/>	D=38, - Halter D=38, - Halter	TRW TRW
	1.1 i 1.4 i 1.8 1.8 D 1.8 D 1.9 D 1.9 D 2.0 HDi 90 Electric	44 55 66 43 44 50 51 66 25	ORGA 09533 ORGA 09533		07.96 07.96 03.97 07.96 11.96 05.96 07.96 04.00 01.98	08.00	24.5229-0255.3	330581	2	L=255	
	1.1 i 1.4 i 1.6 HDi 75 1.6 HDi 90 1.8 D 1.8 D 1.9 D 1.9 D 2.0 HDi 90 Electric	44 55 55 66 43 44 50 51 66 25	ORGA 09534 ORGA 09534		03.08 03.08 02.06 02.06 03.08 02.98 12.98 03.08 03.08 03.08		24.5246-0260.3	330782	2	L=260	
	1.1 i 1.4 i 1.6 HDi 75 1.6 HDi 90 1.8 1.8 D 1.8 D 1.9 D 1.9 D 2.0 HDi 90 Electric	44 55 55 66 66 43 44 50 51 66 25			07.96 07.96 02.06 02.06 03.97 07.96 11.96 05.96 07.96 04.00 01.98	03.08 03.08 03.08 03.08 08.00 03.08 02.98 12.98 03.08 - ESP 12.01	24.3222-1711.3 24.3222-1734.3	020413 020539		Rz 22,20 Rz 22,20	TRW TRW
	1.1 i 1.4 i 1.6 HDi 75 1.6 HDi 90	44 55 55 66	ORGA 08393 ORGA 08393		07.96 07.96 03.97 07.96		24.3727-0314.2 24.3727-0315.2	580314 580315	<input type="checkbox"/> <input type="checkbox"/>	L=1745 L=1818	
	1.1 i 1.4 i 1.6 HDi 75 1.6 HDi 90	44 55 55 66	ORGA 08394 ORGA 08394		03.08 03.08 02.06 02.06	03.08 03.08	24.3727-0314.2 24.3727-0339.2	580314 580339	<input type="checkbox"/> <input type="checkbox"/>	L=1745 L=1850	

PEUGEOT PARTNER Kasten (96-08)										
	1.8 1.8 D 1.8 D 1.9 D 1.9 D 2.0 HDi 90	66 43 ORGA 08394 44 ORGA 08394 50 ORGA 08394 51 ORGA 08394 66		08.00 03.08 02.98 12.98 03.08 04.00 03.08		24.3727-0314.2 24.3727-0339.2	580314 580339	<input type="checkbox"/>	L=1745 L=1850	
	1.1 i 1.4 i 1.6 HDi 75 1.6 HDi 90 1.8 1.8 D 1.8 D 1.9 D 1.9 D 2.0 HDi 90 Electric	44 55 55 66 66 43 44 50 51 66 25		07.96 03.08 07.96 03.08 02.06 03.08 02.06 03.08 03.97 08.00 07.96 03.08 11.96 02.98 05.96 12.98 07.96 03.08 04.00 03.08 01.98 03.08	+ 0,5/0,6 t + 0,5/0,6 t + 0,6 t + 0,6 t + 0,5/0,6 t + 0,6 t + 0,6 t + 0,6 t + 0,6 t + 0,6 t + 0,5/0,6 t	03.6582-0009.3 03.6582-0012.3	320143 320233	- verstärktes Fahrwerk ¹⁾ + verstärktes Fahrwerk ²⁾	BRL 8/1,5 (4) BRL 8/1,5 (4)	ATE ATE
	1.1 i 1.4 i 1.8 1.8 D 1.8 D 1.9 D 1.9 D 1.6 HDi 75 2.0 HDi 90 1.6 HDi 90 1.8 1.9 D 1.9 D 2.0 HDi 90 1.6 HDi 90 1.9 D 1.9 D 2.0 HDi 90	44 55 66 43 44 50 51 55 66 66 66 50 51 66 66 ORGA 11130 50 ORGA 11130 51 ORGA 11130 66 ORGA 11130		07.96 03.08 07.96 03.08 03.97 08.00 07.96 03.08 11.96 02.98 05.96 12.98 07.96 03.08 02.06 03.08 04.00 03.08 02.06 03.08 03.97 08.00 05.96 07.96 04.00	+ BVM MA-Getriebe ³⁾ + BE3-Getriebe ⁴⁾ + BE3-Getriebe ⁴⁾	24.3728-0328.2 24.3728-0329.2 24.3728-0850.2 24.3728-0850.2 24.3728-0343.2	590328 590329 590850 590850 590343		L=617 L=653, + AUT L=909, + AUT L=909, + AUT L=882, + AUT	
PEUGEOT PARTNER Tepee/Kasten/Pritsche (B9) (08-)										
	1.2 THP 110 1.6 1.6 1.6 BlueHDi 100 1.6 BlueHDi 120 1.6 BlueHDi 75 1.6 HDi 1.6 HDi 1.6 HDi 1.6 HDi 1.6 HDi 115 1.6 HDi 4x4 1.6 HDi 90 1.6 i 16V 1.6 i 16V Electrique	81 72 88 73 88 55 55 66 80 82 84 66 68 66 80 49		02.16 08.10 04.10 12.14 12.14 01.15 04.08 04.08 08.10 03.13 04.12 04.10 04.08 04.08 06.13		24.4123-1714.3	010979	+ ESP	Thz 23,81	TRW
	1.2 THP 110 1.6 1.6 1.6 BlueHDi 100 1.6 BlueHDi 120 1.6 BlueHDi 75 1.6 HDi 1.6 HDi 1.6 HDi 1.6 HDi 1.6 HDi 115 1.6 HDi 4x4 1.6 HDi 90 1.6 i 16V 1.6 i 16V Electrique	81 72 88 73 88 55 55 66 80 82 84 66 68 66 80 49		02.16 08.10 04.10 12.14 12.14 01.15 04.08 04.08 08.10 03.13 04.12 04.10 04.08 04.08 06.13		11.9601-9717.2 11.9601-9718.2 11.8171-0008.1 11.0101-5704.2 11.0441-6008.2 11.8116-0356.1	220901 220902 990049 260095 250038 390586	<input type="checkbox"/> <input type="checkbox"/> 2	D=60, - Halter D=60, - Halter Führungsbolzen Hülzensatz Dichtungssatz Haltefeder	ATE ATE ATE ATE ATE
	1.2 THP 110 1.6 1.6 1.6 BlueHDi 100 1.6 BlueHDi 120 1.6 BlueHDi 75 1.6 HDi 1.6 HDi	81 72 88 73 88 55 55 66		02.16 08.10 04.10 12.14 12.14 01.15 04.08 04.08		24.5111-0424.3	331014	2	L=424	

1) - reinforced suspension / - sospensione rinforzata / - châssis renforcé / - suspensión reforzada
2) + reinforced suspension / + sospensione rinforzata / + châssis renforcé / + suspensión reforzada
3) + BVM MA transmission / + scatola cambio BVM MA / + boîte de vitesse BVM MA / + cambio BVM MA
4) + BE3 transmission / + scatola cambio BE3 / + boîte de vitesse BE3 / + cambio BE3
5) + BE4 transmission / + scatola cambio BE4 / + boîte de vitesse BE4 / + cambio BE4

									
PEUGEOT PARTNER Tepee/Kasten/Pritsche (B9) (08-)									
	1.6 HDi	80		04.08	24.5111-0424.3	331014	2	L=424	
	1.6 HDi	82		08.10					
	1.6 HDi 115	84		03.13					
	1.6 HDi 4x4	66		04.12					
	1.6 HDi 90	68		04.10					
	1.6 i 16V	66		04.08					
	1.6 i 16V	80		04.08					
	Electrique	49		06.13					
	1.2 THP 110	81		02.16	24.5246-0216.3	331022	2	L=216	
	1.6	72		08.10					
	1.6	88		04.10					
	1.6 BlueHDi 100	73		12.14					
	1.6 BlueHDi 120	88		12.14					
	1.6 BlueHDi 75	55		01.15					
	1.6 HDi	55		04.08					
	1.6 HDi	66		04.08					
	1.6 HDi	80		04.08					
	1.6 HDi	82		08.10					
	1.6 HDi 115	84		03.13					
	1.6 HDi 4x4	66		04.12					
	1.6 HDi 90	68		04.10					
	1.6 i 16V	66		04.08					
	1.6 i 16V	80		04.08					
	Electrique	49		06.13					
	1.2 THP 110	81		02.16	24.3727-0853.2	580853	2 ↓	L=2398	
	1.6	72		08.10					
	1.6	88		04.10					
	1.6 BlueHDi 100	73		12.14					
	1.6 BlueHDi 120	88		12.14					
	1.6 BlueHDi 75	55		01.15					
	1.6 HDi	55		04.08					
	1.6 HDi	66		04.08					
	1.6 HDi	80		04.08					
	1.6 HDi	82		08.10					
	1.6 HDi 115	84		03.13					
	1.6 HDi 4x4	66		04.12					
	1.6 HDi 90	68		04.10					
	1.6 i 16V	66		04.08					
	1.6 i 16V	80		04.08					
	Electrique	49		06.13					
PEUGEOT RCZ (10-15)									
	1.6 16V	115		03.10	11.9571-9939.2	220923	 - Bremssattel lackiert ¹⁾  - Bremssattel lackiert ¹⁾	D=57, - Halter	ATE
	1.6 THP 150	110		03.11	11.9571-9940.2	220924		D=57, - Halter	ATE
	2.0 HDi	120		03.10	11.0101-5704.2	260095		Hülzensatz	ATE
			+ 18" Rad ²⁾		11.8171-0008.1	990049		Führungsbolzen	ATE
					11.8116-0356.1	390586	2	Haltefeder	ATE
	1.6 16V	147		06.10	11.9601-9883.2	220917	 - Bremssattel lackiert ¹⁾  - Bremssattel lackiert ¹⁾	D=60, - Halter	ATE
	2.0 HDi	120		03.10	11.9601-9884.2	220918		D=60, - Halter	ATE
			+ 19" Rad ³⁾		11.0101-5407.2	260011		Hülzensatz	ATE
					11.8171-0008.1	990049		Führungsbolzen	ATE
					11.0441-6008.2	250038		Dichtungssatz	ATE
	1.6 16V	115		03.10	24.5246-0190.3	330697	2	L=190	
	1.6 16V	147		06.10					
	1.6 THP 150	110		03.11					
	2.0 HDi	120		03.10					
	R	199		10.13					
PORSCHE 911 (993) (93-97)									
	3.6 CARRERA			10.93	09.97	83.6220-0296.3	330324	2	L=295
	3.6 CARRERA 4			07.94	09.97				
	3.6 TURBO 4	300		03.95	09.97				
	3.6 TURBO GT2	316		03.95	09.97				
	3.6 TURBO GT2 4			08.95	09.97				
	3.8 CARRERA	210		06.95	09.97				
	3.8 CARRERA 4	210		06.95	09.97				
	3.8 CARRERA RS	221		06.95	09.97				
	3.8 CARRERA RS 4	221		08.95	09.97				
	3.6 CARRERA			01.95	09.97	83.6116-0226.3	330454	2	L=230
	3.6 CARRERA 4			01.95	09.97				
	3.6 TURBO 4	300		03.95	09.97				
	3.6 TURBO GT2	316		03.95	09.97				
	3.6 TURBO GT2 4			08.95	09.97				
	3.8 CARRERA	210		06.95	09.97				
	3.8 CARRERA 4	210		06.95	09.97				
	3.8 CARRERA RS	221		06.95	09.97				
	3.8 CARRERA RS 4	221		08.95	09.97				
PORSCHE 911 TARGA (993) (95-97)									
	3.6 CARRERA	210		08.95	09.97	83.6220-0296.3	330324	2	L=295
	3.6 CARRERA	210		08.95	09.97	83.6116-0226.3	330454	2	L=230

¹⁾ - brake caliper, painted / - pinza freno, verniciata / - étrier de frein, verni / - pinza de freno, pintada

²⁾ + 18" wheel / + ruota 18" / + roue 18" / + rueda 18"

³⁾ + 19" wheel / + ruota 19" / + roue 19" / + rueda 19"



PORSCHE 911 CABRIO (993) (94-97)

	3.6 CARRERA		07.94	09.97	83.6220-0296.3	330324	2		L=295
	3.6 CARRERA 4		07.94	09.97					
	3.8 CARRERA	210	06.95	09.97					
	3.8 CARRERA 4	210	06.95	09.97					
	3.8 CARRERA RS	221	08.95	09.97					
3.8 CARRERA RS 4	221	08.95	09.97						
	3.6 CARRERA		01.95	09.97	83.6116-0226.3	330454	2		L=230
	3.6 CARRERA 4		01.95	09.97					
	3.8 CARRERA	210	06.95	09.97					
	3.8 CARRERA 4	210	06.95	09.97					
	3.8 CARRERA RS	221	08.95	09.97					
3.8 CARRERA RS 4	221	08.95	09.97						

PORSCHE 911 (996) (97-05)

	3.4 CARRERA		09.97	09.01	24.2123-1717.3	010521			THz 23,81
	3.6 CARRERA		10.01	08.05					
	3.6 S		08.04	08.05					
	3.4 CARRERA 4		06.97	09.01	24.2123-1730.3	010620			THz 23,81
	3.6 CARRERA 4		10.01	08.05					
	3.4 CARRERA		09.97	09.01	83.6239-0297.3	330643	2		L=295
	3.4 CARRERA 4		06.97	09.01					
	3.6 CARRERA		10.01	08.05					
	3.6 CARRERA 4		10.01	08.05					
	3.6 GT2		04.01	08.05					
	3.6 GT3		03.99	08.05					
	3.6 S		08.04	08.05					
	3.6 TURBO 4		06.00	08.05					
		3.4 CARRERA		09.97					
3.4 CARRERA 4			06.97	09.01					
3.6 CARRERA			10.01	08.05					
3.6 CARRERA 4			10.01	08.05					
3.6 GT2			04.01	08.05					
3.6 GT3			03.99	08.05					
3.6 S			08.04	08.05					
3.6 TURBO 4			06.00	08.05					

PORSCHE 911 TARGA (996) (01-05)

	3.6	235	12.01	08.05	24.2123-1717.3	010521			THz 23,81
	3.6	235	12.01	08.05	83.6239-0297.3	330643	2		L=295
	3.6	235	12.01	08.05	83.6239-0297.3	330643	2		L=295

PORSCHE 911 CABRIO (996) (98-05)

	3.4 CARRERA		02.98	09.01	24.2123-1717.3	010521			THz 23,81
	3.6 CARRERA		10.01	08.05					
	3.4 CARRERA 4		02.98	09.01	24.2123-1730.3	010620			THz 23,81
	3.6 CARRERA 4		10.01	08.05					
	3.4 CARRERA		02.98	09.01	83.6239-0297.3	330643	2		L=295
	3.4 CARRERA 4		02.98	09.01					
	3.6 CARRERA		10.01	08.05					
	3.6 CARRERA 4		10.01	08.05					
	3.6 TURBO 4		10.03	08.05	83.6239-0297.3	330643	2		L=295
	3.4 CARRERA		02.98	09.01					
	3.4 CARRERA 4		02.98	09.01					
	3.6 CARRERA		10.01	08.05					
	3.6 CARRERA 4		10.01	08.05	83.6239-0297.3	330643	2		L=295
	3.6 CARRERA 4		10.01	08.05					
	3.6 CARRERA 4		10.01	08.05					
	3.6 TURBO 4		10.03	08.05					

PORSCHE 911 COUPE (997) (04-13)

	3.6 Carrera	239	07.04	09.13	24.2123-1766.3	010825			THz 23,81	TRW
	3.6 Carrera	239	07.04	09.13	83.6239-0297.3	330643	2		L=295	
	3.6 Carrera	254	06.08	09.13						
	3.6 Carrera 4	239	07.04	09.13						
	3.6 Carrera 4	254	06.08	09.13						
	3.6 GT2	390	09.07	09.13						
	3.6 GT2 RS	456	05.10	09.13						
	3.6 GT3	305	03.06	09.13						
	3.6 Turbo	353	03.06	09.13						
	3.8 Carrera 4GTS	300	06.09	09.13						
	3.8 Carrera 4S	261	07.04	09.13						
	3.8 Carrera 4S	280	08.05	09.13						
	3.8 Carrera 4S	283	06.08	09.13						
	3.8 Carrera GTS	300	06.09	09.13						
	3.8 Carrera S	261	07.04	09.13						
	3.8 Carrera S	280	08.05	09.13						
	3.8 Carrera S	283	06.08	09.13						
	3.8 GT3	320	05.09	09.13						
	3.8 GT3 RS	331	08.09	09.13						
	3.8 Turbo	368	09.09	09.13						





PORSCHE 911 COUPE (997) (04-13)

	3.8 Turbo 4S	390		02.10	09.13	83.6239-0297.3	330643	2		L=295
	4.0 GT3 RS	368		07.11	09.13					
	3.6 Carrera	239		07.04	09.13	83.6239-0297.3	330643	2		L=295
	3.6 Carrera	254		06.08	09.13					
	3.6 Carrera 4	239		07.04	09.13					
	3.6 Carrera 4	254		06.08	09.13					
	3.6 GT2	390		09.07	09.13					
	3.6 GT2 RS	456		05.10	09.13					
	3.6 GT3	305		03.06	09.13					
	3.6 Turbo	353		03.06	09.13					
	3.8 Carrera 4GTS	300		06.09	09.13					
	3.8 Carrera 4S	261		07.04	09.13					
	3.8 Carrera 4S	280		08.05	09.13					
	3.8 Carrera 4S	283		06.08	09.13					
	3.8 Carrera GTS	300		06.09	09.13					
	3.8 Carrera S	261		07.04	09.13					
	3.8 Carrera S	280		08.05	09.13					
	3.8 Carrera S	283		06.08	09.13					
	3.8 GT3	320		05.09	09.13					
	3.8 GT3 RS	331		08.09	09.13					
3.8 Turbo	368		09.09	09.13						
3.8 Turbo 4S	390		02.10	09.13						
4.0 GT3 RS	368		07.11	09.13						

PORSCHE 911 CABRIO (997) (05-13)



















	3.6 Carrera	254		06.08	09.13	24.2123-1766.3	010825			THz 23,81	TRW
	3.6 Carrera	239		04.05	09.13						
	3.6 Carrera 4	239		04.05	09.13						
	3.6 Carrera 4	254		06.08	09.13						
	3.6 Carrera	254		06.08	09.13	83.6239-0297.3	330643	2		L=295	
	3.6 Carrera	239		04.05	09.13						
	3.6 Carrera 4	239		04.05	09.13						
	3.6 Carrera 4	254		06.08	09.13						
	3.6 Turbo	353		09.07	09.13						
	3.8 Carrera 4S	261		04.05	09.13						
	3.8 Carrera 4S	280		08.05	09.13						
	3.8 Carrera 4S	283		06.08	09.13						
	3.8 Carrera S	261		04.05	09.13						
	3.8 Carrera S	280		08.05	09.13						
	3.8 Carrera S	283		06.08	09.13						
	3.8 Turbo	368		09.09	09.13						
3.8 Turbo 4S	390		02.10	09.13							
	3.6 Carrera	254		06.08	09.13	83.6239-0297.3	330643	2		L=295	
	3.6 Carrera	239		04.05	09.13						
	3.6 Carrera 4	239		04.05	09.13						
	3.6 Carrera 4	254		06.08	09.13						
	3.6 Turbo	353		09.07	09.13						
	3.8 Carrera 4S	261		04.05	09.13						
	3.8 Carrera 4S	280		08.05	09.13						
	3.8 Carrera 4S	283		06.08	09.13						
	3.8 Carrera S	261		04.05	09.13						
	3.8 Carrera S	280		08.05	09.13						
	3.8 Carrera S	283		06.08	09.13						
	3.8 Turbo	368		09.09	09.13						
3.8 Turbo 4S	390		02.10	09.13							

PORSCHE 911 TARGA (997) (06-13)

	3.6 Carrera 4	239		11.06	09.13	83.6239-0297.3	330643	2		L=295
	3.6 TARGA 4	254		06.08	09.13					
	3.8 Carrera 4S	261		11.06	09.13					
	3.8 TARGA 4S	283		06.08	09.13					
	3.6 Carrera 4	239		11.06	09.13	83.6239-0297.3	330643	2		L=295
	3.6 TARGA 4	254		06.08	09.13					
	3.8 Carrera 4S	261		11.06	09.13					
	3.8 TARGA 4S	283		06.08	09.13					

PORSCHE BOXSTER (986) (96-04)

	2.5	150		09.96	07.99	24.2123-1717.3	010521			THz 23,81					
	2.7	162		08.99	12.00										
	3.2 S	185		08.99	12.00										
	2.7	162		12.01	06.02						24.2123-1730.3	010620			THz 23,81
	2.7	168		07.02	12.04										
3.2 S	185		12.01	06.02											
3.2 S	191		07.02	12.04											
3.2 S	196		01.04	12.04											
	2.5	150		09.96	07.99	83.6239-0297.3	330643	2		L=295					
	2.7	162		08.99	06.02										
	2.7	168		07.02	12.04										
	3.2 S	185		08.99	06.02										
	3.2 S	191		07.02	12.04										
3.2 S	196		01.04	12.04											
	2.5	150		09.96	07.99	83.6239-0297.3	330643	2		L=295					
	2.7	162		08.99	06.02										
	2.7	168		07.02	12.04										
	3.2 S	185		08.99	06.02										
	2.5	150		09.96	07.99	83.6239-0297.3	330643	2		L=295					
	2.7	162		08.99	06.02										
	2.7	168		07.02	12.04										
	3.2 S	185		08.99	06.02										

									
PORSCHE BOXSTER (986) (96-04)									
	3.2 S 3.2 S	191 196		07.02 01.04	12.04 12.04	83.6239-0297.3	330643	2	L=295
	2.5 2.7 2.7 3.2 S 3.2 S 3.2 S	150 162 168 185 191 196		09.96 08.99 07.02 08.99 07.02 01.04	07.99 06.02 12.04 06.02 12.04 12.04	24.2522-1707.3	040103		Nz 22,20
PORSCHE BOXSTER (987) (05-11)									
	2.7 2.7 2.9 3.2 S 3.4 RS 60 SPYDER 3.4 S 3.4 S	176 180 188 206 223 217 228		11.04 06.06 06.09 11.04 08.08 06.06 06.09	07.06 09.11 09.11 07.06 09.11 09.11 09.11	24.2123-1766.3	010825		- Keramikbremse ¹⁾ THz 23,81 TRW
	2.7 2.7 2.9 3.2 S 3.4 RS 60 SPYDER 3.4 S 3.4 S	176 180 188 206 223 217 228		11.04 06.06 06.09 11.04 08.08 06.06 06.09	07.06 09.11 09.11 07.06 09.11 09.11 09.11	83.6239-0297.3	330643	2	L=295
PORSCHE CAYENNE I (03-10)									
	3.2 S 4.5 Turbo 4.5	◀184 ◀250 ◀331		10.03 09.02 09.02	12.06 12.06 12.06	03.0655-0006.2	370006		Wegsensor ATE
	3.0 TDI 3.6 S 4.8 Turbo S 4.8	◀176 ◀213 ◀283 ◀368		02.09 01.07 01.07 01.07	04.10 04.10 04.10 04.10	03.7868-4102.4	300250		10/8" Tandem ATE
	3.2 S 4.5 Turbo 4.5	▶184 ▶250 ▶331		10.03 09.02 09.02	12.06 12.06 12.06	03.0655-0006.2	370006		Wegsensor ATE
	3.0 TDI 3.2 3.6 GTS 4.8 S 4.5 S 4.8 Turbo 4.5 Turbo S 4.5 Turbo S 4.5 Turbo S 4.8 Turbo S 4.8 Turbo S 4.8	◀176 ◀184 ◀213 ◀298 ◀250 ◀283 ◀331 ◀368 ◀383 ◀368 ◀397 ◀404		02.09 10.03 01.07 10.07 09.02 01.07 09.02 01.04 01.04 01.07 02.07 08.08	04.10 12.06 04.10 04.10 12.06 04.10 12.06 04.10 04.10 04.10 04.10 04.10	03.2126-3014.3	010811		THz 26,99 ATE
	3.0 TDI 3.2 3.6 S 4.5 Turbo 4.5	176 184 213 250 331		02.09 10.03 01.07 09.02 09.02	04.10 04.10 04.10 04.10 04.10	24.5237-0515.3	331463	2	L=515
	3.0 TDI 3.2 3.6 GTS 4.8 S 4.5 S 4.8 Turbo 4.5 Turbo S 4.5 Turbo S 4.5 Turbo S 4.8 Turbo S 4.8 Turbo S 4.8	176 184 213 298 250 283 331 368 383 368 397 404		02.09 10.03 01.07 10.07 09.02 01.07 09.02 01.04 03.06 01.07 02.07 08.08	04.10 04.10 04.10 04.10 04.10 04.10 04.10 04.10 04.10 04.10 04.10 04.10	83.7812-0400.3	331214	2	L=400
PORSCHE CAYENNE II (10-)									
	3.0 D 3.0 D 3.0 D 3.0 S E-Hybrid 3.0 S E-Hybrid 3.6 3.6 GTS 3.6 S 4.2 S Diesel 4.2 S Diesel 4.8 GTS 4.8 S 4.8 Turbo 4.8 Turbo S 4.8 Turbo S	155 180 193 245 306 220 324 309 281 283 309 294 368 382 405 419		06.10 06.10 10.14 06.10 10.14 06.10 02.15 10.14 10.12 10.14 06.12 06.10 06.10 10.14 10.12 01.15		83.7812-0400.3	331214	2	L=400

¹⁾ - ceramic brake / - freno in ceramica / - frein de céramique / - freno de cerámica



PORSCH		KW		23		i		ATE		?		i		Key		
PORSCH CAYMAN (987C) (05-12)																
	2.7 2.9 3.4 S 3.4 S 3.4 S Sport R 3.4	180 195 217 235 223 243		05.06 02.09 11.05 02.09 08.08 11.10	05.12 05.12 05.12 05.12 05.12 05.12	24.2123-1766.3	010825					- Keramikbremse 1)	Thz 23,81		TRW	
	2.7 2.9 3.4 S 3.4 S 3.4 S Sport R 3.4	180 195 217 235 223 243		05.06 02.09 11.05 02.09 08.08 11.10	05.12 05.12 05.12 05.12 05.12 05.12	83.6239-0297.3	330643	2					L=295			
PORSCH MACAN (13-)																
	2.0 2.0 3.0 GTS 3.0 S 3.0 S Diesel 3.6 Turbo	174 185 265 250 294		07.14 10.15 10.15 11.13 11.13 11.13		24.5140-0396.3	331372	2					L=396			
PROTON PERSONA 300 / 400 (94-00)																
	1.3 i 1.5 GLi 2.0 TD	55 66		01.94 01.94 09.96	07.00 07.00 07.00	24.3219-1752.3	020505						Rz 19,05			
PROTON WIRA (00-05)																
	1.3 i 12V 1.5 i 12V	55 64		08.00 08.00	09.05 09.05	24.5205-0205.3	330780	2					L=205			
	1.3 i 12V 1.5 i 12V	55 64		08.00 08.00	09.05 09.05	24.3219-1752.3	020505						Rz 19,05			
RENAULT AVANTIME (01-03)																
	2.0 16V Turbo 2.2 dCi 3.0 V6	120 110 152		11.01 05.02 09.01	06.03 06.03 - ASR 06.03 - ASR	03.2123-1486.3	010488						Thz 23,81		ATE	
	2.2 dCi 3.0 V6	110 152		05.02 09.01	06.03 + ASR 06.03 + ASR	03.2123-2621.3	010701						Thz 23,81		ATE	
	2.0 16V Turbo 2.2 dCi 3.0 V6	120 110 152		11.01 05.02 09.01	06.03 06.03 06.03	24.3451-1713.7 24.3451-1714.7	220737 220738		<input type="checkbox"/> <input type="checkbox"/>				D=40/45, - Halter D=40/45, - Halter		TRW TRW	
	2.0 16V Turbo 2.2 dCi 3.0 V6	120 110 152		11.01 05.02 09.01	06.03 06.03 06.03	24.5229-0185.3	330397	2	<input type="checkbox"/>				L=185			
RENAULT CAPTUR (J87) (13-)																
	0.9 TCe 90 1.2 TCe 120 1.5 dCi 110 1.5 dCi 90	66 88 81 66		06.13 06.13 01.15 06.13		24.3541-1849.5 24.3541-1850.5	240707 240708		<input type="checkbox"/> <input type="checkbox"/>				D=54, - Halter D=54, - Halter		TRW TRW	
	0.9 TCe 90 1.2 TCe 120 1.5 dCi 110 1.5 dCi 90	66 88 81 66		06.13 06.13 01.15 06.13		11.9541-9950.2 11.9541-9951.2 11.8170-0002.1 11.8116-0356.1	220843 220844 260110 390586	2 2	<input type="checkbox"/> <input type="checkbox"/>				D=54, - Halter D=54, - Halter Halter Haltefeder		ATE ATE ATE ATE	
	0.9 TCe 90 1.2 TCe 120 1.5 dCi 110 1.5 dCi 90	66 88 81 66		06.13 06.13 01.15 06.13		24.3219-1761.3	020536						Rz 19,05			
	1.2 TCe 120 1.5 dCi 110 1.5 dCi 90	88 81 66		06.13 01.15 06.13		24.3222-1729.3	020526						Rz 22,20			
RENAULT CLIO I Limousine (B/C 57_) (90-98)																
	1.1 1.2 1.2 (5/357F/J/L/R) 1.2 (5/357K.5/357Y) 1.2 (5/357K.5/357Y) 1.2 (B/C 577) 1.2 (B/C 57A/S) 1.2 (B/C 57R) 1.4 1.4 1.4 (B/C 57J) 1.4 (B/C 57J) 1.4 (B/C 57T/Y) 1.4 (B/C 57T/Y) 1.4 (B/C 57T/Y) 1.7 1.8 1.8 (B/C 578) 1.8 (B/C 57C/U) 1.8 16V 1.8 Rsi (B/C 579) 1.8 Rsi (B/C 57H) 1.9 D 1.9 D Electric Williams (B/C 57M) 1.2	44 43 40 43 40 43 40 59 59 55 55 58 58 68 70 66 65 99 80 79 40 47 21 108 44		01.91 05.90 10.94 01.96 01.96 01.96 05.90 01.91 01.91 01.91 01.91 01.91 01.91 01.91 01.91 08.94 01.91 08.91 01.93 08.95 01.97 01.91 05.96 01.94 05.90	09.98 03.96 - ABS/ - Fahrschule 2) 09.98 - ABS/ - Fahrschule 2) 09.98 - ABS/ - Fahrschule 2) 09.98 - ABS/ - Fahrschule 2) 12.96 - ABS/ - Fahrschule 2) 09.98 - ABS/ - Fahrschule 2) 01.96 - ABS/ - Fahrschule 2) 09.98 - RTI/S 09.98 - ABS/ - Fahrschule 2) 09.98 - RTI/S 09.98 - ABS/ - Fahrschule 2) 09.98 - RTI/S 09.98 - ABS/ - Fahrschule 2) 04.95 - ABS 09.98 - ABS 09.98 - ABS 06.94 - ABS 08.95 - ABS 09.98 - ABS 09.98 - ABS/ - Fahrschule 2) 09.98 - ABS/ - Fahrschule 2) 02.98 09.98 03.96 - ABS/ + Fahrschule 3)	03.2120-2031.3	010106							Thz 20,64		ATE
	1.2	44		05.90	03.96 - ABS/ + Fahrschule 3)	03.2119-3389.3	010057						Thz 19,05		ATE	

1) - ceramic brake / - freno in ceramica / - frein de céramique / - freno de cerámica

2) - ABS/ - driving school / - ABS/ - scuola guida / - ABS/ - auto-école / - ABS/ - autoescuela

3) - ABS/ + driving school / - ABS/ + scuola guida / - ABS/ + auto école / - ABS/ + autoescuela



RENAULT CLIO I Limousine (B/C 57_) (90-98)

	1.2 (5/357F/J/L/R) 43 1.2 (5/357K.5/357Y) 40 1.2 (5/357K.5/357Y) 43 1.2 (B/C 577) 40 1.2 (B/C 57A/S) 43 1.2 (B/C 57R) 40 1.4 RTI/S ▶ 59 1.4 RTI/S (B/C 57J) ▶ 55 1.4 RTI/S (B/C 57T/Y) ▶ 58 1.8 ▶ 70 1.8 (B/C 578) ▶ 66 1.8 (B/C 57C/U) ▶ 65 1.8 16V ▶ 99 1.8 Rsi (B/C 579) ▶ 80 1.8 Rsi (B/C 57H) ▶ 79 1.9 D 40 1.9 D 47	10.94 09.98 - ABS/ + Fahrschule ¹⁾ 01.96 09.98 - ABS/ + Fahrschule ¹⁾ 01.96 09.98 - ABS/ + Fahrschule ¹⁾ 01.96 12.96 - ABS/ + Fahrschule ¹⁾ 05.90 09.98 - ABS/ + Fahrschule ¹⁾ 01.91 01.96 - ABS/ + Fahrschule ¹⁾ 01.91 09.98 - ABS 01.91 09.98 - ABS 01.91 09.98 - ABS 01.91 09.98 - ABS 08.94 09.98 - ABS 01.91 09.98 - ABS 08.91 06.94 - ABS 01.93 08.95 - ABS 08.95 09.98 - ABS 01.97 09.98 - ABS/ + Fahrschule ¹⁾ 01.91 09.98 - ABS/ + Fahrschule ¹⁾	03.2119-3389.3 010057		Thz 19,05	ATE
	1.2 ◀ 44 1.2 (5/357F/J/L/R) ◀ 43 1.2 (5/357K.5/357Y) ◀ 40 1.2 (5/357K.5/357Y) ◀ 43 1.2 (B/C 577) ◀ 40 1.2 (B/C 57A/S) ◀ 43 1.2 (B/C 57R) ◀ 40 1.4 ◀ 59 1.4 (B/C 57J) ◀ 55 1.4 (B/C 57T/Y) ◀ 58 1.7 ◀ 68 1.8 ◀ 70 1.8 (B/C 578) ◀ 66 1.8 (B/C 57C/U) ◀ 65 1.8 16V ◀ 99 1.8 Rsi (B/C 579) ◀ 80 1.8 Rsi (B/C 57H) ◀ 79 1.9 D ◀ 40 1.9 D ◀ 47	05.90 03.96 + ABS 10.94 09.98 + ABS 01.96 09.98 + ABS 01.96 09.98 + ABS 05.90 09.98 + ABS 01.91 01.96 + ABS 01.91 09.98 + ABS 01.91 09.98 + ABS 01.91 09.98 + ABS 01.91 04.95 + ABS 01.91 09.98 + ABS 08.94 09.98 + ABS 01.91 09.98 + ABS 08.91 06.94 + ABS 01.93 08.95 + ABS 08.95 09.98 + ABS 01.97 09.98 + ABS 01.91 09.98 + ABS	24.2120-1725.3 010579		Thz 20,64	BDX
	1.1	01.91 04.92	24.3451-1501.5 240263 24.3451-1502.5 240264 24.3481-1611.5 240029 24.3481-1612.5 240030 24.0101-4807.2 260053	 	D=45, - Halter D=45, - Halter D=48, - Halter D=48, - Halter Bremssattel-Zubehör	BDX BDX TRW TRW TRW
	1.1 1.2 1.2 (5/357F/J/L/R) 1.2 (5/357K.5/357Y) 1.2 (5/357K.5/357Y) 1.2 (B/C 577) 1.2 (B/C 57A/S) 1.2 (B/C 57R) 1.4 1.4 (B/C 57J) 1.4 (B/C 57T/Y) 1.9 D (B/C 576) Electric	05.92 09.98 05.90 03.96 10.94 09.98 01.96 09.98 01.96 09.98 01.96 12.96 05.90 09.98 01.91 01.96 01.91 09.98 + Automatikgetriebe ²⁾ 01.91 09.98 + Automatikgetriebe ²⁾ 01.91 09.98 + Automatikgetriebe ²⁾ 01.91 01.94 05.96 02.98	24.3481-1505.5 240047 24.3481-1506.5 240048 24.3481-1611.5 240029 24.3481-1612.5 240030 24.0101-4803.2 260049 24.0101-4807.2 260053	 	D=48, - Halter D=48, - Halter D=48, - Halter D=48, - Halter Bremssattel-Zubehör Bremssattel-Zubehör	BDX BDX TRW TRW BDX TRW
	1.4 1.4 (B/C 57J) 1.4 (B/C 57T/Y) 1.9 D (B/C 57I) 1.9 D (B/C 57L)	01.91 09.98 + Schaltgetriebe ³⁾ 01.91 09.98 + Schaltgetriebe ³⁾ 01.91 09.98 + Schaltgetriebe ³⁾ 07.92 01.94 01.91 01.94	24.3481-1611.5 240029 24.3481-1612.5 240030 24.0101-4807.2 260053	 	D=48, - Halter D=48, - Halter Bremssattel-Zubehör	TRW TRW TRW
	1.4 1.4 (B/C 57J) 1.4 (B/C 57T/Y) 1.4 S 1.4 S (B/C 57J) 1.4 S (B/C 57T/Y) 1.7 1.8 1.8 (B/C 578) 1.8 (B/C 57C/U) 1.8 16V 1.8 Rsi (B/C 579) 1.8 Rsi (B/C 57H) 1.9 D 1.9 D (B/C 576) 1.9 D (B/C 57I) 1.9 D (B/C 57L) Williams (B/C 57M)	04.96 09.98 + Automatikgetriebe ²⁾ 04.96 09.98 + Automatikgetriebe ²⁾ 04.96 09.98 + Automatikgetriebe ²⁾ 01.91 09.98 01.91 09.98 01.91 09.98 01.91 04.95 01.91 09.98 08.94 09.98 01.91 09.98 08.91 08.94 01.93 08.95 08.95 09.98 01.97 09.98 02.94 09.98 02.94 09.98 02.94 09.98 01.94 09.98	24.3481-1505.5 240047 24.3481-1506.5 240048 24.3481-1615.5 240031 24.3481-1616.5 240032 24.0101-4807.2 260053	 	D=48, - Halter D=48, - Halter D=48, - Halter D=48, - Halter Bremssattel-Zubehör	BDX BDX TRW TRW TRW
	1.1 1.2 1.2 (5/357F/J/L/R) 1.2 (5/357K.5/357Y) 1.2 (5/357K.5/357Y) 1.2 (B/C 577) 1.2 (B/C 57A/S) 1.2 (B/C 57R) 1.4 1.4 (B/C 57J)	01.91 09.98 05.90 03.96 10.94 09.98 01.96 09.98 01.96 09.98 01.96 12.96 05.90 09.98 01.91 01.96 01.91 09.98	24.5111-0241.3 330680	2	L=242	

¹⁾ - ABS/ + driving school / - ABS/ + scuola guida / - ABS/ + auto école / - ABS/ + autoescuela
²⁾ + autom.transmission / + scatola cambio automatico / + transmission automatique / + cambio automático
³⁾ + manual transmission / + scatola cambio velocità / + transmission mécanique / + cambio de velocidad























RENAULT CLIO I Limousine (B/C 57_) (90-98)

	1.4 (B/C 57T/Y)	58	01.91	09.98	24.5111-0241.3	330680	2		L=242	
	1.7	68	01.91	04.95						
	1.8	70	01.91	09.98						
	1.8 (B/C 578)	66	08.94	09.98						
	1.8 (B/C 57C/U)	65	01.91	09.98						
	1.8 Rsi (B/C 579)	80	01.93	08.95						
	1.8 Rsi (B/C 57H)	79	08.95	09.98						
	1.9 D	40	01.97	09.98						
	1.9 D	47	01.91	09.98						
	Electric	21	05.96	02.98						
	1.1		01.91	09.98	24.5229-0265.3	330540	2		L=265	
	1.2	44	05.90	03.96 - ABS						
	1.2 (5/357F/J/L/R)	43	10.94	09.98 - ABS						
	1.2 (5/357K.5/357Y)	40	01.96	09.98 - ABS						
	1.2 (5/357K.5/357Y)	43	01.96	09.98 - ABS						
	1.2 (B/C 577)	40	01.96	12.96 - ABS						
	1.2 (B/C 57A/S)	43	05.90	09.98 - ABS						
	1.2 (B/C 57R)	40	01.91	01.96 - ABS						
	1.4	59	01.91	09.98 - ABS						
	1.4 (B/C 57J)	55	01.91	09.98 - ABS						
	1.4 (B/C 57T/Y)	58	01.91	09.98 - ABS						
	1.7	68	01.91	04.95 - ABS/ - Klimaanlage 1)						
	1.7	68	01.91	11.93 - ABS/ + Klimaanlage 2)						
	1.8 (B/C 57C)	65	01.91	11.93 - ABS/ + Klimaanlage 2)						
	1.8 (B/C 57C)	65	01.91	09.98 - ABS/ - Klimaanlage 1)						
	1.8 (B/C 57U)	65	01.91	11.93 - ABS/ + Klimaanlage 2)						
	1.8 (B/C 57U)	65	01.91	09.98 - ABS/ - Klimaanlage 1)						
	1.9 D	40	01.97	09.98 - ABS						
	1.9 D	47	01.91	09.98 - ABS						
	Electric	21	05.96	02.98						
	1.2	44	05.90	03.96 + ABS	24.5229-0220.3	330399	2		L=220	
	1.2 (5/357F/J/L/R)	43	10.94	09.98 + ABS						
	1.2 (5/357K.5/357Y)	40	01.96	09.98 + ABS						
	1.2 (5/357K.5/357Y)	43	01.96	09.98 + ABS						
	1.2 (B/C 577)	40	01.96	12.96 + ABS						
	1.2 (B/C 57A/S)	43	05.90	09.98 + ABS						
	1.2 (B/C 57R)	40	01.91	01.96 + ABS						
	1.4	59	01.91	09.98 + ABS						
	1.4 (B/C 57J)	55	01.91	09.98 + ABS						
	1.4 (B/C 57T/Y)	58	01.91	09.98 + ABS						
	1.7	68	01.91	04.95 + ABS						
	1.7	68	12.93	04.95 - ABS/ + Klimaanlage 2)						
	1.8	70	01.91	09.98						
	1.8 (B/C 57C)	65	01.91	09.98 + ABS						
	1.8 (B/C 57C)	65	12.93	09.98 - ABS/ + Klimaanlage 2)						
	1.8 (B/C 57U)	65	01.91	09.98 + ABS						
	1.8 (B/C 57U)	65	12.93	09.98 - ABS/ + Klimaanlage 2)						
	1.8 Rsi (B/C 579)	80	01.93	08.95						
	1.8 Rsi (B/C 57H)	79	08.95	09.98						
	1.9 D	40	01.97	09.98 + ABS						
	1.9 D	47	01.91	09.98 + ABS						
	Williams (B/C 57M)	108	01.94	09.98						
	1.1		01.91	03.91	24.3220-1624.3	020354			RzR 20,64	BDX
	1.2	44	05.90	03.91 - ABS	24.3220-1623.3	020353			RzR 20,64	BDX
	1.2 (B/C 57A/S)	43	05.90	03.91 - ABS	24.3220-1714.3	020411			RzR 20,64	TRW
	1.2 (B/C 57R)	40	01.91	03.91 - ABS	24.3220-1713.3	020410			RzR 20,64	TRW
	1.4	59	01.91	03.91 - ABS						
	1.4 (B/C 57J)	55	01.91	03.91 - ABS						
	1.4 (B/C 57T/Y)	58	01.91	03.91 - ABS						
	1.7	68	01.91	03.91 - ABS						
	1.8 (B/C 57C)	65	01.91	03.91 - ABS						
	1.9 D (B/C 576)	47	01.91	03.91 - ABS						
	1.9 D (B/C 57L)	47	01.91	03.91 - ABS						
	Electric	21	05.96	02.98						
	1.1		04.91	09.98	24.3220-1623.3	020353			RzR 20,64	BDX
	1.2	44	04.91	03.96 - ABS	24.3220-1624.3	020354			RzR 20,64	BDX
	1.2 (5/357K.5/357Y)	40	01.96	09.98 - ABS	24.3220-1713.3	020410			RzR 20,64	TRW
	1.2 (5/357K.5/357Y)	43	01.96	09.98 - ABS	24.3220-1714.3	020411			RzR 20,64	TRW
	1.2 (B 57N)	43	09.91	04.96						
	1.2 (B/C 577)	40	01.96	12.96 - ABS						
	1.2 (B/C 57A/S)	43	04.91	09.98 - ABS						
	1.2 (B/C 57R)	40	04.91	01.96 - ABS						
	1.4	59	04.91	04.96 - ABS						
	1.4 (B/C 57J)	55	04.91	04.96 - ABS						
	1.4 (B/C 57T/Y)	58	04.91	04.96 - ABS						
	1.7	68	04.91	04.95 - ABS						
	1.8 (357A)	70	10.94	04.96 - ABS						
	1.8 (357D)	70	10.94	04.96 - ABS						
	1.8 (557A)	70	08.94	04.96 - ABS						
	1.8 (557D)	70	08.94	04.96 - ABS						
	1.8 (B/C 578)	66	08.94	04.96 - ABS						
	1.8 (B/C 57C)	65	04.91	04.96 - ABS						
	1.8 (B/C 57U)	65	01.91	11.96 - ABS						
	1.9 D (B/C 576)	47	04.91	04.96 - ABS						
	1.9 D (B/C 57I)	47	07.92	04.96 - ABS						
	1.9 D (B/C 57L)	47	04.91	04.96 - ABS						













1) - ABS/ - air conditioning / - ABS/ - aria condizionata / - ABS/ - air conditionné / - ABS/ - aire acondicionado
 2) - ABS/ + air conditioning / - ABS/ + aria condizionata / - ABS/ + air conditionné / - ABS/ + aire acondicionado

									
RENAULT CLIO I Limousine (B/C 57_) (90-98)									
	1.2 (5/357G)	43	01.94	04.96	24.3220-1623.3	020353		RzR 20,64	BDX
	1.2 (B 57N)	43	05.96	09.98	24.3220-1624.3	020354		RzR 20,64	BDX
	1.4	59	05.96	09.98					
	1.4 (B/C 57J)	55	05.96	09.98					
	1.4 (B/C 57T/Y)	58	05.96	09.98					
	1.8 (557U)	70	09.96	09.98					
	1.8 (B/C 578)	66	05.96	09.98					
	1.8 (B/C 57C)	65	05.96	09.98					
	1.9 D	40	01.97	09.98					
	1.9 D (B/C 576)	47	05.96	09.98					
	1.9 D (B/C 57I)	47	05.96	09.98					
	1.9 D (B/C 57L)	47	05.96	09.98					
	1.2 (B 57N)	43	05.96	09.98	24.3220-1713.3	020410		RzR 20,64	TRW
	1.4	59	05.96	09.98	24.3220-1714.3	020411		RzR 20,64	TRW
	1.4 (B/C 57J)	55	05.96	09.98					
	1.4 (B/C 57T/Y)	58	05.96	09.98					
	1.8 (557U)	70	09.96	09.98					
	1.8 (B/C 578)	66	05.96	09.98					
	1.8 (B/C 57C)	65	05.96	09.98					
	1.9 D	40	01.97	09.98					
	1.9 D (B/C 576)	47	09.96	09.98					
	1.9 D (B/C 57I)	47	09.96	09.98					
	1.9 D (B/C 57L)	47	09.96	09.98					
	1.1	44	01.91	09.98	24.3727-1008.2	581008	2 	L=1430	
	1.2	44	05.90	03.96					
	1.2 (5/357F/J/L/R)	43	10.94	09.98					
	1.2 (5/357K.5/357Y)	40	01.96	09.98					
	1.2 (5/357K.5/357Y)	43	01.96	09.98					
	1.2 (B/C 577)	40	01.96	12.96					
	1.2 (B/C 57A/S)	43	05.90	09.98					
	1.2 (B/C 57R)	40	01.91	01.96					
	1.4	59	01.91	09.98					
	1.4 (B/C 57J)	55	01.91	09.98					
	1.4 (B/C 57T/Y)	58	01.91	09.98					
	1.7	68	01.91	04.95					
	1.8 (B/C 57C/U)	65	01.91	09.98					
	1.9 D	40	01.97	09.98					
	1.9 D	47	01.97	09.98					
	Electric	21	05.96	02.98					
	1.2	44	05.90	03.96	24.3727-1009.2	581009	2 	L=1480	
	1.2 (5/357F/J/L/R)	43	10.94	09.98					
	1.2 (5/357G)	43	01.94	04.96					
	1.2 (5/357K.5/357Y)	40	01.96	09.98					
	1.2 (5/357K.5/357Y)	43	01.96	09.98					
	1.2 (B 57N)	43	09.91	09.98					
	1.2 (B/C 577)	40	01.96	12.96					
	1.2 (B/C 57A/S)	43	05.90	09.98					
	1.2 (B/C 57R)	40	01.91	01.96					
	1.4	59	01.91	09.98					
	1.4 (B/C 57J)	55	01.91	09.98					
	1.4 (B/C 57T/Y)	58	01.91	09.98					
	1.4 RTI/S	59	01.91	09.98					
	1.4 RTI/S (B/C 57J)	55	01.91	09.98					
	1.4 RTI/S (B/C 57T/Y)	58	01.91	09.98					
	1.4 S	59	01.91	09.98					
	1.4 S (B/C 57J)	55	01.91	09.98					
	1.4 S (B/C 57T/Y)	58	01.91	09.98					
	1.7	68	01.91	04.95					
	1.8 (357A)	70	10.94	09.98					
	1.8 (357E)	70	10.94	04.96					
	1.8 (557A)	70	08.94	09.98					
	1.8 (557U)	70	09.96	09.98					
	1.8 (B/C 578)	66	08.94	09.98					
	1.8 (B/C 57C/U)	65	01.91	09.98					
	1.8 16V	99	08.91	06.94					
	1.8 Rsi (B/C 579)	80	01.93	08.95					
	1.8 Rsi (B/C 57H)	79	08.95	09.98					
	Williams (B/C 57M)	108	01.94	09.98					
	1.1	44	01.91	09.98	24.3728-1004.2	591004		L=992	
	1.2	44	05.90	03.96					
	1.2 (5/357F/J/L/R)	43	10.94	09.98					
	1.2 (5/357K.5/357Y)	40	01.96	09.98					
	1.2 (5/357K.5/357Y)	43	01.96	09.98					
	1.2 (B/C 577)	40	01.96	12.96					
	1.2 (B/C 57A/S)	43	05.90	09.98					
	1.2 (B/C 57R)	40	01.91	01.96					
	1.4	59	01.91	09.98					
	1.4 (B/C 57J)	55	01.91	09.98					
	1.4 (B/C 57T/Y)	58	01.91	09.98					
	1.7	68	01.91	04.95					
	1.8	70	01.91	09.98					
	1.8 (B/C 578)	66	08.94	09.98					
	1.8 (B/C 57C/U)	65	01.91	09.98					
	1.8 16V	99	08.91	06.94					
	1.8 Rsi (B/C 579)	80	01.93	08.95					
	1.8 Rsi (B/C 57H)	79	08.95	09.98					
	1.9 D	40	01.97	09.98					

RENAULT CLIO I Limousine (B/C 57_) (90-98)											
	1.9 D Williams (B/C 57M)	47 108		01.91 01.94	09.98 09.98		24.3728-1004.2	591004			L=992
RENAULT CLIO I Kasten (S 57_) (91-98)											
	1.1 1.2 1.2 1.9 D	34 40 44 48		01.91 01.91 01.91 01.91	09.98 09.98 09.98 09.98	- ABS/ - Fahrschule ¹⁾ - ABS/ - Fahrschule ¹⁾ - ABS/ - Fahrschule ¹⁾ - ABS/ - Fahrschule ¹⁾	03.2120-2031.3	010106			Thz 20,64 ATE
	1.2 1.2 1.9 D	40 44 48		01.91 01.91 01.91	09.98 09.98 09.98	- ABS/ + Fahrschule ²⁾ - ABS/ + Fahrschule ²⁾ - ABS/ + Fahrschule ²⁾	03.2119-3389.3	010057			Thz 19,05 ATE
	1.2 1.2 1.9 D	40 44 48		01.91 01.91 01.91	09.98 09.98 09.98	+ ABS + ABS + ABS	24.2120-1725.3	010579			Thz 20,64 BDX
	1.1 1.1 1.2 1.2 1.9 D	34 34 40 44 48		01.91 05.92 01.91 01.91 01.91	04.92 09.98 09.98 09.98 01.94		24.3451-1501.5 24.3451-1502.5 24.3481-1611.5 24.3481-1612.5 24.0101-4807.2	240263 240264 240029 240030 260053	<input type="checkbox"/> <input type="checkbox"/> <input type="checkbox"/> <input type="checkbox"/> <input type="checkbox"/>		D=45, - Halter BDX D=45, - Halter BDX D=48, - Halter TRW D=48, - Halter TRW Bremsattel-Zubehör TRW
	1.1 1.1 1.2 1.2 1.9 D	34 34 40 44 48		01.91 05.92 01.91 01.91 01.91	04.92 09.98 09.98 09.98 01.94		24.3481-1505.5 24.3481-1506.5 24.3481-1611.5 24.3481-1612.5 24.0101-4803.2 24.0101-4806.2	240047 240048 240029 240030 260049 260053	<input type="checkbox"/> <input type="checkbox"/> <input type="checkbox"/> <input type="checkbox"/> <input type="checkbox"/> <input type="checkbox"/>		D=48, - Halter BDX D=48, - Halter BDX D=48, - Halter TRW D=48, - Halter TRW Bremsattel-Zubehör BDX Bremsattel-Zubehör TRW
	1.1 1.2 1.2 1.9 D	34 40 44 48		01.91 01.91 01.91 01.91	09.98 09.98 09.98 09.98		24.5111-0241.3	330680	2		L=242
	1.1 1.2 1.2 1.9 D	34 40 44 48		01.91 01.91 01.91 01.91	09.98 09.98 09.98 09.98	- ABS - ABS - ABS	24.5229-0265.3	330540	2		L=265
	1.2 1.2 1.9 D	40 44 48		01.91 01.91 01.91	09.98 09.98 09.98	+ ABS + ABS + ABS	24.5229-0220.3	330399	2		L=220
	1.1 1.2 1.2 1.9 D	34 40 44 48		01.91 01.91 01.91 01.91	03.91 03.91 03.91 03.91	- ABS - ABS - ABS	24.3220-1624.3 24.3220-1623.3 24.3220-1713.3 24.3220-1714.3	020354 020353 020410 020411	<input type="checkbox"/> <input type="checkbox"/> <input type="checkbox"/> <input type="checkbox"/>		RzR 20,64 BDX RzR 20,64 BDX RzR 20,64 TRW RzR 20,64 TRW
	1.1 1.1 1.2 1.2 1.9 D	34 34 40 44 48		04.91 04.91 04.91 04.91	09.98 09.98 09.98 04.96	- ABS - ABS - ABS - ABS	24.3220-1623.3 24.3220-1624.3 24.3220-1713.3 24.3220-1714.3	020353 020354 020410 020411	<input type="checkbox"/> <input type="checkbox"/> <input type="checkbox"/> <input type="checkbox"/>		RzR 20,64 BDX RzR 20,64 BDX RzR 20,64 TRW RzR 20,64 TRW
	1.9 D	48		05.96	09.98	- ABS	24.3220-1623.3 24.3220-1624.3	020353 020354	<input type="checkbox"/> <input type="checkbox"/>		RzR 20,64 BDX RzR 20,64 BDX
	1.9 D	48		09.96	11.96	- ABS	24.3220-1713.3 24.3220-1714.3	020410 020411	<input type="checkbox"/> <input type="checkbox"/>		RzR 20,64 TRW RzR 20,64 TRW
	1.9 D	48		12.96	09.98	- ABS	24.3220-1713.3 24.3220-1714.3	020410 020411	<input type="checkbox"/> <input type="checkbox"/>		RzR 20,64 TRW RzR 20,64 TRW
	1.1 1.2 1.2 1.9 D	34 40 44 48		01.91 01.91 01.91 01.91	09.98 09.98 09.98 09.98		24.3727-1008.2	581008	2	<input type="checkbox"/>	L=1430
	1.1 1.2 1.2 1.9 D	34 40 44 48		01.91 01.91 01.91 01.91	09.98 09.98 09.98 09.98		24.3728-1004.2	591004			L=992
RENAULT CLIO II Limousine (BB_/CB_) (98-12)											
	1.0 1.2 1.2 1.2 16V 1.2 LPG 1.4 1.4 16V 1.4 16V 1.5 dCi 1.5 dCi 1.5 dCi 1.5 dCi 1.5 dCi 1.5 dCi 1.5 dCi 1.5 dCi 1.6 1.6 16V 1.6 Flex 1.9 D	40 43 44 55 43 55 70 72 47 48 50 59 60 62 74 66 79 81 47		02.00 09.98 03.99 06.01 09.98 10.99 08.00 06.05 06.01 08.04 06.01 06.01 02.07 01.04 09.98 09.98 05.00 09.98	05.01 12.12 05.01 10.03 05.05 07.00 12.12 12.12 12.12 12.12 12.12 12.12 12.12 12.12 12.12 05.05 12.12 12.06 05.05	- ABS - ABS - ABS - ABS	03.7750-1332.4	300155			9" ATE

¹⁾ - ABS/ - driving school / - ABS/ - scuola guida / - ABS/ - auto-école / - ABS/ - autoescuela

²⁾ - ABS/ + driving school / - ABS/ + scuola guida / - ABS/ + auto école / - ABS/ + autoescuela

									
RENAULT CLIO II Limousine (BB /CB_) (98-12)									
	1.9 D	48	02.00	05.05	03.7750-1332.4	300155		9"	ATE
	1.9 dTi	59	02.00	05.05					
	1.2 16V	55	06.01	10.03	03.7853-1502.4	300200	- ESP	9"	ATE
	1.4 16V	70	10.99	07.00	03.7853-0702.4	300195	+ ESP	9"	ATE
	1.4 16V	72	08.00	12.12					
	1.5 dCi	48	06.01	12.12					
	1.5 dCi	50	08.04	12.12					
	1.5 dCi	59	06.01	10.03					
	1.5 dCi	60	06.01	12.12					
1.5 dCi	62	02.07	12.12						
1.5 dCi	74	01.04	12.12						
	1.0	40	02.00	05.01	03.2120-4381.3	010526	- ABS	THz 20,64	ATE
	1.2	43	09.98	12.12	03.2120-4461.3	010571	+ ABS	THz 20,64	ATE
	1.2	44	03.99	05.01	03.2120-4468.3	010789	+ ESP	THz 20,64	ATE
	1.2 16V	55	06.01	10.03					
	1.2 LPG	43	09.98	06.09					
	1.4	55	09.98	05.05					
	1.4 16V	70	10.99	07.00					
	1.4 16V	72	08.00	12.12					
	1.5 dCi	47	06.05	12.12					
	1.5 dCi	48	06.01	12.12					
	1.5 dCi	50	08.04	12.12					
	1.5 dCi	59	06.01	10.03					
	1.5 dCi	60	06.01	12.12					
	1.5 dCi	62	02.07	12.12					
	1.5 dCi	74	01.04	12.12					
	1.6	66	09.98	05.05					
	1.6 16V	79	09.98	12.12					
	1.6 Flex	81	05.00	12.06					
	1.9 D	47	09.98	05.05					
	1.9 D	48	02.00	05.05					
1.9 dTi	59	02.00	05.05						
2.0 16V Sport	124	02.00	12.12	03.2122-1926.3	010916		THz 22,20	ATE	
2.0 16V Sport	132	01.04	12.12						
	1.0	40	02.00	05.01	24.3481-1611.5	240029	<input type="checkbox"/>	D=48, - Halter	TRW
	1.2	43	09.98	06.05	24.3481-1612.5	240030	<input type="checkbox"/>	D=48, - Halter	TRW
	1.2	44	03.99	05.01	24.0101-4807.2	260053		Bremssattel-Zubehör	TRW
	1.2 16V	55	06.01	12.12					
	1.2 LPG	43	09.98	06.09					
	1.4	55	09.98	06.05	- ABS/ + Schaltgetriebe ¹⁾				
	1.9 D	47	09.98	06.05	- ABS/ - Klimaanlage ²⁾				
	1.9 D	48	02.00	06.05	- ABS/ - Klimaanlage ²⁾				
	1.0	40	02.00	05.01	24.3481-1615.5	240031	<input type="checkbox"/>	D=48, - Halter	TRW
	1.2	43	09.98	06.05	24.3481-1616.5	240032	<input type="checkbox"/>	D=48, - Halter	TRW
1.2	44	03.99	05.01	24.0101-4806.2	260052		Bremssattel-Zubehör	TRW	
1.2 16V	55	06.01	12.12						
1.2 LPG	43	09.98	06.09						
1.4	55	09.98	06.05	+ ABS/ + Automatikgetriebe ³⁾					
1.4	55	09.98	06.05	+ ABS/ + Schaltgetriebe ⁴⁾					
1.4 16V	70	10.99	07.00						
1.4 16V	72	08.00	06.05						
1.5 dCi	47	06.05	12.12						
1.5 dCi	48	06.01	06.05						
1.5 dCi	50	08.04	06.05						
1.5 dCi	59	06.01	10.03						
1.5 dCi	60	06.01	06.05						
1.5 dCi	62	02.07	12.12						
1.5 dCi	74	01.04	06.05						
1.6	66	09.98	06.05						
1.6 16V	79	09.98	06.05						
1.6 Flex	81	05.00	12.06						
1.9 D	47	09.98	06.05	+ ABS/ + Klimaanlage ⁵⁾					
1.9 D	48	02.00	06.05	+ ABS/ + Klimaanlage ⁵⁾					
1.9 dTi	59	02.00	06.05						
2.0 16V Sport	124	02.00	06.05	24.3541-1749.5	240427	<input type="checkbox"/>	D=54, - Halter	TRW	
2.0 16V Sport	132	01.04	06.05	24.3541-1750.5	240428	<input type="checkbox"/>	D=54, - Halter	TRW	
	1.0	40	02.00	05.01	24.5111-0321.3	330597	2	L=320	
	1.2	43	09.98	12.12					
	1.2	44	03.99	05.01					
	1.2 16V	55	06.01	12.12					
	1.2 LPG	43	09.98	06.09					
	1.4	55	09.98	05.05					
	1.4 16V	70	10.99	07.00					
	1.4 16V	72	08.00	12.12					
	1.5 dCi	47	06.05	12.12					
	1.5 dCi	48	06.01	12.12					
	1.5 dCi	50	08.04	12.12					
	1.5 dCi	59	06.01	10.03					
	1.5 dCi	60	06.01	12.12					
	1.5 dCi	62	02.07	12.12					
	1.5 dCi	74	01.04	12.12					
	1.6	66	09.98	05.05					
	1.6 16V	79	09.98	12.12					
1.6 Flex	81	05.00	12.06						
1.9 D	47	09.98	05.05						
1.9 D	48	02.00	05.05						

¹⁾ - ABS/ + manual transmission / - ABS/+ scatola camb.velocità / - ABS/ + transmission mécanique / - ABS/ + cambio de velocidad

²⁾ - ABS/ - air conditioning / - ABS/ - aria condizionata / - ABS/ - air conditionné / - ABS/ - aire acondicionado

³⁾ + ABS/ + autom.transmission / + ABS/ + scatola cambio autom. / + ABS/ + transmission automatique / + ABS/ + cambio automático

⁴⁾ + ABS/ + manual transm. / + ABS/+ scatola camb.velocità / + ABS/ + transmission mécanique / + ABS/ + cambio de velocidad













⁵⁾ + ABS/ + air conditioning / + ABS/ + aria condizionata / + ABS/ + air conditionné / + ABS/ + aire acondicionado



RENAULT CLIO II Limousine (BB_/CB_) (98-12)

	1.9 dTi	59	02.00	05.05	24.5111-0321.3	330597	2		L=320
	3.0 V6 Sport	166	11.00	11.02					
	3.0 V6 Sport	187	12.02	12.12	24.5111-0335.3	330778	2		L=335
	2.0 16V Sport	124	02.00	12.12					
	2.0 16V Sport	132	01.04	12.12	24.5111-0321.3	330597	2		L=320
	1.0	40	02.00	05.01					
	1.2	43	09.98	12.12	24.5239-0165.3	330606	2		L=165
	1.2	44	03.99	05.01					
	1.2 16V	55	06.01	12.12	24.5239-0165.3	330606	2		L=165
	1.2 LPG	43	09.98	06.09					
	1.4	55	09.98	05.05	24.5239-0165.3	330606	2		L=165
	1.4 16V	70	10.99	07.00					
	1.4 16V	72	08.00	12.12	24.5239-0165.3	330606	2		L=165
	1.5 dCi	47	06.05	12.12					
	1.5 dCi	48	06.01	12.12	24.5239-0165.3	330606	2		L=165
	1.5 dCi	50	08.04	12.12					
	1.5 dCi	59	06.01	10.03	24.5239-0165.3	330606	2		L=165
	1.5 dCi	60	06.01	12.12					
	1.5 dCi	62	02.07	12.12	24.5239-0165.3	330606	2		L=165
	1.5 dCi	74	01.04	12.12					
	1.6	66	09.98	05.05	24.5239-0165.3	330606	2		L=165
	1.6 16V	79	09.98	05.05					
	1.6 Flex	81	05.00	12.06	24.5239-0165.3	330606	2		L=165
	1.9 D	47	09.98	05.05					
	1.9 D	48	02.00	05.05	24.5239-0165.3	330606	2		L=165
	1.9 dTi	59	02.00	05.05					
	2.0 16V Sport	124	02.00	12.12	24.5239-0165.3	330606	2		L=165
	2.0 16V Sport	132	01.04	12.12					
	3.0 V6 Sport	166	11.00	11.02	24.5111-0321.3	330597	2		L=320
	3.0 V6 Sport	187	12.02	12.12					
	1.0	40	02.00	05.01 - ABS	24.3219-1722.3	020426			Rz 19,05
	1.2	43	09.98	12.12 - ABS					
	1.2	44	03.99	05.01 - ABS	24.3219-1722.3	020426			Rz 19,05
	1.2 16V	55	06.01	12.12 - ABS					
	1.2 LPG	43	09.98	06.09 - ABS	24.3219-1722.3	020426			Rz 19,05
	1.4	55	09.98	05.05 - ABS/ + Schaltgetriebe ¹⁾					
	1.4	55	09.98	05.05 - ABS	24.3219-1722.3	020426			Rz 19,05
	1.9 D	47	09.98	05.05 - ABS/ - Klimaanlage ²⁾					
	1.9 D	48	02.00	05.05 - ABS/ - Klimaanlage ²⁾	24.3219-1722.3	020426			Rz 19,05
	1.0	40	02.00	05.01 + ABS					
	1.2	43	09.98	12.12 + ABS	24.3217-1711.3	020449			Rz 17,46
	1.2	44	03.99	05.01 + ABS					
	1.2 16V	55	06.01	12.12 + ABS	24.3217-1711.3	020449			Rz 17,46
	1.2 LPG	43	09.98	06.09 + ABS					
	1.4	55	09.98	05.05 + ABS/ + Schaltgetriebe ³⁾	24.3217-1711.3	020449			Rz 17,46
	1.4	55	09.98	05.05 + ABS/ + Automatikgetriebe ⁴⁾					
	1.4 16V	70	10.99	07.00	24.3217-1711.3	020449			Rz 17,46
	1.4 16V	72	08.00	12.12					
	1.5 dCi	47	06.05	12.12	24.3217-1711.3	020449			Rz 17,46
	1.5 dCi	48	06.01	12.12					
	1.5 dCi	50	08.04	12.12	24.3217-1711.3	020449			Rz 17,46
	1.5 dCi	59	06.01	10.03					
	1.5 dCi	60	06.01	12.12	24.3217-1711.3	020449			Rz 17,46
	1.5 dCi	62	02.07	12.12					
	1.5 dCi	74	01.04	12.12	24.3217-1711.3	020449			Rz 17,46
	1.6	66	09.98	05.05					
	1.6 16V	79	09.98	12.12	24.3217-1711.3	020449			Rz 17,46
	1.6 Flex	81	05.00	12.06					
	1.9 D	47	09.98	05.05 + ABS/ + Klimaanlage ⁵⁾	24.3217-1711.3	020449			Rz 17,46
	1.9 D	48	02.00	05.05 + ABS/ + Klimaanlage ⁵⁾					
	1.9 dTi	59	02.00	05.05	24.3217-1710.3	020420			Rz 17,78
	1.0	40	02.00	05.01 + ABS					
	1.2	43	09.98	10.07 + ABS	24.3217-1710.3	020420			Rz 17,78
	1.2	44	03.99	05.01 + ABS					
	1.2 16V	55	06.01	10.07 + ABS	24.3217-1710.3	020420			Rz 17,78
	1.2 LPG	43	09.98	10.07 + ABS					
	1.4	55	09.98	05.05 + ABS/ + Schaltgetriebe ³⁾	24.3217-1710.3	020420			Rz 17,78
	1.4	55	09.98	05.05 + ABS/ + Automatikgetriebe ⁴⁾					
	1.4 16V	70	10.99	07.00	24.3217-1710.3	020420			Rz 17,78
	1.4 16V	72	08.00	10.07					
	1.5 dCi	47	06.05	10.07	24.3217-1710.3	020420			Rz 17,78
	1.5 dCi	48	06.01	10.07					
	1.5 dCi	50	08.04	10.07	24.3217-1710.3	020420			Rz 17,78
	1.5 dCi	59	06.01	10.03					
	1.5 dCi	60	06.01	10.07	24.3217-1710.3	020420			Rz 17,78
	1.5 dCi	62	02.07	10.07					
	1.5 dCi	74	01.04	10.07	24.3217-1710.3	020420			Rz 17,78
	1.6	66	09.98	05.05					
	1.6 16V	79	09.98	10.07	24.3217-1710.3	020420			Rz 17,78
	1.6 Flex	81	05.00	12.06					
	1.9 D	47	09.98	05.05 + ABS/ + Klimaanlage ⁵⁾	24.3217-1710.3	020420			Rz 17,78
	1.9 D	48	02.00	05.05 + ABS/ + Klimaanlage ⁵⁾					
	1.9 dTi	59	02.00	05.05	24.3217-1710.3	020420			Rz 17,78
	1.2	43	11.07	12.12 + ABS					
	1.2 16V	55	11.07	12.12 + ABS	24.3217-1727.3	020524			Rz 17,46
	1.2 LPG	43	11.07	06.09 + ABS					

1) - ABS/ + manual transmission / - ABS/ + scatola camb.velocità / - ABS/ + transmission mécanique / - ABS/ + cambio de velocidad
2) - ABS/ - air conditioning / - ABS/ - aria condizionata / - ABS/ - air conditionné / - ABS/ - aire acondicionado
3) + ABS/ + manual transm. / + ABS/ + scatola camb.velocità / + ABS/ + transmission mécanique / + ABS/ + cambio de velocidad
4) + ABS/ + autom.transmission / + ABS/ + scatola cambio autom. / + ABS/ + transmission automatique / + ABS/ + cambio automático
5) + ABS/ + air conditioning / + ABS/ + aria condizionata / + ABS/ + air conditionné / + ABS/ + aire acondicionado

















RENAULT CLIO II Limousine (BB /CB_) (98-12)										
										
	1.4 16V	72		11.07	12.12	24.3217-1727.3	020524		Rz 17,46	
	1.5 dCi	47		11.07	12.12					
	1.5 dCi	48		11.07	12.12					
	1.5 dCi	50		11.07	12.12					
	1.5 dCi	60		11.07	12.12					
	1.5 dCi	62		11.07	12.12					
	1.5 dCi	74		11.07	12.12					
	1.6 16V	79		11.07	12.12					
	1.0	40		02.00	05.01	- ABS	24.3727-1049.2	581049	<input type="checkbox"/>	L=1263
	1.2	43		09.98	12.12	- ABS	24.3727-1048.2	581048	<input checked="" type="checkbox"/>	L=1343
	1.2	44		03.99	05.01	- ABS				
	1.4	55		09.98	05.05	- ABS/ + Schaltgetriebe 1)				
	1.4	55		09.98	05.05	- ABS				
	1.9 D	47		09.98	05.05	- ABS/ - Klimaanlage 2)				
	1.9 D	48		02.00	12.12	- ABS/ - Klimaanlage 2)				
	1.0	40		02.00	05.01	+ ABS	24.3727-1047.2	581047	<input type="checkbox"/>	L=1277
	1.2	43		09.98	12.12	+ ABS	24.3727-1046.2	581046	<input checked="" type="checkbox"/>	L=1355
	1.2	44		03.99	05.01	+ ABS				
	1.4	55		09.98	05.05	- ABS/ + Automatikgetriebe 3)				
	1.4	55		09.98	05.05	+ ABS				
	1.4 16V	70		10.99	07.00					
	1.4 16V	72		08.00	12.12					
	1.6	66		09.98	05.05					
	1.6 16V	79		09.98	12.12					
	1.6 Flex	81		05.00	12.06					
	1.9 D	47		09.98	05.05	+ ABS/ + Klimaanlage 4)				
	1.9 D	48		02.00	05.05	+ ABS/ + Klimaanlage 4)				
	1.9 dTi	59		02.00	05.05					
	1.2 16V	55		06.01	12.12	- ABS	24.3727-1067.2	581067	<input type="checkbox"/>	L=1321
	1.2 LPG	43		09.98	06.09	- ABS	24.3727-1066.2	581066	<input checked="" type="checkbox"/>	L=1402
	1.5 dCi	48		06.01	12.12	- ABS				
	1.5 dCi	50		08.04	12.12	- ABS				
	1.5 dCi	59		06.01	10.03	+ ABS				
	1.5 dCi	60		06.01	12.12	+ ABS				
	1.5 dCi	74		01.04	12.12	+ ABS				
	1.2 16V	55		06.01	12.12	- ESP	24.3727-1061.2	581061	<input type="checkbox"/>	L=1335
	1.5 dCi	48		06.01	12.12	- ESP	24.3727-1060.2	581060	<input checked="" type="checkbox"/>	L=1415
	1.5 dCi	50		08.04	12.12	- ESP				
	1.5 dCi	59		06.01	10.03	- ABS				
	1.5 dCi	60		06.01	12.12	- ABS				
	1.5 dCi	74		01.04	12.12	- ABS				
	1.0	40		02.00	05.01		24.6582-1721.3	320212	- ABS	BRL (4) weiss/lila
	1.2	43		09.98	12.12					
	1.2	44		03.99	05.01					
	1.2 16V	55		06.01	12.12					
	1.2 LPG	43		09.98	06.09					
	1.4	55		09.98	05.05					
	1.4 16V	70		10.99	07.00					
	1.4 16V	72		08.00	12.12					
	1.5 dCi	47		06.05	12.12					
	1.5 dCi	48		06.01	12.12					
	1.5 dCi	50		08.04	12.12					
	1.5 dCi	59		06.01	10.03					
	1.5 dCi	60		06.01	12.12					
	1.5 dCi	62		02.07	12.12					
	1.5 dCi	74		01.04	12.12					
	1.6	66		09.98	05.05					
	1.6 16V	79		09.98	12.12					
	1.6 Flex	81		05.00	12.06					
	1.9 D	47		09.98	05.05					
	1.9 D	48		02.00	05.05					
	1.9 dTi	59		02.00	05.05					
	1.0	40		02.00	05.01		24.3728-1023.2	591023		L=960
	1.2	43		09.98	12.12					
	1.2	44		03.99	05.01					
	1.2 16V	55		06.01	12.12					
	1.2 LPG	43		09.98	06.09					
	1.4	55		09.98	05.05					
	1.4 16V	70		10.99	07.00					
	1.4 16V	72		08.00	12.12					
	1.5 dCi	47		06.05	12.12					
	1.5 dCi	48		06.01	12.12					
	1.5 dCi	50		08.04	12.12					
	1.5 dCi	59		06.01	10.03					
	1.5 dCi	60		06.01	12.12					
	1.5 dCi	62		02.07	12.12					
	1.5 dCi	74		01.04	12.12					
	1.6	66		09.98	05.05					
	1.6 16V	79		09.98	12.12					
	1.6 Flex	81		05.00	12.06					
	1.9 D	47		09.98	05.05					
	1.9 D	48		02.00	05.05					
	1.9 dTi	59		02.00	05.05					













1) - ABS/ + manual transmission / - ABS/+ scatola camb.velocità / - ABS/ + transmission mécanique / - ABS/ + cambio de velocidad













2) - ABS/ - air conditioning / - ABS/ - aria condizionata / - ABS/ - air conditionné / - ABS/ - aire acondicionado

3) - ABS/ + autom.transmission / - ABS/+ scatola cambio autom./ - ABS/ + transmission automatique / - ABS/ + cambio automático

4) + ABS/ + air conditioning / + ABS/ + aria condizionata / + ABS/ + air conditionné / + ABS/ + aire acondicionado

												
RENAULT CLIO II Kasten (SB_) (98-12)												
	1.2	43	09.98	12.12	03.7750-1332.4	300155		9"	ATE			
	1.2	44	03.99	10.03								
	1.5 dCi	48	06.01	12.12						- ABS		
	1.5 dCi	59	06.01	10.04						- ABS		
	1.5 dCi	60	11.03	12.12						- ABS		
	1.9 D	40	03.99	01.00								
	1.9 D	47	09.98	12.12								
	1.9 D (SB)	48	02.00	05.01								
	1.9 dTi	59	02.00	05.01								
	1.5 dCi	48	06.01	12.12						03.7853-1502.4	300200	- ESP
1.5 dCi	59	06.01	10.04	03.7853-0702.4	300195	+ ESP	9"	ATE				
1.5 dCi	60	11.03	12.12									
	1.2	43	09.98	12.12	03.2120-4381.3	010526		THz 20,64	ATE			
	1.2	44	03.99	10.03						03.2120-4461.3	010571	
	1.5 dCi	48	06.01	12.12						03.2120-4468.3	010789	- ABS
	1.5 dCi	59	06.01	10.04								- ESP
	1.5 dCi	60	11.03	12.12								+ ESP
	1.9 D	40	03.99	01.00								
	1.9 D	47	09.98	12.12								
	1.9 D (SB)	48	02.00	05.01								
	1.9 dTi	59	02.00	05.01								
		1.2	43	09.98						12.12	24.3481-1611.5	240029
1.2		44	03.99	10.03	24.3481-1612.5	240030	- ABS					
1.2		43	09.98	12.12	24.3481-1615.5	240031	+ ABS					
1.2		44	03.99	10.03	24.3481-1616.5	240032	+ ABS					
1.5 dCi		48	06.01	12.12	24.0101-4806.2	260052						
1.5 dCi		59	06.01	10.04								
1.5 dCi		60	11.03	12.12								
1.9 D		40	03.99	01.00								
1.9 D		47	09.98	12.12								
1.9 D (SB)		48	02.00	05.01								
1.9 dTi	59	02.00	05.01									
	1.2	43	09.98	12.12	24.5111-0321.3	330597	2	L=320				
	1.2	44	03.99	10.03								
	1.5 dCi	48	06.01	12.12								
	1.5 dCi	59	06.01	10.04								
	1.5 dCi	60	11.03	12.12								
	1.9 D	40	03.99	01.00								
	1.9 D	47	09.98	12.12								
	1.9 D (SB)	48	02.00	05.01								
	1.9 dTi	59	02.00	05.01								
		1.2	43	09.98						12.12	24.5239-0165.3	330606
1.2		44	03.99	10.03								
1.5 dCi		48	06.01	12.12								
1.5 dCi		59	06.01	10.04								
1.5 dCi		60	11.03	12.12								
1.9 D		40	03.99	01.00								
1.9 D		47	09.98	12.12								
1.9 D (SB)		48	02.00	05.01								
1.9 dTi		59	02.00	12.12								
		1.2	43	09.98	12.12	24.3219-1722.3	020426		Rz 19,05	BDX		
	1.2	44	03.99	10.03	- ABS							
	1.9 D (SJ)	47	09.98	12.12	- ABS							
	1.2	43	09.98	12.12	24.3217-1710.3						020420	+ ABS
	1.5 dCi	48	06.01	12.12	24.3217-1711.3						020449	
	1.5 dCi	59	06.01	10.04								
	1.5 dCi	60	11.03	12.12								
	1.9 D	40	03.99	01.00								
	1.9 D	47	09.98	12.12								
	1.9 D (SB)	48	02.00	05.01								
1.9 dTi	59	02.00	05.01									
	1.2	43	09.98	12.12	24.3727-1049.2	581049		L=1263				
	1.9 D (SJ)	47	09.98	12.12						24.3727-1048.2	581048	- ABS
	1.2	43	09.98	12.12						24.3727-1047.2	581047	+ ABS
	1.9 D	40	03.99	01.00						24.3727-1046.2	581046	
	1.9 D (SB)	48	02.00	05.01								
	1.9 D (SJ)	47	09.98	12.12								+ ABS
	1.9 dTi	59	02.00	05.01								
	1.5 dCi	48	06.01	12.12						24.3727-1067.2	581067	- ABS
	1.5 dCi	59	06.01	10.04						24.3727-1066.2	581066	- ABS
	1.5 dCi	60	11.03	12.12								- ABS
1.5 dCi	48	06.01	12.12	24.3727-1061.2	581061	- ESP						
1.5 dCi	59	06.01	10.04	24.3727-1060.2	581060	- ESP						
1.5 dCi	60	11.03	12.12			- ESP						
	1.2	43	09.98	12.12	24.6582-1721.3	320212		- ABS	BRL (4) weiss/lila			
	1.5 dCi	48	06.01	12.12								
	1.5 dCi	59	06.01	10.04								
	1.5 dCi	60	11.03	12.12								
	1.9 D	40	03.99	01.00								
	1.9 D	47	09.98	12.12								
	1.9 D (SB)	48	02.00	05.01								
	1.9 dTi	59	02.00	05.01								

								
RENAULT CLIO II Kasten (SB_) (98-12)								
	1.2	43	09.98	12.12	24.3728-1023.2	591023		L=960
	1.5 dCi	48	06.01	12.12				
	1.5 dCi	59	06.01	10.04				
	1.5 dCi	60	11.03	12.12				
	1.9 D	40	03.99	01.00				
	1.9 D	47	09.98	12.12				
	1.9 D (SB)	48	02.00	05.01				
	1.9 dTi	59	02.00	05.01				
RENAULT CLIO III (BR_/CR_) (05-12)								
	1.2 16V	43	06.06	11.07	03.7863-4502.4	300230	+ ABS	10" ATE
	1.2 16V	48	06.05	11.07				
	1.2 16V	55	06.05	11.07				
	1.2 16V	58	06.05	11.07				
	1.2 16V	74	05.07	11.07				
	1.4 16V	72	06.05	11.07				
	1.5 dCi	48	05.05	10.06				
	1.5 dCi	50	06.05	11.07				
	1.5 dCi	63	06.05	11.07				
	1.5 dCi	76	06.05	11.07				
	1.5 dCi	78	06.05	11.07				
	1.6 16V	65	06.05	11.07				
	1.6 16V	82	06.05	11.07				
	1.6 Hi-Flex	86	05.05	11.07				
	2.0 16V	102	09.06	11.07				
	2.0 16V Sport	145	02.06	12.12	03.7860-3702.4	300305		9" ATE
	2.0 16V Sport	148	09.08	12.12				
	1.2 16V	43	06.06	12.12	03.2123-2821.3	010944	- ABS	THz 23,81 ATE
	1.2 16V	48	06.05	12.12				
	1.2 16V	55	06.05	12.12				
	1.2 16V	58	06.05	12.12				
	1.2 16V	74	05.07	12.12				
	1.2 16V	76	09.10	12.12				
	1.2 16V Hi-Flex	55	07.08	12.12				
	1.4 16V	72	06.05	12.12				
	1.5 dCi	48	05.05	10.06				
	1.5 dCi	50	06.05	12.12				
	1.5 dCi	55	08.10	12.12				
	1.5 dCi	60	11.07	12.12				
	1.5 dCi	63	06.05	12.12				
	1.5 dCi	65	08.10	12.12				
	1.5 dCi	76	06.05	12.12				
	1.5 dCi	78	06.05	12.12				
	1.6 16V	65	06.05	12.12				
	1.6 16V	82	06.05	12.12				
	1.6 16V GT	94	04.09	12.12				
	1.6 Hi-Flex	86	05.05	02.10				
	2.0 16V	102	09.06	12.12				
	2.0 16V Sport	145	02.06	12.12				
	2.0 16V Sport	148	09.08	12.12				
	1.2 16V	43	06.06	11.07	03.2123-3241.3	010882	- ESP	THz 23,81 ATE
	1.2 16V	48	06.05	11.07	03.2123-3493.3	010792	+ ESP	THz 23,81 ATE
	1.2 16V	55	06.05	11.07				
	1.2 16V	58	06.05	11.07				
	1.2 16V	74	05.07	11.07				
	1.4 16V	72	06.05	11.07				
	1.5 dCi	48	05.05	10.06				
	1.5 dCi	50	06.05	11.07				
	1.5 dCi	63	06.05	11.07				
	1.5 dCi	76	06.05	11.07				
	1.5 dCi	78	06.05	11.07				
	1.6 16V	65	06.05	11.07				
	1.6 16V	82	06.05	11.07				
	1.6 Hi-Flex	86	05.05	11.07				
	2.0 16V	102	09.06	11.07				
	1.2 16V	43	12.07	12.12	03.2123-2863.3	010790	- ESP	THz 23,81 ATE
	1.2 16V	48	12.07	12.12	03.2123-2923.3	010791	+ ESP	THz 23,81 ATE
	1.2 16V	55	12.07	12.12				
	1.2 16V	58	12.07	12.12				
	1.2 16V	74	12.07	12.12				
	1.2 16V	76	09.10	12.12				
	1.2 16V Hi-Flex	55	07.08	12.12				
	1.4 16V	72	12.07	12.12				
	1.5 dCi	50	12.07	12.12				
	1.5 dCi	55	08.10	12.12				
	1.5 dCi	60	12.07	12.12				
	1.5 dCi	63	12.07	12.12				
	1.5 dCi	65	08.10	12.12				
	1.5 dCi	76	12.07	12.12				
	1.5 dCi	78	12.07	12.12				
	1.6 16V	65	12.07	12.12				
	1.6 16V	82	12.07	12.12				
	1.6 16V GT	94	04.09	12.12				
	1.6 Hi-Flex	86	12.07	02.10				
	2.0 16V	102	12.07	12.12				
	2.0 16V Sport	145	02.06	12.12	03.2123-3493.3	010792		THz 23,81 ATE
	2.0 16V Sport	148	09.08	12.12				

	 kW									
RENAULT CLIO III (BR_/CR_) (05-12)										
	1.2 16V	43	06.06	12.12	24.3541-1849.5	240707	☐ ☐	D=54, - Halter D=54, - Halter Bremsattel-Zubehör	TRW	
	1.2 16V	48	06.05	12.12	24.3541-1850.5	240708			TRW	
	1.2 16V	55	06.05	12.12	24.0101-5407.2	260140				
	1.2 16V	58	06.05	12.12						
	1.2 16V	74	05.07	12.12						
	1.2 16V	76	09.10	12.12						
	1.2 16V Hi-Flex	55	07.08	12.12						
	1.4 16V	72	06.05	12.12						
	1.5 dCi	47	06.05	12.12						
	1.5 dCi	48	05.05	10.06						
	1.5 dCi	50	06.05	12.12						
	1.5 dCi	55	08.10	12.12						
	1.5 dCi	60	11.07	12.12						
	1.5 dCi	63	06.05	12.12						
	1.5 dCi	65	08.10	12.12						
	1.5 dCi	76	06.05	12.12						
	1.5 dCi	78	06.05	12.12						
	1.6 16V	65	06.05	12.12						
	1.6 16V GT	94	04.09	12.12						
	1.6 Hi-Flex	86	05.05	02.10						
2.0 16V	102	09.06	12.12	11.9541-9546.2	220626	☐	D=54, - Halter Haltefeder	ATE		
2.0 16V	110	11.07	12.12	11.8116-0301.1	390610	2		ATE		
	1.2 16V	43	06.06	12.12	24.5111-0455.3	330914	2	L=455		
	1.2 16V	48	06.05	12.12						
	1.2 16V	55	06.05	12.12						
	1.2 16V	58	06.05	12.12						
	1.2 16V	74	05.07	12.12						
	1.2 16V	76	09.10	12.12						
	1.2 16V Hi-Flex	55	07.08	12.12						
	1.4 16V	72	06.05	12.12						
	1.5 dCi	47	06.05	12.12						
	1.5 dCi	48	05.05	10.06						
	1.5 dCi	50	06.05	12.12						
	1.5 dCi	55	08.10	12.12						
	1.5 dCi	60	11.07	12.12						
	1.5 dCi	63	06.05	12.12						
	1.5 dCi	65	08.12	12.12						
	1.5 dCi	76	06.05	12.12						
	1.5 dCi	78	06.05	12.12						
	1.6 16V	65	06.05	12.12						
	1.6 16V	82	06.05	12.12						
	1.6 16V GT	94	04.09	12.12						
1.6 Hi-Flex	86	05.05	02.10							
	1.2 16V	43	06.06	12.12	24.3347-1703.7	220685	☐ ☐	D=34, - Halter D=34, - Halter Bremsattel-Zubehör	TRW	
	1.2 16V	48	06.05	12.12	24.3347-1704.7	220686			TRW	
	1.2 16V	55	06.05	12.12	24.0101-3803.2	260101			TRW	
	1.2 16V	58	06.05	12.12						
	1.2 16V	74	05.07	12.12						
	1.2 16V	76	09.10	12.12						
	1.2 16V Hi-Flex	55	07.08	12.12						
	1.4 16V	72	06.05	12.12						
	1.5 dCi	48	05.05	10.06						
	1.5 dCi	50	06.05	12.12						
	1.5 dCi	55	08.10	12.12						
	1.5 dCi	60	11.07	12.12						
	1.5 dCi	63	06.05	12.12						
	1.5 dCi	65	08.10	12.12						
	1.5 dCi	76	06.05	12.12						
	1.5 dCi	78	06.05	12.12						
	1.6 16V	65	06.05	12.12						
	1.6 16V	82	06.05	12.12						
	1.6 16V GT	94	04.09	12.12						
	1.6 Hi-Flex	86	05.05	02.10						
2.0 16V	102	09.06	12.12							
2.0 16V Sport	145	02.06	12.12	24.3387-1721.7	220781	☐	D=38, - Halter D=38, - Halter	TRW		
2.0 16V Sport	148	04.09	12.12	24.3387-1722.7	220782	☐		TRW		
	1.2 16V	43	06.06	12.12	24.5229-0193.3	330571	2	L=193 L=185		
	1.2 16V	48	06.05	12.12	24.5229-0185.3	330397			2	
	1.2 16V	55	06.05	12.12						
	1.2 16V	58	06.05	12.12						
	1.2 16V	74	05.07	12.12						
	1.2 16V	76	09.10	12.12						
	1.2 16V Hi-Flex	55	07.08	12.12						
	1.4 16V	72	06.05	12.12						
	1.5 dCi	48	05.05	10.06						
	1.5 dCi	50	06.05	12.12						
	1.5 dCi	55	08.10	12.12						
	1.5 dCi	60	11.07	12.12						
	1.5 dCi	63	06.05	12.12						
	1.5 dCi	65	08.10	12.12						
	1.5 dCi	76	06.05	12.12						
	1.5 dCi	78	06.05	12.12						
	1.6 16V	65	06.05	12.12						
	1.6 16V	82	06.05	12.12						
	1.6 16V GT	94	04.09	12.12						
	1.6 Hi-Flex	86	05.05	02.10						



RENAULT CLIO III (BR_/CR_) (05-12)

	2.0 16V	102		09.06	12.12		24.5229-0193.3	330571	2			
	2.0 16V Sport	145		02.06	12.12		24.5229-0185.3	330397	2			L=193 L=185
	2.0 16V Sport	148		04.09	12.12							
	1.2 16V	43		06.06	12.12		24.3219-1755.3	020508				Rz 19,05
	1.2 16V	48		06.05	12.12							
	1.2 16V	55		06.05	12.12							
	1.2 16V	58		06.05	12.12							
	1.2 16V	74		05.07	12.12							
	1.2 16V	76		09.10	12.12							
	1.2 16V Hi-Flex	55		07.08	12.12							
	1.4 16V	72		06.05	12.12							
	1.5 dCi	48		05.05	10.06							
	1.5 dCi	50		06.05	12.12							
	1.5 dCi	55		08.10	12.12							
	1.5 dCi	60		11.07	12.12							
	1.5 dCi	63		06.05	12.12							
	1.5 dCi	65		08.10	12.12							
	1.5 dCi	76		06.05	12.12							
	1.2 16V	43		06.06	12.12		24.3727-1078.2	581078		<input type="checkbox"/> + Trommelbremse ¹⁾		L=1451
	1.2 16V	48		06.05	12.12		24.3727-1079.2	581079		<input type="checkbox"/> + Trommelbremse ¹⁾		L=1587
	1.2 16V	55		06.05	12.12							
	1.2 16V	58		06.05	12.12							
	1.2 16V	74		05.07	12.12							
	1.2 16V	76		09.10	12.12							
	1.2 16V Hi-Flex	55		07.08	12.12							
	1.4 16V	72		06.05	12.12							
	1.5 dCi	48		05.05	10.06							
	1.5 dCi	50		06.05	12.12							
	1.5 dCi	55		08.10	12.12							
	1.5 dCi	60		11.07	12.12							
	1.5 dCi	63		06.05	12.12							
	1.5 dCi	65		08.10	12.12							
	1.5 dCi	76		06.05	12.12							
	1.6 16V GT	94		04.09	12.12							
	2.0 16V Sport	145		02.06	12.12	- ABS						
	2.0 16V Sport	148		04.09	12.12	- ABS						
	2.0 16V Sport	145		02.06	12.12	+ ABS	24.3727-1092.2	581092		<input type="checkbox"/>		L=1458
	2.0 16V Sport	148		04.09	12.12	+ ABS	24.3727-1093.2	581093		<input type="checkbox"/>		L=1596
	1.2 16V	76		09.10	12.12		24.3727-1091.2	581091		<input type="checkbox"/> + 16" Rad ²⁾		L=1440
	1.5 dCi	55		08.10	12.12		24.3727-1090.2	581090		<input type="checkbox"/> + 16" Rad ²⁾		L=1572
	1.5 dCi	65		08.10	12.12							
	1.2 16V	▶ 43		06.06	12.12		24.2418-1702.3	030136				Gz 18,82
	1.2 16V	▶ 48		06.05	12.12							
	1.2 16V	▶ 55		06.05	12.12							
	1.2 16V	▶ 58		06.05	12.12							
	1.2 16V	▶ 74		05.07	12.12							
	1.2 16V	▶ 76		09.10	12.12							
	1.2 16V Hi-Flex	▶ 55		07.08	12.12							
	1.4 16V	▶ 72		06.05	12.12							
	1.5 dCi	▶ 48		05.05	10.06							
	1.5 dCi	▶ 50		06.05	12.12							
	1.5 dCi	▶ 55		08.10	12.12							
	1.5 dCi	▶ 60		11.07	12.12							
	1.5 dCi	▶ 63		06.05	12.12							
	1.5 dCi	▶ 65		08.10	12.12							
	1.5 dCi	▶ 76		06.05	12.12							
	1.5 dCi	▶ 78		06.05	12.12							
	1.6 16V	▶ 65		06.05	12.12							
	1.6 16V	▶ 82		06.05	12.12							
	1.6 16V GT	▶ 94		04.09	12.12							
	1.6 Hi-Flex	▶ 86		05.05	02.10							

























RENAULT CLIO III Grandtour (KR_) (08-12)















































	1.2 16V	◀ 55		02.08	12.12		03.7863-4502.4	300230		+ ABS		10"	ATE
	1.2 16V	◀ 57		02.08	12.12								
	1.2 16V	◀ 74		02.08	12.12								
	1.2 16V Hi-Flex	◀ 55		07.08	12.12								
	1.4 16V	◀ 72		02.10	12.12								
	1.5 dCi	◀ 48		02.08	12.12								
	1.5 dCi	◀ 50		02.08	12.12								
	1.5 dCi	◀ 63		02.08	12.12								
	1.5 dCi	◀ 76		02.08	12.12								
	1.5 dCi	◀ 78		02.08	12.12								
	1.6 16V	◀ 82		02.08	12.12								
	1.6 16V	◀ 94		11.08	12.12								
	1.2 16V	55		02.08	12.12		03.2123-2821.3	010944		- ABS		THz 23,81	ATE
	1.2 16V	57		02.08	12.12								
	1.2 16V	74		02.08	12.12								
	1.2 16V Hi-Flex	55		07.08	12.12								
	1.5 dCi	48		02.08	12.12								
	1.5 dCi	50		02.08	12.12								
	1.5 dCi	63		02.08	12.12								
	1.5 dCi	76		02.08	12.12								
	1.5 dCi	78		02.08	12.12								
	1.6 16V	82		02.08	12.12								

¹⁾ + drum brake / + freno a tamburo / + freins à tambour / + tambores de freno

²⁾ + 16" wheel / + ruota 16" / + roue 16" / + rueda 16"























									
RENAULT CLIO III Grandtour (KR_) (08-12)									
	1.2 16V	55	02.08	12.12	03.2123-3241.3	010882	- ESP	THz 23,81	ATE
	1.2 16V	57	02.08	12.12	03.2123-3493.3	010792	+ ESP	THz 23,81	ATE
	1.2 16V	74	02.08	12.12					
	1.2 16V Hi-Flex	55	07.08	12.12					
	1.4 16V	72	02.10	12.12					
	1.5 dCi	48	02.08	12.12					
	1.5 dCi	50	02.08	12.12					
	1.5 dCi	63	02.08	12.12					
	1.5 dCi	76	02.08	12.12					
	1.5 dCi	78	02.08	12.12					
	1.6 16V	82	02.08	12.12					
	1.6 16V	94	11.08	12.12	03.2123-2863.3	010790	- ESP	THz 23,81	ATE
					03.2123-2923.3	010791	+ ESP	THz 23,81	ATE
	1.2 16V	55	02.08	12.12	24.3541-1849.5	240707		D=54, - Halter	TRW
	1.2 16V	57	02.08	12.12	24.3541-1850.5	240708		D=54, - Halter	TRW
	1.2 16V	74	02.08	12.12	24.0101-5407.2	260140		Bremssattel-Zubehör	
	1.2 16V Hi-Flex	55	07.08	12.12					
	1.4 16V	72	02.10	12.12					
	1.5 dCi	48	02.08	12.12					
	1.5 dCi	50	02.08	12.12					
	1.5 dCi	63	02.08	12.12					
	1.5 dCi	76	02.08	12.12					
	1.5 dCi	78	02.08	12.12					
	1.6 16V	82	02.08	12.12					
	1.6 16V	94	11.08	12.12					
	1.2 16V	55	02.08	12.12	24.5111-0455.3	330914	2	L=455	
	1.2 16V	57	02.08	12.12					
	1.2 16V	74	02.08	12.12					
	1.2 16V Hi-Flex	55	07.08	12.12					
	1.4 16V	72	02.10	12.12					
	1.5 dCi	48	02.08	12.12					
	1.5 dCi	50	02.08	12.12					
	1.5 dCi	63	02.08	12.12					
	1.5 dCi	76	02.08	12.12					
	1.5 dCi	78	02.08	12.12					
	1.6 16V	82	02.08	12.12					
	1.6 16V	94	11.08	12.12					
	1.2 16V	55	02.08	12.12 + ESP	24.3347-1703.7	220685		D=34, - Halter	TRW
	1.2 16V	57	02.08	12.12 + ESP	24.3347-1704.7	220686		D=34, - Halter	TRW
	1.2 16V	74	02.08	12.12 + ESP	24.0101-3803.2	260101		Bremssattel-Zubehör	TRW
	1.2 16V Hi-Flex	55	07.08	12.12 + ESP					
	1.4 16V	72	02.10	12.12 + ESP					
	1.5 dCi	48	02.08	12.12 + ESP					
	1.5 dCi	50	02.08	12.12 + ESP					
	1.5 dCi	63	02.08	12.12 + ESP					
	1.5 dCi	76	02.08	12.12 + ESP					
	1.5 dCi	78	02.08	12.12 + ESP					
	1.6 16V	82	02.08	12.12 + ESP					
	1.6 16V	94	11.08	12.12 + ESP					
	1.2 16V	55	02.08	12.12	24.5229-0185.3	330397	2	L=185	
	1.2 16V	57	02.08	12.12					
	1.2 16V	74	02.08	12.12					
	1.2 16V Hi-Flex	55	07.08	12.12					
	1.4 16V	72	02.10	12.12					
	1.5 dCi	48	02.08	12.12					
	1.5 dCi	50	02.08	12.12					
	1.5 dCi	63	02.08	12.12					
	1.5 dCi	76	02.08	12.12					
	1.5 dCi	78	02.08	12.12					
	1.6 16V	82	02.08	12.12					
	1.6 16V	94	11.08	12.12					
	1.2 16V	55	02.08	12.12	24.3219-1755.3	020508	- ESP	Rz 19,05	
	1.2 16V	57	02.08	12.12					
	1.2 16V	74	02.08	12.12					
	1.2 16V Hi-Flex	55	07.08	12.12					
	1.4 16V	72	02.10	12.12					
	1.5 dCi	48	02.08	12.12					
	1.5 dCi	50	02.08	12.12					
	1.5 dCi	63	02.08	12.12					
	1.5 dCi	76	02.08	12.12					
	1.5 dCi	78	02.08	12.12					
	1.6 16V	82	02.08	12.12					
	1.6 16V	94	11.08	12.12					
	1.2 16V	55	02.08	12.12	24.3727-1078.2	581078		L=1451	
	1.2 16V	57	02.08	12.12	24.3727-1079.2	581079		L=1587	
	1.2 16V	74	02.08	12.12					
	1.2 16V Hi-Flex	55	07.08	12.12					
	1.4 16V	72	02.10	12.12					
	1.5 dCi	50	02.08	12.12					
	1.5 dCi	76	02.08	12.12					
	1.5 dCi	78	02.08	12.12					
	1.6 16V	82	02.08	12.12					
	1.5 dCi	48	02.08	12.12	24.3727-1091.2	581091		L=1440	
	1.5 dCi	63	02.08	12.12	24.3727-1090.2	581090		L=1572	
	1.6 16V	94	11.08	12.12					

									
RENAULT CLIO III Grandtour (KR_) (08-12)									
	1.2 16V ▶ 55 1.2 16V ▶ 57 1.2 16V ▶ 74 1.2 16V Hi-Flex ▶ 55 1.4 16V ▶ 72 1.5 dCi ▶ 48 1.5 dCi ▶ 50 1.5 dCi ▶ 63 1.5 dCi ▶ 76 1.5 dCi ▶ 78 1.6 16V ▶ 82 1.6 16V ▶ 94		02.08 12.12 02.08 12.12 02.08 12.12 07.08 12.12 02.10 12.12 02.08 12.12 02.08 12.12 02.08 12.12 02.08 12.12 02.08 12.12 02.08 12.12 11.08 12.12			24.2418-1702.3 030136			Gz 18,82
RENAULT CLIO IV (B98_) (12-)									
	1.2 TCe 120 88 1.5 dCi 90 66		03.13 09.12	+ Automatikgetriebe ¹⁾	24.3541-1849.5 240707 24.3541-1850.5 240708		 	D=54, - Halter D=54, - Halter	TRW TRW
	1.6 RS 200 147 1.6 RS Trophy 162		03.13 03.15	+ grauer Sattel ²⁾ + grauer Sattel ²⁾	24.3347-1709.7 221013 24.3347-1710.7 221014		 	D=34, - Halter D=34, - Halter	TRW TRW
	0.9 TCe 90 66 1.2 16V 75 54 1.5 dCi 75 55 1.5 dCi 90 66		09.12 09.12 09.12 09.12	+ Schaltgetriebe ³⁾	24.3217-1711.3 020449			Rz 17,46	BOS
	1.2 TCe 120 88 1.5 dCi 90 66		03.13 09.12	+ Automatikgetriebe ¹⁾	24.3219-1761.3 020536			Rz 19,05	
RENAULT CLIO IV Grandtour (K98_) (12-)									
	0.9 TCe 90 66 1.2 16V 54 1.2 TCe 120 88 1.5 dCi 75 55 1.5 dCi 90 66		11.12 11.12 03.13 11.12 11.12		24.3541-1849.5 240707 24.3541-1850.5 240708		 	D=54, - Halter D=54, - Halter	TRW TRW
	0.9 TCe 90 66 1.2 16V 54 1.2 TCe 120 88 1.5 dCi 75 55 1.5 dCi 90 66		11.12 11.12 03.13 11.12 11.12		24.3219-1761.3 020536			Rz 19,05	
RENAULT DOKKER (K67/F67) (12-)									
	1.5 dCi 75 55 1.5 dCi 90 66 1.6 MPI 61		11.12 11.12 11.12	- ESP - ESP - ESP	24.3541-1849.5 240707 24.3541-1850.5 240708		  	D=54, - Halter D=54, - Halter	TRW TRW
	1.2 TCe 115 85 1.5 dCi 75 55 1.5 dCi 90 66 1.6 MPI 61		01.13 11.12 11.12 11.12	+ ESP + ESP + ESP	11.9541-9950.2 220843 11.9541-9951.2 220844 11.8170-0002.1 260110 11.8116-0356.1 390586	2	   	D=54, - Halter D=54, - Halter Halter Halterfeder	ATE ATE ATE ATE
	1.2 TCe 115 85 1.5 dCi 75 55 1.5 dCi 90 66 1.6 MPI 61		01.13 11.12 11.12 11.12		24.3222-1729.3 020526			Rz 22,20	
RENAULT DUSTER (HS-) (11-)									
	1.5 dCi ◀ 66 1.5 dCi 4x4 ◀ 66 1.6 16V ◀ 75 1.6 16V 4x4 ◀ 75 2.0 ◀ 98 2.0 4x4 ◀ 99		06.11 06.11 06.11 06.11 02.12 02.12		03.7853-4602.4 300302		+ ABS	9"	ATE
	1.5 dCi ◀ 66 1.5 dCi 4x4 ◀ 66 1.6 16V ◀ 75 1.6 16V 4x4 ◀ 75 2.0 ◀ 98 2.0 4x4 ◀ 99		06.11 06.11 06.11 06.11 02.12 02.12		03.2122-2031.3 010938 03.2122-2261.3 010964		+ ABS + ESP	THz 22,20 THz 22,20	ATE ATE
	1.5 dCi 66 1.6 16V 75 1.6 16V 4x4 75 2.0 98		06.11 06.11 06.11 02.12	- ABS - ESP - ESP - ABS	24.3541-1849.5 240707 24.3541-1850.5 240708		   	D=54, - Halter D=54, - Halter	TRW TRW
	1.5 dCi 66 1.5 dCi 4x4 66 1.6 16V 75 1.6 16V 4x4 75 2.0 98 2.0 4x4 99		06.11 06.11 06.11 06.11 02.12 02.12	+ ABS + ESP + ESP + ABS	11.9541-9950.2 220843 11.9541-9951.2 220844 11.8170-0002.1 260110 11.8116-0356.1 390586	2	   	D=54, - Halter D=54, - Halter Halter Halterfeder	ATE ATE ATE ATE
	1.5 dCi 66 1.5 dCi 4x4 66 1.6 16V 75 1.6 16V 4x4 75 2.0 98 2.0 4x4 99		06.11 06.11 06.11 06.11 02.12 02.12		24.5229-0285.3 330032	2		L=285	
	1.5 dCi 66 1.6 16V 75 2.0 98		06.11 06.11 02.12		24.3219-1761.3 020536			Rz 19,05	

¹⁾ + autom.transmission / + scatola cambio automatico / + transmission automatique / + cambio automático













²⁾ + grey caliper / + pinza grigio / + étrier gris / + pinza gris























³⁾ + manual transmission / + scatola cambio velocità / + transmission mécanique / + cambio de velocidad

RENAULT DUSTER (HS-) (11-)											
	1.5 dCi 4x4	66		06.11				24.3219-1763.3	020543		Rz 19,05
	1.6 16V 4x4	75		06.11				24.3219-1764.3	020544		Rz 19,05
	2.0 4x4	99		02.12							
RENAULT ESPACE III (JE_) (96-02)											
	1.9 dTi	72		02.99	10.02	- ABS		03.2123-1546.3	010536		THz 23,81 ATE
	2.0	84		11.96	10.00	- ABS					
	2.0	102		09.01	10.02	- ABS					
	2.0 16V	103		10.98	10.02	- ABS					
	2.2 D	84		11.97	01.00	- ABS		03.2123-1741.3	010537		THz 23,81 ATE
	2.2 dCi	85		07.00	10.02						
	2.2 dT	83		11.96	10.00	- ABS					
	3.0 V6	123		11.96	10.98	- ABS					
	3.0 V6	140		10.98	10.02	- ABS					
	1.9 dTi	72		02.99	10.02	+ ABS		03.2123-1486.3	010488		THz 23,81 ATE
	2.0	84		11.96	10.00	+ ABS					
	2.0	102		09.01	10.02	+ ABS					
	2.0 16V	103		10.98	10.02	+ ABS					
	2.2 D	84		11.97	01.00	+ ABS					
	2.2 dCi	95		10.00	10.02						
	2.2 dT	83		11.96	10.00	+ ABS					
	3.0 V6	123		11.96	10.98	+ ABS					
	3.0 V6	140		10.98	10.02	+ ABS					
	1.9 dTi	72		02.99	10.02			24.3541-1749.3	240427		D=54, - Halter TRW
	2.0	84		11.96	10.00			24.3541-1750.5	240428		D=54, - Halter TRW
	2.0	102		09.01	10.02						
	2.0 16V	103		10.98	10.02						
	2.2 D	84		11.97	01.00			24.3601-1707.5	240229		D=60, - Halter TRW
	2.2 dT	83		11.96	10.00			24.3601-1708.5	240230		D=60, - Halter TRW
	3.0 V6	123		11.96	10.98						
	2.2 dCi	85		07.00	10.02			24.3451-1713.7	220737		D=40/45, - Halter TRW
	2.2 dCi	95		10.00	10.02			24.3451-1714.7	220738		D=40/45, - Halter TRW
	3.0 V6	140		07.00	10.02						
	1.9 dTi	72		02.99	10.02			24.5111-0490.3	330598	2	L=490
	2.0	84		11.96	10.00						
	2.0	102		09.01	10.02						
	2.0 16V	103		10.98	10.02						
	2.2 D	84		11.97	01.00						
	2.2 dCi	85		07.00	10.02						
	2.2 dT	83		11.96	10.00						
	3.0 V6	123		11.96	10.98						
	3.0 V6	140		10.98	10.02						
	1.9 dTi	72		02.99	10.02			24.5229-0185.3	330397	2 	L=185
	2.0	84		11.96	10.00						
	2.0	102		09.01	10.02						
	2.0 16V	103		10.98	10.02						
	2.2 D	84		11.97	01.00						
	2.2 dCi	85		07.00	10.02						
	2.2 dCi	95		10.00	10.02						
	2.2 dT	83		11.96	10.00						
	3.0 V6	123		11.96	10.98						
	3.0 V6	140		10.98	10.02						
	2.0 16V	103		10.98	10.02			24.5111-0260.3	330408	2	L=260
	3.0 V6	123		11.96	10.98						
	3.0 V6	140		10.98	10.02						
	1.9 dTi	72		02.99	10.02			24.3222-1615.3	020285		Rz 22,20 TRW
	2.0	84		11.96	10.00						
	2.2 D	84		11.97	01.00						
	2.2 dCi	85		07.00	10.02						
	2.2 dT	83		11.96	10.00						
	1.9 dTi	72		02.99	10.02			24.3727-1058.2	581058	1 	L=1520/1583
	2.0	84		11.96	10.00			24.3727-1059.2	581059	1 	L=1675/1740
	2.2 D	84		11.97	01.00						
	2.2 dCi	85		07.00	10.02						
	2.2 dT	83		11.96	10.00						
	2.0	84		11.96	10.00			24.3728-1027.2	591027		L=1072, + AUT
	2.0	102		09.01	10.02						
	2.0 16V	103		10.98	10.02						
RENAULT ESPACE IV (JK_) (02-)											
	1.9 dCi	85		04.03	02.05			03.7868-1602.4	300220		10/8" Tandem ATE
	1.9 dCi	88		11.02							
	2.0	98		11.02	02.05						
	2.0 dCi	96		01.06							
	2.0 dCi 110	110		01.06							
	2.0 dCi 130	127		01.06							
	2.0 i	100		11.02							
	2.0 Turbo	120		11.02							
	2.0 Turbo	125		04.05							
	2.2 dCi	102		02.06							
	2.2 dCi	110		11.02							
	3.0 dCi	120		09.05							
	3.0 dCi	130		11.02							
	3.0 dCi	133		01.06							
	3.5 V6	177		11.02							

1) + wheel base 2702 mm / + passo 2702 mm / + empattement 2702 mm / + distancia entre rueda 2702mm

2) + wheel base 2874 mm / + passo 2874 mm / + empattement 2874 mm / + distancia entre rueda 2874mm

RENAULT ESPACE IV (JK_) (02-)											
											
	1.9 dCi	85		04.03	02.05		03.4125-0021.3	010888	- ESP	THz 25,40	ATE
	1.9 dCi	88		11.02							
	2.0	98		11.02	02.05						
	2.0 dCi	96		01.06							
	2.0 dCi 110	110		01.06							
	2.0 dCi 130	127		01.06							
	2.0 i	100		11.02							
	2.0 Turbo	120		11.02							
	2.0 Turbo	125		04.05							
	2.2 dCi	102		02.06							
	2.2 dCi	110		11.02							
	3.0 dCi	120		09.05							
	3.0 dCi	130		11.02							
	3.0 dCi	133		01.06							
	3.5 V6	177		11.02							
	1.9 dCi	85		04.03	12.04		03.4125-0014.3	010794	+ ESP	THz 25,40	ATE
	1.9 dCi	88		11.02	12.04						
	2.0	98		11.02	12.04						
	2.0 i	100		11.02	12.04						
	2.0 Turbo	120		11.02	12.04						
	2.2 dCi	110		11.02	12.04						
	3.0 dCi	130		11.02	12.04						
	3.5 V6	177		11.02	12.04						
	1.9 dCi	85		01.05	02.05		03.4155-0043.3	010795	+ ESP	THz 25,40	ATE
	1.9 dCi	88		01.05							
	2.0	98		01.05	02.05						
	2.0 dCi	96		01.06							
	2.0 dCi 110	110		01.06							
	2.0 dCi 130	127		01.06							
	2.0 i	100		01.05							
	2.0 Turbo	120		01.05							
	2.0 Turbo	125		04.05							
	2.2 dCi	102		02.06							
	2.2 dCi	110		01.05							
	3.0 dCi	120		09.05							
	3.0 dCi	130		01.05							
	3.0 dCi	133		01.06							
	3.5 V6	177		01.05							
	1.9 dCi	85		04.03	02.05		11.9601-9787.2	220585	<input type="checkbox"/>	D=60, - Halter	ATE
	1.9 dCi	88		11.02			11.9601-9788.2	220586	<input type="checkbox"/>	D=60, - Halter	ATE
	2.0	98		11.02	02.05		24.3601-9787.5	240505	<input type="checkbox"/>	D=60, - Halter	ATE
	2.0 dCi	96		01.06			24.3601-9788.5	240506	<input type="checkbox"/>	D=60, - Halter	ATE
	2.0 dCi 110	110		01.06			11.0101-5407.2	260011		Hülsensatz	ATE
	2.0 dCi 130	127		01.06			11.8171-0008.1	990049		Führungsbolzen	ATE
	2.0 i	100		11.02			11.8116-0301.1	390610	2	Haltefeder	ATE
	2.0 Turbo	120		11.02							
	2.0 Turbo	125		04.05							
	2.2 dCi	102		02.06							
	2.2 dCi	110		11.02							
	3.0 dCi	120		09.05							
	3.0 dCi	130		11.02							
	3.0 dCi	133		01.06							
	3.5 V6	177		11.02							
	1.9 dCi	85		04.03	02.05		24.5252-0390.3	330702	2		L=390
	1.9 dCi	88		11.02							
	2.0	98		11.02	02.05						
	2.0 dCi	96		01.06							
	2.0 dCi 110	110		01.06							
	2.0 dCi 130	127		01.06							
	2.0 i	100		11.02							
	2.0 Turbo	120		11.02							
	2.0 Turbo	125		04.05							
	2.2 dCi	102		02.06							
	2.2 dCi	110		11.02							
	3.0 dCi	120		09.05							
	3.0 dCi	130		11.02							
	3.0 dCi	133		01.06							
	3.5 V6	177		11.02							
	1.9 dCi	85		04.03	02.05		11.9387-7001.2	220397	<input type="checkbox"/>	D=38, - Halter	ATE
	1.9 dCi	88		11.02			11.9387-7002.2	220398	<input type="checkbox"/>	D=38, - Halter	ATE
	2.0	98		11.02	02.05		11.8170-0872.1	260121		Halter	ATE
	2.0 dCi	96		01.06			11.8116-0340.1	390595	2	Haltefeder	ATE
	2.0 dCi 110	110		01.06							
	2.0 dCi 130	127		01.06							
	2.0 i	100		11.02							
	2.0 Turbo	120		11.02							
	2.0 Turbo	125		04.05							
	2.2 dCi	102		02.06							
	2.2 dCi	110		11.02							
	3.0 dCi	120		09.05							
	3.0 dCi	130		11.02							
	3.0 dCi	133		01.06							
	3.5 V6	177		11.02							

RENAULT ESPACE IV (JK_) (02-)		RENAULT ESPACE V (JR_) (15-)		RENAULT EXPRESS/RAPID (F40_) (85-98)						
										
RENAULT ESPACE IV (JK_) (02-)										
	1.9 dCi	85	04.03	02.05	24.5251-0185.3	330701	2		L=185	
	1.9 dCi	88	11.02							
	2.0	98	11.02	02.05						
	2.0 dCi	96	01.06							
	2.0 dCi 110	110	01.06							
	2.0 dCi 130	127	01.06							
	2.0 i	100	11.02							
	2.0 Turbo	120	11.02							
	2.0 Turbo	125	04.05							
	2.2 dCi	102	02.06							
	2.2 dCi	110	11.02							
	3.0 dCi	120	09.05							
	3.0 dCi	130	11.02							
	3.0 dCi	133	01.06							
	3.5 V6	177	11.02							
RENAULT ESPACE V (JR_) (15-)										
	1.6 dCi 130	96	06.15		+ elektrische Feststellbremse ¹⁾	24.6238-1707.7	220969		D=38, - Halter	TRW
	1.6 dCi 160	118	06.15		+ elektrische Feststellbremse ¹⁾	24.6238-1708.7	220970		D=38, - Halter	TRW
	1.6 TCe 200	147	02.15		+ elektrische Feststellbremse ¹⁾					
RENAULT EXPRESS/RAPID (F40_) (85-98)										
	1.0	31	09.85	08.91	24.2117-1503.3	010400			THz 17,46	BDX
	1.0 (F400)	27	01.86	05.92						
	1.0	31	09.85	08.91	03.2119-3389.3	010057			THz 19,05	ATE
	1.0 (F400)	27	01.86	05.92						
	1.1	34	09.85	08.91						
	1.1 (F401)	33	07.85	04.95						
	1.1 (F40H)	33	06.87	06.90						
	1.1 (F40T)	33	09.91	09.96						
	1.4 (F402)	43	01.86	06.90						
	1.4 (F40M)	44	06.87	06.90						
	1.4 (F407)	43	01.86	08.91						
	1.6 (F404)	40	01.86	08.91						
	1.9 (F40E)	47	09.92	03.98						
	1.1 (F40T)	33	10.96	03.98	03.2120-2031.3	010106			THz 20,64	ATE
	1.2	40	09.91	08.93						
	1.2	48	05.95	11.98						
	1.2 (F406)	40	10.92	03.98						
	1.2 (F40F)	40	06.90	03.98						
	1.4	43	09.91	08.93						
	1.4	54	09.91	08.93						
	1.4	59	05.95	08.97						
	1.4 (F40A)	43	06.90	03.98						
	1.4 (F40Y)	43	09.91	03.98						
	1.4 i (F407)	43	09.91	03.98						
	1.4 i (F40D)	58	09.94	03.98						
	1.4 i (F40U)	55	09.91	03.98						
	1.4 i (F40V)	55	09.91	03.98						
	1.6 (F404)	40	09.91	08.98						
	1.9 (F40N)	47	06.90	03.98						
	1.9 (F40P)	47	09.91	03.98						
	1.9 (F40R)	40	09.94	03.98						
	1.9 D (G40B)	40	09.95	03.98						
	1.9 D (G40C)	40	09.95	03.98						
	1.0	31	09.85	05.88	24.3451-1501.5	240263			D=45, - Halter	BDX
	1.0 (F400)	27	01.86	05.88	24.3451-1502.5	240264			D=45, - Halter	BDX
	1.1	34	09.85	05.88						
	1.1 (F401)	33	07.85	05.88						
	1.1 (F40H)	33	06.87	05.88						
	1.6 (F404)	40	01.86	05.86						
	1.0	31	06.88	08.91	24.3481-1505.5	240047			D=48, - Halter	BDX
	1.0 (F400)	27	06.88	05.92	24.3481-1506.5	240048			D=48, - Halter	BDX
	1.1	34	06.88	08.91	24.3481-1611.5	240029			D=48, - Halter	TRW
	1.1	34	09.85	05.88	24.3481-1612.5	240030			D=48, - Halter	TRW
	1.1 (F401)	33	06.88	04.95	24.0101-4803.2	260049			Bremssattel-Zubehör	BDX
	1.1 (F401)	33	07.85	05.88	24.0101-4807.2	260053			Bremssattel-Zubehör	TRW
	1.1 (F40H)	33	06.88	06.90						
	1.1 (F40T)	33	09.91	03.98						
	1.2	40	09.91	08.93						
	1.2	48	05.95	11.98						
	1.2 (F406)	40	10.92	03.98						
	1.2 (F40F)	40	06.90	03.98						
	1.4	43	09.91	08.93						
	1.4	54	09.91	08.93						
	1.4	59	05.95	08.97						
	1.4 (F402)	43	01.86	06.90						
	1.4 (F40A)	43	06.90	03.98						
	1.4 (F40M)	44	06.87	06.90						
	1.4 (F40Y)	43	09.91	03.98						
	1.4 i (F407)	43	01.86	03.98						
	1.4 i (F40D)	58	09.94	03.98						
	1.4 i (F40U)	55	09.91	03.98						
	1.4 i (F40V)	55	09.91	03.98						
	1.6 (F404)	40	06.86	08.98						
	1.6 (F404)	40	01.86	08.98						
	1.9 (F40E)	47	09.92	03.98						













¹⁾ + electric parking brake / + freno a mano elettrico / + frein à main électrique / + freno de mano eléctrico

RENAULT EXPRESS/RAPID (F40_) (85-98)											
	1.9 (F40N)	47		06.90	03.98	24.3481-1505.5	240047	<input type="checkbox"/> <input type="checkbox"/> <input type="checkbox"/> <input type="checkbox"/>	D=48, - Halter	BDX	
	1.9 (F40P)	47		09.91	03.98	24.3481-1506.5	240048		D=48, - Halter	BDX	
						24.3481-1611.5	240029		D=48, - Halter	TRW	
						24.3481-1612.5	240030		D=48, - Halter	TRW	
						24.0101-4803.2	260049		Bremssattel-Zubehör	BDX	
					24.0101-4807.2	260053	Bremssattel-Zubehör	TRW			
	1.9 (F40R)	40		09.94	03.98	24.3481-1505.5	240047	<input type="checkbox"/> <input type="checkbox"/>	D=48, - Halter	BDX	
	1.9 D (G40B)	40		09.95	03.98	24.3481-1506.5	240048		D=48, - Halter	BDX	
	1.9 D (G40C)	40		09.95	03.98	24.0101-4803.2	260049		Bremssattel-Zubehör	BDX	
	1.0	31		09.85	08.91	24.5111-0300.3	330407	2	L=300		
	1.0 (F400)	27		01.86	05.92						
	1.1	34		09.85	08.91						
	1.1 (F401)	33		07.85	04.95						
	1.1 (F40H)	33		06.87	06.90						
	1.1 (F40T)	33		09.91	03.98						
	1.2	40		09.91	08.93						
	1.2	48		05.95	11.98						
	1.2 (F406)	40		10.92	03.98						
	1.2 (F40F)	40		06.90	03.98						
	1.4	43		09.91	08.93						
	1.4	54		09.91	08.93						
	1.4	59		05.95	08.97						
	1.4 (F402)	43		01.86	08.91						
	1.4 (F40A)	43		06.90	03.98						
	1.4 (F40M)	44		06.87	08.91						
	1.4 (F40Y)	43		09.91	03.98						
	1.4 i (F407)	43		01.86	03.98						
	1.4 i (F40D)	58		09.94	03.98						
	1.4 i (F40U)	55		09.91	03.98						
	1.4 i (F40V)	55		09.91	03.98						
	1.6 (F404)	40		01.86	08.98						
	1.9 (F40E)	47		09.92	03.98						
	1.9 (F40N)	47		06.90	03.98						
	1.9 (F40P)	47		09.91	03.98						
	1.9 (F40R)	40		09.94	03.98						
	1.9 D (G40B)	40		09.95	03.98						
1.9 D (G40C)	40		09.95	03.98							
	1.0	31		09.85	08.91	24.5229-0240.3	330400	2	L=242		
	1.0 (F400)	27		01.86	05.92						
	1.1	34		09.85	08.91						
	1.1 (F401)	33		07.85	04.95						
	1.1 (F40H)	33		06.87	06.90						
	1.1 (F40T)	33		09.91	03.98						
	1.2	40		09.91	08.93						
	1.2	48		05.95	11.98						
	1.2 (F406)	40		10.92	03.98						
	1.2 (F40F)	40		06.90	03.98						
	1.4	43		09.91	08.93	- erhöhte Zuladung ¹⁾					
	1.4	54		09.91	08.93	- erhöhte Zuladung ¹⁾					
	1.4	59		05.95	08.97	- erhöhte Zuladung ¹⁾					
	1.4 (F402)	43		01.86	08.91						
	1.4 (F40A)	43		06.90	03.98	- erhöhte Zuladung ¹⁾					
	1.4 (F40M)	44		06.87	08.91						
	1.4 i (F407)	43		01.86	03.98						
	1.4 i (F40D)	58		09.94	03.98	- erhöhte Zuladung ¹⁾					
	1.4 i (F40U)	55		09.91	03.98	- erhöhte Zuladung ¹⁾					
	1.4 i (F40V)	55		09.91	03.98	- erhöhte Zuladung ¹⁾					
	1.6 (F404)	40		07.86	08.98	- erhöhte Zuladung ¹⁾					
	1.9 (F40E)	47		09.92	03.98	- erhöhte Zuladung ¹⁾					
	1.9 (F40N)	47		06.90	03.98	- erhöhte Zuladung ¹⁾					
	1.9 (F40P)	47		09.91	03.98	- erhöhte Zuladung ¹⁾					
	1.9 (F40R)	40		09.94	03.98	- erhöhte Zuladung ¹⁾					
	1.9 D (G40B)	40		09.95	03.98	- erhöhte Zuladung ¹⁾					
	1.9 D (G40C)	40		09.95	03.98	- erhöhte Zuladung ¹⁾					
	1.4	43		09.91	08.93	24.5229-0285.3	330032	2	L=285		
	1.4	54		09.91	08.93	+ erhöhte Zuladung ²⁾					
	1.4	59		05.95	08.97	+ erhöhte Zuladung ²⁾					
	1.4 (F40A)	43		06.90	03.98	+ erhöhte Zuladung ²⁾					
	1.4 (F40Y)	43		09.91	03.98						
	1.4 i (F40D)	58		09.94	03.98	+ erhöhte Zuladung ²⁾					
	1.4 i (F40U)	55		09.91	03.98	+ erhöhte Zuladung ²⁾					
	1.4 i (F40V)	55		09.91	03.98	+ erhöhte Zuladung ²⁾					
	1.6 (F404)	40		07.86	08.98	+ erhöhte Zuladung ²⁾					
	1.9 (F40E)	47		09.92	03.98	+ erhöhte Zuladung ²⁾					
	1.9 (F40N)	47		06.90	03.98	+ erhöhte Zuladung ²⁾					
	1.9 (F40P)	47		09.91	03.98	+ erhöhte Zuladung ²⁾					
	1.9 (F40R)	40		09.94	03.98	+ erhöhte Zuladung ²⁾					
	1.9 D (G40B)	40		09.95	03.98	+ erhöhte Zuladung ²⁾					
1.9 D (G40C)	40		09.95	03.98	+ erhöhte Zuladung ²⁾						
	1.0	31		09.85	08.91	24.3222-1709.3	020111	<input type="checkbox"/> <input type="checkbox"/> <input type="checkbox"/> <input type="checkbox"/>	Rz 22,20	BDX	
	1.0 (F400)	27		01.86	05.92	24.3222-1710.3	020112		Rz 22,20	BDX	
	1.1 (F40H)	33		06.87	06.90	24.3222-1106.3	020261		Rz 22,20	TRW	
	1.1 (F40T)	33		09.91	09.96	24.3222-1107.3	020262		Rz 22,20	TRW	
	1.1	34		09.85	08.91	24.3222-1709.3	020111		Rz 22,20	BDX	
1.1 (F401)	33		07.85	04.95	24.3222-1710.3	020112	Rz 22,20	BDX			
1.6 (F404)	40		01.86	06.86	+ ⊕						

¹⁾ - increased payload / - carico utile maggiorato / - charge utile augmentée / - incremento de carga

²⁾ + increased payload / + carico utile maggiorato / + charge utile augmentée / + incremento de carga



RENAULT EXPRESS/RAPID (F40_) (85-98)														
	1.1	34		09.85	08.91	+ ①	24.3220-1118.3	020226		Rz 20,64	BDX			
	1.1 (F401)	33		07.85	04.95	+ ①	24.3220-1119.3	020227						
	1.4 (F402)	43		01.86	06.90									
	1.4 (F40M)	44		06.87	08.91									
	1.4 i (F407)	43		01.86	03.98									
	1.6 (F404)	40		01.86	06.86	- ②								
	1.1	34		09.85	08.91		24.3222-1106.3	020261					Rz 22,20	TRW
	1.1 (F401)	33		07.85	04.95		24.3222-1107.3	020262						
	1.6 (F404)	40		01.86	06.86									
		1.1 (F40T)	33		10.96	03.98		24.3220-1118.3				020226		Rz 20,64
1.2		40		09.91	08.93		24.3220-1119.3	020227						
1.2		48		05.95	11.98									
1.2 (F406)		40		10.92	03.98									
1.2 (F40F)		40		06.90	03.98									
1.4		43		09.91	08.93	- erhöhte Zuladung ①								
1.4		54		09.91	08.93	- erhöhte Zuladung ①								
1.4		59		05.95	08.97	- erhöhte Zuladung ①								
1.4 (F40A)		43		06.90	03.98	- erhöhte Zuladung ①								
1.4 i (F40D)		58		09.94	03.98	- erhöhte Zuladung ①								
1.4 i (F40U)		55		09.91	03.98	- erhöhte Zuladung ①								
1.4 i (F40V)		55		09.91	03.98	- erhöhte Zuladung ①								
1.6 (F404)		40		07.86	08.98	- erhöhte Zuladung ①								
1.9 (F40E)		47		09.92	03.98	- erhöhte Zuladung ①								
1.9 (F40N)		47		06.90	03.98	- erhöhte Zuladung ①								
1.9 (F40P)		47		09.91	03.98	- erhöhte Zuladung ①								
1.9 (F40R)		40		09.94	03.98	- erhöhte Zuladung ①								
1.9 D (G40B)		40		09.95	03.98	- erhöhte Zuladung ①								
1.9 D (G40C)		40		09.95	03.98	- erhöhte Zuladung ①								
		1.4	43		09.91	08.93	+ erhöhte Zuladung ②	24.3222-1615.3	020285		Rz 22,20	TRW		
	1.4	54		09.91	08.93	+ erhöhte Zuladung ②								
	1.4	59		05.95	08.97	+ erhöhte Zuladung ②								
	1.4 (F40A)	43		09.91	03.98	+ erhöhte Zuladung ②								
	1.4 (F40Y)	43		09.91	03.98									
	1.4 i (F40D)	58		09.94	03.98	+ erhöhte Zuladung ②								
	1.4 i (F40U)	55		09.91	03.98	+ erhöhte Zuladung ②								
	1.4 i (F40V)	55		09.91	03.98	+ erhöhte Zuladung ②								
	1.6 (F404)	40		07.86	08.98	+ erhöhte Zuladung ②								
	1.9 (F40E)	47		09.92	03.98	+ erhöhte Zuladung ②								
	1.9 (F40N)	47		09.91	03.98	+ erhöhte Zuladung ②								
	1.9 (F40P)	47		09.91	03.98	+ erhöhte Zuladung ②								
	1.9 (F40R)	40		09.94	03.98	+ erhöhte Zuladung ②								
	1.9 D (G40B)	40		09.95	03.98	+ erhöhte Zuladung ②								
	1.9 D (G40C)	40		09.95	03.98	+ erhöhte Zuladung ②								
		1.0	31		09.85	08.91							24.3727-1005.2	581005
1.0 (F400)		27		01.86	05.92									
1.1		34		09.85	08.91									
1.1 (F401)		33		07.85	08.91									
1.1 (F40H)		33		06.87	06.90									
1.4 (F402)		43		01.86	06.90									
1.4 (F40M)		44		06.87	08.91									
1.4 i (F407)		43		01.86	08.91									
1.6 (F404)		40		01.86	08.91									
		1.1	34		09.85	08.91		24.3727-1035.2	581035		L=1469			
	1.1 (F401)	33		09.91	04.95									
	1.1 (F40T)	33		09.91	03.98									
	1.2	40		09.91	08.93									
	1.2	48		05.95	11.98									
	1.2 (F406)	40		10.92	03.98									
	1.2 (F40F)	40		06.90	03.98									
	1.4	43		09.91	08.93	- erhöhte Zuladung ①								
	1.4	54		09.91	08.93	- erhöhte Zuladung ①								
	1.4	59		05.95	08.97	- erhöhte Zuladung ①								
	1.4 (F40A)	43		06.90	03.98	- erhöhte Zuladung ①								
	1.4 i (F407)	43		09.91	03.98									
	1.4 i (F40D)	58		09.94	03.98	- erhöhte Zuladung ①								
	1.4 i (F40U)	55		09.91	03.98	- erhöhte Zuladung ①								
	1.4 i (F40V)	55		09.91	03.98	- erhöhte Zuladung ①								
	1.6 (F404)	40		09.91	08.98	- erhöhte Zuladung ①								
	1.9 (F40E)	47		09.92	03.98	- erhöhte Zuladung ①								
	1.9 (F40N)	47		06.90	03.98	- erhöhte Zuladung ①								
	1.9 (F40P)	47		09.91	03.98	- erhöhte Zuladung ①								
	1.9 (F40R)	40		09.94	03.98	- erhöhte Zuladung ①								
1.9 D (G40B)	40		09.95	03.98	- erhöhte Zuladung ①									
1.9 D (G40C)	40		09.95	03.98	- erhöhte Zuladung ①									
	1.0	31		09.85	08.91		03.6583-0006.3	320100		BRL 8/3 (4)	ATE			
	1.0 (F400)	27		01.86	08.91									
	1.1	34		09.85	08.91									
	1.1 (F401)	33		07.85	08.91									
	1.1 (F40H)	33		06.87	08.91									
	1.4 (F402)	43		01.86	08.91									
	1.4 (F40M)	44		06.87	08.91									
	1.4 i (F407)	43		01.86	08.91									
	1.6 (F404)	40		01.86	08.91									

① - increased payload / - carico utile maggiorato / - charge utile augmentée / - incremento de carga

② + increased payload / + carico utile maggiorato / + charge utile augmentée / + incremento de carga

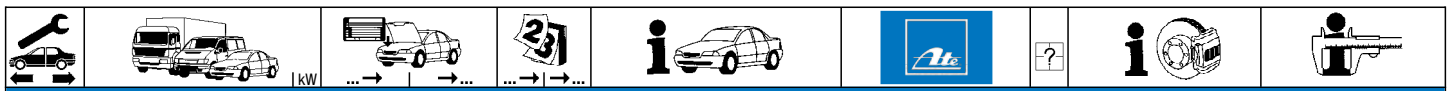

RENAULT EXPRESS/RAPID (F40_) (85-98)

	1.0	31	09.85	08.91	24.3728-1006.2	591006			L=1050
	1.0 (F400)	27	01.86	05.92					
	1.1	34	09.85	08.91					
	1.1 (F401)	33	07.85	04.95					
	1.1 (F40H)	33	06.87	09.91					
	1.1 (F40T)	33	09.91	03.98					
	1.2	40	09.91	08.93					
	1.2	48	05.95	11.98					
	1.2 (F406)	40	10.92	03.98					
	1.2 (F40F)	40	06.90	03.98					
	1.4	43	09.91	08.93					
	1.4	54	09.91	08.93					
	1.4	59	05.95	08.97					
	1.4 (F402)	43	01.86	08.91					
	1.4 (F40A)	43	06.90	03.98					
	1.4 (F40M)	44	06.87	08.91					
	1.4 (F40Y)	43	09.91	03.98					
	1.4 i (F407)	43	01.86	03.98					
	1.4 i (F40D)	58	09.94	03.98					
	1.4 i (F40U)	55	09.91	03.98					
	1.4 i (F40V)	55	09.91	03.98					
	1.6 (F404)	40	01.86	08.98					
	1.9 (F40E)	47	09.92	03.98					
	1.9 (F40N)	47	06.90	03.98					
	1.9 (F40P)	47	09.91	03.98					
	1.9 (F40R)	40	09.94	03.98					
	1.9 D (G40B)	40	09.95	03.98					
	1.9 D (G40C)	40	09.95	03.98					

RENAULT FLUENCE (L30_) (10-)











	1.5 dCi	63	02.10		11.9541-9950.2	220843			D=54, - Halter	ATE
	1.5 dCi	66	02.10		11.9541-9951.2	220844			D=54, - Halter	ATE
	1.5 dCi	70	07.14		11.8170-0002.1	260110			Halter	ATE
	1.5 dCi	78	02.10		11.8116-0356.1	390586	2		Haltefeder	ATE
	1.5 dCi	81	02.10							
	1.6 16V	81	02.10							
	1.6 16V	82	02.10							
	1.6 dCi	96	07.14							
	2.0 16V	101	05.11							
	2.0 16V	103	02.10							
	Z.E.	70	02.12							
	1.5 dCi	63	02.10	- elektrische Feststellbremse ¹⁾	24.3347-1709.7	221013			D=34, - Halter	TRW
	1.5 dCi	66	02.10	- elektrische Feststellbremse ¹⁾	24.3347-1710.7	221014			D=34, - Halter	TRW
	1.5 dCi	70	07.14	- elektrische Feststellbremse ¹⁾						
	1.5 dCi	78	02.10	- elektrische Feststellbremse ¹⁾						
	1.5 dCi	81	02.10	- elektrische Feststellbremse ¹⁾						
	1.6 16V	81	02.10	- elektrische Feststellbremse ¹⁾						
	1.6 16V	82	02.10	- elektrische Feststellbremse ¹⁾						
	1.6 dCi	96	07.14	- elektrische Feststellbremse ¹⁾						
	2.0 16V	101	05.11	- elektrische Feststellbremse ¹⁾						
	2.0 16V	103	02.10	- elektrische Feststellbremse ¹⁾						
	1.5 dCi	63	02.10	+ elektrische Feststellbremse ²⁾	24.6234-1701.7	221015			D=34, - Halter	TRW
	1.5 dCi	66	02.10	+ elektrische Feststellbremse ²⁾	24.6234-1702.7	221016			D=34, - Halter	TRW
	1.5 dCi	70	07.14	+ elektrische Feststellbremse ²⁾						
	1.5 dCi	78	02.10	+ elektrische Feststellbremse ²⁾						
	1.5 dCi	81	02.10	+ elektrische Feststellbremse ²⁾						
	1.6 16V	81	02.10	+ elektrische Feststellbremse ²⁾						
	1.6 16V	82	02.10	+ elektrische Feststellbremse ²⁾						
	1.6 dCi	96	07.14	+ elektrische Feststellbremse ²⁾						
	2.0 16V	101	05.11	+ elektrische Feststellbremse ²⁾						
	2.0 16V	103	02.10	+ elektrische Feststellbremse ²⁾						
	1.5 dCi	63	02.10		24.3219-1755.3	020508			Rz 19,05	
	1.5 dCi	66	02.10							
	1.5 dCi	78	02.10							
	1.5 dCi	81	02.10							
	1.6 16V	81	02.10							
	1.6 16V	82	02.10							
	2.0 16V	103	02.10							

RENAULT KANGOO I (KC_) (98-07)

	1.2	43	03.98	12.07	- ABS	24.2122-1727.3	010586		Thz 22,20	BDX
	1.2 16V	55	06.01	12.07	- ABS					
	1.4	55	03.98	12.07	- ABS					
	1.5 dCi	45	04.05	12.07	- ABS					
	1.5 dCi (KC07)		12.01	12.07	- ABS					
	1.5 dCi (KC08/09)	60	07.02	12.07	- ABS					
	1.6 16V	70	06.01	12.07	- ABS					
	1.6 16V 4x4	70	10.01	12.07	- ABS					
	1.9 D	47	03.98	12.07	- ABS					
	1.9 D (KC0D)	40	03.98	12.07	- ABS					
	1.9 dCi 4x4	62	10.03	12.07	- ABS					
	1.9 dCi 4x4 (KC0V)	59	10.01	12.07	- ABS					
	1.9 dTi (KC0U)	59	02.00	12.07	- ABS					
	1.9 RXED	48	09.99	06.01	- ABS					
	1.2	43	03.98	12.07	+ ABS	24.2122-1744.3	010697		Thz 22,20	
	1.2 16V	55	06.01	12.07	+ ABS					
	1.4	55	03.98	12.07	+ ABS					

¹⁾ - electric parking brake / - freno a mano elettrico / - frein à main électrique / - freno de mano eléctrico
²⁾ + electric parking brake / + freno a mano elettrico / + frein à main électrique / + freno de mano eléctrico



RENAULT KANGOO I (KC_) (98-07)													
	1.5 dCi (KC07) ▶ 60 1.5 dCi (KC08/09) ▶ 70 1.6 16V ▶ 70 1.6 16V 4x4 ▶ 47 1.9 D ▶ 40 1.9 D (KC0D) ▶ 62 1.9 dCi 4x4 ▶ 59 1.9 dCi 4x4 (KCOV) ▶ 59 1.9 dTi (KCOU) ▶ 48 1.9 RXED ▶ 48		12.01 07.02 06.01 10.01 03.98 03.98 10.03 10.01 02.00 09.99	12.07 + ABS 12.07 + ABS 12.07 + ABS 12.07 + ABS 12.07 + ABS 12.07 + ABS 12.07 + ABS 12.07 + ABS 12.07 + ABS 06.01 + ABS	24.2122-1744.3	010697						Thz 22,20	
	1.2 ▶ 43 1.2 16V ▶ 55 1.4 ▶ 55 1.5 dCi ▶ 42 1.5 dCi ▶ 45 1.5 dCi ▶ 62 1.5 dCi (KC07) ▶ 60 1.5 dCi (KC08/09) ▶ 66 1.6 ▶ 70 1.6 16V 2WD ▶ 70 1.6 16V bivalent ▶ 60 1.9 D ▶ 47 1.9 D (KC0D) ▶ 40 1.9 dTi (KCOU) ▶ 59 1.9 RXED ▶ 48 Elektro ▶ 22		03.98 06.01 03.98 07.03 04.05 06.05 12.01 07.02 09.99 06.01 06.05 03.98 03.98 02.00 09.99 01.02	12.07 12.07 12.07 12.07 12.07 12.07 12.07 12.07 06.01 12.07 12.07 12.07 12.07 12.07 06.01 12.04	24.3541-1765.5 24.3541-1766.5	240235 240236	 					D=54, - Halter D=54, - Halter	BOS BOS
	1.2 ▶ 43 1.2 16V ▶ 55 1.4 ▶ 55 1.5 dCi ▶ 42 1.5 dCi ▶ 45 1.5 dCi ▶ 62 1.5 dCi (KC07) ▶ 60 1.5 dCi (KC08/09) ▶ 66 1.6 ▶ 70 1.6 16V ▶ 70 1.6 16V 4x4 ▶ 70 1.6 16V bivalent ▶ 60 1.9 D ▶ 47 1.9 D (KC0D) ▶ 40 1.9 dCi 4x4 ▶ 62 1.9 dCi 4x4 (KCOV) ▶ 59 1.9 dTi (KCOU) ▶ 59 1.9 RXED ▶ 48 Elektro ▶ 22		03.98 06.01 03.98 07.03 04.05 06.05 12.01 07.02 09.99 06.01 06.05 03.98 03.98 02.00 09.99 01.02	12.07 12.07 12.07 12.07 12.07 12.07 12.07 12.07 06.01 12.07 12.07 12.07 12.07 12.07 12.07 06.01 12.04	24.5111-0336.3	330570	2					L=335	
	1.2 ▶ 43 1.2 16V ▶ 55 1.4 ▶ 55 1.5 dCi ▶ 45 1.5 dCi (KC07) ▶ 60 1.5 dCi (KC08/09) ▶ 66 1.6 ▶ 70 1.6 16V ▶ 70 1.6 16V 4x4 ▶ 70 1.6 16V bivalent ▶ 60 1.9 D ▶ 47 1.9 D (KC0D) ▶ 40 1.9 dCi 4x4 ▶ 62 1.9 dCi 4x4 (KCOV) ▶ 59 1.9 dTi (KCOU) ▶ 59 1.9 RXED ▶ 48		03.98 06.01 03.98 04.05 12.01 07.02 09.99 06.01 06.01 10.01 06.05 03.98 03.98 10.03 10.01 02.00 09.99	12.07 12.07 12.07 12.07 12.07 12.07 06.01 12.07 12.07 12.07 12.07 12.07 12.07 12.07 12.07 12.07 06.01	24.5111-0336.3 24.5229-0193.3	330570 330571	 					L=335 L=193	
	1.2 (KC01/OA/OF) ▶ 43 1.2 16V (KC05/OT/OW) ▶ 55 1.4 ▶ 55 1.5 dCi ▶ 42 1.5 dCi ▶ 45 1.5 dCi ▶ 62 1.5 dCi (KC07) ▶ 60 1.5 dCi (KC08/09) ▶ 66 1.6 16V 2WD ▶ 70 1.9 D ▶ 47 1.9 D (KC0D) ▶ 40 1.9 dCi 4x4 ▶ 62 1.9 dCi 4x4 (KCOV) ▶ 59 1.9 dTi (KCOU) ▶ 59 1.9 RXED ▶ 48		03.98 06.01 03.98 07.03 04.05 06.05 12.01 07.02 06.01 03.98 03.98 10.03 02.00 09.99	12.07 - verstärktes Fahrwerk ¹⁾ 12.07 - verstärktes Fahrwerk ¹⁾ 12.07 - verstärktes Fahrwerk ¹⁾ 12.07 - verstärktes Fahrwerk ¹⁾ 12.07 - verstärktes Fahrwerk ¹⁾ 12.07 - verstärktes Fahrwerk ¹⁾ 12.07 - verstärktes Fahrwerk ¹⁾ 12.07 - verstärktes Fahrwerk ¹⁾ 12.07 - verstärktes Fahrwerk ¹⁾ 12.07 - verstärktes Fahrwerk ¹⁾ 12.07 - verstärktes Fahrwerk ¹⁾ 12.07 - verstärktes Fahrwerk ¹⁾ 12.07 - verstärktes Fahrwerk ¹⁾ 06.01 - verstärktes Fahrwerk ¹⁾	24.3222-1716.3	020434					Rz 22,00	BDX	
	1.2 (KC01/OA/OF) ▶ 43 1.2 (KC0K) ▶ 43 1.2 16V (KC05/OT/OW) ▶ 55 1.2 16V (KC06) ▶ 55 1.4 ▶ 55 1.5 dCi ▶ 42 1.5 dCi ▶ 62 1.5 dCi (KC07) ▶ 60 1.5 dCi (KC08/09) ▶ 66 1.6 ▶ 70 1.6 16V 2WD ▶ 70 1.9 D ▶ 47		03.98 03.98 06.01 06.01 03.98 07.03 06.05 12.01 07.02 09.99 06.01 03.98	12.07 + verstärktes Fahrwerk ²⁾ 12.07 + verstärktes Fahrwerk ²⁾ 12.07 + verstärktes Fahrwerk ²⁾ 12.07 + verstärktes Fahrwerk ²⁾ 12.07 + verstärktes Fahrwerk ²⁾ 12.07 + verstärktes Fahrwerk ²⁾ 12.07 + verstärktes Fahrwerk ²⁾ 12.07 + verstärktes Fahrwerk ²⁾ 12.07 + verstärktes Fahrwerk ²⁾ 06.01 + verstärktes Fahrwerk ²⁾ 12.07 + verstärktes Fahrwerk ²⁾ 12.07 + verstärktes Fahrwerk ²⁾	24.3222-1715.3	020433						Rz 22,00	BDX

1) - reinforced suspension / - sospensione rinforzata / - châssis renforcé / - suspensión reforzada
2) + reinforced suspension / + sospensione rinforzata / + châssis renforcé / + suspensión reforzada



RENAULT KANGOO I (KC_) (98-07)

	1.9 D (KC0D) 1.9 dTi (KC0U) 1.9 RXED Elektro	40 59 48 22	03.98 02.00 09.99 01.02	12.07 12.07 06.01 12.04	+ verstärktes Fahrwerk ¹⁾ + verstärktes Fahrwerk ¹⁾ + verstärktes Fahrwerk ¹⁾	24.3222-1715.3 020433			Rz 22,00	BDX
	1.2 1.2 16V (KC05/0T/0W) 1.4 1.5 dCi 1.5 dCi (KC07) 1.5 dCi (KC08/09) 1.6 16V 1.9 D (KC0D) 1.9 D (KC0E/OJ/0N) 1.9 dCi 4x4 1.9 dTi (KC0U) 1.9 RXED	43 55 55 45 60 70 40 47 62 59 48	03.98 06.01 03.98 04.05 12.01 07.02 06.01 03.98 03.98 10.03 02.00 09.99	12.07 12.07 12.07 12.07 12.07 12.07 12.07 12.07 12.07 12.07 12.07 06.01	- erhöhte Zuladung/ - verst.Fahrwerk ²⁾ - erhöhte Zuladung/ - verst.Fahrwerk ²⁾ - erhöhte Zuladung/ - verst.Fahrwerk ²⁾ - erhöhte Zuladung/ - verst.Fahrwerk ²⁾ - erhöhte Zuladung/ - verst.Fahrwerk ²⁾ - erhöhte Zuladung/ - verst.Fahrwerk ²⁾ - erhöhte Zuladung/ - verst.Fahrwerk ²⁾ - erhöhte Zuladung/ - verst.Fahrwerk ²⁾ - erhöhte Zuladung/ - verst.Fahrwerk ²⁾ - erhöhte Zuladung/ - verst.Fahrwerk ²⁾ - erhöhte Zuladung/ - verst.Fahrwerk ²⁾ + erhöhte Zuladung/ + verst.Fahrwerk ³⁾	24.3727-1041.2 24.3727-1042.2	581041 581042	<input type="checkbox"/> <input type="checkbox"/>	L=1423 L=1421	
	1.2 1.2 16V (KC03/06) 1.2 16V (KC05/0T/0W) 1.4 1.5 dCi (KC07) 1.5 dCi (KC08/09) 1.6 1.6 16V 1.9 D (KC02) 1.9 D (KC0D) 1.9 D (KC0E/OJ/0N) 1.9 dTi (KC0U) 1.9 RXED	43 55 55 55 60 66 70 47 40 47 59 48	03.98 06.01 06.01 03.98 12.01 07.02 09.99 06.01 03.98 03.98 03.98 02.00 09.99	12.07 12.07 12.07 12.07 12.07 12.07 12.07 12.07 12.07 12.07 12.07 12.07 06.01	+ erhöhte Zuladung/ + verst.Fahrwerk ³⁾ + erhöhte Zuladung/ + verst.Fahrwerk ³⁾ + erhöhte Zuladung/ + verst.Fahrwerk ³⁾ + erhöhte Zuladung/ + verst.Fahrwerk ³⁾ + erhöhte Zuladung/ + verst.Fahrwerk ³⁾ + erhöhte Zuladung/ + verst.Fahrwerk ³⁾ + erhöhte Zuladung/ + verst.Fahrwerk ³⁾ + erhöhte Zuladung/ + verst.Fahrwerk ³⁾ + erhöhte Zuladung/ + verst.Fahrwerk ³⁾ + erhöhte Zuladung/ + verst.Fahrwerk ³⁾ + erhöhte Zuladung/ + verst.Fahrwerk ³⁾ + erhöhte Zuladung/ + verst.Fahrwerk ³⁾ + erhöhte Zuladung/ + verst.Fahrwerk ³⁾	24.3727-1043.2 24.3727-1044.2	581043 581044	<input type="checkbox"/> <input type="checkbox"/>	L=1432 L=1442	
	1.2 (KC01/0K) 1.2 (KC0A/0F) 1.2 16V (KC03/06/0T) 1.2 16V (KC05/0W) 1.4 (KC0B/0H/0M) 1.4 (KC0C) 1.6 1.6 16V (KC0L) 1.6 16V (KC0P/0S) 1.6 16V 4x4 1.9 D (KC02/0N) 1.9 D (KC0D) 1.9 D (KC0E/0J) 1.9 RXED	43 43 55 55 55 55 66 70 70 70 47 40 47 48	03.98 03.98 06.01 06.01 03.98 03.98 09.99 06.01 06.01 06.01 03.98 03.98 03.98 09.99	12.07 12.07 12.07 12.07 12.07 12.07 06.01 12.07 12.07 12.07 12.07 12.07 12.07 06.01		24.3728-1016.2 591016			L=969	
	1.5 dCi 1.5 dCi (KC07) 1.5 dCi (KC08) 1.5 dCi (KC09)	45 60 60 60	04.05 12.01 07.02 07.02	12.07 12.07 12.07 12.07		24.3728-1023.2 591023			L=960	

RENAULT KANGOO II (KW_) (08-)

	1.2 TCe 115 1.5 dCi 1.5 dCi 1.5 dCi 1.5 dCi 110 1.5 dCi 110 1.5 dCi 75 1.5 dCi 90 1.6 1.6 16V 1.6 16V Hi-Flex Z.E.	84 50 63 76 80 81 55 66 64 78 78 44	05.13 02.08 02.08 02.08 09.10 03.13 11.12 11.12 02.08 02.08 02.08 10.11			24.5111-0485.3 331370	2		L=485	
	1.2 TCe 115 1.5 dCi 1.5 dCi 1.5 dCi 1.5 dCi 110 1.5 dCi 110 1.5 dCi 75 1.5 dCi 90 1.6 1.6 16V 1.6 16V Hi-Flex Z.E.	84 50 63 76 80 81 55 66 64 78 78 44	05.13 02.08 02.08 02.08 09.10 03.13 11.12 11.12 02.08 02.08 02.08 10.11			24.3384-1773.5 24.3384-1774.5	240615 240616	<input type="checkbox"/> <input type="checkbox"/>	D=38, - Halter D=38, - Halter	TRW TRW
	1.5 dCi 1.5 dCi 1.5 dCi 1.5 dCi 110 1.5 dCi 75 1.5 dCi 90 1.6 1.6 16V 1.6 16V Hi-Flex Z.E.	50 63 76 80 55 66 64 78 78 44	02.08 02.08 02.08 09.10 11.12 11.12 02.08 02.08 02.08 10.11			24.5229-0185.3 330397	2	<input type="checkbox"/>	L=185	
	1.5 dCi 1.5 dCi 1.5 dCi	50 63 76	02.08 02.08 02.08	09.09 09.09 09.09		24.5239-0180.3 331464	<input type="checkbox"/>		L=180	

¹⁾ + reinforced suspension / + sospensione rinforzata / + châssis renforcé / + suspensión reforzada

²⁾ - increas.pay./-reinforced susp. / - car.util.magg./ - sospens.rinforzata / - charg.util.augm./ - châss.renf. / - incr.d.carga/-susp.reforzada

³⁾ + increased pay./+reinforced susp. / + car.util.magg./ + sospens.rinforzata / + charg.util.augm./ + châss.renf. / + incr.d.carga/ +susp.reforzada





RENAULT KANGOO II (KW_) (08-)

	1.6	64		02.08	09.09		24.5239-0180.3	331464			L=180
	1.6 16V	78		02.08	09.09						
	1.6 16V Hi-Flex	78		02.08	09.09						
	1.5 dCi	50		10.09	03.11		24.5239-0180.3	331464			L=180
	1.5 dCi	63		10.09	03.11		24.5279-0180.3	331465			L=180
	1.5 dCi	76		10.09	03.11						
	1.5 dCi 110	80		09.10	03.11						
	1.6	64		10.09	03.11						
	1.6 16V	78		10.09	03.11						
	1.6 16V Hi-Flex	78		10.09	03.11						
	1.2 TCe 115	84		05.13			24.5239-0180.3	331464			L=180
	1.5 dCi	50		04.11			24.5201-0180.3	331498			L=180
	1.5 dCi	63		04.11							
1.5 dCi	76		04.11								
1.5 dCi 110	80		04.11								
1.5 dCi 110	81		03.13								
1.5 dCi 75	55		11.12								
1.5 dCi 90	66		11.12								
1.6	64		04.11								
1.6 16V	78		04.11								
1.6 16V Hi-Flex	78		04.11								
Z.E.	44		10.11								
	1.2 TCe 115	84		05.13			24.3727-1082.2	581082	2	+ 15"/16" Rad ²⁾	L=2015
	1.5 dCi	50		02.08							
	1.5 dCi	63		02.08							
	1.5 dCi	76		02.08							
	1.5 dCi 110	80		09.10							
	1.5 dCi 110	81		03.13							
	1.5 dCi 75	55		11.12							
	1.5 dCi 90	66		11.12							
	1.6	64		02.08							
	1.6 16V	78		02.08							
1.6 16V Hi-Flex	78		02.08								
Z.E.	44		10.11								
	1.2 TCe 115	84		05.13			24.2412-1701.3	030139		+ 5-Gang-Getriebe ³⁾	Gz 12,60
	1.5 dCi	50		02.08							
	1.5 dCi	63		02.08							
	1.5 dCi	76		02.08							
	1.5 dCi 110	80		09.10							
	1.5 dCi 110	81		03.13							
	1.5 dCi 75	55		11.12							
	1.5 dCi 90	66		11.12							
	1.6	64		02.08							
	1.6 16V	78		02.08							
1.6 16V Hi-Flex	78		02.08								

RENAULT KANGOO Be Bop (KWO_) (09-10)

	1.5 dCi	55		09.10	12.10	+ 14" Rad ⁴⁾	24.3541-1849.5	240707			D=54, - Halter	TRW
	1.5 dCi	66		06.09	12.10	+ 14" Rad ⁴⁾	24.3541-1850.5	240708			D=54, - Halter	TRW
	1.5 dCi	76		02.09	12.10	+ 14" Rad ⁴⁾						
	1.5 dCi	80		06.09	12.10	+ 14" Rad ⁴⁾						
	1.6 16V	78		02.09	12.10	+ 14" Rad ⁴⁾						
	1.5 dCi	55		09.10	12.10		24.5111-0485.3	331370	2		L=485	
	1.5 dCi	66		06.09	12.10							
	1.5 dCi	76		02.09	12.10							
	1.5 dCi	80		06.09	12.10							
	1.6 16V	78		02.09	12.10							
	1.5 dCi	55		09.10	12.10	+ 15"/16" Rad ²⁾	24.3384-1773.5	240615			D=38, - Halter	TRW
	1.5 dCi	66		06.09	12.10	+ 15"/16" Rad ²⁾	24.3384-1774.5	240616			D=38, - Halter	TRW
	1.5 dCi	76		02.09	12.10	+ 15"/16" Rad ²⁾						
	1.5 dCi	80		06.09	12.10	+ 15"/16" Rad ²⁾						
	1.6 16V	78		02.09	12.10	+ 15"/16" Rad ²⁾						
	1.5 dCi	55		09.10	12.10		24.5229-0185.3	330397	2		L=185	
	1.5 dCi	66		06.09	12.10							
	1.5 dCi	76		02.09	12.10							
	1.5 dCi	80		06.09	12.10							
	1.6 16V	78		02.09	12.10							
	1.5 dCi	66		06.09	09.09		24.5239-0180.3	331464			L=180	
	1.5 dCi	76		02.09	09.09							
	1.5 dCi	80		06.09	09.09							
	1.6 16V	78		02.09	09.09							
	1.5 dCi	55		09.10	12.10		24.5239-0180.3	331464			L=180	
	1.5 dCi	66		10.09	12.10		24.5279-0180.3	331465			L=180	
	1.5 dCi	76		10.09	12.10							
	1.5 dCi	80		10.09	12.10							
	1.6 16V	78		10.09	12.10							
	1.5 dCi	55		09.10	12.10	+ 14" Rad ⁴⁾	24.3222-1729.3	020526			Rz 22,20	
	1.5 dCi	66		06.09	12.10	+ 14" Rad ⁴⁾						
	1.5 dCi	76		02.09	12.10	+ 14" Rad ⁴⁾						
	1.5 dCi	80		06.09	12.10	+ 14" Rad ⁴⁾						
	1.6 16V	78		02.09	12.10	+ 14" Rad ⁴⁾						
	1.5 dCi	55		09.10	12.10	+ 15"/16" Rad ²⁾	24.3727-1082.2	581082	2	+ langer Radstand ⁵⁾	L=2015	
	1.5 dCi	66		06.09	12.10	+ 15"/16" Rad ²⁾						
	1.5 dCi	76		02.09	12.10	+ 15"/16" Rad ²⁾						
	1.5 dCi	80		06.09	12.10	+ 15"/16" Rad ²⁾						
	1.6 16V	78		02.09	12.10	+ 15"/16" Rad ²⁾						















¹⁾ + short wheel base / + passo lungo / + empattement court / + distancia corta entre ejes

²⁾ + 15"/16" wheel / + ruota 15"/16" / + roue 15"/16" / + rueda 15"/16"

³⁾ + 5 gear transmission / + scatola cambio 5 marce / + transmission 5-vitesses / + cambio de 5 velocidades

⁴⁾ + 14" wheel / + ruota 14" / + roue 14" / + rueda 14"























⁵⁾ + long wheel base / + passo lungo / + empattement long / + distancia larga entre ejes

									
RENAULT KANGOO Express/Rapid (FW_) (08-)									
	1.2 TCe 115	84	05.13	+ 14" Rad ¹⁾	24.3541-1849.5	240707	+ belüftete Scheiben ²⁾ + belüftete Scheiben ²⁾	D=54, - Halter D=54, - Halter	TRW TRW
	1.5 dCi	50	02.08	+ 14" Rad ¹⁾	24.3541-1850.5	240708			
	1.5 dCi	76	02.08	+ 14" Rad ¹⁾					
	1.5 dCi 110	80	09.10	+ 14" Rad ¹⁾					
	1.5 dCi 110	81	09.13	+ 14" Rad ¹⁾					
	1.5 dCi 75	55	09.10	+ 14" Rad ¹⁾					
	1.5 dCi 85	63	02.08	+ 14" Rad ¹⁾					
	1.5 dCi 90	66	06.09	+ 14" Rad ¹⁾					
	1.6	64	02.08	+ 14" Rad ¹⁾					
	1.6 16V	78	02.08	+ 14" Rad ¹⁾					
1.6 16V LPG	72	02.08	+ 14" Rad ¹⁾						
Z.E.	44	10.11	+ 14" Rad ¹⁾						
	1.2 TCe 115	84	05.13		24.5111-0485.3	331370		L=485	
	1.5 dCi	50	02.08						
	1.5 dCi	76	02.08						
	1.5 dCi 110	80	09.10						
	1.5 dCi 110	81	09.13						
	1.5 dCi 75	55	09.10						
	1.5 dCi 85	63	02.08						
	1.5 dCi 90	66	06.09						
	1.6	64	02.08						
	1.6 16V	78	02.08						
1.6 16V LPG	72	02.08							
Z.E.	44	10.11							
	1.2 TCe 115	84	05.13	+ 15"/16" Rad ³⁾	24.3384-1773.5	240615	+ belüftete Scheiben ²⁾ + belüftete Scheiben ²⁾	D=38, - Halter D=38, - Halter	TRW TRW
	1.5 dCi	50	02.08	+ 15"/16" Rad ³⁾	24.3384-1774.5	240616			
	1.5 dCi	76	02.08	+ 15"/16" Rad ³⁾					
	1.5 dCi 110	80	09.10	+ 15"/16" Rad ³⁾					
	1.5 dCi 110	81	09.13	+ 15"/16" Rad ³⁾					
	1.5 dCi 75	55	09.10	+ 15"/16" Rad ³⁾					
	1.5 dCi 85	63	02.08	+ 15"/16" Rad ³⁾					
	1.5 dCi 90	66	06.09	+ 15"/16" Rad ³⁾					
	1.6	64	02.08	+ 15"/16" Rad ³⁾					
	1.6 16V	78	02.08	+ 15"/16" Rad ³⁾					
1.6 16V LPG	72	02.08	+ 15"/16" Rad ³⁾						
Z.E.	44	10.11	+ 15"/16" Rad ³⁾						
	1.5 dCi	50	02.08		24.5229-0185.3	330397	+ belüftete Scheiben ²⁾	L=185	
	1.5 dCi	76	02.08						
	1.5 dCi 110	80	09.10						
	1.5 dCi 75	55	09.10						
	1.5 dCi 85	63	02.08						
	1.5 dCi 90	66	06.09						
	1.6	64	02.08						
	1.6 16V	78	02.08						
	1.6 16V LPG	72	02.08						
	Z.E.	44	10.11						
	1.5 dCi	50	02.08	09.09	24.5239-0180.3	331464	+ belüftete Scheiben ²⁾	L=180	
	1.5 dCi	76	02.08	09.09					
	1.5 dCi 85	63	02.08	09.09					
	1.5 dCi 90	66	06.09	09.09					
	1.6	64	02.08	09.09					
	1.6 16V	78	02.08	09.09					
	1.6 16V LPG	72	02.08	09.09					
	1.5 dCi	50	10.09	03.11	24.5239-0180.3	331464	+ belüftete Scheiben ²⁾ + belüftete Scheiben ²⁾	L=180 L=180	
	1.5 dCi	76	10.09	03.11	24.5279-0180.3	331465			
	1.5 dCi 110	80	09.10	03.11					
	1.5 dCi 75	55	09.10	03.11					
	1.5 dCi 85	63	10.09	03.11					
	1.5 dCi 90	66	10.09	03.11					
	1.6	64	10.09	03.11					
1.6 16V	78	10.09	03.11						
1.6 16V LPG	72	10.09	03.11						
	1.2 TCe 115	84	05.13		24.5239-0180.3	331464	+ belüftete Scheiben ²⁾ + belüftete Scheiben ²⁾	L=180 L=180	
	1.5 dCi	50	04.11		24.5201-0180.3	331498			
	1.5 dCi	76	04.11						
	1.5 dCi 110	80	04.11						
	1.5 dCi 110	81	09.13						
	1.5 dCi 75	55	04.11						
	1.5 dCi 85	63	04.11						
	1.5 dCi 90	66	04.11						
	1.6	64	04.11						
	1.6 16V	78	04.11						
1.6 16V LPG	72	04.11							
Z.E.	44	10.11							
	1.2 TCe 115	84	05.13	+ 14" Rad ¹⁾	24.3222-1729.3	020526		Rz 22,20	
	1.5 dCi	50	02.08	+ 14" Rad ¹⁾					
	1.5 dCi	76	02.08	+ 14" Rad ¹⁾					
	1.5 dCi 110	80	09.10	+ 14" Rad ¹⁾					
	1.5 dCi 110	81	09.13	+ 14" Rad ¹⁾					
	1.5 dCi 75	55	09.10	+ 14" Rad ¹⁾					
	1.5 dCi 85	63	02.08	+ 14" Rad ¹⁾					
	1.5 dCi 90	66	06.09	+ 14" Rad ¹⁾					
	1.6	64	02.08	+ 14" Rad ¹⁾					
	1.6 16V	78	02.08	+ 14" Rad ¹⁾					
1.6 16V LPG	72	02.08	+ 14" Rad ¹⁾						
Z.E.	44	10.11	+ 14" Rad ¹⁾						

¹⁾ + 14" wheel / + ruota 14" / + roue 14" / + rueda 14"

²⁾ + ventilated discs / + dischi ventilati / + disques ventilés / + disco ventilado

















³⁾ + 15"/16" wheel / + ruota 15"/16" / + roue 15"/16" / + rueda 15"/16"

RENAULT KANGOO Express/Rapid (FW_) (08-)										
										
	1.2 TCe 115	84		05.13		+ 15"/16" Rad ¹⁾	24.3727-1082.2	581082	2 ↓ + mittlerer Radstand ²⁾	L=2015
	1.5 dCi	50		02.08		+ 15"/16" Rad ¹⁾				
	1.5 dCi	76		02.08		+ 15"/16" Rad ¹⁾				
	1.5 dCi 110	80		09.10		+ 15"/16" Rad ¹⁾				
	1.5 dCi 110	81		09.13		+ 15"/16" Rad ¹⁾				
	1.5 dCi 75	55		09.10		+ 15"/16" Rad ¹⁾				
	1.5 dCi 85	63		02.08		+ 15"/16" Rad ¹⁾				
	1.5 dCi 90	66		06.09		+ 15"/16" Rad ¹⁾				
	1.6	64		02.08		+ 15"/16" Rad ¹⁾				
	1.6 16V	78		02.08		+ 15"/16" Rad ¹⁾				
	1.6 16V LPG	72		02.08		+ 15"/16" Rad ¹⁾				
	Z.E.	44		10.11		+ 15"/16" Rad ¹⁾				
	1.5 dCi	50		02.08			24.2412-1701.3	030139		Gz 12,60
	1.5 dCi 85	63		02.08						
	1.5 dCi 90	66		06.09						
	1.6	64		02.08						
	1.6 16V	78		02.08						
	1.6 16V LPG	72		02.08						
RENAULT KOLEOS (HYO_) (08-15)										
	2.0 dCi	110		09.08	12.09		24.5267-0625.3	331332		L=625
	2.0 dCi	130		09.08	12.09		24.5267-0626.3	331333		L=625
	2.0 dCi 4x4	110		09.08	12.09					
	2.0 dCi 4x4	127		09.08	12.09					
	2.5 16V	126		09.08	12.09					
	2.5 16V 4x4	126		09.08	12.09					
	2.0 dCi	110		09.08	12.09		24.5290-0240.3	331334		L=240
	2.0 dCi	130		09.08	12.09		24.5290-0241.3	331335		L=240
	2.0 dCi 4x4	110		09.08	12.09					
	2.0 dCi 4x4	127		09.08	12.09					
	2.5 16V	126		09.08	12.09					
	2.5 16V 4x4	126		09.08	12.09					
	2.0 dCi	110		09.08			24.3727-1087.2	581087	<input type="checkbox"/> - elektrische Feststellbremse ³⁾	L=1760
	2.0 dCi	130		09.08			24.3727-1088.2	581088	<input type="checkbox"/> - elektrische Feststellbremse ³⁾	L=1760
	2.0 dCi 4x4	110		09.08						
	2.0 dCi 4x4	127		09.08						
	2.5 16V	126		09.08						
	2.5 16V 4x4	126		09.08						
RENAULT LAGUNA I Limousine (B56/556_) (93-00)										
	1.8			04.95	02.01	- ABS	03.2122-1001.3	010562		Thz 22,20 ATE
	1.8 (B56A/B)	66		11.93	02.01	- ABS				
	2.2 D (B56F/2)	61		11.93	02.01	- ABS				
	1.6 16V	79		11.97	01.99		24.2123-1725.3	010549		Thz 23,81
	1.8			02.97	02.01	+ ABS				
	1.8 (B56A/B)	66		02.97	02.01	+ ABS				
	1.8 (B56S/T/0)	66		02.97	02.01	+ ABS				
	1.8 16V (B563,B564)	88		04.98	01.99					
	1.9 dTi	72		10.97	01.99					
	2.0 (B56C/H/N)	83		02.97	02.01	+ ABS				
	2.0 (B56C/H/N)	83		11.93	02.01	- ABS				
	2.0 (L)	70		02.97	01.99	+ ABS				
	2.0 (L)	70		06.95	02.01	- ABS				
	2.0 16V (B56D/M)	102		02.97	01.99	+ ABS				
	2.0 16V (B56D/M)	102		05.95	02.01	- ABS				
	2.2 D (B56F/2)	61		02.97	02.01	+ ABS				
	2.2 dT	83		02.97	01.99	+ ABS				
	2.2 dT	83		03.96	02.01	- ABS				
	3.0 V6	140		03.97	01.99					
	3.0 V6 (B56E/R,B565)	123		02.97	02.01					
	1.6 16V	79		02.99	02.01		24.2123-1701.3	010424		Thz 23,81
	1.8 (B56S/T/0)	66		02.99	02.01	+ ABS				
	1.8 16V (B563,B564)	88		02.99	02.01					
	1.9 dCi	79		09.99	02.01					
	1.9 dTi	72		02.99	02.01					
	2.0 (L)	70		02.99	02.01	+ ABS				
	2.0 (U)	80		03.99	02.01					
	2.0 16V (556A/B)	103		09.99	02.01					
	2.0 16V (B56D/M)	102		02.99	02.01	+ ABS				
	2.2 dT	83		02.99	02.01	+ ABS				
	3.0 V6	140		02.99	02.01					
	1.8			04.95	01.97	+ ABS	10.6123-0312.3	010457		Thz 23,81 (MKIV) ATE
	1.8 (B56A/B)	66		11.93	01.97	+ ABS				
	2.0	84		11.93	01.97	+ ABS				
	2.0 16V (B56D/M)	102		05.95	02.01	+ ABS				
	2.2 D (B56F/2)	61		11.93	01.97	+ ABS				
	2.2 dT	83		03.96	01.97	+ ABS				
	3.0 V6 (B56E/R,B565)	123		11.93	01.97	+ ABS				
	1.8			04.95	02.01		24.3541-1741.5	240215		D=54, - Halter TRW
	1.8 (B56A/B)	66		10.94	02.01		24.3541-1742.5	240216		D=54, - Halter TRW
	1.8 (B56S/T/0)	66		10.94	04.98					
	2.0	84		06.95	04.98					
	2.0 (B56C/H/N)	83		11.93	02.01					
	2.0 (L)	70		06.95	04.98					
	2.2 D (B56F/2)	61		11.93	02.01					

¹⁾ + 15"/16" wheel / + ruota 15"/16" / + roue 15"/16" / + rueda 15"/16"

²⁾ + medium wheelbase / + passo medio / + empattement moyen / + empate medio

³⁾ - electric parking brake / - freno a mano elettrico / - frein à main électrique / - freno de mano eléctrico

									
RENAULT LAGUNA I Limousine (B56/556_) (93-00)									
	1.6 16V	79		11.97 02.01	24.3541-1749.5	240427		D=54, - Halter D=54, - Halter	TRW TRW
	1.8 (B56S/T/0)	66		05.98 02.01	24.3541-1750.5	240428			
	1.8 16V (B563,B564)	88		04.98 02.01					
	1.9 dCi	79		09.99 02.01					
	1.9 dTi	72		10.97 02.01					
	2.0	84		05.98 02.01					
	2.0 (L)	70		05.98 02.01					
	2.0 (U)	80		03.99 02.01					
	2.0 16V	102		09.99 02.01					
	2.0 16V (556A/B)	103		09.99 02.01					
2.0 16V (B56D/M)	102		11.98 02.01						
2.0 16V (B56D/M)	102		05.95 10.98	24.3601-1707.5	240229	TRW TRW	D=60, - Halter D=60, - Halter		
2.2 dT	83		03.96 02.01	24.3601-1708.5	240230				
3.0 V6	140		03.97 02.01						
3.0 V6 (B56E/R,B565)	123		11.93 02.01						
	1.6 16V	79		11.97 02.01	24.5111-0445.3	330504	2	L=445	
	1.8	66		04.95 02.01					
	1.8 (B56A/B)	66		11.93 02.01					
	1.8 (B56S/T/0)	66		08.95 02.01					
	1.8 16V (B563,B564)	88		04.98 02.01					
	1.9 dCi	79		09.99 02.01					
	1.9 dTi	72		10.97 02.01					
	2.0	84		11.93 02.01					
	2.0 (U)	80		03.99 02.01					
	2.0 16V (556A/B)	103		09.99 02.01					
	2.0 16V (B56D/M)	102		05.95 02.01					
	2.2 D (B56F/2)	61		11.93 02.01					
	2.2 dT	83		03.96 02.01					
	3.0 V6	140		03.97 02.01					
3.0 V6 (B56E/R,B565)	123		11.93 02.01						
	1.6 16V	79		11.97 02.01	24.5229-0285.3	330032	2	L=285	
	1.8	66		04.95 02.01					
	1.8 (B56A/B)	66		11.93 02.01					
	1.8 (B56S/T/0)	66		08.95 02.01					
	1.8 16V (B563,B564)	88		04.98 02.01					
	1.9 dCi	79		09.99 02.01					
	1.9 dTi	72		10.97 02.01					
	2.0	84		03.99 02.01					
	2.0 (B56C/H/N)	83		11.93 02.01					
	2.0 (U)	80		03.99 02.01					
	2.0 16V (556A/B)	103		09.99 02.01					
	2.0 16V (B56D/M)	102		05.95 02.01					
	2.2 D (B56F/2)	61		11.93 02.01					
	2.2 dT	83		03.96 02.01					
3.0 V6	140		03.97 02.01						
3.0 V6 (B56E/R,B565)	123		11.93 02.01						
	1.8	66		04.95 02.01	24.5111-0150.3	330497	2	L=150	
	1.8 (B56A/B)	66		11.93 02.99					
	1.8 (B56S/T/0)	66		08.95 02.01					
	1.8 16V (B563,B564)	88		04.98 02.01					
	2.0	84		06.95 02.01					
	2.0 (B56C/H/N)	83		11.93 02.99					
	2.0 (B56C/H/N)	83		11.93 02.01					
	2.0 (L)	70		06.95 02.99					
	2.0 16V (B56D/M)	102		05.95 02.01					
	2.2 D (B56F/2)	61		11.93 02.01					
	2.2 dT	83		03.96 02.99					
	3.0 V6	140		03.97 02.99					
	3.0 V6 (B56E/R,B565)	123		11.93 02.01					
		1.8	66		07.95 02.01	24.3219-1611.3			020367
1.8		66		04.95 06.95					
1.8 (B56A/B)		66		11.93 02.01					
1.8 (B56S/T/0)		66		08.95 04.98					
2.0		84		11.93 02.01					
2.0 (B56C/H/N)		83		07.95 02.01					
2.0 (B56C/H/N)		83		07.95 02.01					
2.0 (B56C/H/N)		83		11.93 06.95					
2.0 (L)		70		07.95 02.01					
2.2 D (B56F/2)		61		11.93 06.95					
	1.6 16V	79		11.97 02.01	24.3220-1711.3	020409	+ GG 1)	Rz 20,64	TRW
	1.8 (B56S/T/0)	66		05.98 02.01					
	1.8 16V (B563,B564)	88		04.98 02.01					
	1.9 dTi	72		10.97 02.01					
	2.0 (U)	80		03.99 02.01					
	2.0 (U)	80		03.99 02.01					
	1.6 16V	79		11.97 02.01	24.3727-1032.2	581032	2	L=1187	
	1.8	66		05.95 02.01					
	1.8	66		08.94 04.95					
	1.8 (B56A/B)	66		05.95 02.01					
	1.8 (B56A/B)	66		11.93 04.95					
	1.8 (B56S/T/0)	66		08.95 02.01					
	1.8 16V (B563,B564)	88		04.98 02.01					
	1.9 dTi	72		10.97 02.01					
	2.0 (B56C/H/N)	83		05.95 02.01					
	2.0 (B56C/H/N)	83		11.93 04.95					
	2.0 (L)	70		06.95 02.01					
	2.0 (U)	80		03.99 02.01					

1) + cast iron / + ghisa / + fonte grise / + fundición de gris



















RENAULT LAGUNA I Limousine (B56/556_) (93-00)















	2.2 D (B56F/2)	61	11.93	02.01	- ABS	24.3727-1032.2	581032	2 ↓	L=1187
	1.8		08.94	04.95	+ ABS	24.3727-1033.2	581033	2 ↓	L=1247
	1.8 (B56A/B)	66	11.93	04.95	+ ABS				
	2.0 (B56C/H/N)	83	11.93	01.97	+ Baccara				
	2.0 (B56C/H/N)	83	11.93	04.95	+ ABS / - Baccara				
	2.0 (L)	70	06.95	01.97	+ Initiale				
	2.0 16V (B56D/M)	102	05.95	01.97	+ ABS				
	2.0 16V (B56D/M)	102	05.95	02.01	- ABS				
	2.2 D (B56F/2)	61	11.93	02.01	+ ABS				
	2.2 dT	83	03.96	01.97	+ ABS				
	2.2 dT	83	03.96	02.01	- ABS				
	3.0 V6 (B56E/R,B565)	123	11.93	01.97					
	1.8 16V (B563,B564)	88	04.98	02.01	+ Initiale	24.3727-1053.2	581053	2 ↓	L=1183
	1.9 dCi	79	09.99	02.01					
	2.0 (B56C/H/N)	83	02.97	02.01	+ Baccara				
	2.0 (L)	70	02.97	02.01	+ Baccara/Initiale				
	2.0 16V (556A/B)	103	09.99	02.01					
	2.0 16V (B56D/M)	102	02.97	02.01	+ ABS				
	2.2 dT	83	02.97	02.01	+ ABS				
	3.0 V6	140	03.97	02.01					
	3.0 V6 (B56E/R,B565)	123	02.97	02.01					
	1.8		04.95	02.01		24.3728-1022.2	591022		L=1248
	1.8 (B56A/B)	66	11.93	02.01					
	1.8 (B56S/T/0)	66	08.95	02.01					
	2.0 (B56C/H/N)	83	11.93	02.01					
	2.0 (L)	70	06.95	04.98					
	3.0 V6 (B56E/R,B565)	123	08.96	02.01					
	1.6 16V	79	10.98	02.01		24.3728-1030.2	591030		L=1125, + AUT
	1.8 (B56S/T/0)	66	10.98	02.01					
	1.8 16V (B563,B564)	88	10.98	02.01					
	1.9 dTi	72	10.98	02.01					
	2.0 (L)	70	10.98	02.01					
	2.0 16V (556A/B)	103	09.99	02.01					

RENAULT LAGUNA I Grandtour (K56_) (95-00)

	1.6 16V	79	11.97	01.99		24.2123-1725.3	010549		THz 23,81
	1.8 (0)	66	02.97	01.99	+ ABS				
	1.8 (0)	66	06.95	02.01	- ABS				
	1.8 (S)	66	02.97	02.01	+ ABS				
	1.8 (S)	66	06.95	02.01	- ABS				
	1.8 (T)	66	02.97	02.01	+ ABS				
	1.8 (T)	66	07.95	02.01	- ABS				
	1.8 (Z)	69	07.95	02.01	- ABS				
	1.8 (Z)	69	02.97	02.01	+ ABS				
	1.8 16V	88	04.98	01.99					
	1.9 dTi	72	10.97	01.99					
	2.0	84	10.98	02.01	- ABS				
	2.0 (C)	83	02.97	02.01	+ ABS				
	2.0 (C)	83	06.95	02.01	- ABS				
	2.0 (H)	83	02.97	02.01	+ ABS				
	2.0 (H)	83	06.95	02.01	- ABS				
	2.0 (L)	70	02.97	01.99	+ ABS				
	2.0 (L)	70	11.95	02.01	- ABS				
	2.0 (N)	83	09.95	02.01					
	2.0 16V (D)	102	09.95	02.01	- ABS				
	2.0 16V (M)	102	02.97	01.99					
	2.0 16V (M)	102	09.95	02.01	- ABS				
	2.2 D		02.97	02.01	+ ABS				
	2.2 D		06.95	02.01	- ABS				
	2.2 dT		03.96	02.01	- ABS				
	2.2 dT		02.97	01.99	+ ABS				
	3.0 V6	140	03.97	01.99					
	3.0 V6 (5)	123	02.97	02.01					
	1.6 16V	79	02.99	02.01		24.2123-1701.3	010424		THz 23,81
	1.8 (0)	66	02.99	02.01	+ ABS				
	1.8 16V	88	02.99	02.01					
	1.9 dCi	79	09.99	02.01					
	1.9 dTi	72	02.99	02.01					
	2.0 (L)	70	02.99	02.01	+ ABS				
	2.0 16V (A)	102	09.99	02.01					
	2.0 16V (B)	102	09.99	02.01					
	2.0 16V (M)	102	02.99	02.01	+ ABS				
	2.2 dT		02.99	02.01	+ ABS				
	3.0 V6	140	02.99	02.01					
	1.8 (0)	66	06.95	01.97	+ ABS	10.6123-0312.3	010457		THz 23,81 (MKIV) ATE
	1.8 (S)	66	06.95	01.97	+ ABS				
	1.8 (T)	66	07.95	01.97	+ ABS				
	1.8 (Z)	69	07.95	01.97	+ ABS				
	2.0	84	10.98	02.01	+ ABS				
	2.0 (C)	83	06.95	01.97	+ ABS				
	2.0 (H)	83	06.95	01.97	+ ABS				
	2.0 (L)	70	11.95	01.97	+ ABS				
	2.0 (N)	83	09.95	02.01	+ ABS				
	2.0 16V (D)	102	09.95	02.01	+ ABS				
	2.0 16V (M)	102	09.95	01.97	+ ABS				
	2.2 D		06.95	01.97	+ ABS				

								
RENAULT LAGUNA I Grandtour (K56_) (95-00)								
	2.2 dT 3.0 V6 (5) 3.0 V6 (R)	123 123 123		03.96 01.97 + ABS 03.96 01.97 + ABS 02.96 02.01 + ABS	10.6123-0312.3	010457		THz 23,81 (MKIV) ATE
	1.8 (O) 1.8 (S) 1.8 (T) 1.8 (Z) 2.0 2.0 (C) 2.0 (H) 2.0 (L) 2.0 (N) 2.2 D	66 66 66 69 84 83 83 70 83 66		06.95 04.98 06.95 02.01 07.95 02.01 07.95 02.01 10.98 02.01 06.95 02.01 06.95 02.01 11.95 04.98 09.95 02.01 06.95 02.01	24.3541-1741.5 24.3541-1742.5	240215 240216	<input type="checkbox"/> <input type="checkbox"/>	D=54, - Halter D=54, - Halter TRW
	1.6 16V 1.8 (O) 1.8 16V (3) 1.8 16V (4) 1.8 16V (Y) 1.9 dCi 1.9 dTi 2.0 (L)	79 66 88 88 88 79 72 70		11.97 02.01 05.98 02.01 02.99 02.01 04.98 02.01 05.99 02.01 09.99 02.01 10.97 02.01 05.98 02.01	24.3541-1749.5 24.3541-1750.5	240427 240428	<input type="checkbox"/> <input type="checkbox"/>	D=54, - Halter D=54, - Halter TRW
	2.0 16V 2.0 16V (A) 2.0 16V (B) 2.0 16V (D) 2.0 16V (M) 2.2 dT 3.0 V6 3.0 V6	103 102 102 102 102 123 140		09.99 02.01 09.99 02.01 09.99 02.01 09.95 02.01 09.95 02.01 03.96 02.01 02.96 02.01 03.97 02.01	24.3601-1707.5 24.3601-1708.5	240229 240230	<input type="checkbox"/> <input type="checkbox"/>	D=60, - Halter D=60, - Halter TRW
	1.6 16V 1.8 (O) 1.8 (S) 1.8 (T) 1.8 (Z) 1.8 16V 1.9 dCi 1.9 dTi 2.0 2.0 2.0 16V 2.2 D 2.2 dT 3.0 V6 3.0 V6	79 66 66 66 69 88 79 72 83 84 102 102 123 140		11.97 02.01 06.95 02.01 06.95 02.01 07.95 02.01 07.95 02.01 04.98 02.01 09.99 02.01 10.97 02.01 06.95 02.01 10.98 02.01 09.95 02.01 06.95 02.01 03.96 02.01 02.96 02.01 03.97 02.01	24.5111-0445.3	330504	2	L=445
	1.6 16V 1.8 (O) 1.8 (S) 1.8 (T) 1.8 (Z) 1.8 16V 1.9 dCi 1.9 dTi 2.0 2.0 2.0 16V 2.2 D 2.2 dT 3.0 V6 3.0 V6	79 66 66 66 69 88 79 72 83 84 102 102 123 140		11.97 02.01 06.95 02.01 06.95 02.01 07.95 02.01 07.95 02.01 04.98 02.01 09.99 02.01 10.97 02.01 06.95 02.01 10.98 02.01 09.95 02.01 06.95 02.01 03.96 02.01 02.96 02.01 03.97 02.01	24.5229-0285.3	330032	2 <input type="checkbox"/>	L=285
	1.8 (O) 1.8 (S) 1.8 (T) 1.8 (Z) 2.0 2.0 2.0 16V (D) 2.0 16V (M) 2.2 D 2.2 dT 3.0 V6 3.0 V6	66 66 66 69 83 84 102 102 66 66 123 140		06.95 02.01 + ABS 06.95 02.01 + ABS 07.95 02.01 + ABS 07.95 02.01 + ABS 06.95 02.01 + ABS 10.98 02.01 + ABS 09.95 02.01 09.95 02.99 06.95 02.01 + ABS 03.96 02.99 02.96 02.01 03.97 02.99	24.5111-0150.3	330497	2	L=150
	1.8 (O) 1.8 (O) 1.8 (S) 1.8 (S) 1.8 (T) 1.8 (T) 1.8 (Z) 1.8 (Z) 2.0 (C) 2.0 (C) 2.0 (H) 2.0 (H) 2.0 (L) 2.0 (L) 2.0 (N)	66 66 66 66 66 66 69 69 83 83 83 83 70 70 83		06.96 04.98 06.95 05.96 - ABS 06.96 02.01 06.95 05.96 - ABS 06.96 02.01 07.95 05.96 - ABS 07.95 05.96 - ABS 06.96 02.01 06.96 02.01 06.95 05.96 - ABS 06.96 02.01 06.95 05.96 - ABS 06.96 04.98 11.95 05.96 - ABS 09.95 02.01	24.3220-1711.3	020409	+ GG ¹⁾	Rz 20,64 TRW

¹⁾ + cast iron / + ghisa / + fonte grise / + fundición de gris

									
RENAULT LAGUNA I Grandtour (K56_) (95-00)									
	2.2 D			06.96 02.01	24.3220-1711.3	020409	+ GG ¹⁾	Rz 20,64	TRW
	2.2 D			06.95 05.96 - ABS					
	1.6 16V	79		11.97 02.01	24.3222-1713.3	020431		Rz 22,20	TRW
	1.8 (0)	66		05.98 02.01					
	1.8 16V (4)	88		04.98 02.01 - Fairway					
	1.9 dTi (KJ)	72		10.97 02.01 - Alize					
	1.9 dTi (SJ)	72		10.97 02.01					
	2.0	84		10.98 01.01					
	2.0 (L)	70		05.98 02.01					
	1.6 16V	79		11.97 02.01	24.3727-1040.2	581040	2 ↓	L=1190	
	1.8 (0)	66		06.96 02.01					
	1.8 (0)	66		06.95 05.96 - ABS					
	1.8 (S)	66		06.96 02.01					
	1.8 (S)	66		06.95 05.96 - ABS					
	1.8 (T)	66		06.96 02.01					
	1.8 (T)	66		07.95 05.96 - ABS					
	1.8 (Z)	69		07.95 05.96 - ABS					
	1.8 (Z)	69		06.96 02.01					
	1.8 16V	88		04.98 02.01					
	1.9 dTi	72		10.97 02.01					
	2.0	84		10.98 02.01					
	2.0 (C)	83		06.96 02.01					
	2.0 (C)	83		06.95 05.96 - ABS					
	2.0 (H)	83		06.96 02.01					
	2.0 (H)	83		06.95 05.96 - ABS					
	2.0 (L)	70		11.95 05.96 - ABS					
	2.0 (N)	83		09.95 02.01					
	2.2 D			06.96 02.01					
	2.2 D			06.95 05.96 - ABS					
	1.8 (0)	66		06.95 05.96 + ABS	24.3727-1033.2	581033	2 ↓	L=1247	
	1.8 (S)	66		06.95 05.96 + ABS					
	1.8 (T)	66		07.95 05.96 + ABS					
	1.8 (Z)	69		07.95 05.96 + ABS					
	2.0	84		10.98 02.01 + ABS					
	2.0 (C)	83		06.95 05.96 + ABS					
	2.0 (H)	83		06.95 05.96 + ABS					
	2.0 (L)	70		11.95 05.96 + ABS					
	2.0 16V (D)	102		09.95 02.01					
	2.0 16V (M)	102		09.95 01.97					
	2.2 D			06.95 05.96 + ABS					
	2.2 dT			03.96 01.97					
	3.0 V6 (5)	123		03.96 01.97					
	3.0 V6 (R)	123		02.96 02.01					
	1.9 dCi	79		09.99 02.01	24.3727-1053.2	581053	2 ↓	L=1183	
	2.0 16V (A)	102		09.99 02.01					
	2.0 16V (B)	102		09.99 02.01					
	2.0 16V (M)	102		02.97 02.01					
	2.2 dT			02.97 02.01					
	3.0 V6	140		03.97 02.01					
	3.0 V6 (5)	123		02.97 02.01					
	1.8 (0)	66		06.95 05.96 + ABS/ - Niveauregulierung ²⁾	24.6583-1740.3	320264		BRL (4)	
	1.8 (S)	66		06.95 05.96 + ABS/ - Niveauregulierung ²⁾					
	1.8 (T)	66		07.95 05.96 + ABS/ - Niveauregulierung ²⁾					
	1.8 (Z)	69		07.95 05.96 + ABS/ - Niveauregulierung ²⁾					
	2.0	83		06.95 05.96 + ABS/ - Niveauregulierung ²⁾					
	2.0	84		10.98 02.01 + ABS/ - Niveauregulierung ²⁾					
	2.0 16V (D)	102		09.95 02.01 - Niveauregulierung ³⁾					
	2.0 16V (M)	102		09.95 01.97 + ABS/ - Niveauregulierung ²⁾					
	2.0 16V (M)	102		09.95 02.01 - ABS/ - Niveauregulierung ⁴⁾					
	3.0 V6 (5)	123		03.96 01.97 - Niveauregulierung ³⁾					
	3.0 V6 (R)	123		02.96 02.01 - Niveauregulierung ³⁾					
	1.8 (0)	66		06.95 04.98	24.3728-1022.2	591022		L=1248	
	1.8 (S)	66		06.95 02.01					
	1.8 (T)	66		06.95 02.01					
	1.8 (Z)	69		07.95 02.01					
	2.0	84		10.98 02.01					
	2.0 (C)	83		06.95 02.01					
	2.0 (H)	83		06.95 02.01					
	2.0 (L)	70		11.95 04.98					
	2.0 (N)	83		09.95 02.01					
	1.6 16V	79		09.98 02.01	24.3728-1030.2	591030		L=1125, + AUT	
	1.8 (0)	66		09.98 02.01					
	1.8 16V	88		09.98 02.01					
	1.9 dTi (KJ)	72		09.98 02.01					
	1.9 dTi (SJ)	72		09.98 02.01					
	2.0 (L)	70		09.98 02.01					
	2.0 16V (A)	102		09.99 02.01					
	2.0 16V (B)	102		09.99 02.01					
RENAULT LAGUNA II Limousine (BG_) (01-07)									
	1.6 16V	79		03.01 05.01	03.0655-0007.2	370007		Wegsensor	ATE
	1.8 16V (04/06/0V)	89		03.01 05.01					
	1.8 16V (0B/0C/0M)	88		03.01 05.01					
	1.8 16V (0J)	85		03.01 05.01					
	1.9 dCi (08/10)	68		03.01 05.01					
	1.9 dCi (0G)	88		03.01 05.01					

¹⁾ + cast iron / + ghisa / + fonte grise / + fundición de gris

²⁾ + ABS/ - suspens.level control / + ABS/ - correttore assetto / + ABS/ - correcteur d'assiette / + ABS/ - regul.alt.suspensión

³⁾ - suspension level control / - correttore assetto / - correcteur d'assiette / - regulación altura suspensión



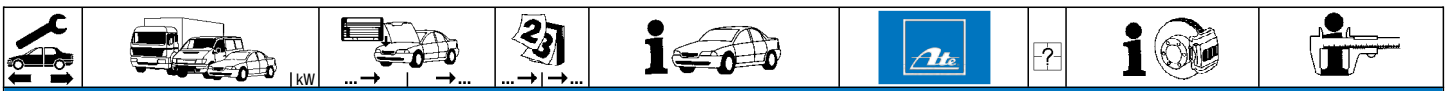

























⁴⁾ - ABS/ - suspens.level control / - ABS/ - correttore assetto / - ABS/ - correcteur d'assiette / - ABS/ - regul.alt.suspensión



RENAULT LAGUNA II Limousine (BG_) (01-07)

	2.0 16V (00/0K/0W) ◀ 99 2.0 16V IDE (0N/0P) ◀103 2.2 dCi ◀110 3.0 V6 ◀152		04.01 05.01 04.01 05.01 03.01 05.01 03.01 05.01	03.0655-0007.2 370007		Wegsensor	ATE
	1.6 16V ◀ 79 1.6 16V ◀ 82 1.8 16V (04/06/0V) ◀ 89 1.8 16V (0B/0C/0M) ◀ 88 1.8 16V (0J) ◀ 85 1.9 dCi ◀ 79 1.9 dCi ◀ 81 1.9 dCi ◀ 96 1.9 dCi (08/10) ◀ 68 1.9 dCi (0E) ◀ 77 1.9 dCi (0G) ◀ 88 1.9 dCi (0R) ◀ 74 2.0 16V ◀125 2.0 16V (00/0K/0W) ◀ 99 2.0 16V IDE (0N/0P) ◀103 2.0 16V Sport ◀150 2.0 16V Turbo ◀120 2.0 dCi ◀110 2.0 dCi 130 ◀127 2.2 dCi ◀102 2.2 dCi ◀110 2.2 dCi (BG09) ◀ 85 3.0 V6 ◀152		06.01 06.07 02.05 06.07 06.01 06.07 06.01 06.07 06.01 06.07 03.01 06.07 01.05 06.07 05.05 06.07 03.04 06.07 06.01 06.07 06.01 06.07 10.01 06.07 01.05 06.07 08.02 06.07 06.01 06.07 01.05 06.07 01.03 06.07 08.05 06.07 01.06 06.07 05.05 06.07 10.01 06.07 04.04 10.05 06.01 06.07	03.7873-1202.4 300197		11"	ATE
	1.6 16V ▶ 79 1.6 16V ▶ 82 1.8 16V (04/06/0V) ▶ 89 1.8 16V (0B/0C/0M) ▶ 88 1.8 16V (0J) ▶ 85 1.9 dCi ▶ 79 1.9 dCi ▶ 81 1.9 dCi ▶ 96 1.9 dCi (08/10) ▶ 68 1.9 dCi (0E) ▶ 77 1.9 dCi (0G) ▶ 88 1.9 dCi (0R) ▶ 74 2.0 16V ▶125 2.0 16V (00/0K/0W) ▶ 99 2.0 16V IDE (0N/0P) ▶103 2.0 16V Sport ▶150 2.0 16V Turbo ▶120 2.0 dCi ▶110 2.0 dCi 130 ▶127 2.2 dCi ▶102 2.2 dCi ▶110 2.2 dCi (BG09) ▶ 85 3.0 V6 ▶152		03.01 06.07 02.05 06.07 03.01 06.07 03.01 06.07 03.01 06.07 03.01 06.07 01.05 06.07 05.05 06.07 03.04 06.07 06.01 06.07 03.01 06.07 10.01 06.07 01.05 06.07 08.02 06.07 04.01 06.07 01.05 06.07 01.03 06.07 08.05 06.07 01.06 06.07 05.05 06.07 10.01 06.07 04.04 10.05 03.01 06.07	03.0655-0007.2 370007		Wegsensor	ATE
	1.6 16V 79 1.8 16V (04/06/0V) 89 1.8 16V (0B/0C/0M) 88 1.8 16V (0J) 85 1.9 dCi 79 1.9 dCi 81 1.9 dCi (08/10) 68 1.9 dCi (0E) 77 1.9 dCi (0G) 88 1.9 dCi (0R) 74 2.0 16V 125 2.0 16V (00/0K/0W) 99 2.0 16V IDE (0N/0P) 103 2.0 16V Sport 150 2.2 dCi 110 2.2 dCi (BG09) 85 3.0 V6 152		03.01 03.05 03.01 03.05 03.01 03.05 03.01 03.05 03.01 03.05 01.05 03.05 03.04 03.05 06.01 03.05 03.01 03.05 10.01 03.05 01.05 03.05 08.02 03.05 04.01 03.05 01.05 03.05 10.01 03.05 04.04 03.05 03.01 03.05	03.4123-0081.3 010585 03.3517-0300.1 390323	- ESP	THz 23.81 Verschlusschraube	ATE
	1.6 16V 79 1.6 16V 82 1.8 16V (04/06/0V) 89 1.8 16V (0B/0C/0M) 88 1.8 16V (0J) 85 1.9 dCi 79 1.9 dCi 81 1.9 dCi 96 1.9 dCi (08/10) 68 1.9 dCi (0E) 77 1.9 dCi (0G) 88 1.9 dCi (0R) 74 2.0 16V 125 2.0 16V (00/0K/0W) 99 2.0 16V IDE (0N/0P) 103 2.0 16V Sport 150 2.0 16V Turbo 120 2.0 dCi 110 2.0 dCi 130 127 2.2 dCi 102		04.05 06.07 02.05 06.07 04.05 06.07 04.05 06.07 04.05 06.07 04.05 06.07 04.05 06.07 04.05 06.07 04.05 06.07 04.05 06.07 04.05 06.07 04.05 06.07 04.05 06.07 04.05 06.07 04.05 06.07 04.05 06.07 04.05 06.07 01.03 06.07 08.05 06.07 01.06 06.07 05.05 06.07	03.4153-0063.3 010773		THz 23.81	ATE



									
RENAULT LAGUNA II Limousine (BG_) (01-07)									
	2.2 dCi 2.2 dCi (BG09) 3.0 V6	110 85 152	04.05 04.05 04.05	06.07 10.05 06.07	03.4153-0063.3	010773		THz 23,81 ATE	
	1.6 16V 1.6 16V 1.8 16V (04/06/0V) 1.8 16V (0B/0C/0M) 1.8 16V (0J) 1.9 dCi 1.9 dCi 1.9 dCi 1.9 dCi (08/10) 1.9 dCi (0E) 1.9 dCi (0G) 1.9 dCi (0R) 2.0 16V (00/0K/0W) 2.0 16V IDE (0N/0P)	79 82 89 88 85 79 81 96 68 77 88 74 99 103	03.01 02.05 03.01 03.01 03.01 03.01 01.05 05.05 03.04 06.01 03.01 10.01 08.02 04.01	06.07 06.07 06.07 06.07 06.07 06.07 06.07 06.07 06.07 06.07 06.07 06.07 06.07 06.07	11.9571-9861.2 11.9571-9841.2 11.9571-9842.2 24.3571-9841.5 24.3571-9842.5 11.8116-0301.1 11.0101-5407.2 11.8171-0008.1	220403 220401 220402 240501 240502 390610 260011 990049	 + Bremsscheibe 280mm ¹⁾  + Bremsscheibe 300mm ²⁾  + Bremsscheibe 300mm ²⁾  + Bremsscheibe 300mm ²⁾	D=57, - Halter D=57, - Halter D=57, - Halter D=57, - Halter Haltefeder Hülzensatz Führungsbolzen	ATE ATE ATE ATE ATE ATE ATE ATE ATE ATE ATE ATE ATE ATE
	2.2 dCi 2.2 dCi 2.2 dCi 2.2 dCi (BG09)	102 110 110 85	05.05 05.05 10.01 04.04	06.07 06.07 11.01 10.05	11.9571-9841.2 11.9571-9842.2 24.3571-9841.5 24.3571-9842.5 11.0101-5407.2 11.8171-0008.1 11.8116-0301.1	220401 220402 240501 240502 260011 990049 390610	   	D=57, - Halter D=57, - Halter D=57, - Halter D=57, - Halter Hülzensatz Führungsbolzen Haltefeder	ATE ATE ATE ATE ATE ATE ATE
	2.0 16V 2.0 16V Sport 2.0 16V Turbo 2.0 dCi 2.0 dCi 130 2.2 dCi 2.2 dCi (BG09) 3.0 V6	125 150 120 110 127 110 85 152	01.05 01.05 01.03 08.05 01.06 12.01 04.04 03.01	06.07 06.07 06.07 06.07 06.07 04.05 10.05 06.07	11.9601-9787.2 11.9601-9788.2 24.3601-9787.5 24.3601-9788.5 11.0441-6008.2 11.0101-5407.2 11.8171-0008.1 11.8116-0301.1	220585 220586 240505 240506 250038 260011 990049 390610	   	D=60, - Halter D=60, - Halter D=60, - Halter D=60, - Halter Dichtungssatz Hülzensatz Führungsbolzen Haltefeder	ATE ATE ATE ATE ATE ATE ATE ATE
	1.6 16V 1.6 16V 1.8 16V (04/06/0V) 1.8 16V (0B/0C/0M) 1.8 16V (0J) 1.9 dCi 1.9 dCi 1.9 dCi 1.9 dCi (08/10) 1.9 dCi (0E) 1.9 dCi (0G) 1.9 dCi (0R) 2.0 16V 2.0 16V (00/0K/0W) 2.0 16V IDE (0N/0P) 2.0 16V Sport 2.0 16V Turbo 2.0 dCi 2.0 dCi 130 2.2 dCi 2.2 dCi 2.2 dCi (BG09) 3.0 V6	79 82 89 88 85 79 81 96 68 77 88 74 125 99 103 150 120 110 127 102 110 85 152	03.01 02.05 03.01 03.01 03.01 03.01 01.05 05.05 03.04 06.01 03.01 10.01 01.05 08.02 04.01 01.05 01.03 08.05 01.06 05.05 10.01 04.04 03.01	06.07 10.05 06.07	24.5252-0390.3	330702	2	L=390	
	1.6 16V 1.6 16V 1.8 16V (04/06/0V) 1.8 16V (0B/0C/0M) 1.8 16V (0J) 1.9 dCi 1.9 dCi 1.9 dCi 1.9 dCi (08/10) 1.9 dCi (0E) 1.9 dCi (0G) 1.9 dCi (0R) 2.0 16V 2.0 16V (00/0K/0W) 2.0 16V IDE (0N/0P) 2.0 16V Sport 2.0 16V Turbo 2.0 dCi 2.0 dCi 130 2.2 dCi 2.2 dCi 2.2 dCi (BG09) 3.0 V6	79 82 89 88 85 79 81 96 68 77 88 74 125 99 103 150 120 110 127 102 110 85 152	03.01 02.05 03.01 03.01 03.01 03.01 01.05 05.05 03.04 06.01 03.01 10.01 01.05 08.02 04.01 01.05 01.03 08.05 01.06 05.05 10.01 04.04 03.01	06.07 10.05 06.07	11.9387-7001.2 11.9387-7002.2 11.8170-0872.1 11.8116-0340.1	220397 220398 260121 390595	 	D=38, - Halter D=38, - Halter Halter Haltefeder	ATE ATE ATE ATE
	1.6 16V 1.6 16V 1.8 16V (04/06/0V) 1.8 16V (0B/0C/0M) 1.8 16V (0J) 1.9 dCi 1.9 dCi 1.9 dCi 1.9 dCi (08/10)	79 82 89 88 85 79 81 96 68	03.01 02.05 03.01 03.01 03.01 03.01 01.05 05.05 03.04	06.07 06.07 06.07 06.07 06.07 06.07 06.07 06.07 06.07	24.5251-0185.3	330701	2	L=185	

¹⁾ + brake disc 280mm / + dischi freno 280mm / + disques de frein 280mm / + disco de freno 280mm

²⁾ + brake disc 300mm / + dischi freno 300mm / + disques de frein 300mm / + disco de freno 300mm

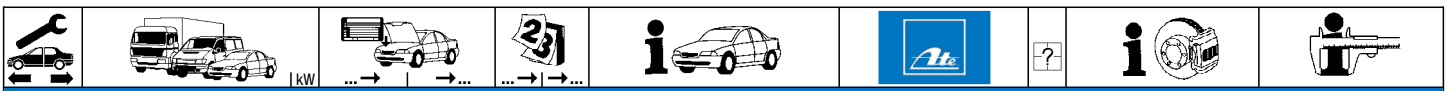

RENAULT LAGUNA II Limousine (BG_) (01-07)

	1.9 dCi (OE)	77	06.01	06.07	24.5251-0185.3	330701	2	L=185
	1.9 dCi (OG)	88	03.01	06.07				
	1.9 dCi (OR)	74	10.01	06.07				
	2.0 16V	125	01.05	06.07				
	2.0 16V (00/OK/OW)	99	08.02	06.07				
	2.0 16V IDE (ON/OP)	103	04.01	06.07				
	2.0 16V Sport	150	01.05	06.07				
	2.0 16V Turbo	120	01.03	06.07				
	2.0 dCi	110	08.05	06.07				
	2.0 dCi 130	127	01.06	06.07				
	2.2 dCi	102	05.05	06.07				
	2.2 dCi	110	10.01	06.07				
	2.2 dCi (BG09)	85	04.04	10.05				
	3.0 V6	152	03.01	06.07				
	1.6 16V	79	03.01	06.07	24.3727-1062.2	581062	2 ↓	L=2220
	1.6 16V	82	02.05	06.07				
	1.8 16V (04/06/0V)	89	03.01	06.07				
	1.8 16V (0B/0C/0M)	88	03.01	06.07				
	1.8 16V (0J)	85	03.01	06.07				
	1.9 dCi	79	03.01	06.07				
	1.9 dCi	81	01.05	06.07				
	1.9 dCi	96	05.05	06.07				
	1.9 dCi (08/10)	68	03.04	06.07				
	1.9 dCi (OE)	77	06.01	06.07				
	1.9 dCi (OG)	88	03.01	06.07				
	1.9 dCi (OR)	74	10.01	06.07				
	2.0 16V	125	01.05	06.07				
	2.0 16V (00/OK/OW)	99	08.02	06.07				
	2.0 16V IDE (ON/OP)	103	04.01	06.07				
	2.0 16V Sport	150	01.05	06.07				
	2.0 16V Turbo	120	01.03	06.07				
	2.0 dCi	110	08.05	06.07				
	2.0 dCi 130	127	01.06	06.07				
	2.2 dCi	102	05.05	06.07				
	2.2 dCi	110	10.01	06.07				
	2.2 dCi (BG09)	85	04.04	10.05				
	3.0 V6	152	03.01	06.07				

RENAULT LAGUNA II Grandtour (KG_) (01-07)

	1.6 16V	↖ 79	03.01	05.01	03.0655-0007.2	370007		Wegsensor	ATE
	1.8 16V (04/06/0V)	↖ 89	03.01	05.01					
	1.8 16V (0B/0C/0M)	↖ 88	03.01	05.01					
	1.8 16V (0J)	↖ 85	03.01	05.01					
	1.9 dCi (OG)	↖ 88	03.01	05.01					
	2.0 16V IDE (ON/OP)	↖ 103	04.01	05.01					
	3.0 V6	↖ 152	03.01	05.01					
	1.6 16V	↖ 79	06.01	06.07	03.7873-1202.4	300197		11"	ATE
	1.6 16V	↖ 82	02.05	06.07					
	1.6 FlexFuel	↖ 76	06.01	10.03					
	1.8 16V (04/06/0V)	↖ 89	06.01	06.07					
	1.8 16V (0B/0C/0M)	↖ 88	06.01	06.07					
	1.8 16V (0J)	↖ 85	06.01	06.07					
	1.9 dCi	↖ 79	03.01	06.07					
	1.9 dCi	↖ 81	01.05	06.07					
	1.9 dCi	↖ 96	05.05	06.07					
	1.9 dCi (08/10)	↖ 68	03.04	06.07					
	1.9 dCi (OE)	↖ 77	06.01	06.07					
	1.9 dCi (OG)	↖ 88	06.01	06.07					
	1.9 dCi (OR)	↖ 74	10.01	06.07					
	2.0 16V	↖ 125	01.05	06.07					
	2.0 16V (00/OK/OW)	↖ 99	08.02	06.07					
	2.0 16V IDE (ON/OP)	↖ 103	06.01	06.07					
	2.0 16V Sport	↖ 150	01.05	06.07					
	2.0 16V Turbo	↖ 120	01.03	06.07					
	2.0 dCi	↖ 110	08.05	06.07					
	2.0 dCi 130	↖ 127	01.06	06.07					
	2.2 dCi	↖ 102	05.05	06.07					
	2.2 dCi	↖ 110	10.01	06.07					
	2.2 dCi (KG09)	↖ 85	04.04	10.05					
	3.0 V6	↖ 152	06.01	06.07					
	1.6 16V	↗ 79	03.01	06.07	03.0655-0007.2	370007		Wegsensor	ATE
	1.6 16V	↗ 82	02.05	06.07					
	1.6 FlexFuel	↗ 76	06.01	10.03					
	1.8 16V (04/06/0V)	↗ 89	03.01	06.07					
	1.8 16V (0B/0C/0M)	↗ 88	03.01	06.07					
	1.8 16V (0J)	↗ 85	03.01	06.07					
	1.9 dCi	↗ 79	03.01	06.07					
	1.9 dCi	↗ 81	01.05	06.07					
	1.9 dCi	↗ 96	05.05	06.07					
	1.9 dCi (08/10)	↗ 68	03.04	06.07					
	1.9 dCi (OE)	↗ 77	06.01	06.07					
	1.9 dCi (OG)	↗ 88	06.01	06.07					
	1.9 dCi (OR)	↗ 74	10.01	06.07					
	2.0 16V	↗ 125	01.05	06.07					
	2.0 16V (00/OK/OW)	↗ 99	08.02	06.07					
	2.0 16V IDE (ON/OP)	↗ 103	04.01	06.07					
	2.0 16V Sport	↗ 150	01.05	06.07					





RENAULT LAGUNA II Grandtour (KG_) (01-07)

	2.0 16V Turbo ▶120 2.0 dCi ▶110 2.0 dCi 130 ▶127 2.2 dCi ▶102 2.2 dCi ▶110 2.2 dCi (KG09) ▶85 3.0 V6 ▶152		01.03 06.07 08.05 06.07 01.06 06.07 05.05 06.07 10.01 06.07 04.04 10.05 03.01 06.07	03.0655-0007.2 370007			Wegsensor	ATE
	1.6 16V 79 1.6 16V 82 1.6 FlexFuel 76 1.8 16V (04/06/0V) 89 1.8 16V (0B/0C/0M) 88 1.8 16V (0J) 85 1.9 dCi 79 1.9 dCi 81 1.9 dCi (08/10) 68 1.9 dCi (0E) 77 1.9 dCi (0G) 88 1.9 dCi (0R) 74 2.0 16V (00/0K/0W) 99 2.0 16V IDE (0N/0P) 103 2.2 dCi 110 2.2 dCi (KG09) 85 3.0 V6 152		03.01 03.05 02.05 03.05 06.01 10.03 03.01 03.05 03.01 03.05 03.01 03.05 03.01 03.05 01.05 03.05 03.04 03.05 06.01 03.05 03.01 03.05 10.01 03.05 08.02 03.05 04.01 03.05 10.01 03.05 04.04 03.05 03.01 03.05	03.4123-0081.3 010585 03.3517-0300.1 390323		- ESP	THz 23,81 Verschlußschraube	ATE
	1.6 16V 79 1.6 16V 82 1.8 16V (04/06/0V) 89 1.8 16V (0B/0C/0M) 88 1.8 16V (0J) 85 1.9 dCi 79 1.9 dCi 81 1.9 dCi 96 1.9 dCi (08/10) 68 1.9 dCi (0E) 77 1.9 dCi (0G) 88 1.9 dCi (0R) 74 2.0 16V 125 2.0 16V (00/0K/0W) 99 2.0 16V IDE (0N/0P) 103 2.0 16V Sport 150 2.0 16V Turbo 120 2.0 dCi 110 2.0 dCi 130 127 2.2 dCi 102 2.2 dCi 110 2.2 dCi (KG09) 85 3.0 V6 152		04.05 06.07 04.05 06.07 04.05 06.07 04.05 06.07 04.05 06.07 04.05 06.07 01.05 06.07 05.05 06.07 04.05 06.07 04.05 06.07 04.05 06.07 04.05 06.07 01.05 06.07 04.05 06.07 04.05 06.07 01.05 06.07 01.03 06.07 08.05 06.07 01.06 06.07 05.05 06.07 04.05 06.07 04.05 06.07 04.05 06.07	03.4153-0063.3 010773			THz 23,81	ATE
	1.6 16V 79 1.6 16V 82 1.6 FlexFuel 76 1.8 16V (04/06/0V) 89 1.8 16V (0B/0C/0M) 88 1.8 16V (0J) 85 1.9 dCi 79 1.9 dCi 81 1.9 dCi 96 1.9 dCi (08/10) 68 1.9 dCi (0E) 77 1.9 dCi (0G) 88 1.9 dCi (0R) 74 2.0 16V (00/0K/0W) 99 2.0 16V IDE (0N/0P) 103		03.01 06.07 02.05 06.07 06.01 10.03 03.01 06.07 03.01 06.07 03.01 06.07 03.01 06.07 01.05 06.07 05.05 06.07 03.04 06.07 06.01 06.07 03.01 06.07 10.01 06.07 08.02 06.07 04.01 06.07	11.9571-9861.2 220403 11.9571-9841.2 220401 11.9571-9842.2 220402 24.3571-9841.5 240501 24.3571-9842.5 240502 11.8116-0301.1 390610 11.0101-5407.2 260011 11.8171-0008.1 990049		<input type="checkbox"/> + Bremsscheibe 280mm ¹⁾ <input type="checkbox"/> + Bremsscheibe 300mm ²⁾ <input type="checkbox"/> + Bremsscheibe 300mm ²⁾ <input type="checkbox"/> + Bremsscheibe 300mm ²⁾ <input type="checkbox"/> + Bremsscheibe 300mm ²⁾	D=57, - Halter D=57, - Halter D=57, - Halter D=57, - Halter D=57, - Halter Haltefeder Hülzensatz Führungsbolzen	ATE ATE ATE ATE ATE ATE ATE ATE
	2.0 dCi 110 2.2 dCi 102 2.2 dCi 110 2.2 dCi 110 2.2 dCi (KG09) 85		08.05 06.07 + 16" Rad ³⁾ 05.05 06.07 05.05 06.07 10.01 11.01 04.04 10.05	11.9571-9841.2 220401 11.9571-9842.2 220402 24.3571-9841.5 240501 24.3571-9842.5 240502 11.8116-0301.1 390610 11.0101-5407.2 260011 11.8171-0008.1 990049		<input type="checkbox"/> <input type="checkbox"/> <input type="checkbox"/> <input type="checkbox"/>	D=57, - Halter D=57, - Halter D=57, - Halter D=57, - Halter Haltefeder Hülzensatz Führungsbolzen	ATE ATE ATE ATE ATE ATE ATE
	2.0 16V 125 2.0 16V Sport 150 2.0 16V Turbo 120 2.0 dCi 110 2.0 dCi 130 127 2.2 dCi 110 3.0 V6 152		01.05 06.07 01.05 06.07 01.03 06.07 08.05 06.07 01.06 06.07 12.01 04.05 03.01 06.07	11.9601-9787.2 220585 11.9601-9788.2 220586 24.3601-9787.5 240505 24.3601-9788.5 240506 11.0441-6008.2 250038 11.0101-5407.2 260011 11.8171-0008.1 990049		<input type="checkbox"/> <input type="checkbox"/> <input type="checkbox"/> <input type="checkbox"/>	D=60, - Halter D=60, - Halter D=60, - Halter D=60, - Halter Dichtungssatz Hülzensatz Führungsbolzen	ATE ATE ATE ATE ATE ATE ATE
	1.6 16V 79 1.6 16V 82 1.6 FlexFuel 76 1.8 16V (04/06/0V) 89 1.8 16V (0B/0C/0M) 88 1.8 16V (0J) 85 1.9 dCi 79 1.9 dCi 81 1.9 dCi 96 1.9 dCi (08/10) 68 1.9 dCi (0E) 77		03.01 06.07 02.05 06.07 06.01 10.03 03.01 06.07 03.01 06.07 03.01 06.07 03.01 06.07 01.05 06.07 05.05 06.07 03.04 06.07 06.01 06.07	24.5252-0390.3 330702		2	L=390	

¹⁾ + brake disc 280mm / + dischi freno 280mm / + disques de frein 280mm / + disco de freno 280mm

²⁾ + brake disc 300mm / + dischi freno 300mm / + disques de frein 300mm / + disco de freno 300mm

³⁾ + 16" wheel / + ruota 16" / + roue 16" / + rueda 16"

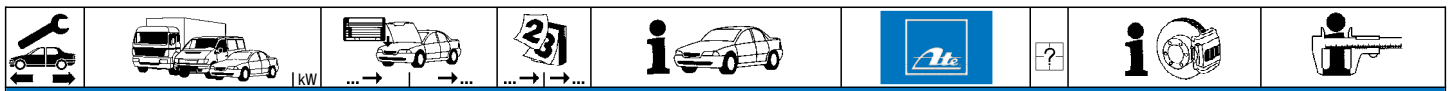

RENAULT LAGUNA II Grandtour (KG_) (01-07)

	1.9 dCi (0G) 88 1.9 dCi (OR) 74 2.0 16V 125 2.0 16V (00/OK/OW) 99 2.0 16V IDE (ON/OP) 103 2.0 16V Sport 150 2.0 16V Turbo 120 2.0 dCi 110 2.0 dCi 130 127 2.2 dCi 102 2.2 dCi 110 2.2 dCi (KG09) 85 3.0 V6 152		03.01 06.07 10.01 06.07 01.05 06.07 08.02 06.07 04.01 06.07 01.05 06.07 01.03 06.07 08.05 06.07 01.06 06.07 05.05 06.07 10.01 06.07 04.04 10.05 03.01 06.07	24.5252-0390.3 330702	2		L=390	
	1.6 16V 79 1.6 16V 82 1.6 FlexFuel 76 1.8 16V (04/06/0V) 89 1.8 16V (0B/0C/0M) 88 1.8 16V (0J) 85 1.9 dCi 79 1.9 dCi 81 1.9 dCi 96 1.9 dCi (08/10) 68 1.9 dCi (0E) 77 1.9 dCi (0G) 88 1.9 dCi (OR) 74 2.0 16V 125 2.0 16V (00/OK/OW) 99 2.0 16V IDE (ON/OP) 103 2.0 16V Sport 150 2.0 16V Turbo 120 2.0 dCi 110 2.0 dCi 130 127 2.2 dCi 102 2.2 dCi 110 2.2 dCi (KG09) 85 3.0 V6 152		03.01 06.07 02.05 06.07 06.01 10.03 03.01 06.07 03.01 06.07 03.01 06.07 01.05 06.07 05.05 06.07 03.04 06.07 06.01 06.07 03.01 06.07 10.01 06.07 01.05 06.07 08.02 06.07 04.01 06.07 01.05 06.07 01.03 06.07 08.05 06.07 01.06 06.07 05.05 06.07 10.01 06.07 04.04 10.05 03.01 06.07	11.9387-7001.2 220397 11.9387-7002.2 220398 11.8170-0872.1 260121 11.8116-0340.1 390595	2	 	D=38, - Halter ATE D=38, - Halter ATE Halter ATE Halterfeder ATE	
	1.6 16V 79 1.6 16V 82 1.6 FlexFuel 76 1.8 16V (04/06/0V) 89 1.8 16V (0B/0C/0M) 88 1.8 16V (0J) 85 1.9 dCi 79 1.9 dCi 81 1.9 dCi 96 1.9 dCi (08/10) 68 1.9 dCi (0E) 77 1.9 dCi (0G) 88 1.9 dCi (OR) 74 2.0 16V 125 2.0 16V (00/OK/OW) 99 2.0 16V IDE (ON/OP) 103 2.0 16V Sport 150 2.0 16V Turbo 120 2.0 dCi 110 2.0 dCi 130 127 2.2 dCi 102 2.2 dCi 110 2.2 dCi (KG09) 85 3.0 V6 152		03.01 06.07 02.05 06.07 06.01 10.03 03.01 06.07 03.01 06.07 03.01 06.07 01.05 06.07 05.05 06.07 03.04 06.07 06.01 06.07 03.01 06.07 10.01 06.07 01.05 06.07 08.02 06.07 04.01 06.07 01.05 06.07 01.03 06.07 08.05 06.07 01.06 06.07 05.05 06.07 10.01 06.07 04.04 10.05 03.01 06.07	24.5251-0185.3 330701	2		L=185	
	1.6 16V 79 1.6 16V 82 1.6 FlexFuel 76 1.8 16V (04/06/0V) 89 1.8 16V (0B/0C/0M) 88 1.8 16V (0J) 85 1.9 dCi 79 1.9 dCi 81 1.9 dCi 96 1.9 dCi (08/10) 68 1.9 dCi (0E) 77 1.9 dCi (0G) 88 1.9 dCi (OR) 74 2.0 16V 125 2.0 16V (00/OK/OW) 99 2.0 16V IDE (ON/OP) 103 2.0 16V Sport 150 2.0 16V Turbo 120 2.0 dCi 110 2.0 dCi 130 127 2.2 dCi 102 2.2 dCi 110 2.2 dCi (KG09) 85 3.0 V6 152		03.01 06.07 02.05 06.07 06.01 10.03 03.01 06.07 03.01 06.07 03.01 06.07 01.05 06.07 05.05 06.07 03.04 06.07 06.01 06.07 03.01 06.07 10.01 06.07 01.05 06.07 08.02 06.07 04.01 06.07 01.05 06.07 01.03 06.07 08.05 06.07 01.06 06.07 05.05 06.07 10.01 06.07 04.04 10.05 03.01 06.07	24.3727-1062.2 581062	2		L=2220	





RENAULT LAGUNA III Limousine (BT0/1) (07-15)



















	1.5 dCi	81		09.07			11.9571-9757.2	220857			D=57, - Halter	ATE
	1.6 16V	81		09.07			11.9571-9758.2	220858			D=57, - Halter	ATE
							11.8116-0301.1	390610	2		Haltefeder	ATE
	2.0 16V	103		09.07			11.9571-9775.2	220859			D=57, - Halter	ATE
	2.0 16V Hi-Flex	103		09.07			11.9571-9776.2	220860			D=57, - Halter	ATE
	2.0 16V Turbo	125		09.07			11.8116-0351.1	390538	2		Haltefeder	ATE
	2.0 dCi	96		09.07		- 4-Rad Lenkung ¹⁾						
	2.0 dCi	110		09.07		- 4-Rad Lenkung ¹⁾						
	2.0 dCi	127		01.08		- 4-Rad Lenkung ¹⁾						
	2.0 dCi GT	131		03.08		- 4-Rad Lenkung ¹⁾						
2.0 16V Turbo GT	150		03.08			11.9601-9753.2	220957			D=60, - Halter	ATE	
2.0 dCi	96		09.07		+ 4-Rad Lenkung ²⁾	11.9601-9754.2	220958			D=60, - Halter	ATE	
2.0 dCi	110		09.07		+ 4-Rad Lenkung ²⁾	11.8116-0351.1	390538	2		Haltefeder	ATE	
2.0 dCi	127		09.07		+ 4-Rad Lenkung ²⁾	11.0441-6008.2	250038			Dichtungssatz	ATE	
2.0 dCi GT	131		03.08		+ 4-Rad Lenkung ²⁾							
3.0 dCi	173		09.08									
3.5 V6	175		04.08									
	1.5 dCi	81		09.07			24.5144-0410.3	331242	2		L=410	
	1.6 16V	81		09.07								
	2.0 16V	103		09.07								
	2.0 16V Hi-Flex	103		09.07								
	2.0 16V Turbo	125		09.07								
	2.0 16V Turbo GT	150		03.08								
	2.0 dCi	96		09.07								
	2.0 dCi	110		09.07								
	2.0 dCi	127		01.08								
	2.0 dCi GT	131		03.08								
3.0 dCi	173		09.08									
3.5 V6	175		04.08									
	1.5 dCi	81		09.07			11.9387-7027.2	220893			D=38, - Halter	ATE
	1.6 16V	81		09.07			11.9387-7028.2	220894			D=38, - Halter	ATE
	2.0 16V	103		09.07			11.8170-0872.1	260121	2		Halter	ATE
	2.0 16V Hi-Flex	103		09.07			11.8116-0340.1	390595			Haltefeder	ATE
	2.0 16V Turbo	125		09.07								
	2.0 16V Turbo GT	150		03.08								
	2.0 dCi	96		09.07								
	2.0 dCi	110		09.07								
	2.0 dCi	127		01.08								
	2.0 dCi GT	131		03.08								
3.0 dCi	173		09.08									
3.5 V6	175		04.08									
	1.5 dCi	81		09.07			24.5251-0185.3	330701	2		L=185	
	1.6 16V	81		09.07								
	2.0 16V	103		09.07								
	2.0 16V Hi-Flex	103		09.07								
	2.0 16V Turbo	125		09.07								
	2.0 16V Turbo GT	150		03.08								
	2.0 dCi	96		09.07		- 4-Rad Lenkung ¹⁾						
	2.0 dCi	110		09.07		- 4-Rad Lenkung ¹⁾						
	2.0 dCi	127		01.08		- 4-Rad Lenkung ¹⁾						
	2.0 dCi GT	131		03.08		- 4-Rad Lenkung ¹⁾						
3.0 dCi	173		09.08									
3.5 V6	175		04.08									
2.0 16V Turbo GT	150		03.08			24.5251-0185.3	330701	2		L=185		
2.0 dCi	96		09.07		+ 4-Rad Lenkung ²⁾							
2.0 dCi	110		09.07		+ 4-Rad Lenkung ²⁾							
2.0 dCi	127		01.08		+ 4-Rad Lenkung ²⁾							
2.0 dCi GT	131		03.08		+ 4-Rad Lenkung ²⁾							
3.0 dCi	173		09.08									
3.5 V6	175		04.08									
	1.5 dCi	81		09.07			24.3727-1089.2	581089	2		L=2224	
	1.6 16V	81		09.07								
	2.0 16V	103		09.07								
	2.0 16V Hi-Flex	103		09.07								
	2.0 16V Turbo	125		09.07								
	2.0 16V Turbo GT	150		03.08								
	2.0 dCi	96		09.07								
	2.0 dCi	110		09.07								
	2.0 dCi	127		01.08								
	2.0 dCi GT	131		03.08								
3.0 dCi	173		09.08									
3.5 V6	175		04.08									

RENAULT LAGUNA III Coupe (DT0/1) (07-15)

	2.0 16V Turbo	125		09.08			11.9571-9775.2	220859			D=57, - Halter	ATE
	2.0 dCi	110		10.07		- 4-Rad Lenkung ¹⁾	11.9571-9776.2	220860			D=57, - Halter	ATE
	2.0 dCi	127		09.08		- 4-Rad Lenkung ¹⁾	11.8116-0351.1	390538	2		Haltefeder	ATE
	2.0 dCi GT	131		03.08		- 4-Rad Lenkung ¹⁾						
	1.5 dCi	81		03.12			11.9571-9757.2	220857			D=57, - Halter	ATE
							11.9571-9758.2	220858			D=57, - Halter	ATE
							11.8116-0301.1	390610	2		Haltefeder	ATE
	2.0 16V Turbo GT	150		03.08			11.9601-9753.2	220957			D=60, - Halter	ATE
	2.0 dCi	110		10.07		+ 4-Rad Lenkung ²⁾	11.9601-9754.2	220958			D=60, - Halter	ATE
	2.0 dCi	127		09.08		+ 4-Rad Lenkung ²⁾	11.0441-6008.2	250038			Dichtungssatz	ATE
2.0 dCi GT	131		03.08		+ 4-Rad Lenkung ²⁾	11.8116-0351.1	390538	2		Haltefeder	ATE	
3.0 dCi	173		09.08									

















¹⁾ - 4 wheel steering / - 4 route sterzanti / - 4 roues directionnelles / + dirección sobre cuatro ruedas

²⁾ + 4 wheel steering / + 4 route sterzanti / + 4 roues directionnelles / + dirección sobre cuatro ruedas

								
RENAULT LAGUNA III Coupe (DT0/1) (07-15)								
	3.0 dCi	177	01.12		11.9601-9753.2	220957	2	D=60, - Halter ATE
	3.5 V6	175	09.08		11.9601-9754.2	220958		
	1.5 dCi	81	03.12		24.5144-0410.3	331242	2	L=410
	2.0 16V Turbo	125	09.08					
	2.0 16V Turbo GT	150	03.08					
	2.0 dCi	110	10.07					
	2.0 dCi	127	09.08					
	2.0 dCi GT	131	03.08					
	3.0 dCi	173	09.08					
	3.5 V6	175	01.12					
	1.5 dCi	81	03.12		11.9387-7027.2	220893	2	D=38, - Halter ATE D=38, - Halter ATE Halter ATE Halterfeder ATE
	2.0 16V Turbo	125	09.08		11.9387-7028.2	220894		
	2.0 16V Turbo GT	150	03.08		11.8170-0872.1	260121		
	2.0 dCi	110	10.07		11.8116-0340.1	390595		
	2.0 dCi	127	09.08					
	2.0 dCi GT	131	03.08					
	3.0 dCi	173	09.08					
	3.5 V6	175	01.12					
	1.5 dCi	81	03.12		24.5251-0185.3	330701	2	L=185
	2.0 16V Turbo	125	09.08					
	2.0 16V Turbo GT	150	03.08					
	2.0 dCi	110	10.07					
	2.0 dCi	127	09.08					
	2.0 dCi GT	131	03.08					
	3.0 dCi	173	09.08					
	3.5 V6	175	01.12					
	1.5 dCi	81	03.12		24.3727-1089.2	581089	2	L=2224
	2.0 16V Turbo	125	09.08					
	2.0 16V Turbo GT	150	03.08					
	2.0 dCi	110	10.07					
	2.0 dCi	127	09.08					
	2.0 dCi GT	131	03.08					
	3.0 dCi	173	09.08					
	3.5 V6	175	01.12					
RENAULT LAGUNA III Grandtour (KT0/1) (07-15)								
	1.5 dCi	81	09.07		11.9571-9757.2	220857	2	D=57, - Halter ATE D=57, - Halter ATE Halterfeder ATE
	1.6 16V	81	09.07		11.9571-9758.2	220858		
	2.0 16V	103	09.07		11.9571-9775.2	220859	2	D=57, - Halter ATE D=57, - Halter ATE Halterfeder ATE
	2.0 16V Hi-Flex	103	09.07		11.9571-9776.2	220860		
	2.0 16V Turbo	125	09.07		11.8116-0351.1	390538		
	2.0 dCi	96	09.07	- 4-Rad Lenkung ¹⁾				
	2.0 dCi	110	09.07	- 4-Rad Lenkung ¹⁾				
	2.0 dCi	127	09.07	- 4-Rad Lenkung ¹⁾				
	2.0 dCi GT	131	03.08	- 4-Rad Lenkung ¹⁾				
	2.0 16V Turbo GT	150	03.08		11.9601-9753.2	220957		
2.0 dCi	96	09.07	+ 4-Rad Lenkung ²⁾	11.9601-9754.2	220958			
2.0 dCi	110	09.07	+ 4-Rad Lenkung ²⁾	11.0441-6008.2	250038			
2.0 dCi	127	09.07	+ 4-Rad Lenkung ²⁾	11.8116-0351.1	390538			
2.0 dCi GT	131	03.08	+ 4-Rad Lenkung ²⁾					
3.0 dCi V6	173	09.08						
3.5 V6	175	04.08						
	1.5 dCi	81	09.07		24.5144-0410.3	331242	2	L=410
	1.6 16V	81	09.07					
	2.0 16V	103	09.07					
	2.0 16V Hi-Flex	103	09.07					
	2.0 16V Turbo	125	09.07					
	2.0 16V Turbo GT	150	03.08					
	2.0 dCi	96	09.07					
	2.0 dCi	110	09.07					
	2.0 dCi	127	09.07					
	2.0 dCi GT	131	03.08					
	3.0 dCi V6	173	09.08					
	3.5 V6	175	04.08					
	1.5 dCi	81	09.07		11.9387-7027.2	220893	2	D=38, - Halter ATE D=38, - Halter ATE Halter ATE Halterfeder ATE
	1.6 16V	81	09.07		11.9387-7028.2	220894		
	2.0 16V	103	09.07		11.8170-0872.1	260121		
	2.0 16V Hi-Flex	103	09.07		11.8116-0340.1	390595		
	2.0 16V Turbo	125	09.07					
	2.0 16V Turbo GT	150	03.08					
	2.0 dCi	96	09.07					
	2.0 dCi	110	09.07					
	2.0 dCi	127	09.07					
	2.0 dCi GT	131	03.08					
	3.0 dCi V6	173	09.08					
	3.5 V6	175	04.08					

























¹⁾ - 4 wheel steering / - 4 route sterzanti / - 4 roues directionnelles / + dirección sobre cuatro ruedas

























²⁾ + 4 wheel steering / + 4 route sterzanti / + 4 roues directionnelles / + dirección sobre cuatro ruedas

											
RENAULT LAGUNA III Grandtour (KT0/1) (07-15)											
	1.5 dCi	81		09.07		24.5251-0185.3	330701	2	L=185		
	1.6 16V	81		09.07							
	2.0 16V	103		09.07							
	2.0 16V Hi-Flex	103		09.07							
	2.0 16V Turbo	125		09.07							
	2.0 dCi	96		09.07	- 4-Rad Lenkung ¹⁾						
	2.0 dCi	110		09.07	- 4-Rad Lenkung ¹⁾						
	2.0 dCi	127		09.07	- 4-Rad Lenkung ¹⁾						
	2.0 dCi GT	131		03.08	- 4-Rad Lenkung ¹⁾						
	2.0 16V Turbo GT	150		03.08		24.5251-0185.3	330701	2	L=185		
2.0 dCi	96		09.07	+ 4-Rad Lenkung ²⁾							
2.0 dCi	110		09.07	+ 4-Rad Lenkung ²⁾							
2.0 dCi	127		09.07	+ 4-Rad Lenkung ²⁾							
2.0 dCi GT	131		03.08	+ 4-Rad Lenkung ²⁾							
3.0 dCi V6	173		09.08								
3.5 V6	175		04.08								
	1.5 dCi	81		09.07		24.3727-1089.2	581089	2	L=2224		
	1.6 16V	81		09.07							
	2.0 16V	103		09.07							
	2.0 16V Hi-Flex	103		09.07							
	2.0 16V Turbo	125		09.07							
	2.0 16V Turbo GT	150		03.08							
	2.0 dCi	96		09.07							
	2.0 dCi	110		09.07							
	2.0 dCi	127		09.07							
	2.0 dCi GT	131		03.08							
	3.0 dCi V6	173		09.08							
	3.5 V6	175		04.08							
	RENAULT LATITUDE (L70_) (11-13)										
	1.5 dCi	81		02.11	06.13	11.9571-9775.2	220859		D=57, - Halter	ATE	
	2.0 16V	103		02.11	06.13	11.9571-9776.2	220860		D=57, - Halter	ATE	
	2.0 16V eco2	103		02.11	06.13	11.0101-5704.2	260095		Hülensatz	ATE	
	2.0 dCi	130		02.11	06.13	11.8116-0351.1	390538	2	Haltefeder	ATE	
	2.0 dCi 150	110		02.11	06.13						
	2.0 dCi 175	127		05.11	06.13						
	2.5 dCi			05.11	06.13						
	3.0 dCi 240	177		02.11	06.13	11.9601-9753.2	220957		D=60, - Halter	ATE	
	1.5 dCi	81		02.11	06.13	11.9387-7035.2	220983		D=38, - Halter	ATE	
	2.0 16V	103		02.11	06.13	11.9387-7036.2	220984		D=38, - Halter	ATE	
	2.0 16V eco2	103		02.11	06.13	11.0230-0984.1	260138		Halter	ATE	
	2.0 dCi	130		02.11	06.13						
	2.0 dCi 150	110		02.11	06.13						
	2.0 dCi 175	127		05.11	06.13						
	2.5 dCi			05.11	06.13						
	3.0 dCi 240	177		02.11	06.13						
	RENAULT LOGAN (LS_) (04-13)										
		1.4	55		09.04	10.09	+ ABS	03.7750-8532.4	300264		9"
1.5 dCi		50		04.07	10.09	+ ABS					
1.5 dCi		63		02.08	10.09	+ ABS					
1.6		64		09.04	10.09	+ ABS					
1.6		77		04.07	10.09	+ ABS					
1.4		55		11.09	04.13	+ ABS	03.7853-4102.4	300271		9"	ATE
1.5 dCi	50		11.09	04.13	+ ABS	03.7853-4602.4	300302		9"	ATE	
1.5 dCi	63		11.09	04.13	+ ABS						
1.6	64		11.09	04.13	+ ABS						
1.6	77		11.09	04.13	+ ABS						
	1.4	55		09.04	04.13	- ABS	24.2120-1762.3	011002		Thz 20,64 - Behälter	
	1.5 dCi	50		04.07	04.13	- ABS					
	1.5 dCi	63		02.08	04.13	- ABS					
	1.6	64		09.04	04.13	- ABS					
	1.6	77		04.07	04.13	- ABS					
	1.4	55		09.04	04.13	+ ABS	24.2120-1754.3	010949		Thz 20,64	
1.5 dCi	50		04.07	04.13	+ ABS						
1.5 dCi	63		02.08	04.13	+ ABS						
1.6	64		09.04	04.13	+ ABS						
1.6	77		04.07	04.13	+ ABS						
	1.4	55		09.04	04.13		24.3481-1611.5	240029		D=48, - Halter	TRW
	1.6	64		09.04	04.13		24.3481-1612.5	240030		D=48, - Halter	TRW
	1.5 dCi	50		04.07	04.13		24.3481-1615.5	240031		D=48, - Halter	TRW
	1.5 dCi	63		02.08	04.13		24.3481-1616.5	240032		D=48, - Halter	TRW
1.6	77		04.07	04.13							
	1.4	55		09.04	04.13		24.5111-0300.3	330407	2	L=300	
	1.5 dCi	50		04.07	04.13						
	1.5 dCi	63		02.08	04.13						
	1.6	64		09.04	04.13						
	1.6	77		04.07	04.13						











¹⁾ - 4 wheel steering / - 4 route sterzanti / - 4 roues directionnelles / + dirección sobre cuatro ruedas

²⁾ + 4 wheel steering / + 4 ruote sterzanti / + 4 roues directionnelles / + dirección sobre cuatro ruedas

									
RENAULT LOGAN (LS_) (04-13)									
	1.4 1.5 dCi 1.5 dCi 1.6 1.6	55 50 63 64 77		09.04 04.07 02.08 09.04 04.07	04.13 04.13 04.13 04.13 04.13	24.5229-0285.3	330032	2	L=285
	1.4 1.5 dCi 1.5 dCi 1.6 1.6	55 50 63 64 77		09.04 04.07 02.08 09.04 04.07	04.13 04.13 04.13 04.13 04.13	24.3219-1722.3 24.3217-1710.3	020426 020420		Rz 19,05 Rz 17,78 BDX TRW
	1.4 1.5 dCi 1.5 dCi 1.6 1.6	55 50 63 64 77		09.04 04.07 02.08 09.04 04.07	04.13 04.13 04.13 04.13 04.13	24.3727-1073.2	581073	2 ↓	L=1680
	1.4 1.5 dCi 1.5 dCi 1.6 1.6	55 50 63 64 77		09.04 04.07 02.08 09.04 04.07	04.13 04.13 04.13 04.13 04.13	24.3728-1031.2	591031		L=1033
RENAULT LOGAN Kombi (KS_) (04-13)									
	1.4 1.5 dCi 1.5 dCi 1.6 1.6	55 50 63 64 77		10.07 04.07 02.08 04.07 04.07	10.09 + ABS 10.09 + ABS 10.09 + ABS 10.09 + ABS 10.09 + ABS	03.7750-8532.4	300264		9" ATE
	1.4 1.5 dCi 1.5 dCi 1.6 1.6	55 50 63 64 77		11.09 11.09 11.09 11.09 11.09	04.13 + ABS 04.13 + ABS 04.13 + ABS 04.13 + ABS 04.13 + ABS	03.7853-4102.4 03.7853-4602.4	300271 300302		9" 9" ATE ATE
	1.4 1.5 dCi 1.5 dCi 1.6 1.6	55 50 63 64 77		10.07 04.07 02.08 04.07 04.07	04.13 - ABS 04.13 - ABS 04.13 - ABS 04.13 - ABS 04.13 - ABS	24.2120-1762.3	011002		THz 20,64 - Behälter
	1.4 1.5 dCi 1.5 dCi 1.6 1.6	55 50 63 64 77		10.07 04.07 02.08 04.07 04.07	04.13 + ABS 04.13 + ABS 04.13 + ABS 04.13 + ABS 04.13 + ABS	24.2120-1754.3	010949		THz 20,64
	1.4 1.5 dCi 1.6	55 50 64		10.07 04.07 04.07	04.13 04.13 04.13	24.3481-1611.5 24.3481-1612.5	240029 240030	<input type="checkbox"/> <input type="checkbox"/>	D=48, - Halter D=48, - Halter TRW TRW
	1.5 dCi 1.6	63 77		02.08 04.07	04.13 04.13	24.3481-1615.5 24.3481-1616.5	240031 240032	<input type="checkbox"/> <input type="checkbox"/>	D=48, - Halter D=48, - Halter TRW TRW
	1.4 1.5 dCi 1.5 dCi 1.6 1.6	55 50 63 64 77		10.07 04.07 02.08 04.07 04.07	04.13 04.13 04.13 04.13 04.13	24.5111-0300.3	330407	2	L=300
	1.4 1.5 dCi 1.5 dCi 1.6 1.6	55 50 63 64 77		10.07 04.07 02.08 04.07 04.07	04.13 04.13 04.13 04.13 04.13	24.5229-0285.3	330032	2	L=285
	1.4 1.5 dCi 1.5 dCi 1.6 1.6	55 50 63 64 77		10.07 04.07 02.08 04.07 04.07	04.13 04.13 04.13 04.13 04.13	24.3219-1722.3 24.3217-1710.3	020426 020420		Rz 19,05 Rz 17,78 BDX TRW
	1.4 1.5 dCi 1.5 dCi 1.6 1.6	55 50 63 64 77		10.07 04.07 02.08 04.07 04.07	04.13 04.13 04.13 04.13 04.13	24.3727-1073.2	581073	2 ↓	L=1680
	1.4 1.5 dCi 1.5 dCi 1.6 1.6	55 50 63 64 77		10.07 04.07 02.08 04.07 04.07	04.13 04.13 04.13 04.13 04.13	24.3728-1031.2	591031		L=1033
RENAULT LOGAN Express (07-13)									
	1.5 dCi 1.6	50 64		04.07 04.07	04.13 04.13	03.7750-8532.4	300264	+ ABS	9" ATE
	1.5 dCi 1.6	50 64		09.07 09.07	04.13 04.13	03.2122-2031.3	010938	+ ABS	THz 22,20 ATE
	1.5 dCi 1.6	50 64		04.07 04.07	04.13 04.13	24.3541-1849.5 24.3541-1850.5	240707 240708	<input type="checkbox"/> <input type="checkbox"/>	D=54, - Halter D=54, - Halter TRW TRW

											
RENAULT LOGAN Express (07-13)											
	1.5 dCi	50		04.07	11.08	24.5111-0300.3	330407	2		L=300	
	1.6	64		04.07	11.08						
	1.5 dCi	50		12.08	04.13	24.5111-0310.3	331393	2		L=310	
	1.6	64		12.08	04.13						
	1.5 dCi	50		04.07	04.13	24.5229-0285.3	330032	2		L=285	
	1.6	64		04.07	04.13						
	1.5 dCi	50		04.07	04.13	24.3219-1761.3	020536		- erhöhte Zuladung ¹⁾	Rz 19,05	
	1.6	64		04.07	04.13	24.3222-1729.3	020526		+ erhöhte Zuladung ²⁾	Rz 22,20	
	1.5 dCi	50		04.07	04.13	24.3727-1074.2	581074	2	↓	L=1993	
	1.6	64		04.07	04.13						
RENAULT LOGAN II (L52) (13-)											
	1.2	55		11.13		11.8116-0264.1	390594	2		Haltefeder	
	1.6	60		04.14						ATE	
	1.6	75		04.14		11.8116-0264.1	390594	2		Haltefeder	
										ATE	
	1.2	55		11.13		24.3217-1711.3	020449			Rz 17,46	
	1.6	60		04.14						BOS	
	1.6	75		04.14							
	1.2	55		11.13		24.3219-1761.3	020536		- ABS	Rz 19,05	
	1.6	60		04.14		24.3222-1729.3	020526		+ ABS	Rz 22,20	
	1.6	75		04.14							
	1.6	75		04.14		24.3727-1073.2	581073	2	↓	L=1680	
RENAULT LOGAN II Kombi (L52) (13-)											
	1.2 16V	54		12.13		24.3219-1761.3	020536			Rz 19,05	
	1.2 16V LPG	53		12.13							
	1.5 dCi	62		12.13							
	1.6	59		12.13							
RENAULT MASTER I Bus (80-98)											
	2.0 (Q--)	58		10.86	07.98	- CH (N S)	24.2125-1704.3	010446		Thz 25,40	
	2.0 (Q--)	59		08.80	09.86	- CH (N S)				TRW	
	2.0 (R--)	58		10.86	08.94						
	2.0 (R--)	59		08.80	09.86						
	2.1 D (Q--)	44		08.80	07.98						
	2.1 D (R--)	44		08.80	08.94						
	2.2 (Q--)	67		08.80	07.98						
	2.2 (R--)	67		08.80	08.94						
	2.4 D	53		09.86	10.89						
	2.4 D (Q--)	52		08.80	08.89	- CH (N S)					
	2.4 D (R--)	52		08.80	08.89						
	2.5 D (Q--)	55		08.89	07.98	- CH (N S)					
	2.5 D (R--)	55		08.89	08.94						
	2.5 TD (Q--)	69		08.89	07.98						
	2.5 TD (R--)	72		08.89	07.98						
	2.0	58		10.86	07.98		24.5112-0455.3	330527	2	L=455	
	2.0	59		08.80	09.86						
	2.1 D	44		08.80	07.98						
	2.2	67		08.80	07.98						
	2.4 D	52		08.80	08.89						
	2.4 D	53		09.86	10.89						
	2.5 D	55		08.89	07.98						
	2.5 TD	69		08.89	07.98						
	2.5 TD	72		08.89	07.98						
		2.0	58		10.86	07.98		24.5112-0315.3	330509	2	L=315
		2.0	59		08.80	09.86					
		2.1 D	44		08.80	07.98					
		2.2	67		08.80	07.98					
		2.4 D	52		08.80	08.89					
		2.4 D	53		09.86	10.89					
2.5 D		55		08.89	07.98						
2.5 TD		69		08.89	07.98						
2.5 TD		72		08.89	07.98						
		2.0	58		10.86	07.98		24.3225-1101.3	020294		Rz 25,40
		2.0	59		08.80	09.86					TRW
		2.1 D	44		08.80	07.98					
		2.2	67		08.80	07.98					
		2.4 D	52		08.80	08.89					
		2.4 D	53		09.86	10.89					
	2.5 D	55		08.89	07.98						
	2.5 TD	69		08.89	07.98						
	2.5 TD	72		08.89	07.98						

¹⁾ - increased payload / - carico utile maggiorato / - charge utile augmentée / - incremento de carga
²⁾ + increased payload / + carico utile maggiorato / + charge utile augmentée / + incremento de carga

RENAULT MASTER I Kasten (80-98)												
	2.0 (Q--)	58		10.86	07.98	- (CH) (N) (S)	24.2125-1704.3	010446		THz 25,40	TRW	
	2.0 (Q--)	59		08.80	09.86	- (CH) (N) (S)						
	2.0 (R--)	58		10.86	07.98							
	2.0 (R--)	59		08.80	09.86							
	2.1 D (Q--)	44		08.80	07.98							
	2.1 D (R--)	44		08.80	07.98							
	2.2 (Q--)	67		08.80	07.98							
	2.2 (R--)	67		08.80	07.98							
	2.4 D (Q--)	52		08.80	08.89	- (CH) (N) (S)						
	2.4 D (R--)	52		08.80	08.89							
	2.5 D (Q--)	55		08.89	07.98	- (CH) (N) (S)						
	2.5 D (R--)	55		08.89	07.98							
	2.5 TD (Q--)	69		08.89	07.98							
	2.5 TD (Q--)	72		08.89	07.98							
	2.5 TD (R--)	69		08.89	07.98							
	2.5 TD (R--)	72		08.89	07.98							
	2.0	58		10.86	07.98		24.5112-0455.3	330527	2		L=455	
	2.0	59		08.80	09.86							
	2.1 D	44		08.80	07.98							
	2.2	67		08.80	07.98							
	2.4 D	52		08.80	08.89							
	2.5 D	55		08.89	07.98							
	2.5 TD	69		08.89	07.98							
	2.5 TD	72		08.89	07.98							
	2.0	58		10.86	07.98		24.5112-0315.3	330509	1	▣	L=315	
	2.0	59		08.80	09.86							
	2.1 D	44		08.80	07.98							
	2.2	67		08.80	07.98							
	2.4 D	52		08.80	08.89							
	2.5 D	55		08.89	07.98							
	2.5 TD	69		08.89	07.98							
	2.5 TD	72		08.89	07.98							
	2.0	58		10.86	07.98		24.3225-1101.3	020294			Rz 25,40	TRW
	2.0	59		08.80	09.86							
	2.1 D	44		08.80	07.98							
	2.2	67		08.80	07.98							
	2.4 D	52		08.80	08.89							
	2.5 D	55		08.89	07.98							
	2.5 TD	69		08.89	07.98							
	2.5 TD	72		08.89	07.98							
RENAULT MASTER I Pritsche/Fahrgestell (80-98)												
	2.0 (Q--)	58		10.86	07.98	- (CH) (N) (S)	24.2125-1704.3	010446			THz 25,40	TRW
	2.0 (Q--)	59		10.82	09.86	- (CH) (N) (S)						
	2.0 (R--)	58		10.86	07.98							
	2.0 (R--)	59		10.82	09.86							
	2.5 D (Q--)	55		08.89	07.98	- (CH) (N) (S)						
	2.5 D (R--)	55		08.89	07.98							
	2.0	58		10.86	07.98		24.5112-0455.3	330527	2		L=455	
	2.0	59		10.82	09.86							
	2.5 D	55		08.89	07.98							
	2.0	58		10.86	07.98		24.5112-0315.3	330509	1	▣	L=315	
	2.0	59		10.82	09.86							
	2.5 D	55		08.89	07.98							
	2.0	58		10.86	07.98		24.3225-1101.3	020294			Rz 25,40	TRW
	2.0	59		10.82	09.86							
	2.5 D	55		08.89	07.98							
	2.0	60		11.89	12.95		24.3728-1032.2	591032			L=1335	
	2.1 D	46		11.89	07.93							
	2.2	71		08.93	02.98							
RENAULT MASTER II Bus (JD/ND_) (98-06)												
	1.9 dCi 80	60		11.01	10.03		24.2025-1708.3	010692		- ABS	THz 25,40	
	1.9 dTi	59		09.00	10.03		24.2025-1706.3	010676		+ ABS	THz 25,40	
	2.2 dCi 90	66		09.00	10.03							
	2.5 D	59		07.98	01.01							
	2.5 dCi 120	84		10.01	10.03							
	2.8 dTi	84		07.98	10.01							
	1.9 dCi 80	60		11.03	08.06		24.2025-1708.3	010692		- ABS	THz 25,40	
	1.9 dTi	59		11.03	08.06		24.2123-1759.3	010768		+ ABS	THz 23,81	BOS
	2.2 dCi 90	66		11.03	08.06							
	2.5 dCi 100	73		10.03	08.06							
	2.5 dCi 120	84		11.03	08.06							
	2.5 D	59		07.98	07.00		24.5134-0562.3	330706	2	▲	L=568	
	2.8 dTi	84		07.98	07.00		24.5134-0518.3	330705	2	▣	L=518	
	1.9 dCi 80	60		11.01	08.06	- ABS	24.5134-0468.3	330704	2	▲	L=468	
	1.9 dTi	59		09.00	08.06	- ABS	24.5134-0457.3	330752	2	▼	L=457	
	2.2 dCi 90	66		09.00	08.06	- ABS						
	2.5 D	59		08.00	01.01							
	2.5 dCi 100	73		10.03	08.06	- ABS						
	2.5 dCi 120	84		10.01	08.06	- ABS						
	2.8 dTi	84		08.00	10.01							
	1.9 dCi 80	60		11.01	10.03	+ ABS	24.5134-0468.3	330704	2	▲	L=468	
	1.9 dTi	59		09.00	10.03	+ ABS	24.5134-0457.3	330752	2	▼	L=457	
	2.2 dCi 90	66		09.00	10.03	+ ABS						



RENAULT MASTER II Bus (JD/ND_) (98-06)

	2.5 dCi 120	84		10.01	10.03	+ ABS	24.5134-0468.3	330704	2		L=468 L=457	
	1.9 dCi 80	60		11.03	08.06	+ ABS	24.5111-0510.3	330819	2		L=510	
	1.9 dTi	59		11.03	08.06	+ ABS						
	2.2 dCi 90	66		11.03	08.06	+ ABS						
	2.5 dCi 100	73		10.03	08.06	+ ABS						
2.5 dCi 120	84		11.03	08.06	+ ABS							
	1.9 dCi 80	60		11.01	08.06		24.3424-1701.5	240561			D=42, - Halter	BOS
	1.9 dTi	59		09.00	08.06		24.3424-1702.5	240562			D=42, - Halter	BOS
	2.2 dCi 90	66		09.00	08.06							
	2.5 D	59		07.98	01.01							
	2.5 dCi 100	73		10.03	08.06							
	2.5 dCi 120	84		10.01	08.06							
	2.8 dTi	84		07.98	10.01							
	1.9 dCi 80	60		11.01	11.03		24.5111-0326.3	330766	2	am Bremsattel ¹⁾	L=326	
	1.9 dTi	59		09.00	11.03							
	2.2 dCi 90	66		09.00	11.03							
	2.5 D	59		07.98	01.01							
	2.5 dCi 100	73		10.03	11.03							
	2.5 dCi 120	84		10.01	11.03							
	2.8 dTi	84		07.98	10.01							
	1.9 dCi 80	60		12.03	08.06		24.5258-0450.3	330824			L=450	
	1.9 dTi	59		12.03	08.06		24.5251-0465.3	330822			L=465	
	2.2 dCi 90	66		12.03	08.06							
	2.5 dCi 100	73		12.03	08.06							
	2.5 dCi 120	84		12.03	08.06							
	2.5 D	59		07.98	07.00		24.3223-1707.3	020435			Rz 23,81	BDX
	2.8 dTi	84		07.98	07.00		24.3223-1708.3	020436			Rz 23,81	BDX
	1.9 dCi 80	60		11.01	08.06		24.3727-0762.2	580762	1		L=1175	
	1.9 dTi	59		09.00	08.06		24.3727-1072.2	581072	2	Länge beachten ²⁾	L=1420	
	2.2 dCi 90	66		09.00	08.06		24.3727-1000.2	581000	2	Länge beachten ²⁾	L=1737	
	2.5 D	59		07.98	01.01							
	2.5 dCi 100	73		10.03	08.06							
	2.5 dCi 120	84		10.01	08.06							
	2.8 dTi	84		07.98	10.01							
	1.9 dCi 80	60		11.01	08.06		24.2415-1710.3	030124			Gz 15,87	
	1.9 dTi	59		09.00	08.06							
	2.2 dCi 90	66		09.00	08.06							
	2.5 D	59		02.99	01.01							
	2.5 dCi 100	73		10.03	08.06							
	2.5 dCi 120	84		10.01	08.06							
	2.8 dTi	84		02.99	10.01							

RENAULT MASTER II Kasten (FD_) (98-06)

	1.9 dCi 80	60		11.01	10.03		24.2025-1708.3	010692		- ABS	THz 25,40
	1.9 dTi	59		09.00	10.03		24.2025-1706.3	010676		+ ABS	THz 25,40
	2.2 dCi 90	65		09.00	10.03						
	2.5 D	59		07.98	01.01						
	2.5 dCi 120	84		10.01	10.03						
	2.8 dTi	84		07.98	10.01						
	2.8 dTi	84		07.98	10.01						
	1.9 dCi 80	60		11.03	08.06		24.2025-1708.3	010692		- ABS	THz 25,40
	1.9 dTi	59		11.03	08.06		24.2123-1759.3	010768		+ ABS	THz 23,81
	2.2 dCi 90	65		11.03	08.06						BOS
	2.5 dCi 100	73		10.03	08.06						
	2.5 dCi 120	84		11.03	08.06						
	3.0 dCi 120	85		06.05	08.06						
	3.0 dCi 140	100		10.03	08.06						
3.0 dCi 160	115		06.05	08.06							
	2.5 D	59		07.98	01.01		24.5134-0562.3	330706	2		L=568
	2.8 dTi	84		07.98	07.00		24.5134-0518.3	330705	2		L=518
	1.9 dCi 80	60		11.01	08.06	- ABS	24.5134-0468.3	330704	2		L=468
	1.9 dTi	59		09.00	08.06	- ABS	24.5134-0457.3	330752	2		L=457
	2.2 dCi 90	65		09.00	08.06	- ABS					
	2.5 D	59		08.00	01.01						
	2.5 dCi 100	73		10.03	08.06	- ABS					
	2.5 dCi 120	84		10.01	08.06	- ABS					
	2.8 dTi	84		08.00	10.01						
	3.0 dCi 120	85		06.05	08.06	- ABS					
	3.0 dCi 140	100		10.03	08.06	- ABS					
	3.0 dCi 160	115		06.05	08.06	- ABS					
	3.0 dCi 160	115		06.05	08.06	- ABS					
	1.9 dCi 80	60		11.01	10.03	+ ABS	24.5134-0468.3	330704	2		L=468
	1.9 dTi	59		09.00	10.03	+ ABS	24.5134-0457.3	330752	2		L=457
	2.2 dCi 90	65		09.00	10.03	+ ABS					
	2.5 D	59		08.00	01.01						
	2.5 dCi 120	84		10.01	10.03	+ ABS					
	2.8 dTi	84		08.00	10.01						
	2.8 dTi	84		08.00	10.01						
	1.9 dCi 80	60		11.03	08.06	+ ABS	24.5111-0510.3	330819	2		L=510
	1.9 dTi	59		11.03	08.06	+ ABS					
	2.2 dCi 90	65		11.03	08.06	+ ABS					
	2.5 dCi 100	73		10.03	08.06	+ ABS					
	2.5 dCi 120	84		11.03	08.06	+ ABS					
	3.0 dCi 120	85		06.05	08.06	+ ABS					
	3.0 dCi 140	100		10.03	08.06	+ ABS					
	3.0 dCi 160	115		06.05	08.06	+ ABS					
	3.0 dCi 160	115		06.05	08.06	+ ABS					
3.0 dCi 160	115		06.05	08.06	+ ABS						

¹⁾ on the brake caliper / sulla pinza freno / sur l'étrier de frein / a la pinza de freno

²⁾ notice length / attenzione lunghezza / faire attention longueur / atención largo

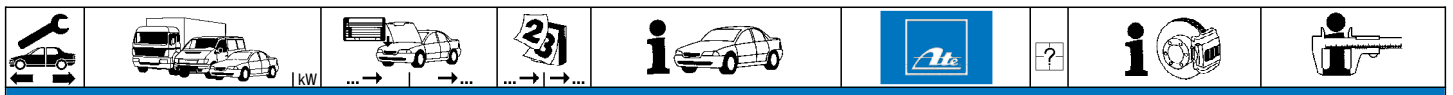

RENAULT MASTER II Kasten (FD_) (98-06)























































	1.9 dCi 80 1.9 dTi 2.2 dCi 90 2.5 D 2.5 dCi 100 2.5 dCi 120 2.8 dTi 3.0 dCi 120 3.0 dCi 140 3.0 dCi 160	60 59 65 59 73 84 84 85 100 115		11.01 09.00 09.00 08.00 10.03 10.01 08.00 06.05 10.03 06.05	08.06 08.06 08.06 01.01 08.06 08.06 10.01 08.06 08.06 08.06	24.3424-1701.5 24.3424-1702.5	240561 240562			D=42, - Halter D=42, - Halter	BOS BOS
	1.9 dCi 80 1.9 dTi 2.2 dCi 90 2.5 D 2.5 dCi 100 2.5 dCi 120 2.8 dTi 3.0 dCi 140	60 59 65 59 73 84 84 100		11.01 09.00 09.00 07.98 10.03 10.01 07.98 10.03	11.03 11.03 11.03 01.01 11.03 11.03 10.01 11.03	24.5111-0326.3	330766	2	am Bremsattel ¹⁾	L=326	
	1.9 dCi 80 1.9 dTi 2.2 dCi 90 2.5 D 2.5 dCi 100 2.5 dCi 120 2.8 dTi 3.0 dCi 120 3.0 dCi 140 3.0 dCi 160	60 59 65 59 73 84 84 85 100 115		12.03 12.03 12.03 12.03 12.03 06.05 12.03 06.05	08.06 08.06 08.06 08.06 08.06 08.06 08.06 08.06 08.06 08.06	24.5258-0450.3 24.5251-0465.3	330824 330822			L=450 L=465	
	2.5 D 2.8 dTi	59 84		07.98 07.98	07.00 07.00	24.3223-1707.3 24.3223-1708.3	020435 020436			Rz 23,81 Rz 23,81	BDX BDX
	1.9 dCi 80 1.9 dTi 2.2 dCi 90 2.5 D 2.5 dCi 100 2.5 dCi 120 2.8 dTi 3.0 dCi 120 3.0 dCi 140 3.0 dCi 160	60 59 65 59 73 84 84 85 100 115		11.01 09.00 09.00 08.00 10.03 10.01 08.00 06.05 10.03 06.05	08.06 08.06 08.06 01.01 08.06 08.06 10.01 08.06 08.06 08.06	24.3727-0762.2 24.3727-1072.2 24.3727-1000.2	580762 581072 581000	1 2 2	Länge beachten ²⁾ Länge beachten ²⁾	L=1175 L=1420 L=1737	
	1.9 dCi 80 1.9 dTi 2.2 dCi 90 2.5 D 2.5 dCi 100 2.5 dCi 120 2.8 dTi 3.0 dCi 120 3.0 dCi 140 3.0 dCi 160	60 59 65 59 73 84 84 85 100 115		11.01 09.00 09.00 02.99 10.03 10.01 02.99 06.05 10.03 06.05	08.06 08.06 08.06 01.01 08.06 08.06 10.01 08.06 08.06 08.06	24.2415-1710.3	030124			Gz 15,87	

RENAULT MASTER II Pritsche/Fahrgestell (ED/HD/UD_) (98-06)

	2.2 dCi 90 2.5 D 2.5 dCi 120 2.8 dTi	66 59 84 84		09.00 07.98 10.01 07.98	10.03 01.01 10.03 10.01	24.2025-1708.3 24.2025-1706.3	010692 010676	- ABS + ABS		Thz 25,40 Thz 25,40	
	2.2 dCi 90 2.5 dCi 100 2.5 dCi 120 3.0 dCi 120 3.0 dCi 140 3.0 dCi 160	66 73 84 85 100 115		11.03 10.03 11.03 06.05 10.03 06.05	08.06 08.06 08.06 08.06 08.06 08.06	24.2025-1708.3 24.2123-1759.3	010692 010768	- ABS + ABS		Thz 25,40 Thz 23,81	BOS
	2.5 D 2.8 dTi	59 84		07.98 07.98	07.00 07.00	24.5134-0562.3 24.5134-0518.3	330706 330705	2 2		L=568 L=518	
	2.2 dCi 90 2.5 D 2.5 dCi 100 2.5 dCi 120 2.8 dTi 3.0 dCi 120 3.0 dCi 140 3.0 dCi 160	66 59 73 84 84 85 100 115		09.00 08.00 10.03 10.01 08.00 06.05 10.03 06.05	08.06 01.01 08.06 08.06 10.01 08.06 08.06 08.06	24.5134-0468.3 24.5134-0457.3	330704 330752	2 2	- ABS - ABS - ABS - ABS - ABS - ABS	L=468 L=457	
	2.2 dCi 90 2.5 dCi 100 2.5 dCi 120 3.0 dCi 120 3.0 dCi 140 3.0 dCi 160	66 73 84 85 100 115		09.00 10.01 11.03 10.03 06.05 10.03 06.05	10.03 10.03 08.06 08.06 08.06 08.06 08.06	24.5134-0468.3 24.5134-0457.3 24.5111-0510.3	330704 330752 330819	2 2 2	+ ABS + ABS + ABS + ABS + ABS + ABS	L=468 L=457 L=510	
	2.2 dCi 90 2.5 D 2.5 dCi 100 2.5 dCi 120 2.8 dTi 3.0 dCi 120 3.0 dCi 140	66 59 73 84 84 85 100		09.00 08.00 10.03 10.01 08.00 06.05 10.03	08.06 01.01 08.06 08.06 10.01 08.06 08.06	24.3424-1701.5 24.3424-1702.5	240561 240562			D=42, - Halter D=42, - Halter	BOS BOS

















¹⁾ on the brake caliper / sulla pinza freno / sur l'étrier de frein / a la pinza de freno

²⁾ notice length / attenzione lunghezza / faire attention longueur / atención largo

										
RENAULT MASTER II Pritsche/Fahrgestell (ED/HD/UD_) (98-06)										
	3.0 dCi 160	115		06.05	08.06		24.3424-1701.5 240561 24.3424-1702.5 240562	 	D=42, - Halter D=42, - Halter	BOS BOS
	2.2 dCi 90 2.5 D 2.5 dCi 100 2.5 dCi 120 2.8 dTi 3.0 dCi 140	66 59 73 84 84 100		09.00 07.98 10.03 10.01 07.98 10.03	08.06 01.01 11.03 11.03 10.01 11.03		24.5111-0326.3 330766	2  am Bremsattel ¹⁾	L=326	
	2.2 dCi 90 2.5 dCi 100 2.5 dCi 120 3.0 dCi 120 3.0 dCi 140 3.0 dCi 160	66 73 84 85 100 115		12.03 12.03 12.03 06.05 11.03 06.05	08.06 08.06 08.06 08.06 08.06 08.06		24.5258-0450.3 330824 24.5251-0465.3 330822	 	L=450 L=465	
	2.5 D 2.8 dTi	59 84		07.98 07.98	07.00 07.00		24.3223-1707.3 020435 24.3223-1708.3 020436	 	Rz 23,81 Rz 23,81	BDX BDX
	2.2 dCi 90 2.5 D 2.5 dCi 100 2.5 dCi 120 2.8 dTi 3.0 dCi 120 3.0 dCi 140 3.0 dCi 160	66 59 73 84 84 85 100 115		09.00 07.98 10.03 10.01 07.98 06.05 10.03 06.05	08.06 01.01 08.06 08.06 10.01 08.06 08.06 08.06		24.3727-0762.2 580762 24.3727-1072.2 581072 24.3727-1000.2 581000	2  2  Länge beachten ²⁾ 2  Länge beachten ²⁾	L=1175 L=1420 L=1737	
	2.2 dCi 90 2.5 D 2.5 dCi 100 2.5 dCi 120 2.8 dTi 3.0 dCi 120 3.0 dCi 140 3.0 dCi 160	66 59 73 84 84 85 100 115		09.00 02.99 10.03 10.01 02.99 06.05 10.03 06.05	08.06 01.01 08.06 08.06 10.01 08.06 08.06 08.06		24.2415-1710.3 030124		Gz 15,87	
RENAULT MASTER II Bus (JD_) (06-10)										
	2.5 dCi 2.5 dCi 2.5 dCi	74 88 107		08.06 08.06 08.06	12.10 - ABS 12.10 - ABS 12.10 - ABS		24.2025-1708.3 010692		Thz 25,40	
	2.5 dCi 2.5 dCi 2.5 dCi	74 88 107		08.06 08.06 08.06	12.10 - ABS 12.10 - ABS 12.10 - ABS		24.5134-0468.3 330704 24.5134-0457.3 330752	2  am Bremsattel ¹⁾	L=468 L=457	
	2.5 dCi 2.5 dCi 2.5 dCi	74 88 107		08.06 08.06 08.06	12.10 + ABS 12.10 + ABS 12.10 + ABS		24.5111-0510.3 330819	2	L=510	
	2.5 dCi 2.5 dCi 2.5 dCi	74 88 107		08.06 08.06 08.06	12.10 12.10 12.10		24.3424-1701.5 240561 24.3424-1702.5 240562	 	D=42, - Halter D=42, - Halter	BOS BOS
	2.5 dCi 2.5 dCi 2.5 dCi	74 88 107		08.06 08.06 08.06	12.10 - ABS 12.10 - ABS 12.10 - ABS		24.5111-0326.3 330766	2  am Bremsattel ¹⁾	L=326	
	2.5 dCi 2.5 dCi 2.5 dCi	74 88 107		08.06 08.06 08.06	12.10 + ABS 12.10 + ABS 12.10 + ABS		24.5258-0450.3 330824 24.5251-0465.3 330822	 	L=450 L=465	
	2.5 dCi 2.5 dCi 2.5 dCi	74 88 107		08.06 08.06 08.06	12.10 12.10 12.10		24.3727-0762.2 580762 24.3727-1000.2 581000	1  2 	L=1175 L=1737	
RENAULT MASTER II Kasten (FD_) (06-10)										
	2.5 dCi 2.5 dCi 2.5 dCi	74 88 107		08.06 08.06 08.06	12.10 - ABS 12.10 - ABS 12.10 - ABS		24.2025-1708.3 010692		Thz 25,40	
	2.5 dCi 2.5 dCi 2.5 dCi	74 88 107		08.06 08.06 08.06	12.10 - ABS 12.10 - ABS 12.10 - ABS		24.5134-0468.3 330704 24.5134-0457.3 330752	2  am Bremsattel ¹⁾	L=468 L=457	
	2.5 dCi 2.5 dCi 2.5 dCi	74 88 107		08.06 08.06 08.06	12.10 + ABS 12.10 + ABS 12.10 + ABS		24.5111-0510.3 330819	2	L=510	
	2.5 dCi 2.5 dCi 2.5 dCi	74 88 107		08.06 08.06 08.06	12.10 12.10 12.10		24.3424-1701.5 240561 24.3424-1702.5 240562	 	D=42, - Halter D=42, - Halter	BOS BOS
	2.5 dCi 2.5 dCi 2.5 dCi	74 88 107		08.06 08.06 08.06	12.10 - ABS 12.10 - ABS 12.10 - ABS		24.5111-0326.3 330766	2  am Bremsattel ¹⁾	L=326	
	2.5 dCi 2.5 dCi 2.5 dCi	74 88 107		08.06 08.06 08.06	12.10 + ABS 12.10 + ABS 12.10 + ABS		24.5258-0450.3 330824 24.5251-0465.3 330822	 	L=450 L=465	
	2.5 dCi 2.5 dCi 2.5 dCi	74 88 107		08.06 08.06 08.06	12.10 12.10 12.10		24.3727-0762.2 580762 24.3727-1000.2 581000	1  2	L=1175 L=1737	

¹⁾ on the brake caliper / sulla pinza freno / sur l'étrier de frein / a la pinza de freno

²⁾ notice length / attenzione lunghezza / faire attention longueur / atención largo

RENAULT MASTER II Pritsche/Fahrgestell (ED/HD/UD_) (06-10)										
	2.5 dCi	74	08.06	12.10	- ABS	24.2025-1708.3	010692		THz 25,40	
	2.5 dCi	88	08.06	12.10	- ABS					
	2.5 dCi	107	08.06	12.10	- ABS					
	2.5 dCi	74	08.06	12.10	- ABS	24.5134-0468.3	330704	2	am Bremsattel 1)	L=468
	2.5 dCi	88	08.06	12.10	- ABS	24.5134-0457.3	330752	2		L=457
	2.5 dCi	107	08.06	12.10	- ABS					
	2.5 dCi	74	08.06	12.10	+ ABS	24.5111-0510.3	330819	2		L=510
	2.5 dCi	88	08.06	12.10	+ ABS					
	2.5 dCi	107	08.06	12.10	+ ABS					
	2.5 dCi	74	08.06	12.10		24.3424-1701.5	240561		D=42, - Halter	BOS
	2.5 dCi	88	08.06	12.10		24.3424-1702.5	240562		D=42, - Halter	BOS
	2.5 dCi	107	08.06	12.10						
	2.5 dCi	74	08.06	12.10	- ABS	24.5111-0326.3	330766	2	am Bremsattel 1)	L=326
	2.5 dCi	88	08.06	12.10	- ABS					
	2.5 dCi	107	08.06	12.10	- ABS					
	2.5 dCi	74	08.06	12.10	+ ABS	24.5258-0450.3	330824			L=450
	2.5 dCi	88	08.06	12.10	+ ABS	24.5251-0465.3	330822			L=465
	2.5 dCi	107	08.06	12.10	+ ABS					
	2.5 dCi	74	08.06	12.10		24.3727-0762.2	580762	1		L=1175
	2.5 dCi	88	08.06	12.10		24.3727-1000.2	581000	2		L=1737
	2.5 dCi	107	08.06	12.10						
RENAULT MASTER III Kasten/Bus (FV/JV) (10-)										
	2.3 dCi FWD	74	02.10			03.7868-5202.4	300309			10" ATE
	2.3 dCi FWD	81	09.14							
	2.3 dCi FWD	92	02.10							
	2.3 dCi FWD	100	07.14							
	2.3 dCi FWD	107	02.10							
	2.3 dCi FWD	110	01.13							
	2.3 dCi FWD	120	07.14							
	2.3 dCi FWD	125	07.15							
	2.3 dCi RWD	74	02.10							
	2.3 dCi RWD	92	02.10							
	2.3 dCi RWD	100	07.14							
	2.3 dCi RWD	107	02.10							
	2.3 dCi RWD	110	01.13							
	2.3 dCi RWD	120	07.14							
	2.3 dCi RWD	125	07.15							
	2.3 dCi FWD	74	02.10			03.2126-3121.3	010967			THz 26,99 ATE
	2.3 dCi FWD	81	09.14							
	2.3 dCi FWD	92	02.10							
	2.3 dCi FWD	100	07.14							
	2.3 dCi FWD	107	02.10							
	2.3 dCi FWD	110	01.13							
	2.3 dCi FWD	120	07.14							
	2.3 dCi FWD	125	07.15							
	2.3 dCi RWD	74	02.10							
	2.3 dCi RWD	92	02.10							
	2.3 dCi RWD	100	07.14							
	2.3 dCi RWD	107	02.10							
	2.3 dCi RWD	110	01.13							
	2.3 dCi RWD	120	07.14							
	2.3 dCi RWD	125	07.15							
	2.3 dCi FWD	74	02.10		+ Einfachbereifung 2)	24.5111-0595.3	331495	2	- Sonderfahrzeuge 3)	L=595
	2.3 dCi FWD	81	09.14		+ Einfachbereifung 2)					
	2.3 dCi FWD	92	02.10		+ Einfachbereifung 2)					
	2.3 dCi FWD	100	07.14		+ Einfachbereifung 2)					
	2.3 dCi FWD	107	02.10		+ Einfachbereifung 2)					
	2.3 dCi FWD	110	01.13		+ Einfachbereifung 2)					
	2.3 dCi FWD	120	07.14		+ Einfachbereifung 2)					
	2.3 dCi FWD	125	07.15		+ Einfachbereifung 2)					
RENAULT MASTER III Pritsche/Fahrgestell (EV/UV) (10-)										
	2.3 dCi FWD	74	02.10			03.7868-5202.4	300309			10" ATE
	2.3 dCi FWD	81	09.14							
	2.3 dCi FWD	92	02.10							
	2.3 dCi FWD	107	02.10							
	2.3 dCi FWD	110	01.13							
	2.3 dCi FWD	120	07.14							
	2.3 dCi RWD	74	02.10							
	2.3 dCi RWD	92	02.10							
	2.3 dCi RWD	100	07.14							
	2.3 dCi RWD	107	02.10							
	2.3 dCi RWD	110	01.13							
	2.3 dCi RWD	120	07.14							
	2.3 dCi FWD	74	02.10			03.2126-3121.3	010967			THz 26,99 ATE
	2.3 dCi FWD	81	09.14							
	2.3 dCi FWD	92	02.10							
	2.3 dCi FWD	107	02.10							
	2.3 dCi FWD	110	01.13							
	2.3 dCi FWD	120	07.14							
	2.3 dCi RWD	74	02.10							
	2.3 dCi RWD	92	02.10							
	2.3 dCi RWD	100	07.14							
	2.3 dCi RWD	107	02.10							
	2.3 dCi RWD	110	01.13							

1) on the brake caliper / sulla pinza freno / sur l'étrier de frein / a la pinza de freno

2) + single tyre / + ruota singola / + roue simple / + cubierta simple





















3) - special vehicles / - veicoli speciali / - véhicules spécial / - vehículo especial



RENAULT MASTER III Pritsche/Fahrgestell (EV/UV) (10-)											
	2.3 dCi RWD	120		07.14			03.2126-3121.3	010967		THz 26,99	ATE
	2.3 dCi FWD	74		02.10	+ Einfachbereifung ¹⁾		24.5111-0595.3	331495	2	- Sonderfahrzeuge ²⁾	L=595
	2.3 dCi FWD	81		09.14	+ Einfachbereifung ¹⁾						
	2.3 dCi FWD	92		02.10	+ Einfachbereifung ¹⁾						
	2.3 dCi FWD	107		02.10	+ Einfachbereifung ¹⁾						
	2.3 dCi FWD	110		01.13	+ Einfachbereifung ¹⁾						
	2.3 dCi FWD	120		07.14	+ Einfachbereifung ¹⁾						

RENAULT MEGANE I Limousine 3/5-tuerig (BA/SA_) (96-02)											
	1.4 16V	70		06.98	12.02 - ABS		03.7760-5602.4	300121		10"	ATE
	1.4 e (V)	55		03.99	12.02 - ABS						
	1.6 16V (11)	79		03.99	12.02 - ABS						
	1.6 16V (1J)	79		03.99	12.02 - ABS						
	1.6 16V (4)	79		04.98	12.02 - ABS/ + verstärktes Fahrwerk ³⁾						
	1.9 D (R)	47		06.98	12.02 - ABS						
	1.9 dCi (5)	75		09.98	12.02 - ABS						
	1.4 16V (D)	70		03.99	12.02 + ABS		03.7863-2002.4	300126		10"	ATE
	1.6 16V (4)	79		04.98	12.02 + ABS/ - verstärktes Fahrwerk ⁴⁾		03.7760-5102.4	300140		10"	ATE
	1.9 dCi (5)	75		09.98	12.02 + ABS						
	1.9 dTi (BAON/SAON)	72		03.99	02.01						
	1.4 16V (W)	70		06.98	12.02 + ABS		03.7760-5502.4	300151		10"	ATE
	1.4 e (E)	55		03.99	12.02 + ABS						
	1.6 16V (11)	79		03.99	12.02 + ABS						
	1.6 16V (1J)	79		03.99	12.02 + ABS						
	1.6 16V (4)	79		04.98	12.02 + ABS/ + verstärktes Fahrzeug ⁵⁾						
	1.9 D (R)	47		06.98	12.02 + ABS						
	1.6 16V (B)	79		03.99	12.02 + ABS		03.7863-2002.4	300126		10"	ATE
	1.8 16V	85		01.01	12.02						
	1.9 dCi (F)	75		02.01	12.02 + ABS						
	1.9 dTi (1U)	59		02.01	12.02 + ABS						
	1.4 e (E)	55		01.96	12.02 - ABS		03.2120-2031.3	010106		THz 20,64	ATE
	1.4 e (V)	55		06.98	02.99 - ABS						
	1.4 Eco (T)	52		01.96	03.99 - ABS						
	1.6 e (F)	66		01.96	03.99 - ABS						
	1.6 e (S)	66		01.96	03.99 - ABS						
	1.6 i	55		01.96	03.99 - ABS						
	1.9 D (9)	47		01.96	12.02 - ABS						
	1.9 D (BA/U)	47		01.96	12.02 - ABS						
	1.9 D (BA/U)	47		01.96	12.02 - ABS/ - Fahrschule ⁶⁾						
	1.9 D (SA/U)	47		01.96	12.02 - ABS						
	1.9 dT (K)	66		03.96	12.02 - ABS						
	1.9 dT (Y)	66		01.96	12.02 - ABS						
	1.9 dTi	72		03.97	02.01 - ABS						
	1.9 TDI	69		09.96	12.02 - ABS						
	2.0 i (7)	84		01.96	12.02						
	2.0 i (G)	84		01.96	12.02 - ABS						
	1.4 16V	70		06.98	12.02 - ABS		03.2122-1541.3	010511		THz 22,20	ATE
	1.4 e (V)	55		03.99	12.02 - ABS						
	1.6 16V (11)	79		03.99	12.02 - ABS						
	1.6 16V (1J)	79		03.99	12.02 - ABS						
	1.6 16V (4)	79		04.98	12.02 - ABS/ + verstärktes Fahrwerk ³⁾						
	1.9 D (R)	47		06.98	12.02 - ABS						
	1.9 dCi (5)	75		09.98	12.02 - ABS						
	1.9 dT (Y)	66		01.96	12.02 - ABS						
	1.9 dTi (BAON)	72		03.97	02.01 - ABS						
	2.0 i (G)	84		01.96	12.02 - ABS						
	1.4 e (E)	55		01.96	12.02 + ABS		24.2120-1723.3	010545		THz 20,64	BDX
	1.4 Eco (T)	52		01.96	03.99 + ABS						
	1.6 e (F)	66		01.96	03.99 + ABS						
	1.6 e (S)	66		01.96	03.99 + ABS						
	1.6 i	55		01.96	03.99 + ABS						
	1.9 D (9)	47		01.96	12.02 + ABS						
	1.9 D (BA/U)	47		01.96	12.02 + ABS/ - Fahrschule ⁷⁾						
	1.9 D (SA/U)	47		01.96	12.02 + ABS						
	1.9 dT (K)	66		01.96	12.02 + ABS						
	1.9 dT (Y)	66		01.96	12.02 + ABS						
	1.9 dTi (8)	72		03.97	02.01 + ABS						
	1.9 dTi (BAON)	72		03.97	02.99 + ABS						
	1.9 dTi (SAON)	72		03.97	02.99 + ABS						
	1.9 TDI	69		09.96	12.02 + ABS						
	2.0 i (G)	84		01.96	12.02 + ABS						
	1.4 16V	70		06.98	12.02		03.2120-4441.3	010510		THz 20,64	ATE
	1.4 e (V)	55		06.98	02.99 + ABS						
	1.9 D (9)	47		01.96	12.02 + ABS						
	1.9 D (BA/U)	47		01.96	12.02 + ABS/ - Fahrschule ⁷⁾						
	1.9 D (R)	47		06.98	12.02						
	1.9 D (SA/U)	47		01.96	12.02 + ABS						
	1.9 dT (K)	66		01.96	12.02 + ABS						
	1.9 dT (Y)	66		01.96	12.02 + ABS						
	1.9 dTi (8)	72		03.97	02.01 + ABS						
	1.9 dTi (BAON)	72		03.97	02.99 + ABS						
	1.9 dTi (SAON)	72		03.97	02.99 + ABS						
	2.0 i (G)	84		01.96	12.02 + ABS						
	1.6 16V (4)	79		04.98	12.02 + ABS/ - verstärktes Fahrwerk ⁴⁾		03.2123-2146.3	010572		THz 23,81	ATE

¹⁾ + single tyre / + ruota singola / + roue simple / + cubierta simple
²⁾ - special vehicles / - veicoli speciali / - véhicules spécial / - vehiculo especial
³⁾ - ABS/ + reinforced suspension / - ABS/ + sospensione rinforzata / - ABS/ + châssis renforcé / - ABS/ + suspensión reforzada
⁴⁾ + ABS/ - reinforced suspension / + ABS/ - sospensione rinforzata / + ABS/ - châssis renforcé / + ABS/ - suspensión reforzada
⁵⁾ + ABS/ + reinforced vehicle / + ABS/ + veicolo rinforzato / + ABS/ + véhicule renforcé / + ABS/ + vehiculo reforzada
⁶⁾ - ABS/ - driving school / - ABS/ - scuola guida / - ABS/ - auto-école / - ABS/ - autoescuela
⁷⁾ + ABS/ - driving school / + ABS/ - scuola guida / + ABS/ - auto école / + ABS/ - autoescuela

										
RENAULT MEGANE I Limousine 3/5-tuerig (BA/SA_) (96-02)										
	1.6 16V (B)	79	03.99	12.02	+ ABS	03.2123-2146.3	010572		THz 23,81	ATE
	1.8 16V	85	01.01	12.02						
	1.9 dCi		09.98	12.02	+ ABS					
	1.9 dTi (1U)	59	02.01	12.02	+ ABS					
	1.9 dTi (BAON)	72	03.99	02.01	+ ABS					
	1.9 dTi (SAON)	72	03.99	02.01	+ ABS					
	1.4 16V	70	03.99	12.02	+ ABS	03.2122-1521.3	010494		THz 22,20	ATE
	1.4 e (V)	55	03.99	12.02	+ ABS					
	1.6 16V (11)	79	03.99	12.02	+ ABS					
	1.6 16V (1J)	79	03.99	12.02	+ ABS					
1.6 16V (4)	79	04.98	12.02	+ ABS/ + verstärktes Fahrwerk 1)						
1.9 D (R)	47	06.98	12.02	+ ABS						
1.9 dT (BY)	66	03.99	12.02	+ ABS						
1.9 dTi (BAON)	72	03.97	02.01	+ ABS						
2.0 i (G)	84	01.96	12.02	+ ABS						
1.4 e	55	01.96	12.02	+ ABS	24.2120-1725.3	010579			THz 20,64	BDX
1.6 e (F)	66	01.96	03.99	+ ABS						
1.9 D (9)	47	01.96	12.02	+ ABS						
1.9 D (A/U)	47	01.96	03.99	+ ABS						
1.9 dT (Y)	66	01.96	12.02	+ ABS						
1.9 dTi (8)	72	03.97	02.01	+ ABS						
1.9 dTi (BAON)	72	03.97	02.99	+ ABS						
2.0 i (G)	84	01.96	12.02	+ ABS						
1.9 D (BA/U)	47	01.96	12.02	- ABS/ + Fahrschule 2)	03.2119-3389.3	010057			THz 19,05	ATE
2.0 16V	108	07.96	12.02		24.2123-1701.3	010424			THz 23,81	
	1.4 e (E)	55	01.96	10.97		24.3481-1611.5	240029		D=48, - Halter	TRW
	1.4 Eco (T)	52	01.96	10.97		24.3481-1612.5	240030		D=48, - Halter	TRW
	1.6 i	55	01.96	10.97		24.0101-4807.2	260053		Bremssattel-Zubehör	TRW
	1.9 D (A)	47	01.96	10.97						
	1.9 D (U)	47	01.96	10.97						
	1.4 16V (D)	70	03.99	12.02		24.3481-1615.5	240031		D=48, - Halter	TRW
	1.4 16V (W)	70	06.98	12.02		24.3481-1616.5	240032		D=48, - Halter	TRW
	1.4 e (E)	55	11.97	12.02		24.0101-4806.2	260052		Bremssattel-Zubehör	TRW
	1.4 e (V)	55	06.98	12.02						
	1.4 Eco (T)	52	11.97	03.99						
	1.6 16V (4)	79	04.98	12.02	+ verstärktes Fahrwerk 3)					
	1.6 e	66	01.96	03.99						
	1.6 i	55	11.97	03.99						
	1.9 D (9)	47	01.96	12.02						
	1.9 D (A)	47	11.97	12.02						
	1.9 D (R)	47	06.98	12.02						
	1.9 D (U)	47	11.97	12.02						
	1.9 dT	66	01.96	01.98						
	1.9 dTi	60	02.00	09.00						
	1.9 dTi (8)	72	03.97	02.01						
1.9 dTi (BAON/SAON)	72	03.97	02.99							
1.9 TDI	69	09.96	12.02							
2.0 i		01.96	12.02							
1.6 16V (11)	79	03.99	12.02		24.3541-1749.5	240427		D=54, - Halter	TRW	
1.6 16V (1J)	79	03.99	12.02		24.3541-1750.5	240428		D=54, - Halter	TRW	
1.6 16V (4)	79	04.98	12.02	- verstärktes Fahrwerk 4)						
1.6 16V (B)	79	03.99	12.02							
1.8 16V	85	01.01	12.02							
1.9 dCi		09.98	12.02							
1.9 dTi (1U)	59	02.01	12.02							
1.9 dTi (BAON/SAON)	72	03.99	02.01							
2.0 16V	108	10.98	12.02							
2.0 16V	108	07.96	09.98		24.3541-1741.5	240215		D=54, - Halter	TRW	
					24.3541-1742.5	240216		D=54, - Halter	TRW	
	1.4 16V	70	06.98	12.02		24.5111-0390.3	330566	2		L=390
	1.4 e	55	01.96	12.02						
	1.4 Eco (T)	52	01.96	03.99						
	1.6 16V	79	04.98	12.02						
	1.6 e	66	01.96	03.99						
	1.6 i	55	01.96	03.99						
	1.8 16V	85	01.01	12.02						
	1.9 D	47	01.96	12.02						
	1.9 dCi		09.98	12.02						
	1.9 dT	66	01.96	12.02						
	1.9 dTi (1U)	59	02.01	12.02						
	1.9 dTi (8)	72	03.97	02.01						
	1.9 dTi (SAON)	72	03.97	02.01						
	1.9 TDI	69	09.96	12.02						
	2.0 16V	108	07.96	12.02						
2.0 i (7)	84	01.96	12.02							
1.9 dTi (BAON)	72	03.97	02.01		24.5111-0390.3	330566	2	Länge beachten 5)	L=390	
2.0 i (G)	84	01.96	12.02							
	1.4 16V	70	06.98	12.02		24.5229-0265.3	330540	2		L=265
	1.4 e	55	01.96	12.02						
	1.4 Eco (T)	52	01.96	03.99						
	1.6 16V	79	04.98	12.02						
	1.6 e	66	01.96	03.99						
	1.6 i	55	01.96	03.99						
	1.8 16V	85	01.01	12.02						
	1.9 D	47	01.96	12.02						
1.9 dCi		09.98	12.02							













1) + ABS/ + reinforced suspens. / + ABS/ + sospensione rinforzata / + ABS/ + châssis renforcé / + ABS/ + suspensión reforzada

2) - ABS/ + driving school / - ABS/ + scuola guida / - ABS/ + auto école / - ABS/ + autoescuela

3) + reinforced suspension / + sospensione rinforzata / + châssis renforcé / + suspensión reforzada

4) - reinforced suspension / - sospensione rinforzata / - châssis renforcé / - suspensión reforzada

5) notice length / attenzione lunghezza / faire attention longueur / atención largu

        									
RENAULT MEGANE I Limousine 3/5-tuerig (BA/SA_) (96-02)									
	1.9 dT	66	01.96	12.02	24.5229-0265.3	330540	2		L=265
	1.9 dTi (1U)	59	02.01	12.02					
	1.9 dTi (8)	72	03.97	02.01					
	1.9 dTi (SAON)	72	03.97	02.01					
	1.9 TDI	69	09.96	12.02					
	2.0 16V	108	07.96	12.02					
	2.0 i (7)	84	01.96	12.02					
	1.9 dTi (BAON)	72	03.97	02.01					
	2.0 i (G)	84	01.96	12.02					
		1.4 16V	70	06.98					
1.4 e (E)		55	01.96	12.02					
1.4 e (V)		55	06.98	02.99					
1.4 e (V)		55	06.98	12.02					
1.4 Eco (T)		52	01.96	03.99					
1.6 16V (11)		79	03.99	12.02					
1.6 16V (1J)		79	03.99	12.02					
1.6 16V (4)		79	04.98	12.02					
1.6 16V (B)		79	03.99	12.02					
1.6 e		66	01.96	03.99					
1.6 i		55	01.96	03.99					
1.9 D (9)		47	01.96	12.02					
1.9 D (A)		47	01.96	12.02					
1.9 D (R)		47	06.98	12.02					
1.9 D (U)		47	01.96	12.02					
1.9 dCi		66	09.98	12.02					
1.9 dT		59	01.96	12.02					
1.9 dTi (1U)		72	02.01	12.02					
1.9 dTi (8)		72	03.97	02.01					
1.9 dTi (BAON/SAON)		72	03.97	02.99					
1.9 dTi (BAON/SAON)		72	03.97	02.01					
1.9 TDI		69	09.96	12.02					
2.0 i		84	01.96	12.02					
1.4 16V (D)		70	03.99	12.02					
1.4 16V (W)		70	06.98	12.02					
1.4 e (V)		55	06.98	12.02					
1.6 16V (4)		79	04.98	12.02					
1.6 16V (B)		79	03.99	12.02					
1.8 16V (12)		85	01.01	12.02					
1.8 16V (1M)		85	01.01	12.02					
1.9 D (R)		47	06.98	12.02					
1.9 dCi (5)		75	09.98	12.02					
1.9 dCi (F)	75	02.01	12.02						
1.9 dTi (BAON/SAON)	72	03.99	02.01						
	1.4 16V (W)	70	06.98	12.02	24.3727-1050.2	581050	2		L=1440
	1.4 e	55	01.96	12.02					
	1.4 Eco (T)	52	01.96	03.99					
	1.6 16V (11)	79	03.99	12.02					
	1.6 16V (1J)	79	03.99	12.02					
	1.6 16V (4)	79	04.98	12.02					
	1.6 e	66	01.96	03.99					
	1.6 i	55	01.96	03.99					
	1.9 D (A)	47	01.96	12.02					
	1.9 D (R)	47	06.98	12.02					
	1.9 D (U)	47	01.96	12.02					
	1.9 dTi (BAON)	72	03.97	02.01					
	2.0 i (G)	84	01.96	12.02					
	1.4 16V (D)	70	03.99	12.02					
	1.6 16V (11)	79	03.99	12.02					
	1.6 16V (1J)	79	03.99	12.02					
	1.6 16V (4)	79	04.98	12.02					
	1.6 16V (B)	79	03.99	12.02					
	1.9 D (9)	47	01.96	12.02					
	1.9 dCi	66	09.98	12.02					
1.9 dT	59	01.96	12.02						
1.9 dTi (1U)	72	02.01	12.02						
1.9 dTi (8)	72	03.97	02.01						
1.9 dTi (BAON)	72	03.97	02.01						
1.9 dTi (SAON)	72	03.97	02.01						
1.9 TDI	69	09.96	12.02						
2.0 i (7)	84	01.96	12.02						
2.0 i (G)	84	01.96	12.02						
	1.4 16V	70	06.98	12.02	24.3728-1018.2	591018			L=972
	1.4 e	55	01.96	12.02					
	1.4 Eco (T)	52	01.96	03.99					
	1.6 16V (11)	79	03.99	12.02					
	1.6 16V (1J)	79	03.99	12.02					
	1.6 16V (4)	79	04.98	12.02					
	1.6 e (F)	66	01.96	03.99					
	1.6 e (S)	66	01.96	03.99					
	1.6 i	55	01.96	03.99					
	1.9 D	47	01.96	12.02					
	1.9 D (SR)	47	12.98	12.02					
	1.9 dT (K)	66	03.96	12.02					
	1.9 dT (Y)	66	03.96	12.02					
	1.9 dTi (1U)	59	02.01	12.02					
	2.0 i (7)	84	12.97	12.02					
	2.0 i (G)	84	01.96	12.02					

1) notice length / attenzione lunghezza / faire attention longueur / atención largo

2) + reinforced suspension / + sospensione rinforzata / + châssis renforcé / + suspensión reforzada

3) - reinforced suspension / - sospensione rinforzata / - châssis renforcé / - suspensión reforzada



RENAULT MEGANE I Limousine 3/5-tuerig (BA/SA_) (96-02)











	1.9 dCi	72	09.98	12.02	24.3728-1024.2	591024		L=973
	1.9 dTi (8)	72	03.97	02.01				
	1.9 dTi (BAON)	72	03.97	02.01				
	1.9 dTi (SAON)	72	03.97	02.01				
	1.9 TDI	69	09.96	12.02				

RENAULT MEGANE I Classic (LA_) (96-02)

	1.4 16V (OD)	70	03.99	12.02	- ABS	03.7760-5602.4	300121	10"	ATE
	1.4 16V (OW)	70	06.98	12.02	- ABS				
	1.4 e (OV)	55	04.98	12.02	- ABS				
	1.6 16V (11)	79	09.99	12.02	- ABS				
	1.6 16V (1C)	79	09.99	12.02	- ABS				
	1.6 16V (O4)	79	04.98	12.02	- ABS/ + verstärktes Fahrwerk ¹⁾				
	1.6 e (OF)	66	09.96	12.02	- ABS/ + verstärktes Fahrwerk ¹⁾				
	1.9 D (OR)	47	09.98	12.02	- ABS				
	1.9 dTi (ON)	72	03.97	02.01	- ABS				
	1.9 TDI	69	09.96	12.02	- ABS				
	2.0 i (OG)	84	09.96	12.02	- ABS				
	1.4 16V (OD)	70	03.99	12.02	+ ABS	03.7863-2002.4	300126	10"	ATE
	1.6 16V (O4)	79	04.98	12.02	+ ABS/ - verstärktes Fahrwerk ²⁾	03.7760-5102.4	300140	10"	ATE
	1.9 dCi (O5)	75	09.98	12.02	+ ABS				
	1.9 dTi (ON)	72	03.99	12.02					
	1.4 16V (OW)	70	06.98	12.02	+ ABS	03.7760-5502.4	300151	10"	ATE
	1.4 e (OE)	55	09.98	12.02	+ ABS				
	1.6 16V (11)	79	09.99	12.02	+ ABS				
	1.6 16V (1C)	79	09.99	12.02	+ ABS				
	1.6 16V (O4)	79	04.98	12.02	+ ABS/ + verstärktes Fahrwerk ³⁾				
	1.6 e (OF)	66	09.96	03.99	+ ABS				
	1.9 D (OR)	47	09.98	12.02	+ ABS				
	1.9 dTi (ON)	72	03.99	12.02	+ ABS				
	1.9 TDI	69	09.96	12.02	+ ABS				
	2.0 i (OG)	84	09.98	12.02	+ ABS				
	1.8 16V	85	01.01	12.02	+ ABS	03.7863-2002.4	300126	10"	ATE
	1.9 dCi (1F)	75	02.01	12.02	+ ABS				
	1.9 dTi (O8)	72	03.97	02.01	+ ABS				
	1.4 e (OE)	55	09.96	12.02	- ABS	03.2120-2031.3	010106	Thz 20,64	ATE
	1.6 e	66	09.96	03.99	- ABS				
	1.6 i	55	09.96	03.99	- ABS				
	1.9 D (OA)	47	09.96	12.02	- ABS				
	1.9 D (OU)	47	09.96	12.02	- ABS				
	1.9 dT	66	09.96	12.02	- ABS				
	1.9 dTi	72	03.97	02.01	- ABS				
	2.0 i (O7)	84	09.96	12.02	- ABS				
	2.0 i (OG)	84	09.96	12.02	- ABS				
	1.4 16V (OD)	70	03.99	12.02	- ABS	03.2122-1541.3	010511	Thz 22,20	ATE
	1.4 16V (OW)	70	06.98	12.02	- ABS				
	1.4 e (OV)	55	04.98	12.02	- ABS				
	1.6 16V (11)	79	09.99	12.02	- ABS				
	1.6 16V (1C)	79	09.99	12.02	- ABS				
	1.6 16V (O4)	79	04.98	12.02	- ABS/ + verstärktes Fahrwerk ¹⁾				
	1.9 D (OR)	47	09.98	12.02	- ABS				
	1.9 dCi (O5)	75	09.98	12.02	- ABS				
	1.9 dTi (ON)	72	03.99	02.01	- ABS				
	1.9 TDI	69	09.96	12.02	- ABS				
	2.0 i (OG)	84	03.99	12.02	- ABS				
	1.4 16V (OD)	70	03.99	12.02	+ ABS	03.2120-4441.3	010510	Thz 20,64	ATE
	1.4 16V (OW)	70	06.98	12.02	+ ABS				
	1.4 e (OE)	55	09.96	03.99	+ ABS				
	1.6 e (OF)	66	09.96	03.99	+ ABS				
	1.6 i	55	09.96	03.99	+ ABS				
	1.9 D (OA)	47	09.96	12.02	+ ABS				
	1.9 D (OU)	47	09.96	12.02	+ ABS				
	1.9 dT (OK)	66	09.96	12.02	+ ABS				
	1.9 dT (OY)	66	09.96	12.02	+ ABS				
	1.9 dTi (O8)	72	03.97	02.01	+ ABS				
	1.9 dTi (ON)	72	03.97	02.01	+ ABS				
	2.0 i (OG)	84	09.96	12.02	+ ABS				
	1.4 e (OE)	55	09.96	12.02	+ ABS	24.2120-1723.3	010545	Thz 20,64	BDX
	1.4 e (OV)	55	09.98	02.99	+ ABS				
	1.6 e (OF)	66	09.96	03.99	+ ABS				
	1.6 i	55	09.96	03.99	+ ABS				
	1.9 D (OA)	47	09.96	12.02	+ ABS				
	1.9 D (OU)	47	09.96	12.02	+ ABS				
	1.9 dT (OK)	66	09.96	12.02	+ ABS				
	1.9 dT (OY)	66	09.96	12.02	+ ABS				
	1.9 dTi (O8)	72	03.97	02.01	+ ABS				
	1.9 dTi (ON)	72	03.97	02.01	+ ABS				
	2.0 i (OG)	84	09.96	12.02	+ ABS				
	1.4 16V (OD)	70	03.99	12.02	+ ABS	03.2122-1521.3	010494	Thz 22,20	ATE
	1.4 16V (OW)	70	06.98	12.02	+ ABS				
	1.4 e (OV)	55	03.99	12.02	+ ABS				
	1.6 16V (11)	79	09.99	12.02					
	1.6 16V (1C)	79	09.99	12.02					
	1.6 16V (O4)	79	04.98	12.02	+ ABS/ + verstärktes Fahrwerk ³⁾				
	1.9 D (OR)	47	09.98	12.02	+ ABS				
	1.9 dTi (ON)	72	08.99	02.01	+ ABS/ + verstärktes Fahrwerk ³⁾				

¹⁾ - ABS/ + reinforced suspension / - ABS/ + sospensione rinforzata / - ABS/ + châssis renforcé / - ABS/ + suspensión reforzada
²⁾ + ABS/ - reinforced suspension / + ABS/ - sospensione rinforzata / + ABS/ - châssis renforcé / + ABS/ - suspensión reforzada
³⁾ + ABS/ + reinforced suspens. / + ABS/ + sospensione rinforzata / + ABS/ + châssis renforcé / + ABS/ + suspensión reforzada



RENAULT MEGANE I Classic (LA_) (96-02)										
	1.9 TDI	69	09.96	12.02	+ ABS	03.2122-1521.3	010494		Thz 22,20	ATE
	2.0 i (0G)	84	08.99	12.02	+ ABS					
	1.6 16V (04)	79	04.98	12.02	+ ABS/ - verstärktes Fahrwerk 1)	03.2123-2146.3	010572		Thz 23,81	ATE
	1.8 16V	85	01.01	12.02	+ ABS					
	1.9 dCi (1F)	75	02.01	12.02	+ ABS					
	1.9 dTi (08)	72	03.97	02.01	+ ABS					
	1.9 dTi (0N)	72	03.97	02.01	+ ABS/ - verstärktes Fahrwerk 1)					
	1.6 e (0F)	66	09.96	03.99	+ ABS	24.2120-1725.3	010579		Thz 20,64	BDX
	1.9 D (0A)	47	09.96	12.02	+ ABS					
	1.9 dT (0Y)	66	09.96	12.02	+ ABS					
1.9 dTi (08)	72	03.97	02.01	+ ABS						
1.9 dTi (0N)	72	03.97	02.99	+ ABS						
2.0 i (0G)	84	09.96	12.02	+ ABS						
	1.4 e (0E)	55	09.96	10.97		24.3481-1611.5	240029		D=48, - Halter	TRW
	1.6 i	55	09.96	10.97		24.3481-1612.5	240030		D=48, - Halter	TRW
	1.9 D (0A)	47	09.96	10.97		24.0101-4807.2	260053		Bremssattel-Zubehör	TRW
	1.9 D (0U)	47	09.96	10.97						
	1.4 16V (0D)	70	03.99	12.02		24.3481-1615.5	240031		D=48, - Halter	TRW
	1.4 16V (0W)	70	06.98	12.02		24.3481-1616.5	240032		D=48, - Halter	TRW
	1.4 e (0E)	55	11.97	12.02	+ ABS	24.0101-4806.2	260052		Bremssattel-Zubehör	TRW
	1.4 e (0V)	55	04.98	12.02						
	1.6 16V (1C)	79	03.99	12.02						
	1.6 16V (04)	79	04.98	12.02	+ verstärktes Fahrwerk 2)					
	1.6 e	66	09.96	03.99						
	1.6 i	55	11.97	03.99						
	1.9 D (0A)	47	11.97	12.02						
	1.9 D (0R)	47	09.98	12.02						
	1.9 D (0U)	47	11.97	12.02						
	1.9 dT	66	09.96	12.02						
	1.9 dTi (1U)	59	02.01	12.02						
	1.9 dTi (08)	72	03.97	02.01						
	1.9 dTi (0N)	72	03.97	02.99						
	1.9 TDI	69	09.96	12.02						
2.0 i (0G)	84	09.96	02.99							
1.4 16V (0D)	70	03.99	12.02		24.3541-1749.5	240427		D=54, - Halter	TRW	
1.6 16V (11)	79	03.99	12.02		24.3541-1750.5	240428		D=54, - Halter	TRW	
1.6 16V (1J)	79	03.99	12.02							
1.6 16V (04)	79	04.98	12.02	+ verstärktes Fahrwerk 3)						
1.6 16V (0B)	79	03.99	12.02							
1.8 16V	85	01.01	12.02							
1.9 dCi	75	09.98	12.02							
1.9 dTi (1U)	59	02.01	12.02							
1.9 dTi (08)	72	03.97	02.01							
1.9 dTi (0N)	72	03.99	02.01							
2.0 i	80	03.99	12.02							
2.0 i (07)	84	09.96	12.02							
2.0 i (0G)	84	03.99	12.02							
	1.4 16V	70	06.98	12.02		24.5111-0390.3	330566	2		L=390
	1.4 e	55	09.96	12.02						
	1.6 16V (04)	79	04.98	12.02						
	1.6 16V (0B)	79	09.98	12.02						
	1.6 e	66	09.96	03.99						
	1.6 i	55	09.96	03.99						
	1.8 16V	85	01.01	12.02						
	1.9 D	47	09.96	12.02						
	1.9 dCi (1F)	75	02.01	12.02						
	1.9 dCi (05)	75	02.01	12.02						
	1.9 dT	66	09.96	12.02						
	1.9 dTi (1U)	59	02.01	12.02						
	1.9 dTi (08)	72	03.97	02.01						
	1.9 TDI	69	09.96	12.02						
	2.0 i (07)	84	09.96	12.02						
	1.9 dTi (0N)	72	03.97	02.01		24.5111-0390.3	330566	2	Länge beachten 4)	L=390
	2.0 i (0G)	84	09.96	12.02						
	1.4 16V	70	06.98	12.02		24.5229-0265.3	330540	2		L=265
	1.4 e	55	09.96	12.02						
	1.6 16V (04)	79	04.98	12.02						
	1.6 16V (0B)	79	09.98	12.02						
	1.6 e	66	09.96	03.99						
	1.6 i	55	09.96	03.99						
	1.8 16V	85	01.01	12.02						
	1.9 D	47	09.96	12.02						
	1.9 dT	66	09.96	12.02						
	1.9 dTi (1U)	59	02.01	12.02						
	1.9 dTi (08)	72	03.97	02.01						
	1.9 TDI	69	09.96	12.02						
2.0 i (07)	84	09.96	12.02							
1.9 dTi (0N)	72	03.97	02.01		24.5229-0265.3	330540	2	Länge beachten 4)	L=265	
2.0 i (0G)	84	09.96	12.02							
	1.4 16V (0D)	70	03.99	12.02	- ABS	24.3217-1705.3	020020			Rz 17,46
	1.4 16V (0W)	70	06.98	12.02	- ABS					
	1.4 e (0E)	55	09.96	12.02						
	1.4 e (0V)	55	04.98	02.99	+ ABS					
	1.4 e (0V)	55	04.98	12.02	- ABS					
	1.6 16V (11)	79	09.99	12.02						
1.6 16V (1C)	79	09.99	12.02							

1) + ABS/ - reinforced suspension / + ABS/ - sospensione rinforzata / + ABS/ - châssis renforcé / + ABS/ - suspensión reforzada

2) + reinforced suspension / + sospensione rinforzata / + châssis renforcé / + suspensión reforzada

3) - reinforced suspension / - sospensione rinforzata / - châssis renforcé / - suspensión reforzada

4) notice length / attenzione lunghezza / faire attention longueur / atención largo



RENAULT MEGANE I Classic (LA_) (96-02)

	1.6 16V (04)	79	04.98	12.02	- ABS	24.3217-1705.3	020020			Rz 17,46					
	1.6 e	66	09.96	03.99											
	1.6 i	55	09.96	03.99											
	1.9 D	47	09.96	12.02											
	1.9 dCi	75	09.98	12.02	- ABS										
	1.9 dT	66	09.96	12.02											
	1.9 dTi (1U)	59	02.01	12.02	- ABS										
	1.9 dTi (08)	72	03.97	02.01	- ABS										
	1.9 dTi (0N)	72	03.97	02.99	+ ABS										
	1.9 dTi (0N)	72	03.97	02.01	- ABS										
	2.0 i (07)	84	09.96	12.02											
	2.0 i (0G)	84	09.96	02.99	+ ABS										
	2.0 i (0G)	84	09.96	12.02	- ABS										
	1.4 16V (0D)	70	03.99	12.02	+ ABS/ - ASR										
	1.4 16V (0W)	70	06.98	12.02	+ ABS										
1.4 e (0V)	55	03.99	12.02	+ ABS											
1.6 16V (04)	79	04.98	12.02	+ ABS											
1.8 16V (12)	85	01.01	12.02	+ ABS/ - ASR											
1.8 16V (1M)	85	01.01	12.02	+ ABS/ - ASR											
1.9 dCi	75	09.98	12.02	+ ABS											
1.9 dTi (1U)	59	02.01	12.02	+ ABS											
1.9 dTi (08)	72	03.97	02.01	+ ABS											
1.9 dTi (0N)	72	03.99	02.01	+ ABS											
2.0 i (0G)	84	03.99	12.02	+ ABS											
1.9 TDI	69	09.96	12.02		24.3220-1711.3	020409	+ GG ¹⁾	Rz 20,64	TRW						
	1.4 16V (0D)	70	03.99	12.02		24.3727-1057.2	581057	2	↓	L=1473					
	1.4 16V (0W)	70	06.98	12.02	- verstärktes Fahrwerk ²⁾										
	1.4 e (0E)	55	09.96	12.02	- verstärktes Fahrwerk ²⁾										
	1.4 e (0V)	55	04.98	12.02											
	1.6 16V (04)	79	04.98	12.02	- verstärktes Fahrwerk ²⁾										
	1.6 16V (0B)	79	09.98	12.02											
	1.6 e (0F)	66	09.96	03.99	- verstärktes Fahrwerk ²⁾										
	1.6 i	55	09.96	03.99											
	1.8 16V	85	01.01	12.02											
	1.9 D	47	09.96	12.02	- verstärktes Fahrwerk ²⁾										
	1.9 dT	66	09.96	12.02											
	1.9 dTi (1U)	59	02.01	12.02	- verstärktes Fahrwerk ²⁾										
	1.9 dTi (08)	72	03.97	02.01											
	1.9 dTi (0N)	72	03.97	02.01	- verstärktes Fahrwerk ²⁾										
	2.0 i (0G)	84	09.96	12.02											
	1.4 16V (0W)	70	06.98	12.02	+ verstärktes Fahrwerk ³⁾						24.3727-1050.2	581050	2	↓	L=1440
	1.4 e (0E)	55	09.96	12.02	+ verstärktes Fahrwerk ³⁾										
	1.6 16V (11)	79	09.99	12.02											
	1.6 16V (1C)	79	09.99	12.02											
	1.6 16V (04)	79	04.98	12.02	+ verstärktes Fahrwerk ³⁾										
1.6 e (0F)	66	09.96	03.99	+ verstärktes Fahrwerk ³⁾											
1.6 e (0S)	66	09.96	03.99												
1.9 D	47	09.96	12.02	+ verstärktes Fahrwerk ³⁾											
1.9 dTi (1U)	59	02.01	12.02	+ verstärktes Fahrwerk ³⁾											
1.9 dTi (0N)	72	03.97	02.01	+ verstärktes Fahrwerk ³⁾											
2.0 i (07)	84	09.96	12.02												
1.9 TDI	69	09.96	12.02		24.3727-1063.2	581063	2	↓	L=1456						
	1.4 e (0E)	55	09.96	12.02	- verstärktes Fahrwerk ²⁾	24.6582-1701.3	320171			BRL (4)					
	1.6 e (0F)	66	09.96	03.99	- verstärktes Fahrwerk ²⁾										
	1.6 i	55	09.96	03.99											
	1.9 D (0A)	47	09.96	12.02	- verstärktes Fahrwerk ²⁾										
	1.4 16V (0W)	70	06.98	12.02		24.3728-1018.2	591018			L=972					
	1.4 e	55	09.96	12.02											
	1.6 16V (11)	79	09.99	12.02											
	1.6 16V (1C)	79	09.99	12.02											
	1.6 16V (04)	79	04.98	12.02											
	1.6 e (0F)	66	09.96	03.99											
	1.6 i	55	09.96	03.99											
	1.9 D (0A)	47	09.96	12.02											
	1.9 D (0R)	47	09.98	12.02											
	1.9 D (0U)	47	09.96	12.02											
	1.9 dT (0K)	66	09.96	12.02											
	1.9 dT (0Y)	66	09.96	12.02											
	1.9 TDI	69	09.96	12.02											
	2.0 i (07)	84	09.96	12.02											
	2.0 i (0G)	84	09.96	12.02											
	1.9 dCi (05)	75	09.98	12.02							24.3728-1024.2	591024			L=973
	1.9 dTi	72	03.97	02.01											

RENAULT MEGANE I Coach (DA_) (95-03)















	1.4 16V (0W)	70	06.98	02.03	- ABS	03.7760-5602.4	300121			10"	ATE												
	1.6 16V (0B)	79	10.00	02.03	- ABS																		
	2.0 16V (0P)	103	10.00	02.03	- ABS																		
	1.4 16V (0W)	70	06.98	02.03	+ ABS							03.7760-5502.4	300151			10"	ATE						
	1.4 16V (0D)	70	10.00	02.03	+ ABS																		
	1.6 16V (0B)	79	10.00	02.03	+ ABS																		
	1.9 dCi (1F)	75	10.00	02.03	+ ABS																		
	2.0 16V (0P)	103	10.00	02.03	+ ABS																		
	1.6 16V (04)	79	04.98	02.03	+ ABS													03.7760-5102.4	300140			10"	ATE
	1.9 dCi (05)	75	10.00	02.03	+ ABS																		
1.9 dTi	72	03.99	02.03																				



























¹⁾ + cast iron / + ghisa / + fonte grise / + fundición de gris



















²⁾ - reinforced suspension / - sospensione rinforzata / - châssis renforcé / - suspensión reforzada

³⁾ + reinforced suspension / + sospensione rinforzata / + châssis renforcé / + suspensión reforzada



									
RENAULT MEGANE I Coach (DA_) (95-03)									
	2.0 16V 2.0 16V (03) 2.0 16V (OH)	◀102 ◀103 ◀108		01.02 02.03 07.98 02.03 03.99 02.03		03.7760-5102.4	300140	10"	ATE
	1.4 16V 1.6 16V (0B) 1.9 dCi (1F) 2.0 16V 2.0 16V (OP)	70 79 75 102 103		06.98 02.03 - ABS 10.00 02.03 - ABS 10.00 02.03 - ABS 01.02 02.03 - ABS 10.00 02.03 - ABS		03.2122-1541.3	010511	THz 22,20	ATE
	1.6 e 1.9 dTi 2.0 i	◀ 66 72 ◀		09.95 02.03 - ABS 05.97 02.03 - ABS 09.95 02.03 - ABS		03.2120-2031.3	010106	THz 20,64	ATE
	2.0 16V (OH)	108		09.95 02.99		24.2123-1701.3	010424	THz 23,81	
	1.4 16V (OW)	◀ 70		06.98 02.03 + ABS		03.2122-1521.3	010494	THz 22,20	ATE
	1.6 e 1.9 dTi 2.0 i	◀ 66 72 ◀		09.95 02.03 + ABS 05.97 02.99 + ABS 09.95 02.03 + ABS		03.2120-4441.3	010510	THz 20,64	ATE
	1.4 16V (OD) 1.6 16V (0B) 1.9 dCi (1F) 2.0 16V 2.0 16V (OP)	◀ 70 ◀ 79 ◀ 75 ◀102 ◀103		10.00 02.03 + ABS 10.00 02.03 + ABS 10.00 02.03 + ABS 01.02 02.03 + ABS 10.00 02.03 + ABS		03.2123-2146.3	010572	THz 23,81	ATE
	1.6 16V (04) 1.9 dCi (05) 1.9 dTi 2.0 16V (03) 2.0 16V (OH)	◀ 79 ◀ 75 72 ◀103 ◀108		04.98 02.03 + ABS 10.00 02.03 + ABS 03.99 02.03 + ABS 07.98 02.03 03.99 02.03		03.2123-2146.3	010572	THz 23,81	ATE
	1.6 e 1.9 dTi 2.0 i	◀ 66 72 ◀		09.95 02.03 + ABS 05.97 02.99 + ABS 09.95 02.03 + ABS		24.2120-1723.3	010545	THz 20,64	BDX
	1.6 e 2.0 i	▶ 66 ▶		09.95 02.03 + ABS 09.95 02.03 + ABS		24.2120-1725.3	010579	THz 20,64	BDX
	1.4 16V (OW) 1.6 e 2.0 i	▶ 70 ▶ 66 ▶		06.98 02.03 09.95 02.03 + ABS 09.95 02.03 + ABS		03.2120-4441.3	010510	THz 20,64	ATE
	1.4 16V (OW) 1.6 e 1.9 dTi 2.0 i	70 66 72 72		06.98 02.03 09.95 02.03 05.97 02.99 09.95 02.03		24.3481-1615.5 24.3481-1616.5 24.0101-4806.2	240031 240032 260052	D=48, - Halter D=48, - Halter Bremsattel-Zubehör	TRW TRW TRW
	1.4 16V (OD) 1.6 16V 1.9 dCi 1.9 dTi 2.0 16V 2.0 16V (03) 2.0 16V (OH) 2.0 16V (OP)	70 79 72 72 102 103 108 103		10.00 02.03 04.98 02.03 10.00 02.03 03.99 02.03 01.02 02.03 07.98 02.03 09.98 02.03 10.00 02.03		24.3541-1749.5 24.3541-1750.5	240427 240428	D=54, - Halter D=54, - Halter	TRW TRW
	2.0 16V (OH)	◀108		09.95 08.98		24.3541-1741.5 24.3541-1742.5	240215 240216	D=54, - Halter D=54, - Halter	TRW TRW
	2.0 16V (OH)	▶108		09.95 08.98		24.3601-1707.5 24.3601-1708.5	240229 240230	D=60, - Halter D=60, - Halter	TRW TRW
	1.4 16V 1.6 16V 1.6 e 1.9 dCi 1.9 dTi 2.0 16V 2.0 16V (03) 2.0 16V (OH) 2.0 16V (OP) 2.0 i	70 79 66 72 72 102 103 108 103 103		06.98 02.03 04.98 02.03 09.95 02.03 10.00 02.03 05.97 02.03 01.02 02.03 07.98 02.03 09.95 02.03 10.00 02.03 09.95 02.03		24.5111-0390.3	330566	2	L=390
	1.4 16V 1.6 16V 1.6 e 1.9 dCi 1.9 dTi 2.0 16V 2.0 16V (03) 2.0 16V (OH) 2.0 16V (OP) 2.0 i	70 79 66 72 72 102 103 108 103 103		06.98 02.03 04.98 02.03 09.95 02.03 10.00 02.03 05.97 02.03 01.02 02.03 07.98 02.03 09.95 02.03 10.00 02.03 09.95 02.03		24.5229-0265.3	330540	2	L=265
	1.4 16V (OW) 1.6 16V (04) 1.6 e 1.9 dCi (05) 1.9 dTi 1.9 dTi 2.0 i	70 79 66 75 72 72 72		06.98 02.03 - ABS 04.98 02.03 - ABS 09.95 02.03 07.98 02.03 - ABS 03.99 02.03 - ABS 05.97 02.99 09.95 02.03		24.3217-1705.3	020020	Rz 17,46	
	1.4 16V (OD) 1.4 16V (OW) 1.6 16V (04) 1.6 16V (0B) 1.9 dCi (1F) 1.9 dCi (05) 1.9 dTi	70 70 79 79 75 75 72		10.00 02.03 + ABS/ - ASR 06.98 02.03 + ABS 04.98 02.03 + ABS 10.00 02.03 + ABS/ - ASR 10.00 02.03 + ABS/ - ASR 10.00 02.03 + ABS 03.99 02.03 + ABS		24.3219-1728.3	020452	Rz 19,05	

												
RENAULT MEGANE I Coach (DA_) (95-03)												
	1.4 16V (0D)	70		10.00	02.03		24.3727-1054.2	581054	2 ↓		L=1367	
	1.6 16V	79		04.98	02.03							
	1.9 dCi			10.00	02.03							
	1.9 dTi	72		05.97	02.03							
	2.0 i			09.95	02.03							
	2.0 16V (0H)	108		09.95	02.03		24.6582-1701.3	320171			BRL (4)	
	1.4 16V (0W)	70		06.98	02.03		24.3728-1018.2	591018			L=972	
	1.6 16V (04)	79		04.98	02.03							
	1.6 e	66		09.95	02.03							
	2.0 16V	102		01.02	02.03							
	2.0 16V (03)	103		07.98	02.03							
	2.0 i			09.95	02.03							
	1.9 dCi (05)	75		07.98	02.03		24.3728-1024.2	591024			L=973	
	1.9 dTi	72		05.97	02.03							
	2.0 16V	102		01.02	02.03							
RENAULT MEGANE I Cabrio (EA_) (96-03)												
	1.4 16V (W)	70		06.98	10.03	- ABS	03.7760-5602.4	300121			10"	ATE
	1.6 16V (B)	79		10.00	10.03	- ABS						
	2.0 16V (P)	103		10.00	10.03	- ABS						
	1.4 16V (W)	70		06.98	10.03	+ ABS	03.7760-5502.4	300151			10"	ATE
	1.6 16V (4)	79		09.98	10.03	+ ABS	03.7760-5102.4	300140			10"	ATE
	2.0 16V	102		01.02	10.03							
	2.0 16V (3)	103		09.98	10.03							
	1.4 16V (D)	70		10.00	10.03	+ ABS	03.7863-2002.4	300126			10"	ATE
	1.6 16V (B)	79		10.00	10.03	+ ABS						
	2.0 16V (P)	103		10.00	10.03	+ ABS						
	1.4 16V	70		06.98	10.03	- ABS	03.2122-1541.3	010511			THz 22,20	ATE
	1.6 16V (B)	79		10.00	10.03	- ABS						
	2.0 16V (P)	103		10.00	10.03	- ABS						
	1.6 e	66		08.96	10.03	- ABS	03.2120-2031.3	010106			THz 20,64	ATE
	2.0 i			12.96	10.03	- ABS						
	1.4 16V (W)	70		06.98	10.03	+ ABS	03.2122-1521.3	010494			THz 22,20	ATE
	1.6 e	66		08.96	10.03	+ ABS	03.2120-4441.3	010510			THz 20,64	ATE
	2.0 i			12.96	10.03	+ ABS						
	1.6 16V (4)	79		09.98	10.03	+ ABS	03.2123-2146.3	010572			THz 23,81	ATE
	2.0 16V	102		01.02	10.03							
	2.0 16V (3)	103		09.98	10.03							
	1.4 16V (D)	70		10.00	10.03	+ ABS	03.2123-2146.3	010572			THz 23,81	ATE
	1.6 16V (B)	79		10.00	10.03	+ ABS						
	2.0 16V (P)	103		10.00	10.03	+ ABS						
	1.6 e	66		08.96	10.03	+ ABS	24.2120-1723.3	010545			THz 20,64	BDX
	2.0 i			12.96	10.03	+ ABS						
	1.6 e	66		08.96	10.03	+ ABS	24.2120-1725.3	010579			THz 20,64	BDX
	2.0 i			12.96	10.03	+ ABS						
	2.0 16V (H)	108		08.96	10.03		24.2123-1701.3	010424			THz 23,81	
	1.4 16V (W)	70		06.98	10.03		24.3481-1615.5	240031			D=48, - Halter	TRW
	1.6 e	66		08.96	10.03		24.3481-1616.5	240032			D=48, - Halter	TRW
	2.0 i			12.96	10.03		24.0101-4806.2	260052			Bremssattel-Zubehör	TRW
	1.4 16V (D)	70		10.00	10.03		24.3541-1749.5	240427			D=54, - Halter	TRW
	1.6 16V	79		09.98	10.03		24.3541-1750.5	240428			D=54, - Halter	TRW
	2.0 16V	102		01.02	10.03							
	2.0 16V (3)	103		09.98	10.03							
	2.0 16V (H)	108		09.98	10.03							
	2.0 16V (P)	103		10.00	10.03							
	2.0 16V (H)	108		08.96	08.98		24.3541-1741.5	240215			D=54, - Halter	TRW
							24.3541-1742.5	240216			D=54, - Halter	TRW
	2.0 16V (H)	108		08.96	08.98		24.3601-1707.5	240229			D=60, - Halter	TRW
							24.3601-1708.5	240230			D=60, - Halter	TRW
	1.4 16V	70		06.98	10.03		24.5111-0390.3	330566	2		L=390	
	1.6 16V	79		09.98	10.03							
	1.6 e	66		08.96	10.03							
	2.0 16V	102		01.02	01.02							
	2.0 16V (3)	103		09.98	10.03							
	2.0 16V (H)	108		08.96	10.03							
	2.0 16V (P)	103		10.00	10.03							
	2.0 i			12.96	10.03							
	1.4 16V	70		06.98	10.03		24.5229-0265.3	330540	2		L=265	
	1.6 16V	79		09.98	10.03							
	1.6 e	66		08.96	10.03							
	2.0 16V	102		01.02	10.03							
	2.0 16V (3)	103		09.98	10.03							
	2.0 16V (H)	108		08.96	10.03							
	2.0 16V (P)	103		10.00	10.03							
	2.0 i			12.96	10.03							
	1.4 16V (W)	70		06.98	10.03	- ABS	24.3217-1705.3	020020			Rz 17,46	
	1.6 16V (4)	79		09.98	10.03	- ABS						
	1.6 e	66		08.96	10.03							
	2.0 i			12.96	10.03							
	1.4 16V (D)	70		10.00	10.03	+ ABS/ - ASR	24.3219-1728.3	020452			Rz 19,05	
	1.4 16V (W)	70		06.98	10.03	+ ABS						

								
RENAULT MEGANE I Cabrio (EA_) (96-03)								
	1.6 16V (4) 1.6 16V (B)	79 79	09.98 10.00	12.03 + ABS 12.03 + ABS / - ASR	24.3219-1728.3	020452		Rz 19,05
	1.4 16V 1.6 16V 1.6 e 2.0 i	70 79 66	06.98 09.98 08.96 12.96	12.03 12.03 12.03 12.03	24.3727-1054.2	581054	2 ↓	L=1367
	1.6 e 2.0 16V (H) 2.0 i	66 108	08.96 08.96 12.96	12.03 12.03 12.03	24.6582-1701.3	320171		BRL (4)
	1.4 16V (W) 1.6 16V (4) 1.6 e 2.0 16V 2.0 16V (3) 2.0 i	70 79 66 102 103	06.98 09.98 08.96 01.02 09.98 12.96	12.03 12.03 12.03 12.03 12.03 12.03	24.3728-1018.2	591018		L=972
RENAULT MEGANE I Grandtour (KA_) (98-03)								
	1.4 16V 1.4 e 1.6 16V 1.6 e 1.9 D 1.9 dTi (1U) 1.9 dTi (ON)	70 55 79 66 47 59 72	09.98 09.98 09.98 09.98 03.99 02.01 01.99	12.03 - ABS 12.03 - ABS 12.03 - ABS 12.03 - ABS 12.03 - ABS 12.03 - ABS 12.03 - ABS	03.7760-5602.4	300121		10" ATE
	1.4 16V (OW) 1.4 e 1.6 e 1.9 D	70 55 66 47	09.98 09.98 03.99 03.99	12.03 + ABS 12.03 + ABS 12.03 + ABS 12.03 + ABS	03.7760-5502.4	300151	+ verstärktes Fahrwerk ¹⁾	10" ATE
	1.6 16V (O4) 1.9 dCi (O5) 1.9 dTi (ON)	79 75 72	09.98 02.01 01.99	12.03 + ABS 12.03 + ABS 12.03 + ABS	03.7760-5102.4	300140	- verstärktes Fahrwerk ²⁾	10" ATE
	1.4 16V (OD) 1.6 16V (OB) 1.8 16V 1.9 dCi (1F) 1.9 dTi (1U)	70 79 85 75 59	03.99 03.99 03.99 02.01 02.01	12.03 + ABS 12.03 + ABS 12.03 + ABS 12.03 + ABS 12.03 + ABS	03.7863-2002.4	300126		10" ATE
	1.6 e	66	09.98	02.99	03.2120-2031.3 24.2120-1723.3	010106 010545	- ABS + ABS	THz 20,64 THz 20,64 ATE BDX
	1.4 16V 1.4 e 1.6 e 1.9 D	70 55 66 47	09.98 09.98 03.99 03.99	12.03 12.03 12.03 12.03	03.2122-1541.3 03.2122-1521.3	010511 010494	- ABS + ABS	THz 22,20 THz 22,20 ATE ATE
	1.6 16V 1.9 dCi 1.9 dTi (ON)	79 75 72	09.98 02.01 01.99	12.03 12.03 12.03	03.2123-1551.3 03.2123-2146.3	010512 010572	- ABS + ABS	THz 23,81 THz 23,81 ATE ATE
	1.8 16V (1A) 1.8 16V (1M) 1.9 dTi (1U) 1.8 16V (12) 1.9 dTi (1U)	85 85 59 85 59	01.01 01.01 02.01 01.01 02.01	12.03 + ABS 12.03 + ABS 12.03 - ABS 12.03 + ABS 12.03 + ABS	03.2123-2146.3	010572 010701		THz 23,81 ATE ATE
	1.4 16V 1.4 e 1.6 e 1.9 D	70 55 66 47	09.98 09.98 09.98 03.99	12.03 12.03 12.03 12.03	24.3481-1615.5 24.3481-1616.5 24.0101-4806.2	240031 240032 260052	<input type="checkbox"/> <input type="checkbox"/>	D=48, - Halter D=48, - Halter Bremsattel-Zubehör TRW TRW TRW
	1.6 16V 1.8 16V 1.9 dCi 1.9 dTi (1U) 1.9 dTi (ON)	79 85 75 59 72	09.98 01.01 02.01 02.01 01.99	12.03 12.03 12.03 12.03 12.03	24.3541-1749.5 24.3541-1750.5	240427 240428	<input type="checkbox"/> <input type="checkbox"/>	D=54, - Halter D=54, - Halter TRW TRW
	1.4 16V 1.4 e 1.6 16V 1.6 e 1.8 16V 1.9 D 1.9 dCi 1.9 dTi (1U) 1.9 dTi (ON)	70 55 79 66 85 47 75 59 72	09.98 09.98 09.98 09.98 01.01 03.99 02.01 02.01 01.99	12.03 12.03 12.03 12.03 12.03 12.03 12.03 12.03 02.01	24.5111-0390.3	330566	2	L=390
	1.4 16V (OD) 1.6 16V (O4) 1.8 16V 1.9 dCi 1.9 dTi (1U) 1.9 dTi (ON)	70 79 85 75 59 72	03.99 07.99 01.01 02.01 02.01 07.99	12.03 12.03 12.03 12.03 12.03 12.01	24.3344-1707.7 24.3344-1708.7	220531 220532	<input type="checkbox"/> <input type="checkbox"/>	D=34, - Halter D=34, - Halter TRW TRW
	1.4 16V 1.4 e 1.6 16V 1.6 e 1.8 16V 1.9 D 1.9 dCi 1.9 dTi (1U) 1.9 dTi (ON)	70 55 79 66 85 47 75 59 72	09.98 09.98 09.98 09.98 01.01 03.99 02.01 02.01 01.99	12.03 12.03 12.03 12.03 12.03 12.03 12.03 12.03 02.01	24.5229-0265.3	330540	2	L=265

¹⁾ + reinforced suspension / + sospensione rinforzata / + châssis renforcé / + suspensión reforzada

²⁾ - reinforced suspension / - sospensione rinforzata / - châssis renforcé / - suspensión reforzada

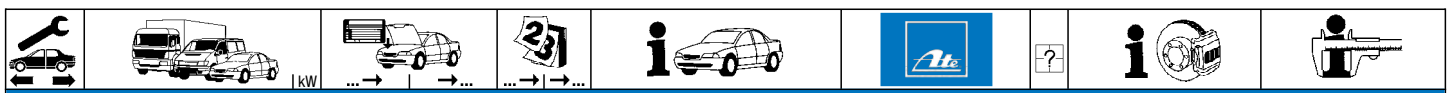

RENAULT MEGANE I Grandtour (KA_) (98-03)

	1.4 16V (0W)	70	09.98	12.03	24.3220-1711.3	020409	+ GG ¹⁾	Rz 20,64	TRW					
	1.4 e	55	09.98	12.03										
	1.6 16V (04)	79	09.98	06.99										
	1.6 e	66	09.98	12.03										
	1.9 D	47	03.99	12.03										
	1.9 dTi (0N)	72	01.99	06.99										
	1.4 16V	70	09.98	12.03	24.3727-1063.2	581063	2 ↓	L=1456						
	1.4 e	55	09.98	12.03										
	1.6 e	66	09.98	12.03										
	1.9 D	47	03.99	12.03										
	1.6 16V	79	09.98	12.03						24.3727-1065.2	581065	☐	L=1519	
	1.8 16V	85	01.01	12.03										
1.9 dCi	75	02.01	12.03											
1.9 dTi (1U)	59	02.01	12.03											
1.9 dTi (0N)	72	01.99	02.01											
	1.4 16V	70	09.98	12.03	24.3728-1018.2	591018		L=972						
	1.4 e	55	09.98	12.03										
	1.6 16V (04)	79	09.98	12.03										
	1.6 e	66	09.98	12.03										
	1.9 D	47	03.99	12.03										
	1.9 dTi (1U)	59	02.01	12.03										
1.9 dCi	75	02.01	12.03	24.3728-1024.2	591024		L=973							
1.9 dTi (1U)	59	02.01	12.03											
1.9 dTi (0N)	72	01.99	12.03											

RENAULT MEGANE II Limousine 3/5-tuerig (BM/CM_) (02-08)

	1.4 16V	72	11.02	11.08	24.2123-1760.3	010779		THz 23,81	TRW													
	1.5 dCi	60	11.02	11.08																		
	1.5 dCi	63	05.05	11.08																		
	1.5 dCi	76	01.07	11.08																		
	1.5 dCi	78	05.05	11.08																		
	1.6 16V	77	06.05	11.08																		
	1.6 16V	83	11.02	11.08																		
	1.6 FlexFuel	77	01.07	11.08																		
	1.9 dCi	85	01.06	11.08																		
	1.9 dCi	88	11.02	11.08																		
	1.9 dCi	96	05.05	11.08																		
	2.0 16V	99	11.02	11.08																		
	2.0 16V	102	06.06	12.10																		
	2.0 16V	169	08.06	11.08																		
	2.0 16V Sport	165	05.04	11.08																		
	2.0 16V Turbo	120	05.04	11.08																		
	2.0 dCi	110	09.05	11.08																		
2.0 dCi	127	01.07	11.08																			
	1.4 16V	72	11.02	11.08	24.3541-1827.5	240407	☐	D=54, - Halter	TRW													
										24.3541-1828.5	240408	☐	D=54, - Halter	TRW								
	1.4 16V	72	10.05	11.08	11.9541-9546.2	220626	☐	D=54, - Halter	ATE													
	1.5 dCi	60	10.05	11.08						11.0101-5407.2	260011	2	Hülensatz	ATE								
	1.5 dCi	63	10.05	11.08											11.8171-0008.1	990049	Führungsbolzen	ATE				
	1.5 dCi	76	01.07	11.08															11.8116-0301.1	390610	Haltefeder	ATE
	1.5 dCi	78	05.05	11.08																		
	1.6 16V	77	06.05	11.08																		
	1.6 16V	83	10.05	11.08																		
	1.6 FlexFuel	77	01.07	11.08																		
	1.9 dCi	85	01.06	11.08																		
	1.9 dCi	88	10.05	11.08																		
	1.9 dCi	96	05.05	11.08																		
	2.0 16V	99	10.05	11.08																		
	2.0 16V	102	06.06	12.10																		
	2.0 16V Turbo	120	10.05	11.08																		
	2.0 dCi	110	09.05	11.08																		
	2.0 dCi	127	01.07	11.08																		
		1.4 16V	72	11.02																		
1.5 dCi		60	11.02	09.05																		
1.5 dCi		63	05.05	09.05																		
1.6 16V		83	11.02	09.05																		
1.9 dCi		88	11.02	09.05																		
2.0 16V		99	11.02	09.05																		
	1.4 16V	72	10.05	11.08	24.5155-0445.3	331057	2	L=445														
	1.5 dCi	60	10.05	11.08																		
	1.5 dCi	63	10.05	11.08																		
	1.5 dCi	76	01.07	11.08																		
	1.5 dCi	78	05.05	11.08																		
	1.6 16V	77	06.05	11.08																		
	1.6 16V	83	10.05	11.08																		
	1.6 FlexFuel	77	01.07	11.08																		
	1.9 dCi	85	01.06	11.08																		
	1.9 dCi	88	10.05	11.08																		
	1.9 dCi	96	05.05	11.08																		
	2.0 16V	99	10.05	11.08																		
	2.0 16V	102	06.06	12.10																		
	2.0 dCi	110	09.05	11.08																		
	2.0 dCi	127	01.07	11.08																		

¹⁾ + cast iron / + ghisa / + fonte grise / + fundición de gris



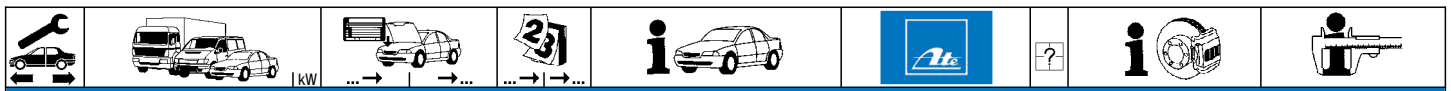

















RENAULT MEGANE II Limousine 3/5-tuerig (BM/CM) (02-08)

	1.4 16V	72	12.02	11.08	24.3347-1705.7	220751	<input type="checkbox"/> <input type="checkbox"/>	D=34, - Halter D=34, - Halter Bremsattel-Zubehör	TRW TRW TRW			
	1.5 dCi	60	12.02	11.08	24.3347-1706.7	220752						
	1.5 dCi	63	05.05	11.08	24.0101-3803.2	260101						
	1.5 dCi	76	01.07	11.08								
	1.5 dCi	78	05.05	11.08								
	1.6 16V	77	06.05	11.08								
	1.6 16V	83	12.02	11.08								
	1.6 FlexFuel	77	01.07	11.08								
	1.9 dCi	85	01.06	11.08								
	1.9 dCi	88	12.02	11.08								
	1.9 dCi	96	05.05	11.08								
	2.0 16V	99	12.02	11.08								
	2.0 16V	102	06.06	12.10								
	2.0 16V	169	08.06	11.08								
2.0 16V Sport	165	05.04	11.08									
2.0 16V Turbo	120	05.04	11.08									
2.0 dCi	110	09.05	11.08									
	1.4 16V	72	11.02	11.08	11.9387-7001.2	220397	<input type="checkbox"/> PR 1334 <input type="checkbox"/> PR 1334 2	D=38, - Halter D=38, - Halter Haltefeder Führungsbolzen Hülzensatz	ATE ATE ATE ATE ATE			
	1.5 dCi	60	11.02	11.08	11.9387-7002.2	220398						
	1.5 dCi	63	05.05	11.08	11.8116-0340.1	390595						
	1.5 dCi	76	01.07	11.08	11.8171-0008.1	990049						
	1.5 dCi	78	05.05	11.08	11.0101-5407.2	260011						
	1.6 16V	77	06.05	11.08								
	1.6 16V	83	11.02	11.08								
	1.6 FlexFuel	77	01.07	11.08								
	1.9 dCi	85	01.06	11.08								
	1.9 dCi	88	11.02	11.08								
	1.9 dCi	96	05.05	11.08								
	2.0 16V	99	11.02	11.08								
	2.0 16V	102	06.06	12.10								
	2.0 16V	169	08.06	11.08								
2.0 16V Sport	165	05.04	11.08									
2.0 16V Turbo	120	05.04	11.08									
2.0 dCi	110	09.05	11.08									
	1.4 16V	72	11.02	08.05	24.5251-0185.3	330701	2 <input type="checkbox"/>	L=185				
	1.5 dCi	60	11.02	08.05								
	1.5 dCi	63	05.05	08.05								
	1.6 16V	83	11.02	08.05								
	1.9 dCi	88	11.02	08.05								
	1.9 dCi	96	05.05	08.05								
	2.0 16V	99	11.02	08.05								
	2.0 16V Sport	165	05.04	08.05								
	2.0 16V Turbo	120	05.04	08.05								
	1.4 16V	72	09.05	11.08	24.5229-0185.3	330397				2 <input type="checkbox"/>	L=185	
	1.5 dCi	60	09.05	11.08								
	1.5 dCi	63	09.05	11.08								
	1.5 dCi	76	01.07	11.08								
	1.5 dCi	78	05.05	11.08								
1.6 16V	77	06.05	11.08									
1.6 16V	83	09.05	11.08									
1.6 FlexFuel	77	01.07	11.08									
1.9 dCi	85	01.06	11.08									
1.9 dCi	88	09.05	11.08									
1.9 dCi	96	09.05	11.08									
2.0 16V	99	09.05	11.08									
2.0 16V	102	06.06	12.10									
2.0 16V	169	08.06	11.08									
2.0 16V Sport	165	09.05	11.08									
2.0 16V Turbo	120	09.05	11.08									
2.0 dCi	110	09.05	11.08									
2.0 dCi	127	01.07	11.08									
	1.4 16V	72	11.02	11.08	24.3727-1070.2	581070	2 <input type="checkbox"/>	L=2023				
	1.5 dCi	60	11.02	11.08								
	1.5 dCi	63	05.05	11.08								
	1.5 dCi	76	01.07	11.08								
	1.5 dCi	78	05.05	11.08								
	1.6 16V	77	06.05	11.08								
	1.6 16V	83	11.02	11.08								
	1.6 FlexFuel	77	01.07	11.08								
	1.9 dCi	85	01.06	11.08								
	1.9 dCi	88	11.02	11.08								
	1.9 dCi	96	05.05	11.08								
	2.0 16V	99	11.02	11.08								
	2.0 16V	102	06.06	12.10								
	2.0 16V	169	08.06	11.08								
2.0 16V Sport	165	05.04	11.08									
2.0 16V Turbo	120	05.04	11.08									
2.0 dCi	110	09.05	11.08									
2.0 dCi	127	01.07	11.08									
	1.4 16V	72	11.02	11.08	24.2418-1701.3	030135	+ 5-Gang-Getriebe 1)	Gz 18,82				
	1.5 dCi	60	11.02	11.08								
	1.5 dCi	63	05.05	11.08								
	1.5 dCi	76	01.07	11.08								
	1.5 dCi	78	05.05	11.08								
	1.6 16V	77	06.05	11.08								
	1.6 16V	83	11.02	11.08								
	1.6 FlexFuel	77	01.07	11.08								

1) + 5 gear transmission / + scatola cambio 5 marce / + transmission 5-vitesses / + cambio de 5 velocidades

								
RENAULT MEGANE II Limousine 3/5-tuerig (BM/CM) (02-08)								
	1.9 dCi	85	01.06	11.08	24.2418-1701.3	030135	+ 5-Gang-Getriebe ¹⁾	Gz 18,82
	1.9 dCi	88	11.02	11.08				
	1.9 dCi	96	05.05	11.08				
	2.0 16V	99	11.02	11.08				
	2.0 16V	102	06.06	12.10				
	2.0 16V	169	08.06	11.08				
	2.0 16V Sport	165	05.04	11.08				
	2.0 16V Turbo	120	05.04	11.08				
	2.0 dCi	110	09.05	11.08				
	2.0 dCi	127	01.07	11.08				
RENAULT MEGANE II Limousine 4-tuerig (LM) (03-08)								
	1.4 16V	60	09.03	08.06	24.2123-1760.3	010779		THz 23,81 TRW
	1.4 16V	72	09.03	12.08				
	1.5 dCi	60	09.03	12.08				
	1.5 dCi	63	05.05	12.08			- Sportfahrwerk ²⁾	
	1.5 dCi	74	02.04	03.06			- Sportfahrwerk ²⁾	
	1.5 dCi	76	01.07	12.08			- Sportfahrwerk ²⁾	
	1.5 dCi	78	05.05	12.08				
	1.6 16V	75	09.03	12.08				
	1.6 16V	77	05.05	12.08				
	1.6 16V	81	09.03	12.08				
	1.6 16V	82	01.07	12.08				
	1.6 16V	83	09.03	12.08				
	1.9 dCi	66	09.03	12.05			- Sportfahrwerk ²⁾	
	1.9 dCi	68	03.04	12.08			- Sportfahrwerk ²⁾	
	1.9 dCi	81	05.05	12.08				
	1.9 dCi	88	09.03	12.08				
	1.9 dCi	96	05.05	12.08				
	2.0 16V	99	09.03	12.08			- Sportfahrwerk ²⁾	
	2.0 16V	101	04.06	11.10				
	2.0 dCi	110	09.05	12.08				
	1.5 dCi	63	05.05	12.08	24.2125-1742.3	010978		THz 25,40 TRW
	1.5 dCi	74	02.04	03.06			+ Sportfahrwerk ³⁾	
	1.5 dCi	76	01.07	12.08			+ Sportfahrwerk ³⁾	
	1.9 dCi	66	09.03	12.05			+ Sportfahrwerk ³⁾	
	1.9 dCi	68	03.04	12.08			+ Sportfahrwerk ³⁾	
	2.0 16V	99	09.03	12.08			+ Sportfahrwerk ³⁾	
	1.4 16V	60	09.03	08.06	24.3541-1827.5	240407		D=54, - Halter TRW
	1.4 16V	72	09.03	12.08	24.3541-1828.5	240408		D=54, - Halter TRW
	1.5 dCi	60	10.05	12.08	11.9541-9546.2	220626		D=54, - Halter ATE
	1.5 dCi	63	10.05	12.08	11.0101-5407.2	260011		Hülsensatz ATE
	1.5 dCi	74	10.05	03.06	11.8171-0008.1	990049		Führungsbolzen ATE
	1.5 dCi	76	01.07	12.08	11.8116-0301.1	390610	2	Haltefeder ATE
	1.5 dCi	78	10.05	12.08				
	1.6 16V	75	10.05	12.08				
	1.6 16V	77	10.05	12.08				
	1.6 16V	81	10.05	12.08				
	1.6 16V	82	01.07	12.08				
	1.6 16V	83	10.05	12.08				
	1.9 dCi	66	10.05	12.05				
	1.9 dCi	68	10.05	12.08				
	1.9 dCi	81	10.05	12.08				
	1.9 dCi	88	10.05	12.08				
	1.9 dCi	96	10.05	12.08				
	2.0 16V	99	10.05	12.08				
	2.0 16V	101	04.06	11.10				
	2.0 dCi	110	09.05	12.08				
	1.4 16V	60	09.03	09.05	24.5111-0429.3	331015	2	L=429
	1.4 16V	72	09.03	09.05				
	1.5 dCi	60	09.03	09.05				
	1.5 dCi	63	05.05	09.05				
	1.5 dCi	74	02.04	09.05				
	1.5 dCi	78	05.05	09.05				
	1.6 16V	75	09.03	09.05				
	1.6 16V	77	05.05	09.05				
	1.6 16V	81	09.03	09.05				
	1.6 16V	83	09.03	09.05				
	1.9 dCi	66	09.03	09.05				
	1.9 dCi	68	03.04	09.05				
	1.9 dCi	81	05.05	09.05				
	1.9 dCi	88	09.03	09.05				
	1.9 dCi	96	05.05	09.05				
	2.0 16V	99	09.03	09.05				
	2.0 16V	101	04.06	11.10				
	1.4 16V	60	10.05	08.06	24.5155-0445.3	331057	2	L=445
	1.4 16V	72	10.05	12.08				
	1.5 dCi	60	10.05	12.08				
	1.5 dCi	63	10.05	12.08				
	1.5 dCi	74	10.05	03.06				
	1.5 dCi	76	01.07	12.08				
	1.5 dCi	78	10.05	12.08				
	1.6 16V	75	10.05	12.08				
	1.6 16V	77	10.05	12.08				
	1.6 16V	81	10.05	12.08				
	1.6 16V	82	01.07	12.08				
	1.6 16V	83	10.05	12.08				

¹⁾ + 5 gear transmission / + scatola cambio 5 marce / + transmission 5-vitesses / + cambio de 5 velocidades

²⁾ - sports suspension / - sospensione sportiva / - châssis de sport / - suspensión deportiva

















³⁾ + sports suspension / + sospensione sportiva / + châssis de sport / + suspensión deportiva





RENAULT MEGANE II Limousine 4-tuerig (LM_) (03-08)

	1.9 dCi	66		10.05	12.05	24.5155-0445.3	331057	2		L=445	
	1.9 dCi	68		10.05	12.08						
	1.9 dCi	81		10.05	12.08						
	1.9 dCi	88		10.05	12.08						
	1.9 dCi	96		10.05	12.08						
	2.0 16V	99		10.05	12.08						
	2.0 dCi	110		09.05	12.08						
	1.4 16V	60 021015			08.06	24.3347-1705.7	220751			D=34, - Halter	TRW
	1.4 16V	72 021015			12.08	24.3347-1706.7	220752			D=34, - Halter	TRW
	1.5 dCi	60 021015			12.08	24.0101-3803.2	260101			Bremssattel-Zubehör	TRW
	1.5 dCi	63 021015			12.08						
	1.5 dCi	74 021015			03.06						
	1.5 dCi	76		01.07	12.08						
	1.5 dCi	78 021015			12.08						
	1.6 16V	75 021015			12.08						
	1.6 16V	77 021015			12.08						
	1.6 16V	81		09.03	12.08						
	1.6 16V	82		01.07	12.08						
	1.6 16V	83 021015			12.08						
	1.9 dCi	66 021015			12.05						
	1.9 dCi	68 021015			12.08						
	1.9 dCi	81 021015			12.08						
	1.9 dCi	88 021015			12.08						
	1.9 dCi	96 021015			12.08						
	2.0 16V	99 021015			12.08						
	2.0 16V	101		04.06	11.10						
	2.0 dCi	110		09.05	12.08						
	1.4 16V	60		09.03	08.06	11.9387-7001.2	220397			D=38, - Halter	ATE
	1.4 16V	72		09.03	12.08	11.9387-7002.2	220398			D=38, - Halter	ATE
	1.5 dCi	60		09.03	12.08	11.8116-0340.1	390595	2		Haltefeder	ATE
	1.5 dCi	63		05.05	12.08	11.8171-0008.1	990049			Führungsbolzen	ATE
	1.5 dCi	74		02.04	03.06	11.0101-5407.2	260011			Hülsensatz	ATE
	1.5 dCi	76		01.07	12.08						
	1.5 dCi	78		05.05	12.08						
	1.6 16V	75		09.03	12.08						
	1.6 16V	77		05.05	12.08						
	1.6 16V	82		01.07	12.08						
	1.6 16V	83		09.03	12.08						
	1.9 dCi	66		09.03	12.05						
	1.9 dCi	68		03.04	12.08						
	1.9 dCi	81		05.05	12.08						
	1.9 dCi	88		09.03	12.08						
	1.9 dCi	96		05.05	12.08						
	2.0 16V	99		09.03	12.08						
	2.0 dCi	110		09.05	12.08						
	1.4 16V	60		09.03	09.05	24.5251-0185.3	330701	2		L=185	
	1.4 16V	72		09.03	09.05						
	1.5 dCi	60		09.03	09.05						
	1.5 dCi	63		05.05	09.05						
	1.5 dCi	74		02.04	09.05						
	1.5 dCi	78		05.05	09.05						
	1.6 16V	75		09.03	09.05						
	1.6 16V	77		05.05	09.05						
	1.6 16V	81		09.03	09.05						
	1.6 16V	83		09.03	09.05						
	1.9 dCi	66		09.03	09.05						
	1.9 dCi	68		03.04	09.05						
	1.9 dCi	81		05.05	09.05						
	1.9 dCi	88		09.03	09.05						
	1.9 dCi	96		05.05	09.05						
	2.0 16V	99		09.03	09.05						
	1.4 16V	60		10.05	08.06	24.5229-0185.3	330397	2		L=185	
	1.4 16V	72		10.05	12.08						
	1.5 dCi	60		10.05	12.08						
	1.5 dCi	63		10.05	12.08						
	1.5 dCi	74		10.05	03.06						
	1.5 dCi	76		01.07	12.08						
	1.5 dCi	78		10.05	12.08						
	1.6 16V	75		10.05	12.08						
	1.6 16V	77		10.05	12.08						
	1.6 16V	81		10.05	12.08						
	1.6 16V	82		01.07	12.08						
	1.6 16V	83		10.05	12.08						
	1.9 dCi	66		10.05	12.05						
	1.9 dCi	68		10.05	12.08						
	1.9 dCi	81		10.05	12.08						
	1.9 dCi	88		10.05	12.08						
	1.9 dCi	96		10.05	12.08						
	2.0 16V	99		10.05	12.08						
	2.0 16V	101		04.06	11.10						
	2.0 dCi	110		09.05	12.08						
	1.4 16V	60		09.03	08.06	24.3727-1069.2	581069	2		L=2080	
	1.4 16V	72		09.03	12.08						
	1.5 dCi	60		09.03	12.08						
	1.5 dCi	63		05.05	12.08						
	1.5 dCi	74		02.04	03.06						
	1.5 dCi	76		01.07	12.08						

								
RENAULT MEGANE II Limousine 4-tuerig (LM_) (03-08)								
	1.5 dCi	78	05.05	12.08	24.3727-1069.2	581069	2	L=2080
	1.6 16V	75	09.03	12.08				
	1.6 16V	77	05.05	12.08				
	1.6 16V	81	09.03	12.08				
	1.6 16V	82	01.07	12.08				
	1.6 16V	83	09.03	12.08				
	1.9 dCi	66	09.03	12.05				
	1.9 dCi	68	03.04	12.08				
	1.9 dCi	81	05.05	12.08				
	1.9 dCi	88	09.03	12.08				
	1.9 dCi	96	05.05	12.08				
	2.0 16V	99	09.03	12.08				
	2.0 16V	101	04.06	11.10				
	2.0 dCi	110	09.05	12.08				
	1.4 16V	60	09.03	08.06	24.2418-1701.3	030135		Gz 18,82
	1.4 16V	72	09.03	12.08				
	1.6 16V	83	09.03	12.08				
RENAULT MEGANE II Coupe/Cabrio (EM_) (03-10)								
	1.5 dCi	63	05.05	04.10	24.2123-1760.3	010779		Thz 23,81 TRW
	1.5 dCi	76	01.07	06.09				
	1.5 dCi	78	03.06	06.08				
	1.6 16V	77	06.05	04.10				
	1.6 16V	82	01.07	04.10				
	1.6 16V	83	09.03	04.10				
	1.9 dCi	81	05.05	04.10				
	1.9 dCi	85	01.06	04.10				
	1.9 dCi	88	09.03	04.10				
	1.9 dCi	96	05.05	02.07				
	2.0 16V	99	09.03	03.07				
	2.0 16V Turbo	120	05.04	04.10				
	2.0 dCi	110	09.05	04.10				
	1.5 dCi	63	10.05	04.10	11.9541-9546.2	220626	+	D=54, - Halter ATE
	1.5 dCi	76	01.07	06.09	11.0101-5407.2	260011		Hülzensatz ATE
	1.5 dCi	78	03.06	06.08	11.8171-0008.1	990049		Führungsbolzen ATE
	1.6 16V	77	10.05	04.10	11.8116-0301.1	390610	2	Haltefeder ATE
	1.6 16V	82	01.07	04.10				
	1.6 16V	83	10.05	04.10				
	1.9 dCi	81	10.05	04.10				
	1.9 dCi	85	01.06	04.10				
	1.9 dCi	88	10.05	04.10				
	1.9 dCi	96	10.05	02.07				
	2.0 16V	99	10.05	03.07				
	2.0 16V Turbo	120	10.05	04.10				
	2.0 dCi	110	09.05	04.10				
	1.5 dCi	63	05.05	09.05	24.5111-0429.3	331015	2	L=429
	1.6 16V	77	06.05	09.05				
	1.6 16V	83	09.03	09.05				
	1.9 dCi	81	05.05	09.05				
	1.9 dCi	88	09.03	09.05				
	1.9 dCi	96	05.05	09.05				
	2.0 16V	99	09.03	09.05				
	1.5 dCi	63	10.05	04.10	24.5155-0445.3	331057	2	L=445
	1.5 dCi	76	01.07	06.09				
	1.5 dCi	78	03.06	06.08				
	1.6 16V	77	10.05	04.10				
	1.6 16V	82	01.07	04.10				
	1.6 16V	83	10.05	04.10				
	1.9 dCi	81	10.05	04.10				
	1.9 dCi	85	01.06	04.10				
	1.9 dCi	88	10.05	04.10				
	1.9 dCi	96	10.05	02.07				
	2.0 16V	99	10.05	03.07				
	2.0 dCi	110	09.05	04.10				
	1.5 dCi	63	05.05	04.07	24.3347-1705.7	220751	+	D=34, - Halter TRW
	1.5 dCi	76	01.07	04.07	24.3347-1706.7	220752	+	D=34, - Halter TRW
	1.5 dCi	78	03.06	04.07	24.0101-3803.2	260101		Bremssattel-Zubehör TRW
	1.6 16V	77	06.05	04.07				
	1.6 16V	82	01.07	04.07				
	1.6 16V	83	09.03	04.07				
	1.9 dCi	81	05.05	04.07				
	1.9 dCi	85	01.06	04.07				
	1.9 dCi	88	09.03	04.07				
	1.9 dCi	96	05.05	02.07				
	2.0 16V	99	09.03	03.07				
	2.0 16V Turbo	120	05.04	04.07				
	2.0 dCi	110	09.05	04.07				
	1.5 dCi	63	05.07	04.10	24.3347-1705.7	220751	+	D=34, - Halter TRW
	1.5 dCi	76	05.07	06.09	24.3347-1706.7	220752	+	D=34, - Halter TRW
	1.5 dCi	78	05.07	06.08	24.0101-3803.2	260101		Bremssattel-Zubehör TRW
	1.6 16V	77	05.07	04.10				
	1.6 16V	82	05.07	04.10				
	1.6 16V	83	05.07	04.10				
	1.9 dCi	81	05.07	04.10				
	1.9 dCi	85	05.07	04.10				
	1.9 dCi	88	05.07	04.10				
								

































RENAULT MEGANE II Coupe/Cabrio (EM_) (03-10)

	2.0 16V Turbo	120	05.07	04.10	24.3347-1705.7	220751	2	D=34, - Halter D=34, - Halter Bremsattel-Zubehör	TRW
	2.0 dCi	110	05.07	04.10	24.3347-1706.7	220752			TRW
					24.0101-3803.2	260101			TRW
	1.5 dCi	63	05.05	08.05	24.5251-0185.3	330701	2	L=185	
	1.6 16V	77	06.05	08.05					
	1.6 16V	83	09.03	08.05					
	1.9 dCi	81	05.05	08.05					
	1.9 dCi	88	09.03	08.05					
	1.9 dCi	96	05.05	08.05					
	2.0 16V	99	09.03	08.05					
	2.0 16V Turbo	120	05.04	08.05					
	1.5 dCi	63	09.05	04.10					
	1.5 dCi	76	01.07	06.09					
	1.5 dCi	78	03.06	06.08					
	1.6 16V	77	09.05	04.10					
	1.6 16V	82	01.07	04.10					
	1.6 16V	83	09.05	04.10					
	1.9 dCi	81	09.05	04.10					
	1.9 dCi	85	01.06	04.10					
	1.9 dCi	88	09.05	04.10					
	1.9 dCi	96	09.05	02.07					
2.0 16V	99	09.05	03.07						
2.0 16V Turbo	120	09.05	04.10						
2.0 dCi	110	09.05	04.10						
	1.6 16V	77	06.05	04.10	24.2418-1701.3	030135		Gz 18,82	
	1.6 16V	82	01.07	04.10					
	1.6 16V	83	09.03	04.10					





RENAULT MEGANE II Grandtour (KM_) (03-08)

	1.4 16V	72	09.03	12.08	24.2123-1760.3	010779		Thz 23,81	TRW					
	1.5 dCi	60	09.03	05.06										
	1.5 dCi	63	05.05	12.08										
	1.5 dCi	74	02.04	03.06										
	1.5 dCi	76	01.07	12.08										
	1.5 dCi	78	05.05	06.08										
	1.6 16V	77	05.05	07.09										
	1.6 16V	82	01.07	12.08										
	1.6 16V	83	09.03	12.08										
	1.6 FlexFuel	77	02.08	12.08										
	1.9 dCi	68	03.04	02.07										
	1.9 dCi	81	05.05	12.08										
	1.9 dCi	88	09.03	12.08										
	1.9 dCi	96	05.05	02.07										
	2.0 16V	99	09.03	12.08										
	2.0 16V	102	12.06	01.11										
	2.0 dCi	110	09.05	12.08										
	1.4 16V	72	10.05	12.08	11.9541-9546.2	220626	2	D=54, - Halter Hülzensatz Führungsbolzen Haltefeder	ATE					
	1.5 dCi	60	10.05	05.06										
	1.5 dCi	63	10.05	12.08										
	1.5 dCi	74	10.05	03.06										
	1.5 dCi	76	01.07	12.08										
	1.5 dCi	78	10.05	06.08										
	1.6 16V	77	10.05	07.09										
	1.6 16V	82	01.07	12.08										
	1.6 16V	83	10.05	12.08										
	1.6 FlexFuel	77	02.08	12.08										
	1.9 dCi	68	10.05	02.07										
	1.9 dCi	81	10.05	12.08										
	1.9 dCi	88	10.05	12.08										
	1.9 dCi	96	10.05	02.07										
	2.0 16V	99	10.05	12.08										
	2.0 16V	102	12.06	01.11										
	2.0 dCi	110	09.05	12.08										
	1.4 16V	72	09.03	09.05	24.5111-0429.3	331015	2	L=429						
	1.5 dCi	60	09.03	09.05										
	1.5 dCi	63	05.05	09.05										
	1.5 dCi	74	02.04	09.05										
	1.5 dCi	78	05.05	09.05										
	1.6 16V	77	05.05	09.05										
	1.6 16V	83	09.03	09.05										
	1.9 dCi	68	03.04	09.05										
	1.9 dCi	81	05.05	09.05										
	1.9 dCi	88	09.03	09.05										
	1.9 dCi	96	05.05	09.05										
	2.0 16V	99	09.03	09.05										
		1.4 16V	72	10.05					12.08	24.5155-0445.3	331057	2	L=445	
		1.5 dCi	60	10.05					05.06					
		1.5 dCi	63	10.05					12.08					
		1.5 dCi	74	10.05					03.06					
		1.5 dCi	76	01.07					12.08					
1.5 dCi		78	10.05	06.08										
1.6 16V		77	10.05	07.09										
1.6 16V		82	01.07	12.08										
1.6 16V		83	10.05	12.08										
1.6 FlexFuel		77	02.08	12.08										
1.9 dCi		68	10.05	02.07										

									
RENAULT MEGANE II Grandtour (KM_) (03-08)									
	1.9 dCi	81		10.05	12.08	24.5155-0445.3	331057	2	L=445
	1.9 dCi	88		10.05	12.08				
	1.9 dCi	96		10.05	02.07				
	2.0 16V	99		10.05	12.08				
	2.0 16V	102		12.06	01.11				
	2.0 dCi	110		09.05	12.08				
	1.4 16V	72		09.03	04.07	24.3347-1705.7	220751		D=34, - Halter TRW
	1.5 dCi	60		09.03	05.06	24.3347-1706.7	220752		D=34, - Halter TRW
	1.5 dCi	63		05.05	04.07	24.0101-3803.2	260101		Bremssattel-Zubehör TRW
	1.5 dCi	74		02.04	03.06				
	1.5 dCi	76		01.07	04.07				
	1.5 dCi	78		05.05	04.07				
	1.6 16V	77		05.05	07.09				
	1.6 16V	82		01.07	04.07				
	1.6 16V	83		09.03	04.07				
	1.9 dCi	68		03.04	02.07				
	1.9 dCi	81		05.05	04.07				
	1.9 dCi	88		09.03	04.07				
	1.9 dCi	96		05.05	02.07				
	2.0 16V	99		09.03	04.07				
	2.0 16V	102		12.06	04.07				
	2.0 dCi	110		09.05	04.07				
	1.4 16V	72		05.07	12.08	24.3347-1705.7	220751		D=34, - Halter TRW
	1.5 dCi	63		05.07	12.08	24.3347-1706.7	220752		D=34, - Halter TRW
	1.5 dCi	76		05.07	12.08	24.0101-3803.2	260101		Bremssattel-Zubehör TRW
	1.5 dCi	78		05.07	06.08				
	1.6 16V	82		05.07	12.08				
	1.6 16V	83		05.07	12.08				
	1.6 FlexFuel	77		02.08	12.08				
	1.9 dCi	81		05.07	12.08				
	1.9 dCi	88		05.07	12.08				
	2.0 16V	99		05.07	12.08				
	2.0 16V	102		05.07	01.11				
	2.0 dCi	110		05.07	12.08				
	1.4 16V	72		09.03	08.05	24.5251-0185.3	330701	2	L=185
	1.5 dCi	60		09.03	08.05				
	1.5 dCi	63		05.05	08.05				
	1.5 dCi	74		02.04	08.05				
	1.5 dCi	78		05.05	08.05				
	1.6 16V	77		05.05	08.05				
	1.6 16V	83		09.03	08.05				
	1.9 dCi	68		03.04	08.05				
	1.9 dCi	81		05.05	08.05				
	1.9 dCi	88		09.03	08.05				
	1.9 dCi	96		05.05	08.05				
	2.0 16V	99		09.03	08.05				
	1.4 16V	72		09.05	12.08	24.5229-0185.3	330397	2 	L=185
	1.5 dCi	60		09.05	05.06				
	1.5 dCi	63		09.05	12.08				
	1.5 dCi	74		09.05	03.06				
	1.5 dCi	76		01.07	12.08				
	1.5 dCi	78		09.05	06.08				
	1.6 16V	77		09.05	07.09				
	1.6 16V	82		01.07	12.08				
	1.6 16V	83		09.05	12.08				
	1.6 FlexFuel	77		02.08	12.08				
	1.9 dCi	68		09.05	02.07				
	1.9 dCi	81		09.05	12.08				
	1.9 dCi	88		09.05	12.08				
	1.9 dCi	96		09.05	02.07				
	2.0 16V	99		09.05	12.08				
	2.0 16V	102		12.06	01.11				
	2.0 dCi	110		09.05	12.08				
	1.4 16V	72		09.03	12.08	24.3727-1069.2	581069	2 	L=2080
	1.5 dCi	60		09.03	05.06				
	1.5 dCi	63		05.05	12.08				
	1.5 dCi	74		02.04	03.06				
	1.5 dCi	76		01.07	12.08				
	1.5 dCi	78		05.05	06.08				
	1.6 16V	77		05.05	07.09				
	1.6 16V	82		01.07	12.08				
	1.6 16V	83		09.03	12.08				
	1.6 FlexFuel	77		02.08	12.08				
	1.9 dCi	68		03.04	02.07				
	1.9 dCi	81		05.05	12.08				
	1.9 dCi	88		09.03	12.08				
	1.9 dCi	96		05.05	02.07				
	2.0 16V	99		09.03	12.08				
	2.0 16V	102		12.06	01.11				
	2.0 dCi	110		09.05	12.08				
	1.4 16V	72		09.03	12.08	24.2418-1701.3	030135		Gz 18,82
	1.5 dCi	60		09.03	05.06				
	1.5 dCi	63		05.05	12.08				
	1.5 dCi	74		02.04	03.06				
	1.5 dCi	76		01.07	12.08				
	1.6 16V	82		01.07	12.08				
	1.6 16V	83		09.03	12.08				

















RENAULT MEGANE II Grandtour (KM_) (03-08)										
	1.6 FlexFuel	77	02.08	12.08	24.2418-1701.3	030135			Gz 18,82	
RENAULT MEGANE III Schrägheck (BZ0_) (08-)										
	1.2 TCe	85	03.12		24.4123-1715.3	010980			Thz 23,81	TRW
	1.2 TCe	97	01.13							
	1.4	96	04.09							
	1.5 dCi	63	12.09							
	1.5 dCi	66	11.08							
	1.5 dCi	70	11.13							
	1.5 dCi	78	02.09							
	1.5 dCi	81	02.09							
	1.5 dCi	96	11.08							
	1.6	74	11.08							
	1.6	81	11.08							
	1.6 16V Bifuel	81	11.08							
	1.6 dCi	96	04.11							
	1.9 dCi	96	11.08							
	2.0	103	02.09							
	2.0	105	01.11							
	2.0 dCi	110	10.10							
	2.0 dCi	118	04.09							
	2.0 dCi	120	07.12							
	2.0 TCe	132	11.08							
	2.0 TCe	140	06.12							
	2.0 TCe	162	11.13							
	1.2 TCe	85	03.12		11.9541-9950.2	220843			D=54, - Halter	ATE
	1.2 TCe	97	01.13		11.9541-9951.2	220844			D=54, - Halter	ATE
	1.4	96	04.09		11.8170-0002.1	260110			Halter	ATE
	1.5 dCi	63	12.09		11.8116-0356.1	390586	2		Haltefeder	ATE
	1.5 dCi	66	11.08							
	1.5 dCi	70	11.13							
	1.5 dCi	78	02.09							
	1.5 dCi	81	02.09							
	1.5 dCi	96	11.08							
	1.6	74	11.08							
	1.6	81	11.08							
	1.6 16V Bifuel	81	11.08							
	1.6 dCi	96	04.11							
	1.9 dCi	96	11.08							
	2.0	103	02.09							
	2.0	105	01.11							
	2.0 dCi	110	10.10		11.9571-9775.2	220859			D=57, - Halter	ATE
	2.0 dCi	118	04.09		11.9571-9776.2	220860			D=57, - Halter	ATE
	2.0 dCi	120	07.12		11.0101-5704.2	260095			Hülzensatz	ATE
	2.0 TCe	132	11.08		11.8116-0351.1	390538	2		Haltefeder	ATE
	2.0 TCe	140	06.12							
	2.0 TCe 220	162	11.13							
	1.2 TCe	85	03.12		24.5111-0426.3	331347	2		L=425	
	1.2 TCe	97	01.13							
	1.4	96	04.09							
	1.5 dCi	63	12.09							
	1.5 dCi	66	11.08							
	1.5 dCi	70	11.13							
	1.5 dCi	78	02.09							
	1.5 dCi	81	02.09							
	1.5 dCi	96	11.08							
	1.6	74	11.08							
	1.6	81	11.08							
	1.6 16V Bifuel	81	11.08							
	1.6 dCi	96	04.11							
	1.9 dCi	96	11.08							
	2.0	103	02.09							
	2.0	105	01.11							
	2.0 dCi	110	10.10							
	2.0 dCi	118	04.09							
	2.0 dCi	120	07.12							
	2.0 TCe	132	11.08							
	2.0 TCe	140	06.12							
	2.0 TCe 220	162	11.13							
	1.2 TCe	85	03.12		24.3347-1709.7	221013		- elektrische Feststellbremse ¹⁾	D=34, - Halter	TRW
	1.2 TCe	97	01.13		24.3347-1710.7	221014		- elektrische Feststellbremse ¹⁾	D=34, - Halter	TRW
	1.4	96	04.09							
	1.5 dCi	63	12.09							
	1.5 dCi	66	11.08							
	1.5 dCi	70	11.13							
	1.5 dCi	78	02.09							
	1.5 dCi	81	02.09							
	1.5 dCi	96	11.08							
	1.6	74	11.08							
	1.6	81	11.08							
	1.6 16V Bifuel	81	11.08							
	1.6 dCi	96	04.11							
	1.9 dCi	96	11.08							
	2.0	103	02.09							
	2.0	105	01.11							
	2.0 dCi	110	10.10							
	2.0 dCi	118	04.09							

¹⁾ - electric parking brake / - freno a mano elettrico / - frein à main électrique / - freno de mano eléctrico















RENAULT MEGANE III Schrägheck (BZO_) (08-)									
	2.0 dCi	120	07.12	24.3347-1709.7	221013	☐ - elektrische Feststellbremse ¹⁾ ☐ - elektrische Feststellbremse ¹⁾	D=34, - Halter D=34, - Halter	TRW TRW	
	2.0 TCe	132	11.08	24.3347-1710.7	221014				
	2.0 TCe	140	06.12						
	2.0 TCe 220	162	11.13						
	1.2 TCe	85	03.12	24.6234-1701.7	221015	☐ + elektrische Feststellbremse ²⁾ ☐ + elektrische Feststellbremse ²⁾	D=34, - Halter D=34, - Halter	TRW TRW	
	1.2 TCe	97	01.13	24.6234-1702.7	221016				
	1.4	96	04.09						
	1.5 dCi	63	12.09						
	1.5 dCi	66	11.08						
	1.5 dCi	70	11.13						
	1.5 dCi	78	02.09						
	1.5 dCi	81	02.09						
	1.5 dCi	96	11.08						
	1.6	74	11.08						
	1.6	81	11.08						
	1.6 16V Bifuel	81	11.08						
	1.6 dCi	96	04.11						
	1.9 dCi	96	11.08						
	2.0	103	02.09						
	2.0	105	01.11						
2.0 dCi	110	10.10							
2.0 dCi	118	04.09							
2.0 dCi	120	07.12							
2.0 TCe	132	11.08							
2.0 TCe	140	06.12							
2.0 TCe 220	162	11.13							
	1.2 TCe	85	03.13	24.5203-0135.3	331403	☐ ☐	L=135 L=135		
	1.2 TCe	97	01.13	24.5201-0135.3	331399				
	1.4	96	04.09						
	1.5 dCi	63	12.09						
	1.5 dCi	66	11.08						
	1.5 dCi	70	11.13						
	1.5 dCi	78	02.09						
	1.5 dCi	81	02.09						
	1.5 dCi	96	11.08						
	1.6	74	11.08						
	1.6	81	11.08						
	1.6 16V Bifuel	81	11.08						
	1.6 dCi	96	04.11						
	1.9 dCi	96	11.08						
	2.0	103	02.09						
	2.0	105	01.11						
	2.0 dCi	110	10.10						
	2.0 dCi	118	04.09						
	2.0 dCi	120	07.12						
	2.0 TCe	132	11.08						
2.0 TCe	140	06.12							
2.0 TCe 220	162	11.13							
	1.2 TCe	85	03.12	24.3727-1080.2	581080	2 ↕	L=1883		
	1.2 TCe	97	01.13						
	1.4	96	04.09						
	1.5 dCi	63	12.09						
	1.5 dCi	66	11.08						
	1.5 dCi	70	11.13						
	1.5 dCi	78	02.09						
	1.5 dCi	81	02.09						
	1.5 dCi	96	11.08						
	1.6	74	11.08						
	1.6	81	11.08						
	1.6 16V Bifuel	81	11.08						
	1.6 dCi	96	04.11						
	1.9 dCi	96	11.08						
	2.0	103	02.09						
	2.0	105	01.11						
	2.0 dCi	110	10.10						
	2.0 dCi	118	04.09						
	2.0 dCi	120	07.12						
	2.0 TCe	132	11.08						
2.0 TCe	140	06.12							
2.0 TCe 220	162	11.13							
RENAULT MEGANE III CC (EZO_) (10-)									
	1.2 TCe	97	04.13	24.4123-1715.3	010980		Thz 23,81	TRW	
	1.4 16V	96	06.10						
	1.5 dCi	78	06.10						
	1.5 dCi	81	06.10						
	1.6 16V	81	06.10						
	1.6 16V Bio-Petrol	81	06.10						
	1.6 dCi	96	04.11						
	1.9 dCi	96	06.10						
	2.0 16V	103	06.10						
	2.0 dCi	118	06.10						
	2.0 TCe	132	06.10						

¹⁾ - electric parking brake / - freno a mano elettrico / - frein à main électrique / - freno de mano eléctrico























²⁾ + electric parking brake / + freno a mano elettrico / + frein à main électrique / + freno de mano eléctrico

								
RENAULT MEGANE III CC (EZO_) (10-)								
	1.2 TCe	97	04.13		11.9541-9950.2	220843	2	D=54, - Halter ATE D=54, - Halter ATE Halter ATE Haltefeder ATE
	1.4 16V	96	06.10		11.9541-9951.2	220844		
	1.5 dCi	78	06.10		11.8170-0002.1	260110		
	1.5 dCi	81	06.10		11.8116-0356.1	390586		
	1.6 16V	81	06.10					
	1.6 16V Bio-Petrol	81	06.10					
	1.6 dCi	96	04.11					
	1.9 dCi	96	06.10					
	2.0 16V	103	06.10					
	2.0 dCi	118	06.10					
2.0 TCe	132	06.10						
	1.2 TCe	97	04.13		24.5111-0426.3	331347	2	L=425
	1.4 16V	96	06.10					
	1.5 dCi	78	06.10					
	1.5 dCi	81	06.10					
	1.6 16V	81	06.10					
	1.6 16V Bio-Petrol	81	06.10					
	1.6 dCi	96	04.11					
	1.9 dCi	96	06.10					
	2.0 16V	103	06.10					
	2.0 dCi	118	06.10					
2.0 TCe	132	06.10						
	1.2 TCe	97	04.13	- elektrische Feststellbremse ¹⁾	24.3347-1709.7	221013	2	D=34, - Halter TRW D=34, - Halter TRW
	1.4 16V	96	06.10	- elektrische Feststellbremse ¹⁾	24.3347-1710.7	221014		
	1.5 dCi	78	06.10	- elektrische Feststellbremse ¹⁾				
	1.5 dCi	81	06.10	- elektrische Feststellbremse ¹⁾				
	1.6 16V	81	06.10	- elektrische Feststellbremse ¹⁾				
	1.6 16V Bio-Petrol	81	06.10	- elektrische Feststellbremse ¹⁾				
	1.6 dCi	96	06.10	- elektrische Feststellbremse ¹⁾				
	1.9 dCi	96	06.10	- elektrische Feststellbremse ¹⁾				
	2.0 16V	103	06.10	- elektrische Feststellbremse ¹⁾				
	2.0 dCi	118	06.10	- elektrische Feststellbremse ¹⁾				
2.0 TCe	132	06.10	- elektrische Feststellbremse ¹⁾					
	1.2 TCe	97	04.13	+ elektrische Feststellbremse ²⁾	24.6234-1701.7	221015	2	D=34, - Halter TRW D=34, - Halter TRW
	1.4 16V	96	06.10	+ elektrische Feststellbremse ²⁾	24.6234-1702.7	221016		
	1.5 dCi	78	06.10	+ elektrische Feststellbremse ²⁾				
	1.5 dCi	81	06.10	+ elektrische Feststellbremse ²⁾				
	1.6 16V	81	06.10	+ elektrische Feststellbremse ²⁾				
	1.6 16V Bio-Petrol	81	06.10	+ elektrische Feststellbremse ²⁾				
	1.6 dCi	96	04.11	+ elektrische Feststellbremse ²⁾				
	1.9 dCi	96	06.10	+ elektrische Feststellbremse ²⁾				
	2.0 16V	103	06.10	+ elektrische Feststellbremse ²⁾				
	2.0 dCi	118	06.10	+ elektrische Feststellbremse ²⁾				
2.0 TCe	132	06.10	+ elektrische Feststellbremse ²⁾					
	1.2 TCe	97	04.13		24.5203-0135.3	331403	2	L=135 L=135
	1.4 16V	96	06.10		24.5201-0135.3	331399		
	1.5 dCi	78	06.10					
	1.5 dCi	81	06.10					
	1.6 16V	81	06.10					
	1.6 16V Bio-Petrol	81	06.10					
	1.6 dCi	96	04.11					
	1.9 dCi	96	06.10					
	2.0 16V	103	06.10					
	2.0 dCi	118	06.10					
2.0 TCe	132	06.10						
	1.4 16V	96	06.10		24.3727-1080.2	581080	1	L=1883
	1.5 dCi	78	06.10					
	1.5 dCi	81	06.10					
	1.6 16V	81	06.10					
	1.6 16V Bio-Petrol	81	06.10					
	1.9 dCi	96	06.10					
	2.0 16V	103	06.10					
	2.0 dCi	118	06.10					
2.0 TCe	132	06.10						
RENAULT MEGANE III Coupe (DZO_) (08-)								
	1.2 TCe	85	03.12		24.4123-1715.3	010980	2	Thz 23,81 TRW
	1.2 TCe	97	01.13					
	1.4 16V	96	04.09					
	1.5 dCi	63	11.08					
	1.5 dCi	66	11.08					
	1.5 dCi	70	07.14					
	1.5 dCi	78	11.08					
	1.5 dCi	81	02.09					
	1.6 16V	74	11.08					
	1.6 16V	81	11.08					
	1.6 16V Bifuel	81	11.08					
	1.6 dCi	96	04.11					
	1.9 dCi	96	11.08					
	2.0 16V	103	05.09					
	2.0 dCi	110	04.09					
	2.0 dCi	118	04.09					
2.0 dCi	120	07.12						
2.0 TCe	132	11.08						
2.0 TCe 250	184	05.09						

¹⁾ - electric parking brake / - freno a mano elettrico / - frein à main électrique / - freno de mano eléctrico
²⁾ + electric parking brake / + freno a mano elettrico / + frein à main électrique / + freno de mano eléctrico

										
RENAULT MEGANE III Coupe (DZO_) (08-)										
	1.2 TCe	85	03.12		11.9541-9950.2	220843	2	D=54, - Halter D=54, - Halter Halter Haltefeder	ATE	
	1.2 TCe	97	01.13		11.9541-9951.2	220844			ATE	
	1.4 16V	96	04.09		11.8170-0002.1	260110			ATE	
	1.5 dCi	63	11.08		11.8116-0356.1	390586			ATE	
	1.5 dCi	66	11.08							
	1.5 dCi	70	07.14							
	1.5 dCi	78	11.08							
	1.5 dCi	81	02.09							
	1.6 16V	74	11.08							
	1.6 16V	81	11.08							
	1.6 16V Bifuel	81	11.08							
	1.6 dCi	96	04.11							
	1.9 dCi	96	11.08							
	2.0 16V	103	05.09							
	2.0 dCi	110	04.09		11.9571-9775.2	220859				
	2.0 dCi	118	04.09		11.9571-9776.2	220860				
	2.0 dCi	120	07.12		11.0101-5704.2	260095				
	2.0 TCe	132	11.08		11.8116-0351.1	390538				
	2.0 TCe	140	06.12							
2.0 TCe 220	162	11.13								
	1.2 TCe	85	03.12		24.5111-0426.3	331347	2	L=425		
	1.2 TCe	97	01.13							
	1.4 16V	96	04.09							
	1.5 dCi	63	11.08							
	1.5 dCi	66	11.08							
	1.5 dCi	70	07.14							
	1.5 dCi	78	11.08							
	1.5 dCi	81	02.09							
	1.6 16V	74	11.08							
	1.6 16V	81	11.08							
	1.6 16V Bifuel	81	11.08							
	1.6 dCi	96	04.11							
	1.9 dCi	96	11.08							
	2.0 16V	103	05.09							
	2.0 dCi	110	04.09							
	2.0 dCi	118	04.09							
	2.0 dCi	120	07.12							
	2.0 TCe	132	11.08							
	2.0 TCe	140	06.12							
2.0 TCe 220	162	11.13								
	1.2 TCe	85	03.12		24.3347-1709.7	221013	2	- elektrische Feststellbremse ¹⁾ - elektrische Feststellbremse ¹⁾	D=34, - Halter	TRW
	1.2 TCe	97	01.13		24.3347-1710.7	221014			D=34, - Halter	TRW
	1.4 16V	96	04.09							
	1.5 dCi	63	11.08							
	1.5 dCi	66	11.08							
	1.5 dCi	70	07.14							
	1.5 dCi	78	11.08							
	1.5 dCi	81	02.09							
	1.6 16V	74	11.08							
	1.6 16V	81	11.08							
	1.6 16V Bifuel	81	11.08							
	1.6 dCi	96	04.11							
	1.9 dCi	96	11.08							
	2.0 16V	103	05.09							
	2.0 dCi	110	04.09							
	2.0 dCi	118	04.09							
	2.0 dCi	120	07.12							
	2.0 TCe	132	11.08							
	2.0 TCe	140	06.12							
2.0 TCe 220	162	11.13								
	1.2 TCe	85	03.12		24.6234-1701.7	221015	2	+ elektrische Feststellbremse ²⁾ + elektrische Feststellbremse ²⁾	D=34, - Halter	TRW
	1.2 TCe	97	01.13		24.6234-1702.7	221016			D=34, - Halter	TRW
	1.4 16V	96	04.09							
	1.5 dCi	63	11.08							
	1.5 dCi	66	11.08							
	1.5 dCi	70	07.14							
	1.5 dCi	78	11.08							
	1.5 dCi	81	02.09							
	1.6 16V	74	11.08							
	1.6 16V	81	11.08							
	1.6 16V Bifuel	81	11.08							
	1.6 dCi	96	04.11							
	1.9 dCi	96	11.08							
	2.0 16V	103	05.09							
	2.0 dCi	110	04.09							
	2.0 dCi	118	04.09							
	2.0 dCi	120	07.12							
	2.0 TCe	132	11.08							
	2.0 TCe	140	06.12							
2.0 TCe 220	162	11.13								
	1.2 TCe	85	03.12		24.5203-0135.3	331403	2	L=135 L=135		
	1.2 TCe	97	01.13		24.5201-0135.3	331399				
	1.4 16V	96	04.09							
	1.5 dCi	63	11.08							
	1.5 dCi	66	11.08							
	1.5 dCi	70	07.14							
1.5 dCi	78	11.08								

¹⁾ - electric parking brake / - freno a mano elettrico / - frein à main électrique / - freno de mano eléctrico
²⁾ + electric parking brake / + freno a mano elettrico / + frein à main électrique / + freno de mano eléctrico

RENAULT MEGANE III Coupe (DZ0_) (08-)									
									
		kW					
	1.5 dCi	81		02.09	24.5203-0135.3	331403			L=135
	1.6 16V	74		11.08	24.5201-0135.3	331399			L=135
	1.6 16V	81		11.08					
	1.6 16V Bifuel	81		11.08					
	1.6 dCi	96		04.11					
	1.9 dCi	96		11.08					
	2.0 16V	103		05.09					
	2.0 dCi	110		04.09					
	2.0 dCi	118		04.09					
	2.0 dCi	120		07.12					
	2.0 R.S. TCe 265	195		08.11					
	2.0 TCe	132		11.08					
	2.0 TCe	140		06.12					
	2.0 TCe 220	162		11.13					
	2.0 TCe 250	184		05.09					
	1.2 TCe	85		03.12	24.3727-1080.2	581080	2 		L=1883
	1.2 TCe	97		01.13					
	1.4 16V	96		04.09					
	1.5 dCi	63		11.08					
	1.5 dCi	66		11.08					
	1.5 dCi	70		07.14					
	1.5 dCi	78		11.08					
	1.5 dCi	81		02.09					
	1.6 16V	74		11.08					
	1.6 16V	81		11.08					
	1.6 16V Bifuel	81		11.08					
	1.6 dCi	96		04.11					
	1.9 dCi	96		11.08					
	2.0 16V	103		05.09					
	2.0 dCi	110		04.09					
	2.0 dCi	118		04.09					
	2.0 dCi	120		07.12					
	2.0 R.S. TCe 265	195		08.11					
	2.0 TCe	132		11.08					
	2.0 TCe	140		06.12					
	2.0 TCe 220	162		11.13					
	2.0 TCe 250	184		05.09					
RENAULT MEGANE III Grandtour (KZ_) (08-)									
	1.2 TCe	85		03.12	24.4123-1715.3	010980			Thz 23,81
	1.2 TCe	97		01.13					TRW
	1.4 16V	96		05.09					
	1.5 dCi	63		08.09					
	1.5 dCi	66		05.09					
	1.5 dCi	70		11.13					
	1.5 dCi	78		05.09					
	1.5 dCi	81		02.09					
	1.6 16V	74		05.09					
	1.6 16V	81		05.09					
	1.6 16V Bifuel	81		11.08					
	1.6 dCi	96		04.11					
	1.9 dCi	96		05.09					
	2.0 16V	103		05.09					
	2.0 dCi	110		08.09					
	2.0 dCi	118		04.09					
	2.0 dCi	120		07.12					
	2.0 TCe	132		05.09					
	2.0 TCe	140		09.12					
	2.0 TCe	162		09.12					
	1.2 TCe	85		03.12	11.9541-9950.2	220843			D=54, - Halter
	1.2 TCe	97		01.13	11.9541-9951.2	220844			ATE
	1.4 16V	96		05.09	11.8170-0002.1	260110			Halter
	1.5 dCi	63		08.09	11.8116-0356.1	390586	2		ATE
	1.5 dCi	66		05.09					Haltefeder
	1.5 dCi	70		11.13					
	1.5 dCi	78		05.09					
	1.5 dCi	81		02.09					
	1.6 16V	74		05.09					
	1.6 16V	81		05.09					
	1.6 16V Bifuel	81		11.08					
	1.6 dCi	96		04.11					
	1.9 dCi	96		05.09					
	2.0 16V	103		05.09					
	2.0 dCi	110		08.09	11.9571-9775.2	220859			D=57, - Halter
	2.0 dCi	118		04.09	11.9571-9776.2	220860			ATE
	2.0 dCi	120		07.12	11.0101-5704.2	260095			Hülsensatz
	2.0 TCe	132		05.09	11.8116-0351.1	390538	2		ATE
	2.0 TCe	140		09.12					Haltefeder
	2.0 TCe	162		09.12					
	1.2 TCe	85		03.12	24.5111-0426.3	331347	2		L=425
	1.2 TCe	97		01.13					
	1.4 16V	96		05.09					
	1.5 dCi	63		08.09					
	1.5 dCi	66		05.09					
	1.5 dCi	70		11.13					
	1.5 dCi	78		05.09					
	1.5 dCi	81		02.09					
									

















RENAULT MEGANE III Grandtour (KZ_) (08-)



















	1.6 16V 1.6 16V 1.6 16V Bifuel 1.6 dCi 1.9 dCi 2.0 16V 2.0 dCi 2.0 dCi 2.0 dCi 2.0 TCe 2.0 TCe 2.0 TCe	74 81 81 96 96 103 110 118 120 132 140 162		05.09 05.09 11.08 04.11 05.09 05.09 08.09 04.09 07.12 05.09 09.12 09.12	24.5111-0426.3	331347	2		L=425	
	1.2 TCe 1.2 TCe 1.4 16V 1.5 dCi 1.5 dCi 1.5 dCi 1.5 dCi 1.5 dCi 1.6 16V 1.6 16V 1.6 16V Bifuel 1.6 dCi 1.9 dCi 2.0 16V 2.0 dCi 2.0 dCi 2.0 dCi 2.0 TCe 2.0 TCe 2.0 TCe	85 97 96 63 66 70 78 81 74 81 81 96 96 103 110 118 120 132 140 162		03.12 01.13 05.09 08.09 05.09 11.13 05.09 02.09 05.09 05.09 11.08 04.11 05.09 05.09 08.09 04.09 07.12 05.09 09.12 06.12	24.3347-1709.7 24.3347-1710.7	221013 221014		<input type="checkbox"/> - elektrische Feststellbremse ¹⁾ <input type="checkbox"/> - elektrische Feststellbremse ¹⁾	D=34, - Halter D=34, - Halter	TRW TRW
	1.2 TCe 1.2 TCe 1.4 16V 1.5 dCi 1.5 dCi 1.5 dCi 1.5 dCi 1.5 dCi 1.6 16V 1.6 16V 1.6 16V Bifuel 1.6 dCi 1.9 dCi 2.0 16V 2.0 dCi 2.0 dCi 2.0 dCi 2.0 TCe 2.0 TCe 2.0 TCe	85 97 96 63 66 70 78 81 74 81 81 96 96 103 110 118 120 132 140 162		03.12 01.13 05.09 08.09 05.09 11.13 05.09 02.09 05.09 05.09 11.08 04.11 05.09 05.09 08.09 04.09 07.12 05.09 09.12 09.12	24.6234-1701.7 24.6234-1702.7	221015 221016		<input type="checkbox"/> + elektrische Feststellbremse ²⁾ <input type="checkbox"/> + elektrische Feststellbremse ²⁾	D=34, - Halter D=34, - Halter	TRW TRW
	1.2 TCe 1.2 TCe 1.4 16V 1.5 dCi 1.5 dCi 1.5 dCi 1.5 dCi 1.5 dCi 1.6 16V 1.6 16V 1.6 16V Bifuel 1.6 dCi 1.9 dCi 2.0 16V 2.0 dCi 2.0 dCi 2.0 dCi 2.0 TCe 2.0 TCe 2.0 TCe	85 97 96 63 66 70 78 81 74 81 81 96 96 103 110 118 120 132 140 162		03.12 01.13 05.09 08.09 05.09 11.13 05.09 02.09 05.09 05.09 11.08 04.11 05.09 05.09 08.09 04.09 07.12 05.09 09.12 06.12	24.5203-0135.3 24.5201-0135.3	331403 331399		<input type="checkbox"/> <input type="checkbox"/>	L=135 L=135	
	1.4 16V 1.5 dCi 1.5 dCi 1.5 dCi 1.6 16V Bifuel 2.0 dCi 2.0 dCi 2.0 dCi 2.0 TCe 2.0 TCe	96 66 78 81 81 110 118 120 132		05.09 05.09 05.09 02.09 11.08 08.09 04.09 07.12 05.09	24.3727-1080.2	581080	2 ↓		L=1883	
	1.2 TCe 1.2 TCe 1.5 dCi 1.5 dCi 1.6 16V 1.6 16V	85 97 63 70 74 81		03.12 01.13 08.09 11.13 05.09 05.09	24.3727-1081.2	581081	2 ↓		L=1940	

¹⁾ - electric parking brake / - freno a mano elettrico / - frein à main électrique / - freno de mano eléctrico
²⁾ + electric parking brake / + freno a mano elettrico / + frein à main électrique / + freno de mano eléctrico



								
RENAULT MEGANE III Grandtour (KZ_) (08-)								
	1.6 dCi	96	04.11		24.3727-1081.2	581081	2 ↓	L=1940
	1.9 dCi	96	05.09					
	2.0 16V	103	05.09					
RENAULT MEGANE IV (B9_) (15-)								
	1.2 TCe 100	74	11.15	- elektrische Feststellbremse 1)	24.3347-1709.7	221013	<input type="checkbox"/>	D=34, - Halter
	1.2 TCe 130	97	11.15	- elektrische Feststellbremse 1)	24.3347-1710.7	221014	<input type="checkbox"/>	D=34, - Halter
	1.5 dCi 110	81	11.15	- elektrische Feststellbremse 1)				
	1.5 dCi 90	66	11.15	- elektrische Feststellbremse 1)				
	1.6 dCi 130	96	11.15	- elektrische Feststellbremse 1)				
	1.2 TCe 100	74	11.15	+ elektrische Feststellbremse 2)	24.6234-1701.7	221015	<input type="checkbox"/>	D=34, - Halter
	1.2 TCe 130	97	11.15	+ elektrische Feststellbremse 2)	24.6234-1702.7	221016	<input type="checkbox"/>	D=34, - Halter
	1.5 dCi 110	81	11.15	+ elektrische Feststellbremse 2)				
	1.5 dCi 90	66	11.15	+ elektrische Feststellbremse 2)				
	1.6 dCi 130	96	11.15	+ elektrische Feststellbremse 2)				
RENAULT MEGANE IV Grandtour (K9_) (15-)								
	1.2 TCe 100	74	04.16	- elektrische Feststellbremse 1)	24.3347-1709.7	221013	<input type="checkbox"/>	D=34, - Halter
	1.2 TCe 130	97	04.16	- elektrische Feststellbremse 1)	24.3347-1710.7	221014	<input type="checkbox"/>	D=34, - Halter
	1.5 dCi 110	81	04.16	- elektrische Feststellbremse 1)				
	1.5 dCi 90	66	04.16	- elektrische Feststellbremse 1)				
	1.6 dCi 130	96	04.16	- elektrische Feststellbremse 1)				
	1.2 TCe 100	74	04.16	+ elektrische Feststellbremse 2)	24.6234-1701.7	221015	<input type="checkbox"/>	D=34, - Halter
	1.2 TCe 130	97	04.16	+ elektrische Feststellbremse 2)	24.6234-1702.7	221016	<input type="checkbox"/>	D=34, - Halter
	1.5 dCi 110	81	04.16	+ elektrische Feststellbremse 2)				
	1.5 dCi 90	66	04.16	+ elektrische Feststellbremse 2)				
	1.6 dCi 130	96	04.16	+ elektrische Feststellbremse 2)				
RENAULT MEGANE SCENIC (JA_) (96-99)								
	1.4 i	51	10.98	09.99	03.7760-5102.4	300140		10"
	1.6 16V	79	10.98	09.99				
	1.6 e	66	10.98	09.99				
	1.6 i	55	10.98	09.99				
	1.9 D (JAOJ)	47	10.98	09.99				
	1.9 D (FAOJ/Y)	47	10.98	09.99				
	1.9 dTi (FAON)	72	10.98	09.99				
	1.9 dTi (JAON)	72	10.98	09.99				
	2.0 i	84	10.98	09.99				
	1.4 i	51	11.96	09.98	- ABS	03.2120-2031.3	010106	Thz 20,64
	1.6 e	66	11.96	09.98	- ABS/ + Schaltgetriebe 3)			
	1.6 i	55	11.96	09.98	- ABS			
	1.4 i	51	10.98	09.99	- ABS	03.2123-1551.3	010512	Thz 23,81
	1.6 16V	79	10.98	09.99	- ABS			
	1.6 e	66	10.98	09.99	- ABS			
	1.6 i	55	10.98	09.99	- ABS			
	1.9 D (JAOJ)	47	10.98	09.99	- ABS			
	1.9 D (FAOJ/Y)	47	10.98	09.99	- ABS			
	1.9 dTi (FAON)	72	10.98	09.99	- ABS			
	1.9 dTi (JAON)	72	10.98	09.99	- ABS			
	2.0 i	84	10.98	09.99	- ABS			
	1.4 i	51	11.96	09.98	+ ABS	24.2120-1723.3	010545	Thz 20,64
	1.6 e	66	11.96	09.98	+ ABS/ + Schaltgetriebe 4)			
	1.6 i	55	11.96	09.98	+ ABS			
	1.6 e	66	11.96	09.98	+ ABS/ + Schaltgetriebe 4)	24.2120-1725.3	010579	Thz 20,64
	1.4 i	51	10.98	09.99	+ ABS	03.2123-2146.3	010572	Thz 23,81
	1.6 16V	79	10.98	09.99	+ ABS			
	1.6 e	66	10.98	09.99	+ ABS			
	1.6 i	55	10.98	09.99	+ ABS			
	1.9 D (FAOJ)	47	10.98	09.99	+ ABS			
	1.9 D (JAOJ)	47	10.98	09.99	+ ABS			
	1.9 dTi (FAON)	72	10.98	09.99	+ ABS			
	1.9 dTi (JAON)	72	10.98	09.99	+ ABS			
	2.0 i	84	10.98	09.99	+ ABS			
	1.4 i	51	11.96	09.98		24.3481-1615.5	240031	D=48, - Halter
	1.6 e	66	11.96	09.98	+ Schaltgetriebe 5)	24.3481-1616.5	240032	D=48, - Halter
	1.6 i	55	11.96	09.98		24.0101-4806.2	260052	Bremssattel-Zubehör
	1.6 16V	79	04.98	09.98		24.3541-1741.5	240215	D=54, - Halter
	1.6 e	66	11.96	09.98	+ Automatikgetriebe 6)	24.3541-1742.5	240216	D=54, - Halter
	1.9 D (F/JAOJ)	47	11.96	09.98				
	1.9 D (FAOY)	47	11.96	09.98				
	1.9 D (JAOY)	47	11.96	09.99				
	1.9 dT	66	11.96	12.97				
	1.9 dT	69	03.97	08.99				
	1.9 dTi (FAON)	72	03.98	09.98				
	1.4 i	51	10.98	09.99		24.3541-1749.5	240427	D=54, - Halter
	1.6 16V	79	10.98	09.99		24.3541-1750.5	240428	D=54, - Halter
	1.6 e	66	10.98	09.99	+ Schaltgetriebe 5)			
	1.6 e	66	10.98	09.99	+ Automatikgetriebe 6)			
	1.6 i	55	10.98	09.99				
	1.9 D (F/JAOJ)	47	10.98	09.99				
	1.9 D (FAOY)	47	10.98	09.99				
	1.9 dTi (FAON)	72	10.98	09.99				

1) - electric parking brake / - freno a mano elettrico / - frein à main électrique / - freno de mano eléctrico
2) + electric parking brake / + freno a mano elettrico / + frein à main électrique / + freno de mano eléctrico
3) - ABS/ + manual transmission / - ABS/+ scatola camb. velocità / + ABS/ + transmission mécanique / - ABS/ + cambio de velocidad
4) + ABS/ + manual transm. / + ABS/+ scatola camb. velocità / + ABS/ + transmission mécanique / + ABS/ + cambio de velocidad
5) + manual transmission / + scatola cambio velocità / + transmission mécanique / + cambio de velocidad
6) + autom. transmission / + scatola cambio automatico / + transmission automatique / + cambio automático

													
RENAULT MEGANE SCENIC (JA_) (96-99)													
	1.9 dTi (JAON)	72		04.97	09.98	24.3541-1741.5	240215	D=54, - Halter D=54, - Halter D=60, - Halter D=60, - Halter	TRW				
	2.0 i	84		11.96	09.98	24.3541-1742.5	240216		TRW				
						24.3601-1707.5	240229		TRW				
						24.3601-1708.5	240230		TRW				
	1.9 dTi (JAON)	72		10.98	09.99	24.3541-1749.5	240427	D=54, - Halter D=54, - Halter D=60, - Halter D=60, - Halter	TRW				
	2.0 i	84		10.98	09.99	24.3541-1750.5	240428		TRW				
						24.3601-1707.5	240229		TRW				
						24.3601-1708.5	240230		TRW				
	1.4 i	51		11.96	09.99	24.5111-0390.3	330566	2	L=390				
	1.6 16V	79		04.98	09.99								
	1.6 e	66		11.96	09.99								
	1.6 i	55		11.96	09.99								
	1.9 D	47		11.96	09.99								
	1.9 dT	66		11.96	12.97								
	1.9 dT	69		03.97	08.99								
	1.9 dTi (F/JAON)	72		04.97	09.99								
	2.0 i	84		11.96	09.99								
	1.6 16V	79		04.98	09.99	24.3344-1707.7	220531	D=34, - Halter D=34, - Halter	TRW				
						24.3344-1708.7	220532		TRW				
	1.4 i	51		11.96	09.99	24.5229-0265.3	330540	2	L=265				
	1.6 16V	79		04.98	09.99								
	1.6 e	66		11.96	09.99								
	1.6 i	55		11.96	09.99								
	1.9 D	47		11.96	09.99								
	1.9 dT	66		11.96	12.97								
	1.9 dT	69		03.97	08.99								
	1.9 dTi (F/JAON)	72		04.97	09.99								
	2.0 i	84		11.96	09.99								
	1.4 i	51		11.96	09.99	24.3220-1711.3	020409	+ GG 1)	Rz 20,64				
	1.6 16V	79		04.98	09.99								
	1.6 e	66		11.96	09.99								
	1.6 i	55		11.96	09.99								
	1.9 D (F/JAOJ)	47		11.96	09.99								
	1.9 dT	66		11.96	09.99								
	1.9 dT	69		03.97	08.99								
	1.9 dTi (F/JAON)	72		04.97	09.99								
	2.0 i	84		11.96	09.99								
	1.4 i	51		11.96	09.99	24.3727-1045.2	581045	2 ↓	L=1476				
	1.6 16V	79		04.98	09.99								
	1.6 e	66		11.96	09.99								
	1.6 i	55		11.96	09.99								
	1.9 D (F/JAOJ)	47		08.99	09.99								
	1.9 D (F/JAOJ)	47		11.96	07.99								
	1.9 D (F/JAOY)	47		11.96	09.99								
	1.9 dT	66		11.96	12.97								
	1.9 dT	69		03.97	08.99								
	1.9 dTi (FAON)	72		03.98	09.99								
	1.9 dTi (JAON)	72		08.99	09.99								
	1.9 dTi (JAON)	72		04.97	07.99								
	2.0 i	84		11.96	09.99								
		1.9 D (F/JAOJ)	47		08.99					09.99	24.3727-1056.2	581056	☐
	1.9 dTi (JAON)	72		08.99	09.99	24.3727-1055.2	581055	☐	L=1479				
	1.4 i	51		11.96	09.99	24.3728-1018.2	591018		L=972				
	1.6 e	66		11.96	09.99								
	1.6 i	55		11.96	09.99								
	1.9 D (FAOJ/Y)	47		11.96	09.99								
	1.9 D (JAOJ/Y)	47		11.96	09.99								
	1.9 dT	66		11.96	12.97								
	1.9 dT	69		03.97	08.99								
	2.0 i	84		11.96	09.99								
		1.6 16V	79		04.98					09.99	24.3728-1024.2	591024	
	1.9 dTi (FAON)	72		03.98	09.99								
	1.9 dTi (JAON)	72		04.97	09.99								
RENAULT MODUS/GRAND MODUS (JPO_) (04-13)													
	1.2 16V	55		08.04	01.05	03.7863-6002.4	300249		10"				
	1.4 16V	72		08.04	01.05								
	1.5 dCi	50		08.04	01.05								
	1.5 dCi	60		08.04	01.05								
	1.5 dCi	63		08.04	01.05								
	1.6 16V	65		08.04	01.05								
	1.6 16V	82		08.04	01.05								
	1.2	58		12.04	06.13	03.7863-4502.4	300230	+ ABS	10"				
	1.2 16V	48		05.05	06.13								
	1.2 16V	55		12.04	06.13								
	1.2 16V	74		05.07	06.13								
	1.4 16V	72		02.05	10.07								
	1.5 dCi	48		02.05	06.13								
	1.5 dCi	50		02.05	06.13								
	1.5 dCi	60		02.05	06.13								
	1.5 dCi	63		02.05	06.13								
	1.5 dCi	76		05.07	10.07								
	1.6 16V	65		02.05	06.13								
	1.6 16V	82		02.05	06.13								

1) + cast iron / + ghisa / + fonte grise / + fundición de gris

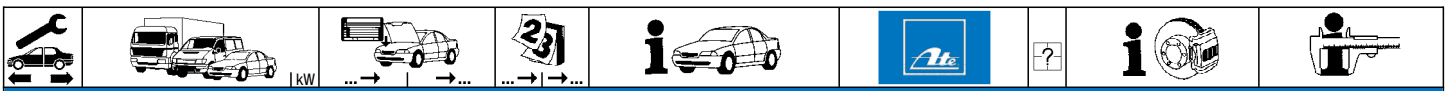

RENAULT MODUS/GRAND MODUS (JPO_) (04-13)

	1.2 16V	55	08.04	01.05	+ ABS/ - ESP	03.2123-2863.3	010790		THz 23,81	ATE						
	1.4 16V	72	08.04	01.05	+ ABS/ - ESP											
	1.5 dCi	50	08.04	01.05	+ ABS/ - ESP											
	1.5 dCi	60	09.04	01.05	+ ABS/ - ESP											
	1.5 dCi	63	08.04	01.05	+ ABS/ - ESP											
	1.6 16V	65	08.04	01.05	+ ABS/ - ESP											
	1.6 16V	82	08.04	01.05	+ ABS/ - ESP											
	1.2 16V	55	08.04	01.05	+ ESP											
	1.4 16V	72	08.04	01.05	+ ESP											
	1.5 dCi	50	08.04	01.05	+ ESP											
1.5 dCi	60	09.04	01.05	+ ESP												
1.5 dCi	63	08.04	01.05	+ ESP												
1.6 16V	65	08.04	01.05	+ ESP												
1.6 16V	82	08.04	01.05	+ ESP												
	1.2	58	12.04	06.13		03.2123-3241.3	010882		THz 23,81	ATE						
	1.2	76	04.11	06.13												
	1.2 16V	48	05.05	06.13												
	1.2 16V	55	02.05	06.13												
	1.2 16V	74	05.07	06.13												
	1.4 16V	72	02.05	06.13												
	1.5 dCi	48	02.05	06.13												
	1.5 dCi	50	02.05	06.13												
	1.5 dCi	60	02.05	06.13												
	1.5 dCi	63	02.05	06.13												
	1.5 dCi	76	05.07	06.13												
	1.5 dCi	78	05.07	06.13												
	1.5 dCi 75	55	10.10	06.13												
	1.5 dCi 90	65	10.10	06.13												
	1.6 16V	65	12.04	06.13												
	1.6 16V	82	12.04	06.13												
		1.2 16V	55	08.04	06.13						- ABS	03.2123-2821.3	010944		THz 23,81	ATE
		1.2 16V	74	05.07	06.13						- ABS					
		1.2 16V Hi-Flex	55	10.08	06.13						- ABS					
		1.4 16V	72	08.04	06.13						- ABS					
1.5 dCi		50	08.04	06.13	- ABS											
1.5 dCi		60	09.05	06.13	- ABS											
1.5 dCi		63	08.04	06.13	- ABS											
1.5 dCi		76	05.07	06.13	- ABS											
1.6 16V		65	08.04	06.13	- ABS											
1.6 16V		82	08.04	06.13	- ABS											
		1.2	58	12.04	06.13		24.3541-1849.5	240707		D=54, - Halter	TRW					
		1.2	76	04.11	06.13											
	1.2 16V	48	05.05	06.13												
	1.2 16V	55	08.04	06.13												
	1.2 16V	74	05.07	06.13												
	1.2 16V Hi-Flex	55	10.08	06.13												
	1.4 16V	72	08.04	06.13												
	1.5 dCi	48	12.04	06.13												
	1.5 dCi	50	08.04	06.13												
	1.5 dCi	60	09.04	06.13												
	1.5 dCi	63	08.04	06.13												
	1.5 dCi	76	05.07	06.13												
	1.5 dCi	78	05.05	06.13												
	1.5 dCi 75	55	10.10	06.13												
	1.5 dCi 90	65	10.10	06.13												
	1.6 16V	65	08.04	06.13												
1.6 16V	82	08.04	06.13													
	1.2	58	12.04	06.13		24.5111-0455.3	330914	2	L=455							
	1.2	76	04.11	06.13												
	1.2 16V	48	05.05	06.13												
	1.2 16V	55	08.04	06.13												
	1.2 16V	74	05.07	06.13												
	1.2 16V Hi-Flex	55	10.08	06.13												
	1.4 16V	72	08.04	06.13												
	1.5 dCi	48	12.04	06.13												
	1.5 dCi	50	08.04	06.13												
	1.5 dCi	60	09.04	06.13												
	1.5 dCi	63	08.04	06.13												
	1.5 dCi	76	05.07	06.13												
	1.5 dCi	78	05.05	06.13												
	1.5 dCi 75	55	10.10	06.13												
	1.5 dCi 90	65	10.10	06.13												
	1.6 16V	65	08.04	06.13												
1.6 16V	82	08.04	06.13													
	1.2	58	12.04	06.13		24.3347-1703.7	220685		D=34, - Halter	TRW						
	1.2	76	04.11	06.13												
	1.2 16V	48	05.05	06.13	+ ESP											
	1.2 16V	55	08.04	06.13	+ ESP											
	1.2 16V	74	05.07	06.13	+ ESP											
	1.2 16V Hi-Flex	55	10.08	06.13	+ ESP											
	1.4 16V	72	08.04	06.13												
	1.5 dCi	48	12.04	06.13	+ ESP											
	1.5 dCi	50	08.04	06.13	+ ESP											
	1.5 dCi	60	09.04	06.13	+ ESP											
1.5 dCi	63	08.04	06.13													
1.5 dCi	76	05.07	06.13													
1.5 dCi	78	05.05	06.13													



RENAULT MODUS/GRAND MODUS (JPO_) (04-13)







	1.5 dCi 75 1.5 dCi 90 1.6 16V 1.6 16V	55 65 65 82		10.10 06.13 + ESP 10.10 06.13 + ESP 08.04 06.13 08.04 06.13	24.3347-1703.7 24.3347-1704.7 24.0101-3803.2	220685 220686 260101		D=34, - Halter D=34, - Halter Bremsattel-Zubehör	TRW TRW TRW
	1.2 1.2 1.2 16V 1.2 16V 1.2 16V 1.2 16V Hi-Flex 1.4 16V 1.5 dCi 1.5 dCi 1.5 dCi 1.5 dCi 1.5 dCi 1.5 dCi 75 1.5 dCi 90 1.6 16V 1.6 16V	58 76 48 55 74 55 72 50 60 63 76 78 55 65 65 82		12.04 06.13 04.11 06.13 05.05 06.13 08.04 06.13 05.07 06.13 10.08 06.13 08.04 06.13 08.04 06.13 09.04 06.13 08.04 06.13 05.07 06.13 05.05 06.13 10.10 06.13 10.10 06.13 08.04 06.13 08.04 06.13	24.5229-0193.3	330571	2	L=193	
	1.2 16V 1.2 16V 1.2 16V Hi-Flex 1.5 dCi 1.5 dCi 1.5 dCi 1.5 dCi 1.5 dCi 75 1.5 dCi 90	48 55 55 48 50 60 63 55 65 65		05.05 06.13 - ESP 08.04 06.13 - ESP 10.08 06.13 - ESP 12.04 06.13 - ESP 08.04 06.13 - ESP 09.05 06.13 - ESP 12.04 06.13 - ESP 10.10 06.13 - ESP 10.10 06.13 - ESP	24.3219-1755.3	020508		Rz 19,05	
	1.2 16V 1.2 16V 1.2 16V 1.2 16V Hi-Flex 1.4 16V 1.5 dCi 1.5 dCi 1.5 dCi 1.5 dCi 1.5 dCi 75 1.5 dCi 90 1.6 16V 1.6 16V	48 55 74 55 72 48 50 60 63 55 65 65 82		05.05 06.13 + Trommelbremse ¹⁾ 08.04 06.13 + Trommelbremse ¹⁾ 05.07 06.13 + Trommelbremse ¹⁾ 10.08 06.13 + Trommelbremse ¹⁾ 12.04 06.13 + Trommelbremse ¹⁾ 12.04 06.13 + Trommelbremse ¹⁾ 08.04 06.13 + Trommelbremse ¹⁾ 09.05 06.13 + Trommelbremse ¹⁾ 12.04 06.13 + Trommelbremse ¹⁾ 10.10 06.13 + Trommelbremse ¹⁾ 10.10 06.13 + Trommelbremse ¹⁾ 12.04 06.13 + Trommelbremse ¹⁾ 12.04 06.13 + Trommelbremse ¹⁾	24.3727-1085.2 24.3727-1086.2 24.3727-1090.2	581085 581086 581090	<input type="checkbox"/> + kurzer Radstand ²⁾ <input type="checkbox"/> + kurzer Radstand ²⁾ <input type="checkbox"/> + langer Radstand ³⁾	L=1387 L=1497 L=1572	
	1.2 1.2 1.2 16V 1.2 16V 1.2 16V 1.2 16V Hi-Flex 1.4 16V 1.5 dCi 1.5 dCi 1.5 dCi 1.5 dCi 1.5 dCi 1.5 dCi 75 1.5 dCi 90 1.6 16V 1.6 16V	58 76 48 55 74 55 72 48 50 60 63 76 78 55 65 65 82		12.04 06.13 + Scheibenbremse ⁴⁾ 04.11 06.13 + Scheibenbremse ⁴⁾ 05.05 06.13 + Scheibenbremse ⁴⁾ 08.04 06.13 + Scheibenbremse ⁴⁾ 05.07 06.13 + Scheibenbremse ⁴⁾ 10.08 06.13 + Scheibenbremse ⁴⁾ 08.04 06.13 + Scheibenbremse ⁴⁾ 12.04 06.13 + Scheibenbremse ⁴⁾ 08.04 06.13 + Scheibenbremse ⁴⁾ 09.04 06.13 + Scheibenbremse ⁴⁾ 08.04 06.13 + Scheibenbremse ⁴⁾ 05.07 06.13 + Scheibenbremse ⁴⁾ 05.05 06.13 + Scheibenbremse ⁴⁾ 10.10 06.13 + Scheibenbremse ⁴⁾ 10.10 06.13 + Scheibenbremse ⁴⁾ 08.04 06.13 + Scheibenbremse ⁴⁾ 08.04 06.13 + Scheibenbremse ⁴⁾	24.3727-1083.2 24.3727-1084.2	581083 581084	<input type="checkbox"/> + kurzer Radstand ²⁾ <input type="checkbox"/> + kurzer Radstand ²⁾	L=1276 L=1375	
	1.2 1.2 16V 1.5 dCi 1.5 dCi 1.5 dCi 75 1.5 dCi 90 1.6 16V	76 74 50 60 63 55 65 82		04.11 06.13 05.07 06.13 12.04 06.13 09.05 06.13 12.04 06.13 10.10 06.13 10.10 06.13 12.04 06.13	24.2418-1703.3	030141		Gz 18,82	
	1.2 16V 1.5 dCi 1.5 dCi 1.5 dCi 1.5 dCi 75 1.5 dCi 90 1.6 16V	74 50 60 63 55 65 82		05.07 06.13 12.04 06.13 09.05 06.13 12.04 06.13 12.04 06.13	24.2418-1702.3	030136		Gz 18,82	

RENAULT SAFRANE (B54_) (92-00)

	2.0 i (B540) 2.1 dT 2.2 i (B541)	77 65 79		09.92 01.95 - ABS 11.93 01.95 - ABS 04.92 01.95 - ABS	03.2122-0621.3	010131		Thz 22,20	ATE
	2.0 i (B540) 2.0 i (B540) 2.0 i (B540) 2.0 i (B542/E) 2.0 i (B54L) 2.1 dT 2.1 dT 2.2 i (B541) 2.2 i (B543)	77 77 77 97 100 65 65 79 101		02.95 07.96 09.92 01.95 + ABS 09.92 01.95 - ABS 04.92 07.96 08.96 12.00 02.95 07.96 11.93 01.95 + ABS 04.92 01.95 + ABS 04.92 07.96	24.2122-1707.3	010438		Thz 22,20	

1) + drum brake / + freno a tamburo / + freins à tambour / + tambores de freno
2) + short wheel base / + passo lungo / + empattement court / + distancia corta entre ejes
3) + long wheel base / + passo lungo / + empattement long / + distancia larga entre ejes
4) + disc brake / + disco freno / + disques de frein / + disco de freno



RENAULT SAFRANE (B54_) (92-00)											
	2.5 dT	83	07.93	05.94	+ Schaltgetriebe 1)	24.2122-1707.3	010438		THz 22,20		
	2.5 dT	83	12.92	06.93							
	2.0 i (B54L)	100	08.96	12.00		24.2123-1701.3	010424		THz 23,81		
	2.2 dT	83	08.96	12.00							
	2.5 20V	121	08.96	12.00							
	2.5 dT	83	06.94	07.96							
	2.5 dT	83	07.93	05.94	+ Automatikgetriebe 2)						
	3.0 V6	123	10.96	12.00							
	3.0 V6	140	03.99	12.00							
	3.0 V6 (B544/B/J)	123	12.92	07.96							
3.0 V6 Biturbo	193	01.93	07.96								
	2.0 i (B540)	77	09.92	07.96		24.3541-1741.5	240215	<input type="checkbox"/>	D=54, - Halter	TRW	
	2.0 i (B542/E)	97	04.92	07.96		24.3541-1742.5	240216	<input type="checkbox"/>	D=54, - Halter	TRW	
	2.0 i (B54L)	100	08.96	12.00							
	2.1 dT	65	11.93	07.96							
	2.2 i (B541)	79	04.92	07.96							
	2.2 i (B543)	101	04.92	07.96							
	2.5 dT	83	09.92	05.94	+ Schaltgetriebe 1)						
	2.5 dT	83	12.92	06.93	+ Automatikgetriebe 2)						
	2.2 dT	83	08.96	12.00		24.3601-1707.5	240229	<input type="checkbox"/>	D=60, - Halter	TRW	
	2.5 20V	121	08.96	12.00		24.3601-1708.5	240230	<input type="checkbox"/>	D=60, - Halter	TRW	
2.5 dT	83	06.94	07.96	+ Schaltgetriebe 1)							
2.5 dT	83	07.93	07.96	+ Automatikgetriebe 2)							
3.0 V6	123	08.96	12.00								
3.0 V6	140	03.99	12.00								
3.0 V6 (B544/B/J)	123	12.92	07.96								
	2.0 i (B540)	77	09.92	07.96		24.5111-0285.3	330608	2	L=285		
	2.0 i (B542/E)	97	04.92	07.96							
	2.0 i (B54L)	100	08.96	12.00							
	2.1 dT	65	11.93	07.96							
	2.2 dT	83	08.96	12.00							
	2.2 i (B541)	79	04.92	07.96							
	2.2 i (B543)	101	04.92	07.96							
	2.5 20V	121	08.96	12.00							
	2.5 dT	83	12.92	07.96							
	3.0 V6	123	08.96	12.00							
3.0 V6	140	03.99	12.00								
3.0 V6 (B544/B/J)	123	12.92	07.96								
	2.0 i (B540)	77	09.92	07.96	+ ABS	24.5111-0386.3	330503	2	L=385		
	2.0 i (B540)	77	02.95	07.96	- ABS						
	2.0 i (B542/E)	97	04.92	07.96							
	2.0 i (B54L)	100	08.96	12.00							
	2.1 dT	65	11.93	07.96	+ ABS						
	2.1 dT	65	02.95	07.96	- ABS						
	2.2 dT	83	08.96	12.00							
	2.2 i (B541)	79	04.92	07.96	+ ABS						
	2.2 i (B541)	79	02.95	07.96	- ABS						
	2.2 i (B543)	101	04.92	07.96							
2.5 20V	121	08.96	12.00								
2.5 dT	83	12.92	07.96								
3.0 V6	123	08.96	12.00								
3.0 V6	140	03.99	12.00								
3.0 V6 (B544)	123	12.92	07.96								
3.0 V6 (B54B/J)	123	12.92	07.96								
3.0 V6 4x4 (B544)	123	02.93	07.96		24.5111-0300.3	330407	2	L=300			
3.0 V6 Biturbo	193	01.93	07.96								
	2.0 i (B540)	77	09.92	01.95	- ABS	24.3222-1615.3	020285		Rz 22,20	TRW	
	2.1 dT	65	11.93	01.95	- ABS						
	2.2 i (B541)	79	04.92	01.95	- ABS						
	2.0 i (B540)	77	09.92	01.95	- ABS	24.3727-1030.2	581030	<input type="checkbox"/>	L=700		
	2.1 dT	65	11.93	01.95	- ABS						
	2.2 i (B541)	79	04.92	01.95	- ABS						
	2.0 i (B540)	77	02.95	07.96		24.3727-1028.2	581028	<input type="checkbox"/>	L=850		
	2.0 i (B540)	77	09.92	01.95	+ ABS	24.3727-1034.2	581034	<input type="checkbox"/>	L=1091		
	2.0 i (B542/E)	97	04.92	07.96							
	2.0 i (B54L)	100	08.96	12.00							
	2.1 dT	65	02.95	07.96							
	2.1 dT	65	11.93	01.95	+ ABS						
	2.2 dT	83	08.96	12.00							
2.2 i (B541)	79	02.95	07.96								
2.2 i (B541)	79	04.92	01.95	+ ABS							
2.2 i (B543)	101	04.92	07.96								
2.5 20V	121	08.96	12.00								
2.5 dT	83	12.92	07.96								
3.0 V6	123	08.96	12.00								
3.0 V6	140	03.99	12.00								
3.0 V6 (B544)	123	12.92	09.96								
3.0 V6 (B54B/J)	123	12.92	07.96								
RENAULT SANDERO (BS0_) (07-)											
	1.4	55	02.09			03.7853-4102.4	300271		+ ABS	9"	ATE
	1.6	62	11.10			03.7853-4602.4	300302		+ ABS	9"	ATE
	1.6	64	02.09								
	1.6	66	05.09								
	1.6	75	12.07								

1) + manual transmission / + scatola cambio velocità / + transmission mécanique / + cambio de velocidad

2) + autom.transmission / + scatola cambio automatico / + transmission automatique / + cambio automático



















RENAULT SANDERO (BSO_) (07-)										
	1.4 1.6 1.6 1.6 1.6	55 62 64 66 75		02.09 11.10 02.09 05.09 12.07		24.2120-1762.3 03.2120-4611.3	011002 010937	- ABS + ABS	THz 20,64 - Behälter THz 20,64	ATE
	1.4 1.6 1.6 1.6 1.6	55 62 64 66 75		02.09 11.10 02.09 05.09 12.07		24.3481-1611.5 24.3481-1612.5	240029 240030	<input type="checkbox"/> - belüftete Scheiben ¹⁾ <input type="checkbox"/> - belüftete Scheiben ¹⁾	D=48, - Halter D=48, - Halter	TRW TRW
	1.4 1.6 1.6 1.6 1.6	55 62 64 66 75		02.09 11.10 02.09 05.09 12.07		24.3481-1615.5 24.3481-1616.5	240031 240032	<input type="checkbox"/> + belüftete Scheiben ²⁾ <input type="checkbox"/> + belüftete Scheiben ²⁾	D=48, - Halter D=48, - Halter	TRW TRW
	1.4 1.6 1.6 1.6 1.6	55 62 64 66 75		02.09 11.10 02.09 05.09 12.07		24.5111-0300.3	330407	2	L=300	
	1.4 1.6 1.6 1.6 1.6	55 62 64 66 75		02.09 11.10 02.09 05.09 12.07		24.5229-0285.3	330032	2	L=285	
	1.4 1.6 1.6 1.6 1.6	55 62 64 66 75		02.09 11.10 02.09 05.09 12.07		24.3217-1710.3	020420		Rz 17,78	TRW
	1.4 1.6 1.6 1.6 1.6	55 62 64 66 75		02.09 11.10 02.09 05.09 12.07		24.3219-1722.3	020426	- ABS	Rz 19,05	BDX
	1.4 1.6 1.6 1.6 1.6	55 64 64 66 75		02.09 02.09 11.10 05.09 12.07		24.3217-1711.3	020449	+ ABS	Rz 17,46	BOS
	1.4 1.6 1.6 1.6 1.6	55 62 64 66 75		02.09 11.10 02.09 05.09 12.07		24.3728-1031.2	591031		L=1033	

RENAULT SANDERO II (13-)										
	1.2 16V 1.2 16V LPG 1.5 dCi 1.6 1.6	54 53 62 59 75		12.13 12.13 12.13 11.13 04.14		24.3219-1761.3	020536		Rz 19,05	



















RENAULT SCENIC I (JA_) (99-03)											
	1.4 16V (OD,1H,0W,10) 1.6 16V (JA00,15,16) 1.8 16V (12,1R,1M,1A) 1.8 16V 4x4 1.9 dCi (JA01,05,1F) 1.9 dCi RX4 1.9 dTi (JA0N) 2.0 16V (1B,1D,0C) 2.0 16V IDE 2.0 16V RX4	70 79 85 85 75 75 72 102 103 102		09.99 06.03 09.99 06.03 01.01 06.03 07.00 06.03 09.99 06.03 11.00 06.03 09.99 06.03 06.00 06.03 09.99 06.03 06.00 06.03	- ABS - ABS - ABS - ABS - ABS - ABS - ABS - ABS - ABS - ABS	03.7760-5102.4	300140			10"	ATE
	1.4 16V (OD,1H,0W,10) 1.6 16V (JA00,15,16) 1.8 16V (12,1R,1M,1A) 1.8 16V 4x4 1.9 D 1.9 dCi (JA01,05,1F) 1.9 dCi RX4 1.9 dTi (JA1U) 2.0 16V IDE 2.0 16V RX4	70 79 85 85 47 75 75 59 103 102		09.99 06.03 09.99 06.03 01.01 06.03 07.00 04.01 09.99 03.01 09.99 06.03 11.00 06.03 01.01 06.03 09.99 06.03 06.00 06.03	+ ABS + ABS + ABS + ABS + ABS + ABS + ABS + ABS + ABS + ABS	03.7863-2002.4	300126			10"	ATE
	1.4 16V (OD,1H,0W,10) 1.6 16V (JA00,15,16) 1.8 16V (12,1R,1M,1A) 1.8 16V 4x4 1.9 dCi (JA01,05,1F) 1.9 dCi RX4 1.9 dTi (JA0N) 2.0 16V (1B,1D,0C) 2.0 16V IDE 2.0 16V RX4	70 79 85 85 75 75 72 102 103 102		09.99 06.03 09.99 06.03 01.01 06.03 07.00 06.03 09.99 06.03 11.00 06.03 09.99 06.03 06.00 06.03 09.99 06.03 06.00 06.03	- ABS - ABS - ABS - ABS - ABS - ABS - ABS - ABS - ABS - ABS	03.2123-1551.3	010512		THz 23,81	ATE	
	1.4 16V (OD,1H,0W,10) 1.6 16V (JA00,15,16)	70 79		09.99 06.03 09.99 06.03	+ ABS/ - ESP + ABS/ - ESP	03.2123-2146.3	010572		THz 23,81	ATE	

1) - ventilated discs / - dischi ventilati / - disques ventilés / - disco ventilado
2) + ventilated discs / + dischi ventilati / + disques ventilés / + disco ventilado















									
RENAULT SCENIC I (JA_) (99-03)									
	1.8 16V (12,1R,1M,1A) ◀ 85 1.8 16V 4x4 ◀ 85 1.9 D ◀ 47 1.9 dCi (JA01,05,1F) ◀ 75 1.9 dCi RX4 ◀ 75 1.9 dTi (JA0N) ◀ 72 1.9 dTi (JA1U) ◀ 59 2.0 16V (1B,1D,0C) ◀ 102 2.0 16V IDE ◀ 103 2.0 16V RX4 ◀ 102		01.01 06.03 + ABS/ - ESP 07.00 04.01 + ABS/ - ESP 09.99 03.01 + ABS/ - ESP 09.99 06.03 + ABS/ - ESP 11.00 06.03 + ABS/ - ESP 09.99 06.03 + ABS 01.01 06.03 + ABS/ - ESP 06.00 06.03 + ABS/ - ESP 09.99 06.03 + ABS/ - ESP 06.00 06.03 + ABS/ - ESP		03.2123-2146.3 010572			Thz 23,81	ATE
	1.4 16V (OD,1H,0W,10) ◀ 70 1.6 16V (JA00,15,16) ◀ 79 1.8 16V (12,1R,1M,1A) ◀ 85 1.8 16V 4x4 ◀ 85 1.9 D ◀ 47 1.9 dCi (JA01,05,1F) ◀ 75 1.9 dCi RX4 ◀ 75 1.9 dTi (JA1U) ◀ 59 2.0 16V (1B,1D,0C) ◀ 102 2.0 16V IDE ◀ 103 2.0 16V RX4 ◀ 102		09.99 06.03 + ABS/ + ESP 09.99 06.03 + ABS/ + ESP 01.01 06.03 + ABS/ + ESP 07.00 04.01 + ABS/ + ESP 09.99 03.01 + ABS/ + ESP 09.99 06.03 + ABS/ + ESP 11.00 06.03 + ABS/ + ESP 01.01 06.03 + ABS/ + ESP 06.00 06.03 + ABS/ + ESP 09.99 06.03 + ABS/ + ESP 06.00 06.03 + ABS/ + ESP		03.2123-2621.3 010701			Thz 23,81	ATE
	1.4 16V (OD,1H,0W,10) 70 1.6 16V (JA00,15,16) 79 1.8 16V (12,1R,1M,1A) 85 1.8 16V 4x4 85 1.9 D 47 1.9 dCi (JA01,05,1F) 75 1.9 dCi RX4 75 1.9 dTi (JA0N) 72 1.9 dTi (JA1U) 59 2.0 16V (1B,1D,0C) 102 2.0 16V IDE 103 2.0 16V RX4 102		09.99 06.03 10.99 06.03 01.01 06.03 07.00 06.03 09.99 03.01 09.99 06.03 11.00 03.02 09.99 06.03 01.01 06.03 06.00 06.03 09.99 06.03 06.00 03.02		24.3541-1749.5 240427 24.3541-1750.5 240428	<input type="checkbox"/> <input type="checkbox"/>		D=54, - Halter D=54, - Halter	TRW TRW
	1.9 dCi RX4 75 2.0 16V RX4 102		04.02 06.03 04.02 06.03		11.9571-9841.2 220401 24.3571-9841.5 240501 11.9571-9842.2 220402 24.3571-9842.5 240502	<input type="checkbox"/> <input type="checkbox"/> <input type="checkbox"/> <input type="checkbox"/>		D=57, - Halter D=57, - Halter D=57, - Halter D=57, - Halter	ATE ATE ATE ATE
	1.4 16V (OD,1H,0W,10) 70 1.6 16V (JA00,15,16) 79 1.8 16V (12,1R,1M,1A) 85 1.8 16V 4x4 85 1.9 D 47 1.9 dCi (JA01,05,1F) 75 1.9 dTi (JA0N) 72 1.9 dTi (JA1U) 59 2.0 16V (1B,1D,0C) 102 2.0 16V IDE 103		09.99 06.03 09.99 06.03 01.01 06.03 07.00 06.03 09.99 03.01 09.99 06.03 09.99 06.03 01.01 06.03 06.00 06.03 09.99 06.03		24.5111-0390.3 330566	2		L=390	
	1.4 16V (OD,1H,0W,10) 70 1.6 16V (JA00,15,16) 79 1.8 16V (12,1R,1M,1A) 85 1.8 16V 4x4 85 1.9 D 47 1.9 dCi (JA01,05,1F) 75 1.9 dTi (JA0N) 72 1.9 dTi (JA1U) 59 2.0 16V (1B,1D,0C) 102 2.0 16V IDE 103		09.99 06.03 + ABS 09.99 06.03 + ABS 01.01 06.03 07.00 06.03 09.99 03.01 09.99 06.03 09.99 06.03 + ABS 01.01 06.03 06.00 06.03 09.99 06.03		24.3344-1707.7 220531 24.3344-1708.7 220532	<input type="checkbox"/> <input type="checkbox"/>		D=34, - Halter D=34, - Halter	TRW TRW
	1.4 16V (OD,1H,0W,10) 70 1.6 16V (JA00,15,16) 79 1.8 16V (12,1R,1M,1A) 85 1.8 16V 4x4 85 1.9 D 47 1.9 dCi (JA01,05,1F) 75 1.9 dTi (JA0N) 72 1.9 dTi (JA1U) 59 2.0 16V (1B,1D,0C) 102 2.0 16V IDE 103		09.99 06.03 09.99 06.03 01.01 06.03 07.00 06.03 09.99 03.01 09.99 06.03 09.99 06.03 01.01 06.03 06.00 06.03 09.99 06.03		24.5229-0265.3 330540	2		L=265	
	1.4 16V (OD,1H,0W,10) 70 1.6 16V (JA00,15,16) 79 1.9 dTi (JA0N) 72		09.99 06.03 - ABS 09.99 06.03 - ABS 09.99 06.03 - ABS		24.3220-1711.3 020409		+ GG ¹⁾	Rz 20,64	TRW
	1.4 16V (OD,1H,0W,10) 70 1.6 16V (JA00,15,16) 79 1.8 16V 4x4 85 1.9 dCi (JA01,05,1F) 75 1.9 dTi (JA0N) 72 2.0 16V (1B,1D,0C) 102		09.99 06.03 + ABS 09.99 06.03 + ABS 07.00 04.01 09.99 06.03 + ABS 09.99 06.03 + ABS 06.00 06.03 + ABS		24.3727-1056.2 581056 24.3727-1055.2 581055	<input type="checkbox"/> <input type="checkbox"/>		L=1508 L=1479	
	1.4 16V (OD,1H,0W,10) 70 1.6 16V (JA00,15,16) 79 1.8 16V (12,1R,1M,1A) 85 1.9 D 47 1.9 dCi (JA01,05,1F) 75 1.9 dTi (JA0N) 72 1.9 dTi (JA1U) 59 2.0 16V (1B,1D,0C) 102 2.0 16V IDE 103		09.99 06.03 - ABS 09.99 06.03 - ABS 01.01 06.03 09.99 03.01 09.99 06.03 - ABS 09.99 06.03 - ABS 01.01 06.03 06.00 06.03 - ABS 09.99 06.03		24.3727-1045.2 581045	2 ↕		L=1476	

¹⁾ + cast iron / + ghisa / + fonte grise / + fundición de gris

								
RENAULT SCENIC I (JA_) (99-03)								
	1.4 16V (0D,1H,0W,10)	70	09.99	06.03	24.3728-1024.2	591024		L=973
	1.6 16V (JA00,15,16)	79	09.99	06.03				
	1.8 16V (12,1R,1M,1A)	85	01.01	06.03				
	1.8 16V 4x4	85	07.00	06.03				
	1.9 D	47	09.99	03.01				
	1.9 dCi (JA01,05,1F)	75	09.99	06.03				
	1.9 dTi (JA0N)	72	09.99	06.03				
	1.9 dTi (JA1U)	59	01.01	06.03				
	2.0 16V (1B,1D,0C)	102	06.00	06.03				
RENAULT SCENIC II (JM_) (03-09)								
	1.4 16V	72	06.03	03.09	24.2123-1760.3	010779		THz 23,81 TRW
	1.5 dCi	60	06.03	03.09				
	1.5 dCi	63	05.05	03.09				
	1.5 dCi	74	11.03	03.09				
	1.5 dCi	76	01.07	03.09				
	1.5 dCi	78	05.05	03.09				
	1.6 16V	77	06.06	03.09				
	1.6 16V	82	01.07	03.09				
	1.6 16V	83	06.03	03.09				
	1.6 Hi-Flex	81	03.05	07.10				
	1.9 D	85	06.06	03.09				
	1.9 dCi	81	05.05	03.09				
	1.9 dCi	88	06.03	03.09				
	1.9 dCi	92	06.03	03.09				
	1.9 dCi	96	05.05	03.09				
	2.0 16V	99	06.03	03.09				
	2.0 16V Turbo	120	05.04	03.09				
	2.0 dCi	110	09.05	03.09				
	1.4 16V	72	10.05	03.09	11.9541-9546.2	220626		D=54, - Halter ATE
	1.5 dCi	78	10.05	03.09	11.0101-5407.2	260011		Hülsensatz ATE
	1.6 16V	77	06.06	03.09	11.8171-0008.1	990049		Führungsbolzen ATE
	2.0 16V	99	10.05	03.09	11.8116-0301.1	390610	2	Haltefeder ATE
	1.5 dCi	60	10.05	03.09	11.0101-5407.2	260011		Hülsensatz ATE
	1.5 dCi	63	10.05	03.09	11.8171-0008.1	990049		Führungsbolzen ATE
	1.5 dCi	74	10.05	03.09	11.8116-0301.1	390610	2	Haltefeder ATE
	1.5 dCi	76	01.07	03.09				
	1.6 16V	77	06.06	03.09				
	1.6 16V	82	01.07	03.09				
	1.6 16V	83	10.05	03.09				
	1.6 Hi-Flex	81	10.05	07.10				
	1.9 D	85	06.06	03.09				
	1.9 dCi	81	10.05	03.09				
	1.9 dCi	88	10.05	03.09				
	1.9 dCi	92	10.05	03.09				
	1.9 dCi	96	10.05	03.09				
	2.0 16V Turbo	120	10.05	03.09				
	2.0 dCi	110	09.05	03.09				
	1.4 16V	72	06.03	09.05	24.5111-0429.3	331015	2	L=429
	1.5 dCi	60	06.03	09.05				
	1.5 dCi	63	05.05	09.05				
	1.5 dCi	74	11.03	09.05				
	1.5 dCi	78	05.05	09.05				
	1.6 16V	83	06.03	09.05				
	1.6 Hi-Flex	81	03.05	09.05				
	1.9 dCi	81	05.05	09.05				
	1.9 dCi	88	06.03	09.05				
	1.9 dCi	92	06.03	09.05				
	1.9 dCi	96	05.05	09.05				
	2.0 16V	99	06.03	09.05				
	2.0 16V Turbo	120	05.04	09.05				
	1.4 16V	72	10.05	03.09	24.5155-0445.3	331057	2	L=445
	1.5 dCi	60	10.05	03.09				
	1.5 dCi	63	10.05	03.09				
	1.5 dCi	74	10.05	03.09				
	1.5 dCi	76	01.07	03.09				
	1.5 dCi	78	10.05	03.09				
	1.6 16V	77	06.06	03.09				
	1.6 16V	82	01.07	03.09				
	1.6 16V	83	10.05	03.09				
	1.6 Hi-Flex	81	10.05	07.10				
	1.9 D	85	06.06	03.09				
	1.9 dCi	81	10.05	03.09				
	1.9 dCi	88	10.05	03.09				
	1.9 dCi	92	10.05	03.09				
	1.9 dCi	96	10.05	03.09				
	2.0 16V	99	10.05	03.09				
	2.0 16V Turbo	120	10.05	03.09				
	2.0 dCi	110	09.05	03.09				
	1.6 16V	77	06.06	03.09	24.3347-1705.7	220751		D=34, - Halter TRW
	1.6 16V	83	06.03	03.09	24.3347-1706.7	220752		D=34, - Halter TRW
	1.6 Hi-Flex	81	03.05	07.10	24.0101-3803.2	260101		Bremssattel-Zubehör TRW
	1.9 dCi	88	06.03	03.09				
	1.9 dCi	92	06.03	03.09				
	1.6 16V	77	06.06	03.09	24.3347-1707.7	220999		D=34, - Halter TRW
	1.6 16V	83	06.03	03.09	24.3347-1708.7	221000		D=34, - Halter TRW
	1.6 Hi-Flex	81	03.05	07.10				

1) - electric parking brake / - freno a mano elettrico / - frein à main électrique / - freno de mano eléctrico
2) + electric parking brake / + freno a mano elettrico / + frein à main électrique / + freno de mano eléctrico

RENAULT SCENIC II (JM_) (03-09)											
	1.9 dCi	81		05.05	03.09	24.3347-1707.7	220999			D=34, - Halter	TRW
	1.9 dCi	88		06.03	03.09	24.3347-1708.7	221000			D=34, - Halter	TRW
	1.9 dCi	92		06.03	03.09						
	1.4 16V	72		06.03	04.07	24.3387-1721.7	220781			D=38, - Halter	TRW
	1.5 dCi	60		06.03	04.07	24.3387-1722.7	220782			D=38, - Halter	TRW
	1.5 dCi	63		05.05	04.07						
	1.5 dCi	74		11.03	04.07						
	1.5 dCi	76		01.07	04.07						
	1.5 dCi	78		05.05	04.07						
	1.6 16V	82		01.07	04.07						
	1.9 D	85		06.06	04.07						
	1.9 dCi	96		05.05	04.07						
	2.0 16V	99		06.03	04.07						
	2.0 16V Turbo	120		05.04	04.07						
	2.0 dCi	110		09.05	04.07						
	1.4 16V	72		05.07	03.09	24.3387-1727.7	221005			D=38, - Halter	TRW
	1.5 dCi	60		05.07	03.09	24.3387-1728.7	221006			D=38, - Halter	TRW
	1.5 dCi	63		05.07	03.09						
	1.5 dCi	74		05.07	03.09						
	1.5 dCi	76		05.07	03.09						
	1.5 dCi	78		05.07	03.09						
	1.6 16V	82		05.07	03.09						
1.9 D	85		05.07	03.09							
1.9 dCi	96		05.07	03.09							
2.0 16V	99		05.07	03.09							
2.0 16V Turbo	120		05.07	03.09							
2.0 dCi	110		05.07	03.09							
	1.4 16V	72		06.03	09.05	24.5251-0185.3	330701	2		L=185	
	1.5 dCi	60		06.03	09.05						
	1.5 dCi	63		05.05	09.05						
	1.5 dCi	74		11.03	09.05						
	1.5 dCi	78		05.05	09.05						
	1.6 16V	83		06.03	09.05						
	1.6 Hi-Flex	81		03.05	09.05						
	1.9 dCi	81		05.05	09.05						
	1.9 dCi	88		06.03	09.05						
	1.9 dCi	92		06.03	09.05						
	1.9 dCi	96		05.05	09.05						
	2.0 16V	99		06.03	09.05						
	2.0 16V Turbo	120		05.04	09.05						
	1.4 16V	72		10.05	03.09	24.5229-0185.3	330397	2		L=185	
	1.5 dCi	60		10.05	03.09						
1.5 dCi	63		10.05	03.09							
1.5 dCi	74		10.05	03.09							
1.5 dCi	76		01.07	03.09							
1.5 dCi	78		10.05	03.09							
1.6 16V	77		06.06	03.09							
1.6 16V	82		01.07	03.09							
1.6 16V	83		10.05	03.09							
1.6 Hi-Flex	81		10.05	07.10							
1.9 D	85		06.06	03.09							
1.9 dCi	81		10.05	03.09							
1.9 dCi	88		10.05	03.09							
1.9 dCi	92		10.05	03.09							
1.9 dCi	96		10.05	03.09							
2.0 16V	99		10.05	03.09							
2.0 16V Turbo	120		10.05	03.09							
2.0 dCi	110		10.05	03.09							
	1.4 16V	72		06.03	03.09	24.3727-1069.2	581069	2		L=2080	
	1.5 dCi	60		06.03	03.09						
	1.5 dCi	63		05.05	03.09						
	1.5 dCi	74		11.03	03.09						
	1.5 dCi	78		05.05	03.09						
	1.6 16V	77		06.06	03.09						
	1.6 16V	83		06.03	03.09						
	1.6 Hi-Flex	81		03.05	07.10						
	1.9 D	85		06.06	03.09						
	1.9 dCi	81		05.05	03.09						
	1.9 dCi	88		06.03	03.09						
	1.9 dCi	92		06.03	03.09						
	1.9 dCi	96		05.05	03.09						
	2.0 16V	99		06.03	03.09						
	2.0 16V Turbo	120		05.04	03.09						
2.0 dCi	110		09.05	03.09							
	1.4 16V	72		06.03	03.09	24.2418-1701.3	030135			Gz 18,82	
	1.5 dCi	60		06.03	03.09						
	1.5 dCi	63		05.05	03.09						
	1.5 dCi	74		11.03	03.09						
	1.5 dCi	76		01.07	03.09						
	1.5 dCi	78		06.03	03.09						
	1.6 16V	77		06.06	03.09						
	1.6 16V	82		01.07	03.09						
	1.6 16V	83		06.03	03.09						
	1.6 Hi-Flex	81		03.05	07.10						

1) + electric parking brake / + freno a mano elettrico / + frein à main électrique / + freno de mano eléctrico

2) - electric parking brake / - freno a mano elettrico / - frein à main électrique / - freno de mano eléctrico



RENAULT SCENIC III (JZ_) (09-)

	1.2 Tce 1.2 Tce 1.4 Tce 1.5 dCi 1.5 dCi 1.5 dCi 1.5 dCi 1.6 16V 1.6 dCi 1.6 E85 1.9 dCi 2.0 16V 2.0 dCi 2.0 dCi	85 97 96 63 70 78 81 81 96 81 96 103 110 118		03.12 03.13 04.09 04.09 11.10 04.09 04.09 04.09 04.11 06.09 04.09 04.09 04.09		24.4123-1715.3 010980			Thz 23,81	TRW
	1.2 Tce 1.2 Tce 1.4 Tce 1.5 dCi 1.5 dCi 1.5 dCi 1.6 16V 1.6 dCi 1.6 E85 1.9 dCi 2.0 16V 2.0 dCi 2.0 dCi	85 97 96 70 78 81 81 96 81 96 103 110 118		03.12 03.13 04.09 11.10 04.09 04.09 04.09 04.11 06.09 04.09 04.09 04.09	+ 16"/17" Rad ¹⁾ + 16"/17" Rad ¹⁾ + 16"/17" Rad ¹⁾ + 16"/17" Rad ¹⁾	11.9571-9775.2 11.9571-9776.2 11.0101-5704.2 11.8116-0351.1	220859 220860 260095 390538	2	D=57, - Halter D=57, - Halter Hülensatz Haltefeder	ATE ATE ATE ATE
	1.5 dCi 1.5 dCi 1.5 dCi 1.5 dCi 1.6 16V 1.6 E85	63 70 78 81 81 81		04.09 11.10 04.09 04.09 04.09 06.09	+ 15" Rad ²⁾ + 15" Rad ²⁾ + 15" Rad ²⁾ + 15" Rad ²⁾ + 15" Rad ²⁾	11.9541-9950.2 11.9541-9951.2 11.8170-0002.1 11.8116-0356.1	220843 220844 260110 390586	2	D=54, - Halter D=54, - Halter Halter Haltefeder	ATE ATE ATE ATE
	1.2 Tce 1.2 Tce 1.4 Tce 1.5 dCi 1.5 dCi 1.5 dCi 1.5 dCi 1.6 16V 1.6 dCi 1.6 E85 1.9 dCi 2.0 16V 2.0 dCi 2.0 dCi	85 97 96 63 70 78 81 81 96 81 96 103 110 118		03.12 03.13 04.09 04.09 11.10 04.09 04.09 04.09 04.11 06.09 04.09 04.09 04.09		24.5111-0426.3 331347	2		L=425	
	1.2 Tce 1.2 Tce 1.4 Tce 1.5 dCi 1.5 dCi 1.5 dCi 1.6 16V 1.6 dCi 1.6 E85 1.9 dCi 2.0 16V	85 97 96 63 70 78 81 96 81 96 103		03.12 03.13 04.09 04.09 11.10 04.09 04.09 04.11 06.09 04.09 04.09	- elektrische Feststellbremse ³⁾ - elektrische Feststellbremse ³⁾ - elektrische Feststellbremse ³⁾ - elektrische Feststellbremse ³⁾ - elektrische Feststellbremse ³⁾ - elektrische Feststellbremse ³⁾ - elektrische Feststellbremse ³⁾ - elektrische Feststellbremse ³⁾ - elektrische Feststellbremse ³⁾ - elektrische Feststellbremse ³⁾	24.3347-1709.7 24.3347-1710.7	221013 221014		D=34, - Halter D=34, - Halter	TRW TRW
	1.2 Tce 1.2 Tce 1.4 Tce 1.5 dCi 1.5 dCi 1.5 dCi 1.6 16V 1.6 dCi 1.6 E85 1.9 dCi 2.0 16V	85 97 96 63 70 78 81 96 81 96 103		03.12 03.13 04.09 04.09 11.10 04.09 04.09 04.11 06.09 04.09 04.09	+ elektrische Feststellbremse ⁴⁾ + elektrische Feststellbremse ⁴⁾ + elektrische Feststellbremse ⁴⁾ + elektrische Feststellbremse ⁴⁾ + elektrische Feststellbremse ⁴⁾ + elektrische Feststellbremse ⁴⁾ + elektrische Feststellbremse ⁴⁾ + elektrische Feststellbremse ⁴⁾ + elektrische Feststellbremse ⁴⁾ + elektrische Feststellbremse ⁴⁾	24.6234-1701.7 24.6234-1702.7	221015 221016		D=34, - Halter D=34, - Halter	TRW TRW
	2.0 dCi 2.0 dCi	110 118		04.09 04.09	+ elektrische Feststellbremse ⁴⁾ + elektrische Feststellbremse ⁴⁾	24.6238-1707.7 24.6238-1708.7	220969 220970		D=38, - Halter D=38, - Halter	TRW TRW
	1.2 Tce 1.2 Tce 1.4 Tce 1.5 dCi 1.5 dCi 1.5 dCi 1.5 dCi 1.6 16V 1.6 dCi 1.6 E85 1.9 dCi 2.0 16V 2.0 dCi	85 97 96 63 70 78 81 81 96 81 96 103 110		03.12 03.13 04.09 04.09 11.10 04.09 04.09 04.09 04.11 06.09 04.09 04.09		24.5201-0135.3 331399	2		L=135	





















¹⁾ + 16"/17" wheel / + ruota 16"/17" / + roue 16"/17" / + ruedas 16"/17"

















²⁾ + 15" wheel / + ruota 15" / + roue 15" / + ruedas 15"

³⁾ - electric parking brake / - freno a mano elettrico / - frein à main électrique / - freno de mano eléctrico

⁴⁾ + electric parking brake / + freno a mano elettrico / + frein à main électrique / + freno de mano eléctrico



									
RENAULT SCENIC III (JZ_) (09-)									
	2.0 dCi	118		04.09		24.5201-0135.3	331399	2 	L=135
RENAULT GRAND SCENIC (JM_) (04-09)									
	1.5 dCi	60		04.04	03.09	24.2123-1760.3	010779		Thz 23,81 TRW
	1.5 dCi	74		04.04	03.09				
	1.5 dCi	76		06.06	03.09				
	1.6			04.04	03.09				
	1.9 dCi	81		05.05	03.09				
	1.9 dCi	88		04.04	03.09				
	1.9 dCi	96		05.05	03.09				
	2.0 16V	99		04.04	03.09				
	2.0 16V Turbo	120		04.04	03.09				
	2.0 dCi	110		09.05	03.09				
	1.5 dCi	60		04.04	09.05	11.0101-5407.2	260011		Hülsensatz ATE
	1.5 dCi	74		04.04	09.05	11.8171-0008.1	990049		Führungsbolzen ATE
	1.6			04.04	09.05				
	1.9 dCi	81		05.05	09.05				
	1.9 dCi	88		04.04	09.05				
	1.9 dCi	96		05.05	09.05				
	2.0 16V	99		04.04	09.05				
	2.0 dCi	110		09.05	09.05				
	1.5 dCi	60		10.05	03.09	11.0101-5407.2	260011		Hülsensatz ATE
	1.5 dCi	74		10.05	03.09	11.8171-0008.1	990049		Führungsbolzen ATE
	1.5 dCi	76		06.06	03.09	11.8116-0301.1	390610	2	Haltefeder ATE
	1.6			10.05	03.09				
	1.9 dCi	81		10.05	03.09				
	1.9 dCi	88		10.05	03.09				
	1.9 dCi	96		10.05	03.09				
	2.0 16V	99		10.05	03.09				
	2.0 16V Turbo	120		10.05	03.09				
	2.0 dCi	110		10.05	03.09				
	1.5 dCi	60		04.04	09.05	24.5111-0429.3	331015	2	L=429
	1.5 dCi	74		04.04	09.05				
	1.6			04.04	09.05				
	1.9 dCi	81		05.05	09.05				
	1.9 dCi	88		04.04	09.05				
	1.9 dCi	96		05.05	09.05				
	2.0 16V	99		04.04	09.05				
	2.0 16V Turbo	120		04.04	09.05				
	2.0 dCi	110		09.05	09.05				
	1.5 dCi	60		10.05	03.09	24.5155-0445.3	331057	2	L=445
	1.5 dCi	74		10.05	03.09				
	1.5 dCi	76		06.06	03.09				
	1.6			10.05	03.09				
	1.9 dCi	81		10.05	03.09				
	1.9 dCi	88		10.05	03.09				
	1.9 dCi	96		10.05	03.09				
	2.0 16V	99		10.05	03.09				
	2.0 16V Turbo	120		10.05	03.09				
	2.0 dCi	110		10.05	03.09				
	1.5 dCi	60		04.04	03.09	24.3387-1721.7	220781		D=38, - Halter TRW
	1.5 dCi	74		04.04	03.09	24.3387-1722.7	220782		D=38, - Halter TRW
	1.5 dCi	76		06.06	03.09				
	1.6			04.04	03.09				
	1.9 dCi	81		05.05	03.09				
	1.9 dCi	88		04.04	03.09				
	1.9 dCi	96		05.05	03.09				
	2.0 16V	99		04.04	03.09				
	2.0 16V Turbo	120		04.04	03.09				
	2.0 dCi	110		09.05	04.07				
	2.0 dCi	110		05.07	03.09	24.3387-1727.7	221005		D=38, - Halter TRW
						24.3387-1728.7	221006		D=38, - Halter TRW
	1.5 dCi	60		04.04	08.05	24.5251-0185.3	330701	2	L=185
	1.5 dCi	74		04.04	08.05				
	1.6			04.04	08.05				
	1.9 dCi	81		05.05	08.05				
	1.9 dCi	88		04.04	08.05				
	1.9 dCi	96		05.05	08.05				
	2.0 16V	99		04.04	08.05				
	2.0 16V Turbo	120		04.04	08.05				
	1.5 dCi	60		09.05	03.09	24.5229-0185.3	330397	2	L=185
	1.5 dCi	74		09.05	03.09				
	1.5 dCi	76		06.06	03.09				
	1.6			09.05	03.09				
	1.9 dCi	81		09.05	03.09				
	1.9 dCi	88		09.05	03.09				
	1.9 dCi	96		09.05	03.09				
	2.0 16V	99		09.05	03.09				
	2.0 16V Turbo	120		09.05	03.09				
	2.0 dCi	110		09.05	03.09				





















									
RENAULT GRAND SCENIC (JM_) (04-09)									
	1.5 dCi	60		04.04	03.09	24.3727-1075.2	581075	2 ↓	L=2100
	1.5 dCi	74		04.04	03.09				
	1.5 dCi	76		06.06	03.09				
	1.6			04.04	03.09				
	1.9 dCi	81		05.05	03.09				
	1.9 dCi	88		04.04	03.09				
	1.9 dCi	96		05.05	03.09				
	2.0 16V	99		04.04	03.09				
	2.0 16V Turbo	120		04.04	03.09				
	1.5 dCi	60		04.04	03.09	24.2418-1701.3	030135	+ 5-Gang-Getriebe ¹⁾	Gz 18,82
	1.5 dCi	74		04.04	03.09				
	1.5 dCi	76		06.06	03.09				
	1.6			04.04	03.09				
	1.9 dCi	81		05.05	03.09				
	1.9 dCi	88		04.04	03.09				
	1.9 dCi	96		05.05	03.09				
	2.0 16V	99		04.04	03.09				
	2.0 16V Turbo	120		04.04	03.09				
RENAULT GRAND SCENIC (JZ_) (09-)									
	1.2 TCe	85		03.12		24.4123-1715.3	010980		Thz 23,81 TRW
	1.2 TCe	97		03.13					
	1.4 16V	96		02.09					
	1.5 dCi	63		04.09					
	1.5 dCi	70		11.10					
	1.5 dCi	78		02.09					
	1.5 dCi	81		04.09					
	1.6 16V	81		02.09					
	1.6 dCi	96		04.11					
	1.9 dCi	96		02.09					
	2.0 16V	103		02.09					
	2.0 dCi	110		02.09					
	2.0 dCi	118		04.09					
	1.2 TCe	85		03.12		11.9571-9775.2	220859	▣	D=57, - Halter ATE
	1.2 TCe	97		03.13		11.9571-9776.2	220860	▣	D=57, - Halter ATE
	1.4 16V	96		02.09		11.0101-5704.2	260095		Hülensatz ATE
	1.5 dCi	70		11.10		11.8116-0351.1	390538	2	Haltefeder ATE
	1.5 dCi	78		02.09					
	1.5 dCi	81		04.09					
	1.6 16V	81		02.09					
	1.6 dCi	96		04.11					
	1.9 dCi	96		02.09					
	2.0 16V	103		02.09					
	1.5 dCi	63		04.09		11.9541-9950.2	220843	▣	D=54, - Halter ATE
						11.9541-9951.2	220844	▣	D=54, - Halter ATE
						11.8170-0002.1	260110		Halter ATE
						11.8116-0356.1	390586	2	Haltefeder ATE
	2.0 dCi	110		02.09		11.9601-9753.2	220957	▣	D=60, - Halter ATE
	2.0 dCi	118		04.09		11.9601-9754.2	220958	▣	D=60, - Halter ATE
						11.0101-5704.2	260095		Hülensatz ATE
						11.0441-6008.2	250038		Dichtungssatz ATE
						11.8116-0351.1	390538	2	Haltefeder ATE
	1.2 TCe	85		03.12		24.5111-0426.3	331347	2	L=425
	1.2 TCe	97		03.13					
	1.4 16V	96		02.09					
	1.5 dCi	63		04.09					
	1.5 dCi	70		11.10					
	1.5 dCi	78		02.09					
	1.5 dCi	81		04.09					
	1.6 16V	81		02.09					
	1.6 dCi	96		04.11					
	1.9 dCi	96		02.09					
	2.0 16V	103		02.09					
	2.0 dCi	110		02.09					
	2.0 dCi	118		04.09					
	1.5 dCi	63		04.09		24.3347-1709.7	221013	▣	D=34, - Halter TRW
						24.3347-1710.7	221014	▣	D=34, - Halter TRW
	1.5 dCi	63		04.09		24.6234-1701.7	221015	▣	D=34, - Halter TRW
						24.6234-1702.7	221016	▣	D=34, - Halter TRW
	1.2 TCe	85		03.12		24.6238-1707.7	220969	▣	D=38, - Halter TRW
	1.2 TCe	97		03.13		24.6238-1708.7	220970	▣	D=38, - Halter TRW
	1.4 16V	96		02.09					
	1.5 dCi	70		11.10					
	1.5 dCi	78		02.09					
	1.5 dCi	81		04.09					
	1.6 16V	81		02.09					
	1.6 dCi	96		04.11					
	1.9 dCi	96		02.09					
	2.0 16V	103		02.09					
	2.0 dCi	110		02.09					
	2.0 dCi	118		04.09					
	1.2 TCe	85		03.12		24.5201-0135.3	331399	2 ▣	L=135
	1.2 TCe	97		03.13					
	1.4 16V	96		02.09					
	1.5 dCi	63		04.09					
	1.5 dCi	70		11.10					





























¹⁾ + 5 gear transmission / + scatola cambio 5 marce / + transmission 5-vitesses / + cambio de 5 velocidades















²⁾ - electric parking brake / - freno a mano elettrico / - frein à main électrique / - freno de mano eléctrico

³⁾ + electric parking brake / + freno a mano elettrico / + frein à main électrique / + freno de mano eléctrico











































								
RENAULT GRAND SCENIC (JZ_) (09-)								
	1.5 dCi	78		02.09	24.5201-0135.3	331399	2	L=135
	1.5 dCi	81		04.09				
	1.6 16V	81		02.09				
	1.6 dCi	96		04.11				
	1.9 dCi	96		02.09				
	2.0 16V	103		02.09				
	2.0 dCi	110		02.09				
	2.0 dCi	118		04.09				
RENAULT SPIDER (95-99)								
	2.0 16V	110		03.95	10.99	24.2123-1702.3	010431	THz 23,81
	2.0 16V	110		03.95	10.99	24.5111-0386.3	330503	L=385
						24.5229-0185.3	330397	L=185
	2.0 16V	110		03.95	10.99	24.5229-0220.3	330399	L=220
RENAULT THALIA I (LB_) (98-)								
	1.2 16V	55		04.02		03.7750-1332.4	300155	9" ATE
	1.4	55		08.00				
	1.4 16V	72		08.00				
	1.5 dCi	47		06.05				
	1.5 dCi	48		04.02				
	1.5 dCi	50		02.03				
	1.5 dCi	60		06.01				
	1.6 16V	79		04.02				
	1.9 D	48		02.98	05.01			
	1.2 16V	55		04.02		03.2120-2031.3	010106	THz 20,64
	1.4	55		08.00		03.2120-4461.3	010571	THz 20,64
	1.4 16V	72		08.00				
	1.5 dCi	47		06.05				
	1.5 dCi	48		04.02				
	1.5 dCi	50		02.03				
	1.5 dCi	60		06.01				
	1.6 16V	79		04.02				
	1.9 D	48		02.98	05.01			
	1.2 16V	55		04.02		24.3481-1611.5	240029	D=48, - Halter
	1.4	55		08.00		24.3481-1612.5	240030	D=48, - Halter
	1.4 16V	72		08.00		24.3481-1615.5	240031	D=48, - Halter
	1.5 dCi	47		06.05		24.3481-1616.5	240032	D=48, - Halter
	1.5 dCi	48		04.02				
	1.5 dCi	50		02.03				
	1.5 dCi	60		06.01				
	1.6 16V	79		04.02				
	1.9 D	48		02.98	05.01			
	1.2 16V	55		04.02		24.5111-0321.3	330597	L=320
	1.4	55		08.00				
	1.4 16V	72		08.00				
	1.5 dCi	47		06.05				
	1.5 dCi	48		04.02				
	1.5 dCi	50		02.03				
	1.5 dCi	60		06.01				
	1.6 16V	79		04.02				
	1.9 D	48		02.98	05.01			
	1.2 16V	55		04.02		24.5239-0165.3	330606	L=165
	1.4	55		08.00				
	1.4 16V	72		08.00				
	1.5 dCi	47		06.05				
	1.5 dCi	48		04.02				
	1.5 dCi	50		02.03				
	1.5 dCi	60		06.01				
	1.6 16V	79		04.02				
	1.9 D	48		02.98	05.01			
	1.4	55		08.00		24.3219-1722.3	020426	Rz 19,05
	1.2 16V	55		04.02		24.3217-1710.3	020420	Rz 17,78
	1.4 16V	72		08.00				
	1.5 dCi	47		06.05				
	1.5 dCi	48		04.02				
	1.5 dCi	50		02.03				
	1.5 dCi	60		06.01				
	1.6 16V	79		04.02				
	1.9 D	48		02.98	05.01			
	1.2 16V	55		04.02		24.3217-1711.3	020449	Rz 17,46
	1.4 16V	72		08.00				
	1.5 dCi	47		06.05				
	1.5 dCi	48		04.02				
	1.5 dCi	50		02.03				
	1.5 dCi	60		06.01				
	1.6 16V	79		04.02				
	1.9 D	48		02.98	05.01			
	1.4	55		08.00		24.3727-1049.2	581049	L=1263
						24.3727-1048.2	581048	L=1343

									
RENAULT THALIA I (LB_) (98-)									
	1.2 16V 1.4	55 55	04.02 08.00			24.3727-1061.2 24.3727-1060.2	581061 581060	<input type="checkbox"/> <input type="checkbox"/>	L=1335 L=1415
	1.2 16V 1.4 1.4 16V 1.5 dCi 1.5 dCi 1.5 dCi 1.6 16V 1.9 D	55 55 72 47 48 50 60 79 48	04.02 08.00 08.00 06.05 04.02 02.03 06.01 04.02 02.98						BRL (4) weiss/lila
	1.2 16V 1.4 1.4 16V	55 55 72	04.02 08.00 08.00			24.3728-1023.2	591023		L=960
RENAULT THALIA II / SYMBOL (LU_) (08-)									
	1.2 16V 1.5 dCi 1.5 dCi 1.6 16V	55 47 62 77	12.10 12.10 12.10 12.10			03.7853-1502.4	300200		9" ATE
	1.2 16V 1.5 dCi 1.5 dCi 1.6 16V	55 47 62 77	09.08 09.08 09.08 09.08			03.2120-2031.3	010106	- ABS + ABS	THz 20,64 ATE THz 20,64 ATE
	1.2 16V 1.5 dCi 1.5 dCi 1.6 16V	55 47 62 77	09.08 09.08 09.08 09.08			24.3481-1611.5 24.3481-1612.5	240029 240030	<input type="checkbox"/> <input type="checkbox"/>	D=48, - Halter TRW D=48, - Halter TRW
	1.2 16V 1.5 dCi 1.5 dCi 1.6 16V	55 47 62 77	09.08 09.08 09.08 09.08			24.3481-1615.5 24.3481-1616.5	240031 240032	<input type="checkbox"/> <input type="checkbox"/>	D=48, - Halter TRW D=48, - Halter TRW
	1.2 16V 1.5 dCi 1.5 dCi 1.6 16V	55 47 62 77	09.08 09.08 09.08 09.08			24.5111-0321.3	330597	2	L=320
	1.2 16V 1.5 dCi 1.5 dCi 1.6 16V	55 47 62 77	09.08 09.08 09.08 09.08			24.5239-0165.3	330606	2	L=165
	1.2 16V 1.5 dCi 1.5 dCi 1.6 16V	55 47 62 77	09.08 09.08 09.08 09.08	05.09 05.09 05.09 05.09		24.3219-1722.3	020426		Rz 19,05 BDX
	1.2 16V 1.5 dCi 1.5 dCi 1.6 16V	55 47 62 77	06.09 06.09 06.09 06.09	09.12 09.12 09.12 09.12		24.3217-1711.3	020449		Rz 17,46 BOS
	1.2 16V 1.5 dCi 1.5 dCi 1.6 16V	55 47 62 77	10.12 10.12 10.12 10.12			24.3217-1730.3	020542		Rz 17,46
	1.2 16V 1.5 dCi 1.5 dCi 1.6 16V	55 47 62 77	09.08 09.08 09.08 09.08			24.3217-1710.3	020420		Rz 17,78 TRW
	1.6 16V	77	09.08			24.6582-1721.3	320212		BRL (4) weiss/lila
	1.2 16V 1.5 dCi 1.6 16V	55 62 77	09.08 09.08 09.08			24.3728-1023.2	591023		L=960
RENAULT TRAFIC I Propulsion (PXX) (89-97)									
	1.7 2.0 2.1 D 2.1 D	50 59 43 47	05.89 05.89 05.89 06.94	08.94 10.97 06.94 10.97		03.2125-3801.3	010215		THz 25,40 ATE
	1.7 (P3-8) 2.0 (PC-2) 2.1 D (P3-3) 2.1 D (P3-3) 2.1 D (PC-3) 2.1 D (PC-3) 2.1 D (PC-F)	50 59 43 47 43 47 47	05.89 05.89 05.89 06.94 05.89 06.94 09.94	08.94 10.97 06.94 10.97 06.94 10.97 10.97	+1,0t +1,4t +1,0t +1,0t +1,4t +1,4t +1,4t	24.5111-0317.3 24.5111-0320.3	330501 330487	2 <input type="checkbox"/> 2 <input type="checkbox"/>	L=315 L=320
	1.7 2.0 2.1 D 2.1 D	50 59 43 47	05.89 05.89 05.89 06.94	08.94 10.97 06.94 10.97		24.3225-1601.3	020359		Rz 25,40 TRW
	1.7 2.0 2.1 D 2.1 D	50 59 43 47	05.89 05.89 05.89 06.94	08.94 10.97 06.94 10.97		03.6512-0100.3	320077		BRL 1/2 (2) ATE

										
RENAULT TRAFIC I Kasten (TXX) (89-01)										
	2.2	70	05.89	06.94	- ABS	03.2125-3701.3	010627	THz 25,40	ATE	
	2.2	74	06.94	10.97	- ABS					
	2.2 4x4	70	05.89	06.94						
	2.2 4x4	74	06.94	10.97						
	2.2	70	05.89	06.94	- ABS	03.2125-3801.3	010215	THz 25,40	ATE	
	2.2	74	06.94	10.97	- ABS					
	2.5 D	55	05.89	10.97						
	2.5 D 4x4	55	05.89	10.97						
	2.2	70	05.89	06.94	+ ABS	03.2125-3701.3	010627	THz 25,40	ATE	
	2.2	74	06.94	10.97	+ ABS					
	2.5 D	55	11.97	03.01		24.2025-1708.3	010692	THz 25,40		
	2.5 D 4x4	55	11.97	03.01		24.2025-1706.3	010676	THz 25,40		
		1.4	35	05.89	06.91		24.5111-0317.3	330501	<input type="checkbox"/> + 1-Kreis-Bremse ¹⁾	L=315
		1.7	50	05.89	08.94		24.5111-0320.3	330487	<input type="checkbox"/> + 1-Kreis-Bremse ¹⁾	L=320
		1.9 D	44	06.97	10.97					
		2.0	59	05.89	08.90					
2.0 4x4		59	05.89	08.90						
2.1 D		43	05.89	06.94						
2.1 D		47	06.94	08.94						
2.1 D		47	09.94	10.97		24.5111-0317.3	330501	<input type="checkbox"/> + 2-Kreis-Bremse ²⁾	L=315	
2.1 D 4x4	43	05.89	06.94		24.5111-0320.3	330487	<input type="checkbox"/> + 2-Kreis-Bremse ²⁾	L=320		
	2.1 D 4x4	47	06.94	10.97						
	2.2	70	05.89	06.94						
	2.2	74	06.94	10.97						
	2.2 4x4	70	05.89	06.94						
	2.2 4x4	74	06.94	10.97						
	2.5 D	55	05.89	03.01						
	2.5 D 4x4	55	05.89	03.01						
		1.4	35	05.89	06.91		24.5111-0386.3	330503	<input type="checkbox"/>	L=385
		1.7	50	05.89	08.94					
		1.9 D	44	06.97	10.97					
		2.0	59	05.89	08.90					
		2.0 4x4	59	05.89	08.90					
		2.1 D	43	05.89	06.94					
		2.1 D	47	06.94	10.97					
2.1 D 4x4		43	05.89	06.94						
2.1 D 4x4		47	06.94	10.97						
2.2		70	05.89	06.94						
2.2		74	06.94	10.97						
2.2 4x4		70	05.89	06.94						
2.2 4x4		74	06.94	10.97						
2.5 D		55	05.89	03.01						
2.5 D 4x4	55	05.89	10.97							
	1.4 (T1-0)	35	05.89	06.91		24.3222-1118.3	020315		Rz 22,20	
	1.7 (T1-8)	50	05.89	08.94						
	1.7 (T3-8)	50	05.89	08.94						
	1.7 (T4-8)	50	05.89	08.94						
	2.1 (T1-3)	43	05.89	06.94						
	2.1 (T1-3)	47	06.94	10.97						
	2.1 (T3-3)	43	05.89	06.94						
	2.1 (T3-3)	47	06.94	10.97						
	2.1 (T4-3)	43	05.89	06.94						
	2.1 (T4-3)	47	06.94	10.97						
	1.7 (T3-8)	50	05.89	08.94		24.3223-1106.3	020317		Rz 23,81	
	1.7 (T4-8)	50	05.89	08.94						
	2.1 (T1-3)	43	05.89	06.94						
	2.1 (T1-3)	47	06.94	10.97						
2.1 (T3-3)	43	05.89	06.94							
2.1 (T3-3)	47	06.94	10.97							
2.1 (T4-3)	43	05.89	06.94							
2.1 (T4-3)	47	06.94	10.97							
	1.9 D	44	06.97	03.01		24.3225-1601.3	020359		Rz 25,40	
	2.1 D	47	09.94	10.97						
	2.1 D 4x4	47	09.94	10.97						
	2.2	74	09.94	10.97						
	2.2 4x4	74	09.94	10.97						
	2.5 D	55	09.94	03.01						
	2.5 D 4x4	55	09.94	03.01						
		1.9 D	44	11.97	03.01	+ ABS	24.3727-1051.2	581051	<input type="checkbox"/>	L=1295
2.5 D		55	11.97	03.01	+ ABS	24.3727-1052.2	581052	<input type="checkbox"/>	L=1390	
2.5 D 4x4		55	11.97	03.01	+ ABS					
	1.4	35	05.89	06.91		03.6512-0100.3	320077		BRL 1/2 (2)	
	1.7	50	05.89	08.94						
	1.9 D	44	06.97	10.97						
	2.0	59	05.89	08.90						
	2.0 4x4	59	05.89	08.90						
	2.1 D	43	05.89	06.94						
	2.1 D	47	06.94	10.97						
	2.1 D 4x4	43	05.89	06.94						
	2.1 D 4x4	47	06.94	10.97						
	2.2	70	05.89	06.94						
	2.2	74	06.94	10.97						
	2.2 4x4	70	05.89	06.94						
	2.2 4x4	74	06.94	10.97						
	2.5 D	55	05.89	03.01						
2.5 D 4x4	55	05.89	03.01							

¹⁾ + single circuit brake / + impianto freni circuito singolo / + frein à 1 circuit / + freno de 1 circuito
²⁾ + two circuit brake / + impianto frenante doppio circuito / + frein à deux circuits / + freno de 2 circuitos





























									
RENAULT TRAFIC I Kasten (TXX) (89-01)									
	2.5 D	55	11.97	03.01	24.3728-1020.2	591020		L=1271	
RENAULT TRAFIC I Bus (TXW) (89-01)									
	2.2	70	05.89	06.94	- ABS	03.2125-3701.3	010627	THz 25,40 ATE	
	2.2	74	06.94	10.97	- ABS				
	2.2 4x4	70	05.89	06.94					
	2.2 4x4	74	06.94	10.97					
	2.2	70	05.89	06.94	- ABS	03.2125-3801.3	010215	THz 25,40 ATE	
	2.2	74	06.94	10.97	- ABS				
	2.5 D	55	05.89	03.01					
	2.5 D 4x4	55	08.89	03.01					
	2.1 D	43	05.89	06.94	+ ABS	03.2125-7002.3	010628	THz 25,40 ATE	
	2.1 D	47	06.94	10.97	+ ABS				
	2.5 D	55	05.89	10.97	+ ABS				
	2.5 D	55	11.97	03.01		24.2025-1708.3	010692	THz 25,40	
	2.5 D 4x4	55	11.97	03.01		24.2025-1706.3	010676	THz 25,40	
								- ABS + ABS	
	1.7	50	05.89	08.94		24.5111-0317.3	330501	L=315	
	1.9 D	44	06.97	03.01		24.5111-0320.3	330487	L=320	
	2.0	59	05.89	08.90					
	2.1 D	43	05.89	06.94					
	2.1 D	47	06.94	10.97					
	2.2	70	05.89	06.94					
	2.2	74	06.94	10.97					
	2.2 4x4	70	05.89	06.94					
	2.2 4x4	74	06.94	10.97					
	2.5 D	55	05.89	03.01					
	2.5 D 4x4	55	08.89	03.01					
		1.7	50	05.89	08.94		24.5111-0386.3	330503	L=385
		1.9 D	44	06.97	03.01				
2.0		59	05.89	08.90					
2.1 D		43	05.89	06.94					
2.1 D		47	06.94	10.97					
2.2		70	05.89	06.94					
2.2		74	06.94	10.97					
2.2 4x4		70	05.89	06.94					
2.2 4x4		74	06.94	10.97					
2.5 D		55	05.89	03.01					
2.5 D 4x4		55	08.89	10.97					
		1.7	50	05.89	08.94		24.3223-1106.3	020317	Rz 23,81 BDX
		1.9 D	44	06.97	03.01				
	2.0	59	05.89	08.90					
	2.1 D	43	05.89	06.94					
	2.1 D	47	06.94	10.97					
	2.2	70	05.89	06.94					
	2.2	74	06.94	10.97					
	2.5 D	55	05.89	03.01					
	2.5 D 4x4	55	08.89	03.01					
		1.7	50	05.89	08.94		24.3225-1601.3	020359	Rz 25,40 TRW
		1.9 D	44	06.97	03.01				
		2.0	59	05.89	08.90				
		2.1 D	43	05.89	06.94				
2.1 D		47	06.94	10.97					
2.2		70	05.89	06.94					
2.2		74	06.94	10.97					
2.5 D		55	05.89	03.01					
2.5 D 4x4		55	08.89	03.01					
		1.9 D	44	11.97	03.01	+ ABS	24.3727-1051.2	581051	L=1295
		2.5 D	55	11.97	03.01	+ ABS	24.3727-1052.2	581052	L=1390
		2.5 D 4x4	55	11.97	03.01	+ ABS			
		1.7	50	05.89	08.94		03.6512-0100.3	320077	BRL 1/2 (2) ATE
	1.9 D	44	06.97	03.01					
	2.0	59	05.89	08.90					
	2.1 D	43	05.89	06.94					
	2.1 D	47	06.94	10.97					
	2.2	70	05.89	06.94					
	2.2	74	06.94	10.97					
	2.2 4x4	70	05.89	06.94					
	2.2 4x4	74	06.94	10.97					
	2.5 D	55	05.89	03.01					
	2.5 D 4x4	55	08.89	03.01					
		2.5 D	55	11.97	03.01	24.3728-1020.2	591020		L=1271
	RENAULT TRAFIC II (JL/FL/EL) (01-14)								
	1.9 dCi	59	04.01	07.03		24.2120-1738.3	010759	THz 20,64 TRW	
	1.9 dCi	75	03.01	09.03		24.2125-1734.3	010878	THz 25,40 TRW	
	1.9 dCi 100	74	03.01	09.03					
	1.9 dCi 80	60	03.01	09.03					
	1.9 dCi	75	10.03	08.14		24.2120-1740.3	010764	THz 20,64 TRW	
	1.9 dCi 100	74	10.03	08.14		24.2125-1734.3	010878	THz 25,40 TRW	
	1.9 dCi 80	60	10.03	08.14					
	2.0 16V	86	08.06	08.14					
									

															
RENAULT TRAFIC II (JL/FL/EL) (01-14)															
	1.9 dCi	▶ 59		04.01	07.03	24.2125-1731.3	010826	- ESP	THz 25,40	TRW					
	1.9 dCi	▶ 75		03.01	08.14										
	1.9 dCi 100	▶ 74		10.03	08.14										
	1.9 dCi 80	▶ 60		03.01	08.14										
	2.0 16V	▶ 86		08.06	08.14										
	2.0 16V	88		03.01	08.14										
	2.0 dCi 90	66		10.06	08.14										
	2.5 dCi	84		08.07	08.14										
	2.5 dCi 135	99		05.03	08.14										
	2.5 DTi	99		03.03	07.03										
	2.0 dCi 115	84		10.06	08.14						24.2120-1748.3	010894	+ ABS/ - ESP	THz 20,64	TRW
	2.5 dCi 115	84		02.08	08.14						24.2120-1753.3	010946	+ ABS/ + ESP	THz 20,64	TRW
	2.5 dCi 145	107		10.06	08.14										
	1.9 dCi	59		04.01	07.03	24.3451-1713.7	220737	<input type="checkbox"/>	D=40/45, - Halter	TRW					
	1.9 dCi	75		03.01	08.14										
	1.9 dCi 100	74		03.01	08.14										
	1.9 dCi 80	60		03.01	08.14										
	2.0 16V	86		08.06	08.14										
	2.0 16V	88		03.01	08.14										
	2.0 dCi 115	84		10.06	08.14										
	2.0 dCi 90	66		10.06	08.14										
	2.5 dCi	84		08.07	08.14										
	2.5 dCi 115	84		02.08	08.14										
	2.5 dCi 135	99		05.03	08.14										
	2.5 dCi 145	107		10.06	08.14										
	2.5 DTi	99		03.03	07.03										
	1.9 dCi	59		04.01	07.03	24.5111-0386.3	330503	2	L=385						
	1.9 dCi	75		03.01	08.14										
	1.9 dCi 100	74		03.01	08.14										
	1.9 dCi 80	60		03.01	08.14										
	2.0 16V	86		08.06	08.14										
	2.0 16V	88		03.01	08.14										
	2.0 dCi 115	84		10.06	08.14										
	2.0 dCi 90	66		10.06	08.14										
	2.5 dCi	84		08.07	08.14										
	2.5 dCi 115	84		02.08	08.14										
	2.5 dCi 135	99		05.03	08.14										
	2.5 dCi 145	107		10.06	08.14										
	2.5 DTi	99		03.03	07.03										
	1.9 dCi	59		11.01	07.03	24.3414-1707.5	240337	<input type="checkbox"/>	D=41, - Halter	TRW					
	1.9 dCi	75		11.01	08.14										
	1.9 dCi 100	74		11.01	08.14										
	1.9 dCi 80	60		11.01	08.14										
	2.0 16V	86		08.06	08.14										
	2.0 16V	88		11.01	08.14										
	2.0 dCi 115	84		10.06	08.14										
	2.0 dCi 90	66		10.06	08.14										
	2.5 dCi	84		08.07	08.14										
	2.5 dCi 115	84		02.08	08.14										
	2.5 dCi 135	99		05.03	08.14										
	2.5 dCi 145	107		10.06	08.14										
	2.5 DTi	99		03.03	07.03										
	1.9 dCi	59		04.01	07.03	24.5229-0200.3	330572	2 <input type="checkbox"/>	L=200						
	1.9 dCi	75		03.01	08.14										
	1.9 dCi 100	74		03.01	08.14										
	1.9 dCi 80	60		03.01	08.14										
	2.0 16V	86		08.06	08.14										
	2.0 16V	88		03.01	08.14										
	2.0 dCi 115	84		10.06	08.14										
	2.0 dCi 90	66		10.06	08.14										
	2.5 dCi	84		08.07	08.14										
	2.5 dCi 115	84		02.08	08.14										
	2.5 dCi 135	99		05.03	08.14										
	2.5 dCi 145	107		10.06	08.14										
	2.5 DTi	99		03.03	07.03										
	1.9 dCi	◀ 59		04.01	07.03	24.3727-0796.2	580796	<input type="checkbox"/> + kurzer Radstand ²⁾	L=1245/498						
	1.9 dCi	◀ 75		03.01	08.14										
	1.9 dCi 100	◀ 74		03.01	08.14										
	1.9 dCi 80	◀ 60		03.01	08.14										
	2.0 16V	◀ 86		08.06	08.14										
	2.0 16V	◀ 88		03.01	08.14										
	2.0 dCi 115	◀ 84		10.06	08.14										
	2.0 dCi 90	◀ 66		10.06	08.14										
	2.5 dCi	◀ 84		08.07	08.14										
	2.5 dCi 115	◀ 84		02.08	08.14										
	2.5 dCi 135	◀ 99		05.03	08.14										
	2.5 dCi 145	◀ 107		10.06	08.14										
	2.5 DTi	◀ 99		03.03	07.03										
	1.9 dCi	59		04.01	07.03	24.3727-1068.2	581068	<input type="checkbox"/>	L=1503						
	1.9 dCi	75		03.01	08.14										
	1.9 dCi 100	74		03.01	08.14										
	1.9 dCi 80	60		03.01	08.14										
	2.0 16V	86		08.06	08.14										
	2.0 16V	88		03.01	08.14										
	2.0 dCi 115	84		10.06	08.14										
	2.0 dCi 90	66		10.06	08.14										
	2.5 dCi	84		08.07	08.14										
	2.5 dCi 115	84		02.08	08.14										
	2.5 dCi 135	99		05.03	08.14										
	2.5 dCi 145	107		10.06	08.14										
	2.5 DTi	99		03.03	07.03										

1) - Pickup/Chassis / - Autocarro a cassone/Telaio / - Camion plateau/Châssis / - Camión plataforma/Chasis

2) + short wheel base / + passo lungo / + empattement court / + distancia corta entre ejes

3) + long wheel base / + passo lungo / + empattement long / + distancia larga entre ejes

											
RENAULT TRAFIC II (JL/FL/EL) (01-14)											
	2.5 dCi 2.5 dCi 115 2.5 dCi 135 2.5 dCi 145 2.5 DTi	84 84 99 107 99		08.07 02.08 05.03 10.06 03.03	08.14 08.14 08.14 08.14 07.03	24.3727-1068.2 24.3727-1071.2	581068 581071	<input type="checkbox"/> <input type="checkbox"/>	L=1503 L=1603		
RENAULT TRAFIC III (14-)											
	1.6 dCi 115 1.6 dCi 120 1.6 dCi 125 1.6 dCi 140 1.6 dCi 145 1.6 dCi 90 1.6 dCi 95	85 88 92 103 107 66 70		05.14 05.14 07.15 05.14 07.15 05.14 07.15		24.5111-0386.3	330503	2	L=385		
	1.6 dCi 115 1.6 dCi 120 1.6 dCi 125 1.6 dCi 140 1.6 dCi 145 1.6 dCi 90 1.6 dCi 95	85 88 92 103 107 66 70		05.14 05.14 07.15 05.14 07.15 05.14 07.15		24.3414-1707.5 24.3414-1708.5	240337 240338	<input type="checkbox"/> <input type="checkbox"/>	D=41, - Halter D=41, - Halter	TRW TRW	
	1.6 dCi 115 1.6 dCi 120 1.6 dCi 125 1.6 dCi 140 1.6 dCi 145 1.6 dCi 90 1.6 dCi 95	85 88 92 103 107 66 70		05.14 05.14 07.15 05.14 07.15 05.14 07.15		24.5229-0200.3 24.5111-0221.3	330572 330818	2 2	am Bremsattel ¹⁾	L=200 L=220	
RENAULT TWINGO I Limousine (C06_) (93-07)											
	1.2 (C060) 1.2 (C063,C064) 1.2 (C066,C068) 1.2 (C067) 1.2 (C06C,C06D,C06K)	44 40 43 40 55		08.04 03.93 05.96 05.96 01.01	07.07 10.96 07.07 07.07 07.07	24.2120-1706.3 24.2120-1723.3	010262 010545	- ABS + ABS	THz 20,64 THz 20,64	BDX	
	1.2 (C063,C064) 1.2 (C066,C068) 1.2 (C067)	40 43 40		03.93 05.96 05.96	10.96 09.98 09.98	24.3451-1711.5 24.3451-1712.5	240251 240252	<input type="checkbox"/> <input type="checkbox"/>	D=45, - Halter D=45, - Halter	BDX BDX	
	1.2 (C060) 1.2 (C066,C068) 1.2 (C066,C068) 1.2 (C067) 1.2 (C067) 1.2 (C067) 1.2 (C06C,C06D,C06K)	44 43 43 40 40 40 55		08.04 10.98 05.96 10.98 05.96 01.01	07.07 07.07 07.07 07.07 07.07 07.07	24.3481-1611.5 24.3481-1612.5 24.0101-4807.2	240029 240030 260053	<input type="checkbox"/> <input type="checkbox"/>	- belüftete Scheiben ³⁾ - belüftete Scheiben ³⁾	D=48, - Halter D=48, - Halter Bremsattel-Zubehör	TRW TRW TRW
	1.2 (C066,C068) 1.2 (C067) 1.2 (C06C,C06D,C06K)	43 40 55		05.96 05.96 01.01	11.03 11.03 07.07	24.3481-1615.5 24.3481-1616.5	240031 240032	<input type="checkbox"/> <input type="checkbox"/>	+ belüftete Scheiben ⁶⁾ + belüftete Scheiben ⁶⁾	D=48, - Halter D=48, - Halter	TRW TRW
	1.2 (C060) 1.2 (C063,C064) 1.2 (C066,C068) 1.2 (C067) 1.2 (C06C,C06D,C06K)	44 40 43 40 55		08.04 03.93 05.96 05.96 01.01	07.07 10.96 07.07 07.07 07.07	24.5111-0241.3	330680	2		L=242	
	1.2 (C063,C064) 1.2 (C066,C068) 1.2 (C067)	40 43 40		03.93 05.96 05.96	10.96 07.07 07.07	24.5229-0185.3	330397	2	- ABS - ABS - ABS	L=185	
	1.2 (C063,C064) 1.2 (C066,C068) 1.2 (C067)	40 43 40		03.93 05.96 05.96	10.96 04.98 04.98	24.5229-0209.3	330670	2	+ ABS + ABS + ABS	L=210	
	1.2 (C06C,C06D,C06K)	55		01.01	07.07				- ABS		
	1.2 (C060) 1.2 (C066,C068) 1.2 (C067)	44 43 40		08.04 05.98 05.98	07.07 07.07 07.07	24.5229-0185.3	330397	2	+ ABS + ABS + ABS	L=185	
	1.2 (C063,C064) 1.2 (C066,C068) 1.2 (C067)	40 43 40		03.93 05.96 05.96	10.96 07.07 07.07	24.3220-1623.3 24.3220-1624.3	020353 020354	<input type="checkbox"/> <input type="checkbox"/>	- ABS - ABS - ABS	RzR 20,64 RzR 20,64	BDX BDX
	1.2 (C063,C064) 1.2 (C066,C068) 1.2 (C067)	40 43 40		03.93 05.96 05.96	10.96 06.98 06.98	24.3220-1117.3	020314		+ ABS + ABS + ABS	Rz 20,64	
	1.2 (C060) 1.2 (C066,C068) 1.2 (C067) 1.2 (C06C,C06D,C06K)	44 43 40 55		08.04 07.98 07.98 01.01	07.07 07.07 07.07 07.07	24.3217-1710.3	020420		+ ABS + ABS	Rz 17,78	TRW
	1.2 (C063,C064) 1.2 (C066,C068) 1.2 (C067) 1.2 (C06C,C06D,C06K)	40 43 40 55		03.93 05.96 05.96 01.01	10.96 07.07 07.07 07.07	24.3727-1038.2 24.3727-1039.2	581038 581039	2 2	- ABS + ABS	L=1442 L=1460	
	1.2 (C060)	44		08.04	07.07	24.3727-1039.2	581039	2		L=1460	
	1.2 (C063,C064) 1.2 (C066,C068) 1.2 (C067)	40 43 40		03.93 05.96 05.96	10.96 01.98 01.98	24.3728-1014.2	591014			L=938	
	1.2 (C060) 1.2 (C066,C068) 1.2 (C067) 1.2 (C06C,C06D,C06K)	44 43 40 55		08.04 02.98 02.98 01.01	07.07 07.07 07.07 07.07	24.3728-1019.2	591019			L=930	

1) on the brake caliper / sulla pinza freno / sur l'étrier de frein / a la pinza de freno
2) + manual transmission / + scatola cambio velocità / + transmission mécanique / + cambio de velocidad
3) - ventilated discs / - dischi ventilati / - disques ventilés / - disco ventilado
4) + autom.transmission / + scatola cambio automatico / + transmission automatique / + cambio automático
5) + reinforced suspension / + sospensione rinforzata / + châssis renforcé / + suspensión reforzada
6) + ventilated discs / + dischi ventilati / + disques ventilés / + disco ventilado
7) - reinforced suspension / - sospensione rinforzata / - châssis renforcé / - suspensión reforzada

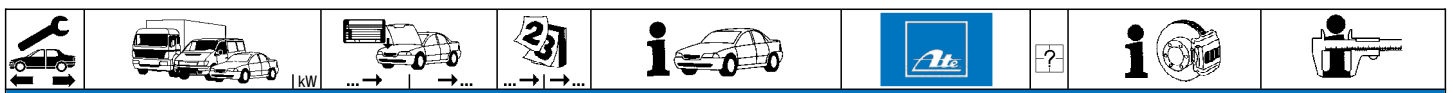

RENAULT TWINGO I Kasten (S06_) (93-07)

	1.2 (S063,S064) 1.2 (S066,S068)	40 43		03.93 05.96	04.96 07.07		24.2120-1706.3 24.2120-1723.3	010262 010545	- ABS + ABS	THz 20,64 THz 20,64	BDX
	1.2 (S063,S064) 1.2 (S066,S068)	40 43		03.93 05.96	04.96 09.98	+ Schaltgetriebe ¹⁾	24.3451-1711.5 24.3451-1712.5	240251 240252	 	D=45, - Halter D=45, - Halter	BDX BDX
	1.2 (S066,S068) 1.2 (S066,S068)	43 43		10.98 05.96	07.07 07.07	+ Schaltgetriebe ¹⁾ + Automatikgetriebe ³⁾	24.3481-1611.5 24.3481-1612.5	240029 240030	 	D=48, - Halter D=48, - Halter	TRW TRW
	1.2 (S066,S068)	43		05.96	11.03		24.3481-1615.5 24.3481-1616.5	240031 240032	 	D=48, - Halter D=48, - Halter	TRW TRW
	1.2 (S063,S064) 1.2 (S066,S068)	40 43		03.93 05.96	04.96 07.07		24.5111-0241.3	330680		L=242	
	1.2 (S063,S064) 1.2 (S066,S068)	40 43		03.93 05.96	04.96 07.07	- ABS - ABS	24.5229-0185.3	330397		L=185	
	1.2 (S063,S064) 1.2 (S066,S068)	40 43		03.93 05.96	04.96 04.98	+ ABS + ABS	24.5229-0209.3	330670		L=210	
	1.2 (S066,S068)	43		05.98	07.07	+ ABS	24.5229-0185.3	330397		L=185	
	1.2 (S063,S064) 1.2 (S066,S068)	40 43		03.93 05.96	04.96 07.07	- ABS - ABS	24.3220-1623.3 24.3220-1624.3	020353 020354	 	RzR 20,64 RzR 20,64	BDX BDX
	1.2 (S063,S064) 1.2 (S066,S068)	40 43		03.93 05.96	04.96 06.98	+ ABS + ABS	24.3220-1117.3	020314		Rz 20,64	
	1.2 (S066,S068)	43		07.98	07.07	+ ABS	24.3217-1710.3	020420		Rz 17,78	TRW
	1.2 (S063,S064) 1.2 (S066,S068)	40 43		03.93 05.96	04.96 07.07		24.3727-1038.2 24.3727-1039.2	581038 581039	2 - ABS 2 + ABS	L=1442 L=1460	
	1.2 (S063,S064) 1.2 (S066,S068)	40 43		03.93 05.96	04.96 01.98		24.3728-1014.2	591014		L=938	
	1.2 (S066,S068)	43		02.98	07.07		24.3728-1019.2	591019		L=930	

RENAULT TWINGO II (CNO_) (07-14)

	1.2 1.2 16V 1.2 16V 1.2 TCe 100 1.2 Turbo 1.5 dCi 1.5 dCi 1.5 dCi 75 1.5 dCi 90	43 55 56 75 74 47 62 55 63		03.07 03.07 03.07 02.11 03.07 03.07 04.08 10.10 10.10	07.14 07.14 07.14 07.14 07.14 07.14 07.14 07.14 07.14		03.7853-3902.4	300270	- ESP	9"	ATE
	1.2 1.2 16V 1.2 16V 1.2 TCe 100 1.2 Turbo 1.5 dCi 1.5 dCi 1.5 dCi 75 1.5 dCi 90	43 55 56 75 74 47 62 55 63		03.07 03.07 03.07 02.11 03.07 03.07 04.08 10.10 10.10	07.14 07.14 07.14 07.14 07.14 07.14 07.14 07.14 07.14		03.7750-7332.4	300298	+ ESP	9"	ATE
	1.6 RS	98		05.08	07.14		03.7750-8832.4	300299		9"	ATE
	1.2 1.2 16V 1.2 16V 1.2 TCe 100 1.2 Turbo 1.5 dCi 1.5 dCi 1.5 dCi 75 1.5 dCi 90	43 55 56 75 74 47 62 55 63		03.07 03.07 03.07 02.11 03.07 03.07 04.08 10.10 10.10	07.14 07.14 07.14 07.14 07.14 07.14 07.14 07.14 07.14		03.2120-4581.3	010915	- ESP	THz 20,64	ATE
	1.2 1.2 16V 1.2 16V 1.2 TCe 100 1.2 Turbo 1.5 dCi 1.5 dCi 1.5 dCi 75 1.5 dCi 90	43 55 56 75 74 47 62 55 63		03.07 03.07 03.07 02.11 03.07 03.07 04.08 10.10 10.10	07.14 07.14 07.14 07.14 07.14 07.14 07.14 07.14 07.14		03.2120-4641.3	010932	+ ESP	THz 20,64	ATE
	1.2 1.5 dCi	43 47		03.07 03.07	07.14 07.14		24.3481-1611.5 24.3481-1612.5	240029 240030	 	D=48, - Halter D=48, - Halter	TRW TRW
	1.2 1.2 16V 1.2 16V 1.2 TCe 100 1.2 Turbo 1.5 dCi 1.5 dCi 1.5 dCi 75 1.5 dCi 90	43 55 56 75 74 47 62 55 63		03.07 03.07 03.07 02.11 03.07 03.07 04.08 10.10 10.10	07.14 07.14 07.14 07.14 07.14 07.14 07.14 07.14 07.14		24.3481-1615.5 24.3481-1616.5	240031 240032	 	D=48, - Halter D=48, - Halter	TRW TRW
	1.6 RS	98		05.08	07.14		11.9571-9757.2 11.9571-9758.2 11.8116-0301.1	220857 220858 390610	 	D=57, - Halter D=57, - Halter Haltefeder	ATE ATE ATE
	1.2 1.2 16V 1.2 16V	43 55 56		03.07 03.07 03.07	07.14 07.14 07.14		24.5111-0321.3	330597		L=320	

1) + manual transmission / + scatola cambio velocità / + transmission mécanique / + cambio de velocidad
2) - ventilated discs / - dischi ventilati / - disques ventilés / - disco ventilado
3) + autom.transmission / + scatola cambio automatico / + transmission automatique / + cambio automático
4) + ventilated discs / + dischi ventilati / + disques ventilés / + disco ventilado



RENAULT TWINGO II (CNO_) (07-14)





















	1.2 TCe 100	75		02.11	07.14	24.5111-0321.3	330597	2		L=320						
	1.2 Turbo	74		03.07	07.14											
	1.5 dCi	47		03.07	07.14											
	1.5 dCi	62		04.08	07.14											
	1.5 dCi 75	55		10.10	07.14											
	1.5 dCi 90	63		10.10	07.14											
	1.6 RS	98		05.08	07.14											
	1.6 RS	98		05.08	07.14	24.5111-0411.3	331394	2	D=34, - Halter D=34, - Halter Bremsattel-Zubehör	TRW TRW TRW						
	1.2	43		03.07	07.14											
	1.2 16V	55		03.07	07.14											
	1.2 16V	56		03.07	07.14	24.5239-0165.3	330606	2		L=165						
	1.2 TCe 100	75		02.11	07.14											
	1.2 Turbo	74		03.07	07.14											
	1.5 dCi	47		03.07	07.14											
	1.5 dCi	62		04.08	07.14											
	1.5 dCi 75	55		10.10	07.14											
	1.5 dCi 90	63		10.10	07.14											
	1.6 RS	98		05.08	07.14											
		1.2	43		03.07						09.12	24.3217-1727.3	020524			Rz 17,46
		1.2 16V	55		03.07						09.12					
		1.2 16V	56		03.07						09.12					
		1.2 TCe 100	75		02.11						09.12					
		1.2 Turbo	74		03.07						09.12					
		1.5 dCi	47		03.07						09.12					
1.5 dCi		62		04.08	09.12											
1.5 dCi 75		55		10.10	09.12											
1.5 dCi 90		63		10.10	09.12											
		1.2	43		10.12	07.14	24.3217-1730.3	020542			Rz 17,46					
		1.2 16V	55		10.12	07.14										
		1.2 16V	56		10.12	07.14										
		1.2 TCe 100	75		10.12	07.14										
		1.2 Turbo	74		10.12	07.14										
	1.5 dCi	47		10.12	07.14											
	1.5 dCi	62		10.12	07.14											
	1.5 dCi 75	55		10.12	07.14											
	1.5 dCi 90	63		10.12	07.14											
		1.2	43		03.07	07.14						24.3727-1077.2	581077	<input type="checkbox"/>		L=1273
		1.2 16V	55		03.07	07.14										
		1.2 16V	56		03.07	07.14										
		1.2 TCe 100	75		02.11	07.14										
		1.2 Turbo	74		03.07	07.14										
1.5 dCi		47		03.07	07.14											
1.5 dCi		62		04.08	07.14											
1.5 dCi 75		55		10.10	07.14											
1.5 dCi 90		63		10.10	07.14											
		1.2	43		03.07	07.14	24.3727-1076.2	581076	<input type="checkbox"/>		L=1355					
		1.2 16V	55		03.07	07.14										
		1.2 16V	56		03.07	07.14										
		1.2 TCe 100	75		02.11	07.14										
		1.2 Turbo	74		03.07	07.14										
	1.5 dCi	47		03.07	07.14											
	1.5 dCi	62		04.08	07.14											
	1.5 dCi 75	55		10.10	07.14											
	1.5 dCi 90	63		10.10	07.14											





















RENAULT VEL SATIS (BJO_) (02-09)

	2.0	◀108		04.05	10.05	03.7858-2802.4	300303		- Distanzregulierer 1) + Distanzregulierer 2)	9/8" Tandem Wegsensor	ATE ATE							
	2.0 16V Turbo	◀120		06.02	10.05													
	2.0 16V Turbo	◀125		04.04	10.05													
	2.2 dCi	◀85		04.04	10.05													
	2.2 dCi	◀102		09.04	10.05													
	2.2 dCi	◀110		06.02	10.05													
	3.0 dCi	◀130		06.02	10.05													
	3.5	◀170		10.04	10.05													
	3.5 V6	◀177		06.02	10.05													
		2.0	▶108		04.05							10.05	03.0655-0005.2	370005		+ Distanzregulierer 2)	Wegsensor	ATE
		2.0 16V Turbo	▶120		06.02							10.05						
		2.0 16V Turbo	▶125		04.04							10.05						
		2.2 dCi	▶85		04.04							10.05						
		2.2 dCi	▶102		09.04							10.05						
2.2 dCi		▶110		06.02	10.05													
3.0 dCi		▶130		06.02	10.05													
3.5		▶170		10.04	10.05													
3.5 V6		▶177		06.02	10.05													
		2.0 16V Turbo	120		06.02	03.05	03.4125-0014.3	010794			Thz 25,40	ATE						
		2.0 16V Turbo	125		04.04	03.05												
		2.2 dCi	85		04.04	03.05												
		2.2 dCi	102		09.04	03.05												
		2.2 dCi	110		06.02	03.05												
	3.0 dCi	130		06.02	03.05													
	3.5	170		10.04	03.05													
	3.5 V6	177		06.02	03.05													
		2.0	108		04.05	12.09							03.4155-0043.3	010795			Thz 25,40	ATE
		2.0 16V Turbo	120		04.05	12.09												
		2.0 16V Turbo	125		04.05	12.09												
		2.0 dCi	110		08.05	12.09												
		2.0 dCi	127		01.06	12.09												
		2.2 dCi	85		04.05	12.09												
2.2 dCi		102		04.05	12.09													
2.2 dCi		110		04.05	12.09													
3.0 dCi		130		04.05	12.09													
3.0 dCi		133		06.06	12.09													
3.5		170		10.04	12.09													

1) - distance regulator / - correttore di distanza / - régulateur de distance / - corrector de distancia

















2) + distance regulator / + correttore di distanza / + régulateur de distance / + corrector de distancia















											
RENAULT VEL SATIS (BJO_) (02-09)											
	3.5 V6	177		04.05	12.09		03.4155-0043.3	010795	THz 25,40	ATE	
	2.0	108		04.05	12.09		11.9601-9787.2	220585	D=60, - Halter D=60, - Halter D=60, - Halter D=60, - Halter Hülzensatz Führungsbolzen Haltefeder	ATE	
	2.0 16V Turbo	120		06.02	12.09		11.9601-9788.2	220586		ATE	
	2.0 16V Turbo	125		04.04	12.09		24.3601-9787.5	240505		ATE	
	2.0 dCi	110		08.05	12.09		24.3601-9788.5	240506		ATE	
	2.0 dCi	127		01.06	12.09		11.0101-5407.2	260011		ATE	
	2.2 dCi	85		04.04	12.09		11.8171-0008.1	990049		ATE	
	2.2 dCi	102		09.04	12.09		11.8116-0301.1	390610		ATE	
	2.2 dCi	110		06.02	12.09						
	3.0 dCi	130		06.02	12.09						
	3.0 dCi	133		06.06	12.09						
	3.5	170		10.04	12.09						
	3.5 V6	177		06.02	12.09						
	2.0	108		04.05	12.09		24.5252-0390.3	330702	2	L=390	
	2.0 16V Turbo	120		06.02	12.09						
	2.0 16V Turbo	125		04.04	12.09						
	2.0 dCi	110		08.05	12.09						
	2.0 dCi	127		01.06	12.09						
	2.2 dCi	85		04.04	12.09						
	2.2 dCi	102		09.04	12.09						
	2.2 dCi	110		06.02	12.09						
	3.0 dCi	130		06.02	12.09						
	3.0 dCi	133		06.06	12.09						
	3.5	170		10.04	12.09						
	3.5 V6	177		06.02	12.09						
	2.0	108		04.05	12.09		11.9387-7001.2	220397	D=38, - Halter D=38, - Halter Halter Haltefeder Führungsbolzen Hülzensatz	ATE	
	2.0 16V Turbo	120		06.02	12.09		11.9387-7002.2	220398		ATE	
	2.0 16V Turbo	125		04.04	12.09		11.8170-0872.1	260121		ATE	
	2.0 dCi	110		08.05	12.09		11.8116-0340.1	390595		ATE	
	2.0 dCi	127		01.06	12.09		11.8171-0008.1	990049		ATE	
	2.2 dCi	85		04.04	12.09		11.0101-5407.2	260011		ATE	
	2.2 dCi	102		09.04	12.09						
	2.2 dCi	110		06.02	12.09						
	3.0 dCi	130		06.02	12.09						
	3.0 dCi	133		06.06	12.09						
	3.5	170		10.04	12.09						
	3.5 V6	177		06.02	12.09						
	2.0 16V Turbo	120		06.02	08.02		24.5111-0335.3	330778	2	L=335	
	2.2 dCi	110		06.02	08.02						
	3.0 dCi	130		06.02	08.02						
	3.5 V6	177		06.02	08.02						
	2.0	108		04.05	12.09		24.5111-0317.3	330501	2	L=315	
	2.0 16V Turbo	120		09.02	12.09						
	2.0 16V Turbo	125		04.04	12.09						
	2.0 dCi	110		08.05	12.09						
	2.0 dCi	127		01.06	12.09						
	2.2 dCi	85		04.04	12.09						
	2.2 dCi	102		09.04	12.09						
	2.2 dCi	110		09.02	12.09						
	3.0 dCi	130		09.02	12.09						
	3.0 dCi	133		06.06	12.09						
	3.5	170		10.04	12.09						
	3.5 V6	177		09.02	12.09						
RENAULT WIND (E4M_) (10-13)											
	1.2 16V Turbo	74		07.10	09.13		03.7750-8832.4	300299		9"	ATE
	1.2 TCe 100	75		02.11	09.13						
	1.6 16V	98		07.10	09.13						
	1.2 16V Turbo	74		07.10	09.13		11.9571-9757.2	220857	D=57, - Halter D=57, - Halter Haltefeder	ATE	
	1.2 TCe 100	75		02.11	09.13		11.9571-9758.2	220858		ATE	
	1.6 16V	98		07.10	09.13		11.8116-0301.1	390610		ATE	
	1.2 16V Turbo	74		07.10	09.13		24.5111-0411.3	331394	2	L=410	
	1.2 TCe 100	75		02.11	09.13						
	1.6 16V	98		07.10	09.13						
	1.2 16V Turbo	74		07.10	09.13		24.3347-1705.7	220751	D=34, - Halter D=34, - Halter Bremsattel-Zubehör	TRW	
	1.2 TCe 100	75		02.11	09.13		24.3347-1706.7	220752		TRW	
	1.6 16V	98		07.10	09.13		24.0101-3803.2	260101		TRW	
	1.2 16V Turbo	74		07.10	09.13		24.5239-0165.3	330606	2	L=165	
	1.2 TCe 100	75		02.11	09.13						
	1.6 16V	98		07.10	09.13						
RENAULT ZOE (12-)											
	Z.E.	65		06.12			24.3541-1849.5	240707	D=54, - Halter D=54, - Halter	TRW	
							24.3541-1850.5	240708		TRW	
	Z.E.	65		06.12			24.3222-1729.3	020526		Rz 22,20	

									
ROVER 25-Serie (RF) (99-05)									
	1.1 16V 1.4 16V 1.4 16V 1.6 16V 1.8 16V 1.8 16V 2.0 iDT 2.0 iDT	55 62 76 80 85 107 74 83		01.04 05.05 10.99 05.05 10.99 05.05 10.99 05.05 10.99 05.05 02.00 05.05 10.99 05.05 01.02 12.04	24.3219-1743.3	020485		Rz 19,05	
ROVER 45-Serie (RT) (00-05)									
	1.4 1.6 1.8 2.0 iDT 2.0 iDT 2.0 V6	76 80 86 74 83 110		02.00 05.05 02.00 05.05 02.00 05.05 02.00 05.05 01.04 05.05 02.00 05.05	24.3541-1813.5 24.3541-1814.5	240381 240382	<input type="checkbox"/> + belüftete Scheiben ¹⁾ <input type="checkbox"/> + belüftete Scheiben ¹⁾	D=54, - Halter D=54, - Halter	TRW TRW
	1.4 1.6 1.8 2.0 iDT 2.0 iDT 2.0 V6	76 74465 80 74465 86 74465 74 74465 83 74465 110 74465		05.05 05.05 05.05 05.05 05.05 05.05	24.3219-1743.3	020485		Rz 19,05	
ROVER 75-Serie (RJ/RX) (99-05)									
	1.8 1.8 Turbo 2.0 CDT 2.0 CDTi 2.0 V6 2.5 V6 2.5 V6	88 110 85 96 110 129 130		02.99 05.05 05.03 05.05 02.99 05.05 02.03 05.05 02.99 05.05 02.99 10.01 08.01 05.05	11.9571-9871.2 11.9571-9872.2 11.0101-5407.2 11.8171-0008.1	220425 220426 260011 990049	<input type="checkbox"/> <input type="checkbox"/> 2	D=57, - Halter D=57, - Halter Hülzensatz Führungsbolzen	ATE ATE ATE ATE
	1.8 1.8 Turbo 2.0 CDT 2.0 CDTi 2.0 V6 2.5 V6 2.5 V6	88 110 85 96 110 129 130		02.99 05.05 05.03 05.05 02.99 05.05 02.03 05.05 02.99 05.05 02.99 10.01 08.01 05.05	11.9361-9961.2 11.9361-9962.2	220855 220856	<input type="checkbox"/> <input type="checkbox"/>	D=36, - Halter D=36, - Halter	ATE ATE
ROVER 200 II-Serie (RF) (95-00)									
	211 214 i 214 Si 216 Si 218 i 16V Vitesse 220 D 220 SDi	44		01.98 03.00 01.96 03.00 11.95 03.00 11.95 03.00 01.96 03.00 01.96 03.00 01.96 03.00 + ABS	24.3541-1813.5 24.3541-1814.5	240381 240382	<input type="checkbox"/> <input type="checkbox"/>	D=54, - Halter D=54, - Halter	
	211 214 i 214 Si 216 Si 218 i 16V Vitesse 220 D 220 SDi	44		01.98 03.00 + ABS 01.96 03.00 + ABS 11.95 03.00 + ABS 01.96 03.00 + ABS 01.97 03.00 + ABS 01.96 03.00 + ABS 01.96 03.00 + ABS	24.3304-1701.5 24.3304-1702.5	240113 240114	<input type="checkbox"/> <input type="checkbox"/>	D=30, - Halter D=30, - Halter	TRW TRW
	211 214 i 214 Si 216 Si 218 i 16V Vitesse 220 D 220 SDi	44		01.98 03.00 - ABS 01.96 03.00 - ABS 11.95 03.00 - ABS 01.96 03.00 - ABS 01.97 03.00 - ABS 01.96 03.00 - ABS 01.96 03.00 - ABS	24.3219-1743.3	020485		Rz 19,05	
ROVER 400-Serie (RT) (95-00)									
	414 Si 416 Si 420 D 420 Di 420 Si	63 77 100		05.95 03.00 06.95 03.00 11.95 03.00 05.95 03.00 12.95 03.00	24.3541-1813.5 24.3541-1814.5	240381 240382	<input type="checkbox"/> + ABS <input type="checkbox"/> + ABS	D=54, - Halter D=54, - Halter	TRW TRW
	414 Si 416 Si 420 D 420 Di 420 Si	63 77 100		05.95 03.00 - ABS 06.95 03.00 - ABS 11.95 03.00 - ABS 05.95 03.00 - ABS 12.95 03.00 - ABS	24.3219-1743.3	020485		Rz 19,05	
ROVER 600-Serie (RH) (93-99)									
	618 i/Si 620 i 620 SDi 620 Si 620 Ti Vitesse 623 Si			03.96 02.99 08.93 02.99 12.94 02.99 08.93 02.99 07.94 02.99 08.93 02.99	24.3571-1777.5 24.3571-1778.5	240749 240750	<input type="checkbox"/> + 14" Rad ²⁾ <input type="checkbox"/> + 14" Rad ²⁾	D=57, - Halter D=57, - Halter	

¹⁾ + ventilated discs / + dischi ventilati / + disques ventilés / + disco ventilado

²⁾ + 14" wheel / + ruota 14" / + roue 14" / + rueda 14"

        											
ROVER STREETWISE (03-05)											
	1.4 1.4 1.8 2.0 TD	62 76 86 74		08.03 08.03 08.03 08.03	05.05 05.05 05.05 05.05	24.3541-1813.5 24.3541-1814.5	240381 240382	<input type="checkbox"/> + ABS <input type="checkbox"/> + ABS		D=54, - Halter D=54, - Halter	TRW TRW
SAAB 9-3 (YS3D) (98-02)											
	2.0 i 2.0 SE Turbo 2.0 Turbo 2.0 Turbo 2.0 Turbo 2.2 TiD 2.3 i	96 147 110 113 136 151 92 110		01.01 01.01 01.01 01.01 01.01 01.01 01.01	09.02 09.02 09.02 09.02 09.02 09.02 09.02	03.7750-2932.4	300175			9"	ATE
	2.0 i 2.0 SE Turbo 2.0 Turbo 2.0 Turbo 2.0 Turbo 2.2 TiD 2.2 TiD 2.3 i	96 147 113 136 151 85 92 110		02.98 02.98 10.98 02.98 10.99 02.98 11.00 02.98	12.00 12.00 12.00 12.00 12.00 11.00 12.00 12.00	03.2123-1121.3	010176			THz 23,81	ATE
	2.0 i 2.0 SE Turbo 2.0 Turbo 2.0 Turbo 2.0 Turbo 2.2 TiD 2.2 TiD 2.3 i	96 147 110 113 136 151 92 110		01.01 01.01 01.01 01.01 01.01 01.01 01.01 01.01	09.02 09.02 09.02 09.02 09.02 09.02 09.02 09.02	03.2123-1626.3	010727			THz 23,81	ATE
	2.3 Turbo	165		10.98	09.02	03.2125-7502.3	010616			THz 25,40	ATE
	2.0 i 2.0 i 2.0 i 2.0 SE Turbo 2.0 SE Turbo 2.0 SE Turbo 2.0 Turbo 2.0 Turbo 2.0 Turbo 2.0 Turbo 2.0 Turbo 2.2 TiD 2.2 TiD 2.2 TiD 2.3 i 2.3 i 2.3 i	96 96 96 147 147 147 113 113 113 136 136 85 85 85 110 110 110	X7020000 X2020000 X7020000 X2020000 X7020000 X2020000 X7020000 X2020000 X7020000 X2020000 X7020000 X2020000 X7020000 X2020000 X7020000 X2020000	02.98 02.98 02.98 02.98 02.98 10.98 10.98 10.98 02.98 02.98 02.98 02.98 02.98 02.98 02.98 02.98	+ (USA) + (USA) - (USA) + (USA) + (USA) + (USA) + (USA) + (USA) + (USA) + (USA) + (USA) + (USA) + (USA) + (USA) + (USA) + (USA)	24.3571-1761.5 24.3571-1762.5 11.8171-0008.1 11.0101-5407.2 11.8116-0292.1	240461 240462 990049 260011 390521	<input type="checkbox"/> <input type="checkbox"/> <input type="checkbox"/> <input type="checkbox"/> <input type="checkbox"/> <input type="checkbox"/> <input type="checkbox"/> <input type="checkbox"/> <input type="checkbox"/> <input type="checkbox"/> <input type="checkbox"/> <input type="checkbox"/> <input type="checkbox"/> <input type="checkbox"/> <input type="checkbox"/> <input type="checkbox"/>	2	D=57, - Halter D=57, - Halter Führungsbolzen Hülzensatz Haltefeder	ATE ATE ATE ATE ATE
	2.0 i 2.0 i 2.0 i 2.0 SE Turbo 2.0 SE Turbo 2.0 SE Turbo 2.0 Turbo 2.0 Turbo 2.0 Turbo 2.0 Turbo 2.0 Turbo 2.0 Turbo 2.0 Turbo 2.0 Turbo 2.2 TiD 2.2 TiD 2.2 TiD 2.2 TiD 2.3 i 2.3 i 2.3 i 2.3 Turbo	96 96 96 147 147 147 110 110 110 113 113 136 136 136 85 85 85 92 110 110 110 165	X7020001 X2020001 X7020001 X2020001 X7020001 X2020001 X7020001 X2020001 X7020001 X2020001 X7020001 X2020001 X7020001 X2020001 X7020001 X2020001 X7020001 X2020001 X7020001 X2020001	09.02 09.02 01.99 09.02 09.02 01.99 09.02 09.02 09.02 09.02 09.02 09.02 09.02 09.02 09.02 11.00 11.00 01.99 11.00 01.99 09.02 09.02 01.99 10.98	+ (USA) + (USA) - (USA) + (USA)	24.3571-1783.5 24.3571-1784.5 11.0101-5407.2 11.0441-5704.2 11.8116-0292.1 11.8171-0008.1	240751 240752 260011 250034 390521 990049	<input type="checkbox"/> <input type="checkbox"/> <input type="checkbox"/> <input type="checkbox"/> <input type="checkbox"/> <input type="checkbox"/> <input type="checkbox"/> <input type="checkbox"/> <input type="checkbox"/> <input type="checkbox"/> <input type="checkbox"/> <input type="checkbox"/> <input type="checkbox"/> <input type="checkbox"/> <input type="checkbox"/> <input type="checkbox"/> <input type="checkbox"/> <input type="checkbox"/> <input type="checkbox"/> <input type="checkbox"/> <input type="checkbox"/> <input type="checkbox"/> <input type="checkbox"/> <input type="checkbox"/> <input type="checkbox"/>	2	D=57, - Halter D=57, - Halter Hülzensatz Dichtungssatz Haltefeder Führungsbolzen	ATE ATE ATE ATE ATE ATE
	2.0 i 2.0 SE Turbo 2.0 Turbo 2.0 Turbo 2.0 Turbo 2.0 Turbo 2.2 TiD 2.2 TiD 2.3 i 2.3 Turbo	96 147 110 113 136 151 85 92 110 165		02.98 02.98 01.01 10.98 02.98 10.99 02.98 11.00 02.98 10.98	09.02 09.02 09.02 09.02 09.02 09.02 11.00 09.02 09.02 09.02	24.5298-0322.3	331314			L=322	

SAAB 9-3 (YS3D) (98-02)		SAAB 9-3 Limousine (YS3F) (03-12)										
	2.0 i	96	02.98 09.02	13.2351-0025.2 210210 13.2351-0026.2 210211 13.0441-3506.2 250052		D=35 D=35 Dichtungssatz	ATE ATE ATE					
	2.0 SE Turbo	147	02.98 09.02									
	2.0 Turbo	110	01.01 09.02									
	2.0 Turbo	113	10.98 09.02									
	2.0 Turbo	136	02.98 09.02									
	2.0 Turbo	151	10.99 09.02									
	2.2 TiD	85	02.98 11.00									
	2.2 TiD	92	11.00 09.02									
2.3 i	110	02.98 09.02										
	2.0 i	96	02.98 09.02	24.5117-0205.3 330669 24.5117-0195.3 330565		L=205 L=198						
	2.0 SE Turbo	147	02.98 09.02									
	2.0 Turbo	110	01.01 09.02									
	2.0 Turbo	113	10.98 09.02									
	2.0 Turbo	136	02.98 09.02									
	2.0 Turbo	151	10.99 09.02									
	2.2 TiD	85	02.98 11.00									
	2.2 TiD	92	11.00 09.02									
2.3 i	110	02.98 09.02										
2.3 Turbo	165	10.98 09.02										
	2.0 i	96	02.98 09.02	24.3727-1106.2 581106	1 	L=2180/1425						
	2.0 SE Turbo	147	02.98 09.02									
	2.0 Turbo	110	01.01 09.02									
	2.0 Turbo	113	10.98 09.02									
	2.0 Turbo	136	02.98 09.02									
	2.0 Turbo	151	10.99 09.02									
	2.2 TiD	85	02.98 11.00									
	2.2 TiD	92	11.00 09.02									
2.3 i	110	02.98 09.02										
2.3 Turbo	165	10.98 09.02										
	2.0 i	96	02.98 09.02	24.2419-1727.3 030116		Gz 19,05						
	2.0 SE Turbo	147	02.98 09.02									
	2.0 Turbo	110	01.01 09.02									
	2.0 Turbo	113	10.98 09.02									
	2.0 Turbo	136	02.98 09.02									
	2.0 Turbo	151	10.99 09.02									
	2.2 TiD	85	02.98 11.00									
	2.2 TiD	92	11.00 09.02									
2.3 i	110	02.98 09.02										
2.3 Turbo	165	10.98 09.02										
	1.8 i	90	03.04 06.12	24.2125-1732.3 010827		Thz 25,40	TRW					
	1.8 t	110	09.02 06.12									
	1.8 t BioPower	110	01.07 06.12									
	1.9 TiD	88	07.04 06.12									
	1.9 TiD	110	07.04 06.12									
	1.9 TTiD	110	07.07 06.12									
	2.0 t	110	09.02 06.12									
	2.0 T Aero	154	09.02 06.12									
	2.0 t BioPower	110	01.07 06.12									
	2.0 t BioPower	145	06.07 06.12									
	2.0 t BioPower XWD	110	09.02 06.12									
	2.0 t XWD	110	01.07 06.12									
	2.0 Turbo Performance	110	04.04 06.12									
	2.2 TiD	92	09.02 06.12									
	2.8 T Aero	184	03.05 12.05									
		1.8 i	90					03.04 06.12 + 15" Rad ¹⁾	11.9571-9781.2 220659 11.9571-9782.2 220660 11.8116-0295.2 390524 11.8116-0356.1 390586 11.0101-5407.2 260011 11.8171-0008.1 990049	 GG / nur paarweise austauschen ²⁾  GG / nur paarweise austauschen ²⁾ 2 + ALU-Sättel ³⁾ 2 + GG-Sättel ⁴⁾	D=57, - Halter D=57, - Halter Hülzensatz Halterfeder Hülzensatz Führungsbolzen	ATE ATE ATE ATE ATE ATE
		1.8 t	110					09.02 06.12 + 15" Rad ¹⁾				
		1.8 t BioPower	110					01.07 06.12 + 15" Rad ¹⁾				
1.8 t BioPower		129	07.07 06.12 + 15" Rad ¹⁾									
1.9 TiD		88	07.04 06.12 + 15" Rad ¹⁾									
1.9 TiD		110	07.04 06.12 + 15" Rad ¹⁾									
1.9 TTiD		110	07.07 06.12 + 15" Rad ¹⁾									
2.0 t		110	09.02 06.12 + 15" Rad ¹⁾									
2.0 Turbo Performance		110	04.04 06.12 + 15" Rad ¹⁾									
2.2 TiD		92	09.02 06.12 + 15" Rad ¹⁾									
2.0 T Aero		154 41039808	51046733	+ (GSA)								
2.0 T Aero		154 41022028	51046733	- (GSA)								
2.0 Turbo Performance		110	04.04									
1.8 i		90 51046734		12.05 - Vector								
1.8 t		110 51046734		12.05 - Vector								
1.9 TiD		88 51046734		12.05 - Vector								
1.9 TiD		110 51046734		12.05 - Vector								
2.0 t		51046734		12.05 - Vector								
2.0 T Aero	154 51046734		12.05 - (GSA)									
2.2 TiD	92 51046734		12.05 - Vector									
2.8 T Aero	184	03.05	12.05									
1.8 i	90	01.06 06.12	- Vector									
1.8 i Vector	90	03.04 06.12										
1.8 t	110	01.06 06.12	- Vector									
1.8 t BioPower	110	01.07 06.12										
1.8 t BioPower	129	07.07 06.12										
1.8 t Vector	110	09.02 06.12										
1.9 TiD	88	01.06 06.12	- Vector									
1.9 TiD	110	01.06 06.12	- Vector									
	1.8 i	90	01.06 06.12	11.9606-9971.2 220589 11.9606-9972.2 220590 11.0441-6008.2 250038 11.8116-0345.2 390596 11.0101-5407.2 260011 11.8171-0008.1 990049	 + 16" Rad ⁵⁾  + 16" Rad ⁵⁾	D=60, - Halter D=60, - Halter Dichtungssatz Halterfeder Hülzensatz Führungsbolzen	ATE ATE ATE ATE ATE ATE					
	1.8 t	110	01.06 06.12									
	1.8 t BioPower	110	01.07 06.12									
	1.8 t BioPower	129	07.07 06.12									
	1.8 t Vector	110	09.02 06.12									
	1.9 TiD	88	01.06 06.12									
	1.9 TiD	110	01.06 06.12									

¹⁾ + 15" wheel / + ruota 15" / + roue 15" / + rueda 15"

²⁾ GG/ replace only in pairs / GG/ sostituire solo a coppie / GG/ ne remplacer que par paires / GG/ reemplazar sólo por pares

³⁾ + aluminium calipers / + pinze in alluminio / + étriers en aluminium / + pinzas de aluminio

⁴⁾ + cast iron caliper / + pinza in ghisa / + étriers en fonte grise / + fundición gris-pinza

⁵⁾ + 16" wheel / + ruota 16" / + roue 16" / + rueda 16"



SAAB 9-3 Limousine (YS3F) (03-12)

	1.9 TiD Vector	88		07.04	06.12		11.9606-9971.2	220589	2	+ 16" Rad 1) + 16" Rad 1)	D=60, - Halter D=60, - Halter Dichtungssatz Haltefeder Hülsensatz Führungsbolzen	ATE ATE ATE ATE ATE ATE				
	1.9 TiD Vector	110		07.04	06.12		11.9606-9972.2	220590								
	1.9 TTiD			07.07	06.12	- Vector	11.0441-6008.2	250038								
	1.9 TTiD			07.07	06.12		11.8116-0345.2	390596								
	2.0 t			01.06	06.12	- Vector	11.0101-5407.2	260011								
	2.0 T Aero	154	41039807	09.02			11.8171-0008.1	990049								
	2.0 T Aero	154		01.06	06.12	- (GSA)										
	2.0 t BioPower			01.07	06.12											
	2.0 t BioPower	145		06.07	06.12											
	2.0 t BioPower XWD			09.02	06.12											
	2.0 t Vector	129		09.02	06.12											
	2.0 t XWD			01.07	06.12											
	2.0 Turbo Performance			04.04	06.12											
	2.2 TiD	92		01.06	06.12	- Vector										
	2.2 TiD Vector	92		09.02	06.12											
	2.8 T Aero	184		01.06	06.12											
	2.8 T Aero	188		07.07	06.12											
	2.8 T Aero	206		07.07	06.12											
	2.8 T Aero V6 XWD	206		04.08	06.12											
	2.8 Turbo V6			04.08	06.12											
	1.8 i	90		03.04	06.12		11.9576-9945.2	220931	2	+ 17" Rad 2) + 17" Rad 2)	D=57, - Halter D=57, - Halter Haltefeder Hülsensatz Führungsbolzen	ATE ATE ATE ATE ATE				
	1.8 t	110		09.02	06.12		11.9576-9946.2	220932								
	1.8 t BioPower	110		01.07	06.12		11.8116-0410.2	390589								
	1.8 t BioPower	129		07.07	06.12		11.0101-5407.2	260011								
	1.9 TiD	88		07.04	06.12		11.8171-0008.1	990049								
	1.9 TiD	110		07.04	06.12											
	1.9 TTiD			07.07	06.12											
	2.0 t			09.02	06.12											
	2.0 t BioPower			01.07	06.12											
	2.0 t BioPower	145		06.07	06.12											
	2.0 t BioPower XWD			09.02	06.12											
	2.0 t XWD			01.07	06.12											
	2.0 Turbo Performance			04.04	06.12											
	2.2 TiD	92		09.02	06.12											
	2.8 T Aero	184		03.05	06.12											
	2.8 T Aero	188		07.07	06.12											
	2.8 T Aero	206		07.07	06.12											
	2.8 T Aero V6 XWD	206		05.08	06.12											
	2.8 Turbo V6			04.08	06.12											
		1.8 i	90		03.04	06.12		83.7807-0412.3					331098	2		L=412
1.8 t		110		09.02	06.12											
1.8 t BioPower		110		01.07	06.12											
1.9 TiD		88		07.04	06.12											
1.9 TiD		110		07.04	06.12											
1.9 TTiD				07.07	06.12											
2.0 t				09.02	06.12											
2.0 T Aero		154		09.02	06.12											
2.0 t BioPower				01.07	06.12											
2.0 t BioPower		145		06.07	06.12											
2.0 t BioPower XWD				09.02	06.12											
2.0 t XWD				01.07	06.12											
2.0 Turbo Performance				04.04	06.12											
2.2 TiD		92		09.02	06.12											
2.8 T Aero		184		03.05	06.12											
2.8 T Aero		188		07.07	06.12											
2.8 T Aero		206		07.07	06.12											
2.8 T Aero V6 XWD		206		04.08	06.12											
2.8 Turbo V6				04.08	06.12											
		1.8 i	90		03.04	06.12		11.9387-7003.2	220567	2	+ 15" Rad 3) + 15" Rad 3) + 15" Rad 3)	D=38, - Halter D=38, - Halter Halter Hülsensatz Führungsbolzen Haltefeder	ATE ATE ATE ATE ATE ATE			
	1.8 t	110		09.02	06.12		11.9387-7004.2	220568								
	1.8 t BioPower	110		01.07	06.12		11.8170-0633.1	260117								
	1.9 TiD	88		07.04	06.12		11.0101-5407.2	260011								
	1.9 TiD	110		07.04	06.12		11.8171-0008.1	990049								
	1.9 TTiD			07.07	06.12		11.8116-0340.1	390595								
	2.0 t			09.02	06.12											
	2.0 T Aero	154		09.02	06.12											
	2.0 t BioPower			01.07	06.12											
	2.0 t BioPower	145		06.07	06.12											
	2.0 Turbo Performance			04.04	06.12											
	2.2 TiD	92		09.02	06.12											
	1.8 t	110	51049406	09.02			11.9407-7003.2	220835	2					+ 16" Rad 1) + 16" Rad 1)	D=40, - Halter D=40, - Halter Hülsensatz Führungsbolzen Haltefeder	ATE ATE ATE ATE ATE
	1.8 t BioPower	110	51049406	01.07			11.9407-7004.2	220836								
	2.0 t		51049406	09.02			11.0101-5407.2	260011								
	2.0 T Aero	154	51049406	09.02			11.8171-0008.1	990049								
	2.0 t BioPower		51049406	01.07			11.8116-0340.1	390595								
	2.0 t BioPower	145	51049406	06.07												
	2.0 t BioPower XWD		51049406	09.02												
	2.0 t Vector	129	51049406	09.03												
2.0 t XWD		51049406	01.07													
2.0 Turbo Performance		51049406	04.04													
2.2 TiD	92	51049406	09.02													
1.8 t	110	51049407		06.12		11.9387-7005.2	220569	2		+ 16" Rad 1) + 16" Rad 1)	D=38, - Halter D=38, - Halter Hülsensatz Führungsbolzen Haltefeder	ATE ATE ATE ATE ATE				
1.8 t BioPower	110	51049407		06.12		11.9387-7006.2	220570									
2.0 t		51049407		06.12		11.0101-5407.2	260011									
2.0 T Aero	154	51049407		06.12		11.8171-0008.1	990049									
2.0 t BioPower		51049407		06.12		11.8116-0340.1	390595									
2.0 t BioPower	145	51049407		06.12												

1) + 16" wheel / + ruota 16" / + roue 16" / + rueda 16"

2) + 17" wheel / + ruota 17" / + roue 17" / + rueda 17"

3) + 15" wheel / + ruota 15" / + roue 15" / + rueda 15"



SAAB 9-3 Limousine (YS3F) (03-12)

	2.0 t BioPower XWD	51049407		06.12		11.9387-7005.2	220569	2	+ 16" Rad ¹⁾ + 16" Rad ¹⁾	D=38, - Halter D=38, - Halter Hülsensatz Führungsbolzen Haltefeder	ATE ATE ATE ATE ATE
	2.0 t Vector	129	51049407	06.12		11.9387-7006.2	220570				
	2.0 t XWD		51049407	06.12		11.0101-5407.2	260011				
	2.0 Turbo Performance		51049407	06.12		11.8171-0008.1	990049				
	2.2 TiD	92	51049407	06.12		11.8116-0340.1	390595				
	2.8 T Aero	184		03.05	06.12						
	2.8 T Aero	188		07.07	06.12						
	2.8 T Aero	206		07.07	06.12						
	2.8 T Aero V6 XWD	206		04.08	06.12						
	2.8 Turbo V6			04.08	06.12						
	1.8 i	90		03.04	06.12		24.5259-0315.3	330882	2		L=315
	1.8 t	110		09.02	06.12						
	1.8 t BioPower	110		01.07	06.12						
	1.9 TiD	88		07.04	06.12						
	1.9 TiD	110		07.04	06.12						
	1.9 TTiD			07.07	06.12						
	2.0 t			09.02	06.12						
	2.0 T Aero	154		09.02	06.12						
	2.0 t BioPower			01.07	06.12						
	2.0 t BioPower	145		06.07	06.12						
	2.0 t BioPower XWD			09.02	06.12						
	2.0 t XWD			01.07	06.12						
	2.0 Turbo Performance			04.04	06.12						
	2.2 TiD	92		09.02	06.12						
	2.8 T Aero	184		03.05	06.12						
	2.8 T Aero	188		07.07	06.12						
	2.8 T Aero	206		07.07	06.12						
	2.8 T Aero V6 XWD	206		04.08	06.12						
	2.8 Turbo V6			04.08	06.12						

SAAB 9-3 SportCombi (05-12)

	1.8 i	90		03.05	06.12		24.2125-1732.3	010827			THz 25,40	TRW				
	1.8 t	110		03.05	06.12											
	1.8 t BioPower	110		01.07	06.12											
	1.8 t BioPower	129		07.07	06.12											
	1.9 TiD	88		03.05	06.12											
	1.9 TiD	110		03.05	06.12											
	1.9 TTiD			07.07	06.12											
	2.0	143		04.06	09.07											
	2.0 t			03.05	06.12											
	2.0 T			03.05	06.12											
	2.0 t BioPower			01.07	06.12											
	2.0 t BioPower	145		06.07	06.12											
	2.0 t BioPower	147		07.07	06.12											
	2.0 t BioPower	162		01.11	06.12											
	2.0 t BioPower XWD			01.07	06.12											
	2.0 t BioPower XWD	162		01.11	06.12											
	2.0 t XWD			01.07	06.12											
	2.0 T XWD	154		07.08	06.12											
	2.0 T XWD	177		03.09	06.12											
	1.8 i	90		03.05	06.12	+ 15" Rad ²⁾	11.9571-9781.2	220659	2	GG / nur paarweise austauschen ³⁾ GG / nur paarweise austauschen ³⁾	D=57, - Halter D=57, - Halter Hülsensatz Führungsbolzen Haltefeder	ATE ATE ATE ATE ATE				
	1.8 t	110		03.05	06.12	+ 15" Rad ²⁾	11.9571-9782.2	220660								
	1.8 t BioPower	110		01.07	06.12	+ 15" Rad ²⁾	11.0101-5407.2	260011								
	1.8 t BioPower	129		07.07	06.12	+ 15" Rad ²⁾	11.8171-0008.1	990049								
	1.9 TiD	88		03.05	06.12	+ 15" Rad ²⁾	11.8116-0356.1	390586								
	1.9 TiD	110		03.05	06.12	+ 15" Rad ²⁾										
	1.9 TTiD			07.07	06.12	+ 15" Rad ²⁾										
	2.0	143		04.06	09.07	+ 15" Rad ²⁾										
	2.0 t			03.05	06.12	+ 15" Rad ²⁾										
2.0 t BioPower			01.07	06.12	+ 15" Rad ²⁾											
2.0 t BioPower	145		06.07	06.12	+ 15" Rad ²⁾											
2.0 t BioPower	147		07.07	06.12	+ 15" Rad ²⁾											
2.0 t BioPower	162		01.11	06.12	+ 15" Rad ²⁾											
2.0 t BioPower XWD			01.07	06.12	+ 15" Rad ²⁾											
2.0 t BioPower XWD	162		01.11	06.12	+ 15" Rad ²⁾											
2.0 t XWD			01.07	06.12	+ 15" Rad ²⁾											
	2.0 T			03.05	12.05		11.9571-9779.2	220657	2	+ 16" Rad ¹⁾ + 16" Rad ¹⁾	D=57, - Halter D=57, - Halter Hülsensatz Führungsbolzen Haltefeder	ATE ATE ATE ATE ATE				
	2.8 T	184		03.05	12.05		11.9571-9780.2	220658								
	2.8 Turbo V6	169		03.05	12.05		11.0101-5407.2	260011								
							11.8171-0008.1	990049								
							11.8116-0356.1	390586								
	2.0 T			01.06	06.12		11.9606-9971.2	220589								
	2.0 T XWD	154		07.08	06.12		11.9606-9972.2	220590								
	2.0 T XWD	177		03.09	06.12		11.0441-6008.2	250038								
	2.8 T	184		01.06	06.12		11.8116-0345.2	390596	2	+ 16" plus Rad ⁴⁾ + 16" plus Rad ⁴⁾	D=60, - Halter D=60, - Halter Dichtungssatz Haltefeder Hülsensatz Führungsbolzen	ATE ATE ATE ATE ATE				
	2.8 T	188		07.07	06.12		11.0101-5407.2	260011								
	2.8 T Aero	206		07.07	06.12		11.8171-0008.1	990049								
	2.8 T Aero	206		04.08	06.12											
	2.8 Turbo V6	169		01.06	06.12											
	2.8 Turbo V6	203		05.08	06.12											
	1.8 i	90		03.05	06.12		11.9576-9945.2	220931					2	+ 17" Rad ⁵⁾ + 17" Rad ⁵⁾	D=57, - Halter D=57, - Halter Haltefeder Hülsensatz Führungsbolzen	ATE ATE ATE ATE ATE
	1.8 t	110		03.05	06.12		11.9576-9946.2	220932								
1.8 t BioPower	110		01.07	06.12		11.8116-0410.2	390589									
1.8 t BioPower	129		07.07	06.12		11.0101-5407.2	260011									
1.9 TiD	88		03.05	06.12		11.8171-0008.1	990049									
1.9 TTiD	110		03.05	06.12												

¹⁾ + 16" wheel / + ruota 16" / + roue 16" / + rueda 16"

²⁾ + 15" wheel / + ruota 15" / + roue 15" / + rueda 15"

³⁾ GG/replace only in pairs / GG/sostituire solo a coppie / GG/ ne remplacer que par paires / GG/ reemplazar sólo por pares



















⁴⁾ + 16" plus wheel / + ruota 16" plus / + roue 16" plus / + rueda 16" plus















⁵⁾ + 17" wheel / + ruota 17" / + roue 17" / + rueda 17"







SAAB 9-3 SportCombi (05-12)		kW		31		i		Atc		?		i		i	
	2.0	143		04.06	09.07	11.9576-9945.2	220931	2	+ 17" Rad 1) + 17" Rad 1)	D=57, - Halter D=57, - Halter Haltefeder Hülzensatz Führungsbolzen	ATE ATE ATE ATE ATE				
	2.0 t			03.05	06.12	11.9576-9946.2	220932								
	2.0 t BioPower			01.07	06.12	11.8116-0410.2	390589								
	2.0 t BioPower	145		06.07	06.12	11.0101-5407.2	260011								
	2.0 t BioPower	147		07.07	06.12	11.8171-0008.1	990049								
	2.0 t BioPower XWD			01.07	06.12										
	2.0 t BioPower XWD	162		01.11	06.12										
	2.0 t BioPower XWD	162		01.11	06.12										
2.0 t XWD			01.07	06.12											
	1.8 i	90		03.05	06.12	83.7807-0412.3	331098	2		L=412					
	1.8 t	110		03.05	06.12										
	1.8 t BioPower	110		01.07	06.12										
	1.8 t BioPower	129		07.07	06.12										
	1.9 TiD	88		03.05	06.12										
	1.9 TiD	110		03.05	06.12										
	1.9 TTiD			07.07	06.12										
	2.0	143		04.06	09.07										
	2.0 t			03.05	06.12										
	2.0 T			03.05	06.12										
	2.0 t BioPower			01.07	06.12										
	2.0 t BioPower	145		06.07	06.12										
	2.0 t BioPower	147		07.07	06.12										
	2.0 t BioPower	162		01.11	06.12										
	2.0 t BioPower XWD			01.07	06.12										
	2.0 t BioPower XWD	162		01.11	06.12										
	2.0 t XWD			01.07	06.12										
	2.0 T XWD	154		07.08	06.12										
	2.0 T XWD	177		03.09	06.12										
	2.8 T	184		03.05	06.12										
2.8 T	188		07.07	06.12											
2.8 T Aero	206		07.07	06.12											
2.8 T Aero V6 XWD	206		04.08	06.12											
2.8 Turbo V6	169		03.05	06.12											
2.8 Turbo V6	203		05.08	06.12											
	1.8 i	90		03.05	06.12	11.9387-7003.2	220567	2	+ 17" Rad 1) + 17" Rad 1)	D=38, - Halter D=38, - Halter Halter Hülzensatz Führungsbolzen Haltefeder	ATE ATE ATE ATE ATE ATE				
	1.8 t	110		03.05	06.12										
	1.8 t BioPower	110		01.07	06.12										
	1.8 t BioPower	129		07.07	06.12										
	1.9 TiD	88		03.05	06.12										
	1.9 TiD	110		03.05	06.12										
	1.9 TTiD			07.07	06.12										
	2.0	143		04.06	09.07										
	2.0 t			03.05	06.12										
	2.0 t BioPower			01.07	06.12										
	2.0 t BioPower	145		06.07	06.12										
	2.0 t BioPower	147		07.07	06.12										
	2.0 t BioPower	162		01.11	06.12										
	2.0 t BioPower XWD			01.07	06.12										
2.0 t BioPower XWD	162		01.11	06.12											
2.0 t XWD			01.07	06.12											
	2.0 T		93171500	03.05		11.9407-7003.2	220835	2		D=40, - Halter D=40, - Halter Hülzensatz Führungsbolzen Haltefeder	ATE ATE ATE ATE ATE				
	2.0 T XWD	154	93171500	07.08											
	2.0 T XWD	177	93171500	03.09											
	2.8 T	184	93171500	03.05											
	2.8 T	188	93171500	07.07											
	2.8 T Aero	206	93171500	07.07											
	2.8 T Aero V6 XWD	206	93171500	04.08											
	2.8 Turbo V6	169	93171500	03.05											
2.8 Turbo V6	203	93171500	05.08												
	2.0 T		93171501	06.12		11.9387-7005.2	220569	2		D=38, - Halter D=38, - Halter Hülzensatz Führungsbolzen Haltefeder	ATE ATE ATE ATE ATE				
	2.0 T XWD	154	93171501	06.12											
	2.0 T XWD	177	93171501	06.12											
	2.8 T	184	93171501	06.12											
	2.8 T	188	93171501	06.12											
	2.8 T Aero	206	93171501	06.12											
	2.8 T Aero V6 XWD	206	93171501	06.12											
	2.8 Turbo V6	169	93171501	06.12											
2.8 Turbo V6	203	93171501	06.12												
	1.8 i	90		03.05	06.12	24.5259-0315.3	330882	2		L=315					
	1.8 t	110		03.05	06.12										
	1.8 t BioPower	110		01.07	06.12										
	1.8 t BioPower	129		07.07	06.12										
	1.9 TiD	88		03.05	06.12										
	1.9 TiD	110		03.05	06.12										
	1.9 TTiD			07.07	06.12										
	2.0	143		04.06	09.07										
	2.0 t			03.05	06.12										
	2.0 T			03.05	06.12										
	2.0 t BioPower			01.07	06.12										
	2.0 t BioPower	145		06.07	06.12										
	2.0 t BioPower	147		07.07	06.12										
	2.0 t BioPower	162		01.11	06.12										
2.0 t BioPower XWD			01.07	06.12											
2.0 t BioPower XWD	162		01.11	06.12											
2.0 t XWD			01.07	06.12											
2.0 T XWD	154		07.08	06.12											
2.0 T XWD	177		03.09	06.12											

1) + 17" wheel / + ruota 17" / + roue 17" / + rueda 17"

								
SAAB 9-3 SportCombi (05-12)								
	2.8 T 2.8 T 2.8 T Aero 2.8 T Aero V6 XWD 2.8 Turbo V6 2.8 Turbo V6	184 188 206 206 169 203		03.05 07.07 07.07 04.08 03.05 05.08	06.12 06.12 06.12 06.12 06.12 06.12	24.5259-0315.3	330882	2 L=315
SAAB 9-3 Cabriolet (YS3D) (98-03)								
	2.0 i 2.0 SE Turbo 2.0 T 2.0 T 2.0 T 2.0 Turbo 2.3 i 2.3 i	96 147 113 136 151 110 110 165		09.00 01.01 09.00 09.00 09.00 09.00 09.00 09.00	07.03 07.03 07.03 07.03 07.03 07.03 07.03 07.03	03.7750-2932.4	300175	9" ATE
	2.0 i 2.0 SE Turbo 2.0 T 2.0 T 2.0 T 2.0 Turbo 2.3 i 2.3 i	96 147 113 136 151 110 110 165		02.98 02.98 10.98 02.98 10.99 02.98 02.98 10.99	08.00 08.00 08.00 08.00 08.00 08.00 08.00 08.00	03.2123-1121.3	010176	THz 23,81 ATE
	2.0 i 2.0 SE Turbo 2.0 T 2.0 T 2.0 T 2.0 Turbo 2.3 i 2.3 i	96 147 113 136 151 110 110 165		09.00 01.01 09.00 09.00 09.00 09.00 09.00 09.00	07.03 07.03 07.03 07.03 07.03 07.03 07.03 07.03	03.2123-1626.3	010727	THz 23,81 ATE
	2.0 i 2.0 i 2.0 i 2.0 SE Turbo 2.0 SE Turbo 2.0 SE Turbo 2.0 T 2.0 T 2.0 T 2.0 T 2.0 T 2.0 T 2.3 i 2.3 i 2.3 i	96 96 96 147 147 147 113 113 113 136 136 136 110 110 110	X7020000 X2020000 X7020000 X2020000 X7020000 X2020000 X7020000 X2020000 X7020000 X2020000 X7020000 X2020000 X7020000 X2020000	02.98 02.98 02.98 02.98 02.98 10.98 10.98 10.98 02.98 02.98 02.98 02.98 02.98 02.98 02.98	+ (USA) + (USA) - (USA) + (USA) + (USA) - (USA) + (USA) + (USA) + (USA) + (USA) + (USA) + (USA) + (USA) + (USA) - (USA)	24.3571-1761.5 24.3571-1762.5 11.8171-0008.1 11.0101-5407.2 11.8116-0292.1	240461 240462 990049 260011 390521	2 D=57, - Halter D=57, - Halter Führungsbolzen Hülzensatz Haltefeder ATE ATE ATE ATE ATE
	2.0 i 2.0 i 2.0 i 2.0 SE Turbo 2.0 SE Turbo 2.0 SE Turbo 2.0 T 2.0 T 2.0 T 2.0 T 2.0 T 2.0 T 2.0 T 2.0 T 2.0 T 2.0 Turbo 2.3 i 2.3 i 2.3 i 2.3 i	96 96 96 147 147 147 113 113 113 136 136 136 110 110 110	X7020001 X2020001 X7020001 X2020001 X7020001 X2020001 X7020001 X2020001 X7020001 X2020001 X7020001 X2020001 X7020001 X2020001	07.03 07.03 01.99 07.03 07.03 07.03 07.03 07.03 07.03 07.03 07.03 07.03 07.03 07.03 07.03 07.03 07.03 07.03 07.03	+ (USA) + (USA) - (USA) + (USA) + (USA) + (USA) + (USA) + (USA) + (USA) + (USA) + (USA) + (USA) + (USA) + (USA) + (USA) + (USA) + (USA) + (USA) + (USA)	24.3571-1783.5 24.3571-1784.5 11.0101-5407.2 11.0441-5704.2 11.8171-0008.1 11.8116-0292.1	240751 240752 260011 250034 990049 390521	2 D=57, - Halter D=57, - Halter Hülzensatz Dichtungssatz Führungsbolzen Haltefeder ATE ATE ATE ATE ATE
	2.0 i 2.0 SE Turbo 2.0 T 2.0 T 2.0 T 2.0 Turbo 2.3 i 2.3 i	96 147 113 136 151 110 110 165		02.98 02.98 10.98 02.98 10.99 01.01 02.98 10.99	07.03 07.03 07.03 07.03 07.03 07.03 07.03 07.03	24.5298-0322.3	331314	2 L=322
	2.0 i 2.0 SE Turbo 2.0 T 2.0 T 2.0 T 2.0 Turbo 2.3 i	96 147 113 136 151 110 110		02.98 02.98 10.98 02.98 10.99 01.01 02.98	07.03 07.03 07.03 07.03 07.03 07.03 07.03	13.2351-0025.2 13.2351-0026.2 13.0441-3506.2	210210 210211 250052	D=35 D=35 Dichtungssatz ATE ATE ATE
	2.0 i 2.0 SE Turbo 2.0 T 2.0 T 2.0 T 2.0 Turbo 2.3 i	96 147 113 136 151 110 110		02.98 02.98 10.98 02.98 10.99 01.01 02.98	07.03 07.03 07.03 07.03 07.03 07.03 07.03	24.5117-0205.3 24.5117-0195.3	330669 330565	L=205 L=198

								
SAAB 9-3 Cabriolet (YS3D) (98-03)								
	2.3 i	165		10.99 07.03	24.5117-0205.3 330669 24.5117-0195.3 330565	 		L=205 L=198
	2.0 i 2.0 SE Turbo 2.0 T 2.0 T 2.0 T 2.0 Turbo 2.3 i 2.3 i	96 147 113 136 151 110 110 165		02.98 07.03 02.98 07.03 10.98 07.03 02.98 07.03 10.99 07.03 01.01 07.03 02.98 07.03 10.99 07.03	24.3727-1106.2 581106	1 		L=2180/1425
	2.0 i 2.0 SE Turbo 2.0 T 2.0 T 2.0 T 2.0 Turbo 2.3 i 2.3 i	96 147 113 136 151 110 110 165		02.98 07.03 02.98 07.03 10.98 07.03 02.98 07.03 10.99 07.03 01.01 07.03 02.98 07.03 10.99 07.03	24.2419-1727.3 030116			Gz 19,05

SAAB 9-3 Cabriolet (YS3F) (03-12)									
	1.8 i 1.8 t 1.8 t BioPower 1.8 t BioPower 1.9 TiD 1.9 TiD 1.9 TTiD 2.0 2.0 t 2.0 T 2.0 t BioPower 2.0 t BioPower 2.0 t BioPower 2.0 Turbo Performance	90 110 110 129 88 110 143 143 147 129 185		01.04 06.12 08.03 06.12 01.07 06.12 07.07 06.12 09.04 06.12 01.06 06.12 07.07 06.12 04.06 09.07 08.03 06.12 08.03 06.12 06.07 06.12 01.07 06.12 07.07 06.12 04.04 06.12	24.2125-1732.3 010827			Thz 25,40 TRW	
	1.8 i 1.8 t 1.8 t BioPower 1.8 t BioPower 1.9 TiD 1.9 TiD 1.9 TTiD 2.0 2.0 t 2.0 T 2.0 t BioPower 2.0 t BioPower 2.0 t BioPower 2.0 t Linear 2.0 Turbo Performance	90 110 110 129 88 110 143 143 147 129 185		01.04 06.12 + 15" Rad ¹⁾ 08.03 06.12 + 15" Rad ¹⁾ 01.07 06.12 + 15" Rad ¹⁾ 07.07 06.12 + 15" Rad ¹⁾ 09.04 06.12 + 15" Rad ¹⁾ 01.06 06.12 + 15" Rad ¹⁾ 07.07 06.12 + 15" Rad ¹⁾ 04.06 06.12 + 15" Rad ¹⁾ 08.03 06.12 + 15" Rad ¹⁾ 08.03 06.12 + 15" Rad / + (USA) ⁵⁾ 06.07 06.12 + 15" Rad ¹⁾ 01.07 06.12 + 15" Rad ¹⁾ 07.07 06.12 + 15" Rad ¹⁾ 08.03 06.12 + 15" Rad ¹⁾ 04.04 06.12 + 15" Rad ¹⁾	11.9571-9781.2 220659 11.9571-9782.2 220660 11.0101-5407.2 260011 11.8171-0008.1 990049 11.8116-0295.2 390524 11.8116-0356.1 390586	 	GG / nur paarweise austauschen ²⁾ GG / nur paarweise austauschen ²⁾	D=57, - Halter D=57, - Halter Hülzensatz Führungsbolzen Haltefeder Haltefeder	ATE ATE ATE ATE ATE ATE
	1.8 i 1.8 t 1.8 t BioPower 1.8 t BioPower 2.0 2.0 t 2.0 T 2.0 t BioPower 2.0 t BioPower 2.0 t BioPower 2.0 Turbo Performance	90 110 110 129 143 143 147 185	51046733 51046733 51046733 51046733 51046733 51046733 51046733 51046733 51046733 51046733 51046733 51046733	01.04 08.03 01.07 07.07 04.06 08.03 08.03 06.07 01.07 07.07 04.04	11.0530-0004.2 220933 11.0101-5407.2 260011 11.8171-0008.1 990049 11.8116-0325.2 390461	2 	+ 16" Rad ⁶⁾	D=57, - Halter Hülzensatz Führungsbolzen Haltefeder	ATE ATE ATE ATE
	1.8 i 1.8 t 1.8 t BioPower 1.8 t BioPower 1.9 TiD 1.9 TiD 1.9 TTiD 2.0 2.0 t 2.0 T 2.0 t BioPower 2.0 t BioPower 2.0 t BioPower 2.0 Turbo Performance	90 110 110 129 88 110 143 143 147 185	51046734 51046734 51046734 51046734 51046734 51046734 51046734 51046734 51046734 51046734 51046734 51046734 51046734	06.12 06.12 06.12 06.12 09.04 06.12 01.06 06.12 07.07 06.12 06.12 06.12 06.12 06.12 06.12 06.12 06.12	11.9571-9779.2 220657 11.9571-9780.2 220658 11.0101-5407.2 260011 11.8171-0008.1 990049 11.8116-0356.1 390586	2	+ 16" Rad ⁶⁾ + 16" Rad ⁶⁾	D=57, - Halter D=57, - Halter Hülzensatz Führungsbolzen Haltefeder	ATE ATE ATE ATE ATE ATE
	2.0 T 2.0 Turbo Performance 2.8 T 2.8 T 2.8 T Aero 2.8 T V6 Aero	185 184 221 188	41022027	08.03 04.04 06.12 02.06 06.12 10.08 06.12 07.07 06.12 06.08 06.12	11.9606-9971.2 220589 11.9606-9972.2 220590 11.0441-6008.2 250038 11.0101-5407.2 260011 11.8171-0008.1 990049 11.8116-0345.2 390596	2	+ 16" plus Rad ⁷⁾ + 16" plus Rad ⁷⁾	D=60, - Halter D=60, - Halter Dichtungssatz Hülzensatz Führungsbolzen Haltefeder	ATE ATE ATE ATE ATE ATE

¹⁾ + 15" wheel / + ruota 15" / + roue 15" / + rueda 15"

²⁾ GG/ replace only in pairs / GG/ sostituire solo a coppie / GG/ ne remplacer que par paires / GG/ reemplazar sólo por pares





³⁾ + aluminium calipers / + pinze in alluminio / + étriers en aluminium / + pinzas de aluminio

⁴⁾ + cast iron caliper / + pinza in ghisa / + étriers en fonte grise / + fundición gris-pinza

⁵⁾ + 15" wheel / + (USA) / + ruota 15" / + (USA) / + roue 15" / + (USA) / + rueda 15" / + (USA)

⁶⁾ + 16" wheel / + ruota 16" / + roue 16" / + rueda 16"

⁷⁾ + 16" plus wheel / + ruota 16" plus / + roue 16" plus / + rueda 16" plus

SAAB 9-3 Cabriolet (YS3F) (03-12)																
	1.8 i	90		01.04	06.12	11.9576-9945.2	220931	2	+ 17" Rad ¹⁾ + 17" Rad ¹⁾	D=57, - Halter D=57, - Halter Haltefeder Hülsensatz Führungsbolzen	ATE ATE ATE ATE ATE					
	1.8 t	110		08.03	06.12		11.9576-9946.2					220932				
	1.8 t BioPower	110		01.07	06.12		11.8116-0410.2					390589				
	1.8 t BioPower	129		07.07	06.12		11.0101-5407.2					260011				
	1.9 TiD	88		09.04	06.12		11.8171-0008.1					990049				
	1.9 TiD	110		01.06	06.12											
	1.9 TTiD			07.07	06.12											
	2.0	143		04.06	09.07											
	2.0 t			08.03	06.12											
	2.0 T			08.03	06.12											
	2.0 t BioPower			06.07	06.12											
	2.0 t BioPower			01.07	06.12											
	2.0 t BioPower	147		07.07	06.12											
	2.0 Turbo Performance	185		04.04	06.12											
2.8 T	184		02.06	06.12												
2.8 T	221		10.08	06.12												
2.8 T Aero	188		07.07	06.12												
2.8 T V6 Aero			06.08	06.12												
	1.8 i	90		01.04	06.12	83.7807-0412.3	331098	2		L=412						
	1.8 t	110		08.03	06.12											
	1.8 t BioPower	110		01.07	06.12											
	1.8 t BioPower	129		07.07	06.12											
	1.9 TiD	88		09.04	06.12											
	1.9 TiD	110		01.06	06.12											
	1.9 TTiD			07.07	06.12											
	2.0	143		04.06	09.07											
	2.0 t			08.03	06.12											
	2.0 T			08.03	06.12											
	2.0 t BioPower			06.07	06.12											
	2.0 t BioPower			01.07	06.12											
	2.0 t BioPower	147		07.07	06.12											
	2.0 Turbo Performance	185		04.04	06.12											
2.8 T	184		02.06	06.12												
2.8 T	221		10.08	06.12												
2.8 T Aero	188		07.07	06.12												
2.8 T V6 Aero			06.08	06.12												
	1.8 i	90		01.04	06.12	11.9387-7003.2	220567	2	+ 17" Rad ¹⁾ + 17" Rad ¹⁾	D=38, - Halter D=38, - Halter Halter Hülsensatz Führungsbolzen Haltefeder	ATE ATE ATE ATE ATE ATE					
	1.8 t	110		08.03	06.12		11.9387-7004.2					220568				
	1.8 t BioPower	110		01.07	06.12		11.8170-0633.1					260117				
	1.8 t BioPower	129		07.07	06.12		11.0101-5407.2					260011				
	1.9 TiD	88		09.04	06.12		11.8171-0008.1					990049				
	1.9 TiD	110		01.06	06.12		11.8116-0340.1					390595				
	1.9 TTiD			07.07	06.12											
	2.0	143		04.06	09.07											
	2.0 t BioPower			06.07	06.12											
	2.0 t BioPower			01.07	06.12											
	2.0 t BioPower	147		07.07	06.12											
	2.0 t Linear	129		08.03	06.12											
	2.0 T		51049406	08.03			11.9407-7003.2					220835	2		D=40, - Halter D=40, - Halter Hülsensatz Führungsbolzen Haltefeder	ATE ATE ATE ATE ATE
	2.0 t Vector	129	51049406	08.03			11.9407-7004.2					220836				
2.0 Turbo Performance	185	51049406	04.04		11.0101-5407.2	260011										
2.0 T		51049407		06.12	11.9387-7005.2	220569	2		D=38, - Halter D=38, - Halter Hülsensatz Führungsbolzen Haltefeder	ATE ATE ATE ATE ATE						
2.0 t Vector	129	51049407		06.12	11.9387-7006.2	220570										
2.0 Turbo Performance	185	51049407		06.12	11.0101-5407.2	260011										
2.8 T	184		02.06	06.12	11.8171-0008.1	990049										
2.8 T	221		10.08	06.12	11.8116-0340.1	390595										
2.8 T Aero	188		07.07	06.12												
2.8 T V6 Aero			06.08	06.12												
	1.8 i	90		01.04	06.12	24.5259-0315.3	330882	2		L=315						
	1.8 t	110		08.03	06.12											
	1.8 t BioPower	110		01.07	06.12											
	1.8 t BioPower	129		07.07	06.12											
	1.9 TiD	88		09.04	06.12											
	1.9 TiD	110		01.06	06.12											
	1.9 TTiD			07.07	06.12											
	2.0	143		04.06	09.07											
	2.0 t			08.03	06.12											
	2.0 T			08.03	06.12											
	2.0 t BioPower			06.07	06.12											
	2.0 t BioPower			01.07	06.12											
	2.0 t BioPower	147		07.07	06.12											
	2.0 Turbo Performance	185		04.04	06.12											
2.8 T	184		02.06	06.12												
2.8 T	221		10.08	06.12												
2.8 T Aero	188		07.07	06.12												
2.8 T V6 Aero			06.08	06.12												
SAAB 9-3 X (09-12)																
	1.9 TTiD	◀ 96		01.10	06.12	24.2125-1732.3	010827			Thz 25,40	TRW					
	1.9 TTiD	◀132		03.09	06.12											
	2.0 T BioPower XWD	◀120		01.11	06.12											
	2.0 T BioPower XWD	◀154		03.09	06.12											
	2.0 T BioPower XWD	◀162		01.11	06.12											
	2.0 T XWD	◀154		03.09	06.12											

¹⁾ + 17" wheel / + ruota 17" / + roue 17" / + rueda 17"



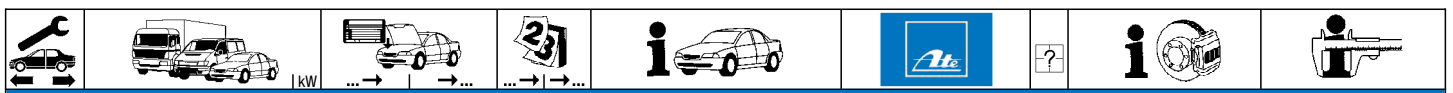





























SAAB 9-3 X (09-12)											
	1.9 TTiD	96	01.10	06.12	+ 15" Rad ¹⁾	11.9571-9781.2	220659	<input type="checkbox"/> GG / nur paarweise austauschen ²⁾ <input type="checkbox"/> GG / nur paarweise austauschen ²⁾ + ALU-Sättel ³⁾ + GG-Sättel ⁴⁾ <input type="checkbox"/> + 16" Rad ⁵⁾ <input type="checkbox"/> + 16" Rad ⁵⁾ <input type="checkbox"/> + 16" plus Rad ⁶⁾ <input type="checkbox"/> + 16" plus Rad ⁶⁾ <input type="checkbox"/> + 17" Rad ⁷⁾ <input type="checkbox"/> + 17" Rad ⁷⁾ <input type="checkbox"/> - 15" Rad ⁸⁾ <input type="checkbox"/> - 15" Rad ⁸⁾	D=57, - Halter	ATE	
	1.9 TTiD	132	03.09	06.12	+ 15" Rad ¹⁾	11.9571-9782.2	220660		D=57, - Halter	ATE	
	2.0 T BioPower XWD	120	01.11	06.12	+ 15" Rad ¹⁾	11.8116-0295.2	390524		2	Haltefeder	ATE
	2.0 T BioPower XWD	154	03.09	06.12	+ 15" Rad ¹⁾	11.8116-0356.1	390586		2	Haltefeder	ATE
	2.0 T BioPower XWD	162	01.11	06.12	+ 15" Rad ¹⁾	11.0101-5407.2	260011			Hülsensatz	ATE
	2.0 T XWD	154	03.09	06.12	+ 15" Rad ¹⁾	11.8171-0008.1	990049			Führungsbolzen	ATE
	1.9 TTiD	96	01.10	06.12		11.9571-9779.2	220657			D=57, - Halter	ATE
	1.9 TTiD	132	03.09	06.12		11.9571-9780.2	220658			D=57, - Halter	ATE
	2.0 T BioPower XWD	120	01.11	06.12		11.8116-0356.1	390586		2	Haltefeder	ATE
	2.0 T BioPower XWD	154	03.09	06.12		11.0101-5407.2	260011			Hülsensatz	ATE
	2.0 T BioPower XWD	162	01.11	06.12		11.8171-0008.1	990049			Führungsbolzen	ATE
	2.0 T XWD	154	03.09	06.12							
	1.9 TTiD	96	01.10	06.12		11.9606-9971.2	220589			D=60, - Halter	ATE
	1.9 TTiD	132	03.09	06.12		11.9606-9972.2	220590			D=60, - Halter	ATE
	2.0 T BioPower XWD	120	01.11	06.12		11.0441-6008.2	250038		2	Dichtungssatz	ATE
	2.0 T BioPower XWD	154	03.09	06.12		11.8116-0345.2	390596			Haltefeder	ATE
	2.0 T BioPower XWD	162	01.11	06.12		11.0101-5407.2	260011			Hülsensatz	ATE
	2.0 T XWD	154	03.09	06.12		11.8171-0008.1	990049			Führungsbolzen	ATE
	1.9 TTiD	96	01.10	06.12		11.9576-9945.2	220931			D=57, - Halter	ATE
	1.9 TTiD	132	03.09	06.12		11.9576-9946.2	220932			D=57, - Halter	ATE
2.0 T BioPower XWD	120	01.11	06.12		11.8116-0410.2	390589	2	Haltefeder	ATE		
2.0 T BioPower XWD	154	03.09	06.12		11.0101-5407.2	260011		Hülsensatz	ATE		
2.0 T BioPower XWD	162	01.11	06.12		11.8171-0008.1	990049		Führungsbolzen	ATE		
2.0 T XWD	154	03.09	06.12								
	1.9 TTiD	96	01.10	06.12		83.7807-0412.3	331098	2	L=412		
	1.9 TTiD	132	03.09	06.12							
	2.0 T BioPower XWD	120	01.11	06.12							
	2.0 T BioPower XWD	154	03.09	06.12							
	2.0 T BioPower XWD	162	01.11	06.12							
	1.9 TTiD	96	01.10	06.12		11.9387-7003.2	220567	<input type="checkbox"/> + 15" Rad ¹⁾ <input type="checkbox"/> + 15" Rad ¹⁾ <input type="checkbox"/> + 15" Rad ¹⁾ <input type="checkbox"/> - 15" Rad ⁸⁾ <input type="checkbox"/> - 15" Rad ⁸⁾	D=38, - Halter	ATE	
	1.9 TTiD	132	03.09	06.12		11.9387-7004.2	220568		D=38, - Halter	ATE	
	2.0 T BioPower XWD	120	01.11	06.12		11.8170-0633.1	260117		2	Haltefeder	ATE
	2.0 T BioPower XWD	154	03.09	06.12		11.8171-0008.1	990049			Führungsbolzen	ATE
	2.0 T BioPower XWD	162	01.11	06.12		11.0101-5407.2	260011			Hülsensatz	ATE
	2.0 T XWD	154	03.09	06.12		11.8116-0340.1	390595		2	Haltefeder	ATE
	1.9 TTiD	96	01.10	06.12		11.9387-7005.2	220569			D=38, - Halter	ATE
	1.9 TTiD	132	03.09	06.12		11.9387-7006.2	220570			D=38, - Halter	ATE
	2.0 T BioPower XWD	120	01.11	06.12		11.8171-0008.1	990049		2	Führungsbolzen	ATE
	2.0 T BioPower XWD	154	03.09	06.12		11.0101-5407.2	260011			Hülsensatz	ATE
2.0 T XWD	154	03.09	06.12		11.8116-0340.1	390595		Haltefeder	ATE		

SAAB 9-5 Limousine (YS3E) (97-10)										
	2.0	136	07.00	12.01		03.7745-3003.4	300157		8/7" Tandem	ATE
	2.0 t	110	09.97	12.01						
	2.0 T	129	10.98	12.01						
	2.0 Turbo SE	141	10.98	07.00						
	2.3 t	125	09.97	12.01						
	2.3 t	136	01.01	12.01						
	2.3 T Aero	169	10.99	09.01						
	2.3 T Aero	184	09.01	12.01						
	3.0 t	147	01.98	12.01						
	3.0 TiD	130	07.01	12.01						
	1.9 TiD	110	01.06	02.10		03.7745-3902.4	300129		8/7" Tandem	ATE
	2.0	136	01.02	02.10						
	2.0 t	110	01.02	02.10						
	2.0 T	129	01.02	02.10						
	2.0 t BioPower	110	01.05	02.10						
2.0 t BioPower	132	06.06	02.10							
2.2 TiD	88	03.02	02.10							
2.3 t	125	01.02	02.10							
2.3 T	134	04.08	02.10							
2.3 t	136	01.02	02.10							
2.3 T	162	07.03	02.10							
2.3 T	188	04.08	02.10							
2.3 T	191	11.05	02.10							
2.3 T Aero	184	01.02	02.10							
2.3 T Aero	225	04.03	03.04							
2.3 t BioPower	136	01.07	02.10							
2.3 t BioPower	152	11.06	02.10							
2.3 t BioPower	154	01.07	02.10							
3.0 t	147	01.02	02.10							
3.0 TiD	130	01.02	02.10							
	2.0	136	07.00	12.01		03.2125-7402.3	010541		Thz 25,40	ATE
	2.0 t	110	09.97	12.01						
	2.0 T	129	10.98	12.01						
	2.0 Turbo SE	141	10.98	07.00						
	2.3 t	125	09.97	12.01						
	2.3 t	136	01.01	12.01						
	2.3 T Aero	169	10.99	09.01						
	2.3 T Aero	184	09.01	12.01						
	3.0 t	147	01.98	12.01						
	3.0 TiD	130	07.01	12.01						
2.0	136	01.02	12.05		03.2125-9901.3	010634		Thz 25,40	ATE	
2.0 t	110	01.02	12.05							

¹⁾ + 15" wheel / + ruota 15" / + roue 15" / + rueda 15"
²⁾ GG/ replace only in pairs / GG/ sostituire solo a coppie / GG/ ne remplacer que par paires / GG/ reemplazar sólo por pares
³⁾ + aluminium calipers / + pinze in alluminio / + étriers en aluminium / + pinzas de aluminio
⁴⁾ + cast iron caliper / + pinza in ghisa / + étriers en fonte grise / + fundición gris-pinza
⁵⁾ + 16" wheel / + ruota 16" / + roue 16" / + rueda 16"
⁶⁾ + 16" plus wheel / + ruota 16" plus / + roue 16" plus / + rueda 16" plus
⁷⁾ + 17" wheel / + ruota 17" / + roue 17" / + rueda 17"
⁸⁾ - 15" wheel / - ruota 15" / - roue 15" / - rueda 15"

										
SAAB 9-5 Limousine (YS3E) (97-10)										
	2.0 T 2.0 t BioPower 2.2 TiD 2.3 t 2.3 t 2.3 T 2.3 T 2.3 T Aero 2.3 T Aero 3.0 t 3.0 TiD	◀129 ◀110 ◀ 88 ◀125 ◀136 ◀162 ◀191 ◀184 ◀225 ◀147 ◀130		01.02 12.05 01.05 12.05 03.02 12.05 01.02 12.05 01.02 12.05 07.03 12.05 11.05 12.05 01.02 12.05 04.03 03.04 01.02 12.05 01.02 12.05		03.2125-9901.3 010634		THz 25,40 ATE		
	1.9 TiD 2.0 2.0 t 2.0 T 2.0 t BioPower 2.0 t BioPower 2.2 TiD 2.3 t 2.3 T 2.3 t 2.3 T 2.3 T 2.3 T 2.3 T Aero 2.3 t BioPower 2.3 t BioPower 2.3 t BioPower 3.0 t 3.0 TiD	◀110 ◀136 ◀110 ◀129 ◀110 ◀132 ◀ 88 ◀125 ◀134 ◀136 ◀162 ◀188 ◀191 ◀184 ◀136 ◀152 ◀154 ◀147 ◀130		01.06 02.10 01.06 02.10 01.06 02.10 01.06 02.10 01.06 02.10 06.06 02.10 01.06 02.10 01.06 02.10 04.08 02.10 01.06 02.10 01.06 02.10 04.08 02.10 01.06 02.10 01.06 02.10 01.07 02.10 11.06 02.10 01.07 02.10 01.06 02.10 01.06 02.10		03.2125-9911.3 010883		THz 25,40 ATE		
	2.0 2.0 t 2.0 T 2.0 Turbo SE 2.3 t 2.3 t 2.3 T Aero 2.3 T Aero 3.0 t 3.0 TiD	▶136 ▶110 ▶129 ▶141 ▶125 ▶136 ▶169 ▶184 ▶147 ▶130		07.00 12.01 09.97 12.01 10.98 12.01 10.98 07.00 09.97 12.01 01.01 12.01 10.99 09.01 09.01 12.01 01.98 12.01 07.01 12.01		03.2125-7502.3 010616		THz 25,40 ATE		
	1.9 TiD 2.0 2.0 t 2.0 T 2.0 t BioPower 2.0 t BioPower 2.0 Turbo SE 2.2 TiD 2.3 t 2.3 T 2.3 t 2.3 T 2.3 T 2.3 T 2.3 T Aero 2.3 T Aero 2.3 T Aero 2.3 t BioPower 2.3 t BioPower 2.3 t BioPower 3.0 t 3.0 TiD	◀110 ◀136 ◀110 ◀129 ◀110 ◀132 ◀141 ◀ 88 ◀125 ◀134 ◀136 ◀162 ◀188 ◀191 ◀169 ◀184 ◀225 ◀136 ◀152 ◀154 ◀147 ◀130		01.06 02.10 07.00 02.10 09.97 02.10 10.98 02.10 01.05 02.10 06.06 02.10 10.98 07.00 03.02 02.10 09.97 02.10 04.08 02.10 01.01 02.10 07.03 02.10 04.08 02.10 11.05 02.10 10.99 09.01 09.01 02.10 04.03 03.04 01.07 02.10 11.06 02.10 01.07 02.10 01.98 02.10 07.01 02.10		43.4006-0001.2 310028		Behälter		
	2.0 t 2.0 t 2.0 T 2.0 Turbo SE 2.0 Turbo SE 2.3 t 2.3 t	110 110 129 141 141 125 125	X3020000 X3020000 X3020000	09.97 09.97 10.98 10.98 10.98 09.97 09.97	+ (USA) - (USA) + (USA) - (USA) + (USA) - (USA)	24.3571-1761.5 24.3571-1762.5 11.8171-0008.1 11.0101-5407.2 11.8116-0292.1 11.0441-5704.2	240461 240462 990049 260011 390521 250034	2 + 15" Rad 1) + 15" Rad 1)	D=57, - Halter D=57, - Halter Führungsbolzen Hülzensatz Haltefeder Dichtungssatz	ATE ATE ATE ATE ATE ATE
	2.0 2.0 2.0 t 2.0 t 2.0 T 2.0 Turbo SE 2.0 Turbo SE 2.3 t 2.3 t 2.3 t 2.3 t	136 X3020001 136 110 X3020001 110 129 141 X3020001 141 125 X3020001 125 136 X3020001 136		07.00 12.01 12.01 01.99 01.99 01.99 07.00 01.99 12.01 01.99 12.01 01.01	+ (USA) - (USA) + (USA) - (USA) + (USA) - (USA) + (USA) - (USA) + (USA) - (USA) + (USA) - (USA)	24.3571-1783.5 24.3571-1784.5 11.0101-5407.2 11.0441-5704.2 11.8171-0008.1 11.8116-0292.1	240751 240752 260011 250034 990049 390521	2 + 15" Rad 1) + 15" Rad 1)	D=57, - Halter D=57, - Halter Hülzensatz Dichtungssatz Führungsbolzen Haltefeder	ATE ATE ATE ATE ATE ATE
	1.9 TiD 2.0 2.0 t 2.0 T 2.0 t BioPower 2.0 t BioPower 2.2 TiD	110 136 110 129 110 132 88		01.06 02.10 07.00 02.10 01.02 02.10 01.02 02.10 01.05 02.10 06.06 02.10 03.02 02.10		24.3571-1783.5 24.3571-1784.5 11.0101-5407.2 11.0441-5704.2 11.8171-0008.1 11.8116-0292.1	240751 240752 260011 250034 990049 390521	2 + 15" Rad 1) + 15" Rad 1)	D=57, - Halter D=57, - Halter Hülzensatz Dichtungssatz Führungsbolzen Haltefeder	ATE ATE ATE ATE ATE ATE

1) + 15" wheel / + ruota 15" / + roue 15" / + rueda 15"

																
SAAB 9-5 Limousine (YS3E) (97-10)																
	2.3 t	125		01.02	02.10	24.3571-1783.5	240751	2	+ 15" Rad ¹⁾ + 15" Rad ¹⁾	D=57, - Halter D=57, - Halter Hülssensatz Dichtungssatz Führungsbolzen Haltefeder	ATE ATE ATE ATE ATE ATE					
	2.3 T	134		04.08	02.10	24.3571-1784.5	240752									
	2.3 t	136		01.02	02.10	11.0101-5407.2	260011									
	2.3 T	162	43510123		02.10	+ (USA) 11.0441-5704.2	250034									
	2.3 T	162		07.03	02.10	- (USA) 11.8171-0008.1	990049									
	2.3 t BioPower	136		01.07	02.10	11.8116-0292.1	390521									
	2.3 t BioPower	152		11.06	02.10											
	2.3 t BioPower	154		01.07	02.10											
	2.0 Turbo SE	141		01.00	07.00	24.3571-1783.5	240751									
	2.3 T Aero	169		10.99	09.01	24.3571-1784.5	240752									
	2.3 T Aero	184		09.01	12.01	11.0101-5407.2	260011									
	3.0 t	147		01.98	12.01	11.0441-5704.2	250034									
3.0 TiD	130		07.01	12.01	11.8171-0008.1	990049										
					11.8116-0292.1	390521		+ 16" Rad ²⁾ + 16" Rad ²⁾	D=57, - Halter D=57, - Halter Hülssensatz Dichtungssatz Führungsbolzen Haltefeder	ATE ATE ATE ATE ATE ATE						
	2.3 T	162		07.03	02.10	+ (USA) 24.3571-1783.5	240751	2	+ 16" Rad ²⁾ + 16" Rad ²⁾	D=57, - Halter D=57, - Halter Hülssensatz Dichtungssatz Führungsbolzen Haltefeder	ATE ATE ATE ATE ATE ATE					
	2.3 T	188		04.08	02.10	24.3571-1784.5	240752									
	2.3 T	191		11.05	02.10	11.0101-5407.2	260011									
	2.3 T Aero	184		01.02	02.10	11.0441-5704.2	250034									
	2.3 T Aero	225		04.03	02.10	11.8171-0008.1	990049									
	3.0 t	147		01.02	02.10	11.8116-0292.1	390521									
	3.0 TiD	130		01.02	02.10											
		1.9 TiD	110		01.06	02.10	24.5231-0426.3					331313	2		L=426	
		2.0	136		07.00	02.10										
		2.0 t	110		09.97	02.10										
		2.0 T	129		10.98	02.10										
		2.0 t BioPower	110		01.05	02.10										
2.0 t BioPower		132		06.06	02.10											
2.0 Turbo SE		141		10.98	07.00											
2.2 TiD		88		03.02	02.10											
2.3 t		125		09.97	02.10											
2.3 T		134		04.08	02.10											
2.3 t		136		01.01	02.10											
2.3 T		162		07.03	02.10											
2.3 T		188		04.08	02.10											
2.3 T		191		11.05	02.10											
2.3 T Aero		169		10.99	09.01											
2.3 T Aero		184		09.01	02.10											
2.3 T Aero		225		04.03	03.04											
2.3 t BioPower		136		01.07	02.10											
2.3 t BioPower		152		11.06	02.10											
2.3 t BioPower		154		01.07	02.10											
3.0 t	147		01.98	02.10												
3.0 TiD	130		07.01	02.10												
	1.9 TiD	110		01.06	02.10	11.9381-9957.2	220661	2	+ 15" Rad ¹⁾ + 15" Rad ¹⁾	D=38, - Halter D=38, - Halter Hülssensatz Führungsbolzen Haltefeder Dichtungssatz	ATE ATE ATE ATE ATE ATE					
	2.0	136	X3025752		02.10	11.9381-9958.2	220662									
	2.0 t	110	X3025752		02.10	11.0101-5407.2	260011									
	2.0 T	129	X3025752		02.10	11.8171-0008.1	990049									
	2.0 t BioPower	110	X3025752		02.10	11.8116-0143.1	390513									
	2.0 t BioPower	132	X3025752		02.10	11.0441-3803.2	250010									
	2.0 Turbo SE	141	X3025752		07.00											
	2.2 TiD	88		03.02	02.10											
	2.3 t	125	X3025752		02.10											
	2.3 T	134	X3025752		02.10											
	2.3 t	136		01.01	02.10											
	2.3 T	162		07.03	02.10											
	2.3 T	188		04.08	02.10											
	2.3 T Aero	169		10.99	09.01											
	2.3 T Aero	184	53500057		02.10	+ (USA)										
	2.3 T Aero	184		09.01	12.01											
	2.3 t BioPower	136	X3025752		02.10											
	2.3 t BioPower	152	X3025752		02.10											
	2.3 t BioPower	154	X3025752		02.10											
	3.0 t	147	X3025752		12.01											
3.0 TiD	130		07.01	12.01												
	2.3 T	188		04.08	02.10	11.3401-0055.2	220519	2	+ 16" Rad ²⁾ + 16" Rad ²⁾	D=40, + Halter D=40, + Halter Führungsbolzen Hülssensatz Haltefeder Dichtungssatz	ATE ATE ATE ATE ATE ATE					
	2.3 T	191		11.05	02.10	11.3401-0056.2	220520									
	2.3 T Aero	184	53500056	01.02	02.10	+ (USA) 11.8171-0008.1	990049									
	2.3 T Aero	184		01.02	02.10	- (USA) 11.0101-5407.2	260011									
	2.3 T Aero	225		04.03	03.04	11.8116-0143.1	390513									
	3.0 t	147		01.02	02.10	11.0441-4002.2	250011									
	3.0 TiD	130		01.02	02.10											
		1.9 TiD	110		01.06	02.10	24.5233-0200.3					330425	2	am Bremsattel ³⁾	L=198 L=180	
2.0		136		07.00	02.10	83.7119-0180.3	330634									
2.0 t		110		09.97	02.10											
2.0 T		129		10.98	02.10											
2.0 t BioPower		110		01.05	02.10											
2.0 t BioPower		132		06.06	02.10											
2.0 Turbo SE		141		10.98	07.00											
2.2 TiD		88		03.02	02.10											
2.3 t		125		09.97	02.10											
2.3 T		134		04.08	02.10											
2.3 t		136		01.01	02.10											
2.3 T		162		07.03	02.10											
2.3 T		188		04.08	02.10											
2.3 T		191		11.05	02.10											
2.3 T Aero		169		10.99	09.01											
2.3 T Aero		184		09.01	02.10											

¹⁾ + 15" wheel / + ruota 15" / + roue 15" / + rueda 15"

²⁾ + 16" wheel / + ruota 16" / + roue 16" / + rueda 16"

³⁾ on the brake caliper / sulla pinza freno / sur l'étrier de frein / a la pinza de freno

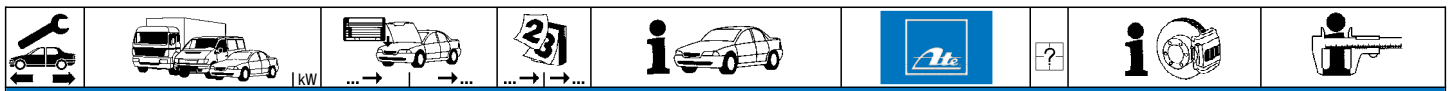

SAAB 9-5 Limousine (YS3E) (97-10)

	2.3 T Aero	225		04.03	03.04	24.5233-0200.3	330425	2			L=198
	2.3 t BioPower	136		01.07	02.10	83.7119-0180.3	330634	2	am Bremsattel 1)		L=180
	2.3 t BioPower	152		11.06	02.10						
	2.3 t BioPower	154		01.07	02.10						
	3.0 t	147		01.98	02.10						
	3.0 TiD	130		07.01	02.10						
	1.9 TiD	110		01.06	02.10	24.3727-1108.2	581108	2	↓		L=1410/1410
	2.0	136 X3001207			02.10 + USA						
	2.0	136 W3075143			02.10 - USA						
	2.0 t	110 X3001207			02.10 + USA						
	2.0 t	110 W3075143			02.10 - USA						
	2.0 T	129 W3075143			02.10						
	2.0 t BioPower	110 X3001207			02.10 + USA						
	2.0 t BioPower	110 W3075143			02.10 - USA						
	2.0 t BioPower	132 X3001207			02.10 + USA						
	2.0 t BioPower	132 W3075143			02.10 - USA						
	2.0 Turbo SE	141 X3001207			02.10 + USA						
	2.0 Turbo SE	141 W3075143			02.10 - USA						
	2.2 TiD	88		03.02	02.10						
	2.3 t	125 X3001207			02.10 + USA						
	2.3 t	125 W3075143			02.10 - USA						
	2.3 T	134 X3001207			02.10 + USA						
	2.3 T	134 W3075143			02.10 - USA						
	2.3 t	136		01.01	02.10						
	2.3 T	162		07.03	02.10						
	2.3 T	188		04.08	02.10						
	2.3 T	191		11.05	02.10						
	2.3 T Aero	169		10.99	09.01						
	2.3 T Aero	184		09.01	02.10						
	2.3 T Aero	225		04.03	03.04						
	2.3 t BioPower	136 X3001207			02.10 + USA						
	2.3 t BioPower	136 W3075143			02.10 - USA						
	2.3 t BioPower	152 X3001207			02.10 + USA						
	2.3 t BioPower	152 W3075143			02.10 - USA						
	2.3 t BioPower	154 X3001207			02.10 + USA						
	2.3 t BioPower	154 W3075143			02.10 - USA						
	3.0 t	147 W3075143			02.10 - USA						
	3.0 t	147 X3001207			02.10 + USA						
	3.0 TiD	130		07.01	02.10						
	2.0 t	110	X3039386	09.97		24.2415-1703.3	030102				Gz 15,87
	2.0 T	129	X3039386	10.98							
	2.3 t	125	X3039386	09.97							
	3.0 t	147	X3039386	01.98							

SAAB 9-5 Kombi (YS3E) (98-10)

	2.0	136		07.00	07.01	03.7745-3003.4	300157			8/7" Tandem	ATE
	2.0 t	110		10.98	12.01						
	2.0 t	141		10.98	12.01						
	2.3 t	125		10.98	12.01						
	2.3 t	136		01.01	12.01						
	2.3 T Aero	169		10.99	09.01						
	3.0 t	147		10.98	12.01						
	3.0 TiD	130		07.01	12.01						
	1.9 TiD	110		01.06	02.10	03.7745-3902.4	300129			8/7" Tandem	ATE
	1.9 TiD	129		01.07	02.10						
	2.0 t	110		01.02	02.10						
	2.0 t	141		01.02	02.10						
	2.0 t BioPower	110		06.06	02.10						
	2.0 t BioPower	110		01.06	02.10						
	2.2 TiD	88		03.02	02.10						
	2.3	224		06.03	08.05						
	2.3 t	125		01.02	02.10						
	2.3 t	136		01.02	02.10						
	2.3 T	162		07.03	02.10						
	2.3 T	188		04.08	02.10						
	2.3 T	191		01.06	02.10						
	2.3 T Aero	184		01.02	02.10						
	2.3 T Aero	225		04.03	03.04						
	2.3 t BioPower	136		01.07	02.10						
	2.3 t BioPower	152		11.06	02.10						
	2.3 t BioPower	154		01.07	02.10						
	3.0 t	147		01.02	02.10						
	3.0 TiD	130		01.02	02.10						
	2.0	136		07.00	07.01	03.2125-7402.3	010541			Thz 25,40	ATE
	2.0 t	110		10.98	12.01						
	2.0 t	141		10.98	12.01						
	2.3 t	125		10.98	12.01						
	2.3 t	136		01.01	12.01						
	2.3 T Aero	169		10.99	09.01						
	3.0 t	147		10.98	12.01						
	3.0 TiD	130		07.01	12.01						
	2.0 t	110		01.02	12.05	03.2125-9901.3	010634			Thz 25,40	ATE
	2.0 t	141		01.02	12.05						
	2.2 TiD	88		03.02	12.05						
	2.3	224		06.03	08.05						
	2.3 t	125		01.02	12.05						
	2.3 t	136		01.02	12.05						

1) on the brake caliper / sulla pinza freno / sur l'étrier de frein / a la pinza de freno



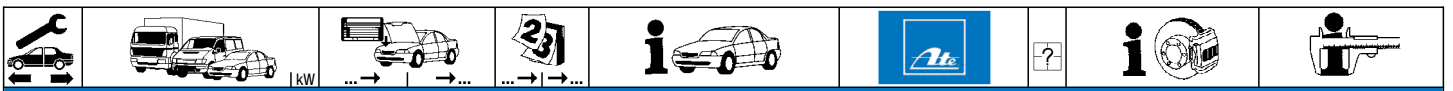



















SAAB 9-5 Kombi (YS3E) (98-10)

	2.3 T 2.3 T 2.3 T Aero 2.3 T Aero 3.0 t 3.0 TiD	◀162 ◀191 ◀184 ◀225 ◀147 ◀130		07.03 11.05 01.02 04.03 01.02 01.02	12.05 12.05 12.05 03.04 12.05 12.05	03.2125-9901.3	010634		THz 25,40	ATE
	1.9 TiD 1.9 TiD 2.0 t 2.0 t 2.0 t BioPower 2.0 t BioPower 2.2 TiD 2.3 t 2.3 t 2.3 T 2.3 T 2.3 T 2.3 T Aero 2.3 t BioPower 2.3 t BioPower 2.3 t BioPower 3.0 t 3.0 TiD	◀110 ◀129 ◀110 ◀141 ◀ ◀110 ◀ 88 ◀125 ◀136 ◀162 ◀188 ◀191 ◀184 ◀136 ◀152 ◀154 ◀147 ◀130		01.06 01.07 01.06 01.06 06.06 01.06 01.06 01.06 01.06 04.08 01.06 01.06 01.07 11.06 01.07 01.06 01.06	02.10 02.10 02.10 02.10 02.10 02.10 02.10 02.10 02.10 02.10 02.10 02.10 02.10 02.10 02.10 02.10 02.10 02.10	03.2125-9911.3	010883		THz 25,40	ATE
	2.0 2.0 t 2.0 t 2.3 t 2.3 t 2.3 T Aero 3.0 t 3.0 TiD	▶136 ▶110 ▶141 ▶125 ▶136 ▶169 ▶147 ▶130		07.00 10.98 10.98 10.98 01.01 10.99 10.98 07.01	07.01 12.01 12.01 12.01 12.01 09.01 12.01 12.01	03.2125-7502.3	010616		THz 25,40	ATE
	1.9 TiD 1.9 TiD 2.0 2.0 t 2.0 t 2.0 t BioPower 2.0 t BioPower 2.2 TiD 2.3 2.3 t 2.3 t 2.3 T 2.3 T 2.3 T 2.3 T Aero 2.3 T Aero 2.3 T Aero 2.3 t BioPower 2.3 t BioPower 2.3 t BioPower 3.0 t 3.0 TiD	◀110 ◀129 ◀136 ◀110 ◀141 ◀ ◀110 ◀ 88 ◀224 ◀125 ◀136 ◀162 ◀188 ◀191 ◀169 ◀184 ◀225 ◀136 ◀152 ◀154 ◀147 ◀130		01.06 01.07 07.00 10.98 10.98 06.06 01.06 03.02 06.03 10.98 01.02 07.03 04.08 01.06 10.99 09.01 04.03 01.07 11.06 01.07 10.98 07.01	02.10 02.10 07.01 07.01 02.10 02.10 02.10 02.10 08.05 02.10 02.10 02.10 02.10 02.10 02.10 02.10 03.04 02.10 02.10 02.10 02.10 02.10 02.10	43.4006-0001.2	310028		Behälter	
	2.0 2.0 2.0 t 2.0 t 2.0 t 2.0 t 2.3 t 2.3 t	136 136 110 110 141 141 125 125	X3020000 X3020000 X3020000 X3020000	07.00 07.00 10.98 10.98 10.98 10.98	+ (USA) - (USA) + (USA) - (USA) + (USA) - (USA)	24.3571-1761.5 24.3571-1762.5 11.8171-0008.1 11.0101-5407.2 11.8116-0292.1 11.0441-5704.2	240461 240462 990049 260011 390521 250034	2 2	D=57, - Halter D=57, - Halter Führungsbolzen Hülzensatz Haltefeder Dichtungssatz	ATE ATE ATE ATE ATE ATE
	2.0 2.0 2.0 t 2.0 t 2.0 t 2.0 t 2.3 t 2.3 t 2.3 t	136 136 110 110 141 141 125 125 136	X3020001 X3020001 X3020001 X3020001	07.00 07.00 01.99 12.01 12.01 01.99 01.99 01.01	+ (USA) - (USA) + (USA) - (USA) + (USA) - (USA)	24.3571-1783.5 24.3571-1784.5 11.0101-5407.2 11.0441-5704.2 11.8171-0008.1 11.8116-0292.1	240751 240752 260011 250034 990049 390521	2 2	D=57, - Halter D=57, - Halter Hülzensatz Dichtungssatz Führungsbolzen Haltefeder	ATE ATE ATE ATE ATE ATE
	1.9 TiD 1.9 TiD 2.0 t 2.0 t BioPower 2.0 t BioPower 2.2 TiD 2.3 t 2.3 t 2.3 T 2.3 T 2.3 t BioPower 2.3 t BioPower 2.3 t BioPower	110 129 110 110 88 125 136 162 162 136 152 154	43510123	01.06 01.07 01.02 06.06 01.06 03.02 01.02 01.02 07.03 01.07 11.06 01.07	02.10 02.10 02.10 02.10 02.10 02.10 02.10 02.10 02.10 02.10 02.10 02.10 02.10	24.3571-1783.5 24.3571-1784.5 11.0101-5407.2 11.0441-5704.2 11.8171-0008.1 11.8116-0292.1	240751 240752 260011 250034 990049 390521	2 2	D=57, - Halter D=57, - Halter Hülzensatz Dichtungssatz Führungsbolzen Haltefeder	ATE ATE ATE ATE ATE ATE









1) + 15" wheel / + ruota 15" / + roue 15" / + rueda 15"

																
SAAB 9-5 Kombi (YS3E) (98-10)																
	2.0	136		07.00	07.01	24.3571-1783.5	240751	 + 16" Rad ¹⁾  + 16" Rad ¹⁾	D=57, - Halter D=57, - Halter Hülsensatz Dichtungssatz Führungsbolzen Haltefeder	ATE ATE ATE ATE ATE ATE						
	2.3 T Aero	169		10.99	09.01	24.3571-1784.5	240752									
	2.3 T Aero	184		09.01	12.01	11.0101-5407.2	260011									
	3.0 t	147		10.98	12.01	11.0441-5704.2	250034									
	3.0 TiD	130		07.01	12.01	11.8171-0008.1	990049									
						11.8116-0292.1	390521									
	2.3	224		06.03	02.10	24.3571-1783.5	240751									
	2.3 T	162		07.03	02.10	24.3571-1784.5	240752									
	2.3 T	188		04.08	02.10	11.0101-5407.2	260011									
	2.3 T	191		01.06	02.10	11.0441-5704.2	250034									
2.3 T Aero	184		01.02	02.10	11.8171-0008.1	990049										
2.3 T Aero	225		04.03	02.10	11.8116-0292.1	390521										
2.3 t BioPower	136		01.07	02.10												
2.3 t BioPower	152		11.06	02.10												
2.3 t BioPower	154		01.07	02.10												
3.0 t	147		01.02	02.10												
3.0 TiD	130		01.02	02.10												
	1.9 TiD	110		01.06	02.10	24.5231-0426.3	331313	2	L=426							
	1.9 TiD	129		01.07	02.10											
	2.0	136		07.00	07.01											
	2.0 t	110		10.98	02.10											
	2.0 t	141		10.98	02.10											
	2.0 t BioPower			06.06	02.10											
	2.0 t BioPower	110		01.06	02.10											
	2.2 TiD	88		03.02	02.10											
	2.3	224		06.03	08.05											
	2.3 t	125		10.98	02.10											
	2.3 t	136		01.02	02.10											
	2.3 T	162		07.03	02.10											
	2.3 T	188		04.08	02.10											
	2.3 T	191		01.06	02.10											
	2.3 T Aero	169		10.99	09.01											
	2.3 T Aero	184		09.01	02.10											
	2.3 T Aero	225		04.03	03.04											
	2.3 t BioPower	136		01.07	02.10											
	2.3 t BioPower	152		11.06	02.10											
	2.3 t BioPower	154		01.07	02.10											
3.0 t	147		10.98	02.10												
3.0 TiD	130		07.01	02.10												
	1.9 TiD	110		01.06	02.10	11.9381-9957.2	220661	 + 15" Rad ²⁾  + 15" Rad ²⁾	D=38, - Halter D=38, - Halter Hülsensatz Führungsbolzen Haltefeder Dichtungssatz	ATE ATE ATE ATE ATE ATE						
	1.9 TiD	129		01.07	02.10											
	2.0	136		07.00	07.01											
	2.0 t	110	X3025752	02.10	02.10											
	2.0 t	141	X3025752	02.10	02.10											
	2.0 t BioPower		X3025752	02.10	02.10											
	2.0 t BioPower	110	X3025752	02.10	02.10											
	2.2 TiD	88		03.02	02.10											
	2.3 t	125	X3025752	02.10	02.10											
	2.3 t	136		01.01	02.10											
	2.3 T	162		07.03	02.10											
	2.3 T Aero	169		10.99	09.01											
	2.3 T Aero	184	53500057	02.10	02.10											
	2.3 T Aero	184		09.01	12.01											
	2.3 t BioPower	136	X3025752	02.10	02.10											
	2.3 t BioPower	152	X3025752	02.10	02.10											
	2.3 t BioPower	154	X3025752	02.10	02.10											
	3.0 t	147	X3025752	12.01	12.01											
	3.0 TiD	130		07.01	12.01											
		2.3	224		06.03						08.05	11.3401-0055.2	220519	 + 16" Rad ¹⁾  + 16" Rad ¹⁾	D=40, + Halter D=40, + Halter Führungsbolzen Hülsensatz Haltefeder Dichtungssatz	ATE ATE ATE ATE ATE ATE
2.3 T		188		04.08	02.10											
2.3 T		191		01.06	02.10											
2.3 T Aero		184	53500056	01.02	02.10											
2.3 T Aero		184		01.02	02.10											
2.3 T Aero		225		04.03	03.04											
3.0 t		147		01.02	02.10											
3.0 TiD		130		01.02	02.10											
		1.9 TiD	110		01.06	02.10	24.5233-0200.3	330425	2	am Bremsattel ³⁾	L=198					
		1.9 TiD	129		01.07	02.10										
	2.0	136		07.00	07.01											
	2.0 t	110		10.98	02.10											
	2.0 t	141		10.98	02.10											
	2.0 t BioPower			06.06	02.10											
	2.0 t BioPower	110		01.06	02.10											
	2.2 TiD	88		03.02	02.10											
	2.3	224		06.03	08.05											
	2.3 t	125		10.98	02.10											
	2.3 t	136		01.02	02.10											
	2.3 T	162		07.03	02.10											
	2.3 T	188		04.08	02.10											
	2.3 T	191		01.06	02.10											
	2.3 T Aero	169		10.99	09.01											
	2.3 T Aero	184		09.01	02.10											
	2.3 T Aero	225		04.03	03.04											
	2.3 t BioPower	136		01.07	02.10											
	2.3 t BioPower	152		11.06	02.10											
	2.3 t BioPower	154		01.07	02.10											
3.0 t	147		10.98	02.10												

¹⁾ + 16" wheel / + ruota 16" / + roue 16" / + rueda 16"

²⁾ + 15" wheel / + ruota 15" / + roue 15" / + rueda 15"

³⁾ on the brake caliper / sulla pinza freno / sur l'étrier de frein / a la pinza de freno

SAAB 9-5 Kombi (YS3E) (98-10)											
	3.0 TiD	130		07.01	02.10	24.5233-0200.3 83.7119-0180.3	330425 330634	2 2	am Bremsattel ¹⁾	L=198 L=180	
	1.9 TiD	110		01.06	02.10	24.3727-1108.2	581108	2	↓	L=1410/1410	
	1.9 TiD	129		01.07	02.10						
	2.0	136 X3001207			07.01 + (USA)						
	2.0	136 W3075143			07.01 - (USA)						
	2.0 t	110 X3001207			02.10 + (USA)						
	2.0 t	110 W3075143			02.10 - (USA)						
	2.0 t	141 X3001207			02.10 + (USA)						
	2.0 t	141 W3075143			02.10 - (USA)						
	2.0 t BioPower	X3001207			02.10 + (USA)						
	2.0 t BioPower	W3075143			02.10 - (USA)						
	2.0 t BioPower	110 X3001207			02.10 + (USA)						
	2.0 t BioPower	110 W3075143			02.10 - (USA)						
	2.2 TiD	88	03.02	02.10							
	2.3	224	06.03	08.05							
	2.3 t	125 X3001207			02.10 + (USA)						
	2.3 t	125 W3075143			02.10 - (USA)						
	2.3 t	136	01.01	02.10							
	2.3 T	162	07.03	02.10							
	2.3 T	188	04.08	02.10							
	2.3 T	191	01.06	02.10							
	2.3 T Aero	169	10.99	09.01							
	2.3 T Aero	184	09.01	02.10							
	2.3 T Aero	225	04.03	03.04							
	2.3 t BioPower	136 X3001207			02.10 + (USA)						
	2.3 t BioPower	136 W3075143			02.10 - (USA)						
	2.3 t BioPower	152 W3075143			02.10 - (USA)						
	2.3 t BioPower	152 X3001207			02.10 + (USA)						
	2.3 t BioPower	154 X3001207			02.10 + (USA)						
	2.3 t BioPower	154 W3075143			02.10 - (USA)						
	3.0 t	147 X3001206			02.10 + (USA)						
	3.0 t	147 W3075143			02.10 - (USA)						
	3.0 TiD	130	07.01	02.10							
	2.0 t	110	X3039386	10.98		24.2415-1703.3	030102			Gz 15,87	
	2.0 t	141	X3039386	10.98							
	2.3 t	125	X3039386	10.98							
	3.0 t	147	X3039386	10.98							
SAAB 9-5 II (10-12)											
	1.6 T	132		03.10	06.12	03.7858-0732.4	300272			9/8" Tandem	ATE
	2.0 T	162		03.10	06.12						
	2.0 T BioPower	162		03.10	06.12						
	2.0 T BioPower XWD	162		03.10	06.12						
	2.0 T XWD	162		03.10	06.12						
	2.0 TiD	118		03.10	06.12						
	2.0 TTiD	140		03.10	06.12						
	2.0 TTiD XWD	140		03.10	06.12						
	2.8 T V6 XWD	221		03.10	06.12						
	1.6 T	132		03.10	06.12						
	2.0 T	162		03.10	06.12						
	2.0 T BioPower	162		03.10	06.12						
	2.0 T BioPower XWD	162		03.10	06.12						
	2.0 T XWD	162		03.10	06.12						
	2.0 TiD	118		03.10	06.12						
	2.0 TTiD	140		03.10	06.12						
	2.0 TTiD XWD	140		03.10	06.12						
	2.8 T V6 XWD	221		03.10	06.12						
	1.6 T	132		03.10	06.12	24.5176-0494.3	331447	2	+ 16" Rad/ -Sportausfuehrung ²⁾	L=494	
	2.0 T	162		03.10	06.12						
	2.0 T BioPower	162		03.10	06.12						
	2.0 T BioPower XWD	162		03.10	06.12						
	2.0 T XWD	162		03.10	06.12						
	2.0 TiD	118		03.10	06.12						
	2.0 TTiD	140		03.10	06.12						
	2.0 TTiD XWD	140		03.10	06.12						
	2.8 T V6 XWD	221		03.10	06.12						
	1.6 T	132		03.10	06.12						24.5176-0384.3
	2.0 T	162		03.10	06.12						
	2.0 T BioPower	162		03.10	06.12						
	2.0 T BioPower XWD	162		03.10	06.12						
	2.0 T XWD	162		03.10	06.12						
	2.0 TiD	118		03.10	06.12						
	2.0 TTiD	140		03.10	06.12						
	2.0 TTiD XWD	140		03.10	06.12						
	2.8 T V6 XWD	221		03.10	06.12						
SAAB 900 (94-98)											
	2.0 16V Turbo	162		09.93	03.98	03.2123-1121.3	010176			THz 23,81	ATE
	2.0 i	162		09.93	03.98						
	2.3 16V	162		09.93	03.98						
	2.5 V6	162		09.93	03.98						
	2.0 16V Turbo	162	T7003723	09.93		03.2123-1121.3	010176			THz 23,81	ATE
	2.0 16V Turbo	162	T2024503	09.93							
	2.0 i	162	T7003723	09.93							
	2.0 i	162	T2024503	09.93							













¹⁾ on the brake caliper / sulla pinza freno / sur l'étrier de frein / a la pinza de freno















²⁾ + 16" wheel/ -sport version / + ruota 16" / - vers.sportiva / + roue 16" / -version sport / + rueda 16" / -modelo deportivo



SAAB 900 (94-98)												
	2.3 16V 2.3 16V			T7003723 T2024503	09.93 09.93			03.2123-1121.3	010176		Thz 23,81	ATE
	2.0 16V Turbo 2.0 i 2.3 16V 2.5 V6				09.93 09.93 09.93 09.93	08.96 08.96 08.96 08.96		11.3541-8085.2 24.3541-8086.5 24.3541-8085.5 11.8171-0008.1 11.0101-5407.2 11.8116-0292.1 11.0441-5704.2	220287 240526 240525 990049 260011 390521 250034	2	D=54, + Halter D=54, - Halter D=54, - Halter Führungsbolzen Hülzensatz Haltefeder Dichtungssatz	ATE ATE ATE ATE ATE ATE
	2.0 16V Turbo 2.0 i 2.3 16V 2.5 V6				09.96 09.96 09.96 09.96	03.98 03.98 03.98 03.98		24.3571-1761.5 24.3571-1762.5 11.0101-5407.2 11.8171-0008.1 11.8116-0292.1	240461 240462 260011 990049 390521	2	D=57, - Halter D=57, - Halter Führungsbolzen Haltefeder	ATE ATE ATE ATE
	2.0 16V Turbo 2.0 i 2.3 16V 2.5 V6				09.93 09.93 09.93 09.93	03.98 03.98 03.98 03.98		24.5298-0322.3	331314	2	L=322	
	2.0 16V Turbo 2.0 i 2.3 16V 2.5 V6				09.93 09.93 09.93 09.93	08.96 08.96 08.96 08.96		13.2351-0013.2 13.2351-0014.2 24.9235-0013.5 24.9235-0014.5 13.0441-3506.2	210010 210011 230001 230002 250052	2	D=35 D=35 D=35 D=35 Dichtungssatz	ATE ATE ATE ATE ATE
	2.0 16V Turbo 2.0 i 2.3 16V 2.5 V6				09.96 09.96 09.96 09.96	03.98 03.98 03.98 03.98		13.2351-0025.2 13.2351-0026.2 13.0441-3506.2	210210 210211 250052	2	D=35 D=35 Dichtungssatz	ATE ATE ATE
	2.0 16V Turbo 2.0 i 2.3 16V 2.5 V6	R2017931 R2017931 R2017931 R2017931			03.98 03.98 03.98 03.98			24.5117-0205.3	330669	2	L=205	
	2.0 16V Turbo 2.0 i 2.3 16V 2.5 V6	R2024559 R2024559 R2024559 R2024559			03.98 03.98 03.98 03.98			24.5117-0195.3	330565	2	L=198	
	2.0 16V Turbo 2.0 16V Turbo 2.0 i 2.0 i 2.3 16V 2.3 16V 2.5 V6 2.5 V6	V7002550 V2011537 V7002550 V2011537 V7002550 V2011537 V7002550 V2011537			03.98 03.98 03.98 03.98 03.98 03.98 03.98 03.98			24.3727-1106.2	581106	2	L=2180/1425	
	2.0 16V Turbo 2.0 i 2.3 16V 2.5 V6				09.93 09.93 09.93 09.93	03.98 03.98 03.98 03.98		24.2419-1727.3	030116		Gz 19,05	
SAAB 9000 (94-98)												
	2.0 16V 2.0 16V Turbo 2.3 16V 2.3 16V Turbo 3.0 V6				09.93 09.93 09.93 09.93 09.94	05.98 05.98 05.98 05.98 05.98	- ASR/ - TCS - ASR/ - TCS - ASR/ - TCS - ASR/ - TCS - ASR/ - TCS	10.6123-0522.3	010633		Thz 23,81	ATE
	2.0 16V 2.0 16V Turbo 2.3 16V 2.3 16V Turbo 3.0 V6				09.93 09.93 09.93 09.93 09.94	05.98 05.98 05.98 05.98 05.98		11.0441-5702.2 11.0101-5407.2 11.8171-0008.1 11.8116-0073.1	250033 260011 990049 390498	2	Dichtungssatz Hülzensatz Führungsbolzen Haltefeder	ATE ATE ATE ATE
	2.0 16V 2.0 16V Turbo 2.3 16V 2.3 16V Turbo 3.0 V6				09.93 09.93 09.93 09.93 09.94	05.98 05.98 05.98 05.98 05.98		83.6169-0505.3	330288	2	L=505	
	2.0 16V 2.0 16V Turbo 2.3 16V 2.3 16V Turbo 3.0 V6				09.93 09.93 09.93 09.93 09.94	05.98 05.98 05.98 05.98 05.98		11.3334-8002.2 11.0441-3302.2 11.0101-5407.2 11.8171-0008.1	220007 250004 260011 990049	2	D=33 Dichtungssatz Hülzensatz Führungsbolzen	ATE ATE ATE ATE
	2.0 16V 2.0 16V Turbo 2.3 16V 2.3 16V Turbo 3.0 V6				09.93 09.93 09.93 09.93 09.94	09.96 08.96 08.96 08.96 08.96		83.6155-0327.3	330287	2	L=325	
	2.0 16V 2.0 16V Turbo 2.3 16V 2.3 16V Turbo 3.0 V6				09.96 09.96 09.96 09.96 09.96	05.98 05.98 05.98 05.98 05.98		83.6169-0325.3	330546	2	L=325	
	2.0 16V 2.0 16V Turbo 2.3 16V 2.3 16V Turbo 3.0 V6				09.93 09.93 09.93 09.93 09.94	08.96 08.96 08.96 08.96 08.96		24.3727-1105.2 24.3727-1107.2	581105 581107	2	L=2025 L=1892	



									
SAAB 9000 (94-98)									
	2.0 16V			09.96	05.98	24.3727-1105.2	581105	<input type="checkbox"/>	L=2025
	2.0 16V Turbo			09.96	05.98	24.3727-1107.2	581107	<input type="checkbox"/>	L=1892
	2.3 16V			09.96	05.98				
	2.3 16V Turbo			09.96	05.98				
	3.0 V6			09.96	05.98				
SEAT ALHAMBRA I (96-10)									
	1.8 T 20V	◀110	7M-W-507041	05.98		03.7760-3002.4	300120		10" ATE
	1.9 TDI	◀66	7M-W-507041	03.96					
	1.9 TDI	◀81	7M-W-507041	10.97					
	2.0 i	◀85	7M-W-507041	03.96					
	1.8 T 20V	◀110	7M-W-507042		05.00	03.7755-1902.4	300138		9/8" Tandem ATE
	1.9 TDI	◀66	7M-W-507042		05.00				
	1.9 TDI	◀81	7M-W-507042		05.00				
	2.0 i	◀85	7M-W-507042		05.00				
	1.8 T 20V	◀110	7M-3-515799	06.00		03.7755-6302.4	300221	- ESP	9/8" Tandem ATE
	1.9 TDI	◀66	7M-3-515799	06.00		03.7858-3302.4	300122	+ ESP	9/8" Tandem ATE
	1.9 TDI	◀85	7M-3-515799	06.00					
	1.9 TDI	◀96	7M-3-515799	11.02					
	1.9 TDI 4motion	◀85	7M-3-515799	02.01					
	2.0 i	◀85	7M-3-515799	06.00					
	2.8 i V6	◀150	7M-3-515799	06.00					
	2.8 i V6 4motion	◀150	7M-3-515799	02.01					
	1.8 T 20V	◀110	7M-3-515800		08.10	03.7755-6302.4	300221	- ESP	9/8" Tandem ATE
	1.9 TDI	◀66	7M-3-515800		08.10	03.7858-9502.4	300205	+ ESP	9/8" Tandem ATE
	1.9 TDI	◀85	7M-3-515800		08.10	03.0655-0006.2	370006	+ ESP	Wegsensor ATE
	1.9 TDI	◀96	7M-3-515800		08.10				
	1.9 TDI	◀110		05.05	08.10				
	1.9 TDI 4motion	◀85	7M-3-515800		08.10				
	1.9 TDI 4motion	◀96		06.05	08.10				
	2.0 i	◀85	7M-3-515800		08.10				
	2.0 TDI	◀103		11.05	08.10				
	2.8 i V6	◀150	7M-3-515800		08.10				
	2.8 i V6 4motion	◀150	7M-3-515800		08.10				
	1.8 T 20V	▶110		05.98	05.00	03.7760-3002.4	300120	+ ABS	10" ATE
	1.9 TDI	▶66		03.96	05.00				
	1.9 TDI	▶81		10.97	05.00				
	2.0 i	▶85		03.96	05.00				
	1.8 T 20V	▶110		06.00	08.10	03.7755-6302.4	300221	- ESP	9/8" Tandem ATE
	1.9 TDI	▶66		06.00	08.10				
	1.9 TDI	▶85		06.00	08.10				
	1.9 TDI	▶96		11.02	08.10				
	1.9 TDI	▶110		05.05	08.10				
	1.9 TDI 4motion	▶85		02.01	08.10				
	1.9 TDI 4motion	▶96		06.05	08.10				
	2.0 i	▶85		06.00	08.10				
	2.0 TDI	▶103		11.05	08.10				
	2.8 i V6	▶150		06.00	08.10				
	2.8 i V6 4motion	▶150		02.01	08.10				
	1.8 T 20V	110	7M-W-507041	05.98		03.2123-1548.3	010478	- ABS	THz 23,81 ATE
	1.9 TDI	66	7M-W-507041	03.96		03.2123-1526.3	010477	+ ABS	THz 23,81 ATE
	1.9 TDI	81	7M-W-507041	10.97		03.3517-5100.1	390326	- ABS	Verschlußschraube ATE
	2.0 i	85	7M-W-507041	03.96					
	1.8 T 20V	110	7M-W-507042		05.00	03.2125-8404.3	010583	- ABS	THz 25,40 ATE
	1.9 TDI	66	7M-W-507042		05.00	03.2125-0332.3	010952	+ ABS	THz 25,40 ATE
	1.9 TDI	81	7M-W-507042		05.00				
	2.0 i	85	7M-W-507042		05.00				
	1.8 T 20V	110	7M-3-515799	06.00		03.2125-0332.3	010952	- ESP	THz 25,40 ATE
	1.9 TDI	66	7M-3-515799	06.00		03.2125-9604.3	010581	+ ESP	THz 25,40 ATE
	1.9 TDI	85	7M-3-515799	06.00					
	1.9 TDI	96	7M-3-515799	11.02					
	1.9 TDI 4motion	85	7M-3-515799	02.01					
	2.0 i	85	7M-3-515799	06.00					
	2.8 i V6	150	7M-3-515799	06.00					
	2.8 i V6 4motion	150	7M-3-515799	02.01					
	1.8 T 20V	110	7M-3-515800		08.10	03.2125-0332.3	010952	- ESP	THz 25,40 ATE
	1.9 TDI	66	7M-3-515800		08.10				
	1.9 TDI	85	7M-3-515800		08.10				
	1.9 TDI	96	7M-3-515800		08.10				
	1.9 TDI	110		05.05	08.10				
	1.9 TDI 4motion	85	7M-3-515800		08.10				
	1.9 TDI 4motion	96		06.05	08.10				
	2.0 i	85	7M-3-515800		08.10				
	2.0 TDI	103		11.05	08.10				
	2.8 i V6	150	7M-3-515800		08.10				
	2.8 i V6 4motion	150	7M-3-515800		08.10				
	1.8 T 20V	110	7M-1-530756	05.98		11.0441-5704.2	250034		Dichtungssatz ATE
	1.9 TDI	66	7M-1-530756	03.96		11.0101-5409.2	260035		Hülssensatz ATE
	1.9 TDI	81	7M-1-530756	10.97		11.8171-0008.1	990049		Führungsbolzen ATE
	1.9 TDI	85	7M-1-530756	06.00		11.8116-0143.1	390513	2	Haltefeder ATE
	2.0 i	85	7M-1-530756	03.96					



















									
SEAT ALHAMBRA I (96-10)									
	1.9 TDI	66	7M-2-500001		08.10	11.9571-9811.2	220485	2	D=57, - Halter ATE D=57, - Halter ATE Dichtungssatz ATE Hülsensatz ATE Führungsbolzen ATE Haltefeder ATE
	1.9 TDI	85	7M-2-500001		08.10	11.9571-9812.2	220486		
	1.9 TDI	96		11.02	08.10	11.0441-5704.2	250034		
	2.0 i	85	7M-2-500001		08.10	11.0101-5706.2	260097		
	2.0 TDI	103		11.05	08.10	11.8171-0067.1	250153		
					08.10	11.8116-0326.1	390471		
	1.8 T 20V	110	7M-2-500001		08.10	11.9571-9819.2	220469		
	1.9 TDI	110		05.05	08.10	11.9571-9820.2	220470		
	1.9 TDI 4motion	85		02.01	08.10	11.0101-5705.2	260096		
	1.9 TDI 4motion	96		06.05	08.10	11.8171-0067.1	250153		
2.8 i V6	150		06.00	08.10	11.8116-0326.1	390471			
2.8 i V6 4motion	150		02.01	08.10					
	1.8 T 20V	110	7M-1-530756	05.98	08.10	24.5166-0454.3	331306	2	L=454
	1.9 TDI	66	7M-1-530756	03.96	08.10				
	1.9 TDI	81		10.97	05.00				
	1.9 TDI	85	7M-1-530756	06.00	08.10				
	1.9 TDI	96	7M-1-530756	11.02	08.10				
	1.9 TDI 4motion	96	7M-1-530756	06.05	08.10				
	2.0 i	85	7M-1-530756	03.96	08.10				
	1.8 T 20V	110	7M-2-500001		08.10	83.6219-0455.3	330592	2	
	1.9 TDI	66	7M-2-500001		08.10				
	1.9 TDI	85	7M-2-500001		08.10				
1.9 TDI	96	7M-2-500001		08.10					
1.9 TDI	110		05.05	08.10					
1.9 TDI 4motion	85		02.01	08.10					
1.9 TDI 4motion	96	7M-2-500001		08.10					
2.0 i	85	7M-2-500001		08.10					
2.0 TDI	103		11.05	08.10					
2.8 i V6	150		06.00	08.10					
2.8 i V6 4motion	150		02.01	08.10					
	1.8 T 20V	110	7M-1-530756	05.98	08.10	24.3384-1707.5	240171	2	D=38, - Halter TRW D=38, - Halter TRW Faltenbalgsatz TRW
	1.9 TDI	66		03.96	08.10	24.3384-1708.5	240172		
	1.9 TDI	81		10.97	05.00	11.0101-5403.2	260010		
	1.9 TDI	85		06.00	08.10				
	1.9 TDI	96		11.02	08.10				
	2.0 i	85		03.96	08.10				
	2.0 TDI	103		11.05	08.10				
	1.8 T 20V	110	7M-2-500001		08.10	24.3384-1715.5	240265		
	1.9 TDI	110		05.05	08.10	24.3384-1716.5	240266		
	1.9 TDI 4motion	85		02.01	08.10				
1.9 TDI 4motion	96		06.05	08.10					
2.8 i V6	150		06.00	08.10					
2.8 i V6 4motion	150		02.01	08.10					
	1.8 T 20V	110		05.98	08.10	24.5225-0370.3	331379	2	am Bremsattel 1)
	1.9 TDI	66		03.96	08.10	83.6113-0140.3	330482		
	1.9 TDI	81		10.97	05.00				
	1.9 TDI	85		06.00	08.10				
	1.9 TDI	96		11.02	08.10				
	1.9 TDI	110		05.05	08.10				
	1.9 TDI 4motion	85		02.01	08.10				
	1.9 TDI 4motion	96		06.05	08.10				
	2.0 i	85		03.96	08.10				
	2.0 TDI	103		11.05	08.10				
2.8 i V6	150		06.00	08.10					
2.8 i V6 4motion	150		02.01	08.10					
	1.8 T 20V	110		05.98	04.00	24.3727-0163.2	580163	2	L=1293
	1.9 TDI	66		03.96	08.10				
	1.9 TDI	81		10.97	05.00				
	1.9 TDI	85		06.00	08.10				
	1.9 TDI	96		11.02	08.10				
	1.9 TDI	110		05.05	08.10				
	2.0 i	85		03.96	08.10				
	2.0 TDI	103		11.05	08.10				
	1.8 T 20V	110		05.00	08.10	24.3727-3404.2	583404		
	1.9 TDI 4motion	85		02.01	08.10				
1.9 TDI 4motion	96		06.05	08.10					
2.8 i V6	150		06.00	08.10					
2.8 i V6 4motion	150		02.01	08.10					
	1.8 T 20V	110		05.98	08.10	24.2419-1722.3	030111		Gz 19,05
	1.9 TDI	66		03.96	08.10				
	1.9 TDI	81		10.97	05.00				
	1.9 TDI	85		06.00	08.10				
	1.9 TDI	96		11.02	08.10				
	1.9 TDI	110		05.05	08.10				
	1.9 TDI 4motion	85		02.01	08.10				
	1.9 TDI 4motion	96		06.05	08.10				
	2.0 i	85		03.96	08.10				
	2.0 TDI	103		11.05	08.10				
2.8 i V6	150		06.00	08.10					
2.8 i V6 4motion	150		02.01	08.10					























1) on the brake caliper / sulla pinza freno / sur l'étrier de frein / a la pinza de freno















SEAT ALHAMBRA II (10-)											
	1.4 TSI 1.8 TFSI 2.0 TDI 2.0 TDI 2.0 TDI 2.0 TDI 2.0 TDI 2.0 TDI 4motion 2.0 TSI	110 118 85 100 103 125 130 103 147	09.10 11.12 04.11 09.10 06.10 09.10 11.12 04.11 09.10			03.7873-4502.4	300284		11"	ATE	
	1.4 TSI 1.8 TFSI 2.0 TDI 2.0 TDI 2.0 TDI 2.0 TDI 2.0 TDI 2.0 TDI 2.0 TDI 2.0 TDI 4Drive 2.0 TDI 4Drive 2.0 TDI 4motion 2.0 TSI 2.0 TSI	110 118 85 100 103 125 130 135 110 135 103 147 162	09.10 11.12 04.11 09.10 06.10 09.10 11.12 05.15 09.10 11.12 05.15 05.16 04.11 09.10 05.15			03.4153-0186.3	010816		Thz 23,81	ATE	
	1.4 TSI 1.8 TFSI 2.0 TDI 2.0 TDI 2.0 TDI 2.0 TDI 2.0 TDI 2.0 TDI 4motion 2.0 TSI	110 118 85 100 103 125 130 103 147	09.10 11.12 04.11 09.10 06.10 09.10 11.12 04.11 09.10	PR: 1LJ PR: 1LJ PR: 1LJ PR: 1LJ PR: 1LJ PR: 1LJ PR: 1LJ		11.9571-9759.2 11.9571-9760.2 11.8171-0008.1 11.0101-5409.2 11.8116-0071.1	220847 220848 990049 260035 390605	2	D=57, - Halter D=57, - Halter Führungsbolzen Hülzensatz Haltefeder	ATE ATE ATE ATE	
	1.4 TSI 1.8 TFSI 2.0 TDI 2.0 TDI 2.0 TDI 2.0 TDI 2.0 TDI 2.0 TDI 4motion 2.0 TSI	110 118 85 100 103 125 130 103 147	09.10 11.12 04.11 09.10 06.10 09.10 11.12 04.11 09.10			24.6241-1709.7 24.6241-1710.7	221021 221022		elektrische Feststellbremse 1) elektrische Feststellbremse 1)	D=41, - Halter D=41, - Halter	TRW TRW
	1.4 TSI 1.8 TFSI 2.0 TDI 2.0 TDI 2.0 TDI 2.0 TDI 2.0 TDI 2.0 TDI 4motion 2.0 TSI	110 118 85 100 103 125 130 103 147	09.10 11.12 04.11 09.10 06.10 09.10 11.12 04.11 09.10			24.5143-0257.3	331167	2		L=257	
SEAT ALTEA (5P1) (04-15)											
	1.2 TSI 1.4 i 16V 1.4 TSI 1.6 i 16V 1.6 LPG 1.6 TDI 1.8 TFSI 1.9 TDI 2.0 FSI 2.0 TDI 2.0 TDI 2.0 TDI 2.0 TFSI	77 63 92 75 75 118 110 100 100 103 125 147	04.10 05.06 11.07 03.04 09.09 10.09 01.07 03.04 03.04 03.04 03.06 03.06	04.10 04.10 04.10 04.10 04.10 04.10 04.10 04.10 04.10 04.10 04.10 04.10	PR: 1AC,1AT PR: 1AC,1AT PR: 1AC,1AT PR: 1AC,1AT PR: 1AC,1AT PR: 1AC,1AT PR: 1AC,1AT PR: 1AC,1AT PR: 1AC,1AT PR: 1AC,1AT PR: 1AC,1AT PR: 1AC,1AT	03.7863-3232.4	300307		10"	ATE	
	1.2 TSI 1.4 i 16V 1.4 TSI 1.6 i 16V 1.6 LPG 1.6 TDI 1.8 TFSI 1.9 TDI 2.0 FSI 2.0 TDI 2.0 TDI 2.0 TDI 2.0 TFSI	77 63 92 75 75 118 110 100 100 103 125 147	04.10 05.06 11.07 03.04 09.09 10.09 01.07 03.04 03.04 03.04 03.06 03.06	04.10 04.10 04.10 04.10 04.10 04.10 04.10 04.10 04.10 04.10 04.10 04.10	PR: 1AS PR: 1AS PR: 1AS PR: 1AS PR: 1AS PR: 1AS PR: 1AS PR: 1AS PR: 1AS PR: 1AS PR: 1AS PR: 1AS	03.7863-9602.4	300206	Kolbendurchmesser Ø 22,20mm 2)	10"	ATE	
	1.2 TSI 1.4 i 16V 1.4 TSI 1.6 i 16V 1.6 LPG 1.6 TDI 1.8 TFSI 1.9 TDI 2.0 FSI	77 63 92 75 75 118 110	05.10 05.10 05.10 05.10 05.10 05.10 05.10			03.7863-3232.4 03.7863-3332.4	300307 300308		10" 10"	ATE ATE	

1) electric parking brake / fr.di stazionamento elettrico / frein à main électrique / freno de mano eléctrico
 2) piston diameter Ø 22,20mm / diametro del pistone Ø 22,20mm / diamètre de piston Ø 22,20mm / diámetro del pistón Ø 22,20mm























	 kW									
SEAT ALTEA (5P1) (04-15)										
	2.0 TDI	100	05.10		03.7863-3232.4	300307		10"	ATE	
	2.0 TDI	103	05.10		03.7863-3332.4	300308		10"	ATE	
	2.0 TDI	125	05.10							
	2.0 TFSI	147	05.10							
	1.2 TSI	77	04.10	04.10	03.2122-2129.3	010799		Thz 22,20	ATE	
	1.4 i 16V	63	05.06	04.10						
	1.4 TSI	92	11.07	04.10						
	1.6 i 16V	75	03.04	04.10						
	1.6 LPG	75	09.09	04.10						
	1.6 TDI		10.09	04.10						
	1.8 TFSI	118	01.07	04.10						
	1.9 TDI		03.04	04.10						
	2.0 FSI	110	03.04	04.10						
	2.0 TDI	100	03.04	04.10						
	2.0 TDI	103	03.04	04.10						
	2.0 TDI	125	03.06	04.10						
	2.0 TFSI	147	03.06	04.10						
	1.2 TSI	77	05.10		03.2122-2129.3	010799		Thz 22,20	ATE	
	1.4 i 16V	63	05.10							
	1.4 TSI	92	05.10							
	1.6 i 16V	75	05.10							
	1.6 LPG	75	05.10							
	1.6 TDI		05.10							
	1.8 TFSI	118	05.10							
	1.9 TDI		05.10							
	2.0 FSI	110	05.10							
	2.0 TDI	100	05.10							
	2.0 TDI	103	05.10							
	2.0 TDI	125	05.10							
	2.0 TFSI	147	05.10							
	1.2 TSI	77	05.10		03.2123-3449.3	010808		Thz 23,81	ATE	
	1.4 i 16V	63	05.10							
	1.4 TSI	92	05.10							
	1.6 i 16V	75	05.10							
	1.6 LPG	75	05.10							
	1.6 TDI		05.10							
	1.8 TFSI	118	05.10							
	1.9 TDI		05.10							
	2.0 FSI	110	05.10							
	2.0 TDI	100	05.10							
	2.0 TDI	103	05.10							
	2.0 TDI	125	05.10							
	2.0 TFSI	147	05.10							
	1.2 TSI	77	04.10		PR: 12F	11.9541-9549.2	220575		D=54, - Halter	ATE
	1.4 i 16V	63	05.06		PR: 12F	11.9541-9550.2	220576		D=54, - Halter	ATE
	1.4 TSI	92	11.07		PR: 12F	11.0101-5409.2	260035		Hülzensatz	ATE
	1.6 i 16V	75	03.04		PR: 12F	11.8171-0069.1	250152		Führungsbolzen	ATE
	1.6 LPG	75	09.09		PR: 12F					
	1.6 TDI		10.09		PR: 12F					
	1.8 TFSI	118	01.07		PR: 12F					
	1.9 TDI		03.04		PR: 12F					
	2.0 FSI	110	03.04		PR: 12F					
	2.0 TDI	100	03.04		PR: 12F					
	2.0 TDI	103	03.04		PR: 12F					
	2.0 TDI	125	03.06		PR: 12F					
	2.0 TFSI	147	03.06		PR: 12F					
	1.2 TSI	77	04.10		PR: 12E	11.9541-9553.2	220563		D=54, - Halter	ATE
	1.4 i 16V	63	05.06		PR: 12E	11.9541-9554.2	220564		D=54, - Halter	ATE
	1.4 TSI	92	11.07		PR: 12E	11.0101-5409.2	260035		Hülzensatz	ATE
	1.6 i 16V	75	03.04		PR: 12E	11.8171-0008.1	990049		Führungsbolzen	ATE
	1.6 LPG	75	09.09		PR: 12E	11.8116-0351.1	390538	2	Haltefeder	ATE
	1.6 TDI		10.09		PR: 12E					
	1.8 TFSI	118	01.07		PR: 12E					
	1.9 TDI		03.04		PR: 12E					
	2.0 FSI	110	03.04		PR: 12E					
	2.0 TDI	100	03.04		PR: 12E					
	2.0 TDI	103	03.04		PR: 12E					
	2.0 TDI	125	03.06		PR: 12E					
	2.0 TFSI	147	03.06		PR: 12E					
	1.2 TSI	77	04.10		PR: 12A,1LJ	11.9541-9553.2	220563		D=54, - Halter	ATE
	1.4 i 16V	63	05.06		PR: 12A,1LJ	11.9541-9554.2	220564		D=54, - Halter	ATE
	1.4 TSI	92	11.07		PR: 12A,1LJ	11.0101-5409.2	260035		Hülzensatz	ATE
	1.6 i 16V	75	03.04		PR: 12A,1LJ	11.8171-0008.1	990049		Führungsbolzen	ATE
	1.6 LPG	75	09.09		PR: 12A,1LJ	11.8116-0351.1	390538	2	Haltefeder	ATE
	1.6 TDI		10.09		PR: 12A,1LJ					
	1.8 TFSI	118	01.07		PR: 12A,1LJ					
	1.9 TDI		03.04		PR: 12A,1LJ					
	2.0 FSI	110	03.04		PR: 12A,1LJ					
	2.0 TDI	100	03.04		PR: 12A,1LJ					
	2.0 TDI	103	03.04		PR: 12A,1LJ					
	2.0 TDI	125	03.06		PR: 12A,1LJ					
	2.0 TFSI	147	03.06		PR: 12A,1LJ					
	1.2 TSI	77	04.10			24.5143-0564.3	331433	2	L=564	
	1.4 i 16V	63	05.06							
	1.4 TSI	92	11.07							
	1.6 i 16V	75	03.04							

	 kW								
SEAT ALTEA (5P1) (04-15)									
	1.6 LPG 75 1.6 TDI 118 1.8 TFSI 110 1.9 TDI 100 2.0 FSI 103 2.0 TDI 125 2.0 TFSI 147		09.09 10.09 01.07 03.04 03.04 03.04 03.06 03.06		24.5143-0564.3	331433	2	L=564	
	1.2 TSI 77 1.4 i 16V 63 1.4 TSI 92 1.6 i 16V 75 1.6 LPG 75 1.6 TDI 118 1.8 TFSI 110 1.9 TDI 100 2.0 FSI 103 2.0 TDI 125 2.0 TFSI 147		04.10 05.06 11.07 03.04 09.09 10.09 01.07 03.04 03.04 03.04 03.04 03.06 03.06	PR: 1KD,1KQ,1KZ PR: 1KD,1KQ,1KZ PR: 1KD,1KQ,1KZ PR: 1KD,1KQ,1KZ PR: 1KD,1KQ,1KZ PR: 1KD,1KQ,1KZ PR: 1KD,1KQ,1KZ PR: 1KD,1KQ,1KZ PR: 1KD,1KQ,1KZ PR: 1KD,1KQ,1KZ PR: 1KD,1KQ,1KZ PR: 1KD,1KQ,1KZ	24.3384-1755.7 24.3384-1756.7	220635 220636	 	D=38, - Halter D=38, - Halter	TRW TRW
	1.2 TSI 77 1.4 i 16V 63 1.4 TSI 92 1.6 i 16V 75 1.6 LPG 75 1.6 TDI 118 1.8 TFSI 110 1.9 TDI 100 2.0 FSI 103 2.0 TDI 125 2.0 TFSI 147		04.10 05.06 11.07 03.04 09.09 10.09 01.07 03.04 03.04 03.04 03.04 03.06 03.06	PR: 1KF,1KJ PR: 1KF,1KJ PR: 1KF,1KJ PR: 1KF,1KJ PR: 1KF,1KJ PR: 1KF,1KJ PR: 1KF,1KJ PR: 1KF,1KJ PR: 1KF,1KJ PR: 1KF,1KJ PR: 1KF,1KJ	24.3414-1709.7 24.3414-1710.7	220631 220632	 	D=41, - Halter D=41, - Halter	TRW TRW
	1.2 TSI 77 1.4 i 16V 63 1.4 TSI 92 1.6 i 16V 75 1.6 LPG 75 1.6 TDI 118 1.8 TFSI 110 1.9 TDI 100 2.0 FSI 103 2.0 TDI 125 2.0 TFSI 147		04.10 05.06 11.07 03.04 09.09 10.09 01.07 03.04 03.04 03.04 03.06 03.06		24.5204-0233.3	331430	2	L=233	
	1.2 TSI 77 1.4 i 16V 63 1.4 TSI 92 1.6 i 16V 75 1.6 LPG 75 1.6 TDI 118 1.8 TFSI 110 1.9 TDI 100 2.0 FSI 103 2.0 TDI 125 2.0 TFSI 147		04.10 05.06 11.07 03.04 09.09 10.09 01.07 03.04 03.04 03.04 03.06 03.06		24.3727-2708.2 24.3727-0195.2	582708 580195	2  2 	L=1447 L=1447	
	1.2 TSI 77 1.4 i 16V 63 1.4 TSI 92 1.6 i 16V 75 1.6 LPG 75 1.6 TDI 118 1.8 TFSI 110 1.9 TDI 100 2.0 FSI 103 2.0 TDI 125 2.0 TFSI 147		04.10 05.06 11.07 03.04 09.09 10.09 01.07 03.04 03.04 03.04 03.06 03.06		24.2415-1713.3	030132		Gz 15,87, + Sensor	
	1.2 TSI 77 1.4 i 16V 63 1.4 TSI 92 1.6 i 16V 75 1.6 TDI 118 1.8 TFSI 110 1.9 TDI 100 2.0 FSI 103 2.0 TDI 125 2.0 TFSI 147		04.10 05.06 11.07 03.04 10.09 01.07 03.04 03.04 03.04 03.06 03.06	06.11 06.11 06.11 12.06 06.11 06.11 06.11 06.11 06.11 06.11 06.11	24.2519-1705.3	040095		Nz 19,05	

									
SEAT ALTEA (5P1) (04-15)									
	1.6 i 16V 1.6 LPG	75 75	01.07 09.09		24.2519-1706.3	040096		Nz 19,05	
SEAT ALTEA XL (5P5) (06-15)									
	1.2 TSI 1.4 i 16V 1.4 TSI 1.6 i 16V 1.6 LPG 1.6 TDI 1.8 TFSI 1.9 TDI 1.9 TDI 4x4 2.0 FSI 2.0 TDI 2.0 TDI 2.0 TDI 4x4 2.0 TFSI 4x4	77 63 92 75 75 75 118 77 77 125 125 125 118 77	04.10 05.08 11.07 10.06 09.09 10.09 10.06 10.06 06.09 10.06 10.06 06.07 06.07	04.10 04.10 04.10 04.10 04.10 04.10 04.10 04.10 04.10 04.10 04.10 04.10 04.10 04.10	PR: 1AC,1AT PR: 1AC,1AT PR: 1AC,1AT PR: 1AC,1AT PR: 1AC,1AT PR: 1AC,1AT PR: 1AC,1AT PR: 1AC,1AT PR: 1AC,1AT PR: 1AC,1AT PR: 1AC,1AT PR: 1AC,1AT PR: 1AC,1AT	03.7863-3232.4	300307	Kolbendurchmesser Ø 22,20mm ¹⁾ 10"	ATE
	1.2 TSI 1.4 i 16V 1.4 TSI 1.6 i 16V 1.6 LPG 1.6 TDI 1.8 TFSI 1.9 TDI 1.9 TDI 4x4 2.0 FSI 2.0 TDI 2.0 TDI 2.0 TDI 4x4 2.0 TFSI 4x4	77 63 92 75 75 75 118 77 77 125 125 125 118 77	04.10 05.08 11.07 10.06 09.09 10.09 10.06 10.06 06.09 10.06 10.06 06.07 06.07	04.10 04.10 04.10 04.10 04.10 04.10 04.10 04.10 04.10 04.10 04.10 04.10 04.10 04.10	PR: 1AS PR: 1AS PR: 1AS PR: 1AS PR: 1AS PR: 1AS PR: 1AS PR: 1AS PR: 1AS PR: 1AS PR: 1AS PR: 1AS PR: 1AS	03.7863-9602.4	300206	Kolbendurchmesser Ø 22,20mm ¹⁾ 10"	ATE
	1.2 TSI 1.4 i 16V 1.4 TSI 1.6 i 16V 1.6 LPG 1.6 TDI 1.8 TFSI 1.9 TDI 1.9 TDI 4x4 2.0 FSI 2.0 TDI 2.0 TDI 2.0 TDI 4x4 2.0 TFSI 4x4	77 63 92 75 75 75 118 77 77 125 125 125 118 77	05.10 05.10 05.10 05.10 05.10 05.10 05.10 05.10 05.10 05.10 05.10 05.10 05.10 05.10			03.7863-3232.4 03.7863-3332.4	300307 300308	10" 10"	ATE ATE
	1.2 TSI 1.4 i 16V 1.4 TSI 1.6 i 16V 1.6 LPG 1.6 TDI 1.8 TFSI 1.9 TDI 1.9 TDI 4x4 2.0 FSI 2.0 TDI 2.0 TDI 2.0 TDI 4x4 2.0 TFSI 4x4	77 63 92 75 75 75 118 77 77 125 125 125 118 77	04.10 05.08 11.07 10.06 09.09 10.09 10.06 10.06 06.09 10.06 10.06 06.07 06.07	04.10 04.10 04.10 04.10 04.10 04.10 04.10 04.10 04.10 04.10 04.10 04.10 04.10 04.10	PR: 1AC,1AT,1AS PR: 1AC,1AT,1AS PR: 1AC,1AT,1AS PR: 1AC,1AT,1AS PR: 1AC,1AT,1AS PR: 1AC,1AT,1AS PR: 1AC,1AT,1AS PR: 1AC,1AT,1AS PR: 1AC,1AT,1AS PR: 1AC,1AT,1AS PR: 1AC,1AT,1AS PR: 1AC,1AT,1AS PR: 1AC,1AT,1AS	03.2122-2129.3	010799	THz 22,20	ATE
	1.2 TSI 1.4 i 16V 1.4 TSI 1.6 i 16V 1.6 LPG 1.6 TDI 1.8 TFSI 1.9 TDI 1.9 TDI 4x4 2.0 FSI 2.0 TDI 2.0 TDI 2.0 TDI 4x4 2.0 TFSI 4x4	77 63 92 75 75 75 118 77 77 125 125 125 118 77	05.10 05.10 05.10 05.10 05.10 05.10 05.10 05.10 05.10 05.10 05.10 05.10 05.10 05.10		PR: 1AC,1AT,1AS PR: 1AC,1AT,1AS PR: 1AC,1AT,1AS PR: 1AC,1AT,1AS PR: 1AC,1AT,1AS PR: 1AC,1AT,1AS PR: 1AC,1AT,1AS PR: 1AC,1AT,1AS PR: 1AC,1AT,1AS PR: 1AC,1AT,1AS PR: 1AC,1AT,1AS PR: 1AC,1AT,1AS PR: 1AC,1AT,1AS	03.2122-2129.3	010799	THz 22,20	ATE
	1.2 TSI 1.4 i 16V 1.4 TSI 1.6 i 16V 1.6 LPG 1.6 TDI 1.8 TFSI 1.9 TDI 1.9 TDI 2.0 FSI 2.0 TDI 2.0 TDI 2.0 TDI	77 63 92 75 75 75 118 77 77 125 125 125	05.10 05.10 05.10 05.10 05.10 05.10 05.10 05.10 05.10 05.10 05.10 05.10 05.10		PR: 1AC,1AT,1LJ PR: 1AC,1AT,1LJ PR: 1AC,1AT,1LJ PR: 1AC,1AT,1LJ PR: 1AC,1AT,1LJ PR: 1AC,1AT,1LJ PR: 1AC,1AT,1LJ PR: 1AC,1AT,1LJ PR: 1AC,1AT,1LJ PR: 1AC,1AT,1LJ PR: 1AC,1AT,1LJ PR: 1AC,1AT,1LJ	03.2123-3449.3	010808	THz 23,81	ATE

¹⁾ piston diameter Ø 22,20mm / diametro del pistone Ø 22,20mm / diamètre de piston Ø 22,20mm / diámetro del pistón Ø 22,20mm



	 kW							
SEAT ALTEA XL (5P5) (06-15)								
	2.0 TDI 4x4 2.0 TFSI 4x4		05.10 05.10	PR: 1AC,1AT,1LJ PR: 1AC,1AT,1LJ	03.2123-3449.3	010808		Thz 23,81 ATE
	1.2 TSI 1.4 i 16V 1.4 TSI 1.6 i 16V 1.6 LPG 1.6 TDI 1.8 TFSI 1.9 TDI 1.9 TDI 4x4 2.0 FSI 2.0 TDI 2.0 TDI 2.0 TDI 4x4 2.0 TFSI 4x4	77 63 92 75 75 77 118 77 125	04.10 05.08 11.07 10.06 09.09 10.09 10.06 10.06 06.09 10.06 10.06 06.07 06.07	PR: 12F PR: 12F PR: 12F PR: 12F PR: 12F PR: 12F PR: 12F PR: 12F PR: 12F PR: 12F PR: 12F PR: 12F	11.9541-9549.2 11.9541-9550.2 11.0101-5409.2 11.8171-0069.1	220575 220576 260035 250152	 	D=54, - Halter D=54, - Halter Hülzensatz Führungsbolzen ATE ATE ATE ATE
	1.2 TSI 1.4 i 16V 1.4 TSI 1.6 i 16V 1.6 LPG 1.6 TDI 1.8 TFSI 1.9 TDI 1.9 TDI 4x4 2.0 FSI 2.0 TDI 2.0 TDI 2.0 TDI 4x4 2.0 TFSI 4x4	77 63 92 75 75 77 118 77 125	04.10 05.08 11.07 10.06 09.09 10.09 10.06 10.06 06.09 10.06 10.06 06.07 06.07	PR: 1ZE PR: 1ZE PR: 1ZE PR: 1ZE PR: 1ZE PR: 1ZE PR: 1ZE PR: 1ZE PR: 1ZE PR: 1ZE PR: 1ZE PR: 1ZE	11.9541-9553.2 11.9541-9554.2 11.0101-5409.2 11.8171-0008.1 11.8116-0351.1	220563 220564 260035 990049 390538	 	D=54, - Halter D=54, - Halter Hülzensatz Führungsbolzen Haltefeder ATE ATE ATE ATE
	1.2 TSI 1.4 i 16V 1.4 TSI 1.6 i 16V 1.6 LPG 1.6 TDI 1.8 TFSI 1.9 TDI 1.9 TDI 4x4 2.0 FSI 2.0 TDI 2.0 TDI 2.0 TDI 4x4 2.0 TFSI 4x4	77 63 92 75 75 77 118 77 125	04.10 05.08 11.07 10.06 09.09 10.09 10.06 10.06 06.09 10.06 10.06 06.07 06.07	PR: 1ZA,1LJ PR: 1ZA,1LJ PR: 1ZA,1LJ PR: 1ZA,1LJ PR: 1ZA,1LJ PR: 1ZA,1LJ PR: 1ZA,1LJ PR: 1ZA,1LJ PR: 1ZA,1LJ PR: 1ZA,1LJ PR: 1ZA,1LJ PR: 1ZA,1LJ	11.9541-9553.2 11.9541-9554.2 11.0101-5409.2 11.8171-0008.1 11.8116-0351.1	220563 220564 260035 990049 390538	 	D=54, - Halter D=54, - Halter Hülzensatz Führungsbolzen Haltefeder ATE ATE ATE ATE
	1.2 TSI 1.4 i 16V 1.4 TSI 1.6 i 16V 1.6 LPG 1.6 TDI 1.8 TFSI 1.9 TDI 1.9 TDI 4x4 2.0 FSI 2.0 TDI 2.0 TDI 2.0 TDI 4x4 2.0 TFSI 4x4	77 63 92 75 75 77 118 77 125	04.10 05.08 11.07 10.06 09.09 10.09 10.06 10.06 06.09 10.06 10.06 06.07 06.07		24.5143-0564.3	331433	2	L=564
	1.2 TSI 1.4 i 16V 1.4 TSI 1.6 i 16V 1.6 LPG 1.6 TDI 1.8 TFSI 1.9 TDI 1.9 TDI 4x4 2.0 FSI 2.0 TDI 2.0 TDI 2.0 TDI 4x4 2.0 TFSI 4x4	77 63 92 75 75 77 118 77 125	04.10 05.08 11.07 10.06 09.09 10.09 10.06 10.06 06.09 10.06 10.06 06.07 06.07	PR: 1KD,1KQ,1KZ PR: 1KD,1KQ,1KZ PR: 1KD,1KQ,1KZ PR: 1KD,1KQ,1KZ PR: 1KD,1KQ,1KZ PR: 1KD,1KQ,1KZ PR: 1KD,1KQ,1KZ PR: 1KD,1KQ,1KZ PR: 1KD,1KQ,1KZ PR: 1KD,1KQ,1KZ PR: 1KD,1KQ,1KZ PR: 1KD,1KQ,1KZ	24.3384-1755.7 24.3384-1756.7	220635 220636	 	D=38, - Halter D=38, - Halter TRW TRW
	1.2 TSI 1.4 i 16V 1.4 TSI 1.6 i 16V 1.6 LPG 1.6 TDI 1.8 TFSI 1.9 TDI 1.9 TDI 4x4 2.0 FSI 2.0 TDI 2.0 TDI 2.0 TDI 4x4	77 63 92 75 75 77 118 77 125	04.10 05.08 11.07 10.06 09.09 10.09 10.06 10.06 06.09 10.06 10.06 06.07 06.07		24.5204-0233.3	331430	2	L=233



SEAT ALTEA XL (5P5) (06-15)

	2.0 TFSI 4x4			06.07		24.5204-0233.3	331430	2		L=233
	1.2 TSI	77		04.10		24.3727-2708.2	582708	2 ↓		L=1447
	1.4 i 16V	63		05.08		24.3727-0195.2	580195	2 ↓		L=1447
	1.4 TSI	92		11.07						
	1.6 i 16V	75		10.06						
	1.6 LPG	75		09.09						
	1.6 TDI			10.09						
	1.8 TFSI	118		10.06						
	1.9 TDI			10.06						
	1.9 TDI 4x4	77		06.09						
	2.0 FSI			10.06						
	2.0 TDI			10.06						
	2.0 TDI	125		10.06						
	2.0 TDI 4x4			06.07						
	2.0 TFSI 4x4			06.07						
	1.2 TSI	77		04.10		24.2415-1713.3	030132			Gz 15,87, + Sensor
	1.4 i 16V	63		05.08						
	1.4 TSI	92		11.07						
	1.6 i 16V	75		10.06						
	1.6 LPG	75		09.09						
	1.6 TDI			10.09						
	1.8 TFSI	118		10.06						
	1.9 TDI			10.06						
	1.9 TDI 4x4	77		06.09						
	2.0 FSI			10.06						
	2.0 TDI			10.06						
	2.0 TDI	125		10.06						
	2.0 TDI 4x4			06.07						
	2.0 TFSI 4x4			06.07						
	1.2 TSI	77		04.10	06.11	24.2519-1705.3	040095			Nz 19,05
	1.4 i 16V	63		05.08	06.11					
	1.4 TSI	92		11.07	06.11					
	1.6 i 16V	75		10.06	12.06					
	1.6 TDI			10.09	06.11					
	1.8 TFSI	118		10.06	06.11					
	1.9 TDI			10.06	06.11					
	1.9 TDI 4x4	77		06.09	06.11					
	2.0 FSI			10.06	06.11					
	2.0 TDI			10.06	06.11					
	2.0 TDI	125		10.06	06.11					
	2.0 TDI 4x4			06.07	06.11					
	2.0 TFSI 4x4			06.07	06.11					
	1.6 i 16V	75		01.07		24.2519-1706.3	040096			Nz 19,05
	1.6 LPG	75		09.09						

SEAT AROSA (6H) (97-05)

	1.0 i	37		05.97	04.05	03.2120-3943.3	010532	- ABS	THz 20,64	ATE
	1.4 i	44		05.97	04.05	03.2122-1344.3	010593	+ ABS	THz 22,20	ATE
	1.4 i 16V	74		10.99	04.05					
	1.4 TDI	55		10.99	04.05					
	1.7 SDI	44		11.97	04.05					
	1.0 i	37		05.97	04.05	03.2122-1184.3	010592	+ ABS	THz 22,20	ATE
	1.4 i	44		05.97	04.05					
	1.4 i 16V	74		10.99	04.05					
	1.4 TDI	55		10.99	04.05					
	1.7 SDI	44		11.97	04.05					
	1.0 i	37		05.97	04.05	11.0441-4808.2	250022		Dichtungssatz	
	1.4 i	44		05.97	04.05	11.0101-4803.2	260008		Hülsensatz	
	1.7 SDI	44		11.97	04.05	24.0102-4803.2	260086		Hülsensatz+Schrauben	
	1.4 i 16V	74		10.99	04.05	24.3481-1735.5	240283		D=48, - Halter	ATE
	1.4 TDI	55		10.99	04.05	24.3481-1736.5	240284		D=48, - Halter	ATE
						11.0101-4801.2	260006		Hülsensatz	ATE
						24.0102-4801.2	260085		Hülsensatz+Schrauben	ATE
						11.0441-4808.2	250022		Dichtungssatz	ATE
	1.4 i 16V	74		10.99	04.05	24.3541-1779.5	240249		D=54, - Halter	TRW
	1.4 TDI	55		10.99	04.05	24.3541-1780.5	240250		D=54, - Halter	TRW
						11.0101-5403.2	260010		Faltenbalgsatz	TRW
	1.0 i	37		05.97	04.05	24.5147-0385.3	331427	2		L=384
	1.4 i	44		05.97	04.05					
	1.4 i 16V	74		10.99	04.05					
	1.4 TDI	55		10.99	04.05					
	1.7 SDI	44		11.97	04.05					
	1.4 i 16V	74		10.99	04.05	24.3344-1711.7	220539		D=34, - Halter	TRW
						24.3344-1712.7	220540		D=34, - Halter	TRW
	1.0 i	37		05.97	04.05	83.7858-0140.3	330837	2		L=140
	1.4 i	44		05.97	04.05					
	1.4 i 16V	74		10.99	04.05					
	1.4 TDI	55		10.99	04.05					
	1.7 SDI	44		11.97	04.05					



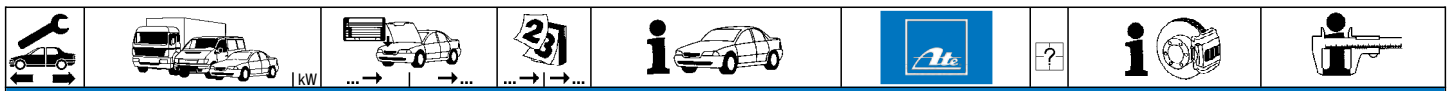















SEAT AROSA (6H) (97-05)

	1.0 i 1.4 i 1.4 TDI 1.7 SDI	37 44 55 44		05.97 05.97 10.99 11.97	04.05 04.05 04.05 04.05	- ABS - ABS - ABS - ABS	24.3215-0903.3	020154			Rz 15,87
	1.0 i 1.4 i 1.4 TDI 1.7 SDI	37 44 55 44		05.97 05.97 10.99 11.97	04.05 04.05 04.05 04.05	+ ABS + ABS + ABS + ABS	24.3217-0908.3	020167			Rz 17,46
	1.0 i 1.4 i 1.7 SDI	37 44 44	6H-W-028000 6H-W-028000 6H-W-028000	05.97 05.97 11.97		- ABS - ABS - ABS	24.3727-2702.2	582702	2 ↓		L=1395
	1.0 i 1.4 i 1.7 SDI	37 44 44	6H-W-028000 6H-W-028000 6H-W-028000	05.97 05.97 11.97		+ ABS + ABS + ABS	24.3727-2707.2	582707	2 ↓		L=1496
	1.0 i 1.4 i 1.4 i 16V 1.4 TDI 1.7 SDI	37 44 74 55 44	6H-W-028001 6H-W-028001 6H-W-028001 6H-W-028001	05.97 05.97 10.99 10.99 11.97	04.05 04.05 04.05 04.05 04.05		24.3727-0159.2	580159	2 ↓		L=1392
	1.0 i 1.4 i 1.4 i 16V 1.4 TDI 1.7 SDI	37 44 74 55 44		05.97 05.97 10.99 10.99 11.97	04.05 04.05 04.05 04.05 04.05		03.6583-0184.3	320229			BRL 8/3 (4) ATE
	1.4 TDI	55		10.99	04.05		24.2519-1701.3	040075			Nz 19,05
	1.0 i 1.4 i 1.4 i 16V 1.7 SDI	37 44 74 44		05.97 05.97 10.99 11.97	04.05 04.05 04.05 04.05		24.3728-2707.2	592707			L=1047, + AUT







SEAT CORDOBA I (93-99)

	1.8 i 16V 2.0 i	95 85		02.94 11.93	05.99 05.99		03.7740-1402.4	300133		- ABS	8" ATE
	1.4 i 1.6 i 1.6 i 1.8 i 1.9 D 1.9 SDI 1.9 TD	55 66 47 55		11.93 11.93 05.94 11.93 11.93 09.95 11.93	05.99 05.99 05.99 05.99 05.99 05.99 05.99		03.2120-3943.3 03.3517-0101.2	010532 390322		- ABS - ABS	THz 20,64 Verschlußschraube ATE
	1.8 i 16V 1.9 TDI 1.9 TDI 2.0 i	95 66 81 85		02.94 07.96 03.97 11.93	05.99 05.99 05.99 05.99		03.2122-1042.3 03.3517-0101.2	010137 390322		- ABS - ABS	THz 22,20 Verschlußschraube ATE
	1.8 i 16V 2.0 i	95 85		02.94 11.93	05.99 05.99		10.6123-0674.3	010639		+ ABS	THz 23,81 ATE
	1.4 i			11.93	12.96	- ABS	24.3481-1745.5 24.3481-1746.5 11.0441-4808.2 11.0101-4803.2 24.0102-4803.2	240277 240278 250022 260008 260086			D=48, - Halter ATE D=48, - Halter ATE Dichtungssatz ATE Hülzensatz ATE Hülzensatz+Schrauben ATE
	1.4 i 1.6 i 1.8 i 1.9 D 1.9 SDI 1.9 TD	66 47 55		11.93 11.93 11.93 09.95 11.93	12.96 12.96 12.96 12.96 12.96	+ ABS	11.0441-4808.2 11.0101-4801.2 24.0102-4801.2	250022 260006 260085			Dichtungssatz ATE Hülzensatz ATE Hülzensatz+Schrauben ATE
	1.8 i 16V 2.0 i	95 85		02.94 11.93	12.96 12.96		24.3541-1609.5 24.3541-1610.5 11.0101-5403.2	240039 240040 260010			D=54, - Halter TRW D=54, - Halter TRW Fallenbalgsatz TRW
	1.4 i 1.6 i 1.6 i 1.8 i 1.8 i 16V 1.9 D 1.9 SDI 1.9 TD 1.9 TDI 1.9 TDI 2.0 i	55 66 95 47 55 66 81 85		01.97 01.97 05.94 01.97 01.97 01.97 01.97 01.97 03.97 01.97	05.99 05.99 05.99 05.99 05.99 05.99 05.99 05.99 05.99 05.99	PR: 1LA PR: 1LA PR: 1LA PR: 1LA PR: 1LA PR: 1LA PR: 1LA PR: 1LA PR: 1LA PR: 1LA	24.3481-1745.5 24.3481-1746.5 11.0441-4808.2 11.0101-4803.2 24.0102-4803.2	240277 240278 250022 260008 260086			D=48, - Halter ATE D=48, - Halter ATE Dichtungssatz ATE Hülzensatz ATE Hülzensatz+Schrauben ATE
	1.4 i 1.6 i 1.6 i 1.8 i 1.8 i 16V 1.9 D 1.9 SDI 1.9 TD 1.9 TDI 1.9 TDI 2.0 i	55 66 95 47 55 66 81 85		01.97 01.97 05.94 01.97 01.97 01.97 01.97 01.97 03.97 01.97	05.99 05.99 05.99 05.99 05.99 05.99 05.99 05.99 05.99 05.99	PR: 1LG,1LM PR: 1LG,1LM PR: 1LG,1LM PR: 1LG,1LM PR: 1LG,1LM PR: 1LG,1LM PR: 1LG,1LM PR: 1LG,1LM PR: 1LG,1LM PR: 1LG,1LM	11.0101-4801.2 11.0441-4808.2	260006 250022			Hülzensatz ATE Dichtungssatz ATE

												
SEAT CORDOBA I (93-99)												
	1.4 i			01.97	05.99	PR: 1LY,1ZK	24.3541-1609.5	240039	D=54, - Halter D=54, - Halter Faltenbalgsatz	TRW TRW TRW		
	1.6 i			01.97	05.99	PR: 1LY,1ZK	24.3541-1610.5	240040				
	1.6 i	55		05.94	05.99	PR: 1LY,1ZK	11.0101-5403.2	260010				
	1.8 i	66		01.97	05.99	PR: 1LY,1ZK						
	1.8 i 16V	95		01.97	05.99	PR: 1LY,1ZK						
	1.9 D			01.97	05.99	PR: 1LY,1ZK						
	1.9 SDI	47		01.97	05.99	PR: 1LY,1ZK						
	1.9 TD	55		01.97	05.99	PR: 1LY,1ZK						
	1.9 TDI	66		01.97	05.99	PR: 1LY,1ZK						
	2.0 i	85		03.97	05.99	PR: 1LY,1ZK						
2.0 i 16V	85		01.97	05.99	PR: 1LY,1ZK							
	1.4 i			01.97	05.99	PR: 1LV,1LW,1LD	24.3541-1731.5	240061	D=54, - Halter D=54, - Halter	TRW TRW		
	1.6 i			01.97	05.99	PR: 1LV,1LW,1LD	24.3541-1732.5	240062				
	1.6 i	55		05.94	05.99	PR: 1LV,1LW,1LD						
	1.8 i	66		01.97	05.99	PR: 1LV,1LW,1LD						
	1.8 i 16V	95		01.97	05.99	PR: 1LV,1LW,1LD						
	1.9 D			01.97	05.99	PR: 1LV,1LW,1LD						
	1.9 SDI	47		01.97	05.99	PR: 1LV,1LW,1LD						
	1.9 TD	55		01.97	05.99	PR: 1LV,1LW,1LD						
	1.9 TDI	66		01.97	05.99	PR: 1LV,1LW,1LD						
	2.0 i	85		03.97	05.99	PR: 1LV,1LW,1LD						
2.0 i 16V	110		01.97	05.99	PR: 1LV,1LW,1LD							
	1.4 i			11.93	05.99		24.5105-0442.3	331432	L=442			
	1.6 i			11.93	05.99							
	1.6 i	55		05.94	05.99							
	1.8 i	66		11.93	05.99							
	1.8 i 16V	95		02.94	05.99							
	1.9 D			11.93	05.99							
	1.9 SDI	47		09.95	05.99							
	1.9 TD	55		11.93	05.99							
	1.9 TDI	66		07.96	05.99							
	2.0 i	85		03.97	05.99							
2.0 i 16V	110		11.93	05.99								
	1.8 i 16V	95	6K-ZR516424	02.94			24.3384-1603.5	240015	D=38, - Halter D=38, - Halter Bremsattel-Zubehör	TRW TRW TRW		
	1.8 i 16V	95	6K-ZR014473	02.94			24.3384-1604.5	240016				
	2.0 i	85	6K-ZR516424	11.93			24.0101-3601.2	260044				
	2.0 i	85	6K-ZR014473	11.93								
	1.8 i 16V	95	6K-ZR516425	6K-ZR610014			24.3384-1707.5	240171				
	1.8 i 16V	95	6K-ZR014474	6K-ZR085725			24.3384-1708.5	240172				
	2.0 i	85	6K-ZR516425	6K-ZR610014			24.0101-3601.2	260044				
	2.0 i	85	6K-ZR014474	6K-ZR085725			11.0101-5403.2	260010				
	1.8 i 16V	95	6K-ZR610015	6K-ZR610015	12.96		24.3384-1737.5	240301				
	1.8 i 16V	95	6K-ZR085726	6K-ZR085726	12.96		24.3384-1738.5	240302				
1.9 TDI	81		6K-X-399999	03.97		11.0101-5403.2	260010					
2.0 i	85	6K-ZR610015		12.96								
2.0 i	85	6K-ZR085726		12.96								
2.0 i 16V	110		6K-X-399999	07.96								
	1.8 i 16V	95		01.97	05.99	PR: 1KK	24.3384-1723.7	220523	D=38(M12x1), - Halter D=38(M12x1), - Halter	TRW TRW		
	1.9 TDI	81	6K-X-400000			PR: 1KK	24.3384-1724.7	220524				
	2.0 i	85		01.97	05.99	PR: 1KK						
	2.0 i 16V	110	6K-X-400000			PR: 1KK						
	1.8 i 16V	95		01.97	05.99	PR: 1KE,1KQ	24.3344-1711.7	220539				
	1.9 TDI	81	6K-X-400000			PR: 1KE,1KQ	24.3344-1712.7	220540				
	2.0 i	85		01.97	05.99	PR: 1KE,1KQ						
	2.0 i 16V	110	6K-X-400000			PR: 1KE,1KQ						
	1.4 i			11.93	05.99		83.7836-0135.3	330816			L=135	
	1.6 i			11.93	05.99							
1.6 i	55		05.94	05.99								
1.8 i	66		11.93	05.99								
1.9 D			11.93	05.99								
1.9 SDI	47		09.95	05.99								
1.9 TD	55		11.93	05.99								
1.9 TDI	66		07.96	05.99								
1.8 i 16V	95		02.94	05.99		24.5170-0161.3	331308					
1.9 TDI	81		03.97	05.99								
2.0 i	85		11.93	05.99								
2.0 i 16V	110		07.96	05.99								
	1.4 i			11.93	12.96		03.3217-2112.3	020027	Rz 17,46 Rz 17,46			
	1.6 i			11.93	12.96		24.3217-0908.3	020167				
	1.8 i	66		11.93	12.96							
	1.9 D			11.93	12.96							
	1.9 SDI	47		09.95	12.96							
	1.9 TD	55		11.93	12.96							
	1.9 TDI	66		07.96	12.96							
	1.4 i			01.97	05.99	PR: 1KA,1KB	24.3217-0908.3	020167				
	1.6 i			01.97	05.99	PR: 1KA,1KB						
	1.6 i	55		05.94	05.99	PR: 1KB						
1.8 i	66		01.97	05.99	PR: 1KB							
1.9 D			01.97	05.99	PR: 1KB							
1.9 SDI	47		01.97	05.99	PR: 1KB							
1.9 TD	55		01.97	05.99	PR: 1KB							
1.9 TDI	66		01.97	05.99	PR: 1KB							
1.4 i			01.97	05.99	PR: 1KM	24.3219-0909.3	020188	Rz 19,05				



























1) + cast iron / + ghisa / + fonte grise / + fundición de gris

2) + aluminium / + alluminio / + aluminium / + aluminio

SEAT CORDOBA I (93-99)										
	1.6 i 1.6 i 1.8 i 1.9 D 1.9 SDI 1.9 TD 1.9 TDI	55 66 47 55 66		01.97 05.94 01.97 05.99 01.97 05.99 01.97 05.99	05.99 PR: 1KM 05.99 PR: 1KM 05.99 PR: 1KM 05.99 PR: 1KM 05.99 PR: 1KM	24.3219-0909.3	020188		Rz 19,05	
	1.4 i 1.4 i 1.6 i 1.6 i 1.9 D 1.9 D 1.9 TD 1.9 TD		6K-ZR549075 6K-ZR037976 6K-ZR549075 6K-ZR037976 6K-ZR549075 6K-ZR037976 6K-ZR549075 6K-ZR037976	11.93 11.93 11.93 11.93 11.93 11.93 11.93 11.93		24.3727-2703.2	582703	2 ↓	L=1503	
	1.4 i 1.4 i 1.6 i 1.6 i 1.9 D 1.9 D 1.9 TD 1.9 TD		6K-ZR549076 6K-ZR037977 6K-ZR549076 6K-ZR037977 6K-ZR549076 6K-ZR037977 6K-ZR549076 6K-ZR037977	11.93 11.93 11.93 11.93 11.93 11.93 11.93 11.93		24.3727-2706.2	582706	2 ↓	L=1532	
	1.4 i 1.4 i 1.6 i 1.6 i		6K-ZR663843 6K-ZR126719 6K-ZR663843 6K-ZR126719	11.93 11.93 11.93 11.93		24.3727-0161.2	580161	2 ↓	L=1512	
	1.4 i 1.6 i		6K-W-169290 6K-W-169290	05.99 05.99		24.3727-0162.2	580162	2 ↓ + ABS	L=1514	
	1.9 D 1.9 D 1.9 TD 1.9 TD		6K-ZR663843 6K-ZR126719 6K-ZR663843 6K-ZR126719	05.99 05.99 05.99 05.99		24.3727-0161.2	580161	2 ↓ - ABS	L=1512	
	1.8 i 16V 1.8 i 16V 2.0 i 2.0 i 2.0 i 16V 2.0 i 16V		95 6K-ZR610015 95 6K-ZR085726 85 6K-ZR610015 85 6K-ZR085726 110 6K-ZR610015 110 6K-ZR085726	11.93 11.93 11.93 11.93 11.93 11.93		24.3727-2704.2	582704	2 ↓	L=1632	
	1.8 i 16V 2.0 i 2.0 i 16V		95 6K-W-169290 85 6K-W-169290 110 6K-W-169290	05.99 05.99 05.99		24.3727-0165.2	580165	2 ↓	L=1641	
	1.4 i 1.6 i 1.6 i 1.8 i 1.8 i 16V 1.9 D 1.9 SDI 1.9 TD 1.9 TDI 1.9 TDI 2.0 i	55 66 95 47 55 66 81 85		11.93 11.93 05.94 11.93 02.94 11.93 09.95 11.93 07.96 03.97 11.93	05.99 05.99 05.99 05.99 05.99 05.99 05.99 05.99 05.99 05.99 05.99	03.0101-0025.2 03.6584-0113.3	320014 320111	+ Druckabhängig ¹⁾ + Lastabhängig ²⁾	BRES 3/35 BRL 8/4 (4)	ATE ATE
	1.9 TDI 1.9 TDI	66 81		07.96 03.97	05.99 05.99	03.2419-9510.3	030028		Gz 19,05	
	1.9 TDI 1.9 TDI	66 81		07.96 03.97	05.99 05.99	24.2523-0908.3	040049		Nz 23,81	
	1.4 i 1.6 i 1.6 i	55		11.93 11.93 05.94	05.99 05.99 05.99	24.3728-2704.2	592704		L=1065, - AUT	
	1.8 i 1.8 i 1.8 i 16V 1.8 i 16V 2.0 i 2.0 i	66 66 95 95 85 85	6K-ZR530332 6K-ZR025747 6K-ZR530332 6K-ZR025747 6K-ZR530332 6K-ZR025747	11.93 11.93 02.94 02.94 11.93 11.93		24.3728-0128.2	590128		L=854, + AUT	
	1.8 i 1.8 i 1.8 i 16V 1.8 i 16V 1.9 D 1.9 TD 2.0 i 2.0 i	66 66 95 95 55 85 85	6K-ZR530333 6K-ZR025748 6K-ZR530333 6K-ZR025748	11.93 11.93 05.99 05.99 05.99 05.99 05.99 05.99		24.3728-0128.2	590128		L=854, + AUT	
SEAT CORDOBA II (6K2) (99-02)										
	1.0 1.4 i 1.4 i 16V 1.6 i 1.8 T 20V 1.9 SDI 1.9 TDI	37 44 115 66		06.99 06.99 06.99 06.99 07.00 06.99 06.99	09.02 09.02 09.02 09.02 09.02 09.02 09.02	03.7750-6302.4	300161	- ABS	9° ATE	

































1) + pressure sensitive / + in funzione della pressione / + asservi à la pression / + dependente de la presión

2) + load sensitive / + dependente dal carico / + asservi à la charge / + dependente de carga

										
SEAT CORDOBA II (6K2) (99-02)										
	1.9 TDI	◀ 81		06.99	09.02	03.7750-6302.4	300161	- ABS	9°	ATE
	1.0	◀ 37		06.99	09.02	10.6350-3902.4	300213	PR: 1KB	9°	ATE
	1.4 i	◀ 44		06.99	09.02	10.6350-4002.4	300285	PR: 1KK,1KM,1KQ	9°	ATE
	1.4 i 16V	◀		06.99	09.02					
	1.6 i	◀		06.99	09.02					
	1.8 T 20V	◀115		07.00	09.02					
	1.9 SDI	◀		06.99	09.02					
	1.9 TDI	◀ 66		06.99	09.02					
	1.9 TDI	◀ 81		06.99	09.02					
	1.0	◀ 37		06.99	09.02	03.2122-1042.3	010137	- ABS	THz 22,20	ATE
	1.4 i	◀ 44		06.99	09.02	03.2123-1424.3	010637	+ ABS	THz 23,81	ATE
	1.4 i 16V	◀		06.99	09.02					
	1.6 i	◀		06.99	09.02					
	1.8 T 20V	◀115		07.00	09.02					
	1.9 SDI	◀		06.99	09.02					
	1.9 TDI	◀ 66		06.99	09.02					
	1.9 TDI	◀ 81		06.99	09.02					
	1.0	37		06.99	09.02	11.0441-4808.2	250022		Dichtungssatz	ATE
	1.4 i	44		06.99	09.02	11.0101-4801.2	260006		Hülsensatz	ATE
	1.4 i 16V			06.99	09.02	24.0102-4801.2	260085		Hülsensatz+Schrauben	ATE
	1.6 i	55		06.99	09.02					
	1.9 SDI			06.99	09.02					
	1.6 i	74		06.99	09.02	24.3541-1609.5	240039		D=54, - Halter	TRW
	1.9 TDI	66		06.99	09.02	24.3541-1610.5	240040		D=54, - Halter	TRW
	1.8 T 20V	115		07.00	09.02	11.0101-5403.2	260010		Faltenbalgsatz	TRW
	1.9 TDI	81		06.99	09.02	24.3541-1731.5	240061		D=54, - Halter	TRW
	1.9 TDI			06.99	09.02	24.3541-1732.5	240062		D=54, - Halter	TRW
	1.0	37		06.99	09.02	24.5105-0442.3	331432	2	L=442	
	1.4 i	44		06.99	09.02					
	1.4 i 16V			06.99	09.02					
	1.6 i			06.99	09.02					
	1.8 T 20V	115		07.00	09.02					
	1.9 SDI			06.99	09.02					
	1.9 TDI	66		06.99	09.02					
	1.9 TDI	81		06.99	09.02					
	1.8 T 20V	115		07.00	09.02	24.3384-1723.7	220523		D=38(M12x1), - Halter	TRW
	1.9 TDI	81		06.99	09.02	24.3384-1724.7	220524		D=38(M12x1), - Halter	TRW
	1.0	37		06.99	09.02	83.7858-0140.3	330837	2	L=140	
	1.4 i	44		06.99	09.02					
	1.4 i 16V			06.99	09.02					
	1.6 i			06.99	09.02					
	1.8 T 20V	115		07.00	09.02					
	1.9 SDI			06.99	09.02					
	1.9 TDI	66		06.99	09.02					
	1.9 TDI	81		06.99	09.02					
	1.0	37		06.99	09.02	24.3217-0908.3	020167		Rz 17,46	
	1.4 i	44		06.99	09.02					
	1.4 i 16V			06.99	09.02					
	1.6 i	55		06.99	09.02					
	1.9 SDI			06.99	09.02					
	1.9 TDI	66		06.99	09.02					
	1.6 i	74		06.99	09.02	24.3219-0909.3	020188		Rz 19,05	
	1.0	37		06.99	09.02	24.3727-0162.2	580162	2 ↓	L=1514	
	1.4 i	44		06.99	09.02					
	1.4 i 16V			06.99	09.02					
	1.6 i			06.99	09.02					
	1.9 SDI			06.99	09.02					
	1.9 TDI	66		06.99	09.02					
	1.8 T 20V	115		07.00	09.02	24.3727-0165.2	580165	2 ↓	L=1641	
	1.9 TDI	81		06.99	09.02					
	1.0	◀ 37		06.99	09.02	24.2415-1712.3	030131		Gz 15,87	
	1.4 i	◀ 44		06.99	09.02					
	1.4 i 16V	◀		06.99	09.02					
	1.6 i	◀		06.99	09.02					
	1.8 T 20V	◀115		07.00	09.02					
	1.9 SDI	◀		06.99	09.02					
	1.9 TDI	◀ 66		06.99	09.02					
	1.9 TDI	◀ 81		06.99	09.02					
	1.0	37		06.99	09.02	24.2519-1701.3	040075	+ Schaltseilzug ¹⁾	Nz 19,05	
	1.4 i	44		06.99	09.02	24.2523-1701.3	040080	+ Schaltgestänge ²⁾	Nz 23,81	
	1.4 i 16V			06.99	09.02					
	1.6 i			06.99	09.02					
	1.8 T 20V	115		07.00	09.02					
	1.9 SDI			06.99	09.02					
	1.9 TDI	66		06.99	09.02					
	1.9 TDI	81		06.99	09.02					
SEAT CORDOBA III (6L2) (02-09)										
	1.2 i	◀ 47		10.02	06.09	03.7750-6302.4	300161		9°	ATE
	1.4 i 16V	◀		10.02	06.09					
	1.4 i 16V	◀ 74		10.02	06.09					
	1.4 TDI	◀		10.02	06.09					
	1.6 i 16V	◀		02.03	06.09					
	1.9 SDI	◀ 47		10.02	06.09					
↓										































¹⁾ + gearshift cable / + leva cambio con cavo / + câble de changem.de vitesse / + cable de acc. del cambio

²⁾ + gearshift linkage / + leva cambio con tiranteria / + tige de changem.de vitesse / + varillaje del cambio

									
SEAT CORDOBA III (6L2) (02-09)									
	1.9 TDI 1.9 TDI 2.0 i 16V	74 96 85		10.02 06.09 10.02 06.09 10.02 06.09	03.7750-6302.4	300161		9" ATE	
	1.2 i 1.4 i 16V 1.4 i 16V 1.4 TDI 1.6 i 16V 1.9 SDI 1.9 TDI 1.9 TDI 2.0 i 16V	47 74 74 74 47 74 96 85		10.02 06.09 10.02 06.09 10.02 06.09 10.02 06.09 02.03 06.09 10.02 06.09 10.02 06.09 10.02 06.09 10.02 06.09	24.2120-1736.3 24.2120-1734.3	010732 010702	- ABS + ABS	THz 20,64 THz 20,64	
	1.2 i 1.4 i 16V 1.4 i 16V 1.4 TDI 1.6 i 16V 1.9 SDI 1.9 TDI 1.9 TDI 2.0 i 16V	47 74 74 74 47 74 96 85		10.02 06.09 PR: 1LQ,1ZF 10.02 06.09 PR: 1LQ,1ZF 10.02 06.09 PR: 1LQ,1ZF 10.02 06.09 PR: 1LQ,1ZF 02.03 06.09 PR: 1LQ,1ZF 10.02 06.09 PR: 1LQ,1ZF 10.02 06.09 PR: 1LQ,1ZF 10.02 06.09 PR: 1LQ,1ZF 10.02 06.09 PR: 1LQ,1ZF	11.9541-9549.2 11.9541-9550.2 11.0101-5409.2 11.8171-0069.1	220575 220576 260035 250152	 	D=54, - Halter D=54, - Halter Hülzensatz Führungsbolzen	ATE ATE ATE ATE
	1.2 i 1.4 i 16V 1.4 i 16V 1.4 TDI 1.6 i 16V 1.9 SDI 1.9 TDI 1.9 TDI 2.0 i 16V	47 74 74 74 47 74 96 85		10.02 06.09 PR: 1LN,1ZH 10.02 06.09 PR: 1LN,1ZH 10.02 06.09 PR: 1LN,1ZH 10.02 06.09 PR: 1LN,1ZH 02.03 06.09 PR: 1LN,1ZH 10.02 06.09 PR: 1LN,1ZH 10.02 06.09 PR: 1LN,1ZH 10.02 06.09 PR: 1LN,1ZH 10.02 06.09 PR: 1LN,1ZH	24.3541-1797.7 24.3541-1798.7	220553 220554	 	D=54, - Halter D=54, - Halter	TRW TRW
	1.2 i 1.4 i 16V 1.4 i 16V 1.4 TDI 1.6 i 16V 1.9 SDI 1.9 TDI 1.9 TDI 2.0 i 16V	47 74 74 74 47 74 96 85		10.02 06.09 10.02 06.09 10.02 06.09 10.02 06.09 02.03 06.09 10.02 06.09 10.02 06.09 10.02 06.09 10.02 06.09	83.6247-0522.3	330595	2	L=522	
	1.2 i 1.4 i 16V 1.4 i 16V 1.4 TDI 1.6 i 16V 1.9 SDI 1.9 TDI 1.9 TDI 2.0 i 16V	47 74 74 74 47 74 96 85		10.02 06.09 10.02 06.09 10.02 06.09 10.02 06.09 02.03 06.09 10.02 06.09 10.02 06.09 10.02 06.09 10.02 06.09	24.3344-1709.7 24.3344-1710.7 24.3384-1729.7 24.3384-1730.7	220537 220538 220541 220542	   	D=34, - Halter D=34, - Halter D=38(M12x1), - Halter D=38(M12x1), - Halter	TRW TRW TRW TRW
	1.2 i 1.4 i 16V 1.4 i 16V 1.4 TDI 1.6 i 16V 1.9 SDI 1.9 TDI 1.9 TDI 2.0 i 16V	47 74 74 74 47 74 96 85		10.02 06.09 10.02 06.09 10.02 06.09 10.02 06.09 02.03 06.09 10.02 06.09 10.02 06.09 10.02 06.09 10.02 06.09	83.7858-0140.3	330837	2	L=140	
	1.2 i 1.4 i 16V 1.4 i 16V 1.4 TDI 1.6 i 16V 1.9 SDI 1.9 TDI 1.9 TDI 2.0 i 16V	47 74 74 74 47 74 96 85		10.02 06.09 10.02 06.09 10.02 06.09 10.02 06.09 02.03 06.09 10.02 06.09 10.02 06.09 10.02 06.09 10.02 06.09	24.3219-0909.3	020188		Rz 19,05	
	1.2 i 1.4 i 16V 1.4 i 16V 1.4 TDI 1.6 i 16V 1.9 SDI 1.9 TDI 1.9 TDI 2.0 i 16V	47 74 74 74 47 74 96 85		10.02 06.09 10.02 06.09 10.02 06.09 10.02 06.09 02.03 06.09 10.02 06.09 10.02 06.09 10.02 06.09 10.02 06.09	24.3727-0199.2	580199	2  - Schlechtwegeausführung ¹⁾	L=1580	
	1.2 i 1.4 i 16V 1.4 i 16V 1.4 TDI 1.6 i 16V 1.9 SDI 1.9 TDI 1.9 TDI 2.0 i 16V	47 74 74 74 47 74 96 85		10.02 06.09 PR: 1JB,1KD,1KK,1KP,1KS,1KT 10.02 06.09 PR: 1JB,1KD,1KK,1KP,1KS,1KT 10.02 06.09 PR: 1JB,1KD,1KK,1KP,1KS,1KT 10.02 06.09 PR: 1JB,1KD,1KK,1KP,1KS,1KT 02.03 06.09 PR: 1JB,1KD,1KK,1KP,1KS,1KT 10.02 06.09 PR: 1JB,1KD,1KK,1KP,1KS,1KT 10.02 06.09 PR: 1JB,1KD,1KK,1KP,1KS,1KT 10.02 06.09 PR: 1JB,1KD,1KK,1KP,1KS,1KT 10.02 06.09 PR: 1JB,1KD,1KK,1KP,1KS,1KT	24.3727-0176.2 24.3727-0198.2	580176 580198	2  + Schlechtwegeausführung ²⁾ 2  + Schlechtwegeausführung ²⁾	L=1640 L=1645	
	1.2 i 1.4 i 16V	47 74		10.02 06.09 PR: 1JB,1KM 10.02 06.09 PR: 1JB,1KM	24.3727-2504.2	582504	2  + Schlechtwegeausführung ²⁾	L=1580	





1) - rough road construction / - versione per percorsi accidentati / - version pour mauvaise route / - versión 4x4

















2) + rough road construction / + versione per percorsi accidentati / + version pour mauvaise route / + versión 4x4

								
SEAT CORDOBA III (6L2) (02-09)								
	1.4 i 16V 1.4 TDI 1.6 i 16V 1.9 SDI 1.9 TDI 1.9 TDI 2.0 i 16V	74 47 74 96 85		10.02 06.09 PR: 1JB,1KM 10.02 06.09 PR: 1JB,1KM 02.03 06.09 PR: 1JB,1KM 10.02 06.09 PR: 1JB,1KM 10.02 06.09 PR: 1JB,1KM 10.02 06.09 PR: 1JB,1KM 10.02 06.09 PR: 1JB,1KM		24.3727-2504.2 582504	2  + Schlechtwegeausführung ¹⁾	L=1580
	1.2 i 1.4 i 16V 1.4 i 16V 1.4 TDI 1.6 i 16V 1.9 SDI 1.9 TDI 1.9 TDI 2.0 i 16V	47 74 47 74 96 85		10.02 06.09 10.02 06.09 10.02 06.09 10.02 06.09 02.03 06.09 10.02 06.09 10.02 06.09 10.02 06.09 10.02 06.09		03.6583-0216.3 320247 03.6584-0120.3 320279	- ABS - ABS	BRL 8/3 (4) BRL 8/4 (4) ATE ATE
SEAT EXEO / ST (09-13)								
	1.6 1.8 T 1.8 TSI 1.8 TSI 2.0 TDI 2.0 TDI 2.0 TDI 2.0 TFSI	75 110 88 118 88 105 125		04.09 06.13 04.09 06.13 09.10 06.13 05.10 06.13 04.09 06.13 04.09 06.13 04.09 06.13 04.09 06.13		03.7858-4502.4 300202		9/8" Tandem ATE
	1.6 1.8 T 1.8 TSI 1.8 TSI 2.0 TDI 2.0 TDI 2.0 TDI 2.0 TFSI	75 110 88 118 88 105 125		04.09 06.13 04.09 06.13 09.10 06.13 05.10 06.13 04.09 06.13 04.09 06.13 04.09 06.13 04.09 06.13		03.2125-0373.3 010810 24.2125-1720.3 010688		THz 25,40 ATE THz 25,40 TRW
	1.6 1.8 T 1.8 TSI 1.8 TSI 2.0 TDI 2.0 TDI 2.0 TDI 2.0 TFSI	75 110 88 118 88 105 125		04.09 06.13 PR: 1LA 04.09 06.13 PR: 1LA 09.10 06.13 PR: 1LA 05.10 06.13 PR: 1LA 04.09 06.13 PR: 1LA 04.09 06.13 PR: 1LA 04.09 06.13 PR: 1LA 04.09 06.13 PR: 1LA		11.9606-9953.2 220587 11.9606-9954.2 220588	 	D=60, - Halter ATE D=60, - Halter ATE
	1.6 1.8 T 1.8 TSI 1.8 TSI 2.0 TDI 2.0 TDI 2.0 TDI 2.0 TFSI	75 110 88 118 88 105 125		04.09 06.13 PR: 1LB 04.09 06.13 PR: 1LB 09.10 06.13 PR: 1LB 05.10 06.13 PR: 1LB 04.09 06.13 PR: 1LB 04.09 06.13 PR: 1LB 04.09 06.13 PR: 1LB 04.09 06.13 PR: 1LB		24.3571-8522.5 240496 24.3571-8521.5 240495	 	D=57, - Halter ATE D=57, - Halter ATE
	1.6 1.8 T 1.8 TSI 1.8 TSI 2.0 TDI 2.0 TDI 2.0 TDI 2.0 TFSI	75 110 88 118 88 105 125		04.09 06.13 PR: 1LT 04.09 06.13 PR: 1LT 09.10 06.13 PR: 1LT 05.10 06.13 PR: 1LT 04.09 06.13 PR: 1LT 04.09 06.13 PR: 1LT 04.09 06.13 PR: 1LT 04.09 06.13 PR: 1LT		11.9571-9836.2 220428 11.9571-9835.2 220427	 	D=57, - Halter ATE D=57, - Halter ATE
	1.6 1.8 T 1.8 TSI 1.8 TSI 2.0 TDI 2.0 TDI 2.0 TDI 2.0 TFSI	75 110 88 118 88 105 125		04.09 06.13 PR: 1LZ 04.09 06.13 PR: 1LZ 09.10 06.13 PR: 1LZ 05.10 06.13 PR: 1LZ 04.09 06.13 PR: 1LZ 04.09 06.13 PR: 1LZ 04.09 06.13 PR: 1LZ 04.09 06.13 PR: 1LZ		24.3541-1763.5 240231 24.3541-1764.5 240232	 	D=54, - Halter TRW D=54, - Halter TRW
	1.6 1.8 T 1.8 TSI 1.8 TSI 2.0 TDI 2.0 TDI 2.0 TDI 2.0 TFSI	75 110 88 118 88 105 125		04.09 06.13 04.09 06.13 09.10 06.13 05.10 06.13 04.09 06.13 04.09 06.13 04.09 06.13 04.09 06.13		24.5237-0308.3 331435	2	L=308
	1.6 1.8 T 1.8 TSI 1.8 TSI 2.0 TDI 2.0 TDI 2.0 TDI 2.0 TFSI	75 110 88 118 88 105 125		04.09 06.13 PR: 1KD,1KP 04.09 06.13 PR: 1KD,1KP 09.10 06.13 PR: 1KD,1KP 05.10 06.13 PR: 1KD,1KP 04.09 06.13 PR: 1KD,1KP 04.09 06.13 PR: 1KD,1KP 04.09 06.13 PR: 1KD,1KP 04.09 06.13 PR: 1KD,1KP		24.3384-1735.7 220547 24.3384-1736.7 220548	 	D=38, - Halter TRW D=38, - Halter TRW
	1.6 1.8 T 1.8 TSI 1.8 TSI	75 110 88 118		04.09 06.13 PR: 1KW 04.09 06.13 PR: 1KW 09.10 06.13 PR: 1KW 05.10 06.13 PR: 1KW		24.3414-1713.7 220793 24.3414-1714.7 220794	 	D=41, - Halter TRW D=41, - Halter TRW

¹⁾ + rough road construction / + versione per percorsi accidentati / + version pour mauvaise route / + versión 4x4



SEAT EXEO / ST (09-13)																																																																																																																																																																																																																																																																																																																																																																												
	<table border="1"> <tr> <td>2.0 TDI</td> <td>88</td> <td>04.09</td> <td>06.13</td> <td>PR: 1KW</td> <td>24.3414-1713.7</td> <td>220793</td> <td rowspan="3">☐ ☐</td> <td rowspan="3">D=41, - Halter D=41, - Halter</td> <td rowspan="3">TRW TRW</td> </tr> <tr> <td>2.0 TDI</td> <td>105</td> <td>04.09</td> <td>06.13</td> <td>PR: 1KW</td> <td>24.3414-1714.7</td> <td>220794</td> </tr> <tr> <td>2.0 TDI</td> <td>125</td> <td>04.09</td> <td>06.13</td> <td>PR: 1KW</td> <td></td> <td></td> </tr> <tr> <td>2.0 TFSI</td> <td></td> <td>04.09</td> <td>06.13</td> <td>PR: 1KW</td> <td></td> <td></td> <td></td> <td></td> <td></td> </tr> </table>	2.0 TDI	88	04.09	06.13	PR: 1KW	24.3414-1713.7	220793	☐ ☐	D=41, - Halter D=41, - Halter	TRW TRW	2.0 TDI	105	04.09	06.13	PR: 1KW	24.3414-1714.7	220794	2.0 TDI	125	04.09	06.13	PR: 1KW			2.0 TFSI		04.09	06.13	PR: 1KW																																																																																																																																																																																																																																																																																																																																														
2.0 TDI	88	04.09	06.13	PR: 1KW	24.3414-1713.7	220793	☐ ☐	D=41, - Halter D=41, - Halter				TRW TRW																																																																																																																																																																																																																																																																																																																																																																
2.0 TDI	105	04.09	06.13	PR: 1KW	24.3414-1714.7	220794																																																																																																																																																																																																																																																																																																																																																																						
2.0 TDI	125	04.09	06.13	PR: 1KW																																																																																																																																																																																																																																																																																																																																																																								
2.0 TFSI		04.09	06.13	PR: 1KW																																																																																																																																																																																																																																																																																																																																																																								
	<table border="1"> <tr> <td>1.6</td> <td>75</td> <td>04.09</td> <td>06.13</td> <td></td> <td>24.5138-0263.3</td> <td>330885</td> <td>2</td> <td>L=263</td> <td></td> </tr> <tr> <td>1.8 T</td> <td>110</td> <td>04.09</td> <td>06.13</td> <td></td> <td></td> <td></td> <td></td> <td></td> <td></td> </tr> <tr> <td>1.8 TSI</td> <td>88</td> <td>09.10</td> <td>06.13</td> <td></td> <td></td> <td></td> <td></td> <td></td> <td></td> </tr> <tr> <td>1.8 TSI</td> <td>118</td> <td>05.10</td> <td>06.13</td> <td></td> <td></td> <td></td> <td></td> <td></td> <td></td> </tr> <tr> <td>2.0 TDI</td> <td>88</td> <td>04.09</td> <td>06.13</td> <td></td> <td></td> <td></td> <td></td> <td></td> <td></td> </tr> <tr> <td>2.0 TDI</td> <td>105</td> <td>04.09</td> <td>06.13</td> <td></td> <td></td> <td></td> <td></td> <td></td> <td></td> </tr> <tr> <td>2.0 TDI</td> <td>125</td> <td>04.09</td> <td>06.13</td> <td></td> <td></td> <td></td> <td></td> <td></td> <td></td> </tr> <tr> <td>2.0 TFSI</td> <td></td> <td>04.09</td> <td>06.13</td> <td></td> <td></td> <td></td> <td></td> <td></td> <td></td> </tr> </table>	1.6	75	04.09	06.13		24.5138-0263.3	330885	2	L=263		1.8 T	110	04.09	06.13							1.8 TSI	88	09.10	06.13							1.8 TSI	118	05.10	06.13							2.0 TDI	88	04.09	06.13							2.0 TDI	105	04.09	06.13							2.0 TDI	125	04.09	06.13							2.0 TFSI		04.09	06.13																																																																																																																																																																																																																																																																																																	
1.6	75	04.09	06.13		24.5138-0263.3	330885	2	L=263																																																																																																																																																																																																																																																																																																																																																																				
1.8 T	110	04.09	06.13																																																																																																																																																																																																																																																																																																																																																																									
1.8 TSI	88	09.10	06.13																																																																																																																																																																																																																																																																																																																																																																									
1.8 TSI	118	05.10	06.13																																																																																																																																																																																																																																																																																																																																																																									
2.0 TDI	88	04.09	06.13																																																																																																																																																																																																																																																																																																																																																																									
2.0 TDI	105	04.09	06.13																																																																																																																																																																																																																																																																																																																																																																									
2.0 TDI	125	04.09	06.13																																																																																																																																																																																																																																																																																																																																																																									
2.0 TFSI		04.09	06.13																																																																																																																																																																																																																																																																																																																																																																									
SEAT IBIZA II (93-99)																																																																																																																																																																																																																																																																																																																																																																												
	<table border="1"> <tr> <td>1.6 i</td> <td>◀</td> <td></td> <td>02.93</td> <td>07.99</td> <td></td> <td>03.7750-6302.4</td> <td>300161</td> <td>- ABS</td> <td>9"</td> <td>ATE</td> </tr> <tr> <td>1.8 i</td> <td>◀</td> <td></td> <td>02.93</td> <td>07.99</td> <td></td> <td></td> <td></td> <td></td> <td></td> <td></td> </tr> <tr> <td>1.8 i 16V</td> <td>◀</td> <td></td> <td>02.94</td> <td>07.99</td> <td></td> <td></td> <td></td> <td></td> <td></td> <td></td> </tr> <tr> <td>1.9 D</td> <td>◀</td> <td></td> <td>02.93</td> <td>07.99</td> <td></td> <td></td> <td></td> <td></td> <td></td> <td></td> </tr> <tr> <td>1.9 SDI</td> <td>◀</td> <td></td> <td>09.95</td> <td>07.99</td> <td></td> <td></td> <td></td> <td></td> <td></td> <td></td> </tr> <tr> <td>1.9 TD</td> <td>◀</td> <td></td> <td>02.93</td> <td>07.99</td> <td></td> <td></td> <td></td> <td></td> <td></td> <td></td> </tr> <tr> <td>2.0 i</td> <td>◀</td> <td></td> <td>02.93</td> <td>07.99</td> <td></td> <td></td> <td></td> <td></td> <td></td> <td></td> </tr> <tr> <td>1.0 i</td> <td>◀</td> <td></td> <td>02.93</td> <td>07.99</td> <td></td> <td>03.7740-1402.4</td> <td>300133</td> <td>- ABS</td> <td>8"</td> <td>ATE</td> </tr> <tr> <td>1.3 i</td> <td>◀</td> <td></td> <td>02.93</td> <td>07.99</td> <td></td> <td></td> <td></td> <td></td> <td></td> <td></td> </tr> <tr> <td>1.4</td> <td>◀</td> <td></td> <td>09.93</td> <td>07.99</td> <td></td> <td></td> <td></td> <td></td> <td></td> <td></td> </tr> <tr> <td>1.6 i</td> <td>◀</td> <td></td> <td>02.93</td> <td>07.99</td> <td></td> <td></td> <td></td> <td></td> <td></td> <td></td> </tr> <tr> <td>1.0 i</td> <td>◀</td> <td>6K-TR069487</td> <td></td> <td>07.99</td> <td></td> <td>10.6350-3902.4</td> <td>300213</td> <td>+ ABS</td> <td>9"</td> <td>ATE</td> </tr> <tr> <td>1.3 i</td> <td>◀</td> <td>6K-TR069487</td> <td></td> <td>07.99</td> <td></td> <td>10.6350-4002.4</td> <td>300285</td> <td>+ ABS</td> <td>9"</td> <td>ATE</td> </tr> <tr> <td>1.4</td> <td>◀</td> <td>6K-TR069487</td> <td></td> <td>07.99</td> <td></td> <td></td> <td></td> <td></td> <td></td> <td></td> </tr> <tr> <td>1.4 i 16V</td> <td>◀</td> <td>74 6K-TR069487</td> <td></td> <td>07.99</td> <td></td> <td></td> <td></td> <td></td> <td></td> <td></td> </tr> <tr> <td>1.6 i</td> <td>◀</td> <td>6K-TR069487</td> <td></td> <td>07.99</td> <td></td> <td></td> <td></td> <td></td> <td></td> <td></td> </tr> <tr> <td>1.8 i</td> <td>◀</td> <td>6K-TR069487</td> <td></td> <td>07.99</td> <td></td> <td></td> <td></td> <td></td> <td></td> <td></td> </tr> <tr> <td>1.8 i 16V</td> <td>◀</td> <td>6K-TR069487</td> <td></td> <td>07.99</td> <td></td> <td></td> <td></td> <td></td> <td></td> <td></td> </tr> <tr> <td>1.9 D</td> <td>◀</td> <td>6K-TR069487</td> <td></td> <td>07.99</td> <td></td> <td></td> <td></td> <td></td> <td></td> <td></td> </tr> <tr> <td>1.9 SDI</td> <td>◀</td> <td>6K-TR069487</td> <td></td> <td>07.99</td> <td></td> <td></td> <td></td> <td></td> <td></td> <td></td> </tr> <tr> <td>1.9 TD</td> <td>◀</td> <td>6K-TR069487</td> <td></td> <td>07.99</td> <td></td> <td></td> <td></td> <td></td> <td></td> <td></td> </tr> <tr> <td>1.9 TDI</td> <td>◀</td> <td>66 6K-TR069487</td> <td></td> <td>07.99</td> <td></td> <td></td> <td></td> <td></td> <td></td> <td></td> </tr> <tr> <td>1.9 TDI</td> <td>◀</td> <td>81 6K-TR069487</td> <td></td> <td>07.99</td> <td></td> <td></td> <td></td> <td></td> <td></td> <td></td> </tr> <tr> <td>2.0 i</td> <td>◀</td> <td>6K-TR069487</td> <td></td> <td>07.99</td> <td></td> <td></td> <td></td> <td></td> <td></td> <td></td> </tr> <tr> <td>2.0 i 16V Cupra</td> <td>◀</td> <td>110 6K-TR069487</td> <td></td> <td>07.99</td> <td></td> <td></td> <td></td> <td></td> <td></td> <td></td> </tr> </table>	1.6 i	◀		02.93	07.99		03.7750-6302.4	300161	- ABS	9"	ATE	1.8 i	◀		02.93	07.99							1.8 i 16V	◀		02.94	07.99							1.9 D	◀		02.93	07.99							1.9 SDI	◀		09.95	07.99							1.9 TD	◀		02.93	07.99							2.0 i	◀		02.93	07.99							1.0 i	◀		02.93	07.99		03.7740-1402.4	300133	- ABS	8"	ATE	1.3 i	◀		02.93	07.99							1.4	◀		09.93	07.99							1.6 i	◀		02.93	07.99							1.0 i	◀	6K-TR069487		07.99		10.6350-3902.4	300213	+ ABS	9"	ATE	1.3 i	◀	6K-TR069487		07.99		10.6350-4002.4	300285	+ ABS	9"	ATE	1.4	◀	6K-TR069487		07.99							1.4 i 16V	◀	74 6K-TR069487		07.99							1.6 i	◀	6K-TR069487		07.99							1.8 i	◀	6K-TR069487		07.99							1.8 i 16V	◀	6K-TR069487		07.99							1.9 D	◀	6K-TR069487		07.99							1.9 SDI	◀	6K-TR069487		07.99							1.9 TD	◀	6K-TR069487		07.99							1.9 TDI	◀	66 6K-TR069487		07.99							1.9 TDI	◀	81 6K-TR069487		07.99							2.0 i	◀	6K-TR069487		07.99							2.0 i 16V Cupra	◀	110 6K-TR069487		07.99																																																																																														
1.6 i	◀		02.93	07.99		03.7750-6302.4	300161	- ABS	9"	ATE																																																																																																																																																																																																																																																																																																																																																																		
1.8 i	◀		02.93	07.99																																																																																																																																																																																																																																																																																																																																																																								
1.8 i 16V	◀		02.94	07.99																																																																																																																																																																																																																																																																																																																																																																								
1.9 D	◀		02.93	07.99																																																																																																																																																																																																																																																																																																																																																																								
1.9 SDI	◀		09.95	07.99																																																																																																																																																																																																																																																																																																																																																																								
1.9 TD	◀		02.93	07.99																																																																																																																																																																																																																																																																																																																																																																								
2.0 i	◀		02.93	07.99																																																																																																																																																																																																																																																																																																																																																																								
1.0 i	◀		02.93	07.99		03.7740-1402.4	300133	- ABS	8"	ATE																																																																																																																																																																																																																																																																																																																																																																		
1.3 i	◀		02.93	07.99																																																																																																																																																																																																																																																																																																																																																																								
1.4	◀		09.93	07.99																																																																																																																																																																																																																																																																																																																																																																								
1.6 i	◀		02.93	07.99																																																																																																																																																																																																																																																																																																																																																																								
1.0 i	◀	6K-TR069487		07.99		10.6350-3902.4	300213	+ ABS	9"	ATE																																																																																																																																																																																																																																																																																																																																																																		
1.3 i	◀	6K-TR069487		07.99		10.6350-4002.4	300285	+ ABS	9"	ATE																																																																																																																																																																																																																																																																																																																																																																		
1.4	◀	6K-TR069487		07.99																																																																																																																																																																																																																																																																																																																																																																								
1.4 i 16V	◀	74 6K-TR069487		07.99																																																																																																																																																																																																																																																																																																																																																																								
1.6 i	◀	6K-TR069487		07.99																																																																																																																																																																																																																																																																																																																																																																								
1.8 i	◀	6K-TR069487		07.99																																																																																																																																																																																																																																																																																																																																																																								
1.8 i 16V	◀	6K-TR069487		07.99																																																																																																																																																																																																																																																																																																																																																																								
1.9 D	◀	6K-TR069487		07.99																																																																																																																																																																																																																																																																																																																																																																								
1.9 SDI	◀	6K-TR069487		07.99																																																																																																																																																																																																																																																																																																																																																																								
1.9 TD	◀	6K-TR069487		07.99																																																																																																																																																																																																																																																																																																																																																																								
1.9 TDI	◀	66 6K-TR069487		07.99																																																																																																																																																																																																																																																																																																																																																																								
1.9 TDI	◀	81 6K-TR069487		07.99																																																																																																																																																																																																																																																																																																																																																																								
2.0 i	◀	6K-TR069487		07.99																																																																																																																																																																																																																																																																																																																																																																								
2.0 i 16V Cupra	◀	110 6K-TR069487		07.99																																																																																																																																																																																																																																																																																																																																																																								
	<table border="1"> <tr> <td>1.0 i</td> <td></td> <td></td> <td>02.93</td> <td>07.99</td> <td></td> <td>03.2120-3943.3</td> <td>010532</td> <td>- ABS</td> <td>THz 20,64</td> <td>ATE</td> </tr> <tr> <td>1.3 i</td> <td></td> <td></td> <td>02.93</td> <td>07.99</td> <td></td> <td>03.3517-0101.2</td> <td>390322</td> <td>- ABS</td> <td>Verschlußschraube</td> <td></td> </tr> <tr> <td>1.4</td> <td></td> <td></td> <td>09.93</td> <td>07.99</td> <td></td> <td></td> <td></td> <td></td> <td></td> <td></td> </tr> <tr> <td>1.6 i</td> <td></td> <td></td> <td>02.93</td> <td>07.99</td> <td></td> <td></td> <td></td> <td></td> <td></td> <td></td> </tr> <tr> <td>1.8 i</td> <td></td> <td></td> <td>02.93</td> <td>07.99</td> <td></td> <td></td> <td></td> <td></td> <td></td> <td></td> </tr> <tr> <td>1.9 D</td> <td></td> <td></td> <td>02.93</td> <td>07.99</td> <td></td> <td></td> <td></td> <td></td> <td></td> <td></td> </tr> <tr> <td>1.9 SDI</td> <td></td> <td></td> <td>09.95</td> <td>07.99</td> <td></td> <td></td> <td></td> <td></td> <td></td> <td></td> </tr> <tr> <td>1.9 TD</td> <td></td> <td></td> <td>02.93</td> <td>07.99</td> <td></td> <td></td> <td></td> <td></td> <td></td> <td></td> </tr> <tr> <td>1.8 i 16V</td> <td></td> <td></td> <td>02.94</td> <td>07.99</td> <td></td> <td>03.2122-1042.3</td> <td>010137</td> <td>- ABS</td> <td>THz 22,20</td> <td>ATE</td> </tr> <tr> <td>1.9 TDI</td> <td>66</td> <td></td> <td>07.96</td> <td>07.99</td> <td></td> <td>03.3517-0101.2</td> <td>390322</td> <td>- ABS</td> <td>Verschlußschraube</td> <td></td> </tr> <tr> <td>1.9 TDI</td> <td>81</td> <td></td> <td>03.97</td> <td>07.99</td> <td></td> <td></td> <td></td> <td></td> <td></td> <td></td> </tr> <tr> <td>2.0 i</td> <td></td> <td></td> <td>02.93</td> <td>07.99</td> <td></td> <td></td> <td></td> <td></td> <td></td> <td></td> </tr> <tr> <td>1.8 i 16V</td> <td>◀</td> <td></td> <td>02.94</td> <td>07.99</td> <td></td> <td>10.6123-0674.3</td> <td>010639</td> <td>+ ABS</td> <td>THz 23,81</td> <td>ATE</td> </tr> <tr> <td>2.0 i</td> <td>◀</td> <td></td> <td>02.93</td> <td>07.99</td> <td></td> <td></td> <td></td> <td></td> <td></td> <td></td> </tr> </table>	1.0 i			02.93	07.99		03.2120-3943.3	010532	- ABS	THz 20,64	ATE	1.3 i			02.93	07.99		03.3517-0101.2	390322	- ABS	Verschlußschraube		1.4			09.93	07.99							1.6 i			02.93	07.99							1.8 i			02.93	07.99							1.9 D			02.93	07.99							1.9 SDI			09.95	07.99							1.9 TD			02.93	07.99							1.8 i 16V			02.94	07.99		03.2122-1042.3	010137	- ABS	THz 22,20	ATE	1.9 TDI	66		07.96	07.99		03.3517-0101.2	390322	- ABS	Verschlußschraube		1.9 TDI	81		03.97	07.99							2.0 i			02.93	07.99							1.8 i 16V	◀		02.94	07.99		10.6123-0674.3	010639	+ ABS	THz 23,81	ATE	2.0 i	◀		02.93	07.99																																																																																																																																																																																																																							
1.0 i			02.93	07.99		03.2120-3943.3	010532	- ABS	THz 20,64	ATE																																																																																																																																																																																																																																																																																																																																																																		
1.3 i			02.93	07.99		03.3517-0101.2	390322	- ABS	Verschlußschraube																																																																																																																																																																																																																																																																																																																																																																			
1.4			09.93	07.99																																																																																																																																																																																																																																																																																																																																																																								
1.6 i			02.93	07.99																																																																																																																																																																																																																																																																																																																																																																								
1.8 i			02.93	07.99																																																																																																																																																																																																																																																																																																																																																																								
1.9 D			02.93	07.99																																																																																																																																																																																																																																																																																																																																																																								
1.9 SDI			09.95	07.99																																																																																																																																																																																																																																																																																																																																																																								
1.9 TD			02.93	07.99																																																																																																																																																																																																																																																																																																																																																																								
1.8 i 16V			02.94	07.99		03.2122-1042.3	010137	- ABS	THz 22,20	ATE																																																																																																																																																																																																																																																																																																																																																																		
1.9 TDI	66		07.96	07.99		03.3517-0101.2	390322	- ABS	Verschlußschraube																																																																																																																																																																																																																																																																																																																																																																			
1.9 TDI	81		03.97	07.99																																																																																																																																																																																																																																																																																																																																																																								
2.0 i			02.93	07.99																																																																																																																																																																																																																																																																																																																																																																								
1.8 i 16V	◀		02.94	07.99		10.6123-0674.3	010639	+ ABS	THz 23,81	ATE																																																																																																																																																																																																																																																																																																																																																																		
2.0 i	◀		02.93	07.99																																																																																																																																																																																																																																																																																																																																																																								
	<table border="1"> <tr> <td>1.0 i</td> <td></td> <td></td> <td>02.93</td> <td>07.99</td> <td>PR: 1LA</td> <td>24.3481-1745.5</td> <td>240277</td> <td>☐ ☐</td> <td>D=48, - Halter</td> <td>ATE</td> </tr> <tr> <td>1.3 i</td> <td></td> <td></td> <td>02.93</td> <td>07.99</td> <td>PR: 1LA</td> <td>24.3481-1746.5</td> <td>240278</td> <td></td> <td>D=48, - Halter</td> <td>ATE</td> </tr> <tr> <td>1.4</td> <td></td> <td></td> <td>09.93</td> <td>07.99</td> <td>PR: 1LA</td> <td>11.0441-4808.2</td> <td>250022</td> <td></td> <td>Dichtungssatz</td> <td>ATE</td> </tr> <tr> <td>1.4 i 16V</td> <td>74</td> <td></td> <td>09.96</td> <td>07.99</td> <td>PR: 1LA</td> <td>11.0101-4803.2</td> <td>260008</td> <td></td> <td>Hülzensatz</td> <td>ATE</td> </tr> <tr> <td>1.6 i</td> <td></td> <td></td> <td>02.93</td> <td>07.99</td> <td>PR: 1LA</td> <td>24.0102-4803.2</td> <td>260086</td> <td></td> <td>Hülzensatz+Schrauben</td> <td>ATE</td> </tr> <tr> <td>1.8 i</td> <td></td> <td></td> <td>02.93</td> <td>07.99</td> <td>PR: 1LA</td> <td></td> <td></td> <td></td> <td></td> <td></td> </tr> <tr> <td>1.8 i 16V</td> <td></td> <td></td> <td>02.94</td> <td>07.99</td> <td>PR: 1LA</td> <td></td> <td></td> <td></td> <td></td> <td></td> </tr> <tr> <td>1.9 D</td> <td></td> <td></td> <td>02.93</td> <td>07.99</td> <td>PR: 1LA</td> <td></td> <td></td> <td></td> <td></td> <td></td> </tr> <tr> <td>1.9 SDI</td> <td></td> <td></td> <td>09.95</td> <td>07.99</td> <td>PR: 1LA</td> <td></td> <td></td> <td></td> <td></td> <td></td> </tr> <tr> <td>1.9 TD</td> <td></td> <td></td> <td>02.93</td> <td>07.99</td> <td>PR: 1LA</td> <td></td> <td></td> <td></td> <td></td> <td></td> </tr> <tr> <td>1.9 TDI</td> <td>66</td> <td></td> <td>07.96</td> <td>07.99</td> <td>PR: 1LA</td> <td></td> <td></td> <td></td> <td></td> <td></td> </tr> <tr> <td>1.9 TDI</td> <td>81</td> <td></td> <td>03.97</td> <td>07.99</td> <td>PR: 1LA</td> <td></td> <td></td> <td></td> <td></td> <td></td> </tr> <tr> <td>2.0 i</td> <td></td> <td></td> <td>02.93</td> <td>07.99</td> <td>PR: 1LA</td> <td></td> <td></td> <td></td> <td></td> <td></td> </tr> <tr> <td>2.0 i 16V Cupra</td> <td>110</td> <td></td> <td>07.96</td> <td>07.99</td> <td>PR: 1LA</td> <td></td> <td></td> <td></td> <td></td> <td></td> </tr> <tr> <td>1.0 i</td> <td></td> <td></td> <td>02.93</td> <td>07.99</td> <td>PR: 1LG,1LM</td> <td>11.0441-4808.2</td> <td>250022</td> <td></td> <td>Dichtungssatz</td> <td>ATE</td> </tr> <tr> <td>1.3 i</td> <td></td> <td></td> <td>02.93</td> <td>07.99</td> <td>PR: 1LG,1LM</td> <td>11.0101-4801.2</td> <td>260006</td> <td></td> <td>Hülzensatz</td> <td>ATE</td> </tr> <tr> <td>1.4</td> <td></td> <td></td> <td>09.93</td> <td>07.99</td> <td>PR: 1LG,1LM</td> <td>24.0102-4801.2</td> <td>260085</td> <td></td> <td>Hülzensatz+Schrauben</td> <td>ATE</td> </tr> <tr> <td>1.4 i 16V</td> <td>74</td> <td></td> <td>09.96</td> <td>07.99</td> <td>PR: 1LG,1LM</td> <td></td> <td></td> <td></td> <td></td> <td></td> </tr> <tr> <td>1.6 i</td> <td></td> <td></td> <td>02.93</td> <td>07.99</td> <td>PR: 1LG,1LM</td> <td></td> <td></td> <td></td> <td></td> <td></td> </tr> <tr> <td>1.8 i</td> <td></td> <td></td> <td>02.93</td> <td>07.99</td> <td>PR: 1LG,1LM</td> <td></td> <td></td> <td></td> <td></td> <td></td> </tr> <tr> <td>1.8 i 16V</td> <td></td> <td></td> <td>02.94</td> <td>07.99</td> <td>PR: 1LG,1LM</td> <td></td> <td></td> <td></td> <td></td> <td></td> </tr> <tr> <td>1.9 D</td> <td></td> <td></td> <td>02.93</td> <td>07.99</td> <td>PR: 1LG,1LM</td> <td></td> <td></td> <td></td> <td></td> <td></td> </tr> <tr> <td>1.9 SDI</td> <td></td> <td></td> <td>09.95</td> <td>07.99</td> <td>PR: 1LG,1LM</td> <td></td> <td></td> <td></td> <td></td> <td></td> </tr> <tr> <td>1.9 TD</td> <td></td> <td></td> <td>02.93</td> <td>07.99</td> <td>PR: 1LG,1LM</td> <td></td> <td></td> <td></td> <td></td> <td></td> </tr> <tr> <td>1.9 TDI</td> <td>66</td> <td></td> <td>07.96</td> <td>07.99</td> <td>PR: 1LG,1LM</td> <td></td> <td></td> <td></td> <td></td> <td></td> </tr> <tr> <td>1.9 TDI</td> <td>81</td> <td></td> <td>03.97</td> <td>07.99</td> <td>PR: 1LG,1LM</td> <td></td> <td></td> <td></td> <td></td> <td></td> </tr> <tr> <td>2.0 i</td> <td></td> <td></td> <td>02.93</td> <td>07.99</td> <td>PR: 1LG,1LM</td> <td></td> <td></td> <td></td> <td></td> <td></td> </tr> <tr> <td>2.0 i 16V Cupra</td> <td>110</td> <td></td> <td>07.96</td> <td>07.99</td> <td>PR: 1LG,1LM</td> <td></td> <td></td> <td></td> <td></td> <td></td> </tr> <tr> <td>1.0 i</td> <td></td> <td></td> <td>02.93</td> <td>07.99</td> <td>PR: 1LY,1ZK</td> <td>24.3541-1609.5</td> <td>240039</td> <td>☐ ☐</td> <td>D=54, - Halter</td> <td>TRW</td> </tr> <tr> <td>1.3 i</td> <td></td> <td></td> <td>02.93</td> <td>07.99</td> <td>PR: 1LY,1ZK</td> <td>24.3541-1610.5</td> <td>240040</td> <td></td> <td>D=54, - Halter</td> <td>TRW</td> </tr> <tr> <td>1.4</td> <td></td> <td></td> <td>09.93</td> <td>07.99</td> <td>PR: 1LY,1ZK</td> <td>11.0101-5403.2</td> <td>260010</td> <td></td> <td>Faltenbalgsatz</td> <td>TRW</td> </tr> <tr> <td>1.4 i 16V</td> <td>74</td> <td></td> <td>09.96</td> <td>07.99</td> <td>PR: 1LY,1ZK</td> <td></td> <td></td> <td></td> <td></td> <td></td> </tr> <tr> <td>1.6 i</td> <td></td> <td></td> <td>02.93</td> <td>07.99</td> <td>PR: 1LY,1ZK</td> <td></td> <td></td> <td></td> <td></td> <td></td> </tr> </table>	1.0 i			02.93	07.99	PR: 1LA	24.3481-1745.5	240277	☐ ☐	D=48, - Halter	ATE	1.3 i			02.93	07.99	PR: 1LA	24.3481-1746.5	240278		D=48, - Halter	ATE	1.4			09.93	07.99	PR: 1LA	11.0441-4808.2	250022		Dichtungssatz	ATE	1.4 i 16V	74		09.96	07.99	PR: 1LA	11.0101-4803.2	260008		Hülzensatz	ATE	1.6 i			02.93	07.99	PR: 1LA	24.0102-4803.2	260086		Hülzensatz+Schrauben	ATE	1.8 i			02.93	07.99	PR: 1LA						1.8 i 16V			02.94	07.99	PR: 1LA						1.9 D			02.93	07.99	PR: 1LA						1.9 SDI			09.95	07.99	PR: 1LA						1.9 TD			02.93	07.99	PR: 1LA						1.9 TDI	66		07.96	07.99	PR: 1LA						1.9 TDI	81		03.97	07.99	PR: 1LA						2.0 i			02.93	07.99	PR: 1LA						2.0 i 16V Cupra	110		07.96	07.99	PR: 1LA						1.0 i			02.93	07.99	PR: 1LG,1LM	11.0441-4808.2	250022		Dichtungssatz	ATE	1.3 i			02.93	07.99	PR: 1LG,1LM	11.0101-4801.2	260006		Hülzensatz	ATE	1.4			09.93	07.99	PR: 1LG,1LM	24.0102-4801.2	260085		Hülzensatz+Schrauben	ATE	1.4 i 16V	74		09.96	07.99	PR: 1LG,1LM						1.6 i			02.93	07.99	PR: 1LG,1LM						1.8 i			02.93	07.99	PR: 1LG,1LM						1.8 i 16V			02.94	07.99	PR: 1LG,1LM						1.9 D			02.93	07.99	PR: 1LG,1LM						1.9 SDI			09.95	07.99	PR: 1LG,1LM						1.9 TD			02.93	07.99	PR: 1LG,1LM						1.9 TDI	66		07.96	07.99	PR: 1LG,1LM						1.9 TDI	81		03.97	07.99	PR: 1LG,1LM						2.0 i			02.93	07.99	PR: 1LG,1LM						2.0 i 16V Cupra	110		07.96	07.99	PR: 1LG,1LM						1.0 i			02.93	07.99	PR: 1LY,1ZK	24.3541-1609.5	240039	☐ ☐	D=54, - Halter	TRW	1.3 i			02.93	07.99	PR: 1LY,1ZK	24.3541-1610.5	240040		D=54, - Halter	TRW	1.4			09.93	07.99	PR: 1LY,1ZK	11.0101-5403.2	260010		Faltenbalgsatz	TRW	1.4 i 16V	74		09.96	07.99	PR: 1LY,1ZK						1.6 i			02.93	07.99	PR: 1LY,1ZK					
1.0 i			02.93	07.99	PR: 1LA	24.3481-1745.5	240277	☐ ☐	D=48, - Halter	ATE																																																																																																																																																																																																																																																																																																																																																																		
1.3 i			02.93	07.99	PR: 1LA	24.3481-1746.5	240278		D=48, - Halter	ATE																																																																																																																																																																																																																																																																																																																																																																		
1.4			09.93	07.99	PR: 1LA	11.0441-4808.2	250022		Dichtungssatz	ATE																																																																																																																																																																																																																																																																																																																																																																		
1.4 i 16V	74		09.96	07.99	PR: 1LA	11.0101-4803.2	260008		Hülzensatz	ATE																																																																																																																																																																																																																																																																																																																																																																		
1.6 i			02.93	07.99	PR: 1LA	24.0102-4803.2	260086		Hülzensatz+Schrauben	ATE																																																																																																																																																																																																																																																																																																																																																																		
1.8 i			02.93	07.99	PR: 1LA																																																																																																																																																																																																																																																																																																																																																																							
1.8 i 16V			02.94	07.99	PR: 1LA																																																																																																																																																																																																																																																																																																																																																																							
1.9 D			02.93	07.99	PR: 1LA																																																																																																																																																																																																																																																																																																																																																																							
1.9 SDI			09.95	07.99	PR: 1LA																																																																																																																																																																																																																																																																																																																																																																							
1.9 TD			02.93	07.99	PR: 1LA																																																																																																																																																																																																																																																																																																																																																																							
1.9 TDI	66		07.96	07.99	PR: 1LA																																																																																																																																																																																																																																																																																																																																																																							
1.9 TDI	81		03.97	07.99	PR: 1LA																																																																																																																																																																																																																																																																																																																																																																							
2.0 i			02.93	07.99	PR: 1LA																																																																																																																																																																																																																																																																																																																																																																							
2.0 i 16V Cupra	110		07.96	07.99	PR: 1LA																																																																																																																																																																																																																																																																																																																																																																							
1.0 i			02.93	07.99	PR: 1LG,1LM	11.0441-4808.2	250022		Dichtungssatz	ATE																																																																																																																																																																																																																																																																																																																																																																		
1.3 i			02.93	07.99	PR: 1LG,1LM	11.0101-4801.2	260006		Hülzensatz	ATE																																																																																																																																																																																																																																																																																																																																																																		
1.4			09.93	07.99	PR: 1LG,1LM	24.0102-4801.2	260085		Hülzensatz+Schrauben	ATE																																																																																																																																																																																																																																																																																																																																																																		
1.4 i 16V	74		09.96	07.99	PR: 1LG,1LM																																																																																																																																																																																																																																																																																																																																																																							
1.6 i			02.93	07.99	PR: 1LG,1LM																																																																																																																																																																																																																																																																																																																																																																							
1.8 i			02.93	07.99	PR: 1LG,1LM																																																																																																																																																																																																																																																																																																																																																																							
1.8 i 16V			02.94	07.99	PR: 1LG,1LM																																																																																																																																																																																																																																																																																																																																																																							
1.9 D			02.93	07.99	PR: 1LG,1LM																																																																																																																																																																																																																																																																																																																																																																							
1.9 SDI			09.95	07.99	PR: 1LG,1LM																																																																																																																																																																																																																																																																																																																																																																							
1.9 TD			02.93	07.99	PR: 1LG,1LM																																																																																																																																																																																																																																																																																																																																																																							
1.9 TDI	66		07.96	07.99	PR: 1LG,1LM																																																																																																																																																																																																																																																																																																																																																																							
1.9 TDI	81		03.97	07.99	PR: 1LG,1LM																																																																																																																																																																																																																																																																																																																																																																							
2.0 i			02.93	07.99	PR: 1LG,1LM																																																																																																																																																																																																																																																																																																																																																																							
2.0 i 16V Cupra	110		07.96	07.99	PR: 1LG,1LM																																																																																																																																																																																																																																																																																																																																																																							
1.0 i			02.93	07.99	PR: 1LY,1ZK	24.3541-1609.5	240039	☐ ☐	D=54, - Halter	TRW																																																																																																																																																																																																																																																																																																																																																																		
1.3 i			02.93	07.99	PR: 1LY,1ZK	24.3541-1610.5	240040		D=54, - Halter	TRW																																																																																																																																																																																																																																																																																																																																																																		
1.4			09.93	07.99	PR: 1LY,1ZK	11.0101-5403.2	260010		Faltenbalgsatz	TRW																																																																																																																																																																																																																																																																																																																																																																		
1.4 i 16V	74		09.96	07.99	PR: 1LY,1ZK																																																																																																																																																																																																																																																																																																																																																																							
1.6 i			02.93	07.99	PR: 1LY,1ZK																																																																																																																																																																																																																																																																																																																																																																							

											
SEAT IBIZA II (93-99)											
	1.8 i			02.93	07.99	PR: 1LY,1ZK	24.3541-1609.5	240039		D=54, - Halter D=54, - Halter Faltenbalgsatz	TRW TRW TRW
	1.8 i 16V			02.94	07.99	PR: 1LY,1ZK	24.3541-1610.5	240040			
	1.9 D			02.93	07.99	PR: 1LY,1ZK	11.0101-5403.2	260010			
	1.9 SDI			09.95	07.99	PR: 1LY,1ZK					
	1.9 TD			02.93	07.99	PR: 1LY,1ZK					
	1.9 TDI	66		07.96	07.99	PR: 1LY,1ZK					
	1.9 TDI	81		03.97	07.99	PR: 1LY,1ZK					
	2.0 i			02.93	07.99	PR: 1LY,1ZK					
	2.0 i 16V Cupra	110		07.96	07.99	PR: 1LY,1ZK					
	1.0 i			02.93	07.99	PR: 1LD,1LV,1LW	24.3541-1731.5	240061			
1.3 i			02.93	07.99	PR: 1LD,1LV,1LW	24.3541-1732.5	240062				
1.4			09.93	07.99	PR: 1LD,1LV,1LW						
1.4 i 16V	74		09.96	07.99	PR: 1LD,1LV,1LW						
1.6 i			02.93	07.99	PR: 1LD,1LV,1LW						
1.8 i			02.93	07.99	PR: 1LD,1LV,1LW						
1.8 i 16V			02.94	07.99	PR: 1LD,1LV,1LW						
1.9 D			02.93	07.99	PR: 1LD,1LV,1LW						
1.9 SDI			09.95	07.99	PR: 1LD,1LV,1LW						
1.9 TD			02.93	07.99	PR: 1LD,1LV,1LW						
1.9 TDI	66		07.96	07.99	PR: 1LD,1LV,1LW						
1.9 TDI	81		03.97	07.99	PR: 1LD,1LV,1LW						
2.0 i			02.93	07.99	PR: 1LD,1LV,1LW						
2.0 i 16V Cupra	110		07.96	07.99	PR: 1LD,1LV,1LW						
	1.0 i			02.93	07.99		24.5105-0442.3	331432	2	L=442	
	1.3 i			02.93	07.99						
	1.4			09.93	07.99						
	1.4 i 16V	74		09.96	07.99						
	1.6 i			02.93	07.99						
	1.8 i			02.93	07.99						
	1.8 i 16V			02.94	07.99						
	1.9 D			02.93	07.99						
	1.9 SDI			09.95	07.99						
	1.9 TD			02.93	07.99						
1.9 TDI	66		07.96	07.99							
1.9 TDI	81		03.97	07.99							
2.0 i			02.93	07.99							
2.0 i 16V Cupra	110		07.96	07.99							
	1.8 i 16V			6K-ZR516424	02.94		24.3384-1603.5	240015		D=38, - Halter D=38, - Halter Bremsattel-Zubehör	TRW TRW TRW
	1.8 i 16V			6K-ZR014473	02.94		24.3384-1604.5	240016			
	2.0 i			6K-ZR516424	02.93		24.0101-3601.2	260044			
	2.0 i			6K-ZR014473	02.93						
	1.8 i 16V		6K-ZR516425		07.99		24.3384-1707.5	240171			
	1.8 i 16V		6K-ZR014474		07.99		24.3384-1708.5	240172			
	2.0 i		6K-ZR516425		07.99		24.0101-3601.2	260044			
	2.0 i		6K-ZR014474		07.99		11.0101-5403.2	260010			
	1.9 TDI	81		03.97	07.99		24.3384-1737.5	240301			
							24.3384-1738.5	240302			
1.0 i			02.93	07.99	PR: 1KK	24.3384-1723.7	220523		D=38(M12x1), - Halter D=38(M12x1), - Halter	TRW TRW	
1.3 i			02.93	07.99	PR: 1KK	24.3384-1724.7	220524				
1.4			09.93	07.99	PR: 1KK						
1.4 i 16V	74		09.96	07.99	PR: 1KK						
1.6 i			02.93	07.99	PR: 1KK						
1.8 i			02.93	07.99	PR: 1KK						
1.8 i 16V			02.94	07.99	PR: 1KK						
1.9 D			02.93	07.99	PR: 1KK						
1.9 SDI			09.95	07.99	PR: 1KK						
1.9 TD			02.93	07.99	PR: 1KK						
1.9 TDI	66		07.96	07.99	PR: 1KK						
1.9 TDI	81		03.97	07.99	PR: 1KK						
2.0 i			02.93	07.99	PR: 1KK						
2.0 i 16V Cupra	110		07.96	07.99	PR: 1KK						
	1.0 i			02.93	07.99		83.7836-0135.3	330816	2	L=135 L=143	
	1.3 i			02.93	07.99		24.5230-0143.3	330402			
	1.4			09.93	07.99						
	1.4 i 16V	74		09.96	07.99						
	1.6 i			02.93	07.99						
	1.8 i			02.93	07.99						
	1.9 D			02.93	07.99						
	1.9 SDI			09.95	07.99						
	1.9 TD			02.93	07.99						
	1.9 TDI	66		07.96	07.99						
1.8 i 16V			02.94	07.99		24.5170-0161.3	331308	2	L=161		
1.9 TDI	81		03.97	07.99							
2.0 i			02.93	07.99							
2.0 i 16V Cupra	110		07.96	07.99							
	1.0 i			02.93	07.99		03.3217-2112.3	020027	- ABS - ABS + ABS	Rz 17,46 Rz 17,46 Rz 19,05	
	1.3 i			02.93	07.99		24.3217-0908.3	020167			
	1.4			09.93	07.99		24.3219-0909.3	020188			
	1.4 i 16V	74		09.96	07.99						
	1.6 i			02.93	07.99						
	1.8 i			02.93	07.99						
	1.8 i 16V			02.94	07.99						
	1.9 D			02.93	07.99						
	1.9 SDI			09.95	07.99						
	1.9 TD			02.93	07.99						
1.9 TDI	66		07.96	07.99							

SEAT IBIZA II (93-99)																							
	1.0 i		6K-ZR549075	02.93	24.3727-2703.2	582703	2 ↓				L=1503												
	1.0 i		6K-ZR037976	02.93																			
	1.3 i		6K-ZR549075	02.93																			
	1.3 i		6K-ZR037976	02.93																			
	1.4		6K-ZR549075	09.93																			
	1.4		6K-ZR037976	09.93																			
	1.4 i 16V	74	6K-ZR549075	09.96																			
	1.4 i 16V	74	6K-ZR037976	09.96																			
	1.6 i		6K-ZR549075	02.93																			
	1.6 i		6K-ZR037976	02.93																			
	1.9 D		6K-ZR549075	02.93																			
	1.9 D		6K-ZR037976	02.93																			
	1.9 TD		6K-ZR549075	02.93																			
	1.9 TD		6K-ZR037976	02.93																			
	1.0 i		6K-ZR549076	6K-ZR663842							24.3727-2706.2	582706	2 ↓				L=1532						
	1.0 i		6K-ZR037977	6K-ZR126718																			
	1.3 i		6K-ZR549076	6K-ZR663842																			
	1.3 i		6K-ZR037977	6K-ZR126718																			
	1.4		6K-ZR549076	6K-ZR663842																			
	1.4		6K-ZR037977	6K-ZR126718																			
1.4 i 16V	74	6K-ZR549076	6K-ZR663842																				
1.4 i 16V	74	6K-ZR037977	6K-ZR126718																				
1.6 i		6K-ZR549076	6K-ZR663842																				
1.6 i		6K-ZR037977	6K-ZR126718																				
1.9 D		6K-ZR549076	6K-ZR663842																				
1.9 D		6K-ZR037977	6K-ZR126718																				
1.9 TD		6K-ZR549076	6K-ZR663842																				
1.9 TD		6K-ZR037977	6K-ZR126718																				
1.0 i		6K-ZR663843	6K-W-169289	24.3727-0161.2	580161	2 ↓				L=1512													
1.0 i		6K-ZR126719	6K-W-169289																				
1.3 i		6K-ZR663843	6K-W-169289																				
1.3 i		6K-ZR126719	6K-W-169289																				
1.4		6K-ZR663843	6K-W-169289																				
1.4		6K-ZR126719	6K-W-169289																				
1.4 i 16V	74	6K-ZR663843	6K-W-169289																				
1.4 i 16V	74	6K-ZR126719	6K-W-169289																				
1.6 i		6K-ZR663843	6K-W-169289																				
1.6 i		6K-ZR126719	6K-W-169289																				
1.0 i		6K-W-169290	07.99							24.3727-0162.2	580162	2 ↓	+ ABS			L=1514							
1.3 i		6K-W-169290	07.99																				
1.4		6K-W-169290	07.99																				
1.4 i 16V	74	6K-W-169290	07.99																				
1.6 i		6K-W-169290	07.99																				
1.9 D		6K-ZR663843	07.99																				
1.9 D		6K-ZR126719	07.99																				
1.9 TD		6K-ZR663843	07.99																				
1.9 TD		6K-ZR126719	07.99																				
1.8 i 16V		6K-ZR610015	6K-V-013236													24.3727-2704.2	582704	2 ↓				L=1632	
1.8 i 16V		6K-ZR085726	6K-V-000537																				
1.9 TDI		6K-ZR610015	6K-V-013236																				
1.9 TDI	81	6K-ZR085726	6K-V-000537																				
2.0 i		6K-ZR610015	6K-V-013236																				
2.0 i		6K-ZR085726	6K-V-000537																				
2.0 i 16V Cupra	110	6K-ZR610015	6K-V-013236																				
2.0 i 16V Cupra	110	6K-ZR085726	6K-V-000537																				
1.8 i 16V		6K-W-169290	07.99	24.3727-0165.2	580165	2 ↓																L=1641	
1.9 TDI	81	6K-W-169290	07.99																				
2.0 i		6K-W-169290	07.99																				
2.0 i 16V Cupra	110	6K-W-169290	07.99																				
	1.0 i									02.93	03.0101-0025.2	320014		+ Druckabhängig ¹⁾									BRES 3/35
	1.3 i									02.93													
	1.4									09.93													
	1.6 i									02.93													
	1.8 i									02.93													
	1.8 i 16V									02.94													
	1.9 D									02.93													
	1.9 SDI									09.95													
	1.9 TD									02.93													
	1.9 TDI	66								07.96													
1.9 TDI	81		03.97																				
2.0 i			02.93																				
	1.9 TDI	66								07.96	03.2419-9510.3	030028					Gz 19,05						
	1.9 TDI	81								03.97													
	1.9 TDI	66								07.96	24.2523-0908.3	040049					Nz 23,81						
	1.9 TDI	81								03.97													
	1.4			09.93	24.3728-2704.2	592704					L=1065, -AUT												
	1.6 i			02.93																			
	1.8 i		6K-ZR530332	02.93																			
	1.8 i		6K-ZR025747	02.93																			
	1.8 i 16V		6K-ZR530332	02.94																			
	1.8 i 16V		6K-ZR025747	02.94																			
	2.0 i		6K-ZR530332	02.93																			
2.0 i		6K-ZR025747	02.93																				

1) + pressure sensitive / + in funzione della pressione / + asservi à la pression / + dependiente de la presión

2) + load sensitive / + dependente dal carico / + asservi à la charge / + dependiente de carga



SEAT IBIZA II (93-99)

















	1.8 i	6K-ZR530333		07.99	24.3728-0128.2	590128			L=854, + AUT
	1.8 i	6K-ZR025748		07.99					
	1.8 i 16V	6K-ZR530333		07.99					
	1.8 i 16V	6K-ZR025748		07.99					
	1.9 D		02.93	07.99					
	1.9 TD		02.93	07.99					
	2.0 i	6K-ZR530333		07.99					
2.0 i	6K-ZR025748		07.99						

SEAT IBIZA III (6K1) (99-02)

	1.0 i			08.99	01.02	03.7750-6302.4	300161		- ABS	9"	ATE							
	1.4 i	44		08.99	01.02													
	1.4 i 16V			08.99	01.02													
	1.6 i			08.99	01.02													
	1.8 T 20V Cupra	115		07.00	01.02													
	1.9 SDI	50		08.99	01.02													
	1.9 TDI	66		08.99	01.02													
1.9 TDI	81		08.99	01.02														
	1.0 i			08.99	01.02	10.6350-3902.4	300213		+ Schaltgetriebe ¹⁾	9"	ATE							
	1.4 i	44		08.99	01.02							PR: 0G1, 0G3, 1KB						
	1.4 i 16V			08.99	01.02							PR: 0G1, 0G3, 1KB						
	1.6 i			08.99	01.02							PR: 0G1, 0G3, 1KB						
	1.8 T 20V Cupra	115		07.00	01.02							PR: 0G1, 0G3, 1KB						
	1.9 SDI	50		08.99	01.02							PR: 0G1, 0G3, 1KB						
	1.9 TDI	66		08.99	01.02							PR: 0G1, 0G3, 1KB						
1.9 TDI	81		08.99	01.02	PR: 0G1, 0G3, 1KB													
	1.0 i			08.99	01.02	10.6350-4002.4	300285		+ Automatikgetriebe ²⁾	9"	ATE							
	1.4 i	44		08.99	01.02							PR: 1KB,1KK,1KM,1KQ,1ZK						
	1.4 i 16V			08.99	01.02							PR: 1KB,1KK,1KM,1KQ,1ZK						
	1.6 i			08.99	01.02							PR: 1KB,1KK,1KM,1KQ,1ZK						
	1.8 T 20V Cupra	115		07.00	01.02							PR: 1KB,1KK,1KM,1KQ,1ZK						
	1.9 SDI	50		08.99	01.02							PR: 1KB,1KK,1KM,1KQ,1ZK						
	1.9 TDI	66		08.99	01.02							PR: 1KB,1KK,1KM,1KQ,1ZK						
1.9 TDI	81		08.99	01.02	PR: 1KB,1KK,1KM,1KQ,1ZK													
	1.0 i			08.99	01.02	10.6350-4002.4	300285		+ Schaltgetriebe ¹⁾	9"	ATE							
	1.4 i	44		08.99	01.02							PR: 0G4						
	1.4 i 16V			08.99	01.02							PR: 0G4						
	1.6 i			08.99	01.02							PR: 0G4						
	1.8 T 20V Cupra	115		07.00	01.02							PR: 0G4						
	1.9 SDI	50		08.99	01.02							PR: 0G4						
	1.9 TDI	66		08.99	01.02							PR: 0G4						
1.9 TDI	81		08.99	01.02	PR: 0G4													
	1.0 i			08.99	01.02	03.2122-1042.3	010137		- ABS	Thz 22,20	ATE							
	1.4 i	44		08.99	01.02							03.2123-1424.3	010637	+ ABS	Thz 23,81	ATE		
	1.4 i 16V			08.99	01.02													
	1.6 i			08.99	01.02													
	1.8 T 20V Cupra	115		07.00	01.02													
	1.9 SDI	50		08.99	01.02													
	1.9 TDI	66		08.99	01.02													
1.9 TDI	81		08.99	01.02														
	1.0 i			08.99	01.02	11.0441-4808.2	250022				Dichtungssatz	ATE						
	1.4 i	44		08.99	01.02								11.0101-4801.2	260006	Hülsensatz	ATE		
	1.4 i 16V			08.99	01.02								24.0102-4801.2	260085	Hülsensatz+Schrauben	ATE		
	1.6 i			08.99	01.02													
	1.9 SDI	50		08.99	01.02													
	1.9 TDI	66		08.99	01.02													
	1.9 TDI	81		08.99	01.02													
	1.0 i			08.99	01.02	24.3541-1609.5	240039	<input type="checkbox"/>			D=54, - Halter	TRW						
	1.4 i	44		08.99	01.02								24.3541-1610.5	240040	<input type="checkbox"/>	D=54, - Halter	TRW	
	1.4 i 16V			08.99	01.02								11.0101-5403.2	260010	<input type="checkbox"/>	Faltenbalsatz	TRW	
	1.6 i			08.99	01.02													
	1.9 SDI	50		08.99	01.02													
	1.9 TDI	66		08.99	01.02													
	1.9 TDI	81		08.99	01.02													
	1.0 i			08.99	01.02	24.3541-1731.5	240061	<input type="checkbox"/>			D=54, - Halter	TRW						
	1.4 i	44		08.99	01.02								24.3541-1732.5	240062	<input type="checkbox"/>	D=54, - Halter	TRW	
	1.4 i 16V			08.99	01.02													
	1.6 i			08.99	01.02													
	1.9 SDI	50		08.99	01.02													
	1.9 TDI	66		08.99	01.02													
	1.9 TDI	81		08.99	01.02													
	1.0 i			08.99	01.02	24.3541-1731.5	240061	<input type="checkbox"/>			D=54, - Halter	TRW						
	1.4 i	44		08.99	01.02								24.3541-1732.5	240062	<input type="checkbox"/>	D=54, - Halter	TRW	
	1.4 i 16V			08.99	01.02													
	1.6 i			08.99	01.02													
	1.9 SDI	50		08.99	01.02													
	1.9 TDI	66		08.99	01.02													
	1.9 TDI	81		08.99	01.02													
	1.0 i		6K-W-000500	08.99		24.3481-1745.5	240277	<input type="checkbox"/>	- ABS		D=48, - Halter	ATE						
	1.4 i	44	6K-W-000500	08.99									24.3481-1746.5	240278	<input type="checkbox"/>	- ABS	D=48, - Halter	ATE
	1.4 i 16V		6K-W-000500	08.99														
	1.6 i		6K-W-000500	08.99														
	1.9 SDI	50	6K-W-000500	08.99														
	1.9 TDI	66	6K-W-000500	08.99														
	1.9 TDI	81	6K-W-000500	08.99														























¹⁾ + manual transmission / + scatola cambio velocità / + transmission mécanique / + cambio de velocidad
²⁾ + autom.transmission / + scatola cambio automatico / + transmission automatique / + cambio automático















	 kW							
SEAT IBIZA III (6K1) (99-02)								
	1.0 i	44	08.99	01.02	24.5105-0442.3	331432	2	L=442
	1.4 i		08.99	01.02				
	1.4 i 16V		08.99	01.02				
	1.6 i		08.99	01.02				
	1.9 SDI	50	08.99	01.02				
	1.9 TDI	66	08.99	01.02				
1.9 TDI	81	08.99	01.02					
	1.0 i	44	08.99	01.02	24.3384-1723.7	220523	☐	D=38(M12x1), - Halter TRW
	1.4 i	44	08.99	01.02	24.3384-1724.7	220524		
	1.4 i 16V		08.99	01.02				
	1.6 i		08.99	01.02				
	1.8 T 20V Cupra	115	07.00	01.02				
	1.9 SDI	50	08.99	01.02				
	1.9 TDI	66	08.99	01.02				
	1.9 TDI	81	08.99	01.02				
	1.0 i	44	08.99	01.02	24.3344-1711.7	220539	☐	D=34, - Halter TRW
1.4 i	44	08.99	01.02	24.3344-1712.7	220540			
1.4 i 16V		08.99	01.02					
1.6 i		08.99	01.02					
1.8 T 20V Cupra	115	07.00	01.02					
1.9 SDI	50	08.99	01.02					
1.9 TDI	66	08.99	01.02					
1.9 TDI	81	08.99	01.02					
	1.0 i	44	08.99	01.02	83.7858-0140.3	330837	2	L=140
	1.4 i		08.99	01.02				
	1.4 i 16V		08.99	01.02				
	1.6 i		08.99	01.02				
	1.8 T 20V Cupra	115	07.00	01.02				
	1.9 SDI	50	08.99	01.02				
1.9 TDI	66	08.99	01.02					
1.9 TDI	81	08.99	01.02					
	1.0 i	44	08.99	01.02	24.3217-0908.3	020167		Rz 17,46
	1.4 i	44	08.99	01.02				
	1.4 i 16V	55	08.99	01.02				
	1.6 i	55	08.99	01.02				
	1.9 SDI	50	08.99	01.02				
	1.9 TDI	66	08.99	01.02				
1.4 i 16V	74	08.99	01.02	24.3219-0909.3	020188		Rz 19,05	
1.6 i	74	08.99	01.02					
	1.0 i	44	08.99	01.02	24.3727-0162.2	580162	2 ↓	L=1514
	1.4 i	44	08.99	01.02				
	1.4 i 16V		08.99	01.02				
	1.6 i		08.99	01.02				
	1.9 SDI	50	08.99	01.02				
	1.9 TDI	66	08.99	01.02				
1.8 T 20V Cupra	115	07.00	01.02	24.3727-0165.2	580165	2 ↓	L=1641	
1.9 TDI	81	08.99	01.02					
	1.0 i	44	08.99	01.02	24.2415-1712.3	030131		Gz 15,87
	1.4 i	44	08.99	01.02				
	1.4 i 16V		08.99	01.02				
	1.6 i		08.99	01.02				
	1.8 T 20V Cupra	115	07.00	01.02				
	1.9 SDI	50	08.99	01.02				
1.9 TDI	66	08.99	01.02					
1.9 TDI	81	08.99	01.02					
	1.0 i	44	08.99	01.02	24.2519-1701.3	040075	+ Schaltseilzug ¹⁾	Nz 19,05
	1.4 i	44	08.99	01.02	24.2523-1701.3	040080		
	1.4 i 16V		08.99	01.02			+ Schaltgestänge ²⁾	Nz 23,81
	1.6 i		08.99	01.02				
	1.8 T 20V Cupra	115	07.00	01.02				
	1.9 SDI	50	08.99	01.02				
1.9 TDI	66	08.99	01.02					
1.9 TDI	81	08.99	01.02					
SEAT IBIZA IV (6L1) (02-10)								
	1.2	44	06.07	05.08	24.2120-1736.3	010732	- ABS	THz 20,64
	1.2 i	47	02.02	02.10	24.2120-1734.3	010702		
	1.2 i 12V	51	05.06	02.10				
	1.4 i 16V	55	02.02	02.10				
	1.4 i 16V	63	05.06	02.10				
	1.4 i 16V	74	02.02	02.10				
	1.4 TDI	51	05.05	02.10				
	1.4 TDI	55	02.02	02.10				
	1.4 TDI	59	05.05	02.10				
	1.6 i 16V	51	02.03	02.10				
	1.8 T Cupra R	132	01.04	02.10				
	1.8 T FR	110	12.03	02.10				
	1.9 SDI	47	02.02	02.10				
	1.9 TDI	74	02.02	02.10				
	1.9 TDI	96	02.02	02.10				
	1.9 TDI Cupra R	118	03.04	02.10				
	2.0	85	04.02	02.10				

¹⁾ + gearshift cable / + leva cambio con cavo / + câble de changem.de vitesse / + cable de acc. del cambio

²⁾ + gearshift linkage / + leva cambio con tiranteria / + tige de changem.de vitesse / + varillaje del cambio

									
SEAT IBIZA IV (6L1) (02-10)									
	1.2 1.2 i 1.2 i 12V 1.4 i 16V 1.4 i 16V 1.4 TDI 1.4 TDI 1.4 TDI 1.6 i 16V 1.8 T FR 1.9 SDI 1.9 TDI 1.9 TDI 1.9 TDI Cupra R 2.0	44 47 51 55 63 74 51 55 59 110 47 74 96 118 85	06.07 02.02 05.06 02.02 05.06 02.02 05.05 02.02 05.05 02.03 12.03 02.02 02.02 03.04 04.02	05.08 PR: 1LQ,1ZF 02.10 PR: 1LQ,1ZF 02.10 PR: 1LQ,1ZF 02.10 PR: 1LQ,1ZF 02.10 PR: 1LQ,1ZF 02.10 PR: 1LQ,1ZF 02.10 PR: 1LQ,1ZF 02.10 PR: 1LQ,1ZF 02.10 PR: 1LQ,1ZF 02.10 PR: 1LQ,1ZF 02.10 PR: 1LQ,1ZF 02.10 PR: 1LQ,1ZF 02.10 PR: 1LQ,1ZF 02.10 PR: 1LQ,1ZF 02.10 PR: 1LQ,1ZF	11.9541-9549.2 11.9541-9550.2 11.0101-5409.2 11.8171-0069.1	220575 220576 260035 250152	 	D=54, - Halter D=54, - Halter Hülzensatz Führungsbolzen	ATE ATE ATE ATE
	1.2 1.2 i 1.2 i 12V 1.4 i 16V 1.4 i 16V 1.4 TDI 1.4 TDI 1.4 TDI 1.6 i 16V 1.8 T FR 1.9 SDI 1.9 TDI 1.9 TDI 1.9 TDI Cupra R 2.0	44 47 51 55 63 74 51 55 59 110 47 74 96 118 85	06.07 02.02 05.06 02.02 05.06 02.02 05.05 02.02 05.05 02.03 12.03 02.02 02.02 03.04 04.02	05.08 PR: 1LN,1ZH 02.10 PR: 1LN,1ZH 02.10 PR: 1LN,1ZH 02.10 PR: 1LN,1ZH 02.10 PR: 1LN,1ZH 02.10 PR: 1LN,1ZH 02.10 PR: 1LN,1ZH 02.10 PR: 1LN,1ZH 02.10 PR: 1LN,1ZH 02.10 PR: 1LN,1ZH 02.10 PR: 1LN,1ZH 02.10 PR: 1LN,1ZH 02.10 PR: 1LN,1ZH 02.10 PR: 1LN,1ZH 02.10 PR: 1LN,1ZH	24.3541-1797.7 24.3541-1798.7	220553 220554	 	D=54, - Halter D=54, - Halter	TRW TRW
	1.8 T Cupra R	132	01.04 02.10		11.9541-9595.2 11.9541-9596.2 11.0441-5409.2 11.0101-5409.2 11.8171-0008.1 11.8116-0143.1	220501 220502 250031 260035 990049 390513	 	D=54, - Halter D=54, - Halter Dichtungssatz Hülzensatz Führungsbolzen Haltefeder	ATE ATE ATE ATE ATE ATE
	1.2 1.2 i 1.2 i 12V 1.4 i 16V 1.4 i 16V 1.4 TDI 1.4 TDI 1.4 TDI 1.6 i 16V 1.8 T FR 1.9 SDI 1.9 TDI 1.9 TDI 2.0	44 47 51 55 63 74 51 55 59 110 47 74 96 85	06.07 02.02 05.06 02.02 05.06 02.02 05.05 02.02 05.05 02.03 12.03 02.02 02.02 02.02 04.02	05.08 02.10 02.10 02.10 02.10 02.10 02.10 02.10 02.10 02.10 02.10 02.10 02.10 02.10 02.10	83.6247-0522.3	330595	2	L=522	
	1.2 1.2 i 1.2 i 12V 1.4 i 16V 1.4 i 16V 1.4 TDI 1.4 TDI 1.4 TDI 1.6 i 16V 1.8 T Cupra R 1.8 T FR 1.9 SDI 1.9 TDI 1.9 TDI 1.9 TDI Cupra R 2.0	44 47 51 55 63 74 51 55 59 132 110 47 74 96 118 85	06.07 02.02 05.06 02.02 05.06 02.02 05.05 02.02 05.05 02.03 01.04 12.03 02.02 02.02 03.04 04.02	05.08 02.10 02.10 02.10 02.10 02.10 02.10 02.10 02.10 02.10 02.10 02.10 02.10 02.10 02.10 02.10	24.3344-1709.7 24.3344-1710.7 24.3384-1729.7 24.3384-1730.7	220537 220538 220541 220542	   	D=34, - Halter D=34, - Halter D=38(M12x1), - Halter D=38(M12x1), - Halter	TRW TRW TRW TRW
	1.2 1.2 i 1.2 i 12V 1.4 i 16V 1.4 i 16V 1.4 TDI 1.4 TDI 1.4 TDI 1.6 i 16V 1.8 T Cupra R 1.8 T FR 1.9 SDI 1.9 TDI 1.9 TDI 1.9 TDI Cupra R 2.0	44 47 51 55 63 74 51 55 59 132 110 47 74 96 118 85	06.07 02.02 05.06 02.02 05.06 02.02 05.05 02.02 05.05 02.03 01.04 12.03 02.02 02.02 03.04 04.02	05.08 PR: 1KD,1KK,1KS,1KT,1KP 02.10 PR: 1KD,1KK,1KS,1KT,1KP 02.10 PR: 1KD,1KK,1KS,1KT,1KP 02.10 PR: 1KD,1KK,1KS,1KT,1KP 02.10 PR: 1KD,1KK,1KS,1KT,1KP 02.10 PR: 1KD,1KK,1KS,1KT,1KP 02.10 PR: 1KD,1KK,1KS,1KT,1KP 02.10 PR: 1KD,1KK,1KS,1KT,1KP 02.10 PR: 1KD,1KK,1KS,1KT,1KP 02.10 PR: 1KD,1KK,1KS,1KT,1KP 02.10 PR: 1KD,1KK,1KS,1KT,1KP 02.10 PR: 1KD,1KK,1KS,1KT,1KP 02.10 PR: 1KD,1KK,1KS,1KT,1KP 02.10 PR: 1KD,1KK,1KS,1KT,1KP 02.10 PR: 1KD,1KK,1KS,1KT,1KP 02.10 PR: 1KD,1KK,1KS,1KT,1KP	83.7858-0140.3	330837	2	L=140	

										
SEAT IBIZA IV (6L1) (02-10)										
	1.2 1.2 i 1.2 i 12V 1.4 i 16V 1.4 i 16V 1.4 i 16V 1.4 TDI 1.4 TDI 1.4 TDI 1.6 i 16V 1.9 SDI 1.9 TDI 1.9 TDI 1.9 TDI Cupra R 2.0	44 47 51 55 63 74 51 55 59 47 74 96 118 85		06.07 02.02 05.06 02.02 05.06 02.02 05.05 02.02 05.05 02.03 02.02 02.02 02.02 03.04 04.02	05.08 02.10 02.10 02.10 02.10 02.10 02.10 02.10 02.10 02.10 02.10 02.10 02.08 02.10	24.3219-0909.3 020188		Rz 19,05		
	1.2 1.2 i 1.2 i 12V 1.4 i 16V 1.4 i 16V 1.4 i 16V 1.4 TDI 1.4 TDI 1.4 TDI 1.6 i 16V 1.8 T Cupra R 1.8 T FR 1.9 SDI 1.9 TDI 1.9 TDI 1.9 TDI Cupra R 2.0	44 47 51 55 63 74 51 55 59 132 110 47 74 96 118 85		06.07 02.02 05.06 02.02 05.06 02.02 05.05 02.02 05.05 02.03 01.04 12.03 02.02 02.02 02.02 03.04 04.02	05.08 02.10 02.10 02.10 02.10 02.10 02.10 02.10 02.10 02.10 02.10 02.10 02.10 02.10 02.08 02.10	24.3727-0199.2 580199	2 ⚡ - Schlechtwegeausführung ¹⁾	L=1580		
	1.2 1.2 i 1.2 i 12V 1.4 i 16V 1.4 i 16V 1.4 i 16V 1.4 TDI 1.4 TDI 1.4 TDI 1.6 i 16V 1.8 T Cupra R 1.8 T FR 1.9 SDI 1.9 TDI 1.9 TDI 1.9 TDI Cupra R 2.0	44 47 51 55 63 74 51 55 59 132 110 47 74 96 118 85		06.07 02.02 05.06 02.02 05.06 02.02 05.05 02.02 05.05 02.03 01.04 12.03 02.02 02.02 02.02 03.04 04.02	05.08 02.10 02.10 02.10 02.10 02.10 02.10 02.10 02.10 02.10 02.10 02.10 02.10 02.10 02.10 02.08 02.10	24.3727-0176.2 24.3727-0198.2 24.3727-0197.2	580176 580198 580197	2 ⚡ + Schlechtwegeausführung ²⁾ 2 ⚡ + Schlechtwegeausführung ²⁾ 2 ⚡ - Schlechtwegeausführung ¹⁾	L=1640 L=1645 L=1645	
	1.2 1.2 i 1.2 i 12V 1.4 i 16V 1.4 i 16V 1.4 i 16V 1.4 TDI 1.4 TDI 1.4 TDI 1.6 i 16V 1.8 T Cupra R 1.8 T FR 1.9 SDI 1.9 TDI 1.9 TDI 1.9 TDI Cupra R 2.0	44 47 51 55 63 74 51 55 59 132 110 47 74 96 118 85		06.07 02.02 05.06 02.02 05.06 02.02 05.05 02.02 05.05 02.03 01.04 12.03 02.02 02.02 02.02 03.04 04.02	05.08 02.10 02.10 02.10 02.10 02.10 02.10 02.10 02.10 02.10 02.10 02.10 02.10 02.10 02.10 02.08 02.10	24.3727-2504.2 582504	2 ⚡ + Schlechtwegeausführung ²⁾	L=1580		
	1.2 1.2 i 1.2 i 12V 1.4 i 16V 1.4 i 16V 1.4 i 16V 1.4 TDI 1.4 TDI 1.4 TDI 1.6 i 16V 1.8 T Cupra R 1.8 T FR 1.9 SDI 1.9 TDI 1.9 TDI 1.9 TDI Cupra R 2.0	44 47 51 55 63 74 51 55 59 132 110 47 74 96 118 85		06.07 02.02 05.06 02.02 05.06 02.02 05.05 02.02 05.05 02.03 01.04 12.03 02.02 02.02 02.02 03.04 04.02	05.08 02.10 02.10 02.10 02.10 02.10 02.10 02.10 02.10 02.10 02.10 02.10 02.10 02.10 02.10 02.08 02.10	03.6583-0216.3 03.6584-0120.3	320247 320279	- ABS - ABS	BRL 8/3 (4) BRL 8/4 (4)	ATE ATE

¹⁾ - rough road construction / - versione per percorsi accidentati / - version pour mauvaise route / - versión 4x4

²⁾ + rough road construction / + versione per percorsi accidentati / + version pour mauvaise route / + versión 4x4

SEAT IBIZA V / ST / SC (08-)										
	1.0	55	05.15	PR: 1LQ,1LR,1ZG	11.9541-9549.2	220575			D=54, - Halter ATE D=54, - Halter ATE Hülzensatz ATE Führungsbolzen ATE	ATE
	1.0 TSI	70	05.15	PR: 1LQ,1LR,1ZG	11.9541-9550.2	220576				
	1.0 TSI	81	05.15	PR: 1LQ,1LR,1ZG	11.0101-5409.2	260035				
	1.2	44	07.09	PR: 1LQ,1LR,1ZG	11.8171-0069.1	250152				
	1.2	51	07.08	PR: 1LQ,1LR,1ZG						
	1.2 TDI	55	04.10	PR: 1LQ,1LR,1ZG						
	1.2 TSI	63	08.12	PR: 1LQ,1LR,1ZG						
	1.2 TSI	66	05.15	PR: 1LQ,1LR,1ZG						
	1.2 TSI	77	09.10	PR: 1LQ,1LR,1ZG						
	1.2 TSI	81	09.15							
	1.4 i 16V	63	07.08	PR: 1LQ,1LR,1ZG						
	1.4 TDI	55	05.15	PR: 1LQ,1LR,1ZG						
	1.4 TDI	59	07.08	PR: 1LQ,1LR,1ZG						
	1.4 TDI	66	05.15	PR: 1LQ,1LR,1ZG						
	1.4 TDI	77	05.15	PR: 1LQ,1LR,1ZG						
	1.4 TSI	110	06.09	PR: 1LQ,1LR,1ZG						
	1.4 TSI FR	103	12.13	PR: 1LQ,1LR,1ZG						
	1.6 i 16V	77	07.08	PR: 1LQ,1LR,1ZG						
	1.6 LPG	60	05.11	PR: 1LQ,1LR,1ZG						
	1.6 TDI	66	06.09	PR: 1LQ,1LR,1ZG						
1.6 TDI	77	06.09	PR: 1LQ,1LR,1ZG							
1.9 TDI	66	07.08	PR: 1LQ,1LR,1ZG							
1.9 TDI	77	07.08	PR: 1LQ,1LR,1ZG							
2.0	85	10.08	PR: 1LQ,1LR,1ZG							
2.0 TDI	105	01.10	PR: 1LQ,1LR,1ZG							
	1.0	55	05.15	PR: 1ZR,1ZS,1ZC	11.9541-9553.2	220563			D=54, - Halter ATE D=54, - Halter ATE Hülzensatz ATE Führungsbolzen ATE Haltefeder ATE	ATE
	1.0 TSI	70	05.15	PR: 1ZR,1ZS,1ZC	11.9541-9554.2	220564				
	1.0 TSI	81	05.15	PR: 1ZR,1ZS,1ZC	11.0101-5407.2	260011				
	1.2	44	07.09	PR: 1ZR,1ZS	11.8171-0008.1	990049				
	1.2	51	07.08	PR: 1ZR,1ZS	11.8116-0351.1	390538				
	1.2 TDI	55	04.10	PR: 1ZR,1ZS						
	1.2 TSI	63	08.12	PR: 1ZR,1ZS						
	1.2 TSI	66	05.15	PR: 1ZR,1ZS,1ZC						
	1.2 TSI	77	09.10	PR: 1ZR,1ZS						
	1.2 TSI	81	09.15	PR: 1ZR,1ZS,1ZC						
	1.4 i 16V	63	07.08	PR: 1ZR,1ZS						
	1.4 TDI	55	05.15	PR: 1ZR,1ZS,1ZC						
	1.4 TDI	59	07.08	PR: 1ZR,1ZS						
	1.4 TDI	66	05.15	PR: 1ZR,1ZS,1ZC						
	1.4 TDI	77	05.15	PR: 1ZR,1ZS,1ZC						
	1.4 TSI	110	06.09	PR: 1ZR,1ZS						
	1.4 TSI FR	103	12.13	PR: 1ZR,1ZS						
	1.6 i 16V	77	07.08	PR: 1ZR,1ZS						
	1.6 LPG	60	05.11	PR: 1ZR,1ZS						
	1.6 TDI	66	06.09	PR: 1ZR,1ZS						
1.6 TDI	77	06.09	PR: 1ZR,1ZS							
1.8 TSI Cupra	141	11.15	PR: 1ZR,1ZS,1ZC							
1.9 TDI	66	07.08	PR: 1ZR,1ZS							
1.9 TDI	77	07.08	PR: 1ZR,1ZS							
2.0	85	10.08	PR: 1ZR,1ZS							
2.0 TDI	105	01.10	PR: 1ZR,1ZS							
	1.2	44	07.09		24.3541-1797.7	220553			D=54, - Halter TRW D=54, - Halter TRW	TRW
	1.2	51	07.08		24.3541-1798.7	220554				
	1.2 TDI	55	04.10							
	1.2 TSI	63	08.12							
	1.2 TSI	77	09.10							
	1.4 i 16V	63	07.08							
	1.4 TDI	59	07.08							
	1.4 TSI	110	06.09							
	1.4 TSI FR	103	12.13							
	1.6 i 16V	77	07.08							
	1.6 LPG	60	05.11							
	1.6 TDI	66	06.09							
	1.6 TDI	77	06.09							
	1.9 TDI	66	07.08							
	1.9 TDI	77	07.08							
2.0	85	10.08								
2.0 TDI	105	01.10								
	1.2	44	07.09	06.10	83.6247-0522.3	330595			L=522	
	1.2	51	07.08	06.10						
	1.2 TDI	55	04.10	06.10						
	1.4 i 16V	63	07.08	06.10						
	1.4 TDI	59	07.08	06.10						
	1.4 TSI	110	06.09	06.10						
	1.4 TSI Cupra	132	06.09	06.10						
	1.6 i 16V	77	07.08	06.10						
	1.6 TDI	66	06.09	06.10						
	1.6 TDI	77	06.09	06.10						
	1.9 TDI	66	07.08	06.10						
	1.9 TDI	77	07.08	06.10						
	2.0	85	10.08	06.10						
	2.0 TDI	105	01.10	06.10						
		1.0	55	05.15		24.5143-0544.3				
1.0 TSI		70	05.15							
1.0 TSI		81	05.15							
1.2		44	07.10							
1.2		51	07.10							

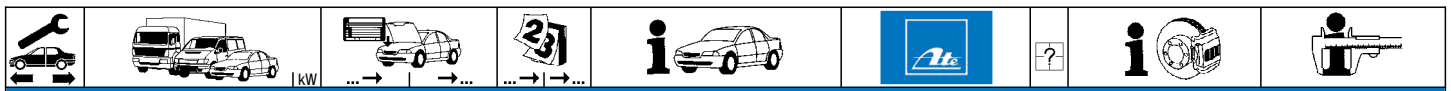

SEAT IBIZA V / ST / SC (08-)

	1.2 TDI 55 1.2 TSI 63 1.2 TSI 66 1.2 TSI 77 1.2 TSI 81 1.4 i 16V 63 1.4 TDI 55 1.4 TDI 59 1.4 TDI 66 1.4 TDI 77 1.4 TSI 110 1.4 TSI Cupra 132 1.4 TSI FR 103 1.6 i 16V 77 1.6 LPG 60 1.6 TDI 66 1.6 TDI 77 1.8 TSI Cupra 141 1.9 TDI 66 1.9 TDI 77 2.0 85 2.0 TDI 105		07.10 08.12 05.15 09.10 09.15 07.10 05.15 07.10 05.15 05.15 07.10 07.10 12.13 07.10 05.11 07.10 07.10 11.15 07.10 07.10 07.10 07.10		24.5143-0544.3	331420	2	PR: 1ZC,1ZD,1ZG	L=544	
	1.0 55 1.0 TSI 70 1.0 TSI 81 1.2 44 1.2 51 1.2 TDI 55 1.2 TSI 63 1.2 TSI 66 1.2 TSI 77 1.2 TSI 81 1.4 i 16V 63 1.4 TDI 55 1.4 TDI 59 1.4 TDI 66 1.4 TDI 77 1.4 TSI Cupra 132 1.6 i 16V 77 1.6 LPG 60 1.6 TDI 66 1.6 TDI 77 1.8 TSI Cupra 141 1.9 TDI 66 1.9 TDI 77 2.0 85 2.0 TDI 105		05.15 05.15 05.15 07.09 07.08 04.10 08.12 05.15 09.10 09.15 07.08 05.15 07.08 05.15 06.09 07.08 05.11 06.09 06.09 11.15 07.08 07.08 10.08 01.10	PR: 1KT PR: 1KT PR: 1KT PR: 1KK,1KT PR: 1KK,1KT PR: 1KK,1KT PR: 1KT PR: 1KK,1KT PR: 1KT PR: 1KT PR: 1KK,1KT PR: 1KT PR: 1KK,1KT PR: 1KT PR: 1KK,1KT PR: 1KK,1KT PR: 1KK,1KT PR: 1KT PR: 1KK,1KT PR: 1KK,1KT PR: 1KT PR: 1KK,1KT PR: 1KK,1KT PR: 1KT	24.3387-1735.5 24.3387-1736.5	240657 240658			D=38, - Halter D=38, - Halter	TRW TRW
	1.0 55 1.0 TSI 70 1.0 TSI 81 1.2 44 1.2 51 1.2 TDI 55 1.2 TSI 63 1.2 TSI 66 1.2 TSI 77 1.2 TSI 81 1.4 i 16V 63 1.4 TDI 55 1.4 TDI 59 1.4 TDI 66 1.4 TDI 77 1.4 TSI Cupra 132 1.6 i 16V 77 1.6 LPG 60 1.6 TDI 66 1.6 TDI 77 1.8 TSI Cupra 141 1.9 TDI 66 1.9 TDI 77 2.0 85 2.0 TDI 105		05.15 05.15 05.15 07.09 07.08 04.10 08.12 05.15 09.10 09.15 07.08 05.15 07.08 05.15 06.09 07.08 05.11 06.09 06.09 11.15 07.08 07.08 10.08 01.10	PR: 1KV PR: 1KV	24.3387-1735.5 24.3387-1736.5	240657 240658			D=38, - Halter D=38, - Halter	TRW TRW
	1.4 TSI 110 1.4 TSI FR 103		06.09 12.13	PR: 1KD,1KS PR: 1KD,1KS	24.3344-1709.7 24.3344-1710.7	220537 220538			D=34, - Halter D=34, - Halter	TRW TRW
	1.0 55 1.0 TSI 70 1.0 TSI 81 1.2 44 1.2 51 1.2 TDI 55 1.2 TSI 63 1.2 TSI 66 1.2 TSI 77 1.2 TSI 81 1.4 i 16V 63 1.4 TDI 55 1.4 TDI 59		05.15 05.15 05.15 07.09 07.08 04.10 08.12 05.15 09.10 09.15 07.08 05.15 07.08		83.7858-0140.3	330837	2		L=140	

SEAT IBIZA V / ST / SC (08-)															
	1.4 TDI	66		05.15	83.7858-0140.3	330837	2		L=140						
	1.4 TDI	77		05.15											
	1.4 TSI	110		06.09											
	1.4 TSI Cupra	132		06.09											
	1.4 TSI FR	103		12.13											
	1.6 i 16V	77		07.08											
	1.6 LPG	60		05.11											
	1.6 TDI	66		06.09											
	1.6 TDI	77		06.09											
	1.8 TSI Cupra	141		11.15											
	1.9 TDI	66		07.08											
	1.9 TDI	77		07.08											
	2.0	85		10.08											
	2.0 TDI	105		01.10											
		1.0	55							05.15	83.7858-0140.3	330837	2		L=140
		1.0 TSI	70							05.15					
		1.0 TSI	81							05.15					
		1.2	44							07.09					
		1.2	51							07.08					
1.2 TDI		55		04.10											
1.2 TSI		63		08.12											
1.2 TSI		66		05.15											
1.2 TSI		77		09.10											
1.2 TSI		81		09.15											
1.4 i 16V		63		07.08											
1.4 TDI		55		05.15											
1.4 TDI		59		07.08											
1.4 TDI		66		05.15											
1.4 TDI		77		05.15											
1.4 TSI		110		06.09											
1.4 TSI Cupra		132		06.09											
1.4 TSI FR		103		12.13											
1.6 i 16V		77		07.08											
1.6 LPG		60		05.11											
1.6 TDI		66		06.09											
1.6 TDI		77		06.09											
1.9 TDI		66		07.08											
1.9 TDI		77		07.08											
2.0		85		10.08											
2.0 TDI		105		01.10											
		1.0	55		05.15	24.3219-0909.3	020188			Rz 19,05					
	1.0 TSI	70		05.15											
	1.0 TSI	81		05.15											
	1.2	44		07.09											
	1.2	51		07.08											
	1.2 TDI	55		04.10											
	1.2 TSI	63		08.12											
	1.2 TSI	66		05.15											
	1.2 TSI	77		09.10											
	1.2 TSI	81		09.15											
	1.4 i 16V	63		07.08											
	1.4 TDI	55		05.15											
	1.4 TDI	59		07.08											
	1.4 TDI	66		05.15											
	1.4 TDI	77		05.15											
	1.6 i 16V	77		07.08											
	1.6 LPG	60		05.11											
	1.9 TDI	66		07.08											
	1.9 TDI	77		07.08											
	1.0	55		05.15	24.3727-3402.2	583402	2	+ HA-Trommelbremse 1)	L=1588						
	1.0 TSI	70		05.15											
	1.0 TSI	81		05.15											
	1.2	44		07.09											
	1.2	51		07.08											
	1.2 TDI	55		04.10											
	1.2 TSI	63		08.12											
	1.2 TSI	66		05.15											
	1.2 TSI	77		09.10											
	1.2 TSI	81		09.15											
	1.4 i 16V	63		07.08											
	1.4 TDI	55		05.15											
	1.4 TDI	59		07.08											
	1.4 TDI	66		05.15											
	1.4 TDI	77		05.15											
	1.6 i 16V	77		07.08											
	1.6 LPG	60		05.11											
	1.9 TDI	66		07.08											
	1.9 TDI	77		07.08											
	1.0	55		05.15	24.3727-3403.2	583403	2	+ HA-Scheibenbremse 2)	L=1642						
	1.0 TSI	70		05.15											
	1.0 TSI	81		05.15											
	1.2	44		07.09											
	1.2	51		07.08											
	1.2 TDI	55		04.10											
	1.2 TSI	63		08.12											
	1.2 TSI	66		05.15											
	1.2 TSI	77		09.10											
	1.2 TSI	81		09.15											

1) + RA drum brake / + P freno a tamburo / + frein à tambour essieu AR / + ET-tambores de freno

2) + RA disc brake / + P disco freno / + frein à disque essieu AR / + ET-disco de freno



SEAT IBIZA V / ST / SC (08-)

	1.2 TSI 81 1.4 i 16V 63 1.4 TDI 55 1.4 TDI 59 1.4 TDI 66 1.4 TDI 77 1.4 TSI 110 1.4 TSI Cupra 132 1.4 TSI FR 103 1.6 i 16V 77 1.6 LPG 60 1.6 TDI 66 1.6 TDI 77 1.8 TSI Cupra 141 1.9 TDI 66 1.9 TDI 77 2.0 85 2.0 TDI 105		09.15 07.08 05.15 07.08 05.15 05.15 06.09 06.09 12.13 07.08 05.11 06.09 06.09 11.15 07.08 07.08 10.08 01.10		24.3727-3403.2 583403	2 ↓ + HA-Scheibenbremse 1)	L=1642	
	1.0 55 1.0 TSI 70 1.0 TSI 81 1.2 44 1.2 51 1.2 TDI 55 1.2 TSI 63 1.2 TSI 66 1.2 TSI 77 1.2 TSI 81 1.4 i 16V 63 1.4 TDI 55 1.4 TDI 59 1.4 TDI 66 1.4 TDI 77 1.6 i 16V 77 1.6 LPG 60 1.9 TDI 66 1.9 TDI 77		05.15 05.15 05.15 07.09 07.08 04.10 08.12 05.15 09.10 09.15 07.08 05.15 07.08 05.15 07.08 05.11 07.08 07.08		03.6583-0216.3 320247 03.6584-0120.3 320279	- ABS - ABS	BRL 8/3 (4) BRL 8/4 (4)	ATE ATE
	1.0 55 1.0 TSI 70 1.0 TSI 81 1.2 44 1.2 51 1.2 TDI 55 1.2 TSI 63 1.2 TSI 66 1.2 TSI 77 1.2 TSI 81 1.4 i 16V 63 1.4 TDI 55 1.4 TDI 59 1.4 TDI 66 1.4 TDI 77 1.4 TSI 110 1.4 TSI Cupra 132 1.4 TSI FR 103 1.6 i 16V 77 1.6 LPG 60 1.6 TDI 66 1.6 TDI 77 1.8 TSI Cupra 141 1.9 TDI 66 1.9 TDI 77 2.0 85 2.0 TDI 105		05.15 05.15 05.15 07.09 07.08 04.10 08.12 05.15 09.10 09.15 07.08 05.15 07.08 05.15 07.08 05.11 07.08 07.08 01.10	PR: OEM PR: OEM PR: OEM PR: OEM PR: OEM PR: OEM PR: OEM PR: OEM PR: OEM PR: OEM PR: OEM PR: OEM PR: OEM PR: OEM PR: OEM PR: OEM PR: OEM PR: OEM PR: OEM	24.2519-1706.3 040096		Nz 19,05	

SEAT INCA (6K9) (96-03)

	1.4 i 44 1.4 i 16V 55 1.6 i 55 1.7 SDI 42 1.9 D 47 1.9 SDI / TDI 47		11.95 08.03 04.00 08.03 11.95 08.03 09.96 08.03 11.95 08.03 11.95 08.03		03.7750-6302.4 300161 10.6350-4002.4 300285	- ABS + ABS	9" 9"	ATE ATE
	1.4 i 44 1.4 i 44 1.4 i 16V 55 1.6 i 55 1.6 i 55 1.7 SDI 42 1.7 SDI 42 1.9 D 47 1.9 D 47 1.9 SDI / TDI 47 1.9 SDI / TDI 47	9K-X-006000 9K-X-006000 9K-X-006000 9K-X-006000 9K-X-006000 9K-X-006000	11.95 08.03 11.95 08.03 04.00 08.03 11.95 08.03 11.95 08.03 09.96 08.03 09.96 08.03 11.95 08.03 11.95 08.03 11.95 08.03 11.95 08.03		03.2122-1042.3 010137 03.3517-0101.2 390322	- ABS - ABS	THz 22,20 Verschleißschraube	ATE
	1.4 i 44 1.4 i 16V 55 1.6 i 55 1.7 SDI 42		11.95 08.03 04.00 08.03 11.95 08.03 09.96 08.03		03.2123-1424.3 010637	+ ABS	THz 23,81	ATE

1) + RA disc brake / + P disco freno / + frein à disque essieu AR / + ET-disco de freno



SEAT INCA (6K9) (96-03)

	1.9 D 1.9 SDI / TDI	47 47		11.95 11.95	08.03 08.03	03.2123-1424.3	010637	+ ABS	THz 23,81	ATE
	1.4 i 1.4 i 16V 1.6 i 1.7 SDI 1.9 D 1.9 SDI / TDI	44 55 55 42 47 47		11.95 04.00 11.95 09.96 11.95 11.95	08.03 08.03 08.03 08.03 08.03 08.03	03.2123-1484.3	010595	+ ABS	THz 23,81	ATE
	1.4 i 1.4 i 16V 1.6 i 1.7 SDI 1.9 D 1.9 SDI / TDI	44 55 55 42 47 47		11.95 04.00 11.95 09.96 11.95 11.95	08.03 08.03 08.03 08.03 08.03 08.03	24.3541-1609.5 24.3541-1610.5 11.0101-5403.2	240039 240040 260010		D=54, - Halter D=54, - Halter Faltenbalgsatz	TRW TRW TRW
	1.4 i 1.4 i 16V 1.6 i 1.7 SDI 1.9 D 1.9 SDI / TDI	44 55 55 42 47 47		11.95 04.00 11.95 09.96 11.95 11.95	08.03 08.03 08.03 08.03 08.03 08.03	24.5105-0442.3	331432	2	L=442	
	1.4 i 1.4 i 16V 1.6 i 1.7 SDI 1.9 D 1.9 SDI / TDI	44 55 55 42 47 47		11.95 04.00 11.95 09.96 11.95 11.95	08.03 08.03 08.03 08.03 08.03 08.03	83.6236-0402.3	330464	2	L=400	
	1.4 i 1.4 i 16V 1.6 i 1.7 SDI 1.9 D 1.9 SDI / TDI	44 55 55 42 47 47		11.95 04.00 11.95 09.96 11.95 11.95	08.03 08.03 08.03 08.03 08.03 08.03	24.3220-0909.3	020210		Rz 20,64	
	1.4 i 1.4 i 16V 1.6 i 1.7 SDI 1.9 D 1.9 SDI / TDI	44 55 55 42 47 47		11.95 04.00 11.95 09.96 11.95 11.95	08.03 08.03 08.03 08.03 08.03 08.03	24.3727-2700.2	582700	2	L=1671	
	1.4 i 1.6 i 1.7 SDI 1.9 D 1.9 SDI / TDI	44 55 42 47 47		11.95 11.95 09.96 11.95 11.95	08.03 08.03 08.03 08.03 08.03	24.3728-2704.2	592704		L=1065, - AUT	
	1.6 i 1.7 SDI 1.9 D 1.9 SDI / TDI	55 42 47 47		11.95 09.96 11.95 11.95	08.03 08.03 08.03 08.03	24.3728-0128.2	590128		L=854, + AUT	

SEAT LEON I (1M1) (99-05)





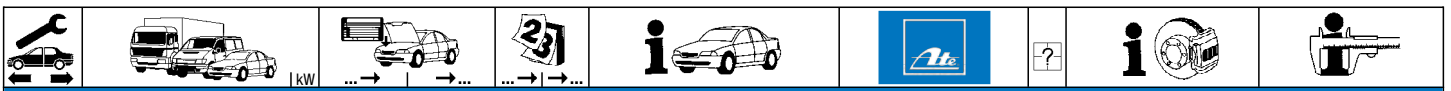















	1.4 i 16V 1.6 i 16V 1.8 20V 1.8 20V T 1.8 20V T 4x4 1.8 T Cupra R 1.8 T Cupra R 1.8 Turbo 4x4 1.9 SDI 1.9 TDI 1.9 TDI 1.9 TDI 1.9 TDI 1.9 TDI 1.9 TDI Syncro 2.3 VR5 2.8 2.8 V6 Cupra 4x4	55 55 92 132 132 154 165 154 50 81 96 110 110 110 110 150 150	1M-1B018341 1M-1B018341 1M-1B018341 1M-1B018341 1M-1B018341 1M-1B018341 1M-1B018341 1M-1B018341 1M-1B018341 1M-1B018341 1M-1B018341 1M-1B018341 1M-1B018341 1M-1B018341 1M-1B018341 1M-1B018341 1M-1B018341 1M-1B018341	11.99 11.99 11.99 11.99 11.99 05.02 07.03 05.02 11.99 11.99 11.99 05.03 02.01 05.02 09.00 05.02 02.01	+ ESP + ESP + ESP + ESP + ESP + ESP + ESP + ESP + ESP + ESP + ESP + ESP + ESP + ESP + ESP + ESP + ESP + ESP	03.7863-0402.4	300124		10"	ATE
	1.4 i 16V 1.6 i 16V 1.8 20V 1.8 20V T 1.8 20V T 4x4 1.8 T Cupra R 1.8 T Cupra R 1.8 Turbo 4x4 1.9 SDI 1.9 TDI 1.9 TDI 1.9 TDI 1.9 TDI 1.9 TDI 1.9 TDI Syncro 2.3 VR5 2.8 2.8 V6 Cupra 4x4	55 55 92 132 132 154 165 154 50 81 96 110 110 110 110 150 150	1M-1R023638 1M-1R023638 1M-1R023638 1M-1R023638 1M-1R023638 1M-1R023638 1M-1R023638 1M-1R023638 1M-1R023638 1M-1R023638 1M-1R023638 1M-1R023638 1M-1R023638 1M-1R023638 1M-1R023638 1M-1R023638 1M-1R023638 1M-1R023638	11.99 11.99 11.99 11.99 11.99 05.02 07.03 05.02 11.99 11.99 11.99 05.03 02.01 05.02 09.00 05.02 02.01	+ ESP + ESP + ESP + ESP + ESP + ESP + ESP + ESP + ESP + ESP + ESP + ESP + ESP + ESP + ESP + ESP + ESP + ESP	03.7863-0402.4	300124		10"	ATE
	1.4 i 16V 1.6 i 16V 1.8 20V 1.8 20V T 1.8 20V T 4x4 1.8 T Cupra R 1.8 T Cupra R	55 55 92 132 132 154 165	1M-1B018342 1M-1B018342 1M-1B018342 1M-1B018342 1M-1B018342 1M-1B018342 1M-1B018342	07.05 07.05 07.05 07.05 07.05 07.05 07.05	+ ESP + ESP + ESP + ESP + ESP + ESP + ESP	03.7860-0602.4	300141		10"	ATE













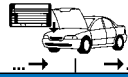







SEAT LEON I (1M1) (99-05)

	1.8 Turbo 4x4	◀154	1M-1B018342			07.05 + ESP	03.7860-0602.4	300141		10"	ATE
	1.9 SDI	◀ 50	1M-1B018342			07.05 + ESP					
	1.9 TDI	◀	1M-1B018342			07.05 + ESP					
	1.9 TDI	◀ 81	1M-1B018342			07.05 + ESP					
	1.9 TDI	◀ 96	1M-1B018342			07.05 + ESP					
	1.9 TDI	◀110	1M-1B018342			07.05 + ESP					
	1.9 TDI Syncro	◀110	1M-1B018342			07.05 + ESP					
	2.3 VR5	◀110	1M-1B018342			07.05 + ESP					
	2.8	◀150	1M-1B018342			07.05 + ESP					
	2.8 V6 Cupra 4x4	◀150	1M-1B018342			07.05 + ESP					
	1.4 i 16V	◀ 55	1M-1R023639			07.05 + ESP	03.7860-0602.4	300141		10"	ATE
1.6 i 16V	◀	1M-1R023639			07.05 + ESP						
1.8 20V	◀ 92	1M-1R023639			07.05 + ESP						
1.8 20V T	◀132	1M-1R023639			07.05 + ESP						
1.8 20V T 4x4	◀132	1M-1R023639			07.05 + ESP						
1.8 T Cupra R	◀154	1M-1R023639			07.05 + ESP						
1.8 T Cupra R	◀165	1M-1R023639			07.05 + ESP						
1.8 Turbo 4x4	◀154	1M-1R023639			07.05 + ESP						
1.9 SDI	◀ 50	1M-1R023639			07.05 + ESP						
1.9 TDI	◀	1M-1R023639			07.05 + ESP						
1.9 TDI	◀ 81	1M-1R023639			07.05 + ESP						
1.9 TDI	◀ 96	1M-1R023639			07.05 + ESP						
1.9 TDI	◀110	1M-1R023639			07.05 + ESP						
1.9 TDI Syncro	◀110	1M-1R023639			07.05 + ESP						
2.3 VR5	◀110	1M-1R023639			07.05 + ESP						
2.8	◀150	1M-1R023639			07.05 + ESP						
2.8 V6 Cupra 4x4	◀150	1M-1R023639			07.05 + ESP						
	1.4 i 16V	◀ 55			11.99	07.05 - ESP	24.2123-1709.3	010503		Thz 23,81	
	1.6 i 16V	◀			11.99	07.05 - ESP					
	1.8 20V	◀ 92			11.99	07.05 - ESP					
	1.8 20V T	◀132			11.99	07.05 - ESP					
	1.8 20V T 4x4	◀132			11.99	07.05 - ESP					
	1.8 T Cupra R	◀154			05.02	07.05 - ESP					
	1.8 T Cupra R	◀165			07.03	07.05 - ESP					
	1.8 Turbo 4x4	◀154			05.02	07.05 - ESP					
	1.9 SDI	◀ 50			11.99	07.05 - ESP					
	1.9 TDI	◀			11.99	07.05 - ESP					
	1.9 TDI	◀ 81			11.99	07.05 - ESP					
1.9 TDI	◀ 96			05.03	07.05 - ESP						
1.9 TDI	◀110			02.01	07.05 - ESP						
1.9 TDI Syncro	◀110			05.02	07.05 - ESP						
2.3 VR5	◀110			09.00	07.05 - ESP						
2.8	◀150			05.02	07.05 - ESP						
2.8 V6 Cupra 4x4	◀150			02.01	07.05 - ESP						
	1.4 i 16V	◀ 55			11.99	08.00 + ESP	03.2123-2024.3	010597		Thz 23,81	ATE
	1.6 i 16V	◀			11.99	08.00 + ESP					
	1.8 20V	◀ 92			11.99	08.00 + ESP					
	1.8 20V T	◀132			11.99	08.00 + ESP					
	1.8 20V T 4x4	◀132			11.99	08.00 + ESP					
	1.9 SDI	◀ 50			11.99	08.00 + ESP					
	1.9 TDI	◀			11.99	08.00 + ESP					
	1.9 TDI	◀ 81			11.99	08.00 + ESP					
	1.4 i 16V	◀ 55			09.00	07.05 + ESP	03.2123-2715.3	010802		Thz 23,81	ATE
	1.6 i 16V	◀			09.00	07.05 + ESP					
	1.8 20V	◀ 92			09.00	07.05 + ESP					
1.8 20V T	◀132			09.00	07.05 + ESP						
1.8 20V T 4x4	◀132			11.99	07.05 + ESP						
1.8 T Cupra R	◀154			05.02	07.05 + ESP						
1.8 T Cupra R	◀165			07.03	07.05 + ESP						
1.8 Turbo 4x4	◀154			05.02	07.05 + ESP						
1.9 SDI	◀ 50			09.00	07.05 + ESP						
1.9 TDI	◀			09.00	07.05 + ESP						
1.9 TDI	◀ 81			11.99	07.05 + ESP						
1.9 TDI	◀ 96			09.00	07.05 + ESP						
1.9 TDI	◀110			02.01	07.05 + ESP						
1.9 TDI Syncro	◀110			05.02	07.05 + ESP						
2.3 VR5	◀110			09.00	07.05 + ESP						
2.8	◀150			05.02	07.05 + ESP						
2.8 V6 Cupra 4x4	◀150			02.01	07.05 + ESP						
	1.4 i 16V	▶ 55			11.99	08.00 + ESP	03.2123-2064.3	010598		Thz 23,81	ATE
	1.6 i 16V	▶			11.99	08.00 + ESP					
	1.8 20V	▶ 92			11.99	08.00 + ESP					
	1.8 20V T	▶132			11.99	08.00 + ESP					
	1.8 20V T 4x4	▶132			11.99	08.00 + ESP					
	1.9 SDI	▶ 50			11.99	08.00 + ESP					
	1.9 TDI	▶			11.99	08.00 + ESP					
	1.9 TDI	▶ 81			11.99	08.00 + ESP					
	1.4 i 16V	▶ 55			09.00	07.05 + ESP	03.2123-2774.3	010803		Thz 23,81	ATE
	1.6 i 16V	▶			09.00	07.05 + ESP					
	1.8 20V	▶ 92			09.00	07.05 + ESP					
1.8 20V T	▶132			09.00	07.05 + ESP						
1.8 20V T 4x4	▶132			11.99	07.05 + ESP						
1.8 T Cupra R	▶154			05.02	07.05 + ESP						
1.8 T Cupra R	▶165			07.03	07.05 + ESP						
1.8 Turbo 4x4	▶154			05.02	07.05 + ESP						
1.9 SDI	▶ 50			09.00	07.05 + ESP						
1.9 TDI	▶			09.00	07.05 + ESP						

	 kW							
SEAT LEON I (1M1) (99-05)								
	1.9 TDI ▶ 81 1.9 TDI ▶ 96 1.9 TDI ▶ 110 1.9 TDI Syncro ▶ 110 2.3 VR5 ▶ 110 2.8 ▶ 150 2.8 V6 Cupra 4x4 ▶ 150			09.00 07.05 + ESP 05.03 07.05 + ESP 02.01 07.05 + ESP 05.02 07.05 + ESP 09.00 07.05 + ESP 05.02 07.05 + ESP 02.01 07.05 + ESP	03.2123-2774.3	010803		Thz 23,81 ATE
	1.4 i 16V 55 1.6 i 16V 92 1.8 20V 132 1.8 20V T 132 1.8 20V T 4x4 132 1.8 T Cupra R 154 1.8 T Cupra R 165 1.8 Turbo 4x4 154 1.9 SDI 50 1.9 TDI 81 1.9 TDI 96 1.9 TDI 110 1.9 TDI Syncro 110 2.3 VR5 110 2.8 150 2.8 V6 Cupra 4x4 150			11.99 07.05 PR: 1LQ,1LS 11.99 07.05 PR: 1LQ,1LS 11.99 07.05 PR: 1LQ,1LS 11.99 07.05 PR: 1LQ,1LS 11.99 07.05 PR: 1LQ,1LS 05.02 07.05 PR: 1LT 07.03 07.05 PR: 1LT 11.99 07.05 PR: 1LQ,1LS 11.99 07.05 PR: 1LQ,1LS 11.99 07.05 PR: 1LQ,1LS 02.01 07.05 PR: 1LQ,1LS 05.02 07.05 PR: 1LQ,1LS 09.00 07.05 PR: 1LQ,1LS 05.02 07.05 PR: 1LQ,1LS 02.01 07.05 PR: 1LT	11.9541-9549.2 220575 11.9541-9550.2 220576 11.8171-0069.1 250152 11.0101-5409.2 260035 11.8171-0008.1 990049 11.8116-0143.1 390513	2	D=54, - Halter ATE D=54, - Halter ATE Führungsbolzen ATE Hülzensatz ATE Führungsbolzen ATE Haltefeder ATE	
	1.4 i 16V 55 1.6 i 16V 92 1.8 20V 132 1.8 20V T 132 1.8 20V T 4x4 132 1.8 Turbo 4x4 154 1.9 SDI 50 1.9 TDI 81 1.9 TDI 96 1.9 TDI 110 1.9 TDI Syncro 110 2.3 VR5 110 2.8 150			11.99 07.05 PR: 1LE 11.99 07.05 PR: 1LE 11.99 07.05 PR: 1LE 11.99 07.05 PR: 1LE 11.99 07.05 PR: 1LE 05.02 07.05 PR: 1LE 11.99 07.05 PR: 1LE 11.99 07.05 PR: 1LE 05.03 07.05 PR: 1LE 02.01 07.05 PR: 1LE 05.02 07.05 PR: 1LE 09.00 07.05 PR: 1LE 05.02 07.05 PR: 1LE	11.3541-8523.2 220115 11.3541-8524.2 220116 24.3541-8523.5 240551 24.3541-8524.5 240552 11.8170-0306.1 260102 11.0441-5409.2 250031 11.0101-5409.2 260035 11.8171-0008.1 990049 11.8116-0143.1 390513	2	D=54, - Halter ATE D=54, - Halter ATE D=54, - Halter ATE D=54, - Halter ATE Halter ATE Dichtungssatz ATE Hülzensatz ATE Führungsbolzen ATE Haltefeder ATE	
	1.4 i 16V 55 1.6 i 16V 92 1.8 20V 132 1.8 20V T 132 1.8 20V T 4x4 132 1.8 Turbo 4x4 154 1.9 SDI 50 1.9 TDI 81 1.9 TDI 96 1.9 TDI 110 1.9 TDI Syncro 110 2.3 VR5 110 2.8 150			11.99 07.05 PR: 1LJ,1ZQ 11.99 07.05 PR: 1LJ,1ZQ 11.99 07.05 PR: 1LJ,1ZQ 11.99 07.05 PR: 1LJ,1ZQ 11.99 07.05 PR: 1LJ,1ZQ 05.02 07.05 PR: 1LJ,1ZQ 11.99 07.05 PR: 1LJ,1ZQ 11.99 07.05 PR: 1LJ,1ZQ 05.03 07.05 PR: 1LJ,1ZQ 02.01 07.05 PR: 1LJ,1ZQ 05.02 07.05 PR: 1LJ,1ZQ 09.00 07.05 PR: 1LJ,1ZQ 05.02 07.05 PR: 1LJ,1ZQ	11.9541-9595.2 220501 11.9541-9596.2 220502 11.0441-5409.2 250031 11.0101-5409.2 260035 11.8171-0008.1 990049 11.8116-0143.1 390513	2	D=54, - Halter ATE D=54, - Halter ATE Dichtungssatz ATE Hülzensatz ATE Führungsbolzen ATE Haltefeder ATE	
	1.4 i 16V 55 1.6 i 16V 92 1.8 20V 132 1.8 20V T 132 1.9 SDI 50 1.9 TDI 81 1.9 TDI 96 1.9 TDI 110 1.9 TDI Syncro 110 2.3 VR5 110			11.99 07.05 11.99 07.05 11.99 07.05 11.99 07.05 11.99 07.05 11.99 07.05 05.03 07.05 02.01 07.05 05.02 07.05 09.00 07.05	24.5143-0439.3	331411	2	L=439
	1.8 20V T 4x4 132 1.8 T Cupra R 154 1.8 T Cupra R 165 1.8 Turbo 4x4 154 2.8 150 2.8 V6 Cupra 4x4 150			11.99 07.05 05.02 07.05 07.03 07.05 05.02 07.05 05.02 07.05 02.01 07.05	24.5143-0569.3	331398	2	L=569
	1.4 i 16V 55			11.99 07.05	24.3384-1729.7 220541 24.3384-1730.7 220542		 	D=38(M12x1), - Halter TRW D=38(M12x1), - Halter TRW
	1.6 i 16V 92 1.8 20V 132 1.8 20V T 132 1.8 20V T 4x4 132 1.8 Turbo 4x4 154 1.9 SDI 50 1.9 TDI 81 1.9 TDI 96 1.9 TDI 110 1.9 TDI Syncro 110 2.3 VR5 110 2.8 150			11.99 07.05 PR: 1KK,1KP,1KQ 11.99 07.05 PR: 1KK,1KP,1KQ 11.99 07.05 PR: 1KK,1KP,1KQ 11.99 07.05 PR: 1KK,1KP,1KQ 05.02 07.05 PR: 1KK,1KP,1KQ 11.99 07.05 PR: 1KK,1KP,1KQ 11.99 07.05 PR: 1KK,1KP,1KQ 05.03 07.05 PR: 1KK,1KP,1KQ 02.01 07.05 PR: 1KK,1KP,1KQ 05.02 07.05 PR: 1KK,1KP,1KQ 09.00 07.05 PR: 1KK,1KP,1KQ 05.02 07.05 PR: 1KK,1KP,1KQ	24.3414-1705.7 220549 24.3414-1706.7 220550		  	D=41, - Halter TRW D=41, - Halter TRW
	1.6 i 16V 92 1.8 20V 132			11.99 07.05 PR: 1KY,2EE 11.99 07.05 PR: 1KY,2EE	24.3384-1745.7 220609 24.3384-1746.7 220610		 	D=38, - Halter TRW D=38, - Halter TRW

										
SEAT LEON I (1M1) (99-05)										
	1.8 20V T 1.8 20V T 4x4 1.8 T Cupra R 1.8 T Cupra R 1.8 Turbo 4x4 1.9 SDI 1.9 TDI 1.9 TDI 1.9 TDI 1.9 TDI 1.9 TDI Syncro 2.3 VR5 2.8 2.8 V6 Cupra 4x4	132 132 154 165 154 50 81 96 110 110 110 150 150		11.99 07.05 11.99 07.05 05.02 07.05 07.03 07.05 05.02 07.05 11.99 07.05 11.99 07.05 11.99 07.05 05.03 07.05 02.01 07.05 05.02 07.05 09.00 07.05 05.02 07.05 02.01 07.05	PR: 1KY,2EE PR: 1KY,2EE PR: 1KY PR: 1KY PR: 1KY,2EE PR: 1KY,2EE PR: 1KY,2EE PR: 1KY,2EE PR: 1KY,2EE PR: 1KY,2EE PR: 1KY,2EE PR: 1KY,2EE PR: 1KY,2EE PR: 1KY	24.3384-1745.7 24.3384-1746.7	220609 220610		D=38, - Halter D=38, - Halter	TRW TRW
	1.4 i 16V 1.6 i 16V 1.8 20V 1.8 20V T 1.8 T Cupra R 1.8 T Cupra R 1.9 SDI 1.9 TDI 1.9 TDI 1.9 TDI 1.9 TDI 2.8 1.8 20V T 4x4 1.8 Turbo 4x4 1.9 TDI Syncro 2.8 V6 Cupra 4x4	55 92 92 132 154 165 50 81 96 110 110 150 132 154 110 150		11.99 07.05 11.99 07.05 11.99 07.05 11.99 07.05 05.02 07.05 07.03 07.05 11.99 07.05 11.99 07.05 11.99 07.05 05.03 07.05 02.01 07.05 02.01 07.05 11.99 07.05 05.02 07.05 05.02 07.05 02.01 07.05		83.7858-0140.3 83.7858-0140.3	330837 330837	2 2	L=140 L=140	
	1.4 i 16V 1.6 i 16V 1.8 20V 1.8 20V T 1.8 20V T 4x4 1.8 T Cupra R 1.8 T Cupra R 1.8 Turbo 4x4 1.9 SDI 1.9 TDI 1.9 TDI 1.9 TDI 1.9 TDI Syncro 2.3 VR5 2.8 2.8 V6 Cupra 4x4	55 92 92 132 132 154 165 154 50 81 96 110 110 110 150 150		11.99 07.05 11.99 07.05 11.99 07.05 11.99 07.05 11.99 07.05 05.02 07.05 07.03 07.05 05.02 07.05 11.99 07.05 11.99 07.05 05.03 07.05 02.01 07.05 05.02 07.05 09.00 07.05 05.02 07.05 02.01 07.05		24.3727-0173.2	580173	2 ↓	L=1693	
	1.4 i 16V 1.6 i 16V 1.8 20V 1.8 20V T 1.8 20V T 4x4 1.8 T Cupra R 1.8 T Cupra R 1.8 Turbo 4x4 1.9 SDI 1.9 TDI 1.9 TDI 1.9 TDI 1.9 TDI Syncro 2.3 VR5 2.8 2.8 V6 Cupra 4x4	55 92 92 132 132 154 165 154 50 81 96 110 110 110 150 150		11.99 07.05 11.99 07.05 11.99 07.05 11.99 07.05 11.99 07.05 05.02 07.05 07.03 07.05 05.02 07.05 11.99 07.05 11.99 07.05 05.03 07.05 02.01 07.05 05.02 07.05 09.00 07.05 05.02 07.05 02.01 07.05		03.6583-0179.3	320228		BRL 8/3 (4)	ATE
	1.4 i 16V 1.6 i 16V 1.8 20V 1.8 20V T 1.8 20V T 4x4 1.8 T Cupra R 1.8 T Cupra R 1.8 Turbo 4x4 1.9 SDI 1.9 TDI 1.9 TDI 1.9 TDI 1.9 TDI Syncro 2.3 VR5 2.8 2.8 V6 Cupra 4x4	55 92 92 132 132 154 165 154 50 81 96 110 110 110 150 150		11.99 07.05 11.99 07.05 11.99 07.05 11.99 07.05 11.99 07.05 05.02 07.05 07.03 07.05 05.02 07.05 11.99 07.05 11.99 07.05 05.03 07.05 02.01 07.05 05.02 07.05 09.00 07.05 05.02 07.05 02.01 07.05		24.2415-1701.3	030095		Gz 15,87	
	1.4 i 16V 1.6 i 16V 1.8 20V 1.8 20V T 1.8 20V T 4x4 1.8 T Cupra R 1.8 T Cupra R	55 92 92 132 132 154 154		11.99 07.05 11.99 07.05 11.99 07.05 11.99 07.05 11.99 07.05 05.02 07.05 05.02 07.05		24.2415-1702.3	030096		Gz 15,87	



SEAT LEON I (1M1) (99-05)

	1.8 T Cupra R ▶165 1.8 Turbo 4x4 ▶154 1.9 SDI ▶50 1.9 TDI ▶ 1.9 TDI ▶81 1.9 TDI ▶96 1.9 TDI ▶110 1.9 TDI Syncro ▶110 2.3 VR5 ▶110 2.8 ▶150 2.8 V6 Cupra 4x4 ▶150		07.03 07.05 05.02 07.05 11.99 07.05 11.99 07.05 11.99 07.05 05.03 07.05 02.01 07.05 05.02 07.05 09.00 07.05 05.02 07.05 02.01 07.05		24.2415-1702.3 030096			Gz 15,87
	1.4 i 16V 55 1.6 i 16V 92 1.8 20V 132 1.8 20V T 132 1.8 T Cupra R 154 1.8 T Cupra R 165 1.8 Turbo 4x4 154 1.9 SDI 50 1.9 TDI 81 1.9 TDI 96 1.9 TDI 110 1.9 TDI Syncro 110 2.3 VR5 110 2.8 150 2.8 V6 Cupra 4x4 150		11.99 07.05 11.99 07.05 11.99 07.05 11.99 07.05 05.02 07.05 07.03 07.05 05.02 07.05 11.99 07.05 11.99 07.05 05.03 07.05 02.01 07.05 05.02 07.05 09.00 07.05 05.02 07.05 02.01 07.05		24.2519-1701.3 040075 24.2523-1701.3 040080		+ Schaltseilzug ¹⁾ + Schaltgestänge ²⁾	Nz 19,05 Nz 23,81

SEAT LEON II (1P1) (05-12)

	1.2 TSI ◀77 1.4 i 16V ◀63 1.4 TSI ◀92 1.6 i ◀75 1.6 LPG / Multifuel ◀75 1.6 TDI Ecomotive ◀77 1.8 TSI ◀118 1.9 TDI ◀ 1.9 TDI ◀81 2.0 Cupra R ◀195 2.0 FSI ◀110 2.0 TDI ◀ 2.0 TDI ◀125 2.0 TFSI ◀136 2.0 TFSI ◀155 2.0 TFSI ◀177		02.10 05.10 PR: 1AC,1AT 06.06 05.10 PR: 1AC,1AT 11.07 05.10 PR: 1AC,1AT 08.05 05.10 PR: 1AC,1AT 12.09 05.10 PR: 1AC,1AT 02.10 05.10 PR: 1AC,1AT 06.07 05.10 PR: 1AC,1AT 08.05 05.10 PR: 1AC,1AT 11.06 05.10 PR: 1AC,1AT 08.05 05.10 PR: 1AC,1AT 02.06 05.10 PR: 1AC,1AT 08.05 05.10 PR: 1AC,1AT 09.05 05.10 PR: 1AC,1AT 11.06 05.10 PR: 1AC,1AT		03.7863-3232.4 300307 03.7863-3332.4 300308		Kolbendurchmesser Ø 22,20mm ³⁾ Kolbendurchmesser Ø 23,81mm ⁴⁾	10" 10"	ATE ATE
	1.2 TSI ◀77 1.4 i 16V ◀63 1.4 TSI ◀92 1.6 i ◀75 1.6 LPG / Multifuel ◀75 1.6 TDI ◀66 1.6 TDI Ecomotive ◀77 1.8 TSI ◀118 1.9 TDI ◀ 1.9 TDI ◀81 2.0 Cupra R ◀195 2.0 FSI ◀110 2.0 TDI ◀ 2.0 TDI ◀125 2.0 TFSI ◀136 2.0 TFSI ◀155 2.0 TFSI ◀177		06.10 10.12 PR: 1AC,1AT 06.10 10.12 PR: 1AC,1AT 06.10 10.12 PR: 1AC,1AT 06.10 10.12 PR: 1AC,1AT 06.10 10.12 PR: 1AC,1AT 11.10 10.12 PR: 1AC,1AT 06.10 10.12 PR: 1AC,1AT 06.10 10.12 PR: 1AC,1AT 06.10 10.12 PR: 1AC,1AT 06.10 10.12 PR: 1AC,1AT 06.10 10.12 PR: 1AC,1AT 06.10 10.12 PR: 1AC,1AT 06.10 10.12 PR: 1AC,1AT 06.10 10.12 PR: 1AC,1AT		03.7863-3232.4 300307 03.7863-3332.4 300308		Kolbendurchmesser Ø 22,20mm ³⁾ Kolbendurchmesser Ø 23,81mm ⁴⁾	10" 10"	ATE ATE
	1.2 TSI ◀77 1.4 i 16V ◀63 1.4 TSI ◀92 1.6 i ◀75 1.6 LPG / Multifuel ◀75 1.6 TDI ◀66 1.6 TDI Ecomotive ◀77 1.8 TSI ◀118 1.9 TDI ◀ 1.9 TDI ◀81 2.0 Cupra R ◀195 2.0 FSI ◀110 2.0 TDI ◀ 2.0 TDI ◀125 2.0 TFSI ◀136 2.0 TFSI ◀155 2.0 TFSI ◀177		02.10 10.12 PR: 1AS 06.06 10.12 PR: 1AS 11.07 10.12 PR: 1AS 08.05 10.12 PR: 1AS 12.09 10.12 PR: 1AS 11.10 10.12 PR: 1AS 02.10 10.12 PR: 1AS 06.07 10.12 PR: 1AS 08.05 10.12 PR: 1AS 11.06 10.12 PR: 1AS 08.05 10.12 PR: 1AS 08.05 10.12 PR: 1AS 02.06 10.12 PR: 1AS 08.05 10.12 PR: 1AS 09.05 10.12 PR: 1AS 11.06 10.12 PR: 1AS		03.7863-9602.4 300206		Kolbendurchmesser Ø 22,20mm ³⁾	10"	ATE
	1.2 TSI ◀77 F1P-6-027023 1.4 i 16V ◀63 F1P-6-027023 1.4 TSI ◀92 F1P-6-027023 1.6 i ◀75 F1P-6-027023 1.6 LPG / Multifuel ◀75 F1P-6-027023 1.6 TDI Ecomotive ◀77 F1P-6-027023 1.8 TSI ◀118 F1P-6-027023		05.10 05.10 05.10 05.10 05.10 05.10 05.10		03.2122-2129.3 010799 03.2123-3449.3 010808		PR: 1AC,1AT,1AS PR: 1AC,1AT,1LJ,1ZA	THz 22,20 THz 23,81	ATE ATE





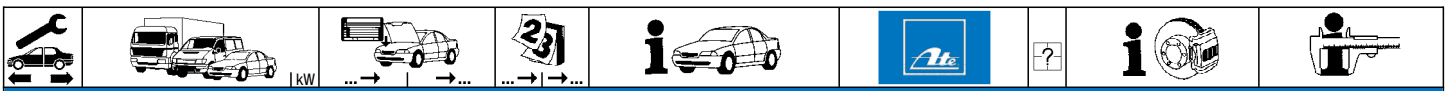









¹⁾ + gearshift cable / + leva cambio con cavo / + câble de changem.de vitesse / + cable de acc. del cambio
²⁾ + gearshift linkage / + leva cambio con tiranteria / + tige de changem.de vitesse / + varillaje del cambio
³⁾ piston diameter Ø 22,20mm / diametro del pistone Ø 22,20mm / diamètre de piston Ø 22,20mm / diámetro del pistón Ø 22,20mm
⁴⁾ piston diameter Ø 23,81mm / diametro del pistone Ø 23,81mm / diamètre de piston Ø 23,81mm / diámetro del pistón Ø 23,81mm



























SEAT LEON II (1P1) (05-12)

	1.9 TDI 1.9 TDI 2.0 Cupra R 2.0 FSI 2.0 TDI 2.0 TDI 2.0 TFSI 2.0 TFSI 2.0 TFSI	◀ FIP-6-027023 ◀ 81 FIP-6-027023 ◀195 FIP-6-027023 ◀110 FIP-6-027023 ◀ FIP-6-027023 ◀125 FIP-6-027023 ◀136 FIP-6-027023 ◀155 FIP-6-027023 ◀177 FIP-6-027023			05.10 05.10 05.10 05.10 05.10 05.10 05.10 05.10 05.10	03.2122-2129.3 03.2123-3449.3	010799 010808	PR: 1AC,1AT,1AS PR: 1AC,1AT,1LJ,1ZA	Thz 22,20 Thz 23,81	ATE ATE
	1.2 TSI 1.4 i 16V 1.4 TSI 1.6 i 1.6 LPG / Multifuel 1.6 TDI 1.6 TDI Ecomotive 1.8 TSI 1.9 TDI 1.9 TDI 2.0 Cupra R 2.0 FSI 2.0 TDI 2.0 TDI 2.0 TFSI 2.0 TFSI 2.0 TFSI	◀ 77 ◀ 63 ◀ 92 ◀ 75 ◀ 75 ◀ 66 ◀ 77 ◀118 ◀ ◀ 81 ◀195 ◀110 ◀ ◀125 ◀136 ◀155 ◀177		06.10 06.10 06.10 06.10 06.10 11.10 06.10 06.10 06.10 06.10 06.10 06.10 06.10 06.10 06.10 06.10 06.10	10.12 PR: 1LB,1ZA,1ZB 10.12 PR: 1LB,1ZA,1ZB 10.12 PR: 1LB,1ZA,1ZB 10.12 PR: 1LB,1ZA,1ZB 10.12 PR: 1LB,1ZA,1ZB 10.12 PR: 1LB,1ZA,1ZB 10.12 PR: 1LB,1ZA,1ZB 10.12 PR: 1LB,1ZA,1ZB 10.12 PR: 1LB,1ZA,1ZB 10.12 PR: 1LB,1ZA,1ZB 10.12 PR: 1LB,1ZA,1ZB 10.12 PR: 1LB,1ZA,1ZB 10.12 PR: 1LB,1ZA,1ZB 10.12 PR: 1LB,1ZA,1ZB 10.12 PR: 1LB,1ZA,1ZB 10.12 PR: 1LB,1ZA,1ZB 10.12 PR: 1LB,1ZA,1ZB	03.2123-3449.3	010808		Thz 23,81	ATE
	1.2 TSI 1.4 i 16V 1.4 TSI 1.6 i 1.6 LPG / Multifuel 1.6 TDI 1.6 TDI Ecomotive 1.8 TSI 1.9 TDI 1.9 TDI 2.0 Cupra R 2.0 FSI 2.0 TDI 2.0 TDI 2.0 TFSI 2.0 TFSI 2.0 TFSI	◀ 77 ◀ 63 ◀ 92 ◀ 75 ◀ 75 ◀ 66 ◀ 77 ◀118 ◀ ◀ 81 ◀195 ◀110 ◀ ◀125 ◀136 ◀155 ◀177		06.10 06.10 06.10 06.10 06.10 11.10 06.10 06.10 06.10 06.10 06.10 06.10 06.10 06.10 06.10 06.10 06.10	10.12 PR: 1ZE,1ZF 10.12 PR: 1ZE,1ZF 10.12 PR: 1ZE,1ZF 10.12 PR: 1ZE,1ZF 10.12 PR: 1ZE,1ZF 10.12 PR: 1ZE,1ZF 10.12 PR: 1ZE,1ZF 10.12 PR: 1ZE,1ZF 10.12 PR: 1ZE,1ZF 10.12 PR: 1ZE,1ZF 10.12 PR: 1ZE,1ZF 10.12 PR: 1ZE,1ZF 10.12 PR: 1ZE,1ZF 10.12 PR: 1ZE,1ZF 10.12 PR: 1ZE,1ZF 10.12 PR: 1ZE,1ZF 10.12 PR: 1ZE,1ZF	03.2122-2129.3	010799		Thz 22,20	ATE
	1.2 TSI 1.4 i 16V 1.4 TSI 1.6 i 1.6 LPG / Multifuel 1.6 TDI 1.6 TDI Ecomotive 1.8 TSI 1.9 TDI 1.9 TDI 2.0 Cupra R 2.0 FSI 2.0 TDI 2.0 TDI 2.0 TFSI 2.0 TFSI 2.0 TFSI	77 63 92 75 75 66 77 118 81 195 110 125 136 155 177		02.10 06.06 11.07 08.05 12.09 11.10 02.10 06.07 08.05 08.05 11.06 08.05 08.05 02.06 08.05 09.05 11.06	10.12 PR: 1ZF,1ZM 10.12 PR: 1ZF,1ZM 10.12 PR: 1ZF,1ZM 10.12 PR: 1ZF,1ZM 10.12 PR: 1ZF,1ZM 10.12 PR: 1ZF,1ZM 10.12 PR: 1ZF,1ZM 10.12 PR: 1ZF,1ZM 10.12 PR: 1ZF,1ZM 10.12 PR: 1ZF,1ZM 10.12 PR: 1ZF,1ZM 10.12 PR: 1ZF,1ZM 10.12 PR: 1ZF,1ZM 10.12 PR: 1ZF,1ZM 10.12 PR: 1ZF,1ZM 10.12 PR: 1ZF,1ZM 10.12 PR: 1ZF,1ZM	11.9541-9549.2 11.9541-9550.2 11.0101-5409.2 11.8171-0069.1	220575 220576 260035 250152	 	D=54, - Halter D=54, - Halter Hülzensatz Führungsbolzen	ATE ATE ATE ATE
	1.2 TSI 1.4 i 16V 1.4 TSI 1.6 i 1.6 LPG / Multifuel 1.6 TDI 1.6 TDI Ecomotive 1.8 TSI 1.9 TDI 1.9 TDI 2.0 Cupra R 2.0 FSI 2.0 TDI 2.0 TDI 2.0 TFSI 2.0 TFSI 2.0 TFSI	77 63 92 75 75 66 77 118 81 195 110 125 136 155 177		02.10 06.06 11.07 08.05 12.09 11.10 02.10 06.07 08.05 08.05 11.06 08.05 08.05 02.06 09.05 11.06	10.12 PR: 1ZE 10.12 PR: 1ZE 10.12 PR: 1ZE 10.12 PR: 1ZE 10.12 PR: 1ZE 10.12 PR: 1ZE 10.12 PR: 1ZE 10.12 PR: 1ZE 10.12 PR: 1ZE 10.12 PR: 1ZE 10.12 PR: 1ZE 10.12 PR: 1ZE 10.12 PR: 1ZE 10.12 PR: 1ZE 10.12 PR: 1ZE 10.12 PR: 1ZE	11.9541-9553.2 11.9541-9554.2 11.0101-5409.2 11.8171-0008.1 11.8116-0351.1	220563 220564 260035 990049 390538	 2	D=54, - Halter D=54, - Halter Hülzensatz Führungsbolzen Haltefeder	ATE ATE ATE ATE ATE
	1.2 TSI 1.4 i 16V 1.4 TSI 1.6 i 1.6 LPG / Multifuel 1.6 TDI 1.6 TDI Ecomotive 1.8 TSI 1.9 TDI 1.9 TDI	77 63 92 75 75 66 77 118 81		02.10 06.06 11.07 08.05 12.09 11.10 02.10 06.07 08.05 08.05	10.12 PR: 1LJ 10.12 PR: 1LJ 10.12 PR: 1LJ 10.12 PR: 1LJ 10.12 PR: 1LJ 10.12 PR: 1LJ 10.12 PR: 1LJ 10.12 PR: 1LJ 10.12 PR: 1LJ 10.12 PR: 1LJ	11.9541-9553.2 11.9541-9554.2 11.0101-5409.2 11.8171-0008.1 11.8116-0351.1	220563 220564 260035 990049 390538	 2	D=54, - Halter D=54, - Halter Hülzensatz Führungsbolzen Haltefeder	ATE ATE ATE ATE ATE

	 kW									
SEAT LEON II (1P1) (05-12)										
	2.0 Cupra R	195	11.06	10.12	PR: 1LJ	11.9541-9553.2	220563	2	D=54, - Halter ATE D=54, - Halter ATE Hülzensatz ATE Führungsbolzen ATE Haltefeder ATE	ATE ATE ATE ATE ATE
	2.0 FSI	110	08.05	10.12	PR: 1LJ	11.9541-9554.2	220564			
	2.0 TDI		08.05	10.12	PR: 1LJ	11.0101-5409.2	260035			
	2.0 TDI	125	02.06	10.12	PR: 1LJ	11.8171-0008.1	990049			
	2.0 TFSI	136	08.05	10.12	PR: 1LJ	11.8116-0351.1	390538			
	2.0 TFSI	155	09.05	10.12	PR: 1LJ					
	2.0 TFSI	177	11.06	10.12	PR: 1LJ					
	1.4 i 16V	63	06.06	09.09	PR: 1LU	11.9576-9995.2	220651			
	1.4 TSI	92	11.07	09.09	PR: 1LU	11.9576-9996.2	220652			
	1.6 i	75	08.05	09.09	PR: 1LU	11.0101-5409.2	260035			
1.8 TSI	118	06.07	09.09	PR: 1LU	11.8171-0008.1	990049				
1.9 TDI		08.05	09.09	PR: 1LU	11.8116-0410.2	390589				
1.9 TDI	81	08.05	09.09	PR: 1LU						
2.0 Cupra R	195	11.06	09.09	PR: 1LU						
2.0 FSI	110	08.05	09.09	PR: 1LU						
2.0 TDI		08.05	09.09	PR: 1LU						
2.0 TDI	125	02.06	09.09	PR: 1LU						
2.0 TFSI	136	08.05	09.09	PR: 1LU						
2.0 TFSI	155	09.05	09.09	PR: 1LU						
2.0 TFSI	177	11.06	09.09	PR: 1LU						
	1.2 TSI	77	02.10	10.12	PR: 1LB	11.9576-9948.2	220810	2	D=57, - Halter ATE Hülzensatz ATE Führungsbolzen ATE Haltefeder ATE	ATE ATE ATE ATE ATE ATE ATE ATE ATE ATE ATE ATE ATE ATE ATE ATE ATE
	1.4 i 16V	63	10.09	10.12	PR: 1LB	11.0101-5409.2	260035			
	1.4 TSI	92	10.09	10.12	PR: 1LB	11.8171-0008.1	990049			
	1.6 i	75	10.09	10.12	PR: 1LB	11.8116-0006.2	390601			
	1.6 LPG / Multifuel	75	12.09	10.12	PR: 1LB					
	1.6 TDI	66	11.10	10.12	PR: 1LB					
	1.6 TDI Ecomotive	77	02.10	10.12	PR: 1LB					
	1.8 TSI	118	10.09	10.12	PR: 1LB					
	1.9 TDI		10.09	10.12	PR: 1LB					
	1.9 TDI	81	10.09	10.12	PR: 1LB					
	2.0 Cupra R	195	10.09	10.12	PR: 1LB					
	2.0 FSI	110	10.09	10.12	PR: 1LB					
	2.0 TDI		10.09	10.12	PR: 1LB					
	2.0 TDI	125	10.09	10.12	PR: 1LB					
	2.0 TFSI	136	10.09	10.12	PR: 1LB					
	2.0 TFSI	155	10.09	10.12	PR: 1LB					
	2.0 TFSI	177	10.09	10.12	PR: 1LB					
	1.2 TSI	77	02.10	10.12	PR: 1ZA,1ZB,1ZE,1ZF	24.5143-0564.3	331433	2	L=564	
	1.4 i 16V	63	06.06	10.12	PR: 1ZA,1ZB,1ZE,1ZF					
	1.4 TSI	92	11.07	10.12	PR: 1ZA,1ZB,1ZE,1ZF					
	1.6 i	75	08.05	10.12	PR: 1ZA,1ZB,1ZE,1ZF					
	1.6 LPG / Multifuel	75	12.09	10.12	PR: 1ZA,1ZB,1ZE,1ZF					
	1.6 TDI	66	11.10	10.12	PR: 1ZA,1ZB,1ZE,1ZF					
	1.6 TDI Ecomotive	77	02.10	10.12	PR: 1ZA,1ZB,1ZE,1ZF					
	1.8 TSI	118	06.07	10.12	PR: 1ZA,1ZB,1ZE,1ZF					
	1.9 TDI		08.05	10.12	PR: 1ZA,1ZB,1ZE,1ZF					
	1.9 TDI	81	08.05	10.12	PR: 1ZA,1ZB,1ZE,1ZF					
	2.0 Cupra R	195	11.06	10.12	PR: 1ZA,1ZB,1ZE,1ZF					
	2.0 FSI	110	08.05	10.12	PR: 1ZA,1ZB,1ZE,1ZF					
	2.0 TDI		08.05	10.12	PR: 1ZA,1ZB,1ZE,1ZF					
	2.0 TDI	125	02.06	10.12	PR: 1ZA,1ZB,1ZE,1ZF					
	2.0 TFSI	136	08.05	10.12	PR: 1ZA,1ZB,1ZE,1ZF					
	2.0 TFSI	155	09.05	10.12	PR: 1ZA,1ZB,1ZE,1ZF					
	2.0 TFSI	177	11.06	10.12	PR: 1ZA,1ZB,1ZE,1ZF					
	1.2 TSI	77	02.10	10.12	PR: 1LB	83.7849-0502.3	331125	2	L=504	
	1.4 i 16V	63	06.06	10.12	PR: 1LB					
	1.4 TSI	92	11.07	10.12	PR: 1LB					
	1.6 i	75	08.05	10.12	PR: 1LB					
	1.6 LPG / Multifuel	75	12.09	10.12	PR: 1LB					
	1.6 TDI	66	11.10	10.12	PR: 1LB					
	1.6 TDI Ecomotive	77	02.10	10.12	PR: 1LB					
	1.8 TSI	118	06.07	10.12	PR: 1LB					
	1.9 TDI		08.05	10.12	PR: 1LB					
	1.9 TDI	81	08.05	10.12	PR: 1LB					
	2.0 Cupra R	195	11.06	10.12	PR: 1LB					
	2.0 FSI	110	08.05	10.12	PR: 1LB					
	2.0 TDI		08.05	10.12	PR: 1LB					
	2.0 TDI	125	02.06	10.12	PR: 1LB					
	2.0 TFSI	136	08.05	10.12	PR: 1LB					
	2.0 TFSI	155	09.05	10.12	PR: 1LB					
	2.0 TFSI	177	11.06	10.12	PR: 1LB					
	1.2 TSI	77	02.10	10.12	PR: 1KD	24.3384-1755.7	220635	2	D=38, - Halter TRW D=38, - Halter TRW	TRW TRW
	1.4 i 16V	63	06.06	10.12	PR: 1KD	24.3384-1756.7	220636			
	1.4 TSI	92	11.07	10.12	PR: 1KD					
	1.6 i	75	08.05	10.12	PR: 1KD					
	1.6 LPG / Multifuel	75	12.09	10.12	PR: 1KD					
	1.6 TDI	66	11.10	10.12	PR: 1KD					
	1.6 TDI Ecomotive	77	02.10	10.12	PR: 1KD					
	1.8 TSI	118	06.07	10.12	PR: 1KD					
	1.9 TDI		08.05	10.12	PR: 1KD					
	1.9 TDI	81	08.05	10.12	PR: 1KD					
	2.0 Cupra R	195	11.06	10.12	PR: 1KD					
	2.0 FSI	110	08.05	10.12	PR: 1KD					
	2.0 TDI		08.05	10.12	PR: 1KD					
	2.0 TDI	125	02.06	10.12	PR: 1KD					
	2.0 TFSI	136	08.05	10.12	PR: 1KD					
	2.0 TFSI	155	09.05	10.12	PR: 1KD					



	 kW											
SEAT LEON II (1P1) (05-12)												
	2.0 TFSI	177		11.06	10.12	PR: 1KD	24.3384-1755.7	220635		D=38, - Halter	TRW	
							24.3384-1756.7	220636		D=38, - Halter	TRW	
	1.2 TSI	77		02.10	10.12	PR: 1KY	24.3414-1709.7	220631		D=41, - Halter	TRW	
	1.4 i 16V	63		06.06	10.12	PR: 1KY	24.3414-1710.7	220632		D=41, - Halter	TRW	
	1.4 TSI	92		11.07	10.12	PR: 1KY						
	1.6 i	75		08.05	10.12	PR: 1KY						
	1.6 LPG / Multifuel	75		12.09	10.12	PR: 1KY						
	1.6 TDI	66		11.10	10.12	PR: 1KY						
	1.6 TDI Ecomotive	77		02.10	10.12	PR: 1KY						
	1.8 TSI	118		06.07	10.12	PR: 1KY						
	1.9 TDI			08.05	10.12	PR: 1KY						
	1.9 TDI	81		08.05	10.12	PR: 1KY						
	2.0 Cupra R	195		11.06	10.12	PR: 1KY						
	2.0 FSI	110		08.05	10.12	PR: 1KY						
	2.0 TDI			08.05	10.12	PR: 1KY						
	2.0 TDI	125		02.06	10.12	PR: 1KY						
	2.0 TFSI	136		08.05	10.12	PR: 1KY						
	2.0 TFSI	155		09.05	10.12	PR: 1KY						
	2.0 TFSI	177		11.06	10.12	PR: 1KY						
		1.2 TSI	77		02.10	10.12	PR: 1KZ	24.3387-1717.7	220757		D=38, - Halter	TRW
1.4 i 16V		63		06.06	10.12	PR: 1KZ	24.3387-1718.7	220758		D=38, - Halter	TRW	
1.4 TSI		92		11.07	10.12	PR: 1KZ						
1.6 i		75		08.05	10.12	PR: 1KZ						
1.6 LPG / Multifuel		75		12.09	10.12	PR: 1KZ						
1.6 TDI		66		11.10	10.12	PR: 1KZ						
1.6 TDI Ecomotive		77		02.10	10.12	PR: 1KZ						
1.8 TSI		118		06.07	10.12	PR: 1KZ						
1.9 TDI				08.05	10.12	PR: 1KZ						
1.9 TDI		81		08.05	10.12	PR: 1KZ						
2.0 Cupra R		195		11.06	10.12	PR: 1KZ						
2.0 FSI		110		08.05	10.12	PR: 1KZ						
2.0 TDI				08.05	10.12	PR: 1KZ						
2.0 TDI		125		02.06	10.12	PR: 1KZ						
2.0 TFSI		136		08.05	10.12	PR: 1KZ						
2.0 TFSI		155		09.05	10.12	PR: 1KZ						
2.0 TFSI		177		11.06	10.12	PR: 1KZ						
		1.4 i 16V	63		06.06	10.09		24.5204-0233.3	331430	2		L=233
		1.4 TSI	92		11.07	10.09						
		1.6 i	75		08.05	10.09						
	1.8 TSI	118		06.07	10.09							
	1.9 TDI			08.05	10.09							
	1.9 TDI	81		08.05	10.09							
	2.0 Cupra R	195		11.06	10.09							
	2.0 FSI	110		08.05	10.09							
	2.0 TDI			08.05	10.09							
	2.0 TDI	125		02.06	10.09							
	2.0 TFSI	136		08.05	10.09							
	2.0 TFSI	155		09.05	10.09							
	2.0 TFSI	177		11.06	10.09							
	1.2 TSI	77		02.10	10.12		83.7847-0254.3	331233			L=255	
	1.2 TSI	77		02.10	10.12		83.7847-0257.3	331234			L=255	
	1.4 i 16V	63		11.09	10.12							
	1.4 TSI	92		12.09	10.12							
	1.6 LPG / Multifuel	75		12.09	10.12							
	1.6 TDI	66		11.10	10.12							
	1.6 TDI Ecomotive	77		02.10	10.12							
1.8 TSI	118		11.09	10.12								
1.9 TDI			11.09	10.12								
1.9 TDI	81		11.09	10.12								
2.0 Cupra R	195		11.09	10.12								
2.0 FSI	110		11.09	10.12								
2.0 TDI			11.09	10.12								
2.0 TDI	125		11.09	10.12								
2.0 TFSI	136		11.09	10.12								
2.0 TFSI	155		11.09	10.12								
2.0 TFSI	177		11.09	10.12								
	1.2 TSI	77		02.10	10.12		24.3727-2708.2	582708	2 		L=1447	
	1.4 i 16V	63		06.06	10.12		24.3727-0195.2	580195	2 		L=1447	
	1.4 TSI	92		11.07	10.12							
	1.6 i	75		08.05	10.12							
	1.6 LPG / Multifuel	75		12.09	10.12							
	1.6 TDI	66		11.10	10.12							
	1.6 TDI Ecomotive	77		02.10	10.12							
	1.8 TSI	118		06.07	10.12							
	1.9 TDI			08.05	10.12							
	1.9 TDI	81		08.05	10.12							
	2.0 Cupra R	195		11.06	10.12							
	2.0 FSI	110		08.05	10.12							
	2.0 TDI			08.05	10.12							
	2.0 TDI	125		02.06	10.12							
	2.0 TFSI	136		08.05	10.12							
2.0 TFSI	155		09.05	10.12								
2.0 TFSI	177		11.06	10.12								

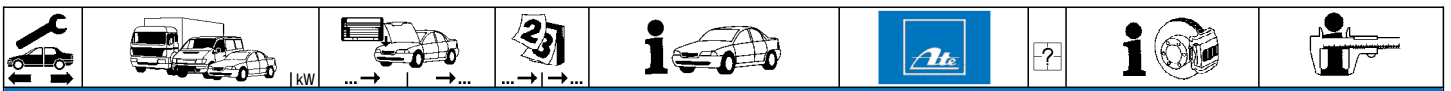

















SEAT LEON II (1P1) (05-12)

















	1.2 TSI	77	02.10	10.12	24.2415-1713.3	030132		Gz 15,87, + Sensor
	1.4 i 16V	63	06.06	10.12				
	1.4 TSI	92	11.07	10.12				
	1.6 i	75	08.05	10.12				
	1.6 LPG / Multifuel	75	12.09	10.12				
	1.6 TDI	66	11.10	10.12				
	1.6 TDI Ecomotive	77	02.10	10.12				
	1.8 TSI	118	06.07	10.12				
	1.9 TDI		08.05	10.12				
	1.9 TDI	81	08.05	10.12				
	2.0 Cupra R	195	11.06	10.12				
	2.0 FSI	110	08.05	10.12				
	2.0 TDI		08.05	10.12				
	2.0 TDI	125	02.06	10.12				
	2.0 TFSI	136	08.05	10.12				
	2.0 TFSI	155	09.05	10.12				
	2.0 TFSI	177	11.06	10.12				
	2.0 TDI		08.05	10.12	24.2519-1706.3	040096		Nz 19,05
	1.4 TSI	92	11.07	06.11	24.2519-1705.3	040095		Nz 19,05
	1.6 i	75	08.05	10.12				
	1.6 LPG / Multifuel	75	12.09	10.12				
	1.6 TDI	66	11.10	10.12				
	1.6 TDI Ecomotive	77	02.10	10.12				
	1.8 TSI	118	06.07	10.12				
	1.9 TDI		08.05	10.12				
	2.0 FSI	110	08.05	10.12				
	2.0 TDI		08.05	10.12				
	2.0 TDI	125	02.06	10.12				
	2.0 TFSI	136	08.05	10.12				

SEAT LEON III (5F) / SC / ST (12-)

	1.0 TSI	◀ 85	05.15		03.4153-5403.3	010994		THz 23,81	ATE
	1.2 TSI	◀ 63	09.12						
	1.2 TSI	◀ 77	09.12						
	1.2 TSI	◀ 81	04.14						
	1.4 TGI	◀ 81	10.13						
	1.4 TSI	◀ 90	09.12						
	1.4 TSI	◀ 92	05.14						
	1.4 TSI	◀103	09.12						
	1.4 TSI	◀110	05.14						
	1.6 TDI	◀ 66	09.12						
	1.6 TDI	◀ 77	09.12						
	1.6 TDI	◀ 81	09.13						
	1.6 TDI 4Drive	◀ 77	04.14						
	1.6 TDI 4Drive	◀ 81	11.14						
	1.8 TSI	◀132	09.12						
	1.8 TSI 4Drive	◀132	11.14						
	2.0 Cupra	◀195	10.13						
	2.0 Cupra	◀206	10.13						
	2.0 TDI	◀ 81	05.13						
	2.0 TDI	◀105	05.13						
	2.0 TDI	◀110	09.12						
	2.0 TDI	◀135	09.12						
	2.0 TDI 4Drive	◀110	04.14						
	2.0 TDI 4Drive	◀135	11.14						
	1.0 TSI	85	05.15	PR: 0N4,0B2	24.3727-2709.3	582709	1 ↓	L=1463	
	1.2 TSI	63	09.12	PR: 0N4,0B2					
	1.2 TSI	77	09.12	PR: 0N4,0B2					
	1.2 TSI	81	04.14	PR: 0N4,0B2					
	1.4 TGI	81	10.13	PR: 0N4,0B2					
	1.4 TSI	90	09.12	PR: 0N4,0B2					
	1.4 TSI	92	05.14	PR: 0N4,0B2					
	1.4 TSI	103	09.12	PR: 0N4,0B2					
	1.4 TSI	110	05.14	PR: 0N4,0B2					
	1.6 TDI	66	09.12	PR: 0N4,0B2					
	1.6 TDI	77	09.12	PR: 0N4,0B2					
	1.6 TDI	81	09.13	PR: 0N4,0B2					
	1.6 TDI 4Drive	77	04.14	PR: 0N4,0B2					
	1.6 TDI 4Drive	81	11.14	PR: 0N4,0B2					
	1.8 TSI	132	09.12	PR: 0N4,0B2					
	1.8 TSI 4Drive	132	11.14	PR: 0N4,0B2					
	2.0 Cupra	195	10.13	PR: 0N4,0B2					
	2.0 Cupra	206	10.13	PR: 0N4,0B2					
	2.0 TDI	81	05.13	PR: 0N4,0B2					
	2.0 TDI	105	05.13	PR: 0N4,0B2					
	2.0 TDI	110	09.12	PR: 0N4,0B2					
	2.0 TDI	135	09.12	PR: 0N4,0B2					
	2.0 TDI 4Drive	110	04.14	PR: 0N4,0B2					
	2.0 TDI 4Drive	135	11.14	PR: 0N4,0B2					
	1.0 TSI	◀ 85	05.15	PR: OEC,OEM	24.2519-1706.3	040096		Nz 19,05	
	1.2 TSI	◀ 63	09.12	PR: OEC,OEM					
	1.2 TSI	◀ 77	09.12	PR: OEC,OEM					
	1.2 TSI	◀ 81	04.14	PR: OEC,OEM					
	1.4 TGI	◀ 81	10.13	PR: OEC,OEM					
	1.4 TSI	◀ 90	09.12	PR: OEC,OEM					
	1.4 TSI	◀ 92	05.14	PR: OEC,OEM					
	1.4 TSI	◀103	09.12	PR: OEC,OEM					



SEAT LEON III (5F) / SC / ST (12-)									
	1.4 TSI 1.6 TDI 1.6 TDI 1.6 TDI 1.6 TDI 4Drive 1.6 TDI 4Drive 1.8 TSI 1.8 TSI 4Drive 2.0 Cupra 2.0 Cupra 2.0 TDI 2.0 TDI 2.0 TDI 2.0 TDI 2.0 TDI 2.0 TDI 4Drive 2.0 TDI 4Drive	110 66 77 81 77 81 132 132 195 206 81 105 110 135 110 135	05.14 09.12 09.12 09.13 04.14 11.14 09.12 11.14 10.13 10.13 05.13 05.13 09.12 09.12 04.14 11.14	PR: OEC,OEM PR: OEC,OEM PR: OEC,OEM PR: OEC,OEM PR: OEC,OEM PR: OEC,OEM PR: OEC,OEM PR: OEC,OEM PR: OEC,OEM PR: OEC,OEM PR: OEC,OEM PR: OEC,OEM PR: OEC,OEM PR: OEC,OEM PR: OEC,OEM PR: OEC,OEM	24.2519-1706.3	040096		Nz 19,05	
SEAT LEON III (5F) ST X-Perience (14-)									
	1.6 TDI 1.8 TSI 2.0 TDI 2.0 TDI	81 132 110 135	09.14 09.14 09.14 09.14	PR: ON4,OB2 PR: ON4,OB2 PR: ON4,OB2 PR: ON4,OB2	24.3727-2709.2	582709	1 ↓	L=1463	
	1.6 TDI 1.8 TSI 2.0 TDI 2.0 TDI	81 132 110 135	09.14 09.14 09.14 09.14	PR: OEC,OEM PR: OEC,OEM PR: OEC,OEM PR: OEC,OEM	24.2519-1706.3	040096		Nz 19,05	
SEAT MARBELLA (87-98)									
	0.8 0.9		01.87 12.92 01.87 10.98		24.2119-0826.3	010349		Thz 19,05	
	0.8 0.9		01.87 12.92 01.87 10.98		24.3219-0803.3	020183		Rz 19,05	
	0.8 0.9		01.87 12.92 01.87 10.98		24.3727-0503.2	580503	1 ↓	L=2670	
	0.8 0.9		01.87 12.92 01.87 10.98		24.3728-2703.2	592703		L=561	
SEAT Mii (12-)									
	1.0 1.0 1.0 EcoFuel	44 55 50	05.12 05.12 11.12		11.9541-9549.2 11.9541-9550.2	220575 220576	 	D=54, - Halter D=54, - Halter	ATE ATE
	1.0 1.0 1.0 EcoFuel	44 55 50	05.12 05.12 11.12		24.3217-0908.3	020167		Rz 17,46	
SEAT TOLEDO I (1L) (91-98)									
	1.6 i		1L-ZD101450 09.91		03.2120-2031.3 03.3517-0101.2	010106 390322		Thz 20,64 Verschlusschraube	ATE
	1.6 i 1.8 i 1.9 D 1.9 TD	1L-ZD101451	1L-ZD315000 1L-ZD315000 09.91 1L-ZD315000 09.91 1L-ZD315000 09.91	- ABS	03.2120-3943.3 03.3517-0101.2	010532 390322		Thz 20,64 Verschlusschraube	ATE
	1.6 i 1.8 i 1.9 D 1.9 TD 1.9 TDI	1L-ZD315001 1L-ZD315001 1L-ZD315001 1L-ZD315001	09.98 09.98 09.98 09.98	- ABS - ABS - ABS - ABS	03.2122-1042.3 03.3517-0101.2	010137 390322		Thz 22,20 Verschlusschraube	ATE
	1.8 i 1.9 TD		09.91 09.91	09.98 + ABS 09.98 + ABS	10.6122-0144.3	010638		Thz 22,20	ATE
	1.8 i 16V 1.9 TDI 2.0 i 2.0 i 16V		09.91 04.95 09.91 03.94	03.94 + ABS 09.98 09.98	10.6123-0674.3	010639		Thz 23,81	ATE
	1.6 i 1.8 i 1.9 D 1.9 TD	55	09.91 09.91 09.91 09.91	08.96 08.96 08.96 08.96	11.0441-4808.2 11.0101-4801.2 24.0102-4801.2	250022 260006 260085		Dichtungssatz Hülsensatz Hülsensatz+Schrauben	ATE ATE ATE
	1.8 i 16V 1.9 TDI 2.0 i		09.91 04.95 09.91	03.94 08.96 + ABS 08.96	24.3541-1609.5 24.3541-1610.5 11.0101-5403.2	240039 240040 260010	 	D=54, - Halter D=54, - Halter Fallenbalgsatz	TRW TRW TRW
	2.0 i 16V	110	03.94	08.96	24.3541-1731.5 24.3541-1732.5 11.0101-5403.2	240061 240062 260010	 	D=54, - Halter D=54, - Halter Fallenbalgsatz	TRW TRW TRW
	1.6 i 1.8 i 1.9 D 1.9 TD 1.9 TDI 2.0 i 2.0 i 16V	55 85 110	09.96 09.96 09.96 09.96 09.96 09.96	09.98 09.98 09.98 09.98 09.98 09.98	PR: 1LG,1LK,1LM PR: 1LG,1LK,1LM PR: 1LG,1LK,1LM PR: 1LG,1LK,1LM PR: 1LG,1LK,1LM PR: 1LG,1LK,1LM	250022 260006 260085		Dichtungssatz Hülsensatz Hülsensatz+Schrauben	ATE ATE ATE

											
SEAT TOLEDO I (1L) (91-98)											
	1.6 i			09.96	09.98	PR: 1LD,1LV	24.3541-1731.5	240061		D=54, - Halter D=54, - Halter Fallenbalgsatz	TRW TRW TRW
	1.8 i			09.96	09.98	PR: 1LD,1LV	24.3541-1732.5	240062			
	1.9 D			09.96	09.98	PR: 1LD,1LV	11.0101-5403.2	260010			
	1.9 TD	55		09.96	09.98	PR: 1LD,1LV					
	1.9 TDI			09.96	09.98	PR: 1LD,1LV					
	2.0 i	85		09.96	09.98	PR: 1LD,1LV					
	2.0 i 16V	110		09.96	09.98	PR: 1LD,1LV					
	1.6 i			09.96	09.98	PR: 1LY,1ZK	24.3541-1609.5	240039			
	1.8 i			09.96	09.98	PR: 1LY,1ZK	24.3541-1610.5	240040			
	1.9 D			09.96	09.98	PR: 1LY,1ZK	11.0101-5403.2	260010			
1.9 TD	55		09.96	09.98	PR: 1LY,1ZK						
1.9 TDI			09.96	09.98	PR: 1LY,1ZK						
2.0 i	85		09.96	09.98	PR: 1LY,1ZK						
2.0 i 16V	110		09.96	09.98	PR: 1LY,1ZK						
	1.6 i		1L-ZD342000	09.91			24.5170-0315.3	331309		L=315	
	1.8 i		1L-ZD342000	09.91							
	1.9 D		1L-ZD342000	09.91							
	1.9 TD	55	1L-ZD342000	09.91							
	1.9 TDI		1L-ZD342000	04.95							
	1.8 i 16V		1L-ZD342000	09.91			83.6225-0287.3	330735			
	2.0 i	85	1L-ZD342000	09.91							
	2.0 i 16V	110	1L-ZD342000	03.94							
	1.6 i		1L-ZD342001		09.98		83.6113-0321.3	330621			
	1.8 i		1L-ZD342001		09.98						
1.8 i 16V		1L-ZD342001		03.94							
1.9 D		1L-ZD342001		09.98							
1.9 TD	55	1L-ZD342001		09.98							
1.9 TDI		1L-ZD342001		09.98							
2.0 i	85	1L-ZD342001		09.98							
2.0 i 16V	110	1L-ZD342001		09.98							
	1.8 i 16V			09.91	03.94		24.3384-1603.5	240015		D=38, - Halter D=38, - Halter Bremsattel-Zubehör	TRW TRW TRW
	2.0 i	85	1L-ZD328000	09.91			24.3384-1604.5	240016			
							24.0101-3601.2	260044			
	1.9 TDI			04.95	08.96		24.3384-1707.5	240171			
	2.0 i	85	1L-ZD328001		08.96		24.3384-1708.5	240172			
	2.0 i 16V	110		03.94	08.96		24.0101-3601.2	260044			
							11.0101-5403.2	260010			
	1.6 i			09.96	09.98	PR: 1KD,1KK	24.3384-1707.5	240171			
	1.8 i			09.96	09.98	PR: 1KD,1KK	24.3384-1708.5	240172			
	1.9 D			09.96	09.98	PR: 1KD,1KK	24.0101-3601.2	260044			
1.9 TD	55		09.96	09.98	PR: 1KD,1KK						
1.9 TDI			09.96	09.98	PR: 1KD,1KK						
2.0 i	85		09.96	09.98	PR: 1KD,1KK						
2.0 i 16V	110		09.96	09.98	PR: 1KD,1KK						
	1.6 i			09.91	09.98		24.5201-0164.3	331414		L=164	
	1.8 i			09.91	09.98						
	1.9 D			09.91	09.98						
	1.9 TD	55		09.91	09.98						
	1.9 TDI			04.95	09.98						
	1.8 i 16V			09.91	03.94		24.5170-0161.3	331308			
	2.0 i	85		09.91	09.98						
	2.0 i 16V	110		03.94	09.98						
	1.6 i			09.91	09.98		03.3217-2112.3	020027			
	1.8 i			09.91	09.98		24.3217-0908.3	020167			
1.9 D			09.91	09.98							
1.9 TD	55		09.91	09.98							
1.9 TDI			04.95	09.98							
1.6 i			09.91	09.98		24.3727-0132.2	580132				
1.8 i			09.91	09.98							
1.9 D			09.91	09.98							
1.9 TD	55		09.91	09.98							
1.9 TDI			04.95	09.98							
1.8 i 16V			09.91	03.94		24.3727-0133.2	580133				
2.0 i	85		09.91	09.98							
2.0 i 16V	110		03.94	09.98							
1.6 i			09.91	09.98		03.6584-0015.3	320109				
1.8 i			09.91	09.98							
1.8 i 16V			09.91	03.94							
1.9 D			09.91	09.98							
1.9 TD	55		09.91	09.98							
1.9 TDI			04.95	09.98							
2.0 i	85		09.91	09.98							
2.0 i 16V	110		03.94	09.98		03.6584-0113.3	320111				
1.9 TDI			04.95	09.98		03.2419-1206.3	030074				
2.0 i 16V	110		03.94	09.98							
1.9 TDI			04.95	09.98		24.2523-0908.3	040049				
2.0 i 16V	110		03.94	09.98							
1.6 i			09.91	09.98		24.3728-0121.2	590121				
1.8 i			09.91	09.98							
1.8 i 16V			09.91	03.94							
1.9 D			09.91	09.98							
1.9 TD	55		09.91	09.98							
1.9 TDI			04.95	09.98							

1) + cast iron / + ghisa / + fonte grise / + fundición de gris

2) + aluminium / + alluminio / + aluminium / + aluminio















SEAT TOLEDO I (1L) (91-98)

	2.0 i 2.0 i 16V	◀ 85 ◀ 110		09.91 03.94	09.98 09.98	24.3728-0121.2	590121			L=800, + AUT
--	--------------------	---------------	--	----------------	----------------	----------------	--------	--	--	--------------

SEAT TOLEDO II (1M2) (98-04)

	1.4 i 16V	◀ 55	1M-1B018341	07.99	+ ESP	03.7863-0402.4	300124			10"	ATE						
	1.6 i	◀	1M-1B018341	10.98	+ ESP												
	1.8 4x4	◀	1M-1B018341	05.01	+ ESP												
	1.8 i 20V	◀	1M-1B018341	10.98	+ ESP												
	1.8 i 20VT	◀ 132	1M-1B018341	05.01	+ ESP												
	1.9 SDI	◀ 50	1M-1B018341	11.99	+ ESP												
	1.9 TDI	◀ 66	1M-1B018341	10.98	+ ESP												
	1.9 TDI	◀ 81	1M-1B018341	10.98	+ ESP												
	1.9 TDI	◀ 96	1M-1B018341	05.03	+ ESP												
	1.9 TDI	◀ 110	1M-1B018341	10.00	+ ESP												
	2.3 i V5	◀	1M-1B018341	10.98	+ ESP												
	2.8	◀ 150	1M-1B018341	10.00	+ ESP												
	2.8 4x4	◀ 150	1M-1B018341	05.02	+ ESP												
	1.4 i 16V	◀ 55	1M-1R023638	07.99	+ ESP												
	1.6 i	◀	1M-1R023638	10.98	+ ESP												
1.8 4x4	◀	1M-1R023638	05.01	+ ESP													
1.8 i 20V	◀	1M-1R023638	10.98	+ ESP													
1.8 i 20VT	◀ 132	1M-1R023638	05.01	+ ESP													
1.9 SDI	◀ 50	1M-1R023638	11.99	+ ESP													
1.9 TDI	◀ 66	1M-1R023638	10.98	+ ESP													
1.9 TDI	◀ 81	1M-1R023638	10.98	+ ESP													
1.9 TDI	◀ 96	1M-1R023638	05.03	+ ESP													
1.9 TDI	◀ 110	1M-1R023638	10.00	+ ESP													
2.3 i V5	◀	1M-1R023638	10.98	+ ESP													
2.8	◀ 150	1M-1R023638	10.00	+ ESP													
2.8 4x4	◀ 150	1M-1R023638	05.02	+ ESP													
1.4 i 16V	◀ 55	1M-1B018342	09.04	+ ESP	03.7860-0602.4	300141			10"	ATE							
1.6 i	◀	1M-1B018342	09.04	+ ESP													
1.8 4x4	◀	1M-1B018342	09.04	+ ESP													
1.8 i 20V	◀	1M-1B018342	09.04	+ ESP													
1.8 i 20VT	◀ 132	1M-1B018342	09.04	+ ESP													
1.9 SDI	◀ 50	1M-1B018342	09.04	+ ESP													
1.9 TDI	◀ 66	1M-1B018342	09.04	+ ESP													
1.9 TDI	◀ 81	1M-1B018342	09.04	+ ESP													
1.9 TDI	◀ 96	1M-1B018342	09.04	+ ESP													
1.9 TDI	◀ 110	1M-1B018342	09.04	+ ESP													
2.3 i V5	◀	1M-1B018342	09.04	+ ESP													
2.8	◀ 150	1M-1B018342	09.04	+ ESP													
2.8 4x4	◀ 150	1M-1B018342	09.04	+ ESP													
1.4 i 16V	◀ 55	1M-1R023639	09.04	+ ESP													
1.6 i	◀	1M-1R023639	09.04	+ ESP													
1.8 4x4	◀	1M-1R023639	09.04	+ ESP													
1.8 i 20V	◀	1M-1R023639	09.04	+ ESP													
1.8 i 20VT	◀ 132	1M-1R023639	09.04	+ ESP													
1.9 SDI	◀ 50	1M-1R023639	09.04	+ ESP													
1.9 TDI	◀ 66	1M-1R023639	09.04	+ ESP													
1.9 TDI	◀ 81	1M-1R023639	09.04	+ ESP													
1.9 TDI	◀ 96	1M-1R023639	09.04	+ ESP													
1.9 TDI	◀ 110	1M-1R023639	09.04	+ ESP													
2.3 i V5	◀	1M-1R023639	09.04	+ ESP													
2.8	◀ 150	1M-1R023639	09.04	+ ESP													
2.8 4x4	◀ 150	1M-1R023639	09.04	+ ESP													
	1.4 i 16V	◀ 55		07.99	09.04	24.2123-1709.3	010503			Thz 23,81							
	1.6 i	◀		10.98	09.04												
	1.8 i 20V	◀		10.98	09.04												
	1.9 SDI	◀ 50		11.99	09.04												
	1.9 TDI	◀ 66		10.98	09.04												
	1.9 TDI	◀ 81		10.98	09.04												
	1.9 TDI	◀ 96		05.03	09.04												
	1.9 TDI	◀ 110		10.00	09.04												
	2.3 i V5	◀		10.98	09.04												
	1.4 i 16V	◀ 55		07.99	08.00							03.2123-2024.3	010597			Thz 23,81	ATE
	1.6 i	◀		10.98	08.00												
	1.8 i 20V	◀		10.98	08.00												
	1.9 SDI	◀ 50		11.99	08.00												
	1.9 TDI	◀ 66		10.98	08.00												
	1.9 TDI	◀ 81		10.98	08.00												
2.3 i V5	◀		10.98	08.00													
1.4 i 16V	◀ 55		09.00	09.04	03.2123-2715.3	010802			Thz 23,81	ATE							
1.6 i	◀		09.00	09.04													
1.8 4x4	◀		05.01	09.04													
1.8 i 20V	◀		09.00	09.04													
1.8 i 20VT	◀ 132		05.01	09.04													
1.9 SDI	◀ 50		09.00	09.04													
1.9 TDI	◀ 66		09.00	09.04													
1.9 TDI	◀ 81		09.00	09.04													
1.9 TDI	◀ 96		05.03	09.04													
1.9 TDI	◀ 110		10.00	09.04													
2.3 i V5	◀		09.00	09.04													
2.8	◀ 150		10.00	09.04													
2.8 4x4	◀ 150		05.02	09.04													





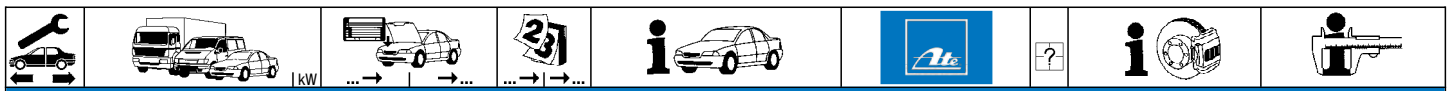













								
SEAT TOLEDO II (1M2) (98-04)								
	1.4 i 16V 1.6 i 1.8 i 20V 1.9 SDI 1.9 TDI 1.9 TDI 2.3 i V5	▶ 55 ▶ ▶ ▶ 50 ▶ 66 ▶ 81		07.99 08.00 + ESP 10.98 08.00 + ESP 10.98 08.00 + ESP 11.99 08.00 + ESP 10.98 08.00 + ESP 10.98 08.00 + ESP 10.98 08.00 + ESP	03.2123-2064.3	010598		Thz 23,81 ATE
	1.4 i 16V 1.6 i 1.8 4x4 1.8 i 20V 1.8 i 20VT 1.9 SDI 1.9 TDI 1.9 TDI 1.9 TDI 1.9 TDI 2.3 i V5 2.8 2.8 4x4	▶ 55 ▶ ▶ ▶ ▶132 ▶ 50 ▶ 66 ▶ 81 ▶ 96 ▶110 ▶ ▶150 ▶150		09.00 09.04 + ESP 09.00 09.04 + ESP 05.01 09.04 + ESP 09.00 09.04 + ESP 09.00 09.04 + ESP 05.01 09.04 + ESP 11.99 09.04 + ESP 09.00 09.04 + ESP 09.00 09.04 + ESP 05.03 09.04 + ESP 10.00 09.04 + ESP 09.00 09.04 + ESP 05.02 09.04 + ESP	03.2123-2774.3	010803		Thz 23,81 ATE
	1.4 i 16V 1.6 i 1.8 4x4 1.8 i 20V 1.8 i 20VT 1.9 SDI 1.9 TDI 1.9 TDI 1.9 TDI 1.9 TDI 2.3 i V5 2.8 2.8 4x4	55 132 50 66 81 96 110 150 150		07.99 09.04 PR: 1LQ,1LR,1LS 10.98 09.04 PR: 1LQ,1LR,1LS 05.01 09.04 PR: 1LQ,1LR,1LS 10.98 09.04 PR: 1LQ,1LR,1LS 05.01 09.04 PR: 1LQ,1LR,1LS 11.99 09.04 PR: 1LQ,1LR,1LS 10.98 09.04 PR: 1LQ,1LR,1LS 10.98 09.04 PR: 1LQ,1LR,1LS 05.03 09.04 PR: 1LQ,1LR,1LS 10.00 09.04 PR: 1LQ,1LR,1LS 10.98 09.04 PR: 1LQ,1LR,1LS 10.00 09.04 PR: 1LQ,1LR,1LS 05.02 09.04 PR: 1LQ,1LR,1LS	11.9541-9549.2 11.9541-9550.2 11.0101-5409.2 11.8171-0069.1	220575 220576 260035 250152	<input type="checkbox"/> <input type="checkbox"/>	D=54, - Halter D=54, - Halter Hülzensatz Führungsbolzen ATE ATE ATE ATE
	1.4 i 16V 1.6 i 1.8 4x4 1.8 i 20V 1.8 i 20VT 1.9 SDI 1.9 TDI 1.9 TDI 1.9 TDI 1.9 TDI 2.3 i V5 2.8 2.8 4x4	55 132 50 66 81 96 110 150 150		07.99 09.04 PR: 1LN,1LE,1ZE,1ZH 10.98 09.04 PR: 1LN,1LE,1ZE,1ZH 05.01 09.04 PR: 1LN,1LE,1ZE,1ZH 10.98 09.04 PR: 1LN,1LE,1ZE,1ZH 05.01 09.04 PR: 1LN,1LE,1ZE,1ZH 11.99 09.04 PR: 1LN,1LE,1ZE,1ZH 04.99 09.04 PR: 1LN,1LE,1ZE,1ZH 10.98 09.04 PR: 1LN,1LE,1ZE,1ZH 05.03 09.04 PR: 1LN,1LE,1ZE,1ZH 10.00 09.04 PR: 1LN,1LE,1ZE,1ZH 10.98 09.04 PR: 1LN,1LE,1ZE,1ZH 10.00 09.04 PR: 1LN,1LE,1ZE,1ZH 05.02 09.04 PR: 1LN,1LE,1ZE,1ZH	11.3541-8523.2 11.3541-8524.2 24.3541-8523.5 24.3541-8524.5 11.8170-0306.1 11.0441-5409.2 11.0101-5409.2 11.8171-0008.1 11.8116-0143.1	220115 220116 240551 240552 260102 250031 260035 990049 390513	<input type="checkbox"/> <input type="checkbox"/> <input type="checkbox"/> <input type="checkbox"/> 2 2	D=54, - Halter D=54, - Halter D=54, - Halter D=54, - Halter Halter Dichtungssatz Hülzensatz Führungsbolzen Haltefeder ATE ATE ATE ATE ATE ATE ATE
	1.4 i 16V 1.6 i 1.8 4x4 1.8 i 20V 1.8 i 20VT 1.9 SDI 1.9 TDI 1.9 TDI 1.9 TDI 1.9 TDI 2.3 i V5 2.8 2.8 4x4	55 132 50 66 81 96 110 150 150		07.99 09.04 PR: 1LJ,1ZQ 10.98 09.04 PR: 1LJ,1ZQ 05.01 09.04 PR: 1LJ,1ZQ 10.98 09.04 PR: 1LJ,1ZQ 05.01 09.04 PR: 1LJ,1ZQ 11.99 09.04 PR: 1LJ,1ZQ 04.99 09.04 PR: 1LJ,1ZQ 10.98 09.04 PR: 1LJ,1ZQ 05.03 09.04 PR: 1LJ,1ZQ 10.00 09.04 PR: 1LJ,1ZQ 10.98 09.04 PR: 1LJ,1ZQ 10.00 09.04 PR: 1LJ,1ZQ 05.02 09.04 PR: 1LJ,1ZQ	11.9541-9595.2 11.9541-9596.2 11.0441-5409.2 11.0101-5409.2 11.8171-0008.1 11.8116-0143.1	220501 220502 250031 260035 990049 390513	<input type="checkbox"/> <input type="checkbox"/> 2	D=54, - Halter D=54, - Halter Dichtungssatz Hülzensatz Führungsbolzen Haltefeder ATE ATE ATE ATE ATE
	1.4 i 16V 1.6 i 1.8 4x4 1.8 i 20V 1.8 i 20VT 1.9 SDI 1.9 TDI 1.9 TDI 1.9 TDI 1.9 TDI 2.3 i V5 2.8 2.8 4x4	55 132 50 66 81 96 110 150 150		07.99 09.04 10.98 09.04 05.01 09.04 10.98 09.04 05.01 09.04 11.99 09.04 10.98 09.04 10.98 09.04 05.03 09.04 10.00 09.04 10.98 09.04 10.00 09.04 05.02 09.04	24.5143-0439.3	331411	2	L=439
	1.4 i 16V 1.6 i 1.8 4x4 1.8 i 20V 1.8 i 20VT 1.9 SDI 1.9 TDI 1.9 TDI 1.9 TDI 1.9 TDI 2.3 i V5 2.8 2.8 4x4	55 132 50 66 81 96 110 150 150	1M-Y-006500	07.99 10.98 05.01 10.98 05.01 11.99 10.98 10.98 05.03 10.00 10.98 10.00 05.02		220523 220524 220535 220536	<input type="checkbox"/> <input type="checkbox"/> <input type="checkbox"/> <input type="checkbox"/>	D=38(M12x1), - Halter D=38(M12x1), - Halter D=41, - Halter D=41, - Halter TRW TRW TRW TRW



SEAT TOLEDO II (1M2) (98-04)

	1.4 i 16V 1.6 i 1.8 4x4 1.8 i 20V 1.8 i 20VT 1.9 SDI 1.9 TDI 1.9 TDI 1.9 TDI 1.9 TDI 2.3 i V5 2.8 2.8 4x4	55 55 55 132 50 66 81 96 110 150 150	1M-Y-006501 1M-Y-006501 1M-Y-006501 1M-Y-006501 1M-Y-006501 1M-Y-006501 1M-Y-006501 1M-Y-006501 1M-Y-006501 1M-Y-006501 1M-Y-006501 1M-Y-006501	09.04 PR: 1KP 09.04 PR: 1KP 09.04 PR: 1KP 09.04 PR: 1KP 09.04 PR: 1KP 09.04 PR: 1KP 09.04 PR: 1KP 09.04 PR: 1KP 09.04 PR: 1KP 09.04 PR: 1KP 09.04 PR: 1KP 09.04 PR: 1KP	24.3414-1705.7 24.3414-1706.7	220549 220550		D=41, - Halter D=41, - Halter	TRW TRW
	1.4 i 16V 1.6 i 1.8 4x4 1.8 i 20V 1.8 i 20VT 1.9 SDI 1.9 TDI 1.9 TDI 1.9 TDI 1.9 TDI 2.3 i V5 2.8 2.8 4x4	55 55 55 132 50 66 81 96 110 150 150	1M-Y-006501 1M-Y-006501 1M-Y-006501 1M-Y-006501 1M-Y-006501 1M-Y-006501 1M-Y-006501 1M-Y-006501 1M-Y-006501 1M-Y-006501 1M-Y-006501 1M-Y-006501 1M-Y-006501	09.04 PR: 1KK,1KQ 09.04 PR: 1KK,1KQ 09.04 PR: 1KK,1KQ 09.04 PR: 1KK,1KQ 09.04 PR: 1KK,1KQ 09.04 PR: 1KK,1KQ 09.04 PR: 1KK,1KQ 09.04 PR: 1KK,1KQ 09.04 PR: 1KK,1KQ 09.04 PR: 1KK,1KQ 09.04 PR: 1KK,1KQ 09.04 PR: 1KK,1KQ 09.04 PR: 1KK,1KQ	24.3384-1729.7 24.3384-1730.7	220541 220542		D=38(M12x1), - Halter D=38(M12x1), - Halter	TRW TRW
	1.4 i 16V 1.6 i 1.8 4x4 1.8 i 20V 1.8 i 20VT 1.9 SDI 1.9 TDI 1.9 TDI 1.9 TDI 1.9 TDI 2.3 i V5 2.8 2.8 4x4	55 55 55 132 50 66 81 96 110 150 150	1M-Y-006501 1M-Y-006501 1M-Y-006501 1M-Y-006501 1M-Y-006501 1M-Y-006501 1M-Y-006501 1M-Y-006501 1M-Y-006501 1M-Y-006501 1M-Y-006501 1M-Y-006501 1M-Y-006501	07.99 09.04 PR: 1KY,2EE 10.98 09.04 PR: 1KY,2EE 05.01 09.04 PR: 1KY,2EE 10.98 09.04 PR: 1KY,2EE 05.01 09.04 PR: 1KY,2EE 11.99 09.04 PR: 1KY,2EE 04.99 09.04 PR: 1KY,2EE 10.98 09.04 PR: 1KY,2EE 05.03 09.04 PR: 1KY,2EE 10.00 09.04 PR: 1KY,2EE 10.98 09.04 PR: 1KY,2EE 10.00 09.04 PR: 1KY,2EE 05.02 09.04 PR: 1KY,2EE	24.3384-1745.7 24.3384-1746.7	220609 220610		D=38, - Halter D=38, - Halter	TRW TRW
	1.4 i 16V 1.6 i 1.8 i 20V 1.8 i 20VT 1.9 SDI 1.9 TDI 1.9 TDI 1.9 TDI 1.9 TDI 2.3 i V5 2.8 2.8 4x4	55 55 132 50 66 81 96 110 150	1M-Y-006501 1M-Y-006501 1M-Y-006501 1M-Y-006501 1M-Y-006501 1M-Y-006501 1M-Y-006501 1M-Y-006501 1M-Y-006501 1M-Y-006501 1M-Y-006501 1M-Y-006501	07.99 09.04 10.98 09.04 10.98 09.04 05.01 09.04 11.99 09.04 10.98 09.04 10.98 09.04 05.03 09.04 10.00 09.04 10.98 09.04 10.00 09.04	83.7858-0140.3	330837	2	L=140	
	1.8 4x4 2.8 4x4	150 150	1M-Y-006501 1M-Y-006501	05.01 09.04 05.02 09.04	83.7858-0140.3	330837	2	L=140	
	1.4 i 16V 1.6 i 1.8 4x4 1.8 i 20V 1.8 i 20VT 1.9 SDI 1.9 TDI 1.9 TDI 1.9 TDI 1.9 TDI 2.3 i V5 2.8 2.8 4x4	55 55 55 132 50 66 81 96 110 150 150	1M-Y-006501 1M-Y-006501 1M-Y-006501 1M-Y-006501 1M-Y-006501 1M-Y-006501 1M-Y-006501 1M-Y-006501 1M-Y-006501 1M-Y-006501 1M-Y-006501 1M-Y-006501 1M-Y-006501	07.99 09.04 10.98 09.04 05.01 09.04 10.98 09.04 05.01 09.04 11.99 09.04 10.98 09.04 10.98 09.04 05.03 09.04 10.00 09.04 10.98 09.04 10.00 09.04 05.02 09.04	24.3727-0149.2	580149	2	L=1688	
	1.4 i 16V 1.6 i 1.8 i 20V 1.9 SDI 1.9 TDI 1.9 TDI 1.9 TDI 1.9 TDI 2.3 i V5	55 55 50 66 81 96 110	1M-Y-006501 1M-Y-006501 1M-Y-006501 1M-Y-006501 1M-Y-006501 1M-Y-006501 1M-Y-006501 1M-Y-006501 1M-Y-006501	07.99 09.04 - ABS 10.98 09.04 - ABS 10.98 09.04 - ABS 11.99 09.04 - ABS 10.98 09.04 - ABS 10.98 09.04 - ABS 05.03 09.04 - ABS 10.00 09.04 - ABS 10.98 09.04 - ABS	03.6583-0179.3	320228		BRL 8/3 (4)	ATE
	1.4 i 16V 1.6 i 1.8 4x4 1.8 i 20V 1.8 i 20VT 1.9 SDI 1.9 TDI 1.9 TDI 1.9 TDI 1.9 TDI 2.3 i V5 2.8	55 55 55 132 50 66 81 96 110 150	1M-Y-006501 1M-Y-006501 1M-Y-006501 1M-Y-006501 1M-Y-006501 1M-Y-006501 1M-Y-006501 1M-Y-006501 1M-Y-006501 1M-Y-006501 1M-Y-006501 1M-Y-006501	07.99 09.04 10.98 09.04 05.01 09.04 10.98 09.04 05.01 09.04 11.99 09.04 10.98 09.04 10.98 09.04 05.03 09.04 10.00 09.04 10.98 09.04 10.00 09.04	24.2415-1701.3	030095		Gz 15,87	

								
SEAT TOLEDO II (1M2) (98-04)								
	2.8 4x4	150	05.02	09.04	24.2415-1701.3	030095		Gz 15,87
	1.4 i 16V	55	07.99	09.04	24.2415-1702.3	030096		Gz 15,87
	1.6 i		10.98	09.04				
	1.8 4x4		05.01	09.04				
	1.8 i 20V		10.98	09.04				
	1.8 i 20VT	132	05.01	09.04				
	1.9 SDI	50	11.99	09.04				
	1.9 TDI	66	10.98	09.04				
	1.9 TDI	81	10.98	09.04				
	1.9 TDI	96	05.03	09.04				
	1.9 TDI	110	10.00	09.04				
	2.3 i V5		10.98	09.04				
	2.8	150	10.00	09.04				
	2.8 4x4	150	05.02	09.04				
	1.4 i 16V	55	07.99	09.04	24.2523-1701.3	040080		Nz 23,81
	1.6 i		10.98	09.04				
	1.8 4x4		05.01	09.04	24.2519-1701.3	040075		Nz 19,05
	1.8 i 20V		10.98	09.04				
	1.8 i 20VT	132	05.01	09.04				
	1.9 SDI	50	11.99	09.04				
	1.9 TDI	66	10.98	09.04				
	1.9 TDI	81	10.98	09.04				
	1.9 TDI	96	05.03	09.04				
	1.9 TDI	110	10.00	09.04				
	2.3 i V5		10.98	09.04				
	2.8	150	10.00	09.04				
	2.8 4x4	150	05.02	09.04				
SEAT TOLEDO III (5P2) (05-09)								
	1.4 16V	63	05.06	03.09	PR: 1AC,1AT	03.7863-3232.4	300307	Kolbendurchmesser Ø 22,20mm ¹⁾ 10" ATE
	1.6 i 16V	75	10.04	03.09	PR: 1AC,1AT			
	1.8 TFSI	118	01.07	03.09	PR: 1AC,1AT			
	1.9 TDI	77	10.04	03.09	PR: 1AC,1AT			
	2.0 FSI	110	10.04	03.09	PR: 1AC,1AT			
	2.0 TDI	125	10.04	03.09	PR: 1AC,1AT			
	2.0 TDI	125	01.06	03.09	PR: 1AC,1AT			
	2.0 TFSI	147	11.05	03.09	PR: 1AC,1AT			
	1.4 16V	63	05.06	03.09		03.7863-9602.4	300206	PR: 1AS 10" ATE
	1.6 i 16V	75	10.04	03.09				
	1.8 TFSI	118	01.07	03.09				
	1.9 TDI	77	10.04	03.09				
	2.0 FSI	110	10.04	03.09				
	2.0 TDI	125	10.04	03.09				
	2.0 TDI	125	01.06	03.09				
	2.0 TFSI	147	11.05	03.09				
	1.4 16V	63	05.06	03.09		03.2122-2129.3	010799	THz 22,20 ATE
	1.6 i 16V	75	10.04	03.09				
	1.8 TFSI	118	01.07	03.09				
	1.9 TDI	77	10.04	03.09				
	2.0 FSI	110	10.04	03.09				
	2.0 TDI	125	10.04	03.09				
	2.0 TDI	125	01.06	03.09				
	2.0 TFSI	147	11.05	03.09				
	1.4 16V	63	05.06	03.09	PR: 1ZF	11.9541-9549.2	220575	D=54, - Halter ATE
	1.6 i 16V	75	10.04	03.09	PR: 1ZF	11.9541-9550.2	220576	D=54, - Halter ATE
	1.8 TFSI	118	01.07	03.09	PR: 1ZF	11.8171-0069.1	250152	Führungsbolzen ATE
	1.9 TDI	77	10.04	03.09	PR: 1ZF			
	2.0 FSI	110	10.04	03.09	PR: 1ZF			
	2.0 TDI	125	10.04	03.09	PR: 1ZF			
	2.0 TDI	125	01.06	03.09	PR: 1ZF			
	2.0 TFSI	147	11.05	03.09	PR: 1ZF			
	1.4 16V	63	05.06	03.09	PR: 1ZE	11.9541-9553.2	220563	D=54, - Halter ATE
	1.6 i 16V	75	10.04	03.09	PR: 1ZE	11.9541-9554.2	220564	D=54, - Halter ATE
	1.8 TFSI	118	01.07	03.09	PR: 1ZE	11.0101-5409.2	260035	Hülzensatz ATE
	1.9 TDI	77	10.04	03.09	PR: 1ZE	11.8171-0008.1	990049	Führungsbolzen ATE
	2.0 FSI	110	10.04	03.09	PR: 1ZE	11.8116-0351.1	390538	Haltefeder ATE
	2.0 TDI	125	10.04	03.09	PR: 1ZE			
	2.0 TDI	125	01.06	03.09	PR: 1ZE			
	2.0 TFSI	147	11.05	03.09	PR: 1ZE			
	1.4 16V	63	05.06	03.09		24.5143-0564.3	331433	L=564
	1.6 i 16V	75	10.04	03.09				
	1.8 TFSI	118	01.07	03.09				
	1.9 TDI	77	10.04	03.09				
	2.0 FSI	110	10.04	03.09				
	2.0 TDI	125	10.04	03.09				
	2.0 TDI	125	01.06	03.09				
	2.0 TFSI	147	11.05	03.09				
	1.4 16V	63	05.06	03.09	PR: 1KD	24.3384-1755.7	220635	D=38, - Halter TRW
	1.6 i 16V	75	10.04	03.09	PR: 1KD	24.3384-1756.7	220636	D=38, - Halter TRW
	1.8 TFSI	118	01.07	03.09	PR: 1KD			
	1.9 TDI	77	10.04	03.09	PR: 1KD			
	2.0 FSI	110	10.04	03.09	PR: 1KD			
	2.0 TDI	125	10.04	03.09	PR: 1KD			
	2.0 TDI	125	01.06	03.09	PR: 1KD			
	2.0 TFSI	147	11.05	03.09	PR: 1KD			

¹⁾ piston diameter Ø 22,20mm / diametro del pistone Ø 22,20mm / diàmetre de piston Ø 22,20mm / diàmetre del pistón Ø 22,20mm



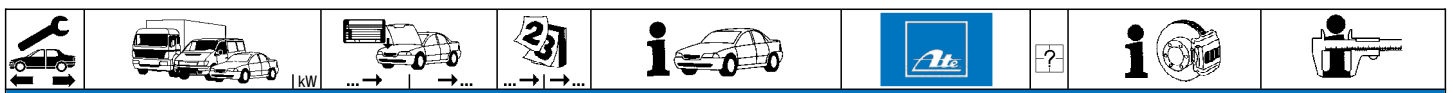

















SEAT TOLEDO III (5P2) (05-09)

	1.4 16V	63	05.06	03.09	PR: 1KJ	24.3387-1717.7	220757	 	D=38, - Halter D=38, - Halter	TRW TRW
	1.6 i 16V	75	10.04	03.09	PR: 1KJ	24.3387-1718.7	220758			
	1.8 TFSI	118	01.07	03.09	PR: 1KJ					
	1.9 TDI	77	10.04	03.09	PR: 1KJ					
	2.0 FSI	110	10.04	03.09	PR: 1KJ					
	2.0 TDI	125	10.04	03.09	PR: 1KJ					
	2.0 TDI	125	01.06	03.09	PR: 1KJ					
	2.0 TFSI	147	11.05	03.09	PR: 1KJ					
	1.4 16V	63	05.06	03.09	PR: 1KF,1KZ	24.3414-1709.7	220631	 	D=41, - Halter D=41, - Halter	TRW TRW
	1.6 i 16V	75	10.04	03.09	PR: 1KF,1KZ	24.3414-1710.7	220632			
	1.8 TFSI	118	01.07	03.09	PR: 1KF,1KZ					
	1.9 TDI	77	10.04	03.09	PR: 1KF,1KZ					
	2.0 FSI	110	10.04	03.09	PR: 1KF,1KZ					
	2.0 TDI	125	10.04	03.09	PR: 1KF,1KZ					
	2.0 TDI	125	01.06	03.09	PR: 1KF,1KZ					
	2.0 TFSI	147	11.05	03.09	PR: 1KF,1KZ					
	1.4 16V	63	05.06	03.09		24.5204-0233.3	331430	2	L=233	
	1.6 i 16V	75	10.04	03.09						
	1.8 TFSI	118	01.07	03.09						
	1.9 TDI	77	10.04	03.09						
	2.0 FSI	110	10.04	03.09						
	2.0 TDI	125	10.04	03.09						
	2.0 TDI	125	01.06	03.09						
	2.0 TFSI	147	11.05	03.09						
	1.4 16V	63	05.06	03.09		24.3727-2708.2	582708	2	L=1447	
	1.6 i 16V	75	10.04	03.09						
	1.8 TFSI	118	01.07	03.09						
	1.9 TDI	77	10.04	03.09						
	2.0 FSI	110	10.04	03.09						
	2.0 TDI	125	10.04	03.09						
	2.0 TDI	125	01.06	03.09						
	2.0 TFSI	147	11.05	03.09						
	1.4 16V	63	05.06	03.09		24.2415-1713.3	030132		Gz 15,87, + Sensor	
	1.6 i 16V	75	10.04	03.09						
	1.8 TFSI	118	01.07	03.09						
	1.9 TDI	77	10.04	03.09						
	2.0 FSI	110	10.04	03.09						
	2.0 TDI	125	10.04	03.09						
	2.0 TDI	125	01.06	03.09						
	2.0 TFSI	147	11.05	03.09						
	1.4 16V	63	05.06	03.09		24.2519-1706.3	040096		Nz 19,05 Nz 19,05	
	1.6 i 16V	75	10.04	03.09		24.2519-1705.3	040095			
	1.8 TFSI	118	01.07	03.09						
	1.9 TDI	77	10.04	03.09						
	2.0 FSI	110	10.04	03.09						
	2.0 TDI	125	10.04	03.09						
	2.0 TDI	125	01.06	03.09						
	2.0 TFSI	147	11.05	03.09						

SEAT TOLEDO IV (KG3) (12-)

	1.2	55	07.12		PR: 1ZG	11.9541-9549.2	220575	 	D=54, - Halter D=54, - Halter	ATE ATE				
	1.2 TSI	63	07.12		PR: 1ZG	11.9541-9550.2	220576							
	1.2 TSI	77	07.12		PR: 1ZG	11.8171-0008.1	990049							
	1.4 TSI	90	07.12		PR: 1ZG	11.0101-5409.2	260035							
	1.6	77	07.13		PR: 1ZG									
	1.6 TDI	66	06.13		PR: 1ZG									
	1.6 TDI	77	07.12		PR: 1ZG									
		1.2	55	07.12		+ Bremsscheibendurchm. 288 mm ¹⁾	11.9541-9553.2				220563	2	D=54, - Halter D=54, - Halter	ATE ATE
1.2 TSI		63	07.12		+ Bremsscheibendurchm. 288 mm ¹⁾	11.9541-9554.2	220564							
1.2 TSI		77	07.12		+ Bremsscheibendurchm. 288 mm ¹⁾	11.8171-0008.1	990049							
1.4 TSI		90	07.12		+ Bremsscheibendurchm. 288 mm ¹⁾	11.0101-5407.2	260011							
1.6		77	07.13		+ Bremsscheibendurchm. 288 mm ¹⁾	11.8116-0351.1	390538							
1.6 TDI		66	06.13		+ Bremsscheibendurchm. 288 mm ¹⁾									
1.6 TDI		77	07.12		+ Bremsscheibendurchm. 288 mm ¹⁾									
		1.2 TSI	66	05.15		PR: 1ZC	11.9541-9553.2	220563	2	D=54, - Halter D=54, - Halter	ATE ATE			
	1.2 TSI	81	05.15		PR: 1ZC	11.9541-9554.2	220564							
	1.4 TDI	66	05.15		PR: 1ZC	11.8171-0008.1	990049							
	1.4 TSI	92	05.15		PR: 1ZC	11.0101-5407.2	260011							
	1.6 TDI	85	05.15		PR: 1ZC	11.8116-0351.1	390538							
		1.2	55	07.12			24.5143-0544.3	331420				2	L=544	
		1.2 TSI	63	07.12										
		1.2 TSI	66	05.15										
1.2 TSI		77	07.12											
1.2 TSI		81	05.15											
1.4 TDI		66	05.15											
1.4 TSI		90	07.12											
1.6 TDI		77	07.13											
	1.2	55	07.12			24.3387-1735.5	240657	 	D=38, - Halter D=38, - Halter	TRW TRW				
	1.2 TSI	63	07.12			24.3387-1736.5	240658							
	1.2 TSI	66	05.15											
	1.2 TSI	77	07.12											
	1.2 TSI	81	05.15											

¹⁾ + brake disc diameter 288mm / + diametro dischi freno 288mm / + diamètre disques frein 288mm / + diámetro disco freno 288mm

SEAT TOLEDO IV (KG3) (12-)											
	1.4 TDI 1.4 TSI 1.4 TSI 1.6 1.6 TDI 1.6 TDI 1.6 TDI	66 90 92 77 66 77 85		05.15 07.12 05.15 07.13 06.13 07.12 05.15			24.3387-1735.5 24.3387-1736.5	240657 240658	 	D=38, - Halter D=38, - Halter	TRW TRW
	1.2 1.2 TSI 1.2 TSI 1.2 TSI 1.2 TSI 1.4 TDI 1.4 TSI 1.4 TSI 1.6 1.6 TDI 1.6 TDI 1.6 TDI	55 63 66 77 81 66 90 92 77 66 77 85		07.12 07.12 05.15 07.12 05.15 05.15 07.12 05.15 07.13 06.13 07.12 05.15			83.7858-0140.3	330837	2		L=140
	1.2 1.2 TSI 1.2 TSI 1.2 TSI 1.2 TSI 1.4 TDI 1.4 TSI 1.4 TSI 1.6 1.6 TDI 1.6 TDI 1.6 TDI	55 63 66 77 81 66 90 92 77 66 77 85		07.12 07.12 05.15 07.12 05.15 05.15 07.12 05.15 07.13 06.13 07.12 05.15			83.7858-0140.3	330837	2		L=140
	1.2 1.2 TSI 1.2 TSI 1.2 TSI 1.2 TSI 1.4 TDI 1.4 TSI 1.4 TSI 1.6 1.6 TDI 1.6 TDI 1.6 TDI	55 63 66 77 81 66 90 92 77 66 77 85		07.12 07.12 05.15 07.12 05.15 05.15 07.12 05.15 07.13 06.13 07.12 05.15			24.3219-1762.3	020550			Rz 19,05
	1.2 1.2 TSI 1.2 TSI 1.2 TSI 1.2 TSI 1.4 TDI 1.4 TSI 1.4 TSI 1.6 1.6 TDI 1.6 TDI 1.6 TDI	55 63 66 77 81 66 90 92 77 66 77 85		07.12 07.12 05.15 07.12 05.15 05.15 07.12 05.15 07.13 06.13 07.12 05.15			24.3727-2711.2 24.3727-2710.2	582711 582710	1  1 	+ Trommelbremse ¹⁾ + Scheibenbremse ²⁾	L=1707 L=1780
	1.2 1.2 TSI 1.2 TSI 1.2 TSI 1.2 TSI 1.4 TDI 1.4 TSI 1.4 TSI 1.6 1.6 TDI 1.6 TDI 1.6 TDI	55 63 66 77 81 66 90 92 77 66 77 85		07.12 07.12 05.15 07.12 05.15 05.15 07.12 05.15 07.13 06.13 07.12 05.15			24.2519-1706.3	040096		PR: OEM PR: OEM PR: OEM PR: OEM PR: OEM PR: OEM PR: OEM PR: OEM PR: OEM PR: OEM PR: OEM PR: OEM	Nz 19,05
SKODA CITIGO (12-)											
	1.0 1.0 1.0 CNG	44 55 50		05.12 05.12 11.12			11.9541-9549.2 11.9541-9550.2	220575 220576	 	D=54, - Halter D=54, - Halter	ATE ATE
	1.0 1.0 1.0 CNG	44 55 50		05.12 05.12 11.12			24.3217-0908.3	020167			Rz 17,46
SKODA FABIA I (6Y) (99-07)											
	1.0 i 1.2 i 1.4 i 1.4 i 16V 1.4 TDI 1.9 SDI 1.9 TDI 1.9 TDI RS 2.0 i	37 47 74 96 85		02.00 08.02 12.07 02.00 12.07 10.99 04.03 12.07 12.99 02.00 09.03 12.07 12.99 12.07	08.02 12.07		24.2120-1736.3 24.2120-1734.3	010732 010702	- ABS + ABS		THz 20,64 THz 20,64
											

¹⁾ + drum brake / + freno a tamburo / + freins à tambour / + tambores de freno

²⁾ + disc brake / + disco freno / + disques de frein / + disco de freno

SKODA FABIA I (6Y) (99-07)										
	1.0 i	37	02.00	08.02	PR: 1LB,1LM	24.3481-1735.5	240283		D=48, - Halter D=48, - Halter	ATE ATE
	1.2 i		08.02	12.07	PR: 1LB,1LM	24.3481-1736.5	240284			
	1.4 i		02.00	12.07	PR: 1LB,1LM					
	1.4 i 16V		10.99	12.07	PR: 1LB,1LM					
	1.4 TDI		04.03	12.07	PR: 1LB,1LM					
	1.9 SDI	47	12.99	12.07	PR: 1LB,1LM					
	1.9 TDI	74	02.00	12.07	PR: 1LB,1LM					
	1.9 TDI RS	96	09.03	12.07	PR: 1LB,1LM					
	2.0 i	85	12.99	12.07	PR: 1LB,1LM					
	1.0 i	37	02.00	08.02	PR: 1LQ,1LR	11.9541-9549.2	220575			
1.2 i		08.02	12.07	PR: 1LQ,1LR	11.9541-9550.2	220576				
1.4 i		02.00	12.07	PR: 1LQ,1LR	11.0101-5409.2	260035				
1.4 i 16V		10.99	12.07	PR: 1LQ,1LR	11.8171-0069.1	250152				
1.4 TDI		04.03	12.07	PR: 1LQ,1LR						
1.9 SDI	47	12.99	12.07	PR: 1LQ,1LR						
1.9 TDI	74	02.00	12.07	PR: 1LQ,1LR						
1.9 TDI RS	96	09.03	12.07	PR: 1LQ,1LR						
2.0 i	85	12.99	12.07	PR: 1LQ,1LR						
1.0 i	37	02.00	08.02	PR: 1LN,1LP	24.3541-1797.7	220553		D=54, - Halter D=54, - Halter	TRW TRW	
1.2 i		08.02	12.07	PR: 1LN,1LP	24.3541-1798.7	220554				
1.4 i		02.00	12.07	PR: 1LN,1LP						
1.4 i 16V		10.99	12.07	PR: 1LN,1LP						
1.4 TDI		04.03	12.07	PR: 1LN,1LP						
1.9 SDI	47	12.99	12.07	PR: 1LN,1LP						
1.9 TDI	74	02.00	12.07	PR: 1LN,1LP						
1.9 TDI RS	96	09.03	12.07	PR: 1LN,1LP						
2.0 i	85	12.99	12.07	PR: 1LN,1LP						
1.0 i	37	02.00	08.02		83.6247-0522.3	330595				
1.2 i		08.02	12.07							
1.4 i		02.00	12.07							
1.4 i 16V		10.99	12.07							
1.4 TDI		04.03	12.07							
1.9 SDI	47	12.99	12.07							
1.9 TDI	74	02.00	12.07							
1.9 TDI RS	96	09.03	12.07							
2.0 i	85	12.99	12.07							
1.4 i 16V		10.99	12.07	PR: 1KK	24.3384-1729.7	220541		D=38(M12x1), - Halter D=38(M12x1), - Halter	TRW TRW	
1.4 TDI		04.03	12.07	PR: 1KK	24.3384-1730.7	220542				
1.9 TDI	74	02.00	12.07	PR: 1KK						
2.0 i	85	12.99	12.07	PR: 1KK						
1.0 i	37	02.00	08.02	PR: 1KK,1KP	83.7858-0140.3	330837		L=140		
1.2 i		08.02	12.07	PR: 1KK,1KP						
1.4 i		02.00	12.07	PR: 1KK,1KP						
1.4 i 16V		10.99	12.07	PR: 1KK,1KP						
1.4 TDI		04.03	12.07	PR: 1KK,1KP						
1.9 SDI	47	12.99	12.07	PR: 1KK,1KP						
1.9 TDI	74	02.00	12.07	PR: 1KK,1KP						
1.9 TDI RS	96	09.03	12.07	PR: 1KK,1KP						
2.0 i	85	12.99	12.07	PR: 1KK,1KP						
1.0 i	37	02.00	08.02		24.3219-0909.3	020188				
1.2 i		08.02	12.07							
1.4 i		02.00	12.07							
1.4 i 16V		10.99	12.07							
1.9 SDI	47	12.99	12.07							
1.0 i	37	02.00	08.02	PR: 1JA,1JC,1JD,1KM	24.3727-0199.2	580199		- Schlechtwegeausführung ¹⁾	L=1580	
1.2 i		08.02	12.07	PR: 1JA,1JC,1JD,1KM						
1.4 i		02.00	12.07	PR: 1JA,1JC,1JD,1KM						
1.4 i 16V		10.99	12.07	PR: 1JA,1JC,1JD,1KM						
1.4 TDI		04.03	12.07	PR: 1JA,1JC,1JD,1KM						
1.9 SDI	47	12.99	12.07	PR: 1JA,1JC,1JD,1KM						
1.9 TDI	74	02.00	12.07	PR: 1JA,1JC,1JD,1KM						
1.9 TDI RS	96	09.03	12.07	PR: 1JA,1JC,1JD,1KM						
2.0 i	85	12.99	12.07	PR: 1JA,1JC,1JD,1KM						
1.0 i	37	02.00	08.02	PR: 1JB,1KK,1KT	24.3727-0176.2	580176				
1.2 i		08.02	12.07	PR: 1JB,1KK,1KT	24.3727-0198.2	580198				
1.4 i		02.00	12.07	PR: 1JB,1KK,1KT						
1.4 i 16V		10.99	12.07	PR: 1JB,1KK,1KT						
1.4 TDI		04.03	12.07	PR: 1JB,1KK,1KT						
1.9 SDI	47	12.99	12.07	PR: 1JB,1KK,1KT						
1.9 TDI	74	02.00	12.07	PR: 1JB,1KK,1KT						
1.9 TDI RS	96	09.03	12.07	PR: 1JB,1KK,1KT						
2.0 i	85	12.99	12.07	PR: 1JB,1KK,1KT						
1.0 i	37	02.00	08.02	PR: 1JB,1KM	24.3727-2504.2	582504		+ Schlechtwegeausführung ²⁾	L=1580	
1.2 i		08.02	12.07	PR: 1JB,1KM						
1.4 i		02.00	12.07	PR: 1JB,1KM						
1.4 i 16V		10.99	12.07	PR: 1JB,1KM						
1.4 TDI		04.03	12.07	PR: 1JB,1KM						
1.9 SDI	47	12.99	12.07	PR: 1JB,1KM						
1.0 i	37	02.00	08.02	PR: 1JA,1JD,1KK,1KP,1KQ	24.3727-0197.2	580197		+ HA-Scheibenbremse ³⁾	L=1645	
1.2 i		08.02	12.07	PR: 1JA,1JD,1KK,1KP,1KQ						
1.4 i		02.00	12.07	PR: 1JA,1JD,1KK,1KP,1KQ						
1.4 i 16V		10.99	12.07	PR: 1JA,1JD,1KK,1KP,1KQ						

1) - rough road construction / - versione per percorsi accidentati / - version pour mauvaise route / - versión 4x4
2) + rough road construction / + versione per percorsi accidentati / + version pour mauvaise route / + versión 4x4
3) + RA disc brake / + P disco freno / + frein à disque essieu AR / + ET-disco de freno



SKODA FABIA I (6Y) (99-07)













	1.4 TDI 1.9 SDI 1.9 TDI 1.9 TDI RS 2.0 i	47 74 96 85	04.03 12.99 02.00 09.03 12.99	12.07 12.07 12.07 12.07 12.07	PR: 1JA,1JD,1KK,1KP,1KQ PR: 1JA,1JD,1KK,1KP,1KQ PR: 1JA,1JD,1KK,1KP,1KQ PR: 1JA,1JD,1KK,1KP,1KQ PR: 1JA,1JD,1KK,1KP,1KQ	24.3727-0197.2	580197	2 ↓ + HA-Scheibenbremse ¹⁾	L=1645	
	1.4 i 1.4 i 16V 1.4 TDI 1.9 SDI 1.9 TDI 1.9 TDI RS 2.0 i	47 74 96 85	02.00 10.99 04.03 12.99 02.00 09.03 12.99	12.07 12.07 12.07 12.07 12.07 12.07 12.07	PR: 1AL PR: 1AL PR: 1AL PR: 1AL PR: 1AL PR: 1AL PR: 1AL	03.6583-0216.3	320247	- ABS / + Schrägheck ²⁾	BRL 8/3 (4)	ATE
	1.4 i 1.4 i 16V 1.4 TDI 1.9 SDI 1.9 TDI 1.9 TDI RS 2.0 i	47 74 96 85	02.00 10.99 04.03 12.99 02.00 09.03 12.99	12.07 12.07 12.07 12.07 12.07 12.07 12.07		03.6584-0120.3	320279	- ABS / - Schrägheck ³⁾	BRL 8/4 (4)	ATE
	1.4 i 1.4 i 16V 1.4 TDI 1.9 SDI 1.9 TDI 1.9 TDI RS 2.0 i	47 74 96 85	02.00 10.99 04.03 12.99 02.00 09.03 12.99	12.07 12.07 12.07 12.07 12.07 12.07 12.07	PR: 1AB, 1LM PR: 1AB, 1LM PR: 1AB, 1LM PR: 1AB, 1LM PR: 1AB, 1LM PR: 1AB, 1LM PR: 1AB, 1LM	03.6043-1733.3	320284	- ABS	BRE 3/25	ATE
	1.0 i 1.2 i 1.4 i 1.4 i 16V 1.4 TDI 1.9 SDI 1.9 TDI 1.9 TDI RS 2.0 i	37 47 74 96 85	02.00 08.02 02.00 10.99 04.03 12.99 02.00 09.03 12.99	08.02 12.07 12.07 12.07 12.07 12.07 12.07 12.07 12.07		24.2415-1702.3	030096		Gz 15,87	
	1.0 i 1.2 i 1.4 i 1.4 i 16V 1.4 TDI 1.9 SDI 1.9 TDI 1.9 TDI RS 2.0 i	37 47 74 96 85	02.00 08.02 02.00 10.99 04.03 12.99 02.00 09.03 12.99	08.02 12.07 12.07 12.07 12.07 12.07 12.07 12.07 12.07		24.2519-1706.3	040096		Nz 19,05	

















SKODA FABIA II (5J) (07-14)

	1.2 1.2 1.2 TDI 1.2 TSI 1.2 TSI 1.4 1.4 TDI 1.4 TDI 1.4 TSI RS 1.6 i 16V 1.6 TDI 1.6 TDI 1.6 TDI 1.6 TDI 1.9 TDI	◀ 44 ◀ 51 ◀ 55 ◀ 63 ◀ 63 ◀ 51 ◀ 59 ◀ 132 ◀ 77 ◀ 55 ◀ 66 ◀ 77 ◀ 77	03.07 03.07 05.10 03.10 03.10 03.07 03.07 03.07 05.10 03.07 04.10 03.10 03.10 03.10 03.07	06.14 06.14 06.14 06.14 06.14 06.14 06.14 06.14 06.14 06.14 06.14 06.14 06.14 06.14 06.14	PR: 1AL,1LQ,1LN,1LR PR: 1AL,1LQ,1LN,1LR PR: 1AL,1LQ,1LN,1LR PR: 1AL,1LQ,1LN,1LR PR: 1AL,1LQ,1LN,1LR PR: 1AL,1LQ,1LN,1LR PR: 1AL,1LQ,1LN,1LR PR: 1AL,1LQ,1LN,1LR PR: 1AL,1LQ,1LN,1LR PR: 1AL,1LQ,1LN,1LR PR: 1AL,1LQ,1LN,1LR PR: 1AL,1LQ,1LN,1LR PR: 1AL,1LQ,1LN,1LR PR: 1AL,1LQ,1LN,1LR PR: 1AL,1LQ,1LN,1LR	24.2120-1736.3	010732	- ABS	Thz 20,64	
	1.2 1.2 1.2 TDI 1.2 TSI 1.2 TSI 1.4 1.4 TDI 1.4 TDI 1.4 TSI RS 1.6 i 16V 1.6 TDI 1.6 TDI 1.6 TDI 1.6 TDI 1.9 TDI	◀ 44 ◀ 51 ◀ 55 ◀ 63 ◀ 63 ◀ 51 ◀ 59 ◀ 132 ◀ 77 ◀ 55 ◀ 66 ◀ 77 ◀ 77	03.07 03.07 05.10 03.10 03.10 03.07 03.07 03.07 05.10 03.07 04.10 03.10 03.10 03.10 03.07	06.14 06.14 06.14 06.14 06.14 06.14 06.14 06.14 06.14 06.14 06.14 06.14 06.14 06.14 06.14	PR: 1AC,1AR,1AT,1LN,1LQ,1LR PR: 1AC,1AR,1AT,1LN,1LQ,1LR PR: 1AC,1AR,1AT,1LN,1LQ,1LR PR: 1AC,1AR,1AT,1LN,1LQ,1LR PR: 1AC,1AR,1AT,1LN,1LQ,1LR PR: 1AC,1AR,1AT,1LN,1LQ,1LR PR: 1AC,1AR,1AT,1LN,1LQ,1LR PR: 1AC,1AR,1AT,1LN,1LQ,1LR PR: 1AC,1AR,1AT,1LN,1LQ,1LR PR: 1AC,1AR,1AT,1LN,1LQ,1LR PR: 1AC,1AR,1AT,1LN,1LQ,1LR PR: 1AC,1AR,1AT,1LN,1LQ,1LR PR: 1AC,1AR,1AT,1LN,1LQ,1LR PR: 1AC,1AR,1AT,1LN,1LQ,1LR PR: 1AC,1AR,1AT,1LN,1LQ,1LR	24.2120-1734.3	010702	+ ABS	Thz 20,64	
	1.2 1.2 1.2 TDI 1.2 TSI 1.2 TSI 1.4 1.4 TDI 1.4 TDI 1.4 TSI RS 1.6 i 16V 1.6 TDI 1.6 TDI 1.6 TDI 1.6 TDI	◀ 44 ◀ 51 ◀ 55 ◀ 63 ◀ 63 ◀ 51 ◀ 59 ◀ 132 ◀ 77 ◀ 55 ◀ 66 ◀ 77 ◀ 66	03.07 03.07 05.10 03.10 03.10 03.07 03.07 03.07 05.10 03.07 04.10 03.10 03.10 03.10	06.14 06.14 06.14 06.14 06.14 06.14 06.14 06.14 06.14 06.14 06.14 06.14 06.14 06.14	PR: 1AC,1AR,1LB,1LM PR: 1AC,1AR,1LB,1LM PR: 1AC,1AR,1LB,1LM PR: 1AC,1AR,1LB,1LM PR: 1AC,1AR,1LB,1LM PR: 1AC,1AR,1LB,1LM PR: 1AC,1AR,1LB,1LM PR: 1AC,1AR,1LB,1LM PR: 1AC,1AR,1LB,1LM PR: 1AC,1AR,1LB,1LM PR: 1AC,1AR,1LB,1LM PR: 1AC,1AR,1LB,1LM PR: 1AC,1AR,1LB,1LM	24.2119-1712.3	010912	+ ABS	Thz 19,05 - Behälter	

1) + RA disc brake / + P disco freno / + frein à disque essieu AR / + ET-disco de freno
 2) - ABS / + hatchback / - ABS / + coda spiovente / - ABS / + arrière profilé / - ABS / + portón tras.alargado
 3) - ABS / - hatchback / - ABS / - coda spiovente / - ABS / - arrière profilé / - ABS / - portón tras.alargado























































									
SKODA FABIA II (5J) (07-14)									
	1.6 TDI 1.9 TDI	77 77	03.10 03.07	06.14 06.14	PR: 1AC,1AR,1LB,1LM PR: 1AC,1AR,1LB,1LM	24.2119-1712.3 010912	+ ABS	ThZ 19,05 - Behälter	
	1.2 1.2 1.2 TDI 1.2 TSI 1.2 TSI 1.4 1.4 TDI 1.4 TDI 1.4 TSI RS 1.6 i 16V 1.6 TDI 1.6 TDI 1.6 TDI 1.9 TDI	44 51 55 63 77 63 51 59 132 77 55 66 77 77	03.07 03.07 05.10 03.10 03.10 03.07 03.07 03.07 05.10 03.07 04.10 03.10 03.07	06.14 06.14 06.14 06.14 06.14 06.14 06.14 06.14 06.14 06.14 06.14 06.14 06.14	PR: 1LB,1LM PR: 1LB,1LM PR: 1LB,1LM PR: 1LB,1LM PR: 1LB,1LM PR: 1LB,1LM PR: 1LB,1LM PR: 1LB,1LM PR: 1LB,1LM PR: 1LB,1LM PR: 1LB,1LM PR: 1LB,1LM PR: 1LB,1LM	24.3481-1735.5 24.3481-1736.5 240283 240284	<input type="checkbox"/> <input type="checkbox"/>	D=48, - Halter D=48, - Halter	ATE ATE
	1.2 1.2 1.2 TDI 1.2 TSI 1.2 TSI 1.4 1.4 TDI 1.4 TDI 1.4 TSI RS 1.6 i 16V 1.6 TDI 1.6 TDI 1.6 TDI 1.9 TDI	44 51 55 63 77 63 51 59 132 77 55 66 77 77	03.07 03.07 05.10 03.10 03.10 03.07 03.07 03.07 05.10 03.07 04.10 03.10 03.07	06.14 06.14 06.14 06.14 06.14 06.14 06.14 06.14 06.14 06.14 06.14 06.14 06.14	PR: 1LQ,1LR,1ZG PR: 1LQ,1LR,1ZG PR: 1LQ,1LR,1ZG PR: 1LQ,1LR,1ZG PR: 1LQ,1LR,1ZG PR: 1LQ,1LR,1ZG PR: 1LQ,1LR,1ZG PR: 1LQ,1LR,1ZG PR: 1LQ,1LR,1ZG PR: 1LQ,1LR,1ZG PR: 1LQ,1LR,1ZG PR: 1LQ,1LR,1ZG PR: 1LQ,1LR,1ZG	11.9541-9549.2 11.9541-9550.2 11.0101-5409.2 11.8171-0069.1 220575 220576 260035 250152	<input type="checkbox"/> <input type="checkbox"/>	D=54, - Halter D=54, - Halter Hülzensatz Führungsbolzen	ATE ATE ATE ATE
	1.2 1.2 1.2 TDI 1.2 TSI 1.2 TSI 1.4 1.4 TDI 1.4 TDI 1.4 TSI RS 1.6 i 16V 1.6 TDI 1.6 TDI 1.6 TDI 1.9 TDI	44 51 55 63 77 63 51 59 132 77 55 66 77 77	03.07 03.07 05.10 03.10 03.10 03.07 03.07 03.07 05.10 03.07 04.10 03.10 03.07	06.14 06.14 06.14 06.14 06.14 06.14 06.14 06.14 06.14 06.14 06.14 06.14 06.14	PR: 1LN,1ZH PR: 1LN,1ZH PR: 1LN,1ZH PR: 1LN,1ZH PR: 1LN,1ZH PR: 1LN,1ZH PR: 1LN,1ZH PR: 1LN,1ZH PR: 1LN,1ZH PR: 1LN,1ZH PR: 1LN,1ZH PR: 1LN,1ZH PR: 1LN,1ZH	24.3541-1797.7 24.3541-1798.7 220563 220564	<input type="checkbox"/> <input type="checkbox"/>	D=54, - Halter D=54, - Halter	TRW TRW
	1.2 1.2 1.2 TDI 1.2 TSI 1.2 TSI 1.4 1.4 TDI 1.4 TDI 1.4 TSI RS 1.6 i 16V 1.6 TDI 1.6 TDI 1.6 TDI 1.9 TDI	44 51 55 63 77 63 51 59 132 77 55 66 77 77	03.07 03.07 05.10 03.10 03.10 03.07 03.07 03.07 05.10 03.07 04.10 03.10 03.07	06.14 06.14 06.14 06.14 06.14 06.14 06.14 06.14 06.14 06.14 06.14 06.14 06.14	PR: 1ZC PR: 1ZC PR: 1ZC PR: 1ZC PR: 1ZC PR: 1ZC PR: 1ZC PR: 1ZC PR: 1ZC PR: 1ZC PR: 1ZC PR: 1ZC PR: 1ZC	11.9541-9553.2 11.9541-9554.2 220563 220564	<input type="checkbox"/> <input type="checkbox"/>	D=54, - Halter D=54, - Halter	ATE ATE
	1.2 1.2 1.2 TDI 1.2 TSI 1.2 TSI 1.4 1.4 TDI 1.4 TDI 1.4 TSI RS 1.6 i 16V 1.6 TDI 1.6 TDI 1.6 TDI 1.9 TDI	44 51 55 63 77 63 51 59 132 77 55 66 77 77	03.07 03.07 05.10 03.10 03.10 03.07 03.07 03.07 05.10 03.07 04.10 03.10 03.07	06.14 06.14 06.14 06.14 06.14 06.14 06.14 06.14 06.14 06.14 06.14 06.14 06.14		83.6247-0522.3 330595	2	L=522	
	1.2 1.2 1.4 1.4 TDI 1.4 TDI 1.6 i 16V 1.9 TDI	44 51 63 51 59 77 77	03.07 03.07 03.07 03.07 03.07 03.07 03.07	05.09 05.09 05.09 05.09 05.09 05.09 05.09	PR: 1KK PR: 1KK PR: 1KK PR: 1KK PR: 1KK PR: 1KK PR: 1KK	24.3384-1729.7 24.3384-1730.7 220541 220542	<input type="checkbox"/> <input type="checkbox"/>	D=38(M12x1), - Halter D=38(M12x1), - Halter	TRW TRW
	1.2 1.2 1.2 TDI 1.2 TSI 1.2 TSI 1.4	44 51 55 63 77 63	06.09 06.09 05.10 03.10 03.10 06.09	06.14 06.14 06.14 06.14 06.14 06.14	PR: 1KT PR: 1KT PR: 1KT PR: 1KT PR: 1KT PR: 1KT	24.3387-1735.5 24.3387-1736.5 240657 240658	<input type="checkbox"/> <input type="checkbox"/>	D=38, - Halter D=38, - Halter	TRW TRW



	 kW								
SKODA FABIA II (5J) (07-14)									
	1.4 TDI	51	06.09	06.14	PR: 1KT	24.3387-1735.5	240657	D=38, - Halter D=38, - Halter	TRW TRW
	1.4 TDI	59	06.09	06.14	PR: 1KT	24.3387-1736.5	240658		
	1.4 TSI RS	132	05.10	06.14	PR: 1KT				
	1.6 i 16V	77	06.09	06.14	PR: 1KT				
	1.6 TDI	55	04.10	06.14	PR: 1KT				
	1.6 TDI	66	03.10	06.14	PR: 1KT				
	1.6 TDI	77	03.10	06.14	PR: 1KT				
	1.9 TDI	77	06.09	06.14	PR: 1KT				
	1.2	44	06.09	06.14	PR: 1KV	24.3387-1735.5	240657	D=38, - Halter D=38, - Halter	TRW TRW
	1.2	51	06.09	06.14	PR: 1KV	24.3387-1736.5	240658		
	1.2 TDI	55	05.10	06.14	PR: 1KV				
	1.2 TSI	63	03.10	06.14	PR: 1KV				
	1.2 TSI	77	03.10	06.14	PR: 1KV				
	1.4	63	06.09	06.14	PR: 1KV				
	1.4 TDI	51	06.09	06.14	PR: 1KV				
	1.4 TDI	59	06.09	06.14	PR: 1KV				
	1.4 TSI RS	132	05.10	06.14	PR: 1KV				
	1.6 i 16V	77	06.09	06.14	PR: 1KV				
	1.6 TDI	55	04.10	06.14	PR: 1KV				
	1.6 TDI	66	03.10	06.14	PR: 1KV				
	1.6 TDI	77	03.10	06.14	PR: 1KV				
	1.9 TDI	77	06.09	06.14	PR: 1KV				
	1.2	44	03.07	06.14		83.7858-0140.3	330837	L=140	
	1.2	51	03.07	06.14					
	1.2 TDI	55	05.10	06.14					
	1.2 TSI	63	03.10	06.14					
	1.2 TSI	77	03.10	06.14					
	1.4	63	03.07	06.14					
	1.4 TDI	51	03.07	06.14					
	1.4 TDI	59	03.07	06.14					
	1.4 TSI RS	132	05.10	06.14					
	1.6 i 16V	77	03.07	06.14					
	1.6 TDI	55	04.10	06.14					
	1.6 TDI	66	03.10	06.14					
	1.6 TDI	77	03.10	06.14					
	1.9 TDI	77	03.07	06.14					
	1.2	44	03.07	06.14		24.3219-0909.3	020188	Rz 19,05	
	1.2	51	03.07	06.14					
	1.2 TDI	55	05.10	06.14					
	1.2 TSI	63	03.10	06.14					
	1.2 TSI	77	03.10	06.14					
	1.4	63	03.07	06.14					
	1.4 TDI	51	03.07	06.14					
	1.4 TDI	59	03.07	06.14					
	1.6 i 16V	77	03.07	06.14					
	1.6 TDI	55	04.10	06.14					
	1.6 TDI	66	03.10	06.14					
	1.6 TDI	77	03.10	06.14					
	1.9 TDI	77	03.07	06.14					
		1.2	44	03.07	06.14	PR: 1JA,1JD,1JE,1KK,1KP,1KQ,1KT	24.3727-0199.2		
1.2		51	03.07	06.14	PR: 1JA,1JD,1JE,1KK,1KP,1KQ,1KT	24.3727-0197.2	580197		
1.2 TDI		55	05.10	06.14	PR: 1JA,1JD,1JE,1KK,1KP,1KQ,1KT				
1.2 TSI		63	03.10	06.14	PR: 1JA,1JD,1JE,1KK,1KP,1KQ,1KT				
1.2 TSI		77	03.10	06.14	PR: 1JA,1JD,1JE,1KK,1KP,1KQ,1KT				
1.4		63	03.07	06.14	PR: 1JA,1JD,1JE,1KK,1KP,1KQ,1KT				
1.4 TDI		51	03.07	06.14	PR: 1JA,1JD,1JE,1KK,1KP,1KQ,1KT				
1.4 TDI		59	03.07	06.14	PR: 1JA,1JD,1JE,1KK,1KP,1KQ,1KT				
1.4 TSI RS		132	05.10	06.14	PR: 1JA,1JD,1JE,1KK,1KP,1KQ,1KT				
1.6 i 16V		77	03.07	06.14	PR: 1JA,1JD,1JE,1KK,1KP,1KQ,1KT				
1.6 TDI		55	04.10	06.14	PR: 1JA,1JD,1JE,1KK,1KP,1KQ,1KT				
1.6 TDI		66	03.10	06.14	PR: 1JA,1JD,1JE,1KK,1KP,1KQ,1KT				
1.6 TDI		77	03.10	06.14	PR: 1JA,1JD,1JE,1KK,1KP,1KQ,1KT				
1.9 TDI		77	03.07	06.14	PR: 1JA,1JD,1JE,1KK,1KP,1KQ,1KT				
	1.2	44	03.07	06.14		03.6583-0216.3	320247	- ABS - ABS	BRL 8/3 (4) BRL 8/4 (4)
	1.2	51	03.07	06.14		03.6584-0120.3	320279		
	1.2 TDI	55	05.10	06.14					
	1.2 TSI	63	03.10	06.14					
	1.2 TSI	77	03.10	06.14					
	1.4	63	03.07	06.14					
	1.4 TDI	51	03.07	06.14					
	1.4 TDI	59	03.07	06.14					
	1.6 i 16V	77	03.07	06.14					
	1.6 TDI	55	04.10	06.14					
	1.6 TDI	66	03.10	06.14					
	1.6 TDI	77	03.10	06.14					
	1.9 TDI	77	03.07	06.14					
		1.2	44	03.07	06.14	PR: OEM	24.2519-1706.3		
1.2		51	03.07	06.14	PR: OEM				
1.2 TDI		55	05.10	06.14	PR: OEM				
1.2 TSI		63	03.10	06.14	PR: OEM				
1.2 TSI		77	03.10	06.14	PR: OEM				
1.4		63	03.07	06.14	PR: OEM				
1.4 TDI		51	03.07	06.14	PR: OEM				
1.4 TDI		59	03.07	06.14	PR: OEM				
1.4 TSI RS		132	05.10	06.14	PR: OEM				
1.6 i 16V		77	03.07	06.14	PR: OEM				
1.6 TDI		55	04.10	06.14	PR: OEM				













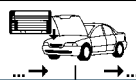





















¹⁾ + RA drum brake / + P freno a tamburo / + frein à tambour essieu AR / + ET-tambores de freno







²⁾ + RA disc brake / + P disco freno / + frein à disque essieu AR / + ET-disco de freno

										
SKODA FABIA II (5J) (07-14)										
	1.6 TDI 1.6 TDI 1.9 TDI	66 77 77	03.10 03.10 03.07	06.14 06.14 06.14	PR: OEM PR: OEM PR: OEM	24.2519-1706.3	040096	Nz 19,05		
SKODA FABIA III (NJ) (14-)										
	1.0 MPI 1.0 MPI 1.2 TSI 1.2 TSI 1.4 TDI 1.4 TDI 1.4 TDI 1.6	44 55 66 81 55 66 77 81	08.14 08.14 08.14 08.14 05.15 08.14 08.14 01.15		PR: 1ZC PR: 1ZC PR: 1ZC PR: 1ZC PR: 1ZC PR: 1ZC PR: 1ZC	11.9541-9553.2 11.9541-9554.2 11.8171-0008.1 11.8116-0351.1 11.0101-5409.2	220563 220564 990049 390538 260035	2 D=54, - Halter D=54, - Halter Führungsbolzen Haltefeder Hülsensatz	ATE ATE ATE ATE	
	1.0 MPI 1.0 MPI 1.2 TSI 1.2 TSI 1.4 TDI 1.4 TDI 1.6	44 55 66 81 66 77 81	08.14 08.14 08.14 08.14 08.14 08.14 01.15		PR: 1ZG PR: 1ZG PR: 1ZG PR: 1ZG PR: 1ZG PR: 1ZG	11.9541-9549.2 11.9541-9550.2 11.8171-0008.1 11.0101-5409.2	220575 220576 990049 260035	2 D=54, - Halter D=54, - Halter Führungsbolzen Hülsensatz	ATE ATE ATE	
	1.0 MPI 1.0 MPI 1.2 TSI 1.2 TSI 1.4 TDI 1.4 TDI 1.4 TDI 1.6	44 55 66 81 55 66 77 81	08.14 08.14 08.14 08.14 05.15 08.14 08.14 01.15		PR: 1KK,1KT,2EJ PR: 1KK,1KT,2EJ PR: 1KK,1KT,2EJ PR: 1KK,1KT,2EJ PR: 1KT PR: 1KK,1KT,2EJ PR: 1KK,1KT,2EJ PR: 1KT	24.3387-1735.5 24.3387-1736.5	240657 240658	2 D=38, - Halter D=38, - Halter	TRW TRW	
	1.0 MPI 1.0 MPI 1.2 TSI 1.2 TSI 1.4 TDI 1.4 TDI 1.4 TDI 1.6	44 55 66 81 55 66 77 81	08.14 08.14 08.14 08.14 05.15 08.14 08.14 01.16			83.7858-0140.3	330837	2 L=140		
	1.0 MPI 1.0 MPI 1.2 TSI 1.2 TSI 1.4 TDI 1.4 TDI 1.4 TDI 1.6	44 55 66 81 55 66 77 81	08.14 08.14 08.14 08.14 05.15 08.14 08.14 01.15			24.3219-0909.3	020188		Rz 19,05	
	1.0 MPI 1.0 MPI 1.2 TSI 1.2 TSI 1.4 TDI 1.4 TDI 1.4 TDI 1.6	44 55 66 81 55 66 77 81	08.14 08.14 08.14 08.14 05.15 08.14 08.14 01.15		PR: 1KM PR: 1KM PR: 1KM PR: 1KM PR: 1KM PR: 1KM PR: 1KM	24.3727-3402.2	583402	2 L=1588		
	1.0 MPI 1.0 MPI 1.2 TSI 1.2 TSI 1.4 TDI 1.4 TDI 1.4 TDI 1.6	44 55 66 81 55 66 77 81	08.14 08.14 08.14 08.14 05.15 08.14 08.14 01.15		PR: OEM PR: OEM PR: OEM PR: OEM PR: OEM PR: OEM PR: OEM	24.2519-1706.3	040096		Nz 19,05	
SKODA FELICIA I (791/795) (95-97)										
	1.3 (135) 1.3 i (136) 1.6 i 1.9 D	50	10.94 10.94 08.95 10.96	02.98 02.98 02.98 02.98		24.2122-1731.3 03.2123-1428.3	010656 010476	- ABS + ABS	Thz 22,20 Thz 23,81	ATE
	1.3 (135) 1.3 i (136) 1.6 i 1.9 D	50	10.94 10.94 08.95 10.96	02.98 02.98 02.98 02.98		24.3541-1737.5 24.3541-1738.5	240197 240198		D=54, - Halter D=54, - Halter	TRW TRW
	1.3 (135) 1.3 i (136) 1.6 i	50	10.94 10.94 08.95	06.96 06.96 06.96		24.5112-0339.3	330771	2 - ABS	L=340	
	1.3 (135) 1.3 i (136) 1.6 i 1.9 D	50	07.96 07.96 07.96 10.96	02.98 02.98 02.98 02.98		24.5166-0325.3	331293	2 - ABS	L=325	
	1.3 (135) 1.3 i (136)	50	10.94 10.94	03.95 03.95		24.5228-0235.3	330395	2	L=235	
	1.3 (135) 1.3 i (136) 1.6 i 1.9 D	50	04.95 04.95 08.95 10.96	02.98 02.98 02.98 02.98		24.5228-0180.3	330761	2	L=180	

								
SKODA FELICIA I (791/795) (95-97)								
	1.3 (135) Lim. 1.3 i (136) Lim. 1.6 i Lim.	50		10.94 02.98 10.94 02.98 08.95 02.98	24.3219-1721.3	020422		Rz 19,05
	1.3 (135) Kombi 1.3 i (136) Kombi 1.6 i Kombi 1.9 D Kombi	50		10.94 02.98 10.94 02.98 08.95 02.98 10.96 02.98	24.3222-1712.3	020424		Rz 22,20
	1.3 (135) 1.3 i (136) 1.6 i 1.9 D	50		10.94 02.98 10.94 02.98 08.95 02.98 10.96 02.98	24.3727-2500.2	582500	2 ↓	L=1752
	1.3 (135) 1.3 i (136) 1.6 i	50		10.94 02.98 10.94 02.98 08.95 02.98	03.6584-0107.3	320110		BRL 8/4 (4) ATE
	1.9 D			10.96 02.98	03.6583-0167.3	320140		BRL 8/3 (4) ATE
	1.3 (135) 1.3 i (136) 1.6 i	50		10.94 02.98 10.94 02.98 08.95 02.98	24.3728-2500.2	592500		L=742
SKODA FELICIA II (6U) (98-01)								
	1.3 i 1.6 i 1.9 D			03.98 08.01 03.98 08.01 03.98 08.01	03.2123-1428.3	010476		THz 23,81 ATE
	1.3 i 1.6 i 1.9 D			03.98 08.01 03.98 08.01 03.98 08.01	24.3541-1737.5 24.3541-1738.5	240197 240198		D=54, - Halter TRW D=54, - Halter TRW
	1.3 i 1.6 i 1.9 D			03.98 08.01 03.98 08.01 03.98 08.01	24.5166-0325.3	331293	2	L=325
	1.3 i 1.6 i 1.9 D			03.98 08.98 03.98 08.98 03.98 08.98	24.5228-0180.3	330761	2	L=180
	1.3 i 1.6 i 1.9 D			09.98 08.01 09.98 08.01 09.98 08.01	83.6236-0175.3	330710	2	L=175
	1.3 i 1.6 i 1.9 D			03.98 08.01 03.98 08.01 03.98 08.01	24.3222-1712.3 24.3219-1721.3	020424 020422	- ABS + ABS	Rz 22,20 Rz 19,05
	1.3 i 1.6 i 1.9 D			03.98 08.01 03.98 08.01 03.98 08.01	24.3727-2500.2	582500	2 ↓	L=1752
SKODA FELICIA PICK-UP (797) (97-00)								
	1.3 1.3 1.6 1.9 D	40 50 55 47		06.97 12.00 06.97 12.00 06.97 12.99 06.97 12.00	24.2122-1731.3 03.2123-1428.3	010656 010476	- ABS + ABS	THz 22,20 THz 23,81 ATE
	1.3 1.3 1.6 1.9 D	40 50 55 47		06.97 12.00 06.97 12.00 06.97 12.99 06.97 12.00	24.3541-1737.5 24.3541-1738.5	240197 240198		D=54, - Halter TRW D=54, - Halter TRW
	1.3 1.3 1.6 1.9 D	40 50 55 47		06.97 12.00 06.97 12.00 06.97 12.99 06.97 12.00	24.5166-0325.3	331293	2	L=325
	1.3 1.3 1.6 1.9 D	40 50 55 47		06.97 12.00 06.97 12.00 06.97 12.99 06.97 12.00	83.6236-0175.3	330710	2	L=175
	1.3 1.3 1.6 1.9 D	40 50 55 47		06.97 12.00 06.97 12.00 06.97 12.99 06.97 12.00	24.3222-1712.3	020424	- ABS - ABS - ABS - ABS	Rz 22,20
	1.3 1.3 1.6 1.9 D	40 50 55 47		06.96 12.00 06.97 12.00 06.96 12.99 06.96 12.00	24.3219-1721.3	020422	+ ABS + ABS + ABS + ABS	Rz 19,05
	1.3 1.3 1.6 1.9 D	40 50 55 47		06.97 12.00 06.97 12.00 06.97 12.99 06.97 12.00	24.3727-2508.2	582508	2 ↓	L=1782
	1.3 1.3 1.6	40 50 55		06.97 12.00 06.97 12.00 06.97 12.99	03.6584-0107.3	320110		BRL 8/4 (4) ATE
	1.9 D	47		06.97 12.00	03.6583-0167.3	320140		BRL 8/3 (4) ATE
	1.3 1.6	40 55		06.96 12.00 06.96 12.99	24.3728-2500.2	592500		L=742

SKODA OCTAVIA I (1U) (97-10)									
	1.4 i 1.6 i 1.8 i 20V 1.8 i 20V Turbo 1.9 SDI 1.9 TDI 1.9 TDI 1.9 TDI 4x4 2.0 i 2.0 i 4x4	◀ ◀ ◀ 92 ◀ 110 ◀ ◀ 66 ◀ 81 ◀ ◀ ◀ 88	04.99 07.00 10.96 07.00 10.96 07.00 03.98 07.00 05.97 07.00 10.96 07.00 08.97 07.00 11.99 07.00 04.99 07.00 01.00 07.00		03.7863-0402.4	300124	+ ESP	10"	ATE
	1.4 i 1.6 i 1.8 i 20V 1.8 i 20V Turbo 1.8 i 20V Turbo 4x4 1.9 SDI 1.9 TDI 1.9 TDI 1.9 TDI 1.9 TDI 1.9 TDI 4x4 2.0 i 2.0 i 4x4 2.0 i 4x4 RS 1.8 T 20V	◀ ◀ ◀ 92 ◀ 110 ◀ 110 ◀ ◀ 66 ◀ 74 ◀ 81 ◀ 96 ◀ ◀ ◀ 85 ◀ 88 ◀ 132	05.01 06.10 05.01 06.10 05.01 06.10 05.01 06.10 05.01 06.10 05.01 06.10 05.01 06.10 05.01 06.10 01.03 06.10 05.01 06.10 05.01 06.10 05.01 06.10 05.01 06.10 05.01 06.10 05.01 06.10	PR: 1AC,1AH,1AJ,1AT PR: 1AC,1AH,1AJ,1AT PR: 1AC,1AH,1AJ,1AT PR: 1AC,1AH,1AJ,1AT PR: 1AC,1AH,1AJ,1AT PR: 1AC,1AH,1AJ,1AT PR: 1AC,1AH,1AJ,1AT PR: 1AC,1AH,1AJ,1AT PR: 1AC,1AH,1AJ,1AT PR: 1AC,1AH,1AJ,1AT PR: 1AC,1AH,1AJ,1AT PR: 1AC,1AH,1AJ,1AT PR: 1AC,1AH,1AJ,1AT PR: 1AC,1AH,1AJ,1AT PR: 1AC,1AH,1AJ,1AT	03.7863-3502.4	300128		10"	ATE
	1.4 i 1.6 i 1.8 i 20V 1.8 i 20V Turbo 1.9 SDI 1.9 TDI 1.9 TDI 1.9 TDI 4x4 2.0 i 2.0 i 4x4	◀ ◀ ◀ 92 ◀ 110 ◀ ◀ 66 ◀ 81 ◀ ◀ ◀ 88	04.99 07.00 10.96 07.00 10.96 07.00 03.98 07.00 05.97 07.00 10.96 07.00 08.97 07.00 11.99 07.00 04.99 07.00 01.00 07.00		24.2123-1709.3 03.2123-2024.3	010503 010597	- ESP + ESP	THz 23,81 THz 23,81	ATE
	1.4 i 1.6 i 1.8 i 20V 1.8 i 20V Turbo 1.8 i 20V Turbo 4x4 1.9 SDI 1.9 TDI 1.9 TDI 1.9 TDI 1.9 TDI 1.9 TDI 4x4 2.0 i 2.0 i 4x4 2.0 i 4x4 RS 1.8 T 20V	◀ ◀ ◀ 92 ◀ 110 ◀ 110 ◀ ◀ 66 ◀ 74 ◀ 81 ◀ 96 ◀ ◀ ◀ 85 ◀ 88 ◀ 132	08.00 06.10 08.00 06.10 08.00 06.10 08.00 06.10 05.01 06.10 08.00 06.10 08.00 06.10 08.00 06.10 08.00 06.10 01.03 06.10 08.00 06.10 08.00 06.10 08.00 06.10 05.01 06.10	PR: 1AM PR: 1AM PR: 1AM PR: 1AM PR: 1AM PR: 1AM PR: 1AM PR: 1AM PR: 1AM PR: 1AM PR: 1AM PR: 1AM PR: 1AM PR: 1AM	24.2123-1709.3	010503		THz 23,81	ATE
	1.4 i 1.6 i 1.8 i 20V 1.8 i 20V Turbo 1.8 i 20V Turbo 4x4 1.9 SDI 1.9 TDI 1.9 TDI 1.9 TDI 1.9 TDI 1.9 TDI 4x4 2.0 i 2.0 i 4x4 2.0 i 4x4 RS 1.8 T 20V	◀ ◀ ◀ 92 ◀ 110 ◀ 110 ◀ ◀ 66 ◀ 74 ◀ 81 ◀ 96 ◀ ◀ ◀ 85 ◀ 88 ◀ 132	08.00 06.10 08.00 06.10 08.00 06.10 08.00 06.10 05.01 06.10 08.00 06.10 08.00 06.10 08.00 06.10 08.00 06.10 01.03 06.10 08.00 06.10 08.00 06.10 08.00 06.10 05.01 06.10	PR: 1AC,1AH,1AJ PR: 1AC,1AH,1AJ PR: 1AC,1AH,1AJ PR: 1AC,1AH,1AJ PR: 1AC,1AH,1AJ PR: 1AC,1AH,1AJ PR: 1AC,1AH,1AJ PR: 1AC,1AH,1AJ PR: 1AC,1AH,1AJ PR: 1AC,1AH,1AJ PR: 1AC,1AH,1AJ PR: 1AC,1AH,1AJ PR: 1AC,1AH,1AJ PR: 1AC,1AH,1AJ	03.2123-2973.3	010951		THz 23,81	ATE
	1.4 i 1.6 i 1.8 i 20V 1.8 i 20V Turbo 1.8 i 20V Turbo 4x4 1.9 SDI 1.9 TDI 1.9 TDI 1.9 TDI 1.9 TDI 1.9 TDI 4x4 2.0 i 2.0 i 4x4 2.0 i 4x4 RS 1.8 T 20V	◀ ◀ ◀ 92 ◀ 110 ◀ 110 ◀ ◀ 66 ◀ 74 ◀ 81 ◀ 96 ◀ ◀ ◀ 85 ◀ 88 ◀ 132	08.00 06.10 08.00 06.10 08.00 06.10 08.00 06.10 05.01 06.10 08.00 06.10 08.00 06.10 08.00 06.10 08.00 06.10 01.03 06.10 08.00 06.10 08.00 06.10 08.00 06.10 05.01 06.10	PR: 1AT PR: 1AT PR: 1AT PR: 1AT PR: 1AT PR: 1AT PR: 1AT PR: 1AT PR: 1AT PR: 1AT PR: 1AT PR: 1AT PR: 1AT PR: 1AT	03.2123-2715.3	010802		THz 23,81	ATE
	1.4 i 1.6 i 1.8 i 20V 1.8 i 20V Turbo 1.8 i 20V Turbo 4x4 1.9 SDI 1.9 TDI 1.9 TDI 1.9 TDI 1.9 TDI 1.9 TDI 4x4 2.0 i 2.0 i 4x4 2.0 i 4x4 RS 1.8 T 20V	▶ ▶ ▶ 92 ▶ 110 ▶ 110 ▶ ▶ 66 ▶ 74 ▶ 81 ▶ 96 ▶ ▶ ▶ 85 ▶ 88 ▶ 132	04.99 07.00 10.96 07.00 10.96 07.00 03.98 07.00 05.97 07.00 10.96 07.00 08.97 07.00		03.2123-2064.3	010598	+ ESP	THz 23,81	ATE

									
SKODA OCTAVIA I (1U) (97-10)									
	1.9 TDI 4x4 ▶		11.99	07.00	03.2123-2064.3	010598	+ ESP	Thz 23,81	ATE
	2.0 i ▶		04.99	07.00					
	2.0 i 4x4 ▶	88	01.00	07.00					
	1.4 i ▶		08.00	06.10	03.2123-2774.3	010803		Thz 23,81	ATE
	1.6 i ▶		08.00	06.10					
	1.8 i 20V ▶	92	08.00	06.10					
	1.8 i 20V Turbo ▶	110	08.00	06.10					
	1.8 i 20V Turbo 4x4 ▶	110	05.01	06.10					
	1.9 SDI ▶		08.00	06.10					
	1.9 TDI ▶	66	08.00	06.10					
	1.9 TDI ▶	74	08.00	06.10					
	1.9 TDI ▶	81	08.00	06.10					
	1.9 TDI ▶	96	01.03	06.10					
	1.9 TDI 4x4 ▶		08.00	06.10					
	2.0 i ▶		08.00	06.10					
	2.0 i 4x4 ▶	85	05.01	06.10					
	2.0 i 4x4 ▶	88	08.00	06.10					
	RS 1.8 T 20V ▶	132	05.01	06.10					
	1.6 i ▶		10.96		11.9541-9549.2	220575		D=54, - Halter	ATE
	1.8 i 20V ▶	92	10.96		11.9541-9550.2	220576		D=54, - Halter	ATE
	1.8 i 20V Turbo ▶	110	03.98		11.0441-5409.2	250031		Dichtungssatz	ATE
	1.9 SDI ▶		05.97		11.0101-5409.2	260035		Hülsensatz	ATE
	1.9 TDI ▶	66	10.96						
	1.9 TDI ▶	81	08.97						
	1.4 i ▶		04.99	06.10	11.9541-9549.2	220575		D=54, - Halter	ATE
	1.6 i ▶	1U-W-104150	06.10	06.10	11.9541-9550.2	220576		D=54, - Halter	ATE
	1.8 i 20V ▶	92 1U-W-104150	06.10	06.10	11.0101-5409.2	260035		Hülsensatz	ATE
	1.8 i 20V Turbo ▶	110 1U-W-104150	06.10	06.10					
	1.8 i 20V Turbo 4x4 ▶	110 1U-W-104150	05.01	06.10					
	1.9 SDI ▶	1U-W-104150	06.10	06.10					
	1.9 TDI ▶	66 1U-W-104150	06.10	06.10					
	1.9 TDI ▶	74 1U-W-104150	08.00	06.10					
	1.9 TDI ▶	81 1U-W-104150	06.10	06.10					
	1.9 TDI ▶	96	01.03	06.10					
	1.9 TDI 4x4 ▶		11.99	06.10					
	2.0 i ▶		04.99	06.10					
	2.0 i 4x4 ▶	85	05.01	06.10					
	2.0 i 4x4 ▶	88	01.00	06.10					
	1.4 i ▶		04.99	06.10	11.3541-8523.2	220115		D=54, - Halter	ATE
	1.6 i ▶		10.96	06.10	11.3541-8524.2	220116		D=54, - Halter	ATE
	1.8 i 20V ▶	92	10.96	06.10	24.3541-8523.5	240551		D=54, - Halter	ATE
	1.8 i 20V Turbo ▶	110	03.98	06.10	24.3541-8524.5	240552		D=54, - Halter	ATE
	1.8 i 20V Turbo 4x4 ▶	110	05.01	06.10	11.8170-0306.1	260102		Halter	ATE
	1.9 SDI ▶		05.97	06.10	11.0441-5409.2	250031		Dichtungssatz	ATE
	1.9 TDI ▶	66	10.96	06.10	11.0101-5409.2	260035		Hülsensatz	ATE
	1.9 TDI ▶	74	10.96	06.10	11.8171-0008.1	990049		Führungsbolzen	ATE
	1.9 TDI ▶	81	08.00	06.10	11.8116-0143.1	390513		Haltefeder	ATE
	1.9 TDI ▶	96	01.03	06.10					
	1.9 TDI 4x4 ▶		11.99	06.10					
	2.0 i ▶		04.99	06.10					
	2.0 i 4x4 ▶	85	05.01	06.10					
	2.0 i 4x4 ▶	88	01.00	06.10					
	RS 1.8 T 20V ▶	132	05.01	06.10	11.9541-9595.2	220501		D=54, - Halter	ATE
					11.9541-9596.2	220502		D=54, - Halter	ATE
					11.0441-5409.2	250031		Dichtungssatz	ATE
					11.0101-5409.2	260035		Hülsensatz	ATE
					11.8171-0008.1	990049		Führungsbolzen	ATE
					11.8116-0143.1	390513		Haltefeder	ATE
	1.4 i ▶		04.99	06.10	24.5143-0439.3	331411		L=439	
	1.6 i ▶		10.96	06.10					
	1.8 i 20V ▶	92	10.96	06.10					
	1.8 i 20V Turbo ▶	110	03.98	06.10					
	1.9 SDI ▶		05.97	06.10					
	1.9 TDI ▶	66	10.96	06.10					
	1.9 TDI ▶	74	08.00	06.10					
	1.9 TDI ▶	81	08.97	06.10					
	1.9 TDI ▶	96	01.03	06.10					
	2.0 i ▶		04.99	06.10					
	1.8 i 20V Turbo 4x4 ▶	110	05.01	06.10	24.5143-0569.3	331398		L=569	
	1.9 TDI 4x4 ▶		11.99	06.10					
	2.0 i 4x4 ▶	85	05.01	06.10					
	2.0 i 4x4 ▶	88	01.00	06.10					
	RS 1.8 T 20V ▶	132	05.01	06.10					
	1.8 i 20V ▶	92	10.96		24.3384-1723.7	220523		D=38(M12x1), - Halter	TRW
	1.8 i 20V Turbo ▶	110	03.98		24.3384-1724.7	220524		D=38(M12x1), - Halter	TRW
	1.9 SDI ▶		05.97						
	1.9 TDI ▶	81	08.97						
	1.6 i ▶		10.96		24.3414-1703.7	220535		D=41, - Halter	TRW
	1.8 i 20V ▶	92 1U-W-130000	06.10	06.10	24.3414-1704.7	220536		D=41, - Halter	TRW
	1.8 i 20V Turbo ▶	110 1U-W-130000	06.10	06.10					
	1.9 SDI ▶	1U-W-130000	06.10	06.10					
	1.9 TDI ▶	66 1U-Y-294000	10.96	06.10					
	1.9 TDI ▶	81 1U-W-130000	06.10	06.10					
	2.0 i ▶	1U-Y-294000	04.99	06.10					
	1.6 i ▶	1U-Y-294001		06.10	24.3414-1705.7	220549		D=41, - Halter	TRW
	1.8 i 20V ▶	92 1U-Y-294001		06.10	24.3414-1706.7	220550		D=41, - Halter	TRW



SKODA OCTAVIA I (1U) (97-10)												
	1.8 i 20V Turbo	110	1U-Y-294001		06.10	PR: 1KP	24.3414-1705.7	220549	<input type="checkbox"/>			
	1.8 i 20V Turbo 4x4	110		05.01	06.10	PR: 1KE	24.3414-1706.7	220550	<input type="checkbox"/>		D=41, - Halter D=41, - Halter	
	1.9 SDI		1U-Y-294001		06.10	PR: 1KP						
	1.9 TDI	66	1U-Y-294001		06.10	PR: 1KP						
	1.9 TDI	74		08.00	06.10	PR: 1KP						
	1.9 TDI	81	1U-Y-294001		06.10	PR: 1KP						
	1.9 TDI	96		01.03	06.10	PR: 1KP						
	1.9 TDI 4x4			11.99	06.10	PR: 1KE						
	2.0 i		1U-Y-294001		06.10	PR: 1KP						
2.0 i 4x4	85		05.01	06.10	PR: 1KE							
2.0 i 4x4	88		01.00	06.10	PR: 1KE							
	1.4 i			04.99	06.10		83.7858-0140.3	330837	2		L=140	
	1.6 i			10.96	06.10							
	1.8 i 20V	92		10.96	06.10							
	1.8 i 20V Turbo	110		03.98	06.10							
	1.9 SDI			05.97	06.10							
	1.9 TDI	66		10.96	06.10							
	1.9 TDI	74		08.00	06.10							
	1.9 TDI	81		08.97	06.10							
	1.9 TDI	96		01.03	06.10							
	2.0 i			04.99	06.10							
	RS 1.8 T 20V	132		05.01	06.10							
	1.8 i 20V Turbo 4x4	110		05.01	06.10		83.7858-0140.3	330837	2		L=140	
	1.9 TDI 4x4			11.99	06.10							
	2.0 i 4x4	85		05.01	06.10							
	2.0 i 4x4	88		01.00	06.10							
		1.4 i			04.99	06.10	PR: 1KG	24.3220-0909.3	020210			Rz 20,64
		1.6 i			10.96	06.10	PR: 1KG					
		1.9 SDI			05.97	06.10	PR: 1KG					
1.9 TDI		66		10.96	06.10	PR: 1KG						
1.4 i				04.99	06.10	PR: 1KN	24.3219-0909.3	020188			Rz 19,05	
1.6 i				10.96	06.10	PR: 1KN						
	1.9 SDI			05.97	06.10	PR: 1KN						
	1.9 TDI	66		10.96	06.10	PR: 1KN						
	1.4 i			04.99	06.10	+ Trommelbremse ¹⁾	24.3727-2503.2	582503	2 ↓	- Schlechtwegeausführung ²⁾	L=1620	
	1.6 i			10.96	06.10	+ Trommelbremse ¹⁾	24.3727-2505.2	582505	2 ↓	+ Schlechtwegeausführung ³⁾	L=1620	
	1.9 SDI		1U-Y-294000	05.97	06.10	+ Trommelbremse ¹⁾						
	1.9 TDI	66	1U-Y-294000	10.96	06.10	+ Trommelbremse ¹⁾						
	1.4 i		1U-Y-294001		06.10	+ Trommelbremse ¹⁾	24.3727-2509.2	582509	2 ↓		L=1620	
	1.6 i		1U-Y-294001		06.10	+ Trommelbremse ¹⁾	24.3727-2511.2	582511	2 ↓		L=1620	
	1.9 SDI		1U-Y-294001		06.10	+ Trommelbremse ¹⁾						
	1.9 TDI	66	1U-Y-294001		06.10	+ Trommelbremse ¹⁾						
	1.6 i		1U-Y-294000	10.96	06.10	+ Scheibenbremse ⁴⁾	24.3727-0149.2	580149	2 ↓		L=1688	
	1.8 i 20V	92	1U-Y-294000	10.96	06.10	+ Scheibenbremse ⁴⁾						
	1.8 i 20V Turbo	110	1U-Y-294000	03.98	06.10	+ Scheibenbremse ⁴⁾						
	1.9 SDI		1U-Y-294000	05.97	06.10	+ Scheibenbremse ⁴⁾						
	1.9 TDI	66	1U-Y-294000	10.96	06.10	+ Scheibenbremse ⁴⁾						
	1.9 TDI	81	1U-Y-294000	08.97	06.10	+ Scheibenbremse ⁴⁾						
	2.0 i		1U-Y-294000	04.99	06.10	+ Scheibenbremse ⁴⁾						
	1.6 i		1U-Y-294001		07.00	+ Scheibenbremse ⁴⁾	24.3727-0173.2	580173	2 ↓		L=1693	
	1.8 i 20V	92	1U-Y-294001		07.00	+ Scheibenbremse ⁴⁾						
	1.8 i 20V Turbo	110	1U-Y-294001		07.00	+ Scheibenbremse ⁴⁾						
	1.9 SDI		1U-Y-294001		07.00	+ Scheibenbremse ⁴⁾						
	1.9 TDI	66	1U-Y-294001		07.00	+ Scheibenbremse ⁴⁾						
	1.9 TDI	81	1U-Y-294001		07.00	+ Scheibenbremse ⁴⁾						
	2.0 i		1U-Y-294001		07.00	+ Scheibenbremse ⁴⁾						
1.8 i 20V Turbo 4x4	110		05.01	06.10		24.3727-0175.2	580175	2 ↓		L=1723		
1.9 TDI 4x4			11.99	06.10								
2.0 i 4x4	85		05.01	06.10								
2.0 i 4x4	88		01.00	06.10								
	1.4 i			04.99	06.10	+ Trommelbremse ¹⁾	03.6584-0107.3	320110			BRL 8/4 (4)	
	1.6 i			10.96	06.10	+ Trommelbremse ¹⁾						
	1.9 SDI			05.97	06.10	+ Trommelbremse ¹⁾						
	1.9 TDI	66		10.96	06.10	+ Trommelbremse ¹⁾						
	1.4 i			04.99	06.10	+ Scheibenbremse ⁴⁾	03.6583-0179.3	320228			BRL 8/3 (4)	
	1.6 i			10.96	06.10	+ Scheibenbremse ⁴⁾						
	1.8 i 20V	92		10.96	06.10	+ Scheibenbremse ⁴⁾						
	1.8 i 20V Turbo	110		03.98	06.10	+ Scheibenbremse ⁴⁾						
	1.8 i 20V Turbo 4x4	110		05.01	06.10	+ Scheibenbremse ⁴⁾						
	1.9 SDI			05.97	06.10	+ Scheibenbremse ⁴⁾						
	1.9 TDI	66		10.96	06.10	+ Scheibenbremse ⁴⁾						
	1.9 TDI	74		08.00	06.10	+ Scheibenbremse ⁴⁾						
	1.9 TDI	81		08.97	06.10	+ Scheibenbremse ⁴⁾						
	1.9 TDI	96		01.03	06.10	+ Scheibenbremse ⁴⁾						
	1.9 TDI 4x4			11.99	06.10	+ Scheibenbremse ⁴⁾						
	2.0 i			04.99	06.10	+ Scheibenbremse ⁴⁾						
2.0 i 4x4	85		05.01	06.10	+ Scheibenbremse ⁴⁾							
2.0 i 4x4	88		01.00	06.10	+ Scheibenbremse ⁴⁾							
RS 1.8 T 20V	132		05.01	06.10	+ Scheibenbremse ⁴⁾							
	1.4 i			04.99	06.10		24.2415-1701.3	030095			Gz 15,87	
	1.6 i			10.96	06.10							
	1.8 i 20V	92		10.96	06.10							
	1.8 i 20V Turbo	110		03.98	06.10							
	1.9 SDI			05.97	06.10							

¹⁾ + drum brake / + freno a tamburo / + freins à tambour / + tambores de freno

²⁾ - rough road construction / - versione per percorsi accidentati / - version pour mauvaise route / - versión 4x4













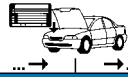





³⁾ + rough road construction / + versione per percorsi accidentati / + version pour mauvaise route / + versión 4x4













⁴⁾ + disc brake / + disco freno / + disques de frein / + disco de freno

SKODA OCTAVIA I (1U) (97-10)																					
	1.9 TDI	◀ 66		10.96	06.10	24.2415-1701.3	030095				Gz 15,87										
	1.9 TDI	◀ 74		08.00	06.10																
	1.9 TDI	◀ 81		08.97	06.10																
	1.9 TDI	◀ 96		01.03	06.10																
	1.9 TDI 4x4	◀		11.99	06.10																
	2.0 i	◀		04.99	06.10																
	2.0 i 4x4	◀ 85		05.01	06.10																
	2.0 i 4x4	◀ 88		01.00	06.10																
	RS 1.8 T 20V	◀132		05.01	06.10																
	1.4 i	▶		04.99	06.10							24.2415-1702.3	030096				Gz 15,87				
	1.6 i	▶		10.96	06.10																
	1.8 i 20V	▶ 92		10.96	06.10																
	1.8 i 20V Turbo	▶110		03.98	06.10																
	1.8 i 20V Turbo 4x4	▶110		05.01	06.10																
1.9 SDI	▶		05.97	06.10																	
1.9 TDI	▶ 66		10.96	06.10																	
1.9 TDI	▶ 74		08.00	06.10																	
1.9 TDI	▶ 81		08.97	06.10																	
1.9 TDI	▶ 96		01.03	06.10																	
1.9 TDI 4x4	▶		11.99	06.10																	
2.0 i	▶		04.99	06.10																	
2.0 i 4x4	▶ 85		05.01	06.10																	
2.0 i 4x4	▶ 88		01.00	06.10																	
RS 1.8 T 20V	▶132		05.01	06.10																	
	1.4 i			04.99	06.10	24.2519-1706.3	040096				Nz 19,05										
	1.6 i			10.96	06.10																
	1.9 SDI			05.97	06.10																
	1.8 i 20V	92		10.96	06.10																
	1.8 i 20V Turbo	110		03.98	06.10																
	1.8 i 20V Turbo 4x4	110		05.01	06.10																
	1.9 TDI	66		10.96	06.10																
	1.9 TDI	74		08.00	06.10																
	1.9 TDI	81		08.97	06.10																
	1.9 TDI	96		01.03	06.10																
	1.9 TDI 4x4			11.99	06.10																
	2.0 i			04.99	06.10																
	2.0 i 4x4	85		05.01	06.10																
	2.0 i 4x4	88		01.00	06.10																
RS 1.8 T 20V	132		05.01	06.10																	
SKODA OCTAVIA II (1Z) (04-13)																					
	1.2 TSI	◀ 77		02.10	01.13	03.7863-3232.4	300307				Kolbendurchmesser Ø 22,20mm ¹⁾	10"	ATE								
	1.4 i 16V	◀		06.04	01.13																
	1.4 TSI	◀ 90		11.08	01.13																
	1.6	◀ 75		09.09	01.13																
	1.6 FSI	◀ 85		06.04	01.13																
	1.6 i 16V	◀ 75		06.04	01.13																
	1.6 TDI	◀ 77		06.09	01.13																
	1.6 TDI 4x4	◀ 77		06.09	01.13																
	1.8 TSI	◀		06.07	01.13																
	1.8 TSI 4x4	◀		11.08	01.13																
	1.9 TDI	◀ 77		06.04	01.13																
	1.9 TDI 4x4	◀ 77		11.04	01.13																
	2.0 FSI	◀110		11.04	01.13																
	2.0 FSI 4x4	◀110		11.04	01.13																
	2.0 RS	◀147		10.05	01.13																
	2.0 TDI	◀ 81		03.10	01.13																
	2.0 TDI	◀100		06.04	01.13																
	2.0 TDI	◀103		06.04	01.13																
	2.0 TDi 4x4	◀ 81		05.11	01.13																
	2.0 TDI 4x4	◀103		07.06	01.13																
	2.0 TDI RS	◀125		04.06	01.13																
	1.2 TSI	◀ 77		02.10	01.13									03.7863-9602.4	300206				PR: 1AS	10"	ATE
	1.4 i 16V	◀		06.04	01.13																
	1.4 TSI	◀ 90		11.08	01.13																
	1.6	◀ 75		09.09	01.13																
	1.6 FSI	◀ 85		06.04	01.13																
	1.6 i 16V	◀ 75		06.04	01.13																
	1.6 TDI	◀ 77		06.09	01.13																
	1.6 TDI 4x4	◀ 77		06.09	01.13																
	1.8 TSI	◀		06.07	01.13																
	1.8 TSI 4x4	◀		11.08	01.13																
	1.9 TDI	◀ 77		06.04	01.13																
	1.9 TDI 4x4	◀ 77		11.04	01.13																
	2.0 FSI	◀110		11.04	01.13																
2.0 FSI 4x4	◀110		11.04	01.13																	
2.0 RS	◀147		10.05	01.13																	
2.0 TDI	◀ 81		03.10	01.13																	
2.0 TDI	◀100		06.04	01.13																	
2.0 TDI	◀103		06.04	01.13																	
2.0 TDi 4x4	◀ 81		05.11	01.13																	
2.0 TDI 4x4	◀103		07.06	01.13																	
2.0 TDI RS	◀125		04.06	01.13																	

¹⁾ piston diameter Ø 22,20mm / diametro del pistone Ø 22,20mm / diamètre de piston Ø 22,20mm / diámetro del pistón Ø 22,20mm



SKODA OCTAVIA II (1Z) (04-13)										
										
	1.2 TSI 1.4 i 16V 1.4 TSI 1.6 1.6 FSI 1.6 i 16V 1.6 TDI 1.6 TDI 4x4 1.8 TSI 1.8 TSI 4x4 1.9 TDI 1.9 TDI 4x4 2.0 FSI 2.0 FSI 4x4 2.0 RS 2.0 TDI 2.0 TDI 2.0 TDI 2.0 TDi 4x4 2.0 TDi 4x4 2.0 TDI RS	77 77 90 75 85 75 77 77 77 77 77 110 110 147 81 100 103 81 103 125	02.10 06.04 11.08 09.09 06.04 06.04 06.09 06.09 06.07 11.08 06.04 11.04 11.04 11.04 10.05 03.10 06.04 06.04 05.11 07.06 04.06	01.13 01.13		03.2122-2129.3	010799		Thz 22,20	ATE
	1.2 TSI 1.4 i 16V 1.4 TSI 1.6 1.6 FSI 1.6 i 16V 1.6 TDI 1.6 TDI 4x4 1.8 TSI 1.8 TSI 4x4 1.9 TDI 1.9 TDI 4x4 2.0 FSI 2.0 FSI 4x4 2.0 TDI 2.0 TDI 2.0 TDI 2.0 TDi 4x4 2.0 TDi 4x4	77 90 75 85 75 77 77 77 77 77 77 77 110 110 81 100 103 81 103	02.10 06.04 11.08 09.09 06.04 06.04 06.09 06.09 06.07 11.08 06.04 11.04 11.04 11.04 03.10 06.04 06.04 05.11 07.06	01.13 01.13 01.13 01.13 01.13 01.13 01.13 01.13 01.13 01.13 01.13 01.13 01.13 01.13 01.13 01.13 01.13 01.13 01.13 01.13	PR: 1ZC, 1ZF, 1ZM PR: 1ZC, 1ZF, 1ZM PR: 1ZC, 1ZF, 1ZM PR: 1ZC, 1ZF, 1ZM PR: 1ZC, 1ZF, 1ZM PR: 1ZC, 1ZF, 1ZM PR: 1ZC, 1ZF, 1ZM PR: 1ZC, 1ZF, 1ZM PR: 1ZC, 1ZF, 1ZM PR: 1ZC, 1ZF, 1ZM PR: 1ZC, 1ZF, 1ZM PR: 1ZC, 1ZF, 1ZM PR: 1ZC, 1ZF, 1ZM PR: 1ZC, 1ZF, 1ZM PR: 1ZC, 1ZF, 1ZM PR: 1ZC, 1ZF, 1ZM PR: 1ZC, 1ZF, 1ZM PR: 1ZC, 1ZF, 1ZM PR: 1ZC, 1ZF, 1ZM	11.9541-9549.2 11.9541-9550.2 11.8171-0069.1	220575 220576 250152	 	D=54, - Halter D=54, - Halter Führungsbolzen	ATE ATE ATE
	1.2 TSI 1.4 i 16V 1.4 TSI 1.6 1.6 FSI 1.6 i 16V 1.6 TDI 1.6 TDI 4x4 1.8 TSI 1.8 TSI 4x4 1.9 TDI 1.9 TDI 4x4 2.0 FSI 2.0 FSI 4x4 2.0 TDI 2.0 TDI 2.0 TDI 2.0 TDi 4x4 2.0 TDi 4x4	77 90 75 85 75 77 77 77 77 77 77 77 110 110 81 100 103 81 103	02.10 06.04 11.08 09.09 06.04 06.04 06.09 06.09 06.07 11.08 06.04 11.04 11.04 11.04 03.10 06.04 06.04 05.11 07.06	01.13 01.13 01.13 01.13 01.13 01.13 01.13 01.13 01.13 01.13 01.13 01.13 01.13 01.13 01.13 01.13 01.13 01.13 01.13 01.13	PR: 1ZE PR: 1ZE PR: 1ZE PR: 1ZE PR: 1ZE PR: 1ZE PR: 1ZE PR: 1ZE PR: 1ZE PR: 1ZE PR: 1ZE PR: 1ZE PR: 1ZE PR: 1ZE PR: 1ZE PR: 1ZE PR: 1ZE PR: 1ZE PR: 1ZE	11.9541-9553.2 11.9541-9554.2 11.0101-5409.2 11.8171-0008.1 11.8116-0351.1	220563 220564 260035 990049 390538	 	D=54, - Halter D=54, - Halter Hülzensatz Führungsbolzen Haltefeder	ATE ATE ATE ATE ATE
	2.0 RS 2.0 TDI RS	147 125	10.05 04.06	01.13 01.13	PR: 1LL,1LP,1ZB PR: 1LL,1LP,1ZB	11.9541-9553.2 11.9541-9554.2 11.0101-5409.2 11.8171-0008.1 11.8116-0351.1	220563 220564 260035 990049 390538	 	D=54, - Halter D=54, - Halter Hülzensatz Führungsbolzen Haltefeder	ATE ATE ATE ATE ATE
	1.2 TSI 1.4 i 16V 1.4 TSI 1.6 1.6 FSI 1.6 i 16V 1.6 TDI 1.6 TDI 4x4 1.8 TSI 1.8 TSI 4x4 1.9 TDI 1.9 TDI 4x4 2.0 FSI 2.0 FSI 4x4 2.0 RS 2.0 TDI 2.0 TDI 2.0 TDI 2.0 TDi 4x4 2.0 TDi 4x4 2.0 TDI RS	77 90 75 85 75 77 77 77 77 77 77 77 110 110 147 81 100 103 81 103 125	02.10 06.04 11.08 09.09 06.04 06.04 06.09 06.09 06.07 11.08 06.04 11.04 11.04 11.04 10.05 03.10 06.04 06.04 05.11 07.06 04.06	01.13 01.13		24.5143-0564.3	331433	2	L=564	

        										
SKODA OCTAVIA II (1Z) (04-13)										
	1.2 TSI 77	02.10	01.13	PR: 1KD	24.3384-1755.7	220635	<input type="checkbox"/> <input type="checkbox"/>	D=38, - Halter	TRW	
	1.4 i 16V		06.04	01.13	PR: 1KD	24.3384-1756.7				220636
	1.4 TSI	90	11.08	01.13	PR: 1KD					
	1.6	75	09.09	01.13	PR: 1KD					
	1.6 FSI	85	06.04	01.13	PR: 1KD					
	1.6 i 16V	75	06.04	01.13	PR: 1KD					
	1.6 TDI	77	06.09	01.13	PR: 1KD					
	1.8 TSI		06.07	01.13	PR: 1KD					
	1.9 TDI	77	06.04	01.13	PR: 1KD					
	2.0 FSI	110	11.04	01.13	PR: 1KD					
	2.0 TDI	81	03.10	01.13	PR: 1KD					
	2.0 TDI	100	06.04	01.13	PR: 1KD					
	2.0 TDI	103	06.04	01.13	PR: 1KD					
2.0 TDi 4x4	81	05.11	01.13	PR: 1KD						
	1.2 TSI 77	02.10	01.13	PR: 1KF	24.3414-1709.7	220631	<input type="checkbox"/> <input type="checkbox"/>	D=41, - Halter	TRW	
	1.4 i 16V		06.04	01.13	PR: 1KF	24.3414-1710.7				220632
	1.4 TSI	90	11.08	01.13	PR: 1KF					
	1.6	75	09.09	01.13	PR: 1KF					
	1.6 FSI	85	06.04	01.13	PR: 1KF					
	1.6 i 16V	75	06.04	01.13	PR: 1KF					
	1.6 TDI	77	06.09	01.13	PR: 1KF					
	1.6 TDI 4x4	77	06.09	01.13	PR: 1KF					
	1.8 TSI		06.07	01.13	PR: 1KF					
	1.8 TSI 4x4		11.08	01.13	PR: 1KF					
	1.9 TDI	77	06.04	01.13	PR: 1KF					
	1.9 TDI 4x4	77	11.04	01.13	PR: 1KF					
	2.0 FSI	110	11.04	01.13	PR: 1KF					
2.0 FSI 4x4	110	11.04	01.13	PR: 1KF						
2.0 TDI	81	03.10	01.13	PR: 1KF						
2.0 TDI	100	06.04	01.13	PR: 1KF						
2.0 TDI	103	06.04	01.13	PR: 1KF						
2.0 TDi 4x4	81	05.11	01.13	PR: 1KF						
2.0 TDi 4x4	103	07.06	01.13	PR: 1KF						
2.0 RS	147	10.05	01.13	PR: 1KP	24.3387-1729.7	221007	<input type="checkbox"/> <input type="checkbox"/>	D=38, rot, - Halter	TRW	
2.0 TDI RS	125	04.06	01.13	PR: 1KP	24.3387-1730.7	221008				
	1.4 i 16V		06.04	10.09	24.5204-0233.3	331430	2	L=233		
	1.4 TSI	90	11.08	10.09						
	1.6	75	09.09	10.09						
	1.6 FSI	85	06.04	10.09						
	1.6 i 16V	75	06.04	10.09						
	1.6 TDI	77	06.09	10.09						
	1.6 TDI 4x4	77	06.09	10.09						
	1.8 TSI		06.07	10.09						
	1.8 TSI 4x4		11.08	10.09						
	1.9 TDI	77	06.04	10.09						
	1.9 TDI 4x4	77	11.04	10.09						
	2.0 FSI	110	11.04	10.09						
	2.0 FSI 4x4	110	11.04	10.09						
2.0 RS	147	10.05	10.09							
2.0 TDI	100	06.04	10.09							
2.0 TDI	103	06.04	10.09							
2.0 TDI 4x4	103	07.06	10.09							
2.0 TDI RS	125	04.06	10.09							
	1.2 TSI 77	02.10	01.13		83.7847-0254.3	331233	<input type="checkbox"/> <input type="checkbox"/>	L=255	L=255	
	1.4 i 16V		11.09	01.13	83.7847-0257.3	331234				
	1.4 TSI	90	11.09	01.13						
	1.6	75	11.09	01.13						
	1.6 FSI	85	11.09	01.13						
	1.6 i 16V	75	11.09	01.13						
	1.6 TDI	77	11.09	01.13						
	1.6 TDI 4x4	77	11.09	01.13						
	1.8 TSI		11.09	01.13						
	1.8 TSI 4x4		11.09	01.13						
	1.9 TDI	77	11.09	01.13						
	1.9 TDI 4x4	77	11.09	01.13						
	2.0 FSI	110	11.09	01.13						
2.0 FSI 4x4	110	11.09	01.13							
2.0 RS	147	11.09	01.13							
2.0 TDI	81	03.10	01.13							
2.0 TDI	100	11.09	01.13							
2.0 TDI	103	11.09	01.13							
2.0 TDi 4x4	81	05.11	01.13							
2.0 TDi 4x4	103	11.09	01.13							
2.0 TDI RS	125	11.09	01.13							
	1.4 i 16V		06.04	11.05	24.3727-2708.2	582708	2	L=1447		
	1.6 FSI	85	06.04	11.05						
	1.6 i 16V	75	06.04	11.05						
	1.9 TDI	77	06.04	11.05						
	1.9 TDI 4x4	77	06.04	11.05						
	2.0 FSI	110	11.04	11.05						
	2.0 FSI 4x4	110	11.04	11.05						
	2.0 RS	147	10.05	11.05						
2.0 TDI	100	06.04	11.05							
2.0 TDI	103	06.04	11.05							
	1.2 TSI 77	02.10	01.13		24.3727-0195.2	580195	2	L=1447		
	1.4 i 16V		12.05	01.13						
	1.4 TSI	90	11.08	01.13						

SKODA OCTAVIA II (1Z) (04-13)

	1.6 1.6 FSI 1.6 i 16V 1.6 TDI 1.6 TDI 4x4 1.8 TSI 1.8 TSI 4x4 1.9 TDI 1.9 TDI 4x4 2.0 FSI 2.0 FSI 4x4 2.0 RS 2.0 TDI 2.0 TDI 2.0 TDI 2.0 TDi 4x4 2.0 TDi 4x4 2.0 TDI RS	75 85 75 77 77 77 110 110 147 81 100 103 81 103 125		09.09 12.05 12.05 06.09 06.09 06.07 11.08 12.05 12.05 12.05 12.05 03.10 12.05 12.05 05.11 07.06 04.06	01.13 01.13 01.13 01.13 01.13 01.13 01.13 01.13 01.13 01.13 01.13 01.13 01.13 01.13 01.13 01.13	24.3727-0195.2	580195	2 ↓	L=1447
	1.2 TSI 1.4 i 16V 1.4 TSI 1.6 1.6 FSI 1.6 i 16V 1.6 TDI 1.6 TDI 4x4 1.8 TSI 1.8 TSI 4x4 1.9 TDI 1.9 TDI 4x4 2.0 FSI 2.0 FSI 4x4 2.0 RS 2.0 TDI 2.0 TDI 2.0 TDI 2.0 TDi 4x4 2.0 TDi 4x4 2.0 TDI RS	77 90 75 85 75 77 77 110 110 147 81 100 103 81 103 125		02.10 06.04 11.08 09.09 06.04 06.04 06.09 06.09 06.07 11.08 06.04 11.04 11.04 11.04 10.05 03.10 06.04 06.04 06.04 05.11 07.06 04.06	01.13 01.13	24.2415-1713.3	030132		Gz 15,87, + Sensor
	1.2 TSI 1.4 i 16V 1.4 TSI 1.6 1.6 FSI 1.6 i 16V 1.6 TDI 1.6 TDI 4x4 1.8 TSI 1.8 TSI 4x4 1.9 TDI 1.9 TDI 4x4 2.0 FSI 2.0 FSI 4x4 2.0 RS 2.0 TDI 2.0 TDI 2.0 TDI 2.0 TDi 4x4 2.0 TDi 4x4 2.0 TDI RS	77 90 75 85 75 77 77 110 110 147 81 100 103 81 103 125		02.10 06.04 11.08 09.09 06.04 06.04 06.09 06.09 06.07 11.08 06.04 11.04 11.04 11.04 10.05 03.10 06.04 06.04 06.04 05.11 07.06 04.06	01.13 01.13	24.2519-1706.3	040096		Nz 19,05
	1.2 TSI 1.4 i 16V 1.4 TSI 1.6 1.6 FSI 1.6 i 16V 1.6 TDI 1.6 TDI 4x4 1.8 TSI 1.8 TSI 4x4 1.9 TDI 1.9 TDI 4x4 2.0 FSI 2.0 FSI 4x4 2.0 RS 2.0 TDI 2.0 TDI 2.0 TDI 2.0 TDi 4x4 2.0 TDi 4x4 2.0 TDI RS	77 90 75 85 75 77 77 110 110 147 81 100 103 81 103 125		02.10 06.04 11.08 09.09 06.04 06.04 06.09 06.09 06.07 11.08 06.04 11.04 11.04 11.04 10.05 03.10 06.04 06.04 06.04 05.11 07.06 04.06	01.13 01.13	24.2519-1705.3	040095		Nz 19,05



SKODA OCTAVIA III (5E) (12-)

	1.0 TSI	85	05.16	PR: 1ZA,1ZB,1ZE,1ZF	03.4153-5403.3	010994		Thz 23,81	ATE
	1.2 TSI	63	02.13	PR: 1ZA,1ZB,1ZE,1ZF					
	1.2 TSI	77	02.13	PR: 1ZA,1ZB,1ZE,1ZF					
	1.2 TSI	81	05.15	PR: 1ZA,1ZB,1ZE,1ZF					
	1.4 TSI	103	11.12	PR: 1ZA,1ZB,1ZE,1ZF					
	1.4 TSI	110	05.15	PR: 1ZA,1ZB,1ZE,1ZF					
	1.4 TSI G-TEC	81	11.13	PR: 1ZA,1ZB,1ZE,1ZF					
	1.6	81	01.14	PR: 1ZA,1ZB,1ZE,1ZF					
	1.6 TDI	66	02.13	PR: 1ZA,1ZB,1ZE,1ZF					
	1.6 TDI	77	02.13	PR: 1ZA,1ZB,1ZE,1ZF					
	1.6 TDI	81	02.13	PR: 1ZA,1ZB,1ZE,1ZF					
	1.6 TDI 4x4	77	11.12	PR: 1ZA,1ZB,1ZE,1ZF					
	1.6 TDI 4x4	81	05.15	PR: 1ZA,1ZB,1ZE,1ZF					
	1.8 TSI	132	11.12	PR: 1ZA,1ZB,1ZE,1ZF					
	1.8 TSI 4x4	132	11.12	PR: 1ZA,1ZB,1ZE,1ZF					
	2.0 TDI	105	11.12	PR: 1ZA,1ZB,1ZE,1ZF					
	2.0 TDI	110	02.13	PR: 1ZA,1ZB,1ZE,1ZF					
	2.0 TDI	135	05.13	PR: 1ZA,1ZB,1ZE,1ZF					
	2.0 TDI 4x4	110	11.12	PR: 1ZA,1ZB,1ZE,1ZF					
	2.0 TDI 4x4	135	09.14	PR: 1ZA,1ZB,1ZE,1ZF					
	2.0 TSI RS	162	05.13	PR: 1ZA,1ZB,1ZE,1ZF					
	2.0 TSI RS	169	05.15	PR: 1ZA,1ZB,1ZE,1ZF					
	1.0 TSI	85	05.16	PR: OEC,OEM	24.2519-1706.3	040096		Nz 19,05	
	1.2 TSI	63	02.13	PR: OEC,OEM					
	1.2 TSI	77	02.13	PR: OEC,OEM					
	1.2 TSI	81	05.15	PR: OEC,OEM					
	1.4 TSI	103	11.12	PR: OEC,OEM					
	1.4 TSI	110	05.15	PR: OEC,OEM					
	1.4 TSI G-TEC	81	11.13	PR: OEC,OEM					
	1.6	81	01.14	PR: OEC,OEM					
	1.6 TDI	66	02.13	PR: OEC,OEM					
	1.6 TDI	77	02.13	PR: OEC,OEM					
	1.6 TDI	81	02.13	PR: OEC,OEM					
	1.6 TDI 4x4	77	11.12	PR: OEC,OEM					
	1.6 TDI 4x4	81	05.15	PR: OEC,OEM					
	1.8 TSI	132	11.12	PR: OEC,OEM					
	1.8 TSI 4x4	132	11.12	PR: OEC,OEM					
	2.0 TDI	105	11.12	PR: OEC,OEM					
	2.0 TDI	110	02.13	PR: OEC,OEM					
	2.0 TDI	135	05.13	PR: OEC,OEM					
	2.0 TDI 4x4	110	11.12	PR: OEC,OEM					
	2.0 TDI 4x4	135	09.14	PR: OEC,OEM					
	2.0 TSI RS	162	05.13	PR: OEC,OEM					
	2.0 TSI RS	169	05.15	PR: OEC,OEM					

SKODA RAPID / RAPID Spaceback (12-)

	1.2	55	10.12	PR: 1ZG	11.9541-9549.2	220575		D=54, - Halter	ATE
	1.2 TSI	63	10.12	PR: 1ZG	11.9541-9550.2	220576		D=54, - Halter	ATE
	1.2 TSI	77	10.12	PR: 1ZG	11.8171-0008.1	990049		Führungsbolzen	ATE
	1.4 TSI	90	10.12	PR: 1ZG	11.0101-5407.2	260011		Hülsensatz	ATE
	1.6	77	07.13	PR: 1ZG					
	1.6 TDI	66	08.13	PR: 1ZG					
	1.6 TDI	77	10.12	PR: 1ZG					
	1.2	55	10.12	PR: 1ZC	11.9541-9553.2	220563		D=54, - Halter	ATE
	1.2 TSI	63	10.12	PR: 1ZC	11.9541-9554.2	220564		D=54, - Halter	ATE
	1.2 TSI	66	05.15	PR: 1ZC	11.8171-0008.1	990049		Führungsbolzen	ATE
	1.2 TSI	77	10.12	PR: 1ZC	11.8116-0351.1	390538	2	Haltefeder	ATE
	1.2 TSI	81	05.15	PR: 1ZC	11.0101-5409.2	260035		Hülsensatz	ATE
	1.4 TDI	66	05.15	PR: 1ZC					
	1.4 TSI	90	10.12	PR: 1ZC					
	1.4 TSI	92	05.15	PR: 1ZC					
	1.6	77	07.13	PR: 1ZC					
	1.6 TDI	66	08.13	PR: 1ZC					
	1.6 TDI	77	10.12	PR: 1ZC					
	1.6 TDI	85	05.15	PR: 1ZC					
	1.2	55	12.12		24.5143-0544.3	331420	2	L=544	
	1.2 TSI	63	12.12						
	1.2 TSI	66	05.15						
	1.2 TSI	77	12.12						
	1.2 TSI	81	05.15						
	1.4 TDI	66	05.15						
	1.4 TSI	90	12.12						
	1.4 TSI	92	05.15						
	1.6	77	07.13						
	1.6 TDI	66	08.13						
	1.6 TDI	77	12.12						
	1.6 TDI	85	05.15						
	1.2	55	10.12	PR: 1KT	24.3387-1735.5	240657		D=38, - Halter	TRW
	1.2 TSI	63	10.12	PR: 1KT	24.3387-1736.5	240658		D=38, - Halter	TRW
	1.2 TSI	66	05.15	PR: 1KT					
	1.2 TSI	77	10.12	PR: 1KT					
	1.2 TSI	81	05.15	PR: 1KT					
	1.4 TDI	66	05.15	PR: 1KT					
	1.4 TSI	90	10.12	PR: 1KT					
	1.4 TSI	92	05.15	PR: 1KT					
	1.6	77	07.13	PR: 1KT					
	1.6 TDI	66	08.13	PR: 1KT					



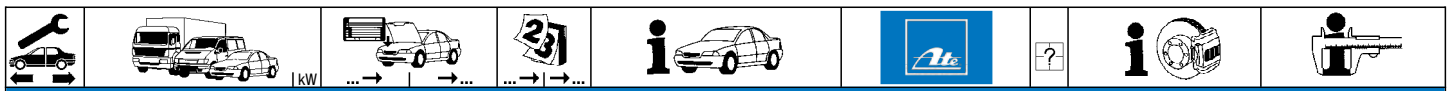

SKODA RAPID / RAPID Spaceback (12-)



















	1.6 TDI 1.6 TDI	77 85		10.12 05.15	PR: 1KT PR: 1KT	24.3387-1735.5 24.3387-1736.5	240657 240658		D=38, - Halter D=38, - Halter	TRW TRW
	1.2 1.2 TSI 1.2 TSI 1.2 TSI 1.2 TSI 1.4 TDI 1.4 TSI 1.4 TSI 1.6 1.6 TDI 1.6 TDI 1.6 TDI	55 63 66 77 81 66 90 92 77 66 77 85		10.12 10.12 05.15 10.12 05.15 05.15 10.12 05.15 07.13 08.13 10.12 05.15		83.7858-0140.3	330837	2	L=140	
	1.2 1.2 TSI 1.2 TSI 1.2 TSI 1.2 TSI 1.4 TDI 1.4 TSI 1.4 TSI 1.6 1.6 TDI 1.6 TDI 1.6 TDI	55 63 66 77 81 66 90 92 77 66 77 85		10.12 10.12 05.15 10.12 05.15 05.15 10.12 05.15 07.13 08.13 10.12 05.15	PR: 1KL PR: 1KL PR: 1KL PR: 1KL PR: 1KL PR: 1KL PR: 1KL PR: 1KL PR: 1KL PR: 1KL PR: 1KL PR: 1KL	24.3219-1762.3	020550		Rz 19,05	
	1.2 1.2 TSI 1.2 TSI 1.2 TSI 1.2 TSI 1.4 TDI 1.4 TSI 1.4 TSI 1.6 1.6 TDI 1.6 TDI 1.6 TDI	55 63 66 77 81 66 90 92 77 66 77 85		10.12 10.12 05.15 10.12 05.15 05.15 10.12 05.15 07.13 08.13 10.12 05.15	PR: 1KT PR: 1KT PR: 1KT PR: 1KT PR: 1KT PR: 1KT PR: 1KT PR: 1KT PR: 1KT PR: 1KT PR: 1KT PR: 1KT	24.3727-2710.2	582710	2	L=1780	
	1.2 1.2 TSI 1.2 TSI 1.2 TSI 1.2 TSI 1.4 TDI 1.4 TDI 1.4 TSI 1.6 1.6 TDI 1.6 TDI 1.6 TDI	55 63 66 77 81 66 66 90 77 66 77 85		10.12 10.12 05.15 10.12 05.15 05.15 10.12 07.13 08.13 10.12 05.15	PR: 1KL PR: 1KL PR: 1KL PR: 1KL PR: 1KL PR: 1KL PR: 1KL PR: 1KL PR: 1KL PR: 1KL PR: 1KL PR: 1KL	24.3727-2711.2	582711	2	L=1707	
	1.2 1.2 TSI 1.2 TSI 1.2 TSI 1.2 TSI 1.4 TDI 1.4 TDI 1.4 TSI 1.6 1.6 TDI 1.6 TDI 1.6 TDI	55 63 66 77 81 66 66 90 77 66 77 85		10.12 10.12 05.15 10.12 05.15 05.15 10.12 07.13 08.13 10.12 05.15	PR: GOC, OEM PR: GOC, OEM PR: GOC, OEM PR: GOC, OEM PR: GOC, OEM PR: GOC, OEM PR: GOC, OEM PR: GOC, OEM PR: GOC, OEM PR: GOC, OEM PR: GOC, OEM PR: GOC, OEM	24.2519-1706.3	040096		Nz 19,05	



















SKODA ROOMSTER (5J) (06-15)

	1.2 1.2 TDI 1.2 TSI 1.2 TSI 1.4 1.4 TDI 1.4 TDI 1.6 1.6 TDI 1.6 TDI 1.9 TDI	◀ 55 63 77 63 51 59 77 66 77 77		07.06 03.10 03.10 03.10 07.06 07.06 07.06 07.06 03.10 03.10 07.06	12.10 12.10 12.10 12.10 12.10 12.10 12.10 12.10 12.10 12.10 12.10	24.2120-1736.3 24.2120-1734.3	010732 010702	- ABS + ABS	THz 20,64 THz 20,64	
	1.2 1.2 TDI 1.2 TSI 1.2 TSI 1.4 1.4 TDI 1.4 TDI 1.6 1.6 TDI 1.6 TDI 1.9 TDI	55 63 77 63 51 59 77 66 77 77		07.06 03.10 03.10 03.10 07.06 07.06 07.06 07.06 03.10 03.10 07.06	04.15 04.15 04.15 04.15 04.15 04.15 04.15 04.15 04.15 04.15 04.15	11.9541-9549.2 11.9541-9550.2 11.0101-5409.2 11.8171-0008.1	220575 220576 260035 990049		D=54, - Halter D=54, - Halter Hülzensatz Führungsbolzen	ATE ATE ATE ATE

SKODA ROOMSTER (5J) (06-15)

	1.2			07.06	04.15	PR: 1LN	24.3541-1797.7	220553	☐ ☐	D=54, - Halter D=54, - Halter	TRW TRW
	1.2 TDI	55		03.10	04.15	PR: 1LN	24.3541-1798.7	220554			
	1.2 TSI	63		03.10	04.15	PR: 1LN					
	1.4	63		07.06	04.15	PR: 1LN					
	1.4 TDI	51		07.06	04.15	PR: 1LN					
	1.4 TDI	59		07.06	04.15	PR: 1LN					
	1.6	77		07.06	04.15	PR: 1LN					
	1.6 TDI	66		03.10	04.15	PR: 1LN					
	1.6 TDI	77		03.10	04.15	PR: 1LN					
	1.9 TDI			07.06	04.15	PR: 1LN					
	1.2			07.06	04.15	PR: 1ZC	11.9541-9553.2	220563	☐ ☐	D=54, - Halter D=54, - Halter Hülzensatz Führungsbolzen Haltefeder	ATE ATE ATE ATE
	1.2 TDI	55		03.10	04.15	PR: 1ZC	11.9541-9554.2	220564			
	1.2 TSI	63		03.10	04.15	PR: 1ZC	11.0101-5409.2	260035			
	1.2 TSI	77		03.10	04.15	PR: 1ZC	11.8171-0008.1	990049			
	1.4	63		07.06	04.15	PR: 1ZC	11.8116-0351.1	390538			
	1.4 TDI	51		07.06	04.15	PR: 1ZC					
	1.4 TDI	59		07.06	04.15	PR: 1ZC					
	1.6	77		07.06	04.15	PR: 1ZC					
	1.6 TDI	66		03.10	04.15	PR: 1ZC					
	1.9 TDI	77		03.10	04.15	PR: 1ZC					
	1.2			07.06	04.15		83.6247-0522.3	330595	2	L=522	
	1.2 TDI	55		03.10	04.15						
	1.2 TSI	63		03.10	04.15						
	1.2 TSI	77		03.10	04.15						
	1.4	63		07.06	04.15						
	1.4 TDI	51		07.06	04.15						
	1.4 TDI	59		07.06	04.15						
	1.6	77		07.06	04.15						
	1.6 TDI	66		03.10	04.15						
	1.9 TDI	77		03.10	04.15						
	1.2			07.06	04.15	PR: 1KK	24.3384-1729.7	220541	☐ ☐	D=38(M12x1), - Halter D=38(M12x1), - Halter	TRW TRW
	1.2 TDI	55		03.10	04.15	PR: 1KK	24.3384-1730.7	220542			
	1.2 TSI	63		03.10	04.15	PR: 1KK					
	1.2 TSI	77		03.10	04.15	PR: 1KK					
	1.4	63		07.06	04.15	PR: 1KK					
	1.4 TDI	51		07.06	04.15	PR: 1KK					
	1.4 TDI	59		07.06	04.15	PR: 1KK					
	1.6	77		07.06	04.15	PR: 1KK					
	1.6 TDI	66		03.10	04.15	PR: 1KK					
	1.9 TDI	77		03.10	04.15	PR: 1KK					
	1.2			07.06	04.15	PR: 1KT	24.3387-1735.5	240657	☐ ☐	D=38, - Halter D=38, - Halter	TRW TRW
	1.2 TDI	55		03.10	04.15	PR: 1KT	24.3387-1736.5	240658			
	1.2 TSI	63		03.10	04.15	PR: 1KT					
	1.2 TSI	77		03.10	04.15	PR: 1KT					
	1.4	63		07.06	04.15	PR: 1KT					
	1.4 TDI	51		07.06	04.15	PR: 1KT					
	1.4 TDI	59		07.06	04.15	PR: 1KT					
	1.6	77		07.06	04.15	PR: 1KT					
	1.6 TDI	66		03.10	04.15	PR: 1KT					
	1.9 TDI	77		03.10	04.15	PR: 1KT					
	1.2			07.06	04.15		83.7858-0140.3	330837	2	L=140	
	1.2 TDI	55		03.10	04.15						
	1.2 TSI	63		03.10	04.15						
	1.2 TSI	77		03.10	04.15						
	1.4	63		07.06	04.15						
	1.4 TDI	51		07.06	04.15						
	1.4 TDI	59		07.06	04.15						
	1.6	77		07.06	04.15						
	1.6 TDI	66		03.10	04.15						
	1.9 TDI	77		03.10	04.15						
	1.2			07.06	04.15	PR: 1KC	24.3219-0909.3	020188		Rz 19,05	
	1.2 TDI	55		03.10	04.15	PR: 1KC					
	1.2 TSI	63		03.10	04.15	PR: 1KC					
	1.2 TSI	77		03.10	04.15	PR: 1KC					
	1.4	63		07.06	04.15	PR: 1KC					
	1.4 TDI	51		07.06	04.15	PR: 1KC					
	1.4 TDI	59		07.06	04.15	PR: 1KC					
	1.6	77		07.06	04.15	PR: 1KC					
	1.6 TDI	66		03.10	04.15	PR: 1KC					
	1.9 TDI	77		03.10	04.15	PR: 1KC					
	1.2			03.10	04.15	PR: 1KL	24.3219-1762.3	020550		Rz 19,05	
	1.2 TDI	55		03.10	04.15	PR: 1KL					
	1.2 TSI	63		03.10	04.15	PR: 1KL					
	1.2 TSI	77		03.10	04.15	PR: 1KL					
	1.4	63		03.10	04.15	PR: 1KL					
	1.4 TDI	51		03.10	04.15	PR: 1KL					
	1.4 TDI	59		03.10	04.15	PR: 1KL					
	1.6	77		03.10	04.15	PR: 1KL					
	1.6 TDI	66		03.10	04.15	PR: 1KL					
	1.9 TDI	77		03.10	04.15	PR: 1KL					

										
SKODA ROOMSTER (5J) (06-15)										
	1.6 TDI 1.9 TDI	77		03.10 03.10	04.15 04.15	PR: 1KL PR: 1KL	24.3219-1762.3	020550	Rz 19,05	
	1.2 1.2 TDI 1.2 TSI 1.2 TSI 1.4 1.4 TDI 1.4 TDI 1.6 1.6 TDI 1.6 TDI 1.9 TDI	55 63 77 63 51 59 77 66 77		07.06 03.10 03.10 03.10 07.06 07.06 07.06 03.10 03.10 07.06	04.15 04.15 04.15 04.15 04.15 04.15 04.15 04.15 04.15 04.15		03.6584-0107.3	320110	- ABS BRL 8/4 (4)	
	1.2 1.2 TDI 1.2 TSI 1.2 TSI 1.4 1.4 TDI 1.4 TDI 1.6 1.6 TDI 1.6 TDI 1.9 TDI	55 63 77 63 51 59 77 66 77		07.06 03.10 03.10 03.10 07.06 07.06 07.06 03.10 03.10 07.06	04.15 04.15 04.15 04.15 04.15 04.15 04.15 04.15 04.15 04.15	PR: OEM PR: OEM PR: OEM PR: OEM PR: OEM PR: OEM PR: OEM PR: OEM PR: OEM PR: OEM	24.2519-1706.3	040096	Nz 19,05	
SKODA SUPERB I (02-08)										
	1.8 i 20V Turbo 1.9 TDI 1.9 TDI 1.9 TDI 1.9 TDI 2.0 i 2.0 TDI 2.5 TDI 2.5 TDI 2.8 i V6	110 74 77 85 96 85 103 114 120 142		12.01 08.02 10.05 01.07 12.01 10.05 12.01 06.03 12.01	02.08 12.07 12.07 12.07 12.07 02.08 12.07 12.07 12.07 12.07		03.2125-0373.3 24.2125-1720.3	010810 010688	THz 25,40 THz 25,40	
	1.8 i 20V Turbo 1.9 TDI 1.9 TDI 1.9 TDI 1.9 TDI 1.9 TDI 2.0 i 2.0 TDI 2.5 TDI 2.5 TDI 2.8 i V6	110 74 77 85 96 85 103 114 120 142		12.01 08.02 10.05 01.07 12.01 12.01 10.05 12.01 06.03 12.01	02.08 12.07 12.07 12.07 12.07 02.08 12.07 12.07 12.07 12.07		24.3571-8522.5 24.3571-8521.5 11.8170-0306.1 11.0441-5704.2 11.0101-5409.2 11.8171-0008.1 11.8116-0143.1	240496 240495 260102 250034 260035 990049 390513	2 2	D=57, - Halter D=57, - Halter Halter Dichtungssatz Hülssensatz Führungsbolzen Haltefeder
	1.8 i 20V Turbo 1.9 TDI 1.9 TDI 1.9 TDI 1.9 TDI 2.0 i 2.0 TDI 2.5 TDI 2.5 TDI 2.8 i V6	110 74 77 85 96 85 103 114 120 142		12.01 08.02 10.05 01.07 12.01 12.01 10.05 12.01 06.03 12.01	02.08 12.07 12.07 12.07 12.07 02.08 12.07 12.07 12.07 12.07		83.7813-0295.3	330799	2	L=295
	1.8 i 20V Turbo 1.9 TDI 1.9 TDI 1.9 TDI 1.9 TDI 2.0 i 2.0 TDI 2.5 TDI 2.5 TDI 2.8 i V6	110 74 77 85 96 85 103 114 120 142		12.01 08.02 10.05 01.07 12.01 12.01 10.05 12.01 06.03 12.01	02.08 12.07 12.07 12.07 12.07 02.08 12.07 12.07 12.07 12.07		24.3384-1731.7 24.3384-1732.7	220543 220544	2	D=38, - Halter D=38, - Halter
	1.8 i 20V Turbo 1.9 TDI 1.9 TDI 1.9 TDI 1.9 TDI 2.0 i 2.0 TDI 2.5 TDI 2.5 TDI 2.8 i V6	110 74 77 85 96 85 103 114 120 142		12.01 08.02 10.05 01.07 12.01 12.01 10.05 12.01 06.03 12.01	02.08 12.07 12.07 12.07 12.07 02.08 12.07 12.07 12.07 12.07		24.5237-0183.3	331454	2	L=183
	1.8 i 20V Turbo 1.9 TDI 1.9 TDI 1.9 TDI 1.9 TDI 2.0 i 2.0 TDI	110 74 77 85 96 85 103		12.01 08.02 10.05 01.07 12.01 12.01 10.05	02.08 12.07 12.07 12.07 12.07 02.08 12.07		24.3727-2506.2 24.3727-2507.2	582506 582507	2	L=1992 L=1992

									
SKODA SUPERB I (02-08)									
	2.5 TDI 2.5 TDI 2.8 i V6	114 120 142		12.01 06.03 12.01	12.07 12.07 12.07	24.3727-2506.2 24.3727-2507.2	582506 582507	<input type="checkbox"/> <input type="checkbox"/>	L=1992 L=1992
	1.8 i 20V Turbo 2.0 i 2.8 i V6	110 85 142		12.01 12.01 12.01	02.08 02.08 12.07	24.2419-1707.3	030092		Gz 19,05
	1.8 i 20V Turbo 1.9 TDI 1.9 TDI 1.9 TDI 1.9 TDI 2.0 i 2.0 TDI 2.5 TDI 2.5 TDI 2.8 i V6	110 74 77 85 96 85 103 114 120 142		12.01 08.02 10.05 01.07 12.01 10.05 12.01 06.03 12.01	02.08 12.07 12.07 12.07 12.07 02.08 12.07 12.07 12.07	24.2522-1706.3	040090		Nz 22,20
SKODA SUPERB II (08-15)									
	1.4 TSI 1.6 TDI 1.8 TFSI 1.8 TSI 4x4 1.9 TDI 2.0 TDI 2.0 TDI 2.0 TDI 4x4 2.0 TSI 3.6 FSI V6 4x4	92 77 77 77 103 125 147 191		08.08 09.10 08.08 10.08 08.08 08.08 10.08 05.10 11.08	02.15 02.15 02.15 02.15 02.15 02.15 02.15 02.15 02.15	03.7863-3332.4	300308		10" ATE
	1.4 TSI 1.6 TDI 1.8 TFSI 1.8 TSI 4x4 1.9 TDI 2.0 TDI 2.0 TDI 2.0 TDI 4x4 2.0 TSI 3.6 FSI V6 4x4	92 77 77 77 103 125 147 191		08.08 09.10 08.08 10.08 08.08 08.08 10.08 05.10 11.08	02.15 02.15 02.15 02.15 02.15 02.15 02.15 02.15 02.15	03.2123-3449.3	010808		Thz 23,81 ATE
	1.4 TSI 1.6 TDI 1.8 TFSI 1.8 TSI 4x4 1.9 TDI 2.0 TDI 2.0 TDI 2.0 TDI 4x4 2.0 TSI 3.6 FSI V6 4x4	92 77 77 77 103 125 147 191		08.08 09.10 08.08 10.08 08.08 08.08 10.08 05.10 11.08	02.15 02.15 02.15 02.15 02.15 02.15 02.15 02.15 02.15	11.9541-9553.2 11.9541-9554.2 11.0101-5409.2 11.8171-0008.1 11.8116-0351.1	220563 220564 260035 990049 390538	<input type="checkbox"/> <input type="checkbox"/> 2	D=54, - Halter ATE D=54, - Halter ATE Hülensatz ATE Führungsbolzen ATE Haltefeder ATE
	1.4 TSI 1.6 TDI 1.8 TFSI 1.8 TSI 4x4 1.9 TDI 2.0 TDI 2.0 TDI 2.0 TDI 4x4 2.0 TSI 3.6 FSI V6 4x4	92 77 77 77 103 125 147 191		08.08 09.10 08.08 10.08 08.08 08.08 10.08 05.10 11.08	02.15 02.15 02.15 02.15 02.15 02.15 02.15 02.15 02.15	11.9541-9553.2 11.9541-9554.2 11.0101-5409.2 11.8171-0008.1 11.8116-0351.1	220563 220564 260035 990049 390538	<input type="checkbox"/> <input type="checkbox"/> 2	D=54, - Halter ATE D=54, - Halter ATE Hülensatz ATE Führungsbolzen ATE Haltefeder ATE
	1.4 TSI 1.6 TDI 1.8 TFSI 1.8 TSI 4x4 1.9 TDI 2.0 TDI 2.0 TDI 2.0 TDI 4x4 2.0 TSI 3.6 FSI V6 4x4	92 77 77 77 103 125 147 191		08.08 09.10 08.08 10.08 08.08 08.08 10.08 05.10 11.08	02.15 02.15 02.15 02.15 02.15 02.15 02.15 02.15 02.15	11.9576-9995.2 11.9576-9996.2 11.0101-5409.2 11.8171-0008.1 11.8116-0410.2	220651 220652 260035 990049 390589	<input type="checkbox"/> <input type="checkbox"/> 2	D=57, - Halter ATE D=57, - Halter ATE Hülensatz ATE Führungsbolzen ATE Haltefeder ATE
	1.4 TSI 1.6 TDI 1.8 TFSI 1.8 TSI 4x4 1.9 TDI 2.0 TDI 2.0 TDI 2.0 TDI 4x4 2.0 TSI 3.6 FSI V6 4x4	92 77 77 77 103 125 147 191		08.08 09.10 08.08 10.08 08.08 08.08 10.08 05.10 11.08	02.15 02.15 02.15 02.15 02.15 02.15 02.15 02.15 02.15	24.5143-0564.3	331433	2	L=564
	1.4 TSI 1.6 TDI 1.8 TFSI 1.8 TSI 4x4 1.9 TDI 2.0 TDI 2.0 TDI 2.0 TDI 4x4	92 77 77 77 103 125		08.08 09.10 08.08 10.08 08.08 08.08 10.08	02.15 02.15 02.15 02.15 02.15 02.15 02.15	83.7849-0502.3	331125	2	L=504













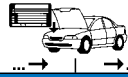



SKODA SUPERB II (08-15)

	2.0 TSI 3.6 FSI V6 4x4	147 191		05.10 10.08	02.15 02.15	PR: 1LK PR: 1LK	83.7849-0502.3	331125	2		L=504	
	1.4 TSI 1.6 TDI 1.8 TFSI 1.9 TDI 2.0 TDI 2.0 TDI 2.0 TSI	92 77 77 103 125 147		08.08 09.10 08.08 08.08 08.08 08.08 05.10	02.15 02.15 02.15 02.15 02.15 02.15 02.15	PR: 1KF,1KJ PR: 1KF,1KJ PR: 1KF,1KJ PR: 1KF,1KJ PR: 1KF,1KJ PR: 1KF,1KJ PR: 1KF,1KJ	24.3414-1709.7 24.3414-1710.7	220631 220632			D=41, - Halter D=41, - Halter	TRW TRW
	1.8 TSI 4x4 2.0 TDI 4x4 3.6 FSI V6 4x4			10.08 10.08 11.08	02.15 02.15 02.15	PR: 2EA PR: 2EA PR: 2EA	24.3417-1711.7 24.3417-1712.7	220883 220884			D=41, - Halter D=41, - Halter	TRW TRW
	1.4 TSI 1.8 TFSI 1.8 TSI 4x4 1.9 TDI 2.0 TDI 2.0 TDI 2.0 TDI 4x4 3.6 FSI V6 4x4	92 77 77 103 125 191		08.08 08.08 10.08 08.08 08.08 08.08 10.08 11.08	10.09 10.09 10.09 10.09 10.09 10.09 10.09 10.09		24.5204-0233.3	331430	2		L=233	
	1.4 TSI 1.6 TDI 1.8 TFSI 1.8 TSI 4x4 1.9 TDI 2.0 TDI 2.0 TDI 2.0 TDI 4x4 2.0 TSI 3.6 FSI V6 4x4	92 77 77 77 103 125 147 191		11.09 09.10 11.09 11.09 11.09 11.09 11.09 05.10 11.09	02.15 02.15 02.15 02.15 02.15 02.15 02.15 02.15 02.15		83.7847-0254.3 83.7847-0257.3	331233 331234			L=255 L=255	
	1.4 TSI 1.8 TFSI 1.8 TSI 4x4 1.9 TDI 2.0 TDI 2.0 TDI 2.0 TDI 4x4 3.6 FSI V6 4x4	92 77 77 103 125 191		08.08 08.08 10.08 08.08 08.08 08.08 10.08 11.08	11.08 11.08 11.08 11.08 11.08 11.08 11.08 11.08	PR: 1SA,1SK PR: 1SA,1SK PR: 1SA,1SK PR: 1SA,1SK PR: 1SA,1SK PR: 1SA,1SK PR: 1SA,1SK PR: 1SA,1SK	24.3727-2510.2	582510	2 ↓		L=1590	
	1.4 TSI 1.6 TDI 1.8 TFSI 1.8 TSI 4x4 1.9 TDI 2.0 TDI 2.0 TDI 2.0 TDI 4x4 2.0 TSI 3.6 FSI V6 4x4	92 77 77 77 103 125 147 191		08.08 09.10 08.08 10.08 08.08 08.08 10.08 05.10 11.08	02.15 02.15 02.15 02.15 02.15 02.15 02.15 02.15 02.15		24.2415-1713.3	030132			Gz 15,87, + Sensor	
	1.4 TSI 1.6 TDI 1.8 TFSI 1.8 TSI 4x4 1.9 TDI 2.0 TDI 2.0 TDI 2.0 TDI 4x4 2.0 TSI 3.6 FSI V6 4x4	92 77 77 77 103 125 147 191		08.08 09.10 08.08 10.08 08.08 08.08 10.08 05.10 11.08	07.11 07.11 07.11 07.11 07.11 07.11 07.11 07.11 07.11	PR: OEJ PR: OEJ PR: OEJ PR: OEJ PR: OEJ PR: OEJ PR: OEJ PR: OEJ PR: OEJ	24.2519-1705.3	040095			Nz 19,05	
	1.4 TSI 1.6 TDI 1.8 TFSI 1.8 TSI 4x4 1.9 TDI 2.0 TDI 2.0 TDI 2.0 TDI 4x4 2.0 TSI 3.6 FSI V6 4x4	92 77 77 77 103 125 147 191		08.08 09.10 08.08 10.08 08.08 08.08 10.08 05.10 11.08	02.15 02.15 02.15 02.15 02.15 02.15 02.15 02.15 02.15	PR: OEM PR: OEM PR: OEM PR: OEM PR: OEM PR: OEM PR: OEM PR: OEM PR: OEM	24.2519-1706.3	040096			Nz 19,05	

SKODA SUPERB II Combi (09-15)

	1.4 TSI 1.6 TDI 1.8 TSI 1.8 TSI 4x4 1.9 TDI 2.0 TDI 2.0 TDI 2.0 TDI 4x4 2.0 TSI 3.6 V6 4x4	◀ 92 ◀ 77 ◀ ◀ ◀ 77 ◀ 103 ◀ 125 ◀ 125 ◀ 147 ◀ 191		11.09 09.10 11.09 11.09 10.09 11.09 11.09 11.09 05.10 11.09	02.15 02.15 02.15 02.15 02.15 02.15 02.15 02.15 02.15 02.15		03.7863-3332.4	300308			10"	ATE
	1.4 TSI 1.6 TDI 1.8 TSI 1.8 TSI 4x4 1.9 TDI	◀ 92 ◀ 77 ◀ ◀ ◀ 77		11.09 09.10 11.09 11.09 10.09	02.15 02.15 02.15 02.15 02.15		03.2123-3449.3	010808			Thz 23,81	ATE

								
SKODA SUPERB II Combi (09-15)								
	2.0 TDI 2.0 TDI 2.0 TDI 4x4 2.0 TSI 3.6 V6 4x4	103 125 125 147 191	11.09 11.09 11.09 05.10 11.09	02.15 02.15 02.15 02.15 02.15	03.2123-3449.3	010808		Thz 23,81 ATE
	1.4 TSI 1.6 TDI 1.8 TSI 1.8 TSI 4x4 1.9 TDI 2.0 TDI 2.0 TDI 2.0 TDI 4x4 2.0 TSI 3.6 V6 4x4	92 77 77 103 125 125 147 191	11.09 09.10 11.09 11.09 10.09 11.09 11.09 11.09 05.10 11.09	02.15 02.15 02.15 02.15 02.15 02.15 02.15 02.15 02.15 02.15	PR: 1ZE PR: 1ZE PR: 1ZE PR: 1ZE PR: 1ZE PR: 1ZE PR: 1ZE PR: 1ZE PR: 1ZE PR: 1ZE	11.9541-9553.2 11.9541-9554.2 11.8171-0008.1 11.8116-0351.1 11.0101-5409.2	220563 220564 990049 390538 260035	2 D=54, - Halter D=54, - Halter Führungsbolzen Haltefeder Hülzensatz ATE ATE ATE ATE
	1.4 TSI 1.6 TDI 1.8 TSI 1.8 TSI 4x4 1.9 TDI 2.0 TDI 2.0 TDI 2.0 TDI 4x4 2.0 TSI 3.6 V6 4x4	92 77 77 103 125 125 147 191	11.09 09.10 11.09 11.09 10.09 11.09 11.09 11.09 05.10 11.09	02.15 02.15 02.15 02.15 02.15 02.15 02.15 02.15 02.15 02.15	PR: 1LJ,1ZA PR: 1LJ,1ZA PR: 1LJ,1ZA PR: 1LJ,1ZA PR: 1LJ,1ZA PR: 1LJ,1ZA PR: 1LJ,1ZA PR: 1LJ,1ZA PR: 1LJ,1ZA PR: 1LJ,1ZA	11.9541-9553.2 11.9541-9554.2 11.8171-0008.1 11.8116-0351.1 11.0101-5409.2	220563 220564 990049 390538 260035	2 D=54, - Halter D=54, - Halter Führungsbolzen Haltefeder Hülzensatz ATE ATE ATE ATE
	1.4 TSI 1.6 TDI 1.8 TSI 1.8 TSI 4x4 1.9 TDI 2.0 TDI 2.0 TDI 2.0 TDI 4x4 2.0 TSI 3.6 V6 4x4	92 77 77 103 125 125 147 191	11.09 09.10 11.09 11.09 10.09 11.09 11.09 11.09 05.10 11.09	02.15 02.15 02.15 02.15 02.15 02.15 02.15 02.15 02.15 02.15	PR: 1LK PR: 1LK PR: 1LK PR: 1LK PR: 1LK PR: 1LK PR: 1LK PR: 1LK PR: 1LK PR: 1LK	11.9576-9995.2 11.9576-9996.2 11.8171-0008.1 11.8116-0410.2 11.0101-5409.2	220651 220652 990049 390589 260035	2 D=57, - Halter D=57, - Halter Führungsbolzen Haltefeder Hülzensatz ATE ATE ATE ATE
	1.4 TSI 1.6 TDI 1.8 TSI 1.8 TSI 4x4 1.9 TDI 2.0 TDI 2.0 TDI 2.0 TDI 4x4 2.0 TSI 3.6 V6 4x4	92 77 77 103 125 125 147 191	11.09 09.10 11.09 11.09 10.09 11.09 11.09 11.09 05.10 11.09	02.15 02.15 02.15 02.15 02.15 02.15 02.15 02.15 02.15 02.15	PR: 1LJ,1ZE PR: 1LJ,1ZE PR: 1LJ,1ZE PR: 1LJ,1ZE PR: 1LJ,1ZE PR: 1LJ,1ZE PR: 1LJ,1ZE PR: 1LJ,1ZE PR: 1LJ,1ZE PR: 1LJ,1ZE	24.5143-0564.3	331433	2 L=564
	1.4 TSI 1.6 TDI 1.8 TSI 1.8 TSI 4x4 1.9 TDI 2.0 TDI 2.0 TDI 2.0 TDI 4x4 2.0 TSI 3.6 V6 4x4	92 77 77 103 125 125 147 191	11.09 09.10 11.09 11.09 10.09 11.09 11.09 11.09 05.10 11.09	02.15 02.15 02.15 02.15 02.15 02.15 02.15 02.15 02.15 02.15	PR: 1LK PR: 1LK PR: 1LK PR: 1LK PR: 1LK PR: 1LK PR: 1LK PR: 1LK PR: 1LK PR: 1LK	83.7849-0502.3	331125	2 L=504
	1.4 TSI 1.6 TDI 1.8 TSI 1.9 TDI 2.0 TDI 2.0 TDI 2.0 TSI	92 77 77 103 125 147	11.09 09.10 11.09 10.09 11.09 11.09 05.10	02.15 02.15 02.15 02.15 02.15 02.15 02.15	PR: 1KF,1KJ PR: 1KF,1KJ PR: 1KF,1KJ PR: 1KF,1KJ PR: 1KF,1KJ PR: 1KF,1KJ PR: 1KF,1KJ	24.3414-1709.7 24.3414-1710.7	220631 220632	2 D=41, - Halter D=41, - Halter TRW TRW
	1.8 TSI 4x4 2.0 TDI 4x4 3.6 V6 4x4	125 191	11.09 11.09 11.09	02.15 02.15 02.15	PR: 2EA PR: 2EA PR: 2EA	24.3417-1711.7 24.3417-1712.7	220883 220884	2 D=41, - Halter D=41, - Halter TRW TRW
	1.4 TSI 1.6 TDI 1.8 TSI 1.8 TSI 4x4 1.9 TDI 2.0 TDI 2.0 TDI 2.0 TDI 4x4 2.0 TSI 3.6 V6 4x4	92 77 77 103 125 125 147 191	11.09 09.10 11.09 11.09 10.09 11.09 11.09 11.09 05.10 11.09	02.15 02.15 02.15 02.15 02.15 02.15 02.15 02.15 02.15 02.15		83.7847-0254.3 83.7847-0257.3	331233 331234	2 L=255 L=255
	1.4 TSI 1.6 TDI 1.8 TSI 1.8 TSI 4x4 1.9 TDI 2.0 TDI 2.0 TDI 2.0 TDI 4x4 2.0 TSI 3.6 V6 4x4	92 77 77 103 125 125 147 191	11.09 09.10 11.09 11.09 10.09 11.09 11.09 11.09 05.10 11.09	02.15 02.15 02.15 02.15 02.15 02.15 02.15 02.15 02.15 02.15		24.2415-1713.3	030132	Gz 15,87, + Sensor



SKODA SUPERB II Combi (09-15)

	1.4 TSI	92		11.09	07.11	PR: OEJ	24.2519-1705.3	040095		Nz 19,05
	1.6 TDI	77		09.10	07.11	PR: OEJ				
	1.8 TSI			11.09	07.11	PR: OEJ				
	1.8 TSI 4x4			11.09	07.11	PR: OEJ				
	1.9 TDI	77		10.09	07.11	PR: OEJ				
	2.0 TDI	103		11.09	07.11	PR: OEJ				
	2.0 TDI	125		11.09	07.11	PR: OEJ				
	2.0 TDI 4x4	125		11.09	07.11	PR: OEJ				
	2.0 TSI	147		05.10	07.11	PR: OEJ				
	3.6 V6 4x4	191		11.09	07.11	PR: OEJ				
	1.4 TSI	92		11.09	02.15	PR: OEM				
	1.6 TDI	77		09.10	02.15	PR: OEM				
	1.8 TSI			11.09	02.15	PR: OEM				
	1.8 TSI 4x4			11.09	02.15	PR: OEM				

SKODA SUPERB III (15-)

	1.4 TSI	92		03.15			24.2519-1706.3	040096	PR: OEC,OEN	Nz 19,05
	1.4 TSI	110		03.15						
	1.4 TSI 4x4	110		03.15						
	1.6 TDI	88		03.15						
	1.8 TSI	132		03.15						
	2.0 TDI	110		03.15						
	2.0 TDI	140		08.15						
	2.0 TDI 4x4	110		03.15						
	2.0 TDI 4x4	140		03.15						
	2.0 TSI	162		03.15						

SKODA SUPERB III Combi (15-)

	1.4 TSI	92		03.15			24.2519-1706.3	040096	PR: OEC,OEN	Nz 19,05
	1.4 TSI	110		03.15						
	1.4 TSI 4x4	110		03.15						
	1.6 TDI	88		03.15						
	1.8 TSI	132		03.15						
	2.0 TDI	110		03.15						
	2.0 TDI	140		03.15						
	2.0 TDI 4x4	110		03.15						
	2.0 TDI 4x4	140		03.15						
	2.0 TSI	162		03.15						



















SKODA YETI (09-)

	1.2 TSI	◀ 77		09.09		PR: 1AC,1AS,1AT,1ZE,1ZF	03.7863-3232.4	300307	Kolbendurchmesser Ø 22,20mm ¹⁾	10"	ATE
	1.2 TSI	◀ 81		05.15		PR: 1AC,1AS,1AT,1ZE,1ZF					
	1.4 TSI	◀ 90		06.10		PR: 1AC,1AS,1AT,1ZE,1ZF					
	1.4 TSI	◀ 92		05.15		PR: 1AC,1AS,1AT,1ZE,1ZF					
	1.4 TSI 4x4	◀ 110		05.15		PR: 1AC,1AS,1AT,1ZE,1ZF					
	1.6	◀ 81		04.14		PR: 1AC,1AS,1AT,1ZE,1ZF					
	1.6 TDI	◀ 77		11.10		PR: 1AC,1AS,1AT,1ZE,1ZF					
	1.8 TSI 4x4	◀ 112		11.09		PR: 1AC,1AS,1AT,1ZE,1ZF					
	1.8 TSI 4x4	◀ 118		05.09		PR: 1AC,1AS,1AT,1ZE,1ZF					
	2.0 TDI	◀ 81		11.09		PR: 1AC,1AS,1AT,1ZE,1ZF					
	2.0 TDI	◀ 103		11.11		PR: 1AC,1AS,1AT,1ZE,1ZF					
	2.0 TDI	◀ 110		05.15		PR: 1AC,1AS,1AT,1ZE,1ZF					
	2.0 TDI 4x4	◀ 81		11.09		PR: 1AC,1AS,1AT,1ZE,1ZF					
	2.0 TDI 4x4	◀ 103		05.09		PR: 1AC,1AS,1AT,1ZE,1ZF					
	2.0 TDI 4x4	◀ 110		05.15		PR: 1AC,1AS,1AT,1ZE,1ZF					
	2.0 TDI 4x4	◀ 125		11.09		PR: 1AC,1AS,1AT,1ZE,1ZF					
	1.2 TSI	◀ 77		09.09		PR: 1AT,1ZA,1ZE,1LK	03.7863-3332.4	300308		10"	ATE
	1.2 TSI	◀ 81		05.15		PR: 1AT,1ZA,1ZE,1LK					
	1.4 TSI	◀ 90		06.10		PR: 1AT,1ZA,1ZE,1LK					
	1.4 TSI	◀ 92		05.15		PR: 1AT,1ZA,1ZE,1LK					
	1.4 TSI 4x4	◀ 110		05.15		PR: 1AT,1ZA,1ZE,1LK					
	1.6	◀ 81		04.14		PR: 1AT,1ZA,1ZE,1LK					
	1.6 TDI	◀ 77		11.10		PR: 1AT,1ZA,1ZE,1LK					
	1.8 TSI 4x4	◀ 112		11.09		PR: 1AT,1ZA,1ZE,1LK					
	1.8 TSI 4x4	◀ 118		05.09		PR: 1AT,1ZA,1ZE,1LK					
	2.0 TDI	◀ 81		11.09		PR: 1AT,1ZA,1ZE,1LK					
	2.0 TDI	◀ 103		11.11		PR: 1AT,1ZA,1ZE,1LK					
	2.0 TDI	◀ 110		05.15		PR: 1AT,1ZA,1ZE,1LK					
	2.0 TDI 4x4	◀ 81		11.09		PR: 1AT,1ZA,1ZE,1LK					
	2.0 TDI 4x4	◀ 103		05.09		PR: 1AT,1ZA,1ZE,1LK					
	2.0 TDI 4x4	◀ 110		05.15		PR: 1AT,1ZA,1ZE,1LK					
	2.0 TDI 4x4	◀ 125		11.09		PR: 1AT,1ZA,1ZE,1LK					
	1.2 TSI	◀ 77		09.09		PR: 1ZE,1ZF	03.2122-2129.3	010799		Thz 22,20	ATE
	1.2 TSI	◀ 81		05.15		PR: 1ZE,1ZF					
	1.4 TSI	◀ 90		06.10		PR: 1ZE,1ZF					
	1.4 TSI	◀ 92		05.15		PR: 1ZE,1ZF					
	1.4 TSI 4x4	◀ 110		05.15		PR: 1ZE,1ZF					
	1.6	◀ 81		04.14		PR: 1ZE,1ZF					

¹⁾ piston diameter Ø 22,20mm / diametro del pistone Ø 22,20mm / diàmetre de piston Ø 22,20mm / diàmetre del pistón Ø 22,20mm

SKODA YETI (09-)

	1.8 TSI 4x4	◀112		11.09	PR: 1ZE,1ZF	03.2122-2129.3	010799		Thz 22,20	ATE																																																		
	1.8 TSI 4x4	◀118		05.09	PR: 1ZE,1ZF																																																							
	2.0 TDI	◀ 81		11.09	PR: 1ZE,1ZF																																																							
	2.0 TDI	◀103		11.11	PR: 1ZE,1ZF																																																							
	2.0 TDI	◀110		05.15	PR: 1ZE,1ZF																																																							
	2.0 TDI 4x4	◀ 81		11.09	PR: 1ZE,1ZF																																																							
	2.0 TDI 4x4	◀103		05.09	PR: 1ZE,1ZF																																																							
	2.0 TDI 4x4	◀110		05.15	PR: 1ZE,1ZF																																																							
	2.0 TDI 4x4	◀125		11.09	PR: 1ZE,1ZF																																																							
	1.2 TSI	◀ 77		09.09	PR: 1ZA	03.2123-3449.3	010808		Thz 23,81	ATE																																																		
	1.2 TSI	◀ 81		05.15	PR: 1ZA																																																							
	1.4 TSI	◀ 90		06.10	PR: 1ZA																																																							
	1.4 TSI	◀ 92		05.15	PR: 1ZA																																																							
	1.4 TSI 4x4	◀110		05.15	PR: 1ZA																																																							
	1.6	◀ 81		04.14	PR: 1ZA																																																							
	1.6 TDI	◀ 77		11.10	PR: 1ZA																																																							
	1.8 TSI 4x4	◀112		11.09	PR: 1ZA																																																							
	1.8 TSI 4x4	◀118		05.09	PR: 1ZA																																																							
	2.0 TDI	◀ 81		11.09	PR: 1ZA																																																							
	2.0 TDI	◀103		11.11	PR: 1ZA																																																							
	2.0 TDI	◀110		05.15	PR: 1ZA																																																							
	2.0 TDI 4x4	◀ 81		11.09	PR: 1ZA																																																							
	2.0 TDI 4x4	◀103		05.09	PR: 1ZA																																																							
	2.0 TDI 4x4	◀110		05.15	PR: 1ZA																																																							
	2.0 TDI 4x4	◀125		11.09	PR: 1ZA																																																							
		1.2 TSI	77		09.09						PR: 1ZF	11.9541-9549.2	220575		D=54, - Halter	ATE																																												
		1.2 TSI	81		05.15						PR: 1ZF						11.9541-9550.2	220576		D=54, - Halter	ATE																																							
1.4 TSI		90		06.10	PR: 1ZF	11.0101-5409.2	260035		Hülzensatz	ATE																																																		
1.4 TSI		92		05.15	PR: 1ZF	11.8171-0069.1	250152										Führungsbolzen	ATE																																										
1.4 TSI 4x4		110		05.15	PR: 1ZF																		Führungsbolzen	ATE																																				
1.6		81		04.14	PR: 1ZF																					Führungsbolzen	ATE																																	
1.6 TDI		77		11.10	PR: 1ZF																								Führungsbolzen	ATE																														
1.8 TSI 4x4		112		11.09	PR: 1ZF																											Führungsbolzen	ATE																											
1.8 TSI 4x4		118		05.09	PR: 1ZF																														Führungsbolzen	ATE																								
2.0 TDI		81		11.09	PR: 1ZF																																	Führungsbolzen	ATE																					
2.0 TDI		103		11.11	PR: 1ZF																																				Führungsbolzen	ATE																		
2.0 TDI		110		05.15	PR: 1ZF																																							Führungsbolzen	ATE															
2.0 TDI 4x4		81		11.09	PR: 1ZF																																										Führungsbolzen	ATE												
2.0 TDI 4x4		103		05.09	PR: 1ZF																																													Führungsbolzen	ATE									
2.0 TDI 4x4		110		05.15	PR: 1ZF																																																Führungsbolzen	ATE						
2.0 TDI 4x4		110		11.09	PR: 1ZF																																																			Führungsbolzen	ATE			
2.0 TDI 4x4		125		11.09	PR: 1ZF																																																						Führungsbolzen	ATE
1.2 TSI		77		09.09	PR: 1ZA,1ZE	11.9541-9553.2	220563																																																					
1.2 TSI	81		05.15	PR: 1ZA,1ZE	11.9541-9554.2							220564		D=54, - Halter	ATE																																													
1.4 TSI	90		06.10	PR: 1ZA,1ZE	11.0101-5409.2							260035							Hülzensatz	ATE																																								
1.4 TSI	92		05.15	PR: 1ZA,1ZE	11.8171-0008.1			990049		Führungsbolzen		ATE																																																
1.4 TSI 4x4	110		05.15	PR: 1ZA,1ZE													Führungsbolzen	ATE																																										
1.6	81		04.14	PR: 1ZA,1ZE																		Führungsbolzen	ATE																																					
1.6 TDI	77		11.10	PR: 1ZA,1ZE																					Führungsbolzen	ATE																																		
1.8 TSI 4x4	112		11.09	PR: 1ZA,1ZE																								Führungsbolzen	ATE																															
1.8 TSI 4x4	118		05.09	PR: 1ZA,1ZE																											Führungsbolzen	ATE																												
2.0 TDI	81		11.09	PR: 1ZA,1ZE																														Führungsbolzen	ATE																									
2.0 TDI	103		11.11	PR: 1ZA,1ZE																																	Führungsbolzen	ATE																						
2.0 TDI	110		05.15	PR: 1ZA,1ZE																																				Führungsbolzen	ATE																			
2.0 TDI 4x4	81		11.09	PR: 1ZA,1ZE																																							Führungsbolzen	ATE																
2.0 TDI 4x4	103		05.09	PR: 1ZA,1ZE																																										Führungsbolzen	ATE													
2.0 TDI 4x4	110		05.15	PR: 1ZA,1ZE																																													Führungsbolzen	ATE										
2.0 TDI 4x4	110		11.09	PR: 1ZA,1ZE																																																Führungsbolzen	ATE							
2.0 TDI 4x4	125		11.09	PR: 1ZA,1ZE																																																			Führungsbolzen	ATE				
	1.2 TSI	77		09.09				24.5143-0564.3																																																	331433	2	L=564	
	1.2 TSI	81		05.15																																																								
	1.4 TSI	90		06.10																																																								
	1.4 TSI	92		05.15																																																								
	1.4 TSI 4x4	110		05.15																																																								
	1.6	81		04.14																																																								
	1.6 TDI	77		11.10																																																								
	1.8 TSI 4x4	112		11.09																																																								
	1.8 TSI 4x4	118		05.09																																																								
	2.0 TDI	81		11.09																																																								
	2.0 TDI	103		11.11																																																								
	2.0 TDI	110		05.15																																																								
	1.2 TSI	77		09.09	PR: 1KD	24.3384-1755.7	220635		D=38, - Halter	TRW																																																		
	1.2 TSI	81		05.15	PR: 1KD						24.3384-1756.7	220636		D=38, - Halter	TRW																																													
	1.4 TSI	90		06.10	PR: 1KD												D=38, - Halter	TRW																																										
	1.4 TSI	92		05.15	PR: 1KD															D=38, - Halter	TRW																																							
	1.6	81		04.14	PR: 1KD																		D=38, - Halter	TRW																																				
	1.6 TDI	77		11.10	PR: 1KD																					D=38, - Halter	TRW																																	
	2.0 TDI	81		11.09	PR: 1KD																								D=38, - Halter	TRW																														
	2.0 TDI	103		11.11	PR: 1KD																											D=38, - Halter	TRW																											
	2.0 TDI	110		05.15	PR: 1KD																														D=38, - Halter	TRW																								
	1.2 TSI	77		09.09	PR: 1KJ						24.3414-1709.7	220631																										D=41, - Halter	TRW																					
	1.4 TSI	90		06.10	PR: 1KJ																																			24.3414-1710.7	220632		D=41, - Halter	TRW																
	1.6 TDI	77		11.10	PR: 1KJ																																									D=41, - Halter	TRW													
1.8 TSI 4x4	112		11.09	PR: 1KJ				D=41, - Halter	TRW																																																			
1.8 TSI 4x4	118		05.09	PR: 1KJ									D=41, - Halter	TRW																																														
																D=41, - Halter	TRW																																											

SKODA YETI (09-)										
										
	2.0 TDI	81	11.09	PR: 1KJ	24.3414-1709.7	220631			D=41, - Halter	TRW
	2.0 TDI	103	11.11	PR: 1KJ	24.3414-1710.7	220632			D=41, - Halter	TRW
	2.0 TDI 4x4	81	11.09	PR: 1KJ						
	2.0 TDI 4x4	103	05.09	PR: 1KJ						
	2.0 TDI 4x4	125	11.09	PR: 1KJ						
	1.2 TSI	77	09.09	10.09	83.7849-0243.3	331099	2		L=243	
	1.8 TSI 4x4	118	05.09	10.09						
	2.0 TDI 4x4	103	05.09	10.09						
	1.2 TSI	77	11.09		83.7847-0254.3	331233			L=255	
	1.2 TSI	81	05.15		83.7847-0257.3	331234			L=255	
	1.4 TSI	90	06.10							
	1.4 TSI	92	05.15							
	1.4 TSI 4x4	110	05.15							
	1.6	81	04.14							
	1.6 TDI	77	11.10							
	1.8 TSI 4x4	112	11.09							
	1.8 TSI 4x4	118	11.09							
	2.0 TDI	81	11.09							
	2.0 TDI	103	11.11							
	2.0 TDI	110	05.15							
	2.0 TDI 4x4	81	11.09							
	2.0 TDI 4x4	103	11.09							
	2.0 TDI 4x4	110	05.15							
	2.0 TDI 4x4	125	11.09							
	1.2 TSI	77	09.09	PR: 1SA,1SK	24.3727-0195.2	580195	2		L=1447	
	1.2 TSI	81	05.15	PR: 1SA,1SK						
	1.4 TSI	90	06.10	PR: 1SA,1SK						
	1.4 TSI	92	05.15	PR: 1SA,1SK						
	1.4 TSI 4x4	110	05.15	PR: 1SA,1SK						
	1.6	81	04.14	PR: 1SA,1SK						
	1.6 TDI	77	11.10	PR: 1SA,1SK						
	1.8 TSI 4x4	112	11.09	PR: 1SA,1SK						
	1.8 TSI 4x4	118	05.09	PR: 1SA,1SK						
	2.0 TDI	81	11.09	PR: 1SA,1SK						
	2.0 TDI	103	11.11	PR: 1SA,1SK						
	2.0 TDI	110	05.15	PR: 1SA,1SK						
	2.0 TDI 4x4	81	11.09	PR: 1SA,1SK						
	2.0 TDI 4x4	103	05.09	PR: 1SA,1SK						
	2.0 TDI 4x4	110	05.15	PR: 1SA,1SK						
	2.0 TDI 4x4	125	11.09	PR: 1SA,1SK						
	1.2 TSI	77	09.09	PR: OEJ, OEM	24.2415-1713.3	030132			Gz 15,87, + Sensor	
	1.2 TSI	81	05.15	PR: OEJ, OEM						
	1.4 TSI	90	06.10	PR: OEJ, OEM						
	1.4 TSI	92	05.15	PR: OEJ, OEM						
	1.4 TSI 4x4	110	05.15	PR: OEJ, OEM						
	1.6	81	04.14	PR: OEJ, OEM						
	1.6 TDI	77	11.10	PR: OEJ, OEM						
	1.8 TSI 4x4	112	11.09	PR: OEJ, OEM						
	1.8 TSI 4x4	118	05.09	PR: OEJ, OEM						
	2.0 TDI	81	11.09	PR: OEJ, OEM						
	2.0 TDI	103	11.11	PR: OEJ, OEM						
	2.0 TDI	110	05.15	PR: OEJ, OEM						
	2.0 TDI 4x4	81	11.09	PR: OEJ, OEM						
	2.0 TDI 4x4	103	05.09	PR: OEJ, OEM						
	2.0 TDI 4x4	110	05.15	PR: OEJ, OEM						
	2.0 TDI 4x4	125	11.09	PR: OEJ, OEM						
	1.2 TSI	77	09.09	PR: OEM	24.2519-1706.3	040096			Nz 19,05	
	1.2 TSI	81	05.15	PR: OEM						
	1.4 TSI	90	06.10	PR: OEM						
	1.4 TSI	92	05.15	PR: OEM						
	1.4 TSI 4x4	110	05.15	PR: OEM						
	1.6	81	04.14	PR: OEM						
	1.6 TDI	77	11.10	PR: OEM						
	1.8 TSI 4x4	112	11.09	PR: OEM						
	1.8 TSI 4x4	118	05.09	PR: OEM						
	2.0 TDI	81	11.09	PR: OEM						
	2.0 TDI	103	11.11	PR: OEM						
	2.0 TDI	110	05.15	PR: OEM						
	2.0 TDI 4x4	81	11.09	PR: OEM						
	2.0 TDI 4x4	103	05.09	PR: OEM						
	2.0 TDI 4x4	110	05.15	PR: OEM						
	2.0 TDI 4x4	125	11.09	PR: OEM						
	1.2 TSI	77	09.09	PR: OEJ	24.2519-1705.3	040095			Nz 19,05	
	1.4 TSI	90	06.10	PR: OEJ						
	1.6	81	04.14	PR: OEJ						
	1.6 TDI	77	11.10	PR: OEJ						
	1.8 TSI 4x4	112	11.09	PR: OEJ						
	1.8 TSI 4x4	118	05.09	PR: OEJ						
	2.0 TDI	81	11.09	PR: OEJ						
	2.0 TDI	103	11.11	PR: OEJ						
	2.0 TDI 4x4	81	11.09	PR: OEJ						
	2.0 TDI 4x4	103	05.09	PR: OEJ						
	2.0 TDI 4x4	110	05.15	PR: OEJ						
	2.0 TDI 4x4	125	11.09	PR: OEJ						









































SMART CABRIO (BM450) (00-03)

	0.6	40		03.00	12.02	24.2119-1711.3	010911	+ 00014462V001000000 verwenden	THz 19,05 - Behälter
	0.6	45		01.01	12.02				
	0.6	52		06.02	12.02				
	0.8 CDI	30		03.01	12.02				
	0.6	40		01.03	01.04				
	0.6	45		01.03	01.04	24.2119-1711.3	010911		THz 19,05 - Behälter
	0.6	52		01.03	01.04				
	0.7	45		01.03	01.04				
	0.7	55		01.03	01.04				
	0.8 CDI	30		01.03	01.04				
	0.6	40		03.00	01.04	24.3421-1707.5	240445		D=42, - Halter
	0.6	45		01.01	01.04				
	0.6	52		06.02	01.04				
	0.7	45		01.03	01.04				
	0.8 CDI	30		03.01	01.04				
	0.6	40		03.00	01.04	24.5112-0315.3	330509	2	L=315
	0.6	45		01.01	01.04				
	0.6	52		06.02	01.04				
	0.7	45		01.03	01.04				
	0.8 CDI	30		03.01	01.04				
	0.6	40		03.00	01.04	24.5146-0330.3	330973	2	L=330
	0.6	45		01.01	01.04				
	0.6	52		06.02	01.04				
	0.7	45		01.03	01.04				
	0.8 CDI	30		03.01	01.04				
	0.6	40	J 000000	03.00		24.3222-1721.3	020456		Rz 22,00
	0.6	45	J 000000	01.01					
	0.6	52	J 000000	06.02					
	0.7	45	J 000000	01.03					
	0.8 CDI	30	J 000000	03.01					
	0.6	40 J 000001			01.04	24.3220-1735.3	020521		Rz 20,64
	0.6	45 J 000001			01.04				
	0.6	52 J 000001			01.04				
	0.7	45 J 000001			01.04				
	0.8 CDI	30 J 000001			01.04				
	0.6	40		03.00	01.04	24.3727-2802.2	582802	1	L=990/990, + Zub
	0.6	45		01.01	01.04				
	0.6	52		06.02	01.04				
	0.7	45		01.03	01.04				
	0.8 CDI	30		03.01	01.04				



























SMART CITY COUPE (BM450) (98-04)

































	0.6	33		07.98	12.02	24.2119-1711.3	010911	+ 00014462V001000000 verwenden	THz 19,05 - Behälter
	0.6	40		07.98	12.02				
	0.6	45		01.01	12.02				
	0.6	52		06.02	12.02				
	0.8 CDI	30		11.99	12.02				
	0.6	33		01.03	01.04	24.2119-1711.3	010911		THz 19,05 - Behälter
	0.6	40		01.03	01.04				
	0.6	45		01.03	01.04				
	0.6	52		01.03	01.04				
	0.8 CDI	30		01.03	01.04				
	0.6	33		07.98	01.04	24.3421-1707.5	240445		D=42, - Halter
	0.6	40		07.98	01.04				
	0.6	45		01.01	01.04				
	0.6	52		06.02	01.04				
	0.8 CDI	30		11.99	01.04				
	0.6	33		07.98	01.04	24.5112-0315.3	330509	2	L=315
	0.6	40		07.98	01.04				
	0.6	45		01.01	01.04				
	0.6	52		06.02	01.04				
	0.8 CDI	30		11.99	01.04				
	0.6	33		07.98	01.04	24.5146-0330.3	330973	2	L=330
	0.6	40		07.98	01.04				
	0.6	45		01.01	01.04				
	0.6	52		06.02	01.04				
	0.8 CDI	30		11.99	01.04				

























										
SMART CITY COUPE (BM450) (98-04)										
	0.6	33		07.98	10.99	24.3217-1713.3	020450		Rz 17,46	
	0.6	40		07.98	10.99	24.3217-1714.3	020451		Rz 17,46	
	0.6	33		11.99	01.04	24.3222-1721.3	020456		Rz 22,00	BOS
	0.6	40		11.99	01.04	24.3222-1722.3	020457		Rz 22,00	
	0.6	45	J 000000	01.01						
	0.6	52	J 000000	06.02						
	0.7	37		01.03	01.04					
	0.7	45		01.03	01.04					
	0.7	55		01.03	01.04					
	0.8 CDI	30	J 000000	11.99						
0.6	45 J 000001		01.04			24.3220-1735.3	020521		Rz 20,64	
0.6	52 J 000001		01.04			24.3220-1736.3	020522		Rz 20,64	
0.8 CDI	30 J 000001		01.04							
	0.6	33		07.98	01.04	24.3727-2802.2	582802	1 		L=990/990, + Zub
	0.6	40		07.98	01.04					
	0.6	45		01.01	01.04					
	0.6	52		06.02	01.04					
	0.7	37		01.03	01.04					
	0.7	45		01.03	01.04					
	0.7	55		01.03	01.04					
	0.8 CDI	30		11.99	01.04					
	SMART CROSSBLADE (BM450) (02-04)									
		0.6	52		06.02	12.02	24.2119-1711.3	010911	+ 00014462V001000000 verwenden	THz 19,05 - Behälter
0.6		52		01.03	01.04	24.2119-1711.3	010911		THz 19,05 - Behälter	
	0.6	52		06.02	01.04	24.3421-1707.5	240445		D=42, - Halter	
						24.3421-1708.5	240446		D=42, - Halter	
	0.6	52		06.02	01.04	24.5112-0315.3	330509	2	L=315	
	0.6	52		06.02	01.04	24.5146-0330.3	330973	2	L=330	
	0.6	52	J 000000	06.02		24.3222-1721.3	020456		Rz 22,00	BOS
	0.6	52 J 000001		01.04		24.3222-1722.3	020457		Rz 22,00	
	0.6	52		01.04		24.3220-1735.3	020521		Rz 20,64	
						24.3220-1736.3	020522		Rz 20,64	
	0.6	52		06.02	01.04	24.3727-2802.2	582802	1 	L=990/990, + Zub	
SMART FORFOUR (BM454) (04-06)										
	1.1			03.04	12.06	24.2122-1770.3	010898		THz 22,20	TRW
	1.3	70		03.04	12.06					
	1.5	80		03.04	12.06					
	1.5	90		11.04	12.06					
	1.5 BRABUS	130		02.05	12.06					
	1.5 CDI	50		08.04	12.06					
	1.5 CDI	70		08.04	12.06					
	1.5 CDI	70		08.04	12.06					
	1.1			03.04	12.06	24.3541-1819.7	220767		D=54, - Halter	TRW
	1.3	70		03.04	12.06	24.3541-1820.7	220768		D=54, - Halter	
	1.5	80		03.04	12.06					
	1.5	90		11.04	12.06					
	1.5 CDI	50		08.04	12.06					
	1.5 CDI	70		08.04	12.06					
	1.5 CDI	70		08.04	12.06					
	1.5 CDI	70		08.04	12.06					
	1.1			03.04	12.06	24.5298-0475.3	331255	2	L=474	
	1.3	70		03.04	12.06					
	1.5	80		03.04	12.06					
	1.5	90		11.04	12.06					
	1.5 BRABUS	130		02.05	12.06					
	1.5 CDI	50		08.04	12.06					
	1.5 CDI	70		08.04	12.06					
	1.5 CDI	70		08.04	12.06					
	1.1			03.04	12.06	24.3344-1725.7	220771		D=34, - Halter	TRW
	1.3	70		03.04	12.06	24.3344-1726.7	220772		D=34, - Halter	
	1.5	80		03.04	12.06					
	1.5	90		11.04	12.06					
	1.5 BRABUS	130		02.05	12.06					
	1.5 CDI	50		08.04	12.06					
	1.5 CDI	70		08.04	12.06					
	1.5 CDI	70		08.04	12.06					
	1.1			03.04	12.06	24.5150-0459.3	331018	2	+ HA-Scheibenbremse ¹⁾	L=459
	1.3	70		03.04	12.06					
	1.5	80		03.04	12.06					
	1.5	90		11.04	12.06					
	1.5 BRABUS	130		02.05	12.06					
	1.5 CDI	50		08.04	12.06					
	1.5 CDI	70		08.04	12.06					
	1.5 CDI	70		08.04	12.06					
	1.1			03.04	12.06	24.3219-1757.3	020517		Rz 19,05	TRW
	1.3	70		03.04	12.06					
	1.5	90		11.04	12.06					
	1.5 CDI	50		08.04	12.06					

¹⁾ + RA disc brake / + P disco freno / + frein à disque essieu AR / + ET-disco de freno



































									
SMART FORTWO CABRIO (BM450) (04-07)									
	0.7 0.7 BRABUS 0.8 CDI	45 55 30		01.04 01.04 01.04	04.07 04.07 04.07	24.2119-1711.3	010911	Thz 19,05 - Behälter	
	0.7 0.7 BRABUS 0.8 CDI	45 55 30		01.04 01.04 01.04	04.07 04.07 04.07	24.3421-1707.5 24.3421-1708.5	240445 240446	D=42, - Halter D=42, - Halter	
	0.7 0.7 BRABUS 0.8 CDI	45 55 30		01.04 01.04 01.04	04.07 04.07 04.07	24.5112-0315.3	330509	L=315	
	0.7 0.7 BRABUS 0.8 CDI	45 55 30		01.04 01.04 01.04	04.07 04.07 04.07	24.5146-0330.3	330973	L=330	
	0.7 0.7 BRABUS 0.8 CDI	45 55 30		01.04 01.04 01.04	04.07 04.07 04.07	24.3222-1721.3 24.3222-1722.3	020456 020457	Rz 22,00 Rz 22,00	BOS BOS
	0.7 0.7 BRABUS 0.8 CDI	45 55 30		01.04 01.04 01.04	04.07 04.07 04.07	24.3727-2802.2	582802	L=990/990, + Zub	
SMART FORTWO COUPE (BM450) (04-07)									
	0.7 0.7 0.7 0.7 BRABUS 0.8 CDI	37 40 45 55 30	J182808 J182805 J182805	01.04 01.04 01.04 01.04	04.07 04.07 04.07 04.07	24.2119-1711.3	010911	Thz 19,05 - Behälter	
	0.7 0.7 0.7 BRABUS 0.8 CDI	37 45 55 30		01.04 01.04 01.04 01.04	04.07 04.07 04.07 04.07	24.3421-1707.5 24.3421-1708.5	240445 240446	D=42, - Halter D=42, - Halter	
	0.7 0.7 0.7 BRABUS 0.8 CDI	37 45 55 30		01.04 01.04 01.04 01.04	04.07 04.07 04.07 04.07	24.5112-0315.3	330509	L=315	
	0.7 0.7 0.7 0.7 BRABUS 0.8 CDI	37 40 45 55 30		01.04 01.04 01.04 01.04 01.04	04.07 04.07 04.07 04.07 04.07	24.5146-0330.3	330973	L=330	
	0.7 0.7 0.7 BRABUS 0.8 CDI	37 45 55 30		01.04 01.04 01.04 01.04	04.07 04.07 04.07 04.07	24.3222-1721.3 24.3222-1722.3	020456 020457	Rz 22,00 Rz 22,00	BOS BOS
	0.7 0.7 0.7 0.7 BRABUS 0.8 CDI	37 40 45 55 30		01.04 01.04 01.04 01.04 01.04	04.07 04.07 04.07 04.07 04.07	24.3220-1735.3 24.3220-1736.3	020521 020522	Rz 20,64 Rz 20,64	
	0.7 0.7 0.7 0.7 BRABUS 0.8 CDI	37 40 45 55 30		01.04 01.04 01.04 01.04 01.04	04.07 04.07 04.07 04.07 04.07	24.3727-2802.2	582802	L=990/990, + Zub	
SMART FORTWO CABRIO (BM451) (07-)									
	0.8 CDI 0.8 CDi 1.0 1.0 BRABUS 1.0 BRABUS 1.0 MHD Hybrid 1.0 Turbo Electric Drive Electric Drive Electric Drive Electric Drive Electric Drive BRABUS	33 40 52 88 71 62 20 30 35 55 60		04.07 08.09 04.07 07.07 04.12 10.07 04.07 12.10 11.09 12.11 04.12 01.13		24.5112-0285.3	330604	L=285	
	0.8 CDI 0.8 CDi 1.0 1.0 BRABUS 1.0 BRABUS 1.0 MHD Hybrid 1.0 Turbo Electric Drive Electric Drive Electric Drive Electric Drive Electric Drive BRABUS	33 40 52 88 71 62 20 30 35 55 60		04.07 08.09 04.07 07.07 04.12 10.07 04.07 12.10 11.09 12.11 04.12 01.13		24.3220-1735.3 24.3220-1736.3	020521 020522	Rz 20,64 Rz 20,64	
SMART FORTWO COUPE (BM451) (07-)									
	0.8 CDI 0.8 CDi 1.0 1.0 1.0 1.0 BRABUS 1.0 MHD Hybrid 1.0 Turbo	33 40 45 52 88 72 71		04.07 08.09 04.07 04.07 01.10 07.07 10.07 04.07		24.5112-0285.3	330604	L=285	
									

SMART FORTWO COUPE (BM451) (07-)												
	Electric Drive	20		12.10				24.5112-0285.3	330604	2		L=285
	Electric Drive	30		11.09								
	Electric Drive	35		12.11								
	Electric Drive	55		04.12								
	Electric Drive BRABUS	60		01.13								
	0.8 CDI	33		04.07				24.3220-1735.3	020521			Rz 20,64
	0.8 CDi	40		08.09				24.3220-1736.3	020522			Rz 20,64
	1.0	45		04.07								
	1.0	52		04.07								
	1.0	88		01.10								
	1.0 BRABUS	72		07.07								
	1.0 MHD Hybrid	71		10.07								
	1.0 Turbo			04.07								
	Electric Drive	20		12.10								
	Electric Drive	30		11.09								
	Electric Drive	35		12.11								
	Electric Drive	55		04.12								
	Electric Drive BRABUS	60		01.13								
SMART ROADSTER (BM452) (03-05)												
	0.7	45		04.03	12.05			24.3421-1707.5	240445			D=42, - Halter
	0.7	60		04.03	12.05			24.3421-1708.5	240446			D=42, - Halter
	0.7 BRABUS	74		03.04	12.05							
SMART ROADSTER COUPE (BM452) (03-05)												
	0.7	45		04.05	12.05			24.3421-1707.5	240445			D=42, - Halter
	0.7	60		04.03	12.05			24.3421-1708.5	240446			D=42, - Halter
	0.7 BRABUS	74		03.04	12.05							
SUBARU FORESTER (97-02)												
	2.0	90		08.97	09.02			24.3219-1759.3	020528			Rz 19,05
	2.0	92		07.98	09.02							
SUBARU FORESTER (02-08)												
	2.0	92		09.02	05.08			24.3219-1759.3	020528			Rz 19,05
	2.0 X	116		09.05	05.08							
SUBARU JUSTY (95-03)												
	1.3 4x4	50		10.95	09.00			24.3217-1725.3	020512			Rz 17,46
								24.3217-1726.3	020513			Rz 17,46
	1.3 4x4	50		10.95	09.00			24.3728-2201.2	592201			L=525
	1.3 4x4	63		10.00	11.03							
SUBARU JUSTY (G3X) (03-07)												
	1.3 i 16V 4WD	69		09.03	08.07			24.2120-1730.3	010678			Thz 20,64
	1.5 i 16V 4WD	73		09.03	08.07							
	1.3 i 16V 4WD	69		09.03	08.07			24.3481-1777.5	240451			D=48, - Halter
	1.5 i 16V 4WD	73		09.03	08.07			24.3481-1778.5	240452			D=48, - Halter
	1.3 i 16V 4WD	69		09.03	08.07			24.5291-0430.3	331084	2		L=430
	1.5 i 16V 4WD	73		09.03	08.07							
	1.3 i 16V 4WD	69		09.03	08.07			24.5284-0283.3	331080	2		L=283
	1.5 i 16V 4WD	73		09.03	08.07							
	1.3 i 16V 4WD	69		09.03	08.07			24.3215-1701.3	020493			Rz 15,87
	1.5 i 16V 4WD	73		09.03	08.07							
	1.3 i 16V 4WD	69		09.03	08.07			24.3728-2200.2	592200			L=660
SUBARU JUSTY (07-11)												
	1.0 i 12V	51		09.07	05.11			24.5235-0205.3	331093	2		L=205
	1.3 AWD	67		03.08	05.11 + CH							
	1.0 i 12V	51		09.07	05.11			24.3217-1721.3	020489			Rz 17,46
	1.3 AWD	67		03.08	05.11 + CH			24.3217-1722.3	020490			Rz 17,46
SUBARU TREZIA (11-)												
	1.3 16V	73		03.11				24.5265-0440.3	331351			L=440
	1.4 D	66		03.11				24.5265-0441.3	331352			L=440
	1.3 16V	73		03.11				24.5235-0200.3	331280			L=198
	1.4 D	66		03.11								





















								
SUZUKI ALTO (93-02)								
	1.0 1.0 16V	39 43		09.94 01.00	06.02 06.02	24.3217-1738.3	020577	Rz 17,46
	1.3 16V 1.6 16V	63 71		10.98 10.98	09.00 09.00	24.3217-1725.3 24.3217-1726.3	020512 020513	Rz 17,46 Rz 17,46
	1.3 16V 1.6 16V	63 71		10.98 10.98	09.00 09.00	24.3727-2003.2 24.3727-2000.2	582003 582000	L=1656 L=1572
	1.3 16V 1.6 16V	63 71		10.98 10.98	09.00 09.00	24.3728-2000.2	592000	L=603
SUZUKI ALTO (02-08)								
	1.1 i 16V (RF410)	46		06.02	12.08	24.3511-1713.5 24.3511-1714.5	240453 240454	D=51, - Halter D=51, - Halter
	1.1 i 16V (RF410)	46		06.02	12.08	24.3215-1702.3	020494	Rz 15,87
SUZUKI ALTO (09-)								
	1.0 i 12V (AMF310)	50		01.09		24.5281-0453.3 24.5281-0452.3	331437 331436	L=452 L=452
	1.0 i 12V (AMF310)	50		01.09		24.5247-0235.3	331374	L=235
	1.0 i 12V (AMF310)	50		01.09		24.3219-1765.3	020547	Rz 19,05
SUZUKI BALENO (95-02)								
	1.3 1.3 i 16V 1.6 i 16V 1.6 i 16V 4x4	52 63 72 72		09.96 07.95 07.95 07.95	05.02 05.02 05.02 05.02	24.3217-1725.3 24.3217-1726.3	020512 020513	Rz 17,46 Rz 17,46
	1.3 1.3 i 16V 1.3 i 16V 1.6 i 16V 1.6 i 16V 1.6 i 16V 4x4 1.6 i 16V 4x4	52 52 63 63 72 72 72		09.96 09.96 07.95 07.95 07.95 07.95 07.95	05.02 05.02 05.02 05.02 05.02 05.02 05.02	24.3727-2003.2 24.3727-2000.2	582003 582000	L=1656 L=1572
	1.3 1.3 i 16V 1.6 i 16V 1.6 i 16V 4x4 1.8 i 16V GT 1.9 TD	52 63 72 72 89 55		09.96 07.95 07.95 07.95 03.96 04.98	05.02 05.02 05.02 05.02 05.02 05.02	24.3728-2000.2	592000	L=603
SUZUKI CARRY (99-04)								
	1.3 1.3 4x4 1.3 i 16V	58 56 58		03.99 02.99 03.00	09.04 09.04 09.04	24.3219-1723.3 24.3219-1758.3	020427 020527	Rz 19,05 Rz 19,05
SUZUKI GRAND VITARA (98-05)								
	1.6 i 16V 1.6 i 16V 4x4 2.0 HDI 2.0 i 16V 2.0 i 16V 4x4 2.0 i 16V 4x4 2.0 i 16V 4x4 2.0 TD 2.0 TD 4x4 2.5 i V6 2.5 i V6 2.7 i V6 2.7 i V6	69 73 80 97 94 94 103 64 63 106 116 127 135		03.98 02.00 07.01 08.98 03.98 03.98 04.98 03.98 04.00 04.98 04.01 09.01 04.03	11.04 09.02 09.05 12.00 11.04 11.04 08.05 09.05 09.05 09.00 09.05 09.05 09.05	24.5291-0756.3 24.5291-0755.3	331196 331195	L=755 L=755
	1.6 i 16V 1.6 i 16V 4x4 2.0 HDI 2.0 i 16V 2.0 i 16V 4x4 2.0 i 16V 4x4 2.0 i 16V 4x4 2.0 TD 2.0 TD 4x4 2.5 i V6 2.5 i V6 2.7 i V6 2.7 i V6	69 73 80 97 94 94 103 64 63 106 116 127 135		03.98 02.00 07.01 08.98 03.98 03.98 04.98 03.98 04.00 04.98 04.01 09.01 04.03	11.04 09.02 09.05 12.00 11.04 11.04 08.05 09.05 09.05 09.00 09.05 09.05 09.05	24.3222-1727.3 24.3222-1728.3	020519 020520	Rz 22,20 Rz 22,20

1) + 5 door / + 5 porte / + 5 portes / + 5 puertas
2) + 4 door / + 4 porte / + 4 portes / + 4 puertas
3) + Van / + Furgone / + Fourgonnette / + Furgón
4) + Convertible / + Cabriolet / + Décapotable / + Cabriolé



































										
SUZUKI GRAND VITARA (05-15)										
	1.6 i 16V 4x4 1.6 i 16V 4x4 1.9 DDiS 2.0 VVTi 4x4 2.7 VVTi	73 78 95 103 138		09.05 04.05 10.05 10.05 10.05	08.08 08.08		24.5291-0756.3 24.5291-0755.3	331196 331195	 	L=755 L=755
	1.6 i 16V 4x4 1.6 i 16V 4x4 1.9 DDiS 2.0 VVTi 4x4 2.7 VVTi	73 78 95 103 138		09.05 04.05 10.05 10.05 10.05	08.08 08.08		24.3222-1727.3 24.3222-1728.3	020519 020520	 	Rz 22,20 Rz 22,20
SUZUKI IGNIS I (00-03)										
	1.3 i 16V 1.3 i 16V 4x4	61 61		10.00 10.00	08.03 08.03		24.3215-1702.3	020494		Rz 15,87
	1.3 i 16V 1.3 i 16V 4x4	61 61		10.00 10.00	08.03 08.03		24.3728-2200.2	592200		L=660
SUZUKI IGNIS II (03-12)										
	1.3 DDiS 1.3 i 16V 1.3 i 16V 4x4 1.5 i 16V 1.5 i 16V 4x4	51 69 69 73 73		09.03 09.03 09.03 09.03 09.03	12.12 + ABS 12.12 + ABS 12.12 + ABS 12.12 + ABS 12.12 + ABS		24.2120-1730.3	010678		Thz 20,64
	1.3 DDiS	51		09.03	12.12		24.3481-1777.5 24.3481-1778.5	240451 240452	 	D=48, - Halter D=48, - Halter
	1.3 DDiS 1.3 i 16V 1.3 i 16V 4x4 1.5 i 16V 1.5 i 16V 4x4	51 69 69 73 73		09.03 09.03 09.03 09.03 09.03	12.12 12.12 12.12 12.12 12.12		24.5291-0430.3	331084	2	L=430
	1.3 DDiS 1.3 i 16V 1.3 i 16V 4x4 1.5 i 16V 1.5 i 16V 4x4	51 69 69 73 73		09.03 09.03 09.03 09.03 09.03	12.12 12.12 12.12 12.12 12.12		24.5284-0283.3	331080	2	L=283
	1.3 i 16V 1.3 i 16V 4x4 1.5 i 16V 1.5 i 16V 4x4 1.5 Sport	69 69 73 73 80		09.03 09.03 09.03 09.03 12.03	12.12 12.12 12.12 12.12 12.12 - Sportfahrwerk ¹⁾		24.3215-1702.3	020494		Rz 15,87
	1.3 DDiS 1.3 i 16V 1.3 i 16V 4x4	51 69 69		09.03 09.03 09.03	12.12 12.12 12.12		24.3215-1701.3 24.3728-2200.2	020493 592200		Rz 15,87 L=660
SUZUKI JIMNY (98-)										
	1.3 4x4 1.3 4x4 1.3 i 16V 1.3 i 16V 1.3 i 16V 4x4 1.3 i 16V 4x4 1.3 i 16V 4x4 1.5 DDiS 4x4 1.5 DDiS 4x4	63 65 59 60 59 60 63 48 63		09.98 09.00 09.98 02.01 09.98 02.01 08.05 12.03 08.05	08.00 08.02		24.2122-1776.3	011001	- ABS	Thz 22,20 - Behälter
	1.3 4x4 1.3 4x4 1.3 i 16V 1.3 i 16V 1.3 i 16V 4x4 1.3 i 16V 4x4 1.3 i 16V 4x4 1.5 DDiS 4x4 1.5 DDiS 4x4	63 65 59 60 59 60 63 48 63		09.98 09.00 09.98 02.01 09.98 02.01 08.05 12.03 08.05	08.00 08.02		24.5291-0508.3 24.5291-0345.3	331085 331165	 	L=508 L=345
	1.3 4x4 1.3 4x4 1.3 i 16V 1.3 i 16V 1.3 i 16V 4x4 1.3 i 16V 4x4 1.3 i 16V 4x4 1.5 DDiS 4x4 1.5 DDiS 4x4	63 65 59 60 59 60 63 48 63		09.98 09.00 09.98 02.01 09.98 02.01 08.05 12.03 08.05	08.00 08.02		24.5279-0360.3	331045	2	L=360
	1.3 4x4 1.3 4x4 1.3 i 16V 1.3 i 16V 1.3 i 16V 4x4 1.3 i 16V 4x4 1.3 i 16V 4x4 1.5 DDiS 4x4 1.5 DDiS 4x4	63 65 59 60 59 60 63 48 63		09.98 09.00 09.98 02.01 09.98 02.01 08.05 12.03 08.05	08.00 08.02		24.3219-1723.3 24.3219-1758.3	020427 020527	 	Rz 19,05 Rz 19,05
										

¹⁾ - sports suspension / - sospensione sportiva / - châssis de sport / - suspensión deportiva



















										
SUZUKI JIMNY (98-)										
	1.3 4x4 1.3 4x4 1.3 i 16V 1.3 i 16V 1.3 i 16V 4x4 1.3 i 16V 4x4 1.3 i 16V 4x4 1.5 DDiS 4x4 1.5 DDiS 4x4	63 65 59 60 59 60 63 48 63		09.98 09.00 09.98 02.01 09.98 02.01 08.05 12.03 08.05	08.00 08.02	24.3728-2001.2	592001	L=1977		
SUZUKI LIANA (01-07)										
	1.3 i 16V 1.4 DDiS 1.6 i 16V 1.6 i 16V 1.6 i 16V 1.6 i 16V 4WD 1.6 i 16V 4WD 1.6 i 16V 4WD	66 66 76 78 79 76 78 79		07.01 04.04 07.01 04.02 01.05 07.01 04.02 01.05	12.07 12.07 12.07 12.07 12.07 12.07 12.07	24.3217-1725.3 24.3217-1726.3	020512 020513	Rz 17,46 Rz 17,46		
SUZUKI SAMURAI (98-04)										
	1.3 i 4x4 (SJ413) 1.3 i 4x4 (SJ413)	51 59		11.98 09.00	12.04 12.07	24.3222-1738.3 24.3222-1739.3	020564 020565	Rz 22,20 Rz 22,20		
	1.3 i 4x4 (SJ413) 1.3 i 4x4 (SJ413)	51 59		09.98 09.00	12.04 12.04	24.3728-2005.2	592005	L=1855		
SUZUKI SPLASH (08-)										
	1.0 12V 1.0 12V 1.2 16V 1.2 VVT 1.2 VVT 1.2 VVT 1.3 CDTi	48 50 63 66 67 69 55		01.08 06.11 01.08 06.11 08.12 09.10 01.08		24.3541-1821.7 24.3541-1822.7 24.0101-3802.2	220695 220696 260100	D=54, - Halter D=54, - Halter Bremsattel-Zubehör	TRW TRW TRW	
	1.0 12V 1.0 12V 1.2 16V 1.2 VVT 1.2 VVT 1.2 VVT 1.3 CDTi	48 50 63 66 67 69 55		01.08 06.11 01.08 06.11 08.12 09.10 01.08		24.5273-0490.3	330940	2	L=490	
	1.0 12V 1.0 12V 1.2 16V 1.2 VVT 1.2 VVT 1.2 VVT 1.3 CDTi	48 50 63 66 67 69 55		01.08 06.11 01.08 06.11 08.12 09.10 01.08		24.5279-0305.3 24.5279-0300.3	330946 331135		L=305 L=300	
	1.0 12V 1.0 12V 1.2 16V 1.2 VVT 1.2 VVT 1.2 VVT 1.3 CDTi	48 50 63 66 67 69 55		01.08 06.11 01.08 06.11 08.12 09.10 01.08		24.3219-1756.3	020511		Rz 19,05	BOS
	1.0 12V 1.0 12V 1.2 16V 1.2 VVT 1.2 VVT 1.2 VVT 1.3 CDTi	48 50 63 66 67 69 55		01.08 06.11 01.08 06.11 08.12 09.10 01.08		24.3727-0793.2 24.3727-0792.2	580793 580792		L=1600 L=1600	
SUZUKI SWIFT II (96-04)										
	1.0 i (SF310) 1.3 i (SF413) 1.3 i (SF413) 1.3 i (SF413) 1.3 i (SF413) 1.3 i (SF413) 1.3 i (SF413)	39 50 50 50 63 63 63		11.96 11.96 11.96 11.96 06.01 06.01 06.01	12.04 05.01 + 5 türg 1) 05.01 + 3 türg 2) 05.01 + 2 türg 3) 12.04 + 5 türg 1) 12.04 + 3 türg 2) 12.04 + 2 türg 3)	24.3215-1704.3	020532	Rz 15,87		
	1.3 i (SF413) 1.3 i (SF413) 1.3 i 4WD (SF413)	50 63 50		11.96 06.01 11.96	05.01 + 4 türg 4) 12.04 + 4 türg 4) 05.01	24.3217-1725.3 24.3217-1726.3	020512 020513	Rz 17,46 Rz 17,46		
	1.0 i (SF310)	39		11.96	12.04	24.3728-2003.2	592003	L=607		
SUZUKI SWIFT III (05-10)										
	1.3 16V 1.3 16V 4x4 1.3 16V 4x4 1.3 DDiS 1.3 DDiS	68 66 68 51 55		02.05 01.06 02.05 08.05 08.05	09.10 09.10 09.10 09.07 09.10	24.3541-1821.7 24.3541-1822.7 24.0101-3802.2	220695 220696 260100	D=54, - Halter D=54, - Halter Bremsattel-Zubehör	TRW TRW TRW	

1) + 5 door / + 5 porte / + 5 portes / + 5 puertas
2) + 3 door / + 3 porte / + 3 portes / + 3 puertas
3) + 2 door / + 2 porte / + 2 portes / + 2 puertas
4) + 4 door / + 4 porte / + 4 portes / + 4 puertas





















									
SUZUKI SWIFT III (05-10)									
	1.5 16V 4x4 1.5 VVTi 1.6 VVTi	74 75 92	02.05 02.05 05.06	09.10 09.10 09.10	24.3541-1821.7 24.3541-1822.7 24.0101-3802.2	220695 220696 260100	 	D=54, - Halter D=54, - Halter Bremsattel-Zubehör	TRW TRW TRW
	1.3 16V 1.3 16V 4x4 1.3 16V 4x4 1.3 DDiS 1.3 DDiS 1.5 16V 4x4 1.5 VVTi	68 66 68 51 55 74 75	02.05 01.06 02.05 08.05 08.05 02.05 02.05	09.10 09.10 09.10 09.07 09.10 09.10 09.10	24.5273-0490.3	330940	2 Produktionsland (H)	L=490	
	1.3 16V 1.3 16V 4x4 1.3 16V 4x4 1.3 DDiS 1.3 DDiS 1.5 16V 4x4 1.5 VVTi 1.6 VVTi	68 66 68 51 55 74 75 92	02.05 01.06 02.05 08.05 08.05 02.05 02.05 05.06	09.10 09.10 09.10 09.07 09.10 09.10 09.10 09.10	24.5279-0305.3 24.5279-0300.3	330946 331135	 	L=305 L=300	
	1.3 16V 1.3 16V 4x4 1.3 16V 4x4 1.3 DDiS 1.3 DDiS 1.5 16V 4x4 1.5 VVTi	68 66 68 51 55 74 75	02.05 01.06 02.05 08.05 08.05 02.05 02.05	09.10 09.10 09.10 09.07 09.10 09.10 09.10	24.3219-1756.3	020511		Rz 19,05	BOS
	1.3 16V 1.3 16V 4x4 1.3 16V 4x4 1.3 DDiS 1.3 DDiS 1.5 16V 4x4 1.5 VVTi	68 66 68 51 55 74 75	02.05 01.06 02.05 08.05 08.05 02.05 02.05	09.10 09.10 09.10 09.07 09.10 09.10 09.10	24.3727-2005.2 24.3727-2004.2	582005 582004	 	L=1625 L=1625	
	1.6 VVTi	92	05.06	09.10	24.3727-2009.2 24.3727-2008.2	582009 582008	 	L=1494 L=1494	
SUZUKI SWIFT IV (10-)									
	1.2 1.2 1.2 1.2 4x4 1.2 4x4 1.2 4x4 1.3 DDiS	66 67 69 66 67 69 55	10.10 08.12 10.10 10.10 08.12 10.10 10.10		24.3727-2011.2 24.3727-2010.2	582011 582010	 	L=1480 L=1480	
SUZUKI SX4 (06-15)									
	1.5 i 16V 1.6 VVT 1.6 VVT 4x4 1.9 DDiS 1.9 DDiS 4x4	73 79 79 88 88	06.06 06.06 06.06 06.06 06.06	Produktionsland (H) Produktionsland (H) Produktionsland (H)	24.3571-1767.7 24.3571-1768.7	220981 220982	  	D=57, - Halter D=57, - Halter	TRW TRW
	1.5 i 16V 1.5 VVT 1.5 VVT 4x4 1.6 DDiS 1.6 VVT 1.6 VVT 1.6 VVT 1.6 VVT 4x4 1.6 VVT 4x4 1.6 VVT 4x4 1.9 DDiS 1.9 DDiS 4x4 2.0 DDiS 2.0 DDiS 4x4	73 82 82 66 74 79 88 79 82 88 88 88 99 99	06.06 07.10 07.10 04.07 06.06 06.06 10.07 06.06 07.09 07.09 06.06 06.06 07.09 07.09	Produktionsland (H) Produktionsland (H) Produktionsland (H) Produktionsland (H) Produktionsland (H) Produktionsland (H) Produktionsland (H)	24.5273-0375.3	331147	2	L=375	
	1.5 i 16V 1.5 VVT 1.5 VVT 4x4 1.6 DDiS 1.6 VVT 1.6 VVT 1.6 VVT 1.6 VVT 4x4 1.6 VVT 4x4 1.6 VVT 4x4 1.9 DDiS 1.9 DDiS 4x4 2.0 DDiS 2.0 DDiS 4x4 2.0 i 16V 2.0 i 16V 2.0 i 16V 4x4 2.0 i 16V 4x4	73 82 82 66 74 79 88 79 82 88 88 88 99 99 107 112 107 112	06.06 07.10 07.10 04.07 06.06 06.06 10.07 06.06 07.09 07.09 06.06 06.06 07.09 07.09 06.06 01.10 06.06 01.10	Produktionsland (J) Produktionsland (J) Produktionsland (J) Produktionsland (J) Produktionsland (J) Produktionsland (J)	24.5279-0300.3	331135	2	L=300	
	1.5 i 16V 1.5 VVT 1.5 VVT 4x4 1.6 DDiS	73 82 82 66	06.06 07.10 07.10 04.07	Produktionsland (H)	24.3219-1756.3	020511	- ABS	Rz 19,05	BOS

1) + RA disc brake / + P disco freno / + frein à disque essieu AR / + ET-disco de freno

















								
SUZUKI SX4 (06-15)								
	1.6 VVT 1.6 VVT 1.6 VVT 1.6 VVT 4x4 1.6 VVT 4x4 1.6 VVT 4x4 1.9 DDiS 1.9 DDiS 4x4 2.0 DDiS 2.0 DDiS 4x4	74 79 88 79 82 88 88 88 99 99		06.06 06.06 10.07 06.06 07.09 07.09 06.06 06.06 07.09 07.09	Produktionsland (H) Produktionsland (H) Produktionsland (H) Produktionsland (H) Produktionsland (H)	24.3219-1756.3 020511	- ABS	Rz 19,05 BOS
	1.5 i 16V 1.5 VVT 1.5 VVT 4x4 1.6 DDiS 1.6 VVT 1.6 VVT 1.6 VVT 1.6 VVT 4x4 1.6 VVT 4x4 1.6 VVT 4x4 1.9 DDiS 1.9 DDiS 4x4 2.0 DDiS 2.0 DDiS 4x4	73 82 82 66 74 79 88 79 82 88 88 88 88 99 99		06.06 07.10 07.10 04.07 06.06 06.06 10.07 06.06 07.09 07.09 06.06 06.06 07.09 07.09	Produktionsland (H) Produktionsland (H) Produktionsland (H) Produktionsland (H) Produktionsland (H)	24.3727-2007.2 24.3727-2006.2 582007 582006	<input type="checkbox"/> + ABS <input type="checkbox"/> + ABS	L=1638 L=1638
SUZUKI VITARA (89-98)								
	1.9 D Allrad 1.9 D Cabrio			01.95 03.98 01.95 03.98		24.3222-1742.3 020569		Rz 22,20
	1.6 1.6 Cabrio 2.0 i V6 1.6 i 16V	◀ ◀ ◀ ◀		01.89 01.95 01.89 01.95 12.94 03.98 02.91 12.94		24.3728-2004.2 592004 24.3728-2002.2 592002		L=1850 L=1843
SUZUKI WAGON R+ (98-00)								
	1.0 i 16V 1.2 i 16V 1.2 i 16V 4WD	48 51 51		02.98 04.00 02.98 04.00 02.98 04.00		24.3215-1702.3 020494		Rz 15,87
SUZUKI WAGON R+ (00-08)								
	1.0 i 12V 1.0 i 12V 1.0 i 16V 1.0 XT Plus 1.2 i 16V 1.3 DDiS 1.3 i 16V 1.3 i 16V 1.3 i 16V 1.3 i 16V 1.3 i 16V 4WD 1.3 i 16V 4WD	39 44 51 74 59 51 56 65 69 56 69		07.03 08.05 06.04 04.08 08.00 07.03 08.00 07.01 06.04 04.08 09.03 04.08 05.00 12.04 08.01 04.08 09.03 04.08 10.01 12.04 09.03 04.08	+ ABS + ABS + ABS + ABS + ABS	24.2120-1730.3 010678		Thz 20,64
	1.3 i 16V 1.3 i 16V 4WD 1.0 i 12V 1.0 i 12V 1.0 i 16V 1.0 XT Plus 1.2 i 16V 1.3 DDiS 1.3 i 16V 1.3 i 16V 1.3 i 16V 4WD 1.3 i 16V 4WD	56 56 39 44 51 74 59 51 65 69 56 69		05.00 12.04 10.01 12.04 07.03 08.05 06.04 04.08 08.00 07.03 08.00 07.01 06.04 04.08 09.03 04.08 08.01 04.08 09.03 04.08 09.03 04.08		24.3481-1757.5 24.3481-1758.5 24.3481-1777.5 24.3481-1778.5 240325 240326 240451 240452	<input type="checkbox"/> <input type="checkbox"/> <input type="checkbox"/> <input type="checkbox"/>	D=48, - Halter D=48, - Halter D=48, - Halter D=48, - Halter BOS BOS
	1.0 i 12V 1.0 i 12V 1.0 i 16V 1.0 XT Plus 1.2 i 16V 1.3 DDiS 1.3 i 16V 1.3 i 16V 1.3 i 16V 1.3 i 16V 4WD 1.3 i 16V 4WD	39 44 51 74 59 51 56 65 69 56 69		07.03 08.05 06.04 04.08 08.00 07.03 08.00 07.01 06.04 04.08 09.03 04.08 05.00 12.04 08.01 04.08 09.03 04.08 10.01 12.04 09.03 04.08		24.5291-0430.3 331084	2	L=430
	1.0 i 12V 1.0 i 12V 1.0 i 16V 1.0 XT Plus 1.2 i 16V 1.3 DDiS 1.3 i 16V 1.3 i 16V 1.3 i 16V 1.3 i 16V 4WD 1.3 i 16V 4WD	39 44 51 74 59 51 56 65 69 56 69		07.03 08.05 06.04 04.08 08.00 07.03 08.00 07.01 06.04 04.08 09.03 04.08 05.00 12.04 08.01 04.08 09.03 04.08 10.01 12.04 09.03 04.08		24.5284-0283.3 331080	2	L=283

SUZUKI WAGON R+ (00-08)										
	1.0 i 12V	39		07.03	08.05		24.3215-1701.3	020493		Rz 15,87
	1.0 i 12V	44		06.04	04.08					
	1.0 i 16V	51		08.00	07.03					
	1.0 XT Plus	74		08.00	07.01					
	1.2 i 16V	59		06.04	04.08					
	1.3 DDiS	51		09.03	04.08					
	1.3 i 16V	65		08.01	04.08					
	1.3 i 16V	56		05.00	12.04		24.3215-1702.3	020494		Rz 15,87
1.3 i 16V	69		09.03	04.08						
1.3 i 16V 4WD	56		10.01	12.04						
1.3 i 16V 4WD	69		09.03	04.08						
	1.3 i 16V	56		05.00	12.04		24.3727-0771.2	580771	<input type="checkbox"/>	L=1516, + Zub
	1.3 i 16V 4WD	56		10.01	12.04		24.3727-0774.2	580774	<input type="checkbox"/>	L=1507, + Zub
TOYOTA AURIS (06-12)										
	1.33 Dual-VVTi	73		01.10	09.12	Produktionsland ⤵	24.5274-0180.3	330941	2	L=180
	1.33 Dual-VVTi	74		05.09	09.12	Produktionsland ⤵				
	1.4 D-4D	66		03.07	09.12	Produktionsland ⤵				
	1.4 VVTi	71		03.07	09.12	Produktionsland ⤵				
	1.5	81		09.09	09.12	Produktionsland ⤵				
	1.5 4WD	77		09.09	09.12	Produktionsland ⤵				
	1.6 16V	97		05.09	09.12	Produktionsland ⤵				
	1.6 VVTi	91		03.07	09.12	Produktionsland ⤵				
	1.8 16V	106		02.09	09.12	Produktionsland ⤵				
	1.8 16V	108		02.09	09.12	Produktionsland ⤵				
	1.8 16V 4WD	100		02.09	09.12	Produktionsland ⤵				
	1.8 VVTi	100		10.06	09.12	Produktionsland ⤵				
	2.0 D-4D	93		03.07	09.12	Produktionsland ⤵				
	1.33 Dual-VVTi	73		01.10	09.12	Produktionsland ⤵	24.5235-0160.3	331325	<input type="checkbox"/> am Bremsattel ¹⁾	L=160
	1.33 Dual-VVTi	74		05.09	09.12	Produktionsland ⤵	24.5235-0128.3	331324	<input type="checkbox"/> am Bremsattel ¹⁾	L=128
	1.4 D-4D	66		03.07	09.12	Produktionsland ⤵				
	1.4 VVTi	71		03.07	09.12	Produktionsland ⤵				
	1.5	81		09.09	09.12	Produktionsland ⤵				
	1.5 4WD	77		09.09	09.12	Produktionsland ⤵				
	1.6 16V	97		05.09	09.12	Produktionsland ⤵				
	1.6 VVTi	91		03.07	09.12	Produktionsland ⤵				
1.8 16V	106		02.09	09.12	Produktionsland ⤵					
1.8 16V	108		02.09	09.12	Produktionsland ⤵					
1.8 16V 4WD	100		02.09	09.12	Produktionsland ⤵					
1.8 VVTi	100		10.06	09.12	Produktionsland ⤵					
2.0 D-4D	93		03.07	09.12	Produktionsland ⤵					
1.33 Dual-VVTi	73		01.10	09.12	Produktionsland Ⓞ	24.5262-0180.3	331180	2	L=180	
1.33 Dual-VVTi	74		05.09	09.12	Produktionsland Ⓞ					
1.4 D-4D	66		03.07	09.12	Produktionsland Ⓞ					
1.4 VVTi	71		03.07	09.12	Produktionsland Ⓞ					
1.5	81		09.09	09.12	Produktionsland Ⓞ					
1.5 4WD	77		09.09	09.12	Produktionsland Ⓞ					
1.6 16V	97		05.09	09.12	Produktionsland Ⓞ					
1.6 VVTi	91		03.07	09.12	Produktionsland Ⓞ					
1.8 16V	106		02.09	09.12	Produktionsland Ⓞ					
1.8 16V	108		02.09	09.12	Produktionsland Ⓞ					
1.8 16V 4WD	100		02.09	09.12	Produktionsland Ⓞ					
1.8 VVTi	100		10.06	09.12	Produktionsland Ⓞ					
2.0 D-4D	93		03.07	09.12	Produktionsland Ⓞ					
1.33 Dual-VVTi	73		01.10	09.12	Produktionsland Ⓞ	24.5261-0130.3	331387	<input type="checkbox"/> am Bremsattel ¹⁾	L=130	
1.33 Dual-VVTi	74		05.09	09.12	Produktionsland Ⓞ					
1.4 D-4D	66		03.07	09.12	Produktionsland Ⓞ					
1.4 VVTi	71		03.07	09.12	Produktionsland Ⓞ					
1.5	81		09.09	09.12	Produktionsland Ⓞ					
1.5 4WD	77		09.09	09.12	Produktionsland Ⓞ					
1.6 16V	97		05.09	09.12	Produktionsland Ⓞ					
1.6 VVTi	91		03.07	09.12	Produktionsland Ⓞ					
1.8 16V	106		02.09	09.12	Produktionsland Ⓞ					
1.8 16V	108		02.09	09.12	Produktionsland Ⓞ					
1.8 16V 4WD	100		02.09	09.12	Produktionsland Ⓞ					
1.8 VVTi	100		10.06	09.12	Produktionsland Ⓞ					
2.0 D-4D	93		03.07	09.12	Produktionsland Ⓞ					
2.2 D-4D	130		03.07	09.12		24.5265-0347.3	331405	<input type="checkbox"/>	L=345	
	1.33 Dual-VVTi	73		01.10	09.12	Produktionsland ⤵	24.3727-1934.2	581934	<input type="checkbox"/>	L=336
	1.33 Dual-VVTi	74		05.09	09.12	Produktionsland ⤵	24.3727-1936.2	581936	<input type="checkbox"/>	L=1576
	1.4 D-4D	66		03.07	09.09	Produktionsland ⤵	24.3727-1935.2	581935	<input type="checkbox"/>	L=1585
	1.4 VVTi	71		03.07	09.12	Produktionsland ⤵				
	1.5	81		09.09	09.12	Produktionsland ⤵				
	1.5 4WD	77		09.09	09.12	Produktionsland ⤵				
	1.6 16V	97		05.09	09.12	Produktionsland ⤵				
	1.6 VVTi	91		03.07	09.12	Produktionsland ⤵				
	1.8 16V	106		02.09	09.12	Produktionsland ⤵				
	1.8 16V	108		02.09	09.12	Produktionsland ⤵				
	1.8 16V 4WD	100		02.09	09.12	Produktionsland ⤵				
	1.8 VVTi	100		10.06	09.12	Produktionsland ⤵				
	2.0 D-4D	93		03.07	09.12	Produktionsland ⤵				
	1.33 Dual-VVTi	73		01.10	09.12	Produktionsland Ⓞ	24.3727-1944.2	581944	<input type="checkbox"/>	L=340
	1.33 Dual-VVTi	74		05.09	09.12	Produktionsland Ⓞ	24.3727-1942.2	581942	<input type="checkbox"/>	L=1892
1.4 D-4D	66		03.07	12.09	Produktionsland Ⓞ	24.3727-1943.2	581943	<input type="checkbox"/>	L=1920	
1.4 VVTi	71		03.07	09.12	Produktionsland Ⓞ					

¹⁾ on the brake caliper / sulla pinza freno / sur l'étrier de frein / a la pinza de freno

























































																	
TOYOTA AURIS (06-12)																	
	1.5	81		09.09	09.12	Produktionsland ^{CE}	24.3727-1944.2	581944	↑							L=340	
	1.5 4WD	77		09.09	09.12	Produktionsland ^{CE}	24.3727-1942.2	581942	□							L=1892	
	1.6 16V	97		05.09	09.12	Produktionsland ^{CE}	24.3727-1943.2	581943	□							L=1920	
	1.6 VVTi	91		03.07	09.12	Produktionsland ^{CE}											
	1.8 16V	106		02.09	09.12	Produktionsland ^{CE}											
	1.8 16V	108		02.09	09.12	Produktionsland ^{CE}											
	1.8 16V 4WD	100		02.09	09.12	Produktionsland ^{CE}											
	1.8 VVTi	100		10.06	09.12	Produktionsland ^{CE}											
	2.0 D-4D	93		03.07	12.09	Produktionsland ^{CE}											
	2.2 D-4D	130		03.07	09.12		24.3727-1944.2	581944	↑							L=340	
	1.33 Dual-VVTi	73		01.10	09.12	Produktionsland ^{CE}	24.2415-1718.3	030142								Gz 15,87	
	1.33 Dual-VVTi	74		05.09	09.12	Produktionsland ^{CE}											
	1.4 VVTi	71		03.07	09.12	Produktionsland ^{CE}											
	1.5	81		09.09	09.12	Produktionsland ^{CE}											
	1.5 4WD	77		09.09	09.12	Produktionsland ^{CE}											
	1.6 16V	97		05.09	09.12	Produktionsland ^{CE}											
	1.6 VVTi	91		03.07	09.12	Produktionsland ^{CE}											
	1.8 16V	106		02.09	09.12	Produktionsland ^{CE}											
	1.8 16V	108		02.09	09.12	Produktionsland ^{CE}											
	1.8 16V 4WD	100		02.09	09.12	Produktionsland ^{CE}											
	1.8 VVTi	100		10.06	09.12	Produktionsland ^{CE}											
2.0 D-4D	93		03.07	09.12	Produktionsland ^{CE}	24.2415-1719.3	030143								Gz 15,87		
2.2 D-4D	130		03.07	09.12													
TOYOTA AURIS (12-)																	
	1.3 VVTi	73		10.12			24.3727-1942.2	581942	□							L=1892	
	1.4 D-4D	66		10.12			24.3727-1943.2	581943	□							L=1920	
	1.6 VVTi	97		10.12		Modelcode ZRE 181											
	1.2	85		03.15			24.2415-1718.3	030142								Gz 15,87	
	1.3 VVTi	73		10.12													
	1.4 D-4D	66		10.12													
	1.6 VVTi	97		10.12													
	1.6 D-4D	82		04.15			24.2415-1719.3	030143								Gz 15,87	
	2.0 D-4D	91		10.12													
TOYOTA AURIS Touring Sports (13-)																	
	1.4 D-4D	66		07.13			24.3727-1942.2	581942	□							L=1892	
							24.3727-1943.2	581943	□							L=1920	
	1.2	85		03.15			24.2415-1718.3	030142								Gz 15,87	
	1.3 VVTi	73		07.13													
	1.4 D-4D	66		07.13													
	1.6 VVTi	97		07.13													
	2.0 D-4D	91		07.13			24.2415-1719.3	030143								Gz 15,87	
TOYOTA AVENSIS (97-03)																	
	1.6 16V (AT220)	74		09.97	09.00		03.7750-2532.4	300225								9"	ATE
	1.6 16V (AT220)	81		09.97	09.00												
	1.6 VVT-i (ZZT220)	81		10.00	02.03												
	1.9 D-4D (CDT220)	85		09.02	02.03												
	1.9 TD (CT220)	61		10.97	05.98												
	2.0 16V (ST220)	94		09.97	09.00												
	2.0 D-4D (CDT220)	81		10.99	02.03												
	2.0 D-4D (CDT220)	85		09.02	02.03												
	2.0 TD (CT220)	61		10.97	05.98												
	2.0 TD (CT220)	66		09.97	02.03												
	2.0 TD (CT220)	66		09.97	02.03												
	1.8 16V (AT221)	81		09.97	09.00		03.7745-4402.4	300295								8/7" Tandem	ATE
	1.8 VVT-i (ZZT221)	95		10.00	02.03												
	2.0 VVT-i (AZT220)	110		08.01	02.03												
	1.6 16V (AT220)	74		09.97	09.00		03.2123-2221.3	010861								THz 23,81	ATE
	1.6 16V (AT220)	81		09.97	09.00												
	1.6 VVT-i (ZZT220)	81		10.00	02.03												
	1.8 16V (AT221)	81		09.97	09.00												
	1.8 VVT-i (ZZT221)	95		10.00	02.03												
	1.9 D-4D (CDT220)	85		09.02	02.03												
	1.9 TD (CT220)	61		10.97	05.98												
	2.0 16V (ST220)	94		09.97	09.00												
2.0 D-4D (CDT220)	81		10.99	02.03													
2.0 D-4D (CDT220)	85		09.02	02.03													
2.0 TD (CT220)	61		10.97	05.98													
2.0 TD (CT220)	66		09.97	02.03													
2.0 VVT-i (AZT220)	110		10.00	02.03													
	1.6 16V (AT220)	74		09.97	09.00	+ HA-Trommelbremse ¹⁾	11.9571-9801.2	220577	☐						D=57, - Halter	ATE	
	1.6 16V (AT220)	81		09.97	09.00	+ HA-Trommelbremse ¹⁾	24.3571-9801.5	240497	☐						D=57, - Halter	ATE	
	1.8 16V (AT221)	81		09.97	09.00	+ HA-Trommelbremse ¹⁾	24.3571-9802.5	240498	☐						D=57, - Halter	ATE	
	1.9 TD (CT220)	61		10.97	05.98	+ HA-Trommelbremse ¹⁾	11.0101-5407.2	260011	☐						Hülensatz	ATE	
	2.0 16V (ST220)	94		09.97	09.00	+ HA-Trommelbremse ¹⁾	11.8171-0008.1	990049	☐						Führungsbolzen	ATE	
	2.0 D-4D (CDT220)	81		10.99	02.03	+ HA-Trommelbremse ¹⁾											
	2.0 TD (CT220)	61		10.97	05.98	+ HA-Trommelbremse ¹⁾											
	2.0 TD (CT220)	66		09.97	02.03	+ HA-Trommelbremse ¹⁾											
	1.6 VVT-i (ZZT220)	81		07.01	02.03	+ HA-Scheibenbremse ²⁾	11.9571-9821.2	220579	☐						D=57, - Halter	ATE	
	1.8 VVT-i (ZZT221)	95		07.01	02.03	+ HA-Scheibenbremse ²⁾	11.9571-9822.2	220580	☐						D=57, - Halter	ATE	
	1.9 D-4D (CDT220)	85		09.02	02.03	+ HA-Scheibenbremse ²⁾	11.0101-5407.2	260011	☐						Hülensatz	ATE	
2.0 16V (ST220)	94		07.01	02.03	+ HA-Scheibenbremse ²⁾	11.8171-0008.1	990049	☐						Führungsbolzen	ATE		
2.0 D-4D (CDT220)	81		07.01	02.03	+ HA-Scheibenbremse ²⁾												
2.0 D-4D (CDT220)	85		09.02	02.03	+ HA-Scheibenbremse ²⁾												

1) + RA drum brake / + P freno a tamburo / + frein à tambour essieu AR / + ET-tambores de freno
 2) + RA disc brake / + P disco freno / + frein à disque essieu AR / + ET-disco de freno

											
TOYOTA AVENSIS (97-03)											
	2.0 TD (CT220) 2.0 VVT-i (AZT220)	66 110		07.01 07.01	02.03 02.03	+ HA-Scheibenbremse ¹⁾ + HA-Scheibenbremse ¹⁾	11.9571-9821.2 11.9571-9822.2 11.0101-5407.2 11.8171-0008.1	220579 220580 260011 990049	<input type="checkbox"/> <input type="checkbox"/>	D=57, - Halter D=57, - Halter Hülzensatz Führungsbolzen	ATE ATE ATE ATE
	1.6 16V (AT220) 1.6 16V (AT220) 1.8 16V (AT221) 1.9 TD (CT220) 2.0 16V (ST220) 2.0 D-4D (CDT220) 2.0 TD (CT220) 2.0 TD (CT220)	74 81 81 61 94 81 61 66		09.97 09.97 09.97 10.97 09.97 10.99 10.97 09.97	09.00 09.00 09.00 05.98 09.00 02.03 05.98 02.03		24.3220-1725.3 24.3220-1726.3	020483 020484	<input type="checkbox"/> <input type="checkbox"/>	Rz 20,64 Rz 20,64	
	1.6 16V (AT220) 1.6 16V (AT220) 1.8 16V (AT221) 1.9 TD (CT220) 2.0 16V (ST220) 2.0 D-4D (CDT220) 2.0 TD (CT220) 2.0 TD (CT220)	74 81 81 61 94 81 61 66		09.97 09.97 09.97 10.97 09.97 10.99 10.97 09.97	09.00 09.00 09.00 05.98 09.00 02.03 05.98 02.03	+ HA-Trommelbremse ²⁾ + HA-Trommelbremse ²⁾ + HA-Trommelbremse ²⁾ + HA-Trommelbremse ²⁾ + HA-Trommelbremse ²⁾ + HA-Trommelbremse ²⁾ + HA-Trommelbremse ²⁾ + HA-Trommelbremse ²⁾	24.3727-1904.2 24.3727-1905.2	581904 581905	<input type="checkbox"/> <input type="checkbox"/>	L=1829 L=1789	
	1.6 VVT-i (ZZT220) 1.8 VVT-i (ZZT221) 2.0 16V (ST220) 2.0 D-4D (CDT220) 2.0 TD (CT220) 2.0 VVT-i (AZT220)	81 95 94 81 66 110		10.00 10.00 10.00 10.99 09.97 10.00	06.01 06.01 06.01 06.01 06.01 06.01	+ HA-Scheibenbremse ¹⁾ + HA-Scheibenbremse ¹⁾ + HA-Scheibenbremse ¹⁾ + HA-Scheibenbremse ¹⁾ + HA-Scheibenbremse ¹⁾ + HA-Scheibenbremse ¹⁾	24.3727-1900.2 24.3727-1910.2	581900 581910	<input type="checkbox"/> <input type="checkbox"/>	L=1805 L=1760	
	1.6 VVT-i (ZZT220) 1.8 VVT-i (ZZT221) 1.9 D-4D (CDT220) 2.0 16V (ST220) 2.0 D-4D (CDT220) 2.0 D-4D (CDT220) 2.0 TD (CT220) 2.0 VVT-i (AZT220)	81 95 85 94 81 85 66 110		07.01 07.01 09.02 07.01 07.01 09.02 07.01 07.01	02.03 02.03 02.03 02.03 02.03 02.03 02.03 02.03	+ HA-Scheibenbremse ¹⁾ + HA-Scheibenbremse ¹⁾ + HA-Scheibenbremse ¹⁾ + HA-Scheibenbremse ¹⁾ + HA-Scheibenbremse ¹⁾ + HA-Scheibenbremse ¹⁾ + HA-Scheibenbremse ¹⁾ + HA-Scheibenbremse ¹⁾	24.3727-1916.2 24.3727-1915.2	581916 581915	<input type="checkbox"/> <input type="checkbox"/>	L=1868 L=1824	
TOYOTA AVENSIS (03-08)											
	1.6 VVT-i 1.8 16V 2.0 D-4D 2.0 D-4D 2.0 VVT-i 2.0 VVT-i 2.2 D-4D 2.2 D-CAT 2.2 TD 2.4 16V 2.4 16V	81 95 85 93 108 114 110 130 74 120 125		04.03 04.03 04.03 03.06 04.03 04.03 10.05 07.05 04.05 10.03 09.03	11.08 11.08 11.08 11.08 11.08 11.08 11.08 11.08 11.08 11.08 11.08		24.5262-0576.3 24.5262-0575.3	330923 330922	<input type="checkbox"/> <input type="checkbox"/>	L=575 L=575	
	1.6 VVT-i 1.8 16V 2.0 D-4D 2.0 D-4D 2.0 VVT-i 2.0 VVT-i 2.2 D-4D 2.2 D-CAT 2.2 TD 2.4 16V 2.4 16V	81 95 85 93 108 114 110 130 74 120 125		04.03 04.03 04.03 03.06 04.03 04.03 10.05 07.05 04.05 10.03 09.03	11.08 11.08 11.08 11.08 11.08 11.08 11.08 11.08 11.08 11.08 11.08		24.5276-0240.3	330943	2	L=240	
	1.6 VVT-i 1.8 16V 2.0 D-4D 2.0 D-4D 2.0 VVT-i 2.0 VVT-i 2.2 D-4D 2.2 D-CAT 2.2 TD 2.4 16V 2.4 16V	81 95 85 93 108 114 110 130 74 120 125		04.03 04.03 04.03 03.06 04.03 04.03 10.05 07.05 04.05 10.03 09.03	11.08 11.08 11.08 11.08 11.08 11.08 11.08 11.08 11.08 11.08 11.08		24.3727-1919.2 24.3727-1930.2 24.3727-1931.2	581919 581930 581931	<input type="checkbox"/> <input type="checkbox"/> <input type="checkbox"/>	L=398 L=1770 L=1823	
TOYOTA AVENSIS (09-)											
	1.6 i 16V 1.8 i 16V 2.0 D-4D 2.0 D-4D 2.0 i 16V 2.2 D-4D 2.2 D-4D	97 108 91 93 112 110 130		02.09 02.09 11.11 02.09 02.09 02.09 02.09			24.5265-0347.3	331405	<input type="checkbox"/>	L=345	
	1.6 i 16V 1.8 i 16V 2.0 i 16V	97 108 112		02.09 02.09 02.09			24.2415-1718.3	030142		Gz 15,87	
	2.0 D-4D 2.0 D-4D 2.2 D-4D 2.2 D-4D	91 93 110 130		11.11 02.09 02.09 02.09			24.2415-1719.3	030143		Gz 15,87	

¹⁾ + RA disc brake / + P disco freno / + frein à disque essieu AR / + ET-disco de freno

²⁾ + RA drum brake / + P freno a tamburo / + frein à tambour essieu AR / + ET-tambores de freno

												
TOYOTA AVENSIS VERSO (01-09)												
	2.0 D-4D 2.0 VVT-i	85 110		08.01 08.01	08.05 11.09		24.5263-0575.3 24.5263-0576.3	330924 330925	 		L=575 L=575	
	2.0 D-4D	85		08.01	08.05		24.3431-1707.7 24.3431-1708.7	220935 220936	 		D=43, - Halter D=43, - Halter	TRW TRW
	2.0 D-4D 2.0 VVT-i	85 110		08.01 08.01	08.05 11.09		24.5145-0176.3 24.5235-0250.3	330965 330917	 		L=175 L=250	
	2.0 D-4D 2.0 VVT-i	◀ 85 ◀ 110		08.01 08.01	08.05 11.09		24.3727-1914.2	581914			L=319	
	2.0 D-4D 2.0 VVT-i	▶ 85 ▶ 110		08.01 08.01	08.05 11.09		24.3727-1914.2	581914			L=319	
TOYOTA AYGO (05-14)												
	1.0 i 12V 1.0 i 12V GPL 1.4 HDi	◀ 50 ◀ 50 ◀ 40		07.05 07.05 07.05	06.14 06.14 08.10	- ESP - ESP - ESP	24.4120-1701.3	010846			Thz 20,64	BOS
	1.0 i 12V 1.0 i 12V GPL 1.4 HDi	50 50 40		07.05 07.05 07.05	06.14 06.14 08.10		24.3481-1791.5 24.3481-1792.5	240731 240732	 		D=48, - Halter D=48, - Halter	
	1.0 i 12V 1.0 i 12V GPL 1.4 HDi	50 50 40		07.05 07.05 07.05	06.14 06.14 08.10		24.5295-0496.3 24.5262-0501.3	331033 331025	 		L=496 L=501	
	1.0 i 12V 1.0 i 12V GPL 1.4 HDi	50 50 40		07.05 07.05 07.05	06.14 06.14 08.10		24.5261-0225.3	330909	2		L=225	
	1.0 i 12V 1.0 i 12V GPL 1.4 HDi	50 50 40		07.05 07.05 07.05	06.14 06.14 08.10		24.3217-1719.3	020482			Rz 17,46	BOS
	1.0 i 12V 1.0 i 12V GPL 1.4 HDi	50 50 40		07.05 07.05 07.05	06.14 06.14 08.10		24.3727-1953.2 24.3727-1952.2	581953 581952	 		L=1487 L=1478	
	1.0 i 12V 1.0 i 12V GPL	◀ 50 ◀ 50		07.05 07.05	06.14 06.14		24.3728-0851.2	590851			L=1596	
TOYOTA AYGO (14-)												
	1.0 12V 1.2	50 60		05.14 05.14			24.3481-1791.5 24.3481-1792.5	240731 240732	 		D=48, - Halter D=48, - Halter	
TOYOTA CAMRY (06-11)												
	2.0 VVT-i 2.4 VVT-i 2.4 VVT-i 2.4 VVT-i 2.4 VVT-i Hybrid 2.4 VVT-i Hybrid 3.5 VVT-i 3.5 VVT-i 3.5 VVT-i	108 116 123 127 105 110 197 204 209		02.07 02.07 02.07 02.07 02.07 02.07 01.08 01.08	08.11 08.11 08.11 08.11 08.11 08.11 08.11 08.11		24.5296-0563.3	331483			L=562	
TOYOTA CARINA E (92-97)												
	1.6 i (AT190) 1.8 i (AT191) 2.0 D (CT190) 2.0 i (ST191)			10.94 10.94 10.94 10.94	09.97 09.97 09.97 09.97	- ABS - ABS - ABS - ABS	03.2123-1181.3	010522			Thz 23,81	ATE
	1.6 i (AT190) 1.8 i (AT191) 2.0 D (CT190)			02.92 02.92 02.92	09.97 09.97 09.97		24.3571-1713.5 24.3571-1714.5	240201 240202	 		D=57, - Halter D=57, - Halter	SUM SUM
	1.6 i (AT190) 1.8 i (AT191) 2.0 D (CT190) 2.0 GTi (ST191) 2.0 i (ST191)			03.94 03.94 03.94 03.94 03.94	09.97 09.97 09.97 09.97 09.97		24.5264-0526.3 24.5264-0525.3	330927 330926	 		L=525 L=525	
	1.6 i (AT190) 1.8 i (AT191) 2.0 D (CT190) 2.0 i (ST191)			02.92 02.92 02.92 02.92	12.95 12.95 12.95 12.95	+ Hosei Bremse ¹⁾ + Hosei Bremse ¹⁾ + Hosei Bremse ¹⁾ + Hosei Bremse ¹⁾	24.3219-1729.3 24.3219-1730.3	020446 020447	 		Rz 19,05 Rz 19,05	
	1.6 i (AT190) 1.8 i (AT191) 2.0 D (CT190) 2.0 i (ST191)			02.92 02.92 02.92 02.92	09.97 09.97 09.97 09.97		24.3727-1932.2 24.3727-1933.2	581932 581933	 		L=1780 L=1727	
TOYOTA CELICA (93-99)												
	1.8 i (AT200)			11.93	11.99		24.3571-1713.5 24.3571-1714.5	240201 240202	 		D=57, - Halter D=57, - Halter	SUM SUM

¹⁾ + Hosei brake / + freno Hosei / + freins Hosei / + freno de Hosei



TOYOTA CELICA (99-05)														
	1.8 VVTi (ZZT230)	105		11.99	09.05			24.5264-0245.3	331133	2			L=245	
	1.8 VVTi TS (ZZT231)	141		11.99	09.05									
TOYOTA COROLLA (92-97)														
	1.3 16V (EE101)			05.92	04.97	+ Europa ¹⁾		24.3541-1705.5	240111	<input type="checkbox"/>			D=54, - Halter	SUM
	1.6 (AE101)			05.92	04.97	+ Europa ¹⁾		24.3541-1706.5	240112	<input type="checkbox"/>			D=54, - Halter	SUM
	1.8 (AE102)			05.92	05.95	+ Europa ¹⁾		24.0101-5405.2	260063				Bremssattel-Zubehör	SUM
	1.8 (AE103)			05.95	04.97	+ Europa/ + Kombiwagen ²⁾								
	1.8 GTi 4WD			11.92	04.95	+ Europa ¹⁾								
	2.0 D (CE100)			05.92	04.97	+ Europa/ - GUS-Staaten ³⁾								
	1.3 (EE100)			05.92	05.95			24.5235-0275.3	331179	2			L=275	
	1.3 16V (EE101)			05.92	04.97									
	1.6 (AE101)			05.92	04.95									
	1.6 GT APEX (AE101)			05.92	05.95									
	2.0 D (CE100)			05.92	04.95									
	1.3 (EE100)			05.92	05.95			24.5235-0275.3	331179	2			L=275	
	1.3 16V (EE101)			05.92	05.95									
	1.6 (AE101)			05.92	05.95									
	1.6 GT APEX (AE101)			05.92	05.95									
	2.0 D (CE100)			05.92	05.95									
	1.3 16V (EE101)			06.95	04.97			24.5260-0280.3	330883	2			L=280	
	1.6 (AE101)			06.95	04.97									
	1.8 (AE103)			05.95	04.97									
	2.0 D (CE100)			06.95	04.97									
	1.3 16V (EE101)			05.92	04.97	+ Europa ¹⁾		24.3219-1729.3	020446	<input type="checkbox"/>			Rz 19,05	
	1.6 (AE101)			05.92	04.97	+ Europa ¹⁾		24.3219-1730.3	020447	<input type="checkbox"/>			Rz 19,05	
	2.0 D (CE100)			05.92	04.97	+ Europa/ - GUS-Staaten ³⁾								
	1.3 (EE100)			05.92	05.95	- Europa ⁴⁾		24.3217-1733.3	020559	<input type="checkbox"/>			Rz 17,46	
	1.3 16V (EE101)			05.92	04.97	- Europa ⁴⁾		24.3217-1734.3	020560	<input type="checkbox"/>			Rz 17,46	
	1.6 (AE101)			05.92	04.97	- Europa ⁴⁾								
	1.8 (AE102)			05.92	05.95	- Europa ⁴⁾								
	1.8 (AE103)			05.95	04.97	- Europa/ + Kombiwagen ⁵⁾								
	2.0 D (CE100)			05.92	04.97	- Europa/ + GUS-Staaten ⁶⁾								
	1.6 GT APEX (AE101)			05.92	05.95	- Europa/ + Coupe ⁷⁾		24.3727-1922.2	581922	<input type="checkbox"/>			L=1448	
	1.8 (AE102)			05.92	05.95	+ Europa ¹⁾		24.3727-1923.2	581923	<input type="checkbox"/>			L=1457	
	1.3 (EE100)			05.92	05.93			24.3727-1907.2	581907	<input type="checkbox"/>			L=1585	
	1.3 16V (EE101)			05.92	05.93			24.3727-1908.2	581908	<input type="checkbox"/>			L=1603	
	1.6 (AE101)			05.92	05.93									
	1.6 GT APEX (AE101)			05.92	05.93	+ Europa/ + Coupe ⁸⁾								
	1.8 (AE102)			08.91	05.95	- Europa ⁴⁾								
	2.0 D (CE100)			05.92	05.93									
TOYOTA COROLLA (97-02)														
	1.4 i 16V (ZZE111)	71		02.00	01.02			03.2122-1691.3	010918				THz 22,20	ATE
	1.6 i 16V (ZZE112)	81		02.00	01.02									
	1.8 i 16V AWD (AE115)	81		05.97	01.02									
	1.9 D (WZE110)	51		02.00	01.02									
	2.0 D-4D (CDE110)	66		09.00	01.02									
	1.4 i (EE111)	63		05.97	01.00	- Schlechtwegeausführung ⁹⁾		24.3541-1705.5	240111	<input type="checkbox"/>			D=54, - Halter	SUM
	1.4 i 16V (ZZE111)	71		02.00	12.01	- Schlechtwegeausführung ⁹⁾		24.3541-1706.5	240112	<input type="checkbox"/>			D=54, - Halter	SUM
	1.6 i (AE111)	81		05.97	01.00	- Schlechtwegeausführung ⁹⁾								
	1.6 i 16V (ZZE112)	81		02.00	12.01	- Schlechtwegeausführung ⁹⁾								
	1.8 i 16V AWD (AE115)	81		05.97	12.01	+ Kombiwagen ¹⁰⁾								
	1.9 D (WZE110)	51		02.00	12.01									
	2.0 D (CE110)	53		05.97	01.00									
	2.0 D-4D (CDE110)	66		09.00	12.01									
	1.4 i 16V (ZZE111)	71		10.99	12.01	Produktionsland ^{6B)}		24.3387-1737.5	240703	<input type="checkbox"/>			D=38, - Halter	TRW
	1.6 i 16V (ZZE112)	81		10.99	12.01	Produktionsland ^{6B)}		24.3387-1738.5	240704	<input type="checkbox"/>			D=38, - Halter	TRW
	1.9 D (WZE110)	51		10.99	12.01	Produktionsland ^{6B)}								
	1.4 i (EE111)	63		05.97	01.00			24.5260-0280.3	330883	2			L=280	
	1.6 i (AE111)	81		05.97	01.00									
	1.4 i (EE111)	63		05.97	01.00			24.3219-1729.3	020446	<input type="checkbox"/>			Rz 19,05	
	1.4 i 16V (ZZE111)	71		02.00	12.01			24.3219-1730.3	020447	<input type="checkbox"/>			Rz 19,05	
	1.6 i (AE111)	81		05.97	01.00									
	1.6 i 16V (ZZE112)	81		02.00	12.01									
	1.8 i 16V AWD (AE115)	81		05.97	12.01	+ Kombiwagen ¹⁰⁾								
	1.9 D (WZE110)	51		02.00	12.01									
	2.0 D (CE110)	53		05.97	01.00									
	1.4 i (EE111)	63		05.97	07.98	+ HA-Trommelbremse ¹¹⁾		24.3727-1918.2	581918	<input type="checkbox"/>			L=292	
	1.4 i 16V (ZZE111)	71		02.00	12.01	+ HA-Trommelbremse ¹¹⁾		24.3727-1907.2	581907	<input type="checkbox"/>			L=1585	
	1.6 i (AE111)	81		05.97	07.98	+ HA-Trommelbremse ¹¹⁾		24.3727-1908.2	581908	<input type="checkbox"/>			L=1603	
	1.6 i 16V (ZZE112)	81		02.00	12.01	+ HA-Trommelbremse ¹¹⁾								
	1.9 D (WZE110)	51		02.00	12.01	+ HA-Trommelbremse ¹¹⁾								
	2.0 D (CE110)	53		05.97	07.98	+ HA-Trommelbremse ¹¹⁾								
	1.4 i (EE111)	63		08.98	01.00	+ HA-Scheibenbremse ¹²⁾		24.3727-1918.2	581918	<input type="checkbox"/>			L=292	
	1.4 i 16V (ZZE111)	71		02.00	12.01	+ HA-Scheibenbremse ¹²⁾		24.3727-1922.2	581922	<input type="checkbox"/>			L=1448	
	1.6 i (AE111)	81		08.98	01.00	+ HA-Scheibenbremse ¹²⁾		24.3727-1923.2	581923	<input type="checkbox"/>			L=1457	
	1.6 i 16V (ZZE112)	81		02.00	12.01	+ HA-Scheibenbremse ¹²⁾								
	1.9 D (WZE110)	51		02.00	12.01	+ HA-Scheibenbremse ¹²⁾								
	2.0 D (CE110)	53		08.98	01.00	+ HA-Scheibenbremse ¹²⁾								
	2.0 D-4D (CDE110)	66		09.00	12.01	+ HA-Scheibenbremse ¹²⁾								

¹⁾ + Europa / + Europa / + Europa / + Europa

²⁾ + Europa/ + Estate / + Europa/ + Station Wagon / + Europa/ + Break / + Europa/ + Break

³⁾ + Europa/ - GUS States / + Europa/ - Stati del GUS / + Europa/ - Etats de la CEI / + Europa/ - estados del GUS

⁴⁾ - Europa / - Europa / - Europa / - Europa

⁵⁾ - Europa/ + Estate / - Europa/ + Station Wagon / - Europa/ + Break / - Europa/ + Break

⁶⁾ - Europa/ + GUS-States / - Europa/ + Stati del GUS / - Europa/ + Etats de la CEI / - Europa/ + estados del GUS

⁷⁾ - Europa/ + Coupe / - Europa/ + Coupé / - Europa/ + Coupé / - Europa/ + Coupé

























⁸⁾ + Europa/ + Coupe / + Europa/ + Coupé / + Europa/ + Coupé / + Europa/ + Coupé

⁹⁾ - rough road construction / - versione per percorsi accidentati / - version pour mauvaise route / - versión 4x4

























¹⁰⁾ + Estate / + Station Wagon / + Break / + Break























































¹¹⁾ + RA drum brake / + P freno a tamburo / + frein à tambour essieu AR / + ET-tambores de freno

¹²⁾ + RA disc brake / + P disco freno / + frein à disque essieu AR / + ET-disco de freno

									
TOYOTA COROLLA (02-04)									
	1.4 VVTi (ZZE120) 71 1.6 VVTi (ZZE121) 81 2.0 D-4D (CDE120) 66 2.0 D-4D (CDE120) 81 2.0 D-4D (CDE120) 85			01.02 05.04 01.02 05.04 01.02 05.04 01.02 05.04 05.03 05.04		24.2120-1749.3 010903	- ESP	Thz 20,64 TRW	
	1.4 VVTi (ZZE120) 71 1.6 VVTi (ZZE121) 81 1.8 VVTi TS (ZZE123) 141 2.0 D-4D (CDE120) 66 2.0 D-4D (CDE120) 81 2.0 D-4D (CDE120) 85			02.02 05.04 08.02 05.04 01.02 05.04 08.02 05.04 01.02 05.04 05.03 05.04	24.3571-1755.5 240409 24.3571-1756.5 240410	<input checked="" type="checkbox"/> Produktionsland [®] <input checked="" type="checkbox"/> Produktionsland [®]	D=57, - Halter D=57, - Halter	TRW TRW	
	1.8 VVTi TS (ZZE123) 141 2.0 D-4D (CDE120) 66 2.0 D-4D (CDE120) 81 2.0 D-4D (CDE120) 85			01.02 05.04 08.02 05.04 01.02 05.04 05.03 05.04	24.5262-0576.3 330923 24.5262-0575.3 330922	<input checked="" type="checkbox"/> <input checked="" type="checkbox"/>	L=575 L=575		
	1.4 VVTi (ZZE120) 71 1.6 VVTi (ZZE121) 81 1.8 VVTi TS (ZZE123) 141 2.0 D-4D (CDE120) 66 2.0 D-4D (CDE120) 81 2.0 D-4D (CDE120) 85			02.02 05.04 08.02 05.04 01.02 05.04 08.02 05.04 01.02 05.04 05.03 05.04	24.3341-1703.5 240443 24.3341-1704.5 240444	<input checked="" type="checkbox"/> Produktionsland [®] <input checked="" type="checkbox"/> Produktionsland [®]	D=34, - Halter D=34, - Halter		
	1.4 VVTi (ZZE120) 71 1.6 VVTi (ZZE121) 81 1.8 VVTi TS (ZZE123) 141 2.0 D-4D (CDE120) 66 2.0 D-4D (CDE120) 81 2.0 D-4D (CDE120) 85			01.02 05.04 01.02 05.04 01.02 05.04 08.02 05.04 01.02 05.04 05.03 05.04	24.5264-0221.3 330995	2	L=221		
	1.4 VVTi (ZZE120) 71 1.6 VVTi (ZZE121) 81 2.0 D-4D (CDE120) 66			01.02 05.04 01.02 05.04 01.02 05.04	24.3727-1919.2 581919 24.3727-1926.2 581926 24.3727-1927.2 581927	<input checked="" type="checkbox"/> Produktionsland [⊙] <input checked="" type="checkbox"/> Produktionsland [⊙] <input checked="" type="checkbox"/> Produktionsland [⊙]	L=398 L=1616 L=1688		
	1.4 VVTi (ZZE120) 71 1.6 VVTi (ZZE121) 81 1.8 VVTi TS (ZZE123) 141 2.0 D-4D (CDE120) 66 2.0 D-4D (CDE120) 81 2.0 D-4D (CDE120) 85			02.02 05.04 08.02 05.04 01.02 05.04 08.02 05.04 01.02 05.04 05.03 05.04	24.3727-1919.2 581919 24.3727-1928.2 581928 24.3727-1929.2 581929	<input checked="" type="checkbox"/> Produktionsland [®] <input checked="" type="checkbox"/> Produktionsland [®] <input checked="" type="checkbox"/> Produktionsland [®]	L=398 L=1637 L=1698		
TOYOTA COROLLA (04-06)									
	1.4 D-4D (NDE120) 66 1.4 VVTi (ZZE120) 71 1.6 VVTi (ZZE121) 81 2.0 D-4D (CDE120) 85			06.04 10.06 06.04 10.06 06.04 10.06 06.04 10.06	- ESP - ESP - ESP - ESP	24.2120-1749.3 010903		Thz 20,64 TRW	
	1.4 VVTi (ZZE120) 71 1.6 VVTi (ZZE121) 81			06.04 10.06 06.04 10.06		24.3571-1755.5 240409 24.3571-1756.5 240410	<input checked="" type="checkbox"/> <input checked="" type="checkbox"/>	D=57, - Halter D=57, - Halter	TRW TRW
	1.4 D-4D (NDE120) 66 1.8 VVTi (ZZE123) 141 2.0 D-4D (CDE120) 85			06.04 10.06 06.04 10.06 06.04 10.06		24.3571-1755.5 240409 24.3571-1756.5 240410	<input checked="" type="checkbox"/> <input checked="" type="checkbox"/>	D=57, - Halter D=57, - Halter	TRW TRW
	1.4 D-4D (NDE120) 66 1.4 VVTi (ZZE120) 71 1.6 VVTi (ZZE121) 81 1.8 VVTi (ZZE123) 141 2.0 D-4D (CDE120) 85			06.04 10.06 06.04 10.06 06.04 10.06 06.04 10.06 06.04 10.06		24.5262-0576.3 330923 24.5262-0575.3 330922	<input checked="" type="checkbox"/> <input checked="" type="checkbox"/>	L=575 L=575	
	1.4 D-4D (NDE120) 66 1.4 VVTi (ZZE120) 71 1.6 VVTi (ZZE121) 81 1.8 VVTi (ZZE123) 141 2.0 D-4D (CDE120) 85			06.04 10.06 06.04 10.06 06.04 10.06 06.04 10.06 06.04 10.06		24.3341-1703.5 240443 24.3341-1704.5 240444	<input checked="" type="checkbox"/> <input checked="" type="checkbox"/>	D=34, - Halter D=34, - Halter	
	1.4 D-4D (NDE120) 66 1.4 VVTi (ZZE120) 71 1.6 VVTi (ZZE121) 81 1.8 VVTi (ZZE123) 141 2.0 D-4D (CDE120) 85			06.04 10.06 06.04 10.06 06.04 10.06 06.04 10.06 06.04 10.06		24.5264-0221.3 330995	2	L=221	
	1.4 D-4D (NDE120) 66 1.4 VVTi (ZZE120) 71 1.6 VVTi (ZZE121) 81 1.6 VVTi (ZZE121) 81 1.8 VVTi (ZZE123) 141 2.0 D-4D (CDE120) 85			06.04 10.06 06.04 10.06 02.04 10.06 06.04 10.06 02.04 10.06 06.04 10.06		24.3727-1919.2 581919 24.3727-1928.2 581928 24.3727-1929.2 581929	<input checked="" type="checkbox"/> <input checked="" type="checkbox"/> <input checked="" type="checkbox"/>	L=398 L=1637 L=1698	
TOYOTA COROLLA (06-13)									
	1.33 16V (NRE150) 74 1.4 D-4D (NDE150) 66 1.4 VVTi (ZZE150) 71 1.6 VVTi (ZRE151) 91 1.6 VVTi (ZRE151) 97 2.0 D-4D (ADE150) 93			10.08 05.13 01.09 05.13 11.06 12.08 11.06 12.08 01.09 05.13 01.07 05.13		24.5274-0180.3 330941	2	L=180	
	1.33 16V (NRE150) 74 1.4 D-4D (NDE150) 66 1.4 VVTi (ZZE150) 71 1.6 VVTi (ZRE151) 91 1.6 VVTi (ZRE151) 97 2.0 D-4D (ADE150) 93			10.08 05.13 01.09 05.13 11.06 12.08 11.06 12.08 01.09 05.13 01.07 05.13		24.5235-0160.3 331325 24.5235-0128.3 331324	<input checked="" type="checkbox"/> am Bremssattel ¹⁾ <input checked="" type="checkbox"/> am Bremssattel ¹⁾	L=160 L=128	





















































¹⁾ on the brake caliper / sulla pinza freno / sur l'étrier de frein / a la pinza de freno

									
TOYOTA COROLLA (06-13)									
	1.33 16V (NRE150)	74		10.08	05.13	24.3727-1936.2	581936	<input type="checkbox"/>	L=1576
	1.4 VVTi (ZZE150)	71		11.06	12.08	24.3727-1935.2	581935	<input type="checkbox"/>	L=1585
	1.6 VVTi (ZRE151)	91		11.06	12.08				
	1.6 VVTi (ZRE151)	97		01.09	05.13				
	1.4 D-4D (NDE150)	66		01.09	05.13	24.3727-1958.2	581958	<input type="checkbox"/>	L=1917
	2.0 D-4D (ADE150)	93		01.07	05.13				
TOYOTA COROLLA (13-)									
	1.33 VVTi	73		06.13		24.2415-1718.3	030142		Gz 15,87
	1.4 D-4D	66		06.13					
	1.6 VVTi	90		06.13					
	1.6 VVTi	97		06.13					
TOYOTA COROLLA VERSO (02-04)									
	1.6 VVTi (ZZE121)	81		01.02	05.04	24.2120-1749.3	010903		Thz 20,64 TRW
	2.0 D-4D (CDE120)	66		01.02	05.04				
	1.6 VVTi (ZZE121)	81		06.02	05.04	24.5262-0576.3	330923	<input type="checkbox"/>	L=575
	2.0 D-4D (CDE120)	66		06.02	05.04	24.5262-0575.3	330922	<input type="checkbox"/>	L=575
	1.6 VVTi (ZZE121)	81		01.02	05.04	24.5264-0221.3	330995	2	L=221
	1.8 VVTi (ZZE122)	99		01.02	05.04				
	2.0 D-4D (CDE120)	66		01.02	05.04				
	1.6 VVTi (ZZE121)	81		01.02	05.04	24.3727-1917.2	581917	<input type="checkbox"/>	L=408
	1.8 VVTi (ZZE122)	99		01.02	05.04	24.3727-1926.2	581926	<input type="checkbox"/>	L=1616
	2.0 D-4D (CDE120)	66		01.02	05.04	24.3727-1927.2	581927	<input type="checkbox"/>	L=1688
TOYOTA COROLLA VERSO (04-09)									
	1.6 VVTi (ZNR10)	81		09.04	03.09	24.3571-1759.5	240459	<input type="checkbox"/>	D=57, - Halter
	1.8 VVTi (ZNR11)	95		09.04	03.09	24.3571-1760.5	240460	<input type="checkbox"/>	D=57, - Halter
	2.0 D-4D (CUR10)	85		09.04	03.09				
	2.2 D-4D (AUR10)	100		09.05	03.09				
	2.2 D-4D (AUR10)	130		09.05	03.09				
	1.6 VVTi (ZNR10)	81		05.04	03.09	24.5262-0576.3	330923	<input type="checkbox"/>	L=575
	1.8 VVTi (ZNR11)	95		05.04	03.09	24.5262-0575.3	330922	<input type="checkbox"/>	L=575
	2.0 D-4D (CUR10)	85		05.04	03.09				
	2.2 D-4D (AUR10)	100		09.05	03.09				
	2.2 D-4D (AUR10)	130		09.05	03.09				
	1.6 VVTi (ZNR10)	81		05.04	03.09	24.5275-0200.3	330942	2	L=200
	1.8 VVTi (ZNR11)	95		05.04	03.09				
	2.0 D-4D (CUR10)	85		05.04	03.09				
	2.2 D-4D (AUR10)	100		09.05	03.09				
	2.2 D-4D (AUR10)	130		09.05	03.09				
	1.6 VVTi (ZNR10)	81		05.04	03.09	24.3727-1941.2	581941	<input type="checkbox"/>	L=276
	1.8 VVTi (ZNR11)	95		05.04	03.09	24.3727-1939.2	581939	<input type="checkbox"/>	L=1927
	2.0 D-4D (CUR10)	85		05.04	03.09	24.3727-1940.2	581940	<input type="checkbox"/>	L=1984
	2.2 D-4D (AUR10)	100		09.05	03.09				
	2.2 D-4D (AUR10)	130		09.05	03.09				
TOYOTA HIACE (06-)									
	2.5 D-4D	70		09.06		24.5265-0263.3	331157	<input type="checkbox"/>	L=263
	2.5 D-4D	86		09.06		24.5265-0264.3	331158	<input type="checkbox"/>	L=263
TOYOTA HILUX (88-97)									
	1.8 (YN85/90)			08.88	07.97	24.3222-1740.3	020566		Rz 22,20
	2.4 D (LN85/90)			08.88	07.97				
	2.4 D 4WD (LN105/110)			08.88	07.97				
	2.4 D 4WD (LN85/90)			01.94	07.97				
	2.4 i 4WD (RN106/110)			08.88	07.97				
TOYOTA HILUX (97-05)									
	2.4 i 4WD	103		08.97	07.01	24.3222-1730.3	020533		Rz 22,20
	2.4 TD 4WD	66		08.97	01.02				
	2.5 D-4D 4WD	75		11.01	07.05				
TOYOTA HILUX (05-)									
	2.5 D-4D 4x4 (KUN25)	75		08.05		24.5235-0275.3	331179	2	L=275
	2.5 D-4D 4x4 (KUN25)	88		12.07					
	2.5 D-4D 4x4 (KUN25)	106		12.07					
	3.0 D-4D 4x4 (KUN26)	126		12.07					
	2.5 D-4D 4x4 (KUN25)	75		08.05		24.3222-1746.3	020582		Rz 22,20
	2.5 D-4D 4x4 (KUN25)	88		12.07					
	2.5 D-4D 4x4 (KUN25)	106		12.07					
	3.0 D-4D 4x4 (KUN26)	126		12.07					
TOYOTA IQ (09-)									
	1.0 i 12V	50		01.09		24.3217-1721.3	020489	<input type="checkbox"/>	Rz 17,46
	1.33	69		01.09		24.3217-1722.3	020490	<input type="checkbox"/>	Rz 17,46
	1.33	72		01.09					
	1.4 D-4D	66		01.09					





















									
TOYOTA PASEO (95-99)									
	1.5 i 16V (EL54)	66		08.95	12.99	24.3217-1733.3	020559	 	Rz 17,46 Rz 17,46
	1.5 i 16V (EL54)	66		08.95	12.97	24.3727-1913.2	581913		L=258
	1.5 i 16V (EL54)	66		01.98	12.99	24.3727-1913.2	581913		L=258
TOYOTA PICNIC (96-01)									
	2.0 i 16V	90		01.01	12.01	24.5264-0526.3	330927	 	L=525 L=525
	2.0 i 16V	94		05.96	12.01	24.5264-0525.3	330926		
	2.2 TD	66		09.97	12.01				
	2.0 i 16V	90		01.01	12.01	24.5235-0190.3	330916	2	L=190
	2.0 i 16V	94		05.96	12.01				
	2.2 TD	66		09.97	12.01				
TOYOTA PREVIA (00-05)									
	2.0 D-4D (CLR30)	85		03.01	12.05	24.3431-1707.7	220935	 	D=43, - Halter D=43, - Halter
	2.4 VVTi (ACR30)	115		08.00	12.05	24.3431-1708.7	220936		TRW TRW
TOYOTA PRIUS (03-09)									
	1.5 VVTi (NHW20)	57		08.03	03.09	24.5264-0205.3	331059	2	L=205
	1.5 VVTi (NHW20)	57		08.03	03.09	24.3727-1948.2	581948	 	L=1775 L=1715
						24.3727-1949.2	581949		
TOYOTA PRIUS (09-15)									
	1.8 Hybrid (ZVW30)	73		01.09		24.5296-0720.3	331494		L=720
TOYOTA RAV4 I (94-00)									
	2.0 16V (SXA10/11)	94		12.97	06.00	24.3217-1728.3	020534		Rz 17,46
	2.0 16V (SXA10/11)	95		04.94	06.00				
	2.0 16V (SXA10/11)	94		12.97	06.00	24.3727-1913.2	581913	 	L=258 L=1345
	2.0 16V (SXA10/11)	95		04.94	06.00	24.3727-1946.2	581946		L=1340
TOYOTA RAV4 II (00-05)									
	1.8 VVTi	92		02.01	07.03 + Schaltgetriebe ¹⁾	24.2120-1757.3	010976		THz 20,64 - Behälter
	2.0 D-4D 4WD	85		09.01	07.03 + Schaltgetriebe ¹⁾				
	2.0 VVTi 4WD	110		06.00	07.03 + Schaltgetriebe ¹⁾				
	1.8 VVTi	92		02.01	07.03 + Automatikgetriebe ²⁾	24.2120-1757.3	010976		THz 20,64 - Behälter
	2.0 D-4D 4WD	85		09.01	07.03 + Automatikgetriebe ²⁾				
	2.0 VVTi 4WD	110		06.00	07.03 + Automatikgetriebe ²⁾				
	1.8 VVTi	92		02.01	11.05	24.5265-0558.3	330929	 	L=558 L=557
	2.0 D-4D 4WD	85		09.01	11.05	24.5265-0557.3	330928		
	2.0 VVTi 4WD	110		06.00	11.05				
	2.4 VVTi 4WD	112		08.03	11.05				
	2.4 VVTi 4WD	120		08.03	11.05				
	1.8 VVTi	92		02.01	11.05	24.5296-0280.3	331034	 	L=280 L=280
	2.0 D-4D 4WD	85		09.01	11.05	24.5296-0281.3	331035		
	2.0 VVTi 4WD	110		06.00	11.05				
	2.4 VVTi 4WD	112		08.03	11.05				
	2.4 VVTi 4WD	120		08.03	11.05				
	1.8 VVTi	92		02.01	11.05 - ABS	24.3219-1754.3	020507		Rz 19,05
	2.0 D-4D 4WD	85		09.01	11.05 - ABS				
	2.0 VVTi 4WD	110		06.00	11.05 - ABS				
	2.4 VVTi 4WD	112		08.03	11.05 - ABS				
	2.4 VVTi 4WD	120		08.03	11.05 - ABS				
	1.8 VVTi	92		02.01	11.05 - ABS	24.3727-1917.2	581917	 	L=408 L=1307
	2.0 D-4D 4WD	85		09.01	11.05 - ABS	24.3727-1924.2	581924		L=1307
	2.0 VVTi 4WD	110		06.00	11.05 - ABS	24.3727-1925.2	581925		
	2.4 VVTi 4WD	112		08.03	11.05 - ABS				
	2.4 VVTi 4WD	120		08.03	11.05 - ABS				
	1.8 VVTi	92		02.01	11.05 + ABS	24.3727-1917.2	581917	 	L=408
	2.0 D-4D 4WD	85		09.01	11.05 + ABS	24.3727-1947.2	581947		L=1425
	2.0 VVTi 4WD	110		06.00	11.05 + ABS	24.3727-1963.2	581963		L=1425
	2.4 VVTi 4WD	112		08.03	11.05 + ABS				
	2.4 VVTi 4WD	120		08.03	11.05 + ABS				
TOYOTA RAV4 III (05-)									
	2.0 16V	116		12.08		24.5295-0680.3	331355	 	L=680 L=680
	2.0 16V 4WD	116		12.08		24.5295-0681.3	331356		
	2.0 VVT-i	109		03.09					
	2.0 VVT-i 4WD	109		03.09					
	2.0 VVT-i 4WD	112		02.07					
	2.2 D-4D	110		12.08					
	2.2 D-4D 4WD	100		02.07					
	2.2 D-4D 4WD	110		12.08					
	2.2 D-CAT 4WD	130		02.07					
	2.4 VVT-i	125		02.07					

¹⁾ + manual transmission / + scatola cambio velocità / + transmission mécanique / + cambio de velocidad

²⁾ + autom.transmission / + scatola cambio automatico / + transmission automatique / + cambio automático

























									
TOYOTA RAV4 III (05-)									
	2.4 VVT-i 4WD 3.5 VVT-i 4WD 3.5 VVT-i 4WD	125 201 206		02.07 02.07 08.07		24.5295-0680.3 24.5295-0681.3	331355 331356	 	L=680 L=680
	2.0 16V 2.0 16V 4WD 2.0 VVT-i 2.0 VVT-i 4WD 2.0 VVT-i 4WD 2.2 D-4D 2.2 D-4D 4WD 2.2 D-4D 4WD 2.2 D-CAT 4WD	116 116 109 109 112 110 100 110 130		12.08 12.08 03.09 03.09 03.06 12.08 03.06 12.08 03.06		24.3727-1956.2	581956		L=320
	2.4 VVT-i 2.4 VVT-i 4WD 3.5 VVT-i 4WD 3.5 VVT-i 4WD	125 125 201 206		11.05 11.05 11.05 08.07	09.07 09.07	24.3727-1956.2	581956		L=320
	2.4 VVT-i 2.4 VVT-i 4WD	125 125		10.07 10.07		24.3727-1956.2	581956		L=320
TOYOTA STARLET (96-99)									
	1.3 i 16V (EP91)	55		05.96 07.99	- ABS	24.3481-1794.5	240744		D=48, - Halter
	1.3 i 16V (EP91)	55		01.96 07.99	- ABS	24.3217-1733.3 24.3217-1734.3	020559 020560	 	Rz 17,46 Rz 17,46
	1.3 i 16V (EP91)	55		01.96 07.99		24.3727-1913.2 24.3727-1950.2 24.3727-1951.2	581913 581950 581951	  	L=258 L=1485 L=1508
TOYOTA URBAN CRUISER (09-)									
	1.33 16V 1.4 D-4D 1.4 D-4D 4WD	74 66 66		04.09 04.09 04.09		24.5265-0440.3 24.5265-0441.3	331351 331352	  	L=440 L=440
	1.33 16V 1.33 16V 1.4 D-4D 1.4 D-4D 4WD	73 74 66 66		04.10 04.09 04.09 04.09		24.3727-1954.2 24.3727-1955.2	581954 581955	 	L=1617 L=1665
TOYOTA VERSO (09-)									
	1.6 16V 1.8 16V 2.0 D-4D 2.2 D-4D 2.2 D-CAT	97 108 93 110 130		02.09 02.09 02.09 02.09 02.09		24.5262-0180.3 24.5261-0130.3	331180 331387	2  am Bremssattel ¹⁾	L=180 L=130
	1.6 16V 1.8 16V 1.6 D-4D 2.0 D-4D 2.0 D-4D 2.2 D-4D 2.2 D-CAT	97 108 82 91 93 110 130		02.09 02.09 11.13 11.12 02.09 02.09 02.09		24.2415-1718.3 24.2415-1719.3	030142 030143		Gz 15,87 Gz 15,87
TOYOTA VERSO S (10-)									
	1.33 1.33 1.4 D4-D	70 73 66		11.10 11.10 11.10		24.5265-0440.3 24.5265-0441.3	331351 331352	 	L=440 L=440
	1.33 1.33 1.4 D4-D	70 73 66		11.10 11.10 11.10		24.5235-0200.3	331280		L=198
	1.33 1.33 1.4 D4-D	70 73 66		11.10 11.10 11.10		24.3727-1961.2 24.3727-1962.2	581961 581962	 	L=1657 L=1695
TOYOTA YARIS (99-05)									
	1.0 i 16V 1.0 i 16V 1.3 i 16V 1.3 i 16V 1.4 D-4D 1.5 VVTi Sport 1.5 VVTi Sport 1.5 VVTi Turbo Sport	48 50 63 64 55 77 78 110		04.03 08.99 09.99 04.02 12.01 01.03 04.01 04.03	08.05 + HA-Scheibenbremse ²⁾ + HA-Scheibenbremse ²⁾ + HA-Scheibenbremse ²⁾ + HA-Scheibenbremse ²⁾ + HA-Scheibenbremse ²⁾ + HA-Scheibenbremse ²⁾ + HA-Scheibenbremse ²⁾ + HA-Scheibenbremse ²⁾	24.3511-1711.5 24.3511-1712.5	240379 240380	 	D=51, - Halter D=51, - Halter
	1.0 i 16V 1.0 i 16V 1.3 i 16V 1.3 i 16V 1.4 D-4D 1.5 VVTi Sport 1.5 VVTi Sport 1.5 VVTi Turbo Sport	48 50 63 64 55 77 78 110		04.03 03.99 09.99 04.02 12.01 01.03 04.01 04.03	08.05 03.03 10.04 08.05 08.05 08.05 03.03 10.04	24.5295-0525.3 24.5295-0526.3	331353 331354	 Produktionsland ☉  Produktionsland ☉	L=525 L=525
	1.0 i 16V 1.0 i 16V 1.3 i 16V 1.3 i 16V	48 50 63 64		04.03 03.99 09.99 04.02	08.05 03.03 10.04 08.05	24.5277-0531.3 24.5277-0530.3	331003 331002	 Produktionsland ☉  Produktionsland ☉	L=530 L=530
				04.02 08.05					

¹⁾ on the brake caliper / sulla pinza freno / sur l'étrier de frein / a la pinza de freno
²⁾ + RA disc brake / + P disco freno / + frein à disque essieu AR / + ET-disco de freno

									
TOYOTA YARIS (99-05)									
	1.4 D-4D	55		12.01	08.05	24.5277-0531.3	331003	<input type="checkbox"/> Produktionsland ☺	L=530
	1.5 VVTi Sport	77		01.03	08.05	24.5277-0530.3	331002	<input type="checkbox"/> Produktionsland ☺	L=530
	1.5 VVTi Sport	78		04.01	03.03				
	1.5 VVTi Turbo Sport	110		04.03	10.04				
	1.0 i 16V	48		04.03	08.05	24.5261-0291.3	330994	2 <input type="checkbox"/> Produktionsland ☺	L=291
	1.0 i 16V	50		03.99	03.03				
	1.3 i 16V	63		05.00	10.04	24.5263-0440.3	331282	<input type="checkbox"/>	L=440
						24.5263-0441.3	331283	<input type="checkbox"/>	L=440
	1.0 i 16V	48		04.03	08.05 + ABS	24.5263-0592.3	331284	<input type="checkbox"/> Produktionsland ☺	L=325/290
	1.0 i 16V	50		03.99	03.03 + ABS	24.5263-0593.3	331285	<input type="checkbox"/> Produktionsland ☺	L=325/290
	1.3 i 16V	64		04.02	08.05 + ABS				
	1.4 D-4D	55		12.01	08.05 + ABS				
	1.4 D-4D	55		12.01	08.05 Produktionsland ☺	24.5263-0594.3	331286	<input type="checkbox"/>	L=325/290
	1.5 VVTi Sport	77		01.03	08.05	24.5263-0595.3	331287	<input type="checkbox"/>	L=325/290
1.5 VVTi Sport	78		04.01	03.03					
1.5 VVTi Turbo Sport	110		04.03	10.04					
	1.0 i 16V	48		04.03	08.05	24.3217-1721.3	020489	<input type="checkbox"/> Produktionsland ☺	Rz 17,46
	1.0 i 16V	50		08.99	03.03	24.3217-1722.3	020490	<input type="checkbox"/> Produktionsland ☺	Rz 17,46
	1.3 i 16V	63		09.99	10.04				
	1.0 i 16V	48		04.03	08.05	24.3219-1744.3	020488	<input type="checkbox"/> Produktionsland ☺	Rz 19,05
	1.0 i 16V	50		03.99	03.03				BOS
	1.3 i 16V	64		04.02	08.05				
	1.4 D-4D	55		12.01	08.05				
	1.0 i 16V	50		03.99	07.99 + HA-Trommelbremse 1)	24.3727-1909.2	581909	<input type="checkbox"/>	L=1543
	1.3 i 16V	63		09.99	10.04 + HA-Trommelbremse 1)	24.3727-1903.2	581903	<input type="checkbox"/>	L=1503
	1.4 D-4D	55		12.01	03.03 + HA-Trommelbremse 1)				
	1.0 i 16V	48		04.03	08.05 + HA-Trommelbremse 1)	24.3727-1921.2	581921	<input type="checkbox"/>	L=1580
	1.0 i 16V	50		08.99	03.03 + HA-Trommelbremse 1)	24.3727-1920.2	581920	<input type="checkbox"/>	L=1553
	1.3 i 16V	64		04.02	08.05 + HA-Trommelbremse 1)				
	1.4 D-4D	55		04.03	08.05 + HA-Trommelbremse 1)				
	1.0 i 16V	48		04.03	08.05 + HA-Scheibenbremse 2)	24.3727-1911.2	581911	<input type="checkbox"/>	L=1520
1.0 i 16V	50		08.99	03.03 + HA-Scheibenbremse 2)	24.3727-1912.2	581912	<input type="checkbox"/>	L=1481	
1.3 i 16V	63		09.99	10.04 + HA-Scheibenbremse 2)					
1.3 i 16V	64		04.02	08.05 + HA-Scheibenbremse 2)					
1.4 D-4D	55		12.01	08.05 + HA-Scheibenbremse 2)					
1.5 VVTi Sport	77		01.03	08.05 + HA-Scheibenbremse 2)					
1.5 VVTi Sport	78		04.01	03.03 + HA-Scheibenbremse 2)					
1.5 VVTi Turbo Sport	110		04.03	10.04 + HA-Scheibenbremse 2)					
TOYOTA YARIS (06-11)									
	1.0 GPL	◀ 51		01.06	08.11	03.7853-3203.4	300241	- ESP	9" ATE
	1.0 VVT-i	◀ 51		01.06	08.11			<input type="checkbox"/> Produktionsland ☺	
	1.3 VVT-i	◀ 63		01.06	08.11			<input type="checkbox"/> Produktionsland ☺	
	1.3 VVT-i	◀ 64		01.06	08.11				
	1.33 VVT-i	◀ 73		07.10	08.11				
	1.33 VVT-i	◀ 74		03.09	08.11				
	1.4 D-4D	◀ 66		01.06	08.11	03.7853-3402.4	300256	- ESP	9" ATE
	1.0 GPL	◀ 51		01.06	08.11	03.7750-7132.4	300255	+ ESP	9" ATE
	1.0 VVT-i	◀ 51		01.06	08.11			<input type="checkbox"/> Produktionsland ☺	
	1.3 VVT-i	◀ 63		01.06	08.11			<input type="checkbox"/> Produktionsland ☺	
	1.3 VVT-i	◀ 64		01.06	08.11				
	1.33 VVT-i	◀ 73		07.10	08.11				
	1.33 VVT-i	◀ 74		03.09	08.11				
	1.4 D-4D	◀ 66		01.06	08.11				
	1.0 GPL	51		01.06	08.11	03.4152-0053.3	010884	- ESP	THz 22,20 - Behälter ATE
	1.0 VVT-i	51		01.06	08.11	03.4152-0058.3	010885	+ ESP	THz 22,20 - Behälter ATE
	1.3 VVT-i	63		01.06	08.11	03.4152-0153.3	011006	- ESP	THz 22,20 - Behälter ATE
	1.3 VVT-i	64		01.06	08.11	03.4152-0158.3	011007	+ ESP	THz 22,20 - Behälter ATE
	1.33 VVT-i	73		07.10	08.11				
	1.33 VVT-i	74		03.09	08.11				
	1.4 D-4D	66		01.06	08.11				
	1.0 GPL	51		01.06	08.11	11.9541-9569.2	220725	<input type="checkbox"/> Produktionsland ☺	D=54, - Halter ATE
	1.0 VVT-i	51		01.06	08.11	11.9541-9570.2	220726	<input type="checkbox"/> Produktionsland ☺	D=54, - Halter ATE
	1.3 VVT-i	63		01.06	08.11	11.0101-5407.2	260011		Hülzensatz ATE
	1.3 VVT-i	64		01.06	08.11	11.8171-0008.1	990049		Führungsbolzen ATE
	1.33 VVT-i	73		07.10	08.11	11.8116-0264.1	390594	2	Haltefeder ATE
	1.33 VVT-i	74		03.09	08.11				
	1.4 D-4D	66		01.06	08.11				
	1.0 GPL	51		01.06	08.11	24.5265-0440.3	331351	<input type="checkbox"/> Produktionsland ☺	L=440
	1.0 VVT-i	51		01.06	08.11	24.5265-0441.3	331352	<input type="checkbox"/> Produktionsland ☺	L=440
	1.8 VVT-i	97		01.06	08.11				
	1.8 VVT-i	98		01.07	08.11				
	1.0 GPL	51		01.06	08.11	24.5286-0488.3	331221	<input type="checkbox"/> Produktionsland ☺	L=488
	1.0 VVT-i	51		01.06	08.11	24.5286-0489.3	331222	<input type="checkbox"/> Produktionsland ☺	L=488
	1.3 VVT-i	63		01.06	08.11				
	1.3 VVT-i	64		01.06	08.11				
	1.33 VVT-i	73		07.10	08.11				
	1.33 VVT-i	74		03.09	08.11				
	1.4 D-4D	66		01.06	08.11				
	1.0 GPL	51		01.06	08.11	11.9347-7005.2	220643	<input type="checkbox"/> Produktionsland ☺	D=34, - Halter ATE
	1.0 VVT-i	51		01.06	08.11	11.9347-7006.2	220644	<input type="checkbox"/> Produktionsland ☺	D=34, - Halter ATE
	1.3 VVT-i	63		01.06	08.11	11.0101-5407.2	260011		Hülzensatz ATE
	1.3 VVT-i	64		01.06	08.11	11.8171-0008.1	990049		Führungsbolzen ATE
	1.33 VVT-i	73		07.10	08.11	11.8116-0340.1	390595	2 <input type="checkbox"/> Produktionsland ☺	Haltefeder ATE
1.33 VVT-i	74		03.09	08.11					

1) + RA drum brake / + P freno a tamburo / + frein à tambour essieu AR / + ET-tambores de freno

2) + RA disc brake / + P disco freno / + frein à disque essieu AR / + ET-disco de freno

									
TOYOTA YARIS (06-11)									
	1.4 D-4D 1.8 VVT-i 1.8 VVT-i	66 97 98		01.06 08.11 01.06 08.11 01.07 08.11		11.9347-7005.2 220643 11.9347-7006.2 220644 11.0101-5407.2 260011 11.8171-0008.1 990049 11.8116-0340.1 390595	☐ Produktionsland (F) ☐ Produktionsland (F)	D=34, - Halter D=34, - Halter Hülzensatz Führungsbolzen Haltefeder	ATE ATE ATE ATE ATE
	1.0 GPL 1.0 VVT-i 1.8 VVT-i 1.8 VVT-i	51 51 97 98		01.06 08.11 01.06 08.11 01.06 08.11 01.07 08.11		24.5235-0200.3 331280	☐ Produktionsland (D)	L=198	
	1.0 GPL 1.0 VVT-i 1.3 VVT-i 1.3 VVT-i 1.33 VVT-i 1.33 VVT-i 1.4 D-4D	51 51 63 64 73 74 66		01.06 08.11 01.06 08.11 01.06 08.11 01.06 08.11 07.10 08.11 03.09 08.11 01.06 08.11		24.5261-0195.3 331077 24.5261-0255.3 331078	☐ Produktionsland (F) ☐ Produktionsland (F)	L=195 L=255	
	1.0 GPL 1.0 VVT-i 1.3 VVT-i 1.3 VVT-i 1.33 VVT-i 1.33 VVT-i 1.4 D-4D	51 51 63 64 73 74 66		01.06 08.11 01.06 08.11 01.06 08.11 01.06 08.11 07.10 08.11 03.09 08.11 01.06 08.11		24.3220-1728.3 020509	☐ Produktionsland (F)	Rz 20,64	
	1.0 GPL 1.0 VVT-i	51 51		01.06 08.11 01.06 08.11	- ABS - ABS	24.3727-1959.2 581959 24.3727-1960.2 581960	☐ Produktionsland (D) ☐ Produktionsland (D)	L=1558 L=1600	
	1.0 GPL 1.0 VVT-i 1.3 VVT-i 1.3 VVT-i 1.33 VVT-i 1.33 VVT-i 1.4 D-4D	51 51 63 64 73 74 66		01.06 08.11 01.06 08.11 01.06 08.11 01.06 08.11 07.10 08.11 03.09 08.11 01.06 08.11	- ABS - ABS - ABS - ABS - ABS - ABS	24.3727-1937.2 581937 24.3727-1938.2 581938	☐ Produktionsland (F) ☐ Produktionsland (F)	L=1555 L=1600	
	1.0 GPL 1.0 VVT-i 1.8 VVT-i 1.8 VVT-i	51 51 97 98		01.06 08.11 01.06 08.11 01.06 08.11 01.07 08.11	+ ABS + ABS	24.3727-1954.2 581954 24.3727-1955.2 581955	☐ Produktionsland (D) ☐ Produktionsland (D)	L=1617 L=1665	
	1.0 GPL 1.0 VVT-i	51 51		01.06 08.11 01.06 08.11		24.2415-1716.3 030138		Gz 15,87	
TOYOTA YARIS (11-)									
	1.0 VVTi 1.3 VVTi 1.3 VVTi 1.3 VVTi 1.3 VVTi 4WD 1.4 D-4D	51 63 70 73 70 66		09.11 01.11 09.11 09.11 09.11 09.11	Produktionsland (F) Produktionsland (F) Produktionsland (F) Produktionsland (F) Produktionsland (F)	11.9541-9569.2 220725 11.9541-9570.2 220726	☐ ☐	D=54, - Halter D=54, - Halter	ATE ATE
	1.0 VVTi 1.3 VVTi 1.3 VVTi 1.3 VVTi 1.3 VVTi 4WD 1.4 D-4D 1.5 Hybrid 1.5 Hybrid	51 63 70 73 70 66 54 55		09.11 01.11 09.11 09.11 09.11 09.11 04.15 03.12	Produktionsland (F) Produktionsland (F) Produktionsland (F) Produktionsland (F) Produktionsland (F)	11.9347-7005.2 220643 11.9347-7006.2 220644	☐ + ESP ☐ + ESP	D=34, - Halter D=34, - Halter	ATE ATE
	1.0 VVTi 1.3 VVTi 1.3 VVTi 1.3 VVTi 1.3 VVTi 4WD	51 63 70 73 70		09.11 01.11 09.11 09.11 09.11	Produktionsland (D) Produktionsland (D) Produktionsland (D) Produktionsland (D) Produktionsland (D)	24.5235-0200.3 331280	☐	L=198	
	1.0 VVTi 1.3 VVTi 1.3 VVTi 1.3 VVTi 1.3 VVTi 4WD 1.4 D-4D	51 63 70 73 70 66		09.11 01.11 09.11 09.11 09.11 09.11	Produktionsland (F) Produktionsland (F) Produktionsland (F) Produktionsland (F) Produktionsland (F)	24.3220-1739.3 020546	- ESP	Rz 20,64	
	1.0 VVTi	51		09.11	Produktionsland (D)	24.2415-1716.3 030138		Gz 15,87	
TOYOTA YARIS VERSO (99-05)									
	1.3 1.3 1.4 D-4D 1.5 1.5 1.5 4WD	62 63 55 77 78 78		01.03 09.05 11.99 03.03 12.01 09.05 05.03 09.05 03.00 03.03 03.00 09.05		24.3511-1711.5 240379 24.3511-1712.5 240380	☐ ☐	D=51, - Halter D=51, - Halter	
	1.3 1.3 1.4 D-4D 1.5 1.5 1.5 4WD	62 63 55 77 78 78		01.03 09.05 11.99 03.03 12.01 09.05 05.03 09.05 03.00 03.03 03.00 09.05		24.5277-0531.3 331003 24.5277-0530.3 331002	☐ ☐	L=530 L=530	



TOYOTA YARIS VERSO (99-05)

	1.3 1.5 1.5 4WD	63 78 78		11.99 03.00 03.00	02.01 02.01 02.01	+ ABS + ABS + ABS	24.3321-1701.7 24.3321-1702.7	220715 220716		D=32, - Halter D=32, - Halter
	1.3 1.3 1.4 D-4D 1.5 1.5 1.5 4WD	62 63 55 77 78 78		01.03 11.99 12.01 05.03 03.00 03.00	09.05 03.03 09.05 09.05 03.03 09.05		24.5261-0291.3	330994	2	L=291
	1.3 1.3	62 63		01.03 11.99	09.05 03.03	- ABS/ + Automatikgetriebe ¹⁾ - ABS/ + Automatikgetriebe ¹⁾	24.3217-1721.3 24.3217-1722.3	020489 020490		Rz 17,46 Rz 17,46
	1.3 1.3 1.4 D-4D 1.5 1.5 1.5 4WD	62 63 55 77 78 78		01.03 11.99 12.01 05.03 03.00 03.00	09.05 03.03 09.05 09.05 03.03 09.05	- ABS/ + Schaltgetriebe ²⁾ - ABS/ + Schaltgetriebe ²⁾ - ABS - ABS - ABS - ABS	24.3219-1749.3	020500		Rz 19,05

VOLKSWAGEN AMAROK (10-)

	2.0 BiTDI 2.0 BiTDI 2.0 BiTDI 4motion 2.0 TDI 2.0 TDI 2.0 TDI 4motion 2.0 TDI 4motion 2.0 TDI 4motion 2.0 TSI 3.0 TDI 4motion	120 132 120 90 103 90 103 132 118 165		09.10 11.11 09.10 09.10 07.12 09.10 06.12 11.11 12.10 09.16			24.3226-1703.3	020573		Rz 26,99
--	--	--	--	--	--	--	----------------	--------	--	----------

VOLKSWAGEN BORA (98-04)

	1.4 16V 1.6 1.6 16V 1.8 1.8 4motion 1.9 SDI 1.9 TDI 1.9 TDI 1.9 TDI 1.9 TDI 4motion 1.9 TDI 4motion 2.0 2.3 V5 2.3 V5 4motion 2.8 V6 4motion	◀ ◀ ◀ ◀ 92 ◀ 92 ◀ ◀ 66 ◀ 81 ◀ 85 ◀ 66 ◀ 85 ◀ 85 ◀ ◀ ◀ ◀ 150		09.98 09.98 02.00 09.98 02.99 09.98 09.98 02.99 02.99 02.99 09.98 09.98 02.99 05.99	08.00 08.00 08.00 08.00 08.00 08.00 08.00 08.00 08.00 08.00 08.00 08.00 08.00 08.00 08.00 08.00	+ ESP + ESP + ESP + ESP + ESP + ESP + ESP + ESP + ESP + ESP + ESP + ESP + ESP + ESP + ESP + ESP	03.7863-0402.4	300124		10" ATE
	1.4 16V 1.6 1.6 16V 1.6 FSI 1.8 1.8 4motion 1.8 T 1.9 SDI 1.9 TDI 1.9 TDI 1.9 TDI 1.9 TDI 1.9 TDI 1.9 TDI 1.9 TDI 4motion 1.9 TDI 4motion 1.9 TDI 4motion 1.9 TDI 4motion 1.9 TDI 4motion 2.0 2.0 4motion 2.3 V5 2.3 V5 4motion 2.8 V6 4motion	◀ ◀ ◀ ◀ ◀ 92 ◀ 92 ◀ 110 ◀ ◀ 66 ◀ 74 ◀ 81 ◀ 85 ◀ 96 ◀ 110 ◀ 66 ◀ 74 ◀ 85 ◀ 96 ◀ 110 ◀ 66 ◀ 74 ◀ 85 ◀ 96 ◀ 110 ◀ 85 ◀ 85 ◀ ◀ ◀ 150		1J-2-373846 1J-2-373846	09.00 09.00 09.00 01.02 09.00	+ ESP + ESP	03.7860-0602.4	300141		10" ATE
	1.4 16V 1.6 1.6 16V 1.6 FSI 1.8 1.8 4motion 1.8 T 1.8 T 1.9 SDI 1.9 TDI 1.9 TDI 1.9 TDI 1.9 TDI 1.9 TDI 1.9 TDI 4motion 1.9 TDI 4motion 1.9 TDI 4motion 1.9 TDI 4motion 2.0 2.0 4motion 2.3 V5 2.3 V5 4motion 2.8 V6 4motion	◀ ◀ ◀ ◀ ◀ 92 ◀ 92 ◀ 110 ◀ 132 ◀ ◀ 74 ◀ 96 ◀ 110 ◀ 74 ◀ 96 ◀ 110 ◀ 74 ◀ 96 ◀ 110 ◀ 85 ◀ 85 ◀ ◀ ◀ 150		1J-2-373847 1J-2-373847	12.04 12.04	+ ESP + ESP	03.7863-3502.4	300128		10" ATE

¹⁾ - ABS/ + autom.transmission / - ABS/ + scatola cambio autom. / - ABS/ + transmission automatique / - ABS/ + cambio automático
²⁾ - ABS/ + manual transmission / - ABS/ + scatola camb.velocità / - ABS/ + transmission mécanique / - ABS/ + cambio de velocidad



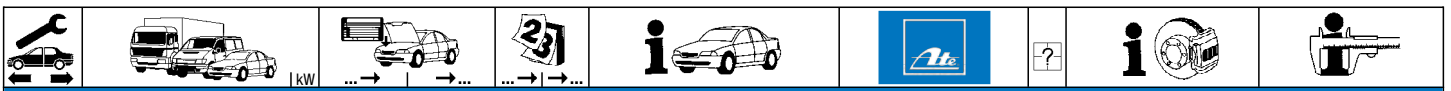

VOLKSWAGEN BORA (98-04)



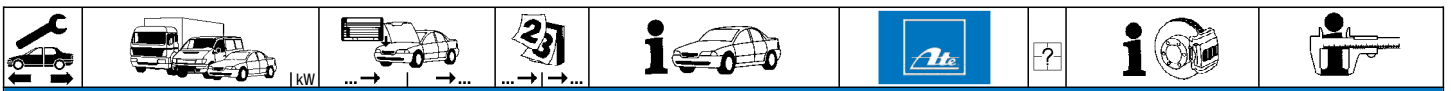

	2.3 V5 2.3 V5 4motion 2.8 V6 4motion	1J-2-373847 1J-2-373847 1J-2-373847		12.04 + ESP 12.04 + ESP 12.04 + ESP	03.7863-3502.4	300128		10"	ATE
	1.4 16V 1.6 1.6 16V 1.6 FSI 1.8 1.8 4motion 1.8 T 1.8 T 1.9 SDI 1.9 TDI 1.9 TDI 1.9 TDI 1.9 TDI 1.9 TDI 1.9 TDI 4motion 1.9 TDI 4motion 1.9 TDI 4motion 1.9 TDI 4motion 1.9 TDI 4motion 1.9 TDI 4motion 2.0 2.0 4motion 2.3 V5 2.3 V5 4motion 2.8 V6 4motion			09.98 12.04 - ESP 09.98 12.04 - ESP 02.00 12.04 - ESP 01.02 12.04 - ESP 09.98 12.04 - ESP 02.99 12.04 - ESP 09.00 12.04 - ESP 05.02 12.04 - ESP 09.98 12.04 - ESP 09.98 06.01 - ESP 09.00 12.04 - ESP 09.98 06.01 - ESP 02.99 06.01 - ESP 04.01 12.04 - ESP 10.00 12.04 - ESP 02.99 06.01 - ESP 09.00 12.04 - ESP 02.99 06.01 - ESP 04.01 12.04 - ESP 10.00 12.04 - ESP 09.98 12.04 - ESP 04.00 12.04 - ESP 09.98 12.04 - ESP 02.99 12.04 - ESP 05.99 12.04 - ESP	24.2123-1709.3	010503		THz 23,81	
	1.4 16V 1.6 1.6 16V 1.8 1.8 4motion 1.9 SDI 1.9 TDI 1.9 TDI 1.9 TDI 1.9 TDI 4motion 1.9 TDI 4motion 1.9 TDI 4motion 1.9 TDI 4motion 2.0 2.3 V5 2.3 V5 4motion 2.8 V6 4motion			09.98 08.00 + ESP 09.98 08.00 + ESP 02.00 08.00 + ESP 09.98 08.00 + ESP 02.99 08.00 + ESP 09.98 08.00 + ESP 09.98 08.00 + ESP 02.99 08.00 + ESP 02.99 08.00 + ESP 09.98 08.00 + ESP 09.98 08.00 + ESP 02.99 08.00 + ESP 02.99 08.00 + ESP 09.98 08.00 + ESP 09.98 08.00 + ESP 02.99 08.00 + ESP 05.99 08.00 + ESP	03.2123-2024.3	010597		THz 23,81	ATE
	1.4 16V 1.6 1.6 16V 1.6 FSI 1.8 1.8 4motion 1.8 T 1.8 T 1.9 SDI 1.9 TDI 1.9 TDI 1.9 TDI 1.9 TDI 4motion 1.9 TDI 4motion 1.9 TDI 4motion 1.9 TDI 4motion 1.9 TDI 4motion 2.0 2.0 4motion 2.3 V5 2.3 V5 4motion 2.8 V6 4motion			09.00 12.04 + ESP 09.00 12.04 + ESP 09.00 12.04 + ESP 01.02 12.04 + ESP 09.00 12.04 + ESP 09.00 12.04 + ESP 09.00 12.04 + ESP 05.02 12.04 + ESP 09.00 12.04 + ESP 09.00 06.01 + ESP 09.00 12.04 + ESP 09.00 06.01 + ESP 09.00 06.01 + ESP 04.01 12.04 + ESP 10.00 12.04 + ESP 09.00 06.01 + ESP 09.00 12.04 + ESP 09.00 06.01 + ESP 04.01 12.04 + ESP 10.00 12.04 + ESP 09.00 12.04 + ESP 04.00 12.04 + ESP 09.00 12.04 + ESP 09.00 12.04 + ESP 09.00 12.04 + ESP	03.2123-2715.3	010802		THz 23,81	ATE
	1.4 16V 1.6 1.6 16V 1.8 1.8 4motion 1.9 SDI 1.9 TDI 1.9 TDI 1.9 TDI 1.9 TDI 4motion 1.9 TDI 4motion 1.9 TDI 4motion 1.9 TDI 4motion 2.0 2.0 4motion 2.3 V5 2.3 V5 4motion 2.8 V6 4motion			09.98 08.00 + ESP 09.98 08.00 + ESP 02.00 08.00 + ESP 09.98 08.00 + ESP 02.99 08.00 + ESP 09.98 08.00 + ESP 09.98 08.00 + ESP 02.99 08.00 + ESP 02.99 08.00 + ESP 09.98 08.00 + ESP 09.98 08.00 + ESP 02.99 08.00 + ESP 02.99 08.00 + ESP 09.98 08.00 + ESP 09.98 08.00 + ESP 02.99 08.00 + ESP 05.99 08.00 + ESP	03.2123-2064.3	010598		THz 23,81	ATE
	1.4 16V 1.6 1.6 16V 1.6 FSI			09.00 12.04 + ESP 09.00 12.04 + ESP 09.00 12.04 + ESP 01.02 12.04 + ESP	03.2123-2774.3	010803		THz 23,81	ATE



VOLKSWAGEN BORA (98-04)

	1.9 TDI 4motion	74		09.00	12.04	PR: 1ZQ	11.9541-9595.2	220501	2		D=54, - Halter D=54, - Halter Dichtungssatz Hülsensatz Führungsbolzen Haltefeder	ATE ATE ATE ATE ATE ATE			
	1.9 TDI 4motion	85		02.99	06.01	PR: 1ZQ	11.9541-9596.2	220502							
	1.9 TDI 4motion	96		04.01	12.04	PR: 1ZQ	11.0441-5409.2	250031							
	1.9 TDI 4motion	110		10.00	12.04	PR: 1ZQ	11.0101-5409.2	260035							
	2.0	85		09.98	12.04	PR: 1ZQ	11.8171-0008.1	990049							
	2.0 4motion	85		04.00	12.04	PR: 1ZQ	11.8116-0143.1	390513							
	2.3 V5			09.98	12.04	PR: 1ZQ									
	2.3 V5 4motion			02.99	12.04	PR: 1ZQ									
	2.8 V6 4motion	150		05.99	12.04	PR: 1ZQ									
	1.4 16V		1J-2W315308	09.98		PR: 1LJ	11.9541-9595.2	220501							
	1.6		1J-2W315308	09.98		PR: 1LJ	11.9541-9596.2	220502							
	1.6 16V		1J-2W315308	02.00		PR: 1LJ	11.0441-5409.2	250031							
	1.6 FSI		1J-2W315308	01.02		PR: 1LJ	11.0101-5409.2	260035							
	1.8	92	1J-2W315308	09.98		PR: 1LJ	11.8171-0008.1	990049							
1.8 4motion	92	1J-2W315308	02.99		PR: 1LJ	11.8116-0143.1	390513								
1.8 T	110	1J-2W315308	09.00		PR: 1LJ										
1.8 T	132	1J-2W315308	05.02		PR: 1LJ										
1.9 SDI		1J-2W315308	09.98		PR: 1LJ										
1.9 TDI	66	1J-2W315308	09.98		PR: 1LJ										
1.9 TDI	74	1J-2W315308	09.00		PR: 1LJ										
1.9 TDI	81	1J-2W315308	09.98		PR: 1LJ										
1.9 TDI	85	1J-2W315308	02.99		PR: 1LJ										
1.9 TDI	96	1J-2W315308	04.01		PR: 1LJ										
1.9 TDI	110	1J-2W315308	10.00		PR: 1LJ										
1.9 TDI 4motion	66	1J-2W315308	02.99		PR: 1LJ										
1.9 TDI 4motion	74	1J-2W315308	09.00		PR: 1LJ										
1.9 TDI 4motion	85	1J-2W315308	02.99		PR: 1LJ										
1.9 TDI 4motion	96	1J-2W315308	04.01		PR: 1LJ										
1.9 TDI 4motion	110	1J-2W315308	10.00		PR: 1LJ										
2.0	85	1J-2W315308	09.98		PR: 1LJ										
2.0 4motion	85	1J-2W315308	04.00		PR: 1LJ										
2.3 V5		1J-2W315308	09.98		PR: 1LJ										
2.3 V5 4motion		1J-2W315308	02.99		PR: 1LJ										
2.8 V6 4motion	150	1J-2W315308	05.99		PR: 1LJ										
1.4 16V		1J-2W315309		12.04	PR: 1LJ	11.9541-9595.2	220501	2		D=54, - Halter D=54, - Halter Dichtungssatz Hülsensatz Führungsbolzen Haltefeder	ATE ATE ATE ATE ATE ATE				
1.6		1J-2W315309		12.04	PR: 1LJ	11.9541-9596.2	220502								
1.6 16V		1J-2W315309		12.04	PR: 1LJ	11.0441-5409.2	250031								
1.6 FSI		1J-2W315309		12.04	PR: 1LJ	11.0101-5409.2	260035								
1.8	92	1J-2W315309		12.04	PR: 1LJ	11.8171-0008.1	990049								
1.8 4motion	92	1J-2W315309		12.04	PR: 1LJ	11.8116-0143.1	390513								
1.8 T	110	1J-2W315309		12.04	PR: 1LJ										
1.8 T	132	1J-2W315309		12.04	PR: 1LJ										
1.9 SDI		1J-2W315309		12.04	PR: 1LJ										
1.9 TDI	66	1J-2W315309		06.01	PR: 1LJ										
1.9 TDI	74	1J-2W315309		12.04	PR: 1LJ										
1.9 TDI	81	1J-2W315309		06.01	PR: 1LJ										
1.9 TDI	85	1J-2W315309		06.01	PR: 1LJ										
1.9 TDI	96	1J-2W315309		12.04	PR: 1LJ										
1.9 TDI	110	1J-2W315309		12.04	PR: 1LJ										
1.9 TDI 4motion	66	1J-2W315309		06.01	PR: 1LJ										
1.9 TDI 4motion	74	1J-2W315309		12.04	PR: 1LJ										
1.9 TDI 4motion	85	1J-2W315309		06.01	PR: 1LJ										
1.9 TDI 4motion	96	1J-2W315309		12.04	PR: 1LJ										
1.9 TDI 4motion	110	1J-2W315309		12.04	PR: 1LJ										
2.0	85	1J-2W315309		12.04	PR: 1LJ										
2.0 4motion	85	1J-2W315309		12.04	PR: 1LJ										
2.3 V5		1J-2W315309		12.04	PR: 1LJ										
2.3 V5 4motion		1J-2W315309		12.04	PR: 1LJ										
2.8 V6 4motion	150	1J-2W315309		12.04	PR: 1LJ										
	1.4 16V		09.98	12.04		24.5143-0439.3	331411					2		L=439	
	1.6		09.98	12.04											
	1.6 16V		02.00	12.04											
	1.6 FSI		01.02	12.04											
	1.8	92	09.98	12.04											
	1.8 4motion	92	02.99	08.00											
	1.8 T	110	09.00	12.04											
	1.8 T	132	05.02	12.04											
	1.9 SDI		09.98	12.04											
	1.9 TDI	66	09.98	06.01											
	1.9 TDI	74	09.00	12.04											
	1.9 TDI	81	09.98	06.01											
	1.9 TDI	85	02.99	06.01											
	1.9 TDI	96	04.01	12.04											
1.9 TDI	110	10.00	12.04												
1.9 TDI 4motion	66	02.99	08.00												
1.9 TDI 4motion	85	02.99	08.00												
2.0	85	09.98	12.04												
2.0 4motion	85	04.00	08.00												
2.3 V5		09.98	12.04												
2.3 V5 4motion		02.99	08.00												
2.8 V6 4motion	150	05.99	08.00												
1.8 4motion	92		09.00	12.04		24.5143-0569.3	331398	2		L=569					
1.9 TDI 4motion	66		09.00	06.01											
1.9 TDI 4motion	74		09.00	12.04											
1.9 TDI 4motion	85		09.00	06.01											
1.9 TDI 4motion	96		04.01	12.04											
1.9 TDI 4motion	110		10.00	12.04											

VOLKSWAGEN BORA (98-04)



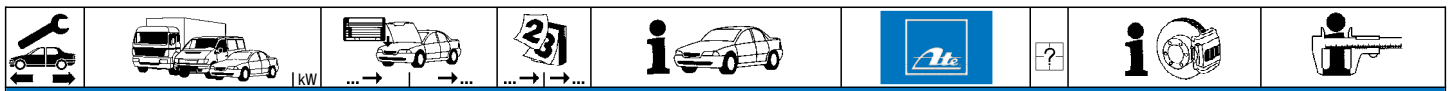



	1.4 16V		1J-YW238580	09.98		24.3727-0149.2	580149	2 ↓	L=1688
	1.6		1J-YW238580	09.98					
	1.8	92	1J-YW238580	09.98					
	1.9 SDI		1J-YW238580	09.98					
	1.9 TDI	66	1J-YW238580	09.98					
	1.9 TDI	81	1J-YW238580	09.98					
	2.0	85	1J-YW238580	09.98					
	1.4 16V		1J-YW238581	12.04		24.3727-0173.2	580173	2 ↓	L=1693
	1.6		1J-YW238581	12.04					
	1.6 16V			02.00	12.04				
	1.6 FSI			01.02	12.04				
	1.8	92	1J-YW238581		12.04				
	1.8 T	110		09.00	12.04				
	1.8 T	132		05.02	12.04				
	1.9 SDI		1J-YW238581		12.04				
	1.9 TDI	66	1J-YW238581		06.01				
	1.9 TDI	74		09.00	12.04				
	1.9 TDI	81	1J-YW238581		06.01				
	1.9 TDI	85	1J-YW238581		06.01				
	1.9 TDI	96		04.01	12.04				
	2.0	110		10.00	12.04				
	2.3 V5	85	1J-YW238581		12.04				
	1.8 4motion	92		02.99	12.04	24.3727-0175.2	580175	2 ↓	L=1723
	1.9 TDI 4motion	66		02.99	06.01				
	1.9 TDI 4motion	74		09.00	12.04				
	1.9 TDI 4motion	85		02.99	06.01				
	1.9 TDI 4motion	96		04.01	12.04				
	1.9 TDI 4motion	110		10.00	12.04				
	2.0 4motion	85		04.00	12.04				
	2.3 V5 4motion			02.99	12.04				
	2.8 V6 4motion	150		05.99	12.04				
	1.4 16V	◀		09.98	12.04	24.2415-1701.3	030095		Gz 15,87
	1.6	◀		09.98	12.04				
	1.6 16V	◀		02.00	12.04				
	1.6 FSI	◀		01.02	12.04				
	1.8	◀ 92		09.98	12.04				
	1.8 4motion	◀ 92		02.99	12.04				
	1.8 T	◀ 110		09.00	12.04				
	1.8 T	◀ 132		05.02	12.04				
	1.9 SDI	◀		09.98	12.04				
	1.9 TDI	◀ 66		09.98	06.01				
	1.9 TDI	◀ 74		09.00	12.04				
	1.9 TDI	◀ 81		09.98	06.01				
	1.9 TDI	◀ 85		02.99	06.01				
	1.9 TDI	◀ 96		04.01	12.04				
	1.9 TDI	◀ 110		10.00	12.04				
	1.9 TDI 4motion	◀ 66		02.99	06.01				
	1.9 TDI 4motion	◀ 74		09.00	12.04				
	1.9 TDI 4motion	◀ 85		02.99	06.01				
	1.9 TDI 4motion	◀ 96		04.01	12.04				
	1.9 TDI 4motion	◀ 110		10.00	12.04				
	2.0	◀ 85		09.98	12.04				
	2.0 4motion	◀ 85		04.00	12.04				
2.3 V5	◀		09.98	12.04					
2.3 V5 4motion	◀		02.99	12.04					
2.8 V6 4motion	◀ 150		05.99	12.04					
	1.4 16V	▶		09.98	12.04	24.2415-1702.3	030096		Gz 15,87
	1.6	▶		09.98	12.04				
	1.6 16V	▶		02.00	12.04				
	1.6 FSI	▶		01.02	12.04				
	1.8	▶ 92		09.98	12.04				
	1.8 4motion	▶ 92		02.99	12.04				
	1.8 T	▶ 110		09.00	12.04				
	1.8 T	▶ 132		05.02	12.04				
	1.9 SDI	▶		09.98	12.04				
	1.9 TDI	▶ 66		09.98	06.01				
	1.9 TDI	▶ 74		09.00	12.04				
	1.9 TDI	▶ 81		09.98	06.01				
	1.9 TDI	▶ 85		02.99	06.01				
	1.9 TDI	▶ 96		04.01	12.04				
	1.9 TDI	▶ 110		10.00	12.04				
	1.9 TDI 4motion	▶ 66		02.99	06.01				
	1.9 TDI 4motion	▶ 74		09.00	12.04				
	1.9 TDI 4motion	▶ 85		02.99	06.01				
	1.9 TDI 4motion	▶ 96		04.01	12.04				
	1.9 TDI 4motion	▶ 110		10.00	12.04				
	2.0	▶ 85		09.98	12.04				
	2.0 4motion	▶ 85		04.00	12.04				
2.3 V5	▶		09.98	12.04					
2.3 V5 4motion	▶		02.99	12.04					
2.8 V6 4motion	▶ 150		05.99	12.04					



VOLKSWAGEN BORA (98-04)





























	1.4 16V			09.98	12.04	24.2519-1701.3	040075	+ Schaltseilzug ¹⁾	Nz 19,05
	1.6			09.98	12.04	24.2523-1701.3	040080	+ Schaltgestänge ²⁾	Nz 23,81
	1.6 16V			02.00	12.04				
	1.6 FSI			01.02	12.04				
	1.8	92		09.98	12.04				
	1.8 4motion	92		02.99	12.04				
	1.8 T	110		09.00	12.04				
	1.8 T	132		05.02	12.04				
	1.9 SDI			09.98	12.04				
	1.9 TDI	66		09.98	06.01				
	1.9 TDI	74		09.00	12.04				
	1.9 TDI	81		09.98	06.01				
	1.9 TDI	85		02.99	06.01				
	1.9 TDI	96		04.01	12.04				
	1.9 TDI	110		10.00	12.04				
	1.9 TDI 4motion	66		02.99	06.01				
	1.9 TDI 4motion	74		09.00	12.04				
	1.9 TDI 4motion	85		02.99	06.01				
	1.9 TDI 4motion	96		04.01	12.04				
	1.9 TDI 4motion	110		10.00	12.04				
	2.0	85		09.98	12.04				
	2.0 4motion	85		04.00	12.04				
	2.3 V5			09.98	12.04				
	2.3 V5 4motion			02.99	12.04				
	2.8 V6 4motion	150		05.99	12.04				

VOLKSWAGEN CADDY II (96-04)

	1.4			11.95	01.04	03.7750-6302.4	300161	- ABS	9"	ATE
	1.6			11.95	01.04					
	1.7 SDI			07.96	01.04					
	1.9 D			11.95	01.04					
	1.9 SDI			11.95	01.04					
	1.9 TDI			09.96	01.04					
	1.4		9K-1-538270	11.95		10.6350-3902.4	300213	+ ABS	9"	ATE
	1.6		9K-1-538270	11.95						
	1.7 SDI		9K-1-538270	07.96						
	1.9 D		9K-1-538270	11.95						
	1.9 SDI		9K-1-538270	11.95						
	1.9 TDI		9K-1-538270	09.96						
	1.4		9K-1-538271	01.04		10.6350-4002.4	300285	+ ABS	9"	ATE
	1.6		9K-1-538271	01.04						
	1.7 SDI		9K-1-538271	01.04						
	1.9 D		9K-1-538271	01.04						
	1.9 SDI		9K-1-538271	01.04						
	1.9 TDI		9K-1-538271	01.04						
	1.4		9K-X-514000	11.95	- ABS	03.2122-1042.3	010137		THz 22,20	ATE
	1.4			11.95	01.04	03.3517-0101.2	390322		Verschlußschraube	
	1.6		9K-X-514000	11.95	- ABS					
	1.6			11.95	01.04					
	1.7 SDI		9K-X-514000	07.96	- ABS					
	1.7 SDI			07.96	01.04					
	1.9 D		9K-X-514000	11.95	- ABS					
	1.9 D			11.95	01.04					
	1.9 SDI		9K-X-514000	11.95	- ABS					
	1.9 SDI			11.95	01.04					
	1.9 TDI		9K-X-514000	09.96	- ABS					
	1.9 TDI			09.96	01.04					
	1.4			11.95	01.04	03.2123-1424.3	010637	+ ABS	THz 23,81	ATE
	1.6			11.95	01.04			+ ABS		
	1.7 SDI			07.96	01.04			+ ABS		
	1.9 D			11.95	01.04			+ ABS		
	1.9 SDI			11.95	01.04			+ ABS		
	1.9 TDI			09.96	01.04			+ ABS		
	1.4			11.95	01.04	03.2123-1484.3	010595	+ ABS	THz 23,81	ATE
	1.6			11.95	01.04			+ ABS		
	1.9 D			11.95	01.04			+ ABS		
	1.9 SDI			11.95	01.04			+ ABS		
	1.9 TDI			09.96	01.04			+ ABS		
	1.4			11.95	01.04	24.3541-1609.5	240039		D=54, - Halter	TRW
	1.6			11.95	01.04	24.3541-1610.5	240040		D=54, - Halter	TRW
	1.7 SDI			07.96	01.04	24.0101-4301.2	260047		Bremssattel-Zubehör	TRW
	1.9 D			11.95	01.04	11.0101-5403.2	260010		Faltenbalsatz	TRW
	1.9 SDI			11.95	01.04					
	1.9 TDI			09.96	01.04					
	1.4			11.95	01.04	24.5105-0442.3	331432	2	L=442	
	1.6			11.95	01.04					
	1.7 SDI			07.96	01.04					
	1.9 D			11.95	01.04					
	1.9 SDI			11.95	01.04					
	1.9 TDI			09.96	01.04					
	1.4			11.95	01.04	83.6236-0402.3	330464	2	L=400	
	1.6			11.95	01.04					
	1.7 SDI			07.96	01.04					
	1.9 D			11.95	01.04					
	1.9 SDI			11.95	01.04					
	1.9 TDI			09.96	01.04					

¹⁾ + gearshift cable / + leva cambio con cavo / + câble de changem.de vitesse / + cable de acc. del cambio
²⁾ + gearshift linkage / + leva cambio con tiranteria / + tige de changem.de vitesse / + varillaje del cambio



	 kW							
VOLKSWAGEN CADDY II (96-04)								
	1.4 1.6 1.7 SDI 1.9 D 1.9 SDI 1.9 TDI			11.95 01.04 11.95 01.04 07.96 01.04 11.95 01.04 11.95 01.04 09.96 01.04		24.3220-0909.3 020210		Rz 20,64
	1.4 1.6 1.7 SDI 1.9 D 1.9 SDI 1.9 TDI			11.95 01.04 11.95 01.04 07.96 01.04 11.95 01.04 11.95 01.04 09.96 01.04		24.3727-2700.2 582700	2 ↓	L=1671
	1.9 TDI	◀		09.96 01.04		03.2419-9510.3 030028		Gz 19,05
	1.9 TDI			09.96 01.04		24.2523-0908.3 040049		Nz 23,81
	1.4	◀		11.95 01.04		24.3728-2707.2 592707		L=1047, + AUT
	1.6	◀		11.95 01.04		24.3728-0128.2 590128		L=854, + AUT
	1.7 SDI	◀		07.96 01.04				
	1.9 D	◀		11.95 01.04				
	1.9 SDI	◀		11.95 01.04				
VOLKSWAGEN CADDY Pickup (97-02)								
	1.6			10.97 12.00		24.2122-1731.3 010656	- ABS	THz 22,20
	1.9 D			10.97 12.00		03.2123-1428.3 010476	+ ABS	THz 23,81 ATE
	1.6			10.97 12.00		24.3541-1737.5 240197		D=54, - Halter TRW
	1.9 D			10.97 12.00		24.3541-1738.5 240198		D=54, - Halter TRW
	1.6			10.97 12.00		24.5166-0325.3 331293	2	L=325
	1.9 D			10.97 12.00				
	1.6			10.97 12.00		83.6236-0175.3 330710	2	L=175
	1.9 D			10.97 12.00				
	1.6			10.97 12.00	- ABS	24.3222-1712.3 020424		Rz 22,20
	1.9 D			10.97 12.00	- ABS			
	1.6			10.97 12.00	+ ABS	24.3219-1721.3 020422		Rz 19,05
	1.9 D			10.97 12.00	+ ABS			
	1.6			10.97 12.00		24.3727-2508.2 582508	2 ↓	L=1782
	1.6			10.97 12.00		03.6583-0167.3 320140		BRL 8/3 (4) ATE
	1.9 D			10.97 12.00		03.6584-0107.3 320110		BRL 8/4 (4) ATE
	1.6	◀		10.97 12.00		24.3728-2500.2 592500		L=742
VOLKSWAGEN CADDY III (04-15)								
	1.2 TSI	◀		09.10		03.7873-4302.4 300312		11" ATE
	1.4	◀ 55		02.04				
	1.4 16V	◀ 59		05.06				
	1.6	◀		04.04				
	1.6 TDI	◀		08.10				
	1.9 TDI	◀ 55		09.05				
	1.9 TDI	◀ 77		02.04				
	1.9 TDI 4motion	◀ 77		05.08				
	2.0 Eco Fuel	◀ 80		04.06				
	2.0 SDI	◀ 51		02.04				
	2.0 TDI	◀ 81		10.10				
	2.0 TDI	◀103		09.07				
	2.0 TDI	◀125		05.12				
	2.0 TDI 4motion	◀ 81		10.10				
		1.2 TSI	◀		09.10		03.2122-2129.3 010799	
1.4		◀ 55		02.04				
1.4 16V		◀ 59		05.06				
1.6		◀		04.04				
1.6 TDI		◀		08.10				
1.9 TDI		◀ 55		09.05				
1.9 TDI		◀ 77		02.04				
1.9 TDI 4motion		◀ 77		05.08				
2.0 Eco Fuel		◀ 80		04.06				
2.0 SDI		◀ 51		02.04				
2.0 TDI		◀ 81		10.10				
2.0 TDI		◀103		09.07				
2.0 TDI		◀125		05.12				
2.0 TDI 4motion		◀ 81		10.10				
		1.2 TSI			09.10	PR: 1ZF,1ZM	11.9541-9549.2 220575	
	1.4	55		02.04	PR: 1ZF,1ZM	11.9541-9550.2 220576		D=54, - Halter ATE
	1.4 16V	59		05.06	PR: 1ZF,1ZM	11.0101-5409.2 260035		Hülsensatz ATE
	1.6			04.04	PR: 1ZF,1ZM	11.8171-0069.1 250152		Führungsbolzen ATE
↓	↓							



VOLKSWAGEN CADDY III (04-15)

	1.6 TDI		08.10	PR: 1ZF,1ZM	11.9541-9549.2	220575	 	D=54, - Halter D=54, - Halter Hülsensatz Führungsbolzen	ATE ATE ATE ATE				
	1.9 TDI	55	09.05	PR: 1ZF,1ZM	11.9541-9550.2	220576							
	1.9 TDI	77	02.04	PR: 1ZF,1ZM	11.0101-5409.2	260035							
	1.9 TDI 4motion	77	05.08	PR: 1ZF,1ZM	11.8171-0069.1	250152							
	2.0 Eco Fuel	80	04.06	PR: 1ZF,1ZM									
	2.0 SDI	51	02.04	PR: 1ZF,1ZM									
	2.0 TDI	81	10.10	PR: 1ZF,1ZM									
	2.0 TDI	103	09.07	PR: 1ZF,1ZM									
	2.0 TDI	125	05.12	PR: 1ZF,1ZM									
	2.0 TDI 4motion	81	10.10	PR: 1ZF,1ZM									
	1.2 TSI		09.10	PR: 1ZE	11.9541-9553.2	220563	 	D=54, - Halter D=54, - Halter Hülsensatz Führungsbolzen Haltefeder	ATE ATE ATE ATE ATE				
	1.4	55	02.04	PR: 1ZE	11.9541-9554.2	220564							
	1.4 16V	59	05.06	PR: 1ZE	11.0101-5409.2	260035							
	1.6		04.04	PR: 1ZE	11.8171-0008.1	990049							
	1.6 TDI		08.10	PR: 1ZE	11.8116-0351.1	390538							
	1.9 TDI	55	09.05	PR: 1ZE									
	1.9 TDI	77	02.04	PR: 1ZE									
	1.9 TDI 4motion	77	05.08	PR: 1ZE									
	2.0 Eco Fuel	80	04.06	PR: 1ZE									
	2.0 SDI	51	02.04	PR: 1ZE									
	2.0 TDI	81	10.10	PR: 1ZE									
	2.0 TDI	103	09.07	PR: 1ZE									
	2.0 TDI	125	05.12	PR: 1ZE									
	2.0 TDI 4motion	81	10.10	PR: 1ZE									
		1.2 TSI		09.10	PR: 1LJ,1ZA	11.9541-9553.2				220563	 	D=54, - Halter D=54, - Halter Hülsensatz Führungsbolzen Haltefeder	ATE ATE ATE ATE ATE
1.4		55	02.04	PR: 1LJ,1ZA	11.9541-9554.2	220564							
1.4 16V		59	05.06	PR: 1LJ,1ZA	11.0101-5409.2	260035							
1.6			04.04	PR: 1LJ,1ZA	11.8171-0008.1	990049							
1.6 TDI			08.10	PR: 1LJ,1ZA	11.8116-0351.1	390538							
1.9 TDI		55	09.05	PR: 1LJ,1ZA									
1.9 TDI		77	02.04	PR: 1LJ,1ZA									
1.9 TDI 4motion		77	05.08	PR: 1LJ,1ZA									
2.0 Eco Fuel		80	04.06	PR: 1LJ,1ZA									
2.0 SDI		51	02.04	PR: 1LJ,1ZA									
2.0 TDI		81	10.10	PR: 1LJ,1ZA									
2.0 TDI		103	09.07	PR: 1LJ,1ZA									
2.0 TDI		125	05.12	PR: 1LJ,1ZA									
2.0 TDI 4motion		81	10.10	PR: 1LJ,1ZA									
		1.2 TSI		09.10		24.5143-0564.3	331433	 	L=564				
	1.4	55	02.04										
	1.4 16V	59	05.06										
	1.6		04.04										
	1.6 TDI		08.10										
	1.9 TDI	55	09.05										
	1.9 TDI	77	02.04										
	1.9 TDI 4motion	77	05.08										
	2.0 Eco Fuel	80	04.06										
	2.0 SDI	51	02.04										
	2.0 TDI	81	10.10										
	2.0 TDI	103	09.07										
	2.0 TDI	125	05.12										
	2.0 TDI 4motion	81	10.10										
		1.4	55	02.04	11.07	24.3417-1701.7	220679				 	D=41, - Halter D=41, - Halter	TRW TRW
1.4 16V		59	05.06	11.07	24.3417-1702.7	220680							
1.6			04.04	11.07									
1.9 TDI		55	09.05	11.07									
1.9 TDI		77	02.04	11.07									
2.0 Eco Fuel		80	04.06	11.07									
2.0 SDI		51	02.04	11.07									
2.0 TDI		103	09.07	11.07									
		1.2 TSI		09.10	PR: 1ZF,2E2	24.3387-1719.7	220773	 	D=38, - Halter D=38, - Halter	TRW TRW			
		1.4	55	12.07	PR: 1ZF,2E2	24.3387-1720.7	220774						
	1.4 16V	59	12.07	PR: 1ZF,2E2									
	1.6		12.07	PR: 1ZF,2E2									
	1.6 TDI		08.10	PR: 1ZF,2E2									
	1.9 TDI	55	12.07	PR: 1ZF,2E2									
	1.9 TDI	77	12.07	PR: 1ZF,2E2									
	1.9 TDI 4motion	77	05.08	PR: 1ZF,2E2									
	2.0 Eco Fuel	80	12.07	PR: 1ZF,2E2									
	2.0 SDI	51	12.07	PR: 1ZF,2E2									
	2.0 TDI	81	10.10	PR: 1ZF,2E2									
	2.0 TDI	103	12.07	PR: 1ZF,2E2									
	2.0 TDI	125	05.12	PR: 1ZF,2E2									
	2.0 TDI 4motion	81	10.10	PR: 1ZF,2E2									
		1.2 TSI		09.10	PR: 1ZE,1LJ	24.3387-1719.7	220773				 	D=38, - Halter D=38, - Halter	TRW TRW
1.4		55	12.07	PR: 1ZE,1LJ	24.3387-1720.7	220774							
1.4 16V		59	12.07	PR: 1ZE,1LJ									
1.6			12.07	PR: 1ZE,1LJ									
1.6 TDI			08.10	PR: 1ZE,1LJ									
1.9 TDI		55	12.07	PR: 1ZE,1LJ									
1.9 TDI		77	12.07	PR: 1ZE,1LJ									
1.9 TDI 4motion		77	05.08	PR: 1ZE,1LJ									
2.0 Eco Fuel		80	12.07	PR: 1ZE,1LJ									
2.0 SDI		51	12.07	PR: 1ZE,1LJ									
2.0 TDI		81	10.10	PR: 1ZE,1LJ									
2.0 TDI		103	12.07	PR: 1ZE,1LJ									
2.0 TDI		125	05.12	PR: 1ZE,1LJ									
2.0 TDI 4motion		81	10.10	PR: 1ZE,1LJ									





VOLKSWAGEN CADDY III (04-15)

	1.2 TSI			09.10	PR: OE1	24.5289-0495.3	331457	2	+ verstärktes Fahrwerk / - kalte Zonen ¹⁾	L=495	
	1.4	55		02.04	PR: OE1	24.5289-0490.3	331389	2	- verstärktes Fahrwerk ²⁾	L=490	
	1.4 16V	59		05.06	PR: OE1						
	1.6			04.04	PR: OE1						
	1.6 TDI			08.10	PR: OE1						
	1.9 TDI	55		09.05	PR: OE1						
	1.9 TDI	77		02.04	PR: OE1						
	2.0 Eco Fuel	80		04.06	PR: OE1						
	2.0 SDI	51		02.04	PR: OE1						
	2.0 TDI	81		10.10	PR: OE1						
2.0 TDI	103		09.07	PR: OE1							
2.0 TDI	125		05.12	PR: OE1							
	1.4	55		02.04	10.09 PR: OE2	24.5289-0432.3	331377	2		L=432	
	1.4 16V	59		05.06	10.09 PR: OE2						
	1.6			04.04	10.09 PR: OE2						
	1.9 TDI	55		09.05	10.09 PR: OE2						
	1.9 TDI	77		02.04	10.09 PR: OE2						
	2.0 Eco Fuel	80		04.06	10.09 PR: OE2						
	2.0 SDI	51		02.04	10.09 PR: OE2						
	2.0 TDI	103		09.07	10.09 PR: OE2						
	2.0 TDI	125		05.12	PR: OE2	24.5289-0432.3	331377	2	- verstärktes Fahrwerk ²⁾	L=432	
	2.0 TDI	125		05.12	PR: OE2	24.5289-0425.3	331388	2	+ verstärktes Fahrwerk ³⁾	L=425	
	1.4	55	2K-8-075000	02.04		24.3727-0188.2	580188	2	↓	L=1713	
	1.4 16V	59	2K-8-075000	05.06							
	1.6		2K-8-075000	04.04							
	1.9 TDI	55	2K-8-075000	09.05							
	1.9 TDI	77	2K-8-075000	02.04							
	1.9 TDI 4motion	77	2K-8-075000	05.08							
	2.0 Eco Fuel	80	2K-8-075000	04.06							
	2.0 SDI	51	2K-8-075000	02.04							
	2.0 TDI	103	2K-8-075000	09.07							
	2.0 TDI	103	2K-8-075001		10.09	PR: OE1	24.3727-0188.2	580188	2	↓	L=1713
1.4 16V	59	2K-8-075001		10.09	PR: OE1						
1.6		2K-8-075001		10.09	PR: OE1						
1.9 TDI	55	2K-8-075001		10.09	PR: OE1						
1.9 TDI	77	2K-8-075001		10.09	PR: OE1						
1.9 TDI 4motion	77	2K-8-075001		10.09	PR: OE1						
2.0 Eco Fuel	80	2K-8-075001		10.09	PR: OE1						
2.0 SDI	51	2K-8-075001		10.09	PR: OE1						
2.0 TDI	103	2K-8-075001		10.09	PR: OE1						
	1.4	55	2K-8-075001		10.09	PR: OE2	24.3727-0194.2	580194	2	↓	L=2030
	1.4 16V	59	2K-8-075001		10.09	PR: OE2					
	1.6		2K-8-075001		10.09	PR: OE2					
	1.9 TDI	55	2K-8-075001		10.09	PR: OE2					
	1.9 TDI	77	2K-8-075001		10.09	PR: OE2					
	1.9 TDI 4motion	77	2K-8-075001		10.09	PR: OE2					
	2.0 Eco Fuel	80	2K-8-075001		10.09	PR: OE2					
	2.0 SDI	51	2K-8-075001		10.09	PR: OE2					
	2.0 TDI	103	2K-8-075001		10.09	PR: OE2					
	2.0 TDI	103	2K-8-075001		10.09	PR: OE2					
	1.2 TSI			09.10	PR: OE1	24.3727-0188.2	580188	2	↓ + verstärktes Fahrwerk ³⁾	L=1713	
	1.4	55		11.09	PR: OE1						
	1.4 16V	59		11.09	PR: OE1						
	1.6			11.09	PR: OE1						
	1.6 TDI			08.10	PR: OE1						
	1.9 TDI	55		11.09	PR: OE1						
	1.9 TDI	77		11.09	PR: OE1						
	2.0 Eco Fuel	80		11.09	PR: OE1						
	2.0 SDI	51		11.09	PR: OE1						
	2.0 TDI	81		10.10	PR: OE1						
2.0 TDI	103		11.09	PR: OE1							
2.0 TDI	125		05.12	PR: OE1							
	1.2 TSI			09.10	PR: OE2	24.3727-0194.2	580194	2	↓	L=2030	
	1.4	55		11.09	PR: OE2						
	1.4 16V	59		11.09	PR: OE2						
	1.6			11.09	PR: OE2						
	1.6 TDI			08.10	PR: OE2						
	1.9 TDI	55		11.09	PR: OE2						
	1.9 TDI	77		11.09	PR: OE2						
	2.0 Eco Fuel	80		11.09	PR: OE2						
	2.0 SDI	51		11.09	PR: OE2						
	2.0 TDI	81		10.10	PR: OE2						
2.0 TDI	103		11.09	PR: OE2							
2.0 TDI	125		05.12	PR: OE2							
	1.2 TSI			09.10		24.2415-1713.3	030132			Gz 15,87, + Sensor	
	1.4	55		02.04							
	1.4 16V	59		05.06							
	1.6			04.04							

¹⁾ + reinforced suspens. / - cold zones / + autotet.rinforzato / - zone fredde / + châssis renforcé / - zones froides / + suspens.reforzada / - zonas frías

²⁾ - reinforced suspension / - sospensione rinforzata / - châssis renforcé / - suspensión reforzada

³⁾ + reinforced suspension / + sospensione rinforzata / + châssis renforcé / + suspensión reforzada

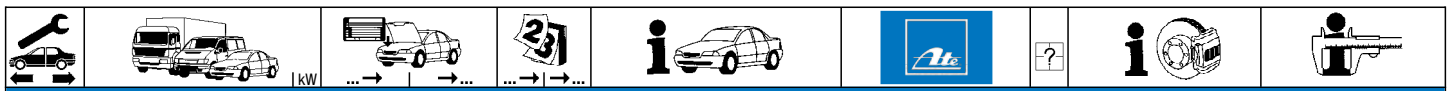

VOLKSWAGEN CADDY III (04-15)

	1.6 TDI		08.10	24.2415-1713.3	030132		Gz 15,87, + Sensor
	1.9 TDI	55	09.05				
	1.9 TDI	77	02.04				
	1.9 TDI 4motion	77	05.08				
	2.0 Eco Fuel	80	04.06				
	2.0 SDI	51	02.04				
	2.0 TDI	81	10.10				
	2.0 TDI	103	09.07				
	2.0 TDI	125	05.12				
	2.0 TDI 4motion	81	10.10				
	1.2 TSI		09.10	24.2519-1706.3	040096	PR: OEM	Nz 19,05
	1.4	55	02.04				
	1.4 16V	59	05.06				
	1.6		04.04				
	1.6 TDI		08.10				
	1.9 TDI	55	09.05				
	1.9 TDI	77	02.04				
	1.9 TDI 4motion	77	05.08				
	2.0 Eco Fuel	80	04.06				
	2.0 SDI	51	02.04				
	2.0 TDI	81	10.10				
	2.0 TDI	103	09.07				
	2.0 TDI	125	05.12				
	2.0 TDI 4motion	81	10.10				
	1.2 TSI		09.10	24.2519-1705.3	040095	PR: OEJ	Nz 19,05
	1.4	55	02.04				
	1.4 16V	59	05.06				
	1.6		04.04				
	1.6 TDI		08.10				
	1.9 TDI	55	09.05				
	1.9 TDI	77	02.04				
	1.9 TDI 4motion	77	05.08				
	2.0 Eco Fuel	80	04.06				
	2.0 SDI	51	02.04				
	2.0 TDI	81	10.10				
	2.0 TDI	103	09.07				
	2.0 TDI	125	05.12				
	2.0 TDI 4motion	81	10.10				

VOLKSWAGEN CADDY IV (15-)

	1.0 TSI	75	11.15	03.2123-3449.3	010808		Thz 23,81	ATE
	1.2 TSI	62	04.15					
	1.4 TGI CNG	81	04.15					
	1.4 TSI	92	04.15					
	1.6 TDI	55	04.15					
	1.6 TDI	75	04.15					
	2.0 TDI	55	04.15					
	2.0 TDI	75	04.15					
	2.0 TDI	81	09.15					
	2.0 TDI	103	04.15					
	2.0 TDI	110	04.15					
	2.0 TDI 4motion	55	04.15					
	2.0 TDI 4motion	81	04.15					
	2.0 TDI 4motion	90	04.15					
	2.0 TDI 4motion	103	04.15					
	2.0 TDI 4motion	110	11.15					
	1.0 TSI	75	11.15	24.2519-1706.3	040096	PR: OEM	Nz 19,05	
	1.2 TSI	62	04.15					
	1.4 TGI CNG	81	04.15					
	1.4 TSI	92	04.15					
	1.6 TDI	55	04.15					
	1.6 TDI	75	04.15					
	2.0 TDI	55	04.15					
	2.0 TDI	75	04.15					
	2.0 TDI	81	09.15					
	2.0 TDI	103	04.15					
	2.0 TDI	110	04.15					
	2.0 TDI 4motion	55	04.15					
	2.0 TDI 4motion	81	04.15					
	2.0 TDI 4motion	90	04.15					
	2.0 TDI 4motion	103	04.15					
	2.0 TDI 4motion	110	11.15					

VOLKSWAGEN CRAFTER (06-)

	2.0 TDI	103	11.15	24.2126-1704.3	010990		Thz 26,99	TRW
	2.0 TDI 4motion	120	11.11					
	2.0 TDI BlueMotion	80	07.11					
	2.0 TDI BlueMotion	100	07.11					
	2.0 TDI BlueMotion	120	07.11					
	2.5 TDI	65	07.11					
	2.5 TDI	80	07.11					
	2.5 TDI	100	07.11					
	2.5 TDI	120	07.11					































VOLKSWAGEN CRAFTER (06-)										
	2.0 TDI	103	11.15	PR: OWC, OWF, OWL	24.5137-0385.3	331089	2		L=385	
	2.0 TDI 4motion	120	11.11	PR: OWC, OWF, OWL						
	2.0 TDI BlueMotion	80	07.11	PR: OWC, OWF, OWL						
	2.0 TDI BlueMotion	100	07.11	PR: OWC, OWF, OWL						
	2.0 TDI BlueMotion	120	07.11	PR: OWC, OWF, OWL						
	2.5 TDI	65	04.06	PR: OWC, OWF, OWL						
	2.5 TDI	80	04.06	PR: OWC, OWF, OWL						
	2.5 TDI	100	04.06	PR: OWC, OWF, OWL						
2.5 TDI	120	04.06	PR: OWC, OWF, OWL							
	2.0 TDI	103	11.15	PR: OWC, OWL	24.5137-0385.3	331089	2		L=385	
	2.0 TDI BlueMotion	80	07.11	PR: OWC, OWL						
	2.0 TDI BlueMotion	100	07.11	PR: OWC, OWL						
	2.0 TDI BlueMotion	120	07.11	PR: OWC, OWL						
	2.5 TDI	65	04.06	PR: OWC, OWL						
	2.5 TDI	80	04.06	PR: OWC, OWL						
	2.5 TDI	100	04.06	PR: OWC, OWL						
	2.5 TDI	120	04.06	PR: OWC, OWL						
	2.0 TDI	103	11.15	PR: OWF	24.5131-0415.3	331238	2	+ Reifen 285/65 1)	L=415	
	2.0 TDI BlueMotion	80	07.11	PR: OWF						
	2.0 TDI BlueMotion	100	07.11	PR: OWF	24.5137-0470.3	331090	2			L=470
	2.0 TDI BlueMotion	120	07.11	PR: OWF						
	2.5 TDI	65	04.06	PR: OWF						
	2.5 TDI	80	04.06	PR: OWF						
	2.5 TDI	100	04.06	PR: OWF						
	2.5 TDI	120	04.06	PR: OWF						

VOLKSWAGEN EOS (06-)													
	2.0 FSI	110	05.06	PR: 1ZD	03.7863-3232.4	300307			10"	ATE			
	2.0 TFSI	147	05.06	PR: 1ZD									
	2.0 TFSI	162	11.13	PR: 1ZD									
	2.0 TSI	155	11.09	PR: 1ZD									
	3.2 V6	184	05.06	PR: 1ZD									
	3.6 V6	191	05.09	PR: 1ZD									
		1.4 TSI	90	10.07							PR: 1ZA,1ZE,1LJ	03.7863-3332.4	300308
1.4 TSI		118	05.08										
1.6 FSI		85	05.06										
2.0 FSI		110	05.06										
2.0 TDI		100	11.10										
2.0 TDI		103	05.06										
2.0 TDI 16V		103	05.08										
2.0 TFSI		147	05.06	PR: 1ZA,1ZE,1LJ									
2.0 TFSI		162	11.13	PR: 1ZA,1ZE,1LJ									
2.0 TSI		155	11.09	PR: 1ZA,1ZE,1LJ									
3.2 V6		184	05.06	PR: 1ZA,1ZE,1LJ									
3.6 V6	191	05.09	PR: 1LK										
	1.4 TSI	90	10.07	PR: 1ZE	03.2123-3449.3	010808	2	PR: 1ZA,1ZE,1LJ,1LK PR: 1AT,1ZD	Thz 23,81	ATE			
	1.4 TSI	118	05.08								03.2122-2129.3	010799	Thz 22,20
	1.6 FSI	85	05.06										
	2.0 FSI	110	05.06										
	2.0 TDI	100	11.10										
	2.0 TDI	103	05.06										
	2.0 TDI 16V	103	05.08										
	2.0 TFSI	147	05.06										
	2.0 TFSI	162	11.13										
	2.0 TSI	155	11.09										
	3.2 V6	184	05.06										
3.6 V6	191	05.09											
	1.4 TSI	90	10.07	PR: 1LJ,1ZA,1ZD	11.9541-9553.2	220563	2	PR: 1LJ,1ZA,1ZD PR: 1LJ,1ZA,1ZD PR: 1LJ,1ZA,1ZD PR: 1LJ,1ZA,1ZD PR: 1LJ,1ZA,1ZD PR: 1LJ,1ZA,1ZD PR: 1LJ,1ZA,1ZD PR: 1LJ,1ZA,1ZD PR: 1LJ,1ZA,1ZD PR: 1LJ,1ZA,1ZD PR: 1LJ,1ZA,1ZD	D=54, - Halter	ATE			
	1.4 TSI	118	05.08								11.9541-9554.2	220564	D=54, - Halter
	1.6 FSI	85	05.06						11.0101-5409.2	260035		Hülsensatz	ATE
	2.0 FSI	110	05.06						11.8171-0008.1	990049		Führungsbolzen	ATE
	2.0 TDI	100	11.10						11.8116-0351.1	390538		Haltefeder	ATE
	2.0 TDI	103	05.06										
	2.0 TDI 16V	103	05.08										
	2.0 TFSI	147	05.06										
	2.0 TFSI	162	11.13										
	2.0 TSI	155	11.09										
	3.2 V6	184	05.06										
3.6 V6	191	05.09											
	1.4 TSI	90	10.07	PR: 1LK	11.9576-9995.2	220651	2	PR: 1LJ,1ZA,1ZD PR: 1LJ,1ZA,1ZD PR: 1LJ,1ZA,1ZD PR: 1LJ,1ZA,1ZD PR: 1LJ,1ZA,1ZD	D=57, - Halter	ATE			
	1.4 TSI	118	05.08								11.9576-9996.2	220652	D=57, - Halter
	1.6 FSI	85	05.06						11.0101-5409.2	260035		Hülsensatz	ATE
	2.0 FSI	110	05.06						11.8171-0008.1	990049		Führungsbolzen	ATE
	2.0 TDI	100	11.10						11.8116-0410.2	390589		Haltefeder	ATE

1) + tyre 285/65 / + cerchio 285/65 / + pneu 285/65 / + cerca 285/65

									
VOLKSWAGEN EOS (06-)									
	2.0 TDI 2.0 TDI 16V 2.0 TFSI 2.0 TFSI 2.0 TSI 3.2 V6 3.6 V6	103 103 147 162 155 184 191	05.06 05.08 05.06 11.13 11.09 05.06 05.09	PR: 1LK PR: 1LK PR: 1LK PR: 1LK PR: 1LK PR: 1LK PR: 1LK	11.9576-9995.2 11.9576-9996.2 11.0101-5409.2 11.8171-0008.1 11.8116-0410.2	220651 220652 260035 990049 390589	 	D=57, - Halter D=57, - Halter Hülzensatz Führungsbolzen Haltefeder	ATE ATE ATE ATE ATE
	1.4 TSI 1.4 TSI 1.6 FSI 2.0 FSI 2.0 TDI 2.0 TDI 2.0 TDI 16V 2.0 TFSI 2.0 TFSI 2.0 TSI 3.2 V6 3.6 V6	90 118 85 110 100 103 103 147 162 155 184 191	10.07 05.08 05.06 05.06 11.10 05.06 05.08 05.06 11.13 11.09 05.06 05.09	PR: 1LJ,1ZD,1ZE PR: 1LJ,1ZD,1ZE PR: 1LJ,1ZD,1ZE PR: 1LJ,1ZD,1ZE PR: 1LJ,1ZD,1ZE PR: 1LJ,1ZD,1ZE PR: 1LJ,1ZD,1ZE PR: 1LJ,1ZD,1ZE PR: 1LJ,1ZD,1ZE PR: 1LJ,1ZD,1ZE PR: 1LJ,1ZD,1ZE PR: 1LJ,1ZD,1ZE	24.5143-0564.3	331433	2	L=564	
	1.4 TSI 1.4 TSI 1.6 FSI 2.0 FSI 2.0 TDI 2.0 TDI 2.0 TDI 16V 2.0 TFSI 2.0 TFSI 2.0 TSI 3.2 V6 3.6 V6	90 118 85 110 100 103 103 147 162 155 184 191	10.07 05.08 05.06 05.06 11.10 05.06 05.08 05.06 11.13 11.09 05.06 05.09	PR: 1KD PR: 1KD PR: 1KD PR: 1KD PR: 1KD PR: 1KD PR: 1KD PR: 1KD PR: 1KD PR: 1KD PR: 1KD PR: 1KD	24.3384-1755.7 24.3384-1756.7	220635 220636	 	D=38, - Halter D=38, - Halter	TRW TRW
	1.4 TSI 1.4 TSI 1.6 FSI 2.0 FSI 2.0 TDI 2.0 TDI 2.0 TDI 16V 2.0 TFSI 2.0 TFSI 2.0 TSI 3.2 V6 3.6 V6	90 118 85 110 100 103 103 147 162 155 184 191	10.07 05.08 05.06 05.06 11.10 05.06 05.08 05.06 11.13 11.09 05.06 05.09	PR: 1KZ PR: 1KZ PR: 1KZ PR: 1KZ PR: 1KZ PR: 1KZ PR: 1KZ PR: 1KZ PR: 1KZ PR: 1KZ PR: 1KZ PR: 1KZ	24.3387-1717.7 24.3387-1718.7 24.0101-3803.2	220757 220758 260101	 	D=38, - Halter D=38, - Halter Bremsattel-Zubehör	TRW TRW TRW
	1.4 TSI 1.4 TSI 1.6 FSI 2.0 FSI 2.0 TDI 2.0 TDI 2.0 TDI 16V 2.0 TFSI 2.0 TFSI 2.0 TSI 3.2 V6 3.6 V6	90 118 85 110 100 103 103 147 162 155 184 191	10.07 05.08 05.06 05.06 11.10 05.06 05.08 05.06 11.13 11.09 05.06 05.09	PR: 1KJ PR: 1KJ PR: 1KJ PR: 1KJ PR: 1KJ PR: 1KJ PR: 1KJ PR: 1KJ PR: 1KJ PR: 1KJ PR: 1KJ PR: 1KJ	24.3414-1709.7 24.3414-1710.7	220631 220632	 	D=41, - Halter D=41, - Halter	TRW TRW
	1.4 TSI 1.4 TSI 1.6 FSI 2.0 FSI 2.0 TDI 2.0 TDI 2.0 TDI 16V 2.0 TFSI 2.0 TFSI 2.0 TSI 3.2 V6 3.6 V6	90 118 85 110 100 103 103 147 162 155 184 191	10.07 05.08 05.06 05.06 11.10 05.06 05.08 05.06 11.13 11.09 05.06 05.09	PR: 2EA PR: 2EA PR: 2EA PR: 2EA PR: 2EA PR: 2EA PR: 2EA PR: 2EA PR: 2EA PR: 2EA PR: 2EA PR: 2EA	24.3417-1711.7 24.3417-1712.7	220883 220884	 	D=41, - Halter D=41, - Halter	TRW TRW
	1.4 TSI 1.4 TSI 1.6 FSI 2.0 FSI 2.0 TDI 2.0 TDI 2.0 TDI 16V 2.0 TFSI	90 118 85 110 100 103 103 147	10.07 05.08 05.06 05.06 11.10 05.06 05.08 05.06	PR: 1KD,1KJ,1KZ,2EA PR: 1KD,1KJ,1KZ,2EA PR: 1KD,1KJ,1KZ,2EA PR: 1KD,1KJ,1KZ,2EA PR: 1KD,1KJ,1KZ,2EA PR: 1KD,1KJ,1KZ,2EA PR: 1KD,1KJ,1KZ,2EA PR: 1KD,1KJ,1KZ,2EA	83.7849-0243.3	331099	2	L=243	

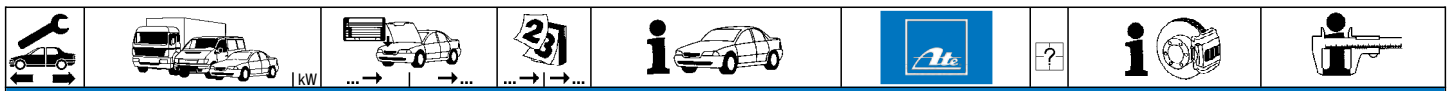

VOLKSWAGEN EOS (06-)

	2.0 TFSI	162	11.13	PR: 1KD,1KJ,1KZ,2EA	83.7849-0243.3	331099	2		L=243
	2.0 TSI	155	11.09	PR: 1KD,1KJ,1KZ,2EA					
	3.2 V6	184	05.06	PR: 1KD,1KJ,1KZ,2EA					
	3.6 V6	191	05.09	PR: 1KD,1KJ,1KZ,2EA					
	1.4 TSI	90	10.07	PR: 1KS	83.7847-0254.3	331233			L=255
	1.4 TSI	118	05.08	PR: 1KS	83.7847-0257.3	331234			L=255
	1.6 FSI	85	05.06	PR: 1KS					
	2.0 FSI	110	05.06	PR: 1KS					
	2.0 TDI	100	11.10	PR: 1KS					
	2.0 TDI	103	05.06	PR: 1KS					
	2.0 TDI 16V	103	05.08	PR: 1KS					
	2.0 TFSI	147	05.06	PR: 1KS					
	2.0 TFSI	162	11.13	PR: 1KS					
2.0 TSI	155	11.09	PR: 1KS						
3.2 V6	184	05.06	PR: 1KS						
3.6 V6	191	05.09	PR: 1KS						
	1.4 TSI	90	10.07		24.3727-2708.2	582708	2		L=1447
	1.4 TSI	118	05.08						
	1.6 FSI	85	05.06						
	2.0 FSI	110	05.06						
	2.0 TDI	100	11.10						
	2.0 TDI	103	05.06						
	2.0 TDI 16V	103	05.08						
	2.0 TFSI	147	05.06						
	2.0 TFSI	162	11.13						
	2.0 TSI	155	11.09						
	3.2 V6	184	05.06						
	3.6 V6	191	05.09						
		1.4 TSI	90	10.07		24.2415-1713.3	030132		
1.4 TSI		118	05.08						
1.6 FSI		85	05.06						
2.0 FSI		110	05.06						
2.0 TDI		100	11.10						
2.0 TDI		103	05.06						
2.0 TDI 16V		103	05.08						
2.0 TFSI		147	05.06						
2.0 TFSI		162	11.13						
2.0 TSI		155	11.09						
3.2 V6		184	05.06						
3.6 V6		191	05.09						
		1.4 TSI	90	10.07	PR: 0EJ	24.2519-1705.3	040095		
	1.4 TSI	118	05.08	PR: 0EJ					
	1.6 FSI	85	05.06	PR: 0EJ					
	2.0 FSI	110	05.06	PR: 0EJ					
	2.0 TDI	100	11.10	PR: 0EJ					
	2.0 TDI	103	05.06	PR: 0EJ					
	2.0 TDI 16V	103	05.08	PR: 0EJ					
	2.0 TFSI	147	05.06	PR: 0EJ					
	2.0 TFSI	162	11.13	PR: 0EJ					
	2.0 TSI	155	11.09	PR: 0EJ					
	3.2 V6	184	05.06	PR: 0EJ					
	3.6 V6	191	05.09	PR: 0EJ					
		1.4 TSI	90	10.07	PR: OEM	24.2519-1706.3	040096		
1.4 TSI		118	05.08	PR: OEM					
1.6 FSI		85	05.06	PR: OEM					
2.0 FSI		110	05.06	PR: OEM					
2.0 TDI		100	11.10	PR: OEM					
2.0 TDI		103	05.06	PR: OEM					
2.0 TDI 16V		103	05.08	PR: OEM					
2.0 TFSI		147	05.06	PR: OEM					
2.0 TFSI		162	11.13	PR: OEM					
2.0 TSI		155	11.09	PR: OEM					
3.2 V6		184	05.06	PR: OEM					
3.6 V6		191	05.09	PR: OEM					

VOLKSWAGEN FOX (05-11)

	1.0		10.03	08.11	PR: 1ZN	24.2120-1734.3	010702	+ ABS	THz 20,64
	1.2		04.05	08.11	PR: 1ZN				
	1.4	55	04.05	08.11	PR: 1ZN				
	1.4 TDI	51	04.05	08.11	PR: 1ZN				
	1.6		10.03	08.11	PR: 1ZN				
	1.9 D	47	12.07	08.11	PR: 1ZN				
	1.0		10.03	08.11	PR: 1ZF, 1AC, 1AT	24.2120-1734.3	010702	+ ABS	THz 20,64
	1.2		04.05	08.11	PR: 1ZF, 1AC, 1AT				
	1.4	55	04.05	08.11	PR: 1ZF, 1AC, 1AT				
	1.4 TDI	51	04.05	08.11	PR: 1ZF, 1AC, 1AT				
	1.6		10.03	08.11	PR: 1ZF, 1AC, 1AT				
	1.9 D	47	12.07	08.11	PR: 1ZF, 1AC, 1AT				
	1.0		10.03	08.11	PR: 1ZN	24.3481-1735.5	240283		D=48, - Halter
	1.2		04.05	08.11	PR: 1ZN	24.3481-1736.5	240284		D=48, - Halter
	1.4	55	04.05	08.11	PR: 1ZN				
	1.4 TDI	51	04.05	08.11	PR: 1ZN				
	1.6		10.03	08.11	PR: 1ZN				
	1.9 D	47	12.07	08.11	PR: 1ZN				















VOLKSWAGEN FOX (05-11)

	1.0 1.2 1.4 1.4 TDI 1.6 1.9 D			10.03 04.05 04.05 10.03 12.07	08.11 08.11 08.11 08.11 08.11	PR: 1ZF PR: 1ZF PR: 1ZF PR: 1ZF PR: 1ZF	11.9541-9549.2 11.9541-9550.2 11.0101-5409.2 11.8171-0069.1	220575 220576 260035 250152		D=54, - Halter D=54, - Halter Hülzensatz Führungsbolzen	ATE ATE ATE ATE
	1.0 1.2 1.4 1.4 TDI 1.6 1.9 D			10.03 04.05 04.05 10.03 12.07	08.11 08.11 08.11 08.11 08.11		83.6247-0522.3	330595	2	L=522	
	1.0 1.2 1.4 1.4 TDI 1.6 1.9 D			10.03 04.05 04.05 10.03 12.07	08.11 08.11 08.11 08.11 08.11		83.7858-0140.3	330837	2	L=140	
	1.0 1.2 1.4 1.4 TDI 1.6 1.9 D			10.03 04.05 04.05 10.03 12.07	08.11 08.11 08.11 08.11 08.11		24.3217-0908.3	020167		Rz 17,46	
	1.0 1.2 1.4 1.4 TDI 1.6 1.9 D			10.03 04.05 04.05 10.03 12.07	08.11 08.11 08.11 08.11 08.11	PR: 1BA PR: 1BA PR: 1BA PR: 1BA PR: 1BA	24.3727-0199.2	580199	2	L=1580	
	1.0 1.2 1.4 1.4 TDI 1.6 1.9 D			10.03 04.05 04.05 10.03 12.07	08.11 08.11 08.11 08.11 08.11		03.6584-0120.3	320279	- ABS	BRL 8/4 (4)	ATE
	1.0 1.2 1.4 1.4 TDI 1.6 1.9 D			10.03 04.05 04.05 10.03 12.07	08.11 08.11 08.11 08.11 08.11		24.2519-1706.3	040096		Nz 19,05	

VOLKSWAGEN GOLF III (92-97)

	1.4 1.6 1.8 1.8 Syncro 1.9 D 1.9 D Ecomatic 1.9 SDI 1.9 TD 1.9 TDI 1.9 TDI 1.9 TDI Syncro 2.0 2.0 GL 2.0 GTI 16V 2.0 Syncro 2.8 VR6			11.91 09.92 11.91 01.93 11.91 08.93 07.95 11.91 10.93 02.96 03.95 11.91 11.91 08.92 07.95 01.92	08.97 08.97 08.97 08.97 08.97 07.95 08.97 08.97 08.97 08.97 08.97 08.97 08.97 08.97 08.97 08.97 08.97	- ABS - ABS - ABS - ABS - ABS - ABS - ABS - ABS - ABS - ABS - ABS - ABS - ABS - ABS - ABS - ABS	03.7750-5502.4	300081		9"	ATE
	1.4 1.6 1.6 1.8 1.8 GT 1.8 Syncro 1.9 D 1.9 D Ecomatic 1.9 TD 1.9 TDI 2.0 GL 2.0 GTI 16V 2.8 VR6 2.9 VR6 Syncro		1H-S-088704 1H-S-088704 1H-S-088704 1H-S-088704 1H-S-088704 1H-S-088704 1H-S-088704 1H-S-088704 1H-S-088704 1H-S-088704 1H-S-088704 1H-S-088704 1H-S-088704 1H-S-088704 1H-S-088704	11.91 09.92 07.94 11.91 11.91 01.93 11.91 08.93 11.91 10.93 11.91 08.92 01.92 10.94		+ ABS + ABS + ABS + ABS + ABS + ABS + ABS + ABS + ABS + ABS + ABS + ABS + ABS + ABS + ABS	10.6360-1003.4	300156		10"	ATE
	1.4 1.6 1.6 1.8 1.8 GT 1.8 Syncro 1.9 D 1.9 D Ecomatic 1.9 SDI 1.9 TD 1.9 TDI 1.9 TDI	1H-S-088705 1H-S-088705 1H-S-088705 1H-S-088705 1H-S-088705 1H-S-088705 1H-S-088705 1H-S-088705 1H-S-088705 1H-S-088705 1H-S-088705 1H-S-088705		08.97 08.97 08.97 08.97 08.97 08.97 08.97 07.95 08.97 08.97 08.97 02.96		+ ABS + ABS + ABS + ABS + ABS + ABS + ABS + ABS + ABS + ABS + ABS + ABS	10.6360-2002.4	300143		10"	ATE



								
VOLKSWAGEN GOLF III (92-97)								
	1.9 TDI Syncro 2.0 GL 2.0 GTI 16V 2.0 Syncro 2.8 VR6 2.9 VR6 Syncro	66 79 110 1H-S-088705 1H-S-088705 1H-S-088705	03.95 08.97 08.97 08.97 07.95 08.97 08.97	+ ABS + ABS + ABS + ABS + ABS + ABS + ABS	10.6360-2002.4	300143		10" ATE
	1.4 1.6 1.8 1.9 D 1.9 D Ecomatic 1.9 SDI 1.9 TD	55 55 55 55 55 55 55	11.91 09.92 11.91 11.91 08.93 07.95 11.91	- ABS - ABS - ABS/ - GT - ABS - ABS - ABS - ABS	03.2120-3943.3 03.3517-0101.2	010532 390322		THz 20,64 Verschlusschraube ATE
	1.6 1.8 GT 1.8 Syncro 1.9 TDI 1.9 TDI 1.9 TDI Syncro 2.0 2.0 GL 2.0 GTI 16V 2.0 Syncro	74 74 74 66 81 66 85 79 110	07.94 11.91 01.93 10.93 02.96 03.95 11.91 11.91 08.92 07.95	- ABS - ABS - ABS - ABS - ABS - ABS - ABS - ABS - ABS - ABS	03.2122-1042.3 03.3517-0101.2	010137 390322		THz 22,20 Verschlusschraube ATE
	1.4 1.6 1.8 1.8 Syncro 1.9 D 1.9 D Ecomatic 1.9 TD	55 55 55 55 55 55	11.91 09.92 11.91 01.93 11.91 08.93 11.91	+ ABS + ABS + ABS/ - GT + ABS + ABS + ABS + ABS	10.6122-0144.3	010638		THz 22,20 ATE
	1.4 1.6 1.8 1.9 D 1.9 D Ecomatic 1.9 SDI 1.9 TD	1H-S-088705 55 1H-S-088705 1H-S-088705 1H-S-088705 1H-S-088705 55	08.97 08.97 08.97 08.97 07.95 08.97 08.97	+ ABS + ABS + ABS/ - GT + ABS + ABS + ABS + ABS	03.2122-1144.3	010636		THz 22,20 ATE
	1.6 1.8 GT 1.9 TDI 2.0 GL 2.0 GTI 16V 2.8 VR6 2.9 VR6 Syncro	74 74 66 79 110 110 110	07.94 11.91 10.93 11.91 08.92 01.92 10.94	+ ABS + ABS + ABS + ABS + ABS + ABS + ABS	10.6123-0674.3	010639		THz 23,81 ATE
	1.6 1.8 GT 1.8 Syncro 1.9 TDI 1.9 TDI 1.9 TDI Syncro 2.0 GL 2.0 GTI 16V 2.0 Syncro 2.8 VR6 2.9 VR6 Syncro	74 1H-S-088705 1H-S-088705 66 81 66 79 110 110 1H-S-088705 1H-S-088705	08.97 08.97 08.97 08.97 02.96 03.95 08.97 08.97 07.95 08.97 08.97	+ ABS + ABS + ABS + ABS + ABS + ABS + ABS + ABS + ABS + ABS + ABS	03.2123-1424.3	010637		THz 23,81 ATE
	1.4 1.6 1.8 1.9 D 1.9 SDI 1.9 TD	1H-S-088705 55 1H-S-088705 1H-S-088705 1H-S-088705 55	08.97 08.97 08.97 08.97 07.95 08.97	+ ABS + ABS + ABS/ - GT + ABS + ABS + ABS	03.2122-1184.3	010592		THz 22,20 ATE
	1.6 1.8 GT 1.9 TDI 1.9 TDI 2.0 GL 2.0 GTI 16V 2.8 VR6	74 1H-S-088705 66 81 79 110 1H-S-088705	08.97 08.97 08.97 08.97 02.96 08.97 08.97	+ ABS + ABS + ABS + ABS + ABS + ABS + ABS	03.2123-1484.3	010595		THz 23,81 ATE
	1.4 1.6 1.8 1.8 Syncro 1.9 D 1.9 D Ecomatic 1.9 SDI 1.9 TD	55 55 55 55 55 55 55	11.91 09.92 11.91 11.91 11.91 08.93 07.95 11.91	- GT/ + Schaltgetriebe ¹⁾ - GT/ + Automatikkgetriebe ²⁾	11.0441-4808.2 11.0101-4801.2 24.0102-4801.2	250022 260006 260085		Dichtungssatz Hülsensatz Hülsensatz+Schrauben ATE ATE ATE
	1.4 1.6 1.8 1.9 D 1.9 SDI 1.9 TD	1H-T-028355 55 1H-T-028355 1H-T-028355 1H-T-028355 55	08.97 08.97 08.97 08.97 08.97 08.97	- ABS - ABS - ABS/ - GT/ + Schaltgetriebe ³⁾ - ABS - ABS - ABS	11.0441-4808.2 11.0101-4801.2 24.0102-4801.2	250022 260006 260085		Dichtungssatz Hülsensatz Hülsensatz+Schrauben ATE ATE ATE





1) - GT/ + manual transm. / - GT/+ scatola cambio velocità / - GT/ + transmission mécanique / - GT/ + cambio de velocidad
2) - GT/ + autom.transmission / - GT/+ scatola cambio autom. / - GT/ + transmission automatique / - GT/ + cambio automático
3) - ABS/ - GT/ + manual transm. / - ABS/ - GT/+ scatola camb.velocità / - ABS/ - GT/ + transmiss. mécanique / - ABS/ - GT/ + cambio de velocidad

VOLKSWAGEN GOLF III (92-97)												
	1.6 CL/GL	74		07.94	08.97	- ABS	24.3541-1739.5	240223		D=54, - Halter	TRW	
	1.8		1H-S-246941	08.97	08.97	+ ABS / - GT/ + Automatikgetriebe 1)	24.3541-1740.5	240224		D=54, - Halter	TRW	
	1.8 Syncro		1H-S-089451	08.97	08.97		11.0101-5403.2	260010		Faltenbalgsatz	TRW	
	1.9 TDI	66		10.93	04.96							
	1.9 TDI Syncro	66		03.95	04.96							
	1.4			05.96	09.96	+ ABS	24.3541-1609.5	240039		- roter Sattel 2)	D=54, - Halter	TRW
	1.6	55		05.96	09.96	+ ABS	24.3541-1610.5	240040		- roter Sattel 2)	D=54, - Halter	TRW
	1.6 GT	74		07.94	08.97		24.0101-4301.2	260047			Bremssattel-Zubehör	TRW
	1.8			05.96	08.97	+ ABS	11.0101-5403.2	260010			Faltenbalgsatz	TRW
	1.8 GT			11.91	08.97							
	1.9 D			05.96	09.96	+ ABS						
	1.9 D Ecomatic		1H-S-246941	07.95	07.95							
1.9 SDI			05.96	09.96	+ ABS							
1.9 TD	55		05.96	09.96	+ ABS							
1.9 TDI	66		05.96	08.97								
1.9 TDI	81		02.96	08.97								
1.9 TDI Syncro	66		05.96	08.97								
2.0 GL	79		11.91	08.97								
2.0 Syncro			07.95	08.97								
1.4			10.96	08.97	+ ABS	11.0441-4808.2	250022			Dichtungssatz	ATE	
1.6	55		10.96	08.97	+ ABS	11.0101-4801.2	260006			Hülsensatz	ATE	
1.9 D			10.96	08.97	+ ABS	24.0102-4801.2	260085			Hülsensatz+Schrauben	ATE	
1.9 SDI			10.96	08.97	+ ABS							
1.9 TD	55		10.96	08.97	+ ABS							
2.0	85		11.91	04.96		24.3541-1731.5	240061		- roter Sattel 2)	D=54, - Halter	TRW	
2.0 GTI 16V	110		08.92	04.96		24.3541-1732.5	240062		- roter Sattel 2)	D=54, - Halter	TRW	
2.8 VR6		1H-S-399999	01.92	01.92		24.0101-4301.2	260047			Bremssattel-Zubehör	TRW	
2.0	85		05.96	08.97		11.3541-8523.2	220115		- roter Sattel 2)	D=54, - Halter	ATE	
2.0 GTI 16V	110		05.96	08.97		11.3541-8524.2	220116		- roter Sattel 2)	D=54, - Halter	ATE	
2.8 VR6		1H-S-400001	08.97	08.97		24.3541-8523.5	240551		- roter Sattel 2)	D=54, - Halter	ATE	
2.9 VR6 Syncro			10.94	08.97		24.3541-8524.5	240552		- roter Sattel 2)	D=54, - Halter	ATE	
						11.8170-0306.1	260102	2		Halter	ATE	
						11.0441-5409.2	250031			Dichtungssatz	ATE	
						11.0101-5409.2	260035			Hülsensatz	ATE	
						11.8171-0008.1	990049			Führungsbolzen	ATE	
						11.8116-0143.1	390513	2		Haltefeder	ATE	
	1.4			11.91	08.97		24.5105-0442.3	331432	2		L=442	
	1.6			09.92	08.97							
	1.8			11.91	08.97							
	1.8 Syncro			01.93	08.97							
	1.9 D			11.91	08.97							
	1.9 D Ecomatic			08.93	07.95							
	1.9 SDI			07.95	08.97							
	1.9 TD	55		11.91	08.97							
	1.9 TDI	66		10.93	08.97							
	1.9 TDI	81		02.96	08.97							
	1.9 TDI Syncro	66		03.95	08.97							
	2.0 GL	79		11.91	08.97							
2.0 Syncro			07.95	08.97								
2.8 VR6			01.92	02.95								
2.9 VR6 Syncro			10.94	02.95								
2.8 VR6			03.95	08.97		83.6232-0465.3	330736	2		L=465		
2.9 VR6 Syncro			03.95	08.97								
	1.8 GT		1H-P-240000	11.91			24.3384-1603.5	240015		D=38, - Halter	TRW	
	2.0	85	1H-P-240000	11.91			24.3384-1604.5	240016		D=38, - Halter	TRW	
	2.8 VR6		1H-P-240000	01.92			24.0101-3601.2	260044			Bremssattel-Zubehör	
	1.6 GT	74		07.94	06.95		24.3384-1707.5	240171		D=38, - Halter	TRW	
	1.8 GT		1H-P-240001	06.95	06.95		24.3384-1708.5	240172		D=38, - Halter	TRW	
	2.0	85	1H-P-240001	06.95	06.95		24.0101-3601.2	260044			Bremssattel-Zubehör	
	2.0 GTI 16V	110		08.92	08.97		11.0101-5403.2	260010			Faltenbalgsatz	
	2.8 VR6			08.92	08.97							
	2.9 VR6 Syncro			10.94	08.97							
	1.6	74		07.95	08.97		24.3384-1707.5	240171		- roter Sattel 2)	D=38, - Halter	TRW
	1.8 GT			07.95	08.97		24.3384-1708.5	240172		- roter Sattel 2)	D=38, - Halter	TRW
	1.9 TDI	81		02.96	08.97		11.0101-5403.2	260010			Faltenbalgsatz	
2.0	85		07.95	08.97								
	1.4			11.91	08.97		83.7836-0135.3	330816	2		L=135	
	1.6			09.92	08.97	- GT						
	1.8			11.91	08.97	- GT						
	1.8 Syncro			01.93	08.97							
	1.9 D			11.91	08.97							
	1.9 D Ecomatic			08.93	07.95							
	1.9 SDI			07.95	08.97							
	1.9 TD	55		11.91	08.97							
	1.9 TDI	66		10.93	08.97							
	1.9 TDI Syncro	66		03.95	08.97							
	2.0 Syncro			07.95	08.97							
	1.6 GT	74		07.94	08.97		83.7836-0135.3	330816	2		L=135	
1.8 GT			11.91	08.97		24.5170-0161.3	331308	2	am Bremssattel 3)	L=161		
1.9 TDI	81		02.96	08.97								
2.0	85		11.91	08.97								
2.0 GL	79		11.91	08.97								
2.0 GTI 16V	110		08.92	08.97								
2.8 VR6			01.92	08.97								
2.9 VR6 Syncro			10.94	08.97								

1) - ABS/ - GT/ + autom.transm. / - ABS/ - GT/+ scatola camb.autom. / - ABS/ - GT/ + transmiss. automatique / - ABS/ - GT/ + cambio automático

2) - red caliper / - pinza rossa / - étrier rouge / - pinza roja

3) on the brake caliper / sulla pinza freno / sur l'étrier de frein / a la pinza de freno



VOLKSWAGEN GOLF III (92-97)											
	1.4			11.91	08.97						
	1.8 CL/GL		1H-S-246940	11.91	08.97	+ Automatikgetriebe ³⁾	03.3215-2311.3	020018	+ GG ¹⁾	Rz 15,87	
	1.9 D Ecomatic		1H-S-246940	08.93			24.3215-0903.3	020154	+ ALU ²⁾	Rz 15,87	
	1.9 TD	55		11.91	08.97						
	1.6	55		09.92	08.97						
	1.6 CL/GL	74	1H-S-246940	07.94	08.97	+ Schaltgetriebe ⁴⁾	03.3217-2112.3	020027	+ GG ¹⁾	Rz 17,46	
	1.6 CL/GL	74		07.94	08.97	+ Automatikgetriebe ³⁾	24.3217-0908.3	020167	+ ALU ²⁾	Rz 17,46	
	1.8 CL/GL		1H-S-246940	11.91		+ Schaltgetriebe ⁴⁾					
	1.8 CL/GL		1H-S-246941		08.97	+ Automatikgetriebe ³⁾					
	1.9 D			11.91	08.97						
1.9 D Ecomatic		1H-S-246941		07.95							
1.9 SDI			07.95	08.97							
1.9 TDI	66		10.93	08.97							
1.6 CL/GL	74	1H-S-246941		08.97	+ Schaltgetriebe ⁴⁾	24.3219-0909.3	020188			Rz 19,05	
1.8 CL/GL		1H-S-246941		08.97	+ Schaltgetriebe ⁴⁾						
1.8 Syncro			1H-S-400000	01.93			24.3220-0909.3	020210		Rz 20,64	
1.8 Syncro		1H-S-400001		08.97			24.3222-0913.3	020255		Rz 22,20	
1.9 TDI Syncro	66			03.95	08.97						
2.0 Syncro				07.95	08.97						
	1.4		1H-S-037799	11.91			24.3727-0135.2	580135	2 ↓	L=1500	
	1.6		1H-S-037799	09.92		- GT					
	1.8		1H-S-037799	11.91		- GT					
	1.9 D		1H-S-037799	11.91							
	1.9 D Ecomatic		1H-S-037799	08.93							
	1.9 TD	55	1H-S-037799	11.91							
	1.9 TDI	66	1H-S-037799	10.93							
	1.4		1H-S-037800		08.97	- GT	24.3727-0160.2	580160	2 ↓	L=1498	
	1.6		1H-S-037800		08.97	- GT					
	1.8		1H-S-037800		08.97	- GT					
	1.9 D		1H-S-037800		08.97						
	1.9 D Ecomatic		1H-S-037800		07.95						
	1.9 SDI			07.95	08.97						
	1.9 TD	55	1H-S-037800		08.97						
	1.9 TDI	66	1H-S-037800		08.97						
	1.8 GT	85		1H-S-037799	11.91			24.3727-0134.2	580134	2 ↓	L=1613
	2.0	79		1H-S-037799	11.91						
	2.0 GL			1H-S-037799	11.91						
2.0 GTI 16V	110		1H-S-037799	08.92							
2.8 VR6			1H-S-037799	01.92							
1.6 GT	74			07.94	08.97		24.3727-0156.2	580156	2 ↓	L=1616	
1.8 GT		1H-S-037800		08.97							
1.9 TDI	81			02.96	08.97						
2.0	85	1H-S-037800		11.91	08.97						
2.0 GL	79	1H-S-037800		11.91	08.97						
2.0 GTI 16V	110	1H-S-037800		08.92	08.97						
2.8 VR6		1H-S-037800		01.92	08.97						
	1.4		1H-V-040000	11.91			03.0101-0025.2	320014		BRES 3/35 ATE	
	1.4		1H-V-040001		08.97		03.6584-0107.3	320110		BRL 8/4 (4) ATE	
	1.6			09.92	08.97	- GT					
	1.8			11.91	08.97	- GT					
	1.9 D			11.91	08.97						
	1.9 D Ecomatic			08.93	07.95						
	1.9 SDI			07.95	08.97						
	1.9 TD	55		11.91	08.97						
	1.9 TDI	66		10.93	08.97						
	1.6 GT	74		07.94	08.97		03.6584-0113.3	320111		BRL 8/4 (4) ATE	
1.8 GT			11.91	08.97							
1.9 TDI	81		02.96	08.97							
2.0	85		11.91	08.97							
2.0 GL	79		11.91	08.97							
2.0 GTI 16V	110		08.92	08.97							
2.8 VR6			01.92	08.97							
1.8 Syncro			01.93	08.97		03.6584-0015.3	320109		BRL 8/4 (4) ATE		
1.9 TDI Syncro	66		03.95	08.97							
2.0 Syncro			07.95	08.97							
2.9 VR6 Syncro			10.94	08.97							
	1.8 Syncro	◀		01.93	08.97		03.2419-9510.3	030028		Gz 19,05	
	1.9 TDI	◀	66	10.93	08.97						
	1.9 TDI	◀	81	02.96	08.97						
	1.9 TDI Syncro	◀	66	03.95	08.97						
	2.0	◀	85	11.91	08.97						
	2.0 GTI 16V	◀	110	08.92	08.97						
	2.0 Syncro	◀		07.95	08.97						
	2.8 VR6	◀		01.92	08.97						
	2.9 VR6 Syncro	◀		10.94	08.97						
	1.9 TDI	▶	66	10.93	08.97		03.2419-9910.3	030031		Gz 19,05	
1.9 TDI	▶	81	02.96	08.97							
2.0	▶	85	11.91	08.97							
2.0 GTI 16V	▶	110	08.92	08.97							
2.8 VR6	▶		01.92	08.97							
	1.8 Syncro	◀		01.93	08.97		24.2523-0908.3	040049		Nz 23,81	
	1.9 TDI	◀	66	10.93	08.97						
	1.9 TDI	◀	81	02.96	08.97						
	1.9 TDI Syncro	◀	66	03.95	08.97						
	2.0	◀	85	11.91	08.97						



1) + cast iron / + ghisa / + fonte grise / + fundición de gris

2) + aluminium / + alluminio / + aluminium / + aluminio

3) + autom.transmission / + scatola cambio automatico / + transmission automatique / + cambio automático

4) + manual transmission / + scatola cambio velocità / + transmission mécanique / + cambio de velocidad

VOLKSWAGEN GOLF III (92-97)										
	2.0 GTI 16V 2.0 Syncro 2.8 VR6 2.9 VR6 Syncro	110		08.92 07.95 01.92 10.94	08.97 08.97 08.97 08.97		24.2523-0908.3	040049		Nz 23,81
	1.4 1.6 1.6			11.91 09.92 07.94	08.97 08.97 12.95	- Motorcode AEX ¹⁾ - Motorcode AEE ²⁾	24.3728-0130.2	590130		L=1025, + AUT
	1.4 1.6 1.6 1.8 1.9 D 1.9 D Ecomatic 1.9 SDI 1.9 TD 2.0 GL			11.91 09.92 07.94 11.91 11.91 08.93 07.95 11.91 11.91	08.97 08.97 08.97 08.97 08.97 07.95 08.97 08.97 08.97	+ Motorcode AEX ³⁾ + Motorcode AEE ⁴⁾	24.3728-0127.2	590127		L=824, + AUT

VOLKSWAGEN GOLF III Variant (93-99)										
	1.4 1.6 1.8 1.8 Syncro 1.9 D 1.9 SDI 1.9 TD 1.9 TDI 1.9 TDI 1.9 TDI Syncro 2.0 2.0 Syncro			07.93 07.94 07.93 07.94 07.93 07.95 07.93 07.93 02.96 07.95 07.93 07.95	04.99 04.99 04.99 04.99 04.99 04.99 04.99 04.99 04.99 04.99 04.99 04.99	- ABS - ABS - ABS - ABS - ABS - ABS - ABS - ABS - ABS - ABS - ABS - ABS	03.7750-5502.4	300081		9" ATE
	1.4 1.6 1.8 1.8 Syncro 1.9 D 1.9 TD 1.9 TDI 1.9 TDI Syncro 2.0 2.0 Syncro 2.9 VR6		1H-SW385334 1H-SW385334 1H-SW385334 1H-SW385334 1H-SW385334 1H-SW385334 1H-SW385334 1H-SW385334 1H-SW385334 1H-SW385334 1H-SW385334	07.93 07.94 07.93 07.94 07.93 07.93 07.93 07.95 07.93 07.95 07.95	+ ABS + ABS + ABS + ABS + ABS + ABS + ABS + ABS + ABS + ABS + ABS		10.6360-1003.4	300156		10" ATE
	1.4 1.6 1.8 1.8 Syncro 1.9 D 1.9 SDI 1.9 TD 1.9 TDI 1.9 TDI 1.9 TDI Syncro 2.0 2.0 Syncro 2.9 VR6	1H-SW385335 74 1H-SW385335 1H-SW385335 1H-SW385335 1H-SW385335		07.95 07.95 02.96 07.95 07.95 07.95 07.95	+ ABS + ABS + ABS + ABS + ABS + ABS + ABS + ABS + ABS + ABS + ABS + ABS		10.6360-2002.4	300143		10" ATE
	1.4 1.6 1.8 1.8 Syncro 1.9 D 1.9 SDI 1.9 TD 1.9 TDI 1.9 TDI 1.9 TDI Syncro 2.0 2.0 Syncro			07.93 07.94 07.93 07.94 07.93 07.95 07.93 07.93 02.96 07.95 07.93 07.95	04.99 04.99 04.99 04.99 04.99 04.99 04.99 04.99 04.99 04.99 04.99 04.99	- ABS - ABS - ABS - ABS - ABS - ABS - ABS - ABS - ABS - ABS - ABS - ABS	03.2120-3943.3 03.3517-0101.2	010532 390322	2	THz 20,64 Verschlußschraube ATE
	1.6 1.8 1.8 Syncro 1.9 D 1.9 SDI 1.9 TD 1.9 TDI 1.9 TDI 1.9 TDI Syncro 2.0 2.0 Syncro	74		07.94 07.93 07.94 07.93 07.95 07.93 07.93 02.96 07.95 07.93 07.95	04.99 04.99 04.99 04.99 04.99 04.99 04.99 04.99 04.99 04.99 04.99	- ABS - ABS - ABS - ABS - ABS - ABS - ABS - ABS - ABS - ABS - ABS	03.2122-1042.3 03.3517-0101.2	010137 390322		THz 22,20 Verschlußschraube ATE
	1.4 1.8 Syncro 1.9 D 1.9 TD 1.9 TDI Syncro 2.0 Syncro		1H-SW385334 1H-SW385334 1H-SW385334 1H-SW385334 1H-SW385334 1H-SW385334	07.93 07.94 07.93 07.93 07.95 07.95	+ ABS + ABS + ABS + ABS + ABS + ABS		10.6122-0144.3	010638		THz 22,20 ATE
	1.4 1.9 D 1.9 SDI 1.9 TD	1H-SW385335 1H-SW385335		07.95 07.95 04.99 04.99	+ ABS + ABS + ABS + ABS		03.2122-1144.3	010636		THz 22,20 ATE
	1.6 1.8 1.9 TDI 2.0 2.9 VR6	74 66	1H-SW385334 1H-SW385334 1H-SW385334 1H-SW385334	07.94 07.93 09.93 07.93	+ ABS + ABS + ABS + ABS		10.6123-0674.3	010639		THz 23,81 ATE
	1.6 1.8 1.8 Syncro 1.9 TDI	74 66	1H-SW385335 1H-SW385335 1H-SW385335 1H-SW385335	04.99 04.99 04.99 04.99	+ ABS + ABS + ABS + ABS		03.2123-1424.3	010637		THz 23,81 ATE

¹⁾ - engine code AEX / - codice motore AEX / - moteur code AEX / - motor code AEX
²⁾ - engine code AEE / - codice motore AEE / - moteur code AEE / - motor code AEE
³⁾ + engine code AEX / + codice motore AEX / + moteur code AEX / + motor code AEX
⁴⁾ + engine code AEE / + codice motore AEE / + moteur code AEE / + motor code AEE

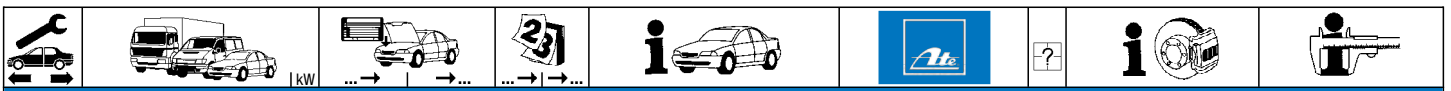

VOLKSWAGEN GOLF III Variant (93-99)

	1.9 TDI Syncro 2.0 Syncro 2.9 VR6	81 66 1H-SW385335 1H-SW385335 1H-SW385335	02.96 04.99 + ABS 04.99 + ABS 04.99 + ABS 04.99 + ABS	03.2123-1424.3 010637		Thz 23,81	ATE	
	1.4 1.9 D 1.9 SDI 1.9 TD	1H-SW385335 1H-SW385335 1H-SW385335 55 1H-SW385335	07.95 04.99 + ABS 04.99 + ABS 04.99 + ABS 04.99 + ABS	03.2122-1184.3 010592		Thz 22,20	ATE	
	1.6 1.8 1.9 TDI 1.9 TDI 2.0	74 1H-SW385335 1H-SW385335 66 1H-SW385335 81 1H-SW385335 81 1H-SW385335	02.96 04.99 + ABS 04.99 + ABS 04.99 + ABS 04.99 + ABS 04.99 + ABS	03.2123-1484.3 010595		Thz 23,81	ATE	
	1.4 1.8 Syncro	1H-TB015953 1H-SW369000	07.93 07.94	11.0441-4808.2 11.0101-4801.2 24.0102-4801.2	250022 260006 260085	Dichtungssatz Hülsensatz Hülsensatz+Schrauben	ATE ATE ATE	
	1.4 1.4	1H-TB015954	05.96 04.99 - ABS 04.96	11.0441-4808.2 11.0101-4801.2 24.0102-4801.2	250022 260006 260085	Dichtungssatz Hülsensatz Hülsensatz+Schrauben	ATE ATE ATE	
	1.6 1.8 1.8 1.8 Syncro 1.9 D 1.9 D 1.9 SDI 1.9 SDI 1.9 TD 1.9 TD 1.9 TDI 1.9 TDI	74 1H-SW369001 1H-TD365209	07.94 05.96 07.93 07.93 05.96 07.93 05.96 07.93 05.96 07.93 05.96 07.93	04.99 - ABS - ABS 04.96 - ABS - ABS - ABS - ABS - ABS - ABS - ABS - ABS - ABS	24.3541-1739.5 24.3541-1740.5 11.0101-5403.2 240223 240224 260010	D=54, - Halter D=54, - Halter Fallenbalgsatz	TRW TRW TRW	
	1.4 1.8 1.8 Syncro 1.9 D 1.9 SDI 1.9 TD 1.9 TD 1.9 TDI 1.9 TDI 1.9 TDI 2.0 2.0 Syncro	1H-TD365210	05.96 05.96 04.99 05.96 05.96 05.96 05.96 05.96 04.99 02.96 07.95 07.93 07.95	09.96 + ABS 04.99 + ABS 04.99 09.96 + ABS 09.96 + ABS 09.96 + ABS 04.99 + ABS 04.99 04.99 04.99 04.99 04.99	24.3541-1609.5 24.3541-1610.5 24.0101-4301.2 11.0101-5403.2	240039 240040 260047 260010	D=54, - Halter D=54, - Halter Bremsattel-Zubehör Fallenbalgsatz	TRW TRW TRW TRW
	1.4 1.9 D 1.9 SDI 1.9 TD	55 66 81 66	10.96 10.96 10.96 10.96	04.99 + ABS 04.99 + ABS 04.99 + ABS 04.99 + ABS	11.0441-4808.2 11.0101-4801.2 24.0102-4801.2	250022 260006 260085	Dichtungssatz Hülsensatz Hülsensatz+Schrauben	ATE ATE ATE
	2.9 VR6		07.95 04.99	11.3541-8523.2 11.3541-8524.2 24.3541-8523.5 24.3541-8524.5 11.8170-0306.1 11.0441-5409.2 11.0101-5409.2 11.8171-0008.1 11.8116-0143.1	220115 220116 240551 240552 260102 250031 260035 990049 390513	D=54, - Halter D=54, - Halter D=54, - Halter D=54, - Halter Halter Dichtungssatz Hülsensatz Führungsbolzen Haltefeder	ATE ATE ATE ATE ATE ATE ATE ATE ATE	
	1.4 1.6 1.8 1.8 Syncro 1.9 D 1.9 SDI 1.9 TD 1.9 TDI 1.9 TDI 1.9 TDI Syncro 2.0 2.0 Syncro 2.9 VR6	74 55 66 81 66	07.93 07.94 07.93 07.94 07.93 07.95 07.93 07.93 02.96 07.95 07.93 07.95	04.99 04.99 04.99 04.99 04.99 04.99 04.99 04.99 04.99 04.99 04.99 04.99	24.5105-0442.3 331432	L=442		
	2.9 VR6		07.95 04.99	83.6232-0465.3 330736	2	L=465		
	2.9 VR6		07.95 04.99	24.3384-1707.5 24.3384-1708.5 24.0101-3601.2 11.0101-5403.2	240171 240172 260044 260010	D=38, - Halter D=38, - Halter Bremsattel-Zubehör Fallenbalgsatz	TRW TRW TRW TRW	
	1.4 1.6 1.8 1.8 Syncro 1.9 D 1.9 SDI 1.9 TD 1.9 TDI 1.9 TDI 1.9 TDI Syncro 2.0 2.0 Syncro	74 55 66 81 66	07.93 07.94 07.93 07.94 07.93 07.95 07.93 07.93 02.96 07.95 07.93 07.95	04.99 04.99 04.99 04.99 04.99 04.99 04.99 04.99 04.99 04.99 04.99 04.99	83.7836-0135.3 330816	L=135		



VOLKSWAGEN GOLF III Variant (93-99)

	2.9 VR6			07.95	04.99		83.7836-0135.3 24.5170-0161.3	330816 331308	2 2	am Bremssattel ¹⁾	L=135 L=161
	1.4			07.93	06.95		03.3217-2112.3 24.3217-0908.3	020027 020167		+ GG ²⁾ + ALU ³⁾	Rz 17,46 Rz 17,46
	1.4			07.95	04.99		24.3219-0909.3	020188			Rz 19,05
	1.6	74		07.94	04.99						
	1.8			07.93	04.99						
	1.9 D			07.93	04.99						
	1.9 SDI			07.95	04.99						
	1.9 TD	55		07.93	04.99						
	1.9 TDI	66		07.93	04.99						
	1.9 TDI	81		02.96	04.99						
	2.0			07.93	04.99						
	1.8 Syncro			07.94	04.99		24.3222-0913.3	020255			Rz 22,20
	1.9 TDI Syncro	66		07.95	04.99						
	2.0 Syncro			07.95	04.99						
	1.4			1H-SW037527	07.93		24.3727-0135.2	580135	2		L=1500
	1.6	74		1H-SW037527	07.94						
	1.8			1H-SW037527	07.93						
	1.9 D			1H-SW037527	07.93						
	1.9 TD	55		1H-SW037527	07.93						
	1.9 TDI	66		1H-SW037527	07.93						
	2.0			1H-SW037527	07.93						
	1.4		1H-SW037528		04.99		24.3727-0160.2	580160	2		L=1498
	1.6	74	1H-SW037528		04.99						
	1.8		1H-SW037528		04.99						
	1.9 D		1H-SW037528		04.99						
	1.9 SDI			07.95	04.99						
	1.9 TD	55	1H-SW037528		04.99						
	1.9 TDI	66	1H-SW037528		04.99						
	1.9 TDI	81		02.96	04.99						
	2.0		1H-SW037528		04.99						
	1.4			07.93	04.99		03.6584-0107.3	320110			BRL 8/4 (4) ATE
	1.6	74		07.94	04.99						
	1.8			07.93	04.99						
	1.9 D			07.93	04.99						
	1.9 SDI			07.95	04.99						
	1.9 TD	55		07.93	04.99						
	1.9 TDI	66		07.93	04.99						
	1.9 TDI	81		02.96	04.99						
	2.0			07.93	04.99						
	1.8 Syncro			07.94	04.99		03.6584-0015.3	320109			BRL 8/4 (4) ATE
	1.9 TDI Syncro	66		07.95	04.99						
	2.0 Syncro			07.95	04.99						
	2.9 VR6			07.95	04.99						
	1.8 Syncro	◀		07.94	04.99		03.2419-9510.3	030028			Gz 19,05
	1.9 TDI	◀ 66		07.93	04.99						
	1.9 TDI	◀ 81		02.96	04.99						
	1.9 TDI Syncro	◀ 66		07.95	04.99						
	2.0 Syncro	◀		07.95	04.99						
	2.9 VR6	◀		07.95	04.99						
	1.9 TDI	▶ 66		07.93	04.99		03.2419-9910.3	030031			Gz 19,05
	1.9 TDI	▶ 81		02.96	04.99						
	1.8 Syncro	◀		07.94	04.99		24.2523-0908.3	040049			Nz 23,81
	1.9 TDI	◀ 66		07.93	04.99						
	1.9 TDI	◀ 81		02.96	04.99						
	1.9 TDI Syncro	◀ 66		07.95	04.99						
	2.0 Syncro	◀		07.95	04.99						
	2.9 VR6	◀		07.95	04.99						
	1.4	◀		07.93	04.99	+ Motorcode ABD,ABU,AEA,AEK ⁴⁾	24.3728-0130.2	590130			L=1025, + AUT
	1.6	◀ 74		07.94	04.99	+ Motorcode ABD,ABU,AEA,AEK ⁴⁾					
	1.4	◀		07.93	04.99	- Motorcode ABD,ABU,AEA,AEK ⁵⁾	24.3728-0127.2	590127			L=824, + AUT
	1.6	◀ 74		07.94	04.99	- Motorcode ABD,ABU,AEA,AEK ⁵⁾					
	1.8	◀		07.93	04.99						
	1.9 D	◀		07.93	04.99						
	1.9 TD	◀ 55		07.93	04.99						
	2.0	◀		07.93	04.99						

VOLKSWAGEN GOLF III Cabriolet (94-02)

	1.6	◀		10.94	02.02	- ABS	03.7750-5502.4	300081			9" ATE
	1.8	◀		09.93	02.02	- ABS					
	1.9 TDI	◀ 66		08.95	02.02	- ABS					
	1.9 TDI	◀ 81		09.96	02.02	- ABS					
	2.0	◀ 85		09.93	02.02	- ABS					
	1.6	◀		1E-S-021846	10.94	+ ABS	10.6360-1003.4	300156			10" ATE
	1.8	◀		1E-S-021846	09.93	+ ABS					
	1.9 TDI	◀ 66		1E-S-021846	08.95	+ ABS					
	2.0	◀ 85		1E-S-021846	09.93	+ ABS					
	1.6	◀	1E-S-021847		02.02	+ ABS	10.6360-2002.4	300143			10" ATE
	1.8	◀	1E-S-021847		02.02	+ ABS					
	1.9 TDI	◀ 66	1E-S-021847		02.02	+ ABS					
	1.9 TDI	◀ 81		09.96	02.02	+ ABS					
	2.0	◀ 85	1E-S-021847		02.02	+ ABS					

¹⁾ on the brake caliper / sulla pinza freno / sur l'étrier de frein / a la pinza de freno



















²⁾ + cast iron / + ghisa / + fonte grise / + fundición de gris

³⁾ + aluminium / + alluminio / + aluminium / + aluminio

⁴⁾ + engine code ABD,ABU,AEA,AEK / + codice motore ABD,ABU,AEA,AEK / + moteur code ABD,ABU,AEA,AEK / + motor code ABD,ABU,AEA,AEK

⁵⁾ - engine code ABD,ABU,AEA,AEK / - codice motore ABD,ABU,AEA,AEK / - moteur code ABD,ABU,AEA,AEK / - motor code ABD,ABU,AEA,AEK



											
VOLKSWAGEN GOLF III Cabriolet (94-02)											
	1.6 1.8 1.9 TDI 1.9 TDI 2.0			10.94 09.93 08.95 09.96 09.93	02.02 02.02 02.02 02.02 02.02	- ABS - ABS - ABS - ABS - ABS	03.2122-1042.3 03.3517-0101.2	010137 390322	THz 22,20 Verschlusschraube	ATE	
	1.6 1.8 1.9 TDI 2.0		1E-S-021846 1E-S-021846 1E-S-021846 1E-S-021846	10.94 09.93 08.95 09.93		+ ABS + ABS + ABS + ABS	10.6123-0674.3	010639	THz 23,81	ATE	
	1.6 1.8 1.9 TDI 1.9 TDI 2.0	1E-S-021847 1E-S-021847 66 1E-S-021847 81 85 1E-S-021847			02.02 02.02 02.02 09.96 02.02	+ ABS + ABS + ABS + ABS + ABS	03.2123-1424.3	010637	THz 23,81	ATE	
	1.6 1.8 1.9 TDI 1.9 TDI 2.0	1E-S-021847 1E-S-021847 66 1E-S-021847 81 85 1E-S-021847			02.02 02.02 02.02 09.96 02.02	+ ABS + ABS + ABS + ABS + ABS	03.2123-1484.3	010595	THz 23,81	ATE	
	1.6 1.8 1.8 1.9 TDI 2.0	55 66 66 85	1E-T-030000 1E-T-030000 1E-T-030000 1E-T-030000	10.94 09.93 09.93 08.95 09.93	02.02		24.3541-1739.5 24.3541-1740.5 11.0101-5403.2	240223 240224 260010	D=54, - Halter D=54, - Halter Faltenbalgsatz	TRW TRW TRW	
	1.6 1.8 1.9 TDI 1.9 TDI 2.0	1E-V-000001 66 1E-V-000001 66 1E-V-000001 81 85 1E-V-000001			02.02 02.02 02.02 09.96 02.02		24.3541-1609.5 24.3541-1610.5 24.0101-4301.2 11.0101-5403.2	240039 240040 260047 260010	D=54, - Halter D=54, - Halter Bremsattel-Zubehör Faltenbalgsatz	TRW TRW TRW TRW	
	1.6 1.8 1.9 TDI 1.9 TDI 2.0	66 81 85		10.94 09.93 08.95 09.96 09.93	02.02 02.02 02.02 02.02 02.02		24.5105-0442.3	331432	2	L=442	
	1.6 1.8 1.9 TDI 1.9 TDI 2.0	66 81 85	1E-X-014000 1E-X-014000 1E-X-014000 1E-X-014000 1E-X-014000	04.98 04.98 04.98 09.96 04.98			24.3384-1707.5 24.3384-1708.5 11.0101-5403.2	240171 240172 260010	D=38, - Halter D=38, - Halter Faltenbalgsatz	TRW TRW TRW	
	1.6 1.8 1.9 TDI 1.9 TDI 2.0	1E-X-014001 1E-X-014001 66 1E-X-014001 81 1E-X-014001 85 1E-X-014001			02.02 02.02 02.02 02.02 02.02		24.3384-1723.7 24.3384-1724.7	220523 220524	D=38(M12x1), - Halter D=38(M12x1), - Halter	TRW TRW	
	1.9 TDI 2.0	81 85	1E-X-016000 1E-X-016000	09.96 09.93			83.7836-0135.3 24.5170-0161.3	330816 331308	2 2	am Bremsattel ¹⁾	L=135 L=161
	1.6 1.8 1.9 TDI 1.9 TDI 2.0	66 81 85		10.94 09.93 08.95 02.02	02.02 02.02 02.02 02.02		83.7836-0135.3	330816	2	L=135	
	1.6 1.8 1.9 TDI 2.0	66 85	1E-SK016363 1E-SK016363 1E-SK016363 1E-SK016363	10.94 09.93 08.95 09.93			03.3217-2112.3 24.3217-0908.3	020027 020167	+ GG ²⁾ + ALU ³⁾	Rz 17,46 Rz 17,46	
	1.6 1.8 1.9 TDI 2.0	1E-SK016364 1E-SK016364 66 1E-SK016364 85 1E-SK016364			03.98 03.98 03.98 03.98		24.3219-0909.3	020188		Rz 19,05	
	1.8 2.0	85	1E-S-005031 1E-S-005031	09.93 09.93			24.3727-0135.2	580135	2 ↓	L=1500	
	1.6 1.8 1.9 TDI 2.0	1E-S-005032 66 85 1E-S-005032		10.94 03.98 08.95 03.98	03.98 03.98 03.98		24.3727-0160.2	580160	2 ↓	L=1498	
	1.6 1.8 1.9 TDI 1.9 TDI 2.0	66 81 85		04.98 04.98 04.98 09.96 04.98	02.02 02.02 02.02 02.02 02.02		24.3727-0156.2	580156	2 ↓	L=1616	
	1.6 1.8 1.9 TDI 2.0	66 85		10.94 09.93 08.95 09.93	02.02 02.02 02.02 02.02		03.6584-0107.3	320110		BRL 8/4 (4)	ATE
	1.9 TDI	81		09.96	02.02		03.6584-0113.3	320111		BRL 8/4 (4)	ATE
	1.6 1.8 1.9 TDI 1.9 TDI 2.0	66 66 81 85		10.94 07.95 08.95 09.96 07.95	02.02 02.02 02.02 02.02 02.02		03.2419-9510.3	030028		Gz 19,05	
	1.6 1.8 1.9 TDI 1.9 TDI	66 66 81 81		10.94 07.95 08.95 09.96	02.02 02.02 02.02 02.02		03.2419-9910.3	030031		Gz 19,05	

¹⁾ on the brake caliper / sulla pinza freno / sur l'étrier de frein / a la pinza de freno

²⁾ + cast iron / + ghisa / + fonte grise / + fundición de gris

³⁾ + aluminium / + alluminio / + aluminium / + aluminio



VOLKSWAGEN GOLF III Cabriolet (94-02)

	2.0	▶ 85		07.95	02.02		03.2419-9910.3	030031		Gz 19,05
	1.6			1E-2-002000	10.94		24.2523-0908.3	040049		Nz 23,81
	1.8	66		1E-2-002000	07.95					
	1.9 TDI	66		1E-2-002000	08.95					
	1.9 TDI	81		1E-2-002000	09.96					
	2.0	85		1E-2-002000	07.95					
	1.6		1E-2-002001		02.02		24.2519-1701.3	040075		Nz 19,05
	1.8	66	1E-2-002001		02.02					
	1.9 TDI	66	1E-2-002001		02.02					
	1.9 TDI	81	1E-2-002001		02.02					
	2.0	85	1E-2-002001		02.02					
	1.8	◀ 55		09.93	02.02		24.3728-0127.2	590127		L=824, + AUT
	1.8	◀ 66		09.93	06.95					
	2.0	◀ 85		09.93	06.95					

VOLKSWAGEN GOLF IV (98-05)

	1.4	◀		10.97	08.00	PR: 1AT	03.7863-0402.4	300124		10"	ATE
	1.6	◀		10.97	08.00	PR: 1AT					
	1.8	◀		10.97	08.00	PR: 1AT					
	1.8 4motion	◀ 92		07.98	08.00	PR: 1AT					
	1.8 T GTI	◀ 132		10.97	08.00	PR: 1AT					
	1.9 SDI	◀ 50		10.97	08.00	PR: 1AT					
	1.9 TDI	◀ 66		10.97	08.00	PR: 1AT					
	1.9 TDI	◀ 81		10.97	08.00	PR: 1AT					
	1.9 TDI	◀ 85		05.99	08.00	PR: 1AT					
	1.9 TDI 4motion	◀ 66		07.98	08.00	PR: 1AT					
	1.9 TDI 4motion	◀ 85		11.99	08.00	PR: 1AT					
	2.0	◀ 85		08.98	08.00	PR: 1AT					
	2.0 4motion	◀ 85		04.00	08.00	PR: 1AT					
	2.3 V5	◀		10.97	08.00	PR: 1AT					
	2.3 V5 4motion	◀		11.98	08.00	PR: 1AT					
	2.8 V6 4motion	◀		01.99	08.00	PR: 1AT					
	1.4	◀		09.00	10.01	PR: 1AT	03.7860-0602.4	300141		10"	ATE
	1.6	◀		09.00	10.01	PR: 1AT					
	1.8	◀		09.00	10.01	PR: 1AT					
	1.8 4motion	◀ 92		09.00	10.01	PR: 1AT					
	1.8 T GTI	◀ 132		09.00	10.01	PR: 1AT					
	1.9 SDI	◀ 50		09.00	10.01	PR: 1AT					
	1.9 TDI	◀ 66		09.00	06.01	PR: 1AT					
	1.9 TDI	◀ 74		09.00	10.01	PR: 1AT					
	1.9 TDI	◀ 81		09.00	10.01	PR: 1AT					
	1.9 TDI	◀ 85		09.00	06.01	PR: 1AT					
	1.9 TDI	◀ 96		04.01	10.01	PR: 1AT					
	1.9 TDI	◀ 110		09.00	10.01	PR: 1AT					
	1.9 TDI 4motion	◀ 66		09.00	06.01	PR: 1AT					
	1.9 TDI 4motion	◀ 74		09.00	10.01	PR: 1AT					
	1.9 TDI 4motion	◀ 85		09.00	06.01	PR: 1AT					
	1.9 TDI 4motion	◀ 96		04.01	10.01	PR: 1AT					
	1.9 TDI 4motion	◀ 110		09.00	10.01	PR: 1AT					
	2.0	◀ 85		09.00	10.01	PR: 1AT					
	2.0 4motion	◀ 85		09.00	10.01	PR: 1AT					
	2.3 V5	◀		09.00	10.03	PR: 1AT					
	2.3 V5 4motion	◀		09.00	10.03	PR: 1AT					
	2.8 V6 4motion	◀		09.00	10.03	PR: 1AT					
	1.4	◀		11.01	10.03	PR: 1AT	03.7863-3502.4	300128		10"	ATE
	1.6	◀		11.01	10.03	PR: 1AT					
	1.6 FSI	◀		01.02	10.03	PR: 1AT					
	1.8	◀		11.01	10.03	PR: 1AT					
	1.8 4motion	◀ 92		11.01	10.03	PR: 1AT					
	1.8 T GTI	◀ 132		11.01	10.03	PR: 1AT					
	1.9 SDI	◀ 50		11.01	10.03	PR: 1AT					
	1.9 TDI	◀ 74		11.01	06.05	PR: 1AT					
	1.9 TDI	◀ 81		11.01	10.03	PR: 1AT					
	1.9 TDI	◀ 96		11.01	10.03	PR: 1AT					
	1.9 TDI	◀ 110		11.01	10.03	PR: 1AT					
	1.9 TDI 4motion	◀ 74		11.01	06.05	PR: 1AT					
	1.9 TDI 4motion	◀ 96		11.01	10.03	PR: 1AT					
	1.9 TDI 4motion	◀ 110		11.01	10.03	PR: 1AT					
	2.0	◀ 85		11.01	10.03	PR: 1AT					
	2.0 4motion	◀ 85		11.01	10.03	PR: 1AT					
	2.3 V5	◀		11.01	10.03	PR: 1AT					
	2.3 V5 4motion	◀		11.01	10.03	PR: 1AT					
	2.8 V6 4motion	◀		11.01	10.03	PR: 1AT					
	3.2 R32 4motion	◀		06.02	10.03	PR: 1AT					
	1.4	◀		10.97	10.03	PR: 1AM,1AC,1AH,1AJ	24.2123-1709.3	010503		Thz 23,81	
	1.6	◀		10.97	10.03	PR: 1AM,1AC,1AH,1AJ					
	1.6 FSI	◀		01.02	10.03	PR: 1AM,1AC,1AH,1AJ					
	1.8	◀		10.97	10.03	PR: 1AM,1AC,1AH,1AJ					
	1.8 4motion	◀ 92		07.98	10.03	PR: 1AM,1AC,1AH,1AJ					
	1.8 T GTI	◀ 132		10.97	10.03	PR: 1AM,1AC,1AH,1AJ					
	1.9 SDI	◀ 50		10.97	10.03	PR: 1AM,1AC,1AH,1AJ					
	1.9 TDI	◀ 66		10.97	06.01	PR: 1AM,1AC,1AH,1AJ					
	1.9 TDI	◀ 74		09.00	06.05	PR: 1AM,1AC,1AH,1AJ					
	1.9 TDI	◀ 81		10.97	10.03	PR: 1AM,1AC,1AH,1AJ					



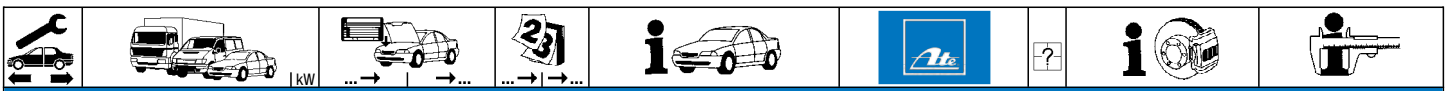

VOLKSWAGEN GOLF IV (98-05)

	1.9 TDI ◀ 85 1.9 TDI ◀ 96 1.9 TDI ◀ 110 1.9 TDI 4motion ◀ 66 1.9 TDI 4motion ◀ 74 1.9 TDI 4motion ◀ 85 1.9 TDI 4motion ◀ 96 1.9 TDI 4motion ◀ 110 2.0 ◀ 85 2.0 4motion ◀ 85 2.3 V5 ◀ 2.3 V5 4motion ◀ 2.8 V6 4motion ◀ 3.2 R32 4motion ◀		05.99 06.01 PR: 1AM,1AC,1AH,1AJ 04.01 10.03 PR: 1AM,1AC,1AH,1AJ 09.00 10.03 PR: 1AM,1AC,1AH,1AJ 07.98 06.01 PR: 1AM,1AC,1AH,1AJ 09.00 06.05 PR: 1AM,1AC,1AH,1AJ 11.99 06.01 PR: 1AM,1AC,1AH,1AJ 04.01 10.03 PR: 1AM,1AC,1AH,1AJ 09.00 10.03 PR: 1AM,1AC,1AH,1AJ 08.98 10.03 PR: 1AM,1AC,1AH,1AJ 04.00 10.03 PR: 1AM,1AC,1AH,1AJ 10.97 10.03 PR: 1AM,1AC,1AH,1AJ 11.98 10.03 PR: 1AM,1AC,1AH,1AJ 01.99 10.03 PR: 1AM,1AC,1AH,1AJ 06.02 10.03 PR: 1AM,1AC,1AH,1AJ	24.2123-1709.3 010503		THz 23,81
	1.4 ◀ 1.6 ◀ 1.8 ◀ 1.8 4motion ◀ 92 1.8 T GTI ◀ 132 1.9 SDI ◀ 50 1.9 TDI ◀ 66 1.9 TDI ◀ 81 1.9 TDI ◀ 85 1.9 TDI 4motion ◀ 66 1.9 TDI 4motion ◀ 85 2.0 ◀ 85 2.0 4motion ◀ 85 2.3 V5 ◀ 2.3 V5 4motion ◀ 2.8 V6 4motion ◀		10.97 08.00 PR: 1AT 10.97 08.00 PR: 1AT 10.97 08.00 PR: 1AT 07.98 08.00 PR: 1AT 10.97 08.00 PR: 1AT 10.97 08.00 PR: 1AT 10.97 08.00 PR: 1AT 05.99 08.00 PR: 1AT 07.98 08.00 PR: 1AT 11.99 08.00 PR: 1AT 08.98 08.00 PR: 1AT 04.00 08.00 PR: 1AT 10.97 08.00 PR: 1AT 11.98 08.00 PR: 1AT 01.99 08.00 PR: 1AT	03.2123-2024.3 010597		THz 23,81 ATE
	1.4 ◀ 1.6 ◀ 1.6 FSI ◀ 1.8 ◀ 1.8 4motion ◀ 92 1.8 T GTI ◀ 132 1.9 SDI ◀ 50 1.9 TDI ◀ 66 1.9 TDI ◀ 74 1.9 TDI ◀ 81 1.9 TDI ◀ 85 1.9 TDI ◀ 96 1.9 TDI ◀ 110 1.9 TDI 4motion ◀ 66 1.9 TDI 4motion ◀ 74 1.9 TDI 4motion ◀ 85 1.9 TDI 4motion ◀ 96 1.9 TDI 4motion ◀ 110 2.0 ◀ 85 2.0 4motion ◀ 85 2.3 V5 ◀ 2.3 V5 4motion ◀ 2.8 V6 4motion ◀ 3.2 R32 4motion ◀		09.00 10.03 PR: 1AT 09.00 10.03 PR: 1AT 01.02 10.03 PR: 1AT 09.00 10.03 PR: 1AT 09.00 10.03 PR: 1AT 09.00 10.03 PR: 1AT 09.00 04.02 PR: 1AT 09.00 06.05 PR: 1AT 09.00 10.03 PR: 1AT 09.00 06.01 PR: 1AT 04.01 10.03 PR: 1AT 09.00 10.03 PR: 1AT 09.00 06.01 PR: 1AT 09.00 06.05 PR: 1AT 09.00 06.01 PR: 1AT 04.01 10.03 PR: 1AT 09.00 10.03 PR: 1AT 09.00 10.03 PR: 1AT 09.00 10.03 PR: 1AT 09.00 10.03 PR: 1AT 11.98 08.00 PR: 1AT 01.99 08.00 PR: 1AT	03.2123-2715.3 010802		THz 23,81 ATE
	1.4 ▶ 1.6 ▶ 1.8 ▶ 1.8 4motion ▶ 92 1.8 T GTI ▶ 132 1.9 SDI ▶ 50 1.9 TDI ▶ 66 1.9 TDI ▶ 81 1.9 TDI ▶ 85 1.9 TDI 4motion ▶ 66 1.9 TDI 4motion ▶ 85 2.0 ▶ 85 2.0 4motion ▶ 85 2.3 V5 ▶ 2.3 V5 4motion ▶ 2.8 V6 4motion ▶		10.97 08.00 PR: 1AT 10.97 08.00 PR: 1AT 10.97 08.00 PR: 1AT 07.98 08.00 PR: 1AT 10.97 08.00 PR: 1AT 10.97 08.00 PR: 1AT 10.97 08.00 PR: 1AT 05.99 08.00 PR: 1AT 07.98 08.00 PR: 1AT 11.99 08.00 PR: 1AT 08.98 08.00 PR: 1AT 04.00 08.00 PR: 1AT 10.97 08.00 PR: 1AT 11.98 08.00 PR: 1AT 01.99 08.00 PR: 1AT	03.2123-2064.3 010598		THz 23,81 ATE
	1.4 ▶ 1.6 ▶ 1.6 FSI ▶ 1.8 ▶ 1.8 4motion ▶ 92 1.8 T GTI ▶ 132 1.9 SDI ▶ 50 1.9 TDI ▶ 66 1.9 TDI ▶ 74 1.9 TDI ▶ 81 1.9 TDI ▶ 85 1.9 TDI ▶ 96 1.9 TDI ▶ 110 1.9 TDI 4motion ▶ 66 1.9 TDI 4motion ▶ 74 1.9 TDI 4motion ▶ 85 1.9 TDI 4motion ▶ 96 1.9 TDI 4motion ▶ 96 2.0 ▶ 85 2.0 4motion ▶ 85		09.00 10.03 PR: 1AT 09.00 10.03 PR: 1AT 01.02 10.03 PR: 1AT 09.00 10.03 PR: 1AT 09.00 10.03 PR: 1AT 09.00 10.03 PR: 1AT 09.00 10.03 PR: 1AT 09.00 06.01 PR: 1AT 09.00 06.05 PR: 1AT 09.00 10.03 PR: 1AT 04.01 10.03 PR: 1AT 09.00 10.03 PR: 1AT 09.00 06.01 PR: 1AT 09.00 06.05 PR: 1AT 09.00 06.01 PR: 1AT 04.01 10.03 PR: 1AT 09.00 10.03 PR: 1AT 09.00 10.03 PR: 1AT 09.00 10.03 PR: 1AT 09.00 10.03 PR: 1AT 09.00 06.01 PR: 1AT 04.01 10.03 PR: 1AT	03.2123-2774.3 010803		THz 23,81 ATE

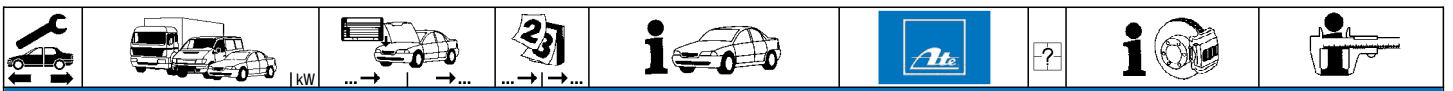

VOLKSWAGEN GOLF IV (98-05)

	1.9 TDI 4motion >>110 2.0 >>85 2.0 4motion >>85 2.3 V5 >> 2.3 V5 4motion >> 2.8 V6 4motion >> 3.2 R32 4motion >>			09.00 09.00 09.00 09.00 09.00 09.00 06.02	10.03 10.03 10.03 10.03 10.03 10.03 10.03	PR: 1AT PR: 1AT PR: 1AT PR: 1AT PR: 1AT PR: 1AT PR: 1AT	03.2123-2774.3 010803			Thz 23,81	ATE ATE ATE ATE ATE ATE ATE
	1.4 1.6 1.6 FSI 1.8 1.8 4motion 92 1.9 SDI 50 1.9 TDI 66 1.9 TDI 74 1.9 TDI 81 1.9 TDI 85 1.9 TDI 4motion 66 1.9 TDI 4motion 74 1.9 TDI 4motion 85 2.0 85 2.0 4motion 85			10.97 10.97 01.02 10.97 07.98 10.97 10.97 09.00 10.97 05.99 07.98 09.00 11.99 08.98 04.00	10.03 10.03 10.03 10.03 10.03 10.03 10.03 10.03 10.03 06.01 06.05 06.05 06.01 10.03 10.03	PR: 1LR,1LS,1LQ,1ZF,1ZM PR: 1LR,1LS,1LQ,1ZF,1ZM PR: 1LR,1LS,1LQ,1ZF,1ZM PR: 1LR,1LS,1LQ,1ZF,1ZM PR: 1LR,1LS,1LQ,1ZF,1ZM PR: 1LR,1LS,1LQ,1ZF,1ZM PR: 1LR,1LS,1LQ,1ZF,1ZM PR: 1LR,1LS,1LQ,1ZF,1ZM PR: 1LR,1LS,1LQ,1ZF,1ZM PR: 1LR,1LS,1LQ,1ZF,1ZM PR: 1LR,1LS,1LQ,1ZF,1ZM PR: 1LR,1LS,1LQ,1ZF,1ZM PR: 1LR,1LS,1LQ,1ZF,1ZM PR: 1LR,1LS,1LQ,1ZF,1ZM PR: 1LR,1LS,1LQ,1ZF,1ZM	11.9541-9549.2 11.9541-9550.2 11.0101-5409.2 11.8171-0069.1 220575 220576 260035 250152			D=54, - Halter D=54, - Halter Hülssensatz Führungsbolzen	ATE ATE ATE ATE ATE ATE ATE ATE ATE ATE ATE ATE ATE ATE ATE
	1.9 TDI 96 1.9 TDI 110 1.9 TDI 4motion 96 1.9 TDI 4motion 110 2.3 V5 2.3 V5 4motion 2.8 V6 4motion			04.01 09.00 04.01 09.00 10.97 11.98 01.99	10.03 10.03 10.03 10.03 10.03 10.03 10.03	PR: 1LE,1LN,1ZE,1ZH PR: 1LE,1LN,1ZE,1ZH PR: 1LE,1LN,1ZE,1ZH PR: 1LE,1LN,1ZE,1ZH PR: 1LE,1LN,1ZE,1ZH PR: 1LE,1LN,1ZE,1ZH PR: 1LE,1LN,1ZE,1ZH	11.3541-8523.2 11.3541-8524.2 11.8170-0306.1 24.3541-8523.5 24.3541-8524.5 11.0441-5409.2 11.0101-5409.2 11.8171-0008.1 11.8116-0143.1 220115 220116 260102 240551 240552 250031 260035 990049 390513			D=54, - Halter D=54, - Halter Halter D=54, - Halter D=54, - Halter Dichtungssatz Hülssensatz Führungsbolzen Haltefeder	ATE ATE ATE ATE ATE ATE ATE ATE ATE ATE ATE ATE ATE ATE ATE
	2.3 V5 2.3 V5 4motion 2.8 V6 4motion	1J-YB115040 1J-YB115040 1J-YB115040	10.97 11.98 01.99			PR: 1LJ,1ZQ PR: 1LJ,1ZQ PR: 1LJ,1ZQ	11.9541-9595.2 11.9541-9596.2 11.0441-5409.2 11.0101-5409.2 11.8171-0008.1 11.8116-0143.1 220501 220502 250031 260035 990049 390513			D=54, - Halter D=54, - Halter Dichtungssatz Hülssensatz Führungsbolzen Haltefeder	ATE ATE ATE ATE ATE ATE ATE ATE ATE ATE ATE ATE ATE ATE ATE
	2.3 V5 2.3 V5 4motion 2.8 V6 4motion	1J-Y-115041 1J-Y-115041 1J-Y-115041	1J-2-315308 1J-2-315308 1J-2-315308			PR: 1LJ,1ZQ PR: 1LJ,1ZQ PR: 1LJ,1ZQ	11.9541-9595.2 11.9541-9596.2 11.0441-5409.2 11.0101-5409.2 11.8171-0008.1 11.8116-0143.1 220501 220502 250031 260035 990049 390513			D=54, - Halter D=54, - Halter Dichtungssatz Hülssensatz Führungsbolzen Haltefeder	ATE ATE ATE ATE ATE ATE ATE ATE ATE ATE ATE ATE ATE ATE ATE
	2.3 V5 2.3 V5 4motion 2.8 V6 4motion	1J-2-315309 1J-2-315309 1J-2-315309		10.03 10.03 10.03		PR: 1LJ,1ZQ PR: 1LJ,1ZQ PR: 1LJ,1ZQ	11.9541-9595.2 11.9541-9596.2 11.0441-5409.2 11.0101-5409.2 11.8171-0008.1 11.8116-0143.1 220501 220502 250031 260035 990049 390513			D=54, - Halter D=54, - Halter Dichtungssatz Hülssensatz Führungsbolzen Haltefeder	ATE ATE ATE ATE ATE ATE ATE ATE ATE ATE ATE ATE ATE ATE ATE
	1.8 T GTI 132			10.97	10.03		11.9541-9595.2 11.9541-9596.2 11.0441-5409.2 11.0101-5409.2 11.8171-0008.1 11.8116-0143.1 220501 220502 250031 260035 990049 390513			D=54, - Halter D=54, - Halter Dichtungssatz Hülssensatz Führungsbolzen Haltefeder	ATE ATE ATE ATE ATE ATE ATE ATE ATE ATE ATE ATE ATE ATE ATE
	3.2 R32 4motion			06.02	10.03	PR: 1ZT	11.9421-9915.2 11.9421-9916.2 11.8171-0008.1 11.8116-0260.1 220869 220870 990049 390597			D=42, - Halter D=42, - Halter Führungsbolzen Haltefeder	ATE ATE ATE ATE ATE ATE ATE ATE ATE ATE ATE ATE ATE ATE ATE
	1.4 1.6 1.6 FSI 1.8 1.8 T GTI 132 1.9 SDI 50 1.9 TDI 66 1.9 TDI 74 1.9 TDI 81 1.9 TDI 85 1.9 TDI 96 1.9 TDI 110 2.0 85 2.3 V5			10.97 10.97 01.02 10.97 10.97 10.97 09.00 10.97 05.99 04.01 09.00 08.98 10.97	10.03 10.03 10.03 10.03 10.03 10.03 06.01 06.05 10.03 06.01 10.03 10.03 10.03 10.03		24.5143-0439.3 331411			L=439	ATE ATE ATE ATE ATE ATE ATE ATE ATE ATE ATE ATE ATE ATE ATE
	1.8 4motion 92 1.9 TDI 4motion 66 1.9 TDI 4motion 74 1.9 TDI 4motion 85 1.9 TDI 4motion 96 1.9 TDI 4motion 110 2.0 4motion 85 2.3 V5 4motion 2.8 V6 4motion			07.98 07.98 09.00 11.99 04.01 09.00 04.00 11.98 01.99	10.03 06.01 06.05 06.01 10.03 10.03 10.03 10.03 10.03		24.5143-0569.3 331398	2		L=569	ATE ATE ATE ATE ATE ATE ATE ATE ATE ATE ATE ATE ATE ATE ATE
	1.4 1.6 1.8 1.9 SDI 50 1.9 TDI 66 1.9 TDI 81	1J-Y-238580 1J-Y-238580 1J-Y-238580 1J-Y-238580 1J-Y-238580 1J-Y-238580	10.97 10.97 10.97 10.97 10.97 10.97			PR: 1KK,1KS,1KV PR: 1KK,1KS,1KV PR: 1KK,1KS,1KV PR: 1KK,1KS,1KV PR: 1KK,1KS,1KV PR: 1KK,1KS,1KV	24.3384-1723.7 24.3384-1724.7 220523 220524			D=38(M12x1), - Halter D=38(M12x1), - Halter	TRW TRW TRW TRW TRW TRW TRW TRW TRW TRW TRW TRW TRW TRW TRW



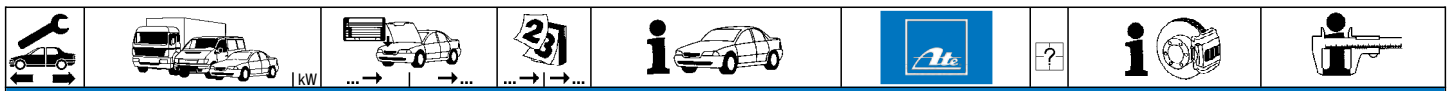



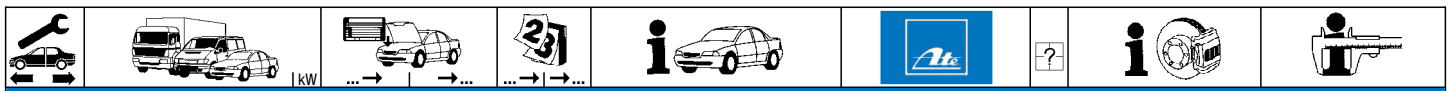

VOLKSWAGEN GOLF IV (98-05)

	1.9 TDI	85	1J-Y-238580	05.99	PR: 1KK,1KS,1KV	24.3384-1723.7	220523		D=38(M12x1), - Halter D=38(M12x1), - Halter	TRW TRW			
	2.0	85	1J-Y-238580	08.98	PR: 1KK,1KS,1KV	24.3384-1724.7	220524						
	2.3 V5		1J-Y-238580	10.97	PR: 1KK,1KS,1KV								
	1.4		1J-Y-238581		10.03 PR: 1KK,1KS,1KV	24.3384-1729.7	220541		D=38(M12x1), - Halter D=38(M12x1), - Halter	TRW TRW			
	1.6		1J-Y-238581		10.03 PR: 1KK,1KS,1KV	24.3384-1730.7	220542						
	1.6 FSI			01.02	10.03 PR: 1KK,1KS,1KV								
	1.8		1J-Y-238581		10.03 PR: 1KK,1KS,1KV								
	1.9 SDI	50	1J-Y-238581		10.03 PR: 1KK,1KS,1KV								
	1.9 TDI	66	1J-Y-238581		06.01 PR: 1KK,1KS,1KV								
	1.9 TDI	74		09.00	06.05 PR: 1KK,1KS,1KV								
	1.9 TDI	81	1J-Y-238581		10.03 PR: 1KK,1KS,1KV								
	1.9 TDI	85	1J-Y-238581		06.01 PR: 1KK,1KS,1KV								
	1.9 TDI	96		04.01	10.03 PR: 1KK,1KS,1KV								
	1.9 TDI	110		09.00	10.03 PR: 1KK,1KS,1KV								
	2.0	85	1J-Y-238581		10.03 PR: 1KK,1KS,1KV								
	2.3 V5		1J-Y-238581		10.03 PR: 1KK,1KS,1KV								
	1.4			10.97	10.03 PR: 1KY	24.3384-1745.7	220609					D=38, - Halter D=38, - Halter	TRW TRW
	1.6			10.97	10.03 PR: 1KY	24.3384-1746.7	220610						
	1.6 FSI			01.02	10.03 PR: 1KY								
	1.8			10.97	10.03 PR: 1KY								
	1.9 SDI	50		10.97	10.03 PR: 1KY								
	1.9 TDI	66		10.97	06.01 PR: 1KY								
	1.9 TDI	74		09.00	06.05 PR: 1KY								
1.9 TDI	81		10.97	10.03 PR: 1KY									
1.9 TDI	85		05.99	06.01 PR: 1KY									
1.9 TDI	96		04.01	10.03 PR: 1KY									
1.9 TDI	110		09.00	10.03 PR: 1KY									
2.0	85		08.98	10.03 PR: 1KY									
2.3 V5			10.97	10.03 PR: 1KY									
1.8 4motion	92		07.98	10.03 PR: 1KE	24.3414-1705.7	220549		D=41, - Halter D=41, - Halter	TRW TRW				
1.9 TDI 4motion	66		07.98	06.01 PR: 1KE	24.3414-1706.7	220550							
1.9 TDI 4motion	74		09.00	06.05 PR: 1KE									
1.9 TDI 4motion	85		11.99	06.01 PR: 1KE									
1.9 TDI 4motion	96		04.01	10.03 PR: 1KE									
1.9 TDI 4motion	110		09.00	10.03 PR: 1KE									
2.0 4motion	85		04.00	10.03 PR: 1KE									
2.3 V5 4motion			11.98	10.03 PR: 1KE									
2.8 V6 4motion			01.99	10.03 PR: 1KU,2EE	24.3384-1745.7	220609					D=38, - Halter D=38, - Halter	TRW TRW	
					24.3384-1746.7	220610							
	1.4			10.97	10.03	83.7858-0140.3	330837	2	L=140				
	1.6			10.97	10.03								
	1.6 FSI			01.02	10.03								
	1.8			10.97	10.03								
	1.8 T GTI	132		10.97	10.03								
	1.9 SDI	50		10.97	10.03								
	1.9 TDI	66		10.97	06.01								
	1.9 TDI	74		09.00	06.05								
	1.9 TDI	81		10.97	10.03								
	1.9 TDI	85		05.99	06.01								
	1.9 TDI	96		04.01	10.03								
	1.9 TDI	110		09.00	10.03								
	2.0	85		08.98	10.03								
	2.3 V5			10.97	10.03								
	1.8 4motion	92		07.98	10.03	83.7858-0140.3	330837				2	L=140	
	1.9 TDI 4motion	66		07.98	06.01								
	1.9 TDI 4motion	74		09.00	06.05								
	1.9 TDI 4motion	85		11.99	06.01								
	1.9 TDI 4motion	96		04.01	10.03								
	1.9 TDI 4motion	110		09.00	10.03								
2.0 4motion	85		04.00	10.03									
2.3 V5 4motion			11.98	10.03									
2.8 V6 4motion			01.99	10.03									
3.2 R32 4motion			06.02	10.03									
	1.4		1J-Y-238580	10.97		24.3727-0149.2	580149	2	L=1688				
	1.6		1J-Y-238580	10.97									
	1.8		1J-Y-238580	10.97									
	1.8 T GTI	132	1J-Y-238580	10.97									
	1.9 SDI	50	1J-Y-238580	10.97									
	1.9 TDI	66	1J-Y-238580	10.97									
	1.9 TDI	81	1J-Y-238580	10.97									
	1.9 TDI	85	1J-Y-238580	05.99									
	2.0	85	1J-Y-238580	08.98									
	1.4		1J-Y-238581		10.03	24.3727-0173.2	580173				2	L=1693	
1.6		1J-Y-238581		10.03									
1.6 FSI			01.02	10.03									
1.8		1J-Y-238581		10.03									
1.8 T GTI	132	1J-Y-238581		10.03									
1.9 SDI	50	1J-Y-238581		10.03									
1.9 TDI	66	1J-Y-238581		06.01									
1.9 TDI	74		09.00	06.05									
1.9 TDI	81	1J-Y-238581		10.03									
1.9 TDI	85	1J-Y-238581		06.01									
1.9 TDI	96		04.01	10.03									
1.9 TDI	110		09.00	10.03									
2.0	85	1J-Y-238581		10.03									
2.3 V5			10.97	10.03									

1) - red caliper / - pinza rossa / - étrier rouge / - pinza roja



VOLKSWAGEN GOLF IV (98-05)

	1.8 4motion 92		07.98	10.03	24.3727-0175.2	580175	2 ↓		L=1723
	1.9 TDI 4motion 66		07.98	10.03					
	1.9 TDI 4motion 74		09.00	06.05					
	1.9 TDI 4motion 85		11.99	10.03					
	1.9 TDI 4motion 96		04.01	10.03					
	1.9 TDI 4motion 110		09.00	10.03					
	2.0 4motion 85		04.00	10.03					
	2.3 V5 4motion		11.98	10.03					
	2.8 V6 4motion		01.99	10.03					
	3.2 R32 4motion		06.02	10.03					
	1.4	◀	10.97	10.03	24.2415-1701.3	030095			Gz 15,87
	1.6	◀	10.97	10.03					
	1.6 FSI	◀	01.02	10.03					
	1.8	◀	10.97	10.03					
	1.8 4motion	◀ 92	07.98	10.03					
	1.8 T GTI	◀ 132	10.97	10.03					
	1.9 SDI	◀ 50	10.97	10.03					
	1.9 TDI	◀ 66	10.97	06.01					
	1.9 TDI	◀ 74	09.00	06.05					
	1.9 TDI	◀ 81	10.97	10.03					
	1.9 TDI	◀ 85	05.99	06.01					
	1.9 TDI	◀ 96	04.01	10.03					
	1.9 TDI	◀ 110	09.00	10.03					
	1.9 TDI 4motion	◀ 66	07.98	06.01					
	1.9 TDI 4motion	◀ 74	09.00	06.05					
	1.9 TDI 4motion	◀ 85	11.99	06.01					
	1.9 TDI 4motion	◀ 96	04.01	10.03					
	1.9 TDI 4motion	◀ 110	09.00	10.03					
	2.0	◀ 85	08.98	10.03					
	2.0 4motion	◀ 85	04.00	10.03					
	2.3 V5	◀	10.97	10.03					
	2.3 V5 4motion	◀	11.98	10.03					
	2.8 V6 4motion	◀	01.99	10.03					
	3.2 R32 4motion	◀	06.02	10.03					
	1.4	▶	10.97	10.03	24.2415-1702.3	030096			Gz 15,87
	1.6	▶	10.97	10.03					
	1.6 FSI	▶	01.02	10.03					
	1.8	▶	10.97	10.03					
	1.8 4motion	▶ 92	07.98	10.03					
	1.8 T GTI	▶ 132	10.97	10.03					
	1.9 SDI	▶ 50	10.97	10.03					
	1.9 TDI	▶ 66	10.97	06.01					
	1.9 TDI	▶ 74	09.00	06.05					
	1.9 TDI	▶ 81	10.97	10.03					
	1.9 TDI	▶ 85	05.99	06.01					
	1.9 TDI	▶ 96	04.01	10.03					
	1.9 TDI	▶ 110	09.00	10.03					
	1.9 TDI 4motion	▶ 66	07.98	06.01					
	1.9 TDI 4motion	▶ 74	09.00	06.05					
	1.9 TDI 4motion	▶ 85	11.99	06.01					
	1.9 TDI 4motion	▶ 96	04.01	10.03					
	1.9 TDI 4motion	▶ 110	09.00	10.03					
	2.0	▶ 85	08.98	10.03					
	2.0 4motion	▶ 85	04.00	10.03					
	2.3 V5	▶	10.97	10.03					
	2.3 V5 4motion	▶	11.98	10.03					
	2.8 V6 4motion	▶	01.99	10.03					
	3.2 R32 4motion	▶	06.02	10.03					
	1.4		10.97	10.03	24.2519-1701.3	040075		+ Schaltseilzug ¹⁾	Nz 19,05
	1.6		10.97	10.03	24.2523-1701.3	040080		+ Schaltgestänge ²⁾	Nz 23,81
	1.6 FSI		01.02	10.03					
	1.8		10.97	10.03					
	1.8 4motion	92	07.98	10.03					
	1.8 T GTI	132	10.97	10.03					
	1.9 SDI	50	10.97	10.03					
	1.9 TDI	66	10.97	06.01					
	1.9 TDI	74	09.00	06.05					
	1.9 TDI	81	10.97	10.03					
	1.9 TDI	96	04.01	10.03					
	1.9 TDI	110	09.00	10.03					
	1.9 TDI 4motion	66	07.98	06.01					
	2.0	85	08.98	10.03					
	2.0 4motion	85	04.00	10.03					
	2.3 V5		10.97	10.03					

VOLKSWAGEN GOLF IV Variant (99-06)

	1.4	◀	05.99	08.00	PR: 1AT	03.7863-0402.4	300124		10"	ATE
	1.6	◀	05.99	08.00	PR: 1AT					
	1.8 4motion	◀ 92	05.99	08.00	PR: 1AT					
	1.8 T	◀ 110	05.00	08.00	PR: 1AT					
	1.9 SDI	◀	05.99	08.00	PR: 1AT					
	1.9 TDI	◀ 66	05.99	08.00	PR: 1AT					
	1.9 TDI	◀ 81	05.99	08.00	PR: 1AT					
	1.9 TDI	◀ 85	05.99	08.00	PR: 1AT					
	1.9 TDI 4motion	◀ 66	05.99	08.00	PR: 1AT					
	1.9 TDI 4motion	◀ 85	11.99	08.00	PR: 1AT					
	2.0	◀ 85	05.99	08.00	PR: 1AT					

¹⁾ + gearshift cable / + leva cambio con cavo / + câble de changem.de vitesse / + cable de acc. del cambio





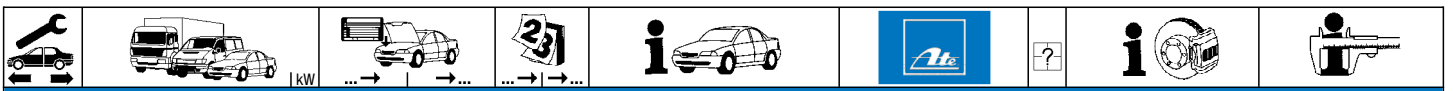







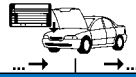







²⁾ + gearshift linkage / + leva cambio con tiranteria / + tige de changem.de vitesse / + varillaje del cambio





VOLKSWAGEN GOLF IV Variant (99-06)

	2.0 4motion	04.00	08.00	PR: 1AT	03.7863-0402.4	300124		10"	ATE
	2.3 V5	05.99	08.00	PR: 1AT					
	2.3 V5 4motion	05.99	08.00	PR: 1AT					
	2.8 V6 4motion	05.99	08.00	PR: 1AT					
	1.4	09.00	10.01	PR: 1AT	03.7860-0602.4	300141		10"	ATE
	1.6	09.00	10.01	PR: 1AT					
	1.8 4motion	09.00	10.01	PR: 1AT					
	1.8 T	09.00	10.01	PR: 1AT					
	1.9 SDI	09.00	10.01	PR: 1AT					
	1.9 TDI	09.00	10.01	PR: 1AT					
	1.9 TDI	09.00	10.01	PR: 1AT					
	1.9 TDI	09.00	10.01	PR: 1AT					
	1.9 TDI	09.00	10.01	PR: 1AT					
1.9 TDI	04.01	10.01	PR: 1AT						
1.9 TDI 4motion	09.00	10.01	PR: 1AT						
1.9 TDI 4motion	09.00	10.01	PR: 1AT						
1.9 TDI 4motion	09.00	10.01	PR: 1AT						
1.9 TDI 4motion	09.00	10.01	PR: 1AT						
1.9 TDI 4motion	04.01	10.01	PR: 1AT						
2.0	09.00	10.01	PR: 1AT						
2.0 4motion	09.00	10.01	PR: 1AT						
2.3 V5	09.00	10.01	PR: 1AT						
2.3 V5 4motion	09.00	10.01	PR: 1AT						
2.8 V6 4motion	09.00	10.01	PR: 1AT						
1.4	11.01	06.06	PR: 1AT	03.7863-3502.4	300128		10"	ATE	
1.6	11.01	06.06	PR: 1AT						
1.6 FSI	01.02	06.06	PR: 1AT						
1.8 4motion	11.01	06.06	PR: 1AT						
1.8 T	11.01	06.06	PR: 1AT						
1.9 SDI	11.01	06.06	PR: 1AT						
1.9 TDI	11.01	06.06	PR: 1AT						
1.9 TDI	11.01	06.06	PR: 1AT						
1.9 TDI	11.01	06.06	PR: 1AT						
1.9 TDI	11.01	06.06	PR: 1AT						
1.9 TDI	11.01	06.06	PR: 1AT						
1.9 TDI	11.01	06.06	PR: 1AT						
1.9 TDI 4motion	11.01	06.06	PR: 1AT						
1.9 TDI 4motion	11.01	06.06	PR: 1AT						
1.9 TDI 4motion	11.01	06.06	PR: 1AT						
1.9 TDI 4motion	11.01	06.06	PR: 1AT						
2.0	11.01	06.06	PR: 1AT						
2.0 4motion	11.01	06.06	PR: 1AT						
2.3 V5	11.01	06.06	PR: 1AT						
2.3 V5 4motion	11.01	06.06	PR: 1AT						
2.8 V6 4motion	11.01	06.06	PR: 1AT						
	1.4	05.99	06.06	PR: 1AM,1AC,1AH,1AJ	24.2123-1709.3	010503		THz 23,81	
	1.6	05.99	06.06	PR: 1AM,1AC,1AH,1AJ					
	1.6 FSI	01.02	06.06	PR: 1AM,1AC,1AH,1AJ					
	1.8 4motion	05.99	06.06	PR: 1AM,1AC,1AH,1AJ					
	1.8 T	05.00	06.06	PR: 1AM,1AC,1AH,1AJ					
	1.9 SDI	05.99	06.06	PR: 1AM,1AC,1AH,1AJ					
	1.9 TDI	05.99	06.06	PR: 1AM,1AC,1AH,1AJ					
	1.9 TDI	09.00	06.06	PR: 1AM,1AC,1AH,1AJ					
	1.9 TDI	05.99	06.06	PR: 1AM,1AC,1AH,1AJ					
	1.9 TDI	05.99	06.06	PR: 1AM,1AC,1AH,1AJ					
	1.9 TDI	04.01	06.06	PR: 1AM,1AC,1AH,1AJ					
	1.9 TDI 4motion	05.99	06.06	PR: 1AM,1AC,1AH,1AJ					
	1.9 TDI 4motion	09.00	06.06	PR: 1AM,1AC,1AH,1AJ					
1.9 TDI 4motion	11.99	06.06	PR: 1AM,1AC,1AH,1AJ						
1.9 TDI 4motion	04.01	06.06	PR: 1AM,1AC,1AH,1AJ						
2.0	05.99	06.06	PR: 1AM,1AC,1AH,1AJ						
2.0 4motion	04.00	06.06	PR: 1AM,1AC,1AH,1AJ						
2.3 V5	05.99	06.06	PR: 1AM,1AC,1AH,1AJ						
2.3 V5 4motion	05.99	06.06	PR: 1AM,1AC,1AH,1AJ						
2.8 V6 4motion	05.99	06.06	PR: 1AM,1AC,1AH,1AJ						
1.4	05.99	08.00	PR: 1AT	03.2123-2024.3	010597		THz 23,81	ATE	
1.6	05.99	08.00	PR: 1AT						
1.8 4motion	05.99	08.00	PR: 1AT						
1.8 T	05.00	08.00	PR: 1AT						
1.9 SDI	05.99	08.00	PR: 1AT						
1.9 TDI	05.99	08.00	PR: 1AT						
1.9 TDI	05.99	08.00	PR: 1AT						
1.9 TDI	05.99	08.00	PR: 1AT						
1.9 TDI 4motion	05.99	08.00	PR: 1AT						
1.9 TDI 4motion	11.99	08.00	PR: 1AT						
2.0	05.99	08.00	PR: 1AT						
2.0 4motion	04.00	08.00	PR: 1AT						
2.3 V5	05.99	08.00	PR: 1AT						
2.3 V5 4motion	05.99	08.00	PR: 1AT						
2.8 V6 4motion	05.99	08.00	PR: 1AT						
1.4	09.00	06.06	PR: 1AT	03.2123-2715.3	010802		THz 23,81	ATE	
1.6	09.00	06.06	PR: 1AT						
1.6 FSI	01.02	06.06	PR: 1AT						
1.8 4motion	09.00	06.06	PR: 1AT						
1.8 T	09.00	06.06	PR: 1AT						
1.9 SDI	09.00	06.06	PR: 1AT						
1.9 TDI	09.00	06.06	PR: 1AT						
1.9 TDI	09.00	06.06	PR: 1AT						
1.9 TDI	09.00	06.06	PR: 1AT						

VOLKSWAGEN GOLF IV Variant (99-06)													
													
	1.9 TDI	85		09.00	06.06	PR: 1AT		03.2123-2715.3	010802			Thz 23,81	ATE
	1.9 TDI	96		04.01	06.06	PR: 1AT							
	1.9 TDI 4motion	66		09.00	06.06	PR: 1AT							
	1.9 TDI 4motion	74		09.00	06.06	PR: 1AT							
	1.9 TDI 4motion	85		09.00	06.06	PR: 1AT							
	1.9 TDI 4motion	96		04.01	06.06	PR: 1AT							
	2.0	85		09.00	06.06	PR: 1AT							
	2.0 4motion			09.00	06.06	PR: 1AT							
	2.3 V5			09.00	06.06	PR: 1AT							
	2.3 V5 4motion			09.00	06.06	PR: 1AT							
	2.8 V6 4motion			09.00	06.06	PR: 1AT							
	1.4			05.99	08.00	PR: 1AT		03.2123-2064.3	010598			Thz 23,81	ATE
	1.6			05.99	08.00	PR: 1AT							
	1.8 4motion	92		05.99	08.00	PR: 1AT							
	1.8 T	110		05.00	08.00	PR: 1AT							
	1.9 SDI			05.99	08.00	PR: 1AT							
	1.9 TDI	66		05.99	08.00	PR: 1AT							
	1.9 TDI	81		05.99	08.00	PR: 1AT							
	1.9 TDI	85		05.99	08.00	PR: 1AT							
	1.9 TDI 4motion	66		05.99	08.00	PR: 1AT							
	1.9 TDI 4motion	85		11.99	08.00	PR: 1AT							
	2.0	85		05.99	08.00	PR: 1AT							
	2.0 4motion			04.00	08.00	PR: 1AT							
	2.3 V5			05.99	08.00	PR: 1AT							
	2.3 V5 4motion			05.99	08.00	PR: 1AT							
	2.8 V6 4motion			05.99	08.00	PR: 1AT							
	1.4			09.00	06.06	PR: 1AT		03.2123-2774.3	010803			Thz 23,81	ATE
	1.6			09.00	06.06	PR: 1AT							
	1.6 FSI			01.02	06.06	PR: 1AT							
	1.8 4motion	92		09.00	06.06	PR: 1AT							
	1.8 T	110		09.00	06.06	PR: 1AT							
	1.9 SDI			09.00	06.06	PR: 1AT							
	1.9 TDI	66		09.00	06.06	PR: 1AT							
	1.9 TDI	74		09.00	06.06	PR: 1AT							
	1.9 TDI	81		09.00	06.06	PR: 1AT							
	1.9 TDI	85		09.00	06.06	PR: 1AT							
	1.9 TDI	96		04.01	06.06	PR: 1AT							
	1.9 TDI 4motion	66		09.00	06.06	PR: 1AT							
	1.9 TDI 4motion	74		09.00	06.06	PR: 1AT							
	1.9 TDI 4motion	85		09.00	06.06	PR: 1AT							
	1.9 TDI 4motion	96		04.01	06.06	PR: 1AT							
	2.0	85		09.00	06.06	PR: 1AT							
	2.0 4motion			09.00	06.06	PR: 1AT							
	2.3 V5			09.00	06.06	PR: 1AT							
	2.3 V5 4motion			09.00	06.06	PR: 1AT							
	2.8 V6 4motion			09.00	06.06	PR: 1AT							
	1.4			05.99	06.06	PR: 1LR,1LS,1ZF,1ZP,1ZM		11.9541-9549.2	220575			D=54, - Halter	ATE
	1.6			05.99	06.06	PR: 1LR,1LS,1ZF,1ZP,1ZM		11.9541-9550.2	220576			D=54, - Halter	ATE
	1.6 FSI			01.02	06.06	PR: 1LR,1LS,1ZF,1ZP,1ZM		11.0101-5409.2	260035			Hülensatz	ATE
	1.8 4motion	92		05.99	06.06	PR: 1LR,1LS,1ZF,1ZP,1ZM		11.8171-0069.1	250152			Führungsbolzen	ATE
	1.9 SDI			05.99	06.06	PR: 1LR,1LS,1ZF,1ZP,1ZM							
	1.9 TDI	66		05.99	06.06	PR: 1LR,1LS,1ZF,1ZP,1ZM							
	1.9 TDI	74		09.00	06.06	PR: 1LR,1LS,1ZF,1ZP,1ZM							
	1.9 TDI	81		05.99	06.06	PR: 1LR,1LS,1ZF,1ZP,1ZM							
	1.9 TDI	85		05.99	06.06	PR: 1LR,1LS,1ZF,1ZP,1ZM							
	1.9 TDI	96		04.01	06.06	PR: 1LR,1LS,1ZF,1ZP,1ZM							
	1.9 TDI 4motion	66		05.99	06.06	PR: 1LR,1LS,1ZF,1ZP,1ZM							
	1.9 TDI 4motion	74		09.00	06.06	PR: 1LR,1LS,1ZF,1ZP,1ZM							
	1.9 TDI 4motion	85		11.99	06.06	PR: 1LR,1LS,1ZF,1ZP,1ZM							
	2.0	85		05.99	06.06	PR: 1LR,1LS,1ZF,1ZP,1ZM							
	2.0 4motion			04.00	06.06	PR: 1LR,1LS,1ZF,1ZP,1ZM							
	1.8 T	110		05.00	06.06	PR: 1ZD,1ZE		11.3541-8523.2	220115			D=54, - Halter	ATE
	1.9 TDI	96		04.01	06.06	PR: 1ZD,1ZE		11.3541-8524.2	220116			D=54, - Halter	ATE
	1.9 TDI 4motion	96		04.01	06.06	PR: 1ZD,1ZE		24.3541-8523.5	240551			D=54, - Halter	ATE
	2.3 V5			05.99	06.06	PR: 1ZD,1ZE		24.3541-8524.5	240552			D=54, - Halter	ATE
	2.3 V5 4motion			05.99	06.06	PR: 1ZD,1ZE		11.8170-0306.1	260102	2		Halter	ATE
								11.0441-5409.2	250031			Dichtungssatz	ATE
								11.0101-5409.2	260035			Hülensatz	ATE
								11.8171-0008.1	990049			Führungsbolzen	ATE
								11.8116-0143.1	390513	2		Haltefeder	ATE
	2.8 V6 4motion			05.99	06.06			11.9541-9595.2	220501			D=54, - Halter	ATE
								11.9541-9596.2	220502			D=54, - Halter	ATE
								11.0441-5409.2	250031			Dichtungssatz	ATE
								11.0101-5409.2	260035			Hülensatz	ATE
								11.8171-0008.1	990049			Führungsbolzen	ATE
								11.8116-0143.1	390513	2		Haltefeder	ATE
	1.4			05.99	06.06			24.5143-0439.3	331411	2		L=439	
	1.6			05.99	06.06								
	1.6 FSI			01.02	06.06								
	1.8 T	110		05.00	06.06								
	1.9 SDI			05.99	06.06								
	1.9 TDI	66		05.99	06.06								
	1.9 TDI	74		09.00	06.06								
	1.9 TDI	81		05.99	06.06								
	1.9 TDI	85		05.99	06.06								
	1.9 TDI	96		04.01	06.06								
	2.0	85		05.99	06.06								



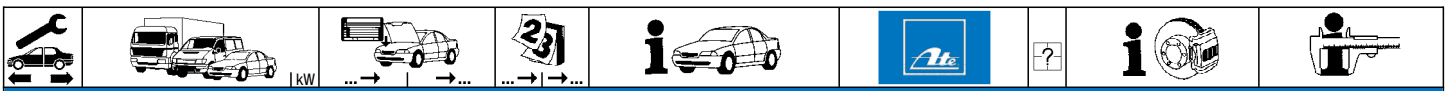

VOLKSWAGEN GOLF IV Variant (99-06)

	2.3 V5			05.99	06.06	24.5143-0439.3	331411	2		L=439
	1.8 4motion	92		05.99	06.06	24.5143-0569.3	331398	2		L=569
	1.9 TDI 4motion	66		05.99	06.06					
	1.9 TDI 4motion	74		09.00	06.06					
	1.9 TDI 4motion	85		11.99	06.06					
	1.9 TDI 4motion	96		04.01	06.06					
	2.0 4motion			04.00	06.06					
	2.3 V5 4motion			05.99	06.06					
	2.8 V6 4motion			05.99	06.06					
	1.4		1J-Y-238580	05.99	PR: 1KP,1KT	24.3414-1703.7	220535			D=41, - Halter TRW
	1.6		1J-Y-238580	05.99	PR: 1KP,1KT	24.3414-1704.7	220536			D=41, - Halter TRW
	1.9 SDI		1J-Y-238580	05.99	PR: 1KP,1KT					
	1.9 TDI	66	1J-Y-238580	05.99	PR: 1KP,1KT					
	1.9 TDI	81	1J-Y-238580	05.99	PR: 1KP,1KT					
	1.9 TDI	85	1J-Y-238580	05.99	PR: 1KP,1KT					
	2.0	85	1J-Y-238580	05.99	PR: 1KP,1KT					
	2.3 V5		1J-Y-238580	05.99	PR: 1KP,1KT					
	1.4		1J-Y-238581	06.06	PR: 1KP,1KT	24.3414-1705.7	220549			D=41, - Halter TRW
	1.6		1J-Y-238581	06.06	PR: 1KP,1KT	24.3414-1706.7	220550			D=41, - Halter TRW
	1.6 FSI			01.02	06.06					
	1.8 4motion	92		05.99	06.06					
	1.8 T	110		05.00	06.06					
	1.9 SDI		1J-Y-238581	06.06	PR: 1KP,1KT					
	1.9 TDI	66	1J-Y-238581	06.06	PR: 1KP,1KT					
	1.9 TDI	74		09.00	06.06					
	1.9 TDI	81	1J-Y-238581	06.06	PR: 1KP,1KT					
	1.9 TDI	85	1J-Y-238581	06.06	PR: 1KP,1KT					
	1.9 TDI	96		04.01	06.06					
	1.9 TDI 4motion	66		05.99	06.06					
	1.9 TDI 4motion	74		09.00	06.06					
	1.9 TDI 4motion	85		11.99	06.06					
	1.9 TDI 4motion	96		04.01	06.06					
	2.0	85	1J-Y-238581	06.06	PR: 1KP,1KT					
	2.0 4motion			04.00	06.06					
	2.3 V5		1J-Y-238581	06.06	PR: 1KP,1KT					
	2.3 V5 4motion			05.99	06.06					
	2.8 V6 4motion			05.99	06.06					
	1.8 4motion	92		05.99	06.06	24.3384-1745.7	220609			D=38, - Halter TRW
	1.9 TDI 4motion	66		05.99	06.06	24.3384-1746.7	220610			D=38, - Halter TRW
	1.9 TDI 4motion	74		09.00	06.06					
	1.9 TDI 4motion	85		11.99	06.06					
	1.9 TDI 4motion	96		04.01	06.06					
	2.0 4motion			04.00	06.06					
	2.3 V5 4motion			05.99	06.06					
	2.8 V6 4motion			05.99	06.06					
	1.4			05.99	06.06	83.7858-0140.3	330837	2		L=140
	1.6			05.99	06.06					
	1.6 FSI			01.02	06.06					
	1.8 T	110		05.00	06.06					
	1.9 SDI			05.99	06.06					
	1.9 TDI	66		05.99	06.06					
	1.9 TDI	74		09.00	06.06					
	1.9 TDI	81		05.99	06.06					
	1.9 TDI	85		05.99	06.06					
	1.9 TDI	96		04.01	06.06					
	2.0	85		05.99	06.06					
	2.3 V5			05.99	06.06					
	1.8 4motion	92		05.99	06.06	83.7858-0140.3	330837	2		L=140
	1.9 TDI 4motion	66		05.99	06.06					
	1.9 TDI 4motion	74		09.00	06.06					
	1.9 TDI 4motion	85		11.99	06.06					
	1.9 TDI 4motion	96		04.01	06.06					
	2.0 4motion			04.00	06.06					
	2.3 V5 4motion			05.99	06.06					
	2.8 V6 4motion			05.99	06.06					
	1.4		1J-Y-238580	05.99		24.3727-0149.2	580149	2		L=1688
	1.6		1J-Y-238580	05.99						
	1.9 SDI		1J-Y-238580	05.99						
	1.9 TDI	66	1J-Y-238580	05.99						
	1.9 TDI	81	1J-Y-238580	05.99						
	1.9 TDI	85	1J-Y-238580	05.99						
	2.0	85	1J-Y-238580	05.99						
	1.4		1J-Y-238581	06.06		24.3727-0173.2	580173	2		L=1693
	1.6		1J-Y-238581	06.06						
	1.6 FSI			01.02	06.06					
	1.8 T	110		05.00	06.06					
	1.9 SDI		1J-Y-238581	06.06						
	1.9 TDI	66	1J-Y-238581	06.06						
	1.9 TDI	74		09.00	06.06					
	1.9 TDI	81	1J-Y-238581	06.06						
	1.9 TDI	85	1J-Y-238581	06.06						
	1.9 TDI	96		04.01	06.06					
	2.0	85	1J-Y-238581	06.06						
	2.3 V5			05.99	06.06					
	1.8 4motion	92		05.99	06.06	24.3727-0175.2	580175	2		L=1723
	1.9 TDI 4motion	66		05.99	06.06					



VOLKSWAGEN GOLF IV Variant (99-06)

	1.9 TDI 4motion 74 1.9 TDI 4motion 85 1.9 TDI 4motion 96 2.0 4motion 2.3 V5 4motion 2.8 V6 4motion		09.00 06.06 11.99 06.06 04.01 06.06 04.00 06.06 05.99 06.06 05.99 06.06	24.3727-0175.2	580175	2 ↓	L=1723
	1.4 1.6 1.6 FSI 1.8 4motion 1.8 T 1.9 SDI 1.9 TDI 1.9 TDI 1.9 TDI 1.9 TDI 1.9 TDI 1.9 TDI 4motion 1.9 TDI 4motion 1.9 TDI 4motion 1.9 TDI 4motion 2.0 2.0 4motion 2.3 V5 2.3 V5 4motion 2.8 V6 4motion	◀ ◀ ◀ ◀ 92 ◀110 ◀ ◀ 66 ◀ 74 ◀ 81 ◀ 85 ◀ 96 ◀ 66 ◀ 74 ◀ 85 ◀ 96 ◀ 85	05.99 06.06 05.99 06.06 01.02 06.06 05.99 06.06 05.00 06.06 05.99 06.06 05.99 06.06 09.00 06.06 05.99 06.06 04.01 06.06 05.99 06.06 09.00 06.06 11.99 06.06 04.01 06.06 05.99 06.06 04.00 06.06 05.99 06.06 05.99 06.06 05.99 06.06	24.2415-1701.3	030095		Gz 15,87
	1.4 1.6 1.6 FSI 1.8 4motion 1.8 T 1.9 SDI 1.9 TDI 1.9 TDI 1.9 TDI 1.9 TDI 1.9 TDI 1.9 TDI 4motion 1.9 TDI 4motion 1.9 TDI 4motion 1.9 TDI 4motion 2.0 2.0 4motion 2.3 V5 2.3 V5 4motion 2.8 V6 4motion	▶ ▶ ▶ ▶ 92 ▶110 ▶ ▶ 66 ▶ 74 ▶ 81 ▶ 85 ▶ 96 ▶ 66 ▶ 74 ▶ 85 ▶ 96 ▶ 85	05.99 06.06 05.99 06.06 01.02 06.06 05.99 06.06 05.00 06.06 05.99 06.06 05.99 06.06 09.00 06.06 05.99 06.06 04.01 06.06 05.99 06.06 09.00 06.06 11.99 06.06 04.01 06.06 05.99 06.06 04.00 06.06 05.99 06.06 05.99 06.06 05.99 06.06	24.2415-1702.3	030096		Gz 15,87
	1.4 1.6 1.6 FSI 1.9 SDI		05.99 06.06 05.99 06.06 01.02 06.06 05.99 06.06	24.2523-1701.3	040080		Nz 23,81
	1.8 4motion 1.8 T 1.9 TDI 1.9 TDI 1.9 TDI 1.9 TDI 4motion 2.0 2.0 4motion 2.3 V5	92 110 66 74 81 66 85	05.99 06.06 05.00 06.06 05.99 06.06 09.00 06.06 05.99 06.06 05.99 06.06 04.00 06.06 05.99 06.06	24.2519-1701.3	040075		Nz 19,05

VOLKSWAGEN GOLF V (03-08)

	1.4 16V 1.4 FSI 1.4 TSI 1.4 TSI 1.4 TSI 1.6 16V 1.6 FSI 1.9 TDI 1.9 TDI 1.9 TDI 4motion 2.0 FSI 2.0 FSI 4motion 2.0 SDI 2.0 TDI 2.0 TDI 2.0 TDI 2.0 TDI 4motion	◀ ◀ 66 ◀ 90 ◀103 ◀125 ◀ 75 ◀ 85 ◀ 66 ◀ 77 ◀ 77 ◀110 ◀110 ◀ 55 ◀100 ◀103 ◀125 ◀103	10.03 09.08 PR: 1AC,1AT 10.03 09.08 PR: 1AC,1AT 05.07 09.08 PR: 1AC,1AT 05.06 09.08 PR: 1AC,1AT 11.05 09.08 PR: 1AC,1AT 01.04 09.08 PR: 1AC,1AT 10.03 09.08 PR: 1AC,1AT 05.04 09.08 PR: 1AC,1AT 10.03 09.08 PR: 1AC,1AT 08.04 09.08 PR: 1AC,1AT 10.03 09.08 PR: 1AC,1AT 08.04 09.08 PR: 1AC,1AT 01.04 09.08 PR: 1AC,1AT 10.03 09.08 PR: 1AC,1AT 11.05 09.08 PR: 1AC,1AT 08.04 09.08 PR: 1AC,1AT	03.7863-3232.4	300307		10" ATE
	1.4 16V 1.4 FSI 1.4 TSI 1.4 TSI 1.4 TSI 1.6 16V 1.6 FSI 1.9 TDI 1.9 TDI	◀ ◀ 66 ◀ 90 ◀103 ◀125 ◀ 75 ◀ 85 ◀ 66 ◀ 77	10.03 09.08 PR: 1AS 10.03 09.08 PR: 1AS 05.07 09.08 PR: 1AS 05.06 09.08 PR: 1AS 11.05 09.08 PR: 1AS 01.04 09.08 PR: 1AS 10.03 09.08 PR: 1AS 05.04 09.08 PR: 1AS 10.03 09.08 PR: 1AS	03.7863-9602.4 03.7863-9802.4	300206 300281	Kolbendurchmesser Ø 22,20mm ¹⁾ PR: 1AS,1LJ	10" 10" ATE

¹⁾ piston diameter Ø 22,20mm / diametro del pistone Ø 22,20mm / diamètre de piston Ø 22,20mm / diámetro del pistón Ø 22,20mm







VOLKSWAGEN GOLF V (03-08)

	1.9 TDI 4motion	77		08.04	09.08	PR: 1AS	03.7863-9602.4	300206	Kolbendurchmesser Ø 22,20mm ¹⁾ PR: 1AS,1LJ	10"	ATE
	2.0 FSI	110		10.03	09.08	PR: 1AS	03.7863-9802.4	300281		10"	ATE
	2.0 FSI 4motion	110		08.04	09.08	PR: 1AS					
	2.0 SDI	55		01.04	09.08	PR: 1AS					
	2.0 TDI	100		10.03	09.08	PR: 1AS					
	2.0 TDI	103		10.03	09.08	PR: 1AS					
	2.0 TDI	125		11.05	09.08	PR: 1AS					
	2.0 TDI 4motion	103		08.04	09.08	PR: 1AS					
2.0 GTI	147		09.04	09.08	PR: 1AC,1AT	03.7863-3332.4	300308	Kolbendurchmesser Ø 23,81mm ²⁾	10"	ATE	
2.0 GTI	169		09.06	09.08	PR: 1AC,1AT						
3.2 R32	184		11.05	09.08	PR: 1AC,1AT						
	1.4 16V		1K-6W078889	10.03			03.2122-2129.3	010799		THz 22,20	ATE
	1.4 FSI	66	1K-6W078889	10.03							
	1.4 TSI	103	1K-6W078889	05.06							
	1.4 TSI	125	1K-6W078889	11.05							
	1.6 16V	75	1K-6W078889	01.04							
	1.6 FSI	85	1K-6W078889	10.03							
	1.9 TDI	66	1K-6W078889	05.04							
	1.9 TDI	77	1K-6W078889	10.03							
	1.9 TDI 4motion	77	1K-6W078889	08.04							
	2.0 FSI	110	1K-6W078889	10.03							
	2.0 FSI 4motion	110	1K-6W078889	08.04							
	2.0 SDI	55	1K-6W078889	01.04							
	2.0 TDI	100	1K-6W078889	10.03							
	2.0 TDI	103	1K-6W078889	10.03							
2.0 TDI	125	1K-6W078889	11.05								
2.0 TDI 4motion	103	1K-6W078889	08.04								
2.0 GTI	147	1K-6W078889	09.04			03.2123-3449.3	010808		THz 23,81	ATE	
2.0 GTI	169	1K-6W078889	09.06								
3.2 R32	184	1K-6W078889	11.05								
	1.4 16V		1K-6W078890		09.08		03.2122-2129.3	010799		THz 22,20	ATE
	1.4 FSI	66	1K-6W078890		09.08						
	1.4 TSI	90		05.07	09.08						
	1.4 TSI	103	1K-6W078890		09.08						
	1.4 TSI	125	1K-6W078890		09.08						
	1.6 16V	75	1K-6W078890		09.08						
	1.6 FSI	85	1K-6W078890		09.08						
	1.9 TDI	66	1K-6W078890		09.08						
	1.9 TDI	77	1K-6W078890		09.08						
	1.9 TDI 4motion	77	1K-6W078890		09.08						
	2.0 FSI	110	1K-6W078890		09.08						
	2.0 FSI 4motion	110	1K-6W078890		09.08						
	2.0 SDI	55	1K-6W078890		09.08						
	2.0 TDI	100	1K-6W078890		09.08						
2.0 TDI	103	1K-6W078890		09.08							
2.0 TDI	125	1K-6W078890		09.08							
2.0 TDI 4motion	103	1K-6W078890		09.08							
2.0 GTI	147	1K-6W078890		09.08		03.2123-3449.3	010808		THz 23,81	ATE	
2.0 GTI	169	1K-6W078890		09.08							
3.2 R32	184	1K-6W078890		09.08							
	1.4 16V			10.03	09.08	PR: 1ZF,1ZM,1ZC	11.9541-9549.2	220575	<input type="checkbox"/> <input type="checkbox"/> D=54, - Halter D=54, - Halter Hülsensatz Führungsbolzen	ATE	
	1.4 FSI	66		10.03	09.08	PR: 1ZF,1ZM,1ZC	11.9541-9550.2	220576		ATE	
	1.4 TSI	90		05.07	09.08	PR: 1ZF,1ZM,1ZC	11.0101-5409.2	260035		ATE	
	1.4 TSI	103		05.06	09.08	PR: 1ZF,1ZM,1ZC	11.8171-0069.1	250152		ATE	
	1.4 TSI	125		11.05	09.08	PR: 1ZF,1ZM,1ZC					
	1.6 16V	75		01.04	09.08	PR: 1ZF,1ZM,1ZC					
	1.6 FSI	85		10.03	09.08	PR: 1ZF,1ZM,1ZC					
	1.9 TDI	66		05.04	09.08	PR: 1ZF,1ZM,1ZC					
	1.9 TDI	77		10.03	09.08	PR: 1ZF,1ZM,1ZC					
	1.9 TDI 4motion	77		08.04	09.08	PR: 1ZF,1ZM,1ZC					
	2.0 FSI	110		10.03	09.08	PR: 1ZF,1ZM,1ZC					
	2.0 FSI 4motion	110		08.04	09.08	PR: 1ZF,1ZM,1ZC					
	2.0 GTI	147		09.04	09.08	PR: 1ZF,1ZM,1ZC					
	2.0 GTI	169		09.06	09.08	PR: 1ZF,1ZM,1ZC					
2.0 SDI	55		01.04	09.08	PR: 1ZF,1ZM,1ZC						
2.0 TDI	100		10.03	09.08	PR: 1ZF,1ZM,1ZC						
2.0 TDI	103		10.03	09.08	PR: 1ZF,1ZM,1ZC						
2.0 TDI	125		11.05	09.08	PR: 1ZF,1ZM,1ZC						
2.0 TDI 4motion	103		08.04	09.08	PR: 1ZF,1ZM,1ZC						
3.2 R32	184		11.05	09.08	PR: 1ZF,1ZM,1ZC						
1.4 16V				10.03	09.08	PR: 1ZE,1ZP	11.9541-9553.2	220563	<input type="checkbox"/> <input type="checkbox"/> D=54, - Halter D=54, - Halter Hülsensatz Führungsbolzen Haltefeder	ATE	
1.4 FSI	66		10.03	09.08	PR: 1ZE,1ZP	11.9541-9554.2	220564	ATE			
1.4 TSI	90		05.07	09.08	PR: 1ZE,1ZP	11.0101-5409.2	260035	ATE			
1.4 TSI	103		05.06	09.08	PR: 1ZE,1ZP	11.8171-0008.1	990049	ATE			
1.4 TSI	125		11.05	09.08	PR: 1ZE,1ZP	11.8116-0351.1	390538	ATE			
1.6 16V	75		01.04	09.08	PR: 1ZE,1ZP						
1.6 FSI	85		10.03	09.08	PR: 1ZE,1ZP						
1.9 TDI	66		05.04	09.08	PR: 1ZE,1ZP						
1.9 TDI	77		10.03	09.08	PR: 1ZE,1ZP						
1.9 TDI 4motion	77		08.04	09.08	PR: 1ZE,1ZP						
2.0 FSI	110		10.03	09.08	PR: 1ZE,1ZP						
2.0 FSI 4motion	110		08.04	09.08	PR: 1ZE,1ZP						
2.0 GTI	147		09.04	09.08	PR: 1ZE,1ZP						
2.0 GTI	169		09.06	09.08	PR: 1ZE,1ZP						
2.0 SDI	55		01.04	09.08	PR: 1ZE,1ZP						
2.0 TDI	100		10.03	09.08	PR: 1ZE,1ZP						

¹⁾ piston diameter Ø 22,20mm / diametro del pistone Ø 22,20mm / diamètre de piston Ø 22,20mm / diámetro del pistón Ø 22,20mm





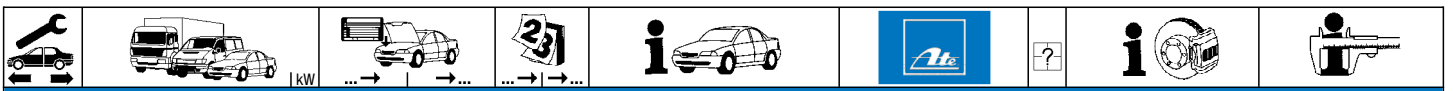

²⁾ piston diameter Ø 23,81mm / diametro del pistone Ø 23,81mm / diamètre de piston Ø 23,81mm / diámetro del pistón Ø 23,81mm

VOLKSWAGEN GOLF V (03-08)											
	2.0 TDI	103		10.03	09.08	PR: 1ZE,1ZP	11.9541-9553.2	220563	2	D=54, - Halter D=54, - Halter Hülzensatz Führungsbolzen Haltefeder	ATE ATE ATE ATE ATE
	2.0 TDI	125		11.05	09.08	PR: 1ZE,1ZP	11.9541-9554.2	220564			
	2.0 TDI 4motion	103		08.04	09.08	PR: 1ZE,1ZP	11.0101-5409.2	260035			
	3.2 R32	184		11.05	09.08	PR: 1ZE,1ZP	11.8171-0008.1	990049			
	1.4 16V			10.03	09.08	PR: 1LJ,1ZD	11.9541-9553.2	220563			
	1.4 FSI	66		10.03	09.08	PR: 1LJ,1ZD	11.9541-9554.2	220564			
	1.4 TSI	90		05.07	09.08	PR: 1LJ,1ZD	11.0101-5409.2	260035			
	1.4 TSI	103		05.06	09.08	PR: 1LJ,1ZD	11.8171-0008.1	990049			
	1.4 TSI	125		11.05	09.08	PR: 1LJ,1ZD	11.8116-0351.1	390538			
	1.6 16V	75		01.04	09.08	PR: 1LJ,1ZD					
	1.6 FSI	85		10.03	09.08	PR: 1LJ,1ZD					
	1.9 TDI	66		05.04	09.08	PR: 1LJ,1ZD					
	1.9 TDI	77		10.03	09.08	PR: 1LJ,1ZD					
	1.9 TDI 4motion	77		08.04	09.08	PR: 1LJ,1ZD					
	2.0 FSI	110		10.03	09.08	PR: 1LJ,1ZD					
2.0 FSI 4motion	110		08.04	09.08	PR: 1LJ,1ZD						
2.0 GTI	147		09.04	09.08	PR: 1LJ,1ZD						
2.0 GTI	169		09.06	09.08	PR: 1LJ,1ZD						
2.0 SDI	55		01.04	09.08	PR: 1LJ,1ZD						
2.0 TDI	100		10.03	09.08	PR: 1LJ,1ZD						
2.0 TDI	103		10.03	09.08	PR: 1LJ,1ZD						
2.0 TDI	125		11.05	09.08	PR: 1LJ,1ZD						
2.0 TDI 4motion	103		08.04	09.08	PR: 1LJ,1ZD						
3.2 R32	184		11.05	09.08	PR: 1LJ,1ZD						
	1.4 16V			10.03	09.08	PR: 1LL,1LV	11.9541-9553.2	220563	2	D=54, - Halter D=54, - Halter Hülzensatz Führungsbolzen Haltefeder	ATE ATE ATE ATE ATE
	1.4 FSI	66		10.03	09.08	PR: 1LL,1LV	11.9541-9554.2	220564			
	1.4 TSI	90		05.07	09.08	PR: 1LL,1LV	11.0101-5409.2	260035			
	1.4 TSI	103		05.06	09.08	PR: 1LL,1LV	11.8171-0008.1	990049			
	1.4 TSI	125		11.05	09.08	PR: 1LL,1LV	11.8116-0351.1	390538			
	1.6 16V	75		01.04	09.08	PR: 1LL,1LV					
	1.6 FSI	85		10.03	09.08	PR: 1LL,1LV					
	1.9 TDI	66		05.04	09.08	PR: 1LL,1LV					
	1.9 TDI	77		10.03	09.08	PR: 1LL,1LV					
	1.9 TDI 4motion	77		08.04	09.08	PR: 1LL,1LV					
	2.0 FSI	110		10.03	09.08	PR: 1LL,1LV					
	2.0 FSI 4motion	110		08.04	09.08	PR: 1LL,1LV					
	2.0 GTI	147		09.04	09.08	PR: 1LL,1LV					
	2.0 GTI	169		09.06	09.08	PR: 1LL,1LV					
	2.0 SDI	55		01.04	09.08	PR: 1LL,1LV					
2.0 TDI	100		10.03	09.08	PR: 1LL,1LV						
2.0 TDI	103		10.03	09.08	PR: 1LL,1LV						
2.0 TDI	125		11.05	09.08	PR: 1LL,1LV						
2.0 TDI 4motion	103		08.04	09.08	PR: 1LL,1LV						
3.2 R32	184		11.05	09.08	PR: 1LL,1LV						
	1.4 16V			10.03	09.08	PR: 1LK,1LM	11.9576-9995.2	220651	2	D=57, - Halter D=57, - Halter Hülzensatz Führungsbolzen Haltefeder	ATE ATE ATE ATE ATE
	1.4 FSI	66		10.03	09.08	PR: 1LK,1LM	11.9576-9996.2	220652			
	1.4 TSI	90		05.07	09.08	PR: 1LK,1LM	11.0101-5409.2	260035			
	1.4 TSI	103		05.06	09.08	PR: 1LK,1LM	11.8171-0008.1	990049			
	1.4 TSI	125		11.05	09.08	PR: 1LK,1LM	11.8116-0410.2	390589			
	1.6 16V	75		01.04	09.08	PR: 1LK,1LM					
	1.6 FSI	85		10.03	09.08	PR: 1LK,1LM					
	1.9 TDI	66		05.04	09.08	PR: 1LK,1LM					
	1.9 TDI	77		10.03	09.08	PR: 1LK,1LM					
	1.9 TDI 4motion	77		08.04	09.08	PR: 1LK,1LM					
	2.0 FSI	110		10.03	09.08	PR: 1LK,1LM					
	2.0 FSI 4motion	110		08.04	09.08	PR: 1LK,1LM					
	2.0 GTI	147		09.04	09.08	PR: 1LK,1LM					
	2.0 GTI	169		09.06	09.08	PR: 1LK,1LM					
	2.0 SDI	55		01.04	09.08	PR: 1LK,1LM					
2.0 TDI	100		10.03	09.08	PR: 1LK,1LM						
2.0 TDI	103		10.03	09.08	PR: 1LK,1LM						
2.0 TDI	125		11.05	09.08	PR: 1LK,1LM						
2.0 TDI 4motion	103		08.04	09.08	PR: 1LK,1LM						
3.2 R32	184		11.05	09.08	PR: 1LK,1LM						
	1.4 16V			10.03	09.08		24.5143-0564.3	331433	2	L=564	
	1.4 FSI	66		10.03	09.08						
	1.4 TSI	90		05.07	09.08						
	1.4 TSI	103		05.06	09.08						
	1.4 TSI	125		11.05	09.08						
	1.6 16V	75		01.04	09.08						
	1.6 FSI	85		10.03	09.08						
	1.9 TDI	66		05.04	09.08						
	1.9 TDI	77		10.03	09.08						
	2.0 FSI	110		10.03	09.08						
	2.0 GTI	147		09.04	09.08						
	2.0 GTI	169		09.06	09.08						
	2.0 SDI	55		01.04	09.08						
	2.0 TDI	100		10.03	09.08						
	2.0 TDI	103		10.03	09.08						
2.0 TDI	125		11.05	09.08							
1.9 TDI 4motion	77		08.04	09.08		24.5143-0564.3	331433	2	PR: 1ZE,1ZP PR: 1LK,1LM	L=564 L=504	
2.0 FSI 4motion	110		08.04	09.08		83.7849-0502.3	331125				
2.0 TDI 4motion	103		08.04	09.08							
3.2 R32	184		11.05	09.08							















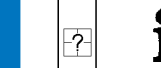

VOLKSWAGEN GOLF V (03-08)

	1.4 16V		10.03	09.08	PR: 1KD,1KQ	24.3384-1755.7	220635		D=38, - Halter D=38, - Halter	TRW TRW
	1.4 FSI	66	10.03	09.08	PR: 1KD,1KQ	24.3384-1756.7	220636			
	1.4 TSI	90	05.07	09.08	PR: 1KD,1KQ					
	1.4 TSI	103	05.06	09.08	PR: 1KD,1KQ					
	1.4 TSI	125	11.05	09.08	PR: 1KD,1KQ					
	1.6 16V	75	01.04	09.08	PR: 1KD,1KQ					
	1.6 FSI	85	10.03	09.08	PR: 1KD,1KQ					
	1.9 TDI	66	05.04	09.08	PR: 1KD,1KQ					
	1.9 TDI	77	10.03	09.08	PR: 1KD,1KQ					
	2.0 FSI	110	10.03	09.08	PR: 1KD,1KQ					
	2.0 GTI	147	09.04	09.08	PR: 1KD,1KQ					
	2.0 GTI	169	09.06	09.08	PR: 1KD,1KQ					
	2.0 SDI	55	01.04	09.08	PR: 1KD,1KQ					
	2.0 TDI	100	10.03	09.08	PR: 1KD,1KQ					
	2.0 TDI	103	10.03	09.08	PR: 1KD,1KQ					
2.0 TDI	125	11.05	09.08	PR: 1KD,1KQ						
	1.4 16V		10.03	09.08	PR: 1KZ	24.3387-1717.7	220757		D=38, - Halter D=38, - Halter Bremsattel-Zubehör	TRW TRW TRW
	1.4 FSI	66	10.03	09.08	PR: 1KZ	24.3387-1718.7	220758			
	1.4 TSI	90	05.07	09.08	PR: 1KZ	24.0101-3803.2	260101			
	1.4 TSI	103	05.06	09.08	PR: 1KZ					
	1.4 TSI	125	11.05	09.08	PR: 1KZ					
	1.6 16V	75	01.04	09.08	PR: 1KZ					
	1.6 FSI	85	10.03	09.08	PR: 1KZ					
	1.9 TDI	66	05.04	09.08	PR: 1KZ					
	1.9 TDI	77	10.03	09.08	PR: 1KZ					
	2.0 FSI	110	10.03	09.08	PR: 1KZ					
	2.0 GTI	147	09.04	09.08	PR: 1KZ					
	2.0 GTI	169	09.06	09.08	PR: 1KZ					
	2.0 SDI	55	01.04	09.08	PR: 1KZ					
	2.0 TDI	100	10.03	09.08	PR: 1KZ					
	2.0 TDI	103	10.03	09.08	PR: 1KZ					
2.0 TDI	125	11.05	09.08	PR: 1KZ						
	1.4 16V		10.03	09.08	PR: 1KE,1KF,1KV,1KY	24.3414-1709.7	220631		D=41, - Halter D=41, - Halter	TRW TRW
	1.4 FSI	66	10.03	09.08	PR: 1KE,1KF,1KV,1KY	24.3414-1710.7	220632			
	1.4 TSI	90	05.07	09.08	PR: 1KE,1KF,1KV,1KY					
	1.4 TSI	103	05.06	09.08	PR: 1KE,1KF,1KV,1KY					
	1.4 TSI	125	11.05	09.08	PR: 1KE,1KF,1KV,1KY					
	1.6 16V	75	01.04	09.08	PR: 1KE,1KF,1KV,1KY					
	1.6 FSI	85	10.03	09.08	PR: 1KE,1KF,1KV,1KY					
	1.9 TDI	66	05.04	09.08	PR: 1KE,1KF,1KV,1KY					
	1.9 TDI	77	10.03	09.08	PR: 1KE,1KF,1KV,1KY					
	1.9 TDI 4motion	77	08.04	09.08	PR: 1KE,1KF,1KV,1KY					
	2.0 FSI	110	10.03	09.08	PR: 1KE,1KF,1KV,1KY					
	2.0 FSI 4motion	110	08.04	09.08	PR: 1KE,1KF,1KV,1KY					
	2.0 GTI	147	09.04	09.08	PR: 1KE,1KF,1KV,1KY					
	2.0 GTI	169	09.06	09.08	PR: 1KE,1KF,1KV,1KY					
	2.0 SDI	55	01.04	09.08	PR: 1KE,1KF,1KV,1KY					
2.0 TDI	100	10.03	09.08	PR: 1KE,1KF,1KV,1KY						
2.0 TDI	103	10.03	09.08	PR: 1KE,1KF,1KV,1KY						
2.0 TDI	125	11.05	09.08	PR: 1KE,1KF,1KV,1KY						
2.0 TDI 4motion	103	08.04	09.08	PR: 1KE,1KF,1KV,1KY						
3.2 R32	184	11.05	09.08	PR: 1KE,1KF,1KV,1KY						
	1.4 16V		10.03	09.08		24.5204-0233.3	331430	2	L=233	
	1.4 FSI	66	10.03	09.08						
	1.4 TSI	90	05.07	09.08						
	1.4 TSI	103	05.06	09.08						
	1.4 TSI	125	11.05	09.08						
	1.6 16V	75	01.04	09.08						
	1.6 FSI	85	10.03	09.08						
	1.9 TDI	66	05.04	09.08						
	1.9 TDI	77	10.03	09.08						
	1.9 TDI 4motion	77	08.04	09.08						
	2.0 FSI	110	10.03	09.08						
	2.0 FSI 4motion	110	08.04	09.08						
	2.0 GTI	147	09.04	09.08						
	2.0 GTI	169	09.06	09.08						
	2.0 SDI	55	01.04	09.08						
2.0 TDI	100	10.03	09.08							
2.0 TDI	103	10.03	09.08							
2.0 TDI	125	11.05	09.08							
2.0 TDI 4motion	103	08.04	09.08							
3.2 R32	184	11.05	09.08							
	1.4 16V		10.03	09.08		24.3727-2708.2	582708	2	L=1447	
	1.4 FSI	66	10.03	09.08						
	1.4 TSI	103	05.06	09.08						
	1.4 TSI	125	11.05	09.08						
	1.6 16V	75	01.04	09.08						
	1.6 FSI	85	10.03	09.08						
	1.9 TDI	66	05.04	09.08						
	1.9 TDI	77	10.03	09.08						
	1.9 TDI 4motion	77	08.04	09.08						
	2.0 FSI	110	10.03	09.08						
	2.0 FSI 4motion	110	08.04	09.08						
	2.0 GTI	147	09.04	09.08						
	2.0 GTI	169	09.06	09.08						
	2.0 SDI	55	01.04	09.08						
	2.0 TDI	100	10.03	09.08						

VOLKSWAGEN GOLF V (03-08)																																																																																																																																																																	
	<table border="1"> <tr> <td>2.0 TDI</td> <td>103</td> <td>10.03</td> <td>09.08</td> <td>24.3727-2708.2</td> <td>582708</td> <td>2 ↓</td> <td>L=1447</td> </tr> <tr> <td>2.0 TDI</td> <td>125</td> <td>11.05</td> <td>09.08</td> <td></td> <td></td> <td></td> <td></td> </tr> <tr> <td>2.0 TDI 4motion</td> <td>103</td> <td>08.04</td> <td>09.08</td> <td></td> <td></td> <td></td> <td></td> </tr> <tr> <td>3.2 R32</td> <td>184</td> <td>11.05</td> <td>09.08</td> <td></td> <td></td> <td></td> <td></td> </tr> </table>	2.0 TDI	103	10.03	09.08	24.3727-2708.2	582708	2 ↓	L=1447	2.0 TDI	125	11.05	09.08					2.0 TDI 4motion	103	08.04	09.08					3.2 R32	184	11.05	09.08																																																																																																																																				
2.0 TDI	103	10.03	09.08	24.3727-2708.2	582708	2 ↓	L=1447																																																																																																																																																										
2.0 TDI	125	11.05	09.08																																																																																																																																																														
2.0 TDI 4motion	103	08.04	09.08																																																																																																																																																														
3.2 R32	184	11.05	09.08																																																																																																																																																														
	<table border="1"> <tr> <td>1.4 16V</td> <td></td> <td>10.03</td> <td>09.08</td> <td>24.2415-1713.3</td> <td>030132</td> <td></td> <td>Gz 15,87, + Sensor</td> </tr> <tr> <td>1.4 FSI</td> <td>66</td> <td>10.03</td> <td>09.08</td> <td></td> <td></td> <td></td> <td></td> </tr> <tr> <td>1.4 TSI</td> <td>90</td> <td>05.07</td> <td>09.08</td> <td></td> <td></td> <td></td> <td></td> </tr> <tr> <td>1.4 TSI</td> <td>103</td> <td>05.06</td> <td>09.08</td> <td></td> <td></td> <td></td> <td></td> </tr> <tr> <td>1.4 TSI</td> <td>125</td> <td>11.05</td> <td>09.08</td> <td></td> <td></td> <td></td> <td></td> </tr> <tr> <td>1.6 16V</td> <td>75</td> <td>01.04</td> <td>09.08</td> <td></td> <td></td> <td></td> <td></td> </tr> <tr> <td>1.6 FSI</td> <td>85</td> <td>10.03</td> <td>09.08</td> <td></td> <td></td> <td></td> <td></td> </tr> <tr> <td>1.9 TDI</td> <td>66</td> <td>05.04</td> <td>09.08</td> <td></td> <td></td> <td></td> <td></td> </tr> <tr> <td>1.9 TDI</td> <td>77</td> <td>10.03</td> <td>09.08</td> <td></td> <td></td> <td></td> <td></td> </tr> <tr> <td>1.9 TDI 4motion</td> <td>77</td> <td>08.04</td> <td>09.08</td> <td></td> <td></td> <td></td> <td></td> </tr> <tr> <td>2.0 FSI</td> <td>110</td> <td>10.03</td> <td>09.08</td> <td></td> <td></td> <td></td> <td></td> </tr> <tr> <td>2.0 FSI 4motion</td> <td>110</td> <td>08.04</td> <td>09.08</td> <td></td> <td></td> <td></td> <td></td> </tr> <tr> <td>2.0 GTI</td> <td>147</td> <td>09.04</td> <td>09.08</td> <td></td> <td></td> <td></td> <td></td> </tr> <tr> <td>2.0 GTI</td> <td>169</td> <td>09.06</td> <td>09.08</td> <td></td> <td></td> <td></td> <td></td> </tr> <tr> <td>2.0 SDI</td> <td>55</td> <td>01.04</td> <td>09.08</td> <td></td> <td></td> <td></td> <td></td> </tr> <tr> <td>2.0 TDI</td> <td>100</td> <td>10.03</td> <td>09.08</td> <td></td> <td></td> <td></td> <td></td> </tr> <tr> <td>2.0 TDI</td> <td>103</td> <td>10.03</td> <td>09.08</td> <td></td> <td></td> <td></td> <td></td> </tr> <tr> <td>2.0 TDI</td> <td>125</td> <td>11.05</td> <td>09.08</td> <td></td> <td></td> <td></td> <td></td> </tr> <tr> <td>2.0 TDI 4motion</td> <td>103</td> <td>08.04</td> <td>09.08</td> <td></td> <td></td> <td></td> <td></td> </tr> <tr> <td>3.2 R32</td> <td>184</td> <td>11.05</td> <td>09.08</td> <td></td> <td></td> <td></td> <td></td> </tr> </table>	1.4 16V		10.03	09.08	24.2415-1713.3	030132		Gz 15,87, + Sensor	1.4 FSI	66	10.03	09.08					1.4 TSI	90	05.07	09.08					1.4 TSI	103	05.06	09.08					1.4 TSI	125	11.05	09.08					1.6 16V	75	01.04	09.08					1.6 FSI	85	10.03	09.08					1.9 TDI	66	05.04	09.08					1.9 TDI	77	10.03	09.08					1.9 TDI 4motion	77	08.04	09.08					2.0 FSI	110	10.03	09.08					2.0 FSI 4motion	110	08.04	09.08					2.0 GTI	147	09.04	09.08					2.0 GTI	169	09.06	09.08					2.0 SDI	55	01.04	09.08					2.0 TDI	100	10.03	09.08					2.0 TDI	103	10.03	09.08					2.0 TDI	125	11.05	09.08					2.0 TDI 4motion	103	08.04	09.08					3.2 R32	184	11.05	09.08				
1.4 16V		10.03	09.08	24.2415-1713.3	030132		Gz 15,87, + Sensor																																																																																																																																																										
1.4 FSI	66	10.03	09.08																																																																																																																																																														
1.4 TSI	90	05.07	09.08																																																																																																																																																														
1.4 TSI	103	05.06	09.08																																																																																																																																																														
1.4 TSI	125	11.05	09.08																																																																																																																																																														
1.6 16V	75	01.04	09.08																																																																																																																																																														
1.6 FSI	85	10.03	09.08																																																																																																																																																														
1.9 TDI	66	05.04	09.08																																																																																																																																																														
1.9 TDI	77	10.03	09.08																																																																																																																																																														
1.9 TDI 4motion	77	08.04	09.08																																																																																																																																																														
2.0 FSI	110	10.03	09.08																																																																																																																																																														
2.0 FSI 4motion	110	08.04	09.08																																																																																																																																																														
2.0 GTI	147	09.04	09.08																																																																																																																																																														
2.0 GTI	169	09.06	09.08																																																																																																																																																														
2.0 SDI	55	01.04	09.08																																																																																																																																																														
2.0 TDI	100	10.03	09.08																																																																																																																																																														
2.0 TDI	103	10.03	09.08																																																																																																																																																														
2.0 TDI	125	11.05	09.08																																																																																																																																																														
2.0 TDI 4motion	103	08.04	09.08																																																																																																																																																														
3.2 R32	184	11.05	09.08																																																																																																																																																														
	<table border="1"> <tr> <td>1.4 TSI</td> <td>103</td> <td>05.06</td> <td>09.08</td> <td>24.2519-1705.3</td> <td>040095</td> <td></td> <td>Nz 19,05</td> </tr> <tr> <td>1.4 TSI</td> <td>125</td> <td>11.05</td> <td>09.08</td> <td></td> <td></td> <td></td> <td></td> </tr> <tr> <td>1.9 TDI</td> <td>77</td> <td>10.03</td> <td>09.08</td> <td></td> <td></td> <td></td> <td></td> </tr> <tr> <td>1.9 TDI 4motion</td> <td>77</td> <td>08.04</td> <td>09.08</td> <td></td> <td></td> <td></td> <td></td> </tr> <tr> <td>2.0 FSI</td> <td>110</td> <td>10.03</td> <td>09.08</td> <td></td> <td></td> <td></td> <td></td> </tr> <tr> <td>2.0 FSI 4motion</td> <td>110</td> <td>08.04</td> <td>09.08</td> <td></td> <td></td> <td></td> <td></td> </tr> <tr> <td>2.0 TDI 4motion</td> <td>103</td> <td>08.04</td> <td>09.08</td> <td></td> <td></td> <td></td> <td></td> </tr> <tr> <td>3.2 R32</td> <td>184</td> <td>11.05</td> <td>09.08</td> <td></td> <td></td> <td></td> <td></td> </tr> </table>	1.4 TSI	103	05.06	09.08	24.2519-1705.3	040095		Nz 19,05	1.4 TSI	125	11.05	09.08					1.9 TDI	77	10.03	09.08					1.9 TDI 4motion	77	08.04	09.08					2.0 FSI	110	10.03	09.08					2.0 FSI 4motion	110	08.04	09.08					2.0 TDI 4motion	103	08.04	09.08					3.2 R32	184	11.05	09.08																																																																																																				
1.4 TSI	103	05.06	09.08	24.2519-1705.3	040095		Nz 19,05																																																																																																																																																										
1.4 TSI	125	11.05	09.08																																																																																																																																																														
1.9 TDI	77	10.03	09.08																																																																																																																																																														
1.9 TDI 4motion	77	08.04	09.08																																																																																																																																																														
2.0 FSI	110	10.03	09.08																																																																																																																																																														
2.0 FSI 4motion	110	08.04	09.08																																																																																																																																																														
2.0 TDI 4motion	103	08.04	09.08																																																																																																																																																														
3.2 R32	184	11.05	09.08																																																																																																																																																														
	<table border="1"> <tr> <td>1.4 16V</td> <td></td> <td>10.03</td> <td>09.08</td> <td>24.2519-1706.3</td> <td>040096</td> <td></td> <td>Nz 19,05</td> </tr> <tr> <td>1.4 FSI</td> <td>66</td> <td>10.03</td> <td>09.08</td> <td></td> <td></td> <td></td> <td></td> </tr> <tr> <td>1.4 TSI</td> <td>90</td> <td>05.07</td> <td>09.08</td> <td></td> <td></td> <td></td> <td></td> </tr> <tr> <td>1.6 16V</td> <td>75</td> <td>01.04</td> <td>09.08</td> <td></td> <td></td> <td></td> <td></td> </tr> <tr> <td>1.6 FSI</td> <td>85</td> <td>10.03</td> <td>09.08</td> <td></td> <td></td> <td></td> <td></td> </tr> <tr> <td>1.9 TDI</td> <td>66</td> <td>05.04</td> <td>09.08</td> <td></td> <td></td> <td></td> <td></td> </tr> <tr> <td>2.0 GTI</td> <td>147</td> <td>09.04</td> <td>09.08</td> <td></td> <td></td> <td></td> <td></td> </tr> <tr> <td>2.0 GTI</td> <td>169</td> <td>09.06</td> <td>09.08</td> <td></td> <td></td> <td></td> <td></td> </tr> <tr> <td>2.0 SDI</td> <td>55</td> <td>01.04</td> <td>09.08</td> <td></td> <td></td> <td></td> <td></td> </tr> <tr> <td>2.0 TDI</td> <td>100</td> <td>10.03</td> <td>09.08</td> <td></td> <td></td> <td></td> <td></td> </tr> <tr> <td>2.0 TDI</td> <td>103</td> <td>10.03</td> <td>09.08</td> <td></td> <td></td> <td></td> <td></td> </tr> <tr> <td>2.0 TDI</td> <td>125</td> <td>11.05</td> <td>09.08</td> <td></td> <td></td> <td></td> <td></td> </tr> </table>	1.4 16V		10.03	09.08	24.2519-1706.3	040096		Nz 19,05	1.4 FSI	66	10.03	09.08					1.4 TSI	90	05.07	09.08					1.6 16V	75	01.04	09.08					1.6 FSI	85	10.03	09.08					1.9 TDI	66	05.04	09.08					2.0 GTI	147	09.04	09.08					2.0 GTI	169	09.06	09.08					2.0 SDI	55	01.04	09.08					2.0 TDI	100	10.03	09.08					2.0 TDI	103	10.03	09.08					2.0 TDI	125	11.05	09.08																																																																				
1.4 16V		10.03	09.08	24.2519-1706.3	040096		Nz 19,05																																																																																																																																																										
1.4 FSI	66	10.03	09.08																																																																																																																																																														
1.4 TSI	90	05.07	09.08																																																																																																																																																														
1.6 16V	75	01.04	09.08																																																																																																																																																														
1.6 FSI	85	10.03	09.08																																																																																																																																																														
1.9 TDI	66	05.04	09.08																																																																																																																																																														
2.0 GTI	147	09.04	09.08																																																																																																																																																														
2.0 GTI	169	09.06	09.08																																																																																																																																																														
2.0 SDI	55	01.04	09.08																																																																																																																																																														
2.0 TDI	100	10.03	09.08																																																																																																																																																														
2.0 TDI	103	10.03	09.08																																																																																																																																																														
2.0 TDI	125	11.05	09.08																																																																																																																																																														
VOLKSWAGEN GOLF V Variant (07-09)																																																																																																																																																																	
	<table border="1"> <tr> <td>1.4</td> <td>◀ 59</td> <td>06.07</td> <td>06.09</td> <td>PR: 1AC,1AT</td> <td>03.7863-3232.4</td> <td>300307</td> <td></td> <td>10"</td> <td>ATE</td> </tr> <tr> <td>1.4 TSI</td> <td>◀ 90</td> <td>06.07</td> <td>06.09</td> <td>PR: 1AC,1AT</td> <td></td> <td></td> <td></td> <td></td> <td></td> </tr> <tr> <td>1.4 TSI</td> <td>◀ 103</td> <td>05.07</td> <td>06.09</td> <td>PR: 1AC,1AT</td> <td></td> <td></td> <td></td> <td></td> <td></td> </tr> <tr> <td>1.6</td> <td>◀ 75</td> <td>05.07</td> <td>06.09</td> <td>PR: 1AC,1AT</td> <td></td> <td></td> <td></td> <td></td> <td></td> </tr> <tr> <td>1.9 TDI</td> <td>◀ 77</td> <td>05.07</td> <td>06.09</td> <td>PR: 1AC,1AT</td> <td></td> <td></td> <td></td> <td></td> <td></td> </tr> <tr> <td>1.9 TDI 4motion</td> <td>◀ 77</td> <td>12.07</td> <td>06.09</td> <td>PR: 1AC,1AT</td> <td></td> <td></td> <td></td> <td></td> <td></td> </tr> <tr> <td>2.0 TDI</td> <td>◀</td> <td>05.07</td> <td>06.09</td> <td>PR: 1AC,1AT</td> <td></td> <td></td> <td></td> <td></td> <td></td> </tr> </table>	1.4	◀ 59	06.07	06.09	PR: 1AC,1AT	03.7863-3232.4	300307		10"	ATE	1.4 TSI	◀ 90	06.07	06.09	PR: 1AC,1AT						1.4 TSI	◀ 103	05.07	06.09	PR: 1AC,1AT						1.6	◀ 75	05.07	06.09	PR: 1AC,1AT						1.9 TDI	◀ 77	05.07	06.09	PR: 1AC,1AT						1.9 TDI 4motion	◀ 77	12.07	06.09	PR: 1AC,1AT						2.0 TDI	◀	05.07	06.09	PR: 1AC,1AT																																																																																															
1.4	◀ 59	06.07	06.09	PR: 1AC,1AT	03.7863-3232.4	300307		10"	ATE																																																																																																																																																								
1.4 TSI	◀ 90	06.07	06.09	PR: 1AC,1AT																																																																																																																																																													
1.4 TSI	◀ 103	05.07	06.09	PR: 1AC,1AT																																																																																																																																																													
1.6	◀ 75	05.07	06.09	PR: 1AC,1AT																																																																																																																																																													
1.9 TDI	◀ 77	05.07	06.09	PR: 1AC,1AT																																																																																																																																																													
1.9 TDI 4motion	◀ 77	12.07	06.09	PR: 1AC,1AT																																																																																																																																																													
2.0 TDI	◀	05.07	06.09	PR: 1AC,1AT																																																																																																																																																													
	<table border="1"> <tr> <td>1.4 TSI</td> <td>◀ 90</td> <td>06.07</td> <td>06.09</td> <td>PR: 1AS</td> <td>03.7863-9602.4</td> <td>300206</td> <td>Kolbendurchmesser Ø 22,20mm ¹⁾</td> <td>10"</td> <td>ATE</td> </tr> <tr> <td>1.4 TSI</td> <td>◀ 118</td> <td>07.08</td> <td>06.09</td> <td>PR: 1AS</td> <td></td> <td></td> <td></td> <td></td> <td></td> </tr> <tr> <td>1.6</td> <td>◀ 75</td> <td>05.07</td> <td>06.09</td> <td>PR: 1AS</td> <td></td> <td></td> <td></td> <td></td> <td></td> </tr> <tr> <td>2.0 TDI</td> <td>◀</td> <td>05.07</td> <td>06.09</td> <td>PR: 1AS</td> <td></td> <td></td> <td></td> <td></td> <td></td> </tr> </table>	1.4 TSI	◀ 90	06.07	06.09	PR: 1AS	03.7863-9602.4	300206	Kolbendurchmesser Ø 22,20mm ¹⁾	10"	ATE	1.4 TSI	◀ 118	07.08	06.09	PR: 1AS						1.6	◀ 75	05.07	06.09	PR: 1AS						2.0 TDI	◀	05.07	06.09	PR: 1AS																																																																																																																													
1.4 TSI	◀ 90	06.07	06.09	PR: 1AS	03.7863-9602.4	300206	Kolbendurchmesser Ø 22,20mm ¹⁾	10"	ATE																																																																																																																																																								
1.4 TSI	◀ 118	07.08	06.09	PR: 1AS																																																																																																																																																													
1.6	◀ 75	05.07	06.09	PR: 1AS																																																																																																																																																													
2.0 TDI	◀	05.07	06.09	PR: 1AS																																																																																																																																																													
	<table border="1"> <tr> <td>1.4 TSI</td> <td>◀ 118</td> <td>07.08</td> <td>06.09</td> <td>PR: 1AC,1AT</td> <td>03.7863-3332.4</td> <td>300308</td> <td></td> <td>10"</td> <td>ATE</td> </tr> <tr> <td>1.4 TSI</td> <td>◀ 125</td> <td>05.07</td> <td>06.09</td> <td>PR: 1AC,1AT</td> <td></td> <td></td> <td></td> <td></td> <td></td> </tr> <tr> <td>2.0</td> <td>◀ 147</td> <td>06.07</td> <td>06.09</td> <td>PR: 1AC,1AT</td> <td></td> <td></td> <td></td> <td></td> <td></td> </tr> </table>	1.4 TSI	◀ 118	07.08	06.09	PR: 1AC,1AT	03.7863-3332.4	300308		10"	ATE	1.4 TSI	◀ 125	05.07	06.09	PR: 1AC,1AT						2.0	◀ 147	06.07	06.09	PR: 1AC,1AT																																																																																																																																							
1.4 TSI	◀ 118	07.08	06.09	PR: 1AC,1AT	03.7863-3332.4	300308		10"	ATE																																																																																																																																																								
1.4 TSI	◀ 125	05.07	06.09	PR: 1AC,1AT																																																																																																																																																													
2.0	◀ 147	06.07	06.09	PR: 1AC,1AT																																																																																																																																																													
	<table border="1"> <tr> <td>1.4 TSI</td> <td>◀ 125</td> <td>05.07</td> <td>06.09</td> <td>PR: 1AS</td> <td>03.7863-9802.4</td> <td>300281</td> <td></td> <td>10"</td> <td>ATE</td> </tr> </table>	1.4 TSI	◀ 125	05.07	06.09	PR: 1AS	03.7863-9802.4	300281		10"	ATE																																																																																																																																																						
1.4 TSI	◀ 125	05.07	06.09	PR: 1AS	03.7863-9802.4	300281		10"	ATE																																																																																																																																																								
	<table border="1"> <tr> <td>1.4</td> <td>◀ 59</td> <td>06.07</td> <td>06.09</td> <td>PR: 1AC,1AT</td> <td>03.2122-2129.3</td> <td>010799</td> <td></td> <td>Thz 22,20</td> <td>ATE</td> </tr> <tr> <td>1.4 TSI</td> <td>◀ 90</td> <td>06.07</td> <td>06.09</td> <td>PR: 1AS</td> <td></td> <td></td> <td></td> <td></td> <td></td> </tr> <tr> <td>1.4 TSI</td> <td>◀ 103</td> <td>05.07</td> <td>06.09</td> <td>PR: 1AS</td> <td></td> <td></td> <td></td> <td></td> <td></td> </tr> <tr> <td>1.4 TSI</td> <td>◀ 118</td> <td>07.08</td> <td>06.09</td> <td>PR: 1AC,1AT</td> <td></td> <td></td> <td></td> <td></td> <td></td> </tr> <tr> <td>1.4 TSI</td> <td>◀ 125</td> <td>05.07</td> <td>06.09</td> <td>PR: 1AS</td> <td></td> <td></td> <td></td> <td></td> <td></td> </tr> <tr> <td>1.6</td> <td>◀ 75</td> <td>05.07</td> <td>06.09</td> <td>PR: 1AS</td> <td></td> <td></td> <td></td> <td></td> <td></td> </tr> <tr> <td>1.9 TDI</td> <td>◀ 77</td> <td>05.07</td> <td>06.09</td> <td>PR: 1AC,1AT</td> <td></td> <td></td> <td></td> <td></td> <td></td> </tr> <tr> <td>1.9 TDI 4motion</td> <td>◀ 77</td> <td>12.07</td> <td>06.09</td> <td>PR: 1AC,1AT</td> <td></td> <td></td> <td></td> <td></td> <td></td> </tr> <tr> <td>2.0</td> <td>◀ 147</td> <td>06.07</td> <td>06.09</td> <td>PR: 1AC,1AT</td> <td></td> <td></td> <td></td> <td></td> <td></td> </tr> <tr> <td>2.0 TDI</td> <td>◀</td> <td>05.07</td> <td>06.09</td> <td>PR: 1AC,1AT</td> <td></td> <td></td> <td></td> <td></td> <td></td> </tr> </table>	1.4	◀ 59	06.07	06.09	PR: 1AC,1AT	03.2122-2129.3	010799		Thz 22,20	ATE	1.4 TSI	◀ 90	06.07	06.09	PR: 1AS						1.4 TSI	◀ 103	05.07	06.09	PR: 1AS						1.4 TSI	◀ 118	07.08	06.09	PR: 1AC,1AT						1.4 TSI	◀ 125	05.07	06.09	PR: 1AS						1.6	◀ 75	05.07	06.09	PR: 1AS						1.9 TDI	◀ 77	05.07	06.09	PR: 1AC,1AT						1.9 TDI 4motion	◀ 77	12.07	06.09	PR: 1AC,1AT						2.0	◀ 147	06.07	06.09	PR: 1AC,1AT						2.0 TDI	◀	05.07	06.09	PR: 1AC,1AT																																																																	
1.4	◀ 59	06.07	06.09	PR: 1AC,1AT	03.2122-2129.3	010799		Thz 22,20	ATE																																																																																																																																																								
1.4 TSI	◀ 90	06.07	06.09	PR: 1AS																																																																																																																																																													
1.4 TSI	◀ 103	05.07	06.09	PR: 1AS																																																																																																																																																													
1.4 TSI	◀ 118	07.08	06.09	PR: 1AC,1AT																																																																																																																																																													
1.4 TSI	◀ 125	05.07	06.09	PR: 1AS																																																																																																																																																													
1.6	◀ 75	05.07	06.09	PR: 1AS																																																																																																																																																													
1.9 TDI	◀ 77	05.07	06.09	PR: 1AC,1AT																																																																																																																																																													
1.9 TDI 4motion	◀ 77	12.07	06.09	PR: 1AC,1AT																																																																																																																																																													
2.0	◀ 147	06.07	06.09	PR: 1AC,1AT																																																																																																																																																													
2.0 TDI	◀	05.07	06.09	PR: 1AC,1AT																																																																																																																																																													
	<table border="1"> <tr> <td>1.4 TSI</td> <td>◀ 118</td> <td>07.08</td> <td>06.09</td> <td>PR: 1LJ,1LL</td> <td>03.2123-3449.3</td> <td>010808</td> <td></td> <td>Thz 23,81</td> <td>ATE</td> </tr> <tr> <td>1.4 TSI</td> <td>◀ 125</td> <td>05.07</td> <td>06.09</td> <td>PR: 1LJ,1LL</td> <td></td> <td></td> <td></td> <td></td> <td></td> </tr> <tr> <td>2.0</td> <td>◀ 147</td> <td>06.07</td> <td>06.09</td> <td>PR: 1LJ,1LL</td> <td></td> <td></td> <td></td> <td></td> <td></td> </tr> </table>	1.4 TSI	◀ 118	07.08	06.09	PR: 1LJ,1LL	03.2123-3449.3	010808		Thz 23,81	ATE	1.4 TSI	◀ 125	05.07	06.09	PR: 1LJ,1LL						2.0	◀ 147	06.07	06.09	PR: 1LJ,1LL																																																																																																																																							
1.4 TSI	◀ 118	07.08	06.09	PR: 1LJ,1LL	03.2123-3449.3	010808		Thz 23,81	ATE																																																																																																																																																								
1.4 TSI	◀ 125	05.07	06.09	PR: 1LJ,1LL																																																																																																																																																													
2.0	◀ 147	06.07	06.09	PR: 1LJ,1LL																																																																																																																																																													
	<table border="1"> <tr> <td>1.4</td> <td>59</td> <td>06.07</td> <td>06.09</td> <td>PR: 12M</td> <td>11.9541-9549.2</td> <td>220575</td> <td rowspan="5"> <input type="checkbox"/> <input type="checkbox"/> </td> <td rowspan="5"> D=54, - Halter D=54, - Halter Führungsbolzen Hülzensatz </td> <td>ATE</td> </tr> <tr> <td>1.4 TSI</td> <td>90</td> <td>06.07</td> <td>06.09</td> <td>PR: 12M</td> <td>11.9541-9550.2</td> <td>220576</td> <td>ATE</td> </tr> <tr> <td>1.4 TSI</td> <td>103</td> <td>05.07</td> <td>06.09</td> <td>PR: 12M</td> <td>11.8171-0069.1</td> <td>250152</td> <td>ATE</td> </tr> <tr> <td>1.4 TSI</td> <td>118</td> <td>07.08</td> <td>06.09</td> <td>PR: 12M</td> <td>11.0101-5409.2</td> <td>260035</td> <td>ATE</td> </tr> <tr> <td>1.4 TSI</td> <td>125</td> <td>05.07</td> <td>06.09</td> <td>PR: 12M</td> <td></td> <td></td> <td></td> </tr> <tr> <td>1.6</td> <td>75</td> <td>05.07</td> <td>06.09</td> <td>PR: 12M</td> <td></td> <td></td> <td></td> <td></td> <td></td> </tr> <tr> <td>1.9 TDI</td> <td>77</td> <td>05.07</td> <td>06.09</td> <td>PR: 12M</td> <td></td> <td></td> <td></td> <td></td> <td></td> </tr> <tr> <td>1.9 TDI 4motion</td> <td>77</td> <td>12.07</td> <td>06.09</td> <td>PR: 12M</td> <td></td> <td></td> <td></td> <td></td> <td></td> </tr> <tr> <td>2.0</td> <td>147</td> <td>06.07</td> <td>06.09</td> <td>PR: 12M</td> <td></td> <td></td> <td></td> <td></td> <td></td> </tr> <tr> <td>2.0 TDI</td> <td></td> <td>05.07</td> <td>06.09</td> <td>PR: 12M</td> <td></td> <td></td> <td></td> <td></td> <td></td> </tr> </table>	1.4	59	06.07	06.09	PR: 12M	11.9541-9549.2	220575	<input type="checkbox"/> <input type="checkbox"/>	D=54, - Halter D=54, - Halter Führungsbolzen Hülzensatz	ATE	1.4 TSI	90	06.07	06.09	PR: 12M	11.9541-9550.2	220576	ATE	1.4 TSI	103	05.07	06.09	PR: 12M	11.8171-0069.1	250152	ATE	1.4 TSI	118	07.08	06.09	PR: 12M	11.0101-5409.2	260035	ATE	1.4 TSI	125	05.07	06.09	PR: 12M				1.6	75	05.07	06.09	PR: 12M						1.9 TDI	77	05.07	06.09	PR: 12M						1.9 TDI 4motion	77	12.07	06.09	PR: 12M						2.0	147	06.07	06.09	PR: 12M						2.0 TDI		05.07	06.09	PR: 12M																																																																									
1.4	59	06.07	06.09	PR: 12M	11.9541-9549.2	220575	<input type="checkbox"/> <input type="checkbox"/>	D=54, - Halter D=54, - Halter Führungsbolzen Hülzensatz			ATE																																																																																																																																																						
1.4 TSI	90	06.07	06.09	PR: 12M	11.9541-9550.2	220576					ATE																																																																																																																																																						
1.4 TSI	103	05.07	06.09	PR: 12M	11.8171-0069.1	250152					ATE																																																																																																																																																						
1.4 TSI	118	07.08	06.09	PR: 12M	11.0101-5409.2	260035					ATE																																																																																																																																																						
1.4 TSI	125	05.07	06.09	PR: 12M																																																																																																																																																													
1.6	75	05.07	06.09	PR: 12M																																																																																																																																																													
1.9 TDI	77	05.07	06.09	PR: 12M																																																																																																																																																													
1.9 TDI 4motion	77	12.07	06.09	PR: 12M																																																																																																																																																													
2.0	147	06.07	06.09	PR: 12M																																																																																																																																																													
2.0 TDI		05.07	06.09	PR: 12M																																																																																																																																																													

¹⁾ piston diameter Ø 22,20mm / diametro del pistone Ø 22,20mm / diàmetre de piston Ø 22,20mm / diàmetre del pistón Ø 22,20mm



										
VOLKSWAGEN GOLF V Variant (07-09)										
	1.4	59	06.07	06.09	PR: 1ZE,1ZP	11.9541-9553.2	220563	2	D=54, - Halter D=54, - Halter Führungsbolzen Hülzensatz Haltefeder	ATE ATE ATE ATE ATE
	1.4 TSI	90	06.07	06.09	PR: 1ZE,1ZP	11.9541-9554.2	220564			
	1.4 TSI	103	05.07	06.09	PR: 1ZE,1ZP	11.8171-0008.1	990049			
	1.4 TSI	118	07.08	06.09	PR: 1ZE,1ZP	11.0101-5409.2	260035			
	1.4 TSI	125	05.07	06.09	PR: 1ZE,1ZP	11.8116-0351.1	390538			
	1.6	75	05.07	06.09	PR: 1ZE,1ZP					
	1.9 TDI	77	05.07	06.09	PR: 1ZE,1ZP					
	1.9 TDI 4motion	77	12.07	06.09	PR: 1ZE,1ZP					
	2.0	147	06.07	06.09	PR: 1ZE,1ZP					
	2.0 TDI		05.07	06.09	PR: 1ZE,1ZP					
	1.4	59	06.07	06.09	PR: 1LJ,1ZD	11.9541-9553.2	220563			
	1.4 TSI	90	06.07	06.09	PR: 1LJ,1ZD	11.9541-9554.2	220564			
	1.4 TSI	103	05.07	06.09	PR: 1LJ,1ZD	11.8171-0008.1	990049			
	1.4 TSI	118	07.08	06.09	PR: 1LJ,1ZD	11.0101-5409.2	260035			
1.4 TSI	125	05.07	06.09	PR: 1LJ,1ZD	11.8116-0351.1	390538				
1.6	75	05.07	06.09	PR: 1LJ,1ZD						
1.9 TDI	77	05.07	06.09	PR: 1LJ,1ZD						
1.9 TDI 4motion	77	12.07	06.09	PR: 1LJ,1ZD						
2.0	147	06.07	06.09	PR: 1LJ,1ZD						
2.0 TDI		05.07	06.09	PR: 1LJ,1ZD						
	1.4	59	06.07	06.09		24.5143-0564.3	331433	2	L=564	
	1.4 TSI	90	06.07	06.09						
	1.4 TSI	103	05.07	06.09						
	1.4 TSI	118	07.08	06.09						
	1.4 TSI	125	05.07	06.09						
	1.6	75	05.07	06.09						
	1.9 TDI	77	05.07	06.09						
	1.9 TDI 4motion	77	12.07	06.09						
	2.0	147	06.07	06.09						
	2.0 TDI		05.07	06.09						
	1.4	59	06.07	06.09	PR: 1KE,1KF,1KJ,1KV	24.3414-1709.7	220631	2	D=41, - Halter D=41, - Halter	TRW TRW
	1.4 TSI	90	06.07	06.09	PR: 1KE,1KF,1KJ,1KV	24.3414-1710.7	220632			
	1.4 TSI	103	05.07	06.09	PR: 1KE,1KF,1KJ,1KV					
	1.4 TSI	118	07.08	06.09	PR: 1KE,1KF,1KJ,1KV					
	1.4 TSI	125	05.07	06.09	PR: 1KE,1KF,1KJ,1KV					
	1.6	75	05.07	06.09	PR: 1KE,1KF,1KJ,1KV					
	1.9 TDI	77	05.07	06.09	PR: 1KE,1KF,1KJ,1KV					
	1.9 TDI 4motion	77	12.07	06.09	PR: 1KE,1KF,1KJ,1KV					
	2.0	147	06.07	06.09	PR: 1KE,1KF,1KJ,1KV					
	2.0 TDI		05.07	06.09	PR: 1KE,1KF,1KJ,1KV					
	1.4	59	06.07	06.09		24.5204-0233.3	331430	2		
	1.4 TSI	90	06.07	06.09						
	1.4 TSI	103	05.07	06.09						
	1.4 TSI	118	07.08	06.09						
	1.4 TSI	125	05.07	06.09						
	1.6	75	05.07	06.09						
	1.9 TDI	77	05.07	06.09						
	1.9 TDI 4motion	77	12.07	06.09						
	2.0	147	06.07	06.09						
	2.0 TDI		05.07	06.09						
	1.4	59	06.07	06.09		24.3727-2708.2	582708	2	L=1447 L=1447	
	1.4 TSI	90	06.07	06.09		24.3727-0195.2	580195			
	1.4 TSI	103	05.07	06.09						
	1.4 TSI	118	07.08	06.09						
	1.4 TSI	125	05.07	06.09						
	1.6	75	05.07	06.09						
	1.9 TDI	77	05.07	06.09						
	1.9 TDI 4motion	77	12.07	06.09						
	2.0	147	06.07	06.09						
	2.0 TDI		05.07	06.09						
	1.4	59	06.07	06.09		24.2415-1713.3	030132		Gz 15,87, + Sensor	
	1.4 TSI	90	06.07	06.09						
	1.4 TSI	103	05.07	06.09						
	1.4 TSI	118	07.08	06.09						
	1.4 TSI	125	05.07	06.09						
	1.6	75	05.07	06.09						
	1.9 TDI	77	05.07	06.09						
	1.9 TDI 4motion	77	12.07	06.09						
	2.0	147	06.07	06.09						
	2.0 TDI		05.07	06.09						
	1.4	59	06.07	06.09		24.2519-1706.3	040096		Nz 19,05	
	1.4 TSI	90	06.07	06.09						
	1.4 TSI	103	05.07	06.09						
	1.4 TSI	118	07.08	06.09						
	1.4 TSI	125	05.07	06.09						
	1.6	75	05.07	06.09						
	1.9 TDI	77	05.07	06.09						
	1.9 TDI 4motion	77	12.07	06.09						
	2.0	147	06.07	06.09						
	2.0 TDI		05.07	06.09						

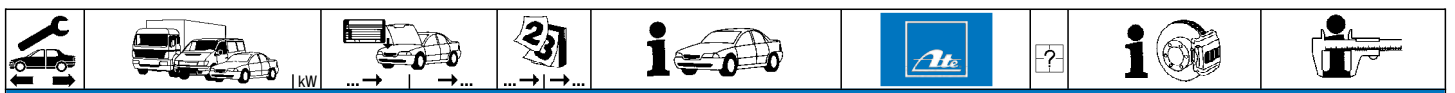





















VOLKSWAGEN GOLF VI (08-)

	1.2 TSI	1K-9-200000	05.09	PR: 1LJ,1LL,1LM	03.7863-3332.4	300308	Kolbendurchmesser Ø 23,81mm ¹⁾	10"	ATE
	1.4	1K-9-200000	10.08	PR: 1LJ,1LL,1LM					
	1.4 TSI	1K-9-200000	10.08	PR: 1LJ,1LL,1LM					
	1.4 TSI	1K-9-200000	10.08	PR: 1LJ,1LL,1LM					
	1.6	1K-9-200000	10.08	PR: 1LJ,1LL,1LM					
	1.6 BiFuel	1K-9-200000	03.09	PR: 1LJ,1LL,1LM					
	1.6 TDI	1K-9-200000	02.09	PR: 1LJ,1LL,1LM					
	1.6 TDI	1K-9-200000	02.09	PR: 1LJ,1LL,1LM					
	1.8 TSI	1K-9-200000	06.09	PR: 1LJ,1LL,1LM					
	2.0 GTi	1K-9-200000	04.09	PR: 1LJ,1LL,1LM					
	2.0 R 4motion	1K-9-200000	11.09	PR: 1LJ,1LL,1LM					
	2.0 TDI	1K-9-200000	10.08	PR: 1LJ,1LL,1LM					
	2.0 TDI	1K-9-200000	10.08	PR: 1LJ,1LL,1LM					
2.0 TDI	1K-9-200000	04.09	PR: 1LJ,1LL,1LM						
2.0 TDI 4motion	1K-9-200000	10.08	PR: 1LJ,1LL,1LM						
1.2 TSI	1K-9-400001	11.10	PR: 1ZA,1ZB,1ZE,1LJ	03.7863-3332.4	300308	Kolbendurchmesser Ø 23,81mm ¹⁾	10"	ATE	
1.4	1K-9-400001	11.10	PR: 1ZA,1ZB,1ZE,1LJ						
1.4 TSI	1K-9-400001	11.10	PR: 1ZA,1ZB,1ZE,1LJ						
1.4 TSI	1K-9-400001	11.10	PR: 1ZA,1ZB,1ZE,1LJ						
1.6	1K-9-400001	11.10	PR: 1ZA,1ZB,1ZE,1LJ						
1.6 BiFuel	1K-9-400001	11.10	PR: 1ZA,1ZB,1ZE,1LJ						
1.6 TDI	1K-9-400001	11.10	PR: 1ZA,1ZB,1ZE,1LJ						
1.6 TDI	1K-9-400001	11.10	PR: 1ZA,1ZB,1ZE,1LJ						
1.8 TSI	1K-9-400001	11.10	PR: 1ZA,1ZB,1ZE,1LJ						
2.0 GTi	1K-9-400001	11.10	PR: 1ZA,1ZB,1ZE,1LJ						
2.0 R 4motion	1K-9-400001	11.10	PR: 1ZA,1ZB,1ZE,1LJ						
2.0 TDI	1K-9-400001	11.10	PR: 1ZA,1ZB,1ZE,1LJ						
2.0 TDI	1K-9-400001	11.10	PR: 1ZA,1ZB,1ZE,1LJ						
2.0 TDI	1K-9-400001	11.10	PR: 1ZA,1ZB,1ZE,1LJ						
2.0 TDI	1K-9-400001	11.10	PR: 1ZA,1ZB,1ZE,1LJ						
2.0 TDI 4motion	1K-9-400001	11.10	PR: 1ZA,1ZB,1ZE,1LJ						
1.2 TSI	1K-9-400001	11.10	PR: 1ZK	03.7860-8802.4	300291		10"	ATE	
1.4	1K-9-400001	11.10	PR: 1ZK						
1.4 TSI	1K-9-400001	11.10	PR: 1ZK						
1.4 TSI	1K-9-400001	11.10	PR: 1ZK						
1.6	1K-9-400001	11.10	PR: 1ZK						
1.6 BiFuel	1K-9-400001	11.10	PR: 1ZK						
1.6 TDI	1K-9-400001	11.10	PR: 1ZK						
1.6 TDI	1K-9-400001	11.10	PR: 1ZK						
1.8 TSI	1K-9-400001	11.10	PR: 1ZK						
2.0 GTi	1K-9-400001	11.10	PR: 1ZK						
2.0 R 4motion	1K-9-400001	11.10	PR: 1ZK						
2.0 TDI	1K-9-400001	11.10	PR: 1ZK						
2.0 TDI	1K-9-400001	11.10	PR: 1ZK						
2.0 TDI	1K-9-400001	11.10	PR: 1ZK						
2.0 TDI	1K-9-400001	11.10	PR: 1ZK						
2.0 TDI 4motion	1K-9-400001	11.10	PR: 1ZK						
1.2 TSI		05.09	PR: 1ZD,1ZF,1ZP,1LV	03.7863-3232.4	300307	Kolbendurchmesser Ø 22,20mm ²⁾	10"	ATE	
1.4		10.08	PR: 1ZD,1ZF,1ZP,1LV						
1.4 TSI		10.08	PR: 1ZD,1ZF,1ZP,1LV						
1.4 TSI		10.08	PR: 1ZD,1ZF,1ZP,1LV						
1.6		10.08	PR: 1ZD,1ZF,1ZP,1LV						
1.6 BiFuel		03.09	PR: 1ZD,1ZF,1ZP,1LV						
1.6 TDI		02.09	PR: 1ZD,1ZF,1ZP,1LV						
1.6 TDI		02.09	PR: 1ZD,1ZF,1ZP,1LV						
1.8 TSI		06.09	PR: 1ZD,1ZF,1ZP,1LV						
2.0 GTi		04.09	PR: 1ZD,1ZF,1ZP,1LV						
2.0 R 4motion		11.09	PR: 1ZD,1ZF,1ZP,1LV						
2.0 TDI		10.08	PR: 1ZD,1ZF,1ZP,1LV						
2.0 TDI		10.08	PR: 1ZD,1ZF,1ZP,1LV						
2.0 TDI		10.08	PR: 1ZD,1ZF,1ZP,1LV						
2.0 TDI		04.09	PR: 1ZD,1ZF,1ZP,1LV						
2.0 TDI 4motion		10.08	PR: 1ZD,1ZF,1ZP,1LV						
	1.2 TSI		05.09	PR: 1ZD,1ZF,1ZP,1LV	03.2122-2129.3	010799		Thz 22,20	ATE
	1.4		10.08	PR: 1ZD,1ZF,1ZP,1LV					
	1.4 TSI		10.08	PR: 1ZD,1ZF,1ZP,1LV					
	1.4 TSI		10.08	PR: 1ZD,1ZF,1ZP,1LV					
	1.6		10.08	PR: 1ZD,1ZF,1ZP,1LV					
	1.6 BiFuel		03.09	PR: 1ZD,1ZF,1ZP,1LV					
	1.6 TDI		02.09	PR: 1ZD,1ZF,1ZP,1LV					
	1.6 TDI		02.09	PR: 1ZD,1ZF,1ZP,1LV					
	1.8 TSI		06.09	PR: 1ZD,1ZF,1ZP,1LV					
	2.0 GTi		04.09	PR: 1ZD,1ZF,1ZP,1LV					
	2.0 R 4motion		11.09	PR: 1ZD,1ZF,1ZP,1LV					
	2.0 TDI		10.08	PR: 1ZD,1ZF,1ZP,1LV					
	2.0 TDI		10.08	PR: 1ZD,1ZF,1ZP,1LV					
2.0 TDI		10.08	PR: 1ZD,1ZF,1ZP,1LV						
2.0 TDI		04.09	PR: 1ZD,1ZF,1ZP,1LV						
2.0 TDI 4motion		10.08	PR: 1ZD,1ZF,1ZP,1LV						
1.2 TSI		05.09	PR: 1ZA,1ZB,1ZE,1LJ	03.2123-3449.3	010808		Thz 23,81	ATE	
1.4		10.08	PR: 1ZA,1ZB,1ZE,1LJ						
1.4 TSI		10.08	PR: 1ZA,1ZB,1ZE,1LJ						
1.4 TSI		10.08	PR: 1ZA,1ZB,1ZE,1LJ						
1.6		10.08	PR: 1ZA,1ZB,1ZE,1LJ						
1.6 BiFuel		03.09	PR: 1ZA,1ZB,1ZE,1LJ						
1.6 TDI		02.09	PR: 1ZA,1ZB,1ZE,1LJ						

¹⁾ piston diameter Ø 23,81mm / diametro del pistone Ø 23,81mm / diamètre de piston Ø 23,81mm / diámetro del pistón Ø 23,81mm

²⁾ piston diameter Ø 22,20mm / diametro del pistone Ø 22,20mm / diamètre de piston Ø 22,20mm / diámetro del pistón Ø 22,20mm



VOLKSWAGEN GOLF VI (08-)														
														
VOLKSWAGEN GOLF VI (08-)														
	1.6 TDI	77	02.09	PR: 1ZA,1ZB,1ZE,1LJ	03.2123-3449.3	010808						Thz 23,81	ATE	
	1.8 TSI	118	06.09	PR: 1ZA,1ZB,1ZE,1LJ										
	2.0 GTi		04.09	PR: 1ZA,1ZB,1ZE,1LJ										
	2.0 R 4motion		11.09	PR: 1ZA,1ZB,1ZE,1LJ										
	2.0 TDI	81	10.08	PR: 1ZA,1ZB,1ZE,1LJ										
	2.0 TDI	100	10.08	PR: 1ZA,1ZB,1ZE,1LJ										
	2.0 TDI	103	10.08	PR: 1ZA,1ZB,1ZE,1LJ										
	2.0 TDI	125	04.09	PR: 1ZA,1ZB,1ZE,1LJ										
	2.0 TDI 4motion	103	10.08	PR: 1ZA,1ZB,1ZE,1LJ										
	1.2 TSI		05.09	PR: 1ZF	11.9541-9549.2	220575						D=54, - Halter	ATE	
	1.4	59	10.08	PR: 1ZF	11.9541-9550.2	220576						D=54, - Halter	ATE	
	1.4 TSI	90	10.08	PR: 1ZF	11.0101-5409.2	260035						Hülsensatz	ATE	
	1.4 TSI	118	10.08	PR: 1ZF	11.8171-0069.1	250152						Führungsbolzen	ATE	
	1.6	75	10.08	PR: 1ZF										
	1.6 BiFuel	75	03.09	PR: 1ZF										
	1.6 TDI	66	02.09	PR: 1ZF										
	1.6 TDI	77	02.09	PR: 1ZF										
	1.8 TSI	118	06.09	PR: 1ZF										
	2.0 GTi		04.09	PR: 1ZF										
	2.0 R 4motion		11.09	PR: 1ZF										
	2.0 TDI	81	10.08	PR: 1ZF										
	2.0 TDI	100	10.08	PR: 1ZF										
	2.0 TDI	103	10.08	PR: 1ZF										
	2.0 TDI	125	04.09	PR: 1ZF										
	2.0 TDI 4motion	103	10.08	PR: 1ZF										
	1.2 TSI		05.09	PR: 1ZE,1ZP	11.9541-9553.2	220563						D=54, - Halter	ATE	
	1.4	59	10.08	PR: 1ZE,1ZP	11.9541-9554.2	220564						D=54, - Halter	ATE	
	1.4 TSI	90	10.08	PR: 1ZE,1ZP	11.0101-5409.2	260035						Hülsensatz	ATE	
	1.4 TSI	118	10.08	PR: 1ZE,1ZP	11.8171-0008.1	990049						Führungsbolzen	ATE	
	1.6	75	10.08	PR: 1ZE,1ZP	11.8116-0351.1	390538	2					Haltefeder	ATE	
	1.6 BiFuel	75	03.09	PR: 1ZE,1ZP										
	1.6 TDI	66	02.09	PR: 1ZE,1ZP										
	1.6 TDI	77	02.09	PR: 1ZE,1ZP										
	1.8 TSI	118	06.09	PR: 1ZE,1ZP										
	2.0 GTi		04.09	PR: 1ZE,1ZP										
	2.0 R 4motion		11.09	PR: 1ZE,1ZP										
	2.0 TDI	81	10.08	PR: 1ZE,1ZP										
	2.0 TDI	100	10.08	PR: 1ZE,1ZP										
	2.0 TDI	103	10.08	PR: 1ZE,1ZP										
	2.0 TDI	125	04.09	PR: 1ZE,1ZP										
	2.0 TDI 4motion	103	10.08	PR: 1ZE,1ZP										
	1.2 TSI		05.09	PR: 1LJ,1LL,1LV,1ZA,1ZB,1ZD	11.9541-9553.2	220563						D=54, - Halter	ATE	
	1.4	59	10.08	PR: 1LJ,1LL,1LV,1ZA,1ZB,1ZD	11.9541-9554.2	220564						D=54, - Halter	ATE	
	1.4 TSI	90	10.08	PR: 1LJ,1LL,1LV,1ZA,1ZB,1ZD	11.0101-5409.2	260035						Hülsensatz	ATE	
	1.4 TSI	118	10.08	PR: 1LJ,1LL,1LV,1ZA,1ZB,1ZD	11.8171-0008.1	990049						Führungsbolzen	ATE	
	1.6	75	10.08	PR: 1LJ,1LL,1LV,1ZA,1ZB,1ZD	11.8116-0351.1	390538	2					Haltefeder	ATE	
	1.6 BiFuel	75	03.09	PR: 1LJ,1LL,1LV,1ZA,1ZB,1ZD										
	1.6 TDI	66	02.09	PR: 1LJ,1LL,1LV,1ZA,1ZB,1ZD										
	1.6 TDI	77	02.09	PR: 1LJ,1LL,1LV,1ZA,1ZB,1ZD										
	1.8 TSI	118	06.09	PR: 1LJ,1LL,1LV,1ZA,1ZB,1ZD										
	2.0 GTi		04.09	PR: 1LJ,1LL,1LV,1ZA,1ZB,1ZD										
	2.0 R 4motion		11.09	PR: 1LJ,1LL,1LV,1ZA,1ZB,1ZD										
	2.0 TDI	81	10.08	PR: 1LJ,1LL,1LV,1ZA,1ZB,1ZD										
	2.0 TDI	100	10.08	PR: 1LJ,1LL,1LV,1ZA,1ZB,1ZD										
	2.0 TDI	103	10.08	PR: 1LJ,1LL,1LV,1ZA,1ZB,1ZD										
	2.0 TDI	125	04.09	PR: 1LJ,1LL,1LV,1ZA,1ZB,1ZD										
	2.0 TDI 4motion	103	10.08	PR: 1LJ,1LL,1LV,1ZA,1ZB,1ZD										
	1.2 TSI		05.09	PR: 1LM	11.9576-9995.2	220651						D=57, - Halter	ATE	
	1.4	59	10.08	PR: 1LM	11.9576-9996.2	220652						D=57, - Halter	ATE	
	1.4 TSI	90	10.08	PR: 1LM	11.0101-5409.2	260035						Hülsensatz	ATE	
	1.4 TSI	118	10.08	PR: 1LM	11.8171-0008.1	990049						Führungsbolzen	ATE	
	1.6	75	10.08	PR: 1LM	11.8116-0410.2	390589	2					Haltefeder	ATE	
	1.6 BiFuel	75	03.09	PR: 1LM										
	1.6 TDI	66	02.09	PR: 1LM										
	1.6 TDI	77	02.09	PR: 1LM										
	1.8 TSI	118	06.09	PR: 1LM										
	2.0 GTi		04.09	PR: 1LM										
	2.0 R 4motion		11.09	PR: 1LM										
	2.0 TDI	81	10.08	PR: 1LM										
	2.0 TDI	100	10.08	PR: 1LM										
	2.0 TDI	103	10.08	PR: 1LM										
	2.0 TDI	125	04.09	PR: 1LM										
	2.0 TDI 4motion	103	10.08	PR: 1LM										
	1.2 TSI		05.09	PR: 1ZK	11.9576-9948.2	220810						D=57, - Halter	ATE	
	1.4	59	10.08	PR: 1ZK	11.0101-5409.2	260035						Hülsensatz	ATE	
	1.4 TSI	90	10.08	PR: 1ZK	11.8171-0008.1	990049						Führungsbolzen	ATE	
	1.4 TSI	118	10.08	PR: 1ZK										
	1.6	75	10.08	PR: 1ZK										
	1.6 BiFuel	75	03.09	PR: 1ZK										
	1.6 TDI	66	02.09	PR: 1ZK										
	1.6 TDI	77	02.09	PR: 1ZK										
	1.8 TSI	118	06.09	PR: 1ZK										
	2.0 GTi		04.09	PR: 1ZK										
	2.0 R 4motion		11.09	PR: 1ZK										
	2.0 TDI	81	10.08	PR: 1ZK										
	2.0 TDI	100	10.08	PR: 1ZK										
	2.0 TDI	103	10.08	PR: 1ZK										
	2.0 TDI	125	04.09	PR: 1ZK										
	2.0 TDI 4motion	103	10.08	PR: 1ZK										

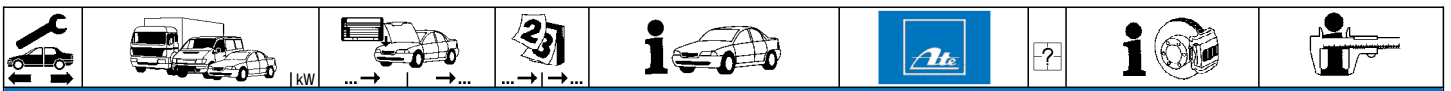

VOLKSWAGEN GOLF VI (08-)

	2.0 TDI 2.0 TDI 4motion	125 103		04.09 10.08	PR: 1ZK PR: 1ZK	11.9576-9948.2 11.0101-5409.2 11.8171-0008.1	220810 260035 990049		D=57, - Halter Hülensatz Führungsbolzen	ATE ATE ATE
	1.2 TSI 1.4 1.4 TSI 1.4 TSI 1.6 1.6 BiFuel 1.6 TDI 1.6 TDI 1.8 TSI 2.0 GTi 2.0 R 4motion 2.0 TDI 2.0 TDI 2.0 TDI 2.0 TDI 2.0 TDI 4motion	59 90 118 75 75 66 77 118 81 100 103 125 103		05.09 10.08 10.08 10.08 10.08 03.09 02.09 02.09 06.09 04.09 11.09 10.08 10.08 10.08 04.09 10.08	PR: 1LJ,1LL,1LV,1ZA,1ZB,1ZD,1ZE,1ZF,1ZP PR: 1LJ,1LL,1LV,1ZA,1ZB,1ZD,1ZE,1ZF,1ZP PR: 1LJ,1LL,1LV,1ZA,1ZB,1ZD,1ZE,1ZF,1ZP PR: 1LJ,1LL,1LV,1ZA,1ZB,1ZD,1ZE,1ZF,1ZP PR: 1LJ,1LL,1LV,1ZA,1ZB,1ZD,1ZE,1ZF,1ZP PR: 1LJ,1LL,1LV,1ZA,1ZB,1ZD,1ZE,1ZF,1ZP PR: 1LJ,1LL,1LV,1ZA,1ZB,1ZD,1ZE,1ZF,1ZP PR: 1LJ,1LL,1LV,1ZA,1ZB,1ZD,1ZE,1ZF,1ZP PR: 1LJ,1LL,1LV,1ZA,1ZB,1ZD,1ZE,1ZF,1ZP PR: 1LJ,1LL,1LV,1ZA,1ZB,1ZD,1ZE,1ZF,1ZP PR: 1LJ,1LL,1LV,1ZA,1ZB,1ZD,1ZE,1ZF,1ZP PR: 1LJ,1LL,1LV,1ZA,1ZB,1ZD,1ZE,1ZF,1ZP PR: 1LJ,1LL,1LV,1ZA,1ZB,1ZD,1ZE,1ZF,1ZP PR: 1LJ,1LL,1LV,1ZA,1ZB,1ZD,1ZE,1ZF,1ZP PR: 1LJ,1LL,1LV,1ZA,1ZB,1ZD,1ZE,1ZF,1ZP PR: 1LJ,1LL,1LV,1ZA,1ZB,1ZD,1ZE,1ZF,1ZP	24.5143-0564.3	331433	2	L=564	
	1.2 TSI 1.4 1.4 TSI 1.4 TSI 1.6 1.6 BiFuel 1.6 TDI 1.6 TDI 1.8 TSI 2.0 GTi 2.0 R 4motion 2.0 TDI 2.0 TDI 2.0 TDI 2.0 TDI 2.0 TDI 4motion	59 90 118 75 75 66 77 118 81 100 103 125 103		05.09 10.08 10.08 10.08 10.08 03.09 02.09 02.09 06.09 04.09 11.09 10.08 10.08 10.08 04.09 10.08	PR: 1ZK PR: 1ZK PR: 1ZK PR: 1ZK PR: 1ZK PR: 1ZK PR: 1ZK PR: 1ZK PR: 1ZK PR: 1ZK PR: 1ZK PR: 1ZK PR: 1ZK PR: 1ZK PR: 1ZK	83.7849-0502.3	331125	2	L=504	
	1.2 TSI 1.4 1.4 TSI 1.4 TSI 1.6 1.6 BiFuel 1.6 TDI 1.6 TDI 1.8 TSI 2.0 GTi 2.0 TDI 2.0 TDI 2.0 TDI 2.0 TDI	59 90 118 75 75 66 77 118 81 100 103 125		05.09 10.08 10.08 10.08 10.08 03.09 02.09 02.09 06.09 04.09 10.08 10.08 10.08 04.09	PR: 1KD PR: 1KD PR: 1KD PR: 1KD PR: 1KD PR: 1KD PR: 1KD PR: 1KD PR: 1KD PR: 1KD PR: 1KD PR: 1KD PR: 1KD	24.3384-1755.7 24.3384-1756.7	220635 220636	 	D=38, - Halter D=38, - Halter	TRW TRW
	1.2 TSI 1.4 1.4 TSI 1.4 TSI 1.6 1.6 BiFuel 1.6 TDI 1.6 TDI 1.8 TSI 2.0 GTi 2.0 TDI 2.0 TDI 2.0 TDI 2.0 TDI	59 90 118 75 75 66 77 118 81 100 103 125		05.09 10.08 10.08 10.08 10.08 03.09 02.09 02.09 06.09 04.09 10.08 10.08 10.08 04.09	10.09 PR: 1KZ PR: 1KZ PR: 1KZ PR: 1KZ PR: 1KZ PR: 1KZ PR: 1KZ PR: 1KZ PR: 1KZ PR: 1KZ PR: 1KZ PR: 1KZ PR: 1KZ	24.3387-1717.7 24.3387-1718.7 24.0101-3803.2	220757 220758 260101	 	D=38, - Halter D=38, - Halter Bremsattel-Zubehör	TRW TRW TRW
	1.2 TSI 1.4 1.4 TSI 1.4 TSI 1.6 1.6 BiFuel 1.6 TDI 1.6 TDI 1.8 TSI 2.0 GTi 2.0 TDI 2.0 TDI 2.0 TDI 2.0 TDI	59 90 118 75 75 66 77 118 81 100 103 125		11.09 11.09 11.09 11.09 11.09 11.09 11.09 11.09 11.09 11.09 11.09 11.09 11.09	PR: 1KY,1KV PR: 1KY,1KV PR: 1KY,1KV PR: 1KY,1KV PR: 1KY,1KV PR: 1KY,1KV PR: 1KY,1KV PR: 1KY,1KV PR: 1KY,1KV PR: 1KY,1KV PR: 1KY,1KV PR: 1KY,1KV PR: 1KY,1KV	24.3387-1729.7 24.3387-1730.7	221007 221008	 	D=38, rot, - Halter D=38, rot, - Halter	TRW TRW
	1.2 TSI 1.4 1.4 TSI 1.4 TSI 1.6 1.6 BiFuel 1.6 TDI 1.6 TDI 1.8 TSI	59 90 118 75 75 66 77 118		05.09 10.08 10.08 10.08 10.08 03.09 02.09 02.09 06.09	10.09 PR: 1KE,1KF PR: 1KE,1KF PR: 1KE,1KF PR: 1KE,1KF PR: 1KE,1KF PR: 1KE,1KF PR: 1KE,1KF PR: 1KE,1KF PR: 1KE,1KF	24.3414-1709.7 24.3414-1710.7	220631 220632	 	D=41, - Halter D=41, - Halter	TRW TRW



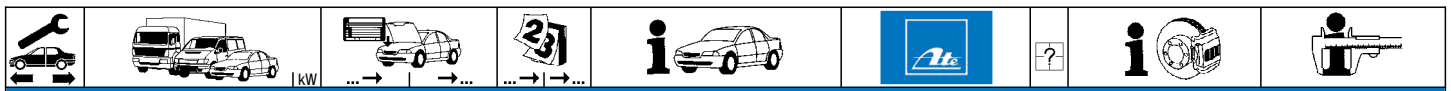

VOLKSWAGEN GOLF VI (08-)

	2.0 GTI 2.0 TDI 2.0 TDI 2.0 TDI 2.0 TDI 2.0 TDI 4motion	81 100 103 125 103	04.09 10.08 10.08 10.08 04.09 10.08	10.09 10.09 10.09 10.09 10.09 10.09	PR: 1KE,1KF PR: 1KE,1KF PR: 1KE,1KF PR: 1KE,1KF PR: 1KE,1KF PR: 1KE,1KF	24.3414-1709.7 24.3414-1710.7	220631 220632		D=41, - Halter D=41, - Halter	TRW TRW
	1.2 TSI 1.4 1.4 TSI 1.4 TSI 1.6 1.6 BiFuel 1.6 TDI 1.6 TDI 1.8 TSI 2.0 GTI 2.0 TDI 2.0 TDI 2.0 TDI 2.0 TDI	59 90 118 75 75 66 77 118 81 100 103 125	05.09 10.08 10.08 10.08 10.08 03.09 02.09 02.09 06.09 04.09 10.08 10.08 10.08 04.09	10.09 10.09 10.09 10.09 10.09 10.09 10.09 10.09 10.09 10.09 10.09 10.09 10.09 10.09	PR: 1KD PR: 1KD PR: 1KD PR: 1KD PR: 1KD PR: 1KD PR: 1KD PR: 1KD PR: 1KD PR: 1KD PR: 1KD PR: 1KD PR: 1KD PR: 1KD	24.5204-0233.3	331430	2	L=233	
	1.2 TSI 1.4 1.4 TSI 1.4 TSI 1.6 1.6 BiFuel 1.6 TDI 1.6 TDI 1.8 TSI 2.0 GTi 2.0 TDI 2.0 TDI 2.0 TDI 2.0 TDI	59 90 118 75 75 66 77 118 81 100 103 125	05.09 10.08 10.08 10.08 10.08 03.09 02.09 02.09 06.09 04.09 10.08 10.08 10.08 04.09	10.09 10.09 10.09 10.09 10.09 10.09 10.09 10.09 10.09 10.09 10.09 10.09 10.09 10.09	PR: 1KE,1KF,1KV,1KY,1KZ PR: 1KE,1KF,1KV,1KY,1KZ PR: 1KE,1KF,1KV,1KY,1KZ PR: 1KE,1KF,1KV,1KY,1KZ PR: 1KE,1KF,1KV,1KY,1KZ PR: 1KE,1KF,1KV,1KY,1KZ PR: 1KE,1KF,1KV,1KY,1KZ PR: 1KE,1KF,1KV,1KY,1KZ PR: 1KE,1KF,1KV,1KY,1KZ PR: 1KE,1KF,1KV,1KY,1KZ PR: 1KE,1KF,1KV,1KY,1KZ PR: 1KE,1KF,1KV,1KY,1KZ PR: 1KE,1KF,1KV,1KY,1KZ PR: 1KE,1KF,1KV,1KY,1KZ	24.5204-0233.3	331430	2	L=233	
	1.2 TSI 1.4 1.4 TSI 1.4 TSI 1.6 1.6 BiFuel 1.6 TDI 1.6 TDI 1.8 TSI 2.0 GTi 2.0 TDI 2.0 TDI 2.0 TDI 2.0 TDI	59 90 118 75 75 66 77 118 81 100 103 125	11.09 11.09 11.09 11.09 11.09 11.09 11.09 11.09 06.09 11.09 11.09 11.09 11.09 11.09	10.09 10.09 10.09 10.09 10.09 10.09 10.09 10.09 10.09 10.09 10.09 10.09 10.09 10.09	PR: 1KS,1KT PR: 1KS,1KT PR: 1KS,1KT PR: 1KS,1KT PR: 1KS,1KT PR: 1KS,1KT PR: 1KS,1KT PR: 1KS,1KT PR: 1KS,1KT PR: 1KS,1KT PR: 1KS,1KT PR: 1KS,1KT PR: 1KS,1KT	83.7847-0254.3 83.7847-0257.3	331233 331234		L=255 L=255	
	2.0 R 4motion 2.0 TDI 4motion	103	11.09 10.08	10.09 10.09	PR: 1KF,1KW PR: 1KF	24.5204-0233.3	331430	2	L=233	
	2.0 R 4motion 2.0 TDI 4motion	103	11.09 11.09	10.09 10.09	PR: 1KS PR: 1KS	83.7847-0254.3 83.7847-0257.3	331233 331234		L=255 L=255	
	1.2 TSI 1.4 1.4 TSI 1.4 TSI 1.6 1.6 BiFuel 1.6 TDI 1.6 TDI 1.8 TSI 2.0 GTi 2.0 R 4motion 2.0 TDI 2.0 TDI 2.0 TDI 2.0 TDI 2.0 TDI 4motion	59 90 118 75 75 66 77 118 81 100 103 125 103	05.09 10.08 10.08 10.08 10.08 03.09 02.09 02.09 06.09 04.09 11.09 10.08 10.08 10.08 04.09 10.08			24.3727-0195.2	580195	2	L=1447	
	1.2 TSI 1.4 1.4 TSI 1.4 TSI 1.6 1.6 BiFuel 1.6 TDI 1.6 TDI 1.8 TSI 2.0 GTi 2.0 R 4motion 2.0 TDI 2.0 TDI 2.0 TDI 2.0 TDI 2.0 TDI 4motion	59 90 118 75 75 66 77 118 81 100 103 125 103	05.09 10.08 10.08 10.08 10.08 03.09 02.09 02.09 06.09 04.09 11.09 10.08 10.08 10.08 04.09 10.08			24.2415-1713.3	030132		Gz 15,87, + Sensor	



VOLKSWAGEN GOLF VI (08-)

	1.4 TSI	90		10.08	06.11	PR: OEJ	24.2519-1705.3	040095		Nz 19,05
	1.4 TSI	118		10.08	06.11	PR: OEJ				
	1.8 TSI	118		06.09	06.11	PR: OEJ				
	1.6 TDI	66		02.09	06.11	PR: OEJ	24.2519-1705.3	040095		Nz 19,05
	1.6 TDI	77		02.09	06.11	PR: OEJ				
	2.0 TDI	81		10.08	06.11	PR: OEJ				
	1.2 TSI			05.09		PR: OEM	24.2519-1706.3	040096		Nz 19,05
	1.4	59		10.08		PR: OEM				
	1.4 TSI	90		10.08		PR: OEM				
	1.4 TSI	118		10.08		PR: OEM				
	1.6	75		10.08		PR: OEM				
	1.6 BiFuel	75		03.09		PR: OEM				
	1.6 TDI	66		02.09		PR: OEM				
	1.6 TDI	77		02.09		PR: OEM				
	1.8 TSI	118		06.09		PR: OEM				
	2.0 GTi			04.09		PR: OEM				
	2.0 R 4motion			11.09		PR: OEM				
2.0 TDI	81		10.08		PR: OEM					
2.0 TDI	100		10.08		PR: OEM					
2.0 TDI	103		10.08		PR: OEM					
2.0 TDI	125		04.09		PR: OEM					
2.0 TDI 4motion	103		10.08		PR: OEM					















VOLKSWAGEN GOLF VI Variant (09-)

	1.4 TSI	90		07.09	11.09	PR: 1AS	03.7863-9602.4	300206	Kolbendurchmesser Ø 22,20mm ¹⁾	10"	ATE
	1.6	75		07.09	11.09	PR: 1AS					
	1.6 MultiFuel	75		07.09	11.09	PR: 1AS					
	1.4 TSI	118		07.09	11.09	PR: 1AC,1AT	03.7863-3332.4	300308	Kolbendurchmesser Ø 23,81mm ²⁾	10"	ATE
	2.0	147		07.09		PR: 1LJ,1ZA	03.7863-3332.4	300308	Kolbendurchmesser Ø 23,81mm ²⁾	10"	ATE
	1.2 TSI			08.09	11.09	PR: 1AC,1AT	03.7863-3232.4	300307		10"	ATE
	1.4	59		07.09	11.09	PR: 1AC,1AT					
	1.4 TSI	90		07.09	11.09	PR: 1AC,1AT					
	1.6	75		07.09	11.09	PR: 1AC,1AT					
	1.6 MultiFuel	75		07.09	11.09	PR: 1AC,1AT					
	1.6 TDI			07.09	11.09	PR: 1AC,1AT					
	1.6 TDI 4motion	77		07.09	11.09	PR: 1AC,1AT					
	2.0 TDI			07.09	11.09	PR: 1AC,1AT					
	1.2 TSI			12.09			03.7863-3232.4	300307		10"	ATE
	1.4	59		12.09							
	1.4 TSI	90		12.09		PR: 1ZP					
	1.4 TSI	118		12.09		PR: 1ZD,1ZP					
1.6	75		12.09								
1.6 MultiFuel	75		12.09								
1.6 TDI			12.09		PR: 1ZP,1ZM						
1.6 TDI 4motion	77		12.09		PR: 1ZP,1ZM						
2.0	147		07.09		PR: 1ZD						
2.0 TDI			12.09								
	1.4 TSI	90		07.09	11.09	PR: 1AS	03.2122-2129.3	010799		Thz 22,20	ATE
	1.6	75		07.09	11.09	PR: 1AS					
	1.6 MultiFuel	75		07.09	11.09	PR: 1AS					
	1.4 TSI	118		07.09	11.09	PR: 1LJ,1LL	03.2123-3449.3	010808		Thz 23,81	ATE
	2.0	147		07.09		PR: 1LJ,1ZA					
	1.2 TSI			08.09	11.09	PR: 1AC,1AT	03.2122-2129.3	010799		Thz 22,20	ATE
	1.4	59		07.09	11.09	PR: 1AC,1AT					
	1.4 TSI	90		07.09	11.09	PR: 1AC,1AT					
	1.4 TSI	118		07.09	11.09	PR: 1AC,1AT					
	1.6	75		07.09	11.09	PR: 1AC,1AT					
	1.6 MultiFuel	75		07.09	11.09	PR: 1AC,1AT					
	1.6 TDI			07.09	11.09	PR: 1AC,1AT					
	1.6 TDI 4motion	77		07.09	11.09	PR: 1AC,1AT					
	2.0 TDI			07.09	11.09	PR: 1AC,1AT					
	1.2 TSI			12.09			03.2122-2129.3	010799		Thz 22,20	ATE
	1.4	59		12.09							
	1.4 TSI	90		12.09		PR: 1ZP					
1.4 TSI	118		12.09		PR: 1ZD,1ZP						
1.6	75		12.09								
1.6 MultiFuel	75		12.09								
1.6 TDI			12.09		PR: 1ZP,1ZM						
1.6 TDI 4motion	77		12.09		PR: 1ZP,1ZM						
2.0	147		07.09		PR: 1ZD						
2.0 TDI			12.09								
	1.2 TSI	59		08.09		PR: 1ZM	11.9541-9549.2	220575		D=54, - Halter	ATE
	1.4	90		07.09		PR: 1ZM	11.9541-9550.2	220576		D=54, - Halter	ATE
	1.4 TSI	90		07.09		PR: 1ZM	11.0101-5409.2	260035		Hülzensatz	ATE
	1.4 TSI	118		07.09		PR: 1ZM	11.8171-0069.1	250152		Führungsbolzen	ATE
	1.6	75		07.09		PR: 1ZM					
	1.6 MultiFuel	75		07.09		PR: 1ZM					
	1.6 TDI			07.09		PR: 1ZM					
	1.6 TDI 4motion	77		07.09		PR: 1ZM					
	2.0	147		07.09		PR: 1ZM					
	2.0 TDI			07.09		PR: 1ZM					

¹⁾ piston diameter Ø 22,20mm / diametro del pistone Ø 22,20mm / diamètre de piston Ø 22,20mm / diámetro del pistón Ø 22,20mm

²⁾ piston diameter Ø 23,81mm / diametro del pistone Ø 23,81mm / diamètre de piston Ø 23,81mm / diámetro del pistón Ø 23,81mm



	 kW											
VOLKSWAGEN GOLF VI Variant (09-)												
	1.2 TSI		08.09	PR: 1LJ,1ZA,1ZD	11.9541-9553.2	220563	2	D=54, - Halter ATE D=54, - Halter ATE Hülzensatz ATE Führungsbolzen ATE Haltefeder ATE				
	1.4	59	07.09	PR: 1LJ,1ZA,1ZD	11.9541-9554.2	220564						
	1.4 TSI	90	07.09	PR: 1LJ,1ZA,1ZD	11.0101-5409.2	260035						
	1.4 TSI	118	07.09	PR: 1LJ,1ZA,1ZD	11.8171-0008.1	990049						
	1.6	75	07.09	PR: 1LJ,1ZA,1ZD	11.8116-0351.1	390538						
	1.6 MultiFuel	75	07.09	PR: 1LJ,1ZA,1ZD								
	1.6 TDI		07.09	PR: 1LJ,1ZA,1ZD								
	1.6 TDI 4motion	77	07.09	PR: 1LJ,1ZA,1ZD								
	2.0	147	07.09	PR: 1LJ,1ZA,1ZD								
	2.0 TDI		07.09	PR: 1LJ,1ZA,1ZD								
	1.2 TSI		08.09	PR: 1ZE,1ZP	11.9541-9553.2	220563						
	1.4	59	07.09	PR: 1ZE,1ZP	11.9541-9554.2	220564						
	1.4 TSI	90	07.09	PR: 1ZE,1ZP	11.0101-5409.2	260035						
	1.4 TSI	118	07.09	PR: 1ZE,1ZP	11.8171-0008.1	990049						
1.6	75	07.09	PR: 1ZE,1ZP	11.8116-0351.1	390538							
1.6 MultiFuel	75	07.09	PR: 1ZE,1ZP									
1.6 TDI		07.09	PR: 1ZE,1ZP									
1.6 TDI 4motion	77	07.09	PR: 1ZE,1ZP									
2.0	147	07.09	PR: 1ZE,1ZP									
2.0 TDI		07.09	PR: 1ZE,1ZP									
	1.2 TSI		08.09	11.11	24.5143-0564.3	331433	2	L=564				
	1.4	59	07.09	11.11								
	1.4 TSI	90	07.09	11.11								
	1.4 TSI	118	07.09	11.11								
	1.6	75	07.09	11.11								
	1.6 MultiFuel	75	07.09	11.11								
	1.6 TDI		07.09	11.11								
	1.6 TDI 4motion	77	07.09	11.11								
	2.0	147	07.09	11.11								
	2.0 TDI		07.09	11.11								
	1.2 TSI		08.09	PR: 1KE,1KF,1KJ	24.3414-1709.7	220631	2	D=41, - Halter TRW D=41, - Halter TRW				
	1.4	59	07.09	PR: 1KE,1KF,1KJ	24.3414-1710.7	220632						
	1.4 TSI	90	07.09	PR: 1KE,1KF,1KJ								
	1.4 TSI	118	07.09	PR: 1KE,1KF,1KJ								
	1.6	75	07.09	PR: 1KE,1KF,1KJ								
	1.6 MultiFuel	75	07.09	PR: 1KE,1KF,1KJ								
	1.6 TDI		07.09	PR: 1KE,1KF,1KJ								
	1.6 TDI 4motion	77	07.09	PR: 1KE,1KF,1KJ								
	2.0	147	07.09	PR: 1KE,1KF,1KJ								
	2.0 TDI		07.09	PR: 1KE,1KF,1KJ								
	1.2 TSI		08.09	11.09	24.5204-0233.3	331430	2	L=233				
	1.4	59	07.09	11.09								
	1.4 TSI	90	07.09	11.09								
	1.4 TSI	118	07.09	11.09								
	1.6	75	07.09	11.09								
	1.6 MultiFuel	75	07.09	11.09								
	1.6 TDI		07.09	11.09								
	1.6 TDI 4motion	77	07.09	11.09								
	2.0	147	07.09	11.09								
	2.0 TDI		07.09	11.09								
	1.2 TSI		12.09	11.11					83.7847-0254.3	331233	2	L=255 L=255
	1.4	59	12.09	11.11								
	1.4 TSI	90	12.09	11.11								
	1.4 TSI	118	12.09	11.11								
1.6	75	12.09	11.11									
1.6 MultiFuel	75	12.09	11.11									
1.6 TDI		12.09	11.11									
1.6 TDI 4motion	77	12.09	11.11									
2.0	147	12.09	11.11									
2.0 TDI		12.09	11.11									
1.2 TSI		12.11		83.7847-0254.3	331233	2	L=255 L=255					
1.4	59	12.11										
1.4 TSI	90	12.11										
1.4 TSI	118	12.11										
1.6	75	12.11										
1.6 MultiFuel	75	12.11										
1.6 TDI		12.11										
1.6 TDI 4motion	77	12.11										
2.0	147	12.11										
2.0 TDI		12.11										
	1.2 TSI		08.09						24.3727-0195.2	580195	2	L=1447
	1.4	59	07.09									
	1.4 TSI	90	07.09									
	1.4 TSI	118	07.09									
	1.6	75	07.09									
	1.6 MultiFuel	75	07.09									
	1.6 TDI		07.09									
	1.6 TDI 4motion	77	07.09									
2.0	147	07.09										
2.0 TDI		07.09										
	1.2 TSI		08.09		24.2415-1713.3	030132	2	Gz 15,87, + Sensor				
	1.4	59	07.09									
	1.4 TSI	90	07.09									
	1.4 TSI	118	07.09									
	1.6	75	07.09									
1.6 MultiFuel	75	07.09										

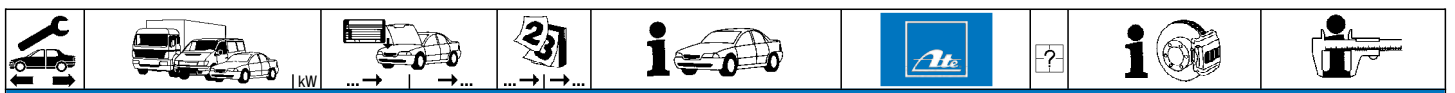

VOLKSWAGEN GOLF VI Variant (09-)

	1.6 TDI 1.6 TDI 4motion 2.0 2.0 TDI	77 147	07.09 07.09 07.09 07.09		24.2415-1713.3	030132		Gz 15,87, + Sensor
	1.4 TSI 1.6 TDI 1.6 TDI 4motion 2.0 TDI	118 77	07.09 07.09 07.09 07.09	07.12 PR: 0EJ 07.12 PR: 0EJ 07.12 PR: 0EJ 07.12 PR: 0EJ	24.2519-1705.3	040095		Nz 19,05
	1.2 TSI 1.4 1.4 TSI 1.4 TSI 1.6 1.6 MultiFuel 1.6 TDI 1.6 TDI 4motion 2.0 2.0 TDI	59 90 118 75 75 77 147	08.09 07.09 07.09 07.09 07.09 07.09 07.09 07.09 07.09	PR: OEM PR: OEM PR: OEM PR: OEM PR: OEM PR: OEM PR: OEM PR: OEM PR: OEM	24.2519-1706.3	040096		Nz 19,05

VOLKSWAGEN GOLF VI Cabriolet (11-)

	1.2 TSI 1.4 TSI 1.4 TSI 1.6 TDI 2.0 R 2.0 TDI 2.0 TSI	77 90 118 77 195 103 155	06.11 06.11 06.11 06.11 01.13 06.11 06.11	PR: 1ZD,1ZP,1LV PR: 1ZD,1ZP,1LV PR: 1ZD,1ZP,1LV PR: 1ZD,1ZP,1LV PR: 1ZD,1ZP,1LV PR: 1ZD,1ZP,1LV PR: 1ZD,1ZP,1LV	03.7863-3232.4	300307		10"	ATE
	1.2 TSI 1.4 TSI 1.4 TSI 1.6 TDI 2.0 R 2.0 TDI 2.0 TSI	77 90 118 77 195 103 155	06.11 06.11 06.11 06.11 01.13 06.11 06.11	PR: 1ZA,1ZB,1ZE PR: 1ZA,1ZB,1ZE PR: 1ZA,1ZB,1ZE PR: 1ZA,1ZB,1ZE PR: 1ZA,1ZB,1ZE PR: 1ZA,1ZB,1ZE PR: 1ZA,1ZB,1ZE	03.7863-3332.4	300308		10"	ATE
	1.2 TSI 1.4 TSI 1.4 TSI 1.6 TDI 2.0 R 2.0 TDI 2.0 TSI	77 90 118 77 195 103 155	06.11 06.11 06.11 06.11 01.13 06.11 06.11	PR: 1ZK PR: 1ZK PR: 1ZK PR: 1ZK PR: 1ZK PR: 1ZK PR: 1ZK	03.7860-8802.4	300291		10"	ATE
	1.2 TSI 1.4 TSI 1.4 TSI 1.6 TDI 2.0 R 2.0 TDI 2.0 TSI	77 90 118 77 195 103 155	06.11 06.11 06.11 06.11 01.13 06.11 06.11	PR: 1ZD,1ZP,1LV PR: 1ZD,1ZP,1LV PR: 1ZD,1ZP,1LV PR: 1ZD,1ZP,1LV PR: 1ZD,1ZP,1LV PR: 1ZD,1ZP,1LV PR: 1ZD,1ZP,1LV	03.2122-2129.3	010799		Thz 22,20	ATE
	1.2 TSI 1.4 TSI 1.4 TSI 1.6 TDI 2.0 R 2.0 TDI 2.0 TSI	77 90 118 77 195 103 155	06.11 06.11 06.11 06.11 01.13 06.11 06.11	PR: 1ZA,1ZB,1ZE,1ZK PR: 1ZA,1ZB,1ZE,1ZK PR: 1ZA,1ZB,1ZE,1ZK PR: 1ZA,1ZB,1ZE,1ZK PR: 1ZA,1ZB,1ZE,1ZK PR: 1ZA,1ZB,1ZE,1ZK PR: 1ZA,1ZB,1ZE,1ZK	03.2123-3449.3	010808		Thz 23,81	ATE
	1.2 TSI 1.4 TSI 1.4 TSI 1.6 TDI 2.0 R 2.0 TDI 2.0 TSI	77 90 118 77 195 103 155	06.11 06.11 06.11 06.11 01.13 06.11 06.11	PR: 1ZE,1ZP PR: 1ZE,1ZP PR: 1ZE,1ZP PR: 1ZE,1ZP PR: 1ZE,1ZP PR: 1ZE,1ZP PR: 1ZE,1ZP	11.9541-9553.2 11.9541-9554.2 11.8171-0008.1 11.0101-5409.2 11.8116-0351.1	220563 220564 990049 260035 390538	2	D=54, - Halter D=54, - Halter Führungsbolzen Hülzensatz Haltefeder	ATE ATE ATE ATE ATE
	1.2 TSI 1.4 TSI 1.4 TSI 1.6 TDI 2.0 R 2.0 TDI 2.0 TSI	77 90 118 77 195 103 155	06.11 06.11 06.11 06.11 01.13 06.11 06.11	PR: 1ZA,1ZD,1ZB PR: 1ZA,1ZD,1ZB PR: 1ZA,1ZD,1ZB PR: 1ZA,1ZD,1ZB PR: 1ZA,1ZD,1ZB PR: 1ZA,1ZD,1ZB PR: 1ZA,1ZD,1ZB	11.9541-9553.2 11.9541-9554.2 11.0101-5409.2 11.8171-0008.1 11.8116-0351.1	220563 220564 260035 990049 390538	2	D=54, - Halter D=54, - Halter Hülzensatz Führungsbolzen Haltefeder	ATE ATE ATE ATE ATE
	1.2 TSI 1.4 TSI 1.4 TSI 1.6 TDI 2.0 R 2.0 TDI 2.0 TSI	77 90 118 77 195 103 155	06.11 06.11 06.11 06.11 01.13 06.11 06.11	PR: 1ZK PR: 1ZK PR: 1ZK PR: 1ZK PR: 1ZK PR: 1ZK PR: 1ZK	11.9576-9948.2 11.8171-0008.1 11.0101-5407.2	220810 990049 260011	1	D=57, - Halter Führungsbolzen Hülzensatz	ATE ATE ATE
	1.2 TSI 1.4 TSI 1.4 TSI 1.6 TDI 2.0 R 2.0 TDI 2.0 TSI	77 90 118 77 195 103 155	06.11 06.11 06.11 06.11 01.13 06.11 06.11		24.5143-0564.3	331433	2	L=564	











VOLKSWAGEN GOLF VI Cabriolet (11-)

	1.2 TSI	77	06.11	PR: 1KD	24.3384-1755.7	220635	D=38, - Halter D=38, - Halter	TRW TRW
	1.4 TSI	90	06.11	PR: 1KD	24.3384-1756.7	220636		
	1.4 TSI	118	06.11	PR: 1KD				
	1.6 TDI	77	06.11	PR: 1KD				
	2.0 R	195	01.13	PR: 1KD				
	2.0 TDI	103	06.11	PR: 1KD				
	2.0 TSI	155	06.11	PR: 1KD				
	1.2 TSI	77	06.11	PR: 1KD	24.5204-0233.3	331430	L=233	
	1.4 TSI	90	06.11	PR: 1KD				
	1.4 TSI	118	06.11	PR: 1KD				
	1.6 TDI	77	06.11	PR: 1KD				
	2.0 R	195	01.13	PR: 1KD				
	2.0 TDI	103	06.11	PR: 1KD				
	2.0 TSI	155	06.11	PR: 1KD				
	1.2 TSI	77	06.11	PR: 1KS,1KT	83.7847-0254.3	331233	L=255 L=255	
	1.4 TSI	90	06.11	PR: 1KS,1KT	83.7847-0257.3	331234		
	1.4 TSI	118	06.11	PR: 1KS,1KT				
	1.6 TDI	77	06.11	PR: 1KS,1KT				
	2.0 R	195	01.13	PR: 1KS,1KT				
	2.0 TDI	103	06.11	PR: 1KS,1KT				
	2.0 TSI	155	06.11	PR: 1KS,1KT				
	1.2 TSI	77	06.11		24.3727-0195.2	580195	L=1447	
	1.4 TSI	90	06.11					
	1.4 TSI	118	06.11					
	1.6 TDI	77	06.11					
	2.0 R	195	01.13					
	2.0 TDI	103	06.11					
	2.0 TSI	155	06.11					
	1.2 TSI	77	06.11		24.2415-1713.3	030132	Gz 15,87, + Sensor	
	1.4 TSI	90	06.11					
	1.4 TSI	118	06.11					
	1.6 TDI	77	06.11					
	2.0 R	195	01.13					
	2.0 TDI	103	06.11					
	2.0 TSI	155	06.11					
	1.2 TSI	77	06.11	PR: OEM	24.2519-1706.3	040096	Nz 19,05	
	1.4 TSI	90	06.11	PR: OEM				
	1.4 TSI	118	06.11	PR: OEM				
	1.6 TDI	77	06.11	PR: OEM				
	2.0 R	195	01.13	PR: OEM				
	2.0 TDI	103	06.11	PR: OEM				
	2.0 TSI	155	06.11	PR: OEM				
1.4 TSI	118	06.11	PR: OEJ	24.2519-1705.3	040095	Nz 19,05		
1.6 TDI	77	06.11	PR: OEJ					

VOLKSWAGEN GOLF VII (12-)

	1.0 TSI	◀ 85	05.15	PR: 1ZA,1ZD,1ZE,1ZF,1ZP	03.4153-5403.3	010994	Thz 23,81	ATE
	1.2 TSI	◀ 63	11.12	PR: 1ZA,1ZD,1ZE,1ZF,1ZP				
	1.2 TSI	◀ 77	11.12	PR: 1ZA,1ZD,1ZE,1ZF,1ZP				
	1.2 TSI	◀ 81	04.14	PR: 1ZA,1ZD,1ZE,1ZF,1ZP				
	1.4 TGI	◀ 81	08.13	PR: 1ZA,1ZD,1ZE,1ZF,1ZP				
	1.4 TSI	◀ 90	11.12	PR: 1ZA,1ZD,1ZE,1ZF,1ZP				
	1.4 TSI	◀ 92	05.14	PR: 1ZA,1ZD,1ZE,1ZF,1ZP				
	1.4 TSI	◀ 103	11.12	PR: 1ZA,1ZD,1ZE,1ZF,1ZP				
	1.4 TSI	◀ 110	05.14	PR: 1ZA,1ZD,1ZE,1ZF,1ZP				
	1.4 TSI Multifuel	◀ 90	04.13	PR: 1ZA,1ZD,1ZE,1ZF,1ZP				
	1.4 TSI Multifuel	◀ 92	12.13	PR: 1ZA,1ZD,1ZE,1ZF,1ZP				
	1.6	◀ 81	05.14	PR: 1ZA,1ZD,1ZE,1ZF,1ZP				
	1.6 TDI	◀ 66	04.13	PR: 1ZA,1ZD,1ZE,1ZF,1ZP				
	1.6 TDI	◀ 77	11.12	PR: 1ZA,1ZD,1ZE,1ZF,1ZP				
	1.6 TDI	◀ 81	06.13	PR: 1ZA,1ZD,1ZE,1ZF,1ZP				
	1.6 TDI 4motion	◀ 77	11.12	PR: 1ZA,1ZD,1ZE,1ZF,1ZP				
	1.6 TDI 4motion	◀ 81	01.13	PR: 1ZA,1ZD,1ZE,1ZF,1ZP				
	2.0 GTD	◀ 135	03.13	PR: 1ZA,1ZD,1ZE,1ZF,1ZP				
	2.0 GTI	◀ 162	03.13	PR: 1ZA,1ZD,1ZE,1ZF,1ZP				
	2.0 GTI	◀ 195	02.16	PR: 1ZA,1ZD,1ZE,1ZF,1ZP				
	2.0 GTI Clubsport S	◀ 228	05.16	PR: 1ZA,1ZD,1ZE,1ZF,1ZP				
	2.0 GTI Performance	◀ 169	03.13	PR: 1ZA,1ZD,1ZE,1ZF,1ZP				
	2.0 R 4motion	◀ 221	09.13	PR: 1ZA,1ZD,1ZE,1ZF,1ZP				
	2.0 TDI	◀ 81	11.12	PR: 1ZA,1ZD,1ZE,1ZF,1ZP				
	2.0 TDI	◀ 105	08.12	PR: 1ZA,1ZD,1ZE,1ZF,1ZP				
	2.0 TDI	◀ 110	11.12	PR: 1ZA,1ZD,1ZE,1ZF,1ZP				
	2.0 TDI 4motion	◀ 110	11.12	PR: 1ZA,1ZD,1ZE,1ZF,1ZP				
	1.0 TSI	85	05.15		24.2519-1706.3	040096	PR: OEC,OEM	Nz 19,05
	1.2 TSI	63	11.12					
	1.2 TSI	77	11.12					
	1.2 TSI	81	04.14					
	1.4 GTE Hybrid	110	05.14					
	1.4 TGI	81	08.13					
	1.4 TSI	90	11.12					
	1.4 TSI	92	05.14					
	1.4 TSI	103	11.12					
	1.4 TSI	110	05.14					
	1.4 TSI Multifuel	90	04.13					
1.4 TSI Multifuel	92	12.13						
1.6	81	05.14						

VOLKSWAGEN GOLF VII (12-)		VOLKSWAGEN GOLF VII Variant (13-)		VOLKSWAGEN GOLF VII Sportsvan (14-)		VOLKSWAGEN GOLF VII ALLTRACK (14-)		VOLKSWAGEN GOLF Plus (05-14)		
	1.6 TDI 66 1.6 TDI 77 1.6 TDI 81 1.6 TDI 4motion 77 1.6 TDI 4motion 81 2.0 GTD 135 2.0 GTI 162 2.0 GTI 195 2.0 GTI Clubsport S 228 2.0 GTI Performance 169 2.0 R 4motion 221 2.0 TDI 81 2.0 TDI 105 2.0 TDI 110 2.0 TDI 4motion 110	66 77 81 77 81 135 162 195 228 169 221 81 105 110 110	04.13 11.12 06.13 11.12 01.13 03.13 03.13 02.16 05.16 03.13 09.13 11.12 08.12 11.12 11.12		24.2519-1706.3	040096	PR: OEC,OEM	Nz 19,05		
	1.0 TSI 85 1.2 TSI 63 1.2 TSI 77 1.2 TSI 81 1.4 TSI 90 1.4 TSI 92 1.4 TSI 103 1.4 TSI 110 1.4 TSI CNG 81 1.4 TSI MultiFuel 90 1.4 TSI MultiFuel 92 1.6 81 1.6 TDI 66 1.6 TDI 77 1.6 TDI 81 1.6 TDI 4motion 2.0 GTD 135 2.0 R 4motion 221 2.0 TDI 81 2.0 TDI 110 2.0 TDI 4motion 110	85 63 77 81 90 92 103 110 81 90 92 81 66 77 81 135 221 81 110 110	05.15 07.13 07.13 04.14 07.13 05.14 07.13 05.14 09.13 04.13 05.14 05.14 07.13 07.13 07.13 07.13 03.15 07.13 07.13 07.13	PR: 1ZA,1ZD,1ZE,1ZF,1ZP PR: 1ZA,1ZD,1ZE,1ZF,1ZP PR: 1ZA,1ZD,1ZE,1ZF,1ZP PR: 1ZA,1ZD,1ZE,1ZF,1ZP PR: 1ZA,1ZD,1ZE,1ZF,1ZP PR: 1ZA,1ZD,1ZE,1ZF,1ZP PR: 1ZA,1ZD,1ZE,1ZF,1ZP PR: 1ZA,1ZD,1ZE,1ZF,1ZP PR: 1ZA,1ZD,1ZE,1ZF,1ZP PR: 1ZA,1ZD,1ZE,1ZF,1ZP PR: 1ZA,1ZD,1ZE,1ZF,1ZP PR: 1ZA,1ZD,1ZE,1ZF,1ZP PR: 1ZA,1ZD,1ZE,1ZF,1ZP PR: 1ZA,1ZD,1ZE,1ZF,1ZP PR: 1ZA,1ZD,1ZE,1ZF,1ZP PR: 1ZA,1ZD,1ZE,1ZF,1ZP PR: 1ZA,1ZD,1ZE,1ZF,1ZP PR: 1ZA,1ZD,1ZE,1ZF,1ZP PR: 1ZA,1ZD,1ZE,1ZF,1ZP PR: 1ZA,1ZD,1ZE,1ZF,1ZP		03.4153-5403.3	010994		THz 23,81	ATE
	1.0 TSI 85 1.2 TSI 63 1.2 TSI 77 1.2 TSI 81 1.4 TSI 90 1.4 TSI 92 1.4 TSI 103 1.4 TSI 110 1.4 TSI CNG 81 1.4 TSI MultiFuel 90 1.4 TSI MultiFuel 92 1.6 81 1.6 TDI 66 1.6 TDI 77 1.6 TDI 81 1.6 TDI 4motion 2.0 GTD 135 2.0 R 4motion 221 2.0 TDI 81 2.0 TDI 110 2.0 TDI 4motion 110	85 63 77 81 90 92 103 110 81 90 92 81 66 77 81 135 221 81 110 110	05.15 07.13 07.13 04.14 07.13 05.14 07.13 05.14 09.13 04.13 05.14 05.14 07.13 07.13 07.13 07.13 03.15 07.13 07.13 07.13		24.2519-1706.3	040096	PR: OEC,OEM	Nz 19,05		
	1.0 TSI 85 1.2 TSI 63 1.2 TSI 81 1.4 TSI 92 1.4 TSI 110 1.4 TSI MultiFuel 92 1.6 81 1.6 TDI 66 1.6 TDI 81 2.0 TDI 81 2.0 TDI 110	85 63 81 92 110 92 81 66 81 81 110	05.15 03.14 03.14 03.14 05.14 04.14 05.14 02.14 05.14 05.14 05.14		24.2519-1706.3	040096	PR: OEC,OEM,OEN	Nz 19,05		
	1.6 TDI 4motion 81 1.8 TSI 4motion 132 2.0 TDI 4motion 110 2.0 TDI 4motion 135	81 132 110 135	12.14 12.14 12.14 12.14	PR: OEC,OEM PR: OEC,OEM PR: OEC,OEM PR: OEC,OEM	24.2519-1706.3	040096		Nz 19,05		
	1.4 16V 66 1.4 FSI 90 1.4 TSI 103 1.4 TSI 118 1.4 TSI 125 1.6 75 1.6 FSI 85	66 90 103 118 125 75 85	01.05 07.05 06.07 05.06 06.08 05.06 05.05 01.05	1K-9-899999 1K-9-899999 1K-9-899999 1K-9-899999 1K-6-565000 1K-9-899999 1K-9-899999	PR: 1AC,1AT PR: 1AC,1AT PR: 1AC,1AT PR: 1AC,1AT PR: 1AC,1AT PR: 1AC,1AT PR: 1AC,1AT PR: 1AC,1AT	03.7863-3232.4	300307	Kolbendurchmesser Ø 22,20mm ¹⁾ 10"	ATE	

¹⁾ piston diameter Ø 22,20mm / diametro del pistone Ø 22,20mm / diamètre de piston Ø 22,20mm / diámetro del pistón Ø 22,20mm



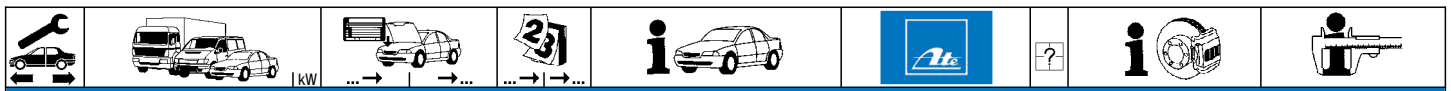

VOLKSWAGEN GOLF Plus (05-14)

	1.9 TDI	66	1K-9-899999	05.05	PR: 1AC,1AT	03.7863-3232.4	300307	Kolbendurchmesser Ø 22,20mm ¹⁾	10"	ATE
	1.9 TDI	77	1K-9-899999	01.05	PR: 1AC,1AT					
	2.0 FSI	110	1K-9-899999	05.05	PR: 1AC,1AT					
	2.0 TDI		1K-9-899999	05.05	PR: 1AC,1AT					
	2.0 TDI	103	1K-9-899999	01.05	PR: 1AC,1AT					
	1.4 16V		1K-9-899999	01.05	PR: 1AS					
	1.4 FSI	66	1K-9-899999	07.05	PR: 1AS					
	1.4 TSI	90	1K-9-899999	06.07	PR: 1AS					
	1.4 TSI	103	1K-9-899999	05.06	PR: 1AS					
	1.4 TSI	118	1K-9-899999	06.08	PR: 1AS					
1.4 TSI	125	1K-6-565000	05.06	PR: 1AS						
1.6	75	1K-9-899999	05.05	PR: 1AS						
1.6 FSI	85	1K-9-899999	01.05	PR: 1AS						
1.9 TDI	66	1K-9-899999	05.05	PR: 1AS						
1.9 TDI	77	1K-9-899999	01.05	PR: 1AS						
2.0 FSI	110	1K-9-899999	05.05	PR: 1AS						
2.0 TDI		1K-9-899999	05.05	PR: 1AS						
2.0 TDI	103	1K-9-899999	01.05	PR: 1AS						
1.4 TSI	125	1K-6-565001	1K-9-899999		PR: 1AC,1AT	03.7863-3332.4	300308	Kolbendurchmesser Ø 23,81mm ²⁾	10"	ATE
1.4 TSI	125	1K-6-565001	1K-9-899999		PR: 1AS	03.7863-9802.4	300281		10"	ATE
1.2 TSI		1K-9-900001		11.10		03.7860-8802.4	300291	PR: 1ZK	10"	ATE
1.4 16V		1K-9-900001		11.10		03.7863-3232.4	300307	PR: 1ZD,1ZF,1ZP,1LV	10"	ATE
1.4 FSI	66	1K-9-900001		11.10		03.7863-3332.4	300308	PR: 1ZA,1ZB,1ZE	10"	ATE
1.4 TSI	90	1K-9-900001		11.10						
1.4 TSI	103	1K-9-900001		11.10						
1.4 TSI	118	1K-9-900001		11.10						
1.4 TSI	125	1K-9-900001		11.10						
1.6	75	1K-9-900001		11.10						
1.6 BiFuel	75	1K-9-900001		11.10						
1.6 FSI	85	1K-9-900001		11.10						
1.6 TDI		1K-9-900001		11.10						
1.9 TDI	66	1K-9-900001		11.10						
1.9 TDI	77	1K-9-900001		11.10						
2.0 FSI	110	1K-9-900001		11.10						
2.0 TDI		1K-9-900001		11.10						
2.0 TDI	81	1K-9-900001		11.10						
2.0 TDI	103	1K-9-900001		11.10						
1.2 TSI				12.10	01.14	03.7863-3232.4	300307	PR: 1ZF,1AC	10"	ATE
1.4 16V				12.10	01.14	03.7863-3332.4	300308	PR: 1ZA,1ZE,1AS,1AT	10"	ATE
1.4 FSI	66			12.10	01.14					
1.4 TSI	90			12.10	01.14					
1.4 TSI	103			12.10	01.14					
1.4 TSI	118			12.10	01.14					
1.4 TSI	125			12.10	01.14					
1.6	75			12.10	01.14					
1.6 BiFuel	75			12.10	01.14					
1.6 FSI	85			12.10	01.14					
1.6 TDI				12.10	01.14					
1.9 TDI	66			12.10	01.14					
1.9 TDI	77			12.10	01.14					
2.0 FSI	110			12.10	01.14					
2.0 TDI				12.10	01.14					
2.0 TDI	81			12.10	01.14					
2.0 TDI	103			12.10	01.14					
	1.4 16V		1K-6-565000	01.05		03.2122-2129.3	010799		Thz 22,20	ATE
	1.4 FSI	66	1K-6-565000	07.05						
	1.4 TSI	103	1K-6-565000	05.06						
	1.4 TSI	125	1K-6-565000	05.06						
	1.6	75	1K-6-565000	05.05						
	1.6 FSI	85	1K-6-565000	01.05						
	1.9 TDI	66	1K-6-565000	05.05						
	1.9 TDI	77	1K-6-565000	01.05						
	2.0 FSI	110	1K-6-565000	05.05						
	2.0 TDI		1K-6-565000	05.05						
2.0 TDI	103	1K-6-565000	01.05							
1.4 16V		1K-8-500000			03.2122-2129.3	010799	PR: 1AC,1AT,1AS	Thz 22,20	ATE	
1.4 FSI	66	1K-6-565001	1K-8-500000		03.2123-3449.3	010808	PR: 1LJ	Thz 23,81	ATE	
1.4 TSI	90	1K-6-565001	1K-8-500000							
1.4 TSI	103	1K-6-565001	1K-8-500000							
1.4 TSI	125	1K-6-565001	1K-8-500000							
1.6	75	1K-6-565001	1K-8-500000							
1.6 FSI	85	1K-6-565001	1K-8-500000							
1.9 TDI	66	1K-6-565001	1K-8-500000							
1.9 TDI	77	1K-6-565001	1K-8-500000							
2.0 FSI	110	1K-6-565001	1K-8-500000							
2.0 TDI		1K-6-565001	1K-8-500000							
2.0 TDI	103	1K-6-565001	1K-8-500000							
1.4 16V		1K-8-500001	1K-9-899999			03.2122-2129.3	010799	PR: 1LK,1ZA,1ZC,1ZD,1ZE,1ZF,1ZM,1ZP	Thz 22,20	ATE
1.4 FSI	66	1K-8-500001	1K-9-899999			03.2123-3449.3	010808	PR: 1LJ	Thz 23,81	ATE
1.4 TSI	90	1K-8-500001	1K-9-899999							
1.4 TSI	103	1K-8-500001	1K-9-899999							
1.4 TSI	118	1K-8-500001	1K-9-899999							
1.4 TSI	125	1K-8-500001	1K-9-899999							
1.6	75	1K-8-500001	1K-9-899999							
1.6 FSI	85	1K-8-500001	1K-9-899999							
1.9 TDI	66	1K-8-500001	1K-9-899999							

¹⁾ piston diameter Ø 22,20mm / diametro del pistone Ø 22,20mm / diamètre de piston Ø 22,20mm / diámetro del pistón Ø 22,20mm



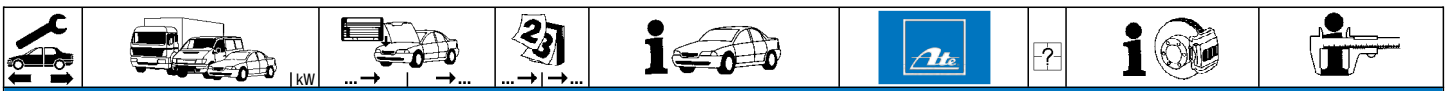



















²⁾ piston diameter Ø 23,81mm / diametro del pistone Ø 23,81mm / diamètre de piston Ø 23,81mm / diámetro del pistón Ø 23,81mm



VOLKSWAGEN GOLF Plus (05-14)

	1.9 TDI 2.0 FSI 2.0 TDI 2.0 TDI	77 110 103	1K-8-500001 1K-8-500001 1K-8-500001 1K-8-500001	1K-9-899999 1K-9-899999 1K-9-899999 1K-9-899999			03.2122-2129.3 03.2123-3449.3	010799 010808	PR: 1LK,1ZA,1ZC,1ZD,1ZE,1ZF,1ZM,1ZP PR: 1LJ	THz 22,20 THz 23,81	ATE ATE	
	1.2 TSI 1.4 16V 1.4 FSI 1.4 TSI 1.4 TSI 1.4 TSI 1.4 TSI 1.6 1.6 BiFuel 1.6 FSI 1.6 TDI 1.9 TDI 1.9 TDI 2.0 FSI 2.0 TDI 2.0 TDI 2.0 TDI	77 110 66 90 103 118 125 75 75 85 66 77 110 81 103	1K-9-900001 1K-9-900001 1K-9-900001 1K-9-900001 1K-9-900001 1K-9-900001 1K-9-900001 1K-9-900001 1K-9-900001 1K-9-900001 1K-9-900001 1K-9-900001 1K-9-900001 1K-9-900001 1K-9-900001 1K-9-900001	1K-C-500000 1K-C-500000 1K-C-500000 1K-C-500000 1K-C-500000 1K-C-500000 1K-C-500000 1K-C-500000 1K-C-500000 1K-C-500000 1K-C-500000 1K-C-500000 1K-C-500000 1K-C-500000 1K-C-500000 1K-C-500000			03.2122-2129.3 03.2123-3449.3	010799 010808	PR: 1ZF PR: 1ZE,1LJ,1ZA	THz 22,20 THz 23,81	ATE ATE	
	1.2 TSI 1.4 16V 1.4 FSI 1.4 TSI 1.4 TSI 1.4 TSI 1.4 TSI 1.6 1.6 BiFuel 1.6 FSI 1.6 TDI 1.9 TDI 1.9 TDI 2.0 FSI 2.0 TDI 2.0 TDI 2.0 TDI	66 90 103 118 125 75 75 85 66 77 110 81 103	1K-C-500001 1K-C-500001 1K-C-500001 1K-C-500001 1K-C-500001 1K-C-500001 1K-C-500001 1K-C-500001 1K-C-500001 1K-C-500001 1K-C-500001 1K-C-500001 1K-C-500001 1K-C-500001 1K-C-500001 1K-C-500001	1K-C-500000 1K-C-500000 1K-C-500000 1K-C-500000 1K-C-500000 1K-C-500000 1K-C-500000 1K-C-500000 1K-C-500000 1K-C-500000 1K-C-500000 1K-C-500000 1K-C-500000 1K-C-500000 1K-C-500000 1K-C-500000	01.14 01.14 01.14 01.14 01.14 01.14 01.14 01.14 01.14 01.14 01.14 01.14 01.14 01.14 01.14 01.14		03.2122-2129.3 03.2123-3449.3	010799 010808	PR: 1ZF,1AC PR: 1ZA,1ZE,1AS,1AT	THz 22,20 THz 23,81	ATE ATE	
	1.2 TSI 1.4 16V 1.4 FSI 1.4 TSI 1.4 TSI 1.4 TSI 1.4 TSI 1.6 1.6 BiFuel 1.6 FSI 1.6 TDI 1.9 TDI 1.9 TDI 2.0 FSI 2.0 TDI 2.0 TDI 2.0 TDI	66 90 103 118 125 75 75 85 66 77 110 81 103			08.09 01.05 07.05 06.07 05.06 06.08 05.06 05.05 05.09 02.09 05.05 05.05 01.09 01.05	01.14 01.14 01.14 01.14 01.14 01.14 01.14 01.14 01.14 01.14 01.14 01.14 01.14 01.14 01.14 01.14	PR: 1ZF,1ZM PR: 1ZF,1ZM PR: 1ZF,1ZM PR: 1ZF,1ZM PR: 1ZF,1ZM PR: 1ZF,1ZM PR: 1ZF,1ZM PR: 1ZF,1ZM PR: 1ZF,1ZM PR: 1ZF,1ZM PR: 1ZF,1ZM PR: 1ZF,1ZM PR: 1ZF,1ZM PR: 1ZF,1ZM PR: 1ZF,1ZM	11.9541-9549.2 11.9541-9550.2 11.0101-5409.2 11.8171-0069.1	220575 220576 260035 250152	<input type="checkbox"/> <input type="checkbox"/>	D=54, - Halter D=54, - Halter Hülsensatz Führungsbolzen	ATE ATE ATE ATE
	1.2 TSI 1.4 16V 1.4 FSI 1.4 TSI 1.4 TSI 1.4 TSI 1.6 1.6 BiFuel 1.6 FSI 1.6 TDI 1.9 TDI 1.9 TDI 2.0 FSI 2.0 TDI 2.0 TDI 2.0 TDI	66 90 103 118 125 75 75 85 66 77 110 81 103			08.09 01.05 07.05 06.07 05.06 06.08 05.06 05.05 05.09 01.05 02.09 05.05 01.05 05.05 01.09 01.05	01.14 01.14 01.14 01.14 01.14 01.14 01.14 01.14 01.14 01.14 01.14 01.14 01.14 01.14 01.14 01.14	PR: 1ZE,1ZP PR: 1ZE,1ZP PR: 1ZE,1ZP PR: 1ZE,1ZP PR: 1ZE,1ZP PR: 1ZE,1ZP PR: 1ZE,1ZP PR: 1ZE,1ZP PR: 1ZE,1ZP PR: 1ZE,1ZP PR: 1ZE,1ZP PR: 1ZE,1ZP PR: 1ZE,1ZP PR: 1ZE,1ZP PR: 1ZE,1ZP PR: 1ZE,1ZP	11.9541-9553.2 11.9541-9554.2 11.0101-5409.2 11.8171-0008.1 11.8116-0351.1	220563 220564 260035 990049 390538	<input type="checkbox"/> <input type="checkbox"/>	D=54, - Halter D=54, - Halter Hülsensatz Führungsbolzen Haltefeder	ATE ATE ATE ATE ATE
	1.2 TSI 1.4 16V 1.4 FSI 1.4 TSI 1.4 TSI 1.4 TSI 1.6 1.6 BiFuel 1.6 FSI 1.6 TDI 1.9 TDI 1.9 TDI 2.0 FSI 2.0 TDI 2.0 TDI 2.0 TDI	66 90 103 118 125 75 75 85 66 77 110 81 103			08.09 01.05 07.05 06.07 05.06 06.08 05.06 05.05 05.09 01.05 02.09 05.05 01.05 05.05 01.09 01.05	01.14 01.14 01.14 01.14 01.14 01.14 01.14 01.14 01.14 01.14 01.14 01.14 01.14 01.14 01.14 01.14	PR: 1LJ,1ZA PR: 1LJ,1ZA PR: 1LJ,1ZA PR: 1LJ,1ZA PR: 1LJ,1ZA PR: 1LJ,1ZA PR: 1LJ,1ZA PR: 1LJ,1ZA PR: 1LJ,1ZA PR: 1LJ,1ZA PR: 1LJ,1ZA PR: 1LJ,1ZA PR: 1LJ,1ZA PR: 1LJ,1ZA PR: 1LJ,1ZA PR: 1LJ,1ZA	11.9541-9553.2 11.9541-9554.2 11.0101-5409.2 11.8171-0008.1 11.8116-0351.1	220563 220564 260035 990049 390538	<input type="checkbox"/> <input type="checkbox"/>	D=54, - Halter D=54, - Halter Hülsensatz Führungsbolzen Haltefeder	ATE ATE ATE ATE ATE



											
VOLKSWAGEN GOLF Plus (05-14)											
	2.0 TDI 2.0 TDI	81 103		01.09 01.05	01.14 01.14	PR: 1LJ,1ZA PR: 1LJ,1ZA	11.9541-9553.2 11.9541-9554.2 11.0101-5409.2 11.8171-0008.1 11.8116-0351.1	220563 220564 260035 990049 390538	 	D=54, - Halter D=54, - Halter Hülensatz Führungsbolzen Haltefeder	ATE ATE ATE ATE ATE
	1.2 TSI 1.4 16V 1.4 FSI 1.4 TSI 1.4 TSI 1.4 TSI 1.4 TSI 1.6 1.6 BiFuel 1.6 FSI 1.6 TDI 1.9 TDI 1.9 TDI 2.0 FSI 2.0 TDI 2.0 TDI 2.0 TDI	 66 90 103 118 125 75 75 85 66 77 110 81 103		08.09 01.05 07.05 06.07 05.06 06.08 05.06 05.05 05.09 01.05 02.09 05.05 01.05 05.05 01.09 01.05	01.14 01.14 01.14 01.14 01.14 01.14 01.14 01.14 01.14 01.14 01.14 01.14 01.14 01.14 01.14 01.14		24.5143-0564.3	331433	2	L=564	
	1.2 TSI 1.4 16V 1.4 FSI 1.4 TSI 1.4 TSI 1.4 TSI 1.4 TSI 1.6 1.6 BiFuel 1.6 FSI 1.6 TDI 1.9 TDI 1.9 TDI 2.0 FSI 2.0 TDI 2.0 TDI 2.0 TDI	 66 90 103 118 125 75 75 85 66 77 110 81 103		08.09 01.05 07.05 06.07 05.06 06.08 05.06 05.05 05.09 01.05 02.09 05.05 01.05 05.05 01.09 01.05	01.14 01.14 01.14 01.14 01.14 01.14 01.14 01.14 01.14 01.14 01.14 01.14 01.14 01.14 01.14 01.14	PR: 1KD PR: 1KD PR: 1KD PR: 1KD PR: 1KD PR: 1KD PR: 1KD PR: 1KD PR: 1KD PR: 1KD PR: 1KD PR: 1KD PR: 1KD PR: 1KD PR: 1KD PR: 1KD	24.3384-1755.7 24.3384-1756.7	220635 220636	 	D=38, - Halter D=38, - Halter	TRW TRW
	1.2 TSI 1.4 16V 1.4 FSI 1.4 TSI 1.4 TSI 1.4 TSI 1.4 TSI 1.6 1.6 BiFuel 1.6 FSI 1.6 TDI 1.9 TDI 1.9 TDI 2.0 FSI 2.0 TDI 2.0 TDI 2.0 TDI	 66 90 103 118 125 75 75 85 66 77 110 81 103		08.09 01.05 07.05 06.07 05.06 06.08 05.06 05.05 05.09 01.05 02.09 05.05 01.05 05.05 01.05	01.14 01.14 01.14 01.14 01.14 01.14 01.14 01.14 01.14 01.14 01.14 01.14 01.14 01.14 01.14	PR: 1KE PR: 1KE PR: 1KE PR: 1KE PR: 1KE PR: 1KE PR: 1KE PR: 1KE PR: 1KE PR: 1KE PR: 1KE PR: 1KE PR: 1KE PR: 1KE PR: 1KE	24.3414-1709.7 24.3414-1710.7	220631 220632	 	D=41, - Halter D=41, - Halter	TRW TRW
	1.4 16V 1.4 FSI 1.4 TSI 1.4 TSI 1.4 TSI 1.6 1.6 FSI 1.9 TDI 1.9 TDI 2.0 FSI 2.0 TDI 2.0 TDI	 66 90 103 125 75 85 66 77 110 81 103	1K-8-500000 1K-8-500000 1K-8-500000 1K-8-500000 1K-8-500000 1K-8-500000 1K-8-500000 1K-8-500000 1K-8-500000 1K-8-500000 1K-8-500000 1K-8-500000	01.05 07.05 06.07 05.06 05.06 05.05 01.05 05.05 01.05 05.05 05.05 01.05	PR: 1KZ PR: 1KZ PR: 1KZ PR: 1KZ PR: 1KZ PR: 1KZ PR: 1KZ PR: 1KZ PR: 1KZ PR: 1KZ PR: 1KZ PR: 1KZ		24.3387-1729.7 24.3387-1730.7 24.0101-3803.2	221007 221008 260101	 	D=38, rot, - Halter D=38, rot, - Halter Bremsattel-Zubehör	TRW TRW TRW
	1.2 TSI 1.4 16V 1.4 FSI 1.4 TSI 1.4 TSI 1.4 TSI 1.6 1.6 BiFuel 1.6 FSI 1.6 TDI 1.9 TDI 1.9 TDI 2.0 FSI 2.0 TDI 2.0 TDI	 1K-8-500001 66 1K-8-500001 90 1K-8-500001 103 1K-8-500001 118 125 1K-8-500001 75 1K-8-500001 75 85 1K-8-500001 66 1K-8-500001 77 1K-8-500001 110 1K-8-500001 81 103 1K-8-500001		08.09 01.14 01.14 01.14 01.14 06.08 01.14 05.09 02.09 01.14 01.14 01.14 01.14 01.14	PR: 1KZ PR: 1KZ PR: 1KZ PR: 1KZ PR: 1KZ PR: 1KZ PR: 1KZ PR: 1KZ PR: 1KZ PR: 1KZ PR: 1KZ PR: 1KZ PR: 1KZ PR: 1KZ		24.3387-1717.7 24.3387-1718.7 24.0101-3803.2	220757 220758 260101	 	D=38, - Halter D=38, - Halter Bremsattel-Zubehör	TRW TRW TRW

VOLKSWAGEN GOLF Plus (05-14)

	1.2 TSI 1.4 16V 1.4 FSI 66 1.4 TSI 90 1.4 TSI 103 1.4 TSI 118 1.4 TSI 125 1.6 75 1.6 BiFuel 75 1.6 FSI 85 1.6 TDI 1.9 TDI 66 1.9 TDI 77 2.0 FSI 110 2.0 TDI 2.0 TDI 81 2.0 TDI 103		08.09 01.14 01.05 01.14 07.05 01.14 06.07 01.14 05.06 01.14 06.08 01.14 05.06 01.14 05.05 01.14 05.09 01.14 01.05 01.14 02.09 01.14 05.05 01.14 01.05 01.14 05.05 01.14 01.09 01.14 01.05 01.14	24.5204-0233.3 331430	2		L=233
	1.4 16V 1.4 FSI 66 1.4 TSI 90 1.4 TSI 103 1.4 TSI 118 1.4 TSI 125 1.6 75 1.6 FSI 85 1.9 TDI 66 1.9 TDI 77 2.0 FSI 110 2.0 TDI 2.0 TDI 103	1K-9-899999 01.05 1K-9-899999 07.05 1K-9-899999 06.07 1K-9-899999 05.06 1K-9-899999 06.08 1K-9-899999 05.06 1K-9-899999 05.05 1K-9-899999 01.05 1K-9-899999 05.05 1K-9-899999 01.05 1K-9-899999 05.05 1K-9-899999 05.05 1K-9-899999 01.05		24.3727-2708.2 582708	2 ↓		L=1447
	1.2 TSI 1.4 16V 1K-9-900001 1.4 FSI 66 1K-9-900001 1.4 TSI 90 1K-9-900001 1.4 TSI 103 1K-9-900001 1.4 TSI 118 1K-9-900001 1.4 TSI 125 1K-9-900001 1.6 75 1K-9-900001 1.6 BiFuel 75 1.6 FSI 85 1K-9-900001 1.6 TDI 1.9 TDI 66 1K-9-900001 1.9 TDI 77 1K-9-900001 2.0 FSI 110 1K-9-900001 2.0 TDI 1K-9-900001 2.0 TDI 81 1K-9-900001 2.0 TDI 103 1K-9-900001	08.09 01.14 01.14 01.14 01.14 01.14 01.14 01.14 05.09 01.14 01.14 02.09 01.14 01.14 01.14 01.14 01.14 01.14 01.14 01.14 01.14 01.14		24.3727-0195.2 580195	2 ↓		L=1447
	1.2 TSI 1.4 16V 1.4 FSI 66 1.4 TSI 90 1.4 TSI 103 1.4 TSI 118 1.4 TSI 125 1.6 75 1.6 BiFuel 75 1.6 FSI 85 1.6 TDI 1.9 TDI 66 1.9 TDI 77 2.0 FSI 110 2.0 TDI 2.0 TDI 81 2.0 TDI 103		08.09 01.14 01.05 01.14 07.05 01.14 06.07 01.14 05.06 01.14 06.08 01.14 05.06 01.14 05.05 01.14 05.09 01.14 01.05 01.14 02.09 01.14 05.05 01.14 01.05 01.14 01.05 01.14 01.09 01.14 01.05 01.14	24.2415-1713.3 030132			Gz 15,87, + Sensor
	1.2 TSI 1.4 16V 1.4 FSI 66 1.4 TSI 90 1.4 TSI 103 1.4 TSI 118 1.4 TSI 125 1.6 75 1.6 BiFuel 75 1.6 FSI 85 1.6 TDI 1.9 TDI 66 1.9 TDI 77 2.0 FSI 110 2.0 TDI 2.0 TDI 81 2.0 TDI 103		08.09 01.14 PR: OEJ 01.05 01.14 PR: OEJ 07.05 01.14 PR: OEJ 06.07 01.14 PR: OEJ 05.06 01.14 PR: OEJ 06.08 01.14 PR: OEJ 05.06 01.14 PR: OEJ 05.05 01.14 PR: OEJ 05.09 01.14 PR: OEJ 01.05 01.14 PR: OEJ 02.09 01.14 PR: OEJ 05.05 01.14 PR: OEJ 01.05 01.14 PR: OEJ 05.05 01.14 PR: OEJ 01.09 01.14 PR: OEJ 01.05 01.14 PR: OEJ	24.2519-1705.3 040095			Nz 19,05
	1.2 TSI 1.4 16V 1.4 FSI 66 1.4 TSI 90 1.4 TSI 103 1.4 TSI 118 1.4 TSI 125 1.6 75 1.6 BiFuel 75 1.6 FSI 85 1.6 TDI 1.9 TDI 66 1.9 TDI 77 2.0 FSI 110 2.0 TDI 2.0 TDI 81 2.0 TDI 103		08.09 01.14 PR: OEM 01.05 01.14 PR: OEM 07.05 01.14 PR: OEM 06.07 01.14 PR: OEM 05.06 01.14 PR: OEM 06.08 01.14 PR: OEM	24.2519-1706.3 040096			Nz 19,05

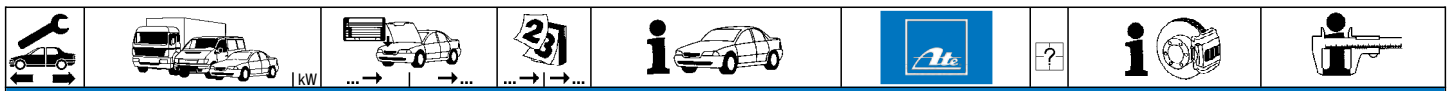

VOLKSWAGEN GOLF Plus (05-14)

	1.4 TSI	125	05.06	01.14	PR: OEM	24.2519-1706.3	040096		Nz 19,05
	1.6	75	05.05	01.14	PR: OEM				
	1.6 BiFuel	75	05.09	01.14	PR: OEM				
	1.6 FSI	85	01.05	01.14	PR: OEM				
	1.6 TDI		02.09	01.14	PR: OEM				
	1.9 TDI	66	05.05	01.14	PR: OEM				
	1.9 TDI	77	01.05	01.14	PR: OEM				
	2.0 FSI	110	05.05	01.14	PR: OEM				
	2.0 TDI		05.05	01.14	PR: OEM				
	2.0 TDI	81	01.09	01.14	PR: OEM				
	2.0 TDI	103	01.05	01.14	PR: OEM				

VOLKSWAGEN JETTA V (05-10)

	1.4 TSI	90	05.07	10.10		03.7863-9602.4	300206	PR: 1AS	10"	ATE
	1.4 TSI	103	06.06	10.10		03.7863-9802.4	300281	PR: 1AS,1LJ	10"	ATE
	1.4 TSI	118	07.08	10.10						
	1.4 TSI	125	06.06	10.10						
	1.6 FSI	85	08.05	10.10						
	1.6 i 16V	75	08.05	10.10						
	1.6 TDI		06.09	10.10						
	1.9 TDI	77	08.05	10.10						
	2.0 FSI	110	08.05	10.10						
	2.0 TDI	100	09.05	10.10						
	2.0 TDI	103	08.05	10.10						
	2.0 TDI	125	06.06	10.10						
	2.0 TFSI		10.05	10.10						
	2.5 FSI		07.08	10.10						

	1.4 TSI	90	05.07	10.10		03.2122-2129.3	010799	PR: 1AS	Thz 22,20	ATE
	1.4 TSI	103	06.06	10.10						
	1.4 TSI	118	07.08	10.10						
	1.4 TSI	125	06.06	10.10						
	1.6 FSI	85	08.05	10.10						
	1.6 i 16V	75	08.05	10.10						
	1.6 TDI		06.09	10.10						
	1.9 TDI	77	08.05	10.10						
	2.0 FSI	110	08.05	10.10						
	2.0 TDI	100	09.05	10.10						
	2.0 TDI	103	08.05	10.10						
	2.0 TDI	125	06.06	10.10						
	2.0 TFSI		10.05	10.10						
	2.5 FSI		07.08	10.10						

	1.4 TSI	90	05.07	10.10	PR: 12M	11.9541-9549.2	220575		D=54, - Halter	ATE
	1.4 TSI	103	06.06	10.10	PR: 12M	11.9541-9550.2	220576		D=54, - Halter	ATE
	1.4 TSI	118	07.08	10.10	PR: 12M	11.0101-5409.2	260035		Hülzensatz	ATE
	1.4 TSI	125	06.06	10.10	PR: 12M	11.8171-0069.1	250152		Führungsbolzen	ATE
	1.6 FSI	85	08.05	10.10	PR: 12M					
	1.6 i 16V	75	08.05	10.10	PR: 12M					
	1.6 TDI		06.09	10.10	PR: 12M					
	1.9 TDI	77	08.05	10.10	PR: 12M					
	2.0 FSI	110	08.05	10.10	PR: 12M					
	2.0 TDI	100	09.05	10.10	PR: 12M					
	2.0 TDI	103	08.05	10.10	PR: 12M					
	2.0 TDI	125	06.06	10.10	PR: 12M					
	2.0 TFSI		10.05	10.10	PR: 12M					
	2.5 FSI		07.08	10.10	PR: 12M					

	1.4 TSI	90	05.07	10.10	PR: 1ZE,1ZP	11.9541-9553.2	220563		D=54, - Halter	ATE
	1.4 TSI	103	06.06	10.10	PR: 1ZE,1ZP	11.9541-9554.2	220564		D=54, - Halter	ATE
	1.4 TSI	118	07.08	10.10	PR: 1ZE,1ZP	11.0101-5409.2	260035		Hülzensatz	ATE
	1.4 TSI	125	06.06	10.10	PR: 1ZE,1ZP	11.8171-0008.1	990049		Führungsbolzen	ATE
	1.6 FSI	85	08.05	10.10	PR: 1ZE,1ZP	11.8116-0351.1	390538	2	Haltefeder	ATE
	1.6 i 16V	75	08.05	10.10	PR: 1ZE,1ZP					
	1.6 TDI		06.09	10.10	PR: 1ZE,1ZP					
	1.9 TDI	77	08.05	10.10	PR: 1ZE,1ZP					
	2.0 FSI	110	08.05	10.10	PR: 1ZE,1ZP					
	2.0 TDI	100	09.05	10.10	PR: 1ZE,1ZP					
	2.0 TDI	103	08.05	10.10	PR: 1ZE,1ZP					
	2.0 TDI	125	06.06	10.10	PR: 1ZE,1ZP					
	2.0 TFSI		10.05	10.10	PR: 1ZE,1ZP					
	2.5 FSI		07.08	10.10	PR: 1ZE,1ZP					

	1.4 TSI	90	05.07	10.10	PR: 1LJ,1ZD	11.9541-9553.2	220563		D=54, - Halter	ATE
	1.4 TSI	103	06.06	10.10	PR: 1LJ,1ZD	11.9541-9554.2	220564		D=54, - Halter	ATE
	1.4 TSI	118	07.08	10.10	PR: 1LJ,1ZD	11.0101-5409.2	260035		Hülzensatz	ATE
	1.4 TSI	125	06.06	10.10	PR: 1LJ,1ZD	11.8171-0008.1	990049		Führungsbolzen	ATE
	1.6 FSI	85	08.05	10.10	PR: 1LJ,1ZD	11.8116-0351.1	390538	2	Haltefeder	ATE
	1.6 i 16V	75	08.05	10.10	PR: 1LJ,1ZD					
	1.6 TDI		06.09	10.10	PR: 1LJ,1ZD					
	1.9 TDI	77	08.05	10.10	PR: 1LJ,1ZD					
	2.0 FSI	110	08.05	10.10	PR: 1LJ,1ZD					
	2.0 TDI	100	09.05	10.10	PR: 1LJ,1ZD					
	2.0 TDI	103	08.05	10.10	PR: 1LJ,1ZD					
	2.0 TDI	125	06.06	10.10	PR: 1LJ,1ZD					
	2.0 TFSI		10.05	10.10	PR: 1LJ,1ZD					
	2.5 FSI		07.08	10.10	PR: 1LJ,1ZD					

VOLKSWAGEN JETTA V (05-10)										
	1.4 TSI	90		05.07	10.10		24.5143-0564.3	331433	2	L=564
	1.4 TSI	103		06.06	10.10					
	1.4 TSI	118		07.08	10.10					
	1.4 TSI	125		06.06	10.10					
	1.6 FSI	85		08.05	10.10					
	1.6 i 16V	75		08.05	10.10					
	1.6 TDI			06.09	10.10					
	1.9 TDI	77		08.05	10.10					
	2.0 FSI	110		08.05	10.10					
	2.0 TDI	100		09.05	10.10					
	2.0 TDI	103		08.05	10.10					
	2.0 TDI	125		06.06	10.10					
	2.0 TFSI			10.05	10.10					
	2.5 FSI			07.08	10.10					
	1.4 TSI	90		05.07	10.10	PR: 1KE,1KF,1KJ	24.3414-1709.7	220631		D=41, - Halter
	1.4 TSI	103		06.06	10.10	PR: 1KE,1KF,1KJ	24.3414-1710.7	220632		D=41, - Halter
	1.4 TSI	118		07.08	10.10	PR: 1KE,1KF,1KJ				
	1.4 TSI	125		06.06	10.10	PR: 1KE,1KF,1KJ				
	1.6 FSI	85		08.05	10.10	PR: 1KE,1KF,1KJ				
	1.6 i 16V	75		08.05	10.10	PR: 1KE,1KF,1KJ				
	1.6 TDI			06.09	10.10	PR: 1KE,1KF,1KJ				
	1.9 TDI	77		08.05	10.10	PR: 1KE,1KF,1KJ				
	2.0 FSI	110		08.05	10.10	PR: 1KE,1KF,1KJ				
	2.0 TDI	100		09.05	10.10	PR: 1KE,1KF,1KJ				
	2.0 TDI	103		08.05	10.10	PR: 1KE,1KF,1KJ				
	2.0 TDI	125		06.06	10.10	PR: 1KE,1KF,1KJ				
	2.0 TFSI			10.05	10.10	PR: 1KE,1KF,1KJ				
	2.5 FSI			07.08	10.10	PR: 1KE,1KF,1KJ				
	1.4 TSI	90		05.07	10.10	PR: 1KV	24.3387-1729.7	221007		D=38, rot, - Halter
	1.4 TSI	103		06.06	10.10	PR: 1KV	24.3387-1730.7	221008		D=38, rot, - Halter
	1.4 TSI	118		07.08	10.10	PR: 1KV				
	1.4 TSI	125		06.06	10.10	PR: 1KV				
	1.6 FSI	85		08.05	10.10	PR: 1KV				
	1.6 i 16V	75		08.05	10.10	PR: 1KV				
	1.6 TDI			06.09	10.10	PR: 1KV				
	1.9 TDI	77		08.05	10.10	PR: 1KV				
	2.0 FSI	110		08.05	10.10	PR: 1KV				
	2.0 TDI	100		09.05	10.10	PR: 1KV				
	2.0 TDI	103		08.05	10.10	PR: 1KV				
	2.0 TDI	125		06.06	10.10	PR: 1KV				
	2.0 TFSI			10.05	10.10	PR: 1KV				
	2.5 FSI			07.08	10.10	PR: 1KV				
	1.4 TSI	90		05.07	10.10		24.5204-0233.3	331430	2	L=233
	1.4 TSI	103		06.06	10.10					
	1.4 TSI	118		07.08	10.10					
	1.4 TSI	125		06.06	10.10					
	1.6 FSI	85		08.05	10.10					
	1.6 i 16V	75		08.05	10.10					
	1.6 TDI			06.09	10.10					
	1.9 TDI	77		08.05	10.10					
	2.0 FSI	110		08.05	10.10					
	2.0 TDI	100		09.05	10.10					
	2.0 TDI	103		08.05	10.10					
	2.0 TDI	125		06.06	10.10					
	2.0 TFSI			10.05	10.10					
	2.5 FSI			07.08	10.10					
	1.4 TSI	90	1K-6-899000	05.07			24.3727-2708.2	582708	2	L=1447
	1.4 TSI	103	1K-6-899000	06.06						
	1.4 TSI	125	1K-6-899000	06.06						
	1.6 FSI	85	1K-6-899000	08.05						
	1.6 i 16V	75	1K-6-899000	08.05						
	1.9 TDI	77	1K-6-899000	08.05						
	2.0 FSI	110	1K-6-899000	08.05						
	2.0 TDI	100	1K-6-899000	09.05						
	2.0 TDI	103	1K-6-899000	08.05						
	2.0 TDI	125	1K-6-899000	06.06						
	2.0 TFSI		1K-6-899000	10.05						
	1.4 TSI	90	1K-7-000001		10.10		24.3727-0195.2	580195	2	L=1447
	1.4 TSI	103	1K-7-000001		10.10					
	1.4 TSI	118		07.08	10.10					
	1.4 TSI	125	1K-7-000001		10.10					
	1.6 FSI	85	1K-7-000001		10.10					
	1.6 i 16V	75	1K-7-000001		10.10					
	1.6 TDI			06.09	10.10					
	1.9 TDI	77	1K-7-000001		10.10					
	2.0 FSI	110	1K-7-000001		10.10					
	2.0 TDI	100	1K-7-000001		10.10					
	2.0 TDI	103	1K-7-000001		10.10					
	2.0 TDI	125	1K-7-000001		10.10					
	2.0 TFSI		1K-7-000001		10.10					
	2.5 FSI			07.08	10.10					
	1.4 TSI	90		05.07	10.10		24.2415-1713.3	030132		Gz 15,87, + Sensor
	1.4 TSI	103		06.06	10.10					
	1.4 TSI	118		07.08	10.10					
	1.4 TSI	125		06.06	10.10					
	1.6 FSI	85		08.05	10.10					
	1.6 i 16V	75		08.05	10.10					



VOLKSWAGEN JETTA V (05-10)

	1.6 TDI		06.09	10.10	24.2415-1713.3	030132			Gz 15,87, + Sensor
	1.9 TDI	77	08.05	10.10					
	2.0 FSI	110	08.05	10.10					
	2.0 TDI	100	09.05	10.10					
	2.0 TDI	103	08.05	10.10					
	2.0 TDI	125	06.06	10.10					
	2.0 TFSI		10.05	10.10					
	2.5 FSI		07.08	10.10					
	1.4 TSI	90	05.07	10.10	24.2519-1706.3	040096		für Getriebe MQ-200 ¹⁾ für Getriebe MQ-250 ²⁾	Nz 19,05 Nz 19,05
	1.4 TSI	103	06.06	10.10					
	1.4 TSI	118	07.08	10.10					
	1.4 TSI	125	06.06	10.10					
	1.6 FSI	85	08.05	10.10					
	1.6 i 16V	75	08.05	10.10					
	1.6 TDI		06.09	10.10					
	1.9 TDI	77	08.05	10.10					
	2.0 FSI	110	08.05	10.10					
	2.0 TDI	100	09.05	10.10					
	2.0 TDI	103	08.05	10.10					
	2.0 TDI	125	06.06	10.10					
	2.0 TFSI		10.05	10.10					
	2.5 FSI		07.08	10.10					

VOLKSWAGEN JETTA VI (10-)

	2.0 TSI	147	04.11		03.7863-3332.4	300308			10"	ATE						
	2.0 TSI	155	12.12													
	1.2 TSI	77	04.11	PR: 1ZM,1ZQ	11.9541-9549.2	220575	2		D=54, - Halter D=54, - Halter Hülzensatz Führungsbolzen	ATE ATE ATE ATE						
	1.4 TSI	90	04.11	PR: 1ZM,1ZQ												
	1.4 TSI	92	08.14	PR: 1ZM,1ZQ												
	1.4 TSI	110	08.14	PR: 1ZM,1ZQ												
	1.4 TSI Hybrid	110	04.11	PR: 1ZM,1ZQ												
	1.6		12.11	PR: 1ZM,1ZQ												
	1.6 TDI	77	04.11	PR: 1ZM,1ZQ												
	1.8 TSI	125	07.14	PR: 1ZM,1ZQ												
	2.0	85	06.10	PR: 1ZM,1ZQ												
	2.0 TDI	81	10.10	PR: 1ZM,1ZQ												
	2.0 TDI	103	04.11	PR: 1ZM,1ZQ												
	2.0 TDI	110	08.14	PR: 1ZM,1ZQ												
	2.0 TSI	147	04.11	PR: 1ZM,1ZQ												
	2.0 TSI	155	12.12	PR: 1ZM,1ZQ												
	1.2 TSI	77	04.11	PR: 1ZE,1ZP							11.9541-9553.2	220563	2		D=54, - Halter D=54, - Halter Hülzensatz Führungsbolzen	ATE ATE ATE ATE
	1.4 TSI	90	04.11	PR: 1ZE,1ZP												
	1.4 TSI	92	08.14	PR: 1ZE,1ZP												
	1.4 TSI	110	08.14	PR: 1ZE,1ZP												
	1.4 TSI Hybrid	110	04.11	PR: 1ZE,1ZP												
	1.6		12.11	PR: 1ZE,1ZP												
1.6 TDI	77	04.11	PR: 1ZE,1ZP													
1.8 TSI	125	07.14	PR: 1ZE,1ZP													
2.0	85	06.10	PR: 1ZE,1ZP													
2.0 TDI	81	10.10	PR: 1ZE,1ZP													
2.0 TDI	103	04.11	PR: 1ZE,1ZP													
2.0 TDI	110	08.14	PR: 1ZE,1ZP													
2.0 TSI	147	04.11	PR: 1ZE,1ZP													
2.0 TSI	155	12.12	PR: 1ZE,1ZP													
1.2 TSI	77	04.11	PR: 1ZA,1ZB,1LV	11.9541-9553.2	220563	2		D=54, - Halter D=54, - Halter Hülzensatz Führungsbolzen	ATE ATE ATE ATE							
1.4 TSI	90	04.11	PR: 1ZA,1ZB,1LV													
1.4 TSI	92	08.14	PR: 1ZA,1ZB,1LV													
1.4 TSI	110	08.14	PR: 1ZA,1ZB,1LV													
1.4 TSI Hybrid	110	04.11	PR: 1ZA,1ZB,1LV													
1.6		12.11	PR: 1ZA,1ZB,1LV													
1.6 TDI	77	04.11	PR: 1ZA,1ZB,1LV													
1.8 TSI	125	07.14	PR: 1ZA,1ZB,1LV													
2.0	85	06.10	PR: 1ZA,1ZB,1LV													
2.0 TDI	81	10.10	PR: 1ZA,1ZB,1LV													
2.0 TDI	103	04.11	PR: 1ZA,1ZB,1LV													
2.0 TSI	147	04.11	PR: 1ZA,1ZB,1LV													
2.0 TSI	155	12.12	PR: 1ZA,1ZB,1LV													
	1.2 TSI	77	04.11							11.11	24.5143-0564.3	331433	2		L=564	
	1.4 TSI	90	04.11							11.11						
	1.4 TSI	92	04.11							11.11						
	1.4 TSI Hybrid	110	04.11							11.11						
	1.6 TDI	77	04.11							11.11						
	2.0	85	06.10							11.11						
	2.0 TDI	81	10.10							11.11						
	1.2 TSI	77	04.11	PR: 1KD,1KU	24.3384-1755.7	220635		D=38, - Halter D=38, - Halter	TRW TRW							
	1.4 TSI	90	04.11	PR: 1KD,1KU												
	1.4 TSI	92	08.14	PR: 1KD,1KU												
	1.4 TSI	110	08.14	PR: 1KD,1KU												
	1.4 TSI Hybrid	110	04.11	PR: 1KD,1KU												
	1.6		12.11	PR: 1KD,1KU												

¹⁾ for transmission MQ-200 / per scatola camb.MQ-200 / pour boîte de vitesse MQ-200 / caja de cambios para MQ-200
²⁾ for transmission MQ-250 / per scatola camb.MQ-250 / pour boîte de vitesse MQ-250 / caja de cambios para MQ-250



VOLKSWAGEN JETTA VI (10-)

	1.6 TDI 1.8 TSI 2.0 2.0 TDI 2.0 TDI 2.0 TDI 2.0 TSI 2.0 TSI	77 125 85 81 103 110 147 155		04.11 07.14 06.10 10.10 04.11 08.14 04.11 12.12	PR: 1KD,1KU PR: 1KD,1KU PR: 1KD,1KU PR: 1KD,1KU PR: 1KD,1KU PR: 1KD,1KU PR: 1KD,1KU PR: 1KD,1KU	24.3384-1755.7 24.3384-1756.7	220635 220636		D=38, - Halter D=38, - Halter	TRW TRW
	1.2 TSI 1.4 TSI 1.4 TSI 1.4 TSI Hybrid 1.6 1.6 TDI 2.0 2.0 TDI 2.0 TDI 2.0 TDI 2.0 TSI 2.0 TSI	77 90 90 110 77 85 81 103 147 155		04.11 04.11 04.11 04.11 12.11 04.11 06.10 10.10 04.11 04.11 12.12		24.5204-0233.3	331430	2	+ HA-Trommelbremse ¹⁾	L=233
	1.2 TSI 1.4 TSI 1.4 TSI 1.4 TSI Hybrid 1.6 1.6 TDI 2.0 2.0 TDI 2.0 TDI 2.0 TDI 2.0 TSI 2.0 TSI	77 90 90 110 77 85 81 103 147 155		04.11 04.11 04.11 04.11 12.11 06.10 10.10 04.11 04.11 11.11		83.7847-0254.3 83.7847-0257.3	331233 331234		+ HA-Scheibenbremse ²⁾ + HA-Scheibenbremse ²⁾	L=255 L=255
	1.2 TSI 1.4 TSI 1.4 TSI 1.4 TSI Hybrid 1.6 1.6 TDI 2.0 2.0 TDI 2.0 TDI 2.0 TDI 2.0 TSI 2.0 TSI	77 90 90 110 77 85 81 103 147 155		12.11 12.11 12.11 12.11 12.11 06.10 12.11 12.11 12.11 12.11 12.12	PR: 1KS,1KT PR: 1KS,1KT PR: 1KS,1KT PR: 1KS,1KT PR: 1KS,1KT PR: 1KS,1KT PR: 1KS,1KT PR: 1KS,1KT PR: 1KS,1KT PR: 1KS,1KT PR: 1KS,1KT	83.7847-0254.3 83.7847-0257.3	331233 331234		+ HA-Scheibenbremse ²⁾ + HA-Scheibenbremse ²⁾	L=255 L=255
	1.2 TSI 1.4 TSI 1.4 TSI 1.4 TSI Hybrid 1.6 1.6 TDI 1.8 TSI 2.0 2.0 TDI 2.0 TDI 2.0 TDI 2.0 TSI 2.0 TSI	77 90 92 110 110 77 125 85 81 103 110 147 155		04.11 04.11 08.14 08.14 04.11 12.11 04.11 07.14 06.10 10.10 04.11 08.14 04.11 12.12	PR: VF1 PR: VF1 PR: VF1 PR: VF1 PR: VF1 PR: VF1 PR: VF1 PR: VF1 PR: VF1 PR: VF1 PR: VF1 PR: VF1 PR: VF1	24.2415-1713.3	030132		Gz 15,87, + Sensor	
	1.2 TSI 1.4 TSI 1.4 TSI 1.4 TSI Hybrid 2.0 TSI	77 90 90 110 147		04.11 04.11 04.11 04.11 10.11	PR: OEJ PR: OEJ PR: OEJ PR: OEJ PR: OEJ	24.2519-1705.3	040095			Nz 19,05
	1.2 TSI 1.4 TSI 1.4 TSI 1.4 TSI 1.4 TSI 1.4 TSI Hybrid 1.6 1.6 TDI 2.0 2.0 TDI 2.0 TDI 2.0 TDI 2.0 TSI 2.0 TSI	77 90 92 110 110 110 77 85 81 103 110 147 155		04.11 04.11 08.14 08.14 04.11 12.11 04.11 06.10 10.10 04.11 08.14 04.11 12.12	PR: OEM PR: OEM PR: OEM PR: OEM PR: OEM PR: OEM PR: OEM PR: OEM PR: OEM PR: OEM PR: OEM PR: OEM PR: OEM	24.2519-1706.3	040096		Nz 19,05	

VOLKSWAGEN LT/LT 4x4 (96-06)

	LT 28 LT 35 LT 46		2D-2-011024 2D-2-011024 2D-2-011024	05.96 05.96 05.96	- ABS - ABS - ABS	24.2123-1728.3	010558			Thz 23,81
	LT 28 LT 35 LT 46		2D-2-011024 2D-2-011024 2D-X-012290	05.96 05.96 05.96	+ ABS + ABS + ABS	24.2123-1711.3	010518			Thz 23,81
	LT 46	2D-X-012291	2D-2-011024		+ ABS	24.2125-1727.3	010723			Thz 25,40
	LT 28 LT 35 LT 46	2D-2-011025 2D-2-011025 2D-2-011025		07.06 07.06 07.06	+ ABS	24.2123-1755.3	010750			Thz 23,81
	LT 46	2D-2-011025		07.06	+ ABS	24.2125-1735.3	010879			Thz 25,40
										TRW

¹⁾ + RA drum brake / + P freno a tamburo / + frein à tambour essieu AR / + ET-tambores de freno

²⁾ + RA disc brake / + P disco freno / + frein à disque essieu AR / + ET-disco de freno



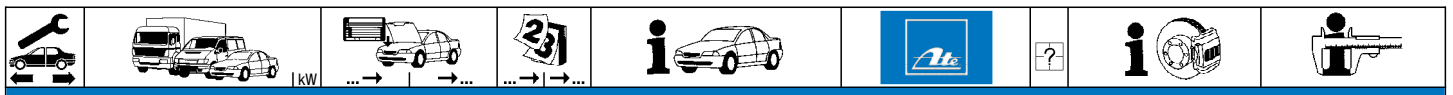



























VOLKSWAGEN LT/LT 4x4 (96-06)

	LT 28			05.96	07.06	11.3601-8513.2	220393	2	D=60, - Halter	ATE
	LT 35			05.96	07.06	11.3601-8514.2	220394			ATE
	LT 46		2D-3-003239	05.96		11.0441-6007.2	250146		Dichtungssatz	ATE
						11.0101-5704.2	260095		Hülzensatz	ATE
						11.8171-0008.1	990049		Führungsbolzen	ATE
						11.8116-0200.1	390505		Haltefeder	ATE
	LT 28			05.96	07.06	24.3441-1701.5	240331	2	D=44, - Halter	PER
	LT 35			05.96	07.06	24.3441-1702.5	240332		D=44, - Halter	PER
	LT 28			05.96	07.06	83.7716-0363.3	330829	2	L=363	
	LT 35			05.96	07.06					
	LT 28			05.96	07.06	11.3451-8501.2	220389	2	D=45, - Halter	ATE
	LT 35			05.96	07.06	11.3451-8502.2	220390		D=45, - Halter	ATE
						11.0441-4502.2	250143		Dichtungssatz	ATE
						11.0101-5409.2	260035		Hülzensatz	ATE
						11.8171-0008.1	990049		Führungsbolzen	ATE
						11.8116-0172.1	390500		Haltefeder	ATE
	LT 35			05.96	07.06	11.3521-8501.2	220391	2	D=52, - Halter	ATE
	LT 35			05.96	07.06	11.3521-8502.2	220392		D=52, - Halter	ATE
						11.0441-5203.2	250144		Dichtungssatz	ATE
						11.0101-5409.2	260035		Hülzensatz	ATE
						11.8171-0008.1	990049		Führungsbolzen	ATE
						11.8116-0191.1	390522		Haltefeder	ATE
	LT 35			05.96	12.03	24.3521-1707.5	240471	2	D=52, - Halter	BOS
	LT 46		2D-2H005686	05.96		24.3521-1708.5	240472		D=52, - Halter	BOS
	LT 28			05.96	07.06	83.7716-0363.3	330829	1	L=363	
	LT 35			05.96	07.06	24.5237-0235.3	330781		2	am Bremssattel 1)
	LT 46			05.96	07.06	83.7716-0363.3	330829	2	L=363	
						24.5237-0235.3	330781		2	am Bremssattel 1)
	LT 28			05.96	07.06	24.3727-0442.2	580442	1	L=1435	
	LT 35			05.96	07.06	24.3727-0438.2	580438		2	L=1513
	LT 28			05.96	07.06	24.3727-0443.2	580443	1	L=1990	
	LT 35			05.96	07.06	24.3727-0438.2	580438		2	L=1513
	LT 35			05.96	07.06	24.3727-0441.2	580441	1	L=2460	
	LT 46			05.96	07.06	24.3727-0438.2	580438		2	L=1513
	LT 46			05.96	07.06	24.3727-0444.2	580444	1	L=1970	
	LT 46			05.96	07.06	24.3727-0179.2	580179		2	L=1525
						24.3727-0180.2	580180		L=1526	
	LT 28			05.96	07.06	24.3727-0181.2	580181	1	L=2440	
	LT 35			05.96	07.06	24.3727-0179.2	580179		2	L=1525
	LT 46			05.96	07.06	24.3727-0180.2	580180		L=1526	
	LT 28			05.96	07.06	24.2419-1712.3	030105		Gz 19,05	
	LT 35			05.96	07.06					
	LT 46			05.96	07.06					
	LT 28			05.96	07.06	24.2522-1703.3	040077		Nz 22,20	
	LT 35			05.96	07.06					
	LT 46			05.96	07.06					

VOLKSWAGEN LUPO (98-05)

	1.4 16V	◀ 74		01.99	08.05	+ ESP	03.7853-0102.4	300252	PR: 1AT,1LX,1ZE	9"	ATE
	1.4 FSI	◀ 77		09.00	08.05	+ ESP					
	1.6 GTI	◀ 92		09.00	08.05	+ ESP					
	1.0			04.98	08.05	- ABS	03.2120-3943.3	010532		Thz 20,64	ATE
	1.2 TDI 3L	45		05.99	08.05	- ABS					
	1.4	44		09.00	08.05	- ABS					
	1.4 16V	55		10.98	08.05	- ABS					
	1.4 TDI	55		01.99	08.05	- ABS					
	1.7 SDI			04.98	08.05	- ABS					
	1.0	◀		04.98	08.05	+ ABS/ - ESP	03.2122-1344.3	010593		Thz 22,20	ATE
	1.2 TDI 3L	◀ 45		06.99	08.05	+ ABS/ - ESP					
	1.4	◀ 44		09.00	08.05	+ ABS/ - ESP					
	1.4 16V	◀ 55		10.98	08.05	+ ABS/ - ESP					
	1.4 TDI	◀ 55		01.99	08.05	+ ABS/ - ESP					
	1.7 SDI	◀		04.98	08.05	+ ABS/ - ESP					
	1.0	▶		04.98	08.05	+ ABS	03.2122-1184.3	010592		Thz 22,20	ATE
	1.2 TDI 3L	▶ 45		06.99	08.05	+ ABS					
	1.4	▶ 44		09.00	08.05	+ ABS					
	1.4 16V	▶ 55		10.98	08.05	+ ABS					
	1.4 16V	▶ 74		01.99	08.05	+ ABS					
	1.4 FSI	▶ 77		09.00	08.05	+ ABS					
	1.4 TDI	▶ 55		01.99	08.05	+ ABS					
	1.6 GTI	▶ 92		09.00	08.05	+ ABS					
1.7 SDI	▶		04.98	08.05	+ ABS						
	1.0	◀		04.98	08.05	+ ABS/ + ESP	03.2122-1724.3	010648		Thz 22,20	ATE
	1.2 TDI 3L	◀ 45		06.99	08.05	+ ABS/ + ESP					
	1.4	◀ 44		09.00	08.05	+ ABS/ + ESP					
	1.4 16V	◀ 55		10.98	08.05	+ ABS/ + ESP					
	1.4 TDI	◀ 55		01.99	08.05	+ ABS/ + ESP					
1.7 SDI	◀		04.98	08.05	+ ABS/ + ESP						
	1.4 16V	◀ 74		01.99	08.05	+ ABS/ - ESP	03.2123-1824.3	010596		Thz 23,81	ATE
	1.4 FSI	◀ 77		09.00	08.05	+ ABS/ - ESP					
	1.6 GTI	◀ 92		09.00	08.05	+ ABS/ - ESP					















1) on the brake caliper / sulla pinza freno / sur l'étrier de frein / a la pinza de freno
 2) + wheel base 3000 mm / + passo 3000 mm / + empattement 3000 mm / + distancia entre ejes 3000 mm
 3) + wheel base 3550 mm / + passo 3550 mm / + empattement 3550 mm / + distancia entre ejes 3550 mm
 4) + wheel base 4025 mm / + passo 4025 mm / + empattement 4025 mm / + distancia entre ejes 4025 mm

	 kW									
VOLKSWAGEN LUPO (98-05)										
	1.2 TDI 3L	45		06.99	08.05	PR: 1ZB	11.9486-0009.2 220841 11.9486-0010.2 220842 11.0101-5409.2 260035 11.8171-0008.1 990049		D=48, - Halter D=48, - Halter Hülzensatz Führungsbolzen	ATE ATE ATE ATE
	1.0			04.98	08.05	PR: 1LM,1ZN,1LB,1ZC	24.3481-1735.5 240283		D=48, - Halter	ATE
	1.4	44		09.00	08.05	PR: 1LM,1ZN,1LB,1ZC	24.3481-1736.5 240284		D=48, - Halter	ATE
	1.4 16V	55		10.98	08.05	PR: 1LM,1ZN,1LB,1ZC	11.0101-4801.2 260006		Hülzensatz	ATE
	1.4 16V	74		01.99	08.05	PR: 1LM,1ZN,1LB,1ZC	24.0102-4801.2 260085		Hülzensatz+Schrauben	ATE
	1.4 FSI	77		09.00	08.05	PR: 1LM,1ZN,1LB,1ZC	11.0441-4808.2 250022		Dichtungssatz	ATE
	1.4 TDI	55		01.99	08.05	PR: 1LM,1ZN,1LB,1ZC				
	1.6 GTI	92		09.00	08.05	PR: 1LM,1ZN,1LB,1ZC				
	1.7 SDI			04.98	08.05	PR: 1LM,1ZN,1LB,1ZC				
	1.0			04.98	08.05	PR: 1ZE,1ZJ,1ZK	24.3541-1779.5 240249		D=54, - Halter	TRW
	1.4	44		09.00	08.05	PR: 1ZE,1ZJ,1ZK	24.3541-1780.5 240250		D=54, - Halter	TRW
	1.4 16V	55		10.98	08.05	PR: 1ZE,1ZJ,1ZK	11.0101-5403.2 260010		Faltenbalsatz	TRW
	1.4 16V	74		01.99	08.05	PR: 1ZE,1ZJ,1ZK				
	1.4 FSI	77		09.00	08.05	PR: 1ZE,1ZJ,1ZK				
	1.4 TDI	55		01.99	08.05	PR: 1ZE,1ZJ,1ZK				
	1.6 GTI	92		09.00	08.05	PR: 1ZE,1ZJ,1ZK				
	1.7 SDI			04.98	08.05	PR: 1ZE,1ZJ,1ZK				
	1.0			04.98	08.05	PR: 1LX	11.0101-5403.2 260010		Faltenbalsatz	TRW
	1.4	44		09.00	08.05	PR: 1LX				
	1.4 16V	55		10.98	08.05	PR: 1LX				
	1.4 16V	74		01.99	08.05	PR: 1LX				
	1.4 FSI	77		09.00	08.05	PR: 1LX				
	1.4 TDI	55		01.99	08.05	PR: 1LX				
	1.6 GTI	92		09.00	08.05	PR: 1LX				
	1.7 SDI			04.98	08.05	PR: 1LX				
	1.0			04.98	08.05		24.5147-0385.3 331427	2	L=384	
	1.4	44		09.00	08.05					
	1.4 16V	55		10.98	08.05					
	1.4 16V	74		01.99	08.05					
	1.4 TDI	55		01.99	08.05					
	1.7 SDI			04.98	08.05					
	1.2 TDI 3L	45		06.99	08.05		83.6243-0393.3 330629	2	L=390	
	1.4 16V	74		05.99	08.05		24.3344-1711.7 220539		D=34, - Halter	TRW
	1.4 FSI	77		09.00	08.05		24.3344-1712.7 220540		D=34, - Halter	TRW
	1.6 GTI	92		09.00	08.05					
	1.0			04.98	08.05		83.7858-0140.3 330837	2	L=140	
	1.2 TDI 3L	45		06.99	08.05					
	1.4	44		09.00	08.05					
	1.4 16V	55		10.98	08.05					
	1.4 16V	74		01.99	08.05					
	1.4 FSI	77		09.00	08.05					
	1.4 TDI	55		01.99	08.05					
	1.6 GTI	92		09.00	08.05					
	1.7 SDI			04.98	08.05					
	1.0			04.98	08.05	- ABS	24.3215-0903.3 020154		Rz 15,87	
	1.2 TDI 3L	45		06.99	08.05	- ABS				
	1.4	44		09.00	08.05	- ABS				
	1.4 16V	55		10.98	08.05	- ABS				
	1.4 TDI	55		01.99	08.05	- ABS				
	1.7 SDI			04.98	08.05	- ABS				
	1.0			04.98	08.05	+ ABS	24.3217-0908.3 020167		Rz 17,46	
	1.4	44		09.00	08.05	+ ABS				
	1.4 16V	55		10.98	08.05	+ ABS				
	1.4 TDI	55		01.99	08.05	+ ABS				
	1.7 SDI			04.98	08.05	+ ABS				
	1.0			04.98	08.05		24.3727-0159.2 580159	2 	L=1392	
	1.2 TDI 3L	45		06.99	08.05					
	1.4	44		09.00	08.05					
	1.4 16V	55		10.98	08.05					
	1.4 TDI	55		01.99	08.05					
	1.7 SDI			04.98	08.05					
	1.4 16V	74		01.99	08.05		24.3727-2707.2 582707	2 	L=1496	
	1.4 FSI	77		09.00	08.05					
	1.6 GTI	92		09.00	08.05					
	1.0			04.98	08.05		03.6583-0184.3 320229		BRL 8/3 (4)	ATE
	1.2 TDI 3L	45		06.99	08.05					
	1.4	44		09.00	08.05					
	1.4 16V	55		10.98	08.05					
	1.4 TDI	55		01.99	08.05					
	1.7 SDI			04.98	08.05					
	1.4 TDI	55		01.99	08.05		24.2519-1701.3 040075		Nz 19,05	
	1.6 GTI	92		09.00	08.05		24.2519-1706.3 040096		Nz 19,05	
	1.0			04.98	08.05		24.3728-2707.2 592707		L=1047, + AUT	
	1.2 TDI 3L	45		06.99	08.05					
	1.4	44		09.00	08.05					
	1.4 16V	55		10.98	08.05					
	1.4 16V	74		01.99	08.05					
	1.4 FSI	77		09.00	08.05					
	1.7 SDI			04.98	08.05					



VOLKSWAGEN NEW BEETLE (98-10)

	1.6 1.8 T 1.9 TDI 1.9 TDI 2.0 2.3 V5 3.2 RSI	◀ ◀110 ◀66 ◀74 ◀85 ◀125 ◀165	9C-Y-613782 9C-Y-613782 9C-Y-613782 9C-Y-613782 9C-Y-613782 9C-Y-613782 9C-Y-613782	11.99 10.99 01.98 10.00 01.98 10.00 04.00	+ ESP + ESP + ESP + ESP + ESP + ESP + ESP	03.7863-0402.4	300124		10"	
	1.4 1.6 1.8 T 1.8 T 1.9 TDI 1.9 TDI 2.0 2.3 V5 3.2 RSI	◀55 ◀9C-Y-613783 ◀110 ◀132 ◀66 ◀74 ◀85 ◀125 ◀165	9C-2-620000 9C-2-620000 9C-Y-613783 9C-2-620000 9C-2-620000 9C-2-620000 9C-2-620000 9C-2-620000 9C-2-620000	08.01 11.01 02.01 	+ ESP + ESP + ESP + ESP + ESP + ESP + ESP + ESP + ESP	03.7860-0602.4	300141		10"	ATE
	1.4 1.6 1.8 T 1.8 T 1.9 TDI 1.9 TDI 2.0 2.3 V5 3.2 RSI	◀55 ◀9C-2-620001 ◀110 ◀132 ◀74 ◀77 ◀85 ◀125 ◀165	9C-2-620001 9C-2-620001 9C-2-620001 9C-2-620001 9C-2-620001 9C-2-620001 9C-2-620001 9C-2-620001 9C-2-620001	08.01 07.05 	+ ESP + ESP + ESP + ESP + ESP + ESP + ESP + ESP + ESP	03.7863-3502.4	300128		10"	
	1.4 1.6 1.8 T 1.8 T 1.9 TDI 1.9 TDI 2.0 2.3 V5 3.2 RSI	◀55 ◀ ◀110 ◀132 ◀66 ◀74 ◀85 ◀125 ◀165		08.01 11.99 10.99 11.01 01.98 10.00 01.98 10.00 04.00	06.05 - ESP 06.05 - ESP 06.05 - ESP 06.05 - ESP 02.01 - ESP 06.05 - ESP 06.05 - ESP 05.05 - ESP 03.03 - ESP	24.2123-1709.3	010503		Thz 23,81	
	1.6 1.8 T 1.9 TDI 1.9 TDI 2.0 2.3 V5 3.2 RSI	◀ ◀110 ◀66 ◀74 ◀85 ◀125 ◀165	9C-Y-613782 9C-Y-613782 9C-Y-613782 9C-Y-613782 9C-Y-613782 9C-Y-613782 9C-Y-613782	11.99 10.99 01.98 10.00 01.98 10.00 04.00	+ ESP + ESP + ESP + ESP + ESP + ESP + ESP	03.2123-2024.3	010597		Thz 23,81	ATE
	1.4 1.6 1.8 T 1.8 T 1.9 TDI 1.9 TDI 2.0 2.3 V5 3.2 RSI	◀55 ◀9C-Y-613783 ◀110 ◀132 ◀66 ◀74 ◀85 ◀125 ◀165	9C-Y-613783 9C-Y-613783 9C-Y-613783 9C-Y-613783 9C-Y-613783 9C-Y-613783 9C-Y-613783 9C-Y-613783 9C-Y-613783	08.01 11.01 07.05 	+ ESP + ESP + ESP + ESP + ESP + ESP + ESP + ESP + ESP	03.2123-2715.3	010802		Thz 23,81	ATE
	1.6 1.8 T 1.9 TDI 1.9 TDI 2.0 2.3 V5 3.2 RSI	▶110 ▶66 ▶74 ▶85 ▶125 ▶165	9C-Y-613782 9C-Y-613782 9C-Y-613782 9C-Y-613782 9C-Y-613782 9C-Y-613782 9C-Y-613782	11.99 10.99 01.98 10.00 01.98 10.00 04.00	+ ESP + ESP + ESP + ESP + ESP + ESP + ESP	03.2123-2064.3	010598		Thz 23,81	ATE
	1.4 1.6 1.8 T 1.8 T 1.9 TDI 1.9 TDI 2.0 2.3 V5 3.2 RSI	▶55 ▶9C-Y-613783 ▶110 ▶132 ▶66 ▶74 ▶77 ▶85 ▶125 ▶165	9C-7-557428 9C-7-557428 9C-Y-613783 9C-7-557428 9C-Y-613783 9C-7-557428 9C-7-557428 9C-7-557428 9C-7-557428 9C-7-557428	08.01 11.01 07.05 	+ ESP + ESP + ESP + ESP + ESP + ESP + ESP + ESP + ESP	03.2123-2774.3	010803		Thz 23,81	ATE
	1.4 1.6 1.8 T 1.9 TDI 1.9 TDI 2.0	▶55 ▶9C-7-557429 ▶110 ▶74 ▶77 ▶85	9C-7-557429 9C-7-557429 9C-7-557429 9C-7-557429 9C-7-557429 9C-7-557429	08.01 11.01 07.05 	+ ESP + ESP + ESP + ESP + ESP + ESP	03.2123-2774.3	010803		Thz 23,81	ATE
	1.4 1.6 1.8 T 1.8 T 1.9 TDI 1.9 TDI 1.9 TDI 2.0	55 110 132 66 74 77 85		08.01 11.99 10.99 11.01 01.98 10.00 07.05 01.98	05.10 PR: 1ZP,1ZM 05.10 PR: 1ZP,1ZM 05.10 PR: 1ZP,1ZM 06.05 PR: 1ZP,1ZM 02.01 PR: 1ZP,1ZM 05.10 PR: 1ZP,1ZM 05.10 PR: 1ZP,1ZM 05.10 PR: 1ZP,1ZM	11.9541-9549.2 11.9541-9550.2 11.0101-5409.2 11.8171-0069.1	220575 220576 260035 250152		D=54, - Halter D=54, - Halter Hülzensatz Führungsbolzen	ATE ATE ATE ATE

VOLKSWAGEN NEW BEETLE (98-10)																
	1.4	55		08.01	05.10	PR: 1ZD,1ZE	11.3541-8523.2	220115	2		D=54, - Halter	ATE				
	1.6			11.99	05.10	PR: 1ZD,1ZE	11.3541-8524.2	220116			D=54, - Halter	ATE				
	1.8 T	110		10.99	05.10	PR: 1ZD,1ZE	24.3541-8523.5	240551			D=54, - Halter	ATE				
	1.8 T	132		11.01	06.05	PR: 1ZD,1ZE	24.3541-8524.5	240552			D=54, - Halter	ATE				
	1.9 TDI	66		01.98	02.01	PR: 1ZD,1ZE	11.8170-0306.1	260102			Halter	ATE				
	1.9 TDI	74		10.00	05.10	PR: 1ZD,1ZE	11.0441-5409.2	250031			Dichtungssatz	ATE				
	1.9 TDI	77		07.05	05.10	PR: 1ZD,1ZE	11.0101-5409.2	260035			Hülssensatz	ATE				
	2.0	85		01.98	05.10	PR: 1ZD,1ZE	11.8171-0008.1	990049			Führungsbolzen	ATE				
							11.8116-0143.1	390513			Haltefeder	ATE				
	2.3 V5	125		10.00	12.05		11.9541-9595.2	220501			D=54, - Halter	ATE				
							11.9541-9596.2	220502			D=54, - Halter	ATE				
							11.0441-5409.2	250031			Dichtungssatz	ATE				
						11.0101-5409.2	260035	Hülssensatz	ATE							
						11.8171-0008.1	990049	Führungsbolzen	ATE							
						11.8116-0143.1	390513	Haltefeder	ATE							
3.2 RSI	165		04.00	03.03		11.9541-9595.2	220501	D=54, - Halter	ATE							
						11.9541-9596.2	220502	D=54, - Halter	ATE							
						11.0441-5409.2	250031	Dichtungssatz	ATE							
						11.0101-5409.2	260035	Hülssensatz	ATE							
						11.8171-0008.1	990049	Führungsbolzen	ATE							
						11.8116-0143.1	390513	Haltefeder	ATE							
	1.4	55		08.01	05.10		24.5143-0439.3	331411	2		L=439					
	1.6			11.99	05.10											
	1.8 T	110		10.99	05.10											
	1.8 T	132		11.01	06.05											
	1.9 TDI	66		01.98	02.01											
	1.9 TDI	74		10.00	05.10											
	1.9 TDI	77		07.05	05.10											
	2.0	85		01.98	05.10											
	2.3 V5	125		10.00	05.05											
	3.2 RSI	165		04.00	03.03											
		1.6		9C-Y-607008	11.99		PR: 1KS,1KV	24.3384-1723.7				220523			D=38(M12x1), - Halter	TRW
		1.8 T	110	9C-Y-607008	10.99		PR: 1KS,1KV	24.3384-1724.7				220524			D=38(M12x1), - Halter	TRW
1.9 TDI		66	9C-Y-607008	01.98		PR: 1KS,1KV										
2.0		85	9C-Y-607008	01.98		PR: 1KS,1KV										
1.4		55		08.01	05.10	PR: 1KS,1KV	24.3384-1729.7	220541			D=38(M12x1), - Halter	TRW				
1.6			9C-Y-607009		05.10	PR: 1KS,1KV	24.3384-1730.7	220542			D=38(M12x1), - Halter	TRW				
1.8 T		110	9C-Y-607009		05.10	PR: 1KS,1KV										
1.8 T		132		11.01	06.05	PR: 1KS,1KV										
1.9 TDI		66	9C-Y-607009		02.01	PR: 1KS,1KV										
1.9 TDI		74		10.00	05.10	PR: 1KS,1KV										
1.9 TDI		77		07.05	05.10	PR: 1KS,1KV										
2.0		85	9C-Y-607009		05.10	PR: 1KS,1KV										
2.3 V5	125		10.00	05.05	PR: 1KS,1KV											
1.8 T	132		11.01	06.05	PR: 1KY	24.3384-1745.7	220609				D=38, - Halter	TRW				
2.3 V5	125		10.00	05.05	PR: 1KY	24.3384-1746.7	220610				D=38, - Halter	TRW				
3.2 RSI	165		04.00	03.03												
	1.4	55		08.01	05.10		83.7858-0140.3	330837	2		L=140					
	1.6			11.99	05.10											
	1.8 T	110		10.99	05.10											
	1.8 T	132		11.01	05.10											
	1.9 TDI	66		01.98	05.10											
	1.9 TDI	74		10.00	05.10											
	1.9 TDI	77		07.05	05.10											
	2.0	85		01.98	05.10											
	2.3 V5	125		10.00	05.10											
	3.2 RSI	165		04.00	05.10											
		1.6		9C-Y-607008	11.99			24.3727-0149.2				580149	2		L=1688	
		1.8 T	110	9C-Y-607008	10.99											
1.9 TDI		66	9C-Y-607008	01.98												
1.9 TDI		74	9C-Y-607008	10.00												
2.0		85	9C-Y-607008	01.98												
1.4		55		08.01	05.10		24.3727-0173.2	580173	2		L=1693					
1.6			9C-Y-607009		05.10											
1.8 T		110	9C-Y-607009		05.10											
1.8 T		132		11.01	05.10											
1.9 TDI		66	9C-Y-607009		05.10											
1.9 TDI		74	9C-Y-607009		05.10											
1.9 TDI		77		07.05	05.10											
2.0	85	9C-Y-607009		05.10												
2.3 V5	125		10.00	05.05	- verstärktes Fahrwerk 1)											
3.2 RSI	165		04.00	03.03	- verstärktes Fahrwerk 1)											
	1.4	55		08.01	06.05	- ABS	03.6583-0179.3	320228						BRL 8/3 (4)	ATE	
	1.6			11.99	06.05	- ABS										
	1.8 T	110		10.99	06.05	- ABS										
	1.8 T	132		11.01	06.05	- ABS										
	1.9 TDI	66		01.98	02.01	- ABS										
	1.9 TDI	74		10.00	06.05	- ABS										
	2.0	85		01.98	06.05	- ABS										
	2.3 V5	125		10.00	05.05	- ABS										
	3.2 RSI	165		04.00	03.03	- ABS										
		1.4	55		08.01	05.10		24.2415-1701.3	030095							Gz 15,87
		1.6			11.99	05.10										
		1.8 T	110		10.99	05.10										
1.8 T		132		11.01	06.05											
1.9 TDI		66		01.98	02.01											
1.9 TDI		74		10.00	05.10											

1) - reinforced suspension / - sospensione rinforzata / - châssis renforcé / - suspensión reforzada

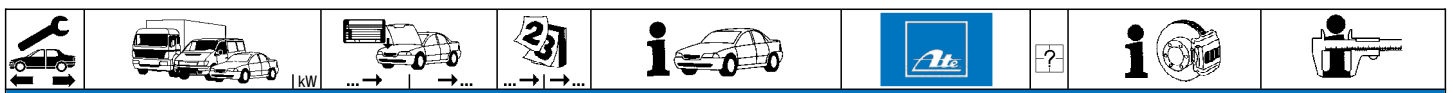



















VOLKSWAGEN NEW BEETLE (98-10)

	1.9 TDI 2.0 2.3 V5 3.2 RSI	◀ 77 ◀ 85 ◀ 125 ◀ 165		07.05 05.10 01.98 05.10 10.00 05.05 04.00 03.03	24.2415-1701.3	030095			Gz 15,87
	1.4 1.6 1.8 T 1.8 T 1.9 TDI 1.9 TDI 1.9 TDI 2.0 2.3 V5 3.2 RSI	▶ 55 ▶ ▶ 110 ▶ 132 ▶ 66 ▶ 74 ▶ 77 ▶ 85 ▶ 125 ▶ 165		08.01 05.10 11.99 05.10 10.99 05.10 11.01 06.05 01.98 02.01 10.00 05.10 07.05 05.10 01.98 05.10 10.00 05.05 04.00 03.03	24.2415-1702.3	030096			Gz 15,87
	1.4 1.6 1.8 T 1.8 T 1.9 TDI 1.9 TDI 1.9 TDI 2.0 2.3 V5 3.2 RSI	55 110 132 66 74 77 85 125 165		08.01 05.10 11.99 05.10 10.99 05.10 11.01 06.05 01.98 02.01 10.00 05.10 07.05 05.10 01.98 05.10 10.00 05.05 04.00 03.03	24.2519-1701.3	040075		für Getriebe MQ-250 ¹⁾	Nz 19,05

VOLKSWAGEN NEW BEETLE Cabriolet (03-10)















	1.4 1.6 1.8 T 1.9 TDI 1.9 TDI 2.0	◀ 55 ◀ 75 ◀ 110 ◀ 74 ◀ 77 ◀ 85		01.03 05.10 + ESP 01.03 05.10 + ESP 12.03 05.10 + ESP 07.03 05.10 + ESP 07.05 05.10 + ESP 01.03 05.10 + ESP	03.7863-3502.4	300128			10" ATE
	1.4 1.6 1.8 T 1.9 TDI 2.0	◀ 55 ◀ 75 ◀ 110 ◀ 74 ◀ 85		01.03 06.05 - ESP 01.03 06.05 - ESP 12.03 06.05 - ESP 07.03 06.05 - ESP 01.03 06.05 - ESP	24.2123-1709.3	010503			Thz 23,81
	1.4 1.6 1.8 T 1.9 TDI 1.9 TDI 2.0	◀ 55 ◀ 75 ◀ 110 ◀ 74 ◀ 77 ◀ 85		01.03 05.10 + ESP 01.03 05.10 + ESP 12.03 05.10 + ESP 07.03 05.10 + ESP 07.05 05.10 + ESP 01.03 05.10 + ESP	03.2123-2715.3	010802			Thz 23,81 ATE
	1.4 1.6 1.8 T 1.9 TDI 1.9 TDI 2.0	▶ 55 ▶ 75 ▶ 110 ▶ 74 ▶ 77 ▶ 85	1Y-7-413420 1Y-7-413420 1Y-7-413420 1Y-7-413420 1Y-7-413420	01.03 01.03 12.03 07.03 07.05 01.03	03.2123-2774.3	010803			Thz 23,81 ATE
	1.4 1.6 1.8 T 1.9 TDI 1.9 TDI 2.0	▶ 55 ▶ 75 ▶ 110 ▶ 74 ▶ 77 ▶ 85	1Y-7-413421 1Y-7-413421 1Y-7-413421 1Y-7-413421 1Y-7-413421 1Y-7-413421	05.10 05.10 05.10 05.10 05.10 05.10	03.2123-2774.3	010803			Thz 23,81 ATE
	1.4 1.6 1.8 T 1.9 TDI 1.9 TDI 2.0	55 75 110 74 77 85		01.03 05.10 PR: 1ZP,1ZM 01.03 05.10 PR: 1ZP,1ZM 12.03 05.10 PR: 1ZP,1ZM 07.03 05.10 PR: 1ZP,1ZM 07.05 05.10 PR: 1ZP,1ZM 01.03 05.10 PR: 1ZP,1ZM	11.9541-9549.2 11.9541-9550.2 11.0101-5409.2 11.8171-0069.1	220575 220576 260035 250152	 	D=54, - Halter D=54, - Halter Hülensatz Führungsbolzen	ATE ATE ATE ATE
	1.4 1.6 1.8 T 1.9 TDI 1.9 TDI 2.0	55 75 110 74 77 85		01.03 05.10 PR: 1ZD,1ZE 01.03 05.10 PR: 1ZD,1ZE 12.03 05.10 PR: 1ZD,1ZE 07.03 05.10 PR: 1ZD,1ZE 07.05 05.10 PR: 1ZD,1ZE 01.03 05.10 PR: 1ZD,1ZE	11.3541-8523.2 11.3541-8524.2 24.3541-8523.5 24.3541-8524.5 11.8170-0306.1 11.0441-5409.2 11.0101-5409.2 11.8171-0008.1 11.8116-0143.1	220115 220116 240551 240552 260102 250031 260035 990049 390513	 2 	D=54, - Halter D=54, - Halter D=54, - Halter D=54, - Halter Halter Dichtungssatz Hülensatz Führungsbolzen Haltefeder	ATE ATE ATE ATE ATE ATE ATE ATE ATE
	1.4 1.6 1.8 T 1.9 TDI 1.9 TDI 2.0	55 75 110 74 77 85		01.03 05.10 01.03 05.10 12.03 05.10 07.03 05.10 07.05 05.10 01.03 05.10	24.5143-0439.3	331411	2		L=439
	1.4 1.6 1.8 T 1.9 TDI 1.9 TDI 2.0	55 75 110 74 77 85		01.03 05.10 PR: 1KS,1KV 01.03 05.10 PR: 1KS,1KV 12.03 05.10 PR: 1KS,1KV 07.03 05.10 PR: 1KS,1KV 07.05 05.10 PR: 1KS,1KV 01.03 05.10 PR: 1KS,1KV	24.3384-1729.7 24.3384-1730.7	220541 220542	 	D=38(M12x1), - Halter D=38(M12x1), - Halter	TRW TRW
	1.4 1.6 1.8 T 1.9 TDI	55 75 110 74		01.03 05.10 01.03 05.10 12.03 05.10 07.03 05.10	83.7858-0140.3	330837	2		L=140





¹⁾ for transmission MQ-250 / per scatola camb.MQ-250 / pour boîte de vitesse MQ-250 / caja de cambios para MQ-250

















										
VOLKSWAGEN NEW BEETLE Cabriolet (03-10)										
	1.9 TDI 2.0	77 85		07.05 01.03	05.10 05.10	83.7858-0140.3	330837	2	L=140	
	1.4 1.6 1.8 T 1.9 TDI 1.9 TDI 2.0	55 75 110 74 77 85		01.03 01.03 12.03 07.03 07.05 01.03	05.10 05.10 05.10 05.10 05.10 05.10	24.3727-0173.2	580173	2	L=1693	
	1.4 1.6 1.8 T 1.9 TDI 1.9 TDI 2.0	55 75 110 74 77 85		01.03 01.03 12.03 07.03 07.05 01.03	05.10 05.10 05.10 05.10 05.10 05.10	24.2415-1701.3	030095		Gz 15,87	
	1.4 1.6 1.8 T 1.9 TDI 1.9 TDI 2.0	55 75 110 74 77 85		01.03 01.03 12.03 07.03 07.05 01.03	05.10 05.10 05.10 05.10 05.10 05.10	24.2415-1702.3	030096		Gz 15,87	
	1.4 1.6 1.8 T 1.9 TDI 1.9 TDI 2.0	55 75 110 74 77 85		01.03 01.03 12.03 07.03 07.05 01.03	05.10 05.10 05.10 05.10 05.10 05.10	24.2519-1701.3	040075	für Getriebe MQ-250 ¹⁾	Nz 19,05	
VOLKSWAGEN BEETLE (11-)										
	1.2 TSI 1.4 TSI 1.4 TSI 1.6 TDI 2.0 TDI 2.0 TDI 2.0 TDI 2.0 TSI 2.0 TSI 2.0 TSI 2.5	77 110 118 77 81 103 110 147 155 162 125		07.11 12.14 04.11 10.11 12.14 04.11 09.14 04.11 05.13 12.14 04.11	PR: 1ZM,1ZQ PR: 1ZM,1ZQ PR: 1ZM,1ZQ PR: 1ZM,1ZQ PR: 1ZM,1ZQ PR: 1ZM,1ZQ PR: 1ZM,1ZQ PR: 1ZM,1ZQ PR: 1ZM,1ZQ PR: 1ZM,1ZQ PR: 1ZM,1ZQ	11.9541-9549.2 11.9541-9550.2 11.0101-5409.2 11.8171-0069.1	220575 220576 260035 250152	2	D=54, - Halter D=54, - Halter Hülzensatz Führungsbolzen	ATE ATE ATE ATE
	1.2 TSI 1.4 TSI 1.4 TSI 1.6 TDI 2.0 TDI 2.0 TDI 2.0 TDI 2.0 TSI 2.0 TSI 2.0 TSI 2.5	77 110 118 77 81 103 110 147 155 162 125		07.11 12.14 04.11 10.11 12.14 04.11 09.14 04.11 05.13 12.14 04.11	PR: 1ZA,1ZE,1ZP PR: 1ZA,1ZE,1ZP PR: 1ZA,1ZE,1ZP PR: 1ZA,1ZE,1ZP PR: 1ZA,1ZE,1ZP PR: 1ZA,1ZE,1ZP PR: 1ZA,1ZE,1ZP PR: 1ZA,1ZE,1ZP PR: 1ZA,1ZE,1ZP PR: 1ZA,1ZE,1ZP PR: 1ZA,1ZE,1ZP	11.9541-9553.2 11.9541-9554.2 11.0101-5409.2 11.8171-0008.1	220563 220564 260035 990049	2	D=54, - Halter D=54, - Halter Hülzensatz Führungsbolzen	ATE ATE ATE ATE
	1.2 TSI 1.4 TSI 1.4 TSI 1.6 TDI 2.0 TDI 2.0 TDI 2.0 TDI 2.0 TSI 2.0 TSI 2.0 TSI 2.5	77 110 118 77 81 103 110 147 155 162 125		07.11 12.14 04.11 10.11 12.14 04.11 09.14 04.11 05.13 12.14 04.11	PR: 1KV,1KV PR: 1KV,1KV PR: 1KV,1KV PR: 1KV,1KV PR: 1KV,1KV PR: 1KV,1KV PR: 1KV,1KV PR: 1KV,1KV PR: 1KV,1KV PR: 1KV,1KV PR: 1KV,1KV	24.3384-1755.7 24.3384-1756.7	220635 220636	2	D=38, - Halter D=38, - Halter	TRW TRW
	1.2 TSI 1.4 TSI	77 118		07.11 04.11		83.7847-0254.3 83.7847-0257.3	331233 331234		+ Scheibenbremse ²⁾ + Scheibenbremse ²⁾	L=255 L=255
	1.4 TSI 1.6 TDI 2.0 TDI 2.0 TDI 2.0 TDI 2.0 TSI 2.0 TSI 2.0 TSI 2.5	110 77 81 103 110 147 155 162 125		12.14 10.11 12.14 04.11 09.14 04.11 05.13 12.14 04.11		83.7847-0254.3 83.7847-0257.3	331233 331234			L=255 L=255





¹⁾ for transmission MQ-250 / per scatola camb.MQ-250 / pour boîte de vitesse MQ-250 / caja de cambios para MQ-250

²⁾ + disc brake / + disco freno / + disques de frein / + disco de freno

	 kW								
VOLKSWAGEN BEETLE (11-)									
	1.2 TSI	77		12.11	PR: ON9	24.3727-3405.2	583405	2 ↓	L=1482
	1.4 TSI	110		12.14	PR: ON9				
	1.4 TSI	118		12.11	PR: ON9				
	1.6 TDI	77		10.11	PR: ON9				
	2.0 TDI	81		12.14	PR: ON9				
	2.0 TDI	103		04.11	PR: ON9				
	2.0 TDI	110		09.14	PR: ON9				
	2.0 TSI	147		12.11	PR: ON9				
	2.0 TSI	155		05.13	PR: ON9				
	2.0 TSI	162		12.14	PR: ON9				
2.5	125		12.11	PR: ON9					
	1.4 TSI	110		12.14	PR: ON4	24.3727-3406.2	583406	1 ↓	L=1498
	2.0 TDI	81		12.14	PR: ON4				
	2.0 TSI	147		04.11	PR: ON4				
	2.0 TSI	155		05.13	PR: ON4				
	2.0 TSI	162		12.14	PR: ON4				
	1.2 TSI	77		07.11	PR: VFO	24.2415-1713.3	030132		Gz 15,87, + Sensor
	1.4 TSI	110		12.14	PR: VFO				
	1.4 TSI	118		04.11	PR: VFO				
	1.6 TDI	77		10.11	PR: VFO				
	2.0 TDI	81		12.14	PR: VFO				
	2.0 TDI	103		04.11	PR: VFO				
	2.0 TDI	110		09.14	PR: VFO				
	2.0 TSI	147		04.11	PR: VFO				
	2.0 TSI	155		05.13	PR: VFO				
	2.0 TSI	162		12.14	PR: VFO				
2.5	125		04.11	PR: VFO					
	1.4 TSI	118		04.11	PR: 0EJ	24.2519-1705.3	040095		Nz 19,05
	1.2 TSI	77		07.11	PR: OEM				
	1.4 TSI	110		12.14	PR: OEM	24.2519-1706.3	040096		Nz 19,05
	1.4 TSI	118		04.11	PR: OEM				
	1.6 TDI	77		10.11	PR: OEM				
	2.0 TDI	81		12.14	PR: OEM				
	2.0 TDI	103		04.11	PR: OEM				
	2.0 TDI	110		09.14	PR: OEM				
	2.0 TSI	147		04.11	PR: OEM				
	2.0 TSI	155		05.13	PR: OEM				
	2.0 TSI	162		12.14	PR: OEM				
	2.5	125		04.11	PR: OEM				

VOLKSWAGEN BEETLE Cabriolet (12-)										
	1.2 TSI	77		11.12	PR: 1ZM,1ZQ	11.9541-9549.2	220575	☐ ☐	D=54, - Halter D=54, - Halter Führungsbolzen Hülzensatz	ATE ATE ATE ATE
	1.4 TSI	110		12.14	PR: 1ZM,1ZQ					
	1.4 TSI	118		11.12	PR: 1ZM,1ZQ					
	1.6 TDI	77		11.12	PR: 1ZM,1ZQ					
	1.8 TSI	125		12.13	PR: 1ZM,1ZQ					
	2.0 TDI	81		12.14	PR: 1ZM,1ZQ					
	2.0 TDI	103		11.12	PR: 1ZM,1ZQ					
	2.0 TDI	110		09.14	PR: 1ZM,1ZQ					
	2.0 TSI	147		11.12	PR: 1ZM,1ZQ					
	2.0 TSI	155		05.13	PR: 1ZM,1ZQ					
2.0 TSI	162		12.14	PR: 1ZM,1ZQ						
2.5	125		12.12	PR: 1ZM,1ZQ						
	1.2 TSI	77		11.12	PR: 1ZE,1ZP	11.9541-9553.2	220563	☐ ☐	D=54, - Halter D=54, - Halter Führungsbolzen Haltefeder Hülzensatz	ATE ATE ATE ATE ATE
	1.4 TSI	110		12.14	PR: 1ZE,1ZP					
	1.4 TSI	118		11.12	PR: 1ZE,1ZP					
	1.6 TDI	77		11.12	PR: 1ZE,1ZP					
	1.8 TSI	125		12.13	PR: 1ZE,1ZP					
	2.0 TDI	81		12.14	PR: 1ZE,1ZP					
	2.0 TDI	103		11.12	PR: 1ZE,1ZP					
	2.0 TDI	110		09.14	PR: 1ZE,1ZP					
	2.0 TSI	147		11.12	PR: 1ZE,1ZP					
	2.0 TSI	155		05.13	PR: 1ZE,1ZP					
2.0 TSI	162		12.14	PR: 1ZE,1ZP						
2.5	125		12.12	PR: 1ZE,1ZP						
	1.2 TSI	77		11.12	PR: 1ZA	11.9541-9553.2	220563	☐ ☐	D=54, - Halter D=54, - Halter Führungsbolzen Haltefeder Hülzensatz	ATE ATE ATE ATE ATE
	1.4 TSI	110		12.14	PR: 1ZA					
	1.4 TSI	118		11.12	PR: 1ZA					
	1.6 TDI	77		11.12	PR: 1ZA					
	1.8 TSI	125		12.13	PR: 1ZA					
	2.0 TDI	81		12.14	PR: 1ZA					
	2.0 TDI	103		11.12	PR: 1ZA					
	2.0 TDI	110		09.14	PR: 1ZA					
	2.0 TSI	147		11.12	PR: 1ZA					
	2.0 TSI	155		05.13	PR: 1ZA					
2.0 TSI	162		12.14	PR: 1ZA						
2.5	125		12.12	PR: 1ZA						
	1.2 TSI	77		11.12	PR: 1LV,1ZB	11.9541-9553.2	220563	☐ ☐	D=54, - Halter D=54, - Halter Führungsbolzen Haltefeder Hülzensatz	ATE ATE ATE ATE ATE
	1.4 TSI	110		12.14	PR: 1LV,1ZB					
	1.4 TSI	118		11.12	PR: 1LV,1ZB					
	1.6 TDI	77		11.12	PR: 1LV,1ZB					
	1.8 TSI	125		12.13	PR: 1LV,1ZB					
	2.0 TDI	81		12.14	PR: 1LV,1ZB					
	2.0 TDI	103		11.12	PR: 1LV,1ZB					
	2.0 TDI	110		09.14	PR: 1LV,1ZB					
	2.0 TSI	147		11.12	PR: 1LV,1ZB					
	2.0 TSI	155		05.13	PR: 1LV,1ZB					
2.0 TSI	162		12.14	PR: 1LV,1ZB						
2.5	125		12.12	PR: 1LV,1ZB						

										
VOLKSWAGEN BEETLE Cabriolet (12-)										
	2.0 TSI 2.0 TSI 2.5	155 162 125		05.13 12.14 12.12	PR: 1LV,1ZB PR: 1LV,1ZB PR: 1LV,1ZB	11.9541-9553.2 11.9541-9554.2 11.8171-0008.1 11.8116-0351.1 11.0101-5409.2	220563 220564 990049 390538 260035	2 2	D=54, - Halter D=54, - Halter Führungsbolzen Haltefeder Hülzensatz	ATE ATE ATE ATE ATE
	1.2 TSI 1.4 TSI 1.4 TSI 1.6 TDI 1.8 TSI 2.0 TDI 2.0 TDI 2.0 TDI 2.0 TSI 2.0 TSI 2.0 TSI 2.5	77 110 118 77 125 81 103 110 147 155 162 125		11.12 12.14 11.12 11.12 12.13 12.14 11.12 09.14 11.12 05.13 12.14 12.12	PR: 1KD,1KU PR: 1KD,1KU PR: 1KD,1KU PR: 1KD,1KU PR: 1KD,1KU PR: 1KD,1KU PR: 1KD,1KU PR: 1KD,1KU PR: 1KD,1KU PR: 1KD,1KU PR: 1KD,1KU PR: 1KD,1KU	24.3384-1755.7 24.3384-1756.7	220635 220636	2 2	D=38, - Halter D=38, - Halter	TRW TRW
	1.2 TSI 1.4 TSI 1.4 TSI 1.6 TDI 1.8 TSI 2.0 TDI 2.0 TDI 2.0 TDI 2.0 TSI 2.0 TSI 2.0 TSI 2.5	77 110 118 77 125 81 103 110 147 155 162 125		11.12 12.14 11.12 11.12 12.13 12.14 11.12 09.14 11.12 05.13 12.14 12.12		83.7847-0254.3 83.7847-0257.3	331233 331234	2 2	L=255 L=255	
	1.2 TSI 1.4 TSI 1.4 TSI 1.6 TDI 1.8 TSI 2.0 TDI 2.0 TDI 2.0 TDI 2.0 TSI 2.0 TSI 2.0 TSI 2.5	77 110 118 77 125 81 103 110 147 155 162 125		11.12 12.14 11.12 11.12 12.13 12.14 11.12 09.14 11.12 05.13 12.14 12.12		24.3727-3406.2	583406	2	L=1498	
	1.2 TSI 1.4 TSI 1.4 TSI 1.6 TDI 1.8 TSI 2.0 TDI 2.0 TDI 2.0 TDI 2.0 TSI 2.0 TSI 2.0 TSI 2.5	77 110 118 77 125 81 103 110 147 155 162 125		11.12 12.14 11.12 11.12 12.13 12.14 11.12 09.14 11.12 05.13 12.14 12.12	PR: VF1 PR: VF1 PR: VF1 PR: VF1 PR: VF1 PR: VF1 PR: VF1 PR: VF1 PR: VF1 PR: VF1 PR: VF1 PR: VF1	24.2415-1713.3	030132	2	Gz 15,87, + Sensor	
	1.2 TSI 1.4 TSI 1.4 TSI 1.6 TDI 1.8 TSI 2.0 TDI 2.0 TDI 2.0 TDI 2.0 TSI 2.0 TSI 2.0 TSI 2.5	77 110 118 77 125 81 103 110 147 155 162 125		11.12 12.14 11.12 11.12 12.13 12.14 11.12 09.14 11.12 05.13 12.14 12.12	PR: VF0 PR: VF0 PR: VF0 PR: VF0 PR: VF0 PR: VF0 PR: VF0 PR: VF0 PR: VF0 PR: VF0 PR: VF0 PR: VF0	24.2415-1713.3	030132	2	Gz 15,87, + Sensor	
	1.2 TSI 1.4 TSI 1.4 TSI 1.6 TDI 1.8 TSI 2.0 TDI 2.0 TDI 2.0 TDI 2.0 TSI 2.0 TSI 2.0 TSI 2.5	77 110 118 77 125 81 103 110 147 155 162 125		11.12 12.14 11.12 11.12 12.13 12.14 11.12 09.14 11.12 05.13 12.14 12.12	PR: OEM PR: OEM PR: OEM PR: OEM PR: OEM PR: OEM PR: OEM PR: OEM PR: OEM PR: OEM PR: OEM PR: OEM	24.2519-1706.3	040096	2	Nz 19,05	
VOLKSWAGEN PASSAT (97-05)										
	1.6 1.8 1.8 1.8 4motion 1.8 T 1.9 TDI 1.9 TDI 1.9 TDI	85 92 66 81 85	3B-X-800000 3B-X-800000 3B-X-800000 3B-X-800000 3B-X-800000 3B-X-800000 3B-X-800000 3B-X-800000	10.96 01.97 10.96 10.96 10.96 10.96 10.96 08.98	- ESP - ESP/ +  / + GUS-Staaten ¹⁾ - ESP - ESP - ESP - ESP - ESP - ESP	24.2123-1717.3	010521	2	Thz 23,81	

¹⁾ - ESP/ +  / + GUS States / - ESP/ +  / + Stati del GUS / - ESP/ +  / + Etats de la CEI / - ESP/ +  / + estados del GUS

VOLKSWAGEN PASSAT (97-05)

	1.9 TDI 4motion		3B-X-800000	10.96	- ESP	24.2123-1717.3	010521		THz 23,81				
	2.3		3B-X-800000	10.96	- ESP								
	2.3 4motion		3B-X-800000	06.97	- ESP								
	2.5 TDI		3B-X-800000	08.98	- ESP								
	2.5 TDI 4motion		3B-X-800000	08.98	- ESP								
	2.8	132	3B-X-800000	01.97	- ESP/ + / + GUS-Staaten ¹⁾								
	2.8	142	3B-X-800000	08.96	- ESP								
	2.8 4motion		3B-X-800000	10.96	- ESP								
	1.6		3B-Y-000001	3B-1-400000	- ESP	24.2125-1712.3	010622		THz 25,40				
	1.8	85	3B-Y-000001		09.00 - ESP/ + / + GUS-Staaten ¹⁾								
	1.8	92	3B-Y-000001		09.00 - ESP								
	1.8 4motion		3B-Y-000001		09.00 - ESP								
	1.8 T		3B-Y-000001	3B-1-400000	- ESP								
	1.9 TDI	66	3B-Y-000001		09.00 - ESP								
	1.9 TDI	74		3B-1-400000	10.00 - ESP								
	1.9 TDI	81	3B-Y-000001	3B-1-400000	- ESP								
	1.9 TDI	85	3B-Y-000001	3B-1-400000	- ESP								
	1.9 TDI	96		3B-1-400000	10.00 - ESP								
	1.9 TDI 4motion		3B-Y-000001	3B-1-400000	- ESP								
	1.9 TDI 4motion	96		3B-1-400000	10.00 - ESP								
	2.0	85		3B-1-400000	10.00 - ESP								
	2.0 4motion	85		3B-1-400000	10.00 - ESP								
	2.3		3B-Y-000001	3B-1-400000	- ESP								
	2.3 4motion		3B-Y-000001	3B-1-400000	- ESP								
	2.5 TDI		3B-Y-000001	3B-1-400000	- ESP								
	2.5 TDI 4motion		3B-Y-000001	3B-1-400000	- ESP								
	2.8	132	3B-Y-000001	3B-1-400000	- ESP/ + / + GUS-Staaten ¹⁾								
	2.8	142	3B-Y-000001	3B-1-400000	- ESP								
	2.8 4motion		3B-Y-000001	3B-1-400000	- ESP								
	1.6		3B-X-800000	10.96	+ ESP					24.2123-1730.3	010620		THz 23,81
	1.8	85	3B-X-800000	01.97	+ ESP/ + / + GUS-Staaten ²⁾								
	1.8	92	3B-X-800000	10.96	+ ESP								
	1.8 4motion		3B-X-800000	10.96	+ ESP								
	1.8 T		3B-X-800000	10.96	+ ESP								
	1.9 TDI	66	3B-X-800000	10.96	+ ESP								
	1.9 TDI	81	3B-X-800000	10.96	+ ESP								
	1.9 TDI	85	3B-X-800000	08.98	+ ESP								
	1.9 TDI 4motion		3B-X-800000	10.96	+ ESP								
	2.3		3B-X-800000	10.96	+ ESP								
	2.3 4motion		3B-X-800000	06.97	+ ESP								
	2.5 TDI		3B-X-800000	08.98	+ ESP								
	2.5 TDI 4motion		3B-X-800000	08.98	+ ESP								
	2.8	132	3B-X-800000	01.97	+ ESP/ + / + GUS-Staaten ²⁾								
	2.8	142	3B-X-800000	08.96	+ ESP								
	2.8 4motion		3B-X-800000	10.96	+ ESP								
	1.6		3B-Y-000001	3B-1-400000	+ ESP	24.2125-1713.3	010623		THz 25,40				
	1.8	85	3B-Y-000001		09.00 + ESP/ + / + GUS-Staaten ²⁾								
	1.8	92	3B-Y-000001		09.00 + ESP								
	1.8 4motion		3B-Y-000001		09.00 + ESP								
	1.8 T		3B-Y-000001	3B-1-400000	+ ESP								
	1.9 TDI	66	3B-Y-000001		09.00 + ESP								
	1.9 TDI	74		3B-1-400000	10.00 + ESP								
	1.9 TDI	81	3B-Y-000001	3B-1-400000	+ ESP								
	1.9 TDI	85	3B-Y-000001	3B-1-400000	+ ESP								
	1.9 TDI	96		3B-1-400000	10.00 + ESP								
	1.9 TDI 4motion		3B-Y-000001	3B-1-400000	+ ESP								
	1.9 TDI 4motion	96		3B-1-400000	10.00 + ESP								
	2.0	85		3B-1-400000	10.00 + ESP								
	2.0 4motion	85		3B-1-400000	10.00 + ESP								
	2.3		3B-Y-000001	3B-1-400000	+ ESP								
	2.3 4motion		3B-Y-000001	3B-1-400000	+ ESP								
	2.5 TDI		3B-Y-000001	3B-1-400000	+ ESP								
	2.5 TDI 4motion		3B-Y-000001	3B-1-400000	+ ESP								
	2.8	132	3B-Y-000001	3B-1-400000	+ ESP/ + / + GUS-Staaten ²⁾								
	2.8	142	3B-Y-000001	3B-1-400000	+ ESP								
	2.8 4motion		3B-Y-000001	3B-1-400000	+ ESP								
	1.6			05.02	06.05	03.2125-0373.3	010810		THz 25,40				
	1.8 T			05.02	06.05								
	1.9 TDI	74		05.02	06.05								
	1.9 TDI	81		05.02	06.05								
	1.9 TDI	85		05.02	06.05								
	1.9 TDI	96		05.02	06.05								
	1.9 TDI 4motion			05.02	06.05								
	1.9 TDI 4motion	96		05.02	06.05								
	2.0	85		05.02	06.05								
	2.0	96		05.02	06.05								
	2.0 4motion	85		05.02	06.05								
	2.0 TDI	100		12.03	06.05								
	2.3			05.02	06.05								
	2.3 4motion			05.02	06.05								
	2.5 TDI			05.02	06.05								
	2.5 TDI 4motion			05.02	06.05								
	2.8	132		05.02	06.05 + / + GUS-Staaten ³⁾								
	2.8	142		05.02	06.05								
	2.8 4motion			05.02	06.05								
	4.0 W8 4motion			05.02	06.05								
	1.6		3B-2-000001		06.05	24.2125-1720.3	010688		THz 25,40	TRW			

¹⁾ - ESP/ + / + GUS States / - ESP/ + / + Stati del GUS / - ESP/ + / + Etats de la CEI / - ESP/ + / + estados del GUS
²⁾ + ESP/ + / + GUS States / + ESP/ + / + Stati del GUS / + ESP/ + / + Etats de la CEI / + ESP/ + / + estados del GUS
³⁾ + / + GUS States / + / + Stati del GUS / + / + Etats de la CEI / + / + estados del GUS



VOLKSWAGEN PASSAT (97-05)

	1.8 T 1.9 TDI 1.9 TDI 1.9 TDI 1.9 TDI 1.9 TDI 4motion 1.9 TDI 4motion 2.0 2.0 2.0 4motion 2.0 TDI 2.3 2.3 4motion 2.5 TDI 2.5 TDI 4motion 2.8 2.8 2.8 4motion 4.0 W8 4motion	3B-2-000001 74 3B-2-000001 81 3B-2-000001 85 3B-2-000001 96 3B-2-000001 3B-2-000001 96 3B-2-000001 85 3B-2-000001 96 85 3B-2-000001 100 3B-2-000001 3B-2-000001 3B-2-000001 3B-2-000001 132 3B-2-000001 142 3B-2-000001 3B-2-000001		06.05 06.05 06.05 06.05 06.05 06.05 06.05 06.05 05.02 06.05 06.05 12.03 06.05 06.05 06.05 06.05 06.05 06.05 06.05 06.05 06.05 06.05 09.01 06.05		24.2125-1720.3 010688			THz 25,40	TRW
	1.6 1.8 1.8 1.8 4motion 1.9 TDI	85 92 66		10.96 09.00 PR: 1LZ,1ZJ 01.97 09.00 + (M) / + GUS-Staaten 1) 10.96 09.00 PR: 1LZ,1ZJ 10.96 09.00 PR: 1LZ,1ZJ		24.3541-1763.5 240231 24.3541-1764.5 240232			D=54, - Halter D=54, - Halter	TRW TRW
	1.6 1.8 1.8 4motion 1.8 T 1.9 TDI 1.9 TDI 1.9 TDI 4motion 2.3 2.3 4motion 2.8 2.8 2.8 4motion	92 66 81 85 132 142	3B-X-124107 3B-X-124107 3B-X-124107 3B-X-124107 3B-X-124107 3B-X-124107 3B-X-124107 3B-X-124107 3B-X-124107 3B-X-124107 3B-X-124107 3B-X-124107	10.96 PR: 1LB,1LE,1ZC 10.96 PR: 1LB,1LE,1ZC 10.96 PR: 1LB,1LE,1ZC 10.96 PR: 1LB,1LE,1ZC 10.96 PR: 1LB,1LE,1ZC 08.98 PR: 1LB,1LE,1ZC 10.96 PR: 1LB,1LE,1ZC 10.96 PR: 1LB,1LE,1ZC 06.97 PR: 1LB,1LE,1ZC 01.97 + (M) / + GUS-Staaten 1) 08.96 PR: 1LB,1LE,1ZC 10.96 PR: 1LB,1LE,1ZC		24.3571-8522.5 240496 24.3571-8521.5 240495 11.0441-5704.2 250034 11.0101-5409.2 260035 11.8171-0008.1 990049 11.8116-0143.1 390513		2	D=57, - Halter D=57, - Halter Dichtungssatz Hülssensatz Führungsbolzen Haltefeder	ATE ATE ATE ATE ATE ATE
	1.6 1.8 1.8 4motion 1.8 T 1.9 TDI 1.9 TDI 1.9 TDI 1.9 TDI 1.9 TDI 4motion 1.9 TDI 4motion 2.0 2.0 2.0 4motion 2.0 TDI 2.3 2.3 4motion 2.5 TDI 2.5 TDI 4motion 2.8 2.8 2.8 4motion	3B-X-124108 92 3B-X-124108 3B-X-124108 3B-X-124108 66 3B-X-124108 74 81 3B-X-124108 85 3B-X-124108 96 3B-X-124108 96 85 96 85 100 3B-X-124108 3B-X-124108 08.98 08.98 132 3B-X-124108 142 3B-X-124108 3B-X-124108		06.05 PR: 1LB,1LE,1ZC 06.05 PR: 1LB,1LE,1ZC 06.05 PR: 1LB,1LE,1ZC 06.05 PR: 1LB,1LE,1ZC 06.05 PR: 1LB,1LE,1ZC 10.00 06.05 PR: 1LB,1LE,1ZC 06.05 PR: 1LB,1LE,1ZC 06.05 PR: 1LB,1LE,1ZC 06.05 PR: 1LB,1LE,1ZC 06.05 PR: 1LB,1LE,1ZC 06.05 PR: 1LB,1LE,1ZC 06.05 PR: 1LB,1LE,1ZC 06.05 PR: 1LB,1LE,1ZC 06.05 PR: 1LB,1LE,1ZC 09.00 PR: 1LB,1LE,1ZC 09.00 PR: 1LB,1LE,1ZC 08.98 PR: 1LB,1LE,1ZC 08.98 PR: 1LB,1LE,1ZC 06.05 + (M) / + GUS-Staaten 1) 09.00 PR: 1LB,1LE,1ZC 09.00 PR: 1LB,1LE,1ZC		24.3571-8522.5 240496 24.3571-8521.5 240495 11.8170-0306.1 260102 06.05 PR: 1LB,1LE,1ZC 11.0441-5704.2 250034 11.0101-5409.2 260035 11.8171-0008.1 990049 11.8116-0143.1 390513		2	D=57, - Halter D=57, - Halter Halter Dichtungssatz Hülssensatz Führungsbolzen Haltefeder	ATE ATE ATE ATE ATE ATE
	2.0 TDI 2.3 2.3 4motion 2.5 TDI 2.5 TDI 4motion 2.8 2.8 4motion 4.0 W8 4motion	100 142		12.03 06.05 PR: 1LT 10.00 06.05 PR: 1LT 10.00 06.05 PR: 1LT 10.00 06.05 PR: 1LT 10.00 06.05 PR: 1LT 10.00 06.05 PR: 1LT 10.00 06.05 PR: 1LT 09.01 06.05 PR: 1ZF,1ZG		11.9571-9836.2 220428 11.9571-9835.2 220427 11.0441-5704.2 250034 11.0101-5409.2 260035 11.8171-0008.1 990049 11.8116-0143.1 390513		2	D=57, - Halter D=57, - Halter Dichtungssatz Hülssensatz Führungsbolzen Haltefeder	ATE ATE ATE ATE ATE ATE
	1.6 1.8 1.8 1.8 4motion 1.8 T 1.9 TDI 1.9 TDI 1.9 TDI 1.9 TDI 1.9 TDI 1.9 TDI 4motion 1.9 TDI 4motion 2.0 2.0 2.0 4motion 2.0 TDI 2.3 2.3 4motion 2.5 TDI	85 92 66 74 81 85 96 96 85 96 85 100		10.96 06.05 01.97 09.00 + (M) / + GUS-Staaten 1) 10.96 09.00 10.96 09.00 10.96 06.05 10.96 09.00 10.96 06.05 10.96 06.05 10.00 06.05 08.98 06.05 10.00 06.05 10.00 06.05 10.00 06.05 05.02 06.05 10.00 06.05 12.03 06.05 10.96 06.05 06.97 06.05 08.98 06.05		83.7813-0295.3 330799		2	L=295	

1) + (M) / + GUS States / + (M) / + Stati del GUS / + (M) / + Etats de la CEI / + (M) / + estados del GUS



VOLKSWAGEN PASSAT (97-05)

	2.5 TDI 4motion 2.8 2.8 2.8 4motion 4.0 W8 4motion	132 142	08.98 01.97 08.96 10.96 09.01	06.05 06.05 + / + GUS-Staaten ¹⁾ 06.05 06.05 06.05	83.7813-0295.3 330799	2		L=295		
	1.6 1.8 1.8 1.8 T 1.9 TDI 1.9 TDI 1.9 TDI 1.9 TDI 1.9 TDI 2.0 2.0 TDI 2.3 2.5 TDI 2.8 2.8	85 92 92 66 74 81 85 96 96 100	10.96 01.97 10.96 10.96 10.96 10.00 10.96 08.98 10.00 05.02 12.03 10.96 08.98 01.97 08.96	06.05 06.05 + / + GUS-Staaten ¹⁾ 06.05 06.05 06.05 06.05 06.05 06.05 06.05 06.05 06.05 06.05 06.05 06.05 06.05 06.05 06.05	PR: 1KD,1KE,1KF,1KW PR: 1KD,1KE,1KF,1KW PR: 1KD,1KE,1KF,1KW PR: 1KD,1KE,1KF,1KW PR: 1KD,1KE,1KF,1KW PR: 1KD,1KE,1KF,1KW PR: 1KD,1KE,1KF,1KW PR: 1KD,1KE,1KF,1KW PR: 1KD,1KE,1KF,1KW PR: 1KD,1KE,1KF,1KW PR: 1KD,1KE,1KF,1KW PR: 1KD,1KE,1KF,1KW PR: 1KD,1KE,1KF,1KW PR: 1KD,1KE,1KF,1KW	24.3384-1731.7 24.3384-1732.7	220543 220544		D=38, - Halter D=38, - Halter	TRW TRW
	1.8 4motion 1.9 TDI 4motion 1.9 TDI 4motion 2.0 4motion 2.3 4motion 2.5 TDI 4motion 2.8 4motion 4.0 W8 4motion	96 85	10.96 10.96 10.00 10.00 06.97 08.98 10.96 09.01	06.05 06.05 06.05 06.05 06.05 06.05 06.05 06.05	PR: 1KD,1KF PR: 1KD,1KF PR: 1KD,1KF PR: 1KD,1KF PR: 1KD,1KF PR: 1KD,1KF PR: 1KD,1KF	24.3384-1733.7 24.3384-1734.7	220545 220546		D=38, - Halter D=38, - Halter	TRW TRW
	1.8 4motion 1.9 TDI 4motion 1.9 TDI 4motion 2.0 4motion 2.3 4motion 2.5 TDI 4motion 2.8 4motion 4.0 W8 4motion	96 85	10.96 10.96 10.00 10.00 06.97 08.98 10.96 09.01	06.05 06.05 06.05 06.05 06.05 06.05 06.05 06.05	PR: 1KE,1KW PR: 1KE,1KW PR: 1KE,1KW PR: 1KE,1KW PR: 1KE,1KW PR: 1KE,1KW PR: 1KE,1KW	24.3437-1701.7 24.3437-1702.7	220761 220762		D=43, - Halter D=43, - Halter	TRW TRW
	1.6 1.8 1.8 1.8 T 1.9 TDI 1.9 TDI 1.9 TDI 1.9 TDI 1.9 TDI 2.0 2.0 2.0 TDI 2.3 2.5 TDI 2.8 2.8	85 92 92 66 74 81 85 96 96 100	10.96 01.97 10.96 10.96 10.96 10.00 10.96 08.98 10.00 05.02 12.03 10.96 08.98 01.97 08.96	06.05 06.05 + / + GUS-Staaten ¹⁾ 06.05 06.05 06.05 06.05 06.05 06.05 06.05 06.05 06.05 06.05 06.05 06.05 06.05 06.05 06.05	24.5237-0183.3 24.5243-0190.3	331454 330678	2 2	am Bremssattel ²⁾	L=183 L=190	
	1.8 4motion 1.9 TDI 4motion 1.9 TDI 4motion 2.0 4motion 2.3 4motion 2.5 TDI 4motion 2.8 4motion	96 85	10.96 10.96 10.00 10.00 06.97 08.98 10.96	09.00 06.05 06.05 06.05 09.00 09.00 09.00		24.5243-0310.3	330755	2	L=310	
	2.3 4motion 2.5 TDI 4motion 2.8 4motion		10.00 10.00 10.00	06.05 06.05 06.05		24.5142-0290.3	330950	2	L=290	
	1.6 1.8 1.8 1.8 T 1.9 TDI 1.9 TDI 1.9 TDI 1.9 TDI 1.9 TDI 2.0 2.0 2.0 TDI 2.3 2.5 TDI 2.8 2.8	85 92 92 66 74 81 85 96 96 100	10.96 01.97 10.96 10.96 10.96 10.00 10.96 08.98 10.00 10.00 05.02 12.03 10.96 08.98 01.97 08.96	06.05 06.05 + / + GUS-Staaten ¹⁾ 06.05 06.05 06.05 06.05 06.05 06.05 06.05 06.05 06.05 06.05 06.05 06.05 06.05 06.05 06.05	24.3727-0174.2 24.3727-0170.2	580174 580170		L=1890 L=1890		
	1.6 1.8 1.8 1.8 T 1.9 TDI 1.9 TDI 1.9 TDI 2.3	85 92 92 66 81 85	10.96 01.97 10.96 10.96 10.96 10.00 10.96 08.98	06.05 06.05 + / + GUS-Staaten ¹⁾ 06.05 06.05 06.05 06.05 06.05 06.05	3B-V-100000 3B-V-100000 3B-V-100000 3B-V-100000 3B-W-070000 3B-W-070000	10.96 01.97 10.96 10.96 10.96 10.96 08.98	030091		Gz 19,05	

¹⁾ + / + GUS States / + / + Stati del GUS / + / + Etats de la CEI / + / + estados del GUS

²⁾ on the brake caliper / sulla pinza freno / sur l'étrier de frein / a la pinza de freno

VOLKSWAGEN PASSAT (97-05)

	2.5 TDI	◀			08.98	06.05		24.2419-1706.3	030091		Gz 19,05
	2.8	◀132	3B-V-100000		01.97		+ (VRS) / + GUS-Staaten 1)				
	2.8	◀142	3B-V-100000		08.96						
	1.6	◀	3B-V-100001			06.05		24.2419-1707.3	030092		Gz 19,05
	1.8	◀85	3B-V-100001			09.00	+ (VRS) / + GUS-Staaten 1)				
	1.8	◀92	3B-V-100001			09.00					
	1.8 4motion	◀			10.96	09.00					
	1.8 T	◀	3B-V-100001			06.05					
	1.9 TDI	◀66	3B-W-070001			09.00					
	1.9 TDI	◀74			10.00	06.05					
	1.9 TDI	◀81	3B-W-070001			06.05					
	1.9 TDI	◀96			10.00	06.05					
	1.9 TDI 4motion	◀			10.96	06.05					
	1.9 TDI 4motion	◀96			10.00	06.05					
	2.0	◀85			10.00	06.05					
	2.0	◀96			05.02	06.05					
	2.0 4motion	◀85			10.00	06.05					
	2.0 TDI	◀100			12.03	06.05					
	2.3	◀	3B-V-100001			06.05					
	2.3 4motion	◀			06.97	06.05					
	2.5 TDI 4motion	◀			08.98	06.05					
	2.8	◀132	3B-V-100001			06.05	+ (VRS) / + GUS-Staaten 1)				
	2.8	◀142	3B-V-100001			06.05					
	2.8 4motion	◀			10.96	06.05					
	4.0 W8 4motion	◀			09.01	06.05					
	1.6	▶	3B-V-100001	3B-Y-125000				24.2419-1705.3	030090		Gz 19,05
	1.8	▶85	3B-V-100001	3B-Y-125000			+ (VRS) / + GUS-Staaten 1)				
	1.8	▶92	3B-V-100001	3B-Y-125000							
	1.8 4motion	▶		3B-Y-125000	10.96						
	1.8 T	▶	3B-V-100001	3B-Y-125000							
1.9 TDI	▶66	3B-W-070001	3B-Y-125000								
1.9 TDI	▶81	3B-W-070001	3B-Y-125000								
1.9 TDI 4motion	▶		3B-Y-125000	10.96							
2.3	▶	3B-V-100001	3B-Y-125000								
2.3 4motion	▶		3B-Y-125000	06.97							
2.5 TDI 4motion	▶		3B-Y-125000	08.98							
2.8	▶132	3B-V-100001	3B-Y-125000			+ (VRS) / + GUS-Staaten 1)					
2.8	▶142	3B-V-100001	3B-Y-125000								
2.8 4motion	▶		3B-Y-125000	10.96							
	1.6		3B-V-100000	10.96			24.2519-1702.3	040074		Nz 19,05	
	1.8	85	3B-V-100000	01.97		+ (VRS) / + GUS-Staaten 1)					
	1.8	92	3B-V-100000	10.96							
	1.8 4motion		3B-V-100000	10.96							
	1.8 T		3B-V-100000	10.96							
	1.9 TDI	66	3B-W-070000	10.96							
	1.9 TDI	81	3B-W-070000	10.96							
	1.9 TDI	85	3B-W-070000	08.98							
	1.9 TDI 4motion		3B-W-070000	06.97							
	2.3		3B-V-100000	10.96							
	2.3 4motion		3B-V-100000	06.97							
	2.5 TDI		3B-W-070000	08.98							
	2.5 TDI 4motion		3B-W-070000	08.98							
	2.8	132	3B-V-100000	01.97			+ (VRS) / + GUS-Staaten 1)				
	2.8	142	3B-V-100000	08.96							
	2.8 4motion		3B-V-100000	10.96							
	1.6		3B-V-100001		06.05			24.2522-1706.3	040090		Nz 22,20
	1.8	85	3B-V-100001		06.05	+ (VRS) / + GUS-Staaten 1)					
	1.8	92	3B-V-100001		06.05						
	1.8 4motion		3B-V-100001		06.05						
	1.8 T		3B-V-100001		06.05						
	1.9 TDI	66	3B-W-070001		06.05						
	1.9 TDI	74			10.00	06.05					
	1.9 TDI	81	3B-W-070001		06.05						
	1.9 TDI	85	3B-W-070001		06.05						
	1.9 TDI	96			10.00	06.05					
	1.9 TDI 4motion		3B-W-070001		06.05						
	1.9 TDI 4motion	96			10.00	06.05					
	2.0	85			10.00	06.05					
	2.0	96			05.02	06.05					
2.0 TDI	100			12.03	06.05						
2.3		3B-V-100001		06.05							
2.3 4motion		3B-V-100001		06.05							
2.5 TDI		3B-W-070001		06.05							
2.5 TDI 4motion		3B-W-070001		06.05							
2.8	132	3B-V-100001		06.05	+ (VRS) / + GUS-Staaten 1)						
2.8	142	3B-V-100001		06.05							
2.8 4motion		3B-V-100001		06.05							

VOLKSWAGEN PASSAT Limousine (05-10)

	1.4 TSI	◀			10.07	07.10	- ESP	03.7873-4402.4	300292		11"	ATE
	1.6	◀75			03.05	07.10	- ESP					
	1.6 FSI	◀85			03.05	07.10	- ESP					
	1.6 TDI	◀77			08.09	07.10	- ESP					
	1.8 TSI	◀112			11.09	07.10	- ESP					
	1.8 TSI	◀118			10.07	07.10	- ESP					
	1.9 TDI	◀77			03.05	07.10	- ESP					
	2.0 FSI	◀			03.05	07.10	- ESP					
	↓											

1) + (VRS) / + GUS States / + (VRS) / + Stati del GUS / + (VRS) / + Etats de la CEI / + (VRS) / + estados del GUS

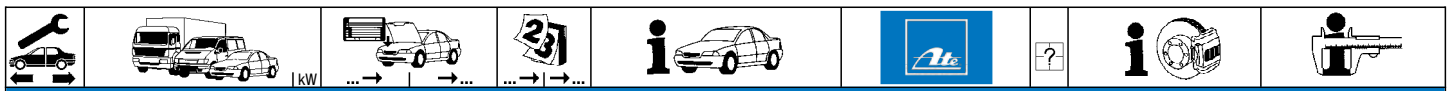

VOLKSWAGEN PASSAT Limousine (05-10)

	2.0 FSI	147	03.05	07.10	- ESP	03.7873-4402.4	300292		11"	ATE							
	2.0 FSI 4motion	110	03.05	07.10	- ESP												
	2.0 TDI		03.05	07.10	- ESP												
	2.0 TDI		03.05	07.10	- ESP												
	2.0 TDI	120	08.05	07.10	- ESP												
	2.0 TDI	125	08.05	07.10	- ESP												
	2.0 TDI 16V	103	03.05	07.10	- ESP												
	2.0 TDI 4motion	103	03.05	07.10	- ESP												
	2.0 TDI 4motion	125	05.09	07.10	- ESP												
	3.2 V6 FSI 4motion	184	09.05	07.10	- ESP												
	1.4 TSI		10.07	07.10	+ ESP						03.7873-3902.4	300254		11"	ATE		
	1.6	75	03.05	07.10	+ ESP												
	1.6 FSI	85	03.05	07.10	+ ESP												
	1.6 TDI	77	08.09	07.10	+ ESP												
	1.8 TSI	112	11.09	07.10	+ ESP												
1.8 TSI	118	10.07	07.10	+ ESP													
1.9 TDI	77	03.05	07.10	+ ESP													
2.0 FSI		03.05	07.10	+ ESP													
2.0 FSI	147	03.05	07.10	+ ESP													
2.0 FSI 4motion	110	03.05	07.10	+ ESP													
2.0 TDI		03.05	07.10	+ ESP													
2.0 TDI		03.05	07.10	+ ESP													
2.0 TDI	120	08.05	07.10	+ ESP													
2.0 TDI	125	08.05	07.10	+ ESP													
2.0 TDI 16V	103	03.05	07.10	+ ESP													
2.0 TDI 4motion	103	03.05	07.10	+ ESP													
2.0 TDI 4motion	125	05.09	07.10	+ ESP													
3.2 V6 FSI 4motion	184	09.05	07.10	+ ESP													
3.6 R36	220	04.07	07.10		03.7873-4002.4	300211		11"	ATE								
										03.7873-4502.4	300284						
	1.4 TSI		10.07	07.10	PR: 1ZG	03.4152-0116.3	010814		11"	ATE							
	1.6	75	03.05	07.10	PR: 1ZG												
	1.6 FSI	85	03.05	07.10	PR: 1ZG												
	1.6 TDI	77	08.09	07.10	PR: 1ZG												
	1.8 TSI	112	11.09	07.10	PR: 1ZG												
	1.8 TSI	118	10.07	07.10	PR: 1ZG												
	1.9 TDI	77	03.05	07.10	PR: 1ZG												
	2.0 FSI		03.05	07.10	PR: 1ZG												
	2.0 FSI	147	03.05	07.10	PR: 1ZG												
	2.0 FSI 4motion	110	03.05	07.10	PR: 1ZG												
	2.0 TDI		03.05	07.10	PR: 1ZG												
	2.0 TDI		03.05	07.10	PR: 1ZG												
	2.0 TDI	120	08.05	07.10	PR: 1ZG												
	2.0 TDI	125	08.05	07.10	PR: 1ZG												
	2.0 TDI 16V	103	03.05	07.10	PR: 1ZG												
	2.0 TDI 4motion	103	03.05	07.10	PR: 1ZG												
	2.0 TDI 4motion	125	05.09	07.10	PR: 1ZG												
	3.2 V6 FSI 4motion	184	09.05	07.10	PR: 1ZG												
	3.6 R36	220	04.07	07.10	PR: 1ZG												
	1.4 TSI		10.07	07.10	PR: 1LJ,1LK,1LH,1LM						03.4153-0186.3	010816		11"	ATE		
	1.6	75	03.05	07.10	PR: 1LJ,1LK,1LH,1LM												
	1.6 FSI	85	03.05	07.10	PR: 1LJ,1LK,1LH,1LM												
	1.6 TDI	77	08.09	07.10	PR: 1LJ,1LK,1LH,1LM												
	1.8 TSI	112	11.09	07.10	PR: 1LJ,1LK,1LH,1LM												
	1.8 TSI	118	10.07	07.10	PR: 1LJ,1LK,1LH,1LM												
	1.9 TDI	77	03.05	07.10	PR: 1LJ,1LK,1LH,1LM												
	2.0 FSI		03.05	07.10	PR: 1LJ,1LK,1LH,1LM												
	2.0 FSI	147	03.05	07.10	PR: 1LJ,1LK,1LH,1LM												
	2.0 FSI 4motion	110	03.05	07.10	PR: 1LJ,1LK,1LH,1LM												
	2.0 TDI		03.05	07.10	PR: 1LJ,1LK,1LH,1LM												
	2.0 TDI		03.05	07.10	PR: 1LJ,1LK,1LH,1LM												
	2.0 TDI	120	08.05	07.10	PR: 1LJ,1LK,1LH,1LM												
	2.0 TDI	125	08.05	07.10	PR: 1LJ,1LK,1LH,1LM												
2.0 TDI 16V	103	03.05	07.10	PR: 1LJ,1LK,1LH,1LM													
2.0 TDI 4motion	103	03.05	07.10	PR: 1LJ,1LK,1LH,1LM													
2.0 TDI 4motion	125	05.09	07.10	PR: 1LJ,1LK,1LH,1LM													
3.2 V6 FSI 4motion	184	09.05	07.10	PR: 1LJ,1LK,1LH,1LM													
3.6 R36	220	04.07	07.10	PR: 1LJ,1LK,1LH,1LM													
	1.4 TSI		10.07	07.10	PR: 1LJ,1LH,1ZG,1ZM	11.9541-9553.2	220563	2	D=54, - Halter	ATE							
	1.6	75	03.05	07.10	PR: 1LJ,1LH,1ZG,1ZM												
	1.6 FSI	85	03.05	07.10	PR: 1LJ,1LH,1ZG,1ZM											11.9541-9554.2	220564
	1.6 TDI	77	08.09	07.10	PR: 1LJ,1LH,1ZG,1ZM												
	1.8 TSI	112	11.09	07.10	PR: 1LJ,1LH,1ZG,1ZM											11.0101-5409.2	260035
	1.8 TSI	118	10.07	07.10	PR: 1LJ,1LH,1ZG,1ZM												
	1.9 TDI	77	03.05	07.10	PR: 1LJ,1LH,1ZG,1ZM											11.8171-0008.1	990049
	2.0 FSI		03.05	07.10	PR: 1LJ,1LH,1ZG,1ZM												
	2.0 FSI	147	03.05	07.10	PR: 1LJ,1LH,1ZG,1ZM											11.8116-0351.1	390538
	2.0 FSI 4motion	110	03.05	07.10	PR: 1LJ,1LH,1ZG,1ZM												
	2.0 TDI		03.05	07.10	PR: 1LJ,1LH,1ZG,1ZM												
	2.0 TDI		03.05	07.10	PR: 1LJ,1LH,1ZG,1ZM												
	2.0 TDI	120	08.05	07.10	PR: 1LJ,1LH,1ZG,1ZM												
	2.0 TDI	125	08.05	07.10	PR: 1LJ,1LH,1ZG,1ZM												
	2.0 TDI 16V	103	03.05	07.10	PR: 1LJ,1LH,1ZG,1ZM												
	2.0 TDI 4motion	103	03.05	07.10	PR: 1LJ,1LH,1ZG,1ZM												
	2.0 TDI 4motion	125	05.09	07.10	PR: 1LJ,1LH,1ZG,1ZM												
	3.2 V6 FSI 4motion	184	09.05	07.10	PR: 1LJ,1LH,1ZG,1ZM												
	3.6 R36	220	04.07	07.10	PR: 1LJ,1LH,1ZG,1ZM												

VOLKSWAGEN PASSAT Limousine (05-10)

	1.4 TSI			10.07	07.10	PR: 1LK,1LM	11.9576-9995.2	220651	2		D=57, - Halter D=57, - Halter Hülzensatz Führungsbolzen Haltefeder	ATE ATE ATE ATE ATE							
	1.6	75		03.05	07.10	PR: 1LK,1LM	11.9576-9996.2	220652											
	1.6 FSI	85		03.05	07.10	PR: 1LK,1LM	11.0101-5409.2	260035											
	1.6 TDI	77		08.09	07.10	PR: 1LK,1LM	11.8171-0008.1	990049											
	1.8 TSI	112		11.09	07.10	PR: 1LK,1LM	11.8116-0410.2	390589											
	1.8 TSI	118		10.07	07.10	PR: 1LK,1LM													
	1.9 TDI	77		03.05	07.10	PR: 1LK,1LM													
	2.0 FSI			03.05	07.10	PR: 1LK,1LM													
	2.0 FSI	147		03.05	07.10	PR: 1LK,1LM													
	2.0 FSI 4motion	110		03.05	07.10	PR: 1LK,1LM													
	2.0 TDI			03.05	07.10	PR: 1LK,1LM													
	2.0 TDI	120		08.05	07.10	PR: 1LK,1LM													
	2.0 TDI	125		08.05	07.10	PR: 1LK,1LM													
	2.0 TDI 16V	103		03.05	07.10	PR: 1LK,1LM													
	2.0 TDI 4motion	103		03.05	07.10	PR: 1LK,1LM													
	2.0 TDI 4motion	125		05.09	07.10	PR: 1LK,1LM													
	3.2 V6 FSI 4motion	184		09.05	07.10	PR: 1LK,1LM													
	3.6 R36	220		04.07	07.10	PR: 1LK,1LM													
		1.4 TSI			10.07	07.10	PR: 1LJ,1LH,1ZG	83.7247-0603.3					330899	2		L=603			
1.6		75		03.05	07.10	PR: 1LJ,1LH,1ZG													
1.6 FSI		85		03.05	07.10	PR: 1LJ,1LH,1ZG													
1.6 TDI		77		08.09	07.10	PR: 1LJ,1LH,1ZG													
1.8 TSI		112		11.09	07.10	PR: 1LJ,1LH,1ZG													
1.8 TSI		118		10.07	07.10	PR: 1LJ,1LH,1ZG													
1.9 TDI		77		03.05	07.10	PR: 1LJ,1LH,1ZG													
2.0 FSI				03.05	07.10	PR: 1LJ,1LH,1ZG													
2.0 FSI		147		03.05	07.10	PR: 1LJ,1LH,1ZG													
2.0 FSI 4motion		110		03.05	07.10	PR: 1LJ,1LH,1ZG													
2.0 TDI				03.05	07.10	PR: 1LJ,1LH,1ZG													
2.0 TDI		120		03.05	07.10	PR: 1LJ,1LH,1ZG													
2.0 TDI		125		08.05	07.10	PR: 1LJ,1LH,1ZG													
2.0 TDI		103		08.05	07.10	PR: 1LJ,1LH,1ZG													
2.0 TDI 16V		103		03.05	07.10	PR: 1LJ,1LH,1ZG													
2.0 TDI 4motion		103		03.05	07.10	PR: 1LJ,1LH,1ZG													
2.0 TDI 4motion		125		05.09	07.10	PR: 1LJ,1LH,1ZG													
3.2 V6 FSI 4motion		184		09.05	07.10	PR: 1LJ,1LH,1ZG													
3.6 R36		220		04.07	07.10	PR: 1LJ,1LH,1ZG													
	1.4 TSI			10.07	07.10	PR: 1LK	83.7249-0536.3	330900	2		L=536								
	1.6	75		03.05	07.10	PR: 1LK													
	1.6 FSI	85		03.05	07.10	PR: 1LK													
	1.6 TDI	77		08.09	07.10	PR: 1LK													
	1.8 TSI	112		11.09	07.10	PR: 1LK													
	1.8 TSI	118		10.07	07.10	PR: 1LK													
	1.9 TDI	77		03.05	07.10	PR: 1LK													
	2.0 FSI			03.05	07.10	PR: 1LK													
	2.0 FSI	147		03.05	07.10	PR: 1LK													
	2.0 FSI 4motion	110		03.05	07.10	PR: 1LK													
	2.0 TDI			03.05	07.10	PR: 1LK													
	2.0 TDI	120		03.05	07.10	PR: 1LK													
	2.0 TDI	125		08.05	07.10	PR: 1LK													
	2.0 TDI	103		08.05	07.10	PR: 1LK													
	2.0 TDI 16V	103		03.05	07.10	PR: 1LK													
	2.0 TDI 4motion	103		03.05	07.10	PR: 1LK													
	2.0 TDI 4motion	125		05.09	07.10	PR: 1LK													
	3.2 V6 FSI 4motion	184		09.05	07.10	PR: 1LK													
	3.6 R36	220		04.07	07.10	PR: 1LK													
	1.6	75		03.05	04.07	PR: 1KU	24.6238-1701.7	220819		☐ elektrische Feststellbremse ¹⁾	D=38, - Halter	TRW							
	1.6 FSI	85		03.05	04.07	PR: 1KU													
	1.9 TDI	77		03.05	04.07	PR: 1KU													
	2.0 FSI			03.05	04.07	PR: 1KU													
	2.0 FSI	147		03.05	04.07	PR: 1KU													
	2.0 FSI 4motion	110		03.05	04.07	PR: 1KU													
	2.0 TDI			03.05	04.07	PR: 1KU													
	2.0 TDI	120		03.05	04.07	PR: 1KU													
	2.0 TDI	125		08.05	04.07	PR: 1KU													
	2.0 TDI 16V	103		08.05	04.07	PR: 1KU													
	2.0 TDI 4motion	103		03.05	04.07	PR: 1KU													
	2.0 TDI 4motion	103		03.05	04.07	PR: 1KU													
	3.2 V6 FSI 4motion	184		09.05	04.07	PR: 1KU													
	3.6 R36	220		04.07	04.07	PR: 1KU													
		1.4 TSI			10.07	07.10							PR: 1KU	24.6238-1705.7	220939		☐ elektrische Feststellbremse ¹⁾	D=38, - Halter	TRW
		1.6	75		05.07	07.10							PR: 1KU						
		1.6 FSI	85		05.07	07.10							PR: 1KU						
		1.6 TDI	77		08.09	07.10							PR: 1KU						
		1.8 TSI	112		11.09	07.10							PR: 1KU						
1.8 TSI		118		10.07	07.10	PR: 1KU													
1.9 TDI		77		05.07	07.10	PR: 1KU													
2.0 FSI				05.07	07.10	PR: 1KU													
2.0 FSI		147		05.07	07.10	PR: 1KU													
2.0 FSI 4motion		110		05.07	07.10	PR: 1KU													
2.0 TDI				05.07	07.10	PR: 1KU													
2.0 TDI		120		05.07	07.10	PR: 1KU													
2.0 TDI		125		05.07	07.10	PR: 1KU													
2.0 TDI 16V		103		03.05	07.10	PR: 1KU													
2.0 TDI 4motion		103		05.07	07.10	PR: 1KU													
2.0 TDI 4motion		103		05.07	07.10	PR: 1KU													

¹⁾ electric parking brake / fr.di stazionamento elettrico / frein à main électrique / freno de mano eléctrico



VOLKSWAGEN PASSAT Limousine (05-10)

	2.0 TDI 4motion	125	05.09	07.10	PR: 1KU	24.6238-1705.7	220939	<input type="checkbox"/> elektrische Feststellbremse ¹⁾	D=38, - Halter	TRW	
	3.2 V6 FSI 4motion	184	05.07	07.10	PR: 1KU	24.6238-1706.7	220940	<input type="checkbox"/> elektrische Feststellbremse ¹⁾	D=38, - Halter	TRW	
	3.6 R36	220	05.07	07.10	PR: 1KU						
	1.6	75	03.05	04.07	PR: 2EA,2EL	24.6241-1705.7	220941	<input type="checkbox"/> elektrische Feststellbremse ¹⁾	D=41, - Halter	TRW	
	1.6 FSI	85	03.05	04.07	PR: 2EA,2EL	24.6241-1706.7	220942	<input type="checkbox"/> elektrische Feststellbremse ¹⁾	D=41, - Halter	TRW	
	1.9 TDI	77	03.05	04.07	PR: 2EA,2EL						
	2.0 FSI		03.05	04.07	PR: 2EA,2EL						
	2.0 FSI	147	03.05	04.07	PR: 2EA,2EL						
	2.0 FSI 4motion	110	03.05	04.07	PR: 2EA,2EL						
	2.0 TDI		03.05	04.07	PR: 2EA,2EL						
	2.0 TDI	120	08.05	04.07	PR: 2EA,2EL						
	2.0 TDI	125	08.05	04.07	PR: 2EA,2EL						
	2.0 TDI 16V	103	03.05	04.07	PR: 2EA,2EL						
	2.0 TDI 4motion	103	03.05	04.07	PR: 2EA,2EL						
	3.2 V6 FSI 4motion	184	09.05	04.07	PR: 2EA,2EL						
	3.6 R36	220	04.07	04.07	PR: 2EA,2EL						
	1.4 TSI		10.07	07.10	PR: 2EA	24.6241-1711.5	240713	<input type="checkbox"/> elektrische Feststellbremse ¹⁾	D=41, - Halter	TRW	
	1.6	75	05.07	07.10	PR: 2EA	24.6241-1712.5	240714	<input type="checkbox"/> elektrische Feststellbremse ¹⁾	D=41, - Halter	TRW	
	1.6 FSI	85	05.07	07.10	PR: 2EA						
	1.6 TDI	77	08.09	07.10	PR: 2EA						
	1.8 TSI	112	11.09	07.10	PR: 2EA						
	1.8 TSI	118	10.07	07.10	PR: 2EA						
	1.9 TDI	77	05.07	07.10	PR: 2EA						
2.0 FSI		05.07	07.10	PR: 2EA							
2.0 FSI	147	05.07	07.10	PR: 2EA							
2.0 FSI 4motion	110	05.07	07.10	PR: 2EA							
2.0 TDI		05.07	07.10	PR: 2EA							
2.0 TDI	120	08.05	07.10	PR: 2EA							
2.0 TDI	125	05.07	07.10	PR: 2EA							
2.0 TDI 16V	103	03.05	07.10	PR: 2EA							
2.0 TDI 4motion	103	05.07	07.10	PR: 2EA							
2.0 TDI 4motion	125	05.09	07.10	PR: 2EA							
3.2 V6 FSI 4motion	184	05.07	07.10	PR: 2EA							
3.6 R36	220	05.07	07.10	PR: 2EA							
	1.4 TSI		10.07	07.10	PR: 1KW	24.6241-1709.7	221021	<input type="checkbox"/> elektrische Feststellbremse ¹⁾	D=41, - Halter	TRW	
	1.6	75	05.07	07.10	PR: 1KW	24.6241-1710.7	221022	<input type="checkbox"/> elektrische Feststellbremse ¹⁾	D=41, - Halter	TRW	
	1.6 FSI	85	05.07	07.10	PR: 1KW						
	1.6 TDI	77	08.09	07.10	PR: 1KW						
	1.8 TSI	112	11.09	07.10	PR: 1KW						
	1.8 TSI	118	10.07	07.10	PR: 1KW						
	1.9 TDI	77	05.07	07.10	PR: 1KW						
	2.0 FSI		05.07	07.10	PR: 1KW						
	2.0 FSI	147	05.07	07.10	PR: 1KW						
	2.0 FSI 4motion	110	05.07	07.10	PR: 1KW						
	2.0 TDI		05.07	07.10	PR: 1KW						
	2.0 TDI	120	08.05	07.10	PR: 1KW						
	2.0 TDI	125	05.07	07.10	PR: 1KW						
	2.0 TDI 16V	103	03.05	07.10	PR: 1KW						
	2.0 TDI 4motion	103	05.07	07.10	PR: 1KW						
	2.0 TDI 4motion	125	05.09	07.10	PR: 1KW						
	3.2 V6 FSI 4motion	184	05.07	07.10	PR: 1KW						
	3.6 R36	220	05.07	07.10	PR: 1KW						
		1.4 TSI		10.07	07.10		24.5204-0233.3	331430	2		L=233
		1.6	75	03.05	07.10						
1.6 FSI		85	03.05	07.10							
1.6 TDI		77	08.09	07.10							
1.8 TSI		112	11.09	07.10							
1.8 TSI		118	10.07	07.10							
1.9 TDI		77	03.05	07.10							
2.0 FSI			03.05	07.10							
2.0 FSI		147	03.05	07.10							
2.0 FSI 4motion		110	03.05	07.10							
2.0 TDI			03.05	07.10							
2.0 TDI		120	08.05	07.10							
2.0 TDI		125	08.05	07.10							
2.0 TDI 16V		103	03.05	07.10							
2.0 TDI 4motion		103	03.05	07.10							
2.0 TDI 4motion		125	05.09	07.10							
3.2 V6 FSI 4motion	184	09.05	07.10								
3.6 R36	220	04.07	07.10								
	1.9 TDI	77	03.05	07.10		24.2519-1705.3	040095	für Getriebe MQ-250 ²⁾	Nz 19,05		
	2.0 FSI		03.05	07.10							
	2.0 FSI 4motion	110	03.05	07.10							
	1.4 TSI		10.07	07.10		24.2519-1706.3	040096	für Getriebe MQ-200 ³⁾	Nz 19,05		
	1.6	75	03.05	07.10							
	1.6 FSI	85	03.05	07.10							
	1.6 TDI	77	08.09	07.10							
	1.8 TSI	112	11.09	07.10							
	1.8 TSI	118	10.07	07.10							
	1.9 TDI	77	03.05	07.10							
2.0 FSI		03.05	07.10								
2.0 FSI	147	03.05	07.10								
2.0 FSI 4motion	110	03.05	07.10								

¹⁾ electric parking brake / fr.di stazionamento elettrico / frein à main électrique / freno de mano eléctrico





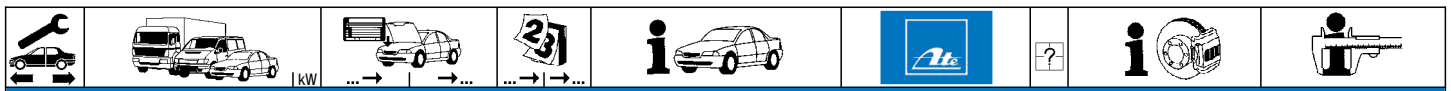



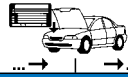

²⁾ for transmission MQ-250 / per scatola camb.MQ-250 / pour boîte de vitesse MQ-250 / caja de cambios para MQ-250

³⁾ for transmission MQ-200 / per scatola camb.MQ-200 / pour boîte de vitesse MQ-200 / caja de cambios para MQ-200



VOLKSWAGEN PASSAT Variant (05-10)

	3.6 R36 ◀220		04.07 07.10 PR: 1LJ,1LK,1LH,1LM	03.4153-0186.3 010816			THz 23,81	ATE
	1.4 TSI ◀90		10.07 07.10 PR: 1ZG	03.4152-0116.3 010814			THz 22,20	ATE
	1.6 ◀75		07.05 07.10 PR: 1ZG					
	1.6 FSI ◀85		07.05 07.10 PR: 1ZG					
	1.6 TDI ◀77		08.09 07.10 PR: 1ZG					
	1.8 TSI ◀112		11.09 07.10 PR: 1ZG					
	1.8 TSI ◀118		10.07 07.10 PR: 1ZG					
	1.9 TDI ◀77		07.05 07.10 PR: 1ZG					
	2.0 FSI ◀		07.05 07.10 PR: 1ZG					
	2.0 FSI 4motion ◀110		09.05 07.10 PR: 1ZG					
	2.0 TDI ◀		11.05 07.10 PR: 1ZG					
	2.0 TDI ◀		07.05 07.10 PR: 1ZG					
	2.0 TDI ◀90		07.05 07.10 PR: 1ZG					
	2.0 TDI ◀100		07.05 07.10 PR: 1ZG					
	2.0 TDI ◀125		07.05 07.10 PR: 1ZG					
	2.0 TDI 16V ◀103		08.05 07.10 PR: 1ZG					
	2.0 TDI 4motion ◀103		09.05 07.10 PR: 1ZG					
	2.0 TDI 4motion ◀125		05.09 07.10 PR: 1ZG					
	2.0 TFSI ◀147		07.05 07.10 PR: 1ZG					
	3.2 V6 FSI 4motion ◀184		11.05 07.10 PR: 1ZG					
	3.6 R36 ◀220		04.07 07.10 PR: 1ZG					
	1.4 TSI 90		10.07 07.10 PR: 1LJ,1LH,1ZG,1ZM	11.9541-9553.2 220563	<input type="checkbox"/>		D=54, - Halter	ATE
	1.6 75		07.05 07.10 PR: 1LJ,1LH,1ZG,1ZM	11.9541-9554.2 220564	<input type="checkbox"/>		D=54, - Halter	ATE
	1.6 FSI 85		07.05 07.10 PR: 1LJ,1LH,1ZG,1ZM	11.0101-5409.2 260035			Hülzensatz	ATE
	1.6 TDI 77		08.09 07.10 PR: 1LJ,1LH,1ZG,1ZM	11.8171-0008.1 990049			Führungsbolzen	ATE
	1.8 TSI 112		11.09 07.10 PR: 1LJ,1LH,1ZG,1ZM	11.8116-0351.1 390538	2		Haltefeder	ATE
	1.8 TSI 118		10.07 07.10 PR: 1LJ,1LH,1ZG,1ZM					
	1.9 TDI 77		07.05 07.10 PR: 1LJ,1LH,1ZG,1ZM					
	2.0 FSI		07.05 07.10 PR: 1LJ,1LH,1ZG,1ZM					
	2.0 FSI 4motion 110		09.05 07.10 PR: 1LJ,1LH,1ZG,1ZM					
	2.0 TDI		11.05 07.10 PR: 1LJ,1LH,1ZG,1ZM					
	2.0 TDI		07.05 07.10 PR: 1LJ,1LH,1ZG,1ZM					
	2.0 TDI 90		07.05 07.10 PR: 1LJ,1LH,1ZG,1ZM					
	2.0 TDI 100		07.05 07.10 PR: 1LJ,1LH,1ZG,1ZM					
	2.0 TDI 125		07.05 07.10 PR: 1LJ,1LH,1ZG,1ZM					
	2.0 TDI 16V 103		08.05 07.10 PR: 1LJ,1LH,1ZG,1ZM					
	2.0 TDI 4motion 103		09.05 07.10 PR: 1LJ,1LH,1ZG,1ZM					
	2.0 TDI 4motion 125		05.09 07.10 PR: 1LJ,1LH,1ZG,1ZM					
	2.0 TFSI 147		07.05 07.10 PR: 1LJ,1LH,1ZG,1ZM					
	3.2 V6 FSI 4motion 184		11.05 07.10 PR: 1LJ,1LH,1ZG,1ZM					
	3.6 R36 220		04.07 07.10 PR: 1LJ,1LH,1ZG,1ZM					
	1.4 TSI 90		10.07 07.10 PR: 1LK,1LM	11.9576-9995.2 220651	<input type="checkbox"/>		D=57, - Halter	ATE
	1.6 75		07.05 07.10 PR: 1LK,1LM	11.9576-9996.2 220652	<input type="checkbox"/>		D=57, - Halter	ATE
	1.6 FSI 85		07.05 07.10 PR: 1LK,1LM	11.0101-5409.2 260035			Hülzensatz	ATE
	1.6 TDI 77		08.09 07.10 PR: 1LK,1LM	11.8171-0008.1 990049			Führungsbolzen	ATE
	1.8 TSI 112		11.09 07.10 PR: 1LK,1LM	11.8116-0410.2 390589	2		Haltefeder	ATE
	1.8 TSI 118		10.07 07.10 PR: 1LK,1LM					
	1.9 TDI 77		07.05 07.10 PR: 1LK,1LM					
	2.0 FSI		07.05 07.10 PR: 1LK,1LM					
	2.0 FSI 4motion 110		09.05 07.10 PR: 1LK,1LM					
	2.0 TDI		11.05 07.10 PR: 1LK,1LM					
	2.0 TDI		07.05 07.10 PR: 1LK,1LM					
	2.0 TDI 90		07.05 07.10 PR: 1LK,1LM					
	2.0 TDI 100		07.05 07.10 PR: 1LK,1LM					
	2.0 TDI 125		07.05 07.10 PR: 1LK,1LM					
	2.0 TDI 16V 103		08.05 07.10 PR: 1LK,1LM					
	2.0 TDI 4motion 103		09.05 07.10 PR: 1LK,1LM					
	2.0 TDI 4motion 125		05.09 07.10 PR: 1LK,1LM					
	2.0 TFSI 147		07.05 07.10 PR: 1LK,1LM					
	3.2 V6 FSI 4motion 184		11.05 07.10 PR: 1LK,1LM					
	3.6 R36 220		04.07 07.10 PR: 1LK,1LM					
	1.4 TSI 90		10.07 07.10 PR: 1LJ,1LH,1ZG	83.7247-0603.3 330899	2		L=603	
	1.6 75		07.05 07.10 PR: 1LJ,1LH,1ZG					
	1.6 FSI 85		07.05 07.10 PR: 1LJ,1LH,1ZG					
	1.6 TDI 77		08.09 07.10 PR: 1LJ,1LH,1ZG					
	1.8 TSI 112		11.09 07.10 PR: 1LJ,1LH,1ZG					
	1.8 TSI 118		10.07 07.10 PR: 1LJ,1LH,1ZG					
	1.9 TDI 77		07.05 07.10 PR: 1LJ,1LH,1ZG					
	2.0 FSI		07.05 07.10 PR: 1LJ,1LH,1ZG					
	2.0 FSI 4motion 110		09.05 07.10 PR: 1LJ,1LH,1ZG					
	2.0 TDI		11.05 07.10 PR: 1LJ,1LH,1ZG					
	2.0 TDI		07.05 07.10 PR: 1LJ,1LH,1ZG					
	2.0 TDI 90		07.05 07.10 PR: 1LJ,1LH,1ZG					
	2.0 TDI 100		07.05 07.10 PR: 1LJ,1LH,1ZG					
	2.0 TDI 125		07.05 07.10 PR: 1LJ,1LH,1ZG					
	2.0 TDI 16V 103		08.05 07.10 PR: 1LJ,1LH,1ZG					
	2.0 TDI 4motion 103		09.05 07.10 PR: 1LJ,1LH,1ZG					
	2.0 TDI 4motion 125		05.09 07.10 PR: 1LJ,1LH,1ZG					
	2.0 TFSI 147		07.05 07.10 PR: 1LJ,1LH,1ZG					
	3.2 V6 FSI 4motion 184		11.05 07.10 PR: 1LJ,1LH,1ZG					
	3.6 R36 220		04.07 07.10 PR: 1LJ,1LH,1ZG					
	1.4 TSI 90		10.07 07.10 PR: 1LK	83.7249-0536.3 330900	2		L=536	
	1.6 75		07.05 07.10 PR: 1LK					
	1.6 FSI 85		07.05 07.10 PR: 1LK					
	1.6 TDI 77		08.09 07.10 PR: 1LK					
	1.8 TSI 112		11.09 07.10 PR: 1LK					
	1.8 TSI 118		10.07 07.10 PR: 1LK					

VOLKSWAGEN PASSAT Variant (05-10)												
												
	1.9 TDI	77		07.05	07.10	PR: 1LK	83.7249-0536.3	330900	2		L=536	
	2.0 FSI			07.05	07.10	PR: 1LK						
	2.0 FSI 4motion	110		09.05	07.10	PR: 1LK						
	2.0 TDI			11.05	07.10	PR: 1LK						
	2.0 TDI			07.05	07.10	PR: 1LK						
	2.0 TDI	90		07.05	07.10	PR: 1LK						
	2.0 TDI	100		07.05	07.10	PR: 1LK						
	2.0 TDI	125		07.05	07.10	PR: 1LK						
	2.0 TDI 16V	103		08.05	07.10	PR: 1LK						
	2.0 TDI 4motion	103		09.05	07.10	PR: 1LK						
	2.0 TDI 4motion	125		05.09	07.10	PR: 1LK						
	2.0 TFSI	147		07.05	07.10	PR: 1LK						
	3.2 V6 FSI 4motion	184		11.05	07.10	PR: 1LK						
	1.6	75		07.05	04.07	PR: 1KU	24.6238-1701.7	220819		<input type="checkbox"/> elektrische Feststellbremse ¹⁾	D=38, - Halter	TRW
	1.6 FSI	85		07.05	04.07	PR: 1KU	24.6238-1702.7	220820		<input type="checkbox"/> elektrische Feststellbremse ¹⁾	D=38, - Halter	TRW
	1.9 TDI	77		07.05	04.07	PR: 1KU						
	2.0 FSI			07.05	04.07	PR: 1KU						
	2.0 FSI 4motion	110		09.05	04.07	PR: 1KU						
	2.0 TDI			11.05	04.07	PR: 1KU						
	2.0 TDI			07.05	04.07	PR: 1KU						
	2.0 TDI	90		07.05	04.07	PR: 1KU						
	2.0 TDI	100		07.05	04.07	PR: 1KU						
	2.0 TDI	125		07.05	04.07	PR: 1KU						
	2.0 TDI 16V	103		08.05	04.07	PR: 1KU						
	2.0 TDI 4motion	103		09.05	04.07	PR: 1KU						
	2.0 TFSI	147		07.05	04.07	PR: 1KU						
	3.2 V6 FSI 4motion	184		11.05	04.07	PR: 1KU						
	3.6 R36	220		04.07	04.07	PR: 1KU						
	1.4 TSI	90		10.07	07.10	PR: 1KU	24.6238-1705.7	220939		<input type="checkbox"/> elektrische Feststellbremse ¹⁾	D=38, - Halter	TRW
	1.6	75		05.07	07.10	PR: 1KU	24.6238-1706.7	220940		<input type="checkbox"/> elektrische Feststellbremse ¹⁾	D=38, - Halter	TRW
	1.6 FSI	85		05.07	07.10	PR: 1KU						
	1.6 TDI	77		08.09	07.10	PR: 1KU						
	1.8 TSI	112		11.09	07.10	PR: 1KU						
	1.8 TSI	118		10.07	07.10	PR: 1KU						
	1.9 TDI	77		05.07	07.10	PR: 1KU						
	2.0 FSI			05.07	07.10	PR: 1KU						
	2.0 FSI 4motion	110		05.07	07.10	PR: 1KU						
	2.0 TDI			05.07	07.10	PR: 1KU						
	2.0 TDI	90		05.07	07.10	PR: 1KU						
	2.0 TDI	100		05.07	07.10	PR: 1KU						
	2.0 TDI	125		05.07	07.10	PR: 1KU						
	2.0 TDI 16V	103		05.07	07.10	PR: 1KU						
	2.0 TDI 4motion	103		05.07	07.10	PR: 1KU						
	2.0 TDI 4motion	125		05.09	07.10	PR: 1KU						
	2.0 TFSI	147		05.07	07.10	PR: 1KU						
	3.2 V6 FSI 4motion	184		05.07	07.10	PR: 1KU						
	3.6 R36	220		05.07	07.10	PR: 1KU						
	1.6	75		07.05	04.07	PR: 2EA,2EL	24.6241-1705.7	220941		<input type="checkbox"/> elektrische Feststellbremse ¹⁾	D=41, - Halter	TRW
	1.6 FSI	85		07.05	04.07	PR: 2EA,2EL	24.6241-1706.7	220942		<input type="checkbox"/> elektrische Feststellbremse ¹⁾	D=41, - Halter	TRW
	1.9 TDI	77		07.05	04.07	PR: 2EA,2EL						
	2.0 FSI			07.05	04.07	PR: 2EA,2EL						
	2.0 FSI 4motion	110		09.05	04.07	PR: 2EA,2EL						
	2.0 TDI			11.05	04.07	PR: 2EA,2EL						
	2.0 TDI			07.05	04.07	PR: 2EA,2EL						
	2.0 TDI	90		07.05	04.07	PR: 2EA,2EL						
	2.0 TDI	100		07.05	04.07	PR: 2EA,2EL						
	2.0 TDI	125		07.05	04.07	PR: 2EA,2EL						
	2.0 TDI 16V	103		08.05	04.07	PR: 2EA,2EL						
	2.0 TDI 4motion	103		09.05	04.07	PR: 2EA,2EL						
	2.0 TFSI	147		07.05	04.07	PR: 2EA,2EL						
	3.2 V6 FSI 4motion	184		11.05	04.07	PR: 2EA,2EL						
	3.6 R36	220		04.07	04.07	PR: 2EA,2EL						
	1.4 TSI	90		10.07	07.10	PR: 2EA,2EL	24.6241-1711.5	240713		<input type="checkbox"/> elektrische Feststellbremse ¹⁾	D=41, - Halter	TRW
	1.6	75		05.07	07.10	PR: 2EA,2EL	24.6241-1712.5	240714		<input type="checkbox"/> elektrische Feststellbremse ¹⁾	D=41, - Halter	TRW
	1.6 FSI	85		05.07	07.10	PR: 2EA,2EL						
	1.6 TDI	77		08.09	07.10	PR: 2EA,2EL						
	1.8 TSI	112		11.09	07.10	PR: 2EA,2EL						
	1.8 TSI	118		10.07	07.10	PR: 2EA,2EL						
	1.9 TDI	77		05.07	07.10	PR: 2EA,2EL						
	2.0 FSI			05.07	07.10	PR: 2EA,2EL						
	2.0 FSI 4motion	110		05.07	07.10	PR: 2EA,2EL						
	2.0 TDI			11.05	07.10	PR: 2EA,2EL						
	2.0 TDI			05.07	07.10	PR: 2EA,2EL						
	2.0 TDI	90		05.07	07.10	PR: 2EA,2EL						
	2.0 TDI	100		05.07	07.10	PR: 2EA,2EL						
	2.0 TDI	125		05.07	07.10	PR: 2EA,2EL						
	2.0 TDI 16V	103		05.07	07.10	PR: 2EA,2EL						
	2.0 TDI 4motion	103		05.07	07.10	PR: 2EA,2EL						
	2.0 TDI 4motion	125		05.09	07.10	PR: 2EA,2EL						
	2.0 TFSI	147		05.07	07.10	PR: 2EA,2EL						
	3.2 V6 FSI 4motion	184		05.07	07.10	PR: 2EA,2EL						
	3.6 R36	220		05.07	07.10	PR: 2EA,2EL						
	1.4 TSI	90		10.07	07.10	PR: 1KW	24.6241-1709.7	221021		<input type="checkbox"/> elektrische Feststellbremse ¹⁾	D=41, - Halter	TRW
	1.6	75		07.05	07.10	PR: 1KW	24.6241-1710.7	221022		<input type="checkbox"/> elektrische Feststellbremse ¹⁾	D=41, - Halter	TRW
	1.6 FSI	85		07.05	07.10	PR: 1KW						
	1.6 TDI	77		08.09	07.10	PR: 1KW						

¹⁾ electric parking brake / fr.di stazionamento elettrico / frein à main électrique / freno de mano eléctrico

























VOLKSWAGEN PASSAT Variant (05-10)

	1.8 TSI 112 1.8 TSI 118 1.9 TDI 77 2.0 FSI 2.0 FSI 4motion 110 2.0 TDI 2.0 TDI 90 2.0 TDI 100 2.0 TDI 125 2.0 TDI 16V 103 2.0 TDI 4motion 103 2.0 TDI 4motion 125 2.0 TFSI 147 3.2 V6 FSI 4motion 184 3.6 R36 220		11.09 07.10 PR: 1KW 10.07 07.10 PR: 1KW 07.05 07.10 PR: 1KW 07.05 07.10 PR: 1KW 09.05 07.10 PR: 1KW 11.05 07.10 PR: 1KW 07.05 07.10 PR: 1KW 07.05 07.10 PR: 1KW 07.05 07.10 PR: 1KW 08.05 07.10 PR: 1KW 09.05 07.10 PR: 1KW 05.09 07.10 PR: 1KW 07.05 07.10 PR: 1KW 11.05 07.10 PR: 1KW 04.07 07.10 PR: 1KW	24.6241-1709.7 221021 24.6241-1710.7 221022	<input type="checkbox"/> elektrische Feststellbremse 1) <input type="checkbox"/> elektrische Feststellbremse 1)	D=41, - Halter D=41, - Halter	TRW TRW
	1.4 TSI 90 1.6 75 1.6 FSI 85 1.6 TDI 77 1.8 TSI 112 1.8 TSI 118 1.9 TDI 77 2.0 FSI 2.0 FSI 4motion 110 2.0 TDI 2.0 TDI 90 2.0 TDI 100 2.0 TDI 125 2.0 TDI 16V 103 2.0 TDI 4motion 103 2.0 TDI 4motion 125 2.0 TFSI 147 3.2 V6 FSI 4motion 184 3.6 R36 220		10.07 07.10 07.05 07.10 07.05 07.10 08.09 07.10 11.09 07.10 10.07 07.10 07.05 07.10 07.05 07.10 09.05 07.10 11.05 07.10 07.05 07.10 07.05 07.10 07.05 07.10 08.05 07.10 09.05 07.10 05.09 07.10 07.05 07.10 11.05 07.10 04.07 07.10	24.5204-0233.3 331430	2	L=233	
	1.9 TDI 77 2.0 FSI		07.05 07.10 07.05 07.10	24.2519-1705.3 040095	für Getriebe MQ-250 2)	Nz 19,05	
	1.4 TSI 90 1.6 75 1.6 FSI 85 1.6 TDI 77 1.8 TSI 112 1.8 TSI 118 1.9 TDI 77 2.0 FSI 2.0 FSI 4motion 110 2.0 TDI 2.0 TDI 90 2.0 TDI 100 2.0 TDI 125 2.0 TDI 16V 103 2.0 TDI 4motion 103 2.0 TDI 4motion 125 2.0 TFSI 147 3.2 V6 FSI 4motion 184 3.6 R36 220		10.07 07.10 07.05 07.10 07.05 07.10 08.09 07.10 11.09 07.10 10.07 07.10 07.05 07.10 07.05 07.10 09.05 07.10 11.05 07.10 07.05 07.10 07.05 07.10 07.05 07.10 08.05 07.10 09.05 07.10 05.09 07.10 07.05 07.10 09.05 07.10 04.07 07.10	24.2519-1706.3 040096	für Getriebe MQ-200 3)	Nz 19,05	













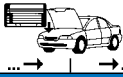





VOLKSWAGEN PASSAT CC (08-11)













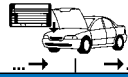











	1.8 TSI 2.0 TDI 2.0 TDI 2.0 TDI 4motion 2.0 TDI 4motion 2.0 TSI	112 125 103 125 118	04.08 05.10 PR: 1AT,1ZG 04.08 05.10 PR: 1AT,1ZG 06.08 05.10 PR: 1AT,1ZG 08.09 05.10 PR: 1AT,1ZG 11.09 05.10 PR: 1AT,1ZG 04.08 05.10 PR: 1AT,1ZG	03.7873-4402.4 300292		11"	ATE
	1.4 TSI MultiFuel 1.8 TSI 2.0 TDI 2.0 TDI 2.0 TDI 4motion 2.0 TDI 4motion 2.0 TSI	118 118 125 103 125 118	01.11 09.11 PR: 1ZG 06.10 09.11 PR: 1ZG 06.10 09.11 PR: 1ZG 06.10 09.11 PR: 1ZG 06.10 09.11 PR: 1ZG 06.10 09.11 PR: 1ZG	03.7873-4402.4 300292		11"	ATE
	1.8 TSI 2.0 TDI 2.0 TDI 2.0 TDI 4motion 2.0 TDI 4motion 2.0 TSI 3.6 V6 4motion	118 125 103 125 118 220	04.08 10.10 PR: 1AS,1ZG 04.08 10.10 PR: 1AS,1ZG 06.08 10.10 PR: 1AS,1ZG 08.09 10.10 PR: 1AS,1ZG 11.09 10.10 PR: 1AS,1ZG 04.08 10.10 PR: 1AS,1ZG 04.08 10.10 PR: 1AS,1ZG	03.7873-3902.4 300254		11"	ATE
	1.8 TSI 2.0 TDI 2.0 TDI 2.0 TDI 4motion 2.0 TDI 4motion 2.0 TSI 3.6 V6 4motion	118 125 103 125 118 220	04.08 10.10 PR: 1AT,1LH,1LK,1ZM 04.08 10.10 PR: 1AT,1LH,1LK,1ZM 06.08 10.10 PR: 1AT,1LH,1LK,1ZM 08.09 10.10 PR: 1AT,1LH,1LK,1ZM 11.09 10.10 PR: 1AT,1LH,1LK,1ZM 04.08 10.10 PR: 1AT,1LH,1LK,1ZM 04.08 10.10 PR: 1AT,1LH,1LK,1ZM	03.7873-4002.4 300211 03.7873-4502.4 300284		11" 11"	ATE ATE

1) electric parking brake / fr.di stazionamento elettrico / frein à main électrique / freno de mano eléctrico
 2) for transmission MQ-250 / per scatola camb.MQ-250 / pour boîte de vitesse MQ-250 / caja de cambios para MQ-250
 3) for transmission MQ-200 / per scatola camb.MQ-200 / pour boîte de vitesse MQ-200 / caja de cambios para MQ-200

								
VOLKSWAGEN PASSAT CC (08-11)								
	1.4 TSI MultiFuel 1.8 TSI 2.0 TDI 2.0 TDI 2.0 TDI 4motion 2.0 TDI 4motion 2.0 TSI 3.6 V6 4motion	118 118 125 103 125 125 125 220	01.11 11.10 11.10 11.10 11.10 11.10 11.10 11.10	09.11 09.11 09.11 09.11 09.11 09.11 09.11 09.11	PR: 1LA,1LB,1ZM PR: 1LA,1LB,1ZM PR: 1LA,1LB,1ZM PR: 1LA,1LB,1ZM PR: 1LA,1LB,1ZM PR: 1LA,1LB,1ZM PR: 1LA,1LB,1ZM PR: 1LA,1LB,1ZM	03.7873-4502.4	300284	11" ATE
	1.4 TSI MultiFuel 1.8 TSI 2.0 TDI 2.0 TDI 2.0 TDI 4motion 2.0 TDI 4motion 2.0 TSI 3.6 V6 4motion	118 118 125 103 125 125 125 220	01.11 04.08 04.08 06.08 08.09 11.09 04.08 04.08	09.11 09.11 09.11 09.11 09.11 09.11 09.11 09.11	PR: 1ZG PR: 1ZG PR: 1ZG PR: 1ZG PR: 1ZG PR: 1ZG PR: 1ZG PR: 1ZG	03.4152-0116.3	010814	Thz 22,20 ATE
	1.4 TSI MultiFuel 1.8 TSI 2.0 TDI 2.0 TDI 2.0 TDI 4motion 2.0 TDI 4motion 2.0 TSI 3.6 V6 4motion	118 118 125 103 125 125 125 220	01.11 04.08 04.08 06.08 08.09 11.09 04.08 04.08	09.11 09.11 09.11 09.11 09.11 09.11 09.11 09.11	PR: 1LH,1LK,1ZM PR: 1LH,1LK,1ZM PR: 1LH,1LK,1ZM PR: 1LH,1LK,1ZM PR: 1LH,1LK,1ZM PR: 1LH,1LK,1ZM PR: 1LH,1LK,1ZM PR: 1LH,1LK,1ZM	03.4153-0186.3	010816	Thz 23,81 ATE
	1.4 TSI MultiFuel 1.8 TSI 2.0 TDI 2.0 TDI 2.0 TDI 4motion 2.0 TDI 4motion 2.0 TSI 3.6 V6 4motion	118 118 125 103 125 125 125 220	01.11 04.08 04.08 06.08 08.09 11.09 04.08 04.08	09.11 09.11 09.11 09.11 09.11 09.11 09.11 09.11	PR: 1LH,1ZM,1ZG PR: 1LH,1ZM,1ZG PR: 1LH,1ZM,1ZG PR: 1LH,1ZM,1ZG PR: 1LH,1ZM,1ZG PR: 1LH,1ZM,1ZG PR: 1LH,1ZM,1ZG PR: 1LH,1ZM,1ZG	11.9541-9553.2 11.9541-9554.2 11.8171-0008.1 11.0101-5409.2 11.8116-0351.1	220563 220564 990049 260035 390538	2 D=54, - Halter D=54, - Halter Führungsbolzen Hülzensatz Haltefeder ATE ATE ATE ATE ATE
	1.4 TSI MultiFuel 1.8 TSI 2.0 TDI 2.0 TDI 2.0 TDI 4motion 2.0 TDI 4motion 2.0 TSI 3.6 V6 4motion	118 118 125 103 125 125 125 220	01.11 04.08 04.08 06.08 08.09 11.09 04.08 04.08	09.11 09.11 09.11 09.11 09.11 09.11 09.11 09.11	PR: 1LK PR: 1LK PR: 1LK PR: 1LK PR: 1LK PR: 1LK PR: 1LK PR: 1LK	11.9576-9995.2 11.9576-9996.2 11.8171-0008.1 11.0101-5409.2 11.8116-0410.2	220651 220652 990049 260035 390589	2 D=57, - Halter D=57, - Halter Führungsbolzen Hülzensatz Haltefeder ATE ATE ATE ATE ATE
	1.4 TSI MultiFuel 1.8 TSI 2.0 TDI 2.0 TDI 2.0 TDI 4motion 2.0 TDI 4motion 2.0 TSI 3.6 V6 4motion	118 118 125 103 125 125 125 220	01.11 04.08 04.08 06.08 08.09 11.09 04.08 04.08	09.11 09.11 09.11 09.11 09.11 09.11 09.11 09.11	PR: 1LH,1ZM,1ZG PR: 1LH,1ZM,1ZG PR: 1LH,1ZM,1ZG PR: 1LH,1ZM,1ZG PR: 1LH,1ZM,1ZG PR: 1LH,1ZM,1ZG PR: 1LH,1ZM,1ZG PR: 1LH,1ZM,1ZG	83.7247-0603.3	330899	2 L=603
	1.4 TSI MultiFuel 1.8 TSI 2.0 TDI 2.0 TDI 2.0 TDI 4motion 2.0 TDI 4motion 2.0 TSI 3.6 V6 4motion	118 118 125 103 125 125 125 220	01.11 04.08 04.08 06.08 08.09 11.09 04.08 04.08	09.11 09.11 09.11 09.11 09.11 09.11 09.11 09.11	PR: 1LK PR: 1LK PR: 1LK PR: 1LK PR: 1LK PR: 1LK PR: 1LK PR: 1LK	83.7249-0536.3	330900	2 L=536
	1.4 TSI MultiFuel 1.8 TSI 2.0 TDI 2.0 TDI 2.0 TDI 4motion 2.0 TDI 4motion 2.0 TSI 3.6 V6 4motion	118 118 125 103 125 125 125 220	01.11 04.08 04.08 06.08 08.09 11.09 04.08 04.08	09.11 09.11 09.11 09.11 09.11 09.11 09.11 09.11	PR: 1KU PR: 1KU PR: 1KU PR: 1KU PR: 1KU PR: 1KU PR: 1KU PR: 1KU	24.6238-1705.7 24.6238-1706.7	220939 220940	2 elektrische Feststellbremse 1) elektrische Feststellbremse 1) D=38, - Halter D=38, - Halter TRW TRW
	1.4 TSI MultiFuel 1.8 TSI 2.0 TDI 2.0 TDI 2.0 TDI 4motion 2.0 TDI 4motion 2.0 TSI 3.6 V6 4motion	118 118 125 103 125 125 125 220	01.11 04.08 04.08 06.08 08.09 11.09 04.08 04.08	09.11 09.11 09.11 09.11 09.11 09.11 09.11 09.11	PR: 2EA PR: 2EA PR: 2EA PR: 2EA PR: 2EA PR: 2EA PR: 2EA PR: 2EA	24.6241-1711.5 24.6241-1712.5	240713 240714	2 elektrische Feststellbremse 1) elektrische Feststellbremse 1) D=41, - Halter D=41, - Halter TRW TRW
	1.4 TSI MultiFuel 1.8 TSI 2.0 TDI 2.0 TDI 2.0 TDI 4motion 2.0 TDI 4motion 2.0 TSI 3.6 V6 4motion	118 118 125 103 125 125 125 220	01.11 04.08 04.08 06.08 08.09 11.09 04.08 04.08	09.11 09.11 09.11 09.11 09.11 09.11 09.11 09.11	PR: 1KW PR: 1KW PR: 1KW PR: 1KW PR: 1KW PR: 1KW PR: 1KW PR: 1KW	24.6241-1709.7 24.6241-1710.7	221021 221022	2 elektrische Feststellbremse 1) elektrische Feststellbremse 1) D=41, - Halter D=41, - Halter TRW TRW
	1.4 TSI MultiFuel 1.8 TSI 2.0 TDI 2.0 TDI 2.0 TDI 4motion 2.0 TDI 4motion	118 118 125 103 125 125	01.11 04.08 04.08 06.08 08.09 11.09	09.11 09.11 09.11 09.11 09.11 09.11	PR: 1KU,2EA PR: 1KU,2EA PR: 1KU,2EA PR: 1KU,2EA PR: 1KU,2EA PR: 1KU,2EA	24.5204-0233.3	331430	2 L=233















1) electric parking brake / fr.di stazionamento elettrico / frein à main électrique / freno de mano eléctrico

VOLKSWAGEN PASSAT CC (08-11)								
	 kW							
	2.0 TSI 3.6 V6 4motion 220	04.08 04.08	09.11 09.11	PR: 1KU,2EA PR: 1KU,2EA	24.5204-0233.3	331430	2	L=233
	1.4 TSI MultiFuel 1.8 TSI 2.0 TDI 2.0 TDI 125 2.0 TDI 4motion 103 2.0 TDI 4motion 125 2.0 TSI 3.6 V6 4motion 220	01.11 04.08 04.08 06.08 08.09 11.09 04.08 04.08	09.11 09.11 09.11 09.11 09.11 09.11 09.11 09.11	PR: 1KW PR: 1KW PR: 1KW PR: 1KW PR: 1KW PR: 1KW PR: 1KW PR: 1KW	24.5143-0257.3	331167	2	L=257
	1.4 TSI MultiFuel 1.8 TSI 2.0 TDI 2.0 TDI 125 2.0 TDI 4motion 103 2.0 TDI 4motion 125 2.0 TSI 3.6 V6 4motion 220	01.11 04.08 04.08 06.08 08.09 11.09 04.08 04.08	09.11 09.11 09.11 09.11 09.11 09.11 09.11 09.11	PR: 0EJ PR: 0EJ PR: 0EJ PR: 0EJ PR: 0EJ PR: 0EJ PR: 0EJ PR: 0EJ	24.2519-1705.3	040095		Nz 19,05
VOLKSWAGEN PASSAT CC (11-)								
	1.4 TSI <110 1.4 TSI <118 1.8 TSI <118 2.0 TDI <100 2.0 TDI <103 2.0 TDI <110 2.0 TDI <125 2.0 TDI <130 2.0 TDI <135 2.0 TDI 4motion <103 2.0 TDI 4motion <125 2.0 TDI 4motion <130 2.0 TSI <155 3.6 V6 4motion <220	05.15 11.11 11.11 11.11 11.11 05.15 11.11 12.12 05.15 11.11 11.11 12.12 11.11 11.11	PR: 1LA,1LB,1ZM PR: 1LA,1LB,1ZM PR: 1LA,1LB,1ZM PR: 1LA,1LB,1ZM PR: 1LA,1LB,1ZM PR: 1LA,1LB,1ZM PR: 1LA,1LB,1ZM PR: 1LA,1LB,1ZM PR: 1LA,1LB,1ZM PR: 1LA,1LB,1ZM PR: 1LA,1LB,1ZM PR: 1LA,1LB,1ZM PR: 1LA,1LB,1ZM PR: 1LA,1LB,1ZM	03.7873-4502.4	300284			11" ATE
	1.4 TSI <110 1.4 TSI <118 1.8 TSI <118 2.0 TDI <100 2.0 TDI <103 2.0 TDI <110 2.0 TDI <125 2.0 TDI <130 2.0 TDI <135 2.0 TDI 4motion <103 2.0 TDI 4motion <125 2.0 TDI 4motion <130 2.0 TSI <155 3.6 V6 4motion <220	05.15 11.11 11.11 11.11 11.11 05.15 11.11 12.12 05.15 11.11 11.11 12.12 11.11 11.11	PR: 1ZG PR: 1ZG PR: 1ZG PR: 1ZG PR: 1ZG PR: 1ZG PR: 1ZG PR: 1ZG PR: 1ZG PR: 1ZG PR: 1ZG PR: 1ZG PR: 1ZG PR: 1ZG	03.7873-4402.4	300292			11" ATE
	1.4 TSI <110 1.4 TSI <118 1.8 TSI <118 2.0 TDI <100 2.0 TDI <103 2.0 TDI <110 2.0 TDI <125 2.0 TDI <130 2.0 TDI <135 2.0 TDI 4motion <103 2.0 TDI 4motion <125 2.0 TDI 4motion <130 2.0 TSI <155 3.6 V6 4motion <220	05.15 11.11 11.11 11.11 11.11 05.15 11.11 12.12 05.15 11.11 11.11 12.12 11.11 11.11	PR: 1LA,1LB,1ZM PR: 1LA,1LB,1ZM PR: 1LA,1LB,1ZM PR: 1LA,1LB,1ZM PR: 1LA,1LB,1ZM PR: 1LA,1LB,1ZM PR: 1LA,1LB,1ZM PR: 1LA,1LB,1ZM PR: 1LA,1LB,1ZM PR: 1LA,1LB,1ZM PR: 1LA,1LB,1ZM PR: 1LA,1LB,1ZM PR: 1LA,1LB,1ZM PR: 1LA,1LB,1ZM	03.4153-0186.3	010816			Thz 23,81 ATE
	1.4 TSI <110 1.4 TSI <118 1.8 TSI <118 2.0 TDI <100 2.0 TDI <103 2.0 TDI <110 2.0 TDI <125 2.0 TDI <130 2.0 TDI <135 2.0 TDI 4motion <103 2.0 TDI 4motion <125 2.0 TDI 4motion <130 2.0 TSI <155 3.6 V6 4motion <220	05.15 11.11 11.11 11.11 11.11 05.15 11.11 12.12 05.15 11.11 11.11 12.12 11.11 11.11	PR: 1ZG PR: 1ZG PR: 1ZG PR: 1ZG PR: 1ZG PR: 1ZG PR: 1ZG PR: 1ZG PR: 1ZG PR: 1ZG PR: 1ZG PR: 1ZG PR: 1ZG PR: 1ZG	03.4152-0116.3	010814			Thz 22,20 ATE
	1.4 TSI 110 1.4 TSI 118 1.8 TSI 118 2.0 TDI 100 2.0 TDI 103 2.0 TDI 110 2.0 TDI 125 2.0 TDI 130 2.0 TDI 135 2.0 TDI 4motion 103 2.0 TDI 4motion 125 2.0 TDI 4motion 130	05.15 11.11 11.11 11.11 11.11 05.15 11.11 12.12 05.15 11.11 11.11 11.11	PR: 1ZM,1ZG PR: 1ZM,1ZG PR: 1ZM,1ZG PR: 1ZM,1ZG PR: 1ZM,1ZG PR: 1ZM,1ZG PR: 1ZM,1ZG PR: 1ZM,1ZG PR: 1ZM,1ZG PR: 1ZM,1ZG PR: 1ZM,1ZG PR: 1ZM,1ZG	11.9541-9553.2 220563 11.9541-9554.2 220564 11.8171-0008.1 990049 11.0101-5409.2 260035 11.8116-0351.1 390538	2		D=54, - Halter ATE D=54, - Halter ATE Führungsbolzen ATE Hülzensatz ATE Haltefeder ATE	
	2.0 TDI 103 2.0 TDI 110 2.0 TDI 125 2.0 TDI 130 2.0 TDI 135 2.0 TDI 4motion 103 2.0 TDI 4motion 125	11.11 05.15 11.11 12.12 05.15 11.11 11.11	PR: 1ZM,1ZG PR: 1ZM,1ZG PR: 1ZM,1ZG PR: 1ZM,1ZG PR: 1ZM,1ZG PR: 1ZM,1ZG PR: 1ZM,1ZG					















VOLKSWAGEN PASSAT CC (11-)										
										
	2.0 TDI 4motion 2.0 TSI 3.6 V6 4motion	130 155 220	12.12 11.11 11.11	PR: 1ZM,1ZG PR: 1ZM,1ZG PR: 1ZM,1ZG	11.9541-9553.2 11.9541-9554.2 11.8171-0008.1 11.0101-5409.2 11.8116-0351.1	220563 220564 990049 260035 390538	 	D=54, - Halter D=54, - Halter Führungsbolzen Hülzensatz Haltefeder	ATE ATE ATE ATE ATE	
	1.4 TSI 1.4 TSI 1.8 TSI 2.0 TDI 2.0 TDI 2.0 TDI 2.0 TDI 2.0 TDI 2.0 TDI 2.0 TDI 4motion 2.0 TDI 4motion 2.0 TDI 4motion 2.0 TSI 3.6 V6 4motion	110 118 118 100 103 110 125 130 135 103 125 130 155 220	05.15 11.11 11.11 11.11 11.11 05.15 11.11 12.12 05.15 11.11 11.11 12.12 11.11 11.11	PR: 1KW PR: 1KW PR: 1KW PR: 1KW PR: 1KW PR: 1KW PR: 1KW PR: 1KW PR: 1KW PR: 1KW PR: 1KW PR: 1KW PR: 1KW PR: 1KW	24.6241-1709.7 24.6241-1710.7	221021 221022	 	elektrische Feststellbremse ¹⁾ elektrische Feststellbremse ¹⁾	D=41, - Halter D=41, - Halter	TRW TRW
	1.4 TSI 1.4 TSI 1.8 TSI 2.0 TDI 2.0 TDI 2.0 TDI 2.0 TDI 2.0 TDI 2.0 TDI 2.0 TDI 4motion 2.0 TDI 4motion 2.0 TDI 4motion 2.0 TSI 3.6 V6 4motion	110 118 118 100 103 110 125 130 135 103 125 130 155 220	05.15 11.11 11.11 11.11 11.11 05.15 11.11 12.12 05.15 11.11 11.11 12.12 11.11 11.11	PR: 2EA PR: 2EA PR: 2EA PR: 2EA PR: 2EA PR: 2EA PR: 2EA PR: 2EA PR: 2EA PR: 2EA PR: 2EA PR: 2EA PR: 2EA PR: 2EA	24.6241-1711.5 24.6241-1712.5	240713 240714	 	elektrische Feststellbremse ¹⁾ elektrische Feststellbremse ¹⁾	D=41, - Halter D=41, - Halter	TRW TRW
	1.4 TSI 1.4 TSI 1.8 TSI 2.0 TDI 2.0 TDI 2.0 TDI 2.0 TDI 2.0 TDI 2.0 TDI 2.0 TDI 4motion 2.0 TDI 4motion 2.0 TDI 4motion 2.0 TSI 3.6 V6 4motion	110 118 118 100 103 110 125 130 135 103 125 130 155 220	05.15 11.11 11.11 11.11 11.11 05.15 11.11 12.12 05.15 11.11 11.11 12.12 11.11 11.11	PR: 1KW PR: 1KW PR: 1KW PR: 1KW PR: 1KW PR: 1KW PR: 1KW PR: 1KW PR: 1KW PR: 1KW PR: 1KW PR: 1KW PR: 1KW PR: 1KW	24.5143-0257.3	331167			L=257	
	1.4 TSI 1.4 TSI 1.8 TSI 2.0 TDI 2.0 TDI 2.0 TDI 2.0 TDI 2.0 TDI 2.0 TDI 2.0 TDI 4motion 2.0 TDI 4motion 2.0 TDI 4motion 2.0 TSI 3.6 V6 4motion	110 118 118 100 103 110 125 130 135 103 125 130 155 220	05.15 11.11 11.11 11.11 11.11 05.15 11.11 12.12 05.15 11.11 11.11 12.12 11.11 11.11	PR: 2EA PR: 2EA PR: 2EA PR: 2EA PR: 2EA PR: 2EA PR: 2EA PR: 2EA PR: 2EA PR: 2EA PR: 2EA PR: 2EA PR: 2EA PR: 2EA	24.5204-0233.3	331430			L=233	
VOLKSWAGEN PASSAT / PASSAT VARIANT (10-14)										
	1.4 TSI 1.4 TSI 1.4 TSI 1.6 TDI 1.8 TSI 2.0 TDI 2.0 TDI 2.0 TDI 2.0 TDI 4motion 2.0 TDI 4motion 2.0 TDI 4motion 2.0 TSI 3.6 FSI 4motion	◀ 90 ◀ 110 ◀ 118 ◀ 77 ◀ 118 ◀ ◀ 125 ◀ 130 ◀ 103 ◀ 125 ◀ 130 ◀ 155 ◀ 220	08.10 08.10 11.12 08.10 08.10 08.10 08.10 08.10 08.10 08.10 01.13 11.10 01.11	10.14 10.14 10.14 10.14 10.14 10.14 10.14 10.14 10.14 10.14 10.14 10.14 10.14	PR: 1LA,1LB,1ZM PR: 1LA,1LB,1ZM PR: 1LA,1LB,1ZM PR: 1LA,1LB,1ZM PR: 1LA,1LB,1ZM PR: 1LA,1LB,1ZM PR: 1LA,1LB,1ZM PR: 1LA,1LB,1ZM PR: 1LA,1LB,1ZM PR: 1LA,1LB,1ZM PR: 1LA,1LB,1ZM PR: 1LA,1LB,1ZM PR: 1LA,1LB,1ZM	03.7873-4502.4	300284		11"	ATE
	1.4 TSI 1.4 TSI 1.4 TSI 1.6 TDI 1.8 TSI 2.0 TDI 2.0 TDI 2.0 TDI 2.0 TDI 4motion 2.0 TDI 4motion 2.0 TDI 4motion 2.0 TSI 2.0 TDI 4motion	◀ 90 ◀ 110 ◀ 118 ◀ 77 ◀ 118 ◀ ◀ 125 ◀ 130 ◀ 103 ◀ 125 ◀ 130 ◀ 155 ◀ 130	08.10 08.10 11.12 08.10 08.10 08.10 08.10 08.10 08.10 08.10 01.13	10.14 10.14 10.14 10.14 10.14 10.14 10.14 10.14 10.14 10.14 10.14	PR: 1ZG PR: 1ZG PR: 1ZG PR: 1ZG PR: 1ZG PR: 1ZG PR: 1ZG PR: 1ZG PR: 1ZG PR: 1ZG PR: 1ZG	03.7873-4402.4	300292		11"	ATE

¹⁾ electric parking brake / fr.di stazionamento elettrico / frein à main électrique / freno de mano eléctrico

























	 kW								
VOLKSWAGEN PASSAT / PASSAT VARIANT (10-14)									
	2.0 TSI 3.6 FSI 4motion	155 220	11.10 01.11	10.14 10.14	PR: 1ZG PR: 1ZG	03.7873-4402.4	300292		11" ATE
	1.4 TSI 1.4 TSI 1.4 TSI 1.6 TDI 1.8 TSI 2.0 TDI 2.0 TDI 2.0 TDI 4motion 2.0 TDI 4motion 2.0 TDI 4motion 2.0 TSI 3.6 FSI 4motion	90 110 118 77 118 125 130 103 125 130 155 220	08.10 08.10 11.12 08.10 08.10 08.10 08.10 08.10 08.10 01.13 11.10 01.11	10.14 10.14 10.14 10.14 10.14 10.14 10.14 10.14 10.14 10.14 10.14 10.14	PR: 1LA,1LB,1ZM PR: 1LA,1LB,1ZM PR: 1LA,1LB,1ZM PR: 1LA,1LB,1ZM PR: 1LA,1LB,1ZM PR: 1LA,1LB,1ZM PR: 1LA,1LB,1ZM PR: 1LA,1LB,1ZM PR: 1LA,1LB,1ZM PR: 1LA,1LB,1ZM PR: 1LA,1LB,1ZM PR: 1LA,1LB,1ZM	03.4153-0186.3	010816		Thz 23,81 ATE
	1.4 TSI 1.4 TSI 1.4 TSI 1.6 TDI 1.8 TSI 2.0 TDI 2.0 TDI 2.0 TDI 4motion 2.0 TDI 4motion 2.0 TDI 4motion 2.0 TSI 3.6 FSI 4motion	90 110 118 77 118 125 130 103 125 130 155 220	08.10 08.10 11.12 08.10 08.10 08.10 12.12 08.10 08.10 01.13 11.10 01.11	10.14 10.14 10.14 10.14 10.14 10.14 10.14 10.14 10.14 10.14 10.14 10.14	PR: 1ZG PR: 1ZG PR: 1ZG PR: 1ZG PR: 1ZG PR: 1ZG PR: 1ZG PR: 1ZG PR: 1ZG PR: 1ZG PR: 1ZG PR: 1ZG	03.4152-0116.3	010814		Thz 22,20 ATE
	1.4 TSI 1.4 TSI 1.4 TSI 1.6 TDI 1.8 TSI 2.0 TDI 2.0 TDI 2.0 TDI 4motion 2.0 TDI 4motion 2.0 TDI 4motion 2.0 TSI 3.6 FSI 4motion	90 110 118 77 118 125 130 103 125 130 155 220	08.10 08.10 11.12 08.10 08.10 08.10 12.12 08.10 08.10 01.13 11.10 01.11	10.14 10.14 10.14 10.14 10.14 10.14 10.14 10.14 10.14 10.14 10.14 10.14	PR: 1ZM,1ZG PR: 1ZM,1ZG PR: 1ZM,1ZG PR: 1ZM,1ZG PR: 1ZM,1ZG PR: 1ZM,1ZG PR: 1ZM,1ZG PR: 1ZM,1ZG PR: 1ZM,1ZG PR: 1ZM,1ZG PR: 1ZM,1ZG PR: 1ZM,1ZG	11.9541-9553.2 11.9541-9554.2 11.8171-0008.1 11.8116-0351.1 11.0101-5409.2	220563 220564 990049 390538 260035	2	D=54, - Halter ATE D=54, - Halter ATE Führungsbolzen ATE Haltefeder ATE Hülzensatz ATE
	1.4 TSI 1.4 TSI 1.4 TSI 1.6 TDI 1.8 TSI 2.0 TDI 2.0 TDI 2.0 TDI 4motion 2.0 TDI 4motion 2.0 TDI 4motion 2.0 TSI 3.6 FSI 4motion	90 110 118 77 118 125 130 103 125 130 155 220	08.10 08.10 11.12 08.10 08.10 08.10 12.12 08.10 08.10 01.13 11.10 01.11	10.14 10.14 10.14 10.14 10.14 10.14 10.14 10.14 10.14 10.14 10.14 10.14	PR: 1KW PR: 1KW PR: 1KW PR: 1KW PR: 1KW PR: 1KW PR: 1KW PR: 1KW PR: 1KW PR: 1KW PR: 1KW PR: 1KW	24.6241-1709.7 24.6241-1710.7	221021 221022	<input type="checkbox"/> elektrische Feststellbremse 1) <input type="checkbox"/> elektrische Feststellbremse 1)	D=41, - Halter TRW D=41, - Halter TRW
	1.4 TSI 1.4 TSI 1.4 TSI 1.6 TDI 1.8 TSI 2.0 TDI 2.0 TDI 2.0 TDI 4motion 2.0 TDI 4motion 2.0 TDI 4motion 2.0 TSI 3.6 FSI 4motion	90 110 118 77 118 125 130 103 125 130 155 220	08.10 08.10 11.12 08.10 08.10 08.10 12.12 08.10 08.10 01.13 11.10 01.11	10.14 10.14 10.14 10.14 10.14 10.14 10.14 10.14 10.14 10.14 10.14 10.14	PR: 2EA PR: 2EA PR: 2EA PR: 2EA PR: 2EA PR: 2EA PR: 2EA PR: 2EA PR: 2EA PR: 2EA PR: 2EA PR: 2EA	24.6241-1711.5 24.6241-1712.5	240713 240714	<input type="checkbox"/> elektrische Feststellbremse 1) <input type="checkbox"/> elektrische Feststellbremse 1)	D=41, - Halter TRW D=41, - Halter TRW
	1.4 TSI 1.4 TSI 1.4 TSI 1.6 TDI 1.8 TSI 2.0 TDI 2.0 TDI 2.0 TDI 4motion 2.0 TDI 4motion 2.0 TDI 4motion 2.0 TSI 3.6 FSI 4motion	90 110 118 77 118 125 130 103 125 130 155 220	08.10 08.10 11.12 08.10 08.10 08.10 12.12 08.10 08.10 01.13 11.10 01.11	10.14 10.14 10.14 10.14 10.14 10.14 10.14 10.14 10.14 10.14 10.14 10.14	PR: 2EA PR: 2EA PR: 2EA PR: 2EA PR: 2EA PR: 2EA PR: 2EA PR: 2EA PR: 2EA PR: 2EA PR: 2EA PR: 2EA	24.5204-0233.3	331430	2	L=233
	1.4 TSI 1.4 TSI 1.4 TSI 1.6 TDI 1.8 TSI	90 110 118 77 118	08.10 08.10 11.12 08.10 08.10	10.14 10.14 10.14 10.14 10.14	PR: 1KW PR: 1KW PR: 1KW PR: 1KW PR: 1KW	24.5143-0257.3	331167	2	L=257

1) electric parking brake / fr.di stazionamento elettrico / frein à main électrique / freno de mano eléctrico

								
VOLKSWAGEN PASSAT / PASSAT VARIANT (10-14)								
	2.0 TDI 2.0 TDI 2.0 TDI 2.0 TDI 4motion 2.0 TDI 4motion 2.0 TDI 4motion 2.0 TSI 3.6 FSI 4motion	125 130 103 125 130 155 220	08.10 08.10 12.12 08.10 08.10 01.13 11.10 01.11	10.14 PR: 1KW 10.14 PR: 1KW 10.14 PR: 1KW 10.14 PR: 1KW 10.14 PR: 1KW 10.14 PR: 1KW 10.14 PR: 1KW 10.14 PR: 1KW	24.5143-0257.3	331167	2	L=257
	1.4 TSI 1.4 TSI 1.4 TSI 1.6 TDI 1.8 TSI 2.0 TDI 2.0 TDI 2.0 TDI 4motion 2.0 TDI 4motion 2.0 TDI 4motion 2.0 TDI 4motion 2.0 TSI 3.6 FSI 4motion	90 110 118 77 118 125 130 103 125 130 155 220	08.10 08.10 11.12 08.10 08.10 08.10 12.12 08.10 08.10 01.13 11.10 01.11	10.14 PR: OEM 10.14 PR: OEM 10.14 PR: OEM 10.14 PR: OEM 10.14 PR: OEM 10.14 PR: OEM 10.14 PR: OEM 10.14 PR: OEM 10.14 PR: OEM 10.14 PR: OEM 10.14 PR: OEM 10.14 PR: OEM	24.2519-1706.3	040096		Nz 19,05
	1.4 TSI 1.4 TSI 1.4 TSI 1.6 TDI 1.8 TSI 2.0 TDI 2.0 TDI 2.0 TDI 4motion 2.0 TDI 4motion 2.0 TDI 4motion 2.0 TDI 4motion 2.0 TSI 3.6 FSI 4motion	90 110 118 77 118 125 130 103 125 130 155 220	08.10 08.10 11.12 08.10 08.10 08.10 12.12 08.10 08.10 01.13 11.10 01.11	10.14 PR: OEJ 10.14 PR: OEJ 10.14 PR: OEJ 10.14 PR: OEJ 10.14 PR: OEJ 10.14 PR: OEJ 10.14 PR: OEJ 10.14 PR: OEJ 10.14 PR: OEJ 10.14 PR: OEJ 10.14 PR: OEJ 10.14 PR: OEJ	24.2519-1705.3	040095		Nz 19,05
VOLKSWAGEN PASSAT ALLTRACK (12-14)								
	1.8 TSI 1.8 TSI 2.0 TDI 2.0 TDI 4motion 2.0 TDI 4motion 2.0 TDI 4motion 2.0 TSI 4motion	112 118 103 103 125 130 155	01.12 01.12 01.12 01.12 01.12 01.13 01.12	PR: 1LA,1LB,1ZM PR: 1LA,1LB,1ZM PR: 1LA,1LB,1ZM PR: 1LA,1LB,1ZM PR: 1LA,1LB,1ZM PR: 1LA,1LB,1ZM PR: 1LA,1LB,1ZM	03.7873-4502.4	300284		11" ATE
	1.8 TSI 1.8 TSI 2.0 TDI 2.0 TDI 4motion 2.0 TDI 4motion 2.0 TDI 4motion 2.0 TSI 4motion	112 118 103 103 125 130 155	01.12 01.12 01.12 01.12 01.12 01.13 01.12	PR: 1ZG PR: 1ZG PR: 1ZG PR: 1ZG PR: 1ZG PR: 1ZG PR: 1ZG	03.7873-4402.4	300292		11" ATE
	1.8 TSI 1.8 TSI 2.0 TDI 2.0 TDI 4motion 2.0 TDI 4motion 2.0 TDI 4motion 2.0 TSI 4motion	112 118 103 103 125 130 155	01.12 01.12 01.12 01.12 01.12 01.13 01.12	PR: 1LA,1LB,1ZM PR: 1LA,1LB,1ZM PR: 1LA,1LB,1ZM PR: 1LA,1LB,1ZM PR: 1LA,1LB,1ZM PR: 1LA,1LB,1ZM PR: 1LA,1LB,1ZM	03.4153-0186.3	010816		THz 23,81 ATE
	1.8 TSI 1.8 TSI 2.0 TDI 2.0 TDI 4motion 2.0 TDI 4motion 2.0 TDI 4motion 2.0 TSI 4motion	112 118 103 103 125 130 155	01.12 01.12 01.12 01.12 01.12 01.13 01.12	PR: 1ZG PR: 1ZG PR: 1ZG PR: 1ZG PR: 1ZG PR: 1ZG PR: 1ZG	03.4152-0116.3	010814		THz 22,20 ATE
	1.8 TSI 1.8 TSI 2.0 TDI 2.0 TDI 4motion 2.0 TDI 4motion 2.0 TDI 4motion 2.0 TSI 4motion	112 118 103 103 125 130 155	01.12 01.12 01.12 01.12 01.12 01.13 01.12	PR: 1ZM,1ZG PR: 1ZM,1ZG PR: 1ZM,1ZG PR: 1ZM,1ZG PR: 1ZM,1ZG PR: 1ZM,1ZG PR: 1ZM,1ZG	11.9541-9553.2 11.9541-9554.2 11.0101-5409.2 11.8171-0008.1 11.8116-0351.1	220563 220564 260035 990049 390538	2	D=54, - Halter ATE D=54, - Halter ATE Hülensatz ATE Führungsbolzen ATE Halterfeder ATE
	1.8 TSI 1.8 TSI 2.0 TDI 2.0 TDI 4motion 2.0 TDI 4motion 2.0 TDI 4motion 2.0 TSI 4motion	112 118 103 103 125 130 155	01.12 01.12 01.12 01.12 01.12 01.13 01.12	PR: 1KW PR: 1KW PR: 1KW PR: 1KW PR: 1KW PR: 1KW PR: 1KW	24.6241-1709.7 24.6241-1710.7	221021 221022	<input type="checkbox"/> elektrische Feststellbremse 1) <input type="checkbox"/> elektrische Feststellbremse 1)	D=41, - Halter TRW D=41, - Halter TRW
	1.8 TSI 1.8 TSI 2.0 TDI 2.0 TDI 4motion 2.0 TDI 4motion 2.0 TDI 4motion 2.0 TSI 4motion	112 118 103 103 125 130 155	01.12 01.12 01.12 01.12 01.12 01.13 01.12	PR: 2EA PR: 2EA PR: 2EA PR: 2EA PR: 2EA PR: 2EA PR: 2EA	24.6241-1711.5 24.6241-1712.5	240713 240714	<input type="checkbox"/> elektrische Feststellbremse 1) <input type="checkbox"/> elektrische Feststellbremse 1)	D=41, - Halter TRW D=41, - Halter TRW

1) electric parking brake / fr.di stazionamento elettrico / frein à main électrique / freno de mano eléctrico



	 KW								
VOLKSWAGEN PASSAT ALLTRACK (12-14)									
	1.8 TSI	112	01.12	PR: 1KW	24.5143-0257.3	331167	2	L=257	
	1.8 TSI	118	01.12	PR: 1KW					
	2.0 TDI	103	01.12	PR: 1KW					
	2.0 TDI 4motion	103	01.12	PR: 1KW					
	2.0 TDI 4motion	125	01.12	PR: 1KW					
	2.0 TDI 4motion	130	01.13	PR: 1KW					
	2.0 TSI 4motion	155	01.12	PR: 1KW					
	1.8 TSI	112	01.12	PR: 2EA	24.5204-0233.3	331430	2	L=233	
	1.8 TSI	118	01.12	PR: 2EA					
	2.0 TDI	103	01.12	PR: 2EA					
	2.0 TDI 4motion	103	01.12	PR: 2EA					
	2.0 TDI 4motion	125	01.12	PR: 2EA					
	2.0 TDI 4motion	130	01.13	PR: 2EA					
	2.0 TSI 4motion	155	01.12	PR: 2EA					
		1.8 TSI	112	01.12	PR: 0EJ	24.2519-1705.3	040095		Nz 19,05
		1.8 TSI	118	01.12	PR: 0EJ				
		2.0 TDI	103	01.12	PR: 0EJ				
		2.0 TDI 4motion	103	01.12	PR: 0EJ				
2.0 TDI 4motion		125	01.12	PR: 0EJ					
2.0 TDI 4motion		130	01.13	PR: 0EJ					
	2.0 TSI 4motion	155	01.12	PR: 0EJ					
	1.8 TSI	112	01.12	PR: OEM, OEN	24.2519-1706.3	040096		Nz 19,05	
	1.8 TSI	118	01.12	PR: OEM, OEN					
	2.0 TDI	103	01.12	PR: OEM, OEN					
	2.0 TDI 4motion	103	01.12	PR: OEM, OEN					
	2.0 TDI 4motion	125	01.12	PR: OEM, OEN					
	2.0 TDI 4motion	130	01.13	PR: OEM, OEN					
	2.0 TSI 4motion	155	01.12	PR: OEM, OEN					
	VOLKSWAGEN PASSAT / PASSAT VARIANT (14-)								
		1.4 GTE Hybrid	115	06.15		24.2519-1706.3	040096	PR: 0EJ	Nz 19,05
		1.4 TDI	77	11.14					
		1.4 TDI	103	11.14					
1.4 TSI		92	11.14						
1.4 TSI		110	11.14						
1.4 TSI		118	11.14						
1.4 TSI 4motion		110	02.15						
1.6 TDI		88	11.14						
1.8 TSI		132	11.14						
2.0 TDI		110	11.14						
2.0 TDI		135	07.15						
2.0 TDI		140	11.14						
2.0 TDI 4motion		110	02.15						
2.0 TDI 4motion		140	11.14						
2.0 TDI 4motion		176	11.14						
2.0 TSI		155	11.14						
2.0 TSI	162	05.15							
2.0 TSI 4motion	206	05.15							
VOLKSWAGEN PASSAT ALLTRACK (15-)									
	2.0 TDI 4motion	110	05.15		24.2519-1706.3	040096	PR: OEC,OEN	Nz 19,05	
	2.0 TDI 4motion	135	07.15						
	2.0 TDI 4motion	140	05.15						
	2.0 TDI 4motion	176	05.15						
	2.0 TSI 4motion	162	07.15						
VOLKSWAGEN PHAETON (02-)									
	3.0 TDI 4motion		09.04	PR: 12K,1ZL	11.8171-0067.1	250153		Führungsbolzen	
	3.0 V6 TDI 4motion		04.08	PR: 12K,1ZL	11.8116-0347.2	390535	2	Haltefeder	
	3.2 V6		04.02	PR: 12K,1ZL				ATE	
	3.2 V6 4motion		02.04	PR: 12K,1ZL				ATE	
	3.6 V6 4motion		11.08	PR: 12K,1ZL					
	4.2 V8 4motion		05.03	PR: 12K,1ZL					
	5.0 V10 TDI 4motion		11.02	PR: 12K,1ZL					
6.0 W12 4motion		04.02	PR: 12K,1ZL						
	3.0 TDI 4motion		09.04		83.7849-0419.3	331114	2	L=422	
	3.0 V6 TDI 4motion		04.08						
	3.2 V6		04.02						
	3.2 V6 4motion		02.04						
	3.6 V6 4motion		11.08						
	4.2 V8 4motion		05.03						
	5.0 V10 TDI 4motion		11.02						
6.0 W12 4motion		04.02							
	3.0 TDI 4motion		09.04		83.7858-0165.3	331107		L=165	
	3.0 V6 TDI 4motion		04.08		83.7849-0145.3	331106		L=145	
	3.2 V6		04.02						
	3.2 V6 4motion		02.04						
	3.6 V6 4motion		11.08						
	4.2 V8 4motion		05.03						
	5.0 V10 TDI 4motion		11.02						
6.0 W12 4motion		04.02							

VOLKSWAGEN POLO III (95-01)								
	1.05 1.3 1.4 1.4 1.4 16V 1.6 1.9 D 1.9 SDI	40 44 74 55	6N-T-300000 6N-T-300000 6N-T-300000 6N-T-300000 6N-T-300000 6N-T-300000 6N-T-300000	10.94 10.94 07.95 07.95 04.96 10.94 10.94 10.94	+ ABS + ABS + ABS + ABS + ABS + ABS + ABS	03.7750-6002.4	300134	9" ATE
	1.0 1.05 1.3 1.4 1.4 1.4 16V 1.4 16V 1.4 TDI 1.6 1.6 GTI 1.7 SDI 1.9 D 1.9 SDI	40 44 55 74 55 55		07.96 10.94 10.94 07.95 07.95 01.99 04.96 01.99 10.94 04.98 05.97 10.94 10.94	09.01 + ESP 09.96 + ESP 04.97 + ESP 09.01 + ESP 09.01 + ESP 09.01 + ESP 09.01 + ESP 09.01 + ESP 09.99 + ESP 09.01 + ESP 09.01 + ESP 09.01 + ESP 09.01 + ESP	03.7853-0102.4	300252	PR: 1AT,1LX,1ZE,1ZJ,1ZK 9" ATE
	1.0 1.05 1.3 1.4 1.4 1.4 16V 1.6 1.7 SDI 1.9 D 1.9 SDI	40 44 55 55		07.96 10.94 10.94 07.95 07.95 01.99 10.94 05.97 10.94 10.94	- ABS - ABS - ABS - ABS - ABS - ABS - ABS - ABS - ABS - ABS	03.2120-3943.3 03.3517-0101.2	010532 390322	THz 20,64 Verschlußschraube ATE
	1.05 1.3 1.4 1.4 16V 1.4 TDI 1.6 1.9 D 1.9 SDI	44 74 55 55	6N-T-250000 6N-T-250000 6N-T-250000 6N-T-250000 6N-T-250000 6N-T-250000	10.94 10.94 07.95 04.96 01.99 10.94 10.94 10.94	+ ABS + ABS + ABS - ABS - ABS + ABS + ABS + ABS	03.2122-1184.3	010592	THz 22,20 ATE
	1.0 1.05 1.3 1.4 1.6 1.7 SDI 1.9 D 1.9 SDI	6N-V-000001 6N-V-000001 44 6N-V-000001 55 6N-V-000001		07.96 09.96 04.97 09.01 09.99 05.97 09.01 09.01	+ ABS + ABS + ABS + ABS + ABS + ABS + ABS + ABS	03.2122-1344.3	010593	THz 22,20 ATE
	1.4 16V 1.4 16V 1.4 TDI 1.6 GTI	74 74 55	6N-T-300000	04.96 09.01 01.99 04.98	+ ABS + ABS + ABS + ABS	03.2123-1484.3 03.2123-1824.3	010595 010596	THz 23,81 ATE ATE
	1.05 1.3 1.6 1.9 D 1.9 SDI	55	6N-SY087410 6N-SY087410 6N-SY087410 6N-SY087410 6N-SY087410	10.94 10.94 10.94 10.94 10.94		11.0441-4808.2 11.0101-4803.2 24.0102-4803.2	250022 260008 260086	Dichtungssatz Hülssensatz Hülssensatz+Schrauben ATE ATE ATE
	1.05 1.3 1.6 1.9 D 1.9 SDI	55	6N-SW008500 6N-SW008500 6N-SW008500 6N-SW008500 6N-SW008500	10.94 10.94 10.94 10.94 10.94		11.0441-4808.2 11.0101-4803.2 24.0102-4803.2	250022 260008 260086	Dichtungssatz Hülssensatz Hülssensatz+Schrauben ATE ATE ATE
	1.05 1.3 1.4 1.4 1.6 1.9 D 1.9 SDI	6N-SY087411 40 6N-SY087411 44 6N-SY087411 55 6N-SY087411	6N-TY140000 6N-TY140000 6N-TY140000 6N-TY140000 6N-TY140000 6N-TY140000 6N-TY140000	10.94 10.94 10.94 10.94 10.94 10.94 10.94		24.3481-1749.5 24.3481-1750.5 11.0441-4808.2 11.0101-4801.2 24.0102-4801.2	240281 240282 250022 260006 260085	D=48, - Halter D=48, - Halter Dichtungssatz Hülssensatz Hülssensatz+Schrauben ATE ATE ATE ATE ATE
	1.05 1.3 1.4 1.4 1.6 1.9 D 1.9 SDI	6N-SW008501 40 6N-SW008501 44 6N-SW008501 55 6N-SW008501	6N-TW082000 6N-TW082000 6N-TW082000 6N-TW082000 6N-TW082000 6N-TW082000 6N-TW082000	10.94 10.94 10.94 10.94 10.94 10.94 10.94		24.3481-1749.5 24.3481-1750.5 11.0441-4808.2 11.0101-4801.2 24.0102-4801.2	240281 240282 250022 260006 260085	D=48, - Halter D=48, - Halter Dichtungssatz Hülssensatz Hülssensatz+Schrauben ATE ATE ATE ATE ATE
	1.0 1.05 1.3 1.4 1.4 1.4 16V 1.6 1.7 SDI 1.9 D 1.9 SDI	6N-TY140001 40 6N-TY140001 44 6N-TY140001 55 55 6N-TY140001		07.96 09.96 04.97 09.01 09.01 01.99 09.99 05.97 09.01 09.01	- ABS	24.3481-1735.5 24.3481-1736.5 11.0441-4808.2 11.0101-4801.2 24.0102-4801.2	240283 240284 250022 260006 260085	D=48, - Halter D=48, - Halter Dichtungssatz Hülssensatz Hülssensatz+Schrauben ATE ATE ATE ATE ATE



VOLKSWAGEN POLO III (95-01)

	1.9 SDI		6N-V-045000	10.94	- ABS	24.3727-0161.2	580161	2 ↓	L=1512
	1.0		6N-V-045001	09.01	- ABS	24.3727-0161.2	580161	2 ↓	L=1512
	1.4	40	6N-V-045001	09.01	- ABS				
	1.4	44	6N-V-045001	09.01	- ABS				
	1.4 16V	55		01.99	- ABS				
	1.4 16V	74	6N-V-045001	09.01	- ABS/ - ⊕				
	1.4 TDI	55		01.99	- ABS				
	1.6	55	6N-V-045001	09.99	- ABS				
	1.7 SDI		6N-V-045001	09.01	- ABS				
	1.9 D		6N-V-045001	09.01	- ABS				
	1.9 SDI		6N-V-045001	09.01	- ABS				
	1.0		6N-WW130000	07.96	+ ABS	24.3727-0161.2	580161	2 ↓	L=1512
	1.05			10.94	+ ABS				
	1.3			10.94	+ ABS				
	1.4	40	6N-WW130000	07.95	+ ABS				
	1.4	44	6N-WW130000	07.95	+ ABS				
	1.4 16V	74	6N-WW130000	04.96	+ ABS/ - ⊕				
	1.6	55	6N-WW130000	10.94	+ ABS				
	1.7 SDI		6N-WW130000	05.97	+ ABS				
	1.9 D		6N-WW130000	10.94	+ ABS				
	1.9 SDI		6N-WW130000	10.94	+ ABS				
	1.0		6N-WW130001	09.01	+ ABS	24.3727-0162.2	580162	2 ↓	L=1514
	1.4	40	6N-WW130001	09.01	+ ABS				
	1.4	44	6N-WW130001	09.01	+ ABS				
	1.4 16V	74	6N-WW130001	09.01	+ ABS/ - ⊕				
	1.6	55	6N-WW130001	09.99	+ ABS				
	1.7 SDI		6N-WW130001	09.01	+ ABS				
	1.9 D		6N-WW130001	09.01	+ ABS				
	1.9 SDI		6N-WW130001	09.01	+ ABS				
	1.4 16V	55		01.99	09.99 + ABS	24.3727-0165.2	580165	2 ↓	L=1641
	1.4 16V	74	6N-WW130001	09.99	+ ⊕				
	1.4 TDI	55		01.99	09.99 + ABS				
	1.6 GTI		6N-WW130001	09.99					
	1.4 16V	55		10.99	09.01 + ABS	24.3727-0165.2	580165	2 ↓	L=1641
	1.4 16V	74		10.99	09.01 + ⊕				
	1.4 TDI	55		10.99	09.01 + ABS				
	1.6 GTI			10.99	09.01				
	1.0			07.96	09.01	03.6583-0184.3	320229		BRL 8/3 (4) ATE
	1.05			10.94	09.96				
	1.3			10.94	04.97				
	1.4	40		07.95	09.01				
	1.4	44		07.95	09.01				
	1.4 16V	55		01.99	09.01 - ABS				
	1.4 16V	74		04.96	09.01 - Motorsport 1)				
	1.4 TDI	55		01.99	09.01 - ABS				
	1.6	55		10.94	09.99				
	1.7 SDI			05.97	09.01				
	1.9 D			10.94	09.01				
	1.9 SDI			10.94	09.01				
	1.4 16V	74		04.96	09.01 + Motorsport 2)	03.6583-0167.3	320140		BRL 8/3 (4) ATE
	1.4 16V	55		01.99	09.01 + ABS	03.6583-0179.3	320228		BRL 8/3 (4) ATE
	1.4 16V	74		04.96	09.01 + ⊕				
	1.4 TDI	55		01.99	09.01 + ABS				
	1.6 GTI			04.98	09.01				
	1.4 TDI	55		01.99	09.01	24.2519-1701.3	040075		Nz 19,05
	1.0			07.96	09.01 - Fahrschulwagen 3)	24.3728-2707.2	592707		L=1047, + AUT
	1.05			10.94	09.96 - Fahrschulwagen 3)				
	1.3			10.94	04.97 - Fahrschulwagen 3)				
	1.4	40		07.95	09.01 - Fahrschulwagen 3)				
	1.4	44		07.95	09.01 - Fahrschulwagen 3)				
	1.4 16V	55		01.99	09.01 - Fahrschulwagen 3)				
	1.4 16V	74		04.96	09.01 - Fahrschulwagen 3)				
	1.6	55		10.94	09.99 - Fahrschulwagen 3)				
	1.6 GTI			04.98	09.01 - Fahrschulwagen 3)				
	1.7 SDI			05.97	09.01 - Fahrschulwagen 3)				
	1.9 D			10.94	09.01 - Fahrschulwagen 3)				
	1.9 SDI			10.94	09.01 - Fahrschulwagen 3)				

VOLKSWAGEN POLO IV (02-09)

	1.2	40	9N-5-180000	11.01	- ABS/ + Servolenkung 4)	24.2120-1736.3	010732		Thz 20,64
	1.4 16V		9N-5-180000	11.01	- ABS				
	1.4 16V	63		05.06	- ABS				
	1.4 16V	74	9N-5-180000	11.01	- ABS				
	1.4 FSI		9N-5-180000	11.01	- ABS				
	1.4 TDI		9N-5-180000	11.01	- ABS				
	1.6 16V	77	9N-5-180000	05.06	- ABS				
	1.9 SDI		9N-5-180000	11.01	- ABS				
	1.9 TDI	74	9N-5-180000	11.01	- ABS				
	1.9 TDI	96	9N-5-180000	10.03	- ABS				
	2.0	85	9N-5-180000	04.02	- ABS				
	1.4 16V		9N-5-180000	11.01	+ ABS	24.2120-1734.3	010702		Thz 20,64
	1.4 16V	63	9N-5-180000	05.06	+ ABS				
	1.4 16V	74	9N-5-180000	11.01	+ ABS				

1) - motorsports / - motorsports / - Motorsport / - motorismo

2) + motorsports / + motorsports / + Motorsport / + motorismo

3) - driving school vehicle / - veicolo scuola guida / - véhicule auto école / - vehículo autoescuela

4) - ABS/ + power steering / - ABS/ + servosterzo / - ABS/ + direction assistée / - ABS/ + dirección asistida



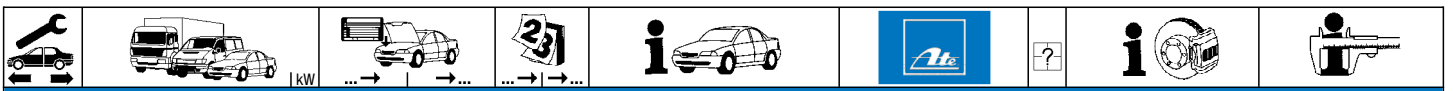













VOLKSWAGEN POLO IV (02-09)

	1.4 FSI 1.4 TDI 1.6 16V 1.9 SDI 1.9 TDI 1.9 TDI 2.0		9N-5-180000 9N-5-180000 9N-5-180000 9N-5-180000 9N-5-180000 9N-5-180000 9N-5-180000	11.01 11.01 05.06 11.01 11.01 10.03 04.02	+ ABS + ABS + ABS + ABS + ABS + ABS + ABS	24.2120-1734.3	010702			THz 20,64	
	1.2 1.2 1.2 1.4 16V 1.4 16V 1.4 16V 1.4 FSI 1.4 TDI 1.6 16V 1.8 GTI 1.8 GTI 1.9 SDI 1.9 TDI 1.9 TDI 2.0	40 51 51 63 74 74 77 110 132 74 96 85	9N-5-500001 9N-5-500001 9N-5-500001 9N-5-500001 9N-5-500001 9N-5-500001 9N-5-500001 9N-5-500001 9N-5-500001 9N-5-500001 9N-5-500001 9N-5-500001 9N-5-500001 9N-5-500001 9N-5-500001	11.01 05.09 04.07 05.09 05.09 05.09 05.09 05.09 05.09 09.05 06.06 05.09 05.09 05.09 05.09	05.09 05.09 05.09 05.09 05.09 05.09 05.09 05.09 05.09 05.09 05.09 05.09 05.09 05.09 05.09	24.2120-1736.3	010732	- ABS		THz 20,64	
	1.2 1.2 1.2 1.4 16V 1.4 16V 1.4 16V 1.4 FSI 1.4 TDI 1.6 16V 1.8 GTI 1.8 GTI 1.9 SDI 1.9 TDI 1.9 TDI 2.0	40 51 51 63 74 74 77 110 132 74 96 85	9N-5-500001 9N-5-500001 9N-5-500001 9N-5-500001 9N-5-500001 9N-5-500001 9N-5-500001 9N-5-500001 9N-5-500001 9N-5-500001 9N-5-500001 9N-5-500001 9N-5-500001 9N-5-500001 9N-5-500001	11.01 05.09 04.07 05.09 05.09 05.09 05.09 05.09 05.09 09.05 06.06 05.09 05.09 05.09 05.09	05.09 05.09 05.09 05.09 05.09 05.09 05.09 05.09 05.09 05.09 05.09 05.09 05.09 05.09 05.09	24.2119-1712.3 24.2120-1734.3	010912 010702	+ ABS + ABS		THz 19,05 - Behälter THz 20,64	
	1.2 1.2 1.2 1.4 16V 1.4 16V 1.4 16V 1.4 FSI 1.4 TDI 1.6 16V 1.8 GTI 1.8 GTI 1.9 SDI 1.9 TDI 1.9 TDI 2.0	40 51 51 63 74 74 77 110 132 74 96 85		11.01 11.01 04.07 11.01 05.06 11.01 11.01 11.01 05.06 09.05 06.06 11.01 11.01 10.03 04.02	05.09 PR: 1LM,1ZN 05.09 PR: 1LM,1ZN 05.09 PR: 1LM,1ZN 05.09 PR: 1LM,1ZN 05.09 PR: 1LM,1ZN 05.09 PR: 1LM,1ZN 05.09 PR: 1LM,1ZN 05.09 PR: 1LM,1ZN 05.09 PR: 1LM,1ZN 05.09 PR: 1LM,1ZN 05.09 PR: 1LM,1ZN 05.09 PR: 1LM,1ZN 05.09 PR: 1LM,1ZN 05.09 PR: 1LM,1ZN 05.09 PR: 1LM,1ZN	24.3481-1735.5 24.3481-1736.5	240283 240284			D=48, - Halter D=48, - Halter	ATE ATE
	1.2 1.2 1.2 1.4 16V 1.4 16V 1.4 16V 1.4 FSI 1.4 TDI 1.6 16V 1.8 GTI 1.8 GTI 1.9 SDI 1.9 TDI 1.9 TDI 2.0	40 51 51 63 74 74 77 110 132 74 96 85		11.01 11.01 04.07 11.01 05.06 11.01 11.01 11.01 05.06 09.05 06.06 11.01 11.01 10.03 04.02	05.09 PR: 1LQ,1LR,1ZF,1ZG 05.09 PR: 1LQ,1LR,1ZF,1ZG 05.09 PR: 1LQ,1LR,1ZF,1ZG 05.09 PR: 1LQ,1LR,1ZF,1ZG 05.09 PR: 1LQ,1LR,1ZF,1ZG 05.09 PR: 1LQ,1LR,1ZF,1ZG 05.09 PR: 1LQ,1LR,1ZF,1ZG 05.09 PR: 1LQ,1LR,1ZF,1ZG 05.09 PR: 1LQ,1LR,1ZF,1ZG 05.09 PR: 1LQ,1LR,1ZF,1ZG 05.09 PR: 1LQ,1LR,1ZF,1ZG 05.09 PR: 1LQ,1LR,1ZF,1ZG 05.09 PR: 1LQ,1LR,1ZF,1ZG 05.09 PR: 1LQ,1LR,1ZF,1ZG 05.09 PR: 1LQ,1LR,1ZF,1ZG	11.9541-9549.2 11.9541-9550.2 11.0101-5409.2 11.8171-0069.1	220575 220576 260035 250152			D=54, - Halter D=54, - Halter Hülzensatz Führungsbolzen	ATE ATE ATE ATE
	1.2 1.2 1.2 1.4 16V 1.4 16V 1.4 16V 1.4 FSI 1.4 TDI 1.6 16V 1.8 GTI 1.8 GTI 1.9 SDI 1.9 TDI 1.9 TDI 2.0	40 51 51 63 74 74 77 110 132 74 96 85		11.01 11.01 04.07 11.01 05.06 11.01 11.01 11.01 05.06 09.05 06.06 11.01 11.01 10.03 04.02	05.09 PR: 1LN,1ZD,1ZH 05.09 PR: 1LN,1ZD,1ZH 05.09 PR: 1LN,1ZD,1ZH 05.09 PR: 1LN,1ZD,1ZH 05.09 PR: 1LN,1ZD,1ZH 05.09 PR: 1LN,1ZD,1ZH 05.09 PR: 1LN,1ZD,1ZH 05.09 PR: 1LN,1ZD,1ZH 05.09 PR: 1LN,1ZD,1ZH 05.09 PR: 1LN,1ZD,1ZH 05.09 PR: 1LN,1ZD,1ZH 05.09 PR: 1LN,1ZD,1ZH 05.09 PR: 1LN,1ZD,1ZH 05.09 PR: 1LN,1ZD,1ZH 05.09 PR: 1LN,1ZD,1ZH	24.3541-1797.7 24.3541-1798.7	220553 220554			D=54, - Halter D=54, - Halter	TRW TRW

VOLKSWAGEN POLO IV (02-09)		kW		PR: 1LJ		11.9541-9595.2 220501		11.9541-9596.2 220502		D=54, - Halter		ATE	
	1.2	40	11.01	05.09	PR: 1LJ	11.9541-9595.2	220501	2			D=54, - Halter	ATE	
	1.2	51	11.01	05.09	PR: 1LJ	11.9541-9596.2	220502						
	1.2		04.07	05.09	PR: 1LJ	11.0441-5409.2	250031						
	1.4 16V		11.01	05.09	PR: 1LJ	11.0101-5409.2	260035						
	1.4 16V	63	05.06	05.09	PR: 1LJ	11.8171-0008.1	990049						
	1.4 16V	74	11.01	05.09	PR: 1LJ	11.8116-0143.1	390513						
	1.4 FSI		11.01	05.09	PR: 1LJ								
	1.4 TDI		11.01	05.09	PR: 1LJ								
	1.6 16V	77	05.06	05.09	PR: 1LJ								
	1.8 GTI	110	09.05	05.09	PR: 1LJ								
	1.8 GTI	132	06.06	05.09	PR: 1LJ								
	1.9 SDI		11.01	05.09	PR: 1LJ								
	1.9 TDI	74	11.01	05.09	PR: 1LJ								
	1.9 TDI	96	10.03	05.09	PR: 1LJ								
	2.0	85	04.02	05.09	PR: 1LJ								
	1.2	40	11.01	05.09		83.6247-0522.3	330595	2		L=522			
	1.2	51	11.01	05.09									
	1.2		04.07	05.09									
	1.4 16V		11.01	05.09									
	1.4 16V	63	05.06	05.09									
	1.4 16V	74	11.01	05.09									
	1.4 FSI		11.01	05.09									
	1.4 TDI		11.01	05.09									
	1.6 16V	77	05.06	05.09									
	1.8 GTI	110	09.05	05.09									
	1.8 GTI	132	06.06	05.09									
	1.9 SDI		11.01	05.09									
	1.9 TDI	74	11.01	05.09									
	1.9 TDI	96	10.03	05.09									
	2.0	85	04.02	05.09									
	1.2	40	11.01	05.09	PR: 1KD,1KS,1KV	24.3344-1709.7	220537	2		D=34, - Halter	TRW		
	1.2	51	11.01	05.09	PR: 1KD,1KS,1KV	24.3344-1710.7	220538						
	1.2		04.07	05.09	PR: 1KD,1KS,1KV								
	1.4 16V		11.01	05.09	PR: 1KD,1KS,1KV								
	1.4 16V	63	05.06	05.09	PR: 1KD,1KS,1KV								
	1.4 16V	74	11.01	05.09	PR: 1KD,1KS,1KV								
	1.4 FSI		11.01	05.09	PR: 1KD,1KS,1KV								
	1.4 TDI		11.01	05.09	PR: 1KD,1KS,1KV								
	1.6 16V	77	05.06	05.09	PR: 1KD,1KS,1KV								
	1.8 GTI	110	09.05	05.09	PR: 1KD,1KS,1KV								
	1.8 GTI	132	06.06	05.09	PR: 1KD,1KS,1KV								
	1.9 TDI	74	11.01	05.09	PR: 1KD,1KS,1KV								
	1.9 TDI	96	10.03	05.09	PR: 1KD,1KS,1KV								
	2.0	85	04.02	05.09	PR: 1KD,1KS,1KV								
		1.2	40	11.01	05.09	PR: 1KK,1KT	24.3384-1729.7					220541	2
1.2		51	11.01	05.09	PR: 1KK,1KT	24.3384-1730.7	220542						
1.2			04.07	05.09	PR: 1KK,1KT								
1.4 16V			11.01	05.09	PR: 1KK,1KT								
1.4 16V		63	05.06	05.09	PR: 1KK,1KT								
1.4 16V		74	11.01	05.09	PR: 1KK,1KT								
1.4 FSI			11.01	05.09	PR: 1KK,1KT								
1.4 TDI			11.01	05.09	PR: 1KK,1KT								
1.6 16V		77	05.06	05.09	PR: 1KK,1KT								
1.8 GTI		110	09.05	05.09	PR: 1KK,1KT								
1.8 GTI		132	06.06	05.09	PR: 1KK,1KT								
1.9 SDI			11.01	05.09	PR: 1KK,1KT								
1.9 TDI		74	11.01	05.09	PR: 1KK,1KT								
1.9 TDI		96	10.03	05.09	PR: 1KK,1KT								
2.0		85	04.02	05.09	PR: 1KK,1KT								
	1.2	40	11.01	05.09		83.7858-0140.3	330837	2		L=140			
	1.2	51	11.01	05.09									
	1.2		04.07	05.09									
	1.4 16V		11.01	05.09									
	1.4 16V	63	05.06	05.09									
	1.4 16V	74	11.01	05.09									
	1.4 FSI		11.01	05.09									
	1.4 TDI		11.01	05.09									
	1.6 16V	77	05.06	05.09									
	1.8 GTI	110	09.05	05.09									
	1.8 GTI	132	06.06	05.09									
	1.9 SDI		11.01	05.09									
	1.9 TDI	74	11.01	05.09									
	1.9 TDI	96	10.03	05.09									
	2.0	85	04.02	05.09									
	1.2	40	11.01	05.09	PR: 1KB	24.3217-0908.3	020167	2		Rz 17,46			
	1.2	51	11.01	05.09	PR: 1KB								
	1.2		04.07	05.09	PR: 1KB								
	1.4 16V		11.01	05.09	PR: 1KB								
	1.4 FSI		11.01	05.09	PR: 1KB								
	1.4 TDI		11.01	05.09	PR: 1KB								
1.9 SDI		11.01	05.09	PR: 1KB									
	1.2	40	11.01	05.09		24.3727-0199.2	580199	2	- Schlechtwegeausführung ¹⁾	L=1580			
	1.2	51	11.01	05.09									
	1.2		04.07	05.09									
	1.4 16V		11.01	05.09									
	1.4 16V	63	05.06	05.09									
1.4 16V	74	11.01	05.09										

¹⁾ - rough road construction / - versione per percorsi accidentati / - version pour mauvaise route / - versión 4x4



									
VOLKSWAGEN POLO IV (02-09)									
	1.4 FSI			11.01	05.09	24.3727-0199.2	580199	2 ↓ - Schlechtwegeausführung 1)	L=1580
	1.4 TDI			11.01	05.09				
	1.6 16V	77		05.06	05.09				
	1.8 GTI	110		09.05	05.09				
	1.8 GTI	132		06.06	05.09				
	1.9 SDI			11.01	05.09				
	1.9 TDI	74		11.01	05.09				
	1.9 TDI	96		10.03	05.09				
	2.0	85		04.02	05.09				
	1.2			11.01	05.09	24.3727-0176.2	580176	2 ↓ + Schlechtwegeausführung 2)	L=1640
	1.2	40		11.01	05.09	24.3727-0198.2	580198	2 ↓ + Schlechtwegeausführung 2)	L=1645
	1.2	51		04.07	05.09				
	1.4 16V			11.01	05.09				
	1.4 16V	63		05.06	05.09				
	1.4 16V	74		11.01	05.09				
	1.4 FSI			11.01	05.09				
	1.4 TDI			11.01	05.09				
	1.6 16V	77		05.06	05.09				
	1.8 GTI	110		09.05	05.09				
	1.8 GTI	132		06.06	05.09				
	1.9 SDI			11.01	05.09				
	1.9 TDI	74		11.01	05.09				
	1.9 TDI	96		10.03	05.09				
	2.0	85		04.02	05.09				
	1.2			11.01	05.09	24.3727-2504.2	582504	2 ↓ + Schlechtwegeausführung 2)	L=1580
	1.2	40		11.01	05.09				
	1.2	51		04.07	05.09				
	1.4 16V			11.01	05.09				
	1.4 16V	63		05.06	05.09				
	1.4 16V	74		11.01	05.09				
	1.4 FSI			11.01	05.09				
	1.4 TDI			11.01	05.09				
	1.6 16V	77		05.06	05.09				
	1.8 GTI	110		09.05	05.09				
	1.8 GTI	132		06.06	05.09				
	1.9 SDI			11.01	05.09				
	1.9 TDI	74		11.01	05.09				
	1.9 TDI	96		10.03	05.09				
	2.0	85		04.02	05.09				
	1.2			11.01	05.09	24.3727-0197.2	580197	2 ↓	L=1645
	1.2	40		11.01	05.09				
	1.2	51		04.07	05.09				
	1.4 16V			11.01	05.09				
	1.4 16V	63		05.06	05.09				
	1.4 16V	74		11.01	05.09				
	1.4 FSI			11.01	05.09				
	1.4 TDI			11.01	05.09				
	1.6 16V	77		05.06	05.09				
	1.8 GTI	110		09.05	05.09				
	1.8 GTI	132		06.06	05.09				
	1.9 SDI			11.01	05.09				
	1.9 TDI	74		11.01	05.09				
	1.9 TDI	96		10.03	05.09				
	2.0	85		04.02	05.09				
	1.2	40		11.01	05.09	03.6583-0216.3	320247		BRL 8/3 (4) ATE
	1.4 16V			11.01	05.09	03.6584-0120.3	320279		BRL 8/4 (4) ATE
	1.4 16V	63		05.06	05.09				
	1.4 16V	74		11.01	05.09				
	1.4 FSI			11.01	05.09				
	1.4 TDI			11.01	05.09				
	1.6 16V	77		05.06	05.09				
	1.9 SDI			11.01	05.09				
	1.9 TDI	74		11.01	05.09				
	1.9 TDI	96		10.03	05.09				
	2.0	85		04.02	05.09				
	1.2			11.01	05.09	24.2415-1702.3	030096		Gz 15,87
	1.2	40		11.01	05.09				
	1.2	51		04.07	05.09				
	1.4 16V			11.01	05.09				
	1.4 16V	63		05.06	05.09				
	1.4 16V	74		11.01	05.09				
	1.4 FSI			11.01	05.09				
	1.4 TDI			11.01	05.09				
	1.6 16V	77		05.06	05.09				
	1.8 GTI	110		09.05	05.09				
	1.8 GTI	132		06.06	05.09				
	1.9 SDI			11.01	05.09				
	1.9 TDI	74		11.01	05.09				
	1.9 TDI	96		10.03	05.09				
	2.0	85		04.02	05.09				
	1.2			11.01	05.09	24.2519-1706.3	040096	für Getriebe NQ-200 3)	Nz 19,05
	1.2	40		11.01	05.09				
	1.2	51		04.07	05.09				
	1.4 16V			11.01	05.09				
	1.4 16V	63		05.06	05.09				
	1.4 16V	74		11.01	05.09				

1) - rough road construction / - versione per percorsi accidentati / - version pour mauvaise route / - versión 4x4

2) + rough road construction / + versione per percorsi accidentati / + version pour mauvaise route / + versión 4x4

3) for transmission NQ-200 / per scatola camb.NQ-200 / pour boîte de vitesse NQ-200 / caja de cambios para NMQ-200

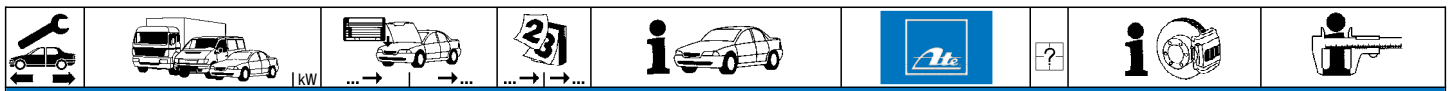

VOLKSWAGEN POLO IV (02-09)

	1.4 FSI			11.01	05.09	24.2519-1706.3	040096	für Getriebe NQ-200 ¹⁾	Nz 19,05
	1.4 TDI			11.01	05.09				
	1.6 16V	77		05.06	05.09				
	1.8 GTI	110		09.05	05.09				
	1.8 GTI	132		06.06	05.09				
	1.9 SDI			11.01	05.09				
	1.9 TDI	74		11.01	05.09				
	1.9 TDI	96		10.03	05.09				
	2.0	85		04.02	05.09				

VOLKSWAGEN POLO V (09-)

	1.0	44		01.14	PR: 1ZG,1LR,1ZJ	11.9541-9549.2	220575	☐ ☐	D=54, - Halter D=54, - Halter Hülzensatz Führungsbolzen	ATE ATE ATE ATE
	1.0	55		01.14	PR: 1ZG,1LR,1ZJ	11.9541-9550.2	220576			
	1.0	70		11.14	PR: 1ZG,1LR,1ZJ	11.0101-5409.2	260035			
	1.0 TSI	81		11.14	PR: 1ZG,1LR,1ZJ	11.8171-0008.1	990049			
	1.2	44		03.09	PR: 1ZG,1LR,1ZJ					
	1.2	51		03.09	PR: 1ZG,1LR,1ZJ					
	1.2 TDI	55		10.09	PR: 1ZG,1LR,1ZJ					
	1.2 TSI	66		05.11	PR: 1ZG,1LR,1ZJ					
	1.2 TSI	77		06.09	PR: 1ZG,1LR,1ZJ					
	1.2 TSI	81		01.14	PR: 1ZG,1LR,1ZJ					
	1.4	63		03.09	PR: 1ZG,1LR,1ZJ					
	1.4 BiFuel	60		03.10	PR: 1ZG,1LR,1ZJ					
	1.4 GTI	132		05.10	PR: 1ZG,1LR,1ZJ					
	1.4 TDI	55		03.14	PR: 1ZG,1LR,1ZJ					
	1.4 TDI	66		02.14	PR: 1ZG,1LR,1ZJ					
	1.4 TDI	77		05.14	PR: 1ZG,1LR,1ZJ					
	1.4 TSI	103		10.12	PR: 1ZG,1LR,1ZJ					
	1.4 TSI	110		05.14	PR: 1ZG,1LR,1ZJ					
	1.6			07.14	PR: 1ZG,1LR,1ZJ					
	1.6 BiFuel	60		01.11	PR: 1ZG,1LR,1ZJ					
	1.6 TDI	55		03.09	PR: 1ZG,1LR,1ZJ					
	1.6 TDI	66		06.09	PR: 1ZG,1LR,1ZJ					
	1.6 TDI	77		06.09	PR: 1ZG,1LR,1ZJ					
	1.8 GTI	141		11.14	PR: 1ZG,1LR,1ZJ					
	2.0 R WRC	162		08.13	PR: 1ZG,1LR,1ZJ					
	1.0	44		01.14	PR: 1LN,1ZC	11.9541-9553.2	220563	☐ ☐	D=54, - Halter D=54, - Halter Führungsbolzen Hülzensatz Haltefeder	ATE ATE ATE ATE ATE
	1.0	55		01.14	PR: 1LN,1ZC	11.9541-9554.2	220564			
	1.0	70		11.14	PR: 1LN,1ZC	11.8171-0008.1	990049			
	1.0 TSI	81		11.14	PR: 1LN,1ZC	11.0101-5409.2	260035			
	1.2	44		03.09	PR: 1LN,1ZC	11.8116-0351.1	390538	2		
	1.2	51		03.09	PR: 1LN,1ZC					
	1.2 TDI	55		10.09	PR: 1LN,1ZC					
	1.2 TSI	66		05.11	PR: 1LN,1ZC					
	1.2 TSI	77		06.09	PR: 1LN,1ZC					
	1.2 TSI	81		01.14	PR: 1LN,1ZC					
	1.4	63		03.09	PR: 1LN,1ZC					
	1.4 BiFuel	60		03.10	PR: 1LN,1ZC					
	1.4 GTI	132		05.10	PR: 1LN,1ZC					
	1.4 TDI	55		03.14	PR: 1LN,1ZC					
	1.4 TDI	66		02.14	PR: 1LN,1ZC					
	1.4 TDI	77		05.14	PR: 1LN,1ZC					
	1.4 TSI	103		10.12	PR: 1LN,1ZC					
	1.4 TSI	110		05.14	PR: 1LN,1ZC					
	1.6			07.14	PR: 1LN,1ZC					
	1.6 BiFuel	60		01.11	PR: 1LN,1ZC					
	1.6 TDI	55		03.09	PR: 1LN,1ZC					
	1.6 TDI	66		06.09	PR: 1LN,1ZC					
	1.6 TDI	77		06.09	PR: 1LN,1ZC					
	1.8 GTI	141		11.14	PR: 1LN,1ZC					
	2.0 R WRC	162		08.13	PR: 1LN,1ZC					
	1.2	44		03.09	PR: 1ZD	11.9541-9553.2	220563	☐ ☐	D=54, - Halter D=54, - Halter Hülzensatz Führungsbolzen Haltefeder	ATE ATE ATE ATE ATE
	1.2	51		03.09	PR: 1ZD	11.9541-9554.2	220564			
	1.2 TDI	55		10.09	PR: 1ZD	11.0101-5409.2	260035			
	1.2 TSI	66		05.11	PR: 1ZD	11.8171-0008.1	990049			
	1.2 TSI	77		06.09	PR: 1ZD	11.8116-0351.1	390538	2		
	1.2 TSI	81		01.14	PR: 1ZD					
	1.4	63		03.09	PR: 1ZD					
	1.4 BiFuel	60		03.10	PR: 1ZD					
	1.4 GTI	132		05.10	PR: 1ZD					
	1.4 TSI	103		10.12	PR: 1ZD					
	1.6			07.14	PR: 1ZD					
	1.6 BiFuel	60		01.11	PR: 1ZD					
	1.6 TDI	55		03.09	PR: 1ZD					
	1.6 TDI	66		06.09	PR: 1ZD					
	1.6 TDI	77		06.09	PR: 1ZD					
	2.0 R WRC	162		08.13	PR: 1ZD					
	1.2	44		03.09	PR: 1ZP,1ZR	11.9541-9553.2	220563	☐ ☐	D=54, - Halter D=54, - Halter Hülzensatz Führungsbolzen Haltefeder	ATE ATE ATE ATE ATE
	1.2	51		03.09	PR: 1ZP,1ZR	11.9541-9554.2	220564			
	1.2 TDI	55		10.09	PR: 1ZP,1ZR	11.0101-5409.2	260035			
	1.2 TSI	66		05.11	PR: 1ZP,1ZR	11.8171-0008.1	990049			
	1.2 TSI	77		06.09	PR: 1ZP,1ZR	11.8116-0351.1	390538	2		
	1.2 TSI	81		01.14	PR: 1ZP,1ZR					
	1.4	63		03.09	PR: 1ZP,1ZR					
	1.4 BiFuel	60		03.10	PR: 1ZP,1ZR					
	1.4 GTI	132		05.10	PR: 1ZP,1ZR					
	1.4 TSI	103		10.12	PR: 1ZP,1ZR					

¹⁾ for transmission NQ-200 / per scatola camb.NQ-200 / pour boîte de vitesse NQ-200 / caja de cambios para NMQ-200



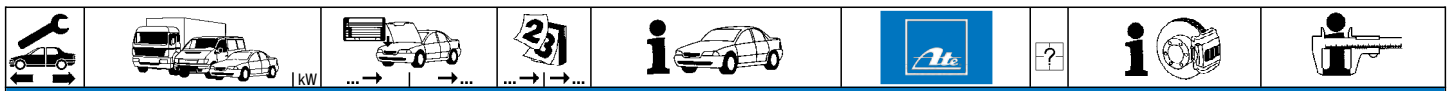

VOLKSWAGEN POLO V (09-)

	1.6		07.14	PR: 1ZP,1ZR	11.9541-9553.2	220563	2		D=54, - Halter ATE D=54, - Halter ATE Hülensatz ATE Führungsbolzen ATE Halterfeder ATE	ATE					
	1.6 BiFuel	60	01.11	PR: 1ZP,1ZR	11.9541-9554.2	220564									
	1.6 TDI	55	03.09	PR: 1ZP,1ZR	11.0101-5409.2	260035									
	1.6 TDI	66	06.09	PR: 1ZP,1ZR	11.8171-0008.1	990049									
	1.6 TDI	77	06.09	PR: 1ZP,1ZR	11.8116-0351.1	390538									
	1.8 GTI	141	11.14	PR: 1ZP,1ZR											
2.0 R WRC	162	08.13	PR: 1ZP,1ZR												
	1.0	44	01.14	PR: 1KK,1KT,2EJ	24.3387-1735.5	240657	2		D=38, - Halter TRW D=38, - Halter TRW	TRW					
	1.0	55	01.14	PR: 1KK,1KT,2EJ	24.3387-1736.5	240658									
	1.0	70	11.14	PR: 1KK,1KT,2EJ											
	1.0 TSI	81	11.14	PR: 1KK,1KT,2EJ											
	1.2	44	03.09	PR: 1KK,1KT,2EJ											
	1.2	51	03.09	PR: 1KK,1KT,2EJ											
	1.2 TDI	55	10.09	PR: 1KK,1KT,2EJ											
	1.2 TSI	66	05.11	PR: 1KK,1KT,2EJ											
	1.2 TSI	77	06.09	PR: 1KK,1KT,2EJ											
	1.2 TSI	81	01.14	PR: 1KK,1KT,2EJ											
	1.4	63	03.09	PR: 1KK,1KT,2EJ											
	1.4 BiFuel	60	03.10	PR: 1KK,1KT,2EJ											
	1.4 GTI	132	05.10	PR: 1KK,1KT,2EJ											
	1.4 TDI	55	03.14	PR: 1KK,1KT,2EJ											
	1.4 TDI	66	02.14	PR: 1KK,1KT,2EJ											
	1.4 TDI	77	05.14	PR: 1KK,1KT,2EJ											
	1.4 TSI	103	10.12	PR: 1KK,1KT,2EJ											
	1.4 TSI	110	05.14	PR: 1KK,1KT,2EJ											
	1.6		07.14	PR: 1KK,1KT,2EJ											
	1.6 BiFuel	60	01.11	PR: 1KK,1KT,2EJ											
	1.6 TDI	55	03.09	PR: 1KK,1KT,2EJ											
	1.6 TDI	66	06.09	PR: 1KK,1KT,2EJ											
	1.6 TDI	77	06.09	PR: 1KK,1KT,2EJ											
	1.8 GTI	141	11.14	PR: 1KK,1KT,2EJ											
2.0 R WRC	162	08.13	PR: 1KK,1KT,2EJ												
	1.2	44	03.09	PR: 1KV	24.3387-1735.5	240657	2		D=38, - Halter TRW D=38, - Halter TRW	TRW					
	1.2	51	03.09	PR: 1KV	24.3387-1736.5	240658									
	1.2 TDI	55	10.09	PR: 1KV											
	1.2 TSI	66	05.11	PR: 1KV											
	1.2 TSI	77	06.09	PR: 1KV											
	1.2 TSI	81	01.14	PR: 1KV											
	1.4	63	03.09	PR: 1KV											
	1.4 BiFuel	60	03.10	PR: 1KV											
	1.4 GTI	132	05.10	PR: 1KV											
	1.4 TSI	103	10.12	PR: 1KV											
	1.6		07.14	PR: 1KV											
	1.6 BiFuel	60	01.11	PR: 1KV											
	1.6 TDI	55	03.09	PR: 1KV											
	1.6 TDI	66	06.09	PR: 1KV											
	1.6 TDI	77	06.09	PR: 1KV											
	1.8 GTI	141	11.14	PR: 1KV											
	2.0 R WRC	162	08.13	PR: 1KV											
		1.0	44	01.14		83.7858-0140.3					330837	2		L=140	
		1.0	55	01.14											
		1.0	70	11.14											
		1.0 TSI	81	11.14											
		1.2	44	03.09											
		1.2	51	03.09											
		1.2 TDI	55	10.09											
1.2 TSI		66	05.11												
1.2 TSI		77	06.09												
1.2 TSI		81	01.14												
1.4		63	03.09												
1.4 BiFuel		60	03.10												
1.4 GTI		132	05.10												
1.4 TDI		55	03.14												
1.4 TDI		66	02.14												
1.4 TDI		77	05.14												
1.4 TSI		103	10.12												
1.4 TSI		110	05.14												
1.6			07.14												
1.6 BiFuel		60	01.11												
1.6 TDI		55	03.09												
1.6 TDI		66	06.09												
1.6 TDI		77	06.09												
1.8 GTI		141	11.14												
2.0 R WRC	162	08.13													
	1.0	44	01.14		83.7858-0140.3	330837	2		L=140						
	1.0	55	01.14												
	1.0	70	11.14												
	1.0 TSI	81	11.14												
	1.2	44	03.09												
	1.2	51	03.09												
	1.2 TDI	55	10.09												
	1.2 TSI	66	05.11												
	1.2 TSI	77	06.09												
	1.2 TSI	81	01.14												
	1.4	63	03.09												
	1.4 BiFuel	60	03.10												
1.4 TDI	55	03.14													

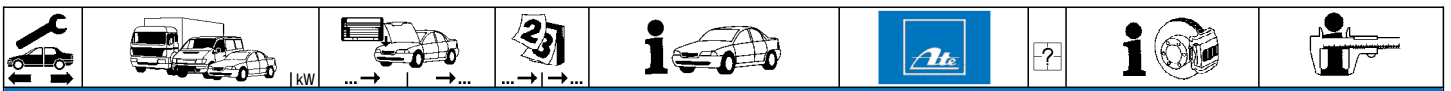



VOLKSWAGEN POLO V (09-)









	1.4 TDI 66 1.4 TDI 77 1.4 TSI 103 1.4 TSI 110 1.6 1.6 BiFuel 60 1.6 TDI 55 1.6 TDI 66 1.6 TDI 77		02.14 05.14 10.12 05.14 07.14 01.11 03.09 06.09 06.09		83.7858-0140.3	330837	2		L=140
	1.2 44 1.2 51 1.2 TDI 55 1.2 TSI 66 1.2 TSI 77 1.2 TSI 81 1.4 63 1.4 BiFuel 60 1.4 TDI 55 1.4 TDI 66 1.4 TDI 77 1.4 TSI 103 1.4 TSI 110 1.6 1.6 BiFuel 60 1.6 TDI 55 1.6 TDI 66 1.6 TDI 77		03.09 03.09 10.09 05.11 06.09 01.14 03.09 03.10 03.14 02.14 05.14 10.12 05.14 07.14 01.11 03.09 06.09 06.09	PR: 1KB PR: 1KB PR: 1KB PR: 1KB PR: 1KB PR: 1KB PR: 1KB PR: 1KB PR: 1KB PR: 1KB PR: 1KB PR: 1KB PR: 1KB PR: 1KB PR: 1KB PR: 1KB PR: 1KB	24.3217-0908.3	020167			Rz 17,46
	1.0 44 1.0 55 1.0 70 1.0 TSI 81 1.2 44 1.2 51 1.2 TDI 55 1.2 TSI 66 1.2 TSI 77 1.2 TSI 81 1.4 63 1.4 BiFuel 60 1.4 TDI 55 1.4 TDI 66 1.4 TDI 77 1.4 TSI 103 1.4 TSI 110 1.6 1.6 BiFuel 60 1.6 TDI 55 1.6 TDI 66 1.6 TDI 77		01.14 01.14 11.14 11.14 03.09 03.09 10.09 05.11 06.09 01.14 03.09 03.10 03.14 02.14 05.14 10.12 05.14 07.14 01.11 03.09 06.09 06.09	PR: 1KM PR: 1KM	24.3219-0909.3	020188			Rz 19,05
	1.0 44 1.0 55 1.0 70 1.0 TSI 81 1.2 44 1.2 51 1.2 TDI 55 1.2 TSI 66 1.2 TSI 77 1.2 TSI 81 1.4 63 1.4 BiFuel 60 1.4 TDI 55 1.4 TDI 66 1.4 TDI 77 1.4 TSI 103 1.4 TSI 110 1.6 1.6 BiFuel 60 1.6 TDI 55 1.6 TDI 66 1.6 TDI 77		01.14 01.14 11.14 11.14 03.09 03.09 10.09 05.11 06.09 01.14 03.09 03.10 03.14 02.14 05.14 10.12 05.14 07.14 01.11 03.09 06.09 06.09	PR: 1KM PR: 1KM	24.3727-3402.2	583402	2		L=1588
	1.0 44 1.0 55 1.0 70 1.0 TSI 81 1.2 44 1.2 51 1.2 TDI 55 1.2 TSI 66 1.2 TSI 77 1.2 TSI 81 1.4 63 1.4 BiFuel 60 1.4 GTI 132 1.4 TDI 55 1.4 TDI 66 1.4 TDI 77		01.14 01.14 11.14 11.14 03.09 03.09 10.09 05.11 06.09 01.14 03.09 03.10 05.10 03.14 02.14 05.14	PR: 1KK,1KT,1KV,2EJ PR: 1KK,1KT,1KV,2EJ PR: 1KK,1KT,1KV,2EJ PR: 1KK,1KT,1KV,2EJ PR: 1KK,1KT,1KV,2EJ PR: 1KK,1KT,1KV,2EJ PR: 1KK,1KT,1KV,2EJ PR: 1KK,1KT,1KV,2EJ PR: 1KK,1KT,1KV,2EJ PR: 1KK,1KT,1KV,2EJ PR: 1KK,1KT,1KV,2EJ PR: 1KK,1KT,1KV,2EJ PR: 1KK,1KT,1KV,2EJ PR: 1KK,1KT,1KV,2EJ PR: 1KK,1KT,1KV,2EJ PR: 1KK,1KT,1KV,2EJ	24.3727-3403.2	583403	2		L=1642



VOLKSWAGEN POLO V (09-)

	1.4 TSI 103 1.4 TSI 110 1.6 60 1.6 BiFuel 55 1.6 TDI 66 1.6 TDI 77 1.8 GTI 141 2.0 R WRC 162		10.12 05.14 07.14 01.11 03.09 06.09 06.09 11.14 08.13	PR: 1KK,1KT,1KV,2EJ PR: 1KK,1KT,1KV,2EJ PR: 1KK,1KT,1KV,2EJ PR: 1KK,1KT,1KV,2EJ PR: 1KK,1KT,1KV,2EJ PR: 1KK,1KT,1KV,2EJ PR: 1KK,1KT,1KV,2EJ PR: 1KK,1KT,1KV,2EJ PR: 1KK,1KT,1KV,2EJ	24.3727-3403.2 583403	2 ↓	L=1642
	1.0 44 1.0 55 1.0 70 1.0 TSI 81 1.2 44 1.2 51 1.2 TDI 55 1.2 TSI 66 1.2 TSI 77 1.2 TSI 81 1.4 63 1.4 BiFuel 60 1.4 GTI 132 1.4 TDI 55 1.4 TDI 66 1.4 TDI 77 1.4 TSI 103 1.4 TSI 110 1.6 60 1.6 BiFuel 55 1.6 TDI 66 1.6 TDI 77 1.8 GTI 141 2.0 R WRC 162		01.14 01.14 11.14 11.14 03.09 03.09 10.09 05.11 06.09 01.14 03.09 03.10 05.10 03.14 02.14 05.14 10.12 05.14 07.14 01.11 03.09 06.09 06.09 11.14 08.13	PR: OEM PR: OEM	24.2519-1706.3 040096		Nz 19,05

VOLKSWAGEN POLO Classic (96-01)

	1.4 1.6 1.7 SDI 1.9 SDI	◀	12.95 09.97 07.97 12.95	09.01 - ABS 09.01 - ABS 09.01 - ABS 09.01 - ABS	03.7740-1402.4 300133		8"	ATE
	1.6 1.8 1.9 TDI 1.9 TDI 2.0	◀	12.95 03.98 09.96 06.98 03.99	09.01 - ABS 09.01 - ABS/ +  09.01 - ABS 09.01 - ABS 09.01 - ABS/ + 	03.7750-6302.4 300161		9"	ATE
	1.4 1.6 1.6 1.7 SDI 1.8 1.9 SDI 1.9 TDI 1.9 TDI 2.0	◀	12.95 11.95 05.96 07.97 03.98 12.95 09.96 06.98 03.99	09.01 + ABS 09.01 + ABS 09.01 + ABS 09.01 + ABS 09.01 + ABS/ +  09.01 + ABS 09.01 + ABS 09.01 + ABS 09.01 + ABS/ + 	10.6350-3902.4 300213 10.6350-4002.4 300285	PR: 1KB PR: 1KK,1KM,1KQ	9" 9"	ATE ATE
	1.4 1.4 1.6 1.6 1.7 SDI 1.7 SDI 1.9 SDI 1.9 SDI	▶	12.95 12.95 09.01 11.97 07.97 12.95 12.95	- ABS - ABS - ABS - ABS - ABS - ABS - ABS	03.2120-3943.3 010532		Thz 20,64	ATE
	1.6 1.6 1.6 1.9 TDI 1.9 TDI 1.9 TDI 1.9 TDI 2.0	▶	11.95 12.95 12.95 09.96 09.96 06.98 06.98 03.99	- ABS - ABS - ABS - ABS - ABS - ABS - ABS - ABS/ + 	03.2122-1042.3 010137		Thz 22,20	ATE
	1.4 1.6 1.6 1.7 SDI 1.8 1.9 SDI 1.9 TDI 1.9 TDI	▶	12.95 11.95 05.96 07.97 03.98 12.95 09.96 06.98	+ ABS + ABS + ABS + ABS + ABS/ +  + ABS + ABS + ABS	03.2122-1144.3 010636		Thz 22,20	ATE
	1.4 1.6 1.6 1.7 SDI 1.9 SDI 1.9 TDI 1.9 TDI	▶	12.95 11.95 05.96 07.97 12.95 09.96 06.98	+ ABS + ABS + ABS + ABS + ABS + ABS + ABS	03.2122-1184.3 010592		Thz 22,20	ATE



VOLKSWAGEN POLO Classic (96-01)

	1.4		6K-V-022628	12.95	- ABS	24.3481-1745.5	240277		D=48, - Halter	ATE							
						24.3481-1746.5	240278		D=48, - Halter	ATE							
	1.4		6K-V-022629	12.95	+ ABS	11.0441-4808.2	250022		Dichtungssatz	ATE							
	1.4											09.01	11.0101-4801.2	260006	Hülsensatz	ATE	
	1.6	55										05.96	09.01	24.0102-4803.2	260008	Hülsensatz+Schrauben	ATE
	1.7 SDI											07.97	09.01				
	1.9 SDI											12.95	09.01				
	1.6	55		05.96	09.01	24.3541-1609.5	240039			D=54, - Halter	TRW						
	1.6	74		05.96	09.01	24.3541-1610.5	240040			D=54, - Halter	TRW						
	1.8			03.98	09.01	+ MEX	24.0101-4301.2			260047	Bremssattel-Zubehör	TRW					
	1.9 TDI	66		09.96	09.01		11.0101-5403.2			260010	Faltenbalgsatz	TRW					
	1.9 TDI	81		06.98	09.01												
2.0	85		03.99	09.01	+ MEX												
	1.4			12.95	09.01	24.5105-0442.3	331432		L=442								
	1.6	55		11.95	09.01												
	1.6	74		05.96	09.01												
	1.7 SDI			07.97	09.01												
	1.8			03.98	09.01												
	1.9 SDI			12.95	09.01												
	1.9 TDI	66		09.96	09.01												
	1.9 TDI	81		06.98	09.01												
	2.0	85		03.99	09.01												
	1.9 TDI	81		06.98	09.99						24.3384-1737.5	240301		D=38, - Halter	TRW		
1.9 TDI	81		10.99	09.01	24.3384-1738.5	240302	D=38, - Halter	TRW									
	1.4			12.95	09.99	24.3344-1711.7	220539		D=34, - Halter	TRW							
	1.6	55		11.95	09.99						24.3344-1712.7	220540	D=34, - Halter	TRW			
	1.6	74		05.96	09.99												
	1.7 SDI			07.97	09.99												
	1.8			03.98	09.99						+ MEX						
	1.9 SDI			12.95	09.99												
	1.9 TDI	66		09.96	09.99												
	1.9 TDI	81		06.98	09.99												
	2.0	85		03.99	09.99						+ MEX						
		1.4			10.99						09.01	83.7858-0140.3	330837		L=140		
1.6		55		10.99	09.01												
1.6		74		10.99	09.01												
1.7 SDI				10.99	09.01												
1.8				10.99	09.01												
1.9 SDI				10.99	09.01												
1.9 TDI		66		10.99	09.01												
1.9 TDI		81		10.99	09.01												
2.0		85		10.99	09.01												
		1.4			12.95	09.01	03.3217-2112.3	020027		Rz 17,46							
	1.6	55		11.95	09.01	03.3217-0908.3						020167	+ ALU 2)	Rz 17,46			
	1.4			12.95	09.01	+ ABS						24.3219-0909.3	020188	Rz 19,05			
	1.6	55		11.95	09.01	+ ABS											
	1.6	74		12.95	09.01												
	1.7 SDI			07.97	09.01												
	1.8			03.98	09.01	+ MEX											
	1.9 SDI			12.95	09.01												
	1.9 TDI	66		09.96	09.01												
	2.0	85		03.99	09.01	+ MEX											
	1.4		6K-V-013236	12.95	- ABS	24.3727-0161.2	580161		L=1512								
	1.6	55	6K-V-013236	11.95	- ABS												
	1.4		6K-V-013237	09.01	- ABS												
	1.6	55	6K-V-013237	09.01	- ABS												
	1.4		6K-W-591018	12.95	+ ABS												
	1.6	55	6K-W-591018	11.95	+ ABS												
	1.6	74	6K-W-591018	12.95													
	1.7 SDI		6K-W-591018	07.97													
	1.8		6K-W-591018	03.98	+ MEX												
	1.9 SDI		6K-W-591018	12.95													
1.9 TDI	66	6K-W-591018	09.96														
1.4		6K-W-591019	09.01	+ ABS	24.3727-0162.2	580162		L=1514									
1.6	55	6K-W-591019	09.01	+ ABS													
1.6	74	6K-W-591019	09.01														
1.7 SDI		6K-W-591019	09.01														
1.8		6K-W-591019	09.01	+ MEX													
1.9 SDI		6K-W-591019	09.01														
1.9 TDI	66	6K-W-591019	09.01														
2.0	85	6K-W-591019	03.99	+ MEX													
1.9 TDI	81	6K-W-591019	09.01	+ MEX													
1.9 TDI	81	6K-W-591019	09.01														
	1.4			12.95	09.01	03.6584-0113.3	320111		BRL 8/4 (4)	ATE							
	1.6	55		11.95	09.01												
	1.6	74		05.96	09.01												
	1.7 SDI			07.97	09.01												
	1.8			03.98	09.01												
	1.9 SDI			12.95	09.01												
	1.9 TDI	66		09.96	09.01												
	1.9 TDI	85		03.99	09.01												
	1.9 TDI	85		03.99	09.01												
	1.9 TDI	66		09.96	09.01												

1) + cast iron / + ghisa / + fonte grise / + fundición de gris

2) + aluminium / + alluminio / + aluminium / + aluminio



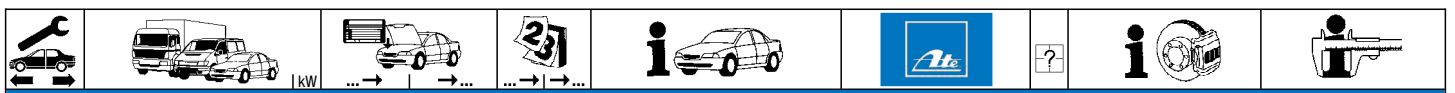





















VOLKSWAGEN POLO Classic (96-01)

	1.9 TDI	81		06.98	09.01		03.6583-0179.3	320228		BRL 8/3 (4)	ATE
	1.9 TDI	66		09.96	09.01		03.2419-9510.3	030028		Gz 19,05	
	1.9 TDI	81		06.98	09.01						
	1.9 TDI	66		09.96	09.01		24.2523-0908.3	040049		Nz 23,81	
	1.9 TDI	81		06.98	09.01						
	1.4	◀		12.95	09.01		24.3728-2707.2	592707		L=1047, + AUT	
	1.6	◀ 55		05.96	09.01						
	1.6	◀ 74		11.95	09.01		24.3728-0128.2	590128		L=854, + AUT	
	1.8	◀		03.98	09.01	+ MEX					
	1.9 SDI	◀		12.95	09.01						
	2.0	◀ 85		03.99	09.01	+ MEX					

VOLKSWAGEN POLO Variant (97-01)

	1.4	◀		03.97	09.01	- ABS	03.7740-1402.4	300133		8"	ATE
	1.6	◀		05.97	09.01	- ABS	03.7750-6302.4	300161		9"	ATE
	1.7 SDI	◀		08.97	09.01	- ABS					
	1.8	◀		05.97	09.01	- ABS					
	1.9 SDI	◀		03.97	09.01	- ABS					
	1.9 TDI	◀ 66		01.97	09.01	- ABS					
	1.9 TDI	◀ 81		06.98	09.01	- ABS					
	1.4	◀		03.97	09.01	PR: 1KB	10.6350-3902.4	300213	+ ABS	9"	ATE
	1.6	◀		05.97	09.01	PR: 1KB					
	1.7 SDI	◀		08.97	09.01	PR: 1KB					
	1.8	◀		05.97	09.01	PR: 1KB					
	1.9 SDI	◀		03.97	09.01	PR: 1KB					
	1.9 TDI	◀ 66		01.97	09.01	PR: 1KB					
	1.9 TDI	◀ 81		06.98	09.01	PR: 1KB					
	1.4	◀		03.97	09.01	- ABS	03.2122-1042.3	010137		Thz 22,20	ATE
	1.6	◀		05.97	09.01	- ABS					
	1.7 SDI	◀		08.97	09.01	- ABS					
	1.8	◀		05.97	09.01	- ABS					
	1.9 SDI	◀		03.97	09.01	- ABS					
	1.9 TDI	◀ 66		01.97	09.01	- ABS					
	1.9 TDI	◀ 81		06.98	09.01	- ABS					
	1.4	◀		03.97	09.01	+ ABS	03.2122-1144.3	010636		Thz 22,20	ATE
	1.6	◀		05.97	09.01	+ ABS					
	1.7 SDI	◀		08.97	09.01	+ ABS					
	1.8	◀		05.97	09.01	+ ABS					
	1.9 SDI	◀		03.97	09.01	+ ABS					
	1.9 TDI	◀ 66		01.97	09.01	+ ABS					
	1.9 TDI	◀ 81		06.98	09.01	+ ABS					
	1.4	▶		03.97	09.01	+ ABS	03.2122-1184.3	010592		Thz 22,20	ATE
	1.6	▶		05.97	09.01	+ ABS					
	1.7 SDI	▶		08.97	09.01	+ ABS					
	1.8	▶		05.97	09.01	+ ABS					
	1.9 SDI	▶		03.97	09.01	+ ABS					
	1.9 TDI	▶ 66		01.97	09.01	+ ABS					
	1.9 TDI	▶ 81		06.98	09.01	+ ABS					
	1.4	◀		03.97	09.01	- ABS	24.3481-1745.5	240277		D=48, - Halter	ATE
	1.4	◀		03.97	09.01	- ABS	24.3481-1746.5	240278		D=48, - Halter	ATE
	1.4	◀		03.97	09.01	- ABS	11.0441-4808.2	250022		Dichtungssatz	ATE
	1.4	◀		03.97	09.01	- ABS	11.0101-4803.2	260008		Hülzensatz	ATE
	1.4	◀		03.97	09.01	- ABS	24.0102-4803.2	260086		Hülzensatz+Schrauben	ATE
	1.4	◀		03.97	09.01	+ ABS	11.0441-4808.2	250022		Dichtungssatz	ATE
	1.6	◀ 55		05.97	09.01	+ ABS	11.0101-4801.2	260006		Hülzensatz	ATE
	1.7 SDI	◀		08.97	09.01		24.0102-4801.2	260085		Hülzensatz+Schrauben	ATE
	1.9 SDI	◀		03.97	09.01						
	1.6	◀ 74		05.97	09.01		24.3541-1609.5	240039		D=54, - Halter	TRW
	1.8	◀		05.97	09.01		24.3541-1610.5	240040		D=54, - Halter	TRW
	1.9 TDI	◀ 66		01.97	09.01		24.0101-4301.2	260047		Bremssattel-Zubehör	TRW
	1.9 TDI	◀ 81		06.98	09.01		11.0101-5403.2	260010		Faltenbalgsatz	TRW
	1.4	◀		03.97	09.01		24.5105-0442.3	331432	2	L=442	
	1.6	◀		05.97	09.01						
	1.7 SDI	◀		08.97	09.01						
	1.8	◀		05.97	09.01						
	1.9 SDI	◀		03.97	09.01						
	1.9 TDI	◀ 66		01.97	09.01						
	1.9 TDI	◀ 81		06.98	09.01						
	1.9 TDI	◀ 81		06.98	09.01		24.3384-1723.7	220523		D=38(M12x1), - Halter	TRW
	1.9 TDI	◀ 81		06.98	09.01		24.3384-1724.7	220524		D=38(M12x1), - Halter	TRW
	1.4	◀	6K-X-609999	03.97			24.5230-0143.3	330402	2	L=143	
	1.6	◀	6K-X-609999	05.97							
	1.7 SDI	◀	6K-X-609999	08.97							
	1.8	◀	6K-X-609999	05.97							
	1.9 SDI	◀	6K-X-609999	03.97							
	1.9 TDI	◀ 66	6K-X-609999	01.97							
	1.9 TDI	◀ 81	6K-X-609999	06.98							
	1.4	◀	6K-X-610000		09.01		83.7858-0140.3	330837	2	L=140	
	1.6	◀	6K-X-610000		09.01						
	1.7 SDI	◀	6K-X-610000		09.01						

VOLKSWAGEN POLO Variant (97-01)										
										
1.8 1.9 SDI 1.9 TDI 1.9 TDI	6K-X-610000 6K-X-610000 66 6K-X-610000 81 6K-X-610000			09.01 09.01 09.01 09.01					83.7858-0140.3 330837 2	L=140
	1.4 1.6 1.7 SDI 1.8 1.9 SDI 1.9 TDI	66		03.97 05.97 08.97 05.97 03.97 01.97	09.01 09.01 09.01 09.01 09.01 09.01				24.3219-0909.3 020188	Rz 19,05
	1.4 1.6 1.7 SDI 1.8 1.9 SDI 1.9 TDI	66	6K-W-591018 6K-W-591018 6K-W-591018 6K-W-591018 6K-W-591018 6K-W-591018	03.97 05.97 08.97 05.97 03.97 01.97					24.3727-0161.2 580161 2 ↓	L=1512
	1.4 1.6 1.7 SDI 1.8 1.9 SDI 1.9 TDI	66	6K-W-591019 6K-W-591019 6K-W-591019 6K-W-591019 6K-W-591019 6K-W-591019	09.01 09.01 09.01 09.01 09.01 09.01					24.3727-0162.2 580162 2 ↓	L=1514
	1.4 1.6 1.9 SDI			06.98 03.97 05.97 03.97	09.01 09.01 09.01 09.01				24.3727-0165.2 580165 2 ↓	L=1641
	1.8 1.9 TDI 1.9 TDI	66 81		05.97 01.97 06.98	09.01 09.01 09.01				03.6584-0113.3 320111	BRL 8/4 (4) ATE
	1.9 TDI 1.9 TDI	66 81		01.97 06.98	09.01 09.01				03.6583-0179.3 320228	BRL 8/3 (4) ATE
	1.9 TDI 1.9 TDI	66 81		01.97 06.98	09.01 09.01				03.2419-9510.3 030028	Gz 19,05
	1.9 TDI 1.9 TDI	66 81		01.97 06.98	09.01 09.01				24.2523-0908.3 040049	Nz 23,81
	1.4 1.6 1.6	55 74		03.97 05.97 05.97	09.01 09.01 09.01				24.3728-2707.2 592707	L=1047, + AUT
									24.3728-0128.2 590128	L=854, + AUT
VOLKSWAGEN SCIROCCO (08-)										
	1.4 TSI 1.4 TSI 1.4 TSI 2.0 R 2.0 R 2.0 TDI 2.0 TDI 2.0 TDI 2.0 TDI 2.0 TDI 2.0 TSI 2.0 TSI 2.0 TSI 2.0 TSI	90 92 118 195 206 103 110 125 130 132 147 155 162		09.08 11.13 08.08 11.09 08.14 10.08 11.13 05.09 01.13 11.13 08.08 11.09 11.13	PR: 12A,1ZE,1LJ PR: 12A,1ZE,1LJ PR: 12A,1ZE,1LJ PR: 12A,1ZE,1LJ PR: 12A,1ZE,1LJ PR: 12A,1ZE,1LJ PR: 12A,1ZE,1LJ PR: 12A,1ZE,1LJ PR: 12A,1ZE,1LJ PR: 12A,1ZE,1LJ PR: 12A,1ZE,1LJ PR: 12A,1ZE,1LJ PR: 12A,1ZE,1LJ PR: 12A,1ZE,1LJ				03.7863-3332.4 300308	Kolbendurchmesser Ø 23,81mm ¹⁾ 10" ATE
	1.4 TSI 1.4 TSI 1.4 TSI 2.0 R 2.0 R 2.0 TDI 2.0 TDI 2.0 TDI 2.0 TDI 2.0 TDI 2.0 TSI 2.0 TSI 2.0 TSI 2.0 TSI	90 92 118 195 206 103 110 125 130 132 147 155 162		09.08 11.13 08.08 11.09 08.14 10.08 11.13 05.09 01.13 11.13 08.08 11.09 11.13	PR: 12D,1ZP PR: 12D,1ZP PR: 12D,1ZP PR: 12D,1ZP PR: 12D,1ZP PR: 12D,1ZP PR: 12D,1ZP PR: 12D,1ZP PR: 12D,1ZP PR: 12D,1ZP PR: 12D,1ZP PR: 12D,1ZP PR: 12D,1ZP				03.7863-3232.4 300307	Kolbendurchmesser Ø 22,20mm ²⁾ 10" ATE
	1.4 TSI 1.4 TSI 1.4 TSI 2.0 R 2.0 R 2.0 TDI 2.0 TDI 2.0 TDI 2.0 TDI 2.0 TDI 2.0 TSI 2.0 TSI 2.0 TSI 2.0 TSI	90 92 118 195 206 103 110 125 130 132 147 155 162		09.08 11.13 08.08 11.09 08.14 10.08 11.13 05.09 01.13 11.13 08.08 11.09 11.13	PR: 12K PR: 12K PR: 12K PR: 12K PR: 12K PR: 12K PR: 12K PR: 12K PR: 12K PR: 12K PR: 12K PR: 12K PR: 12K				03.7860-8802.4 300291	10" ATE
	1.4 TSI 1.4 TSI 1.4 TSI 2.0 R 2.0 R 2.0 TDI	90 92 118 195 206 103		09.08 11.13 08.08 11.09 08.14 10.08	PR: 12D,1ZP PR: 12D,1ZP PR: 12D,1ZP PR: 12D,1ZP PR: 12D,1ZP PR: 12D,1ZP				03.2122-2129.3 010799	Thz 22,20 ATE

¹⁾ piston diameter Ø 23,81mm / diametro del pistone Ø 23,81mm / diamètre de piston Ø 23,81mm / diámetro del pistón Ø 23,81mm

















²⁾ piston diameter Ø 22,20mm / diametro del pistone Ø 22,20mm / diamètre de piston Ø 22,20mm / diámetro del pistón Ø 22,20mm





VOLKSWAGEN SCIROCCO (08-)

	2.0 TDI 2.0 TDI 2.0 TDI 2.0 TSI 2.0 TSI 2.0 TSI	◀110 ◀125 ◀130 ◀132 ◀147 ◀155 ◀162	11.13 05.09 01.13 11.13 08.08 11.09 11.13	PR: 1ZD,1ZP PR: 1ZD,1ZP PR: 1ZD,1ZP PR: 1ZD,1ZP PR: 1ZD,1ZP PR: 1ZD,1ZP	03.2122-2129.3	010799		Thz 22,20	ATE
	1.4 TSI 1.4 TSI 1.4 TSI 2.0 R 2.0 R 2.0 TDI 2.0 TDI 2.0 TDI 2.0 TDI 2.0 TSI 2.0 TSI 2.0 TSI	◀ 90 ◀ 92 ◀118 ◀195 ◀206 ◀103 ◀110 ◀125 ◀130 ◀132 ◀147 ◀155 ◀162	09.08 11.13 08.08 11.09 08.14 10.08 11.13 01.13 11.13 11.13 08.08 11.09 11.13	PR: 1ZA,1ZE,1LJ,1ZK PR: 1ZA,1ZE,1LJ,1ZK PR: 1ZA,1ZE,1LJ,1ZK PR: 1ZA,1ZE,1LJ,1ZK PR: 1ZA,1ZE,1LJ,1ZK PR: 1ZA,1ZE,1LJ,1ZK PR: 1ZA,1ZE,1LJ,1ZK PR: 1ZA,1ZE,1LJ,1ZK PR: 1ZA,1ZE,1LJ,1ZK PR: 1ZA,1ZE,1LJ,1ZK PR: 1ZA,1ZE,1LJ,1ZK PR: 1ZA,1ZE,1LJ,1ZK	03.2123-3449.3	010808		Thz 23,81	ATE
	1.4 TSI 1.4 TSI 1.4 TSI 2.0 R 2.0 R 2.0 TDI 2.0 TDI 2.0 TDI 2.0 TDI 2.0 TSI 2.0 TSI 2.0 TSI	90 92 118 195 206 103 110 125 130 132 147 155 162	09.08 11.13 08.08 11.09 08.14 10.08 11.13 05.09 01.13 11.13 08.08 11.09 11.13	PR: 1ZE,1ZP PR: 1ZE,1ZP PR: 1ZE,1ZP PR: 1ZE,1ZP PR: 1ZE,1ZP PR: 1ZE,1ZP PR: 1ZE,1ZP PR: 1ZE,1ZP PR: 1ZE,1ZP PR: 1ZE,1ZP PR: 1ZE,1ZP PR: 1ZE,1ZP	11.9541-9553.2 11.9541-9554.2 11.0101-5409.2 11.8171-0008.1 11.8116-0351.1	220563 220564 260035 990049 390538	2	D=54, - Halter D=54, - Halter Hülzensatz Führungsbolzen Haltefeder	ATE ATE ATE ATE ATE
	1.4 TSI 1.4 TSI 1.4 TSI 2.0 R 2.0 R 2.0 TDI 2.0 TDI 2.0 TDI 2.0 TDI 2.0 TSI 2.0 TSI 2.0 TSI	90 92 118 195 206 103 110 125 130 132 147 155 162	09.08 11.13 08.08 11.09 08.14 10.08 11.13 05.09 01.13 11.13 08.08 11.09 11.13	PR: 1LJ,1ZA,1ZD PR: 1LJ,1ZA,1ZD PR: 1LJ,1ZA,1ZD PR: 1LJ,1ZA,1ZD PR: 1LJ,1ZA,1ZD PR: 1LJ,1ZA,1ZD PR: 1LJ,1ZA,1ZD PR: 1LJ,1ZA,1ZD PR: 1LJ,1ZA,1ZD PR: 1LJ,1ZA,1ZD PR: 1LJ,1ZA,1ZD PR: 1LJ,1ZA,1ZD	11.9541-9553.2 11.9541-9554.2 11.0101-5409.2 11.8171-0008.1 11.8116-0351.1	220563 220564 260035 990049 390538	2	D=54, - Halter D=54, - Halter Hülzensatz Führungsbolzen Haltefeder	ATE ATE ATE ATE ATE
	1.4 TSI 1.4 TSI 1.4 TSI 2.0 R 2.0 R 2.0 TDI 2.0 TDI 2.0 TDI 2.0 TDI 2.0 TSI 2.0 TSI 2.0 TSI	90 92 118 195 206 103 110 125 130 132 147 155 162	09.08 11.13 08.08 11.09 08.14 10.08 11.13 05.09 01.13 11.13 08.08 11.09 11.13	PR: 1ZB PR: 1ZB PR: 1ZB PR: 1ZB PR: 1ZB PR: 1ZB PR: 1ZB PR: 1ZB PR: 1ZB PR: 1ZB PR: 1ZB PR: 1ZB	11.9541-9553.2 11.9541-9554.2 11.0101-5409.2 11.8171-0008.1 11.8116-0351.1	220563 220564 260035 990049 390538	2	D=54, - Halter D=54, - Halter Hülzensatz Führungsbolzen Haltefeder	ATE ATE ATE ATE ATE
	1.4 TSI 1.4 TSI 1.4 TSI 2.0 R 2.0 R 2.0 TDI 2.0 TDI 2.0 TDI 2.0 TDI 2.0 TSI 2.0 TSI 2.0 TSI	90 92 118 195 206 103 110 125 130 132 147 155 162	09.08 11.13 08.08 11.09 08.14 10.08 11.13 05.09 01.13 11.13 08.08 11.09 11.13	PR: 1ZK PR: 1ZK PR: 1ZK PR: 1ZK PR: 1ZK PR: 1ZK PR: 1ZK PR: 1ZK PR: 1ZK PR: 1ZK PR: 1ZK PR: 1ZK	11.9576-9948.2 11.0101-5407.2 11.8171-0069.1	220810 260011 250152		D=57, - Halter Hülzensatz Führungsbolzen	ATE ATE ATE
	1.4 TSI 1.4 TSI 1.4 TSI 2.0 R 2.0 R 2.0 TDI 2.0 TDI 2.0 TDI 2.0 TDI 2.0 TSI 2.0 TSI 2.0 TSI	90 92 118 195 206 103 110 125 130 132 147 155 162	09.08 11.13 08.08 11.09 08.14 10.08 11.13 05.09 01.13 11.13 08.08 11.09 11.13	PR: G03,G07,G08,G11,G45 PR: G03,G07,G08,G11,G45 PR: G03,G07,G08,G11,G45 PR: G03,G07,G08,G11,G45 PR: G03,G07,G08,G11,G45 PR: G03,G07,G08,G11,G45 PR: G03,G07,G08,G11,G45 PR: G03,G07,G08,G11,G45 PR: G03,G07,G08,G11,G45 PR: G03,G07,G08,G11,G45 PR: G03,G07,G08,G11,G45 PR: G03,G07,G08,G11,G45	24.5143-0564.3	331433	2	L=564	
	1.4 TSI	90	09.08	PR: G04,G09,G33	83.7849-0502.3	331125	2	L=504	

									
VOLKSWAGEN SCIROCCO (08-)									
	1.4 TSI 92 1.4 TSI 118 2.0 R 195 2.0 R 206 2.0 TDI 103 2.0 TDI 110 2.0 TDI 125 2.0 TDI 130 2.0 TSI 132 2.0 TSI 147 2.0 TSI 155 2.0 TSI 162		11.13 08.08 11.09 08.14 10.08 11.13 05.09 01.13 11.13 08.08 11.09 11.13	PR: G04,G09,G33 PR: G04,G09,G33 PR: G04,G09,G33 PR: G04,G09,G33 PR: G04,G09,G33 PR: G04,G09,G33 PR: G04,G09,G33 PR: G04,G09,G33 PR: G04,G09,G33 PR: G04,G09,G33 PR: G04,G09,G33 PR: G04,G09,G33	83.7849-0502.3	331125	2	L=504	
	1.4 TSI 90 1.4 TSI 92 1.4 TSI 118 2.0 R 195 2.0 R 206 2.0 TDI 103 2.0 TDI 110 2.0 TDI 125 2.0 TDI 130 2.0 TSI 132 2.0 TSI 147 2.0 TSI 155 2.0 TSI 162		09.08 11.13 08.08 11.09 08.14 10.08 11.13 05.09 01.13 11.13 08.08 11.09 11.13	PR: 1KD PR: 1KD PR: 1KD PR: 1KD PR: 1KD PR: 1KD PR: 1KD PR: 1KD PR: 1KD PR: 1KD PR: 1KD PR: 1KD	24.3384-1755.7 24.3384-1756.7 24.0101-3803.2	220635 220636 260101		D=38, - Halter D=38, - Halter Bremsattel-Zubehör	TRW TRW TRW
	1.4 TSI 90 1.4 TSI 92 1.4 TSI 118 2.0 R 195 2.0 R 206 2.0 TDI 103 2.0 TDI 110 2.0 TDI 125 2.0 TDI 130 2.0 TSI 132 2.0 TSI 147 2.0 TSI 155 2.0 TSI 162		09.08 11.13 08.08 11.09 08.14 10.08 11.13 05.09 01.13 11.13 08.08 11.09 11.13	PR: 1KE PR: 1KE PR: 1KE PR: 1KE PR: 1KE PR: 1KE PR: 1KE PR: 1KE PR: 1KE PR: 1KE PR: 1KE PR: 1KE	24.3414-1709.7 24.3414-1710.7 24.0101-3803.2	220631 220632 260101		D=41, - Halter D=41, - Halter Bremsattel-Zubehör	TRW TRW TRW
	1.4 TSI 90 1.4 TSI 92 1.4 TSI 118 2.0 R 195 2.0 R 206 2.0 TDI 103 2.0 TDI 110 2.0 TDI 125 2.0 TDI 130 2.0 TSI 132 2.0 TSI 147 2.0 TSI 155 2.0 TSI 162		09.08 11.13 08.08 11.09 08.14 10.08 11.13 05.09 01.13 11.13 08.08 11.09 11.13	PR: 1KW PR: 1KW PR: 1KW PR: 1KW PR: 1KW PR: 1KW PR: 1KW PR: 1KW PR: 1KW PR: 1KW PR: 1KW PR: 1KW	24.0101-3803.2	260101		Bremsattel-Zubehör	TRW
	1.4 TSI 90 1.4 TSI 118 2.0 TDI 103 2.0 TDI 125 2.0 TSI 147		09.08 10.09 10.08 10.09 05.09 10.09 08.08 10.09	PR: 1KD,1KE PR: 1KD,1KE PR: 1KD,1KE PR: 1KD,1KE PR: 1KD,1KE PR: 1KD,1KE PR: 1KD,1KE PR: 1KD,1KE	83.7849-0243.3	331099	2	L=243	
	1.4 TSI 90 1.4 TSI 92 1.4 TSI 118 2.0 R 195 2.0 R 206 2.0 TDI 103 2.0 TDI 110 2.0 TDI 125 2.0 TDI 130 2.0 TSI 132 2.0 TSI 147 2.0 TSI 155 2.0 TSI 162		11.09 11.13 11.09 11.09 08.14 11.09 11.13 11.09 01.13 11.13 11.09 11.09 11.13	PR: 1KS PR: 1KS PR: 1KS PR: 1KS PR: 1KS PR: 1KS PR: 1KS PR: 1KS PR: 1KS PR: 1KS PR: 1KS PR: 1KS	83.7847-0254.3 83.7847-0257.3	331233 331234		L=255 L=255	
	1.4 TSI 90 1.4 TSI 92 1.4 TSI 118 2.0 R 195 2.0 R 206 2.0 TDI 103 2.0 TDI 110 2.0 TDI 125 2.0 TDI 130 2.0 TSI 132 2.0 TSI 147 2.0 TSI 155 2.0 TSI 162		11.09 11.13 11.09 11.09 08.14 11.09 11.13 11.09 01.13 11.13 11.09 11.09 11.13	PR: 1KW PR: 1KW PR: 1KW PR: 1KW PR: 1KW PR: 1KW PR: 1KW PR: 1KW PR: 1KW PR: 1KW PR: 1KW PR: 1KW	83.7849-0243.3	331099	2	L=243	
	1.4 TSI 90 1.4 TSI 92 1.4 TSI 118 2.0 R 195		09.08 11.13 08.08 11.09		24.3727-0195.2	580195	2 	L=1447	



VOLKSWAGEN SCIROCCO (08-)

	2.0 R	206		08.14		24.3727-0195.2	580195	2 ↓	L=1447
	2.0 TDI	103		10.08					
	2.0 TDI	110		11.13					
	2.0 TDI	125		05.09					
	2.0 TDI	130		01.13					
	2.0 TSI	132		11.13					
	2.0 TSI	147		08.08					
	2.0 TSI	155		11.09					
	2.0 TSI	162		11.13					
	1.4 TSI	90		09.08		24.2415-1713.3	030132		Gz 15,87, + Sensor
	1.4 TSI	92		11.13					
	1.4 TSI	118		08.08					
	2.0 R	195		11.09					
	2.0 R	206		08.14					
	2.0 TDI	103		10.08					
	2.0 TDI	110		11.13					
	2.0 TDI	125		05.09					
	2.0 TDI	130		01.13					
	2.0 TSI	132		11.13					
	2.0 TSI	147		08.08					
	2.0 TSI	155		11.09					
	2.0 TSI	162		11.13					
	1.4 TSI	90		09.08	PR: OEJ	24.2519-1705.3	040095		Nz 19,05
	1.4 TSI	92		11.13	PR: OEJ				
	1.4 TSI	118		08.08	PR: OEJ				
	2.0 R	195		11.09	PR: OEJ				
	2.0 R	206		08.14	PR: OEJ				
	2.0 TDI	103		10.08	PR: OEJ				
	2.0 TDI	110		11.13	PR: OEJ				
	2.0 TDI	125		05.09	PR: OEJ				
	2.0 TDI	130		01.13	PR: OEJ				
	2.0 TSI	132		11.13	PR: OEJ				
	2.0 TSI	147		08.08	PR: OEJ				
	2.0 TSI	155		11.09	PR: OEJ				
	2.0 TSI	162		11.13	PR: OEJ				
	1.4 TSI	90		09.08	PR: OEM	24.2519-1706.3	040096		Nz 19,05
	1.4 TSI	92		11.13	PR: OEM				
	1.4 TSI	118		08.08	PR: OEM				
	2.0 R	195		11.09	PR: OEM				
	2.0 R	206		08.14	PR: OEM				
	2.0 TDI	103		10.08	PR: OEM				
	2.0 TDI	110		11.13	PR: OEM				
	2.0 TDI	125		05.09	PR: OEM				
	2.0 TDI	130		01.13	PR: OEM				
	2.0 TSI	132		11.13	PR: OEM				
	2.0 TSI	147		08.08	PR: OEM				
	2.0 TSI	155		11.09	PR: OEM				
	2.0 TSI	162		11.13	PR: OEM				

VOLKSWAGEN SHARAN I (95-10)

	1.8 T	110	7M-W-060000	09.97		03.7760-3002.4	300120		10" ATE
	1.9 TDI	66	7M-W-060000	09.95					
	1.9 TDI	81	7M-W-060000	09.96					
	2.0		7M-W-060000	09.95					
	2.8 VR6	128	7M-W-060000	09.95					
	2.8 VR6 Syncro	128	7M-W-060000	11.96					
	1.8 T	110	7M-W-020919		04.00	03.7755-1902.4	300138		9/8" Tandem ATE
	1.9 TDI	66	7M-W-020919		04.00				
	1.9 TDI	81	7M-W-020919		04.00				
	2.0		7M-W-020919		04.00				
	2.8 VR6	128	7M-W-020919		04.00				
	2.8 VR6 Syncro	128	7M-W-020919		04.00				
	1.8 T	110	7M-W-020918	09.97		03.7760-3002.4	300120		10" ATE
	1.9 TDI	66	7M-W-020918	09.95					
	1.9 TDI	81	7M-W-020918	09.96					
	2.0		7M-W-020918	09.95					
	2.8 VR6	128	7M-W-020918	09.95					
	2.8 VR6 Syncro	128	7M-W-020918	11.96					
	1.8 T	110		05.00	04.02	03.7755-6302.4	300221	PR: 1AT	9/8" Tandem ATE
	1.9 TDI	66		05.00	04.02				
	1.9 TDI	85		05.00	04.02				
	1.9 TDI 4motion	85		05.00	04.02				
	2.0			05.00	04.02				
	2.8 V6 24V	150		04.00	04.02				
	2.8 V6 24V 4motion	150		04.00	04.02				
	1.8 T	110	7M-3-029999	05.00	+ ESP	03.7858-3302.4	300122		9/8" Tandem ATE
	1.9 TDI	66	7M-3-029999	05.00	+ ESP				
	1.9 TDI	85	7M-3-029999	05.00	+ ESP				
	1.9 TDI 4motion	85	7M-3-029999	05.00	+ ESP				
	2.0		7M-3-029999	05.00	+ ESP				
	2.8 V6 24V	150	7M-3-029999	04.00	+ ESP				
	2.8 V6 24V 4motion	150	7M-3-029999	04.00	+ ESP				
	1.8 T	110	7M-3-030364		06.10 + ESP	03.0655-0006.2	370006		Wegsensor ATE
	1.9 TDI	66	7M-3-030364		06.10 + ESP				
	1.9 TDI	85	7M-3-030364		06.10 + ESP				
	1.9 TDI 4motion	85	7M-3-030364		06.10 + ESP				

VOLKSWAGEN SHARAN I (95-10)														
	2.0	▶150	7M-3-030364			06.10	+ ESP	03.0655-0006.2	370006		Wegsensor	ATE		
	2.8 V6 24V	▶150	7M-3-030364			06.10	+ ESP							
	2.8 V6 24V 4motion	▶150	7M-3-030364			06.10	+ ESP							
	1.8 T	◀110				05.02	06.10	- ESP	03.7755-6302.4	300221		9/8" Tandem	ATE	
	1.9 TDI	◀66				05.02	06.10	- ESP						
	1.9 TDI	◀85				05.02	06.10	- ESP						
	1.9 TDI	◀96				11.02	06.10	- ESP						
	1.9 TDI	◀110				06.05	06.10	- ESP						
	1.9 TDI 4motion	◀85				05.02	06.10	- ESP						
	2.0	◀				05.02	06.10	- ESP						
2.0 TDI	◀				11.05	06.10	- ESP							
2.8 V6 24V	◀150				05.02	06.10	- ESP							
2.8 V6 24V 4motion	◀150				05.02	06.10	- ESP							
	1.8 T	110	7M-W-020918	09.97				03.2123-1548.3	010478		- ABS	THz 23,81	ATE	
	1.9 TDI	66	7M-W-020918	09.95				03.2123-1526.3	010477		+ ABS	THz 23,81	ATE	
	1.9 TDI	81	7M-W-020918	09.96				03.3517-5100.1	390326			Verschlußschraube	ATE	
	2.0		7M-W-020918	09.95										
	2.8 VR6	128	7M-W-020918	09.95										
	2.8 VR6 Syncro	128	7M-W-020918	11.96										
	1.8 T	110	7M-W-020919			04.00	- ABS	03.2125-8404.3	010583			THz 25,40	ATE	
	1.9 TDI	66	7M-W-020919			04.00	- ABS							
	1.9 TDI	81	7M-W-020919			04.00	- ABS							
	2.0		7M-W-020919			04.00	- ABS							
2.8 VR6	128	7M-W-020919			04.00	- ABS								
2.8 VR6 Syncro	128	7M-W-020919			04.00	- ABS								
	1.8 T	110	7M-W-020919			04.02	- ESP	03.2125-0332.3	010952			THz 25,40	ATE	
	1.9 TDI	66	7M-W-020919			04.02	- ESP							
	1.9 TDI	81	7M-W-020919			04.00	- ESP							
	2.0		7M-W-020919			04.02	- ESP							
	2.8 VR6	128	7M-W-020919			04.02	- ESP							
	2.8 VR6 Syncro	128	7M-W-020919			04.02	- ESP							
	1.8 T	110	7M-3-029999	05.00				03.2125-9604.3	010581			THz 25,40	ATE	
	1.9 TDI	66	7M-3-029999	05.00										
	1.9 TDI	85	7M-3-029999	05.00										
	1.9 TDI 4motion	85	7M-3-029999	05.00										
2.0		7M-3-029999	05.00											
2.8 V6 24V	150	7M-3-029999	04.00											
2.8 V6 24V 4motion	150	7M-3-029999	04.00											
	1.8 T	▶110				05.02	06.10	- ESP	03.2125-0332.3	010952		THz 25,40	ATE	
	1.9 TDI	▶66				05.02	05.05	- ESP						
	1.9 TDI	▶85				05.02	05.05	- ESP						
	1.9 TDI	▶96				11.02	05.05	- ESP						
	1.9 TDI 4motion	▶85				05.02	05.05	- ESP						
	2.0	▶				05.02	05.05	- ESP						
	2.8 VR6	▶128				05.02	05.05	- ESP						
	2.8 VR6 Syncro	▶128				05.02	05.05	- ESP						
		1.8 T	110	7M-1-070000	09.97				11.0441-5704.2	250034			Dichtungssatz	ATE
		1.9 TDI	66	7M-1-070000	09.95				11.0101-5409.2	260035			Hülzensatz	ATE
1.9 TDI		81	7M-1-070000	09.96				11.8171-0008.1	990049			Führungsbolzen	ATE	
1.9 TDI		85	7M-1-070000	05.00				11.8116-0143.1	390513	2		Haltefeder	ATE	
2.0			7M-1-070000	09.95										
2.8 VR6		128	7M-1-070000	09.95										
2.8 VR6 Syncro		128	7M-1-070000	11.96										
1.9 TDI		66	7M-2-000001			06.10		11.9571-9811.2	220485		☐	D=57, - Halter	ATE	
1.9 TDI		85	7M-2-000001			06.10		11.9571-9812.2	220486		☐	D=57, - Halter	ATE	
1.9 TDI		96				11.02	06.10	11.0441-5704.2	250034			Dichtungssatz	ATE	
2.0		7M-2-000001			06.10		11.0101-5706.2	260097			Hülzensatz	ATE		
2.0 TDI					11.05	06.10	11.8171-0067.1	250153			Führungsbolzen	ATE		
								11.8116-0326.1	390471	2		Haltefeder	ATE	
	1.8 T	110	7M-2-000001			06.10		11.9571-9819.2	220469		☐	D=57, - Halter	ATE	
	1.9 TDI	110				06.10		11.9571-9820.2	220470		☐	D=57, - Halter	ATE	
	1.9 TDI 4motion	85				06.05	06.10	11.0101-5705.2	260096			Hülzensatz	ATE	
	2.8 V6 24V	150				05.00	06.10	11.8171-0067.1	250153			Führungsbolzen	ATE	
	2.8 V6 24V 4motion	150				04.00	06.10	11.8116-0272.1	390598			Haltefeder	ATE	
		1.8 T	110	7M-1-070000	09.97				24.5166-0454.3	331306	2		L=454	
		1.9 TDI	66	7M-1-070000	09.95									
		1.9 TDI	81				09.96	04.00						
		1.9 TDI	85				05.00	04.00						
		2.0		7M-1-070000	09.95									
2.8 VR6		128				09.95	04.00							
2.8 VR6 Syncro		128				11.96	04.00							
1.8 T		110	7M-1-070001			06.10		83.6219-0455.3	330592	2		L=455		
1.9 TDI		66	7M-1-070001			06.10								
1.9 TDI		85				05.00	06.10							
1.9 TDI	96				11.02	06.10								
1.9 TDI	110				06.05	06.10								

1) + front wheel drive / + trazione anteriore / + traction avant / + traccion delantera























VOLKSWAGEN SHARAN I (95-10)

	1.9 TDI 4motion 2.0 2.0 TDI 2.8 V6 24V 2.8 V6 24V 4motion	85 7M-1-070001 150 150	06.10 06.10 11.05 04.00 04.00	06.10 06.10 06.10 06.10	83.6219-0455.3	330592	2		L=455	
	1.8 T 1.9 TDI 1.9 TDI 1.9 TDI 1.9 TDI 2.0 2.0 TDI 2.8 VR6 2.8 VR6 Syncro	110 66 81 85 96 128 128	7M-1-070000 09.97 09.95 09.96 05.00 11.02 09.95 11.05 09.95 11.96	06.10 06.10 04.00 06.10 06.10 06.10 04.00 04.00	24.3384-1707.5 24.3384-1708.5 11.0101-5403.2	240171 240172 260010			D=38, - Halter D=38, - Halter Faltenbalgsatz	TRW TRW TRW
	1.8 T 1.9 TDI 1.9 TDI 4motion 2.8 V6 24V 2.8 V6 24V 4motion	110 110 85 150 150	7M-2-000001 06.10 06.05 05.00 04.00 04.00	06.10 06.10 06.10 06.10 06.10	24.3384-1715.5 24.3384-1716.5	240265 240266			D=38, - Halter D=38, - Halter	TRW TRW
	1.8 T 1.9 TDI 1.9 TDI 1.9 TDI 1.9 TDI 1.9 TDI 1.9 TDI 4motion 2.0 2.0 TDI 2.8 V6 24V 2.8 V6 24V 4motion 2.8 VR6 2.8 VR6 Syncro	110 66 81 85 96 110 85 150 150 128 128	09.97 09.95 09.96 05.00 11.02 06.05 05.00 09.95 11.05 04.00 04.00 09.95 11.96	06.10 06.10 04.00 06.10 06.10 06.10 06.10 06.10 06.10 06.10 06.10 06.10 06.10	24.5225-0370.3 83.6113-0140.3	331379 330482	2 2	am Bremsattel 1)	L=373 L=140	
	1.8 T 1.9 TDI 1.9 TDI 1.9 TDI 1.9 TDI 2.0 2.8 VR6 2.8 VR6 Syncro	110 66 81 85 96 128 128	7M-1-070000 09.97 09.95 09.96 05.00 11.02 09.95 11.96	06.10 06.10 04.00 06.10 06.10 06.10 04.00	24.3727-0163.2	580163	2		L=1293	
	1.8 T 1.9 TDI 4motion 2.8 V6 24V 2.8 V6 24V 4motion	110 85 150 150	7M-2-000001 06.10 05.00 04.00 04.00	06.10 06.10 06.10 06.10	24.3727-3404.2	583404	2		L=1320	
	1.8 T 1.9 TDI 1.9 TDI 1.9 TDI 1.9 TDI 1.9 TDI 4motion 2.0 2.0 TDI 2.8 V6 24V 2.8 V6 24V 4motion 2.8 VR6 2.8 VR6 Syncro	110 66 81 85 96 110 85 150 150 128 128	09.97 09.95 09.96 05.00 11.02 06.05 05.00 09.95 11.05 04.00 04.00 09.95 11.96	06.10 06.10 04.00 06.10 06.10 06.10 06.10 06.10 06.10 06.10 06.10 06.10	24.2419-1722.3	030111			Gz 19,05	

















VOLKSWAGEN SHARAN II (10-)

	1.4 TSI 1.8 TSI 2.0 TDI 2.0 TDI 2.0 TDI 2.0 TDI 4motion 2.0 TSI	110 118 100 125 130 100 147	07.10 05.12 07.10 07.10 01.13 05.11 10.10		03.7873-4502.4	300284			11"	ATE
	1.4 TSI 1.4 TSI 1.8 TSI 2.0 TDI 2.0 TDI 2.0 TDI 2.0 TDI 2.0 TDI 2.0 TDI 2.0 TDI 2.0 TDI 2.0 TDI 4motion 2.0 TDI 4motion 2.0 TDI 4motion 2.0 TDI 4motion 2.0 TDI 4motion 2.0 TSI 2.0 TSI	110 110 118 85 100 103 110 125 130 135 100 103 110 135 147 162	07.10 04.15 05.12 04.15 07.10 04.15 04.15 07.10 01.13 04.15 05.11 04.15 04.15 05.16 10.10 04.15		03.4153-0186.3	010816			THz 23,81	ATE

1) on the brake caliper / sulla pinza freno / sur l'étrier de frein / a la pinza de freno

										
VOLKSWAGEN SHARAN II (10-)										
	1.4 TSI 1.8 TSI 2.0 TDI 2.0 TDI 2.0 TDI 2.0 TDI 4motion 2.0 TSI	110 118 100 125 130 100 147	07.10 05.12 07.10 07.10 01.13 05.11 10.10	PR: 1LJ PR: 1LJ PR: 1LJ PR: 1LJ PR: 1LJ PR: 1LJ PR: 1LJ	11.9571-9759.2 11.9571-9760.2 11.8171-0008.1 11.0101-5409.2 11.8116-0071.1	220847 220848 990049 260035 390605	2	D=57, - Halter D=57, - Halter Führungsbolzen Hülzensatz Haltefeder	ATE ATE ATE ATE ATE	
	1.4 TSI 1.8 TSI 2.0 TDI 2.0 TDI 2.0 TDI 2.0 TDI 4motion 2.0 TSI	110 118 100 125 130 100 147	07.10 05.12 07.10 07.10 01.13 05.11 10.10		24.6241-1709.7 24.6241-1710.7	221021 221022		☐ elektrische Feststellbremse 1) ☐ elektrische Feststellbremse 1)	D=41, - Halter D=41, - Halter	TRW TRW
	1.4 TSI 1.8 TSI 2.0 TDI 2.0 TDI 2.0 TDI 2.0 TDI 4motion 2.0 TSI	110 118 100 125 130 100 147	07.10 05.12 07.10 07.10 01.13 05.11 10.10		24.5143-0257.3	331167	2		L=257	
VOLKSWAGEN TARO (89-97)										
	1.8 2.2 2.4 D		04.89 06.89 04.89	7A-RH010000 7A-RH010000 7A-RH010000	24.3222-1740.3	020566			Rz 22,20	
VOLKSWAGEN TIGUAN (07-)										
	1.4 TSI 1.4 TSI 1.4 TSI 1.4 TSI 4motion 2.0 TDI 2.0 TDI 2.0 TDI 2.0 TDI 4motion 2.0 TDI 4motion 2.0 TDI 4motion 2.0 TDI 4motion 2.0 TDI 4motion 2.0 TFSI 4motion 2.0 TSI 4motion	90 92 81 103 110 103 110 135 110 110 135 110	11.07 08.10 05.15 09.07 04.10 03.08 05.15 01.08 11.07 05.15 05.15 02.08 11.07		03.7873-4002.4 03.7873-4502.4	300211 300284			11" 11"	ATE ATE
	1.4 TSI 1.4 TSI 1.4 TSI 1.4 TSI 4motion 2.0 TDI 2.0 TDI 2.0 TDI 2.0 TDI 4motion 2.0 TDI 4motion 2.0 TDI 4motion 2.0 TDI 4motion 2.0 TFSI 4motion 2.0 TSI 4motion	90 92 81 103 110 103 110 135 110 110 135 110	11.07 08.10 05.15 09.07 04.10 03.08 05.15 01.08 11.07 05.15 05.15 02.08 11.07		03.4153-0186.3	010816			Thz 23,81	ATE
	1.4 TSI 1.4 TSI 1.4 TSI 1.4 TSI 4motion 2.0 TDI 2.0 TDI 2.0 TDI 2.0 TDI 4motion 2.0 TDI 4motion 2.0 TDI 4motion 2.0 TDI 4motion 2.0 TFSI 4motion 2.0 TSI 4motion	90 92 81 103 110 103 110 135 110 110 135 110	11.07 08.10 05.15 09.07 04.10 03.08 05.15 01.08 11.07 05.15 05.15 02.08 11.07		11.9571-9759.2 11.9571-9760.2 11.8171-0008.1 11.0101-5409.2 11.8116-0071.1	220847 220848 990049 260035 390605	2	D=57, - Halter D=57, - Halter Führungsbolzen Hülzensatz Haltefeder	ATE ATE ATE ATE ATE	
	1.4 TSI 1.4 TSI 1.4 TSI 1.4 TSI 4motion 2.0 TDI 2.0 TDI 2.0 TDI 2.0 TDI 4motion 2.0 TDI 4motion 2.0 TDI 4motion 2.0 TDI 4motion 2.0 TFSI 4motion 2.0 TSI 4motion	90 92 81 103 110 103 110 135 110 110 135 110	11.07 08.10 05.15 09.07 04.10 03.08 05.15 01.08 11.07 05.15 05.15 02.08 11.07		24.5143-0578.3	331168	2		L=578	
	1.4 TSI 1.4 TSI 1.4 TSI 1.4 TSI 4motion 2.0 TDI 2.0 TDI	90 92 81 103	11.07 08.10 05.15 09.07 04.10 03.08		24.6241-1709.7 24.6241-1710.7	221021 221022		☐ elektrische Feststellbremse 1) ☐ elektrische Feststellbremse 1)	D=41, - Halter D=41, - Halter	TRW TRW

1) electric parking brake / fr.di stazionamento elettrico / frein à main électrique / freno de mano eléctrico

	 kW									
VOLKSWAGEN TIGUAN (07-)										
	2.0 TDI 110		05.15		24.6241-1709.7	221021	<input type="checkbox"/>	elektrische Feststellbremse ¹⁾	D=41, - Halter	TRW
	2.0 TDI 4motion		01.08		24.6241-1710.7	221022	<input type="checkbox"/>	elektrische Feststellbremse ¹⁾	D=41, - Halter	TRW
	2.0 TDI 4motion	103	11.07							
	2.0 TDI 4motion	110	05.15							
	2.0 TDI 4motion	135	05.15							
	2.0 TFSI 4motion		02.08							
	2.0 TSI 4motion		11.07							
	1.4 TSI		11.07		24.5143-0257.3	331167	2		L=257	
	1.4 TSI	90	08.10							
	1.4 TSI	92	05.15							
	1.4 TSI 4motion		09.07							
	2.0 TDI	81	04.10							
	2.0 TDI	103	03.08							
	2.0 TDI	110	05.15							
	2.0 TDI 4motion		01.08							
	2.0 TDI 4motion	103	11.07							
	2.0 TDI 4motion	110	05.15							
	2.0 TDI 4motion	135	05.15							
	2.0 TFSI 4motion		02.08							
	2.0 TSI 4motion		11.07							
VOLKSWAGEN TOUAREG I (03-10)										
	2.5 R5 TDI	◀	01.03	11.06	03.0655-0006.2	370006			Wegsensor	ATE
	3.0 V6 TDI	◀	11.04	11.06						
	3.2 V6	◀	11.02	12.05						
	3.6 V6 FSI	◀206	01.06	11.06						
	4.2 V8	◀228	12.02	11.06						
	5.0 V10 TDI	◀230	11.02	11.06						
	6.0 W12	◀331	08.04	11.06						
	2.5 R5 TDI	◀	12.06	03.10	03.7868-3702.4	300208		PR: 1LB,1LE,LF	10/8" Tandem	ATE
	3.0 V6 TDI	◀	12.06	03.10						
	3.0 V6 TDI	◀176	10.07	03.10						
	3.6 V6 FSI	◀206	12.06	03.10						
	4.2 V8 FSI	◀257	12.06	03.10						
	5.0 TDI R50	◀258	01.08	03.10						
	5.0 V10 TDI	◀230	12.06	03.10						
	2.5 R5 TDI	◀	12.06	03.10	03.7868-5302.4	300251		PR: 1LA	10/8" Tandem	ATE
	3.0 V6 TDI	◀	12.06	03.10						
	3.0 V6 TDI	◀176	10.07	03.10						
	3.6 V6 FSI	◀206	12.06	03.10						
	4.2 V8 FSI	◀257	12.06	03.10						
	5.0 TDI R50	◀258	01.08	03.10						
	5.0 V10 TDI	◀230	12.06	03.10						
	2.5 R5 TDI	▶	01.03	11.06	03.0655-0006.2	370006			Wegsensor	ATE
	3.0 V6 TDI	▶	11.04	11.06						
	3.2 V6	▶	11.02	12.05						
	3.6 V6 FSI	▶206	01.06	11.06						
	4.2 V8	▶228	12.02	11.06						
	5.0 V10 TDI	▶230	11.02	11.06						
	6.0 W12	▶331	08.04	11.06						
	2.5 R5 TDI	◀	01.03	03.10	03.2126-3014.3	010811			Thz 26,99	ATE
	3.0 V6 TDI	◀	11.04	03.10						
	3.0 V6 TDI	◀176	10.07	03.10						
	3.2 V6	◀	11.02	12.05						
	3.6 V6 FSI	◀206	01.06	03.10						
	4.2 V8	◀228	12.02	11.06						
	4.2 V8 FSI	◀257	12.06	03.10						
	5.0 TDI R50	◀258	01.08	03.10						
	5.0 V10 TDI	◀230	11.02	03.10						
	6.0 W12	◀331	08.04	11.06						
	2.5 R5 TDI		01.03	03.10	24.3601-9947.5	240597	<input type="checkbox"/>		D=60, - Halter	ATE
	3.0 V6 TDI		11.04	03.10	24.3601-9948.5	240598	<input type="checkbox"/>		D=60, - Halter	ATE
	3.0 V6 TDI	176	10.07	03.10	11.0441-6008.2	250038			Dichtungssatz	ATE
	3.2 V6		11.02	12.05	11.0101-5706.2	260097			Hülssensatz	ATE
	3.6 V6 FSI	206	01.06	03.10	11.8171-0067.1	250153			Führungsbolzen	ATE
	4.2 V8	228	12.02	11.06	11.8116-0237.1	390509	2		Haltefeder	ATE
	4.2 V8 FSI	257	12.06	03.10						
	5.0 TDI R50	258	01.08	03.10						
	5.0 V10 TDI	230	11.02	03.10						
	6.0 W12	331	08.04	11.06						
	2.5 R5 TDI		01.03	03.10	83.6169-0685.3	330984	2		L=685	
	3.0 V6 TDI		11.04	03.10						
	3.0 V6 TDI	176	10.07	03.10						
	3.2 V6		11.02	12.05						
	3.6 V6 FSI	206	01.06	03.10						
	4.2 V8	228	12.02	11.06						
	4.2 V8 FSI	257	12.06	03.10						
	5.0 TDI R50	258	01.08	03.10						
	5.0 V10 TDI	230	11.02	03.10						
	6.0 W12	331	08.04	11.06						
	2.5 R5 TDI		01.03	03.10	24.5237-0515.3	331463	2		L=515	
	3.0 V6 TDI		11.04	03.10						
	3.0 V6 TDI	176	10.07	03.10						
	3.2 V6		11.02	12.05						
	3.6 V6 FSI	206	01.06	03.10						
	4.2 V8	228	12.02	11.06						
	4.2 V8 FSI	257	12.06	03.10						
	5.0 TDI R50	258	01.08	03.10						
	5.0 V10 TDI	230	11.02	03.10						
	6.0 W12	331	08.04	11.06						
										

¹⁾ electric parking brake / fr.di stazionamento elettrico / frein à main électrique / freno de mano eléctrico



VOLKSWAGEN TOUAREG I (03-10)























	4.2 V8 FSI	257	12.06	03.10	PR: 1LC,1LF,1LE	24.5237-0515.3	331463	2		L=515	
	5.0 TDI R50	258	01.08	03.10	PR: 1LC,1LF,1LE						
	5.0 V10 TDI	230	11.02	03.10	PR: 1LC,1LF,1LE						
	6.0 W12	331	08.04	11.06	PR: 1LC,1LF,1LE						
	2.5 R5 TDI		01.03	03.10	PR: 1LT,1LU						
3.0 V6 TDI		11.04	03.10	PR: 1LT,1LU	83.7769-0713.3	331097	2		L=713		
3.0 V6 TDI	176	10.07	03.10	PR: 1LT,1LU							
3.6 V6 FSI	206	01.06	03.10	PR: 1LT,1LU							
4.2 V8 FSI	257	12.06	03.10	PR: 1LT,1LU							
5.0 TDI R50	258	01.08	03.10	PR: 1LT,1LU							
5.0 V10 TDI	230	11.02	03.10	PR: 1LT,1LU							
	2.5 R5 TDI		01.03	03.10	PR: 1KE	11.9441-9967.2	220807	2		D=44, - Halter	ATE
	3.0 V6 TDI		11.04	03.10	PR: 1KE						
	3.0 V6 TDI	176	10.07	03.10	PR: 1KE						
	3.2 V6		11.02	12.05	PR: 1KE						
	3.6 V6 FSI	206	01.06	03.10	PR: 1KE						
	4.2 V8	228	12.02	11.06	PR: 1KE						
	4.2 V8 FSI	257	12.06	03.10	PR: 1KE						
	5.0 TDI R50	258	01.08	03.10	PR: 1KE						
	5.0 V10 TDI	230	11.02	03.10	PR: 1KE						
	6.0 W12	331	08.04	11.06	PR: 1KE						
	2.5 R5 TDI		01.03	03.10	PR: 1KE	83.6238-0408.3	330895	2		L=408	
	3.0 V6 TDI		11.04	03.10	PR: 1KE						
	3.0 V6 TDI	176	10.07	03.10	PR: 1KE						
	3.2 V6		11.02	12.05	PR: 1KE						
	3.6 V6 FSI	206	01.06	03.10	PR: 1KE						
	4.2 V8	228	12.02	11.06	PR: 1KE						
	4.2 V8 FSI	257	12.06	03.10	PR: 1KE						
	5.0 TDI R50	258	01.08	03.10	PR: 1KE						
	5.0 V10 TDI	230	11.02	03.10	PR: 1KE						
	6.0 W12	331	08.04	11.06	PR: 1KE						
	2.5 R5 TDI		01.03	03.10	PR: 1KF,1KQ,2ED	83.7812-0400.3	331214	2		L=400	
	3.0 V6 TDI		11.04	03.10	PR: 1KF,1KQ,2ED						
	3.0 V6 TDI	176	10.07	03.10	PR: 1KF,1KQ,2ED						
	3.2 V6		11.02	12.05	PR: 1KF,1KQ,2ED						
	3.6 V6 FSI	206	01.06	03.10	PR: 1KF,1KQ,2ED						
	4.2 V8	228	12.02	11.06	PR: 1KF,1KQ,2ED						
	4.2 V8 FSI	257	12.06	03.10	PR: 1KF,1KQ,2ED						
	5.0 TDI R50	258	01.08	03.10	PR: 1KF,1KQ,2ED						
	5.0 V10 TDI	230	11.02	03.10	PR: 1KF,1KQ,2ED						
	6.0 W12	331	08.04	11.06	PR: 1KF,1KQ,2ED						
	2.5 R5 TDI	◀	01.03	03.10		24.3727-3400.2	583400	1		L=1890	
	3.0 V6 TDI	◀	11.04	03.10							
	3.0 V6 TDI	◀176	10.07	03.10							
	3.2 V6	◀	11.02	12.05							
	3.6 V6 FSI	◀206	01.06	03.10							
	4.2 V8	◀228	12.02	11.06							
	4.2 V8 FSI	◀257	12.06	03.10							
	5.0 TDI R50	◀258	01.08	03.10							
	5.0 V10 TDI	◀230	11.02	03.10							
	6.0 W12	◀331	08.04	11.06							
	2.5 R5 TDI	▶	01.03	03.10		24.3727-3401.2	583401	2		L=1750	
	3.0 V6 TDI	▶	11.04	03.10							
	3.0 V6 TDI	▶176	10.07	03.10							
	3.2 V6	▶	11.02	12.05							
	3.6 V6 FSI	▶206	01.06	03.10							
	4.2 V8	▶228	12.02	11.06							
	4.2 V8 FSI	▶257	12.06	03.10							
	5.0 TDI R50	▶258	01.08	03.10							
	5.0 V10 TDI	▶230	11.02	03.10							
	6.0 W12	▶331	08.04	11.06							

VOLKSWAGEN TOUAREG II (10-)

	3.0 V6 TDI	150	04.10		PR: 1LC,1LE	24.5237-0515.3	331463	2		L=515
	3.0 V6 TDI	165	06.10		PR: 1LC,1LE					
	3.0 V6 TDI	176	04.10		PR: 1LC,1LE					
	3.0 V6 TDI	180	05.11		PR: 1LC,1LE					
	3.0 V6 TDI	193	09.14		PR: 1LC,1LE					
	3.0 V6 TSI Hybrid	245	04.10		PR: 1LC,1LE					
	3.6 V6 FSI	206	04.10		PR: 1LC,1LE					
	4.2 V8 FSI	265	01.11		PR: 1LC,1LE					
	4.2 V8 TDI	250	04.10		PR: 1LC,1LE					
	3.0 V6 TDI	150	04.10		PR: 1LG,1LJ,1LW					
3.0 V6 TDI	165	06.10		PR: 1LG,1LJ,1LW						
3.0 V6 TDI	176	04.10		PR: 1LG,1LJ,1LW						
3.0 V6 TDI	180	05.11		PR: 1LG,1LJ,1LW						
3.0 V6 TDI	193	09.14		PR: 1LJ,1LW						
3.0 V6 TSI Hybrid	245	04.10		PR: 1LG,1LJ,1LW						
3.6 V6 FSI	206	04.10		PR: 1LG,1LJ,1LW						
4.2 V8 FSI	265	01.11		PR: 1LG,1LJ,1LW						
4.2 V8 TDI	250	04.10		PR: 1LG,1LJ,1LW						
	3.0 V6 TDI	150	04.10			83.7812-0400.3	331214	2		L=400
	3.0 V6 TDI	165	06.10							
	3.0 V6 TDI	176	04.10							
	3.0 V6 TDI	180	05.11							
	3.0 V6 TDI	193	09.14							



VOLKSWAGEN TOUAREG II (10-)		VOLKSWAGEN TOURAN I (03-15)						
VOLKSWAGEN TOUAREG II (10-)		VOLKSWAGEN TOURAN I (03-15)						
	3.0 V6 TSI Hybrid	245	04.10		83.7812-0400.3	331214	2	L=400
	3.6 V6 FSI	206	04.10					
	4.2 V8 FSI	265	01.11					
	4.2 V8 TDI	250	04.10					
	1.2 TSI	77	05.10	PR: 1AT	03.7873-4302.4	300312		11" ATE
	1.4 TSI	103	09.06	PR: 1AT				
	1.4 TSI	125	11.06	PR: 1AT				
	1.4 TSI EcoFuel	110	05.09	PR: 1AT				
	1.6	75	07.03	PR: 1AT				
	1.6 FSI	85	02.03	PR: 1AT				
	1.6 TDI		05.10	PR: 1AT				
	1.9 TDI	66	11.04	PR: 1AT				
	1.9 TDI	74	02.03	PR: 1AT				
	1.9 TDI	77	08.03	PR: 1AT				
	2.0 Eco Fuel	80	02.06	PR: 1AT				
	2.0 FSI	85	10.04	PR: 1AT				
	2.0 FSI	110	10.03	PR: 1AT				
	2.0 TDI		08.03	PR: 1AT				
	2.0 TDI	81	02.03	PR: 1AT				
	2.0 TDI	125	02.06	PR: 1AT				
	2.0 TDI	130	01.13	PR: 1AT				
	1.2 TSI	77	05.10	PR: 1AS	03.7873-3702.4	300283		11" ATE
	1.4 TSI	103	09.06	PR: 1AS				
	1.4 TSI	125	11.06	PR: 1AS				
	1.4 TSI EcoFuel	110	05.09	PR: 1AS				
	1.6	75	07.03	PR: 1AS				
	1.6 FSI	85	02.03	PR: 1AS				
	1.6 TDI		05.10	PR: 1AS				
	1.9 TDI	66	11.04	PR: 1AS				
	1.9 TDI	74	02.03	PR: 1AS				
	1.9 TDI	77	08.03	PR: 1AS				
	2.0 Eco Fuel	80	02.06	PR: 1AS				
	2.0 FSI	85	10.04	PR: 1AS				
	2.0 FSI	110	10.03	PR: 1AS				
	2.0 TDI		08.03	PR: 1AS				
	2.0 TDI	81	02.03	PR: 1AS				
	2.0 TDI	125	02.06	PR: 1AS				
	2.0 TDI	130	01.13	PR: 1AS				
	1.2 TSI	77	05.10	PR: 1ZE,1ZP	03.2122-2129.3	010799		Thz 22,20 ATE
	1.4 TSI	103	09.06	PR: 1ZE,1ZP				
	1.4 TSI	125	11.06	PR: 1ZE,1ZP				
	1.4 TSI EcoFuel	110	05.09	PR: 1ZE,1ZP				
	1.6	75	07.03	PR: 1ZE,1ZP				
	1.6 FSI	85	02.03	PR: 1ZE,1ZP				
	1.6 TDI		05.10	PR: 1ZE,1ZP				
	1.9 TDI	66	11.04	PR: 1ZE,1ZP				
	1.9 TDI	74	02.03	PR: 1ZE,1ZP				
	1.9 TDI	77	08.03	PR: 1ZE,1ZP				
	2.0 Eco Fuel	80	02.06	PR: 1ZE,1ZP				
	2.0 FSI	85	10.04	PR: 1ZE,1ZP				
	2.0 FSI	110	10.03	PR: 1ZE,1ZP				
	2.0 TDI		08.03	PR: 1ZE,1ZP				
	2.0 TDI	81	02.03	PR: 1ZE,1ZP				
	2.0 TDI	125	02.06	PR: 1ZE,1ZP				
	2.0 TDI	130	01.13	PR: 1ZE,1ZP				
	1.2 TSI	77	05.10	PR: 1ZE,1ZP	11.9541-9553.2	220563		D=54, - Halter ATE
	1.4 TSI	103	09.06	PR: 1ZE,1ZP	11.9541-9554.2	220564		D=54, - Halter ATE
	1.4 TSI	125	11.06	PR: 1ZE,1ZP	11.0101-5407.2	260011		Hülsensatz ATE
	1.4 TSI EcoFuel	110	05.09	PR: 1ZE,1ZP	11.8171-0008.1	990049		Führungsbolzen ATE
	1.6	75	07.03	PR: 1ZE,1ZP	11.8116-0351.1	390538		Haltefeder ATE
	1.6 FSI	85	02.03	PR: 1ZE,1ZP				
	1.6 TDI		05.10	PR: 1ZE,1ZP				
	1.9 TDI	66	11.04	PR: 1ZE,1ZP				
	1.9 TDI	74	02.03	PR: 1ZE,1ZP				
	1.9 TDI	77	08.03	PR: 1ZE,1ZP				
	2.0 Eco Fuel	80	02.06	PR: 1ZE,1ZP				
	2.0 FSI	85	10.04	PR: 1ZE,1ZP				
	2.0 FSI	110	10.03	PR: 1ZE,1ZP				
	2.0 TDI		08.03	PR: 1ZE,1ZP				
	2.0 TDI	81	02.03	PR: 1ZE,1ZP				
	2.0 TDI	125	02.06	PR: 1ZE,1ZP				
	2.0 TDI	130	01.13	PR: 1ZE,1ZP				
	1.2 TSI	77	05.10	PR: 1LJ,1ZA,1ZD	11.9541-9553.2	220563		D=54, - Halter ATE
	1.4 TSI	103	09.06	PR: 1LJ,1ZA,1ZD	11.9541-9554.2	220564		D=54, - Halter ATE
	1.4 TSI	125	11.06	PR: 1LJ,1ZA,1ZD	11.0101-5407.2	260011		Hülsensatz ATE
	1.4 TSI EcoFuel	110	05.09	PR: 1LJ,1ZA,1ZD	11.8171-0008.1	990049		Führungsbolzen ATE
	1.6	75	07.03	PR: 1LJ,1ZA,1ZD	11.8116-0351.1	390538		Haltefeder ATE
	1.6 FSI	85	02.03	PR: 1LJ,1ZA,1ZD				
	1.6 TDI		05.10	PR: 1LJ,1ZA,1ZD				
	1.9 TDI	66	11.04	PR: 1LJ,1ZA,1ZD				
	1.9 TDI	74	02.03	PR: 1LJ,1ZA,1ZD				
	1.9 TDI	77	08.03	PR: 1LJ,1ZA,1ZD				
	2.0 Eco Fuel	80	02.06	PR: 1LJ,1ZA,1ZD				
	2.0 FSI	85	10.04	PR: 1LJ,1ZA,1ZD				
	2.0 FSI	110	10.03	PR: 1LJ,1ZA,1ZD				
	2.0 TDI		08.03	PR: 1LJ,1ZA,1ZD				

VOLKSWAGEN TOURAN I (03-15)									
									
	2.0 TDI 2.0 TDI 2.0 TDI	81 125 130	02.03 02.06 01.13	PR: 1LJ,1ZA,1ZD PR: 1LJ,1ZA,1ZD PR: 1LJ,1ZA,1ZD	11.9541-9553.2 11.9541-9554.2 11.0101-5407.2 11.8171-0008.1 11.8116-0351.1	220563 220564 260011 990049 390538	 	D=54, - Halter D=54, - Halter Hülzensatz Führungsbolzen Haltefeder	ATE ATE ATE ATE ATE
	1.2 TSI 1.4 TSI 1.4 TSI 1.4 TSI EcoFuel 1.6 1.6 FSI 1.6 TDI 1.9 TDI 1.9 TDI 1.9 TDI 2.0 Eco Fuel 2.0 FSI 2.0 FSI 2.0 TDI 2.0 TDI 2.0 TDI	77 103 125 110 75 85 66 74 77 80 85 110 81 125 130	05.10 09.06 11.06 05.09 07.03 02.03 05.10 11.04 02.03 08.03 02.06 10.04 10.03 08.03 02.03 01.13		24.5143-0564.3	331433	2	L=564	
	1.2 TSI 1.4 TSI 1.4 TSI 1.4 TSI EcoFuel 1.6 1.6 FSI 1.6 TDI 1.9 TDI 1.9 TDI 1.9 TDI 2.0 Eco Fuel 2.0 FSI 2.0 FSI 2.0 TDI 2.0 TDI 2.0 TDI	77 103 125 110 75 85 66 74 77 80 85 110 81 125	05.10 09.06 11.06 05.09 07.03 02.03 05.10 11.04 02.03 08.03 02.06 10.04 10.03 08.03 02.03 02.06	PR: 1KE,1KF,1KJ PR: 1KE,1KF,1KJ PR: 1KE,1KF,1KJ PR: 1KE,1KF,1KJ PR: 1KE,1KF,1KJ PR: 1KE,1KF,1KJ PR: 1KE,1KF,1KJ PR: 1KE,1KF,1KJ PR: 1KE,1KF,1KJ PR: 1KE,1KF,1KJ PR: 1KE,1KF,1KJ PR: 1KE,1KF,1KJ PR: 1KE,1KF,1KJ PR: 1KE,1KF,1KJ PR: 1KE,1KF,1KJ PR: 1KE,1KF,1KJ	24.3414-1709.7 24.3414-1710.7	220631 220632	 	D=41, - Halter D=41, - Halter	TRW TRW
	1.6 1.6 FSI 1.9 TDI 1.9 TDI 1.9 TDI 2.0 FSI 2.0 FSI 2.0 TDI 2.0 TDI	75 85 66 74 77 85 110 81	07.03 02.03 11.04 02.03 08.03 10.04 10.03 08.03 02.03	12.05 12.05 12.05 12.05 12.05 12.05 12.05 12.05 12.05	24.5204-0233.3	331430	2	L=233	
	1.4 TSI 1.4 TSI 1.4 TSI EcoFuel 1.6 1.6 FSI 1.9 TDI 1.9 TDI 1.9 TDI 2.0 Eco Fuel 2.0 FSI 2.0 FSI 2.0 TDI 2.0 TDI 2.0 TDI	103 125 110 75 85 66 74 77 80 85 110 81 125	09.06 11.06 05.09 01.06 01.06 01.06 01.06 01.06 02.06 01.06 01.06 01.06 01.06 02.06	10.09 10.09 10.09 10.09 10.09 10.09 10.09 10.09 10.09 10.09 10.09 10.09 10.09 10.09	83.7849-0236.3	330873	2	L=233	
	1.2 TSI 1.4 TSI 1.4 TSI 1.4 TSI EcoFuel 1.6 1.6 FSI 1.6 TDI 1.9 TDI 1.9 TDI 1.9 TDI 2.0 Eco Fuel 2.0 FSI 2.0 FSI 2.0 TDI 2.0 TDI 2.0 TDI	77 103 125 110 75 85 66 74 77 80 85 110 81 125 130	05.10 11.09 11.09 11.09 11.09 11.09 05.10 11.09 11.09 11.09 11.09 11.09 11.09 11.09 11.09 01.13		83.7847-0254.3 83.7847-0257.3	331233 331234	 	L=255 L=255	
	1.2 TSI 1.4 TSI 1.4 TSI 1.6 1.6 FSI 1.6 TDI 1.9 TDI 1.9 TDI 1.9 TDI	77 103 125 75 85 66 74 77	1T-6-120000 1T-6-120000 1T-6-120000 1T-6-120000 1T-6-120000 1T-6-120000 1T-6-120000 1T-6-120000 1T-6-120000	05.10 09.06 11.06 07.03 02.03 05.10 11.04 02.03 08.03	24.3727-0186.2	580186	2 	L=1563	

VOLKSWAGEN TOURAN I (03-15)

	2.0 FSI	85	1T-6-120000	10.04		24.3727-0186.2	580186	2 ↓		L=1563
	2.0 FSI	110	1T-6-120000	10.03						
	2.0 TDI		1T-6-120000	08.03						
	2.0 TDI	81	1T-6-120000	02.03						
	2.0 TDI	125	1T-6-120000	02.06						
	1.2 TSI	77	1T-6-120001			24.3727-0196.2	580196	2 ↓		L=1561
	1.4 TSI	103	1T-6-120001							
	1.4 TSI	125	1T-6-120001							
	1.6	75	1T-6-120001							
	1.6 FSI	85	1T-6-120001							
	1.6 TDI		1T-6-120001							
	1.9 TDI	66	1T-6-120001							
	1.9 TDI	74	1T-6-120001							
	1.9 TDI	77	1T-6-120001							
	2.0 FSI	85	1T-6-120001							
	2.0 FSI	110	1T-6-120001							
	2.0 TDI		1T-6-120001							
	2.0 TDI	81	1T-6-120001							
	2.0 TDI	125	1T-6-120001							
	2.0 TDI	130			01.13					
	1.4 TSI	103		09.06	10.09	24.2415-1713.3	030132			Gz 15,87, + Sensor
	1.4 TSI	125		11.06	10.09					
	1.4 TSI EcoFuel	110		05.09	10.09					
	1.6	75		07.03	10.09					
	1.6 FSI	85		02.03	10.09					
	1.9 TDI	66		11.04	10.09					
	1.9 TDI	74		02.03	10.09					
	1.9 TDI	77		08.03	10.09					
	2.0 Eco Fuel	80		02.06	10.09					
	2.0 FSI	85		10.04	10.09					
	2.0 FSI	110		10.03	10.09					
	2.0 TDI			08.03	10.09					
	2.0 TDI	81		02.03	10.09					
2.0 TDI	125		02.06	10.09						
	1.2 TSI	77		05.10		24.2415-1713.3	030132			Gz 15,87, + Sensor
	1.4 TSI	103		11.09						
	1.4 TSI	125		11.09						
	1.4 TSI EcoFuel	110		11.09						
	1.6	75		11.09						
	1.6 FSI	85		11.09						
	1.6 TDI			05.10						
	1.9 TDI	66		11.09						
	1.9 TDI	74		11.09						
	1.9 TDI	77		11.09						
	2.0 Eco Fuel	80		11.09						
	2.0 FSI	85		11.09						
	2.0 FSI	110		11.09						
2.0 TDI			11.09							
2.0 TDI	81		11.09							
2.0 TDI	125		11.09							
2.0 TDI	130		01.13							
	1.4 TSI	103		09.06	04.10	24.2519-1705.3	040095			Nz 19,05
	1.4 TSI	125		11.06	04.10					
	1.4 TSI EcoFuel	110		05.09	04.10					
	1.6	75		07.03	04.10					
	1.6 FSI	85		02.03	04.10					
	1.2 TSI	77		05.10		24.2519-1706.3	040096			Nz 19,05
	1.4 TSI	103		11.09						
	1.4 TSI	125		11.09						
	1.4 TSI EcoFuel	110		11.09						
	1.6	75		11.09						
	1.6 FSI	85		11.09						
	1.6 TDI			05.10						
	1.9 TDI	66		11.09						
	1.9 TDI	74		11.09						
	1.9 TDI	77		11.09						
	2.0 Eco Fuel	80		11.09						
	2.0 FSI	85		11.09						
	2.0 FSI	110		11.09						
2.0 TDI			11.09							
2.0 TDI	81		11.09							
2.0 TDI	125		11.09							
2.0 TDI	130		01.13							

VOLKSWAGEN TOURAN II (15-)

	1.2 TSI	81		09.15	PR: OEC	24.2519-1706.3	040096			Nz 19,05
	1.4 TSI	110		09.15	PR: OEC					
	1.6 TDI	81		09.15	PR: OEC					
	1.6 TDI	85		05.16	PR: OEC					
	1.8 TSI	132		11.15	PR: OEC					
	2.0 TDI	81		11.15	PR: OEC					
	2.0 TDI	110		09.15	PR: OEC					
	2.0 TDI	140		11.15	PR: OEC					

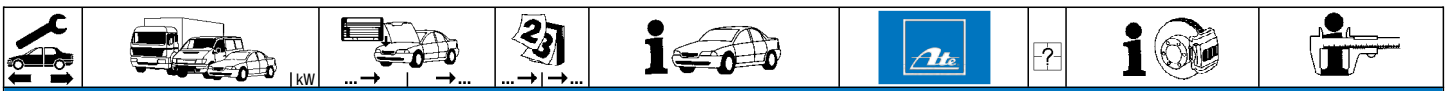

VOLKSWAGEN TRANSPORTER (T4) (90-03)

	1.8		12.90	07.92		03.7750-7402.4	300084		9"	ATE
	1.9 D		70-S-127805	07.90						
	1.9 TD		70-S-127805	10.92						
	2.0		70-S-127805	07.90						
	2.4 D		70-S-127805	07.90						
	2.4 D Syncro		70-S-127805	11.92						
	2.5		70-S-127805	10.90						
	2.5 Syncro		70-S-127805	11.92						
	1.9 D	70-S-127806		06.95		03.7755-4202.4	300164		9/8" Tandem	ATE
	1.9 TD	70-S-127806		06.95						
	2.0	70-S-127806		06.95						
	2.4 D	70-S-127806		06.95						
	2.4 D Syncro	70-S-127806		06.95						
	2.5	70-S-127806		06.95						
	2.5 Syncro	70-S-127806		06.95						
	1.9 D		70-T-199000	07.95		03.7755-4202.4	300164		9/8" Tandem	ATE
	1.9 TD		70-T-199000	07.95						
	2.0		70-T-199000	07.95						
	2.4 D		70-T-199000	07.95						
	2.4 D Syncro		70-T-199000	07.95						
	2.5		70-T-199000	07.95						
	2.5 Syncro		70-T-199000	07.95						
	2.5 TDI		70-T-199000	09.95						
2.5 TDI Syncro		70-T-199000	09.95							
2.8		70-T-199000	11.95							
	1.9 D		70-T-199000	07.95		03.7750-7402.4	300084		9"	ATE
	1.9 TD		70-T-199000	07.95						
	2.0		70-T-199000	07.95						
	2.4 D		70-T-199000	07.95						
	2.4 D Syncro		70-T-199000	07.95						
	2.5		70-T-199000	07.95						
	2.5 Syncro		70-T-199000	07.95						
	2.5 TDI		70-T-199000	09.95						
2.5 TDI Syncro		70-T-199000	09.95							
2.8		70-T-199000	11.95							
	1.9 D	70-T-200001		09.03	+ TRW-Sättel	03.7755-4202.4	300164		9/8" Tandem	ATE
	1.9 TD	70-T-200001		09.03	+ TRW-Sättel					
	2.0	70-T-200001		09.03	+ TRW-Sättel					
	2.4 D	70-T-200001		09.03	+ TRW-Sättel					
	2.4 D Syncro	70-T-200001		09.03	+ TRW-Sättel					
	2.5	70-T-200001		09.03	+ TRW-Sättel					
	2.5 Syncro	70-T-200001		09.03	+ TRW-Sättel					
	2.5 TDI	70-T-200001		09.03	+ TRW-Sättel					
2.5 TDI Syncro	70-T-200001		09.03	+ TRW-Sättel						
2.8	70-T-200001		09.03	+ TRW-Sättel						
	1.9 D			05.98	09.03 + ATE-Sättel ¹⁾	03.7755-4302.4	300165		9/8" Tandem	ATE
	1.9 TD			05.98	09.03 + ATE-Sättel ¹⁾					
	2.0			05.98	09.03 + ATE-Sättel ¹⁾					
	2.4 D			05.98	09.03 + ATE-Sättel ¹⁾					
	2.4 D Syncro			05.98	09.03 + ATE-Sättel ¹⁾					
	2.5			05.98	09.03 + ATE-Sättel ¹⁾					
	2.5 Syncro			05.98	09.03 + ATE-Sättel ¹⁾					
	2.5 TDI			05.98	09.03 + ATE-Sättel ¹⁾					
2.5 TDI Syncro			05.98	09.03 + ATE-Sättel ¹⁾						
2.8			05.98	09.03 + ATE-Sättel ¹⁾						
	1.8		12.90	07.92	- ABS	03.2122-1042.3	010137		THz 22,20	ATE
	1.9 D		70-S-127805	07.90	- ABS	03.3517-0101.2	390322		Verschlußschraube	
	1.9 TD		70-S-127805	10.92	- ABS					
	2.0		70-S-127805	07.90	- ABS					
	2.4 D		70-S-127805	07.90	- ABS					
	2.4 D Syncro		70-S-127805	11.92	- ABS					
	2.5		70-S-127805	10.90	- ABS					
	2.5 Syncro		70-S-127805	11.92	- ABS					
	1.9 D	70-S-127806		09.03	- ABS/ + TRW-Sättel	03.2123-1548.3	010478		THz 23,81	ATE
	1.9 TD	70-S-127806		09.03	- ABS/ + TRW-Sättel					
	2.0	70-S-127806		09.03	- ABS/ + TRW-Sättel					
	2.4 D	70-S-127806		09.03	- ABS/ + TRW-Sättel					
	2.4 D Syncro	70-S-127806		09.03	- ABS/ + TRW-Sättel					
	2.5	70-S-127806		09.03	- ABS/ + TRW-Sättel					
	2.5 Syncro	70-S-127806		09.03	- ABS/ + TRW-Sättel					
	2.5 TDI			09.95	09.03 - ABS/ + TRW-Sättel					
2.5 TDI Syncro			09.95	09.03 - ABS/ + TRW-Sättel						
2.8			11.95	09.03 - ABS/ + TRW-Sättel						
	1.9 D			05.96	09.03 - ABS/+ATE-Sättel ²⁾	03.2125-8111.3	010479		THz 25,40	ATE
	1.9 TD			05.96	09.03 - ABS/+ATE-Sättel ²⁾					
	2.0			05.96	09.03 - ABS/+ATE-Sättel ²⁾					
	2.4 D			05.96	09.03 - ABS/+ATE-Sättel ²⁾					
	2.4 D Syncro			05.96	09.03 - ABS/+ATE-Sättel ²⁾					
	2.5			05.96	09.03 - ABS/+ATE-Sättel ²⁾					
	2.5 Syncro			05.96	09.03 - ABS/+ATE-Sättel ²⁾					
	2.5 TDI			05.96	09.03 - ABS/+ATE-Sättel ²⁾					
2.5 TDI Syncro			05.96	09.03 - ABS/+ATE-Sättel ²⁾						
2.8			11.95	09.03 - ABS/+ATE-Sättel ²⁾						
↓	1.8			12.90	+ ABS	03.2122-0646.3	010133		THz 22,20	ATE
	1.9 D		70-S-127805	07.90	+ ABS					
	1.9 TD		70-S-127805	10.92	+ ABS					

¹⁾ + ATE callipers / + pinze ATE / + étriers ATE / + pinzas ATE

²⁾ - ABS/ + ATE caliper / - ABS/ + pinza ATE / - ABS/ + étriers ATE / - ABS/ + pinzas ATE





VOLKSWAGEN TRANSPORTER (T4) (90-03)

	2.0 2.4 D 2.4 D Syncro 2.5 2.5 Syncro		70-S-127805 70-S-127805 70-S-127805 70-S-127805 70-S-127805	07.90 07.90 11.92 10.90 11.92	+ ABS + ABS + ABS + ABS + ABS	03.2122-0646.3	010133		Thz 22,20	ATE
	1.9 D 1.9 TD 2.0 2.4 D 2.4 D Syncro 2.5 2.5 Syncro 2.5 TDI 2.8	70-S-127806 70-S-127806 70-S-127806 70-S-127806 70-S-127806 70-S-127806 70-S-127806		09.03 09.03 09.03 09.03 09.03 09.03 09.03 09.95 11.95	+ ABS/ + TRW-Sättel + ABS/ + TRW-Sättel + ABS/ + TRW-Sättel + ABS/ + TRW-Sättel + ABS/ + TRW-Sättel + ABS/ + TRW-Sättel + ABS/ + TRW-Sättel + ABS/ + TRW-Sättel + ABS/ + TRW-Sättel	03.2123-1526.3	010477		Thz 23,81	ATE
	1.9 D 1.9 TD 2.0 2.4 D 2.4 D Syncro 2.5 2.5 Syncro 2.5 TDI 2.5 TDI Syncro 2.8			05.96 05.96 05.96 05.96 05.96 05.96 05.96 05.96 05.96 05.96	- ESP/ + ATE-Sättel ¹⁾ - ESP/ + ATE-Sättel ¹⁾ - ESP/ + ATE-Sättel ¹⁾ - ESP/ + ATE-Sättel ¹⁾ - ESP/ + ATE-Sättel ¹⁾ - ESP/ + ATE-Sättel ¹⁾ - ESP/ + ATE-Sättel ¹⁾ - ESP/ + ATE-Sättel ¹⁾ - ESP/ + ATE-Sättel ¹⁾ - ESP/ + ATE-Sättel ¹⁾	03.2125-9704.3	010603		Thz 25,40	ATE
	1.9 D 1.9 TD 2.0 2.4 D 2.4 D Syncro 2.5 2.5 Syncro 2.5 TDI 2.5 TDI Syncro 2.8	70-Y-027264 70-Y-027264 70-Y-027264 70-Y-027264 70-Y-027264 70-Y-027264 70-Y-027264 70-Y-027264 70-Y-027264 70-Y-027264		09.03 09.03 09.03 09.03 09.03 09.03 09.03 09.03 09.03 09.03	+ ESP/ + ATE-Sättel ²⁾ + ESP/ + ATE-Sättel ²⁾ + ESP/ + ATE-Sättel ²⁾ + ESP/ + ATE-Sättel ²⁾ + ESP/ + ATE-Sättel ²⁾ + ESP/ + ATE-Sättel ²⁾ + ESP/ + ATE-Sättel ²⁾ + ESP/ + ATE-Sättel ²⁾ + ESP/ + ATE-Sättel ²⁾ + ESP/ + ATE-Sättel ²⁾	03.2125-9704.3	010603		Thz 25,40	ATE
	1.8 1.9 D 1.9 TD 2.0 2.4 D 2.4 D Syncro 2.5 2.5 Syncro 2.5 TDI 2.5 TDI Syncro 2.8			12.90 07.90 10.92 07.90 07.90 11.92 10.90 11.92 09.95 09.95 11.95	PR: 1LA,1LP PR: 1LA,1LP PR: 1LA,1LP PR: 1LA,1LP PR: 1LA,1LP PR: 1LA,1LP PR: 1LA,1LP PR: 1LA,1LP PR: 1LA,1LP PR: 1LA,1LP PR: 1LA,1LP	24.0101-3401.2 11.0101-5403.2	260043 260010		Bremssattel-Zubehör Falltenbalsatz	TRW TRW
	1.9 D 1.9 TD 2.0 2.4 D 2.4 D Syncro 2.5 2.5 Syncro 2.5 TDI 2.5 TDI Syncro 2.8			07.90 10.92 07.90 07.90 11.92 10.90 11.92 09.95 09.95 11.95	PR: 1LE PR: 1LE PR: 1LE PR: 1LE PR: 1LE PR: 1LE PR: 1LE PR: 1LE PR: 1LE PR: 1LE	24.3541-1775.7 24.3541-1776.7	220529 220530		D=54, - Halter D=54, - Halter	TRW TRW
	1.9 D 1.9 TD 2.0 2.4 D 2.4 D Syncro 2.5 2.5 Syncro 2.5 TDI 2.5 TDI Syncro 2.8			05.96 05.96 05.96 05.96 07.95 05.96 07.95 05.96 09.95 11.95	PR: 1LU PR: 1LU PR: 1LU PR: 1LU PR: 1LU PR: 1LU PR: 1LU PR: 1LU PR: 1LU PR: 1LU	11.0441-5704.2 11.0101-5409.2 11.8171-0008.1 11.8116-0237.1	250034 260035 990049 390509	2	Dichtungssatz Hülzensatz Führungsbolzen Haltefeder	ATE ATE ATE ATE
	1.9 D 1.9 TD 2.0 2.4 D 2.5 2.5 TDI 2.8		70-1-000954 70-1-000954 70-1-000954 70-1-000954 70-1-000954 70-1-000954 70-1-000954	05.97 05.97 05.97 05.97 05.97 05.97 05.97	PR: 1LB PR: 1LB PR: 1LB PR: 1LB PR: 1LB PR: 1LB PR: 1LB	11.0441-5704.2 11.0101-5704.2 11.8171-0008.1	250034 260095 990049		Dichtungssatz Hülzensatz Führungsbolzen	ATE ATE ATE
	1.9 D 1.9 TD 2.0 2.4 D 2.4 D Syncro 2.5 2.5 Syncro 2.5 TDI 2.5 TDI Syncro 2.8	70-1-000955 70-1-000955 70-1-000955 70-1-000955 70-1-000955 70-1-000955 70-1-000955 70-1-000955 70-1-000955 70-1-000955		09.03 09.03 09.03 09.03 09.03 07.95 09.03 07.95 09.03 09.95 09.03	PR: 1LB PR: 1LB PR: 1LB PR: 1LB PR: 1LB PR: 1LB PR: 1LB PR: 1LB PR: 1LB PR: 1LB PR: 1LB	11.9571-9819.2 11.9571-9820.2 11.0101-5705.2 11.8171-0067.1 11.8116-0272.1	220469 220470 260096 250153 390598	2	D=57, - Halter D=57, - Halter Hülzensatz Führungsbolzen Haltefeder	ATE ATE ATE ATE ATE

¹⁾ - ESP/ + ATE calipers / - ESP/ + pinze ATE / - ESP/ + étriers ATE / - ESP/ + pinzas ATE

²⁾ + ESP/ + ATE calipers / + ESP/ + pinze ATE / + ESP/ + étriers ATE / + ESP/ + pinzas ATE

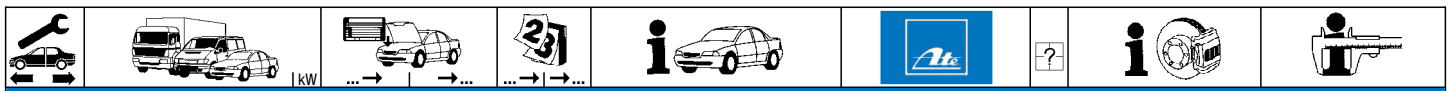

VOLKSWAGEN TRANSPORTER (T4) (90-03)

	1.8			12.90	07.92	24.5237-0334.3	331443	2		L=334	
	1.9 D			07.90	07.95						
	1.9 TD			10.92	07.95						
	2.0			07.90	07.95						
	2.4 D			07.90	07.95						
	2.4 D Syncro			11.92	07.95						
	2.5			10.90	07.95						
	2.5 Syncro			11.92	07.95						
	1.9 D			08.95	04.97	24.5237-0345.3	331367	2		L=345	
	1.9 TD			08.95	04.97						
	2.0			08.95	04.97						
	2.4 D			08.95	04.97						
	2.4 D Syncro			08.95	04.97						
	2.5			08.95	04.97						
	2.5 Syncro			08.95	04.97						
	2.5 TDI			09.95	04.97						
2.5 TDI Syncro			09.95	04.97							
2.8			05.96	04.97							
	1.9 D		70-X-250000	05.97		24.5237-0345.3	331367	2	- Belagverschleiß-Anzeige ¹⁾	L=345	
	1.9 TD		70-X-250000	05.97							
	2.0		70-X-250000	05.97							
	2.4 D		70-X-250000	05.97							
	2.4 D Syncro		70-X-250000	05.97							
	2.5		70-X-250000	05.97							
	2.5 Syncro		70-X-250000	05.97							
	2.5 TDI		70-X-250000	05.97							
2.5 TDI Syncro		70-X-250000	05.97								
2.8		70-X-250000	05.97								
	1.9 D			05.97	04.99	83.6255-0353.3	330481		+ Belagverschleiß-Anzeige ²⁾	L=350	
	1.9 TD			05.97	04.99	83.6255-0340.3	330745		+ Belagverschleiß-Anzeige ²⁾	L=340	
	2.0			05.97	04.99						
	2.4 D			05.97	04.99						
	2.4 D Syncro			05.97	04.99						
	2.5			05.97	04.99						
	2.5 Syncro			05.97	04.99						
	2.5 TDI			05.97	04.99						
2.5 TDI Syncro			05.97	04.99							
2.8			05.97	04.99							
	1.9 D			05.99	09.03	83.6255-0337.3	330744		PR: 2E2/ + Belagverschleiß-Anzeige ³⁾	L=335	
	1.9 TD			05.99	09.03	24.5237-0345.3	331367		PR: 2E2/ + Belagverschleiß-Anzeige ³⁾	L=345	
	2.0			05.99	09.03	83.6255-0353.3	330481		PR: 2E3/ + Belagverschleiß-Anzeige ⁴⁾	L=350	
	2.4 D			05.99	09.03	83.6255-0340.3	330745		PR: 2E3/ + Belagverschleiß-Anzeige ⁴⁾	L=340	
	2.4 D Syncro			05.99	09.03						
	2.5			05.99	09.03						
	2.5 Syncro			05.99	09.03						
	2.5 TDI			05.99	09.03						
2.5 TDI Syncro			05.99	09.03							
2.8			05.99	09.03							
	1.9 D	70-T-200000	70-V-120000			24.3384-1717.5	240267			D=38, - Halter	TRW
	1.9 TD	70-T-200000	70-V-120000			24.3384-1718.5	240268			D=38, - Halter	TRW
	2.0	70-T-200000	70-V-120000								
	2.4 D	70-T-200000	70-V-120000								
	2.5	70-T-200000	70-V-120000								
	2.5 TDI	70-T-200000	70-V-120000								
	2.5 TDI Syncro	70-T-200000	70-V-120000								
	2.8	70-T-200000	70-V-120000								
	1.9 D		70-V-120001		09.03	24.3384-1715.5	240265			D=38, - Halter	TRW
	1.9 TD		70-V-120001		09.03	24.3384-1716.5	240266			D=38, - Halter	TRW
	2.0		70-V-120001		09.03						
	2.4 D		70-V-120001		09.03						
	2.4 D Syncro			05.96	09.03						
	2.5	70-V-120001		09.03	09.03						
	2.5 Syncro			05.96	09.03						
	2.5 TDI	70-V-120001		09.03	09.03						
2.5 TDI Syncro			05.96	09.03							
2.8	70-V-120001		09.03	09.03							
	1.8			12.90	07.92	24.5201-0164.3	331414	2		L=164	
	1.9 D		70-T-199999	07.90							
	1.9 TD		70-T-199999	10.92							
	2.0		70-T-199999	07.90							
	2.4 D		70-T-199999	07.90							
	2.4 D Syncro		70-T-199999	11.92							
	2.5		70-T-199999	10.90							
	2.5 Syncro		70-T-199999	11.92							
2.5 TDI		70-T-199999	09.95								
2.5 TDI Syncro		70-T-199999	09.95								
	1.9 D	70-T-200000		09.03		24.5201-0164.3	331414	2	- Schlechtwegeausführung ⁵⁾	L=164	
	1.9 TD	70-T-200000		09.03		24.5225-0160.3	331366	2	+ Schlechtwegeausführung ⁶⁾	L=160	
	2.0	70-T-200000		09.03		24.5170-0161.3	331308	2	- 16" Rad/ am Bremsattel ⁷⁾	L=161	
	2.4 D	70-T-200000		09.03		24.5113-0170.3	331361	2	+ 16" Rad/ am Bremsattel ⁸⁾	L=170	
	2.4 D Syncro	70-T-200000		09.03							
	2.5	70-T-200000		09.03							
	2.5 Syncro	70-T-200000		09.03							
	2.5 TDI	70-T-200000		09.03							
2.5 TDI Syncro	70-T-200000		09.03								
2.8	70-T-200000		09.03								

¹⁾ - pad wear indicator / - indicatore usura guarniz.fr. / - indicat.d'usure d.garnitures / - indicad.desgaste la guarnic.

²⁾ + pad wear indicator / + indicat.usura guarniz.freno / + indicat.d'usure d.garnitures / + indicad.desgaste la guarnic.

³⁾ PR: 2E2/ + brake wear indicator / PR: 2E2/ + indicatore d'usura guarnizioni freni / PR: 2E2/ + indicateur d'usure des garnitures / PR: 2E2/ + indicador de desgaste de pastillas

⁴⁾ PR: 2E3/ + brake wear indicator / PR: 2E3/ + indicatore d'usura guarnizioni freni / PR: 2E3/ + indicateur d'usure des garnitures / PR: 2E3/ + indicador de desgaste de pastillas

⁵⁾ - rough road construction / - versione per percorsi accidentati / - version pour mauvaise route / - versión 4x4

⁶⁾ + rough road construction / + versione per percorsi accidentati / + version pour mauvaise route / + versión 4x4

⁷⁾ - 16" wheel/on the br.caliper / - ruota 16",sulla pinza freno / - roue 16",sur étrier frein / - rueda 16",la pinza d.freno

⁸⁾ + 16" wheel,on brake caliper / + ruota 16",sulla pinza fr. / + roue 16",sur étrier frein / + rueda 16",la pinza d.freno



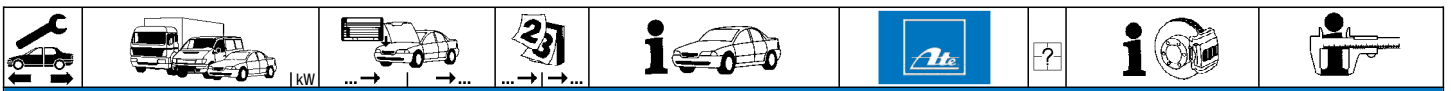

VOLKSWAGEN TRANSPORTER (T4) (90-03)

	1.8 1.9 D 1.9 TD 2.0 2.4 D 2.4 D Syncro 2.5 2.5 Syncro 2.5 TDI 2.5 TDI Syncro		70-T-199999 70-T-199999 70-T-199999 70-T-199999 70-T-199999 70-T-199999 70-T-199999 70-T-199999 70-T-199999 70-T-199999	12.90 07.90 10.92 07.90 07.90 11.92 10.90 11.92 09.95 09.95	07.92		24.3220-0910.3	020211		Rz 20,64
	1.8 1.9 D 1.9 TD 2.0 2.4 D 2.4 D Syncro 2.5 2.5 Syncro 2.5 TDI 2.5 TDI Syncro		70-T-199999 70-T-199999 70-T-199999 70-T-199999 70-T-199999 70-T-199999 70-T-199999 70-T-199999 70-T-199999 70-T-199999	12.90 07.90 10.92 07.90 07.90 11.92 10.90 11.92 09.95 09.95	07.92		24.3727-0131.2	580131	2 ↓	L=844
	1.9 D 1.9 TD 2.0 2.4 D 2.4 D Syncro 2.5 2.5 Syncro 2.5 TDI 2.5 TDI Syncro 2.8	70-T-200000 70-T-200000 70-T-200000 70-T-200000 70-T-200000 70-T-200000 70-T-200000 70-T-200000 70-T-200000 70-T-200000	70-V-120000 70-V-120000 70-V-120000 70-V-120000 70-V-120000 70-V-120000 70-V-120000 70-V-120000 70-V-120000 70-V-120000				24.3727-0157.2	580157	2 ↓	L=949
	1.9 D 1.9 TD 2.0 2.4 D 2.4 D Syncro 2.5 2.5 Syncro 2.5 TDI 2.5 TDI Syncro 2.8	70-V-120001 70-V-120001 70-V-120001 70-V-120001 70-V-120001 70-V-120001 70-V-120001 70-V-120001 70-V-120001 70-V-120001	70-W-039000 70-W-039000 70-W-039000 70-W-039000 70-W-039000 70-W-039000 70-W-039000 70-W-039000 70-W-039000 70-W-039000				24.3727-0177.2	580177	2 ↓	L=953
	1.9 D 1.9 TD 2.0 2.4 D 2.4 D Syncro 2.5 2.5 Syncro 2.5 TDI 2.5 TDI Syncro 2.8	70-W-039001 70-W-039001 70-W-039001 70-W-039001 70-W-039001 70-W-039001 70-W-039001 70-W-039001 70-W-039001 70-W-039001		09.03 09.03 09.03 09.03 09.03 09.03 09.03 09.03 09.03 09.03			24.3727-0177.2	580177	2 ↓	L=953
	1.9 D 1.9 TD 2.0 2.4 D 2.4 D Syncro 2.5 2.5 Syncro			07.90 10.92 07.90 07.90 11.92 10.90 11.92	09.03 09.03 09.03 09.03 09.03 09.03		03.2419-9710.3	030030		Gz 19,05
	2.5 TDI 2.5 TDI Syncro 2.8			09.95 09.95 11.95	09.03 09.03 09.03		24.2415-1706.3	030088		Gz 15,87
	1.8 1.9 D 1.9 TD 2.0 2.4 D 2.4 D Syncro 2.5 2.5 Syncro 2.5 TDI 2.5 TDI Syncro 2.8		70-V-020000 70-V-020000 70-V-020000 70-V-020000 70-V-020000 70-V-020000 70-V-020000 70-V-020000 70-V-020000 70-V-020000 70-V-020000	12.90 07.90 10.92 07.90 07.90 11.92 10.90 11.92 09.95 09.95 11.95	07.92		24.2523-0908.3	040049		Nz 23,81
	1.9 D 1.9 TD 2.0 2.4 D 2.4 D Syncro 2.5 2.5 Syncro 2.5 TDI 2.5 TDI Syncro 2.8	70-V-020001 70-V-020001 70-V-020001 70-V-020001 70-V-020001 70-V-020001 70-V-020001 70-V-020001 70-V-020001 70-V-020001		09.03 09.03 09.03 09.03 09.03 09.03 09.03 09.03 09.03 09.03			24.2519-1701.3	040075		Nz 19,05
	1.8 1.9 D 1.9 TD 2.0 2.4 D			12.90 07.90 10.92 07.90 07.90	07.92 09.03 09.03 09.03 09.03		24.3728-0122.2	590122		L=1225, + AUT

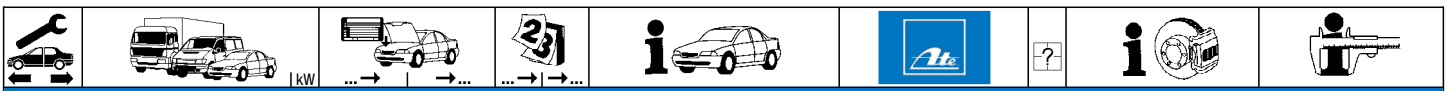

VOLKSWAGEN TRANSPORTER (T4) (90-03)

	2.4 D Syncro			11.92	09.03	24.3728-0122.2	590122		L=1225, + AUT
	2.5			10.90	09.03				
	2.5 Syncro			11.92	09.03				
	2.5 TDI			09.95	09.03				
	2.5 TDI Syncro			09.95	09.03				
	2.8			11.95	09.03				

VOLKSWAGEN TRANSPORTER (T5) BUS / MULTIVAN / KASTEN (03-)

	1.9 TDI	62	7H-A-050000	01.06	PR: 1AJ,1AE,1AC,1AR	03.7765-1002.4	300246		10/9" Tandem	ATE
	1.9 TDI	63	7H-A-050000	04.03	PR: 1AJ,1AE,1AC,1AR					
	1.9 TDI	75	7H-A-050000	06.06	PR: 1AJ,1AE,1AC,1AR					
	1.9 TDI	77	7H-A-050000	04.03	PR: 1AJ,1AE,1AC,1AR					
	2.0		7H-A-050000	06.03	PR: 1AJ,1AE,1AC,1AR					
	2.0 BiTDI	132	7H-A-050000	09.09	PR: 1AJ,1AE,1AC,1AR					
	2.0 BiTDI 4motion	132	7H-A-050000	09.09	PR: 1AJ,1AE,1AC,1AR					
	2.0 TDI	62	7H-A-050000	09.09	PR: 1AJ,1AE,1AC,1AR					
	2.0 TDI	75	7H-A-050000	09.09	PR: 1AJ,1AE,1AC,1AR					
	2.0 TDI	103	7H-A-050000	09.09	PR: 1AJ,1AE,1AC,1AR					
	2.0 TDI 4motion	103	7H-A-050000	09.09	PR: 1AJ,1AE,1AC,1AR					
	2.5 TDI		7H-A-050000	02.03	PR: 1AJ,1AE,1AC,1AR					
	2.5 TDI	96	7H-A-050000	02.03	PR: 1AJ,1AE,1AC,1AR					
	2.5 TDI 4motion	96	7H-A-050000	07.04	PR: 1AJ,1AE,1AC,1AR					
	2.5 TDI 4motion	128	7H-A-050000	07.04	PR: 1AJ,1AE,1AC,1AR					
	3.2 V6		7H-A-050000	02.03	PR: 1AJ,1AE,1AC,1AR					
	3.2 V6 4motion		7H-A-050000	07.04	PR: 1AJ,1AE,1AC,1AR					
	1.9 TDI	62	7H-A-050000	01.06	PR: 1AT	03.0655-0006.2	370006		Wegsensor	ATE
	1.9 TDI	63	7H-A-050000	04.03	PR: 1AT					
	1.9 TDI	75	7H-A-050000	06.06	PR: 1AT					
	1.9 TDI	77	7H-A-050000	04.03	PR: 1AT					
	2.0		7H-A-050000	06.03	PR: 1AT					
	2.0 BiTDI	132	7H-A-050000	09.09	PR: 1AT					
	2.0 BiTDI 4motion	132	7H-A-050000	09.09	PR: 1AT					
	2.0 TDI	62	7H-A-050000	09.09	PR: 1AT					
	2.0 TDI	75	7H-A-050000	09.09	PR: 1AT					
	2.0 TDI	103	7H-A-050000	09.09	PR: 1AT					
	2.0 TDI 4motion	103	7H-A-050000	09.09	PR: 1AT					
	2.5 TDI		7H-A-050000	02.03	PR: 1AT					
	2.5 TDI	96	7H-A-050000	02.03	PR: 1AT					
	2.5 TDI 4motion	96	7H-A-050000	07.04	PR: 1AT					
	2.5 TDI 4motion	128	7H-A-050000	07.04	PR: 1AT					
	3.2 V6		7H-A-050000	02.03	PR: 1AT					
	3.2 V6 4motion		7H-A-050000	07.04	PR: 1AT					
	1.9 TDI	62	7H-A-050000	01.06	PR: 1AK	03.7868-3702.4	300208		10/8" Tandem	ATE
	1.9 TDI	63	7H-A-050000	04.03	PR: 1AK					
	1.9 TDI	75	7H-A-050000	06.06	PR: 1AK					
	1.9 TDI	77	7H-A-050000	04.03	PR: 1AK					
	2.0		7H-A-050000	06.03	PR: 1AK					
	2.0 BiTDI	132	7H-A-050000	09.09	PR: 1AK					
	2.0 BiTDI 4motion	132	7H-A-050000	09.09	PR: 1AK					
	2.0 TDI	62	7H-A-050000	09.09	PR: 1AK					
	2.0 TDI	75	7H-A-050000	09.09	PR: 1AK					
	2.0 TDI	103	7H-A-050000	09.09	PR: 1AK					
	2.0 TDI 4motion	103	7H-A-050000	09.09	PR: 1AK					
	2.5 TDI		7H-A-050000	02.03	PR: 1AK					
	2.5 TDI	96	7H-A-050000	02.03	PR: 1AK					
	2.5 TDI 4motion	96	7H-A-050000	07.04	PR: 1AK					
	2.5 TDI 4motion	128	7H-A-050000	07.04	PR: 1AK					
	3.2 V6		7H-A-050000	02.03	PR: 1AK					
	3.2 V6 4motion		7H-A-050000	07.04	PR: 1AK					
	1.9 TDI	62	7H-A-050000	01.06		03.2126-3014.3	010811		THz 26,99	ATE
	1.9 TDI	63	7H-A-050000	04.03						
	1.9 TDI	75	7H-A-050000	06.06						
	1.9 TDI	77	7H-A-050000	04.03						
	2.0		7H-A-050000	06.03						
	2.0 BiTDI	132	7H-A-050000	09.09						
	2.0 BiTDI 4motion	132	7H-A-050000	09.09						
	2.0 TDI	62	7H-A-050000	09.09						
	2.0 TDI	75	7H-A-050000	09.09						
	2.0 TDI	100	7H-A-050000	05.10						
	2.0 TDI	103	7H-A-050000	09.09						
	2.0 TDI 4motion	100	7H-A-050000	05.10						
	2.0 TDI 4motion	103	7H-A-050000	09.09						
	2.5 TDI		7H-A-050000	02.03						
	2.5 TDI	96	7H-A-050000	02.03						
	2.5 TDI 4motion	96	7H-A-050000	07.04						
	2.5 TDI 4motion	128	7H-A-050000	07.04						
	3.2 V6		7H-A-050000	02.03						
	3.2 V6 4motion		7H-A-050000	07.04						
	1.9 TDI	62	7H-A-200001			03.2126-3144.3	010941		THz 26,99	ATE
	1.9 TDI	63	7H-A-200001							
	1.9 TDI	75	7H-A-200001							
	1.9 TDI	77	7H-A-200001							
	2.0		7H-A-200001							
	2.0 BiTDI	132	7H-A-200001							
	2.0 BiTDI 4motion	132	7H-A-200001							
	2.0 TDI	62	7H-A-200001							
	2.0 TDI	75	7H-A-200001							



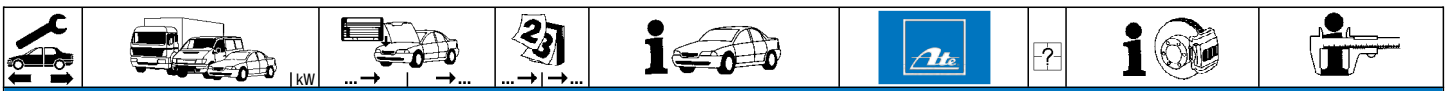

























VOLKSWAGEN TRANSPORTER (T5) BUS / MULTIVAN / KASTEN (03-)

	2.0 TDI	62		09.09	PR: OWL,OWN,OWM,OWP,OWQ	24.5140-0514.3	331290	2		L=520	
	2.0 TDI	75		09.09	PR: OWL,OWN,OWM,OWP,OWQ						
	2.0 TDI	100		05.10	PR: OWL,OWN,OWM,OWP,OWQ						
	2.0 TDI	103		09.09	PR: OWL,OWN,OWM,OWP,OWQ						
	2.0 TDI 4motion	100		05.10	PR: OWL,OWN,OWM,OWP,OWQ						
	2.0 TDI 4motion	103		09.09	PR: OWL,OWN,OWM,OWP,OWQ						
	2.5 TDI			02.03	PR: OWL,OWN,OWM,OWP,OWQ						
	2.5 TDI	96		02.03	PR: OWL,OWN,OWM,OWP,OWQ						
	2.5 TDI 4motion	96		07.04	PR: OWL,OWN,OWM,OWP,OWQ						
	2.5 TDI 4motion	128		07.04	PR: OWL,OWN,OWM,OWP,OWQ						
	3.2 V6			02.03	PR: OWL,OWN,OWM,OWP,OWQ						
	3.2 V6 4motion			07.04	PR: OWL,OWN,OWM,OWP,OWQ						
		1.9 TDI	62		01.06						PR: OWR
1.9 TDI		63		04.03	PR: OWR						
1.9 TDI		75		06.06	PR: OWR						
1.9 TDI		77		04.03	PR: OWR						
2.0				06.03	PR: OWR						
2.0 BiTDI		132		09.09	PR: OWR						
2.0 BiTDI 4motion		132		09.09	PR: OWR						
2.0 TDI		62		09.09	PR: OWR						
2.0 TDI		75		09.09	PR: OWR						
2.0 TDI		100		05.10	PR: OWR						
2.0 TDI		103		09.09	PR: OWR						
2.0 TDI 4motion		100		05.10	PR: OWR						
2.0 TDI 4motion		103		09.09	PR: OWR						
2.5 TDI				02.03	PR: OWR						
2.5 TDI		96		02.03	PR: OWR						
2.5 TDI 4motion		96		07.04	PR: OWR						
2.5 TDI 4motion		128		07.04	PR: OWR						
3.2 V6				02.03	PR: OWR						
3.2 V6 4motion				07.04	PR: OWR						
	1.9 TDI	62		01.06	PR: 1BA,1BB,1BJ,1BV,1MG,1MK,1ML,2MD,2MF,2MG,2ML	24.5140-0514.3	331290	2		L=520	
	1.9 TDI	63		04.03	PR: 1BA,1BB,1BJ,1BV,1MG,1MK,1ML,2MD,2MF,2MG,2ML						
	1.9 TDI	75		06.06	PR: 1BA,1BB,1BJ,1BV,1MG,1MK,1ML,2MD,2MF,2MG,2ML						
	1.9 TDI	77		04.03	PR: 1BA,1BB,1BJ,1BV,1MG,1MK,1ML,2MD,2MF,2MG,2ML						
	2.0			06.03	PR: 1BA,1BB,1BJ,1BV,1MG,1MK,1ML,2MD,2MF,2MG,2ML						
	2.0 BiTDI	132		09.09	PR: 1BA,1BB,1BJ,1BV,1MG,1MK,1ML,2MD,2MF,2MG,2ML						
	2.0 BiTDI 4motion	132		09.09	PR: 1BA,1BB,1BJ,1BV,1MG,1MK,1ML,2MD,2MF,2MG,2ML						
	2.0 TDI	62		09.09	PR: 1BA,1BB,1BJ,1BV,1MG,1MK,1ML,2MD,2MF,2MG,2ML						
	2.0 TDI	75		09.09	PR: 1BA,1BB,1BJ,1BV,1MG,1MK,1ML,2MD,2MF,2MG,2ML						
	2.0 TDI	84		05.11	PR: 1BA,1BB,1BJ,1BV,1MG,1MK,1ML,2MD,2MF,2MG,2ML						
	2.0 TDI	100		05.10	PR: 1BA,1BB,1BJ,1BV,1MG,1MK,1ML,2MD,2MF,2MG,2ML						
	2.0 TDI	103		09.09	PR: 1BA,1BB,1BJ,1BV,1MG,1MK,1ML,2MD,2MF,2MG,2ML						
	2.0 TDI 4motion	100		05.10	PR: 1BA,1BB,1BJ,1BV,1MG,1MK,1ML,2MD,2MF,2MG,2ML						
	2.0 TDI 4motion	103		09.09	PR: 1BA,1BB,1BJ,1BV,1MG,1MK,1ML,2MD,2MF,2MG,2ML						
	2.0 TSI			05.11	PR: 1BA,1BB,1BJ,1BV,1MG,1MK,1ML,2MD,2MF,2MG,2ML						
	2.0 TSI 4motion	150		07.11	PR: 1BA,1BB,1BJ,1BV,1MG,1MK,1ML,2MD,2MF,2MG,2ML						
	2.5 TDI			02.03	PR: 1BA,1BB,1BJ,1BV,1MG,1MK,1ML,2MD,2MF,2MG,2ML						
	2.5 TDI	96		02.03	PR: 1BA,1BB,1BJ,1BV,1MG,1MK,1ML,2MD,2MF,2MG,2ML						
	2.5 TDI 4motion	96		07.04	PR: 1BA,1BB,1BJ,1BV,1MG,1MK,1ML,2MD,2MF,2MG,2ML						
2.5 TDI 4motion	128		07.04	PR: 1BA,1BB,1BJ,1BV,1MG,1MK,1ML,2MD,2MF,2MG,2ML							
3.2 V6			02.03	PR: 1BA,1BB,1BJ,1BV,1MG,1MK,1ML,2MD,2MF,2MG,2ML							
3.2 V6 4motion			07.04	PR: 1BA,1BB,1BJ,1BV,1MG,1MK,1ML,2MD,2MF,2MG,2ML							
	1.9 TDI	62		01.06	PR: 1BH,1BX,1MR,2MQ,2MZ,2MU,2MT	83.6113-0552.3	330864	2		L=552	
	1.9 TDI	63		04.03	PR: 1BH,1BX,1MR,2MQ,2MZ,2MU,2MT						
	1.9 TDI	75		06.06	PR: 1BH,1BX,1MR,2MQ,2MZ,2MU,2MT						
	1.9 TDI	77		04.03	PR: 1BH,1BX,1MR,2MQ,2MZ,2MU,2MT						
	2.0			06.03	PR: 1BH,1BX,1MR,2MQ,2MZ,2MU,2MT						
	2.0 BiTDI	132		09.09	PR: 1BH,1BX,1MR,2MQ,2MZ,2MU,2MT						
	2.0 BiTDI 4motion	132		09.09	PR: 1BH,1BX,1MR,2MQ,2MZ,2MU,2MT						
	2.0 TDI	62		09.09	PR: 1BH,1BX,1MR,2MQ,2MZ,2MU,2MT						
	2.0 TDI	75		09.09	PR: 1BH,1BX,1MR,2MQ,2MZ,2MU,2MT						
	2.0 TDI	84		05.11	PR: 1BH,1BX,1MR,2MQ,2MZ,2MU,2MT						
	2.0 TDI	100		05.10	PR: 1BH,1BX,1MR,2MQ,2MZ,2MU,2MT						
	2.0 TDI	103		09.09	PR: 1BH,1BX,1MR,2MQ,2MZ,2MU,2MT						
	2.0 TDI 4motion	100		05.10	PR: 1BH,1BX,1MR,2MQ,2MZ,2MU,2MT						
	2.0 TDI 4motion	103		09.09	PR: 1BH,1BX,1MR,2MQ,2MZ,2MU,2MT						
	2.0 TSI			05.11	PR: 1BH,1BX,1MR,2MQ,2MZ,2MU,2MT						
	2.0 TSI 4motion	150		07.11	PR: 1BH,1BX,1MR,2MQ,2MZ,2MU,2MT						
	2.5 TDI			02.03	PR: 1BH,1BX,1MR,2MQ,2MZ,2MU,2MT						
	2.5 TDI	96		02.03	PR: 1BH,1BX,1MR,2MQ,2MZ,2MU,2MT						
	2.5 TDI 4motion	96		07.04	PR: 1BH,1BX,1MR,2MQ,2MZ,2MU,2MT						
2.5 TDI 4motion	128		07.04	PR: 1BH,1BX,1MR,2MQ,2MZ,2MU,2MT							
3.2 V6			02.03	PR: 1BH,1BX,1MR,2MQ,2MZ,2MU,2MT							
3.2 V6 4motion			07.04	PR: 1BH,1BX,1MR,2MQ,2MZ,2MU,2MT							
	1.9 TDI	63	7H-5-120000	04.03	PR: OWL,OWN,OWM,OWP,OWQ	24.3414-1711.7	220677			D=41, - Halter	TRW
	1.9 TDI	77	7H-5-120000	04.03	PR: OWL,OWN,OWM,OWP,OWQ						
	2.0		7H-5-120000	06.03	PR: OWL,OWN,OWM,OWP,OWQ						
	2.5 TDI		7H-5-120000	02.03	PR: OWL,OWN,OWM,OWP,OWQ						
	2.5 TDI	96	7H-5-120000	02.03	PR: OWL,OWN,OWM,OWP,OWQ						
	2.5 TDI 4motion	96	7H-5-120000	07.04	PR: OWL,OWN,OWM,OWP,OWQ						
	2.5 TDI 4motion	128	7H-5-120000	07.04	PR: OWL,OWN,OWM,OWP,OWQ						
3.2 V6		7H-5-120000	02.03	PR: OWL,OWN,OWM,OWP,OWQ							
3.2 V6 4motion		7H-5-120000	07.04	PR: OWL,OWN,OWM,OWP,OWQ							



									
VOLKSWAGEN TRANSPORTER (T5) BUS / MULTIVAN / KASTEN (03-)									
	1.9 TDI	62	7H-8-027999	01.06	PR: OWR	11.9441-9949.2	220803	  D=44, - Halter ATE D=44, - Halter ATE Hülsensatz ATE Führungsbolzen ATE Haltefeder ATE	
	1.9 TDI	63	7H-8-027999	04.03	PR: OWR	11.9441-9950.2	220804		
	1.9 TDI	75	7H-8-027999	06.06	PR: OWR	11.0101-5409.2	260035		
	1.9 TDI	77	7H-8-027999	04.03	PR: OWR	11.8171-0008.1	990049		
	2.0		7H-8-027999	06.03	PR: OWR	11.8116-0310.1	390611		
	2.5 TDI		7H-8-027999	02.03	PR: OWR				
	2.5 TDI	96	7H-8-027999	02.03	PR: OWR				
	2.5 TDI 4motion	96	7H-8-027999	07.04	PR: OWR				
	2.5 TDI 4motion	128	7H-8-027999	07.04	PR: OWR				
	3.2 V6		7H-8-027999	02.03	PR: OWR				
	3.2 V6 4motion		7H-8-027999	07.04	PR: OWR				
	1.9 TDI	62	7H-8-028000	7H-8-200000	PR: OWR	24.3414-1711.7	220677		  D=41, - Halter TRW D=41, - Halter TRW
	1.9 TDI	63	7H-8-028000	7H-8-200000	PR: OWR	24.3414-1712.7	220678		
	1.9 TDI	75	7H-8-028000	7H-8-200000	PR: OWR				
	1.9 TDI	77	7H-8-028000	7H-8-200000	PR: OWR				
	2.0		7H-8-028000	7H-8-200000	PR: OWR				
	2.5 TDI		7H-8-028000	7H-8-200000	PR: OWR				
	2.5 TDI	96	7H-8-028000	7H-8-200000	PR: OWR				
	2.5 TDI 4motion	96	7H-8-028000	7H-8-200000	PR: OWR				
	2.5 TDI 4motion	128	7H-8-028000	7H-8-200000	PR: OWR				
	3.2 V6		7H-8-028000	7H-8-200000	PR: OWR				
	3.2 V6 4motion		7H-8-028000	7H-8-200000	PR: OWR				
	1.9 TDI	62	7H-6-000001	7H-A-050000	PR: 2E3,2E4	24.3414-1711.7	220677	  D=41, - Halter TRW D=41, - Halter TRW	
	1.9 TDI	63	7H-6-000001	7H-A-050000	PR: 2E3,2E4	24.3414-1712.7	220678		
	1.9 TDI	75	7H-6-000001	7H-A-050000	PR: 2E3,2E4				
	1.9 TDI	77	7H-6-000001	7H-A-050000	PR: 2E3,2E4				
	2.0		7H-6-000001	7H-A-050000	PR: 2E3,2E4				
	2.0 BiTDI	132	7H-6-000001	7H-A-050000	PR: 2E3,2E4				
	2.0 BiTDI 4motion	132	7H-6-000001	7H-A-050000	PR: 2E3,2E4				
	2.0 TDI	62	7H-6-000001	7H-A-050000	PR: 2E3,2E4				
	2.0 TDI	75	7H-6-000001	7H-A-050000	PR: 2E3,2E4				
	2.0 TDI	103	7H-6-000001	7H-A-050000	PR: 2E3,2E4				
	2.0 TDI 4motion	103	7H-6-000001	7H-A-050000	PR: 2E3,2E4				
	2.5 TDI		7H-6-000001	7H-A-050000	PR: 2E3,2E4				
	2.5 TDI	96	7H-6-000001	7H-A-050000	PR: 2E3,2E4				
	2.5 TDI 4motion	96	7H-6-000001	7H-A-050000	PR: 2E3,2E4				
	2.5 TDI 4motion	128	7H-6-000001	7H-A-050000	PR: 2E3,2E4				
	3.2 V6		7H-6-000001	7H-A-050000	PR: 2E3,2E4				
	3.2 V6 4motion		7H-6-000001	7H-A-050000	PR: 2E3,2E4				
	1.9 TDI	62	7H-A-200001			24.3414-1711.7	220677	  D=41, - Halter TRW D=41, - Halter TRW	
	1.9 TDI	63	7H-A-200001			24.3414-1712.7	220678		
	1.9 TDI	75	7H-A-200001						
	1.9 TDI	77	7H-A-200001						
	2.0		7H-A-200001						
	2.0 BiTDI	132	7H-A-200001						
	2.0 BiTDI 4motion	132	7H-A-200001						
	2.0 TDI	62	7H-A-200001						
	2.0 TDI	75	7H-A-200001						
	2.0 TDI	84		05.11					
	2.0 TDI	100	7H-A-200001						
	2.0 TDI	103	7H-A-200001						
	2.0 TDI 4motion	100	7H-A-200001						
	2.0 TDI 4motion	103	7H-A-200001						
	2.0 TSI			05.11					
	2.0 TSI 4motion	150		07.11					
	2.5 TDI		7H-A-200001						
	2.5 TDI	96	7H-A-200001						
	2.5 TDI 4motion	96	7H-A-200001						
	2.5 TDI 4motion	128	7H-A-200001						
	3.2 V6		7H-A-200001						
	3.2 V6 4motion		7H-A-200001						
	1.9 TDI	62		01.06	- Bremskraftregler ¹⁾	24.5140-0241.3	330948	  am Bremsattel ²⁾ am Bremsattel ²⁾ L=240 L=240 L=250	
	1.9 TDI	63		04.03	- Bremskraftregler ¹⁾	24.5140-0240.3	330947		
	1.9 TDI	75		06.06	- Bremskraftregler ¹⁾	24.5237-0250.3	330880		
	1.9 TDI	77		04.03	- Bremskraftregler ¹⁾				
	2.0			06.03	- Bremskraftregler ¹⁾				
	2.0 BiTDI	132		09.09	- Bremskraftregler ¹⁾				
	2.0 BiTDI 4motion	132		09.09	- Bremskraftregler ¹⁾				
	2.0 TDI	62		09.09	- Bremskraftregler ¹⁾				
	2.0 TDI	75		09.09	- Bremskraftregler ¹⁾				
	2.0 TDI	100		05.10	- Bremskraftregler ¹⁾				
	2.0 TDI	103		09.09	- Bremskraftregler ¹⁾				
	2.0 TDI 4motion	100		05.10	- Bremskraftregler ¹⁾				
	2.0 TDI 4motion	103		09.09	- Bremskraftregler ¹⁾				
	2.5 TDI			02.03	- Bremskraftregler ¹⁾				
	2.5 TDI	96		02.03	- Bremskraftregler ¹⁾				
	2.5 TDI 4motion	96		07.04	- Bremskraftregler ¹⁾				
	2.5 TDI 4motion	128		07.04	- Bremskraftregler ¹⁾				
	3.2 V6			02.03	- Bremskraftregler ¹⁾				
	3.2 V6 4motion			07.04	- Bremskraftregler ¹⁾				
	1.9 TDI	62		01.06	+ Bremskraftregler ³⁾	24.5137-0190.3	330878	2 am Bremsattel ²⁾ 2 am Bremsattel ²⁾ L=190 L=194 L=250	
	1.9 TDI	63		04.03	+ Bremskraftregler ³⁾	24.5140-0194.3	331383		
	1.9 TDI	75		06.06	+ Bremskraftregler ³⁾	24.5237-0250.3	330880		
	1.9 TDI	77		04.03	+ Bremskraftregler ³⁾				
	2.0			06.03	+ Bremskraftregler ³⁾				
	2.0 BiTDI	132		09.09	+ Bremskraftregler ³⁾				
	2.0 BiTDI 4motion	132		09.09	+ Bremskraftregler ³⁾				

1) - brake pressure regulator / - correttore di frenata / - correcteur de freinage / - corrector de frenado
 2) on the brake caliper / sulla pinza freno / sur l'étrier de frein / a la pinza de freno
 3) + brake pressure regulator / + correttore di frenata / + correcteur de freinage / + corrector de frenado

VOLKSWAGEN TRANSPORTER (T5) BUS / MULTIVAN / KASTEN (03-)										
	2.0 TDI	62		09.09	+ Bremskraftregler ¹⁾	24.5137-0190.3	330878	2	am Bremsattel ²⁾	L=190
	2.0 TDI	75		09.09	+ Bremskraftregler ¹⁾	24.5140-0194.3	331383	2	am Bremsattel ²⁾	L=194
	2.0 TDI	100		05.10	+ Bremskraftregler ¹⁾	24.5237-0250.3	330880	2		L=250
	2.0 TDI	103		09.09	+ Bremskraftregler ¹⁾					
	2.0 TDI 4motion	100		05.10	+ Bremskraftregler ¹⁾					
	2.0 TDI 4motion	103		09.09	+ Bremskraftregler ¹⁾					
	2.5 TDI			02.03	+ Bremskraftregler ¹⁾					
	2.5 TDI	96		02.03	+ Bremskraftregler ¹⁾					
	2.5 TDI 4motion	96		07.04	+ Bremskraftregler ¹⁾					
	2.5 TDI 4motion	128		07.04	+ Bremskraftregler ¹⁾					
	3.2 V6			02.03	+ Bremskraftregler ¹⁾					
	3.2 V6 4motion			07.04	+ Bremskraftregler ¹⁾					
	1.9 TDI	62		01.06	PR: OWR	24.5140-0241.3	330948		<input type="checkbox"/> am Bremsattel ²⁾	L=240
	1.9 TDI	63		04.03	PR: OWR	24.5140-0240.3	330947		<input type="checkbox"/> am Bremsattel ²⁾	L=240
	1.9 TDI	75		06.06	PR: OWR	24.5237-0250.3	330880	2		L=250
	1.9 TDI	77		04.03	PR: OWR					
	2.0			06.03	PR: OWR					
2.0 BiTDI	132		09.09	PR: OWR						
2.0 BiTDI 4motion	132		09.09	PR: OWR						
2.0 TDI	62		09.09	PR: OWR						
2.0 TDI	75		09.09	PR: OWR						
2.0 TDI	100		05.10	PR: OWR						
2.0 TDI	103		09.09	PR: OWR						
2.0 TDI 4motion	100		05.10	PR: OWR						
2.0 TDI 4motion	103		09.09	PR: OWR						
2.5 TDI			02.03	PR: OWR						
2.5 TDI	96		02.03	PR: OWR						
2.5 TDI 4motion	96		07.04	PR: OWR						
2.5 TDI 4motion	128		07.04	PR: OWR						
3.2 V6			02.03	PR: OWR						
3.2 V6 4motion			07.04	PR: OWR						
1.9 TDI	62		01.06	PR: OE1,OE2,OVL,OWN,OWM,OWP,OWQ	24.5140-0194.3	331383	2		L=194	
1.9 TDI	63		04.03	PR: OE1,OE2,OVL,OWN,OWM,OWP,OWQ						
1.9 TDI	75		06.06	PR: OE1,OE2,OVL,OWN,OWM,OWP,OWQ						
1.9 TDI	77		04.03	PR: OE1,OE2,OVL,OWN,OWM,OWP,OWQ						
2.0			06.03	PR: OE1,OE2,OVL,OWN,OWM,OWP,OWQ						
2.0 BiTDI	132		09.09	PR: OE1,OE2,OVL,OWN,OWM,OWP,OWQ						
2.0 BiTDI 4motion	132		09.09	PR: OE1,OE2,OVL,OWN,OWM,OWP,OWQ						
2.0 TDI	62		09.09	PR: OE1,OE2,OVL,OWN,OWM,OWP,OWQ						
2.0 TDI	75		09.09	PR: OE1,OE2,OVL,OWN,OWM,OWP,OWQ						
2.0 TDI	84		05.11	PR: OE1,OE2,OVL,OWN,OWM,OWP,OWQ						
2.0 TDI	100		05.10	PR: OE1,OE2,OVL,OWN,OWM,OWP,OWQ						
2.0 TDI	103		09.09	PR: OE1,OE2,OVL,OWN,OWM,OWP,OWQ						
2.0 TDI 4motion	100		05.10	PR: OE1,OE2,OVL,OWN,OWM,OWP,OWQ						
2.0 TDI 4motion	103		09.09	PR: OE1,OE2,OVL,OWN,OWM,OWP,OWQ						
2.0 TSI			05.11	PR: OE1,OE2,OVL,OWN,OWM,OWP,OWQ						
2.0 TSI 4motion	150		07.11	PR: OE1,OE2,OVL,OWN,OWM,OWP,OWQ						
2.5 TDI			02.03	PR: OE1,OE2,OVL,OWN,OWM,OWP,OWQ						
2.5 TDI	96		02.03	PR: OE1,OE2,OVL,OWN,OWM,OWP,OWQ						
2.5 TDI 4motion	96		07.04	PR: OE1,OE2,OVL,OWN,OWM,OWP,OWQ						
2.5 TDI 4motion	128		07.04	PR: OE1,OE2,OVL,OWN,OWM,OWP,OWQ						
3.2 V6			02.03	PR: OE1,OE2,OVL,OWN,OWM,OWP,OWQ						
3.2 V6 4motion			07.04	PR: OE1,OE2,OVL,OWN,OWM,OWP,OWQ						
	1.9 TDI	62		01.06	PR: OE1,OE2,OVL,OWN,OWM,OWP,OWQ	24.3727-0184.2	580184	2		L=1303
	1.9 TDI	63		04.03	PR: OE1,OE2,OVL,OWN,OWM,OWP,OWQ					
	1.9 TDI	75		06.06	PR: OE1,OE2,OVL,OWN,OWM,OWP,OWQ					
	1.9 TDI	77		04.03	PR: OE1,OE2,OVL,OWN,OWM,OWP,OWQ					
	2.0			06.03	PR: OE1,OE2,OVL,OWN,OWM,OWP,OWQ					
	2.0 BiTDI	132		09.09	PR: OE1,OE2,OVL,OWN,OWM,OWP,OWQ					
	2.0 TDI	62		09.09	PR: OE1,OE2,OVL,OWN,OWM,OWP,OWQ					
	2.0 TDI	75		09.09	PR: OE1,OE2,OVL,OWN,OWM,OWP,OWQ					
	2.0 TDI	100		05.10	PR: OE1,OE2,OVL,OWN,OWM,OWP,OWQ					
	2.0 TDI	103		09.09	PR: OE1,OE2,OVL,OWN,OWM,OWP,OWQ					
	2.5 TDI			02.03	PR: OE1,OE2,OVL,OWN,OWM,OWP,OWQ					
	2.5 TDI	96		02.03	PR: OE1,OE2,OVL,OWN,OWM,OWP,OWQ					
	3.2 V6			02.03	PR: OE1,OE2,OVL,OWN,OWM,OWP,OWQ					
	2.0 BiTDI 4motion	132	7H-A-200001			24.3727-0184.2	580184	2	PR: G0C,G0K,G1C	L=1303
	2.0 TDI	84		05.11						
	2.0 TDI 4motion	100	7H-A-200001							
	2.0 TDI 4motion	103	7H-A-200001							
2.0 TSI			05.11							
2.0 TSI 4motion	150		07.11							
2.5 TDI 4motion	96	7H-A-200001								
2.5 TDI 4motion	128	7H-A-200001								
3.2 V6 4motion		7H-A-200001								
VOLKSWAGEN TRANSPORTER (T5) PRITSCH / FAHRGESTELL (03-)										
	1.9 TDI	62	7J-A-010000	01.06	PR: 1AJ,1AE,1AC,1AR	03.7765-1002.4	300246			10/9" Tandem
	1.9 TDI	63	7J-A-010000	04.03	PR: 1AJ,1AE,1AC,1AR					ATE
	1.9 TDI	75	7J-A-010000	06.06	PR: 1AJ,1AE,1AC,1AR					
	1.9 TDI	77	7J-A-010000	04.03	PR: 1AJ,1AE,1AC,1AR					
	2.0	85	7J-A-010000	06.03	PR: 1AJ,1AE,1AC,1AR					
	2.0 BiTDI	132	7J-A-010000	09.09	PR: 1AJ,1AE,1AC,1AR					
	2.0 BiTDI 4motion	132	7J-A-010000	09.09	PR: 1AJ,1AE,1AC,1AR					
	2.0 TDI	62	7J-A-010000	09.09	PR: 1AJ,1AE,1AC,1AR					
	2.0 TDI	75	7J-A-010000	09.09	PR: 1AJ,1AE,1AC,1AR					
	2.0 TDI	103	7J-A-010000	09.09	PR: 1AJ,1AE,1AC,1AR					

¹⁾ + brake pressure regulator / + correttore di frenata / + correcteur de freinage / + corrector de frenado

²⁾ on the brake caliper / sulla pinza freno / sur l'étrier de frein / a la pinza de freno



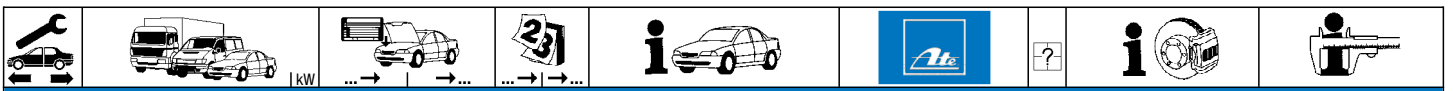

VOLKSWAGEN TRANSPORTER (T5) PRITSCH / FAHRGESTELL (03-)

	2.0 TDI 4motion	103	7J-A-010000	09.09	PR: 1AJ,1AE,1AC,1AR	03.7765-1002.4	300246		10/9" Tandem	ATE						
	2.5 TDI	96	7J-A-010000	02.03	PR: 1AJ,1AE,1AC,1AR											
	2.5 TDI	128	7J-A-010000	02.03	PR: 1AJ,1AE,1AC,1AR											
	2.5 TDI 4motion	96	7J-A-010000	07.04	PR: 1AJ,1AE,1AC,1AR											
	2.5 TDI 4motion	128	7J-A-010000	07.04	PR: 1AJ,1AE,1AC,1AR											
	3.2 V6	170	7J-A-010000	02.04	PR: 1AJ,1AE,1AC,1AR											
	3.2 V6	173	7J-A-010000	08.03	PR: 1AJ,1AE,1AC,1AR											
	1.9 TDI	62	7J-A-010000	01.06	PR: 1AT	03.0655-0006.2	370006		Wegsensor	ATE						
	1.9 TDI	63	7J-A-010000	04.03	PR: 1AT											
	1.9 TDI	75	7J-A-010000	06.06	PR: 1AT											
	1.9 TDI	77	7J-A-010000	04.03	PR: 1AT											
	2.0	85	7J-A-010000	06.03	PR: 1AT											
	2.0 BiTDI	132	7J-A-010000	09.09	PR: 1AT											
	2.0 BiTDI 4motion	132	7J-A-010000	09.09	PR: 1AT											
	2.0 TDI	62	7J-A-010000	09.09	PR: 1AT											
	2.0 TDI	75	7J-A-010000	09.09	PR: 1AT											
	2.0 TDI	103	7J-A-010000	09.09	PR: 1AT											
	2.0 TDI 4motion	103	7J-A-010000	09.09	PR: 1AT											
2.5 TDI	96	7J-A-010000	02.03	PR: 1AT												
2.5 TDI	128	7J-A-010000	02.03	PR: 1AT												
2.5 TDI 4motion	96	7J-A-010000	07.04	PR: 1AT												
2.5 TDI 4motion	128	7J-A-010000	07.04	PR: 1AT												
3.2 V6	170	7J-A-010000	02.04	PR: 1AT												
3.2 V6	173	7J-A-010000	08.03	PR: 1AT												
	1.9 TDI	62	7J-A-010000	01.06	PR: 1AK						03.7868-3702.4	300208		10/8" Tandem	ATE	
	1.9 TDI	63	7J-A-010000	04.03	PR: 1AK											
	1.9 TDI	75	7J-A-010000	06.06	PR: 1AK											
	1.9 TDI	77	7J-A-010000	04.03	PR: 1AK											
	2.0	85	7J-A-010000	06.03	PR: 1AK											
	2.0 BiTDI	132	7J-A-010000	09.09	PR: 1AK											
	2.0 BiTDI 4motion	132	7J-A-010000	09.09	PR: 1AK											
	2.0 TDI	62	7J-A-010000	09.09	PR: 1AK											
	2.0 TDI	75	7J-A-010000	09.09	PR: 1AK											
	2.0 TDI	103	7J-A-010000	09.09	PR: 1AK											
	2.0 TDI 4motion	103	7J-A-010000	09.09	PR: 1AK											
	2.5 TDI	96	7J-A-010000	02.03	PR: 1AK											
	2.5 TDI	128	7J-A-010000	02.03	PR: 1AK											
	2.5 TDI 4motion	96	7J-A-010000	07.04	PR: 1AK											
	2.5 TDI 4motion	128	7J-A-010000	07.04	PR: 1AK											
	3.2 V6	170	7J-A-010000	02.04	PR: 1AK											
	3.2 V6	173	7J-A-010000	08.03	PR: 1AK											
		1.9 TDI	62	7J-A-010000	01.06		03.2126-3014.3	010811		Thz 26,99						ATE
		1.9 TDI	63	7J-A-010000	04.03											
		1.9 TDI	75	7J-A-010000	06.06											
		1.9 TDI	77	7J-A-010000	04.03											
		2.0	85	7J-A-010000	06.03											
		2.0 BiTDI	132	7J-A-010000	09.09											
		2.0 BiTDI 4motion	132	7J-A-010000	09.09											
2.0 TDI		62	7J-A-010000	09.09												
2.0 TDI		75	7J-A-010000	09.09												
2.0 TDI		103	7J-A-010000	09.09												
2.0 TDI 4motion		103	7J-A-010000	09.09												
2.5 TDI		96	7J-A-010000	02.03												
2.5 TDI		128	7J-A-010000	02.03												
2.5 TDI 4motion		96	7J-A-010000	07.04												
2.5 TDI 4motion		128	7J-A-010000	07.04												
3.2 V6		170	7J-A-010000	02.04												
3.2 V6		173	7J-A-010000	08.03												
		1.9 TDI	62	7J-A-200001							03.2126-3144.3	010941		Thz 26,99	ATE	
		1.9 TDI	63	7J-A-200001												
		1.9 TDI	75	7J-A-200001												
		1.9 TDI	77	7J-A-200001												
		2.0	85	7J-A-200001												
		2.0 BiTDI	132	7J-A-200001												
		2.0 BiTDI 4motion	132	7J-A-200001												
	2.0 TDI	62	7J-A-200001													
	2.0 TDI	75	7J-A-200001													
	2.0 TDI	84		05.11												
	2.0 TDI	100		05.10												
	2.0 TDI	103	7J-A-200001													
	2.0 TDI 4motion	100		05.10												
	2.0 TDI 4motion	103	7J-A-200001													
	2.0 TSI	110		07.12												
	2.5 TDI	96	7J-A-200001													
	2.5 TDI	128	7J-A-200001													
	2.5 TDI 4motion	96	7J-A-200001													
	2.5 TDI 4motion	128	7J-A-200001													
	3.2 V6	170	7J-A-200001													
	3.2 V6	173	7J-A-200001													
		1.9 TDI	62		01.06	PR: 2E3	24.3601-9947.5	240597		D=60, - Halter						ATE
		1.9 TDI	63		04.03	PR: 2E3										
		1.9 TDI	75		06.06	PR: 2E3										
1.9 TDI		77		04.03	PR: 2E3											
2.0		85		06.03	PR: 2E3											
2.0 BiTDI		132		09.09	PR: 2E3											
2.0 BiTDI 4motion		132		09.09	PR: 2E3											
2.0 TDI		62		09.09	PR: 2E3											

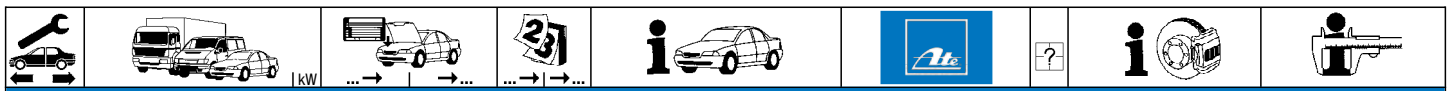

VOLKSWAGEN TRANSPORTER (T5) PRITSCH / FAHRGESTELL (03-)

	2.0 TDI	75		09.09	PR: 2E3	24.3601-9947.5	240597	2	D=60, - Halter D=60, - Halter Dichtungssatz Hülsensatz Führungsbolzen Haltefeder	ATE ATE ATE ATE ATE ATE				
	2.0 TDI	84		05.11	PR: 2E3	24.3601-9948.5	240598							
	2.0 TDI	100		05.10	PR: 2E3	11.0441-6008.2	250038							
	2.0 TDI	103		09.09	PR: 2E3	11.0101-5706.2	260097							
	2.0 TDI 4motion	100		05.10	PR: 2E3	11.8171-0067.1	250153							
	2.0 TDI 4motion	103		09.09	PR: 2E3	11.8116-0237.1	390509							
	2.0 TSI	110		07.12	PR: 2E3									
	2.5 TDI	96		02.03	PR: 2E3									
	2.5 TDI	128		02.03	PR: 2E3									
	2.5 TDI 4motion	96		07.04	PR: 2E3									
	2.5 TDI 4motion	128		07.04	PR: 2E3									
	3.2 V6	170		02.04	PR: 2E3									
	3.2 V6	173		08.03	PR: 2E3									
	1.9 TDI	62	7J-A-010000	01.06	PR: 2E4	11.9601-9721.2	220875	2	D=60, - Halter D=60, - Halter Halter Dichtungssatz Hülsensatz Führungsbolzen Haltefeder	ATE ATE ATE ATE ATE ATE ATE				
	1.9 TDI	63	7J-A-010000	04.03	PR: 2E4	11.9601-9722.2	220876							
	1.9 TDI	75	7J-A-010000	06.06	PR: 2E4	11.8170-0955.1	260109							
	1.9 TDI	77	7J-A-010000	04.03	PR: 2E4	11.0441-6008.2	250038							
	2.0	85	7J-A-010000	06.03	PR: 2E4	11.0101-5706.2	260097							
	2.0 BiTDI	132	7J-A-010000	09.09	PR: 2E4	11.8171-0067.1	250153							
	2.0 BiTDI 4motion	132	7J-A-010000	09.09	PR: 2E4	11.8116-0237.1	390509							
	2.0 TDI	62	7J-A-010000	09.09	PR: 2E4	11.8116-0367.1	390600							
	2.0 TDI	75	7J-A-010000	09.09	PR: 2E4									
	2.0 TDI	103	7J-A-010000	09.09	PR: 2E4									
	2.0 TDI 4motion	103	7J-A-010000	09.09	PR: 2E4									
	2.5 TDI	96	7J-A-010000	02.03	PR: 2E4									
	2.5 TDI	128	7J-A-010000	02.03	PR: 2E4									
	2.5 TDI 4motion	96	7J-A-010000	07.04	PR: 2E4									
	2.5 TDI 4motion	128	7J-A-010000	07.04	PR: 2E4									
	3.2 V6	170	7J-A-010000	02.04	PR: 2E4									
	3.2 V6	173	7J-A-010000	08.03	PR: 2E4									
		1.9 TDI	62	7J-A-200001		PR: 2E4	11.9441-9933.2				220911	2	D=44, - Halter D=44, - Halter Führungsbolzen Haltefeder	ATE ATE ATE
		1.9 TDI	63	7J-A-200001		PR: 2E4	11.9441-9934.2				220912			
		1.9 TDI	75	7J-A-200001		PR: 2E4	11.8171-0096.1				250155			
1.9 TDI		77	7J-A-200001		PR: 2E4	11.8116-0126.2	390608							
2.0		85	7J-A-200001		PR: 2E4									
2.0 BiTDI		132	7J-A-200001		PR: 2E4									
2.0 BiTDI 4motion		132	7J-A-200001		PR: 2E4									
2.0 TDI		62	7J-A-200001		PR: 2E4									
2.0 TDI		75	7J-A-200001		PR: 2E4									
2.0 TDI		84		05.11	PR: 2E4									
2.0 TDI		100		05.10	PR: 2E4									
2.0 TDI		103	7J-A-200001		PR: 2E4									
2.0 TDI 4motion		100		05.10	PR: 2E4									
2.0 TDI 4motion		103	7J-A-200001		PR: 2E4									
2.0 TSI		110		07.12	PR: 2E4									
2.5 TDI		96	7J-A-200001		PR: 2E4									
2.5 TDI		128	7J-A-200001		PR: 2E4									
2.5 TDI 4motion		96	7J-A-200001		PR: 2E4									
2.5 TDI 4motion		128	7J-A-200001		PR: 2E4									
3.2 V6		170	7J-A-200001		PR: 2E4									
3.2 V6	173	7J-A-200001		PR: 2E4										
	1.9 TDI	62		01.06	PR: OWL,OWN,OWM,OWP,OWQ	24.5140-0514.3	331290	2	L=520					
	1.9 TDI	63		04.03	PR: OWL,OWN,OWM,OWP,OWQ									
	1.9 TDI	75		06.06	PR: OWL,OWN,OWM,OWP,OWQ									
	1.9 TDI	77		04.03	PR: OWL,OWN,OWM,OWP,OWQ									
	2.0	85		06.03	PR: OWL,OWN,OWM,OWP,OWQ									
	2.0 BiTDI	132		09.09	PR: OWL,OWN,OWM,OWP,OWQ									
	2.0 BiTDI 4motion	132		09.09	PR: OWL,OWN,OWM,OWP,OWQ									
	2.0 TDI	62		09.09	PR: OWL,OWN,OWM,OWP,OWQ									
	2.0 TDI	75		09.09	PR: OWL,OWN,OWM,OWP,OWQ									
	2.0 TDI	84		05.11	PR: OWL,OWN,OWM,OWP,OWQ									
	2.0 TDI	100		05.10	PR: OWL,OWN,OWM,OWP,OWQ									
	2.0 TDI	103		09.09	PR: OWL,OWN,OWM,OWP,OWQ									
	2.0 TDI 4motion	100		05.10	PR: OWL,OWN,OWM,OWP,OWQ									
	2.0 TDI 4motion	103		09.09	PR: OWL,OWN,OWM,OWP,OWQ									
	2.0 TSI	110		07.12	PR: OWL,OWN,OWM,OWP,OWQ									
	2.5 TDI	96		02.03	PR: OWL,OWN,OWM,OWP,OWQ									
	2.5 TDI	128		02.03	PR: OWL,OWN,OWM,OWP,OWQ									
	2.5 TDI 4motion	96		07.04	PR: OWL,OWN,OWM,OWP,OWQ									
	2.5 TDI 4motion	128		07.04	PR: OWL,OWN,OWM,OWP,OWQ									
	3.2 V6	170		02.04	PR: OWL,OWN,OWM,OWP,OWQ									
3.2 V6	173		08.03	PR: OWL,OWN,OWM,OWP,OWQ										
	1.9 TDI	62		01.06	PR: OWR	83.6113-0552.3	330864	2	L=552					
	1.9 TDI	63		04.03	PR: OWR									
	1.9 TDI	75		06.06	PR: OWR									
	1.9 TDI	77		04.03	PR: OWR									
	2.0	85		06.03	PR: OWR									
	2.0 BiTDI	132		09.09	PR: OWR									
	2.0 BiTDI 4motion	132		09.09	PR: OWR									
	2.0 TDI	62		09.09	PR: OWR									
	2.0 TDI	75		09.09	PR: OWR									
	2.0 TDI	84		05.11	PR: OWR									
	2.0 TDI	100		05.10	PR: OWR									
	2.0 TDI	103		09.09	PR: OWR									
	2.0 TDI 4motion	100		05.10	PR: OWR									
2.0 TDI 4motion	103		09.09	PR: OWR										
2.0 TSI	110		07.12	PR: OWR										



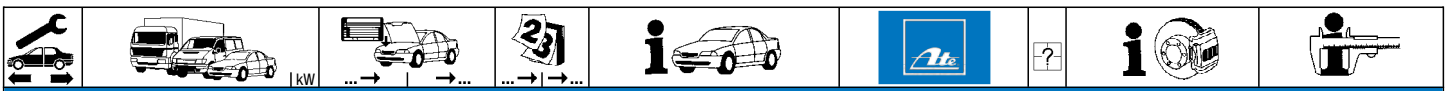

VOLKSWAGEN TRANSPORTER (T5) PRITSCH / FAHRGESTELL (03-)

	2.5 TDI	96		02.03	PR: OWR	83.6113-0552.3	330864	2		L=552							
	2.5 TDI	128		02.03	PR: OWR												
	2.5 TDI 4motion	96		07.04	PR: OWR												
	2.5 TDI 4motion	128		07.04	PR: OWR												
	3.2 V6	170		02.04	PR: OWR												
	3.2 V6	173		08.03	PR: OWR												
	1.9 TDI	62		01.06	PR: 1BA,1BB,1BJ,1BV,1MG,1MK,1ML,2MD,2MF,2MG,2ML	24.5140-0514.3	331290	2		L=520							
	1.9 TDI	63		04.03	PR: 1BA,1BB,1BJ,1BV,1MG,1MK,1ML,2MD,2MF,2MG,2ML												
	1.9 TDI	75		06.06	PR: 1BA,1BB,1BJ,1BV,1MG,1MK,1ML,2MD,2MF,2MG,2ML												
	1.9 TDI	77		04.03	PR: 1BA,1BB,1BJ,1BV,1MG,1MK,1ML,2MD,2MF,2MG,2ML												
	2.0	85		06.03	PR: 1BA,1BB,1BJ,1BV,1MG,1MK,1ML,2MD,2MF,2MG,2ML												
	2.0 BiTDI	132		09.09	PR: 1BA,1BB,1BJ,1BV,1MG,1MK,1ML,2MD,2MF,2MG,2ML												
	2.0 BiTDI 4motion	132		09.09	PR: 1BA,1BB,1BJ,1BV,1MG,1MK,1ML,2MD,2MF,2MG,2ML												
	2.0 TDI	62		09.09	PR: 1BA,1BB,1BJ,1BV,1MG,1MK,1ML,2MD,2MF,2MG,2ML												
	2.0 TDI	75		09.09	PR: 1BA,1BB,1BJ,1BV,1MG,1MK,1ML,2MD,2MF,2MG,2ML												
	2.0 TDI	84		05.11	PR: 1BA,1BB,1BJ,1BV,1MG,1MK,1ML,2MD,2MF,2MG,2ML												
	2.0 TDI	100		05.10	PR: 1BA,1BB,1BJ,1BV,1MG,1MK,1ML,2MD,2MF,2MG,2ML												
	2.0 TDI	103		09.09	PR: 1BA,1BB,1BJ,1BV,1MG,1MK,1ML,2MD,2MF,2MG,2ML												
	2.0 TDI 4motion	100		05.10	PR: 1BA,1BB,1BJ,1BV,1MG,1MK,1ML,2MD,2MF,2MG,2ML												
	2.0 TDI 4motion	103		09.09	PR: 1BA,1BB,1BJ,1BV,1MG,1MK,1ML,2MD,2MF,2MG,2ML												
	2.0 TSI	110		07.12	PR: 1BA,1BB,1BJ,1BV,1MG,1MK,1ML,2MD,2MF,2MG,2ML												
	2.5 TDI	96		02.03	PR: 1BA,1BB,1BJ,1BV,1MG,1MK,1ML,2MD,2MF,2MG,2ML												
	2.5 TDI	128		02.03	PR: 1BA,1BB,1BJ,1BV,1MG,1MK,1ML,2MD,2MF,2MG,2ML												
	2.5 TDI 4motion	96		07.04	PR: 1BA,1BB,1BJ,1BV,1MG,1MK,1ML,2MD,2MF,2MG,2ML												
	2.5 TDI 4motion	128		07.04	PR: 1BA,1BB,1BJ,1BV,1MG,1MK,1ML,2MD,2MF,2MG,2ML												
	3.2 V6	170		02.04	PR: 1BA,1BB,1BJ,1BV,1MG,1MK,1ML,2MD,2MF,2MG,2ML												
	3.2 V6	173		08.03	PR: 1BA,1BB,1BJ,1BV,1MG,1MK,1ML,2MD,2MF,2MG,2ML												
		1.9 TDI	62		01.06						PR: 1BH,1BX,1MR,2MQ,2MZ,2MU,2MT	83.6113-0552.3	330864	2		L=552	
		1.9 TDI	63		04.03						PR: 1BH,1BX,1MR,2MQ,2MZ,2MU,2MT						
		1.9 TDI	75		06.06						PR: 1BH,1BX,1MR,2MQ,2MZ,2MU,2MT						
1.9 TDI		77		04.03	PR: 1BH,1BX,1MR,2MQ,2MZ,2MU,2MT												
2.0		85		06.03	PR: 1BH,1BX,1MR,2MQ,2MZ,2MU,2MT												
2.0 BiTDI		132		09.09	PR: 1BH,1BX,1MR,2MQ,2MZ,2MU,2MT												
2.0 BiTDI 4motion		132		09.09	PR: 1BH,1BX,1MR,2MQ,2MZ,2MU,2MT												
2.0 TDI		62		09.09	PR: 1BH,1BX,1MR,2MQ,2MZ,2MU,2MT												
2.0 TDI		75		09.09	PR: 1BH,1BX,1MR,2MQ,2MZ,2MU,2MT												
2.0 TDI		84		05.11	PR: 1BH,1BX,1MR,2MQ,2MZ,2MU,2MT												
2.0 TDI		100		05.10	PR: 1BH,1BX,1MR,2MQ,2MZ,2MU,2MT												
2.0 TDI		103		09.09	PR: 1BH,1BX,1MR,2MQ,2MZ,2MU,2MT												
2.0 TDI 4motion		100		05.10	PR: 1BH,1BX,1MR,2MQ,2MZ,2MU,2MT												
2.0 TDI 4motion		103		09.09	PR: 1BH,1BX,1MR,2MQ,2MZ,2MU,2MT												
2.0 TSI		110		07.12	PR: 1BH,1BX,1MR,2MQ,2MZ,2MU,2MT												
2.5 TDI		96		02.03	PR: 1BH,1BX,1MR,2MQ,2MZ,2MU,2MT												
2.5 TDI		128		02.03	PR: 1BH,1BX,1MR,2MQ,2MZ,2MU,2MT												
2.5 TDI 4motion		96		07.04	PR: 1BH,1BX,1MR,2MQ,2MZ,2MU,2MT												
2.5 TDI 4motion		128		07.04	PR: 1BH,1BX,1MR,2MQ,2MZ,2MU,2MT												
3.2 V6		170		02.04	PR: 1BH,1BX,1MR,2MQ,2MZ,2MU,2MT												
3.2 V6		173		08.03	PR: 1BH,1BX,1MR,2MQ,2MZ,2MU,2MT												
		1.9 TDI	62	7J-A-010000	01.06	PR: 2E3,2E4	24.3414-1711.7	220677			D=41, - Halter						TRW
		1.9 TDI	63	7J-A-010000	04.03	PR: 2E3,2E4											
		1.9 TDI	75	7J-A-010000	06.06	PR: 2E3,2E4											
	1.9 TDI	77	7J-A-010000	04.03	PR: 2E3,2E4												
	2.0	85	7J-A-010000	06.03	PR: 2E3,2E4												
	2.0 BiTDI	132	7J-A-010000	09.09	PR: 2E3,2E4												
	2.0 BiTDI 4motion	132	7J-A-010000	09.09	PR: 2E3,2E4												
	2.0 TDI	62	7J-A-010000	09.09	PR: 2E3,2E4												
	2.0 TDI	75	7J-A-010000	09.09	PR: 2E3,2E4												
	2.0 TDI	103	7J-A-010000	09.09	PR: 2E3,2E4												
	2.0 TDI 4motion	103	7J-A-010000	09.09	PR: 2E3,2E4												
	2.5 TDI	96	7J-A-010000	02.03	PR: 2E3,2E4												
	2.5 TDI	128	7J-A-010000	02.03	PR: 2E3,2E4												
	2.5 TDI 4motion	96	7J-A-010000	07.04	PR: 2E3,2E4												
	2.5 TDI 4motion	128	7J-A-010000	07.04	PR: 2E3,2E4												
	3.2 V6	170	7J-A-010000	02.04	PR: 2E3,2E4												
	3.2 V6	173	7J-A-010000	08.03	PR: 2E3,2E4												
		1.9 TDI	62	7J-8-000788	01.06	PR: OWR,0E0,0E9						11.9441-9949.2	220803			D=44, - Halter	
1.9 TDI		63	7J-8-000788	04.03	PR: OWR,0E0,0E9												
1.9 TDI		75	7J-8-000788	06.06	PR: OWR,0E0,0E9												
1.9 TDI		77	7J-8-000788	04.03	PR: OWR,0E0,0E9												
2.0		85	7J-8-000788	06.03	PR: OWR,0E0,0E9												
2.5 TDI		96	7J-8-000788	02.03	PR: OWR,0E0,0E9												
2.5 TDI		128	7J-8-000788	02.03	PR: OWR,0E0,0E9												
2.5 TDI 4motion		96	7J-8-000788	07.04	PR: OWR,0E0,0E9												
2.5 TDI 4motion		128	7J-8-000788	07.04	PR: OWR,0E0,0E9												
3.2 V6		170	7J-8-000788	02.04	PR: OWR,0E0,0E9												
3.2 V6		173	7J-8-000788	08.03	PR: OWR,0E0,0E9												
		1.9 TDI	62	7J-8-030000		PR: OWR,0E0,0E9	24.3414-1711.7	220677			D=41, - Halter						TRW
	1.9 TDI	63	7J-8-030000		PR: OWR,0E0,0E9												
	1.9 TDI	75	7J-8-030000		PR: OWR,0E0,0E9												
	1.9 TDI	77	7J-8-030000		PR: OWR,0E0,0E9												
	2.0	85	7J-8-030000		PR: OWR,0E0,0E9												
	2.5 TDI	96	7J-8-030000		PR: OWR,0E0,0E9												
	2.5 TDI	128	7J-8-030000		PR: OWR,0E0,0E9												
	2.5 TDI 4motion	96	7J-8-030000		PR: OWR,0E0,0E9												
	2.5 TDI 4motion	128	7J-8-030000		PR: OWR,0E0,0E9												
	3.2 V6	170	7J-8-030000		PR: OWR,0E0,0E9												
	3.2 V6	173	7J-8-030000		PR: OWR,0E0,0E9												



VOLKSWAGEN TRANSPORTER (T5) PRITSCH / FAHRGESTELL (03-)

	1.9 TDI	77	04.03	PR: 0E1,0E2,0WL,0WN,0WM,0WP,0WQ	24.5140-0194.3	331383	2		L=194
	2.0	85	06.03	PR: 0E1,0E2,0WL,0WN,0WM,0WP,0WQ					
	2.0 BiTDI	132	09.09	PR: 0E1,0E2,0WL,0WN,0WM,0WP,0WQ					
	2.0 BiTDI 4motion	132	09.09	PR: 0E1,0E2,0WL,0WN,0WM,0WP,0WQ					
	2.0 TDI	62	09.09	PR: 0E1,0E2,0WL,0WN,0WM,0WP,0WQ					
	2.0 TDI	75	09.09	PR: 0E1,0E2,0WL,0WN,0WM,0WP,0WQ					
	2.0 TDI	84	05.11						
	2.0 TDI	100	05.10	PR: 0E1,0E2,0WL,0WN,0WM,0WP,0WQ					
	2.0 TDI	103	09.09	PR: 0E1,0E2,0WL,0WN,0WM,0WP,0WQ					
	2.0 TDI 4motion	100	05.10	PR: 0E1,0E2,0WL,0WN,0WM,0WP,0WQ					
	2.0 TDI 4motion	103	09.09	PR: 0E1,0E2,0WL,0WN,0WM,0WP,0WQ					
	2.0 TSI	110	07.12						
	2.5 TDI	96	02.03	PR: 0E1,0E2,0WL,0WN,0WM,0WP,0WQ					
	2.5 TDI	128	02.03	PR: 0E1,0E2,0WL,0WN,0WM,0WP,0WQ					
	2.5 TDI 4motion	96	07.04	PR: 0E1,0E2,0WL,0WN,0WM,0WP,0WQ					
2.5 TDI 4motion	128	07.04	PR: 0E1,0E2,0WL,0WN,0WM,0WP,0WQ						
3.2 V6	170	02.04	PR: 0E1,0E2,0WL,0WN,0WM,0WP,0WQ						
3.2 V6	173	08.03	PR: 0E1,0E2,0WL,0WN,0WM,0WP,0WQ						

VOLKSWAGEN TRANSPORTER (T6) (15-)

	2.0 TDI	62	04.15		24.3601-9947.5	240597	2	+ 16" Rad ¹⁾	D=60, - Halter	ATE						
	2.0 TDI	75	04.15													
	2.0 TDI	103	04.15													
	2.0 TDI	110	04.15													
	2.0 TDI	132	04.15													
	2.0 TDI	150	06.15													
	2.0 TDI 4motion	103	06.15													
	2.0 TDI 4motion	110	08.15													
	2.0 TDI 4motion	132	06.15													
	2.0 TDI 4motion	150	06.15													
	2.0 TSI	110	04.15													
	2.0 TSI	150	04.15													
	2.0 TSI 4motion	150	06.15													
	2.0 TDI	62	04.15								11.9441-9933.2	220911	2	+ 17" Rad ²⁾	D=44, - Halter	ATE
	2.0 TDI	75	04.15													
2.0 TDI	103	04.15														
2.0 TDI	110	04.15														
2.0 TDI	132	04.15														
2.0 TDI	150	06.15														
2.0 TDI 4motion	103	06.15														
2.0 TDI 4motion	110	08.15														
2.0 TDI 4motion	132	06.15														
2.0 TDI 4motion	150	06.15														
2.0 TSI	110	04.15														
2.0 TSI	150	04.15														
2.0 TSI 4motion	150	06.15														

1) + 16" wheel / + ruota 16" / + roue 16" / + rueda 16"
 2) + 17" wheel / + ruota 17" / + roue 17" / + rueda 17"
 3) + reinforced suspension / + sospensione rinforzata / + châssis renforcé / + suspensión reforzada
 4) - reinforced suspension / - sospensione rinforzata / - châssis renforcé / - suspensión reforzada



VOLKSWAGEN TRANSPORTER (T6) (15-)





































	2.0 TSI 4motion	150		06.15		24.3414-1711.7	220677		D=41, - Halter	TRW
						24.3414-1712.7	220678		D=41, - Halter	TRW
	2.0 TDI	62		04.15		24.5237-0250.4	330880	2	L=250	
	2.0 TDI	75		04.15						
	2.0 TDI	103		04.15						
	2.0 TDI	110		04.15						
	2.0 TDI	132		04.15						
	2.0 TDI	150		06.15						
	2.0 TDI 4motion	103		06.15						
	2.0 TDI 4motion	110		08.15						
	2.0 TDI 4motion	132		06.15						
	2.0 TDI 4motion	150		06.15						
	2.0 TSI	110		04.15						
	2.0 TSI	150		04.15						
	2.0 TSI 4motion	150		06.15						

VOLKSWAGEN VENTO (92-98)

	1.4			11.91	09.98 - ABS	03.7750-5502.4	300081		9"	ATE
	1.6			09.92	09.98 - ABS					
	1.8			01.92	09.98 - ABS					
	1.9 D			11.91	09.98 - ABS					
	1.9 SDI			04.97	09.98 - ABS					
	1.9 TD	55		11.91	09.98 - ABS					
	1.9 TDI	66		07.93	09.98 - ABS					
	1.9 TDI	81		02.96	09.98 - ABS					
	2.0			11.91	09.98 - ABS					
	1.4		1H-S-385334	11.91	+ ABS	10.6360-1003.4	300156		10"	ATE
	1.6		1H-S-385334	09.92	+ ABS					
	1.8		1H-S-385334	01.92	+ ABS					
	1.9 D		1H-S-385334	11.91	+ ABS					
	1.9 TD	55	1H-S-385334	11.91	+ ABS					
	1.9 TDI	66	1H-S-385334	07.93	+ ABS					
	2.0		1H-S-385334	11.91	+ ABS					
	2.8 VR6		1H-S-385334	01.92	+ ABS					
	1.4		1H-S-385335		09.98 + ABS	10.6360-2002.4	300143		10"	ATE
	1.6		1H-S-385335		09.98 + ABS					
	1.8		1H-S-385335		09.98 + ABS					
	1.9 D		1H-S-385335		09.98 + ABS					
	1.9 SDI			04.97	09.98 + ABS					
	1.9 TD	55	1H-S-385335		09.98 + ABS					
	1.9 TDI	66	1H-S-385335		09.98 + ABS					
	1.9 TDI	81		02.96	09.98 + ABS					
	2.0		1H-S-385335		09.98 + ABS					
	2.8 VR6		1H-S-385335		09.98 + ABS					
	1.4			11.91	09.98 - ABS	03.2120-3943.3	010532		THz 20,64	ATE
	1.6			09.92	09.98 - ABS	03.3517-0101.2	390322		Verschlußschraube	
	1.8			01.92	09.98 - ABS/ - GT					
	1.9 D			11.91	09.98 - ABS					
	1.9 SDI			04.97	09.98 - ABS					
	1.9 TD	55		11.91	09.98 - ABS					
	1.6	55	1H-S-430001		09.98 - ABS/ + Automatikgetriebe 1)	03.2122-1042.3	010137		THz 22,20	ATE
	1.6	74		07.94	09.98 - ABS	03.3517-0101.2	390322		Verschlußschraube	
	1.8 GT			01.92	09.98 - ABS					
	1.9 TD	55	1H-S-430001		09.98 - ABS					
	1.9 TDI	66		07.93	09.98 - ABS					
	1.9 TDI	81		02.96	09.98 - ABS					
	2.0			11.91	09.98 - ABS					
	1.4		1H-S-385334	11.91	+ ABS	10.6122-0144.3	010638		THz 22,20	ATE
	1.6	55	1H-S-385334	09.92	+ ABS					
	1.8		1H-S-385334	01.92	+ ABS/ - GT					
	1.9 D		1H-S-385334	11.91	+ ABS					
	1.9 TD	55	1H-S-385334	11.91	+ ABS					
	1.4		1H-S-385335		09.98 + ABS	03.2122-1144.3	010636		THz 22,20	ATE
	1.6	55	1H-S-385335		09.98 + ABS					
	1.8		1H-S-385335		09.98 + ABS/ - GT					
	1.9 D		1H-S-385335		09.98 + ABS					
	1.9 SDI			04.97	09.98 + ABS					
	1.9 TD	55	1H-S-385335		09.98 + ABS					
	1.6	74		07.94	+ ABS	10.6123-0674.3	010639		THz 23,81	ATE
	1.8 GT			01.92	+ ABS					
	1.9 TDI	66		07.93	+ ABS					
	2.0			11.91	+ ABS					
	2.8 VR6			01.92	+ ABS					
	1.6	74	1H-S-385335		09.98 + ABS	03.2123-1424.3	010637		THz 23,81	ATE
	1.8 GT		1H-S-385335		09.98 + ABS					
	1.9 TDI	66	1H-S-385335		09.98 + ABS					
	1.9 TDI	81		02.96	09.98 + ABS					
	2.0		1H-S-385335		09.98 + ABS					
	2.8 VR6		1H-S-385335		09.98 + ABS					
	1.4		1H-S-385335		09.98 + ABS	03.2122-1184.3	010592		THz 22,20	ATE
	1.6	55	1H-S-385335		09.98 + ABS					
	1.8		1H-S-385335		09.98 + ABS/ - GT					
	1.9 D		1H-S-385335		09.98 + ABS					
	1.9 SDI			04.97	09.98 + ABS					
	1.9 TD	55	1H-S-385335		09.98 + ABS					

1) - ABS/ + autom.transmission / - ABS/ + scatola cambio autom. / - ABS/ + transmission automatique / - ABS/ + cambio automatico



VOLKSWAGEN VENTO (92-98)									
									
	1.6 1.8 GT 1.9 TDI 1.9 TDI 2.0 2.8 VR6	74 1H-S-385335 66 81 1H-S-385335 1H-S-385335			09.98 + ABS 09.98 + ABS 09.98 + ABS 09.98 + ABS 09.98 + ABS 09.98 + ABS	03.2123-1484.3 010595			Thz 23,81 ATE
	1.4 1.6 1.6 1.8 1.8 CL/GL 1.9 D 1.9 TD	55 55 55 66 55 55	1H-T-015953 1H-T-015953 1H-T-015953 1H-S-430000 1H-T-015953 1H-S-430000	11.91 09.92 09.92 01.92 11.91 11.91	+ Automatikgetriebe ¹⁾ + Schaltgetriebe ²⁾ + Schaltgetriebe ²⁾	11.0441-4808.2 11.0101-4801.2 24.0102-4801.2	250022 260006 260085		Dichtungssatz Hülsensatz Hülsensatz+Schrauben ATE ATE ATE
	1.4 1.6 1.8 1.9 D 1.9 SDI	55 55 55 1H-T-015954 04.97	1H-T-015954 1H-T-015954 1H-T-015954 1H-T-015954	09.98 09.98 09.98 09.98 09.98	- ABS + Schaltgetriebe ²⁾ + Schaltgetriebe ²⁾ - ABS - ABS	11.0441-4808.2 11.0101-4801.2 24.0102-4801.2	250022 260006 260085		Dichtungssatz Hülsensatz Hülsensatz+Schrauben ATE ATE ATE
	1.6 1.6 CL/GL 1.8 1.8 CL/GL 1.9 TD 1.9 TDI	55 74 55 66 55 66	1H-S-430001 1H-S-430001 1H-S-430001 1H-S-430001 1H-S-430001	09.98 09.98 01.92 09.98 09.98 09.98	+ Automatikgetriebe ¹⁾ + Automatikgetriebe ¹⁾	24.3541-1739.5 24.3541-1740.5 11.0101-5403.2	240223 240224 260010	 	D=54, - Halter D=54, - Halter Faltenbalgsatz TRW TRW TRW
	1.4 1.6 GT 1.8 GT 1.9 D 1.9 TDI 2.0 CL/GL	74 66 81		05.96 07.94 01.92 05.96 02.96 11.91	+ ABS + ABS + ABS	24.3541-1609.5 24.3541-1610.5 24.0101-4301.2 11.0101-5403.2	240039 240040 260047 260010	 	D=54, - Halter D=54, - Halter Bremsattel-Zubehör Faltenbalgsatz TRW TRW TRW TRW
	1.4 1.9 D 1.9 SDI			10.96 10.96 04.97	+ ABS + ABS + ABS	11.0441-4808.2 11.0101-4801.2 24.0102-4801.2	250022 260006 260085		Dichtungssatz Hülsensatz Hülsensatz+Schrauben ATE ATE ATE
	2.0 GT 2.8 VR6		1H-S-560000	11.91 01.92	04.96	24.3541-1731.5 24.3541-1732.5 24.0101-4301.2	240061 240062 260047	 	D=54, - Halter D=54, - Halter Bremsattel-Zubehör TRW TRW TRW
	2.0 GT 2.8 VR6		1H-S-560001	05.96 09.98	09.98	11.3541-8523.2 11.3541-8524.2 24.3541-8523.5 24.3541-8524.5 11.8170-0306.1 11.0441-5409.2 11.0101-5409.2 11.8171-0008.1 11.8116-0143.1	220115 220116 240551 240552 260102 250031 260035 990049 390513	        	D=54, - Halter D=54, - Halter D=54, - Halter D=54, - Halter Halter Dichtungssatz Hülsensatz Führungsbolzen Haltefeder ATE ATE ATE ATE ATE ATE ATE
	1.4 1.6 1.8 1.9 D 1.9 SDI 1.9 TD 1.9 TDI 2.0 2.8 VR6	55 66 81		11.91 09.92 01.92 11.91 04.97 11.91 07.93 02.96 11.91	09.98 09.98 09.98 09.98 09.98 09.98 09.98 09.98	24.5105-0442.3	331432	2	L=442
	2.8 VR6	1H-S-560001		09.98		83.6232-0465.3	330736	2	L=465
	1.8 GT 2.0 2.8 VR6		1H-P-240000 1H-P-240000 1H-P-240000	01.92 11.91 01.92		24.3384-1603.5 24.3384-1604.5 24.0101-3601.2	240015 240016 260044	 	D=38, - Halter D=38, - Halter Bremsattel-Zubehör TRW TRW TRW
	1.6 GT 1.8 GT 1.9 GT TDI 1.9 TDI 2.0 2.8 VR6	74 1H-P-240001 66 81 1H-P-240001 1H-P-240001		07.94 06.95 07.93 02.96 09.98 09.98		24.3384-1707.5 24.3384-1708.5 24.0101-3601.2 11.0101-5403.2	240171 240172 260044 260010	 	D=38, - Halter D=38, - Halter Bremsattel-Zubehör Faltenbalgsatz TRW TRW TRW TRW
	1.8 GT			07.95	09.98	24.3384-1707.5 24.3384-1708.5 11.0101-5403.2	240171 240172 260010	 	D=38, - Halter D=38, - Halter Faltenbalgsatz TRW TRW TRW
	1.4 1.6 1.8 1.9 D 1.9 SDI 1.9 TD 1.9 TDI	55 66		11.91 09.92 01.92 11.91 04.97 11.91 07.93	09.98 09.98 09.98 09.98 09.98 09.98 09.98			2	L=135
	1.6 GT 1.8 GT 1.9 GT TDI 1.9 TDI 2.0 2.8 VR6	74 66 81		07.94 01.92 07.93 02.96 11.91 01.92	09.98 09.98 09.98 09.98 09.98 09.98	83.7836-0135.3 24.5170-0161.3	330816 331308	2 2	L=135 L=161 am Bremsattel ³⁾
	1.4 1.6 1.6 1.8 1.8 CL/GL	55 55 55 66	1H-S-430000 1H-S-430000 1H-S-430000	11.91 09.92 09.92 01.92 01.92	09.98 09.98 09.98 09.98	03.3217-2112.3 24.3217-0908.3	020027 020167		+ GG ⁴⁾ + ALU ⁵⁾ Rz 17,46 Rz 17,46











¹⁾ + autom.transmission / + scatola cambio automatico / + transmission automatique / + cambio automático

²⁾ + manual transmission / + scatola cambio velocità / + transmission mécanique / + cambio de velocidad

³⁾ on the brake caliper / sulla pinza freno / sur l'étrier de frein / a la pinza de freno

⁴⁾ + cast iron / + ghisa / + fonte grise / + fundición de gris

⁵⁾ + aluminium / + alluminio / + aluminium / + aluminio

VOLKSWAGEN VENTO (92-98)									
	1.9 D 1.9 SDI 1.9 TD			11.91 04.97 11.91	09.98 09.98	03.3217-2112.3 24.3217-0908.3	020027 020167	+ GG ¹⁾ + ALU ²⁾	Rz 17,46 Rz 17,46
	1.6 1.6 CL/GL 1.8 1.8 CL/GL 1.9 TD 1.9 TDI	55 74 55 66 55 66	1H-S-430001 1H-S-430001	09.98 07.94 01.92 09.98 09.98 07.93	09.98 09.98 09.98 09.98 09.98 09.98	24.3219-0909.3	020188		Rz 19,05
	1.4 1.6 1.8 1.9 D 1.9 TD 1.9 TDI	55	1H-S-037527 1H-S-037527 1H-S-037527 1H-S-037527 1H-S-037527 1H-S-037527	11.91 09.92 01.92 11.91 11.91 07.93	09.98 09.98 09.98 09.98 09.98 09.98	24.3727-0135.2	580135	2 ↓	L=1500
	1.4 1.6 1.8 1.9 D 1.9 SDI 1.9 TD 1.9 TDI	55 66	1H-S-037528 1H-S-037528 1H-S-037528 1H-S-037528 1H-S-037528 1H-S-037528	09.98 09.98 09.98 09.98 04.97 09.98 09.98	09.98 09.98 09.98 09.98 09.98 09.98	24.3727-0160.2	580160	2 ↓	L=1498
	1.8 GT 1.9 GT TDI 2.0 2.8 VR6	66	1H-S-037527 1H-S-037527 1H-S-037527 1H-S-037527	01.92 07.93 11.91 01.92	09.98 09.98 09.98 09.98	24.3727-0134.2	580134	2 ↓	L=1613
	1.6 GT 1.8 GT 1.9 GT TDI 1.9 TDI 2.0 2.8 VR6	74 66 81	1H-S-037528 1H-S-037528 1H-S-037528 1H-S-037528	07.94 01.92 02.96 01.92	09.98 09.98 09.98 09.98	24.3727-0156.2	580156	2 ↓	L=1616
	1.4 1.6 1.8 1.9 D 1.9 SDI 1.9 TD 1.9 TDI	55		11.91 09.92 01.92 11.91 04.97 11.91 07.93	09.98 09.98 09.98 09.98 09.98 09.98 09.98	03.6584-0107.3	320110		BRL 8/4 (4) ATE
	1.6 GT 1.8 GT 1.9 GT TDI 1.9 TDI 2.0 2.8 VR6	74 66 81		07.94 01.92 07.93 02.96 11.91 01.92	09.98 09.98 09.98 09.98 09.98 09.98	03.6584-0113.3	320111		BRL 8/4 (4) ATE
	1.8 GT 1.9 TDI 1.9 TDI 2.8 VR6	66 81		01.92 07.93 02.96 01.92	09.98 09.98 09.98 09.98	03.2419-9510.3	030028		Gz 19,05
	1.8 GT 1.9 TDI 1.9 TDI 2.8 VR6	66 81		01.92 07.93 02.96 01.92	09.98 09.98 09.98 09.98	03.2419-9910.3	030031		Gz 19,05
	1.8 GT 1.9 TDI 1.9 TDI 2.8 VR6	66 81		01.92 07.93 02.96 01.92	09.98 09.98 09.98 09.98	24.2523-0908.3	040049		Nz 23,81
	1.4 1.6 1.8 1.9 D 1.9 TD 2.0	55		11.91 09.92 01.92 11.91 11.91 11.91	09.98 09.98 09.98 09.98 09.98 09.98	24.3728-0130.2	590130		L=1025, + AUT
	1.8 1.9 D 1.9 TD 2.0	55		01.92 11.91 11.91 11.91	09.98 09.98 09.98 09.98	24.3728-0127.2	590127		L=824, + AUT
VOLKSWAGEN UP / LOAD UP (11-)									
	1.0 1.0 1.0 1.0 EcoFuel e-up	44 55 66 50 60		12.11 12.11 05.16 11.12 09.13	PR: 1LA,1ZQ PR: 1LA,1ZQ PR: 1LA,1ZQ PR: 1LA,1ZQ PR: 1LA,1ZQ	11.9541-9549.2 11.9541-9550.2 11.0101-5409.2 11.8171-0008.1	220575 220576 260035 990049	2	D=54, - Halter ATE D=54, - Halter ATE Hülzensatz ATE Führungsbolzen ATE
	1.0 1.0 1.0 1.0 EcoFuel e-up	44 55 66 50 60		12.11 12.11 05.16 11.12 09.13		24.3217-0908.3 24.3219-0909.3	020167 020188		Rz 17,46 Rz 19,05
VOLKSWAGEN XL1 (14-)									
	0.8 TDI Hybrid	35		02.14		83.6247-0522.3	330595	2	L=522
	0.8 TDI Hybrid	35		02.14		24.5204-0233.3	331430	2	L=233

1) + cast iron / + ghisa / + fonte grise / + fundición de gris

2) + aluminium / + alluminio / + aluminium / + aluminio

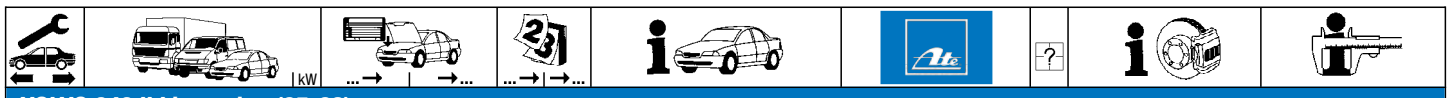





















VOLVO 940 II Limousine (95-98)										
	2.0 T 2.3 2.3 2.3 T 2.3 ti 2.4 TD Intercooler	114 85 96 121 99 90		04.96 08.94 08.94 08.94 01.95 08.94	10.98 07.95 10.98 10.98 10.98 10.98	03.2023-0875.3	010890		THz 23,81/20,64 - B.	ATE
	2.0 T 2.3 2.3 2.3 T 2.3 ti 2.4 TD Intercooler	114 85 96 121 99 90		04.96 08.94 08.94 08.94 01.95 08.94	10.98 07.95 10.98 10.98 10.98 10.98	24.3571-1707.5 24.3571-1708.5 24.0101-3601.2	240079 240080 260044		D=57, - Halter D=57, - Halter Bremsattel-Zubehör	TRW TRW TRW
	2.0 T 2.3 2.3 2.3 T 2.3 ti 2.4 TD Intercooler	114 85 96 121 99 90		04.96 08.94 08.94 08.94 01.95 08.94	10.98 07.95 10.98 10.98 10.98 10.98	83.6134-0335.3	330277	2	L=335	
	2.0 T 2.3 2.3 2.3 T 2.3 ti 2.4 TD Intercooler	114 85 96 121 99 90		04.96 08.94 08.94 08.94 01.95 08.94	10.98 07.95 10.98 10.98 10.98 10.98	24.9238-0087.5 24.9238-0088.5 13.2401-0027.2 13.2401-0028.2 24.9240-0028.5 13.0441-3815.2 13.0441-3819.2 13.0441-4014.2	230035 230036 210045 210046 230018 250069 250072 250079		D=38 D=38 D=40 D=40 D=40 Dichtungssatz Dichtungssatz Dichtungssatz	ATE ATE ATE ATE ATE ATE ATE ATE
	2.0 T 2.3 2.3 2.3 T 2.3 ti 2.4 TD Intercooler	114 85 96 121 99 90		04.96 08.94 08.94 08.94 01.95 08.94	10.98 07.95 10.98 10.98 10.98 10.98	83.6124-0305.3	330723	2	L=305	
	2.3 2.3 2.3 T 2.3 ti 2.4 TD Intercooler	85 96 121 99 90		08.94 08.94 08.94 01.95 08.94	07.95 10.98 10.98 10.98 10.98	03.6055-0430.3	320065		BR 5/25 (4)	ATE
	2.0 T	114		04.96	10.98	03.6055-0431.3	320142		BR 5/35 (4)	ATE
	2.3 2.3 2.3 ti	85 96 99		08.94 08.94 01.95	07.95 10.98 10.98	24.2419-0941.3	030067		Gz 19,05	
	2.0 T 2.3 2.3 T 2.4 TD Intercooler	114 121 90		04.96 08.94 08.94	10.98 10.98 10.98	24.2419-0928.3	030056		Gz 19,05	
	2.3 2.3 2.3 ti	85 96 99		08.94 08.94 01.95	07.95 10.98 10.98	24.2520-0905.3	040057		Nz 20,64	
	2.0 T 2.3 T 2.4 TD Intercooler	114 121 90		04.96 08.94 08.94	10.98 10.98 10.98	03.2522-0420.3	040086		Nz 22,20	

VOLVO 940 II Kombi (95-98)										
	2.0 T 2.3 2.3 2.3 T 2.3 ti 2.4 TD Intercooler	114 85 96 121 126 99 90		04.96 08.94 08.94 08.94 08.95 01.95 08.94	10.98 07.95 10.98 10.98 10.98 10.98 10.98	03.2023-0875.3	010890		THz 23,81/20,64 - B.	ATE
	2.0 T 2.3 2.3 2.3 T 2.3 ti 2.4 TD Intercooler	114 85 96 121 99 90		04.96 08.94 08.94 08.94 01.95 08.94	10.98 07.95 10.98 10.98 10.98 10.98	24.3571-1707.5 24.3571-1708.5 24.0101-3601.2	240079 240080 260044		D=57, - Halter D=57, - Halter Bremsattel-Zubehör	TRW TRW TRW
	2.0 T 2.3 2.3 2.3 T 2.3 ti 2.4 TD Intercooler	114 85 96 121 126 99 90		04.96 08.94 08.94 08.94 08.95 01.95 08.94	10.98 07.95 10.98 10.98 10.98 10.98 10.98	83.6134-0335.3	330277	2	L=335	
	2.0 T 2.3 2.3 2.3 T 2.3 ti 2.4 TD Intercooler	114 85 96 121 126 99 90		04.96 08.94 08.94 08.94 08.95 01.95 08.94	10.98 07.95 10.98 10.98 10.98 10.98 10.98	24.9238-0087.5 24.9238-0088.5 13.2401-0027.2 13.2401-0028.2 24.9240-0028.5 13.0441-3815.2 13.0441-3819.2 13.0441-4014.2	230035 230036 210045 210046 230018 250069 250072 250079		D=38 D=38 D=40 D=40 D=40 Dichtungssatz Dichtungssatz Dichtungssatz	ATE ATE ATE ATE ATE ATE ATE ATE
	2.0 T 2.3 2.3 2.3 T 2.3 T	114 85 96 121 126		04.96 08.94 08.94 08.94 08.95	10.98 07.95 10.98 10.98 10.98	83.6124-0305.3	330723	2	L=305	















1) - multi link axle / - assale Multi-link / - essieu multi-link / - eje Multi-Link
 2) f.predec.13.2381-0067/-0068.2 / p.prece.13.2381-0067.2/-0068.2 / p.préd.13.2381-0067.2/-0068.2 / p.prede.13.2381-0067.2/-0068.2
 3) f.predec.13.2401-0023/-0024.2 / p.prece.13.2401-0023.2/-0024.2 / p.préd.13.2401-0023.2/-0024.2 / p.prede.13.2401-0023.2/-0024.2



									
VOLVO 940 II Kombi (95-98)									
	2.3 ti 2.4 TD Intercooler	99 90		01.95 08.94	10.98 10.98	83.6124-0305.3	330723	2	L=305
	2.0 T 2.3 2.3 2.3 T 2.3 T 2.3 ti 2.4 TD Intercooler	114 85 96 121 126 99 90		04.96 08.94 08.94 08.94 08.95 01.95 08.94	10.98 07.95 10.98 10.98 10.98 10.98 10.98	03.6055-0431.3	320142		BR 5/35 (4) ATE
	2.3 2.3 2.3 ti	85 96 99		08.94 08.94 01.95	07.95 10.98 10.98	24.2419-0941.3	030067		Gz 19,05
	2.0 T 2.3 T 2.3 T 2.4 TD Intercooler	114 121 126 90		04.96 08.94 08.95 08.94	10.98 10.98 10.98 10.98	24.2419-0928.3	030056		Gz 19,05
	2.3 2.3 2.3 ti	85 96 99		08.94 08.94 01.95	07.95 10.98 10.98	24.2520-0905.3	040057		Nz 20,64
	2.0 T 2.3 T 2.3 T 2.4 TD Intercooler	114 121 126 90		04.96 08.94 08.95 08.94	10.98 10.98 10.98 10.98	03.2522-0420.3	040086		Nz 22,20
VOLVO C30 Coupe (06-12)									
	1.6 1.6 D 1.6 D Efficiency 1.8 1.8 FlexiFuel 2.0 2.0 D 2.4 D5 2.4 D5 2.4 i 2.5 T5 2.5 T5 Electric	74 80 77 92 92 107 100 120 132 125 162 169 82		09.06 09.06 09.08 09.06 04.07 09.06 09.06 10.06 09.06 09.06 09.06 03.07 12.10	12.12 12.12 12.12 12.12 12.12 12.12 12.12 12.12 12.12 12.12 12.12 12.12 12.12	03.7863-4832.4 03.0655-0007.2	300289 370007		10" Wegsensor ATE ATE
	1.6 1.6 D 1.6 D Efficiency 1.8 1.8 FlexiFuel 2.0 2.0 D 2.4 D5 2.4 D5 2.4 i 2.5 T5 2.5 T5	74 80 77 92 92 107 100 120 132 125 162 169		09.06 09.06 09.08 09.06 04.07 09.06 09.06 10.06 09.06 09.06 09.06 03.07	12.12 12.12 12.12 12.12 12.12 12.12 12.12 12.12 12.12 12.12 12.12 12.12	03.0655-0007.2	370007		Wegsensor ATE
	1.6 1.6 D 1.6 D Efficiency 1.8 1.8 FlexiFuel 2.0 2.0 D 2.4 D5 2.4 D5 2.4 i 2.5 T5 2.5 T5 Electric	74 80 77 92 92 107 100 120 132 125 162 169 82		09.06 09.06 09.08 09.06 04.07 09.06 09.06 10.06 09.06 09.06 09.06 03.07 12.10	12.12 12.12 12.12 12.12 12.12 12.12 12.12 12.12 12.12 12.12 12.12 12.12 12.12	03.2123-3593.3	010919		THz 23,81 ATE
	1.6 1.6 D 1.6 D Efficiency 1.6 D2 1.8 1.8 FlexiFuel 2.0 2.0 D 2.0 D3 2.0 D4 2.4 D5 2.4 D5 2.4 i 2.5 T5 2.5 T5 Electric	74 80 77 84 92 92 107 100 110 130 120 132 125 162 169 82		09.06 09.06 09.08 10.10 09.06 04.07 09.06 09.06 10.10 10.10 10.06 09.06 09.06 09.06 03.07 12.10	12.12 12.12 12.12 12.12 12.12 12.12 12.12 12.12 12.12 12.12 12.12 12.12 12.12 12.12 12.12 12.12	24.3571-9813.5 24.3571-9814.5 11.0230-0818.1 11.0101-5407.2 11.8171-0008.1 11.8116-0356.1	240557 240558 260135 260011 990049 390586	2 + 15"/16" Rad 1) + 15"/16" Rad 1) + 15"/16" Rad 1)	D=57, - Halter ATE D=57, - Halter ATE Halter ATE Hülzensatz ATE Führungsbolzen ATE Halterfeder ATE
	1.6 1.6 D 1.6 D Efficiency 1.6 D2 1.8 1.8 FlexiFuel	74 80 77 84 92 92		09.06 09.06 09.08 10.10 09.06 04.07	12.12 12.12 12.12 12.12 12.12 12.12	83.7716-0398.3	330987	2	L=395

1) + 15"/16" wheel / + ruota 15"/16" / + roue 15"/16" / + rueda 15"/16"



VOLVO C30 Coupe (06-12)											
											
		kW							
	2.0	107		09.06	12.12	83.7716-0398.3	330987	2			L=395
	2.0 D	100		09.06	12.12						
	2.0 D3	110		10.10	12.12						
	2.0 D4	130		10.10	12.12						
	2.4 D5	120		10.06	12.12						
	2.4 D5	132		09.06	12.12						
	2.4 i	125		09.06	12.12						
	2.5 T5	162		09.06	12.12						
	2.5 T5	169		03.07	12.12						
	Electric	82		12.10	12.12						
	1.6	74	146186	09.06		11.9387-7015.2	220627				D=38, - Halter
	1.6 D	80	146186	09.06		11.9387-7016.2	220628				D=38, - Halter
	1.6 D Efficiency	77	146186	09.08		11.0230-0698.2	260091				Halter
	1.6 D2	84	146186	10.10		11.0101-5407.2	260011				Hülzensatz
	1.8	92	146186	09.06		11.8171-0008.1	990049				Führungsbolzen
	1.8 FlexiFuel	92	146186	04.07		11.8116-0340.1	390595	2			Haltefeder
	2.0	107	146186	09.06							
	2.0 D	100	146186	09.06							
	2.0 D3	110	146186	10.10							
	2.0 D4	130	146186	10.10							
	2.4 D5	120	146186	10.06							
	2.4 D5	132	146186	09.06							
	2.4 i	125	146186	09.06							
	2.5 T5	162	146186	09.06							
	2.5 T5	169	146186	09.06							
	Electric	82 128	146186	03.07							
					12.12						
	1.6	74	146187		12.12	11.9387-7083.2	220959				D=38, - Halter
	1.6 D	80	146187		12.12	11.9387-7084.2	220960				D=38, - Halter
	1.6 D Efficiency	77	146187		12.12	11.0230-0698.2	260091				Halter
	1.6 D2	84	146187		12.12	11.0101-5407.2	260011				Hülzensatz
	1.8	92	146187		12.12	11.8171-0008.1	990049				Führungsbolzen
	1.8 FlexiFuel	92	146187		12.12	11.8116-0340.1	390595	2			Haltefeder
	2.0	107	146187		12.12						
	2.0 D	100	146187		12.12						
	2.0 D3	110	146187		12.12						
	2.0 D4	130	146187		12.12						
	2.4 D5	120	146187		12.12						
	2.4 D5	132	146187		12.12						
	2.4 i	125	146187		12.12						
	2.5 T5	162	146187		12.12						
	2.5 T5	169	146187		12.12						
	Electric	82	127	12.10							
	1.6	74		09.06	12.12	83.7788-0383.3	330972	2			L=382
	1.6 D	80		09.06	12.12						
	1.6 D Efficiency	77		09.08	12.12						
	1.6 D2	84		10.10	12.12						
	1.8	92		09.06	12.12						
	1.8 FlexiFuel	92		04.07	12.12						
	2.0	107		09.06	12.12						
	2.0 D	100		09.06	12.12						
	2.0 D3	110		10.10	12.12						
	2.0 D4	130		10.10	12.12						
	2.4 D5	120		10.06	12.12						
	2.4 D5	132		09.06	12.12						
	2.4 i	125		09.06	12.12						
	2.5 T5	162		09.06	12.12						
	2.5 T5	169		03.07	12.12						
	Electric	82		12.10	12.12						
VOLVO C70 Coupe (97-02)											
	2.0	132		03.97	12.98	03.7760-3602.4	300176				10"
	2.0 T	166		03.97	12.98						
	2.3 T5	176		03.97	12.98						
	2.5 T	142		03.97	12.98						
	2.0	132		01.99	09.02	03.0655-0004.2	370004				Wegsensor
	2.0 T	120		03.00	09.02						
	2.0 T	166		01.99	09.02						
	2.3 T5	176		01.99	09.02						
	2.5	121		03.99	09.02						
	2.5	125		11.99	09.02						
	2.5 T	142		01.99	09.02						
	2.0	132		01.99	09.02	03.0655-0004.2	370004				Wegsensor
	2.0 T	120		03.00	09.02						
	2.0 T	166		01.99	09.02						
	2.3 T5	176		01.99	09.02						
	2.5	121		03.99	09.02						
	2.5	125		11.99	09.02						
	2.5 T	142		01.99	09.02						
	2.0	132		03.97	12.98	03.2023-1084.3	010591		- ASR		THz 23,81/20,64
	2.0 T	166		03.97	12.98	03.2023-1044.3	010590		+ ASR		THz 23,81/20,64
	2.3 T5	176		03.97	12.98						
	2.5 T	142		03.97	12.98						
	2.0	132		01.99	09.02	03.2123-2164.3	010599				THz 23,81
	2.0 T	120		03.00	09.02						
	2.0 T	166		01.99	09.02						
	2.3 T5	176		01.99	09.02						
↓											

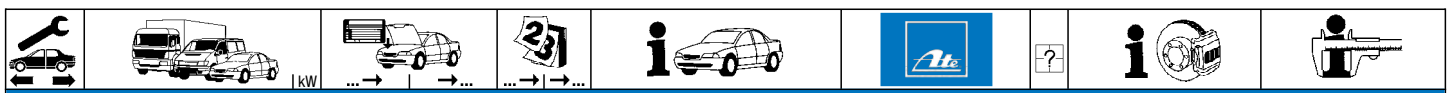

































VOLVO C70 Coupe (97-02)											
	2.5	121		03.99	09.02		03.2123-2164.3	010599		THz 23,81	ATE
	2.5	125		11.99	09.02						
	2.5 T	142		01.99	09.02						
	2.0	132		03.97	09.02		11.9571-9971.2	220605		D=57, - Halter	ATE
	2.0 T	120		03.00	09.02		11.9571-9972.2	220606		D=57, - Halter	ATE
	2.0 T	166		03.97	09.02		11.8116-0073.1	390498	2	Haltefeder	ATE
	2.3 T5	176		03.97	09.02						
	2.5	121		03.99	09.02						
	2.5	125		11.99	09.02						
	2.5 T	142		03.97	09.02						
	2.0	132		03.97	09.02		83.6113-0331.3	330982	2	am Bremsattel ¹⁾	L=330
	2.0 T	120		03.00	09.02						
	2.0 T	166		03.97	09.02						
	2.3 T5	176		03.97	09.02						
	2.5	121		03.99	09.02						
	2.5	125		11.99	09.02						
	2.5 T	142		03.97	09.02						
	2.0	132		03.97	09.02		13.2381-0097.2	210239		D=38	ATE
	2.0 T	120		03.00	09.02		13.2381-0098.2	210240		D=38	ATE
	2.0 T	166		03.97	09.02		24.9238-0097.5	230037		D=38	ATE
	2.3 T5	176		03.97	09.02		24.9238-0098.5	230038		D=38	ATE
	2.5	121		03.99	09.02		13.0441-3819.2	250072		Dichtungssatz	ATE
	2.5	125		11.99	09.02						
	2.5 T	142		03.97	09.02						
	2.0	132	10849	03.97			24.5201-0204.3	331400	2		L=204
	2.0 T	166	10849	03.97							
	2.3 T5	176	10849	03.97							
	2.5 T	142	10849	03.97							
	2.0	132	10850		09.02		83.6204-0180.3	330547	2		L=180
	2.0 T	120		03.00	09.02						
	2.0 T	166	10850		09.02						
	2.3 T5	176	10850		09.02						
	2.5	121		03.99	09.02						
	2.5	125		11.99	09.02						
	2.5 T	142	10850		09.02						
	2.0	132		03.97	09.02		24.2419-1724.3	030113			Gz 19,05
	2.0 T	120		03.00	09.02						
	2.0 T	166		03.97	09.02						
	2.3 T5	176		03.97	09.02						
	2.5	121		03.99	09.02						
	2.5	125		11.99	09.02						
	2.5 T	142		03.97	09.02						

VOLVO C70 I Cabrio (98-06)											
	2.0	132		03.98	12.98		03.7760-3602.4	300176		10"	ATE
	2.0 T	166		03.98	12.98						
	2.3 T5	176		03.98	12.98						
	2.5	125		06.98	12.98						
	2.5 T	142		03.98	12.98						
	2.0	132		01.99	02.06		03.0655-0004.2	370004		Wegsensor	ATE
	2.0 T	120		03.00	02.06						
	2.0 T	166		01.99	02.06						
	2.3 T5	176		01.99	02.06						
	2.3 T5	180		07.02	02.06						
	2.4 T	147		07.02	02.06						
	2.5	125		01.99	02.06						
	2.5 T	142		01.99	02.06						
	2.0	132		01.99	02.06		03.0655-0004.2	370004		Wegsensor	ATE
	2.0 T	120		03.00	02.06						
	2.0 T	166		01.99	02.06						
	2.3 T5	176		01.99	02.06						
	2.3 T5	180		07.02	02.06						
	2.4 T	147		07.02	02.06						
	2.5	125		01.99	02.06						
	2.5 T	142		01.99	02.06						
	2.0	132		03.98	12.98		03.2023-1084.3	010591	- ASR	THz 23,81/20,64	ATE
	2.0 T	166		03.98	12.98		03.2023-1044.3	010590	+ ASR	THz 23,81/20,64	ATE
	2.3 T5	176		03.98	12.98						
	2.5	125		06.98	12.98						
	2.5 T	142		03.98	12.98						
	2.0	132		01.99	02.06		03.2123-2164.3	010599		THz 23,81	ATE
	2.0 T	120		03.00	02.06						
	2.0 T	166		01.99	02.06						
	2.3 T5	176		01.99	02.06						
	2.3 T5	180		07.02	02.06						
	2.4 T	147		07.02	02.06						
	2.5	125		01.99	02.06						
	2.5 T	142		01.99	02.06						
	2.0	132		03.98	02.06		11.9571-9971.2	220605		D=57, - Halter	ATE
	2.0 T	120		03.00	02.06		11.9571-9972.2	220606		D=57, - Halter	ATE
	2.0 T	166		03.98	02.06		11.8116-0073.1	390498	2	Haltefeder	ATE
	2.3 T5	176		03.98	02.06						
	2.3 T5	180		07.02	02.06						
	2.4 T	147		07.02	02.06						
	2.5	125		06.98	02.06						
	2.5 T	142		03.98	02.06						

¹⁾ on the brake caliper / sulla pinza freno / sur l'étrier de frein / a la pinza de freno



											
VOLVO C70 I Cabrio (98-06)											
	2.0 2.0 T 2.0 T 2.3 T5 2.3 T5 2.4 T 2.5 2.5 T	132 120 166 176 180 147 125 142		03.98 03.00 03.98 03.98 07.02 07.02 06.98 03.98	02.06 02.06 02.06 02.06 02.06 02.06 02.06 02.06	83.6113-0331.3 83.6134-0335.3 24.5170-0361.3	330982 330277 331310	2 2 2 2 2 2 2 2	am Bremsattel ¹⁾ + 15" Rad ²⁾ + 16" Rad ³⁾	L=330 L=335 L=361	
	2.0 2.0 T 2.0 T 2.3 T5 2.3 T5 2.4 T 2.5 2.5 T	132 120 166 176 180 147 125 142		03.98 03.00 03.98 03.98 07.02 07.02 06.98 03.98	02.06 02.06 02.06 02.06 02.06 02.06 02.06 02.06	13.2381-0097.2 13.2381-0098.2 24.9238-0097.5 24.9238-0098.5 13.0441-3815.2	210239 210240 230037 230038 250069	2 2 2 2 2 2 2 2	   	D=38 D=38 D=38 D=38 Dichtungssatz	ATE ATE ATE ATE ATE
	2.0 2.0 T 2.3 T5 2.5 2.5 T	132 166 176 125 142	1209 1209 1209 1209	03.98 03.98 03.98 06.98 03.98		24.5201-0204.3	331400	2		L=204	
	2.0 2.0 T 2.0 T 2.3 T5 2.3 T5 2.4 T 2.5 2.5 T	132 1210 120 166 1210 176 1210 180 147 125 1210 142 1210		03.00 07.02 07.02 02.06 02.06	02.06 02.06 02.06 02.06 02.06 02.06 02.06 02.06	83.6204-0180.3	330547	2		L=180	
	2.0 2.0 T 2.0 T 2.3 T5 2.3 T5 2.4 T 2.5 2.5 T	132 120 166 176 180 147 125 142		03.98 03.00 03.98 03.98 07.02 07.02 06.98 03.98	02.06 02.06 02.06 02.06 02.06 02.06 02.06 02.06	24.2419-1724.3	030113			Gz 19,05	
VOLVO C70 II Cabrio (06-13)											
	2.0 D 2.4 2.4 D 2.4 D5 2.4 i 2.5 T5 2.5 T5	1100 1103 1120 1132 1125 1162 1169		06.08 03.06 03.07 03.06 03.06 03.06 03.07	07.13 07.13 07.13 07.13 07.13 07.13 07.13	03.7863-4832.4 03.0655-0007.2	300289 370007			10" Wegsensor	ATE ATE
	2.4 2.4 D 2.4 D5 2.4 i 2.5 T5 2.5 T5	1103 1120 1132 1125 1162 1169		03.06 03.07 03.06 03.06 03.06 03.07	07.13 07.13 07.13 07.13 07.13 07.13	03.0655-0007.2	370007			Wegsensor	ATE
	2.0 D 2.0 D 2.0 D	1100 1100 50576 1100 50576	50575	06.08 07.13		03.0655-0007.2 03.0655-0007.2	370007 370007			Wegsensor Wegsensor	ATE ATE
	2.0 D 2.4 2.4 D 2.4 D5 2.4 i 2.5 T5 2.5 T5	1100 1103 1120 1132 1125 1162 1169		06.08 03.06 03.07 03.06 03.06 03.06 03.07	07.13 07.13 07.13 07.13 07.13 07.13 07.13	03.2123-3593.3	010919			THz 23,81	ATE
	2.0 D 2.0 D3 2.0 D4 2.4 2.4 D 2.4 D5 2.4 i 2.5 T5 2.5 T5	100 110 130 103 120 132 125 162 169		06.08 10.10 10.10 03.06 03.07 03.06 03.06 03.06 03.07	07.13 07.13 07.13 07.13 07.13 07.13 07.13 07.13 07.13	24.3571-9813.5 24.3571-9814.5 11.0230-0818.1 11.8116-0356.1	240557 240558 260135 390586	2	  	D=57, - Halter D=57, - Halter Halter Halterfeder	ATE ATE ATE ATE
	2.0 D 2.0 D3 2.0 D4 2.4 2.4 D 2.4 D5 2.4 i 2.5 T5 2.5 T5	100 110 130 103 120 132 125 162 169		06.08 10.10 10.10 03.06 03.07 03.06 03.06 03.06 03.07	07.13 07.13 07.13 07.13 07.13 07.13 07.13 07.13 07.13	11.9576-9975.2 11.9576-9976.2 11.8116-0345.2	220649 220650 390596	2	  	D=57, - Halter D=57, - Halter Halterfeder	ATE ATE ATE
	2.0 D 2.4 2.4 D5 2.4 i	100 103 132 125		06.08 03.06 03.06 03.06	07.13 07.13 07.13 07.13	83.7716-0398.3	330987	2		L=395	
	2.5 T5 2.5 T5	162 169		03.06 03.07	07.13 07.13	83.7788-0414.3	330988	2		L=411	

¹⁾ on the brake caliper / sulla pinza freno / sur l'étrier de frein / a la pinza de freno

²⁾ + 15" wheel / + ruota 15" / + roue 15" / + rueda 15"

³⁾ + 16" wheel / + ruota 16" / + roue 16" / + rueda 16"

⁴⁾ + 15"/16" wheel / + ruota 15"/16" / + roue 15"/16" / + rueda 15"/16"

⁵⁾ + 17" wheel / + ruota 17" / + roue 17" / + rueda 17"



VOLVO C70 II Cabrio (06-13)

	2.0 D3	110		10.10	07.13		83.7788-0383.3	330972	2		L=382	
	2.0 D4	130		10.10	07.13		83.7716-0398.3	330987	2	+ 15"/16" Rad 1)	L=395	
	2.4 D	120		03.07	07.13		83.7788-0414.3	330988	2	+ 17" Rad 2)	L=411	
	2.0 D	100	77106	06.08			11.9387-7015.2	220627			D=38, - Halter	ATE
	2.0 D3	110	77106	10.10			11.9387-7016.2	220628			D=38, - Halter	ATE
	2.0 D4	130	77106	10.10			11.0230-0698.2	260091			Halter	ATE
	2.4	103	77106	03.06			11.0101-5407.2	260011			Hülzensatz	ATE
	2.4 D	120	77106	03.07			11.8171-0008.1	990049			Führungsbolzen	ATE
	2.4 D5	132	77106	03.06			11.8116-0340.1	390595	2		Haltefeder	ATE
	2.4 i	125	77106	03.06								
	2.5 T5	162	77106	03.06								
	2.5 T5	169	77106	03.07								
	2.0 D	100	77107		07.13		11.9387-7083.2	220959			D=38, - Halter	ATE
	2.0 D3	110	77107		07.13		11.9387-7084.2	220960			D=38, - Halter	ATE
	2.0 D4	130	77107		07.13		11.0230-0698.2	260091			Halter	ATE
	2.4	103	77107		07.13		11.0101-5407.2	260011			Hülzensatz	ATE
	2.4 D	120	77107		07.13		11.8171-0008.1	990049			Führungsbolzen	ATE
	2.4 D5	132	77107		07.13		11.8116-0340.1	390595	2		Haltefeder	ATE
	2.4 i	125	77107		07.13							
	2.5 T5	162	77107		07.13							
	2.5 T5	169	77107		07.13							
	2.0 D	100		06.08	07.13		83.7788-0383.3	330972	2		L=382	
	2.0 D3	110		10.10	07.13							
	2.0 D4	130		10.10	07.13							
	2.4	103		03.06	07.13							
	2.4 D	120		03.07	07.13							
	2.4 D5	132		03.06	07.13							
	2.4 i	125		03.06	07.13							
	2.5 T5	162		03.06	07.13							
	2.5 T5	169		03.07	07.13							

VOLVO S40 I (95-03)

	1.6	77		09.95	08.97		24.2122-1718.3	010517			Thz 22,20	
	1.8 (1731)	85		07.95	08.97							
	1.9 T4	147		05.97	08.97							
	1.9 TD	66		07.95	08.97							
	2.0	100		07.95	08.97							
	2.0	103		07.95	08.97							
	1.6	77		09.97	08.99		24.2123-1746.3	010682			Thz 23,81	
	1.6	80		03.99	12.03							
	1.8 (1731)	85		09.97	08.99							
	1.8 (1783)	90		03.99	12.03							
	1.8 i (1834)	90		06.01	12.03							
	1.8 i (1834)	92		03.98	12.03							
	1.9 DI	70		03.99	07.00							
	1.9 DI	75		07.00	12.03							
	1.9 DI	85		07.00	12.03							
	1.9 T4	147		09.97	07.00							
	1.9 TD	66		09.97	08.99							
	2.0	100		09.97	12.03							
	2.0	103		09.97	08.99							
	2.0 T	118		10.97	07.00							
	2.0 T	120		06.01	12.03							
	2.0 T	121		07.00	06.01							
	2.0 T4	147		07.00	12.03							
	1.6	77		09.95	08.97		24.3541-1783.5	240269			D=54, - Halter	TRW
	1.8 (1731)	85		07.95	08.97		24.3541-1784.5	240270			D=54, - Halter	TRW
	1.9 T4	147		05.97	08.97							
	1.9 TD	66		07.95	08.97							
	2.0	100		07.95	08.97							
	2.0	103		07.95	08.97							
	1.6	77		09.97	08.99		24.3541-1785.5	240271			D=54, - Halter	TRW
	1.6	80		03.99	12.03		24.3541-1786.5	240272			D=54, - Halter	TRW
	1.8 (1731)	85		09.97	08.99							
	1.8 (1783)	90		03.99	12.03							
	1.8 i (1834)	90		06.01	12.03							
	1.8 i (1834)	92		03.98	12.03							
	1.9 DI	70		03.99	07.00							
	1.9 DI	75		07.00	12.03							
	1.9 DI	85		07.00	12.03							
	1.9 T4	147		09.97	07.00							
	1.9 TD	66		09.97	08.99							
	2.0	100		09.97	12.03							
	2.0	103		09.97	08.99							
	2.0 T	118		10.97	07.00							
	2.0 T	120		06.01	12.03							
	2.0 T	121		07.00	06.01							
	2.0 T4	147		07.00	12.03							
	1.6	77		09.95	08.99		24.5248-0461.3	330707	2		L=460	
	1.6	80		03.99	12.03							
	1.8 (1731)	85		07.95	08.99							
	1.8 (1783)	90		03.99	12.03							
	1.8 i (1834)	90		06.01	12.03							
	1.8 i (1834)	92		03.98	12.03							
	1.9 DI	70		03.99	07.00							
	1.9 DI	75		07.00	12.03							

1) + 15"/16" wheel / + ruota 15"/16" / + roue 15"/16" / + rueda 15"/16"



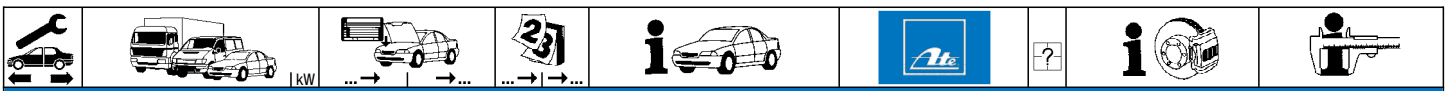

2) + 17" wheel / + ruota 17" / + roue 17" / + rueda 17"

















VOLVO S40 I (95-03)

	1.9 DI	85		07.00	12.03	24.5248-0461.3	330707	2		L=460					
	1.9 T4	147		05.97	07.00										
	1.9 TD	66		07.95	08.99										
	2.0	100		07.95	12.03										
	2.0	103		07.95	08.99										
	2.0 T	118		10.97	07.00										
	2.0 T	120		06.01	12.03										
	2.0 T	121		07.00	06.01										
	2.0 T4	147		07.00	12.03										
	1.6	77	426760	09.95		24.3384-1721.5	240255	<input type="checkbox"/>		D=38, - Halter					
	1.6	80	426760	03.99											
	1.8 (1731)	85	426760	07.95											
	1.8 (1783)	90	426760	03.99											
	1.8 i (1834)	92	426760	03.98											
	1.9 DI	70	426760	03.99											
	1.9 T4	147	426760	05.97											
	1.9 TD	66	426760	07.95											
	2.0	100	426760	07.95											
	2.0	103	426760	07.95											
	2.0 T	118	426760	10.97											
	1.6	77	426761		08.99						24.3384-1743.5	240319	<input type="checkbox"/>		D=38, - Halter
	1.6	80	426761		12.03										
	1.8 (1731)	85	426761		08.99										
	1.8 (1783)	90	426761		12.03										
1.8 i (1834)	90		06.01	12.03											
1.8 i (1834)	92	426761		12.03											
1.9 DI	70	426761		07.00											
1.9 DI	75		07.00	12.03											
1.9 DI	85		07.00	12.03											
1.9 T4	147	426761		07.00											
1.9 TD	66	426761		08.99											
2.0	100	426761		12.03											
2.0	103	426761		08.99											
2.0 T	118	426761		07.00											
2.0 T	120		06.01	12.03											
2.0 T	121		07.00	06.01											
2.0 T4	147		07.00	12.03											
	1.6	77		09.95	08.99	24.5249-0416.3	330708	2		L=416					
	1.6	80		03.99	12.03										
	1.8 (1731)	85		07.95	08.99										
	1.8 (1783)	90		03.99	12.03										
	1.8 i (1834)	90		06.01	12.03										
	1.8 i (1834)	92		03.98	12.03										
	1.9 DI	70		03.99	07.00										
	1.9 DI	75		07.00	12.03										
	1.9 DI	85		07.00	12.03										
	1.9 T4	147		05.97	07.00										
	1.9 TD	66		07.95	08.99										
	2.0	100		07.95	12.03										
	2.0	103		07.95	08.99										
	2.0 T	118		10.97	07.00										
	2.0 T	120		06.01	12.03										
	2.0 T	121		07.00	06.01										
	2.0 T4	147		07.00	12.03										
		1.6	77		09.95						08.99	24.3727-1304.2	581304	<input type="checkbox"/>	
1.6		80	599999	03.99											
1.8 (1731)		85		07.95	08.99										
1.8 (1783)		90	599999	03.99											
1.8 i (1834)		90	599999	06.01											
1.8 i (1834)		92	599999	03.98											
1.9 DI		70		03.99	07.00										
1.9 DI		75	599999	07.00											
1.9 DI		85	599999	07.00											
1.9 T4		147		05.97	07.00										
1.9 TD		66		07.95	08.99										
2.0		100	599999	07.95											
2.0		103		07.95	08.99										
2.0 T		118		10.97	07.00										
2.0 T		120	599999	06.01											
2.0 T	121	599999	07.00												
2.0 T4	147	599999	07.00												
	1.6	80	600000	985261		24.3727-1315.2	581315	<input type="checkbox"/>		L=1620					
	1.8 (1783)	90	600000	985261											
	1.8 i (1834)	90	600000	985261											
	1.8 i (1834)	90	600000	985261											
	1.9 DI	75	600000	985261											
	1.9 DI	85	600000	985261											
	2.0	100	600000	985261											
	2.0 T	120	600000	985261											
	2.0 T	121	600000	985261											
	2.0 T4	147	600000	985261											
	1.6	80	985262		12.03	24.3727-1314.2	581314	<input type="checkbox"/>		L=1620					
	1.8 (1783)	90	985262		12.03										
	1.8 i (1834)	90	985262		12.03										
	1.8 i (1834)	90	985262		12.03										
	1.9 DI	75	985262		12.03										
	1.9 DI	85	985262		12.03										

VOLVO S40 I (95-03)																																																																																																																																																																																																																																																																					
	<table border="1"> <tr><td>2.0</td><td>100</td><td>985262</td><td></td><td></td><td>12.03</td><td></td><td>24.3727-1315.2</td><td>581315</td><td><input type="checkbox"/></td><td></td><td>L=1620</td></tr> <tr><td>2.0 T</td><td>120</td><td>985262</td><td></td><td></td><td>12.03</td><td></td><td>24.3727-1314.2</td><td>581314</td><td><input type="checkbox"/></td><td></td><td>L=1620</td></tr> <tr><td>2.0 T</td><td>121</td><td>985262</td><td></td><td></td><td>12.03</td><td></td><td></td><td></td><td></td><td></td><td></td></tr> <tr><td>2.0 T4</td><td>147</td><td>895262</td><td></td><td></td><td>12.03</td><td></td><td></td><td></td><td></td><td></td><td></td></tr> </table>	2.0	100	985262			12.03		24.3727-1315.2	581315	<input type="checkbox"/>		L=1620	2.0 T	120	985262			12.03		24.3727-1314.2	581314	<input type="checkbox"/>		L=1620	2.0 T	121	985262			12.03							2.0 T4	147	895262			12.03																																																																																																																																																																																																																										
2.0	100	985262			12.03		24.3727-1315.2	581315	<input type="checkbox"/>		L=1620																																																																																																																																																																																																																																																										
2.0 T	120	985262			12.03		24.3727-1314.2	581314	<input type="checkbox"/>		L=1620																																																																																																																																																																																																																																																										
2.0 T	121	985262			12.03																																																																																																																																																																																																																																																																
2.0 T4	147	895262			12.03																																																																																																																																																																																																																																																																
	<table border="1"> <tr><td>1.8 (1783)</td><td>90</td><td></td><td></td><td>03.99</td><td>12.03</td><td></td><td>24.2419-1728.3</td><td>030117</td><td></td><td></td><td>Gz 19,05</td></tr> <tr><td>1.9 DI</td><td>70</td><td></td><td></td><td>03.99</td><td>07.00</td><td></td><td></td><td></td><td></td><td></td><td></td></tr> <tr><td>1.9 DI</td><td>75</td><td></td><td></td><td>07.00</td><td>12.03</td><td></td><td></td><td></td><td></td><td></td><td></td></tr> <tr><td>1.9 DI</td><td>85</td><td></td><td></td><td>07.00</td><td>12.03</td><td></td><td></td><td></td><td></td><td></td><td></td></tr> <tr><td>1.9 T4</td><td>147</td><td></td><td></td><td>05.97</td><td>07.00</td><td></td><td></td><td></td><td></td><td></td><td></td></tr> <tr><td>2.0</td><td>100</td><td></td><td></td><td>07.95</td><td>12.03</td><td></td><td></td><td></td><td></td><td></td><td></td></tr> <tr><td>2.0 T</td><td>118</td><td></td><td></td><td>10.97</td><td>07.00</td><td></td><td></td><td></td><td></td><td></td><td></td></tr> <tr><td>2.0 T</td><td>120</td><td></td><td></td><td>06.01</td><td>12.03</td><td></td><td></td><td></td><td></td><td></td><td></td></tr> <tr><td>2.0 T</td><td>121</td><td></td><td></td><td>07.00</td><td>06.01</td><td></td><td></td><td></td><td></td><td></td><td></td></tr> <tr><td>2.0 T4</td><td>147</td><td></td><td></td><td>07.00</td><td>12.03</td><td></td><td></td><td></td><td></td><td></td><td></td></tr> </table>	1.8 (1783)	90			03.99	12.03		24.2419-1728.3	030117			Gz 19,05	1.9 DI	70			03.99	07.00							1.9 DI	75			07.00	12.03							1.9 DI	85			07.00	12.03							1.9 T4	147			05.97	07.00							2.0	100			07.95	12.03							2.0 T	118			10.97	07.00							2.0 T	120			06.01	12.03							2.0 T	121			07.00	06.01							2.0 T4	147			07.00	12.03																																																																																																																																																		
1.8 (1783)	90			03.99	12.03		24.2419-1728.3	030117			Gz 19,05																																																																																																																																																																																																																																																										
1.9 DI	70			03.99	07.00																																																																																																																																																																																																																																																																
1.9 DI	75			07.00	12.03																																																																																																																																																																																																																																																																
1.9 DI	85			07.00	12.03																																																																																																																																																																																																																																																																
1.9 T4	147			05.97	07.00																																																																																																																																																																																																																																																																
2.0	100			07.95	12.03																																																																																																																																																																																																																																																																
2.0 T	118			10.97	07.00																																																																																																																																																																																																																																																																
2.0 T	120			06.01	12.03																																																																																																																																																																																																																																																																
2.0 T	121			07.00	06.01																																																																																																																																																																																																																																																																
2.0 T4	147			07.00	12.03																																																																																																																																																																																																																																																																
VOLVO S40 II (04-12)																																																																																																																																																																																																																																																																					
	<table border="1"> <tr><td>1.6 D</td><td>◀ 80</td><td></td><td></td><td>04.07</td><td>05.12</td><td></td><td>03.7863-4832.4</td><td>300289</td><td></td><td></td><td>10" Wegsensor</td><td>ATE</td></tr> <tr><td>1.6 D</td><td>◀ 81</td><td></td><td></td><td>01.05</td><td>05.12</td><td></td><td>03.0655-0007.2</td><td>370007</td><td></td><td></td><td></td><td>ATE</td></tr> <tr><td>1.6 i</td><td>◀ 74</td><td></td><td></td><td>01.05</td><td>05.12</td><td></td><td></td><td></td><td></td><td></td><td></td><td></td></tr> <tr><td>1.8</td><td>◀ 92</td><td></td><td></td><td>04.04</td><td>05.12</td><td></td><td></td><td></td><td></td><td></td><td></td><td></td></tr> <tr><td>1.8 FlexiFuel</td><td>◀ 92</td><td></td><td></td><td>04.07</td><td>05.12</td><td></td><td></td><td></td><td></td><td></td><td></td><td></td></tr> <tr><td>2.0 D</td><td>◀ 100</td><td></td><td></td><td>01.04</td><td>05.12</td><td></td><td></td><td></td><td></td><td></td><td></td><td></td></tr> <tr><td>2.0 D4</td><td>◀ 96</td><td></td><td></td><td>07.05</td><td>05.12</td><td></td><td></td><td></td><td></td><td></td><td></td><td></td></tr> <tr><td>2.0 FlexiFuel</td><td>◀ 107</td><td></td><td></td><td>10.06</td><td>05.12</td><td></td><td></td><td></td><td></td><td></td><td></td><td></td></tr> <tr><td>2.0 i</td><td>◀ 107</td><td></td><td></td><td>10.06</td><td>05.12</td><td></td><td></td><td></td><td></td><td></td><td></td><td></td></tr> <tr><td>2.4</td><td>◀ 103</td><td></td><td></td><td>01.04</td><td>05.12</td><td></td><td></td><td></td><td></td><td></td><td></td><td></td></tr> <tr><td>2.4</td><td>◀ 125</td><td></td><td></td><td>01.04</td><td>05.12</td><td></td><td></td><td></td><td></td><td></td><td></td><td></td></tr> <tr><td>2.4 4X4</td><td>◀ 125</td><td></td><td></td><td>08.06</td><td>05.12</td><td></td><td></td><td></td><td></td><td></td><td></td><td></td></tr> <tr><td>2.4 D5</td><td>◀ 132</td><td></td><td></td><td>03.06</td><td>05.12</td><td></td><td></td><td></td><td></td><td></td><td></td><td></td></tr> <tr><td>2.5 T5</td><td>◀ 162</td><td></td><td></td><td>01.04</td><td>05.12</td><td></td><td></td><td></td><td></td><td></td><td></td><td></td></tr> <tr><td>2.5 T5</td><td>◀ 169</td><td></td><td></td><td>03.07</td><td>05.12</td><td></td><td></td><td></td><td></td><td></td><td></td><td></td></tr> <tr><td>2.5 T5 AWD</td><td>◀ 162</td><td></td><td></td><td>04.04</td><td>05.12</td><td></td><td></td><td></td><td></td><td></td><td></td><td></td></tr> <tr><td>2.5 T5 AWD</td><td>◀ 169</td><td></td><td></td><td>03.07</td><td>05.12</td><td></td><td></td><td></td><td></td><td></td><td></td><td></td></tr> </table>	1.6 D	◀ 80			04.07	05.12		03.7863-4832.4	300289			10" Wegsensor	ATE	1.6 D	◀ 81			01.05	05.12		03.0655-0007.2	370007				ATE	1.6 i	◀ 74			01.05	05.12								1.8	◀ 92			04.04	05.12								1.8 FlexiFuel	◀ 92			04.07	05.12								2.0 D	◀ 100			01.04	05.12								2.0 D4	◀ 96			07.05	05.12								2.0 FlexiFuel	◀ 107			10.06	05.12								2.0 i	◀ 107			10.06	05.12								2.4	◀ 103			01.04	05.12								2.4	◀ 125			01.04	05.12								2.4 4X4	◀ 125			08.06	05.12								2.4 D5	◀ 132			03.06	05.12								2.5 T5	◀ 162			01.04	05.12								2.5 T5	◀ 169			03.07	05.12								2.5 T5 AWD	◀ 162			04.04	05.12								2.5 T5 AWD	◀ 169			03.07	05.12																																														
1.6 D	◀ 80			04.07	05.12		03.7863-4832.4	300289			10" Wegsensor	ATE																																																																																																																																																																																																																																																									
1.6 D	◀ 81			01.05	05.12		03.0655-0007.2	370007				ATE																																																																																																																																																																																																																																																									
1.6 i	◀ 74			01.05	05.12																																																																																																																																																																																																																																																																
1.8	◀ 92			04.04	05.12																																																																																																																																																																																																																																																																
1.8 FlexiFuel	◀ 92			04.07	05.12																																																																																																																																																																																																																																																																
2.0 D	◀ 100			01.04	05.12																																																																																																																																																																																																																																																																
2.0 D4	◀ 96			07.05	05.12																																																																																																																																																																																																																																																																
2.0 FlexiFuel	◀ 107			10.06	05.12																																																																																																																																																																																																																																																																
2.0 i	◀ 107			10.06	05.12																																																																																																																																																																																																																																																																
2.4	◀ 103			01.04	05.12																																																																																																																																																																																																																																																																
2.4	◀ 125			01.04	05.12																																																																																																																																																																																																																																																																
2.4 4X4	◀ 125			08.06	05.12																																																																																																																																																																																																																																																																
2.4 D5	◀ 132			03.06	05.12																																																																																																																																																																																																																																																																
2.5 T5	◀ 162			01.04	05.12																																																																																																																																																																																																																																																																
2.5 T5	◀ 169			03.07	05.12																																																																																																																																																																																																																																																																
2.5 T5 AWD	◀ 162			04.04	05.12																																																																																																																																																																																																																																																																
2.5 T5 AWD	◀ 169			03.07	05.12																																																																																																																																																																																																																																																																
	<table border="1"> <tr><td>1.6 D</td><td>▶ 80</td><td></td><td></td><td>04.07</td><td>05.12</td><td></td><td>03.0655-0007.2</td><td>370007</td><td></td><td></td><td>Wegsensor</td><td>ATE</td></tr> <tr><td>1.6 D</td><td>▶ 81</td><td></td><td></td><td>01.05</td><td>05.12</td><td></td><td></td><td></td><td></td><td></td><td></td><td></td></tr> <tr><td>1.6 i</td><td>▶ 74</td><td></td><td></td><td>01.05</td><td>05.12</td><td></td><td></td><td></td><td></td><td></td><td></td><td></td></tr> <tr><td>1.8</td><td>▶ 92</td><td></td><td></td><td>04.04</td><td>05.12</td><td></td><td></td><td></td><td></td><td></td><td></td><td></td></tr> <tr><td>1.8 FlexiFuel</td><td>▶ 92</td><td></td><td></td><td>04.07</td><td>05.12</td><td></td><td></td><td></td><td></td><td></td><td></td><td></td></tr> <tr><td>2.0 D</td><td>▶ 100</td><td></td><td></td><td>01.04</td><td>05.12</td><td></td><td></td><td></td><td></td><td></td><td></td><td></td></tr> <tr><td>2.0 D4</td><td>▶ 96</td><td></td><td></td><td>07.05</td><td>05.12</td><td></td><td></td><td></td><td></td><td></td><td></td><td></td></tr> <tr><td>2.0 FlexiFuel</td><td>▶ 107</td><td></td><td></td><td>10.06</td><td>05.12</td><td></td><td></td><td></td><td></td><td></td><td></td><td></td></tr> <tr><td>2.0 i</td><td>▶ 107</td><td></td><td></td><td>10.06</td><td>05.12</td><td></td><td></td><td></td><td></td><td></td><td></td><td></td></tr> <tr><td>2.4</td><td>▶ 103</td><td></td><td></td><td>01.04</td><td>05.12</td><td></td><td></td><td></td><td></td><td></td><td></td><td></td></tr> <tr><td>2.4</td><td>▶ 125</td><td></td><td></td><td>01.04</td><td>05.12</td><td></td><td></td><td></td><td></td><td></td><td></td><td></td></tr> <tr><td>2.4 4X4</td><td>▶ 125</td><td></td><td></td><td>08.06</td><td>05.12</td><td></td><td></td><td></td><td></td><td></td><td></td><td></td></tr> <tr><td>2.4 D5</td><td>▶ 132</td><td></td><td></td><td>03.06</td><td>05.12</td><td></td><td></td><td></td><td></td><td></td><td></td><td></td></tr> <tr><td>2.5 T5</td><td>▶ 162</td><td></td><td></td><td>01.04</td><td>05.12</td><td></td><td></td><td></td><td></td><td></td><td></td><td></td></tr> <tr><td>2.5 T5</td><td>▶ 169</td><td></td><td></td><td>03.07</td><td>05.12</td><td></td><td></td><td></td><td></td><td></td><td></td><td></td></tr> <tr><td>2.5 T5 AWD</td><td>▶ 162</td><td></td><td></td><td>04.04</td><td>05.12</td><td></td><td></td><td></td><td></td><td></td><td></td><td></td></tr> <tr><td>2.5 T5 AWD</td><td>▶ 169</td><td></td><td></td><td>03.07</td><td>05.12</td><td></td><td></td><td></td><td></td><td></td><td></td><td></td></tr> </table>	1.6 D	▶ 80			04.07	05.12		03.0655-0007.2	370007			Wegsensor	ATE	1.6 D	▶ 81			01.05	05.12								1.6 i	▶ 74			01.05	05.12								1.8	▶ 92			04.04	05.12								1.8 FlexiFuel	▶ 92			04.07	05.12								2.0 D	▶ 100			01.04	05.12								2.0 D4	▶ 96			07.05	05.12								2.0 FlexiFuel	▶ 107			10.06	05.12								2.0 i	▶ 107			10.06	05.12								2.4	▶ 103			01.04	05.12								2.4	▶ 125			01.04	05.12								2.4 4X4	▶ 125			08.06	05.12								2.4 D5	▶ 132			03.06	05.12								2.5 T5	▶ 162			01.04	05.12								2.5 T5	▶ 169			03.07	05.12								2.5 T5 AWD	▶ 162			04.04	05.12								2.5 T5 AWD	▶ 169			03.07	05.12																																														
1.6 D	▶ 80			04.07	05.12		03.0655-0007.2	370007			Wegsensor	ATE																																																																																																																																																																																																																																																									
1.6 D	▶ 81			01.05	05.12																																																																																																																																																																																																																																																																
1.6 i	▶ 74			01.05	05.12																																																																																																																																																																																																																																																																
1.8	▶ 92			04.04	05.12																																																																																																																																																																																																																																																																
1.8 FlexiFuel	▶ 92			04.07	05.12																																																																																																																																																																																																																																																																
2.0 D	▶ 100			01.04	05.12																																																																																																																																																																																																																																																																
2.0 D4	▶ 96			07.05	05.12																																																																																																																																																																																																																																																																
2.0 FlexiFuel	▶ 107			10.06	05.12																																																																																																																																																																																																																																																																
2.0 i	▶ 107			10.06	05.12																																																																																																																																																																																																																																																																
2.4	▶ 103			01.04	05.12																																																																																																																																																																																																																																																																
2.4	▶ 125			01.04	05.12																																																																																																																																																																																																																																																																
2.4 4X4	▶ 125			08.06	05.12																																																																																																																																																																																																																																																																
2.4 D5	▶ 132			03.06	05.12																																																																																																																																																																																																																																																																
2.5 T5	▶ 162			01.04	05.12																																																																																																																																																																																																																																																																
2.5 T5	▶ 169			03.07	05.12																																																																																																																																																																																																																																																																
2.5 T5 AWD	▶ 162			04.04	05.12																																																																																																																																																																																																																																																																
2.5 T5 AWD	▶ 169			03.07	05.12																																																																																																																																																																																																																																																																
	<table border="1"> <tr><td>1.6 D</td><td>◀ 80</td><td></td><td></td><td>04.07</td><td>05.12</td><td></td><td>03.2123-3593.3</td><td>010919</td><td></td><td></td><td>Thz 23,81</td><td>ATE</td></tr> <tr><td>1.6 D</td><td>◀ 81</td><td></td><td></td><td>01.05</td><td>05.12</td><td></td><td></td><td></td><td></td><td></td><td></td><td></td></tr> <tr><td>1.6 i</td><td>◀ 74</td><td></td><td></td><td>01.05</td><td>05.12</td><td></td><td></td><td></td><td></td><td></td><td></td><td></td></tr> <tr><td>1.8</td><td>◀ 92</td><td></td><td></td><td>04.04</td><td>05.12</td><td></td><td></td><td></td><td></td><td></td><td></td><td></td></tr> <tr><td>1.8 FlexiFuel</td><td>◀ 92</td><td></td><td></td><td>04.07</td><td>05.12</td><td></td><td></td><td></td><td></td><td></td><td></td><td></td></tr> <tr><td>2.0 D</td><td>◀ 100</td><td></td><td></td><td>01.04</td><td>05.12</td><td></td><td></td><td></td><td></td><td></td><td></td><td></td></tr> <tr><td>2.0 D4</td><td>◀ 96</td><td></td><td></td><td>07.05</td><td>05.12</td><td></td><td></td><td></td><td></td><td></td><td></td><td></td></tr> <tr><td>2.0 FlexiFuel</td><td>◀ 107</td><td></td><td></td><td>10.06</td><td>05.12</td><td></td><td></td><td></td><td></td><td></td><td></td><td></td></tr> <tr><td>2.0 i</td><td>◀ 107</td><td></td><td></td><td>10.06</td><td>05.12</td><td></td><td></td><td></td><td></td><td></td><td></td><td></td></tr> <tr><td>2.4</td><td>◀ 103</td><td></td><td></td><td>01.04</td><td>05.12</td><td></td><td></td><td></td><td></td><td></td><td></td><td></td></tr> <tr><td>2.4</td><td>◀ 125</td><td></td><td></td><td>01.04</td><td>05.12</td><td></td><td></td><td></td><td></td><td></td><td></td><td></td></tr> <tr><td>2.4 4X4</td><td>◀ 125</td><td></td><td></td><td>08.06</td><td>05.12</td><td></td><td></td><td></td><td></td><td></td><td></td><td></td></tr> <tr><td>2.4 D5</td><td>◀ 132</td><td></td><td></td><td>03.06</td><td>05.12</td><td></td><td></td><td></td><td></td><td></td><td></td><td></td></tr> <tr><td>2.5 T5</td><td>◀ 162</td><td></td><td></td><td>01.04</td><td>05.12</td><td></td><td></td><td></td><td></td><td></td><td></td><td></td></tr> <tr><td>2.5 T5</td><td>◀ 169</td><td></td><td></td><td>03.07</td><td>05.12</td><td></td><td></td><td></td><td></td><td></td><td></td><td></td></tr> <tr><td>2.5 T5 AWD</td><td>◀ 162</td><td></td><td></td><td>04.04</td><td>05.12</td><td></td><td></td><td></td><td></td><td></td><td></td><td></td></tr> <tr><td>2.5 T5 AWD</td><td>◀ 169</td><td></td><td></td><td>03.07</td><td>05.12</td><td></td><td></td><td></td><td></td><td></td><td></td><td></td></tr> </table>	1.6 D	◀ 80			04.07	05.12		03.2123-3593.3	010919			Thz 23,81	ATE	1.6 D	◀ 81			01.05	05.12								1.6 i	◀ 74			01.05	05.12								1.8	◀ 92			04.04	05.12								1.8 FlexiFuel	◀ 92			04.07	05.12								2.0 D	◀ 100			01.04	05.12								2.0 D4	◀ 96			07.05	05.12								2.0 FlexiFuel	◀ 107			10.06	05.12								2.0 i	◀ 107			10.06	05.12								2.4	◀ 103			01.04	05.12								2.4	◀ 125			01.04	05.12								2.4 4X4	◀ 125			08.06	05.12								2.4 D5	◀ 132			03.06	05.12								2.5 T5	◀ 162			01.04	05.12								2.5 T5	◀ 169			03.07	05.12								2.5 T5 AWD	◀ 162			04.04	05.12								2.5 T5 AWD	◀ 169			03.07	05.12																																														
1.6 D	◀ 80			04.07	05.12		03.2123-3593.3	010919			Thz 23,81	ATE																																																																																																																																																																																																																																																									
1.6 D	◀ 81			01.05	05.12																																																																																																																																																																																																																																																																
1.6 i	◀ 74			01.05	05.12																																																																																																																																																																																																																																																																
1.8	◀ 92			04.04	05.12																																																																																																																																																																																																																																																																
1.8 FlexiFuel	◀ 92			04.07	05.12																																																																																																																																																																																																																																																																
2.0 D	◀ 100			01.04	05.12																																																																																																																																																																																																																																																																
2.0 D4	◀ 96			07.05	05.12																																																																																																																																																																																																																																																																
2.0 FlexiFuel	◀ 107			10.06	05.12																																																																																																																																																																																																																																																																
2.0 i	◀ 107			10.06	05.12																																																																																																																																																																																																																																																																
2.4	◀ 103			01.04	05.12																																																																																																																																																																																																																																																																
2.4	◀ 125			01.04	05.12																																																																																																																																																																																																																																																																
2.4 4X4	◀ 125			08.06	05.12																																																																																																																																																																																																																																																																
2.4 D5	◀ 132			03.06	05.12																																																																																																																																																																																																																																																																
2.5 T5	◀ 162			01.04	05.12																																																																																																																																																																																																																																																																
2.5 T5	◀ 169			03.07	05.12																																																																																																																																																																																																																																																																
2.5 T5 AWD	◀ 162			04.04	05.12																																																																																																																																																																																																																																																																
2.5 T5 AWD	◀ 169			03.07	05.12																																																																																																																																																																																																																																																																
	<table border="1"> <tr><td>1.6 D</td><td>80</td><td></td><td></td><td>04.07</td><td>05.12</td><td></td><td>24.3571-9813.5</td><td>240557</td><td><input type="checkbox"/></td><td>- 17" Rad ¹⁾</td><td>D=57, - Halter</td><td>ATE</td></tr> <tr><td>1.6 D</td><td>81</td><td></td><td></td><td>01.05</td><td>05.12</td><td></td><td>24.3571-9814.5</td><td>240558</td><td><input type="checkbox"/></td><td>- 17" Rad ¹⁾</td><td>D=57, - Halter</td><td>ATE</td></tr> <tr><td>1.6 D2</td><td>84</td><td></td><td></td><td>10.10</td><td>05.12</td><td></td><td>11.0230-0818.1</td><td>260135</td><td></td><td>- 17" Rad ¹⁾</td><td>Halter</td><td>ATE</td></tr> <tr><td>1.6 i</td><td>74</td><td></td><td></td><td>01.05</td><td>05.12</td><td></td><td>11.8116-0356.1</td><td>390586</td><td></td><td></td><td>Haltefeder</td><td>ATE</td></tr> <tr><td>1.8</td><td>92</td><td></td><td></td><td>04.04</td><td>05.12</td><td></td><td>11.0101-5407.2</td><td>260011</td><td></td><td></td><td>Hülsensatz</td><td>ATE</td></tr> <tr><td>1.8 FlexiFuel</td><td>92</td><td></td><td></td><td>04.07</td><td>05.12</td><td></td><td>11.8171-0008.1</td><td>990049</td><td></td><td></td><td>Führungsbolzen</td><td>ATE</td></tr> <tr><td>2.0 D</td><td>100</td><td></td><td></td><td>01.04</td><td>05.12</td><td></td><td></td><td></td><td></td><td></td><td></td><td></td></tr> <tr><td>2.0 D3</td><td>110</td><td></td><td></td><td>10.10</td><td>05.12</td><td></td><td></td><td></td><td></td><td></td><td></td><td></td></tr> <tr><td>2.0 D4</td><td>96</td><td></td><td></td><td>07.05</td><td>05.12</td><td></td><td></td><td></td><td></td><td></td><td></td><td></td></tr> <tr><td>2.0 D4</td><td>130</td><td></td><td></td><td>10.10</td><td>05.12</td><td></td><td></td><td></td><td></td><td></td><td></td><td></td></tr> <tr><td>2.0 FlexiFuel</td><td>107</td><td></td><td></td><td>10.06</td><td>05.12</td><td></td><td></td><td></td><td></td><td></td><td></td><td></td></tr> <tr><td>2.0 i</td><td>107</td><td></td><td></td><td>10.06</td><td>05.12</td><td></td><td></td><td></td><td></td><td></td><td></td><td></td></tr> <tr><td>2.4</td><td>103</td><td></td><td></td><td>01.04</td><td>05.12</td><td></td><td></td><td></td><td></td><td></td><td></td><td></td></tr> <tr><td>2.4</td><td>125</td><td></td><td></td><td>01.04</td><td>05.12</td><td></td><td></td><td></td><td></td><td></td><td></td><td></td></tr> <tr><td>2.4 4X4</td><td>125</td><td></td><td></td><td>08.06</td><td>05.12</td><td></td><td></td><td></td><td></td><td></td><td></td><td></td></tr> <tr><td>2.4 D5</td><td>132</td><td></td><td></td><td>03.06</td><td>05.12</td><td></td><td></td><td></td><td></td><td></td><td></td><td></td></tr> <tr><td>2.5 T5</td><td>162</td><td></td><td></td><td>01.04</td><td>05.12</td><td></td><td></td><td></td><td></td><td></td><td></td><td></td></tr> <tr><td>2.5 T5</td><td>169</td><td></td><td></td><td>03.07</td><td>05.12</td><td></td><td></td><td></td><td></td><td></td><td></td><td></td></tr> <tr><td>2.5 T5 AWD</td><td>162</td><td></td><td></td><td>04.04</td><td>05.12</td><td></td><td></td><td></td><td></td><td></td><td></td><td></td></tr> <tr><td>2.5 T5 AWD</td><td>169</td><td></td><td></td><td>03.07</td><td>05.12</td><td></td><td></td><td></td><td></td><td></td><td></td><td></td></tr> </table>	1.6 D	80			04.07	05.12		24.3571-9813.5	240557	<input type="checkbox"/>	- 17" Rad ¹⁾	D=57, - Halter	ATE	1.6 D	81			01.05	05.12		24.3571-9814.5	240558	<input type="checkbox"/>	- 17" Rad ¹⁾	D=57, - Halter	ATE	1.6 D2	84			10.10	05.12		11.0230-0818.1	260135		- 17" Rad ¹⁾	Halter	ATE	1.6 i	74			01.05	05.12		11.8116-0356.1	390586			Haltefeder	ATE	1.8	92			04.04	05.12		11.0101-5407.2	260011			Hülsensatz	ATE	1.8 FlexiFuel	92			04.07	05.12		11.8171-0008.1	990049			Führungsbolzen	ATE	2.0 D	100			01.04	05.12								2.0 D3	110			10.10	05.12								2.0 D4	96			07.05	05.12								2.0 D4	130			10.10	05.12								2.0 FlexiFuel	107			10.06	05.12								2.0 i	107			10.06	05.12								2.4	103			01.04	05.12								2.4	125			01.04	05.12								2.4 4X4	125			08.06	05.12								2.4 D5	132			03.06	05.12								2.5 T5	162			01.04	05.12								2.5 T5	169			03.07	05.12								2.5 T5 AWD	162			04.04	05.12								2.5 T5 AWD	169			03.07	05.12							
1.6 D	80			04.07	05.12		24.3571-9813.5	240557	<input type="checkbox"/>	- 17" Rad ¹⁾	D=57, - Halter	ATE																																																																																																																																																																																																																																																									
1.6 D	81			01.05	05.12		24.3571-9814.5	240558	<input type="checkbox"/>	- 17" Rad ¹⁾	D=57, - Halter	ATE																																																																																																																																																																																																																																																									
1.6 D2	84			10.10	05.12		11.0230-0818.1	260135		- 17" Rad ¹⁾	Halter	ATE																																																																																																																																																																																																																																																									
1.6 i	74			01.05	05.12		11.8116-0356.1	390586			Haltefeder	ATE																																																																																																																																																																																																																																																									
1.8	92			04.04	05.12		11.0101-5407.2	260011			Hülsensatz	ATE																																																																																																																																																																																																																																																									
1.8 FlexiFuel	92			04.07	05.12		11.8171-0008.1	990049			Führungsbolzen	ATE																																																																																																																																																																																																																																																									
2.0 D	100			01.04	05.12																																																																																																																																																																																																																																																																
2.0 D3	110			10.10	05.12																																																																																																																																																																																																																																																																
2.0 D4	96			07.05	05.12																																																																																																																																																																																																																																																																
2.0 D4	130			10.10	05.12																																																																																																																																																																																																																																																																
2.0 FlexiFuel	107			10.06	05.12																																																																																																																																																																																																																																																																
2.0 i	107			10.06	05.12																																																																																																																																																																																																																																																																
2.4	103			01.04	05.12																																																																																																																																																																																																																																																																
2.4	125			01.04	05.12																																																																																																																																																																																																																																																																
2.4 4X4	125			08.06	05.12																																																																																																																																																																																																																																																																
2.4 D5	132			03.06	05.12																																																																																																																																																																																																																																																																
2.5 T5	162			01.04	05.12																																																																																																																																																																																																																																																																
2.5 T5	169			03.07	05.12																																																																																																																																																																																																																																																																
2.5 T5 AWD	162			04.04	05.12																																																																																																																																																																																																																																																																
2.5 T5 AWD	169			03.07	05.12																																																																																																																																																																																																																																																																

¹⁾ - 17" wheel / - ruota 17" / - roue 17" / - rueda 17"

																		
VOLVO S40 II (04-12)																		
	1.6 D	80		04.07	05.12			11.9576-9975.2	220649			+	17" Rad ¹⁾					
	1.6 D	81		01.05	05.12			11.9576-9976.2	220650			+	17" Rad ¹⁾					
	1.6 D2	84		10.10	05.12			11.8116-0345.2	390596	2		+	17" Rad ¹⁾					
	1.6 i	74		01.05	05.12			11.0101-5407.2	260011									
	1.8	92		04.04	05.12			11.8171-0008.1	990049									
	1.8 FlexiFuel	92		04.07	05.12													
	2.0 D	100		01.04	05.12													
	2.0 D3	110		10.10	05.12													
	2.0 D4	96		07.05	05.12													
	2.0 D4	130		10.10	05.12													
	2.0 FlexiFuel	107		10.06	05.12													
	2.0 i	107		10.06	05.12													
	2.4	103		01.04	05.12													
	2.4	125		01.04	05.12													
	2.4 4X4	125		08.06	05.12													
	2.4 D5	132		03.06	05.12													
	2.5 T5	162		01.04	05.12													
	2.5 T5	169		03.07	05.12													
	2.5 T5 AWD	162		04.04	05.12													
	2.5 T5 AWD	169		03.07	05.12													
	1.6 D	80		04.07	05.12			83.7716-0398.3	330987	2		-	17" Rad ²⁾					
	1.6 D	81		01.05	05.12			83.7788-0414.3	330988	2		+	17" Rad ¹⁾					
	1.6 D2	84		10.10	05.12													
	1.6 i	74		01.05	05.12													
	1.8	92		04.04	05.12													
	1.8 FlexiFuel	92		04.07	05.12													
	2.0 D	100		01.04	05.12													
	2.0 D3	110		10.10	05.12													
	2.0 D4	96		07.05	05.12													
	2.0 D4	130		10.10	05.12													
	2.0 FlexiFuel	107		10.06	05.12													
	2.0 i	107		10.06	05.12													
	2.4	103		01.04	05.12													
	2.4	125		01.04	05.12													
	2.4 4X4	125		08.06	05.12													
	2.4 D5	132		03.06	05.12													
	2.5 T5	162		01.04	05.12													
	2.5 T5	169		03.07	05.12													
	2.5 T5 AWD	162		04.04	05.12			83.7788-0414.3	330988	2		-	17" Rad ²⁾					
	2.5 T5 AWD	169		03.07	05.12			83.7788-0425.3	331232	2		+	17" Rad ¹⁾					
	1.6 D	80	462752	04.07				11.9387-7015.2	220627									
	1.6 D	81	462752	01.05				11.9387-7016.2	220628									
	1.6 D2	84	462752	10.10				11.0230-0698.2	260091									
	1.6 i	74	462752	01.05				11.0101-5407.2	260011									
	1.8	92	462752	04.04				11.8171-0008.1	990049									
	1.8 FlexiFuel	92	462752	04.07				11.8116-0340.1	390595	2								
	2.0 D	100	462752	01.04														
	2.0 D3	110	462752	10.10														
	2.0 D4	96	462752	07.05														
	2.0 D4	130	462752	10.10														
	2.0 FlexiFuel	107	462752	10.06														
	2.0 i	107	462752	10.06														
	2.4	103	462752	01.04														
	2.4	125	462752	01.04														
	2.4 4X4	125	462752	08.06														
	2.4 D5	132	462752	03.06														
	2.5 T5	162	462752	01.04														
	2.5 T5	169	462752	03.07														
	2.5 T5 AWD	162	462752	04.04														
	2.5 T5 AWD	169	462752	03.07														
	1.6 D	80	462753		05.12			11.9387-7083.2	220959									
	1.6 D	81	462753		05.12			11.9387-7084.2	220960									
	1.6 D2	84	462753		05.12			11.0230-0698.2	260091									
	1.6 i	74	462753		05.12			11.0101-5407.2	260011									
	1.8	92	462753		05.12			11.8171-0008.1	990049									
	1.8 FlexiFuel	92	462753		05.12			11.8116-0340.1	390595	2								
	2.0 D	100	462753		05.12													
	2.0 D3	110	462753		05.12													
	2.0 D4	96	462753		05.12													
	2.0 D4	130	462753		05.12													
	2.0 FlexiFuel	107	462753		05.12													
	2.0 i	107	462753		05.12													
	2.4	103	462753		05.12													
	2.4	125	462753		05.12													
	2.4 4X4	125	462753		05.12													
	2.4 D5	132	462753		05.12													
	2.5 T5	162	462753		05.12													
	2.5 T5	169	462753		05.12													
	2.5 T5 AWD	162	462753		05.12													
	2.5 T5 AWD	169	462753		05.12													
	1.6 D	80		04.07	05.12			83.7788-0383.3	330972	2								
	1.6 D	81		01.05	05.12													
	1.6 D2	84		10.10	05.12													
	1.6 i	74		01.05	05.12													
	1.8	92		04.04	05.12													
	1.8 FlexiFuel	92		04.07	05.12													
	2.0 D	100		01.04	05.12													

¹⁾ + 17" wheel / + ruota 17" / + roue 17" / + rueda 17"

²⁾ - 17" wheel / - ruota 17" / - roue 17" / - rueda 17"



VOLVO S60 I (00-09)

	2.4 Bi-Fuel	◀103	9499	06.02		03.2125-7708.3	010739	+ DSTC	THz 25,40	ATE
	2.4 D	◀ 96	9499	12.01						
	2.4 D5	◀120	9499	07.01						
	2.4 T	◀147	9499	11.00						
	2.4 T AWD	◀147	9499	11.01						
	2.4 T5	◀191	9499	04.04						
	2.5 T	◀154	9499	02.04						
	2.5 T AWD	◀154	9499	04.04						
	R 2.5 T	◀220	9499	04.04						
	R 2.5 T AWD	◀221	9499	03.03						
	2.0 T	▶132 9500		01.09		03.2125-7713.3	010819	+ DSTC	THz 25,40	ATE
	2.3 T5	▶184 9500		04.04						
	2.3 T5	▶195 9500		09.02						
	2.4	▶103 9500		01.09						
	2.4	▶125 9500		01.09						
	2.4 Bi-Fuel	▶103 9500		01.09						
	2.4 D	▶ 93	09.05	01.09						
	2.4 D	▶ 96 9500		01.09						
	2.4 D5	▶120 9500		01.09						
	2.4 D5	▶136	09.05	01.09						
	2.4 T	▶147 9500		01.09						
	2.4 T AWD	▶147 9500		01.09						
	2.4 T5	▶191 9500		01.09						
	2.5 AWD	▶224	09.03	04.10						
	2.5 T	▶154 9500		01.09						
	2.5 T AWD	▶154 9500		01.09						
	R 2.5 T	▶220 9500		05.07						
	R 2.5 T AWD	▶221 9500		01.09						
	2.0 T	▶132 8536		01.09		03.2125-7638.3	010738	- DSTC	THz 25,40	ATE
	2.3 T5	▶184 8536		04.04						
	2.3 T5	▶195 8536		09.02						
	2.4	▶103 8536		01.09						
	2.4	▶125 8536		01.09						
	2.4 Bi-Fuel	▶103	06.02	01.09						
	2.4 D	▶ 93	09.05	01.09						
	2.4 D	▶ 96 8536		01.09						
	2.4 D5	▶120 8536		01.09						
	2.4 D5	▶136	09.05	01.09						
	2.4 T	▶147 8536		01.09						
	2.4 T AWD	▶147 8536		01.09						
	2.4 T5	▶191	04.04	01.09						
	2.5 T	▶154	02.04	01.09						
	2.5 T AWD	▶154	04.04	01.09						
	R 2.5 T	▶220 8536		05.07						
	R 2.5 T AWD	▶221	03.03	01.09						
	2.0 T	▶132	11551	09.01		03.2125-7637.3	010707	+ DSTC	THz 25,40	ATE
	2.3 T5	▶184	11551	08.00						
	2.3 T5	▶195	11551	07.00						
	2.4	▶103	11551	11.00						
	2.4	▶125	11551	11.00						
	2.4 Bi-Fuel	▶103	11551	06.02						
	2.4 D	▶ 96	11551	12.01						
	2.4 D5	▶120	11551	07.01						
	2.4 T	▶147	11551	11.00						
	2.4 T AWD	▶147	11551	11.01						
	2.4 T5	▶191	11551	04.04						
	2.5 T	▶154	11551	02.04						
	2.5 T AWD	▶154	11551	04.04						
	R 2.5 T	▶220	11551	04.04						
	R 2.5 T AWD	▶221	11551	03.03						
	2.0 T	▶132 11552		01.09		03.2125-7638.3	010738	+ DSTC	THz 25,40	ATE
	2.3 T5	▶184 11552		04.04						
	2.3 T5	▶195 11552		09.02						
	2.4	▶103 11552		01.09						
	2.4	▶125 11552		01.09						
	2.4 Bi-Fuel	▶103 11552		01.09						
	2.4 D	▶ 93	09.05	01.09						
	2.4 D	▶ 96 11552		01.09						
	2.4 D5	▶120 11552		01.09						
	2.4 D5	▶136	09.05	01.09						
	2.4 T	▶147 11552		01.09						
	2.4 T AWD	▶147 11552		01.09						
	2.4 T5	▶191 11552		01.09						
	2.5 AWD	▶224	09.03	04.10						
	2.5 T	▶154 11552		01.09						
	2.5 T AWD	▶154 11552		01.09						
	R 2.5 T	▶220 11552		05.07						
	R 2.5 T AWD	▶221 11552		01.09						
	2.0 T	132		09.01	01.09	24.3601-9829.5	240507	■ + 15"/16" Rad ¹⁾	D=60, - Halter	ATE
	2.3 T5	184		08.00	04.04	24.3601-9830.5	240508	■ + 15"/16" Rad ¹⁾	D=60, - Halter	ATE
	2.3 T5	195		07.00	09.02	11.9571-9863.2	220513	■ + 17" Rad ²⁾	D=57, - Halter	ATE
	2.4	103		11.00	01.09	11.9571-9864.2	220514	■ + 17" Rad ²⁾	D=57, - Halter	ATE
	2.4	125		11.00	01.09	11.8116-0366.2	390587	■ + 17" Rad ²⁾	Haltefeder	ATE
	2.4 Bi-Fuel	103		06.02	01.09	11.8171-0067.1	250153		Führungsbolzen	ATE
	2.4 D	93		09.05	01.09	11.0101-5407.2	260011		Hülzensatz	ATE
	2.4 D	96		12.01	01.09	11.8171-0008.1	990049		Führungsbolzen	ATE
	2.4 D5	120		07.01	01.09					ATE

¹⁾ + 15"/16" wheel / + ruota 15"/16" / + roue 15"/16" / + rueda 15"/16"

²⁾ + 17" wheel / + ruota 17" / + roue 17" / + rueda 17"

VOLVO S60 I (00-09)

	2.4 D5	136		09.05	01.09	24.3601-9829.5	240507	2	<input type="checkbox"/> + 15"/16" Rad ¹⁾ <input type="checkbox"/> + 15"/16" Rad ¹⁾ <input type="checkbox"/> + 17" Rad ²⁾ <input type="checkbox"/> + 17" Rad ²⁾ <input type="checkbox"/> + 17" Rad ²⁾	D=60, - Halter D=60, - Halter D=57, - Halter D=57, - Halter Haltefeder Führungsbolzen Hülsensatz Führungsbolzen	ATE ATE ATE ATE ATE ATE ATE
	2.4 T	147		11.00	01.09	24.3601-9830.5	240508				
	2.4 T AWD	147		11.01	01.09	11.9571-9863.2	220513				
	2.4 T5	191		04.04	01.09	11.9571-9864.2	220514				
	2.5 T	154		02.04	01.09	11.8116-0366.2	390587				
	2.5 T AWD	154		04.04	01.09	11.8171-0067.1	250153				
						11.0101-5407.2	260011				
					11.8171-0008.1	990049					
	2.0 T	132		09.01	01.09	83.6113-0321.3	330621	2	- 17" Rad ³⁾	L=320	
	2.3 T5	184		08.00	04.04						
	2.3 T5	195		07.00	09.02						
	2.4	103		11.00	01.09						
	2.4	125		11.00	01.09						
	2.4 Bi-Fuel	103		06.02	01.09						
	2.4 D	93		09.05	01.09						
	2.4 D	96		12.01	01.09						
	2.4 D5	120		07.01	01.09						
	2.4 D5	136		09.05	01.09						
	2.4 T	147		11.00	01.09						
	2.4 T AWD	147		11.01	01.09						
	2.4 T5	191		04.04	01.09						
	2.5 AWD	224		09.03	04.10						
	2.5 T	154		02.04	01.09						
	2.5 T AWD	154		04.04	01.09						
		2.0 T	132		09.01						
2.3 T5		184		08.00	04.04						
2.3 T5		195		07.00	09.02						
2.4		103		11.00	01.09						
2.4		125		11.00	01.09						
2.4 Bi-Fuel		103		06.02	01.09						
2.4 D		93		09.05	01.09						
2.4 D		96		12.01	01.09						
2.4 D5		120		07.01	01.09						
2.4 D5		136		09.05	01.09						
2.4 T		147		11.00	01.09						
2.4 T AWD		147		11.01	01.09						
2.4 T5		191		04.04	01.09						
2.5 AWD		224		09.03	04.10						
2.5 T		154		02.04	01.09						
2.5 T AWD		154		04.04	01.09						
		2.0 T	132		09.01	01.09	11.9421-9979.2	220497	2	<input type="checkbox"/> <input type="checkbox"/> <input type="checkbox"/> <input type="checkbox"/>	D=42, - Halter D=42, - Halter D=42, - Halter D=42, - Halter Hülsensatz Führungsbolzen Haltefeder
	2.3 T5	184		08.00	04.04						
	2.3 T5	195		07.00	09.02						
	2.4	103		11.00	01.09						
	2.4	125		11.00	01.09						
	2.4 Bi-Fuel	103		06.02	01.09						
	2.4 D	93		09.05	01.09						
	2.4 D	96		12.01	01.09						
	2.4 D5	120		07.01	01.09						
	2.4 D5	136		09.05	01.09						
	2.4 T	147		11.00	01.09						
	2.4 T AWD	147		11.01	01.09						
	2.4 T5	191		04.04	01.09						
	2.5 AWD	224		09.03	04.10						
	2.5 T	154		02.04	01.09						
	2.5 T AWD	154		04.04	01.09						
		2.0 T	132		09.01	01.09					
2.3 T5		184		08.00	04.04						
2.3 T5		195		07.00	09.02						
2.4		103		11.00	01.09						
2.4		125		11.00	01.09						
2.4 Bi-Fuel		103		06.02	01.09						
2.4 D		93		09.05	01.09						
2.4 D		96		12.01	01.09						
2.4 D5		120		07.01	01.09						
2.4 D5		136		09.05	01.09						
2.4 T		147		11.00	01.09						
2.4 T AWD		147		11.01	01.09						
2.4 T5		191		04.04	01.09						
2.5 AWD		224		09.03	04.10						
2.5 T		154		02.04	01.09						
2.5 T AWD		154		04.04	01.09						
		2.0 T	132		09.01	12.04	24.3727-1311.2	581311	2	↓	L=1926
	2.3 T5	184		08.00	04.04						
	2.3 T5	195		07.00	09.02						
	2.4	103		11.00	12.04						
	2.4	125		11.00	12.04						
	2.4 D	96		12.01	12.04						
	2.4 D5	120		07.01	12.04						
2.4 T	147		11.00	12.04							
2.4 T5	191		04.04	12.04							
2.5 T	154		02.04	12.04							

¹⁾ + 15"/16" wheel / + ruota 15"/16" / + roue 15"/16" / + rueda 15"/16"

²⁾ + 17" wheel / + ruota 17" / + roue 17" / + rueda 17"

³⁾ - 17" wheel / - ruota 17" / - roue 17" / - rueda 17"



VOLVO S60 II (10-)

	1.5 T2	90	10.15		03.0655-0007.2	370007		+ Kollisionswarnsystem ¹⁾	Wegsensor	ATE
	1.6 D DRIVE	84	01.11							
	2.0 T	149	04.10							
	2.0 T4	140	05.15							
	2.5 T5 AWD	186	09.12							
	D2	84	04.13							
	D3	100	05.12							
	D3	120	04.10							
	D4	120	05.12							
	D5	151	04.10							
	D5	158	06.11							
	D5	169	04.14							
	D5 AWD	151	04.10							
	D5 AWD	158	06.11							
	D5 AWD	169	04.14							
	T3	110	04.10							
	T3	112	03.15							
	T4	132	04.10							
	T4F	132	04.11							
	T5	176	04.10							
T5	180	09.13								
T6	225	09.13								
T6 AWD	224	04.10								
T6 AWD	225	09.15								
T6 AWD	242	04.14								
	2.0 D5	165	03.15		03.7755-9703.4	300239		- Kollisionswarnsystem ²⁾	9/8" Tandem	ATE
	2.0 T	132	12.13		03.0655-0007.2	370007		+ Kollisionswarnsystem ¹⁾	Wegsensor	ATE
	D2	88	03.15							
	D3	110	03.15							
	D4	133	09.13							
	D4	140	03.15							
	D4 AWD	140	03.15							
	1.5 T2	90	10.15	+ Bremsscheibendurchm. 300 mm ³⁾	11.9601-9711.2	220873			D=60, - Halter	ATE
	1.6 D Drive	84	01.11	+ Bremsscheibendurchm. 300 mm ³⁾	11.9601-9712.2	220874			D=60, - Halter	ATE
	2.0 D5	165	03.15	+ Bremsscheibendurchm. 300 mm ³⁾	11.0230-0934.1	260128			Halter	ATE
	2.0 T	132	12.13	+ Bremsscheibendurchm. 300 mm ³⁾	11.8116-0206.1	390593	2		Haltefeder	ATE
	2.0 T	149	04.10	+ Bremsscheibendurchm. 300 mm ³⁾	11.0101-5407.2	260011			Hülzensatz	ATE
	2.0 T4	140	05.15	+ Bremsscheibendurchm. 300 mm ³⁾	11.8171-0008.1	990049			Führungsbolzen	ATE
	2.5 T5 AWD	186	09.12	+ Bremsscheibendurchm. 300 mm ³⁾	11.0441-6008.2	250038			Dichtungssatz	ATE
	D2	84	04.13	+ Bremsscheibendurchm. 300 mm ³⁾						
	D2	88	03.15	+ Bremsscheibendurchm. 300 mm ³⁾						
	D3	100	05.12	+ Bremsscheibendurchm. 300 mm ³⁾						
	D3	110	03.15	+ Bremsscheibendurchm. 300 mm ³⁾						
	D3	120	04.10	+ Bremsscheibendurchm. 300 mm ³⁾						
	D4	120	05.12	+ Bremsscheibendurchm. 300 mm ³⁾						
	D4	133	09.13	+ Bremsscheibendurchm. 300 mm ³⁾						
	D4	140	03.15	+ Bremsscheibendurchm. 300 mm ³⁾						
	D4 AWD	140	03.15	+ Bremsscheibendurchm. 300 mm ³⁾						
	D5	151	04.10	+ Bremsscheibendurchm. 300 mm ³⁾						
	D5	158	06.11	+ Bremsscheibendurchm. 300 mm ³⁾						
	D5	169	04.14	+ Bremsscheibendurchm. 300 mm ³⁾						
	D5 AWD	151	04.10	+ Bremsscheibendurchm. 300 mm ³⁾						
D5 AWD	158	06.11	+ Bremsscheibendurchm. 300 mm ³⁾							
D5 AWD	169	04.14	+ Bremsscheibendurchm. 300 mm ³⁾							
T3	110	04.10	+ Bremsscheibendurchm. 300 mm ³⁾							
T3	112	03.15	+ Bremsscheibendurchm. 300 mm ³⁾							
T4	132	04.10	+ Bremsscheibendurchm. 300 mm ³⁾							
T4F	132	04.11	+ Bremsscheibendurchm. 300 mm ³⁾							
T5	176	04.10	+ Bremsscheibendurchm. 300 mm ³⁾							
T5	180	09.13	+ Bremsscheibendurchm. 300 mm ³⁾							
T6	225	09.13	+ Bremsscheibendurchm. 300 mm ³⁾							
T6 AWD	224	04.10	+ Bremsscheibendurchm. 300 mm ³⁾							
T6 AWD	225	09.15	+ Bremsscheibendurchm. 300 mm ³⁾							
T6 AWD	242	04.14	+ Bremsscheibendurchm. 300 mm ³⁾							
	1.5 T2	90	10.15	+ Bremsscheibendurchm. 316mm ⁴⁾	11.9606-9949.2	220879			D=60, - Halter	ATE
	1.6 D Drive	84	01.11	+ Bremsscheibendurchm. 316mm ⁴⁾	11.9606-9950.2	220880			D=60, - Halter	ATE
	2.0 D5	165	03.15	+ Bremsscheibendurchm. 316mm ⁴⁾	11.8116-0388.2	390588			Haltefeder	ATE
	2.0 T	132	12.13	+ Bremsscheibendurchm. 316mm ⁴⁾	11.0441-6008.2	250038	2		Dichtungssatz	ATE
	2.0 T	149	04.10	+ Bremsscheibendurchm. 316mm ⁴⁾	11.0101-5704.2	260095			Hülzensatz	ATE
	2.0 T4	140	05.15	+ Bremsscheibendurchm. 316mm ⁴⁾						
	2.5 T5 AWD	186	09.12	+ Bremsscheibendurchm. 316mm ⁴⁾						
	D2	84	04.13	+ Bremsscheibendurchm. 316mm ⁴⁾						
	D2	88	03.15	+ Bremsscheibendurchm. 316mm ⁴⁾						
	D3	100	05.12	+ Bremsscheibendurchm. 316mm ⁴⁾						
	D3	110	03.15	+ Bremsscheibendurchm. 316mm ⁴⁾						
	D3	120	04.10	+ Bremsscheibendurchm. 316mm ⁴⁾						
	D4	120	05.12	+ Bremsscheibendurchm. 316mm ⁴⁾						
	D4	133	09.13	+ Bremsscheibendurchm. 316mm ⁴⁾						
	D4	140	03.15	+ Bremsscheibendurchm. 316mm ⁴⁾						
	D4 AWD	140	03.15	+ Bremsscheibendurchm. 316mm ⁴⁾						
	D5	151	04.10	+ Bremsscheibendurchm. 316mm ⁴⁾						
	D5	158	06.11	+ Bremsscheibendurchm. 316mm ⁴⁾						
D5	169	04.14	+ Bremsscheibendurchm. 316mm ⁴⁾							
D5 AWD	151	04.10	+ Bremsscheibendurchm. 316mm ⁴⁾							
D5 AWD	158	06.11	+ Bremsscheibendurchm. 316mm ⁴⁾							
D5 AWD	169	04.14	+ Bremsscheibendurchm. 316mm ⁴⁾							
T3	110	04.10	+ Bremsscheibendurchm. 316mm ⁴⁾							

¹⁾ + collision warning system / + sistema anti-collosione / + système anticollision / + sistema anticollision

²⁾ - collision warning system / - sistema anti-collosione / - système anticollision / - sistema anticollision

³⁾ + brake disc diameter 300mm / + diametro dischi freno 300mm / + diamètre disques frein 300mm / + diámetro disco freno 300mm

⁴⁾ + brake disc diameter 316mm / + diametro dischi freno 316mm / + diamètre disques frein 316mm / + diámetro disco freno 316mm

VOLVO S60 II (10-)

	T3	112	03.15	+ Bremsscheibendurchm. 316mm ¹⁾	11.9606-9949.2	220879	2		D=60, - Halter D=60, - Halter Haltefeder Dichtungssatz Hülsensatz	ATE ATE ATE ATE ATE
	T4	132	04.10	+ Bremsscheibendurchm. 316mm ¹⁾	11.9606-9950.2	220880				
	T4F	132	04.11	+ Bremsscheibendurchm. 316mm ¹⁾	11.8116-0388.2	390588				
	T5	176	04.10	+ Bremsscheibendurchm. 316mm ¹⁾	11.0441-6008.2	250038				
	T5	180	09.13	+ Bremsscheibendurchm. 316mm ¹⁾	11.0101-5704.2	260095				
	T6	225	09.13	+ Bremsscheibendurchm. 316mm ¹⁾						
	T6 AWD	224	04.10	+ Bremsscheibendurchm. 316mm ¹⁾						
	T6 AWD	225	09.15	+ Bremsscheibendurchm. 316mm ¹⁾						
	T6 AWD	242	04.14	+ Bremsscheibendurchm. 316mm ¹⁾						
	1.5 T2	90	10.15	+ Bremsscheibendurchm. 336 mm ²⁾	11.9606-9945.2	220727				
	1.6 D DRIVE	84	01.11	+ Bremsscheibendurchm. 336 mm ²⁾	11.9606-9946.2	220728				
	2.0 D5	165	03.15	+ Bremsscheibendurchm. 336 mm ²⁾	11.8116-0388.2	390588				
	2.0 T	132	12.13	+ Bremsscheibendurchm. 336 mm ²⁾	11.0441-6008.2	250038				
	2.0 T	149	04.10	+ Bremsscheibendurchm. 336 mm ²⁾	11.0101-5704.2	260095				
	2.0 T4	140	05.15	+ Bremsscheibendurchm. 336 mm ²⁾						
2.5 T5 AWD	186	09.12	+ Bremsscheibendurchm. 336 mm ²⁾							
D2	84	04.13	+ Bremsscheibendurchm. 336 mm ²⁾							
D2	88	03.15	+ Bremsscheibendurchm. 336 mm ²⁾							
D3	100	05.12	+ Bremsscheibendurchm. 336 mm ²⁾							
D3	110	03.15	+ Bremsscheibendurchm. 336 mm ²⁾							
D3	120	04.10	+ Bremsscheibendurchm. 336 mm ²⁾							
D4	120	05.12	+ Bremsscheibendurchm. 336 mm ²⁾							
D4	133	09.13	+ Bremsscheibendurchm. 336 mm ²⁾							
D4	140	03.15	+ Bremsscheibendurchm. 336 mm ²⁾							
D4 AWD	140	03.15	+ Bremsscheibendurchm. 336 mm ²⁾							
D5	151	04.10	+ Bremsscheibendurchm. 336 mm ²⁾							
D5	158	06.11	+ Bremsscheibendurchm. 336 mm ²⁾							
D5	169	04.14	+ Bremsscheibendurchm. 336 mm ²⁾							
D5 AWD	151	04.10	+ Bremsscheibendurchm. 336 mm ²⁾							
D5 AWD	158	06.11	+ Bremsscheibendurchm. 336 mm ²⁾							
D5 AWD	169	04.14	+ Bremsscheibendurchm. 336 mm ²⁾							
T3	110	04.10	+ Bremsscheibendurchm. 336 mm ²⁾							
T3	112	03.15	+ Bremsscheibendurchm. 336 mm ²⁾							
T4	132	04.10	+ Bremsscheibendurchm. 336 mm ²⁾							
T4F	132	04.11	+ Bremsscheibendurchm. 336 mm ²⁾							
T5	176	04.10	+ Bremsscheibendurchm. 336 mm ²⁾							
T5	180	09.13	+ Bremsscheibendurchm. 336 mm ²⁾							
T6	225	09.13	+ Bremsscheibendurchm. 336 mm ²⁾							
T6 AWD	224	04.10	+ Bremsscheibendurchm. 336 mm ²⁾							
T6 AWD	225	09.15	+ Bremsscheibendurchm. 336 mm ²⁾							
T6 AWD	242	04.14	+ Bremsscheibendurchm. 336 mm ²⁾							
	1.5 T2	90	10.15		24.5162-0390.3	331199	2	+ 16" Rad ³⁾	L=390 L=375	
	1.6 D DRIVE	84	01.11		24.5162-0375.3	331203	2	+ 17" Rad ⁴⁾		
	2.0 D5	165	03.15							
	2.0 T	149	04.10							
	2.0 T4	140	05.15							
	2.5 T5 AWD	186	09.12							
	D2	84	04.13							
	D2	88	03.15							
	D3	100	05.12							
	D3	110	03.15							
	D3	120	04.10							
	D4	120	05.12							
	D4	133	09.13							
	D4	140	03.15							
	D4 AWD	140	03.15							
D5	151	04.10								
D5	158	06.11								
D5	169	04.14								
D5 AWD	151	04.10								
D5 AWD	158	06.11								
D5 AWD	169	04.14								
T3	110	04.10								
T3	112	03.15								
T4	132	04.10								
T4F	132	04.11								
T5	176	04.10								
T5	180	09.13								
T6	225	09.13								
T6 AWD	224	04.10								
T6 AWD	225	09.15								
T6 AWD	242	04.14								
	1.5 T2	90	10.15		24.6241-1703.7	220971	2	+ belüftete Scheiben ⁵⁾	D=41, - Halter D=41, - Halter	TRW TRW
	1.6 D DRIVE	84	01.11		24.6241-1704.7	220972				
	2.0 D5	165	03.15							
	2.0 T	149	04.10							
	2.0 T4	140	05.15							
	2.5 T5 AWD	186	09.12							
	D2	84	04.13							
	D2	88	03.15							
	D3	100	05.12							
	D3	110	03.15							
D3	120	04.10								
D4	120	05.12								
D4	133	09.13								
D4	140	03.15								
D4 AWD	140	03.15								

¹⁾ + brake disc diameter 316mm / + diametro dischi freno 316mm / + diamètre disques frein 316mm / + diámetro disco freno 316mm

²⁾ + brake disc diameter 336mm / + diametro dischi freno 336mm / + diamètre disques frein 336mm / + diámetro disco freno 336mm

³⁾ + 16" wheel / + ruota 16" / + roue 16" / + rueda 16"

⁴⁾ + 17" wheel / + ruota 17" / + roue 17" / + rueda 17"

⁵⁾ + ventilated discs / + dischi ventilati / + disques ventilés / + disco ventilado

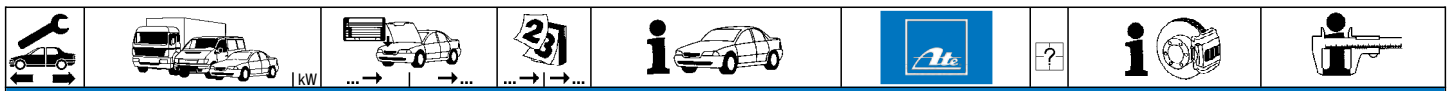

VOLVO S60 II (10-)											
	D5	151		04.10		24.6241-1703.7	220971		+ belüftete Scheiben ¹⁾	D=41, - Halter	TRW
	D5	158		06.11		24.6241-1704.7	220972		+ belüftete Scheiben ¹⁾	D=41, - Halter	TRW
	D5	169		04.14							
	D5 AWD	151		04.10							
	D5 AWD	158		06.11							
	D5 AWD	169		04.14							
	T3	110		04.10							
	T3	112		03.15							
	T4	132		04.10							
	T4F	132		04.11							
	T5	176		04.10							
	T5	180		09.13							
	T6	225		09.13							
	T6 AWD	224		04.10							
	T6 AWD	225		09.15							
	T6 AWD	242		04.14							

VOLVO S70 (97-00)											
	2.0	93		01.97	11.00	03.7760-3602.4	300176			10"	ATE
	2.0	105		01.97	11.00						
	2.0 20V	120		01.97	11.00						
	2.0 20V	132		01.97	11.00						
	2.0 T	155		01.97	11.00						
	2.0 T	166		01.97	11.00						
	2.3	195		04.99	09.00						
	2.3 T	184		01.97	11.00						
	2.3 T5	176		01.97	11.00						
	2.4	103		08.99	11.00						
	2.4	125		01.97	11.00						
	2.4 AWD	106		10.98	05.99						
	2.4 AWD	103		04.99	09.00						
	2.4 AWD	106		11.96	05.99						
	2.4 AWD	142		11.96	09.00						
	2.4 Blu-Fuel	103		07.97	09.00						
	2.4 T	142		01.97	11.00						
	2.5	106		01.97	11.00						
	2.5	121		06.98	11.00						
	2.5 Bifuel	103		01.97	11.00						
	2.5 Bifuel	103		07.99	11.00						
	2.5 Bifuel	106		10.98	11.00						
	2.5 TDI	103		01.97	11.00						
	2.5 TDI AWD	103		10.99	09.00						
	2.0	93		01.97	12.98	03.2023-1084.3	010591			THz 23,81/20,64	ATE
	2.0	105		01.97	12.98						
	2.0 20V	120		01.97	12.98						
	2.0 20V	132		01.97	12.98						
	2.0 T	155		01.97	12.98						
	2.0 T	166		01.97	12.98						
	2.3 T	184		01.97	12.98						
	2.3 T5	176		01.97	12.98						
	2.4	125		01.97	12.98						
	2.4 AWD	106		10.98	12.98						
	2.4 AWD	106		11.96	12.98						
	2.4 AWD	142		11.96	12.98						
	2.4 T	142		01.97	12.98						
	2.5	106		01.97	12.98						
	2.5	121		06.98	12.98						
	2.5 Bifuel	103		01.97	12.98						
	2.5 Bifuel	106		10.98	12.98						
	2.5 TDI	103		01.97	12.98						
	2.0	93		01.97	12.98	03.2023-1044.3	010590			THz 23,81/20,64	ATE
	2.0	105		01.97	12.98						
	2.0 20V	120		01.97	12.98						
	2.0 20V	132		01.97	12.98						
	2.0 T	155		01.97	12.98						
	2.0 T	166		01.97	12.98						
	2.3 T	184		01.97	12.98						
	2.3 T5	176		01.97	12.98						
	2.4	125		01.97	12.98						
	2.4 AWD	106		10.98	12.98						
	2.4 AWD	106		11.96	12.98						
	2.4 AWD	142		11.96	12.98						
	2.4 T	142		01.97	12.98						
	2.5	106		01.97	12.98						
	2.5	121		06.98	12.98						
	2.5 Bifuel	103		01.97	12.98						
	2.5 Bifuel	106		10.98	12.98						
	2.5 TDI	103		01.97	12.98						
	2.0	93		01.99	11.00	03.2123-2164.3	010599			THz 23,81	ATE
	2.0	105		01.99	11.00						
	2.0 20V	120		01.99	11.00						
	2.0 20V	132		01.99	11.00						
	2.0 T	155		01.99	11.00						
	2.0 T	166		01.99	11.00						
	2.3	195		04.99	09.00						
	2.3 T	184		01.99	11.00						
	2.3 T5	176		01.99	11.00						

1) + ventilated discs / + dischi ventilati / + disques ventilés / + disco ventilado

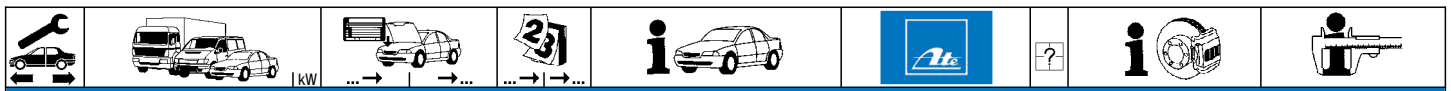

VOLVO S70 (97-00)

	2.0	93	587049	01.97	24.5201-0204.3	331400	2	L=204
	2.0	105	587049	01.97				
	2.0 20V	120	587049	01.97				
	2.0 20V	132	587049	01.97				
	2.0 T	155	587049	01.97				
	2.0 T	166	587049	01.97				
	2.3	195	587049	04.99				
	2.3 T	184	587049	01.97				
	2.3 T5	176	587049	01.97				
	2.4	125	587049	01.97				
	2.4 AWD		587049	10.98				
	2.4 AWD	103	587049	04.99				
	2.4 AWD	106	587049	11.96				
	2.4 AWD	142	587049	11.96				
	2.4 Blu-Fuel	103	587049	07.97				
	2.4 T	142	587049	01.97				
	2.5	106	587049	01.97				
	2.5 TDI	103	587049	01.97				
	2.5 TDi AWD	103	587049	10.99				
	2.0	93 587050		11.00	83.6204-0180.3	330547	2	L=180
	2.0	105 587050		11.00				
	2.0 20V	120 587050		11.00				
	2.0 20V	132 587050		11.00				
	2.0 T	155 587050		11.00				
	2.0 T	166 587050		11.00				
	2.3	195 587050		09.00				
	2.3 T	184 587050		11.00				
	2.3 T5	176 587050		11.00				
	2.4	103 587050		11.00				
	2.4	125 587050		11.00				
	2.4 AWD	587050		05.99				
	2.4 AWD	103 587050		09.00				
	2.4 AWD	106 587050		05.99				
	2.4 AWD	142 587050		09.00				
	2.4 Blu-Fuel	103 587050		09.00				
	2.4 T	142 587050		11.00				
	2.5	106 587050		11.00				
	2.5	121		06.98 11.00				
	2.5 Bifuel	103		07.99 11.00				
	2.5 Bifuel	106		10.98 11.00				
	2.5 TDI	103 587050		11.00				
	2.5 TDi AWD	103 587050		09.00				
	2.0	93		01.97 11.00	24.3727-1308.2	581308	2 ↓	L=1670
	2.0	105		01.97 11.00				
	2.0 20V	120		01.97 11.00				
	2.0 20V	132		01.97 11.00				
	2.0 T	155		01.97 11.00				
	2.0 T	166		01.97 11.00				
	2.3	195		04.99 09.00				
	2.3 T	184		01.97 11.00				
	2.3 T5	176		01.97 11.00				
	2.4	103		08.99 11.00				
	2.4	125		01.97 11.00				
	2.4 AWD			10.98 05.99				
	2.4 AWD	103		04.99 09.00				
	2.4 AWD	106		11.96 05.99				
	2.4 AWD	142		11.96 09.00				
	2.4 Blu-Fuel	103		07.97 09.00				
	2.4 T	142		01.97 11.00				
	2.5	106		01.97 11.00				
	2.5	121		06.98 11.00				
	2.5 Bifuel	103		07.99 11.00				
	2.5 Bifuel	106		10.98 11.00				
	2.5 TDI	103		01.97 11.00				
	2.5 TDi AWD	103		10.99 09.00				
	2.0	93	459999	01.97	24.2419-0939.3	030065	- Rohrleitung 1)	Gz 19,05
	2.0	105	459999	01.97				
	2.0 20V	120	459999	01.97				
	2.0 20V	132	459999	01.97				
	2.0 T	155	459999	01.97				
	2.0 T	166	459999	01.97				
	2.3	195	459999	04.99				
	2.3 T	184	459999	01.97				
	2.3 T5	176	459999	01.97				
	2.4	125	459999	01.97				
	2.4 AWD		459999	10.98				
	2.4 AWD	103	459999	04.99				
	2.4 AWD	106	459999	11.96				
	2.4 AWD	142	459999	11.96				
	2.4 T	142	459999	01.97				
	2.5	106	459999	01.97				
	2.5 TDI	103	459999	01.97				
	2.5 TDi AWD	103	459999	10.99				
	2.0	93 460000		11.00	24.2419-1724.3	030113		Gz 19,05
	2.0	105 460000		11.00				
	2.0 20V	120 460000		11.00				
	2.0 20V	132 460000		11.00				

1) - pipe line / - tubazione / - conduite rigide / - latiguillo

VOLVO S70 (97-00)

	2.0 T	155 460000		11.00	24.2419-1724.3	030113		Gz 19,05
	2.0 T	166 460000		11.00				
	2.3	195 460000		09.00				
	2.3 T	184 460000		12.98				
	2.3 T5	176 460000		12.98				
	2.4	103	08.99	11.00				
	2.4	125 460000		12.98				
	2.4 AWD	460000		05.99				
	2.4 AWD	103 460000		09.00				
	2.4 AWD	106 460000		05.99				
	2.4 AWD	142 460000		09.00				
	2.4 Blu-Fuel	103	07.97	09.00				
	2.4 T	142 460000		12.98				
	2.5	106 460000		12.98				
	2.5	121	06.98	11.00				
	2.5 Bifuel	103	07.99	11.00				
	2.5 Bifuel	106	10.98	11.00				
	2.5 TDI	103 460000		12.98				
	2.5 TDi AWD	103 460000		09.00				
	2.0	93	459999	01.97	24.2522-0907.3	040043		Nz 22,20
	2.0	105	459999	01.97				
	2.0 20V	120	459999	01.97				
	2.0 20V	132	459999	01.97				
	2.3	195	459999	04.99				
	2.3 T	184	459999	01.97				
	2.4	125	459999	01.97				
	2.4 AWD		459999	10.98				
	2.4 AWD	103	459999	04.99				
	2.4 AWD	106	459999	11.96				
	2.4 AWD	142	459999	11.96				
	2.4 T	142	459999	01.97				
	2.5	106	459999	01.97				
	2.5	121	459999	01.97				
	2.5 TDI	103	459999	01.97				
	2.5 TDi AWD	103	459999	10.99				

VOLVO S80 I (98-06)

	2.0	120		06.98	12.01	03.7755-3402.4	300189	- DSTC	9/8" Tandem	ATE
	2.0 T	132		12.99	12.01	03.0655-0004.2	370004		Wegsensor	ATE
	2.0 T	166		06.98	12.01					
	2.4	103		01.99	12.01					
	2.4	125		01.99	12.01					
	2.4 Bi-Fuel	103		09.01	12.01					
	2.4 D	96		10.01	12.01					
	2.4 D5	120		08.01	12.01					
	2.4 T	147		06.00	12.01					
	2.5 TDI	103		01.99	12.01					
	2.8 T6	200		05.98	12.01					
	2.9	147		03.99	12.01					
	2.9	150		05.98	12.01					
	3.0	144		06.01	12.01					
	3.0 T6	200		06.01	12.01					
	2.0	120		01.02	02.06	03.7755-4702.4	300224	- DSTC	9/8" Tandem	ATE
	2.0 T	132		01.02	02.06	03.7858-3532.4	300233	+ DSTC	9/8" Tandem	ATE
	2.0 T	166		01.02	02.06	03.0655-0001.2	370001		Wegsensor	ATE
	2.4	103		01.02	02.06					
	2.4	125		01.02	02.06					
	2.4 Bi-Fuel	103		01.02	02.06					
	2.4 D	96		01.02	02.06					
	2.4 D5	120		01.02	02.06					
	2.4 T	147		01.02	02.06					
	2.5 T	154		07.03	02.06					
	2.5 TDI	103		01.02	02.06					
	2.8 T6	200		01.02	02.06					
	2.9	147		01.02	02.06					
	2.9	150		01.02	02.06					
	3.0	144		01.02	02.06					
	3.0 T6	200		01.02	02.06					
	2.0	120	174095	06.98		03.2125-7637.3	010707	- DSTC	THz 25,40	ATE
	2.0 T	166	174095	06.98		03.2125-7708.3	010739	+ DSTC	THz 25,40	ATE
	2.4	103	174095	01.99						
	2.4	125	174095	01.99						
	2.5 TDI	103	174095	01.99						
	2.8 T6	200	174095	05.98						
	2.9	147	174095	03.99						
	2.9	150	174095	05.98						
	2.0	120 174096		02.06		03.2125-7743.3	010921	- DSTC	THz 25,40	ATE
	2.0 T	132		12.99	02.06	03.2125-7713.3	010819	+ DSTC	THz 25,40	ATE
	2.0 T	166 174096		02.06						
	2.4	103 174096		02.06						
	2.4	125 174096		02.06						
	2.4 Bi-Fuel	103		09.01	02.06					
	2.4 D	96		10.01	02.06					
	2.4 D5	120		08.01	02.06					
	2.4 T	147		06.00	02.06					
	2.5 T	154		07.03	02.06					
	2.5 TDI	103 174096		02.06						



VOLVO S80 I (98-06)

	2.8 T6 ▶200 174096 2.9 ▶147 174096 2.9 ▶150 174096 3.0 ▶144 3.0 T6 ▶200		02.06 02.06 02.06 02.06 06.01 06.01	03.2125-7743.3 010921 03.2125-7713.3 010819	- DSTC + DSTC	THz 25,40 THz 25,40	ATE ATE
	2.0 ▶120 174096 2.0 T ▶132 2.0 T ▶166 174096 2.4 ▶103 174096 2.4 ▶125 174096 2.4 Bi-Fuel ▶103 2.4 D ▶96 2.4 D5 ▶120 2.4 T ▶147 2.5 T ▶154 2.5 TDI ▶103 174096 2.8 T6 ▶200 174096 2.9 ▶147 174096 2.9 ▶150 174096 3.0 ▶144 3.0 T6 ▶200		02.06 12.99 02.06 02.06 02.06 02.06 09.01 02.06 10.01 02.06 08.01 02.06 06.00 02.06 07.03 02.06 02.06 02.06 02.06 02.06 06.01 02.06 06.01 02.06	03.2125-7638.3 010738		THz 25,40	ATE
	2.0 120 2.0 T 132 2.0 T 166 2.4 103 2.4 125 2.4 Bi-Fuel 103 2.4 D 96 2.4 D5 120 2.4 T 147 2.5 T 154 2.5 TDI 103 2.8 T6 200 2.9 147 2.9 150 3.0 144 3.0 T6 200		06.98 02.06 12.99 02.06 06.98 02.06 01.99 02.06 01.99 02.06 09.01 02.06 10.01 02.06 08.01 02.06 06.00 02.06 07.03 02.06 01.99 02.06 05.98 02.06 03.99 02.06 05.98 02.06 06.01 02.06 06.01 02.06	24.3601-9829.5 240507 24.3601-9830.5 240508 11.9571-9863.2 220513 11.9571-9864.2 220514 11.8116-0366.2 390587 11.0101-5407.2 260011 11.8171-0008.1 990049	2 - 17" Rad ¹⁾ - 17" Rad ¹⁾ + 17" Rad ²⁾ + 17" Rad ²⁾	D=60, - Halter D=60, - Halter D=57, - Halter D=57, - Halter Haltefeder Hülsensatz Führungsbolzen	ATE ATE ATE ATE ATE ATE
	2.0 120 2.0 T 132 2.0 T 166 2.4 103 2.4 125 2.4 Bi-Fuel 103 2.4 D 96 2.4 D5 120 2.4 T 147 2.5 T 154 2.5 TDI 103 2.8 T6 200 2.9 147 2.9 150 3.0 144 3.0 T6 200		06.98 02.06 12.99 02.06 06.98 02.06 01.99 02.06 01.99 02.06 09.01 02.06 10.01 02.06 08.01 02.06 06.00 02.06 07.03 02.06 01.99 02.06 05.98 02.06 03.99 02.06 05.98 02.06 06.01 02.06 06.01 02.06	83.6113-0321.3 330621	2	L=320	
	2.0 120 2.0 T 132 2.0 T 166 2.4 103 2.4 125 2.4 Bi-Fuel 103 2.4 D 96 2.4 D5 120 2.4 T 147 2.5 T 154 2.5 TDI 103 2.8 T6 200 2.9 147 2.9 150 3.0 144 3.0 T6 200		06.98 02.06 12.99 02.06 06.98 02.06 01.99 02.06 01.99 02.06 09.01 02.06 10.01 02.06 08.01 02.06 06.00 02.06 07.03 02.06 01.99 02.06 05.98 02.06 03.99 02.06 05.98 02.06 06.01 02.06 06.01 02.06	11.9421-9979.2 220497 11.9421-9980.2 220498 24.3421-9979.5 240475 24.3421-9980.5 240476 11.0101-5407.2 260011 11.8171-0008.1 990049 11.8116-0236.1 390507	2 - 17" Rad ¹⁾ - 17" Rad ¹⁾ + 17" Rad ²⁾ + 17" Rad ²⁾	D=42, - Halter D=42, - Halter D=42, - Halter D=42, - Halter Hülsensatz Führungsbolzen Haltefeder	ATE ATE ATE ATE ATE ATE
	2.0 120 2.0 T 132 2.0 T 166 2.4 103 2.4 125 2.4 Bi-Fuel 103 2.4 D 96 2.4 D5 120 2.4 T 147 2.5 T 154 2.5 TDI 103 2.8 T6 200 2.9 147 2.9 150 3.0 144 3.0 T6 200		06.98 02.06 12.99 02.06 06.98 02.06 01.99 02.06 01.99 02.06 09.01 02.06 10.01 02.06 08.01 02.06 06.00 02.06 07.03 02.06 01.99 02.06 05.98 02.06 03.99 02.06 05.98 02.06 06.01 02.06 06.01 02.06	83.7724-0268.3 331076	2	L=265	

1) - 17" wheel / - ruota 17" / - roue 17" / - rueda 17"
 2) + 17" wheel / + ruota 17" / + roue 17" / + rueda 17"

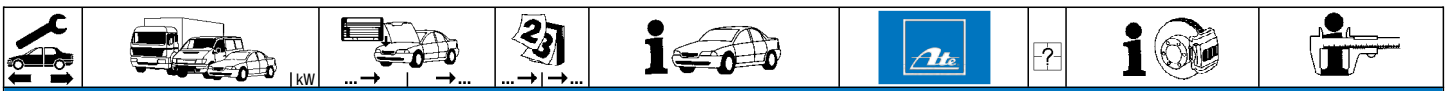

VOLVO S80 I (98-06)

	2.0	120		06.98	02.06	24.3727-1312.2	581312	2 ↓		L=1993
	2.0 T	132		12.99	02.06					
	2.0 T	166		06.98	02.06					
	2.4	103		01.99	02.06					
	2.4	125		01.99	02.06					
	2.4 D	96		10.01	02.06					
	2.4 D5	120		08.01	02.06					
	2.4 T	147		06.00	02.06					
	2.5 TDI	103		01.99	02.06					
	2.8 T6	200		05.98	02.06					
	2.9	147		03.99	02.06					
	2.9	150		05.98	02.06					
	3.0	144		06.01	02.06					
	3.0 T6	200		06.01	02.06					

VOLVO S80 II (06-)

	1.6 D DRIVE	◀		01.10		03.7755-9703.4	300239		- Kollisionswarnsystem ¹⁾	9/8" Tandem	ATE
	2.0	◀107		09.07							
	2.0 D	◀100		09.07							
	2.0 FlexiFuel	◀107		09.07							
	2.0 T	◀149		01.10							
	2.0 TDi	◀100		02.08							
	2.4 D	◀120		03.06							
	2.4 D	◀129		04.09							
	2.4 D5	◀136		03.06							
	2.4 D5	◀151		11.08							
	2.4 D5	158		06.11							
	2.4 D5 AWD	◀136		01.07							
	2.4 D5 AWD	◀151		01.10							
	2.4 D5 AWD	158		06.11							
	2.5 T	◀147		03.06							
	2.5 T	170		01.10							
	2.5 T	183		09.12							
	2.5 T	187		01.12							
	2.5 T AWD	◀147		10.06							
	2.5 T FlexiFuel	◀147		04.08							
	2.5 T FlexiFuel	170		01.10							
	3.0 T6 AWD	◀210		01.07							
	3.2	◀		03.06							
	3.2 AWD	◀		01.07							
	D2	84		04.13							
	D3	100		05.12							
	D3	◀120		01.10							
	D4	133		09.13							
	T4	132		10.10							
	T4F	132		05.11							
	T6 AWD	224		10.10							
	1.6 D DRIVE	◀	151000	01.10		03.7858-5032.4	300275		+ Kollisionswarnsystem ²⁾	9/8" Tandem	ATE
	2.4 D5	158	151000	06.11		03.0655-0007.2	370007			Wegsensor	ATE
	2.4 D5 AWD	158	151000	06.11							
	2.5 T	170	151000	01.10							
	2.5 T FlexiFuel	170	151000	01.10							
	D2	84	151000	04.13							
	D3	100	151000	05.12							
	D3	◀120	151000	01.10							
	T4	132	151000	10.10							
	T4F	132	151000	05.11							
	T6 AWD	224	151000	10.10							
	1.6 D DRIVE	◀	151001			03.0655-0007.2	370007		+ Kollisionswarnsystem ²⁾	Wegsensor	ATE
	2.4 D5	158	151001								
	2.4 D5 AWD	158	151001								
	2.5 T	170	151001								
	2.5 T	183		09.12							
	2.5 T	187		01.12							
	2.5 T FlexiFuel	170	151001								
	D2	84	151001								
	D3	100	151001								
	D3	◀120	151001								
	D4	133		09.13							
	T4	132	151001								
	T4F	132	151001								
	T6 AWD	224	151001								
	2.0	◀107		09.07		03.7858-4832.4	300274		+ Kollisionswarnsystem ²⁾	9/8" Tandem	ATE
	2.0 D	◀100		09.07		03.0655-0007.2	370007		+ Kollisionswarnsystem ²⁾	Wegsensor	ATE
	2.0 FlexiFuel	◀107		09.07							
	2.0 T	◀149		01.10							
	2.0 TDi	◀100		02.08							
	2.4 D	◀120		03.06							
	2.4 D	◀129		04.09							
	2.4 D5	◀136		03.06							
	2.4 D5	◀151		11.08							
	2.4 D5 AWD	◀136		01.07							
	2.4 D5 AWD	◀151		01.10							
	2.5 T	◀147		03.06							
	2.5 T AWD	◀147		10.06							
	2.5 T FlexiFuel	◀147		04.08							
	3.0 T6 AWD	◀210		01.07							

¹⁾ - collision warning system / - sistema anti-collosione / - système anticollision / - sistema anticollisión
²⁾ + collision warning system / + sistema anti-collosione / + système anticollision / + sistema anticollisión





VOLVO S80 II (06-)									
	3.2		03.06	03.7858-4832.4	300274	+ Kollisionswarnsystem ¹⁾	9/8" Tandem	ATE	
	3.2 AWD		01.07	03.0655-0007.2	370007	+ Kollisionswarnsystem ¹⁾	Wegsensor	ATE	
	2.0 Drive-E	180	12.14	03.7755-9703.4	300239	- Kollisionswarnsystem ²⁾	9/8" Tandem	ATE	
	T5	177	10.10	03.7858-5032.4	300275	+ Kollisionswarnsystem ¹⁾	9/8" Tandem	ATE	
	T5	180	09.13	03.0655-0007.2	370007	+ Kollisionswarnsystem ¹⁾	Wegsensor	ATE	
	1.6 D DRIVE		01.10	03.0655-0007.2	370007		Wegsensor	ATE	
	2.0		09.07						
	2.0 D		09.07						
	2.0 FlexiFuel		09.07						
	2.0 T		01.10						
	2.0 TDi		02.08						
	2.4 D		03.06						
	2.4 D		04.09						
	2.4 D5		03.06						
	2.4 D5		11.08						
2.4 D5 AWD		01.07							
2.4 D5 AWD		01.10							
2.5 T		03.06							
2.5 T AWD		10.06							
2.5 T FlexiFuel		04.08							
3.0 T6 AWD		01.07							
3.2		03.06							
3.2 AWD		01.07							
D3		01.10							
T5		10.10		03.7858-4832.4	300274	+ Kollisionswarnsystem ¹⁾	9/8" Tandem	ATE	
T5		09.13		03.0655-0007.2	370007	+ Kollisionswarnsystem ¹⁾	Wegsensor	ATE	
	1.6 D DRIVE		01.10	11.9601-9711.2	220873	+ 16" Rad ³⁾	D=60, - Halter	ATE	
	2.0	107	09.07	11.9601-9712.2	220874	+ 16" Rad ³⁾	D=60, - Halter	ATE	
	2.0 D	100	09.07	11.0230-0934.1	260128	+ 16" Rad ³⁾	Halter	ATE	
	2.0 Drive-E	180	12.14	11.0441-6008.2	250038		Dichtungssatz	ATE	
	2.0 FlexiFuel	107	09.07						
	2.0 T	149	01.10						
	2.0 TDi	100	02.08						
	2.4 D	120	03.06						
	2.4 D	129	04.09						
	2.4 D5	136	03.06						
	2.4 D5	151	11.08						
	2.4 D5	158	06.11						
	2.4 D5 AWD	136	01.07						
	2.4 D5 AWD	151	01.10						
	2.4 D5 AWD	158	06.11						
	2.5 T	147	03.06						
	2.5 T	170	01.10						
	2.5 T	183	09.12						
	2.5 T	187	01.12						
	2.5 T AWD	147	10.06						
	2.5 T FlexiFuel	147	04.08						
	2.5 T FlexiFuel	170	01.10						
	3.0 T6 AWD	210	01.07						
	3.2		03.06						
	3.2 AWD		01.07						
	4.4 V8 AWD	232	03.06						
	D2	84	04.13						
	D3	100	05.12						
	D3	120	01.10						
	D4	133	09.13						
	T4	132	10.10						
	T4F	132	05.11						
	T5	177	10.10						
	T5	180	09.13						
	T6 AWD	224	10.10						
1.6 D DRIVE		01.10		11.9606-9949.2	220879	+ 17" Rad ⁴⁾	D=60, - Halter	ATE	
2.0	107	09.07		11.9606-9950.2	220880	+ 17" Rad ⁴⁾	D=60, - Halter	ATE	
2.0 D	100	09.07		11.8116-0206.1	390593		Haltefeder	ATE	
2.0 Drive-E	180	12.14		11.0441-6008.2	250038		Dichtungssatz	ATE	
2.0 FlexiFuel	107	09.07		11.0101-5704.2	260095		Hülsensatz	ATE	
2.0 T	149	01.10							
2.0 TDi	100	02.08							
2.4 D	120	03.06							
2.4 D	129	04.09							
2.4 D5	136	03.06							
2.4 D5	151	11.08							
2.4 D5	158	06.11							
2.4 D5 AWD	136	01.07							
2.4 D5 AWD	151	01.10							
2.4 D5 AWD	158	06.11							
2.5 T	147	03.06							
2.5 T	170	01.10							
2.5 T	183	09.12							
2.5 T	187	01.12							
2.5 T AWD	147	10.06							
2.5 T FlexiFuel	147	04.08							
2.5 T FlexiFuel	170	01.10							
3.0 T6 AWD	210	01.07							
3.2		03.06							
3.2 AWD		01.07							
4.4 V8 AWD	232	03.06							

¹⁾ + collision warning system / + sistema anti-collosione / + système anticollision / + sistema anticollision

²⁾ - collision warning system / - sistema anti-collosione / - système anticollision / - sistema anticollision

³⁾ + 16" wheel / + ruota 16" / + roue 16" / + rueda 16"

⁴⁾ + 17" wheel / + ruota 17" / + roue 17" / + rueda 17"

VOLVO S80 II (06-)													
	D2	84	04.13	11.9606-9949.2	220879	2	+ 17" Rad ¹⁾	D=60, - Halter D=60, - Halter Haltefeder Dichtungssatz Hülsensatz	ATE ATE ATE ATE ATE				
	D3	100	05.12	11.9606-9950.2	220880		+ 17" Rad ¹⁾						
	D3	120	01.10	11.8116-0206.1	390593								
	D4	133	09.13	11.0441-6008.2	250038								
	T4	132	10.10	11.0101-5704.2	260095								
	T4F	132	05.11										
	T5	177	10.10										
	T5	180	09.13										
	T6 AWD	224	10.10										
	1.6 D Drive		01.10	11.9606-9945.2	220727	2	+ 18" Rad ²⁾			D=60, - Halter D=60, - Halter Haltefeder Hülsensatz Führungsbolzen Dichtungssatz	ATE ATE ATE ATE ATE ATE		
	2.0	107	09.07	11.9606-9946.2	220728		+ 18" Rad ²⁾						
	2.0 D	100	09.07	11.8116-0388.2	390588								
	2.0 Drive-E	180	12.14	11.0101-5704.2	260095								
	2.0 FlexiFuel	107	09.07	11.8171-0008.1	990049								
	2.0 T	149	01.10	11.0441-6008.2	250038								
	2.0 TDi	100	02.08										
	2.4 D	120	03.06										
	2.4 D	129	04.09										
	2.4 D5	136	03.06										
	2.4 D5	151	11.08										
	2.4 D5	158	06.11										
2.4 D5 AWD	136	01.07											
2.4 D5 AWD	151	01.10											
2.4 D5 AWD	158	06.11											
2.5 T	147	03.06											
2.5 T	170	01.10											
2.5 T	183	09.12											
2.5 T	187	01.12											
2.5 T AWD	147	10.06											
2.5 T FlexiFuel	147	04.08											
2.5 T FlexiFuel	170	01.10											
3.0 T6 AWD	210	01.07											
3.2		03.06											
3.2 AWD		01.07											
4.4 V8 AWD	232	03.06											
D2	84	04.13											
D3	100	05.12											
D3	120	01.10											
D4	133	09.13											
T4	132	10.10											
T4F	132	05.11											
T5	177	10.10											
T5	180	09.13											
T6 AWD	224	10.10											
	1.6 D Drive		01.10	24.5162-0390.3	331199	2	+ 16" Rad ³⁾	L=390 L=375					
	2.0	107	09.07	24.5162-0375.3	331203		+ 17"/18" Rad ⁴⁾						
	2.0 D	100	09.07										
	2.0 Drive-E	180	12.14										
	2.0 FlexiFuel	107	09.07										
	2.0 T	149	01.10										
	2.0 TDi	100	02.08										
	2.4 D	120	03.06										
	2.4 D	129	04.09										
	2.4 D5	136	03.06										
	2.4 D5	151	11.08										
	2.4 D5	158	06.11										
	2.4 D5 AWD	136	01.07										
	2.4 D5 AWD	151	01.10										
	2.4 D5 AWD	158	06.11										
	2.5 T	147	03.06										
	2.5 T	170	01.10										
	2.5 T	183	09.12										
	2.5 T	187	01.12										
	2.5 T AWD	147	10.06										
	2.5 T FlexiFuel	147	04.08										
2.5 T FlexiFuel	170	01.10											
3.0 T6 AWD	210	01.07											
3.2		03.06											
3.2 AWD		01.07											
4.4 V8 AWD	232	03.06											
D2	84	04.13											
D3	100	05.12											
D3	120	01.10											
D4	133	09.13											
T4	132	10.10											
T4F	132	05.11											
T5	177	10.10											
T5	180	09.13											
T6 AWD	224	10.10											
	1.6 D Drive		01.10	24.6238-1703.7	220967	2	+ elektrische Feststellbremse ⁶⁾	D=38, - Halter D=38, - Halter	TRW TRW				
	2.0	107	09.07	24.6238-1704.7	220968		+ elektrische Feststellbremse ⁶⁾						
	2.0 D	100	09.07										
	2.0 Drive-E	180	12.14										
	2.0 FlexiFuel	107	09.07										
	2.0 T	149	01.10										
2.0 TDi	100	02.08											
2.4 D	120	03.06											

¹⁾ + 17" wheel / + ruota 17" / + roue 17" / + rueda 17"

²⁾ + 18" wheel / + ruota 18" / + roue 18" / + rueda 18"

³⁾ + 16" wheel / + ruota 16" / + roue 16" / + rueda 16"

⁴⁾ + 17"/18" wheel / + ruota 17"/18" / + roue 17"/18" / + rueda 17"/18"

⁵⁾ + solid discs / + dischi massiccio / + disques massive / + disco macizo

⁶⁾ + electric parking brake / + freno a mano elettrico / + frein à main électrique / + freno de mano eléctrico



VOLVO S80 II (06-)

	2.4 D	129	04.09	+ massive Scheiben ¹⁾	24.6238-1703.7	220967	+ elektrische Feststellbremse ²⁾	D=38, - Halter	TRW
	2.4 D5	136	03.06	+ massive Scheiben ¹⁾	24.6238-1704.7	220968	+ elektrische Feststellbremse ²⁾	D=38, - Halter	TRW
	2.4 D5	151	11.08	+ massive Scheiben ¹⁾					
	2.4 D5	158	06.11	+ massive Scheiben ¹⁾					
	2.4 D5 AWD	136	01.07	+ massive Scheiben ¹⁾					
	2.4 D5 AWD	151	01.10	+ massive Scheiben ¹⁾					
	2.4 D5 AWD	158	06.11	+ massive Scheiben ¹⁾					
	2.5 T	147	03.06	+ massive Scheiben ¹⁾					
	2.5 T	170	01.10	+ massive Scheiben ¹⁾					
	2.5 T	183	09.12	+ massive Scheiben ¹⁾					
	2.5 T	187	01.12	+ massive Scheiben ¹⁾					
	2.5 T AWD	147	10.06	+ massive Scheiben ¹⁾					
	2.5 T FlexFuel	147	04.08	+ massive Scheiben ¹⁾					
	2.5 T FlexiFuel	170	01.10	+ massive Scheiben ¹⁾					
	3.0 T6 AWD	210	01.07	+ massive Scheiben ¹⁾					
	3.2		03.06	+ massive Scheiben ¹⁾					
	3.2 AWD		01.07	+ massive Scheiben ¹⁾					
	4.4 V8 AWD	232	03.06	+ massive Scheiben ¹⁾					
	D3	100	05.12	+ massive Scheiben ¹⁾					
	D3	120	01.10	+ massive Scheiben ¹⁾					
D4	133	09.13	+ massive Scheiben ¹⁾						
T5	180	09.13	+ massive Scheiben ¹⁾						
	1.6 D DRIVE		01.10	+ belüftete Scheiben ³⁾	24.6241-1703.7	220971	+ elektrische Feststellbremse ²⁾	D=41, - Halter	TRW
	2.0	107	09.07	+ belüftete Scheiben ³⁾	24.6241-1704.7	220972	+ elektrische Feststellbremse ²⁾	D=41, - Halter	TRW
	2.0 D	100	09.07	+ belüftete Scheiben ³⁾					
	2.0 Drive-E	180	12.14	+ belüftete Scheiben ³⁾					
	2.0 FlexiFuel	107	09.07	+ belüftete Scheiben ³⁾					
	2.0 T	149	01.10	+ belüftete Scheiben ³⁾					
	2.0 TDi	100	02.08	+ belüftete Scheiben ³⁾					
	2.4 D	120	03.06	+ belüftete Scheiben ³⁾					
	2.4 D	129	04.09	+ belüftete Scheiben ³⁾					
	2.4 D5	136	03.06	+ belüftete Scheiben ³⁾					
	2.4 D5	151	11.08	+ belüftete Scheiben ³⁾					
	2.4 D5	158	06.11	+ belüftete Scheiben ³⁾					
	2.4 D5 AWD	136	01.07	+ belüftete Scheiben ³⁾					
	2.4 D5 AWD	151	01.10	+ belüftete Scheiben ³⁾					
	2.4 D5 AWD	158	06.11	+ belüftete Scheiben ³⁾					
	2.5 T	147	03.06	+ belüftete Scheiben ³⁾					
	2.5 T	170	01.10	+ belüftete Scheiben ³⁾					
	2.5 T	183	09.12	+ belüftete Scheiben ³⁾					
	2.5 T	187	01.12	+ belüftete Scheiben ³⁾					
	2.5 T AWD	147	10.06	+ belüftete Scheiben ³⁾					
	2.5 T FlexFuel	147	04.08	+ belüftete Scheiben ³⁾					
	2.5 T FlexiFuel	170	01.10	+ belüftete Scheiben ³⁾					
	3.0 T6 AWD	210	01.07	+ belüftete Scheiben ³⁾					
	3.2		03.06	+ belüftete Scheiben ³⁾					
	3.2 AWD		01.07	+ belüftete Scheiben ³⁾					
	4.4 V8 AWD	232	03.06	+ belüftete Scheiben ³⁾					
	D2	84	04.13	+ belüftete Scheiben ³⁾					
	D3	100	05.12	+ belüftete Scheiben ³⁾					
	D3	120	01.10	+ belüftete Scheiben ³⁾					
	D4	133	09.13	+ belüftete Scheiben ³⁾					
T4	132	10.10	+ belüftete Scheiben ³⁾						
T4F	132	05.11	+ belüftete Scheiben ³⁾						
T5	177	10.10	+ belüftete Scheiben ³⁾						
T5	180	09.13	+ belüftete Scheiben ³⁾						
T6 AWD	224	10.10	+ belüftete Scheiben ³⁾						
	1.6 D DRIVE		01.10		24.5162-0185.3	331202	+ mechanische Feststellbremse ⁴⁾	L=185	
	2.0	107	09.07						
	2.0 D	100	09.07						
	2.0 Drive-E	180	12.14						
	2.0 FlexiFuel	107	09.07						
	2.0 T	149	01.10						
	2.0 TDi	100	02.08						
	2.4 D	120	03.06						
	2.4 D	129	04.09						
	2.4 D5	136	03.06						
	2.4 D5	151	11.08						
	2.4 D5	158	06.11						
	2.4 D5 AWD	136	01.07						
	2.4 D5 AWD	151	01.10						
	2.4 D5 AWD	158	06.11						
	2.5 T	170	01.10						
	2.5 T	183	09.12						
	2.5 T	187	01.12						
	2.5 T AWD	147	10.06						
	2.5 T AWD	147	03.06						
2.5 T FlexFuel	147	04.08							
2.5 T FlexiFuel	170	01.10							
3.0 T6 AWD	210	01.07							
3.2		03.06							
3.2 AWD		01.07							
4.4 V8 AWD	232	03.06							
D2	84	04.13							
D3	100	05.12							
D3	120	01.10							
T4	132	10.10							

¹⁾ + solid discs / + dischi massiccio / + disques massive / + disco macizo
²⁾ + electric parking brake / + freno a mano elettrico / + frein à main électrique / + freno de mano eléctrico
³⁾ + ventilated discs / + dischi ventilati / + disques ventilés / + disco ventilado
⁴⁾ + mechanical parking brake / + fr. stazionamento meccanico / + frein à main mécanique / + freno de mano mecánica

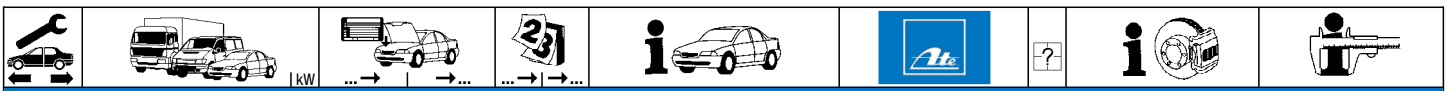























VOLVO S80 II (06-)

	T4F	132		05.11		24.5162-0185.3	331202	2	+ mechanische Feststellbremse ¹⁾	L=185
	T5	177		10.10						
	T5	180		09.13						
	T6 AWD	224		10.10						
	1.6 D DRiVe	▶	36584	01.10		24.5162-0185.3	331202	2	+ mechanische Feststellbremse ¹⁾	L=185
	2.0	▶107	36584	09.07						
	2.0 D	▶100	36584	09.07						
	2.0 FlexiFuel	▶107	36584	09.07						
	2.0 T	▶149	36584	01.10						
	2.0 TDi	▶100	36584	02.08						
	2.4 D	▶120	36584	03.06						
	2.4 D	▶129	36584	04.09						
	2.4 D5	▶136	36584	03.06						
	2.4 D5	▶151	36584	11.08						
	2.4 D5 AWD	▶136	36584	01.07						
	2.4 D5 AWD	▶151	36584	01.10						
	2.5 T	▶147	36584	03.06						
	2.5 T	▶170	36584	01.10						
	2.5 T AWD	▶147	36584	10.06						
	2.5 T FlexFuel	▶147	36584	04.08						
	3.0 T6 AWD	▶210	36584	01.07						
	3.2	▶	36584	03.06						
	3.2 AWD	▶	36584	01.07						
	D3	▶120	36584	01.10						
	1.6 D DRiVe		66719	01.10		24.5133-0310.3	331197		+ elektrische Feststellbremse ²⁾	L=310
	2.0	107	66719	09.07						
	2.0 D	100	66719	09.07						
	2.0 FlexiFuel	107	66719	09.07						
	2.0 T	149	66719	01.10						
	2.0 TDi	100	66719	02.08						
	2.4 D	120	66719	03.06						
	2.4 D	129	66719	04.09						
	2.4 D5	136	66719	03.06						
	2.4 D5	151	66719	11.08						
	2.4 D5	158	66719	06.11						
	2.4 D5 AWD	136	66719	01.07						
	2.4 D5 AWD	151	66719	01.10						
	2.4 D5 AWD	158	66719	06.11						
	2.5 T	147	66719	03.06						
	2.5 T	170	66719	01.10						
	2.5 T	170	66719	01.10						
	2.5 T AWD	147	66719	10.06						
	2.5 T FlexFuel	147	66719	04.08						
	2.5 T FlexiFuel	170	66719	01.10						
	3.0 T6 AWD	210	66719	01.07						
	3.2		66719	03.06						
	3.2 AWD		66719	01.07						
	4.4 V8 AWD	232	66719	03.06						
	D2	84	66719	04.13						
	D3	100	66719	05.12						
	D3	120	66719	01.10						
	T4	132	66719	10.10						
	T4F	132	66719	05.11						
	T5	177	66719	10.10						
	T6 AWD	224	66719	10.10						
	1.6 D DRiVe	66720	115163			24.5133-0311.3	331198		+ elektrische Feststellbremse ²⁾	L=310
	2.0	107 66720	115163							
	2.0 D	100 66720	115163							
	2.0 FlexiFuel	107 66720	115163							
	2.0 T	149 66720	115163							
	2.0 TDi	100 66720	115163							
	2.4 D	120 66720	115163							
	2.4 D	129 66720	115163							
	2.4 D5	136 66720	115163							
	2.4 D5	151 66720	115163							
	2.4 D5	158 66720	115163							
	2.4 D5 AWD	136 66720	115163							
	2.4 D5 AWD	151 66720	115163							
	2.4 D5 AWD	158 66720	115163							
	2.5 T	147 66720	115163							
	2.5 T	170 66720	115163							
	2.5 T	183	115163	09.12						
	2.5 T	187	115163	01.12						
	2.5 T AWD	147 66720	115163							
	2.5 T FlexFuel	147 66720	115163							
	2.5 T FlexiFuel	170 66720	115163							
	3.0 T6 AWD	210 66720	115163							
	3.2	66720	115163							
	3.2 AWD	66720	115163							
	4.4 V8 AWD	232 66720	115163							
	D2	84 66720	115163							
	D3	100 66720	115163							
	D3	120 66720	115163							
	T4	132 66720	115163							
	T4F	132 66720	115163							
	T5	177 66720	115163							
	T6 AWD	224 66720	115163							

¹⁾ + mechanical parking brake / + fr. stazionamento meccanico / + frein à main mécanique / + freno de mano mecánica

²⁾ + electric parking brake / + freno a mano elettrico / + frein à main électrique / + freno de mano eléctrico





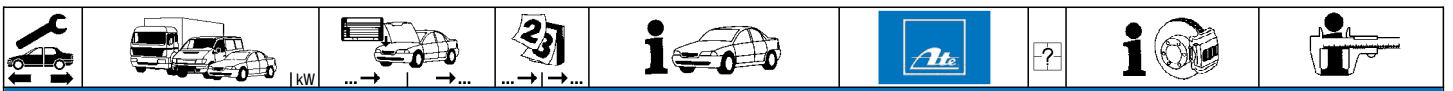









								
VOLVO S90 I (97-98)								
	2.5 2.5 2.9 2.9	125 132 132 150		11.96 11.96 01.97 01.97	10.98 10.97 05.98 05.98	03.2023-0875.3	010890	THz 23,81/20,64 - B. ATE
	2.5 2.5 2.9 2.9	125 132 132 150		11.96 11.96 01.97 01.97	10.98 10.97 05.98 05.98	24.3571-1707.5 24.3571-1708.5 24.0101-3601.2	240079 240080 260044	D=57, - Halter TRW D=57, - Halter TRW Bremsattel-Zubehör TRW
	2.5 2.5 2.9 2.9	125 132 132 150		11.96 11.96 01.97 01.97	10.98 10.97 05.98 05.98	83.6124-0380.3	330268	2 L=380
	2.5 2.5 2.9 2.9	125 132 132 150		11.96 11.96 01.97 01.97	10.98 10.97 05.98 05.98	83.6134-0300.3	330725	2 L=300
	2.5 2.5 2.9 2.9	125 132 132 150		11.96 11.96 01.97 01.97	10.98 10.97 05.98 05.98	03.6055-0430.3	320065	BR 5/25 (4) ATE
	2.5 2.5 2.9 2.9	125 132 132 150		11.96 11.96 01.97 01.97	10.98 10.97 05.98 05.98	24.2419-0941.3	030067	Gz 19,05
	2.5 2.5 2.9 2.9	125 132 132 150		11.96 11.96 01.97 01.97	10.98 10.97 05.98 05.98	24.2419-0928.3	030056	Gz 19,05
	2.5 2.5 2.9 2.9	125 132 132 150		11.96 11.96 01.97 01.97	10.98 10.97 05.98 05.98	03.2522-0420.3	040086	Nz 22,20
VOLVO V40 (95-04)								
	1.6 1.8 (1731) 1.9 T4 1.9 TD 2.0 2.0	77 85 147 66 100 103		12.95 07.95 05.97 07.95 07.95 07.95	08.97 08.97 08.97 08.97 08.97 08.97	24.2122-1718.3	010517	THz 22,20
	1.6 1.6 1.8 (1731) 1.8 (1783) 1.8 i (1834) 1.8 i (1834) 1.9 DI 1.9 DI 1.9 DI 1.9 T4 1.9 TD 2.0 2.0 2.0 T 2.0 T 2.0 T 2.0 T4	77 80 85 90 90 92 70 75 85 147 66 100 103 118 120 121 147		09.97 03.99 09.97 03.99 06.01 03.98 03.99 07.00 07.00 09.97 09.97 09.97 09.97 10.97 06.01 07.00 07.00	08.99 07.04 08.99 07.04 07.04 07.04 07.00 07.04 07.04 07.00 08.99 07.04 08.99 07.00 07.04 06.01 04.04	24.2123-1746.3	010682	THz 23,81
	1.6 1.8 (1731) 1.9 T4 1.9 TD 2.0 2.0	77 85 147 66 100 103		12.95 07.95 05.97 07.95 07.95 07.95	08.97 08.97 08.97 08.97 08.97 08.97	24.3541-1783.5 24.3541-1784.5	240269 240270	D=54, - Halter TRW D=54, - Halter TRW
	1.6 1.6 1.8 (1731) 1.8 (1783) 1.8 i (1834) 1.8 i (1834) 1.9 DI 1.9 DI 1.9 DI 1.9 T4 1.9 TD 2.0 2.0 2.0 T 2.0 T 2.0 T 2.0 T4	77 80 85 90 90 92 70 75 85 147 66 100 103 118 120 121 147		09.97 03.99 09.97 03.99 06.01 03.98 03.99 07.00 07.00 09.97 09.97 09.97 09.97 10.97 06.01 07.00 07.00	08.99 07.04 08.99 07.04 07.04 07.04 07.00 07.04 07.04 07.00 08.99 07.04 08.99 07.00 07.04 06.01 04.04	24.3541-1785.5 24.3541-1786.5	240271 240272	D=54, - Halter TRW D=54, - Halter TRW
	1.6 1.6 1.8 (1731) 1.8 (1783) 1.8 i (1834) 1.8 i (1834)	77 80 85 90 90 92		12.95 03.99 07.95 03.99 06.01 03.98	08.99 07.04 08.99 07.04 07.04 07.04	24.5248-0461.3	330707	2 L=460



VOLVO V40 (95-04)





	1.9 DI	70		03.99	07.00	24.5248-0461.3	330707	2		L=460
	1.9 DI	75		07.00	07.04					
	1.9 DI	85		07.00	07.04					
	1.9 T4	147		05.97	07.00					
	1.9 TD	66		07.95	08.99					
	2.0	100		07.95	07.04					
	2.0	103		07.95	08.99					
	2.0 T	118		10.97	07.00					
	2.0 T	120		06.01	07.04					
	2.0 T	121		07.00	06.01					
	2.0 T4	147		07.00	04.04					
	1.6	77	426760	12.95	08.99	24.3384-1721.5	240255	<input type="checkbox"/>		D=38, - Halter
	1.8 (1731)	85	426760	07.95	07.00	24.3384-1722.5	240256	<input type="checkbox"/>		D=38, - Halter
	1.9 DI	85	426760	07.00	07.00					
	1.9 T4	147	426760	05.97	07.00					
	1.9 TD	66	426760	07.95	08.99					
	2.0	100	426760	07.95	07.04					
	2.0 T	118	426760	10.97	07.00					
	1.6	77	426761	03.99	08.99	24.3384-1743.5	240319	<input type="checkbox"/>		D=38, - Halter
	1.6	80	426761	03.99	07.04	24.3384-1744.5	240320	<input type="checkbox"/>		D=38, - Halter
	1.8 (1731)	85	426761	08.99	08.99					
	1.8 (1783)	90	426761	03.99	07.04					
	1.8 i (1834)	90	426761	06.01	07.04					
	1.8 i (1834)	92	426761	03.98	07.04					
	1.9 DI	70	426761	03.99	07.00					
	1.9 DI	75	426761	07.00	07.04					
	1.9 DI	85	426761	07.00	07.04					
	1.9 T4	147	426761	07.00	07.00					
	1.9 TD	66	426761	08.99	08.99					
	2.0	100	426761	07.04	07.04					
	2.0	103	426761	08.99	08.99					
	2.0 T	118	426761	07.00	07.00					
	2.0 T	120	426761	06.01	07.04					
	2.0 T	121	426761	07.00	06.01					
	2.0 T4	147	426761	07.00	04.04					
	1.6	77		12.95	08.99	24.5249-0416.3	330708	2		L=416
	1.6	80		03.99	07.04					
	1.8 (1731)	85		07.95	08.99					
	1.8 (1783)	90		03.99	07.04					
	1.8 i (1834)	90		06.01	07.04					
	1.8 i (1834)	92		03.98	07.04					
	1.9 DI	70		03.99	07.00					
	1.9 DI	75		07.00	07.04					
	1.9 DI	85		07.00	07.04					
	1.9 T4	147		05.97	07.00					
	1.9 TD	66		07.95	08.99					
	2.0	100		07.95	07.04					
	2.0	103		07.95	08.99					
	2.0 T	118		10.97	07.00					
	2.0 T	120		06.01	07.04					
	2.0 T	121		07.00	06.01					
	2.0 T4	147		07.00	04.04					
	1.6	77	599999	12.95	08.99	24.3727-1304.2	581304	<input type="checkbox"/>		L=1590
	1.6	80	599999	03.99	07.00	24.3727-1300.2	581300	<input type="checkbox"/>		L=1590
	1.8 (1731)	85	599999	07.95	08.99					
	1.8 (1783)	90	599999	03.99	07.04					
	1.8 i (1834)	90	599999	06.01	07.04					
	1.8 i (1834)	92	599999	03.98	07.04					
	1.9 DI	70	599999	03.99	07.00					
	1.9 DI	75	599999	07.00	07.04					
	1.9 DI	85	599999	07.00	07.04					
	1.9 T4	147	599999	05.97	07.00					
	1.9 TD	66	599999	07.95	08.99					
	2.0	100	599999	07.95	07.04					
	2.0	103	599999	07.95	08.99					
	2.0 T	118	599999	10.97	07.00					
	2.0 T	120	599999	06.01	07.04					
	2.0 T	121	599999	07.00	06.01					
	2.0 T4	147	599999	07.00	04.04					
	1.6	77	600000	985261		24.3727-1315.2	581315	<input type="checkbox"/>		L=1620
	1.8 (1783)	90	600000	985261		24.3727-1314.2	581314	<input type="checkbox"/>		L=1620
	1.8 i (1834)	90	600000	985261						
	1.8 i (1834)	92	600000	985261						
	1.9 DI	75	600000	985261						
	1.9 DI	85	600000	985261						
	2.0	100	600000	985261						
	2.0 T	120	600000	985261						
	2.0 T4	147	600000	985261						
	1.6	80	985262		07.04	24.3727-1315.2	581315	<input type="checkbox"/>		L=1620
	1.8 (1783)	90	985262		07.04	24.3727-1314.2	581314	<input type="checkbox"/>		L=1620
	1.8 i (1834)	90	985262		07.04					
	1.8 i (1834)	92	985262		07.04					
	1.9 DI	75	985262		07.04					
	1.9 DI	85	985262		07.04					
	2.0	100	985262		07.04					
	2.0 T	120	985262		07.04					
	2.0 T4	147	985262		07.04					















VOLVO V40 (95-04)														
														
VOLVO V40 (95-04)														
	1.9 DI	70		03.99	07.00	24.2419-1728.3	030117					Gz 19,05		
	1.9 DI	75		07.00	07.04									
	1.9 DI	85		07.00	07.04									
	1.9 T4	147		05.97	07.00									
	2.0	100		07.95	07.04									
	2.0 T	118		10.97	07.00									
	2.0 T	120		06.01	07.04									
	2.0 T	121		07.00	06.01									
	2.0 T4	147		07.00	04.04									
VOLVO V40 (12-)														
	D2	84		09.12		24.3571-9813.5	240557			+ 15"/16" Rad 1)		D=57, - Halter	ATE	
	D2	88		02.15		24.3571-9814.5	240558			+ 15"/16" Rad 1)		D=57, - Halter	ATE	
	D3	110		09.12		11.8171-0008.1	990049					Führungsbolzen	ATE	
	D4	130		09.12		11.0101-5407.2	260011					Hülsensatz	ATE	
	D4	140		05.14		11.8116-0345.2	390596	2				Haltefeder	ATE	
	T2	90		02.15										
	T2 GTDi	88		03.13										
	T3	112		02.15										
	T3 GTDi	110		09.12										
	T4	132		04.13										
	T4	140		08.15										
	T4	147		04.14										
	T4 GTDi	132		09.12										
	T5	157		03.13										
	T5	180		05.14										
	T5 AWD	180		05.14										
	D2	84		09.12		11.9576-9975.2	220649			+ 17" Rad 2)		D=57, - Halter	ATE	
	D2	88		02.15		11.9576-9976.2	220650			+ 17" Rad 2)		D=57, - Halter	ATE	
	D3	110		09.12		11.8171-0008.1	990049					Führungsbolzen	ATE	
	D4	130		09.12		11.0101-5407.2	260011					Hülsensatz	ATE	
	D4	140		05.14		11.8116-0345.2	390596	2				Haltefeder	ATE	
	T2	90		02.15										
	T2 GTDi	88		03.13										
	T3	112		02.15										
	T3 GTDi	110		09.12										
	T4	132		04.13										
	T4	140		08.15										
	T4	147		04.14										
	T4 AWD	132		04.13										
	T4 AWD	140		05.14										
	T4 GTDi	132		09.12										
	T5	157		03.13										
	T5	180		05.14										
	T5	187		09.12										
	T5 AWD	157		03.13										
	T5 AWD	180		05.14										
	T5 AWD	187		01.13										
	D2	84		09.12		11.9387-7083.2	220959					D=38, - Halter	ATE	
	D2	88		02.15		11.9387-7084.2	220960					D=38, - Halter	ATE	
	D3	110		09.12		11.0230-0698.2	260091					Halter	ATE	
	D4	130		09.12		11.8171-0008.1	990049					Führungsbolzen	ATE	
	D4	140		05.14		11.0101-5407.2	260011					Hülsensatz	ATE	
	T2	90		02.15		11.8116-0340.1	390595	2				Haltefeder	ATE	
	T2 GTDi	88		03.13										
	T3	112		02.15										
	T3 GTDi	110		09.12										
	T4	132		04.13										
	T4	140		08.15										
	T4	147		04.14										
	T4 AWD	132		04.13										
	T4 AWD	140		05.14										
	T4 GTDi	132		09.12										
	T5	157		03.13										
	T5	180		05.14										
	T5	187		09.12										
	T5 AWD	157		03.13										
	T5 AWD	180		05.14										
	T5 AWD	187		01.13										
VOLVO V50 (04-12)														
	1.6 D	◀ 80		04.07	05.12	03.7863-4832.4	300289					10"	ATE	
	1.6 D	◀ 81		01.05	05.12	03.0655-0007.2	370007					Wegsensor	ATE	
	1.6 i	◀ 74		01.05	05.12									
	1.8	◀ 92		04.04	05.12									
	1.8 FlexiFuel	◀ 92		04.07	05.12									
	2.0 D	◀ 100		04.04	05.12									
	2.0 FlexiFuel	◀ 107		01.10	05.12									
	2.0 i	◀ 107		10.06	05.12									
	2.4	◀ 103		04.04	05.12									
	2.4	◀ 125		04.04	05.12									
	2.4 AWD	◀ 125		08.06	05.12									
	2.4 D5	◀ 132		03.06	05.12									
	2.4 Tdi	◀ 120		05.07	05.12									
	2.5 T5	◀ 162		04.04	05.12									
	2.5 T5	◀ 169		03.07	05.12									
	2.5 T5 AWD	◀ 162		04.04	05.12									

1) + 15"/16" wheel / + ruota 15"/16" / + roue 15"/16" / + rueda 15"/16"

2) + 17" wheel / + ruota 17" / + roue 17" / + rueda 17"

VOLVO V50 (04-12)												
	2.5 T5 AWD	◀169		03.07	05.12		03.7863-4832.4	300289		10"	Wegsensor	ATE
	1.6 D	▶80		04.07	05.12		03.0655-0007.2	370007			Wegsensor	ATE
	1.6 D	▶81		01.05	05.12							
	1.6 i	▶74		01.05	05.12							
	1.8	▶92		04.04	05.12							
	1.8 FlexiFuel	▶92		04.07	05.12							
	2.0 D	▶100		04.04	05.12							
	2.0 FlexiFuel	▶107		01.10	05.12							
	2.0 i	▶107		10.06	05.12							
	2.4	▶103		04.04	05.12							
	2.4	▶125		04.04	05.12							
	2.4 AWD	▶125		08.06	05.12							
	2.4 D5	▶132		03.06	05.12							
	2.4 Tdi	▶120		05.07	05.12							
	2.5 T5	▶162		04.04	05.12							
	2.5 T5	▶169		03.07	05.12							
	2.5 T5 AWD	▶162		04.04	05.12							
	2.5 T5 AWD	▶169		03.07	05.12							
	1.6 D	◀80		04.07	05.12		03.2123-3593.3	010919			Thz 23,81	ATE
	1.6 D	◀81		01.05	05.12							
	1.6 i	◀74		01.05	05.12							
	1.8	◀92		04.04	05.12							
	1.8 FlexiFuel	◀92		04.07	05.12							
	2.0 D	◀100		04.04	05.12							
	2.0 FlexiFuel	◀107		01.10	05.12							
	2.0 i	◀107		10.06	05.12							
	2.4	◀103		04.04	05.12							
	2.4	◀125		04.04	05.12							
	2.4 AWD	◀125		08.06	05.12							
	2.4 D5	◀132		03.06	05.12							
	2.4 Tdi	◀120		05.07	05.12							
	2.5 T5	◀162		04.04	05.12							
	2.5 T5	◀169		03.07	05.12							
	2.5 T5 AWD	◀162		04.04	05.12							
	2.5 T5 AWD	◀169		03.07	05.12							
	1.6 D	80		04.07	05.12		24.3571-9813.5	240557	2	☐ - 17" Rad ¹⁾	D=57, - Halter	ATE
	1.6 D	81		01.05	05.12		24.3571-9814.5	240558		☐ - 17" Rad ¹⁾	D=57, - Halter	ATE
	1.6 D2	84		01.10	05.12		11.0230-0818.1	260135		☐ - 17" Rad ¹⁾	Halter	ATE
	1.6 i	74		01.05	05.12		11.8116-0356.1	390586			Haltefeder	ATE
	1.8	92		04.04	05.12		11.0101-5407.2	260011			Hülzensatz	ATE
	1.8 FlexiFuel	92		04.07	05.12		11.8171-0008.1	990049			Führungsbolzen	ATE
	2.0 D	100		04.04	05.12							
	2.0 D3	110		10.10	05.12							
	2.0 D4	130		10.10	05.12							
	2.0 FlexiFuel	107		01.10	05.12							
	2.0 i	107		10.06	05.12							
	2.4	103		04.04	05.12							
	2.4	125		04.04	05.12							
	2.4 AWD	125		08.06	05.12							
	2.4 D5	132		03.06	05.12							
	2.4 Tdi	120		05.07	05.12							
	2.5 T5	162		04.04	05.12							
	2.5 T5	169		03.07	05.12							
	2.5 T5 AWD	162		04.04	05.12							
	2.5 T5 AWD	169		03.07	05.12							
	1.6 D	80		04.07	05.12		11.9576-9975.2	220649	2	☐ + 17" Rad ²⁾	D=57, - Halter	ATE
	1.6 D	81		01.05	05.12		11.9576-9976.2	220650		☐ + 17" Rad ²⁾	D=57, - Halter	ATE
	1.6 D2	84		01.10	05.12		11.8116-0345.2	390596			Haltefeder	ATE
	1.6 i	74		01.05	05.12		11.0101-5407.2	260011			Hülzensatz	ATE
	1.8	92		04.04	05.12		11.8171-0008.1	990049			Führungsbolzen	ATE
	1.8 FlexiFuel	92		04.07	05.12							
	2.0 D	100		04.04	05.12							
	2.0 D3	110		10.10	05.12							
	2.0 D4	130		10.10	05.12							
	2.0 FlexiFuel	107		01.10	05.12							
	2.0 i	107		10.06	05.12							
	2.4	103		04.04	05.12							
	2.4	125		04.04	05.12							
	2.4 AWD	125		08.06	05.12							
	2.4 D5	132		03.06	05.12							
	2.4 Tdi	120		05.07	05.12							
	2.5 T5	162		04.04	05.12							
	2.5 T5	169		03.07	05.12							
	2.5 T5 AWD	162		04.04	05.12							
	2.5 T5 AWD	169		03.07	05.12							
	1.6 D	80		04.07	05.12		83.7716-0398.3	330987	2	- 17" Rad ¹⁾	L=395	
	1.6 D	81		01.05	05.12		83.7788-0414.3	330988	2	+ 17" Rad ²⁾	L=411	
	1.6 D2	84		01.10	05.12							
	1.6 i	74		01.05	05.12							
	1.8	92		04.04	05.12							
	1.8 FlexiFuel	92		04.07	05.12							
	2.0 D	100		04.04	05.12							
	2.0 D3	110		10.10	05.12							
	2.0 D4	130		10.10	05.12							
	2.0 FlexiFuel	107		01.10	05.12							
	2.0 i	107		10.06	05.12							

1) - 17" wheel / - ruota 17" / - roue 17" / - rueda 17"
2) + 17" wheel / + ruota 17" / + roue 17" / + rueda 17"

												
VOLVO V50 (04-12)												
	2.4	103		04.04	05.12	83.7716-0398.3	330987	2	- 17" Rad ¹⁾	L=395		
	2.4	125		04.04	05.12	83.7788-0414.3	330988	2	+ 17" Rad ²⁾	L=411		
	2.4 AWD	125		08.06	05.12							
	2.4 D5	132		03.06	05.12							
	2.4 Tdi	120		05.07	05.12							
	2.5 T5	162		04.04	05.12							
	2.5 T5	169		03.07	05.12							
	2.5 T5 AWD	162		04.04	05.12	83.7788-0414.3	330988	2	- 17" Rad ¹⁾	L=411		
	2.5 T5 AWD	169		03.07	05.12	83.7788-0425.3	331232	2	+ 17" Rad ²⁾	L=425		
		1.6 D	80	491291	04.07		11.9387-7015.2	220627	2		D=38, - Halter D=38, - Halter Halter Hülsensatz Führungsbolzen Haltefeder	ATE ATE ATE ATE ATE
1.6 D		81	491291	01.05		11.9387-7016.2	220628					
1.6 D2		84	491291	01.10		11.0230-0698.2	260091					
1.6 i		74	491291	01.05		11.0101-5407.2	260011					
1.8		92	491291	04.04		11.8171-0008.1	990049					
1.8 FlexiFuel		92	491291	04.07		11.8116-0340.1	390595					
2.0 D		100	491291	04.04								
2.0 D3		110	491291	10.10								
2.0 D4		130	491291	10.10								
2.0 FlexiFuel		107	491291	01.10								
2.0 i		107	491291	10.06								
2.4		103	491291	04.04								
2.4		125	491291	04.04								
2.4 AWD		125	491291	08.06								
2.4 D5		132	491291	03.06								
2.4 Tdi		120	491291	05.07								
2.5 T5		162	491291	04.04								
2.5 T5		169	491291	03.07								
2.5 T5 AWD		162	491291	04.04								
2.5 T5 AWD		169	491291	03.07								
1.6 D		80	491292		05.12		11.9387-7083.2	220959				
1.6 D		81	491292		05.12		11.9387-7084.2	220960				
1.6 D2		84	491292		05.12		11.0230-0698.2	260091				
1.6 i		74	491292		05.12		11.0101-5407.2	260011				
1.8		92	491292		05.12		11.8171-0008.1	990049				
1.8 FlexiFuel		92	491292		05.12		11.8116-0340.1	390595				
2.0 D		100	491292		05.12							
2.0 D3		110	491292		05.12							
2.0 D4		130	491292		05.12							
2.0 FlexiFuel		107	491292		05.12							
2.0 i		107	491292		05.12							
2.4		103	491292		05.12							
2.4		125	491292		05.12							
2.4 AWD		125	491292		05.12							
2.4 D5	132	491292		05.12								
2.4 Tdi	120	491292		05.12								
2.5 T5	162	491292		05.12								
2.5 T5	169	491292		05.12								
2.5 T5 AWD	162	491292		05.12								
2.5 T5 AWD	169	491292		05.12								
	1.6 D	80		04.07	05.12	83.7788-0383.3	330972	2		L=382		
	1.6 D	81		01.05	05.12							
	1.6 D2	84		01.10	05.12							
	1.6 i	74		01.05	05.12							
	1.8	92		04.04	05.12							
	1.8 FlexiFuel	92		04.07	05.12							
	2.0 D	100		04.04	05.12							
	2.0 D3	110		10.10	05.12							
	2.0 D4	130		10.10	05.12							
	2.0 FlexiFuel	107		01.10	05.12							
	2.0 i	107		10.06	05.12							
	2.4	103		04.04	05.12							
	2.4	125		04.04	05.12							
	2.4 AWD	125		08.06	05.12							
	2.4 D5	132		03.06	05.12							
	2.4 Tdi	120		05.07	05.12							
	2.5 T5	162		04.04	05.12							
	2.5 T5	169		03.07	05.12							
	2.5 T5 AWD	162		04.04	05.12	83.7788-0386.3	331231	2		L=386		
	2.5 T5 AWD	169		03.07	05.12							
VOLVO V60 (10-)												
	1.5 T2	90		01.16		03.0655-0007.2	370007		+ Kollisionswarnsystem ³⁾	Wegsensor	ATE	
	1.6 DRiVe	84		06.11								
	2.0 T	149		11.10								
	2.0 T4	140		05.15								
	2.4 D5	158		06.11								
	2.4 D5 AWD	158		06.11								
	2.4 D5 Hybrid AWD	120		03.15								
	2.4 D6 Plug-in-Hybrid	158		11.12								
	D 3	100		10.12								
	D 3	120		11.10								
	D 5	151		11.10								
	D 5 AWD	151		11.10								
	D5	169		04.14								
	D5 AWD	169		04.14								
	T 6 AWD	224		11.10								
	T3	110		11.10								

¹⁾ - 17" wheel / - ruota 17" / - roue 17" / - rueda 17"

²⁾ + 17" wheel / + ruota 17" / + roue 17" / + rueda 17"

³⁾ + collision warning system / + sistema anti-collozione / + système anticollision / + sistema anticollisión



























































































VOLVO V60 (10-)										
	D5	165		03.15	+ belüftete Scheiben ¹⁾	24.6241-1703.7	220971	<input type="checkbox"/> elektrische Feststellbremse ²⁾	D=41, - Halter	TRW
	D5	169		04.14	+ belüftete Scheiben ¹⁾	24.6241-1704.7	220972	<input type="checkbox"/> elektrische Feststellbremse ²⁾	D=41, - Halter	TRW
	D5 AWD	169		04.14	+ belüftete Scheiben ¹⁾					
	D6 Hybrid AWD	162		03.15	+ belüftete Scheiben ¹⁾					
	T 6 AWD	224		11.10	+ belüftete Scheiben ¹⁾					
	T3	110		11.10	+ belüftete Scheiben ¹⁾					
	T3	112		03.15	+ belüftete Scheiben ¹⁾					
	T4	132		11.10	+ belüftete Scheiben ¹⁾					
	T4F	132		04.11	+ belüftete Scheiben ¹⁾					
	T5	157		04.14	+ belüftete Scheiben ¹⁾					
	T5	177		11.10	+ belüftete Scheiben ¹⁾					
	T5	180		10.13	+ belüftete Scheiben ¹⁾					
	T6	225		10.13	+ belüftete Scheiben ¹⁾					
	T6 AWD	225		10.13	+ belüftete Scheiben ¹⁾					
	T6 AWD	242		04.14	+ belüftete Scheiben ¹⁾					

VOLVO V70 I (97-00)										
	2.0	93		01.97	03.00	03.7760-3602.4	300176		10"	ATE
	2.0	105		01.97	03.00					
	2.0 20V	120		01.97	03.00					
	2.0 20V	132		01.97	03.00					
	2.0 T	155		01.97	03.00					
	2.0 T	166		01.97	03.00					
	2.0 T AWD	166		01.97	03.00					
	2.3 AWD	184		04.97	09.98					
	2.3 T	184		01.97	03.00					
	2.3 T AWD	184		04.97	03.00					
	2.3 T5	176		01.97	03.00					
	2.3 T5 AWD	176		01.97	03.00					
	2.4	103		08.99	03.00					
	2.4	125		01.97	03.00					
	2.4 AWD	121		10.98	05.99					
	2.4 Bi-Fuel	103		08.99	03.00					
	2.4 T	142		01.97	03.00					
	2.5	106		01.97	03.00					
	2.5	121		06.98	03.00					
	2.5 AWD	195		03.99	03.00					
	2.5 Bi-Fuel	106		10.98	08.99					
	2.5 T AWD	142		01.97	03.00					
	2.5 TDI	103		01.97	03.00					
	2.0	93		01.97	12.98	03.2023-1084.3	010591		THz 23,81/20,64	ATE
	2.0	105		01.97	12.98					
	2.0 20V	120		01.97	12.98					
	2.0 20V	132		01.97	12.98					
	2.0 T	155		01.97	12.98					
	2.0 T	166		01.97	12.98					
	2.0 T AWD	166		01.97	12.98					
	2.3 AWD	184		04.97	09.98					
	2.3 T	184		01.97	12.98					
	2.3 T AWD	184		04.97	12.98					
	2.3 T5	176		01.97	12.98					
	2.3 T5 AWD	176		01.97	12.98					
	2.4	125		01.97	12.98					
	2.4 AWD	121		10.98	05.99					
	2.4 T	142		01.97	12.98					
	2.5	106		01.97	12.98					
	2.5	121		06.98	12.98					
	2.5 Bi-Fuel	106		10.98	12.98					
	2.5 T AWD	142		01.97	12.98					
	2.5 TDI	103		01.97	12.98					
	2.0	93		01.97	12.98	03.2023-1044.3	010590		THz 23,81/20,64	ATE
	2.0	105		01.97	12.98					
	2.0 20V	120		01.97	12.98					
	2.0 20V	132		01.97	12.98					
	2.0 T	155		01.97	12.98					
	2.0 T	166		01.97	12.98					
	2.0 T AWD	166		01.97	12.98					
	2.3 AWD	184		04.97	12.98					
	2.3 T	184		01.97	12.98					
	2.3 T AWD	184		04.97	12.98					
	2.3 T5	176		01.97	12.98					
	2.3 T5 AWD	176		01.97	12.98					
	2.4	125		01.97	12.98					
	2.4 AWD	121		10.98	12.98					
	2.4 T	142		01.97	12.98					
	2.5	106		01.97	12.98					
	2.5	121		06.98	12.98					
	2.5 Bi-Fuel	106		10.98	12.98					
	2.5 T AWD	142		01.97	12.98					
	2.5 TDI	103		01.97	12.98					
	2.0	93		01.99	03.00	03.2123-2164.3	010599		THz 23,81	ATE
	2.0	105		01.99	03.00					
	2.0 20V	120		01.99	03.00					
	2.0 20V	132		01.99	03.00					
	2.0 T	155		01.99	03.00					
	2.0 T	166		01.99	03.00					
	2.0 T AWD	166		01.99	03.00					

¹⁾ + ventilated discs / + dischi ventilati / + disques ventilés / + disco ventilado
²⁾ electric parking brake / fr.di stazionamento elettrico / frein à main électrique / freno de mano eléctrico



										
VOLVO V70 I (97-00)										
	2.3 AWD 2.3 T 2.3 T AWD 2.3 T5 2.3 T5 AWD 2.4 2.4 2.4 AWD 2.4 Bi-Fuel 2.4 T 2.5 2.5 2.5 AWD 2.5 Bi-Fuel 2.5 T AWD 2.5 TDI	184 184 176 176 103 125 121 103 142 106 121 195 106 142 103		01.99 01.99 01.99 01.99 08.99 01.99 01.99 08.99 01.99 01.99 01.99 03.99 01.99 01.99 01.99	05.99 03.00 03.00 03.00 03.00 03.00 05.99 03.00 03.00 03.00 03.00 03.00 08.99 03.00 03.00	03.2123-2164.3	010599	Thz 23,81 ATE		
	2.0 2.0 2.0 20V 2.0 20V 2.0 T 2.0 T 2.0 T AWD 2.3 AWD 2.3 T 2.3 T AWD 2.3 T5 2.3 T5 AWD 2.4 2.4 2.4 AWD 2.4 Bi-Fuel 2.4 T 2.5 2.5 2.5 AWD 2.5 Bi-Fuel 2.5 T AWD 2.5 TDI	93 105 120 132 155 166 166 184 184 176 176 103 125 121 103 142 106 121 195 106 142 103		01.97 01.97 01.97 01.97 01.97 01.97 04.97 04.97 04.97 01.97 08.99 01.97 10.98 08.99 01.97 01.97 06.98 03.99 10.98 01.97 01.97	03.00 03.00 03.00 03.00 03.00 03.00 09.98 03.00 03.00 03.00 03.00 03.00 03.00 05.99 03.00 03.00 03.00 03.00 08.99 03.00 03.00	11.9571-9971.2 11.9571-9972.2 11.0441-5702.2 11.0101-5407.2 11.8171-0008.1 11.8116-0073.1	220605 220606 250033 260011 990049 390498	                                                   	D=57, - Halter D=57, - Halter Dichtungssatz Hülssensatz Führungsbolzen Haltefeder	ATE ATE ATE ATE ATE ATE
	2.0 2.0 2.0 20V 2.0 20V 2.0 T 2.0 T 2.0 T AWD 2.3 AWD 2.3 T 2.3 T AWD 2.3 T5 2.3 T5 AWD 2.4 2.4 2.4 AWD 2.4 Bi-Fuel 2.4 T 2.5 2.5 2.5 AWD 2.5 Bi-Fuel 2.5 T AWD 2.5 TDI	93 105 120 132 155 166 166 184 184 176 176 103 125 121 103 142 106 121 195 106 142 103		01.97 01.97 01.97 01.97 01.97 01.97 04.97 04.97 04.97 01.97 08.99 01.97 10.98 08.99 01.97 01.97 06.98 03.99 10.98 01.97 01.97	03.00 03.00 03.00 03.00 03.00 03.00 09.98 03.00 03.00 03.00 03.00 03.00 03.00 05.99 03.00 03.00 03.00 03.00 03.00 08.99 03.00 03.00	83.6134-0335.3 24.5170-0361.3 83.6113-0331.3	330277 331310 330982	2 2 2	+ 15" Rad ¹⁾ + 16" Rad ²⁾ am Bremsattel ³⁾	L=335 L=361 L=330
	2.0 2.0 2.0 20V 2.0 20V 2.0 T 2.0 T 2.3 AWD 2.3 T 2.3 T5 2.4 2.4 2.4 AWD 2.4 Bi-Fuel 2.4 T 2.5 2.5 2.5 AWD 2.5 Bi-Fuel 2.5 T AWD 2.5 TDI	93 105 120 132 155 166 184 176 103 125 121 103 142 106 121 195 106 142 103		01.97 01.97 01.97 01.97 01.97 01.97 04.97 04.97 04.97 01.97 10.98 08.99 08.99 01.97 06.98 03.99 10.98 01.97 01.97	03.00 03.00 03.00 03.00 03.00 03.00 09.98 03.00 03.00 03.00 05.99 03.00 03.00 03.00 03.00 03.00 08.99 03.00 03.00	13.2381-0097.2 13.2381-0098.2 24.9238-0097.5 24.9238-0098.5 13.0441-3819.2	210239 210240 230037 230038 250072	                      	D=38 D=38 D=38 D=38 Dichtungssatz	ATE ATE ATE ATE ATE
	2.0 2.0 2.0 20V 2.0 20V 2.0 T 2.0 T 2.3 AWD	93 105 120 132 155 166	566120 566120 566120 566120 566120 566120 566120	01.97 01.97 01.97 01.97 01.97 01.97 04.97		24.5201-0204.3	331400	2	L=204	

1) + 15" wheel / + ruota 15" / + roue 15" / + rueda 15"
2) + 16" wheel / + ruota 16" / + roue 16" / + rueda 16"
3) on the brake caliper / sulla pinza freno / sur l'étrier de frein / a la pinza de freno

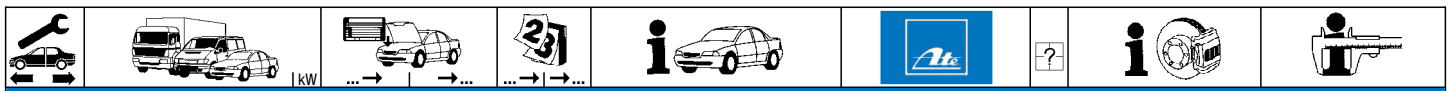

VOLVO V70 I (97-00)

	2.3 T	184	566120	01.97	24.5201-0204.3	331400	2		L=204					
	2.3 T5	176	566120	01.97										
	2.4	125	566120	01.97										
	2.4 AWD	121	566120	10.98										
	2.4 T	142	566120	01.97										
	2.5	106	566120	01.97										
	2.5	121	566120	06.98										
	2.5 Bi-Fuel	106	566120	10.98										
	2.5 TDI	103	566120	01.97										
	2.0	93	566121	03.00						83.6204-0180.3	330547	2		L=180
	2.0	105	566121	03.00										
	2.0 20V	120	566121	03.00										
	2.0 20V	132	566121	03.00										
	2.0 T	155	566121	03.00										
	2.0 T	166	566121	03.00										
2.3 AWD		566121	09.98											
2.3 T	184	566121	03.00											
2.3 T5	176	566121	03.00											
2.4	103		08.99											
2.4	125	566121	03.00											
2.4 AWD	121	566121	05.99											
2.4 Bi-Fuel	103		08.99											
2.4 T	142	566121	03.00											
2.5	106	566121	03.00											
2.5	121	566121	03.00											
2.5 Bi-Fuel	106	566121	08.99											
2.5 TDI	103	566121	03.00											
2.0 T AWD	166	528556	01.97	83.6134-0270.3	330779	2		L=270						
2.3 T AWD	184	528556	04.97											
2.3 T5 AWD	176	528556	01.97											
2.5 T AWD	142	528556	01.97											
2.0 T AWD	166	528557	587043	83.7769-0275.3	331207	2		L=275						
2.3 T AWD	184	528557	587043											
2.3 T5 AWD	176	528557	587043											
2.5 T AWD	142	528557	587043											
2.0 T AWD	166	587044	03.00	83.6134-0270.3	330779	2		L=270						
2.3 T AWD	184	587044	03.00											
2.3 T5 AWD	176	587044	03.00											
2.5 AWD	195		03.99											
2.5 T AWD	142	587044	03.00											
	2.0	93		01.97	24.3727-1308.2	581308	2		L=1670					
	2.0	105		01.97										
	2.0 20V	120		01.97										
	2.0 20V	132		01.97										
	2.0 T	155		01.97										
	2.0 T	166		01.97										
	2.3 AWD			04.97										
	2.3 T	184		01.97										
	2.3 T5	176		01.97										
	2.4	103		08.99										
	2.4	125		01.97										
	2.4 AWD	121		10.98										
	2.4 Bi-Fuel	103		08.99										
	2.4 T	142		01.97										
	2.5	106		01.97										
2.5	121		06.98											
2.5 Bi-Fuel	106		10.98											
2.5 TDI	103		01.97											
	2.0	◀ 93	395001	01.97	24.2419-0939.3	030065		- Rohrleitung 1)	Gz 19,05					
	2.0	◀ 105	395001	01.97										
	2.0 20V	◀ 120	395001	01.97										
	2.0 20V	◀ 132	395001	01.97										
	2.0 T	◀ 155	395001	01.97										
	2.0 T	◀ 166	395001	01.97										
	2.0 T AWD	◀ 166	395001	01.97										
	2.3 AWD	◀	395001	04.97										
	2.3 T	◀ 184	395001	01.97										
	2.3 T AWD	◀ 184	395001	04.97										
	2.3 T5	◀ 176	395001	01.97										
	2.3 T5 AWD	◀ 176	395001	01.97										
	2.4	◀ 125	395001	01.97										
	2.4 AWD	◀ 121	395001	10.98										
	2.4 T	◀ 142	395001	01.97										
2.5	◀ 106	395001	01.97											
2.5 T AWD	◀ 142	395001	01.97											
2.5 TDI	◀ 103	395001	01.97											
	2.0	◀ 93	395002	03.00	24.2419-1724.3	030113			Gz 19,05					
	2.0	◀ 105	395002	03.00										
	2.0 20V	◀ 120	395002	03.00										
	2.0 20V	◀ 132	395002	03.00										
	2.0 T	◀ 155	395002	03.00										
	2.0 T	◀ 166	395002	03.00										
	2.0 T AWD	◀ 166	395002	03.00										
	2.3 AWD	◀	395002	09.98										
	2.3 T	◀ 184	395002	03.00										
	2.3 T AWD	◀ 184	395002	03.00										

1) - pipe line / - tubazione / - conduite rigide / - latiguillo





VOLVO V70 I (97-00)										
	2.3 T5	176	395002		03.00	24.2419-1724.3	030113			Gz 19,05
	2.3 T5 AWD	176	395002		03.00					
	2.4	103		08.99	03.00					
	2.4	125	395002		03.00					
	2.4 AWD	121	395002		05.99					
	2.4 Bi-Fuel	103		08.99	03.00					
	2.4 T	142	395002		03.00					
	2.5	106	395002		03.00					
	2.5	121		06.98	03.00					
	2.5 AWD	195		03.99	03.00					
	2.5 Bi-Fuel	106		10.98	08.99					
	2.5 T AWD	142	395002		03.00					
	2.5 TDI	103	395002		03.00					
	2.0	93	395001	01.97		24.2522-0907.3	040043			Nz 22,20
	2.0	105	395001	01.97						
	2.0 20V	120	395001	01.97						
	2.0 20V	132	395001	01.97						
	2.4	125	395001	01.97						
	2.4 AWD	121	395001	10.98						
	2.4 T	142	395001	01.97						
	2.5	106	395001	01.97						
	2.5 T AWD	142	395001	01.97						
	2.5 TDI	103	395001	01.97						

VOLVO V70 II (00-07)											
	2.0 T	132		07.01	12.01	03.7755-3402.4	300189	- DSTC		9/8" Tandem Wegsensor	ATE
	2.3	195		10.00	12.01	03.0655-0004.2	370004				ATE
	2.3 T5	184		03.00	12.01						
	2.4			03.00	12.01						
	2.4	103		03.00	12.01						
	2.4 4X4	121		03.00	12.01						
	2.4 Bi-Fuel	103		09.01	12.01						
	2.4 D	96		12.01	12.01						
	2.4 D5	120		08.01	12.01						
	2.4 T	147		03.00	12.01						
	2.4 T AWD	147		09.01	12.01						
	2.5 TDI	103		03.00	12.01						
	2.0 T	132		01.02	07.07	03.7755-4702.4	300224	- DSTC		9/8" Tandem	ATE
	2.3	195		10.00	09.04	03.7858-3532.4	300233	+ DSTC		9/8" Tandem	ATE
	2.3 T5	184		01.02	07.07	03.0655-0001.2	370001			Wegsensor	ATE
	2.4			01.02	07.07						
	2.4	103		01.02	07.07						
	2.4 4X4	121		01.02	09.03						
	2.4 Bi-Fuel	103		01.02	07.07						
	2.4 D	93		05.05	07.07						
	2.4 D	96		01.02	07.07						
	2.4 D5	120		01.02	07.07						
	2.4 D5	136		12.05	07.07						
	2.4 D5 AWD	120		03.03	07.07						
	2.4 D5 AWD	136		12.05	07.07						
	2.4 T	147		01.02	07.07						
	2.4 T AWD	147		01.02	07.07						
	2.4 T5	191		04.04	07.07						
	2.5 R Sport	221		12.02	08.07						
	2.5 T	154		04.04	07.07						
	2.5 T AWD	154		09.02	07.07						
	2.5 TDI	103		01.02	07.07						
	R 2.5 T AWD	221		03.03	07.07						
	2.0 T	132		01.05	07.07	03.0655-0001.2	370001			Wegsensor	ATE
	2.3 T5	184		01.05	07.07						
	2.4			01.05	07.07						
	2.4	103		01.05	07.07						
	2.4 Bi-Fuel	103		01.05	07.07						
	2.4 D	93		05.05	07.07						
	2.4 D	96		01.05	07.07						
	2.4 D5	120		01.05	07.07						
	2.4 D5	136		12.05	07.07						
	2.4 D5 AWD	120		01.05	07.07						
	2.4 D5 AWD	136		12.05	07.07						
	2.4 T	147		01.05	07.07						
	2.4 T AWD	147		01.05	07.07						
	2.4 T5	191		01.05	07.07						
	2.5 T	154		01.05	07.07						
	2.5 T AWD	154		01.05	07.07						
	2.5 TDI	103		01.05	07.07						
	R 2.5 T AWD	221		01.05	07.07						
	2.0 T	132	68132	07.01		03.2125-7637.3	010707	- DSTC		Thz 25,40	ATE
	2.3	195	68132	10.00							
	2.3 T5	184	68132	03.00							
	2.4		68132	03.00							
	2.4	103	68132	03.00							
	2.4 4X4	121	68132	03.00							
	2.4 Bi-Fuel	103	68132	09.01							
	2.4 D	96	68132	12.01							
	2.4 D5	120	68132	08.01							
	2.4 T	147	68132	03.00							
	2.4 T AWD	147	68132	09.01							

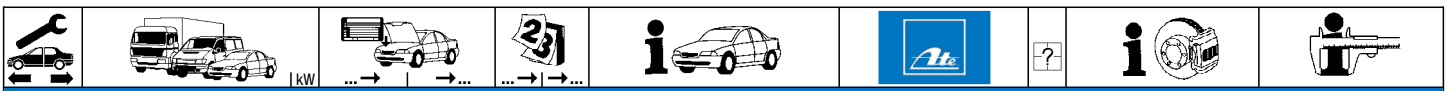

VOLVO V70 II (00-07)

	2.5 TDI	103	68132	03.00		03.2125-7637.3	010707	- DSTC	THz 25,40	ATE
	2.0 T	132 68133				03.2125-7743.3	010921	- DSTC	THz 25,40	ATE
	2.3	195 68133								
	2.3 T5	184 68133								
	2.4	68133								
	2.4	103 68133								
	2.4 4X4	121 68133								
	2.4 Bi-Fuel	103 68133								
	2.4 D	93		05.05						
	2.4 D	96 68133								
	2.4 D5	120 68133								
	2.4 D5	136		12.05						
	2.4 D5 AWD	120		03.03						
	2.4 D5 AWD	136		12.05						
	2.4 T	147 68133								
	2.4 T AWD	147 68133								
	2.4 T5	191		04.04						
	2.5 T	154		04.04						
	2.5 T AWD	154		09.02						
	2.5 TDI	103 68133								
	R 2.5 T AWD	221		03.03						
	2.0 T	132	70377	07.01		03.2125-7708.3	010739	+ DSTC	THz 25,40	ATE
	2.3	195	70377	10.00						
	2.3 T5	184	70377	03.00						
	2.4	68133	70377	03.00						
	2.4	103	70377	03.00						
	2.4 4X4	121	70377	03.00						
	2.4 Bi-Fuel	103	70377	09.01						
	2.4 D	96	70377	12.01						
	2.4 D5	120	70377	08.01						
	2.4 T	147	70377	03.00						
	2.4 T AWD	147	70377	09.01						
	2.5 TDI	103	70377	03.00						
	2.0 T	132 70378		07.07		03.2125-7713.3	010819	+ DSTC	THz 25,40	ATE
	2.3	195 70378		09.04						
	2.3 T5	184 70378		07.07						
	2.4	70378		07.07						
	2.4	103 70378		07.07						
	2.4 4X4	121 70378		09.03						
	2.4 Bi-Fuel	103 70378		07.07						
	2.4 D	93		05.05						
	2.4 D	96 70378		07.07						
	2.4 D5	120 70378		07.07						
	2.4 D5	136		12.05						
	2.4 D5 AWD	120		03.03						
	2.4 D5 AWD	136		12.05						
	2.4 T	147 70378		07.07						
	2.4 T AWD	147 70378		07.07						
	2.4 T5	191		04.04						
	2.5 R Sport	221		12.02						
	2.5 T	154		04.04						
	2.5 T AWD	154		09.02						
	2.5 TDI	103 70378		07.07						
	R 2.5 T AWD	221		03.03						
	2.0 T	132 68133		07.07		03.2125-7638.3	010738	- DSTC	THz 25,40	ATE
	2.3	195 68133		09.04						
	2.3 T5	184 68133		07.07						
	2.4	68133		07.07						
	2.4	103 68133		07.07						
	2.4 4X4	121 68133		09.03						
	2.4 Bi-Fuel	103 68133		07.07						
	2.4 D	93		05.05						
	2.4 D	96 68133		07.07						
	2.4 D5	120 68133		07.07						
	2.4 D5	136		12.05						
	2.4 D5 AWD	120 68133		07.07						
	2.4 D5 AWD	136		12.05						
	2.4 T	147 68133		07.07						
	2.4 T AWD	147 68133		07.07						
	2.4 T5	191		04.04						
	2.5 T	154		04.04						
	2.5 T AWD	154		09.02						
	2.5 TDI	103 68133		07.07						
	2.0 T	132	67770	07.01		03.2125-7637.3	010707	+ DSTC	THz 25,40	ATE
	2.3	195	67770	10.00						
	2.3 T5	184	67770	03.00						
	2.4	67770	67770	03.00						
	2.4	103	67770	03.00						
	2.4 4X4	121	67770	03.00						
	2.4 Bi-Fuel	103	67770	09.01						
	2.4 D	96	67770	12.01						
	2.4 D5	120	67770	08.01						
	2.4 T	147	67770	03.00						
	2.4 T AWD	147	67770	09.01						
	2.5 TDI	103	67770	03.00						
	2.0 T	132 67771		07.07		03.2125-7638.3	010738	+ DSTC	THz 25,40	ATE





VOLVO V70 II (00-07)											
	2.5 T	154		04.04	07.07	83.6113-0321.3	330621	2	- 17" Rad 1)	L=320	
	2.5 T AWD	154		09.02	07.07	83.6124-0304.3	330983	2	+ 17" Rad 2)	L=300	
	2.5 TDI	103		03.00	07.07						
	2.0 T	132		07.01	07.07	11.9421-9979.2	220497			D=42, - Halter	ATE
	2.3	195		10.00	09.04	11.9421-9980.2	220498			D=42, - Halter	ATE
	2.3 T5	184		03.00	07.07	24.3421-9979.5	240475			D=42, - Halter	ATE
	2.4			03.00	07.07	24.3421-9980.5	240476			D=42, - Halter	ATE
	2.4	103		03.00	07.07	11.0101-5407.2	260011			Hülzensatz	ATE
	2.4 4X4	121		03.00	09.03	11.8171-0008.1	990049			Führungsbolzen	ATE
	2.4 Bi-Fuel	103		09.01	07.07	11.8116-0236.1	390507	2		Haltefeder	ATE
	2.4 D	93		05.05	07.07						
	2.4 D	96		12.01	07.07						
	2.4 D5	120		08.01	07.07						
	2.4 D5	136		12.05	07.07						
	2.4 D5 AWD	120		03.03	07.07						
	2.4 D5 AWD	136		12.05	07.07						
	2.4 T	147		03.00	07.07						
	2.4 T AWD	147		09.01	07.07						
	2.4 T5	191		04.04	07.07						
	2.5 T	154		04.04	07.07						
	2.5 T AWD	154		09.02	07.07						
	2.5 TDI	103		01.03	07.07						
	2.0 T	132		07.01	07.07	83.7724-0268.3	331076	2		L=265	
	2.3	195		10.00	09.04						
	2.3 T5	184		03.00	07.07						
	2.4			03.00	07.07						
	2.4	103		03.00	07.07						
	2.4 4X4	121		03.00	09.03						
	2.4 Bi-Fuel	103		09.01	07.07						
	2.4 D	93		05.05	07.07						
	2.4 D	96		12.01	07.07						
	2.4 D5	120		08.01	07.07						
	2.4 D5	136		12.05	07.07						
	2.4 D5 AWD	120		03.03	07.07						
	2.4 D5 AWD	136		12.05	07.07						
	2.4 T	147		03.00	07.07						
	2.4 T AWD	147		09.01	07.07						
	2.4 T5	191		04.04	07.07						
	2.5 T	154		04.04	07.07						
	2.5 T AWD	154		09.02	07.07						
	2.5 TDI	103		03.00	07.07						
	2.0 T	132		07.01	07.07	24.3727-1303.2	581303	2	- (GM) (USA)	L=1962	
	2.3	195		10.00	09.04						
	2.3 T5	184		03.00	07.07						
	2.4			03.00	07.07						
	2.4	103		03.00	07.07						
	2.4 4X4	121		03.00	09.03						
	2.4 D	93		05.05	07.07						
	2.4 D	96		12.01	07.07						
	2.4 D5	120		08.01	07.07						
	2.4 D5	136		12.05	07.07						
	2.4 T	147		03.00	07.07						
	2.4 T5	191		04.04	07.07						
	2.5 R Sport	221		12.02	08.07						
	2.5 T	154		04.04	07.07						
	2.5 TDI	103		03.00	07.07						

VOLVO V70 III (07-)											
	1.6 T4F	132	213000	01.11		03.7755-9703.4	300239		- Kollisionswarnsystem 3)	9/8" Tandem	ATE
	2.0 BiFuel	157	213000	03.13		03.7858-5032.4	300275		+ Kollisionswarnsystem 4)	9/8" Tandem	ATE
	2.0 D3	100	213000	05.12		03.0655-0007.2	370007		+ Kollisionswarnsystem 4)	Wegsensor	ATE
	2.0 D3	120	213000	03.10							
	2.4 D	120	213000	08.07							
	2.4 D	129	213000	10.09							
	2.4 D5	136	213000	08.07							
	2.4 D5	151	213000	12.09							
	2.4 D5	158	213000	06.11							
	2.4 D5 AWD	136	213000	10.07							
	2.4 D5 AWD	151	213000	12.09							
	2.4 D5 AWD	158	213000	06.11							
	2.5 T	147	213000	08.07							
	2.5 T	170	213000	10.09							
	2.5 T FlexiFuel	147	213000	04.08							
	2.5 T FlexiFuel	170	213000	10.09							
	3.0 T6 AWD	210	213000	08.07							
	3.0 T6 AWD	224	213000	04.11							
	3.2	175	213000	08.07							
	3.2 AWD	175	213000	08.07							
	T4	132	213000	10.10							
	T5	180		10.13							
	1.6 T4F	132	213001			03.0655-0007.2	370007		+ Kollisionswarnsystem 4)	Wegsensor	ATE
	2.0 BiFuel	157		03.13							
	2.0 D3	100	213001								
	2.0 D3	120	213001								
	2.0 D4	120		01.13							
	2.0 GDI	157		03.13							
	2.4 D	120	213001								

1) - 17" wheel / - ruota 17" / - roue 17" / - rueda 17"

2) + 17" wheel / + ruota 17" / + roue 17" / + rueda 17"

3) - collision warning system / - sistema anti-collozione / - système anticollision / - sistema anticollisión

4) + collision warning system / + sistema anti-collozione / + système anticollision / + sistema anticollisión





VOLVO V70 III (07-)

	2.5 T	147	08.07	+ Bremsscheibendurchm. 316mm ¹⁾	11.9606-9949.2	220879	2		D=60, - Halter ATE D=60, - Halter ATE Haltefeder ATE Führungsbolzen ATE Hülzensatz ATE Dichtungssatz ATE			
	2.5 T	170	10.09	+ Bremsscheibendurchm. 316mm ¹⁾	11.9606-9950.2	220880						
	2.5 T FlexiFuel	147	04.08	+ Bremsscheibendurchm. 316mm ¹⁾	11.8116-0388.2	390588						
	2.5 T FlexiFuel	170	10.09	+ Bremsscheibendurchm. 316mm ¹⁾	11.8171-0008.1	990049						
	3.0 T6 AWD	210	08.07	+ Bremsscheibendurchm. 316mm ¹⁾	11.0101-5704.2	260095						
	3.0 T6 AWD	224	04.11	+ Bremsscheibendurchm. 316mm ¹⁾	11.0441-6008.2	250038						
	3.2	175	08.07	+ Bremsscheibendurchm. 316mm ¹⁾								
	3.2 AWD	175	08.07	+ Bremsscheibendurchm. 316mm ¹⁾								
	D2	88	03.15	+ Bremsscheibendurchm. 316mm ¹⁾								
	D3	110	03.15	+ Bremsscheibendurchm. 316mm ¹⁾								
	D4	133	10.13	+ Bremsscheibendurchm. 316mm ¹⁾								
	D4 AWD	133	10.13	+ Bremsscheibendurchm. 316mm ¹⁾								
	T4	132	10.10	+ Bremsscheibendurchm. 316mm ¹⁾								
	T4	140	03.15	+ Bremsscheibendurchm. 316mm ¹⁾								
	T5	177	01.10	+ Bremsscheibendurchm. 316mm ¹⁾								
	T5	180	10.13	+ Bremsscheibendurchm. 316mm ¹⁾								
	1.6 DRIVE		01.10	+ Bremsscheibendurchm. 336 mm ²⁾	11.9606-9945.2	220727				2		D=60, - Halter ATE D=60, - Halter ATE Haltefeder ATE Hülzensatz ATE Führungsbolzen ATE Dichtungssatz ATE
	1.6 T4F	132	01.11	+ Bremsscheibendurchm. 336 mm ²⁾	11.9606-9946.2	220728						
	2.0	107	10.07	+ Bremsscheibendurchm. 336 mm ²⁾	11.8116-0388.2	390588						
	2.0 BiFuel	157	03.13	+ Bremsscheibendurchm. 336 mm ²⁾	11.0101-5704.2	260095						
2.0 D	100	10.07	+ Bremsscheibendurchm. 336 mm ²⁾	11.8171-0008.1	990049							
2.0 D3	100	05.12	+ Bremsscheibendurchm. 336 mm ²⁾	11.0441-6008.2	250038							
2.0 D3	120	03.10	+ Bremsscheibendurchm. 336 mm ²⁾									
2.0 D4	120	01.13	+ Bremsscheibendurchm. 336 mm ²⁾									
2.0 FlexiFuel	107	09.07	+ Bremsscheibendurchm. 336 mm ²⁾									
2.0 GDI	157	03.13	+ Bremsscheibendurchm. 336 mm ²⁾									
2.0 T	149	01.10	+ Bremsscheibendurchm. 336 mm ²⁾									
2.4 D	120	08.07	+ Bremsscheibendurchm. 336 mm ²⁾									
2.4 D	129	10.09	+ Bremsscheibendurchm. 336 mm ²⁾									
2.4 D4 AWD	120	01.13	+ Bremsscheibendurchm. 336 mm ²⁾									
2.4 D5	136	08.07	+ Bremsscheibendurchm. 336 mm ²⁾									
2.4 D5	151	12.09	+ Bremsscheibendurchm. 336 mm ²⁾									
2.4 D5	158	06.11	+ Bremsscheibendurchm. 336 mm ²⁾									
2.4 D5 AWD	136	10.07	+ Bremsscheibendurchm. 336 mm ²⁾									
2.4 D5 AWD	151	12.09	+ Bremsscheibendurchm. 336 mm ²⁾									
2.4 D5 AWD	158	06.11	+ Bremsscheibendurchm. 336 mm ²⁾									
2.5 T	147	08.07	+ Bremsscheibendurchm. 336 mm ²⁾									
2.5 T	170	10.09	+ Bremsscheibendurchm. 336 mm ²⁾									
2.5 T FlexiFuel	147	04.08	+ Bremsscheibendurchm. 336 mm ²⁾									
2.5 T FlexiFuel	170	10.09	+ Bremsscheibendurchm. 336 mm ²⁾									
3.0 T6 AWD	210	08.07	+ Bremsscheibendurchm. 336 mm ²⁾									
3.0 T6 AWD	224	04.11	+ Bremsscheibendurchm. 336 mm ²⁾									
3.2	175	08.07	+ Bremsscheibendurchm. 336 mm ²⁾									
3.2 AWD	175	08.07	+ Bremsscheibendurchm. 336 mm ²⁾									
D2	88	03.15	+ Bremsscheibendurchm. 336 mm ²⁾									
D3	110	03.15	+ Bremsscheibendurchm. 336 mm ²⁾									
D4	133	10.13	+ Bremsscheibendurchm. 336 mm ²⁾									
D4 AWD	133	10.13	+ Bremsscheibendurchm. 336 mm ²⁾									
T4	132	10.10	+ Bremsscheibendurchm. 336 mm ²⁾									
T4	140	03.15	+ Bremsscheibendurchm. 336 mm ²⁾									
T5	177	01.10	+ Bremsscheibendurchm. 336 mm ²⁾									
T5	180	10.13	+ Bremsscheibendurchm. 336 mm ²⁾									
	1.6 DRIVE		01.10		24.5162-0390.3	331199	2		L=390 L=375			
	1.6 T4F	132	01.11		24.5162-0375.3	331203						
	2.0	107	10.07									
	2.0 BiFuel	157	03.13									
	2.0 D	100	10.07									
	2.0 D3	100	05.12									
	2.0 D3	120	03.10									
	2.0 D4	120	01.13									
	2.0 FlexiFuel	107	09.07									
	2.0 GDI	157	03.13									
	2.0 T	149	01.10									
	2.4 D	120	08.07									
	2.4 D	129	10.09									
	2.4 D4 AWD	120	01.13									
	2.4 D5	136	08.07									
	2.4 D5	151	12.09									
	2.4 D5	158	06.11									
	2.4 D5 AWD	136	10.07									
	2.4 D5 AWD	151	12.09									
	2.4 D5 AWD	158	06.11									
2.5 T	147	08.07										
2.5 T	170	10.09										
2.5 T FlexiFuel	147	04.08										
2.5 T FlexiFuel	170	10.09										
3.0 T6 AWD	210	08.07										
3.0 T6 AWD	224	04.11										
3.2	175	08.07										
3.2 AWD	175	08.07										
D2	88	03.15										
D3	110	03.15										
D4	133	10.13										
D4 AWD	133	10.13										
T4	132	10.10										
T4	140	03.15										
T5	177	01.10										













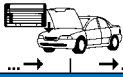



¹⁾ + brake disc diameter 316mm / + diametro dischi freno 316mm / + diamètre disques frein 316mm / + diámetro disco freno 316mm

²⁾ + brake disc diameter 336mm / + diametro dischi freno 336mm / + diamètre disques frein 336mm / + diámetro disco freno 336mm

³⁾ + 16" wheel / + ruota 16" / + roue 16" / + rueda 16"

⁴⁾ + 17"/18" wheel / + ruota 17"/18" / + roue 17"/18" / + rueda 17"/18"



VOLVO V70 III (07-)											
		kw									
	T5	180		10.13		24.5162-0390.3 24.5162-0375.3	331199 331203	2 2	+ 16" Rad ¹⁾ + 17"/18" Rad ²⁾	L=390 L=375	
	1.6 DRIVE 2.0 2.0 BiFuel 2.0 D 2.0 FlexiFuel 2.0 GDI 2.0 T 2.4 D 2.4 D 2.4 D5 2.4 D5 AWD 2.4 D5 AWD 2.5 T 2.5 T 2.5 T FlexiFuel 2.5 T FlexiFuel 3.0 T6 AWD 3.2 3.2 AWD T5	107 157 100 107 157 149 120 129 136 151 136 151 147 170 147 170 210 175 175 177		01.10 10.07 03.13 10.07 09.07 03.13 01.10 08.07 10.09 08.07 12.09 10.07 12.09 08.07 10.09 04.08 10.09 08.07 08.07 01.10		24.6238-1703.7 24.6238-1704.7	220967 220968		 - belüftete Scheiben ³⁾  - belüftete Scheiben ³⁾	D=38, - Halter D=38, - Halter	TRW TRW
	1.6 DRIVE 1.6 T4F 2.0 2.0 BiFuel 2.0 D 2.0 D3 2.0 D3 2.0 D4 2.0 FlexiFuel 2.0 GDI 2.0 T 2.4 D 2.4 D 2.4 D4 AWD 2.4 D5 2.4 D5 2.4 D5 AWD 2.4 D5 AWD 2.4 D5 AWD 2.4 D5 AWD 2.5 T 2.5 T 2.5 T FlexiFuel 2.5 T FlexiFuel 3.0 T6 AWD 3.0 T6 AWD 3.2 3.2 AWD D2 D3 D4 D4 AWD T4 T4 T5 T5	132 107 157 100 100 120 120 107 157 149 120 129 120 136 151 158 136 151 158 147 170 147 170 210 224 175 175 88 110 133 133 132 140 177 180		01.10 01.11 10.07 03.13 10.07 05.12 03.10 01.13 09.07 03.13 01.10 08.07 10.09 01.13 08.07 12.09 06.11 10.07 12.09 06.11 08.07 10.09 04.08 10.09 08.07 04.11 08.07 03.15 03.15 10.13 10.13 10.10 03.15 01.10 10.13		24.6241-1703.7 24.6241-1704.7	220971 220972		 + belüftete Scheiben ⁴⁾  + belüftete Scheiben ⁴⁾	D=41, - Halter D=41, - Halter	TRW TRW
	1.6 DRIVE 1.6 T4F 2.0 2.0 D 2.0 D3 2.0 D3 2.0 D4 2.0 FlexiFuel 2.0 T 2.4 D 2.4 D 2.4 D4 AWD 2.4 D5 2.4 D5 2.4 D5 AWD 2.4 D5 AWD 2.4 D5 AWD 2.5 T 2.5 T 2.5 T FlexiFuel 2.5 T FlexiFuel 3.0 T6 AWD 3.0 T6 AWD 3.2 3.2 AWD T4 T4	▶132 ▶107 ▶100 ▶100 ▶120 ▶120 ▶107 ▶149 ▶120 ▶129 ▶120 ▶136 ▶151 ▶158 ▶136 ▶151 ▶158 ▶147 ▶170 ▶147 ▶170 ▶210 ▶224 ▶175 ▶175 ▶132	24894 24894	01.10 01.11 10.07 10.07 05.12 03.10 01.13 09.07 01.10 08.07 10.09 01.13 08.07 12.09 10.07 12.09 06.11 08.07 10.09 04.08 10.09 08.07 04.11 08.07 03.15 03.15 10.13 10.13 10.10		24.5162-0185.3	331202	2	+ mechanische Feststellbremse ⁵⁾	L=185	

¹⁾ + 16" wheel / + ruota 16" / + roue 16" / + rueda 16"

²⁾ + 17"/18" wheel / + ruota 17"/18" / + roue 17"/18" / + rueda 17"/18"

³⁾ - ventilated discs / - dischi ventilati / - disques ventilés / - disco ventilado

⁴⁾ + ventilated discs / + dischi ventilati / + disques ventilés / + disco ventilado

⁵⁾ + mechanical parking brake / + fr. stazionamento meccanico / + frein à main mécanique / + freno de mano mecánica

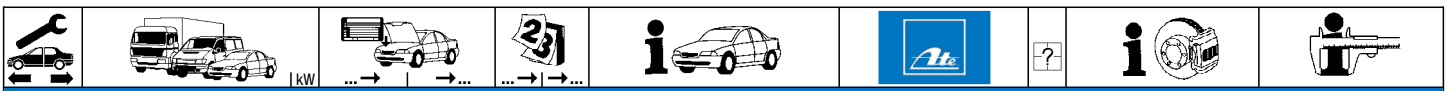













VOLVO V70 III (07-)

	T5	▶177	24894	01.10		24.5162-0185.3	331202	2 + mechanische Feststellbremse ¹⁾ L=185
	1.6 DRIVE	▶ 24895				24.5162-0185.3	331202	2 + mechanische Feststellbremse ¹⁾ L=185
	1.6 T4F	▶132 24895						
	2.0	▶107 24895						
	2.0 D	▶100 24895						
	2.0 D3	▶100 24895						
	2.0 D3	▶120 24895						
	2.0 D4	▶120 24895						
	2.0 FlexiFuel	▶107 24895						
	2.0 T	▶149 24895						
	2.4 D	▶120 24895						
	2.4 D	▶129 24895						
	2.4 D4 AWD	▶120 24895						
	2.4 D5	▶136 24895						
	2.4 D5	▶151 24895						
	2.4 D5 AWD	▶136 24895						
	2.4 D5 AWD	▶151 24895						
	2.4 D5 AWD	▶158 24895						
	2.4 D5 AWD	▶158 24895						
	2.5 T	▶147 24895						
	2.5 T	▶170 24895						
	2.5 T FlexiFuel	▶147 24895						
	2.5 T FlexiFuel	▶170 24895						
	3.0 T6 AWD	▶210 24895						
	3.0 T6 AWD	▶224 24895						
	3.2	▶175 24895						
	3.2 AWD	▶175 24895						
	T4	▶132 24895						
	T5	▶177 24895						
	1.6 DRIVE	◀		01.10		24.5162-0185.3	331202	2 + mechanische Feststellbremse ¹⁾ L=185
	1.6 T4F	◀132		01.10				
	2.0	◀107		10.07				
	2.0 BiFuel	◀157		03.13				
	2.0 D	◀100		10.07				
	2.0 D3	◀100		05.12				
	2.0 D3	◀120		03.10				
	2.0 D4	◀120		01.13				
	2.0 FlexiFuel	◀107		09.07				
	2.0 GDI	◀157		03.13				
	2.0 T	◀149		01.10				
	2.4 D	◀120		08.07				
	2.4 D	◀129		10.09				
	2.4 D4 AWD	◀120		01.13				
	2.4 D5	◀136		08.07				
	2.4 D5	◀151		12.09				
	2.4 D5	◀158		06.11				
	2.4 D5 AWD	◀136		10.07				
	2.4 D5 AWD	◀151		12.09				
	2.4 D5 AWD	◀158		06.11				
	2.5 T	◀147		08.07				
	2.5 T	◀170		10.09				
	2.5 T FlexiFuel	◀147		04.08				
	2.5 T FlexiFuel	◀170		10.09				
	3.0 T6 AWD	◀210		08.07				
	3.0 T6 AWD	◀224		04.11				
	3.2	◀175		08.07				
	3.2 AWD	◀175		08.07				
	D2	◀ 88		03.15				
	D3	◀110		03.15				
	D4	133		10.13				
	D4 AWD	133		10.13				
	T4	◀132		10.10				
	T4	◀140		03.15				
	T5	◀177		01.10				
	T5	180		10.13				
	1.6 DRIVE		24894	01.10		24.5133-0310.3	331197	☐ + elektrische Feststellbremse ²⁾ L=310
	1.6 T4F	132	24894	01.11				
	2.0	107	24894	10.07				
	2.0 BiFuel	157	24894	03.13				
	2.0 D	100	24894	10.07				
	2.0 D3	100	24894	05.12				
	2.0 D3	120	24894	03.10				
	2.0 D4	120	24894	01.13				
	2.0 FlexiFuel	107	24894	09.07				
	2.0 GDI	157	24894	03.13				
	2.0 T	149	24894	01.10				
	2.4 D	120	24894	08.07				
	2.4 D	129	24894	10.09				
	2.4 D4 AWD	120	24894	01.13				
	2.4 D5	136	24894	08.07				
	2.4 D5	151	24894	12.09				
	2.4 D5	158	24894	06.11				
	2.4 D5 AWD	136	24894	10.07				
	2.4 D5 AWD	151	24894	12.09				
	2.4 D5 AWD	158	24894	06.11				
	2.5 T	147	24894	08.07				
	2.5 T	170	24894	10.09				

¹⁾ + mechanical parking brake / + fr. stazionamento meccanico / + frein à main mécanique / + freno de mano mecánica

²⁾ + electric parking brake / + freno a mano elettrico / + frein à main électrique / + freno de mano eléctrico















VOLVO V70 III (07-)		VOLVO V90 I (97-98)		VOLVO XC60 (08-)					
	2.5 T FlexiFuel	147	24894	04.08	24.5133-0310.3	331197		+ elektrische Feststellbremse ¹⁾	L=310
	2.5 T FlexiFuel	170	24894	10.09					
	3.0 T6 AWD	210	24894	08.07					
	3.0 T6 AWD	224	24894	04.11					
	3.2	175	24894	08.07					
	3.2 AWD	175	24894	08.07					
	T4	132	24894	10.10					
	T5	177	24894	01.10					
	1.6 DRIVE	24895	125608		24.5133-0311.3	331198		+ elektrische Feststellbremse ¹⁾	L=310
	1.6 T4F	132 24895	125608						
	2.0	107 24895	125608						
	2.0 BiFuel	157 24895	125608						
	2.0 D	100 24895	125608						
	2.0 D3	100 24895	125608						
	2.0 D3	120 24895	125608						
	2.0 D4	120 24895	125608						
	2.0 FlexiFuel	107 24895	125608						
	2.0 GDI	157 24895	125608						
	2.0 T	149 24895	125608						
	2.4 D	120 24895	125608						
	2.4 D	129 24895	125608						
	2.4 D4 AWD	120 24895	125608						
	2.4 D5	136 24895	125608						
	2.4 D5	151 24895	125608						
	2.4 D5	158 24895	125608						
	2.4 D5 AWD	136 24895	125608						
	2.4 D5 AWD	151 24895	125608						
	2.4 D5 AWD	158 24895	125608						
	2.5 T	147 24895	125608						
	2.5 T	170 24895	125608						
	2.5 T FlexiFuel	147 24895	125608						
	2.5 T FlexiFuel	170 24895	125608						
	3.0 T6 AWD	210 24895	125608						
	3.0 T6 AWD	224 24895	125608						
	3.2	175 24895	125608						
	3.2 AWD	175 24895	125608						
	T4	132 24895	125608						
	T5	177 24895	125608						
	2.5	125		11.96 10.98	03.2023-0875.3	010890			Thz 23,81/20,64 - B. ATE
	2.5	132		11.96 10.97					
	2.9	132		01.97 12.98					
	2.9	150		01.97 12.98					
	2.5	125		11.96 10.98	24.3571-1707.5	240079			D=57, - Halter TRW
	2.5	132		11.96 10.97	24.3571-1708.5	240080			D=57, - Halter TRW
	2.9	132		01.97 12.98	24.0101-3601.2	260044			Bremssattel-Zubehör TRW
	2.9	150		01.97 12.98					
	2.5	125		11.96 10.98	83.6124-0380.3	330268	2		L=380
	2.5	132		11.96 10.97					
	2.9	132		01.97 12.98					
	2.9	150		01.97 12.98					
	2.5	125		11.96 10.98	83.6134-0300.3	330725	2		L=300
	2.5	132		11.96 10.97					
	2.9	132		01.97 12.98					
	2.9	150		01.97 12.98					
	2.5	125		11.96 10.98	03.6055-0430.3	320065			BR 5/25 (4) ATE
	2.5	132		11.96 10.97					
	2.9	132		01.97 12.98					
	2.9	150		01.97 12.98					
	2.5	◀125		11.96 10.98	24.2419-0941.3	030067			Gz 19,05
	2.5	◀132		11.96 10.97					
	2.9	◀132		01.97 12.98					
	2.9	◀150		01.97 12.98					
	2.5	▶125		11.96 10.98	24.2419-0928.3	030056			Gz 19,05
	2.5	▶132		11.96 10.97					
	2.9	▶132		01.97 12.98					
	2.9	▶150		01.97 12.98					
	2.5	125		11.96 10.98	03.2522-0420.3	040086			Nz 22,20
	2.5	132		11.96 10.97					
	2.9	132		01.97 12.98					
	2.9	150		01.97 12.98					
VOLVO XC60 (08-)									
	2.0 D3 DRIVE	120		03.10	03.7755-0132.4	300265		- Kollisionswarnsystem ²⁾	9/8" Tandem ATE
	2.4 D	120		07.09	03.7858-5132.4	300276		+ Kollisionswarnsystem ³⁾	9/8" Tandem ATE
	2.4 D	129		04.09	03.0655-0007.2	370007		+ Kollisionswarnsystem ³⁾	Wegsensor ATE
	2.4 D AWD	120		09.08					
	2.4 D AWD	129		06.09					
	2.4 D5	158		06.11					
	2.4 D5 AWD	136		09.08					
	2.4 D5 AWD	151		04.09					
	2.4 D5 AWD	158	236999	06.11					
	3.0 T6 AWD	210		09.08					
	3.0 T6 AWD	224	236999	03.10					
	3.2 AWD	175		04.09					



































¹⁾ + electric parking brake / + freno a mano elettrico / + frein à main électrique / + freno de mano eléctrico

²⁾ - collision warning system / - sistema anti-collozione / - système anticollision / - sistema anticollisión

³⁾ + collision warning system / + sistema anti-collozione / + système anticollision / + sistema anticollisión

											
VOLVO XC60 (08-)											
	3.2 AWD	179	236999	03.10	03.7755-0132.4	300265	- Kollisionswarnsystem ¹⁾	9/8" Tandem	ATE		
	D4 AWD	133	236999	10.13	03.7858-5132.4	300276	+ Kollisionswarnsystem ²⁾	9/8" Tandem	ATE		
	D4 AWD	140	236999	03.15	03.0655-0007.2	370007	+ Kollisionswarnsystem ²⁾	Wegsensor	ATE		
	D5 AWD	162	236999	03.15							
	D5 AWD	169	236999	04.14							
	T6 AWD	242	236999	04.14							
	2.0 T	149		03.10	03.0655-0007.2	370007	+ Kollisionswarnsystem ²⁾	Wegsensor	ATE		
	T5	177		09.10							
	T5 AWD	187		04.14							
	2.4 D5 AWD	158 237000			03.0655-0007.2	370007	+ Kollisionswarnsystem ²⁾	Wegsensor	ATE		
	3.0 T6 AWD	224 237000									
	3.2 AWD	179 237000									
	D5 AWD	169 237000									
	D3	110		03.15	03.7755-0132.4	300265	- Kollisionswarnsystem ¹⁾	9/8" Tandem	ATE		
D4	133		10.13	03.0655-0007.2	370007	+ Kollisionswarnsystem ²⁾	Wegsensor	ATE			
D4	140		03.15								
D4 AWD	133 237000										
D4 AWD	140 237000										
D5 AWD	162 237000										
T6 AWD	242 237000										
T5	180		10.13	03.7755-9703.4	300239	- Kollisionswarnsystem ¹⁾	9/8" Tandem	ATE			
T5 AWD	180		10.13	03.0655-0007.2	370007	+ Kollisionswarnsystem ²⁾	Wegsensor	ATE			
T6	225		10.13								
T6 AWD	225		10.13								
	2.0 D3	100		04.12	11.0101-7003.2	260124	2	Hülsensatz Haltefeder Führungsbolzen	ATE		
	2.0 D3 DRIVe	120		03.10	11.8116-0133.1	390511			ATE		
	2.0 T	149		03.10	11.8171-0096.1	250155			ATE		
	2.4 D	120		07.09							
	2.4 D	129		04.09							
	2.4 D AWD	120		09.08							
	2.4 D AWD	129		06.09							
	2.4 D5	158		06.11							
	2.4 D5 AWD	136		09.08							
	2.4 D5 AWD	151		04.09							
	2.4 D5 AWD	158		06.11							
	3.0 T6 AWD	210		09.08							
	3.0 T6 AWD	224		03.10							
	3.2 AWD	175		04.09							
	3.2 AWD	179		03.10							
	D4	133		10.13							
	D4 AWD	133		10.13							
	D5 AWD	169		04.14							
	T5	177		09.10							
	T5	180		10.13							
	T5 AWD	180		10.13							
	T5 AWD	187		04.14							
	T6	225		10.13							
	T6 AWD	225		10.13							
	T6 AWD	242		04.14							
	D3	110		03.15	11.8171-0096.1	250155				Führungsbolzen	ATE
	D4	140		03.15							
	D4 AWD	140		03.15							
D5 AWD	162		03.15								
	2.0 D3	100		04.12	24.6241-1703.7	220971	+ belüftete Scheiben ³⁾	D=41, - Halter	TRW		
	2.0 D3 DRIVe	120		03.10	24.6241-1704.7	220972	+ belüftete Scheiben ³⁾	D=41, - Halter	TRW		
	2.0 T	149		03.10							
	2.4 D	120		07.09							
	2.4 D	129		04.09							
	2.4 D AWD	120		09.08							
	2.4 D AWD	129		06.09							
	2.4 D5	158		06.11							
	2.4 D5 AWD	136		09.08							
	2.4 D5 AWD	151		04.09							
	2.4 D5 AWD	158		06.11							
	3.0 T6 AWD	210		09.08							
	3.0 T6 AWD	224		03.10							
	3.2 AWD	175		04.09							
	3.2 AWD	179		03.10							
	D3	110		03.15							
	D4	133		10.13							
	D4	140		03.15							
	D4 AWD	133		10.13							
	D4 AWD	140		03.15							
	D5 AWD	162		03.15							
	D5 AWD	169		04.14							
	T5	177		09.10							
	T5	180		10.13							
	T5 AWD	180		10.13							
	T5 AWD	187		04.14							
	T6	225		10.13							
	T6 AWD	225		10.13							
T6 AWD	242		04.14								

1) - collision warning system / - sistema anti-collosione / - système anticollision / - sistema anticollisión
2) + collision warning system / + sistema anti-collosione / + système anticollision / + sistema anticollisión
3) + ventilated discs / + dischi ventilati / + disques ventilés / + disco ventilado



















									
VOLVO XC70 I CROSS COUNTRY (00-07)									
	2.4 T XC AWD		11.97	12.01	03.7755-3402.4 03.0655-0004.2	300189 370004	- DSTC	9/8" Tandem Wegsensor	ATE ATE
	2.4 AWD	121	03.00	09.03	03.7755-4702.4	300224	- DSTC	9/8" Tandem Wegsensor	ATE ATE
	2.4 D5 AWD	136	12.05	07.07	03.0655-0001.2	370001			
	2.4 T XC AWD		01.02	09.02					
	2.5 D5 XC AWD	120	09.02	07.07					
	2.5 T XC AWD	154	09.02	07.07					
	2.4 AWD	121	03.00	09.03	03.7858-3532.4	300233	+ DSTC	9/8" Tandem Wegsensor	ATE ATE
	2.4 D5 AWD	136	12.05	07.07	03.0655-0001.2	370001			
	2.4 T XC AWD		11.97	09.02					
	2.5 D5 XC AWD	120	09.02	07.07					
	2.5 T XC AWD	154	09.02	07.07					
	2.4 T XC AWD	11000	11.97		03.2125-7637.3	010707	- DSTC	Thz 25,40	ATE
	2.4 AWD	121	03.00	09.03	03.2125-7743.3	010921	- DSTC	Thz 25,40	ATE
	2.4 D5 AWD	136	12.05	07.07					
	2.4 T XC AWD	11001		09.02					
	2.5 D5 XC AWD	120	09.02	07.07					
	2.5 T XC AWD	154	09.02	07.07					
	2.4 T XC AWD	66913	11.97		03.2125-7708.3	010739	+ DSTC	Thz 25,40	ATE
	2.4 AWD	121	03.00	09.03	03.2125-7713.3	010819	+ DSTC	Thz 25,40	ATE
	2.4 D5 AWD	136	12.05	07.07					
	2.4 T XC AWD	66914		09.02					
	2.5 D5 XC AWD	120	09.02	07.07					
	2.5 T XC AWD	154	09.02	07.07					
	2.4 T XC AWD	11000	11.97		03.2125-7638.3	010738	- DSTC	Thz 25,40	ATE
	2.4 AWD	121	03.00	09.03	03.2125-7637.3	010707	- DSTC	Thz 25,40	ATE
	2.4 D5 AWD	136	12.05	07.07					
	2.4 T XC AWD	11001		09.02					
	2.5 D5 XC AWD	120	09.02	07.07					
	2.5 T XC AWD	154	09.02	07.07					
	2.4 T XC AWD	69018	11.97		03.2125-7637.3	010707	+ DSTC	Thz 25,40	ATE
	2.4 AWD	121	03.00	09.03	03.2125-7638.3	010738	+ DSTC	Thz 25,40	ATE
	2.4 T XC AWD	69019		09.02					
	2.5 D5 XC AWD	120	09.02	07.07					
	2.5 T XC AWD	154	09.02	07.07					
	2.4 AWD	121	03.00	09.03	24.3601-9829.5	240507	 + 15"/16" Rad 1)	D=60, - Halter	ATE
	2.4 D5 AWD	136	12.05	07.07	24.3601-9830.5	240508	 + 15"/16" Rad 1)	D=60, - Halter	ATE
	2.4 T XC AWD		11.97	09.02	11.0101-5407.2	260011		Hülsensatz	ATE
	2.5 D5 XC AWD	120	09.02	07.07	11.8171-0008.1	990049		Führungsbolzen	ATE
	2.5 T XC AWD	154	09.02	07.07					
	2.4 AWD	121	03.00	09.03	11.9571-9863.2	220513	 + 17" Rad 2)	D=57, - Halter	ATE
	2.4 D5 AWD	136	12.05	07.07	11.9571-9864.2	220514	 + 17" Rad 2)	D=57, - Halter	ATE
	2.4 T XC AWD		11.97	09.02	11.8116-0366.2	390587	2 + 17" Rad 2)	Haltefeder	ATE
	2.5 D5 XC AWD	120	09.02	07.07	11.0101-5407.2	260011		Hülsensatz	ATE
	2.5 T XC AWD	154	09.02	07.07	11.8171-0008.1	990049		Führungsbolzen	ATE
	2.4 AWD	121	03.00	09.03	83.7713-0347.3	330986	2	L=345	
	2.4 D5 AWD	136	12.05	07.07					
	2.4 T XC AWD		11.97	09.02					
	2.5 D5 XC AWD	120	09.02	07.07					
	2.5 T XC AWD	154	09.02	07.07					
	2.4 AWD	121	03.00	09.03	11.9421-9979.2	220497	 	D=42, - Halter	ATE
	2.4 D5 AWD	136	12.05	07.07	11.9421-9980.2	220498	 	D=42, - Halter	ATE
	2.4 T XC AWD		11.97	09.02	24.3421-9979.5	240475	 	D=42, - Halter	ATE
	2.5 D5 XC AWD	120	09.02	07.07	24.3421-9980.5	240476	 	D=42, - Halter	ATE
	2.5 T XC AWD	154	09.02	07.07	11.8171-0008.1	990049		Führungsbolzen	ATE
					11.0101-5407.2	260011		Hülsensatz	ATE
					11.8116-0236.1	390507	2	Haltefeder	ATE
	2.4 AWD	121	03.00	09.03	83.7724-0268.3	331076	2	L=265	
	2.4 D5 AWD	136	12.05	07.07					
	2.4 T XC AWD		11.97	09.02					
	2.5 D5 XC AWD	120	09.02	07.07					
	2.5 T XC AWD	154	09.02	07.07					
VOLVO XC70 II CROSS COUNTRY (07-)									
	2.0 D3	120	08.11		03.7755-9703.4	300239		9/8" Tandem	ATE
	2.0 D3 AWD	120	08.11		03.7755-0132.4	300265	+  	9/8" Tandem	ATE
	2.4 D	129	01.10						
	2.4 D AWD	120	08.07						
	2.4 D5 AWD	136	08.07						
	2.4 D5 AWD	151	12.09						
	2.4 D5 AWD	158	06.11						
	3.0 T6 AWD	210	01.08						
	3.0 T6 AWD	224	01.10						
	3.2	179	08.07						
	3.2 AWD	175	08.07						
	3.2 AWD	179	08.07						
	D5 AWD	162	03.15						
	T5	180	10.13						
	2.0 D3	120	08.11		03.7858-5132.4	300276	+  	9/8" Tandem	ATE
	2.0 D3 AWD	120	08.11		03.7858-5032.4	300275	-  	9/8" Tandem	ATE
	2.4 D	129	01.10		03.0655-0007.2	370007		Wegsensor	ATE
	2.4 D AWD	120	08.07						
	2.4 D5 AWD	136	08.07						
	2.4 D5 AWD	151	12.09						
	2.4 D5 AWD	158	06.11						

1) + 15"/16" wheel / + ruota 15"/16" / + roue 15"/16" / + rueda 15"/16"

2) + 17" wheel / + ruota 17" / + roue 17" / + rueda 17"

3) - collision warning system (CMbB) / - sistema anti-collozione (CMbB) / - système anticollision (CMbB) / - sistema anticollisión (CMbB)

4) + collision warning system (CMbB) / + sistema anti-collozione (CMbB) / + système anticollision (CMbB) / + sistema anticollisión (CMbB)

										
VOLVO XC70 II CROSS COUNTRY (07-)										
	3.0 T6 AWD	210	01.08	+ Kollisionswarnsystem (CMbB) ¹⁾	03.7858-5132.4	300276	+  	9/8" Tandem	ATE	
	3.0 T6 AWD	224	01.10	+ Kollisionswarnsystem (CMbB) ¹⁾	03.7858-5032.4	300275	-  	9/8" Tandem	ATE	
	3.2	179	08.07	+ Kollisionswarnsystem (CMbB) ¹⁾	03.0655-0007.2	370007		Wegsensor	ATE	
	3.2 AWD	175	08.07	+ Kollisionswarnsystem (CMbB) ¹⁾						
	3.2 AWD	179	08.07	+ Kollisionswarnsystem (CMbB) ¹⁾						
	D5 AWD	162	03.15	+ Kollisionswarnsystem (CMbB) ¹⁾						
	T5	180	10.13	+ Kollisionswarnsystem (CMbB) ¹⁾						
	D4	133	10.13		03.7755-9703.4	300239	- Kollisionswarnsystem ²⁾	9/8" Tandem	ATE	
	D4 AWD	133	10.13							
	T5 AWD	187	08.15							
	2.0 D3	120	08.11		11.9601-9711.2	220873	+ 16" Rad ³⁾	D=60, - Halter	ATE	
	2.0 D3 AWD	120	08.11		11.9601-9712.2	220874	+ 16" Rad ³⁾	D=60, - Halter	ATE	
	2.4 D	129	01.10		11.0230-0934.1	260128	+ 16" Rad ³⁾	Halter	ATE	
	2.4 D AWD	120	08.07		11.8116-0206.1	390593	+ 16" Rad ³⁾	Haltefeder	ATE	
	2.4 D5 AWD	136	08.07		11.0101-5407.2	260011		Hülsensatz	ATE	
	2.4 D5 AWD	151	12.09		11.8171-0008.1	990049		Führungsbolzen	ATE	
	2.4 D5 AWD	158	06.11		11.0441-6008.2	250038		Dichtungssatz	ATE	
	3.0 T6 AWD	210	01.08							
	3.0 T6 AWD	224	01.10							
	3.2	179	08.07							
	3.2 AWD	175	08.07							
	3.2 AWD	179	08.07							
	D4	133	10.13							
	D4 AWD	133	10.13							
	D5 AWD	162	03.15							
	T5	180	10.13							
	T5 AWD	187	08.15							
		2.0 D3	120	08.11		11.9606-9949.2	220879	+ 17" Rad ⁴⁾	D=60, - Halter	ATE
		2.0 D3 AWD	120	08.11		11.9606-9950.2	220880	+ 17" Rad ⁴⁾	D=60, - Halter	ATE
		2.4 D	129	01.10		11.8116-0388.2	390588		Haltefeder	ATE
2.4 D AWD		120	08.07		11.8171-0008.1	990049		Führungsbolzen	ATE	
2.4 D5 AWD		136	08.07		11.0101-5704.2	260095		Hülsensatz	ATE	
2.4 D5 AWD		151	12.09		11.0441-6008.2	250038		Dichtungssatz	ATE	
2.4 D5 AWD		158	06.11							
3.0 T6 AWD		210	01.08							
3.0 T6 AWD		224	01.10							
3.2		179	08.07							
3.2 AWD		175	08.07							
3.2 AWD		179	08.07							
D4		133	10.13							
D4 AWD		133	10.13							
D5 AWD		162	03.15							
T5		180	10.13							
T5 AWD		187	08.15							
		2.0 D3	120	08.11		11.9606-9945.2	220727	+ 18" Rad ⁵⁾	D=60, - Halter	ATE
		2.0 D3 AWD	120	08.11		11.9606-9946.2	220728	+ 18" Rad ⁵⁾	D=60, - Halter	ATE
		2.4 D	129	01.10		11.8116-0388.2	390588	+ 18" Rad ⁵⁾	Haltefeder	ATE
	2.4 D AWD	120	08.07		11.8171-0008.1	990049	+ 18" Rad ⁵⁾	Führungsbolzen	ATE	
	2.4 D5 AWD	136	08.07		11.0101-5704.2	260095		Hülsensatz	ATE	
	2.4 D5 AWD	151	12.09							
	2.4 D5 AWD	158	06.11							
	3.0 T6 AWD	210	01.08							
	3.0 T6 AWD	224	01.10							
	3.2	179	08.07							
	3.2 AWD	175	08.07							
	3.2 AWD	179	08.07							
	D4	133	10.13							
	D4 AWD	133	10.13							
	D5 AWD	162	03.15							
	T5	180	10.13							
	T5 AWD	187	08.15							
		2.0 D3	120	08.11		24.5162-0390.3	331199	2 + 16" Rad ³⁾	L=390	
		2.0 D3 AWD	120	08.11		24.5162-0405.3	331194	2 + 17"/18" Rad ⁶⁾	L=405	
		2.4 D	129	01.10						
2.4 D AWD		120	08.07							
2.4 D5 AWD		136	08.07							
2.4 D5 AWD		151	12.09							
2.4 D5 AWD		158	06.11							
3.0 T6 AWD		210	01.08							
3.0 T6 AWD		224	01.10							
3.2		179	08.07							
3.2 AWD		175	08.07							
3.2 AWD		179	08.07							
D4		133	10.13							
D4 AWD	133	10.13								
D5 AWD	162	03.15								
T5	180	10.13								
T5 AWD	187	08.15								
	2.0 D3	120	08.11		24.6238-1703.7	220967	+ belüftete Scheiben ⁷⁾	D=38, - Halter	TRW	
	2.0 D3 AWD	120	08.11		24.6238-1704.7	220968	+ belüftete Scheiben ⁷⁾	D=38, - Halter	TRW	
	2.4 D	129	01.10							
	2.4 D AWD	120	08.07							
	2.4 D5 AWD	136	08.07							
	2.4 D5 AWD	151	12.09	118000						
	2.4 D5 AWD	158	06.11							
3.0 T6 AWD	210	01.08								
3.0 T6 AWD	224	01.10	118000							

¹⁾ + collision warning system (CMbB) / + sistema anti-collosione (CMbB) / + système anticollision (CMbB) / + sistema anticollisión (CMbB)

²⁾ - collision warning system / - sistema anti-collosione / - système anticollision / - sistema anticollisión

³⁾ + 16" wheel / + ruota 16" / + roue 16" / + rueda 16"

⁴⁾ + 17" wheel / + ruota 17" / + roue 17" / + rueda 17"

⁵⁾ + 18" wheel / + ruota 18" / + roue 18" / + rueda 18"

⁶⁾ + 17"/18" wheel / + ruota 17"/18" / + roue 17"/18" / + rueda 17"/18"

⁷⁾ - ventilated discs / - dischi ventilati / - disques ventilés / - disco ventilado



VOLVO XC70 II CROSS COUNTRY (07-)











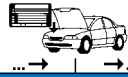

	3.2	179	118000	08.07	24.6238-1703.7	220967	☐ - belüftete Scheiben ¹⁾ ☐ - belüftete Scheiben ¹⁾	D=38, - Halter D=38, - Halter	TRW TRW
	3.2 AWD	175		08.07	24.6238-1704.7	220968			
	3.2 AWD	179	118000	08.07					
	2.0 D3	120		08.11	24.6241-1703.7	220971	☐ + belüftete Scheiben ²⁾ ☐ + belüftete Scheiben ²⁾	D=41, - Halter D=41, - Halter	TRW TRW
	2.0 D3 AWD	120		08.11	24.6241-1704.7	220972			
	2.4 D	129		01.10					
	2.4 D AWD	120		08.07					
	2.4 D5 AWD	136		08.07					
	2.4 D5 AWD	151		12.09					
	2.4 D5 AWD	158		06.11					
	3.0 T6 AWD	210		01.08					
	3.0 T6 AWD	224		01.10					
	3.2	179		08.07					
	3.2 AWD	175		08.07					
	3.2 AWD	179		08.07					
	D4	133		10.13					
	D4 AWD	133		10.13					
D5 AWD	162		03.15						
T5	180		10.13						
T5 AWD	187		08.15						
	2.0 D3	▶120	19120	08.11	24.5162-0185.3	331202	2 + mechanische Feststellbremse ³⁾	L=185	
	2.0 D3 AWD	▶120	19120	08.11					
	2.4 D	▶129	19120	01.10					
	2.4 D AWD	▶120	19120	08.07					
	2.4 D5 AWD	▶136	19120	08.07					
	2.4 D5 AWD	▶151	19120	12.09					
	2.4 D5 AWD	▶158	19120	06.11					
	3.0 T6 AWD	▶210	19120	01.08					
	3.0 T6 AWD	▶224	19120	01.10					
	3.2	▶179	19120	08.07					
	3.2 AWD	▶175	19120	08.07					
	3.2 AWD	▶179	19120	08.07					
	2.0 D3	▶120 19121			24.5162-0185.3	331202			
	2.0 D3 AWD	▶120 19121							
	2.4 D	▶129 19121							
	2.4 D AWD	▶120 19121							
	2.4 D5 AWD	▶136 19121							
2.4 D5 AWD	▶151 19121								
2.4 D5 AWD	▶158 19121								
3.0 T6 AWD	▶210 19121								
3.0 T6 AWD	▶224 19121								
3.2	▶179 19121								
3.2 AWD	▶175 19121								
3.2 AWD	▶179 19121								
2.0 D3	◀120			08.11	24.5162-0185.3	331202			
2.0 D3 AWD	◀120			08.11					
2.4 D	◀129			01.10					
2.4 D AWD	◀120			08.07					
2.4 D5 AWD	◀136			08.07					
2.4 D5 AWD	◀151			12.09					
2.4 D5 AWD	◀158			06.11					
3.0 T6 AWD	◀210			01.08					
3.0 T6 AWD	◀224			01.10					
3.2	◀179			08.07					
3.2 AWD	◀175			08.07					
3.2 AWD	◀179			08.07					
D4	133			10.13					
D4 AWD	133			10.13					
D5 AWD	162			03.15					
T5	180			10.13					
T5 AWD	187			08.15					
2.0 D3	120	19120		08.11	24.5133-0310.3	331197	☐ + elektrische Feststellbremse ⁴⁾	L=310	
2.0 D3 AWD	120	19120		08.11					
2.4 D	129	19120		01.10					
2.4 D AWD	120	19120		08.07					
2.4 D5 AWD	136	19120		08.07					
2.4 D5 AWD	151	19120		12.09					
2.4 D5 AWD	158	19120		06.11					
3.0 T6 AWD	210	19120		01.08					
3.0 T6 AWD	224	19120		01.10					
3.2	179	19120		08.07					
3.2 AWD	175	19120		08.07					
3.2 AWD	179	19120		08.07					
2.0 D3	120 19121	75766			24.5133-0311.3	331198			
2.0 D3 AWD	120 19121	75766							
2.4 D	129 19121	75766							
2.4 D AWD	120 19121	75766							
2.4 D5 AWD	136 19121	75766							
2.4 D5 AWD	151 19121	75766							
2.4 D5 AWD	158 19121	75766							
3.0 T6 AWD	210 19121	75766							
3.0 T6 AWD	224 19121	75766							
3.2	179 19121	75766							
3.2 AWD	175 19121	75766							
3.2 AWD	179 19121	75766							

¹⁾ - ventilated discs / - dischi ventilati / - disques ventilés / - disco ventilado

²⁾ + ventilated discs / + dischi ventilati / + disques ventilés / + disco ventilado

³⁾ + mechanical parking brake / + fr. stazionamento meccanico / + frein à main mécanique / + freno de mano mecánica

⁴⁾ + electric parking brake / + freno a mano elettrico / + frein à main électrique / + freno de mano eléctrico

										
VOLVO XC90 (02-14)										
	2.4 D3	◀120		04.10	12.14	03.7858-3632.4	300234	9/8" Tandem Wegsensor	ATE	
	2.4 D5	◀120		04.09	12.14	03.0655-0001.2	370001		ATE	
	2.4 D5	◀136		05.06	12.14					
	2.4 D5 AWD	◀120		10.02	12.14					
	2.4 D5 AWD	◀147		01.11	12.14					
	2.5 T	◀154		10.02	12.14					
	2.5 T AWD	◀154		10.12	12.14					
	3.0 T6	◀200		10.02	12.14					
	3.2	◀175		05.06	12.14					
	4.0 V8	◀232		04.10	12.14					
				01.05	12.14					
	2.4 D5	◀120		04.09	12.14	03.7858-3032.4	300257	+ 18" Rad ¹⁾ 9/8" Tandem Wegsensor	ATE	
	2.4 D5	◀136		05.06	12.14	03.0655-0001.2	370001		ATE	
	2.4 D5 AWD	◀120		10.02	12.14					
	2.4 D5 AWD	◀147		01.11	12.14					
	2.5 T	◀154		10.02	12.14					
	2.5 T AWD	◀154		10.12	12.14					
	3.0 T6	◀200		10.02	12.14					
	3.2	◀175		05.06	12.14					
	4.0 V8	◀232		01.05	12.14					
	2.4 D5	▶120		04.09	12.14	03.0655-0001.2	370001	Wegsensor	ATE	
	2.4 D5	▶136		05.06	12.14					
	2.4 D5 AWD	▶120		10.02	12.14					
	2.4 D5 AWD	▶147		01.11	12.14					
	2.5 T	▶154		10.02	12.14					
	2.5 T AWD	▶154		10.12	12.14					
	3.0 T6	▶200		10.02	12.14					
	2.4 D3	◀120		04.10	12.14	03.2125-7713.3	010819	THz 25,40	ATE	
	2.4 D5	◀120		04.09	12.14					
	2.4 D5	◀136		05.06	12.14					
	2.4 D5 AWD	◀120		10.02	12.14					
	2.4 D5 AWD	◀147		01.11	12.14					
	2.5 T	◀154		10.02	12.14					
	2.5 T AWD	◀154		10.12	12.14					
	3.0 T6	◀200		10.02	12.14					
	3.2	◀175		05.06	12.14					
	4.0 V8	◀232		04.10	12.14					
				01.05	12.14					
	2.4 D5	▶120		04.09	12.14	03.2125-7638.3	010738	THz 25,40	ATE	
	2.4 D5	▶136		05.06	12.14					
	2.4 D5 AWD	▶120		10.02	12.14					
	2.4 D5 AWD	▶147		01.11	12.14					
	2.5 T	▶154		10.02	12.14					
	2.5 T AWD	▶154		10.12	12.14					
	2.4 D3	120		04.10	12.14	11.8116-0366.2	390587	+ 16" Rad ²⁾ Haltefeder Führungsbolzen Führungsbolzen Hülsensatz Hülsensatz	ATE	
	2.4 D5	120		04.09	12.14	11.8171-0067.1	250153		ATE	
	2.4 D5	136		05.06	12.14	11.8171-0096.1	250155		ATE	
	2.4 D5 AWD	120		10.02	12.14	11.0101-6006.2	260098		ATE	
	2.4 D5 AWD	147		01.11	12.14	11.0101-7003.2	260124		ATE	
	2.5 T	154		10.02	12.14					
	2.5 T AWD	154		10.12	12.14					
	3.0 T6	200		10.02	12.14					
	3.2	175		05.06	12.14					
	4.0 V8	232		04.10	12.14					
				01.05	12.14					
	2.4 D3	120		04.10	12.14	11.9606-9959.2	220729	+ 17,5" Rad ³⁾ D=60, - Halter D=60, - Halter Haltefeder Führungsbolzen Führungsbolzen Hülsensatz Hülsensatz	ATE	
	2.4 D5	120		04.09	12.14	11.9606-9960.2	220730		ATE	
	2.4 D5	136		05.06	12.14	11.8116-0133.1	390511		ATE	
	2.4 D5 AWD	120		10.02	12.14	11.8171-0067.1	250153		ATE	
	2.4 D5 AWD	147		01.11	12.14	11.8171-0096.1	250155		ATE	
	2.5 T	154		10.02	12.14	11.0101-6006.2	260098		ATE	
	2.5 T AWD	154		10.12	12.14	11.0101-7003.2	260124		ATE	
	3.0 T6	200		10.02	12.14					
	3.2	175		05.06	12.14					
	4.0 V8	232		04.10	12.14					
				01.05	12.14					
	2.4 D3	120		04.10	12.14	83.7713-0366.3	331100	L=365		
	2.4 D5	120		04.09	12.14					
	2.4 D5	136		05.06	12.14					
	2.4 D5 AWD	120		10.02	12.14					
	2.4 D5 AWD	147		01.11	12.14					
	2.5 T	154		10.02	12.14					
	2.5 T AWD	154		10.12	12.14					
	3.0 T6	200		10.02	12.14					
	3.2	175		05.06	12.14					
	4.0 V8	232		04.10	12.14					
				01.05	12.14					

1) + 18" wheel / + ruota 18" / + roue 18" / + rueda 18"

2) + 16" wheel / + ruota 16" / + roue 16" / + rueda 16"

3) + 17,5" wheel / + ruota 17,5" / + roue 17,5" / + rueda 17,5"

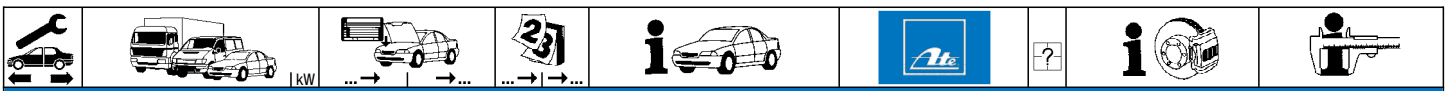

VOLVO XC90 (02-14)

	2.4 D3	120	04.10	12.14	11.9441-9965.2	220735	2	D=44, - Halter D=44, - Halter Halter Haltefeder Führungsbolzen Hülzensatz	ATE
	2.4 D5	120	04.09	12.14	11.9441-9966.2	220736			ATE
	2.4 D5	136	05.06	12.14	11.8170-0675.1	260118			ATE
	2.4 D5 AWD	120	10.02	12.14	11.8116-0327.1	390599			ATE
	2.4 D5 AWD	147	01.11	12.14	11.8171-0008.1	990049			ATE
	2.5 T	154	10.02	12.14	11.0101-5704.2	260095			ATE
	2.5 T AWD	154	10.12	12.14					
	3.0 T6	200	10.02	12.14					
	3.2	175	05.06	12.14					
	3.2	179	04.10	12.14					
	4.0 V8	232	01.05	12.14					
	2.4 D3	120	04.10	12.14	83.7704-0266.3	330979	2	L=265	
	2.4 D5	120	04.09	12.14					
	2.4 D5	136	05.06	12.14					
	2.4 D5 AWD	120	10.02	12.14					
	2.4 D5 AWD	147	01.11	12.14					
	2.5 T	154	10.02	12.14					
	2.5 T AWD	154	10.12	12.14					
	3.0 T6	200	10.02	12.14					
	3.2	175	05.06	12.14					
	3.2	179	04.10	12.14					
	4.0 V8	232	01.05	12.14					

VOLVO XC90 (14-)

	2.0 D5 AWD	165	09.14		11.8171-0096.1	250155		Führungsbolzen	ATE
	2.0 T5 AWD	187	06.15						
	2.0 T6 AWD	235	09.14						
	2.0 T8 Hybrid	235	09.14						



- D** Abbildungen Hauptbremszylinder
- EN** Illustrations master cylinder
- FR** Illustrations Maître-cylindres
- IT** Illustrazioni pompe Freno
- ES** Ilustraciones cilindro freno
- NL** Afbeeldingen hoofdremcilinders
- DA** Tegning hovedbremsecylinder
- SV** Avbildningar huvudbromscylinder
- HU** Ábrák – főfékhengerek
- PT** Figuras Cilindro principal do travão
- RU** Рисунки главных тормозных цилиндров
- CZ** Zobrazení hlavního brzdového válce
- PL** Rysunki pomp hamulcowych
- EL** Εικόνες κεντρικών κυλίνδρων πέδησης
- TR** Ana fren silindiri resimleri
- ZH** 主缸制动缸图片
- JA** 図版 マスターブレーキシリンダー
- AR** صور إسطوانة المكبح الرئيسي

K24-H

Abbildungen Hauptbremszylinder

Illustrations master cylinder - Illustrazioni pompe freno -

Illustrations Maître cylindres - Ilustraciones cilindro maestro freno

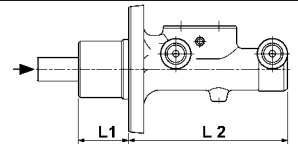

03.2020-0402.3 010001

Ø 20,64/19,05



3x M10x1



L1 L2
18,5 161,5

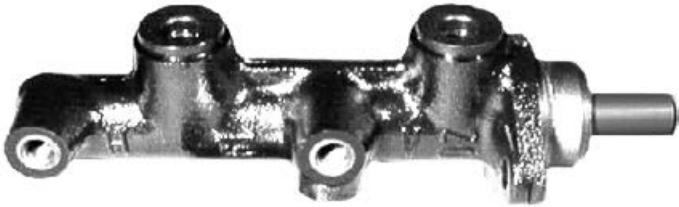

03.2022-0109.3 010003

Ø 22,30/15,75



2x M10x1



L1 L2
16,0 212,3



03.2022-0111.3 010004

Ø 22,30/15,75



2x M10x1



L1 L2
16,0 212,3

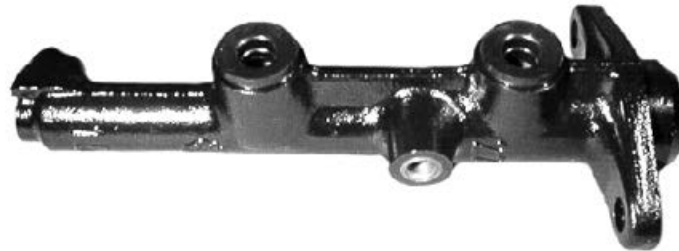

03.2022-0112.3 010005

Ø 22,30/15,75



2x M10x1



L1 L2
16,0 212,3



03.2022-0602.3 010006

Ø 22,20/19,05



2x M10x1

1x M12x1



L1 L2
33,1 148,5

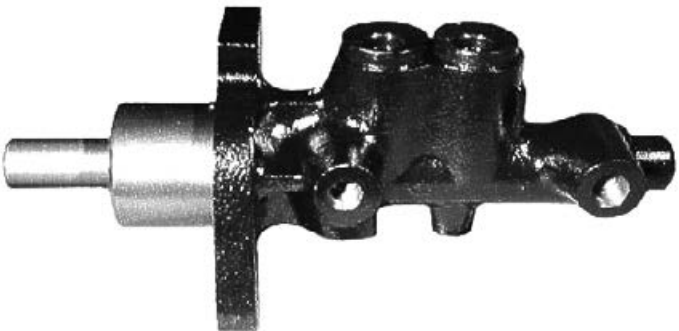

03.2022-0702.3 010007

Ø 22,20/15,75



2x M10x1

1x M12x1



L1 L2
20,0 174,5



03.2022-1201.3 010009

Ø 22,20/17,46



3x M10x1



L1 L2
18,5 168,0



03.2022-1402.3 010010

Ø 22,20/19,05



1x M10x1

1x M12x1



L1 L2
21,5 174,5

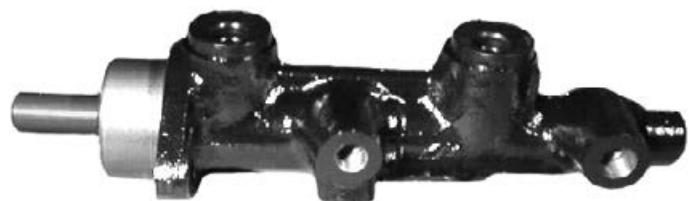



Abbildungen Hauptbremszylinder

Illustrations master cylinder - Illustrazioni pompe freno -

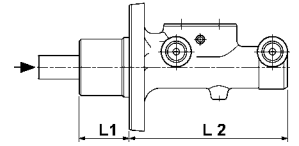
Illustrations Maître cylindres - Ilustraciones cilindro maestro freno

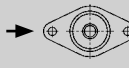



03.2022-1602.3 010011
 Ø 22,20/19,05  2x M10x1 →  L1 L2
 21,5 174,5



03.2022-2624.3 010588
 Ø 22,20/20,64  1x M10x1
 1x M12x1 →  L1 L2
 33,3 113,2





03.2022-2829.3 010589
 Ø 22,20/20,64  5x M12x1 →  L1 L2
 39,9 116,4



03.2023-0164.3 010014
 Ø 23,81/19,05  3x M10x1 →  L1 L2
 18,5 159,5





03.2023-0166.3 010015
 Ø 23,81/19,05  3x M10x1 →  L1 L2
 18,5 159,5

03.2023-0172.3 010016
 Ø 23,81/19,05  3x M10x1 →  L1 L2
 18,5 159,5



03.2023-0183.3 010017
 Ø 23,81/19,05  2x M10x1 →  L1 L2
 17,6 159,0

03.2023-0230.3 010019
 Ø 23,81/19,05  3x M10x1 →  L1 L2
 57,4 109,1



Abbildungen Hauptbremszylinder

Illustrations master cylinder - Illustrazioni pompe freno -

Illustrations Maître cylindres - Ilustraciones cilindro maestro freno

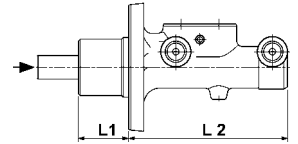

03.2023-0262.3 010020

Ø 23,81/20,64



2x M10x1



L1 L2
17,6 159,0

03.2023-0503.3 010022

Ø 23,81/16,84



4x M10x1



L1 L2
16,0 226,5

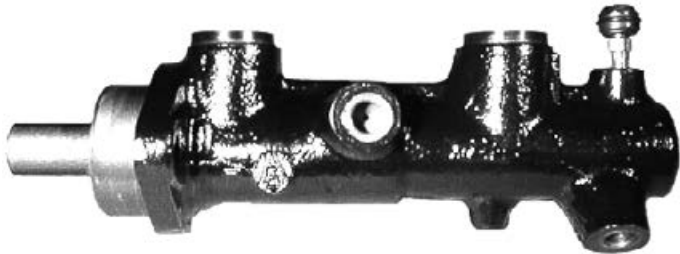

03.2023-0542.3 010024

Ø 23,81/20,64



3x M10x1



L1 L2
17,6 159,0

03.2023-0562.3 010025

Ø 23,81/20,64



3x M10x1



L1 L2
21,1 159,8



03.2023-0642.3 010026

Ø 23,81/20,64



1x M10x1
1x M12x1



L1 L2
43,0 148,0

03.2023-0825.3 010028

Ø 23,81/19,05



3x M10x1



L1 L2
57,4 109,6

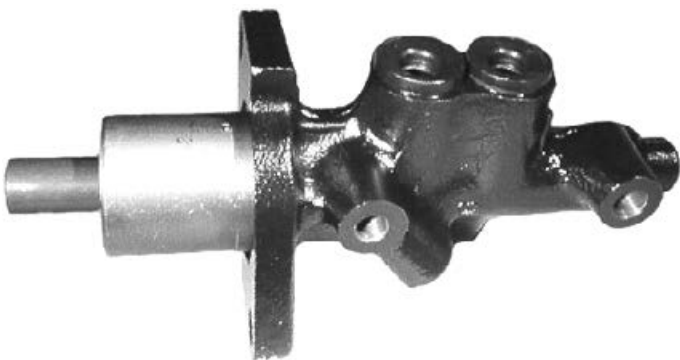

03.2023-0875.3 010890

Ø 23,81



4x M10x1



L1 L2
16,0 183,0

03.2023-0987.3 010473

Ø 23,81



1x M10x1
1x M12x1



L1 L2
38,3 131,5





Abbildungen Hauptbremszylinder

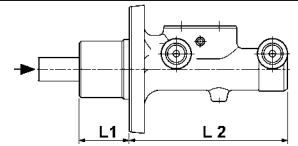

Illustrations master cylinder - Illustrazioni pompe freno -

Illustrations Maître cylindres - Ilustraciones cilindro maestro freno





03.2023-1044.3 010590
 Ø 23,81/20,64  2x M10x1
 1x M12x1  L1 L2
 41,7 132,5





03.2023-1066.3 010032
 Ø 23,81/19,05  1x M10x1
 1x M12x1  L1 L2
 49,8 109,0





03.2023-1084.3 010591
 Ø 23,81/20,64  3x M10x1
 L1 L2
 38,3 132,5



03.2023-1741.3 010703
 Ø 23,81/20,64  4x M12x1
 L1 L2
 12,0 169,5





03.2023-1812.3 010570
 Ø 23,81/19,05  1x M10x1
 2x M12x1  L1 L2
 4,0 147,0



03.2023-1904.3 010724
 Ø 23,81/20,64  5x M12x1
 L1 L2
 36,9 116,4



03.2023-1949.3 010725
 Ø 23,81/20,64  4x M12x1
 L1 L2
 35,9 116,4

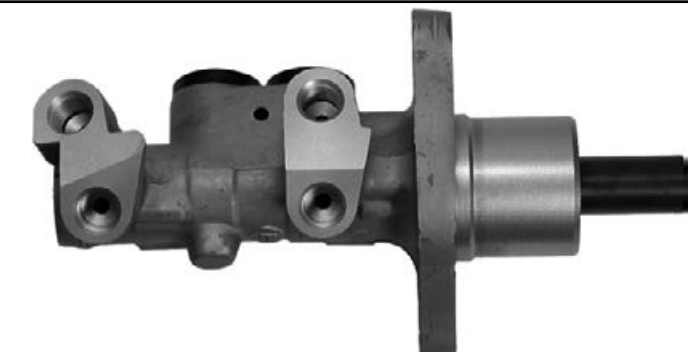

03.2023-2004.3 010788
 Ø 23,81/19,05  4x M12x1
 L1 L2
 4,0 147,0



Abbildungen Hauptbremszylinder

Illustrations master cylinder - Illustrazioni pompe freno -

Illustrations Maître cylindres - Ilustraciones cilindro maestro freno

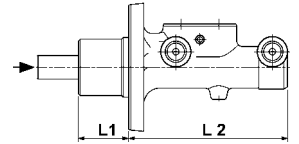

03.2023-2204.3 010644
 Ø 23,81/22,20  5x M12x1 →  L1 L2
 36,9 116,4

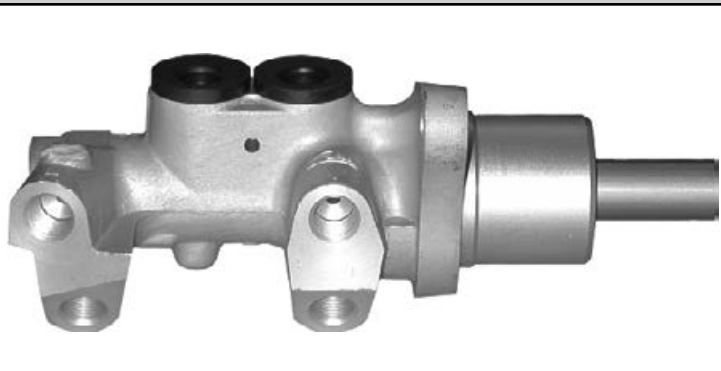



03.2023-2249.3 010869
 Ø 23,81/22,20  4x M12x1 →  L1 L2
 35,9 116,4





03.2023-2256.3 010870
 Ø 23,81/22,20  2x M12x1
 1x M12x1 →  L1 L2
 35,9 116,4



03.2023-2304.3 010646
 Ø 23,81/22,20  1x M10x1
 1x M12x1 →  L1 L2
 32,8 113,2



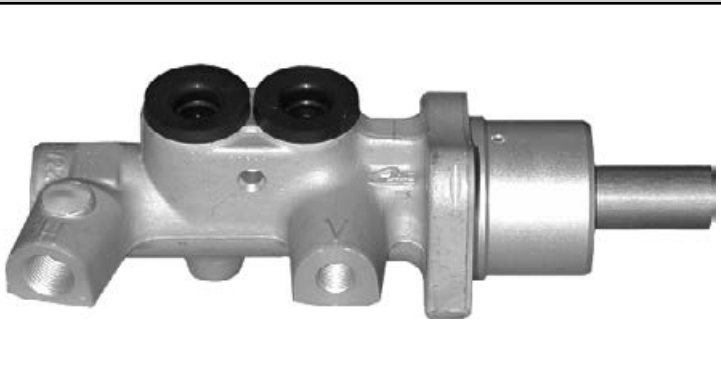

03.2023-2344.3 010647
 Ø 23,81/22,20  1x M10x1
 1x M12x1 →  L1 L2
 32,8 113,2



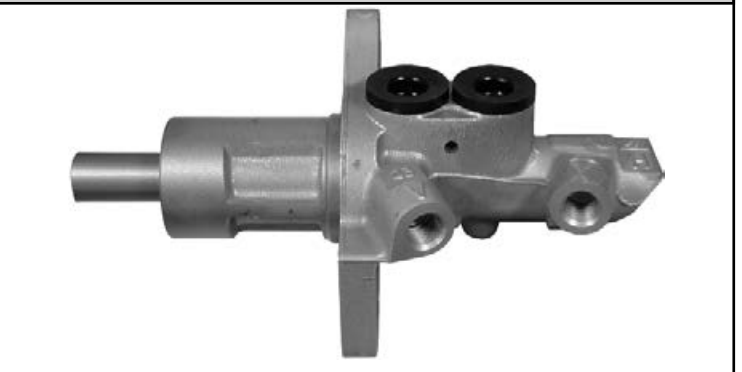

03.2023-2407.3 010796
 Ø 23,81/22,20  2x M12x1 →  L1 L2
 59,2 105,7

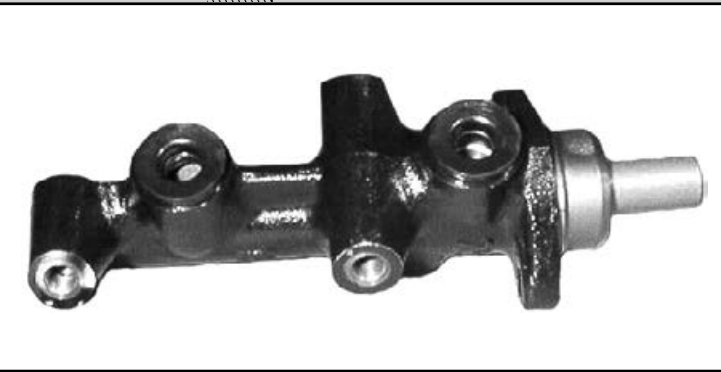

03.2025-0111.3 010033
 Ø 25,40/19,05  3x M10x1 →  L1 L2
 18,5 178,0



03.2025-0211.3 010034
 Ø 25,40/19,05  3x M10x1 →  L1 L2
 57,8 108,0

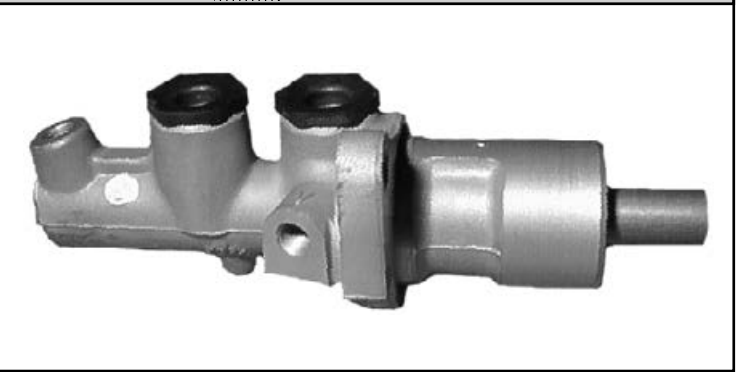

Abbildungen Hauptbremszylinder

Illustrations master cylinder - Illustrazioni pompe freno -

Illustrations Maître cylindres - Ilustraciones cilindro maestro freno

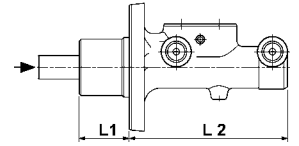

03.2025-1211.3 010475

Ø 25,40/20,64



2x M10x1



L1 L2
53,9 118,0



03.2025-1741.3 010705

Ø 25,40/20,64



4x M12x1

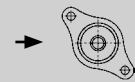

L1 L2
12,0 169,5



03.2025-1904.3 010797

Ø 25,40/22,20



2x M12x1



L1 L2
59,2 105,7



03.2025-2301.3 010895

Ø 25,40/22,20



2x M12x1

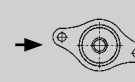

L1 L2
57,6 114,3



03.2026-0462.3 010728

Ø 26,99/25,40



2x M10x1

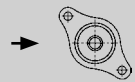

L1 L2
57,4 115,9



03.2026-0512.3 010038

Ø 26,99/25,40



2x M10x1

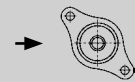

L1 L2
57,6 115,9



03.2026-0562.3 010729

Ø 26,99/25,40



1x M10x1
1x M12x1

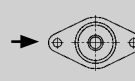

L1 L2
57,4 115,9



03.2026-0712.3 010730

Ø 26,99/25,40



1x M10x1
1x M12x1

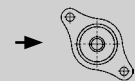

L1 L2
39,5 119,8



Abbildungen Hauptbremszylinder

Illustrations master cylinder - Illustrazioni pompe freno -

Illustrations Maître cylindres - Ilustraciones cilindro maestro freno

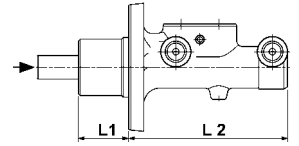

03.2117-1601.3 010039

Ø 17,46



2x M10x1

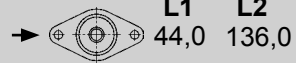

L1 L2
44,0 136,0

03.2117-3311.3 010040

Ø 17,46



4x M10x1

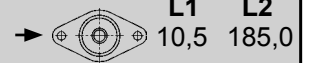

L1 L2
10,5 185,0



03.2119-0525.3 010046

Ø 19,05



3x M10x1



L1 L2
18,8 162,5

03.2119-0781.3 010052

Ø 19,05



3x M10x1

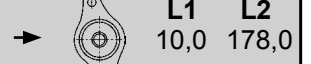

L1 L2
10,0 178,0

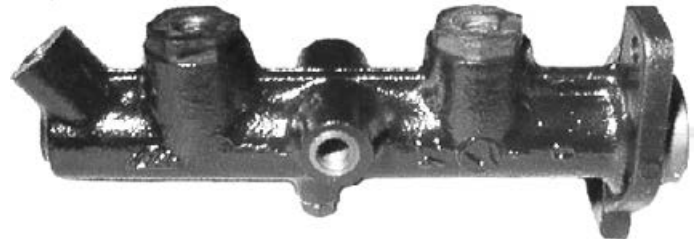

03.2119-0881.3 010053

Ø 19,05



2x M10x1



L1 L2
44,0 135,5

03.2119-1281.3 010054

Ø 19,05



2x M10x1
2x M12x1

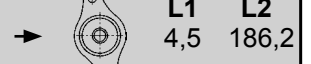

L1 L2
4,5 186,2

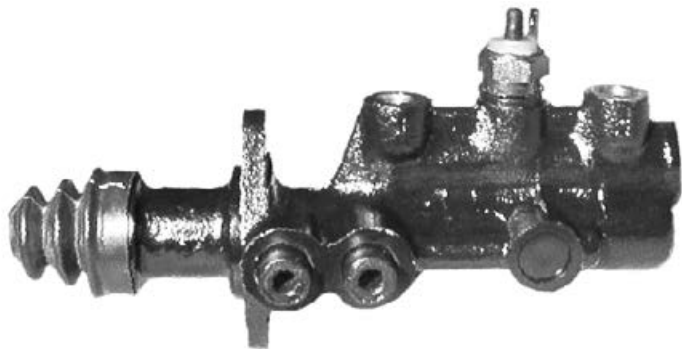

03.2119-2301.3 010055

Ø 19,05



2x M10x1



L1 L2
44,0 135,5

03.2119-3389.3 010057

Ø 19,05



4x M10x1



L1 L2
40,0 114,9





Abbildungen Hauptbremszylinder

Illustrations master cylinder - Illustrazioni pompe freno -

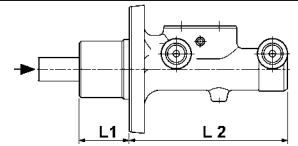

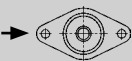
Illustrations Maître cylindres - Ilustraciones cilindro maestro freno



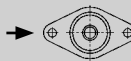

03.2119-3391.3 010058
 Ø 19,05  2x M10x1 →  L1 L2
 40,0 114,9



03.2119-6207.3 010060
 Ø 19,05  3x M10x1 →  L1 L2
 18,8 162,5



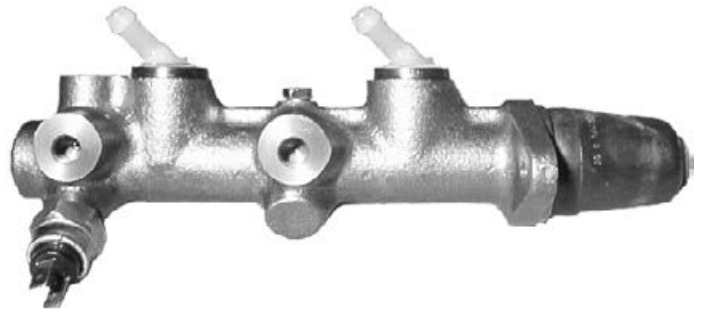

03.2119-6713.3 010061
 Ø 19,05  4x M10x1 →  L1 L2
 42,5 154,0



03.2119-8511.3 010062
 Ø 19,05  3x M10x1 →  L1 L2
 14,5 182,0





03.2119-8611.3 010063
 Ø 19,05  3x M10x1 →  L1 L2
 14,5 182,0

03.2119-8711.3 010064
 Ø 19,05  3x M10x1 →  L1 L2
 14,5 182,0



03.2119-8911.3 010066
 Ø 19,05  2x M10x1 →  L1 L2
 29,5 166,9

03.2119-9011.3 010067
 Ø 19,05  2x M10x1 →  L1 L2
 29,5 166,9



Abbildungen Hauptbremszylinder

Illustrations master cylinder - Illustrazioni pompe freno -

Illustrations Maître cylindres - Ilustraciones cilindro maestro freno

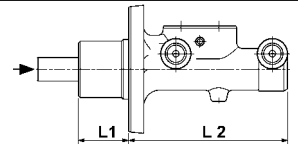

03.2119-9111.3 010068

Ø 19,05

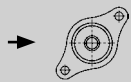
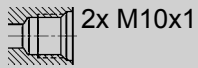

L1 L2
29,5 167,0

03.2120-0148.3 010070

Ø 20,64

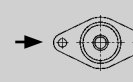

L1 L2
18,8 162,5



03.2120-0151.3 010071

Ø 20,64

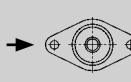
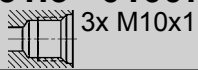

L1 L2
18,8 162,5

03.2120-0322.3 010074

Ø 20,64

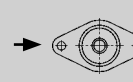

L1 L2
18,8 157,5

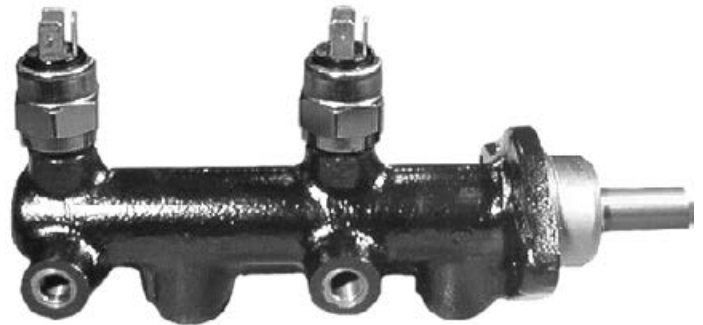

03.2120-0538.3 010077

Ø 20,64

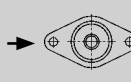
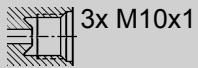

L1 L2
18,8 181,0

03.2120-0562.3 010078

Ø 20,64

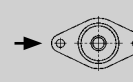

L1 L2
18,8 000,0



03.2120-0622.3 010079

Ø 20,64

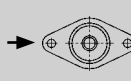
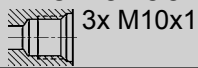

L1 L2
18,8 162,5

03.2120-0851.3 010082

Ø 20,64

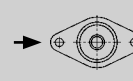

L1 L2
14,5 197,5





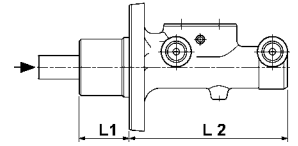

Abbildungen Hauptbremszylinder

Illustrations master cylinder - Illustrazioni pompe freno -



Illustrations Maître cylindres - Ilustraciones cilindro maestro freno



03.2120-1122.3 010084
 Ø 20,64  3x M10x1 →  L1 L2
 10,0 206,5

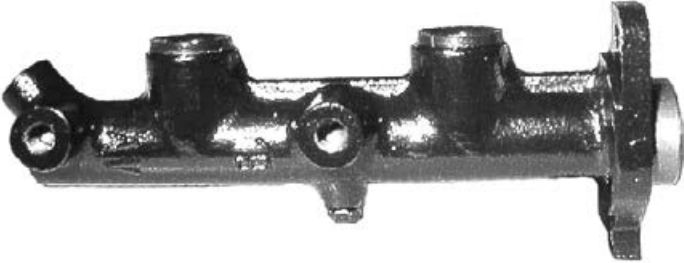

03.2120-1142.3 010085
 Ø 20,64  3x M10x1 →  L1 L2
 18,8 167,0



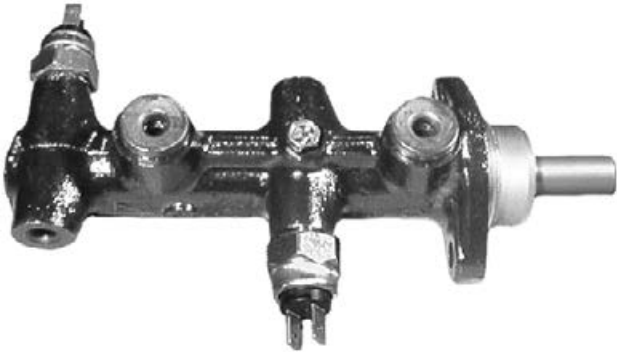

03.2120-1491.3 010089
 Ø 20,64  4x M10x1 →  L1 L2
 18,5 157,5



03.2120-1531.3 010092
 Ø 20,64  4x M10x1 →  L1 L2
 18,5 157,5





03.2120-1802.3 010099
 Ø 20,64  2x M10x1 →  L1 L2
 20,1 163,5

03.2120-1821.3 010100
 Ø 20,64  6x M10x1 →  L1 L2
 16,6 168,9



03.2120-1897.3 010103
 Ø 20,64  2x M10x1 →  L1 L2
 40,0 114,9

03.2120-1981.3 010105
 Ø 20,64  2x M10x1
 1x M12x1 →  L1 L2
 15,5 198,5





Abbildungen Hauptbremszylinder

Illustrations master cylinder - Illustrazioni pompe freno -

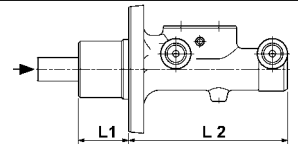
Illustrations Maître cylindres - Ilustraciones cilindro maestro freno



03.2120-2031.3 010106
 Ø 20,64 4x M10x1 →  L1 L2
 32,4 114,9

03.2120-2082.3 010107
 Ø 20,64 3x M10x1 →  L1 L2
 18,5 162,5



03.2120-2331.3 010110
 Ø 20,64 4x M10x1 →  L1 L2
 34,4 103,7

03.2120-2381.3 010111
 Ø 20,64 2x M10x1
 2x M15x1 →  L1 L2
 15,5 198,5



03.2120-2421.3 010112
 Ø 20,64 4x M10x1 →  L1 L2
 15,5 198,5

03.2120-2462.3 010113
 Ø 20,64 3x M10x1 →  L1 L2
 18,5 166,0



03.2120-2597.3 010115
 Ø 20,64 4x M10x1 →  L1 L2
 20,0 169,5

03.2120-2598.3 010116
 Ø 20,64 4x M10x1 →  L1 L2
 20,0 169,5





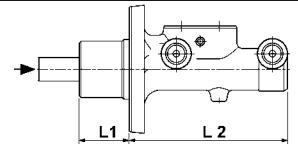

Abbildungen Hauptbremszylinder

Illustrations master cylinder - Illustrazioni pompe freno -



Illustrations Maître cylindres - Ilustraciones cilindro maestro freno



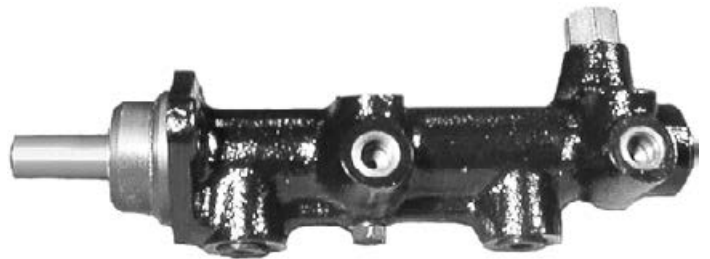

03.2120-2682.3 010118
 Ø 20,64  4x M10x1 →  L1 L2
 36,0 114,9



03.2120-3412.3 010121
 Ø 20,64  5x M10x1 →  L1 L2
 18,8 162,5





03.2120-3943.3 010532
 Ø 20,64  4x M10x1 →  L1 L2
 35,4 109,7



03.2120-4166.3 010452
 Ø 20,64  4x M10x1 →  L1 L2
 29,9 115,9





03.2120-4221.3 010605
 Ø 20,64  2x M10x1 →  L1 L2
 29,9 115,9

03.2120-4241.3 010524
 Ø 20,64  2x M10x1 →  L1 L2
 29,9 115,9



03.2120-4246.3 010614
 Ø 20,64  2x M10x1 →  L1 L2
 29,9 115,9

03.2120-4321.3 010525
 Ø 20,64  2x M10x1
 2x M12x1 →  L1 L2
 29,9 115,9

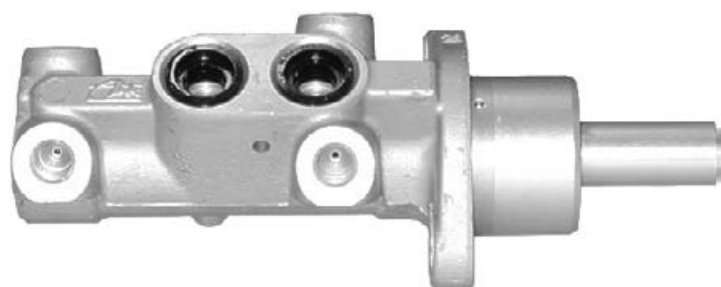

Abbildungen Hauptbremszylinder

Illustrations master cylinder - Illustrazioni pompe freno -

Illustrations Maître cylindres - Ilustraciones cilindro maestro freno

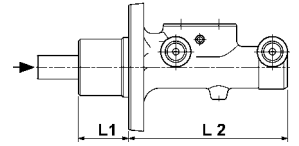

03.2120-4381.3 010526

Ø 20,64

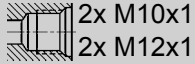

L1 L2
29,9 124,7

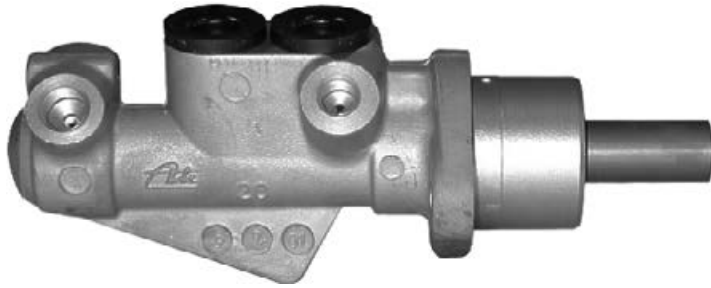

03.2120-4441.3 010510

Ø 20,64



L1 L2
31,5 115,9



03.2120-4461.3 010571

Ø 20,64

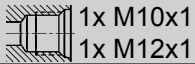

L1 L2
31,5 124,7



03.2120-4468.3 010789

Ø 20,64



L1 L2
31,5 124,7



03.2120-4504.3 010123

Ø 20,64

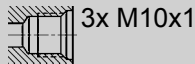

L1 L2
18,8 162,5

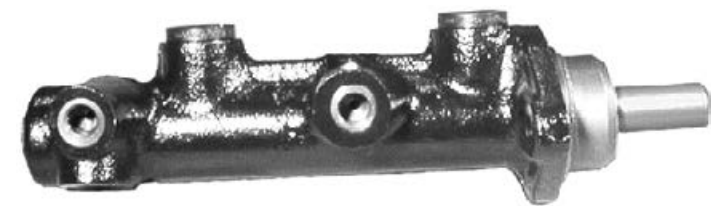

03.2120-4581.3 010915

Ø 20,64



L1 L2
31,5 124,7



03.2120-5503.3 010124

Ø 20,64

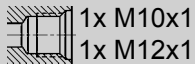

L1 L2
18,8 162,5



03.2120-8411.3 010125

Ø 20,64



L1 L2
20,0 192,0





Abbildungen Hauptbremszylinder

Illustrations master cylinder - Illustrazioni pompe freno -

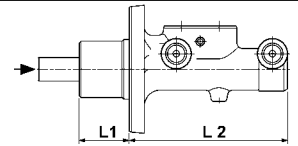

Illustrations Maître cylindres - Ilustraciones cilindro maestro freno



03.2122-0142.3 010128
 Ø 22,20  3x M10x1 →  L1 L2
 18,5 157,5

03.2122-0264.3 010129
 Ø 22,20  2x M10x1
 2x M12x1 →  L1 L2
 33,1 118,0

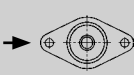

03.2122-0282.3 010130
 Ø 22,20  1x M10x1
 1x M12x1 →  L1 L2
 28,6 134,2

03.2122-0621.3 010131
 Ø 22,20  4x M10x1 →  L1 L2
 33,2 131,7

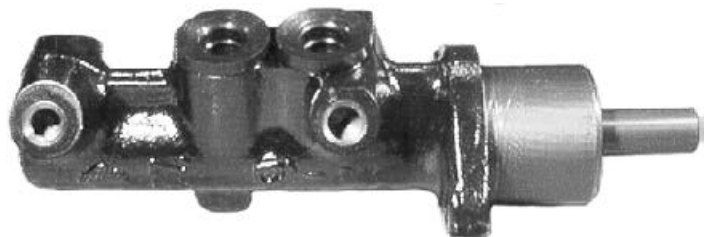

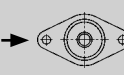
03.2122-0626.3 010539
 Ø 22,20  2x M10x1 →  L1 L2
 33,2 131,7

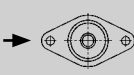
03.2122-0646.3 010133
 Ø 22,20  2x M10x1 →  L1 L2
 36,0 115,7

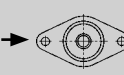

03.2122-0704.3 010134
 Ø 22,20  2x M10x1 →  L1 L2
 19,5 182,5

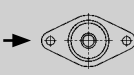
03.2122-0903.3 010136
 Ø 22,20  3x M10x1 →  L1 L2
 14,5 208,0



Abbildungen Hauptbremszylinder

Illustrations master cylinder - Illustrazioni pompe freno -

Illustrations Maître cylindres - Ilustraciones cilindro maestro freno

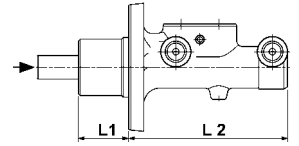

03.2122-1001.3 010562

Ø 22,20

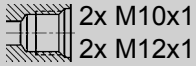

2x M10x1
2x M12x1

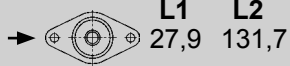

L1 L2
27,9 131,7



03.2122-1042.3 010137

Ø 22,20



4x M10x1

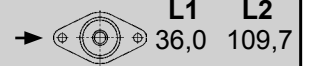

L1 L2
36,0 109,7



03.2122-1144.3 010636

Ø 22,20

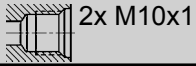

2x M10x1

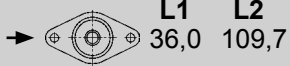

L1 L2
36,0 109,7



03.2122-1184.3 010592

Ø 22,20



2x M12x1

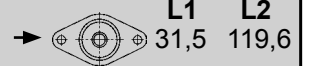

L1 L2
31,5 119,6



03.2122-1331.3 010607

Ø 22,20

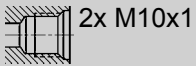

2x M10x1

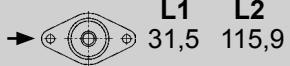

L1 L2
31,5 115,9



03.2122-1344.3 010593

Ø 22,20



2x M10x1

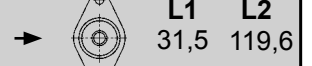

L1 L2
31,5 119,6



03.2122-1351.3 010528

Ø 22,20

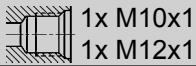

1x M10x1
1x M12x1



L1 L2
31,5 115,9



03.2122-1356.3 010529

Ø 22,20

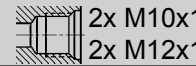

2x M10x1
2x M12x1

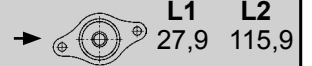

L1 L2
27,9 115,9



Abbildungen Hauptbremszylinder

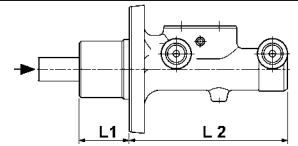

Illustrations master cylinder - Illustrazioni pompe freno -

Illustrations Maître cylindres - Ilustraciones cilindro maestro freno

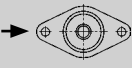

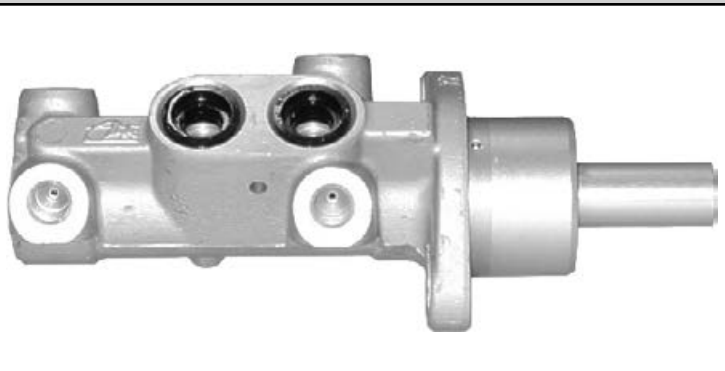
03.2122-1421.3 010615
 Ø 22,20  2x M10x1 →  L1 L2
 31,5 115,9



03.2122-1461.3 010610
 Ø 22,20  2x M10x1 →  L1 L2
 31,5 109,4

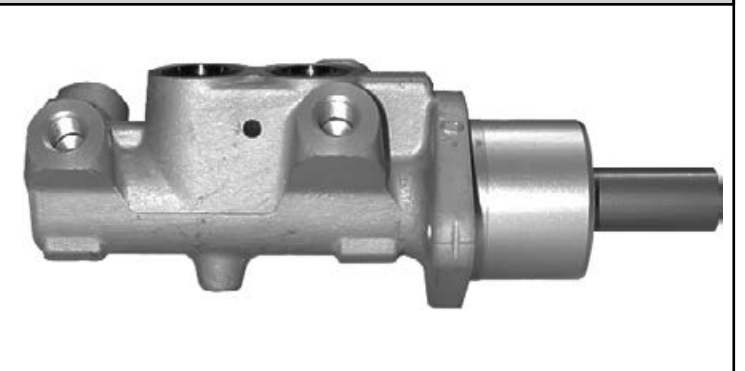

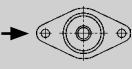
03.2122-1521.3 010494
 Ø 22,20  2x M10x1 →  L1 L2
 31,5 119,0



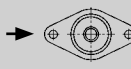

03.2122-1541.3 010511
 Ø 22,20  4x M10x1 →  L1 L2
 27,4 119,0

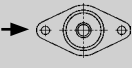

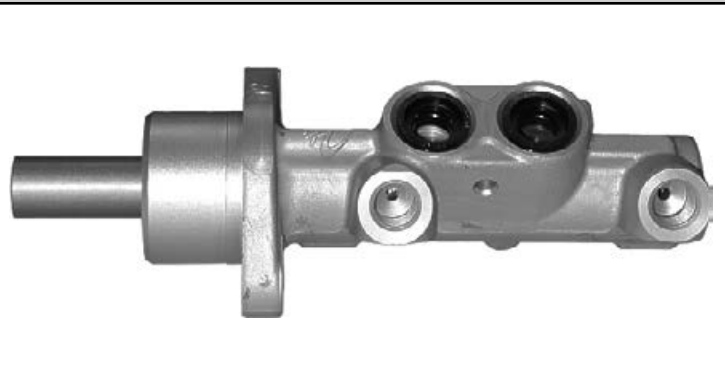

03.2122-1564.3 010594
 Ø 22,20  2x M12x1 →  L1 L2
 26,5 124,0



03.2122-1588.3 010733
 Ø 22,20  4x M10x1 →  L1 L2
 27,4 124,0



03.2122-1663.3 010734
 Ø 22,20  3x M12x1 →  L1 L2
 4,1 143,3

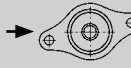

03.2122-1691.3 010918
 Ø 22,20  2x M10x1 →  L1 L2
 33,1 114,5



Abbildungen Hauptbremszylinder

Illustrations master cylinder - Illustrazioni pompe freno -

Illustrations Maître cylindres - Ilustraciones cilindro maestro freno

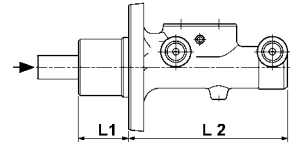

03.2122-1724.3 010648

Ø 22,20

1x M10x1
3x M12x1

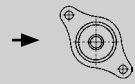

L1 L2
4,1 139,6

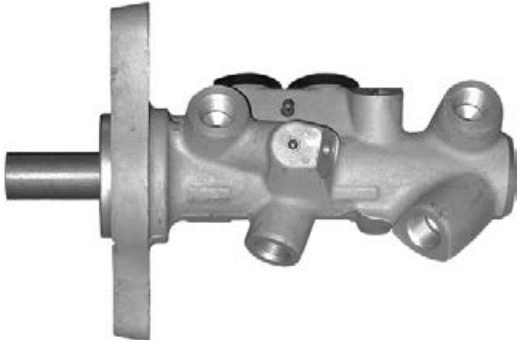

03.2122-1824.3 010892

Ø 22,20

3x M12x1

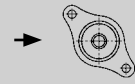

L1 L2
42,1 109,3



03.2122-1853.3 010893

Ø 22,20

2x M12x1

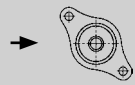

L1 L2
40,9 109,3



03.2122-1883.3 010735

Ø 22,20

3x M12x1

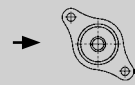

L1 L2
6,4 143,3



03.2122-1888.3 010736

Ø 22,20

3x M12x1

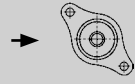

L1 L2
6,4 143,3



03.2122-1906.3 010761

Ø 22,20

2x 3/8"-
24UNF-2B

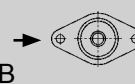

L1 L2
18,8 157,5



03.2122-1942.3 010700

Ø 22,20

3x M12x1

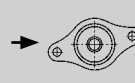

L1 L2
30,5 117,7



03.2122-2023.3 010798

Ø 22,20

2x M10x1
2x M12x1

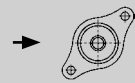

L1 L2
43,2 125,8



Abbildungen Hauptbremszylinder

Illustrations master cylinder - Illustrazioni pompe freno -

Illustrations Maître cylindres - Ilustraciones cilindro maestro freno

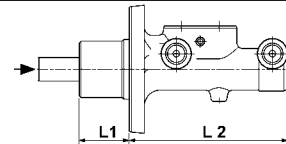

03.2122-2129.3 010799

Ø 22,20



2x M12x1



L1 L2
36,1 134,9



03.2122-2163.3 010800

Ø 22,20



3x M12x1



L1 L2
39,8 128,2



03.2122-2202.3 010140

Ø 22,20



2x M12x1



L1 L2
18,8 162,0



03.2122-2905.3 010141

Ø 22,20



4x M10x1



L1 L2
14,5 208,0



03.2122-4902.3 010144

Ø 22,20



2x M12x1



L1 L2
18,8 157,5



03.2122-6202.3 010148

Ø 22,20



5x M10x1



L1 L2
18,8 157,5



03.2122-6911.3 010153

Ø 22,20



2x M10x1



L1 L2
18,5 166,0



03.2122-6912.3 010154

Ø 22,20



2x M10x1



L1 L2
18,5 166,0



Abbildungen Hauptbremszylinder

Illustrations master cylinder - Illustrazioni pompe freno -

Illustrations Maître cylindres - Ilustraciones cilindro maestro freno

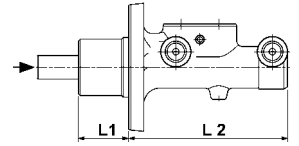

03.2122-7513.3 010155
 Ø 22,20 2x M10x1 → L1 L2
 18,5 166,4

03.2122-8012.3 010156
 Ø 22,20 4x M10x1 → L1 L2
 18,5 166,0

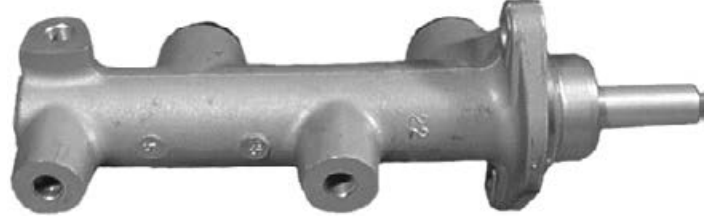

03.2122-8806.3 010157
 Ø 22,20 2x M10x1 1x M12x1 → L1 L2
 20,0 181,0

03.2122-9612.3 010159
 Ø 22,20 4x M10x1 → L1 L2
 36,0 103,7

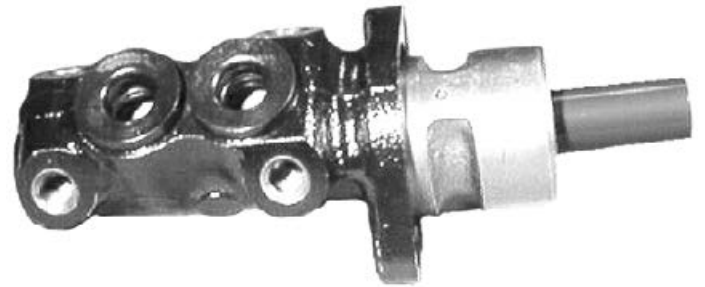
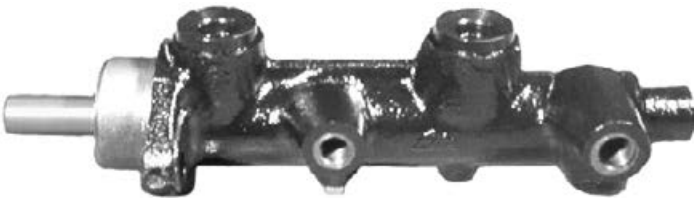

03.2122-9631.3 010160
 Ø 22,20 4x M10x1 → L1 L2
 36,0 103,7

03.2122-9812.3 010161
 Ø 22,20 4x M10x1 → L1 L2
 36,0 103,7



03.2123-0162.3 010162
 Ø 23,81 2x M10x1 → L1 L2
 18,5 166,0

03.2123-0242.3 010163
 Ø 23,81 2x M10x1 → L1 L2
 18,5 179,5

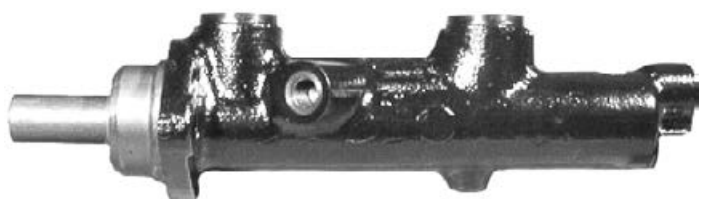

Abbildungen Hauptbremszylinder

Illustrations master cylinder - Illustrazioni pompe freno -

Illustrations Maître cylindres - Ilustraciones cilindro maestro freno

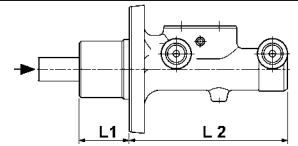

03.2123-0271.3 010164
 Ø 23,81 2x M10x1 → L1 18,5 L2 157,5

03.2123-0291.3 010165
 Ø 23,81 2x M10x1 → L1 18,5 L2 157,5



03.2123-0491.3 010167
 Ø 23,81 4x M10x1 → L1 36,0 L2 115,7

03.2123-0522.3 010168
 Ø 23,81 1x M10x1 1x M14x1 → L1 18,5 L2 200,5

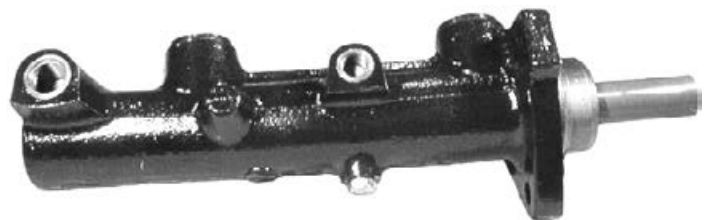

03.2123-0566.3 010169
 Ø 23,81 4x M10x1 → L1 36,0 L2 115,7

03.2123-0609.3 010171
 Ø 23,81 3x M10x1 → L1 18,8 L2 153,0



03.2123-0614.3 010172
 Ø 23,81 3x M10x1 → L1 18,8 L2 153,0

03.2123-0921.3 010174
 Ø 23,81 2x M10x1 → L1 37,9 L2 125,2





Abbildungen Hauptbremszylinder

Illustrations master cylinder - Illustrazioni pompe freno -

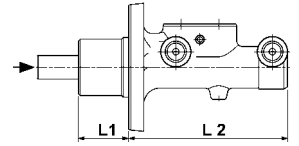

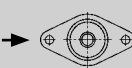
Illustrations Maître cylindres - Ilustraciones cilindro maestro freno





03.2123-1003.3 010175
 Ø 23,81  3x M10x1 →  L1 L2
 18,8 153,0



03.2123-1121.3 010176
 Ø 23,81  1x M10x1
 1x M12x1 →  L1 L2
 29,1 118,0



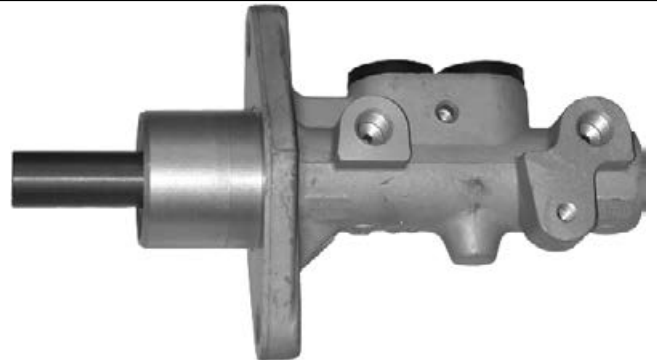

03.2123-1181.3 010522
 Ø 23,81  2x M10x1 →  L1 L2
 13,2 145,8



03.2123-1424.3 010637
 Ø 23,81  2x M10x1 →  L1 L2
 34,4 116,6





03.2123-1428.3 010476
 Ø 23,81  2x M10x1 →  L1 L2
 34,4 116,6

03.2123-1484.3 010595
 Ø 23,81  2x M12x1 →  L1 L2
 31,5 119,6



03.2123-1486.3 010488
 Ø 23,81  2x M12x1 →  L1 L2
 31,5 119,6

03.2123-1526.3 010477
 Ø 23,81  2x M12x1 →  L1 L2
 31,5 119,6



Abbildungen Hauptbremszylinder

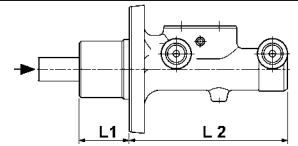

Illustrations master cylinder - Illustrazioni pompe freno -

Illustrations Maître cylindres - Ilustraciones cilindro maestro freno

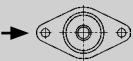

03.2123-1546.3 010536
 Ø 23,81  4x M10x1 →  L1 L2
 27,9 114,1





03.2123-1548.3 010478
 Ø 23,81  4x M10x1 →  L1 L2
 27,9 114,1





03.2123-1551.3 010512
 Ø 23,81  4x M10x1 →  L1 L2
 27,9 114,1



03.2123-1581.3 010487
 Ø 23,81  2x M12x1 →  L1 L2
 33,1 125,8





03.2123-1622.3 010470
 Ø 23,81  1x M10x1
 2x M12x1 →  L1 L2
 31,5 119,6

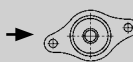



03.2123-1626.3 010727
 Ø 23,81  1x M10x1
 2x M12x1 →  L1 L2
 31,5 119,6



03.2123-1722.3 010471
 Ø 23,81  2x M12x1 →  L1 L2
 56,0 95,1



03.2123-1741.3 010537
 Ø 23,81  4x M10x1 →  L1 L2
 27,9 113,1



Abbildungen Hauptbremszylinder

Illustrations master cylinder - Illustrazioni pompe freno -

Illustrations Maître cylindres - Ilustraciones cilindro maestro freno

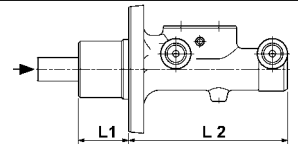

03.2123-1824.3 010596
 Ø 23,81 2x M10x1 → L1 L2
 31,5 119,6



03.2123-2024.3 010597
 Ø 23,81 1x M10x1 3x M12x1 → L1 L2
 4,1 137,8



03.2123-2064.3 010598
 Ø 23,81 4x M12x1 → L1 L2
 12,5 128,9



03.2123-2146.3 010572
 Ø 23,81 2x M10x1 → L1 L2
 31,5 119,0



03.2123-2164.3 010599
 Ø 23,81 2x M12x1 → L1 L2
 40,3 130,0



03.2123-2221.3 010861
 Ø 23,81 2x M10x1 → L1 L2
 13,2 145,7



03.2123-2243.3 010748
 Ø 23,81 2x M12x1 → L1 L2
 26,5 124,0



03.2123-2561.3 010629
 Ø 23,81 3x M12x1 → L1 L2
 23,9 133,8





Abbildungen Hauptbremszylinder

Illustrations master cylinder - Illustrazioni pompe freno -

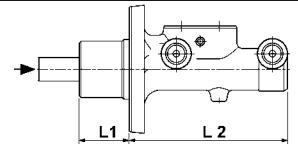
Illustrations Maître cylindres - Ilustraciones cilindro maestro freno



03.2123-2581.3 010613
 Ø 23,81  2x M12x1 →  L1 L2
 31,5 119,6

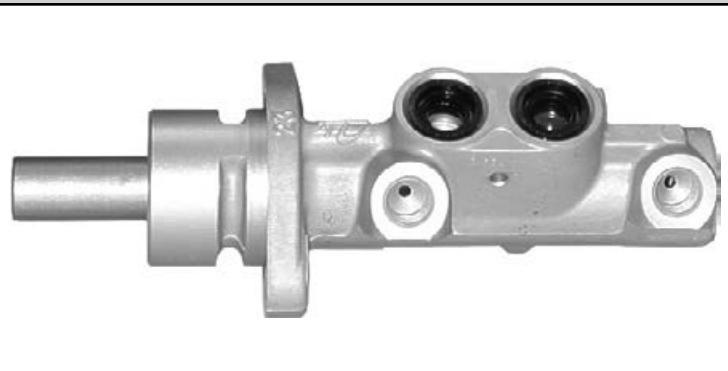

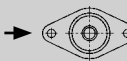

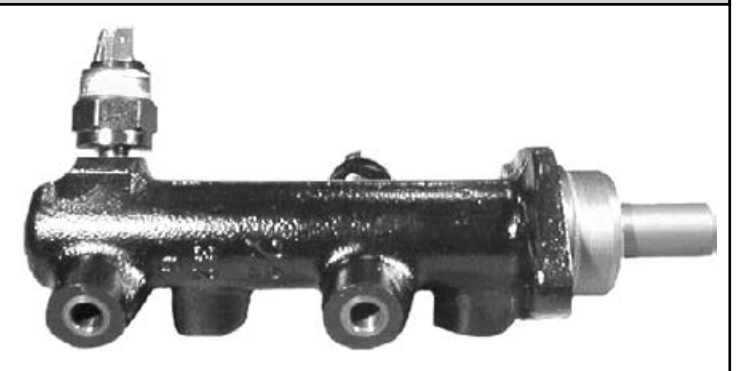
03.2123-2604.3 010178
 Ø 23,81  2x M10x1 →  L1 L2
 18,8 176,3



03.2123-2621.3 010701
 Ø 23,81  2x M12x1 →  L1 L2
 30,5 124,8





03.2123-2654.3 010801
 Ø 23,81  4x M12x1 →  L1 L2
 34,9 121,4



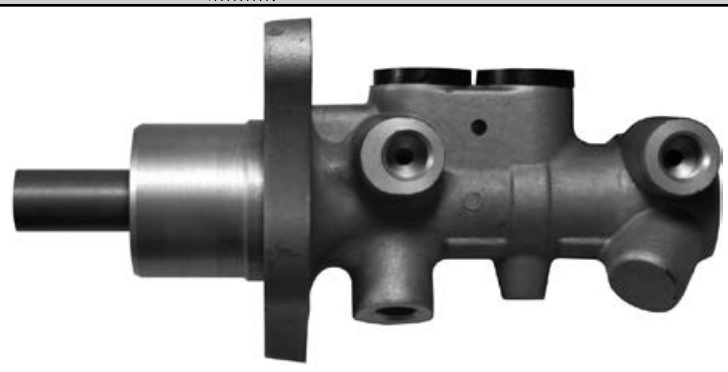

03.2123-2715.3 010802
 Ø 23,81  4x M12x1 →  L1 L2
 34,9 121,4



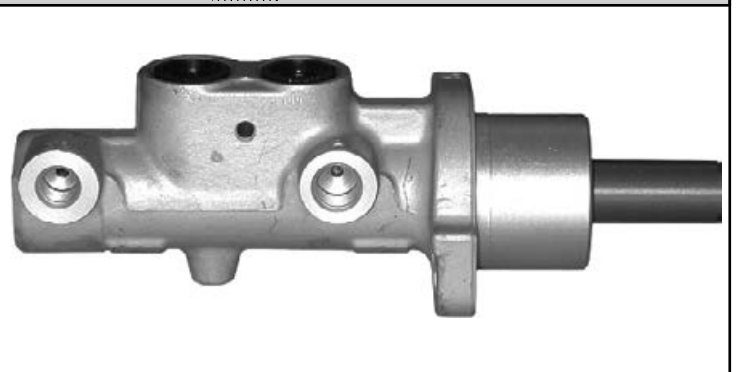

03.2123-2721.3 010632
 Ø 23,81  1x M10x1
 1x M12x1 →  L1 L2
 31,5 119,6



03.2123-2761.3 010886
 Ø 23,81  2x M12x1 →  L1 L2
 30,5 123,7



03.2123-2774.3 010803
 Ø 23,81  4x M12x1 →  L1 L2
 26,6 130,2



Abbildungen Hauptbremszylinder

Illustrations master cylinder - Illustrazioni pompe freno -

Illustrations Maître cylindres - Ilustraciones cilindro maestro freno

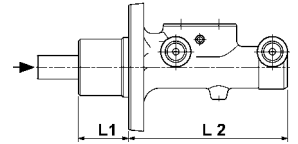

03.2123-2781.3 010631

Ø 23,81

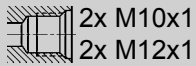

L1 L2
27,9 119,6



03.2123-2863.3 010790

Ø 23,81



L1 L2
29,2 116,0



03.2123-2923.3 010791

Ø 23,81

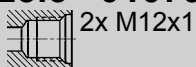

L1 L2
28,2 119,0



03.2123-3041.3 010887

Ø 23,81



L1 L2
41,5 101,7



03.2123-3103.3 010781

Ø 23,81

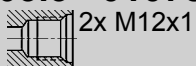

L1 L2
37,0 116,3



03.2123-3123.3 010806

Ø 23,81

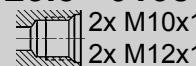

L1 L2
43,2 125,8



03.2123-3241.3 010882

Ø 23,81

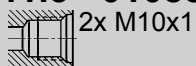

L1 L2
29,2 116,0



03.2123-3302.3 010180

Ø 23,81

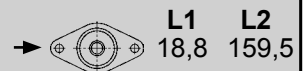

L1 L2
18,8 159,5





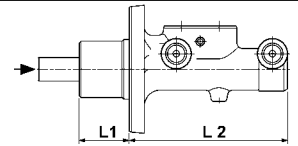

Abbildungen Hauptbremszylinder

Illustrations master cylinder - Illustrazioni pompe freno -

Illustrations Maître cylindres - Ilustraciones cilindro maestro freno





03.2123-3402.3 010181
 Ø 23,81  3x M10x1 →  L1 L2
 18,8 153,0



03.2123-3449.3 010808
 Ø 23,81  2x M12x1 →  L1 L2
 36,1 134,9



03.2123-3493.3 010792
 Ø 23,81  2x M12x1 →  L1 L2
 28,2 119,0

03.2123-3549.3 010809
 Ø 23,81  2x M12x1 →  L1 L2
 36,1 134,9

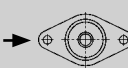

03.2123-3593.3 010919
 Ø 23,81  2x M12x1 →  L1 L2
 37,0 116,3

03.2123-4911.3 010182
 Ø 23,81  3x M10x1 →  L1 L2
 18,8 181,0

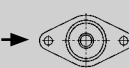

03.2123-5212.3 010183
 Ø 23,81  2x M10x1 →  L1 L2
 18,5 166,0

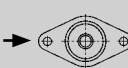
03.2123-6002.3 010184
 Ø 23,81  2x M10x1 →  L1 L2
 18,5 175,0



Abbildungen Hauptbremszylinder

Illustrations master cylinder - Illustrazioni pompe freno -

Illustrations Maître cylindres - Ilustraciones cilindro maestro freno

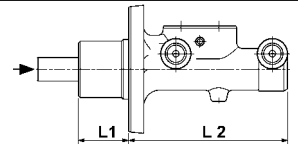

03.2123-6207.3 010185

Ø 23,81



3x M10x1



L1

L2

18,8 181,0

03.2123-6802.3 010186

Ø 23,81



5x M10x1



L1

L2

18,8 157,5



03.2123-7002.3 010187

Ø 23,81



5x M10x1



L1

L2

18,8 157,5

03.2123-7902.3 010191

Ø 23,81



3x M10x1



L1

L2

18,8 170,5



03.2123-8311.3 010192

Ø 23,81



2x M10x1



L1

L2

18,5 166,0

03.2123-8312.3 010193

Ø 23,81



2x M10x1



L1

L2

18,5 166,0



03.2123-8512.3 010194

Ø 23,81



4x M10x1



L1

L2

18,5 166,0

03.2123-8611.3 010195

Ø 23,81



3x M10x1



L1

L2

18,5 162,5





Abbildungen Hauptbremszylinder

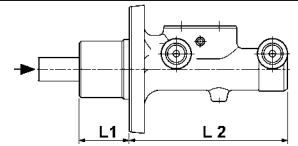

Illustrations master cylinder - Illustrazioni pompe freno -

Illustrations Maître cylindres - Ilustraciones cilindro maestro freno





03.2123-8711.3 010196
 Ø 23,81  2x M10x1 →  L1 18,5 L2 166,4



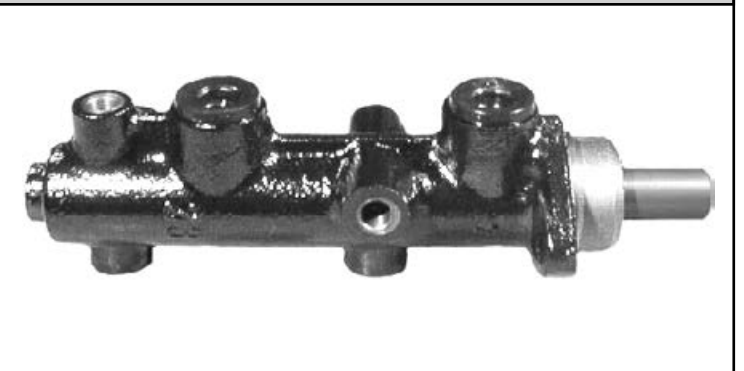

03.2123-8902.3 010197
 Ø 23,81  3x M10x1 →  L1 18,5 L2 170,5





03.2123-9002.3 010198
 Ø 23,81  3x M10x1 →  L1 18,5 L2 170,5





03.2125-0161.3 010920
 Ø 25,40  2x M10x1 →  L1 9,0 L2 142,0





03.2125-0293.3 010817
 Ø 25,40  2x M12x1 →  L1 35,2 L2 133,8



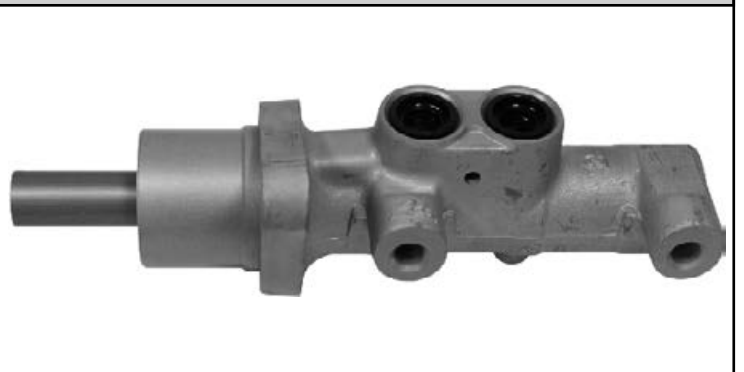

03.2125-0298.3 010818
 Ø 25,40  2x M10x1 →  L1 35,2 L2 133,8

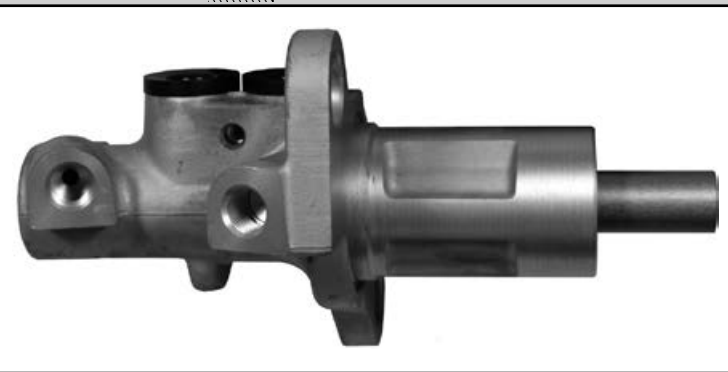

03.2125-0373.3 010810
 Ø 25,40  2x M12x1 →  L1 64,2 L2 93,5



03.2125-0483.3 010783
 Ø 25,40  2x M12x1 →  L1 37,0 L2 117,5



Abbildungen Hauptbremszylinder

Illustrations master cylinder - Illustrazioni pompe freno -

Illustrations Maître cylindres - Ilustraciones cilindro maestro freno

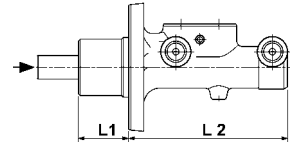

03.2125-0661.3 010917

Ø 25,40

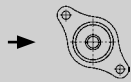
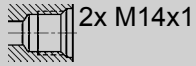

L1 L2
37,0 117,5

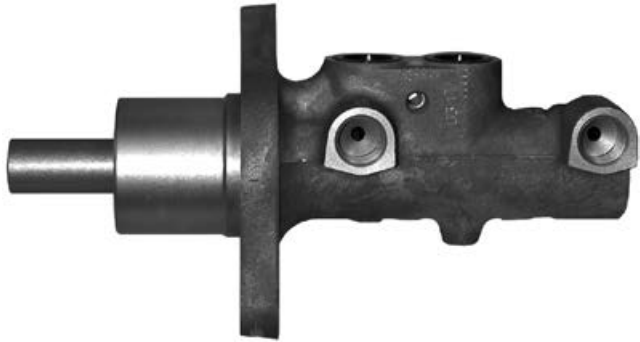

03.2125-1102.3 010202

Ø 25,40

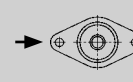
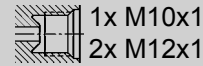

L1 L2
18,8 166,5



03.2125-1302.3 010203

Ø 25,40

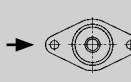

L1 L2
18,8 159,5



03.2125-1712.3 010204

Ø 25,40

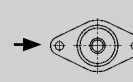

L1 L2
18,5 166,0



03.2125-1902.3 010206

Ø 25,40

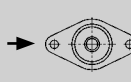
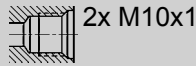

L1 L2
18,5 155,0



03.2125-2102.3 010207

Ø 25,40

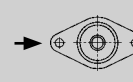
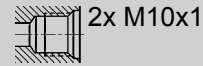

L1 L2
18,5 158,5



03.2125-2510.3 010209

Ø 25,40

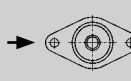
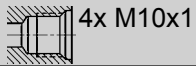

L1 L2
18,5 166,0



03.2125-2802.3 010210

Ø 25,40

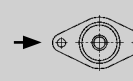

L1 L2
18,5 163,5





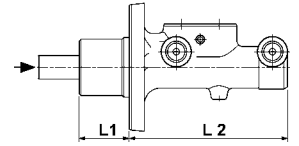

Abbildungen Hauptbremszylinder

Illustrations master cylinder - Illustrazioni pompe freno -



Illustrations Maître cylindres - Ilustraciones cilindro maestro freno





03.2125-3011.3 010211
 Ø 25,40  2x M10x1 →  L1 L2
 55,4 114,5



03.2125-3210.3 010212
 Ø 25,40  4x M10x1 →  L1 L2
 36,0 116,2



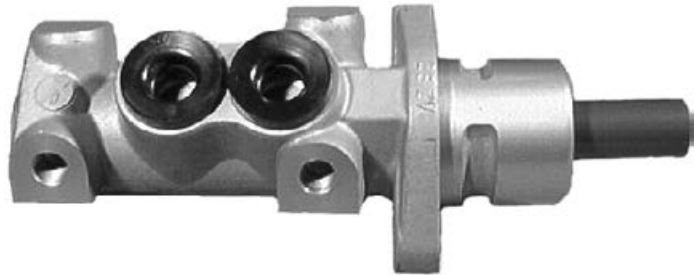

03.2125-3610.3 010214
 Ø 25,40  2x M10x1 →  L1 L2
 36,0 116,2



03.2125-3701.3 010627
 Ø 25,40  5x M10x1 →  L1 L2
 18,5 166,0



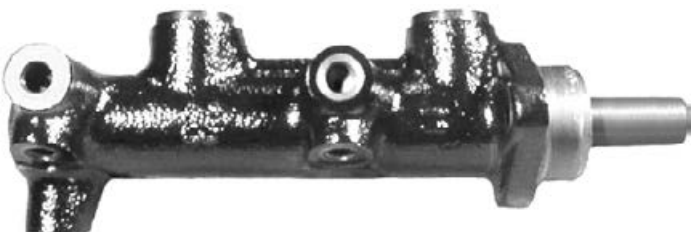

03.2125-3801.3 010215
 Ø 25,40  5x M10x1 →  L1 L2
 18,5 166,0

03.2125-7002.3 010628
 Ø 25,40  2x M10x1 →  L1 L2
 10,2 166,0



03.2125-7310.3 010743
 Ø 25,40  2x M12x1 →  L1 L2
 11,6 141,0

03.2125-7402.3 010541
 Ø 25,40  1x M10x1
 2x M12x1 →  L1 L2
 31,5 120,8

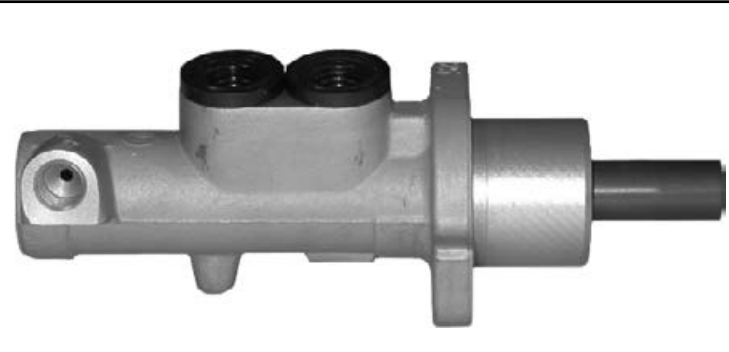



Abbildungen Hauptbremszylinder

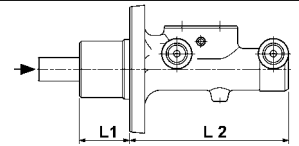

Illustrations master cylinder - Illustrazioni pompe freno -

Illustrations Maître cylindres - Ilustraciones cilindro maestro freno

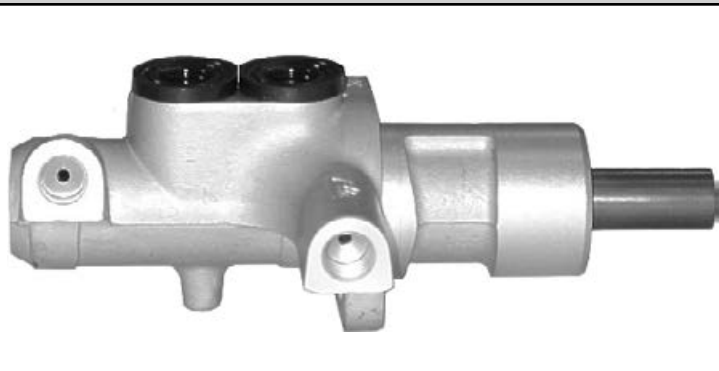

03.2125-7502.3 010616
 Ø 25,40  2x M12x1 →  L1 L2
 56,0 96,3



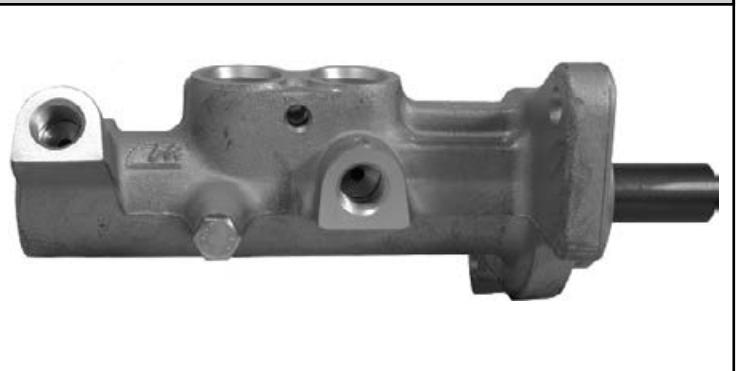

03.2125-7637.3 010707
 Ø 25,40  2x M12x1 →  L1 L2
 11,6 140,7



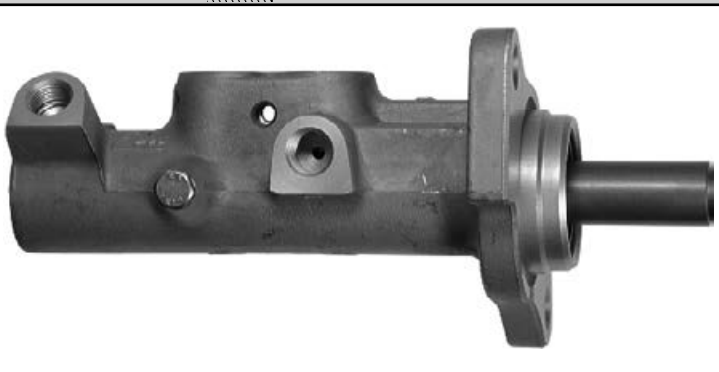

03.2125-7638.3 010738
 Ø 25,40  2x M12x1 →  L1 L2
 11,6 140,7





03.2125-7708.3 010739
 Ø 25,40  4x M12x1 →  L1 L2
 11,6 140,7



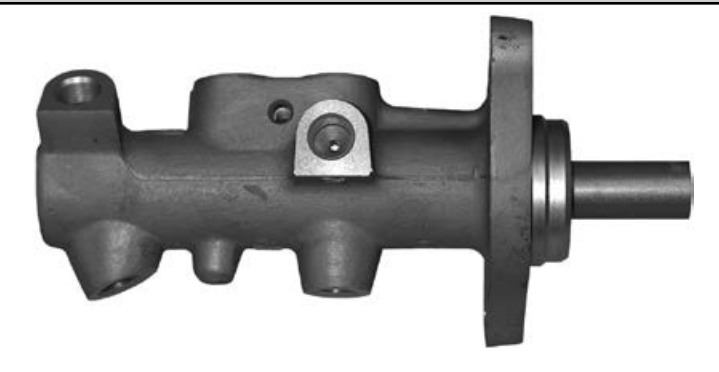

03.2125-7713.3 010819
 Ø 25,40  4x M12x1 →  L1 L2
 11,6 140,7



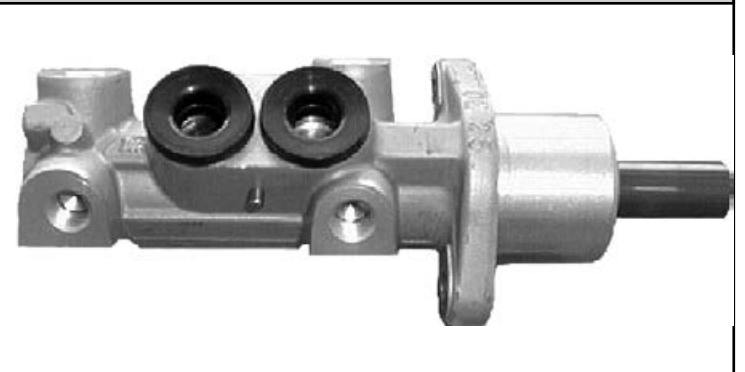

03.2125-8111.3 010479
 Ø 25,40  4x M10x1 →  L1 L2
 31,5 120,8

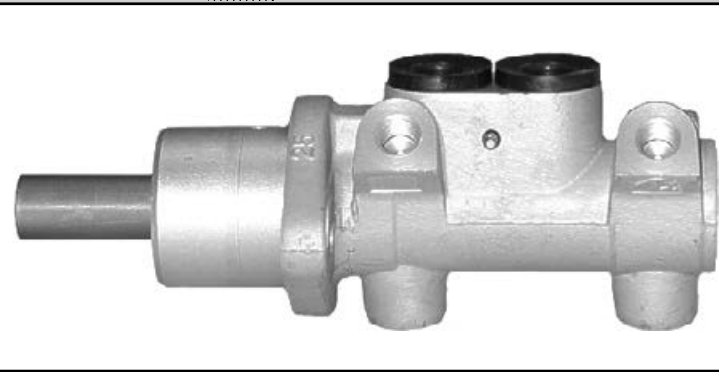

03.2125-8404.3 010583
 Ø 25,40  4x M10x1 →  L1 L2
 34,6 108,0



03.2125-9604.3 010581
 Ø 25,40  1x M10x1
 4x M12x1 →  L1 L2
 14,6 131,5

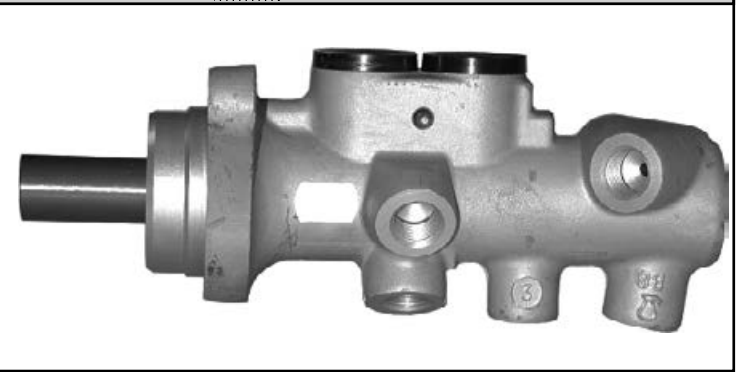

Abbildungen Hauptbremszylinder

Illustrations master cylinder - Illustrazioni pompe freno -

Illustrations Maître cylindres - Ilustraciones cilindro maestro freno

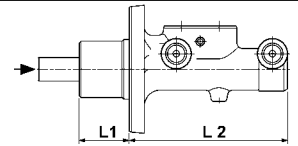

03.2125-9704.3 010603
 Ø 25,40 2x M12x1 → L1 32,9 L2 125,5



03.2125-9901.3 010634
 Ø 25,40 1x M10x1 2x M12x1 → L1 44,7 L2 110,9

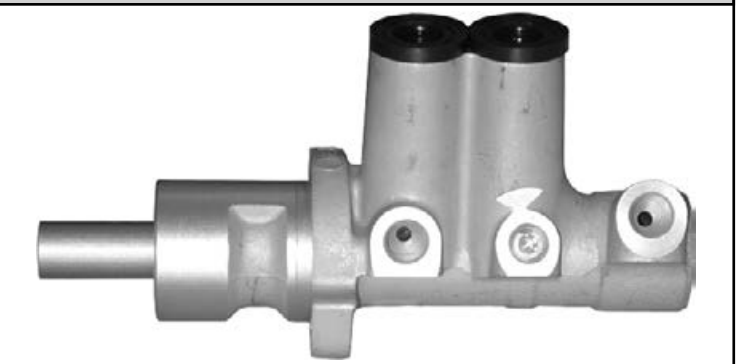

03.2125-9911.3 010883
 Ø 25,40 2x M12x1 → L1 44,7 L2 112,4



03.2126-0512.3 010217
 Ø 26,99 2x M10x1 → L1 18,5 L2 155,0

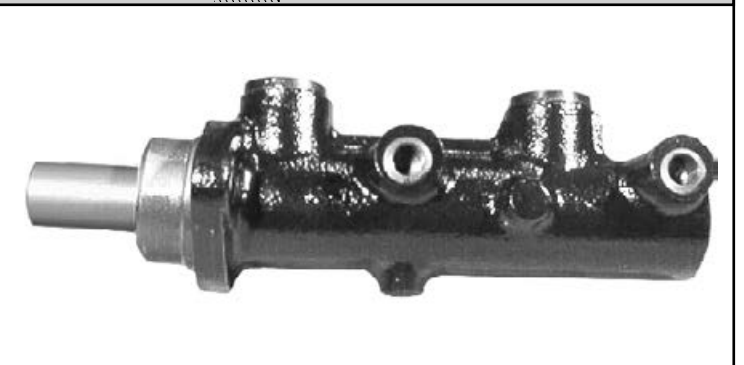

03.2126-3014.3 010811
 Ø 26,99 2x M12x1 → L1 18,7 L2 133,5



03.2126-3063.3 010812
 Ø 26,99 2x M12x1 → L1 23,3 L2 128,9



03.2130-0102.3 010221
 Ø 30,00 1x M10x1 1x M14x1,5 → L1 18,5 L2 204,5



03.2320-0201.3 010234
 Ø 28,57/20,64 1x M12x1 → L1 23,5 L2 198,5

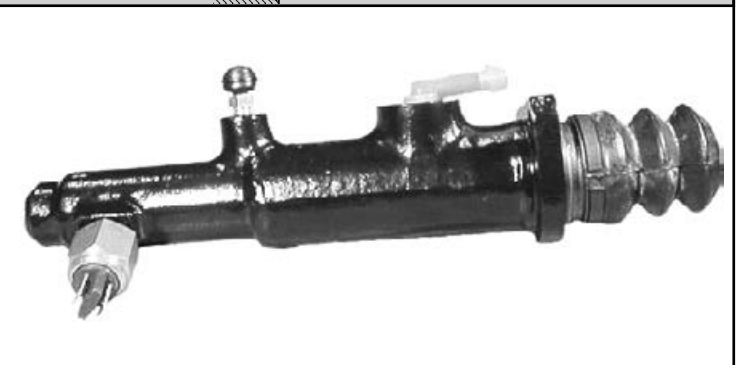

Abbildungen Hauptbremszylinder

Illustrations master cylinder - Illustrazioni pompe freno -

Illustrations Maître cylindres - Ilustraciones cilindro maestro freno

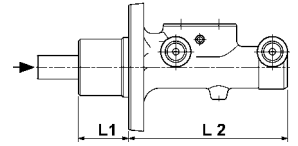

03.3115-2102.3 010247

Ø 15,87



4x M10x1



L1 L2
13,0 111,0



03.3115-2651.3 010250

Ø 15,87



3x M10x1



L1 L2
13,0 118,5



03.3117-1408.3 010255

Ø 17,46



3x M10x1



L1 L2
14,5 125,0



03.3119-0201.3 010257

Ø 19,05



3x M10x1



L1 L2
14,5 116,0



03.3119-0211.3 010258

Ø 19,05



3x M10x1



L1 L2
14,5 116,0



03.3119-0507.3 010264

Ø 19,05



3x M10x1



L1 L2
14,5 116,0



03.3119-6457.3 010269

Ø 19,05



3x M10x1



L1 L2
42,5 97,0



03.3119-6551.3 010270

Ø 19,05



3x M10x1



L1 L2
14,5 116,0





Abbildungen Hauptbremszylinder

Illustrations master cylinder - Illustrazioni pompe freno -

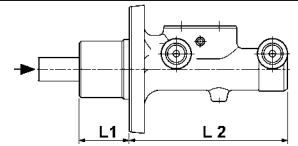
Illustrations Maître cylindres - Ilustraciones cilindro maestro freno

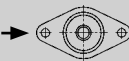



03.3119-7251.3 010272
 Ø 19,05  2x M10x1 →  L1 L2
 14,5 116,0



03.3122-0101.3 010277
 Ø 22,20  3x M10x1 →  L1 L2
 14,5 116,0





03.3125-0401.3 010290
 Ø 25,40  1x M14x1,5
 1x M22x1,5 →  L1 L2
 23,5 120,5

03.3126-0505.3 010294
 Ø 26,99  1x M12x1
 1x M14x1,5 →  L1 L2
 50,0 117,0





03.3131-0102.3 010296
 Ø 31,75  4x M14x1
 1x M22x1,5 →  L1 L2
 27,0 140,0

03.3131-0601.3 010299
 Ø 31,75  1x M14x1,5
 1x M22x1,5 →  L1 L2
 21,0 177,0



03.3134-0300.3 010308
 Ø 34,92  1x M14x1,5
 1x M22x1,5 →  L1 L2
 31,0 194,0

03.3138-2001.3 010310
 Ø 38,10  1x M14x1,5
 1x M22x1,5 →  L1 L2
 31,0 195,5



Abbildungen Hauptbremszylinder

Illustrations master cylinder - Illustrazioni pompe freno -

Illustrations Maître cylindres - Ilustraciones cilindro maestro freno

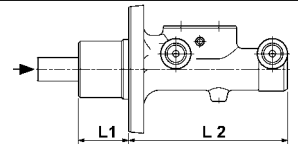

03.3138-2010.3 010311
 Ø 38,10
 1x M14x1,5
 1x M22x1,5



L1 L2
 31,0 195,5

03.3150-0101.3 010321
 Ø 50,80
 3x M14x1,5
 1x M22x1,5



L1 L2
 86,0 172,0



03.4055-0013.3 010793
 Ø 25,40
 2x M12x1



L1 L2
 20,0 106,0

03.4122-0031.3 010611
 Ø 22,20
 4x M10x1



L1 L2
 14,0 85,1



03.4122-0041.3 010612
 Ø 22,20
 2x M10x1



L1 L2
 14,0 85,1

03.4122-0054.3 010813
 Ø 22,20
 2x M12x1



L1 L2
 13,7 87,9



03.4123-0019.3 010584
 Ø 23,81
 4x M12x1



L1 L2
 5,5 102,3

03.4123-0081.3 010585
 Ø 23,81
 3x M12x1



L1 L2
 5,5 102,3

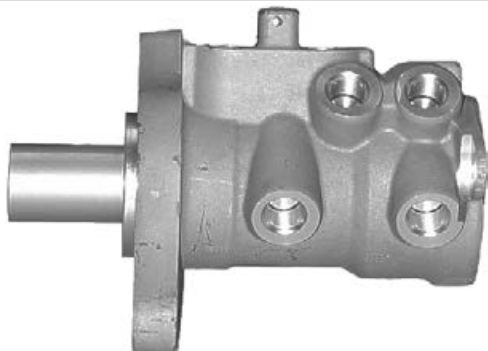



Abbildungen Hauptbremszylinder

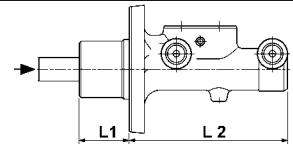

Illustrations master cylinder - Illustrazioni pompe freno -

Illustrations Maître cylindres - Ilustraciones cilindro maestro freno



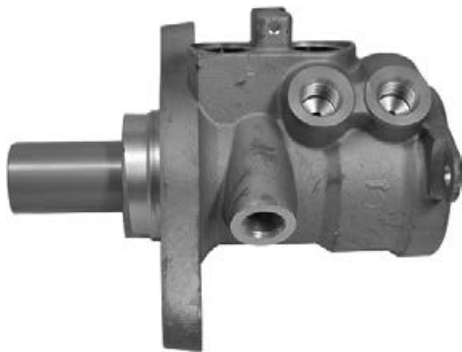

03.4123-0153.3 010659
 Ø 23,81  3x M12x1 →  L1 L2
 12,8 90,3





03.4125-0014.3 010794
 Ø 25,40  3x M12x1 →  L1 L2
 4,2 105,0



03.4125-0021.3 010888
 Ø 25,40  2x M12x1 →  L1 L2
 4,2 105,0





03.4152-0053.3 010884
 Ø 22,20  2x M10x1 →  L1 L2
 27,9 91,0



03.4152-0058.3 010885
 Ø 22,20  2x M12x1 →  L1 L2
 27,9 91,0





03.4152-0116.3 010814
 Ø 22,20  2x M12x1 →  L1 L2
 27,1 117,0



03.4153-0063.3 010773
 Ø 23,81  2x M10x1 →  L1 L2
 9,9 105,1



03.4153-0173.3 010815
 Ø 23,81  2x M12x1 →  L1 L2
 31,7 92,2



Abbildungen Hauptbremszylinder

Illustrations master cylinder - Illustrazioni pompe freno -

Illustrations Maître cylindres - Ilustraciones cilindro maestro freno

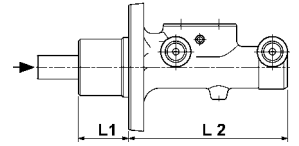

03.4153-0186.3 010816

Ø 23,81

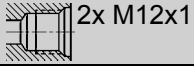

L1 L2
27,1 117,0



03.4155-0043.3 010795

Ø 25,40

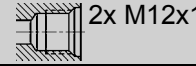

L1 L2
9,9 105,0



03.4155-0156.3 010862

Ø 25,40

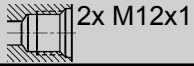

L1 L2
24,2 90,7



10.6120-0287.3 010334

Ø 20,64

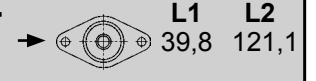
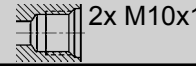

L1 L2
39,8 121,1

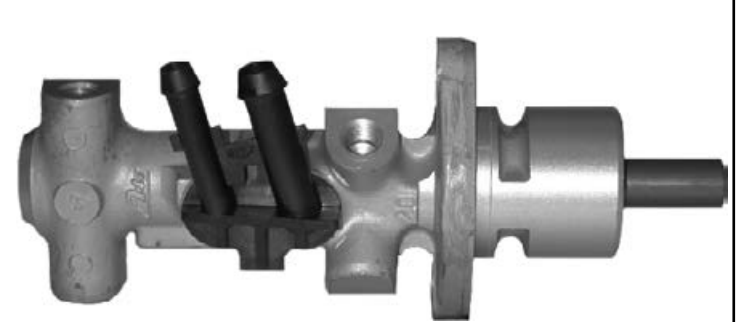

10.6122-0144.3 010638

Ø 22,20

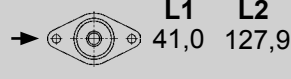
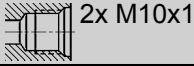

L1 L2
41,0 127,9



10.6123-0154.3 010578

Ø 23,81

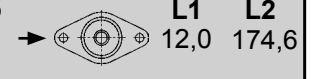
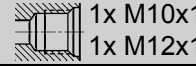

L1 L2
12,0 174,6



10.6123-0239.3 010335

Ø 23,81

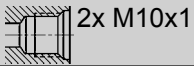

L1 L2
43,3 132,0



10.6123-0312.3 010457

Ø 23,81

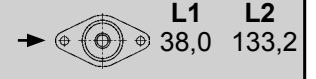

L1 L2
38,0 133,2





Abbildungen Hauptbremszylinder

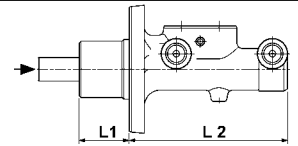

Illustrations master cylinder - Illustrazioni pompe freno -

Illustrations Maître cylindres - Ilustraciones cilindro maestro freno





10.6123-0522.3 010633
 Ø 23,81  2x M10x1 →  L1 L2
 38,0 142,0





10.6123-0674.3 010639
 Ø 23,81  2x M10x1 →  L1 L2
 41,0 127,9



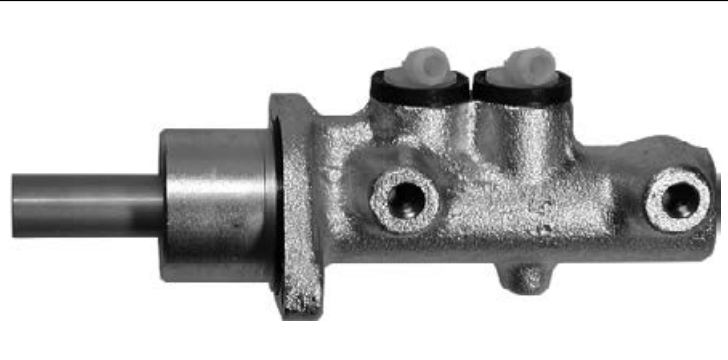

20.5522-1093.3 010731
 Ø 22,20  2x M10x1 →  L1 L2
 31,5 120,0





20.5522-1128.3 010747
 Ø 22,20  2x M10x1 →  L1 L2
 31,5 120,0





24.2022-1601.3 010340
 Ø 22,20/17,46  3x M10x1 →  L1 L2
 58,0 113,0





24.2023-1601.3 010341
 Ø 23,81  3x M10x1 →  L1 L2
 50,0 120,5

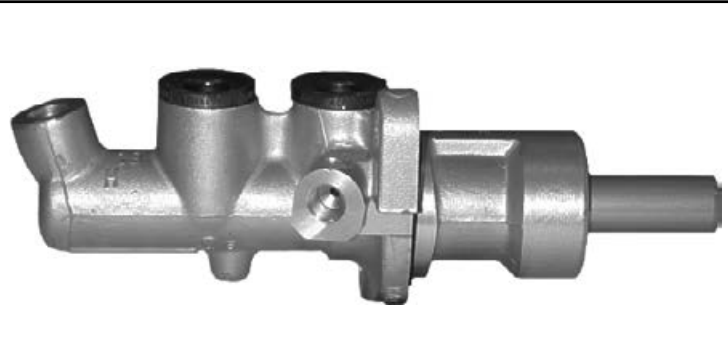

24.2023-1701.3 010514
 Ø 23,81/19,05  1x M10x1
 1x M12x1 →  L1 L2
 51,5 106,0



24.2023-1702.3 010534
 Ø 23,81/19,05  3x M12x1 →  L1 L2
 24,0 125,0



Abbildungen Hauptbremszylinder

Illustrations master cylinder - Illustrazioni pompe freno -

Illustrations Maître cylindres - Ilustraciones cilindro maestro freno

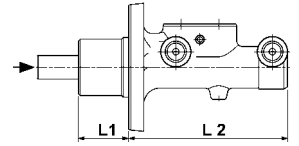

24.2023-1704.3 010635
 Ø 23,81 3x M12x1 →  L1 L2
 14,0 135,0



24.2025-1702.3 010515
 Ø 25,40/19,05 1x M10x1 1x M12x1 →  L1 L2
 51,3 106,2

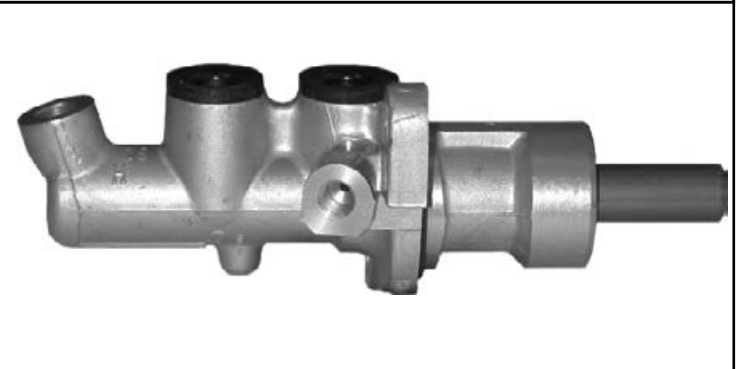

24.2025-1703.3 010516
 Ø 25,40/19,05 2x M12x1 →  L1 L2
 51,3 106,2



24.2025-1704.3 010619
 Ø 25,40 1x M10x1 2x M12x1 →  L1 L2
 51,3 107,7



24.2025-1705.3 010624
 Ø 25,40/20,64 1x M10x1 1x M12x1 →  L1 L2
 51,5 108,0

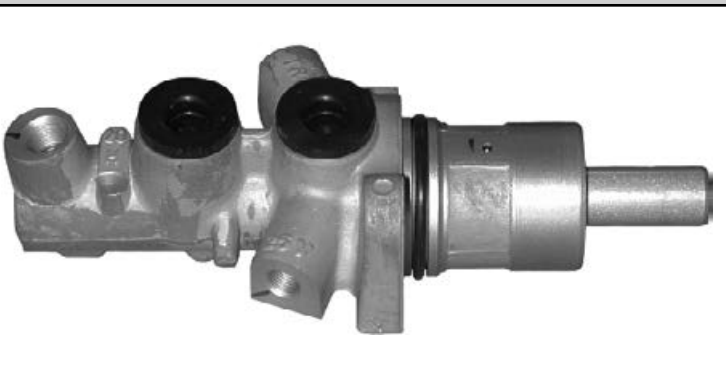

24.2025-1706.3 010676
 Ø 25,40 1x M10x1 1x M12x1 →  L1 L2
 33,0 127,0



24.2025-1707.3 010691
 Ø 25,40 2x M12x1 →  L1 L2
 51,7 108,5



24.2025-1708.3 010692
 Ø 25,40 3x M10x1 2x M12x1 →  L1 L2
 33,0 127,0



Abbildungen Hauptbremszylinder

Illustrations master cylinder - Illustrazioni pompe freno -

Illustrations Maître cylindres - Ilustraciones cilindro maestro freno

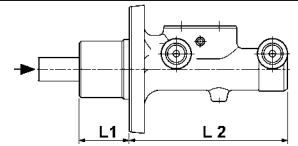

24.2025-1709.3 010693
 Ø 25,40  2x M12x1 →  L1 L2
 51,3 108,0

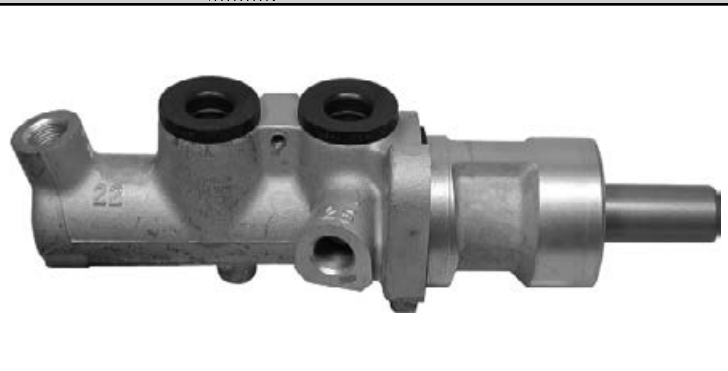

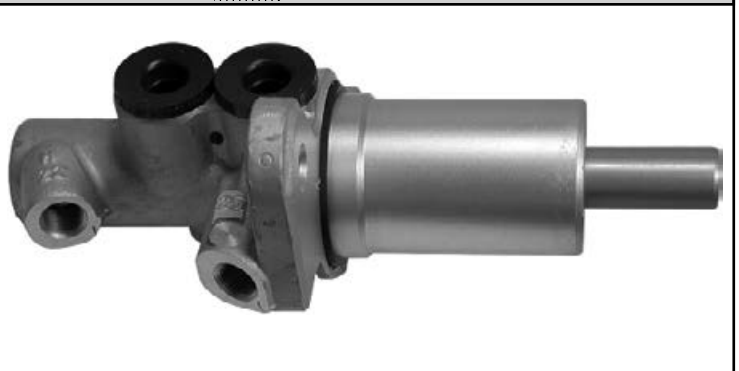

24.2025-1710.3 010833
 Ø 25,40/22,20  2x M12x1 →  L1 L2
 69,3 90,0





24.2026-1701.3 010746
 Ø 26,99/20,64  3x M12x1 →  L1 L2
 51,2 107,3



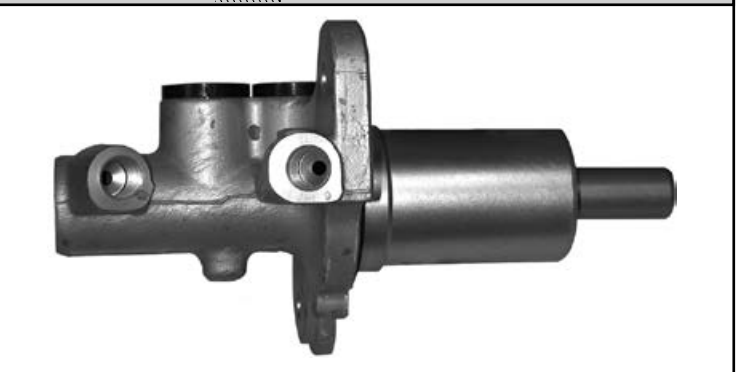

24.2026-1702.3 010850
 Ø 26,99/22,20  2x M12x1 →  L1 L2
 69,2 90,5



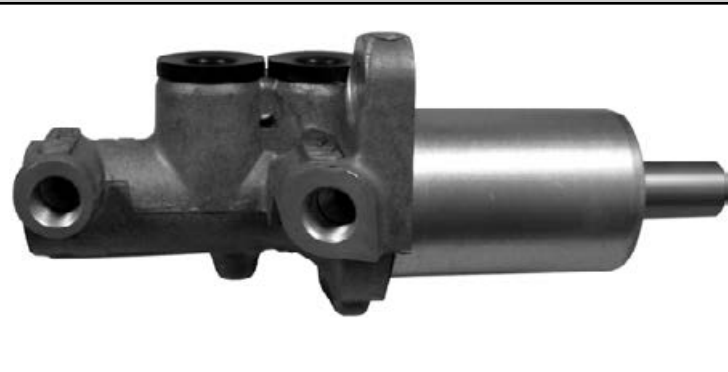

24.2026-1703.3 010910
 Ø 26,99/22,20  2x M12x1 →  L1 L2
 68,5 90,5



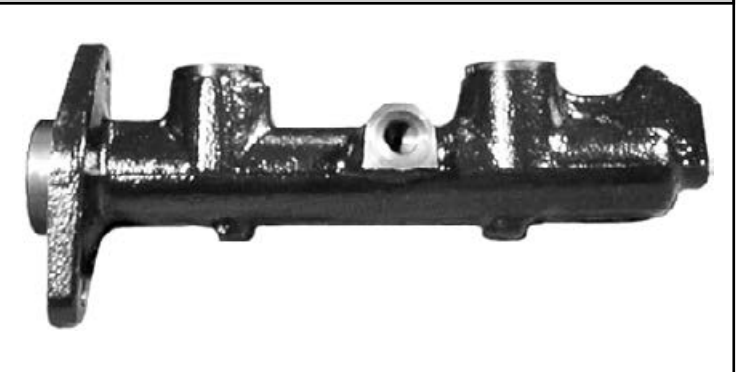

24.2117-1501.3 010398
 Ø 17,46  2x M10x1 →  L1 L2
 8,5 182,5



24.2117-1503.3 010400
 Ø 17,46  2x M10x1
 2x M12x1 →  L1 L2
 10,5 176,5



24.2119-0806.3 010345
 Ø 19,05  3x M10x1,25 →  L1 L2
 12,0 178,5

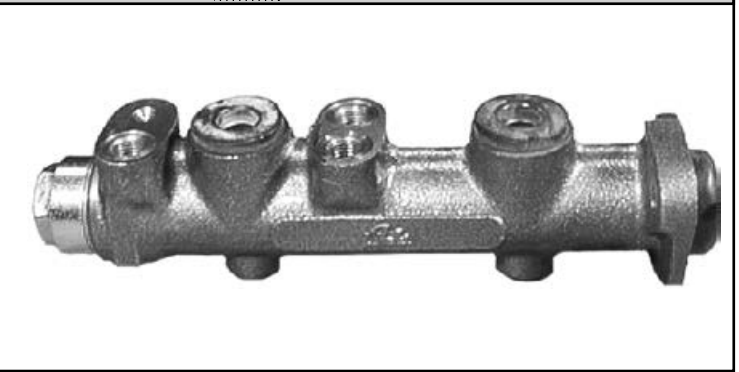



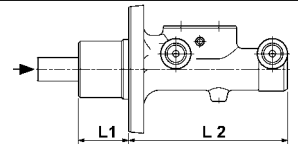

Abbildungen Hauptbremszylinder

Illustrations master cylinder - Illustrazioni pompe freno -



Illustrations Maître cylindres - Ilustraciones cilindro maestro freno





24.2119-0815.3 010347
 Ø 19,05  3x M10x1,25 →  L1 L2
 12,0 177,5



24.2119-0826.3 010349
 Ø 19,05  3x M10x1 →  L1 L2
 12,0 178,4





24.2119-0827.3 010350
 Ø 19,05  3x M10x1 →  L1 L2
 12,0 178,0



24.2119-0829.3 010351
 Ø 19,05  3x M10x1 →  L1 L2
 9,0 194,1





24.2119-0831.3 010416
 Ø 19,05  3x M10x1,25 →  L1 L2
 9,5 190,0

24.2119-0832.3 010417
 Ø 19,05  3x M10x1,25 →  L1 L2
 9,5 190,0



24.2119-0833.3 010418
 Ø 19,05  4x M10x1 →  L1 L2
 10,5 190,0

24.2119-0905.3 010353
 Ø 19,05  3x M10x1
 1x M12x1 →  L1 L2
 15,5 187,0





Abbildungen Hauptbremszylinder

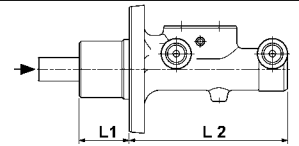

Illustrations master cylinder - Illustrazioni pompe freno -

Illustrations Maître cylindres - Ilustraciones cilindro maestro freno





24.2119-1503.3 010404
 Ø 19,05  3x M10x1 →  L1 L2
 8,5 192,0





24.2119-1702.3 010435
 Ø 19,05  4x M10x1 →  L1 L2
 40,0 115,2





24.2119-1703.3 010323
 Ø 19,05  3x M10x1 →  L1 L2
 9,0 175,0





24.2119-1704.3 010339
 Ø 19,05  3x M10x1 →  L1 L2
 10,0 193,0





24.2119-1705.3 010460
 Ø 19,05  2x M10x1 →  L1 L2
 8,5 192,5



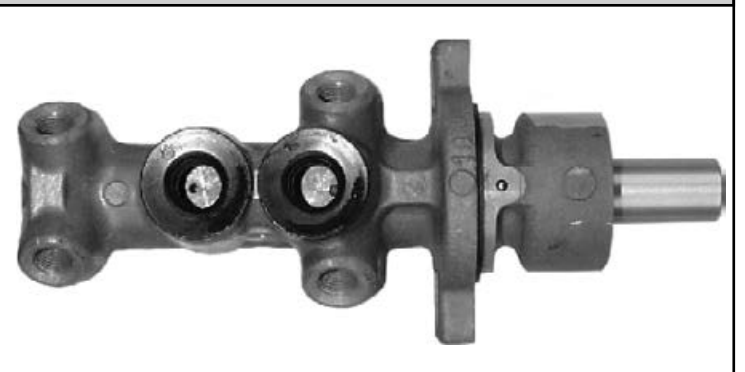

24.2119-1708.3 010543
 Ø 19,05  4x M10x1 →  L1 L2
 34,5 116,5



24.2119-1709.3 010876
 Ø 19,05  2x M10x1 →  L1 L2
 18,0 164,0



24.2119-1710.3 010880
 Ø 19,05  2x M10x1 →  L1 L2
 17,0 130,0



Abbildungen Hauptbremszylinder

Illustrations master cylinder - Illustrazioni pompe freno -

Illustrations Maître cylindres - Ilustraciones cilindro maestro freno

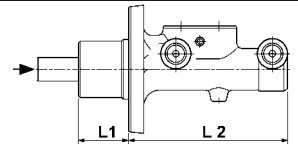

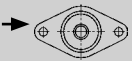
24.2119-1711.3 010911
 Ø 19,05  2x M12x1 →  L1 L2
 41,0 116,5





24.2119-1712.3 010912
 Ø 19,05  2x M12x1 →  L1 L2
 69,2 90,5



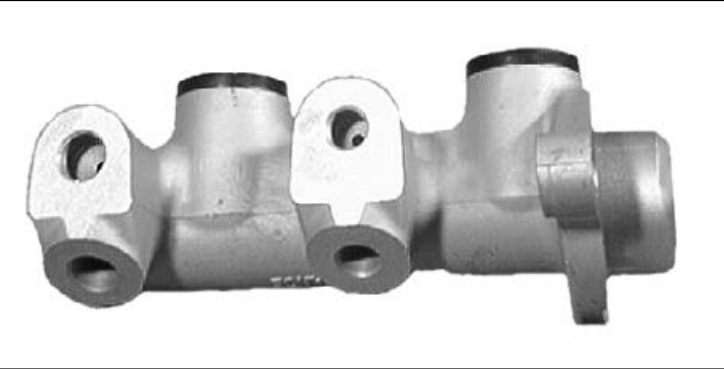

24.2120-0702.3 010361
 Ø 20,64  2x M10x1
 2x M12x1 →  L1 L2
 16,0 130,0





24.2120-0801.3 010362
 Ø 20,64  3x M10x1 →  L1 L2
 9,0 190,2





24.2120-0802.3 010363
 Ø 20,64  3x M10x1 →  L1 L2
 39,1 120,4





24.2120-0803.3 010415
 Ø 20,64  4x M10x1,25 →  L1 L2
 9,0 178,5

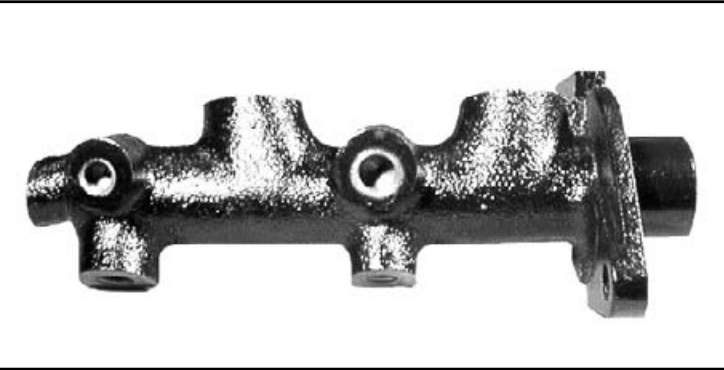

24.2120-0905.3 010364
 Ø 20,64  1x M10x1
 1x M12x1 →  L1 L2
 25,0 193,0



24.2120-0912.3 010366
 Ø 20,64  4x M10x1 →  L1 L2
 18,8 166,2



Abbildungen Hauptbremszylinder

Illustrations master cylinder - Illustrazioni pompe freno -

Illustrations Maître cylindres - Ilustraciones cilindro maestro freno

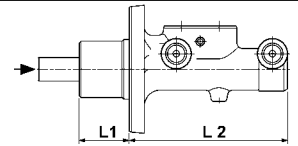

24.2120-0913.3 010392
 Ø 20,64
 1x M10x1
 1x M12x1/2x M15x1
 L1 16,0 L2 130,5

24.2120-1502.3 010405
 Ø 20,64
 2x M8x1,25
 L1 0 L2 182,5



24.2120-1503.3 010397
 Ø 20,64
 3x M10x1
 1x M12x1
 L1 8,5 L2 174,0

24.2120-1604.3 010370
 Ø 20,64
 1x M10x1
 1x M12x1
 L1 16,5 L2 172,5

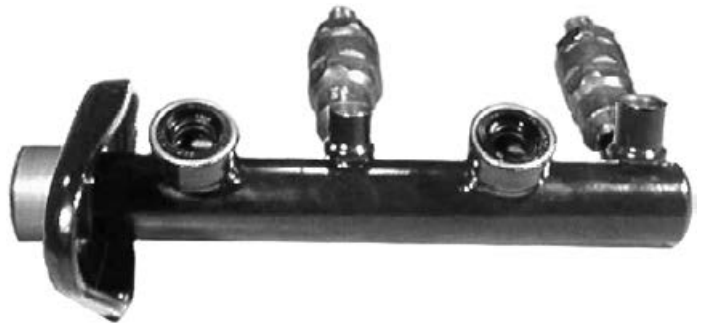
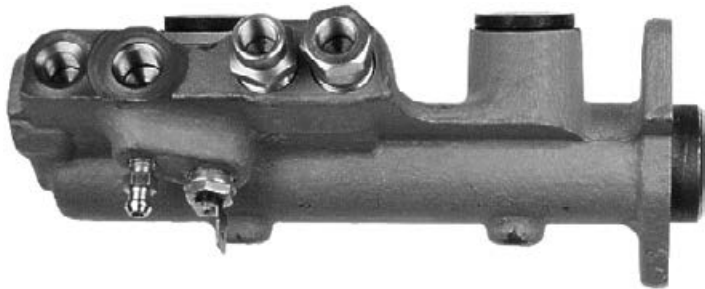

24.2120-1606.3 010582
 Ø 20,64
 4x M10x1
 L1 17,0 L2 174,0

24.2120-1701.3 010427
 Ø 20,64
 2x M10x1
 L1 38,0 L2 114,2



24.2120-1704.3 010429
 Ø 20,64
 2x M10x1
 2x M12x1
 L1 40,0 L2 114,2

24.2120-1706.3 010262
 Ø 20,64
 4x M10x1
 L1 40,1 L2 118,0

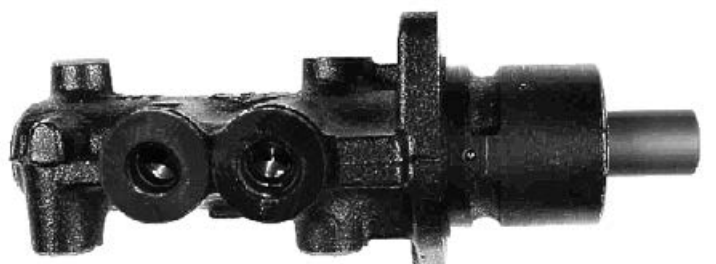

Abbildungen Hauptbremszylinder

Illustrations master cylinder - Illustrazioni pompe freno -

Illustrations Maître cylindres - Ilustraciones cilindro maestro freno

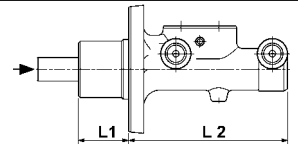

24.2120-1709.3 010276
 Ø 20,64
 2x M10x1
 2x M12x1
 L1 10,0 L2 201,0

24.2120-1710.3 010468
 Ø 20,64
 4x M10x1
 L1 33,5 L2 130,0



24.2120-1715.3 010469
 Ø 20,64
 3x M10x1
 1x M12x1
 L1 8,5 L2 173,5

24.2120-1718.3 010491
 Ø 20,64
 3x M10x1
 L1 9,0 L2 173,0

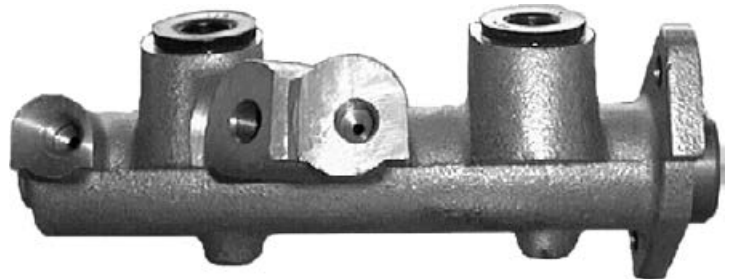

24.2120-1721.3 010553
 Ø 20,64
 2x M10x1
 1x M12x1
 L1 51,3 L2 143,8

24.2120-1723.3 010545
 Ø 20,64
 2x M10x1
 L1 34,5 L2 118,0

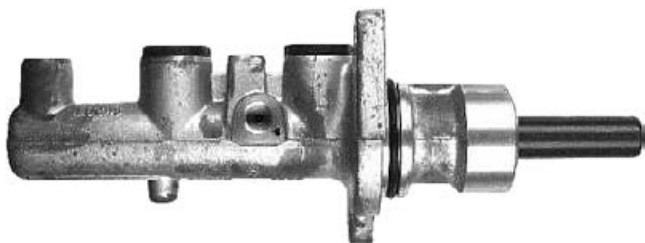

24.2120-1725.3 010579
 Ø 20,64
 2x M10x1
 L1 34,5 L2 118,0

24.2120-1726.3 010564
 Ø 20,64
 1x M10x1
 1x M12x1
 L1 33,0 L2 120,0



Abbildungen Hauptbremszylinder

Illustrations master cylinder - Illustrazioni pompe freno -

Illustrations Maître cylindres - Ilustraciones cilindro maestro freno

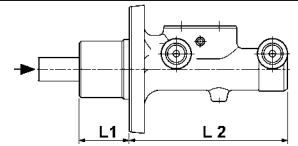

24.2120-1728.3 010626
 Ø 20,64 2x M10x1 → L1 L2
 34,5 116,2



24.2120-1730.3 010678
 Ø 20,64 2x M10x1 → L1 L2
 34,5 116,2



24.2120-1733.3 010686
 Ø 20,64 3x M10x1 → L1 L2
 33,5 128,5



24.2120-1734.3 010702
 Ø 20,64 2x M12x1 → L1 L2
 38,5 139,5



24.2120-1735.3 010726
 Ø 20,64 2x M12x1 → L1 L2
 33,0 130,5



24.2120-1736.3 010732
 Ø 20,64 4x M12x1 → L1 L2
 28,1 138,2



24.2120-1737.3 010757
 Ø 20,64 2x M10x1 2x M12x1 → L1 L2
 30,0 117,0



24.2120-1738.3 010759
 Ø 20,64 2x M10x1 2x M12x1 → L1 L2
 51,0 139,0



Abbildungen Hauptbremszylinder

Illustrations master cylinder - Illustrazioni pompe freno -

Illustrations Maître cylindres - Ilustraciones cilindro maestro freno

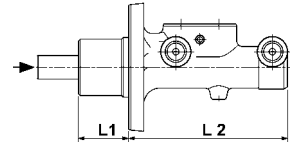

24.2120-1739.3 010762

Ø 20,64

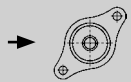
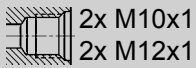

L1 L2
19,0 171,0



24.2120-1740.3 010764

Ø 20,64

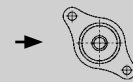
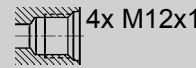

L1 L2
51,0 139,0



24.2120-1741.3 010775

Ø 20,64

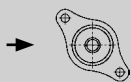

L1 L2
24,0 132,0

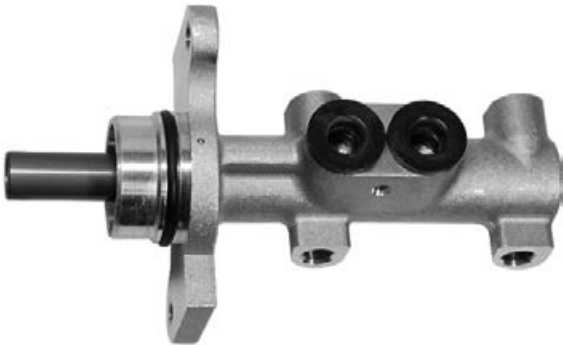

24.2120-1742.3 010776

Ø 20,64

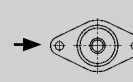

L1 L2
33,0 125,0



24.2120-1743.3 010777

Ø 20,64

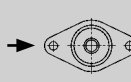
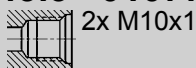

L1 L2
33,0 125,0



24.2120-1744.3 010820

Ø 20,64

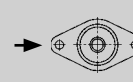

L1 L2
36,5 132,5



24.2120-1745.3 010834

Ø 20,64

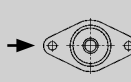
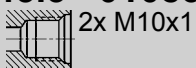

L1 L2
30,5 131,0



24.2120-1746.3 010835

Ø 20,64

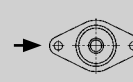

L1 L2
33,0 130,5





Abbildungen Hauptbremszylinder

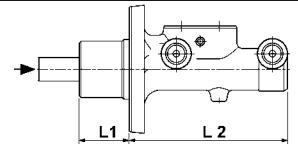

Illustrations master cylinder - Illustrazioni pompe freno -

Illustrations Maître cylindres - Ilustraciones cilindro maestro freno





24.2120-1747.3 010836
 Ø 20,64  2x M10x1 →  L1 L2
 36,5 134,0





24.2120-1748.3 010894
 Ø 20,64  2x M12x1 →  L1 L2
 25,0 162,0





24.2120-1749.3 010903
 Ø 20,64  2x M10x1 →  L1 L2
 15,5 153,5





24.2120-1751.3 010909
 Ø 20,64  2x M10x1 →  L1 L2
 15,5 153,5





24.2120-1752.3 010928
 Ø 20,64  2x M10x1 →  L1 L2
 26,0 157,0





24.2120-1754.3 010949
 Ø 20,64  1x M10x1
 1x M12x1 →  L1 L2
 23,5 107,0

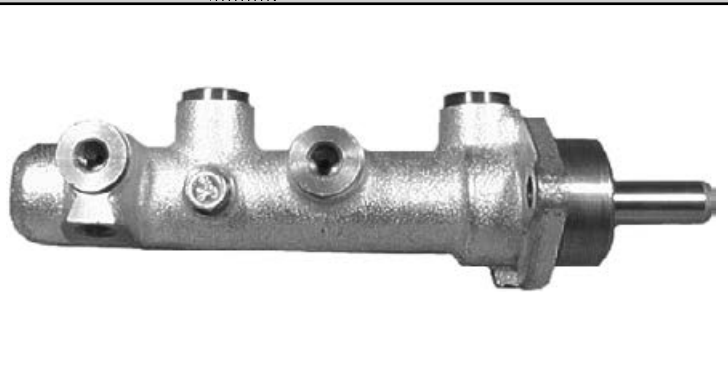

24.2122-0801.3 010373
 Ø 22,20  3x M10x1 →  L1 L2
 18,8 167,0



24.2122-0906.3 010378
 Ø 22,20  1x M10x1
 1x M12x1 →  L1 L2
 22,9 187,1

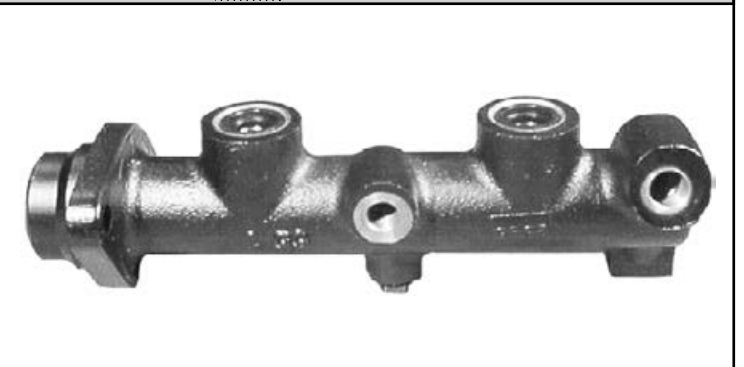

Abbildungen Hauptbremszylinder

Illustrations master cylinder - Illustrazioni pompe freno -

Illustrations Maître cylindres - Ilustraciones cilindro maestro freno

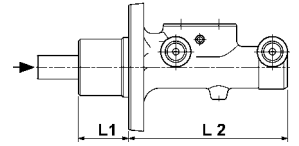

24.2122-1501.3 010403
 Ø 22,20
 2x M10x1
 2x M12x1
 L1 10,5 L2 200,0



24.2122-1603.3 010381
 Ø 22,20
 1x M10x1
 1x M12x1
 L1 16,5 L2 173,5



24.2122-1702.3 010421
 Ø 22,20
 1x M10x1
 1x M12x1
 L1 10,0 L2 203,5

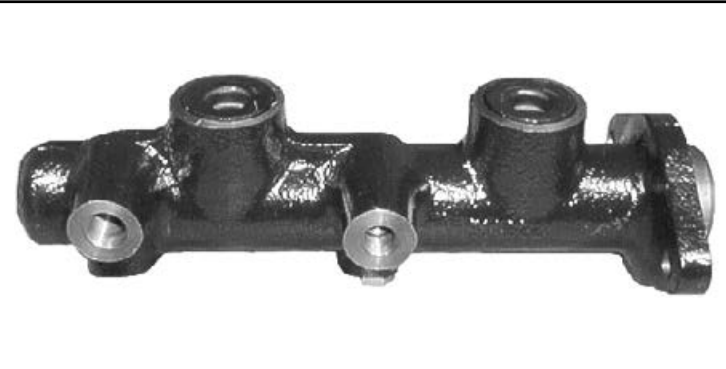

24.2122-1703.3 010422
 Ø 22,20
 4x M10x1
 L1 36,2 L2 115,2

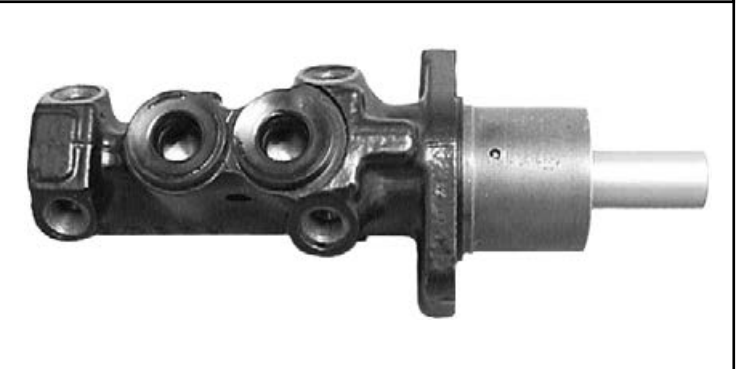

24.2122-1704.3 010423
 Ø 22,20
 4x M10x1
 L1 39,0 L2 115,5

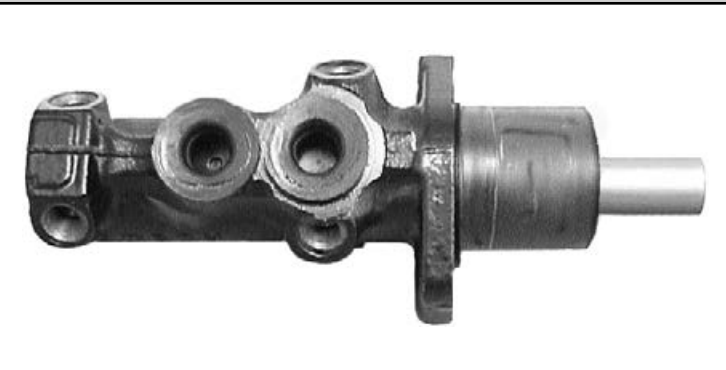

24.2122-1705.3 010434
 Ø 22,20
 4x M10x1
 L1 36,5 L2 118,0

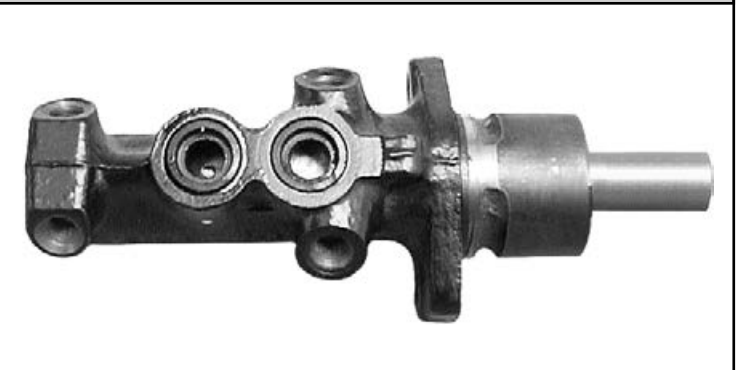

24.2122-1707.3 010438
 Ø 22,20
 4x M10x1
 L1 36,5 L2 128,0



24.2122-1708.3 010437
 Ø 22,20
 2x M10x1
 L1 35,0 L2 131,5



Abbildungen Hauptbremszylinder

Illustrations master cylinder - Illustrazioni pompe freno -

Illustrations Maître cylindres - Ilustraciones cilindro maestro freno

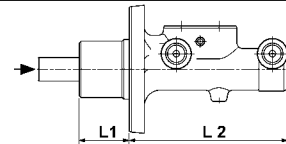

24.2122-1712.3 010462

Ø 22,20

3x M10x1
1x M12x1

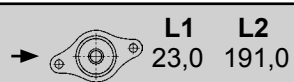

24.2122-1713.3 010463

Ø 22,20

3x M10x1

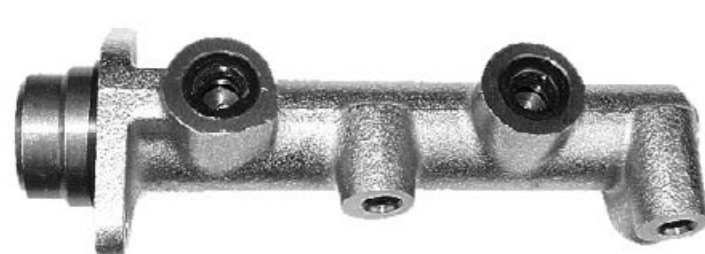
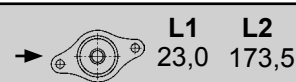

24.2122-1714.3 010480

Ø 22,20

2x M10x1

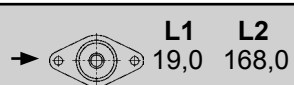

24.2122-1715.3 010481

Ø 22,20

5x M10x1

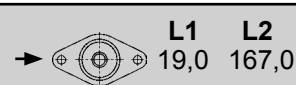

24.2122-1716.3 010485

Ø 22,20

4x M10x1

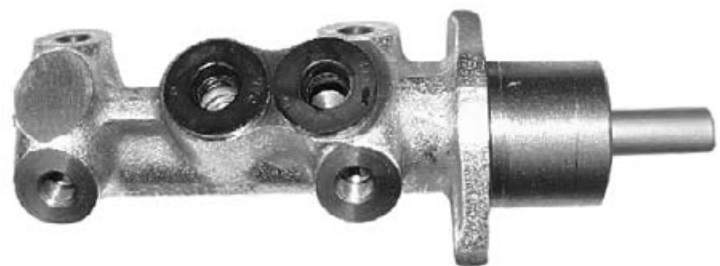
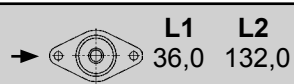

24.2122-1718.3 010517

Ø 22,20

2x M10x1

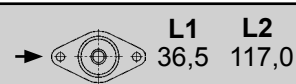

24.2122-1724.3 010561

Ø 22,20

1x M10x1
1x M12x1

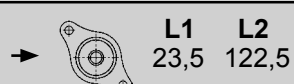

24.2122-1727.3 010586

Ø 22,20

2x M10x1
2x M12x1

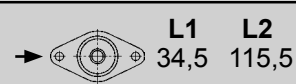

Abbildungen Hauptbremszylinder

Illustrations master cylinder - Illustrazioni pompe freno -

Illustrations Maître cylindres - Ilustraciones cilindro maestro freno

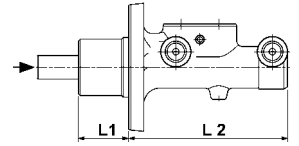

24.2122-1731.3 010656
 Ø 22,20 4x M10x1 → L1 L2
 36,0 150,2



24.2122-1733.3 010668
 Ø 22,20 2x M10x1 2x M12x1 → L1 L2
 34,5 165,0



24.2122-1740.3 010711
 Ø 22,20 1x M10x1 1x M12x1 → L1 L2
 27,5 118,5



24.2122-1741.3 010695
 Ø 22,20 4x M10x1 → L1 L2
 36,0 115,0



24.2122-1742.3 010696
 Ø 22,20 2x M10x1 → L1 L2
 35,0 131,5



24.2122-1743.3 010712
 Ø 22,20 2x M10x1 2x M12x1 → L1 L2
 29,0 117,0

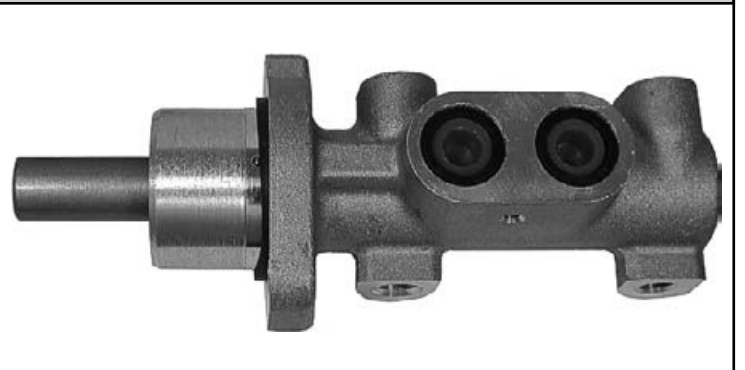

24.2122-1744.3 010697
 Ø 22,20 1x M10x1 1x M12x1 → L1 L2
 34,6 116,0



24.2122-1750.3 010740
 Ø 22,20 4x M10x1 → L1 L2
 29,5 120,5



Abbildungen Hauptbremszylinder

Illustrations master cylinder - Illustrazioni pompe freno -

Illustrations Maître cylindres - Ilustraciones cilindro maestro freno

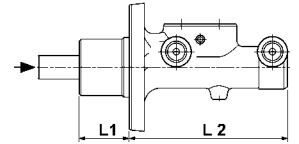

24.2122-1757.3 010769

Ø 22,20



2x M12x1

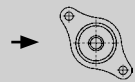

L1 L2
31,0 132,0



24.2122-1760.3 010821

Ø 22,20



4x M10x1

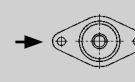

L1 L2
33,0 125,0



24.2122-1761.3 010822

Ø 22,20



2x M10x1

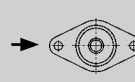

L1 L2
16,0 154,3



24.2122-1762.3 010837

Ø 22,20



2x M12x1

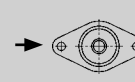

L1 L2
30,0 131,0



24.2122-1763.3 010838

Ø 22,20



2x M12x1

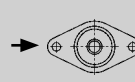

L1 L2
33 125,0



24.2122-1764.3 010851

Ø 22,20



2x M12x1



L1 L2
26,5 138,0



24.2122-1765.3 010839

Ø 22,20



2x M12x1

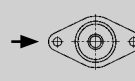

L1 L2
16,0 154,0



24.2122-1766.3 010840

Ø 22,20



2x M12x1

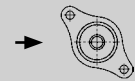

L1 L2
25,0 135,0



Abbildungen Hauptbremszylinder

Illustrations master cylinder - Illustrazioni pompe freno -

Illustrations Maître cylindres - Ilustraciones cilindro maestro freno

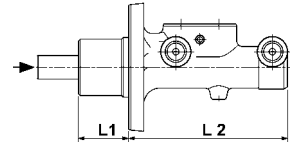

24.2122-1767.3 010841

Ø 22,20

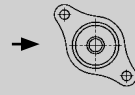
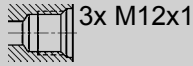

L1 L2
25,0 135,0

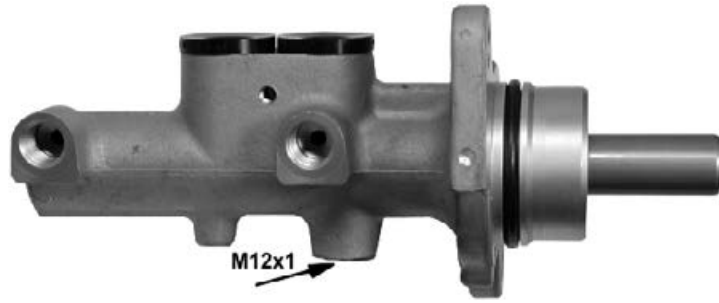

24.2122-1768.3 010853

Ø 22,20



L1 L2
30,0 131,0



24.2122-1770.3 010898

Ø 22,20

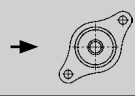
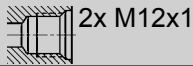

L1 L2
45,0 114,0



24.2122-1771.3 010901

Ø 22,20



L1 L2
15,5 153,5



24.2122-1772.3 010902

Ø 22,20

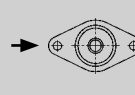
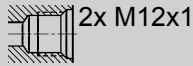

L1 L2
19,0 153,0



24.2123-0901.3 010382

Ø 23,81

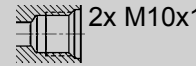

L1 L2
18,8 165,0



24.2123-1602.3 010384

Ø 23,81

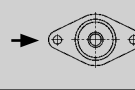

L1 L2
32,0 126,5



24.2123-1606.3 010386

Ø 23,81

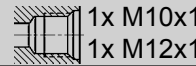

L1 L2
36,0 119,0



Abbildungen Hauptbremszylinder

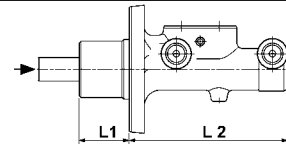

Illustrations master cylinder - Illustrazioni pompe freno -

Illustrations Maître cylindres - Ilustraciones cilindro maestro freno

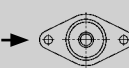



24.2123-1701.3 010424
 Ø 23,81  4x M10x1 →  L1 L2
 36,5 126,7



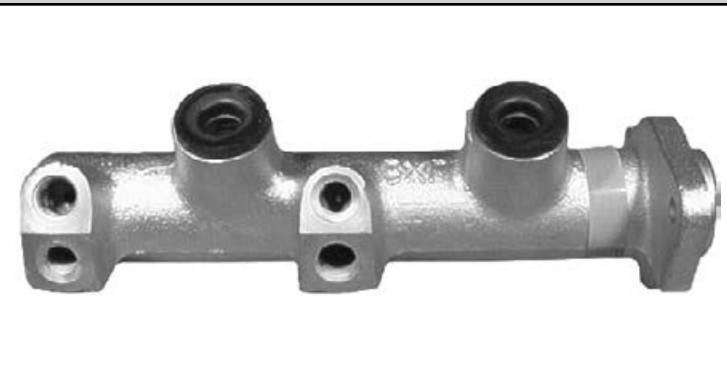

24.2123-1702.3 010431
 Ø 23,81  2x M10x1
 2x M12x1 →  L1 L2
 10,5 200,0



24.2123-1705.3 010440
 Ø 23,81  2x M10x1
 1x M12x1 →  L1 L2
 10,0 203,0



24.2123-1707.3 010492
 Ø 23,81  4x M10x1 →  L1 L2
 36,0 117,5



24.2123-1709.3 010503
 Ø 23,81  2x M12x1 →  L1 L2
 32,0 122,0

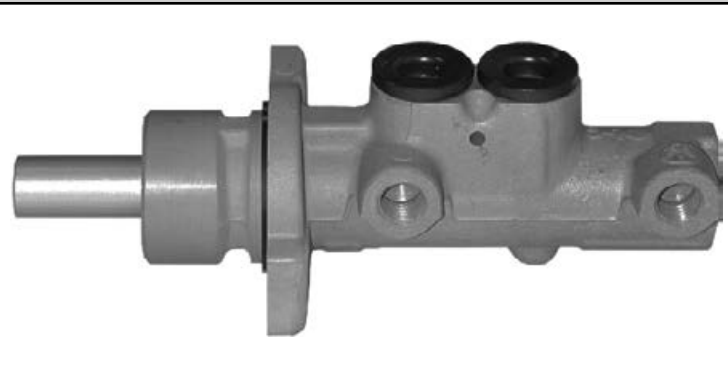

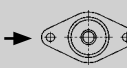
24.2123-1710.3 010504
 Ø 23,81  4x M10x1 →  L1 L2
 36,0 118,0

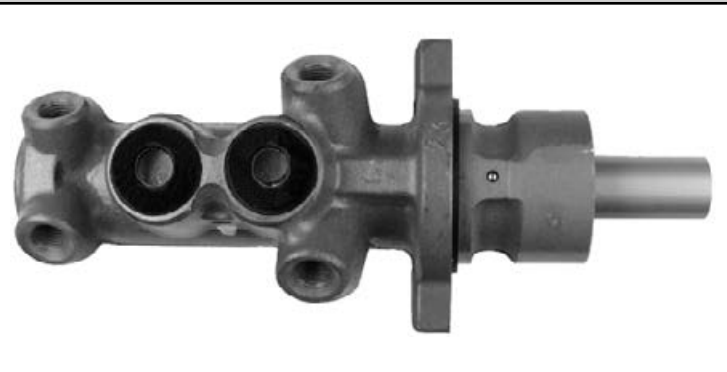

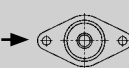
24.2123-1711.3 010518
 Ø 23,81  2x M10x1 →  L1 L2
 35,0 165,0

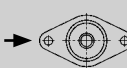

24.2123-1712.3 010519
 Ø 23,81  4x M10x1 →  L1 L2
 36,0 120,0

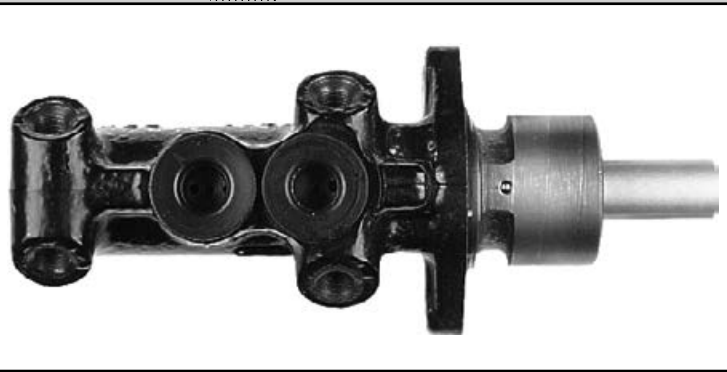

Abbildungen Hauptbremszylinder

Illustrations master cylinder - Illustrazioni pompe freno -

Illustrations Maître cylindres - Ilustraciones cilindro maestro freno

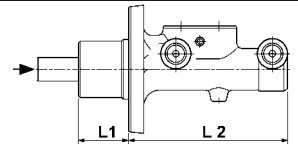



24.2123-1713.3 010505
 Ø 23,81  2x M12x1 →  L1 L2
 34,5 127,0



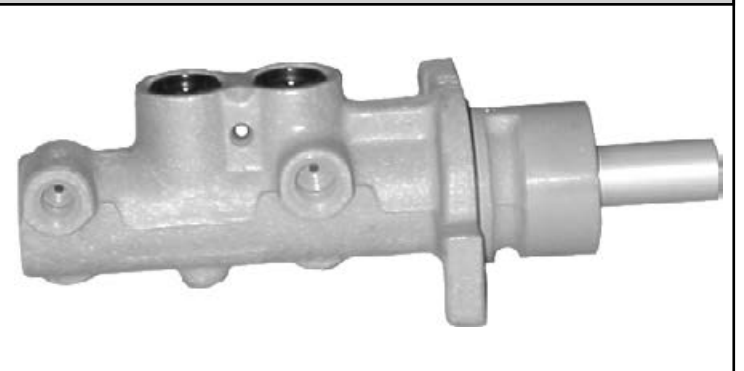

24.2123-1714.3 010587
 Ø 23,81  2x M10x1
 2x M12x1 →  L1 L2
 33,0 120,5





24.2123-1715.3 010520
 Ø 23,81  1x M10x1
 1x M12x1 →  L1 L2
 33,0 120,5





24.2123-1717.3 010521
 Ø 23,81  2x M12x1 →  L1 L2
 39,5 121,5



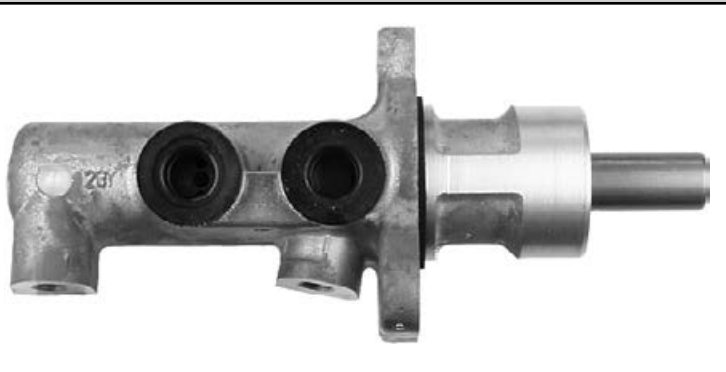

24.2123-1718.3 010507
 Ø 23,81  2x M10x1 →  L1 L2
 42,0 116,0





24.2123-1725.3 010549
 Ø 23,81  2x M10x1
 2x M12x1 →  L1 L2
 36,5 126,5

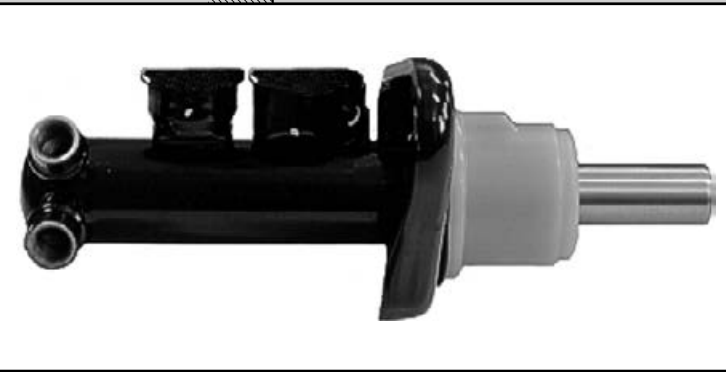

24.2123-1726.3 010557
 Ø 23,81  3x M10x1 →  L1 L2
 36,0 110,0



24.2123-1728.3 010558
 Ø 23,81  2x M10x1 →  L1 L2
 36,0 128,0



Abbildungen Hauptbremszylinder

Illustrations master cylinder - Illustrazioni pompe freno -

Illustrations Maître cylindres - Ilustraciones cilindro maestro freno

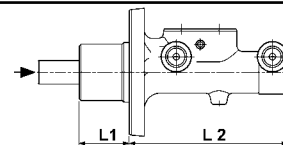

24.2123-1729.3 010567
 Ø 23,81 2x M10x1 → L1 35,0 L2 150,8



24.2123-1730.3 010620
 Ø 23,81 1x M10x1 1x M12x1 → L1 39,5 L2 120,5

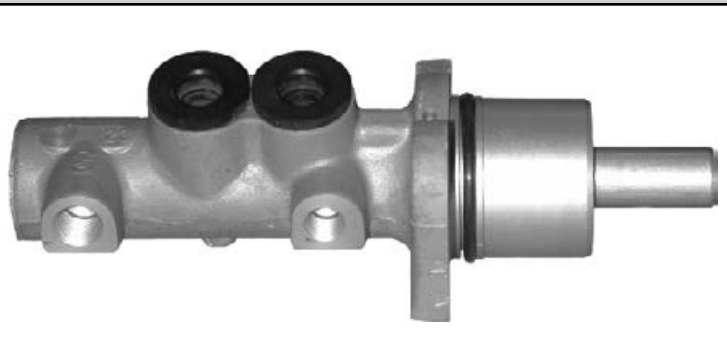

24.2123-1731.3 010621
 Ø 23,81 2x M12x1 → L1 32,0 L2 124,5

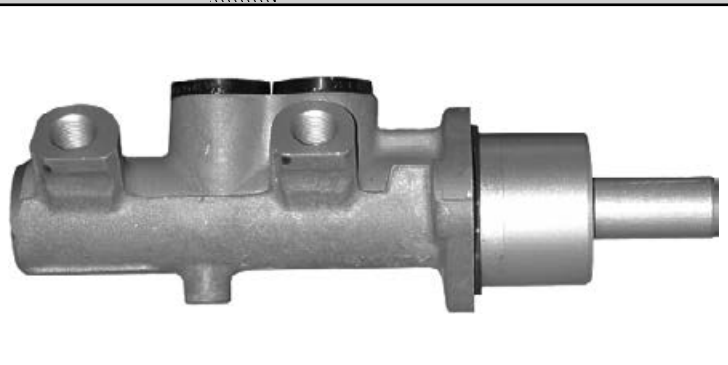

24.2123-1732.3 010625
 Ø 23,81 4x M10x1 → L1 36,0 L2 105,5



24.2123-1733.3 010657
 Ø 23,81 2x M10x1 → L1 36,5 L2 126,7



24.2123-1734.3 010640
 Ø 23,81 1x M10x1 1x M12x1 → L1 39,5 L2 119,5

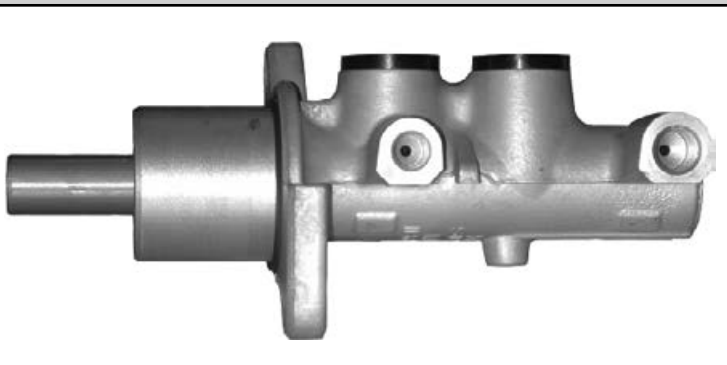

24.2123-1735.3 010652
 Ø 23,81 2x M10x1 → L1 17,0 L2 174,0



24.2123-1737.3 010654
 Ø 23,81 4x M10x1 → L1 17,0 L2 174,0



Abbildungen Hauptbremszylinder

Illustrations master cylinder - Illustrazioni pompe freno -

Illustrations Maître cylindres - Ilustraciones cilindro maestro freno

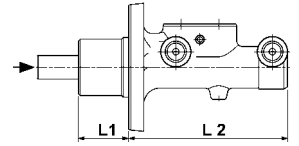

24.2123-1738.3 010658

Ø 23,81

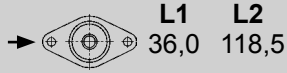
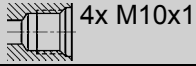

L1 L2
36,0 118,5



24.2123-1739.3 010661

Ø 23,81



L1 L2
40,0 121,0

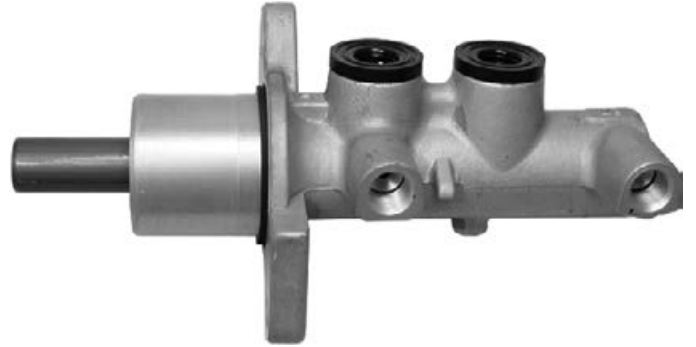

24.2123-1740.3 010662

Ø 23,81

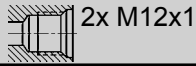

L1 L2
51,5 112,0



24.2123-1741.3 010681

Ø 23,81

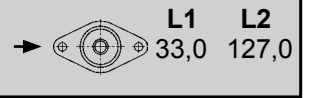

L1 L2
33,0 127,0



24.2123-1742.3 010671

Ø 23,81

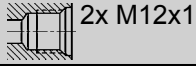

L1 L2
33,0 121,0



24.2123-1746.3 010682

Ø 23,81

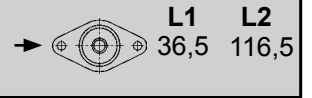
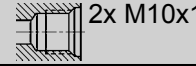

L1 L2
36,5 116,5



24.2123-1749.3 010713

Ø 23,81

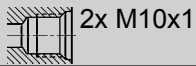

L1 L2
33,0 120,0



24.2123-1751.3 010698

Ø 23,81

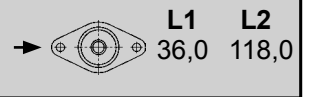
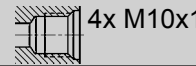

L1 L2
36,0 118,0



Abbildungen Hauptbremszylinder

Illustrations master cylinder - Illustrazioni pompe freno -

Illustrations Maître cylindres - Ilustraciones cilindro maestro freno

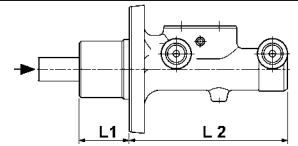

24.2123-1754.3 010741
 Ø 23,81 2x M12x1 → L1 67,0 L2 111,5



24.2123-1755.3 010750
 Ø 23,81 2x M10x1 → L1 67,0 L2 110,0

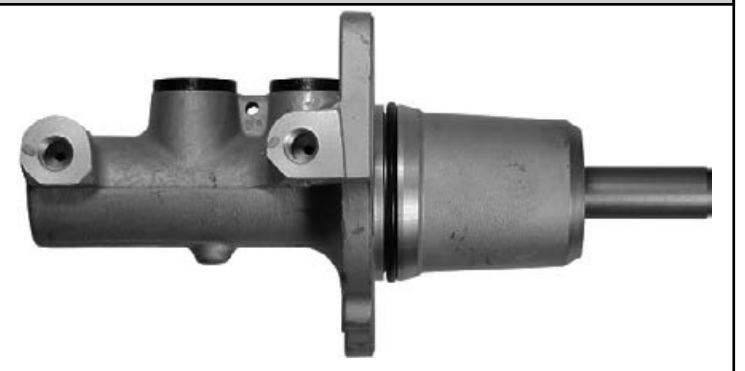

24.2123-1756.3 010756
 Ø 23,81 3x M10x1 → L1 10,0 L2 203,0

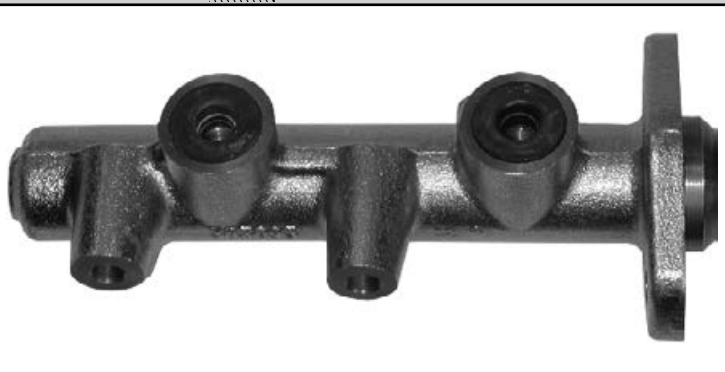

24.2123-1759.3 010768
 Ø 23,81 2x M12x1 → L1 39,0 L2 143,2



24.2123-1760.3 010779
 Ø 23,81 2x M12x1 → L1 25,0 L2 155,0

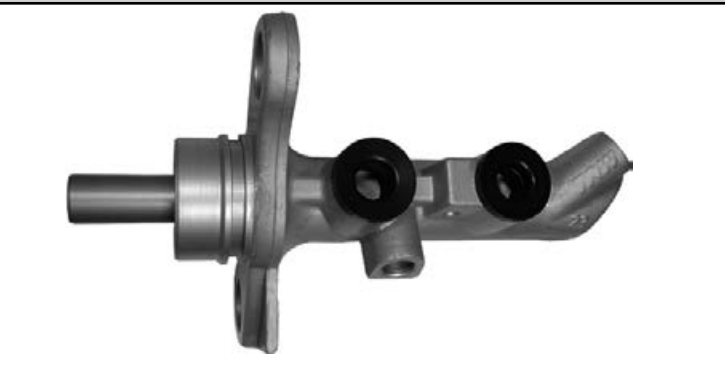

24.2123-1761.3 010780
 Ø 23,81 2x M10x1 → L1 15,0 L2 152,0



24.2123-1762.3 010823
 Ø 23,81 2x M10x1 → L1 15,0 L2 161,0

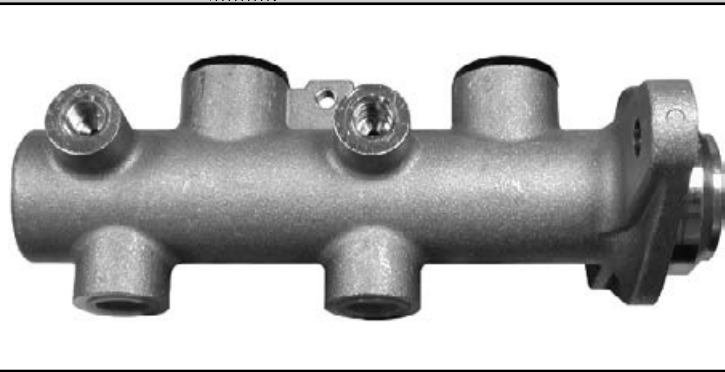

24.2123-1763.3 010842
 Ø 23,81 2x M10x1 → L1 32,5 L2 131,0

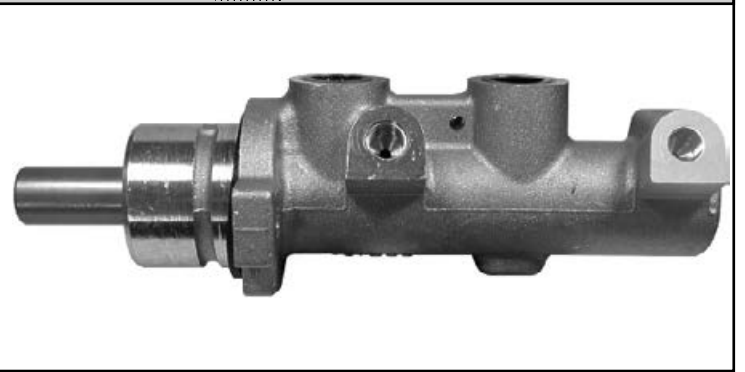

Abbildungen Hauptbremszylinder

Illustrations master cylinder - Illustrazioni pompe freno -

Illustrations Maître cylindres - Ilustraciones cilindro maestro freno

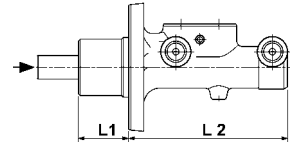

24.2123-1764.3 010824

Ø 23,81

1x M10x1
1x M12x1

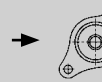

L1 L2
29,0 132,0



24.2123-1766.3 010825

Ø 23,81

2x M12x1

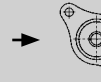

L1 L2
40,0 121,0



24.2123-1767.3 010844

Ø 23,81

2x M10x1

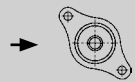

L1 L2
31,0 131,0



24.2123-1768.3 010845

Ø 23,81

2x M12x1

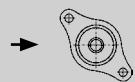

L1 L2
31,0 131,0



24.2123-1769.3 010863

Ø 23,81

2x M12x1

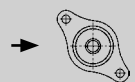

L1 L2
32,5 131,0



24.2123-1772.3 010858

Ø 23,81

2x M12x1

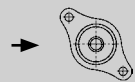

L1 L2
73,0 122,0



24.2123-1774.3 010877

Ø 23,81

2x M10x1

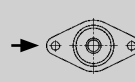

L1 L2
15,5 153,0



24.2123-1777.3 010943

Ø 23,81

1x M10x1
1x M12x1

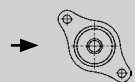

L1 L2
39,5 120,0





Abbildungen Hauptbremszylinder

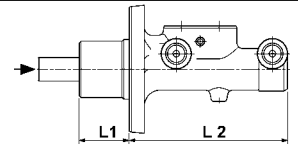

Illustrations master cylinder - Illustrazioni pompe freno -

Illustrations Maître cylindres - Ilustraciones cilindro maestro freno





24.2125-1702.3 010482
 Ø 25,40  2x M10x1 →  L1 L2
 19,0 173,5





24.2125-1703.3 010483
 Ø 25,40  5x M10x1 →  L1 L2
 9,0 168,0





24.2125-1704.3 010446
 Ø 25,40  1x M10x1
 1x M12x1 →  L1 L2
 15,5 189,0



24.2125-1706.3 010496
 Ø 25,40  2x M10x1
 2x M12x1 →  L1 L2
 43,0 99,0



24.2125-1707.3 010497
 Ø 25,40  2x M12x1 →  L1 L2
 42,5 110,5



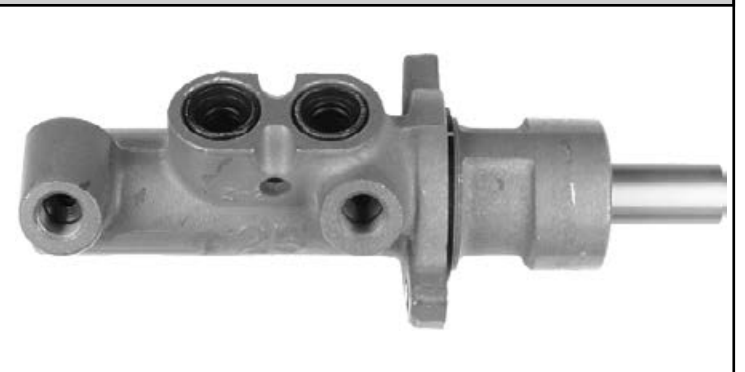

24.2125-1708.3 010498
 Ø 25,40  2x M12x1 →  L1 L2
 46,8 112,0



24.2125-1709.3 010499
 Ø 25,40  2x M12x1 →  L1 L2
 38,0 125,0



24.2125-1710.3 010559
 Ø 25,40  4x M10x1 →  L1 L2
 36,5 109,0



Abbildungen Hauptbremszylinder

Illustrations master cylinder - Illustrazioni pompe freno -

Illustrations Maître cylindres - Ilustraciones cilindro maestro freno

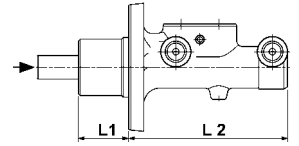

24.2125-1712.3 010622

Ø 25,40

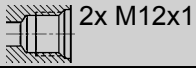

L1 L2
49,5 111,5



24.2125-1713.3 010623

Ø 25,40

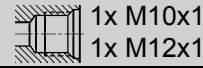

L1 L2
49,0 111,0



24.2125-1714.3 010641

Ø 25,40

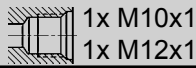

L1 L2
39,5 120,0



24.2125-1716.3 010663

Ø 25,40



L1 L2
57,0 120,0



24.2125-1719.3 010666

Ø 25,40

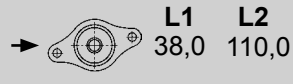
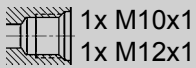

L1 L2
38,0 110,0



24.2125-1720.3 010688

Ø 25,40



L1 L2
69,5 92,0

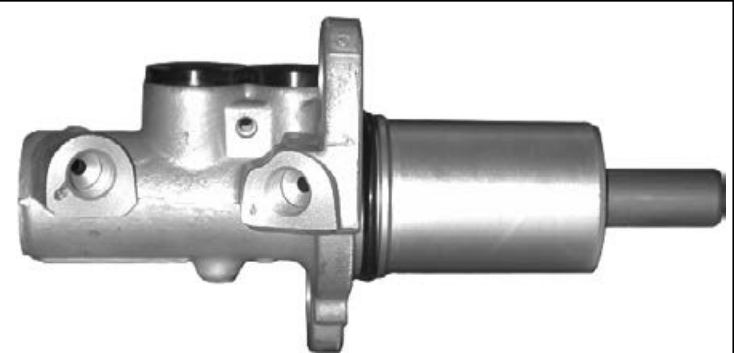

24.2125-1723.3 010689

Ø 25,40

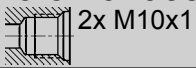

L1 L2
47,5 113,5



24.2125-1724.3 010690

Ø 25,40

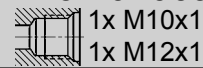

L1 L2
47,5 112,5



Abbildungen Hauptbremszylinder

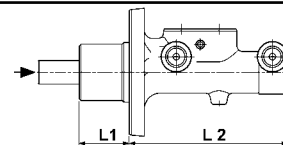

Illustrations master cylinder - Illustrazioni pompe freno -

Illustrations Maître cylindres - Ilustraciones cilindro maestro freno

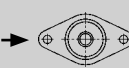



24.2125-1725.3 010717
 Ø 25,40  5x M10x1 →  L1 L2
 33,0 147,0



24.2125-1726.3 010718
 Ø 25,40  2x M10x1 →  L1 L2
 33,0 147,0



24.2125-1727.3 010723
 Ø 25,40  2x M10x1 →  L1 L2
 35,0 165,3



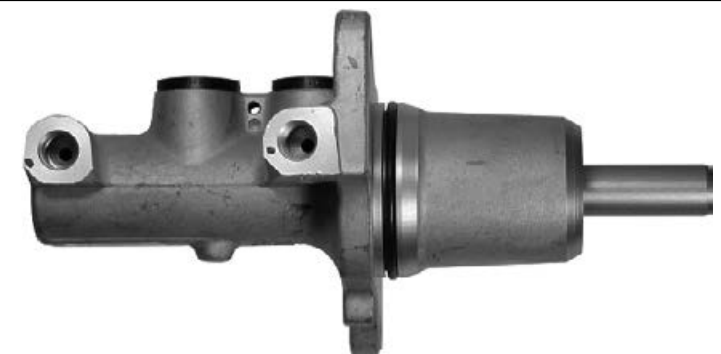

24.2125-1728.3 010751
 Ø 25,40  2x M12x1 →  L1 L2
 67,0 111,5





24.2125-1731.3 010826
 Ø 25,40  2x M12x1 →  L1 L2
 47,5 113,0





24.2125-1732.3 010827
 Ø 25,40  2x M12x1 →  L1 L2
 40,0 122,0



24.2125-1733.3 010830
 Ø 25,40  1x M10x1
 1x M12x1 →  L1 L2
 40,0 122,0



24.2125-1734.3 010878
 Ø 25,40  2x M12x1 →  L1 L2
 47,5 115,0



Abbildungen Hauptbremszylinder

Illustrations master cylinder - Illustrazioni pompe freno -

Illustrations Maître cylindres - Ilustraciones cilindro maestro freno

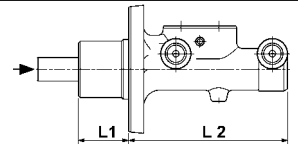

24.2125-1735.3 010879

Ø 25,40



2x M10x1

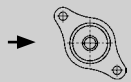

L1 L2
67,0 111,5



24.2125-1736.3 010904

Ø 25,40



2x M12x1

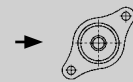

L1 L2
31,0 129,0



24.2125-1737.3 010906

Ø 25,40



1x M10x1

1x M12x1

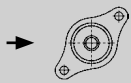

L1 L2
31,0 129,0



24.2125-1738.3 010931

Ø 25,40



3x M10x1

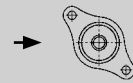

L1 L2
34,0 114,0



24.2133-0901.3 010387

Ø 33,34



1x M10x1

1x M14x1,5

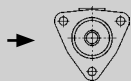

L1 L2
65,0 155,0

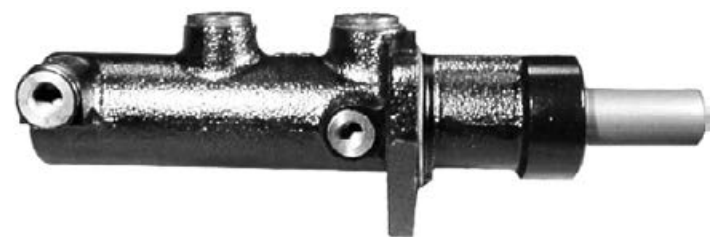

24.3119-1702.3 010465

Ø 19,05



1x M16x1,5

3x 3/8"-24 UNF-2B



L1 L2
5,5 135,5



24.3119-1703.3 010466

Ø 19,05



1x M16x1,5

3x 3/8"-24 UNF-2B

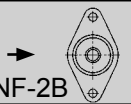

L1 L2
5,5 135,5

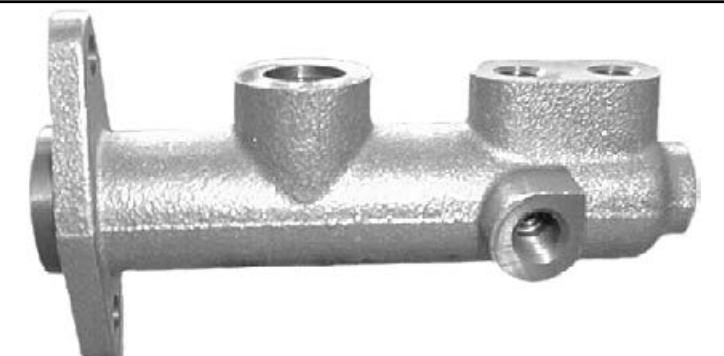

24.3120-1702.3 010467

Ø 20,64



1x M16x1,5

3x 3/8"-24 UNF-2B

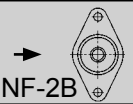

L1 L2
5,5 131,5

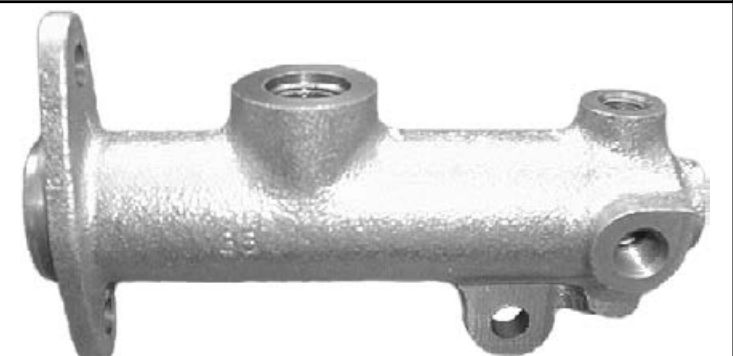

Abbildungen Hauptbremszylinder

Illustrations master cylinder - Illustrazioni pompe freno -

Illustrations Maître cylindres - Ilustraciones cilindro maestro freno

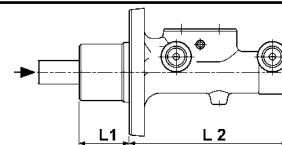

24.4025-1701.3 010719

Ø 25,40

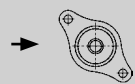
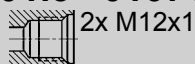

L1 L2
51,0 67,2



24.4120-1701.3 010846

Ø 20,64

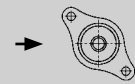

L1 L2
32,0 83,0



24.4120-1702.3 010913

Ø 20,64

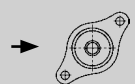

L1 L2
6,0 119,0



24.4122-1701.3 010533

Ø 22,20

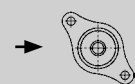
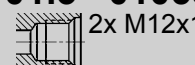

L1 L2
10,2 109,0



24.4122-1703.3 010843

Ø 22,20

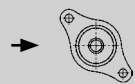

L1 L2
6,0 112,0



24.4122-1704.3 010847

Ø 22,20

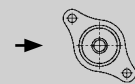
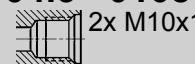

L1 L2
6,0 112,0



24.4122-1705.3 010852

Ø 22,20

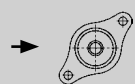
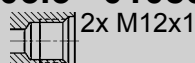

L1 L2
32,0 78,0



24.4122-1708.3 010865

Ø 22,20

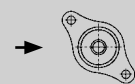

L1 L2
20,0 95,0



Abbildungen Hauptbremszylinder

Illustrations master cylinder - Illustrazioni pompe freno -

Illustrations Maître cylindres - Ilustraciones cilindro maestro freno

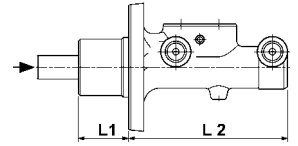

24.4122-1714.3 010914

Ø 20,64



2x M10x1



L1 L2
6,0 119,0



24.4123-1703.3 010831

Ø 23,81



2x M12x1



L1 L2
55,0 53,0



24.4123-1704.3 010828

Ø 23,81



2x M12x1



L1 L2
6,0 112,0



24.4123-1705.3 010832

Ø 23,81



2x M10x1



L1 L2
6,0 112,0



24.4123-1706.3 010848

Ø 23,81



2x M12x1



L1 L2
32,0 115,0



24.4123-1708.3 010859

Ø 23,81



2x M10x1



L1 L2
32,0 83,5



24.4123-1712.3 010897

Ø 23,81



2x M12x1



L1 L2
14,0 95,0



24.4123-1713.3 010905

Ø 23,81



2x M12x1



L1 L2
31,7 93,5



Abbildungen Hauptbremszylinder

Illustrations master cylinder - Illustrazioni pompe freno -

Illustrations Maître cylindres - Ilustraciones cilindro maestro freno

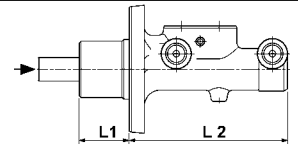

24.4125-1701.3 010867

Ø 25,40



2x M12x1



L1

L2

10,0 123,0

24.4125-1703.3 010907

Ø 25,40



2x M12x1



L1

L2

18,0 90,0

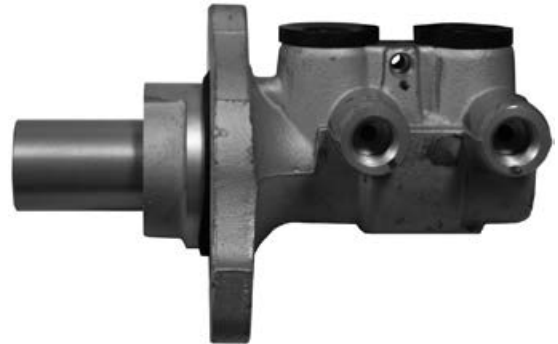
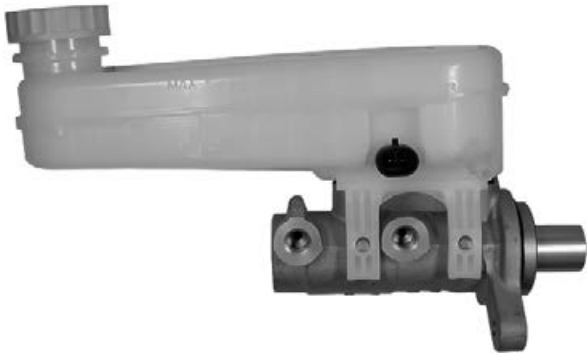

24.4125-1704.3 010908

Ø 25,40



2x M12x1



L1

L2

18,0 90,0

24.4126-1701.3 010868

Ø 26,99



2x M12x1



L1

L2

10,0 123,0





- D** Armaturen
- EN** Fittings
- FR** Composants et accessoires
- IT** Attrezzature
- ES** Accesorios
- NL** Armaturen
- DA** Fittings
- SV** Tillbehör
- HU** Tartozékok
- PT** Equipamentos
- RU** Приспособления
- CZ** Armatury
- PL** Armatury
- EL** Εξαρτήματα συναρμολογής
- TR** Armatürler
- ZH** 儀軀板
- JA** 計器類
- AR** بطاقة المكبح

K24-H

Armaturen

Fittings - Attrezzature - Composants et accessoires - Accesorios

Gewindedarstellung und Dichtflächen-Anordnung bei Innengewinden der Anschlußarmaturen

Representation of threads and sealing surface arrangement in case of internal-threads

Rappresentazione della filattatura e disposizione delle superfici di tenuta nella filettatura interna dei pezzi di attacco

Présentation de filet et arrangement de face d'étanchéité en case de filetage intérieure des armatures

Ilustración de roscas y disposición de superficies de contacto en roscas interiores de los accesorios de conexión

Abdichtung durch Bördel nach DIN 74234
Sealing by flaring according to DIN 74234 tenuta
Stagna tramite flangiatura DIN 74234
Etanchement par colet selon DIN 74234
Junta mediante reborde según DIN 74234

Abdichtung mit Dichtring nach DIN 7603
Sealing by seal ring according to DIN 7603
Tenuta stagna tramite guarnizione DIN 7603
Etanchement par joint selon DIN 7603
Junta con retén según DIN 7603

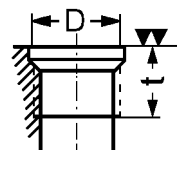
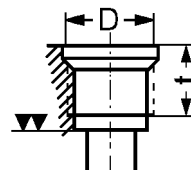
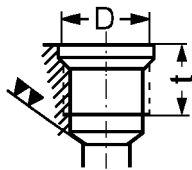
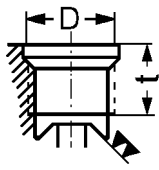

Gewinde Ausführung

Thread design
Esecuzione filettata
Exécution filet
Ejecución de rosca

A 1

A 2

A 3

A 4

Bördel

Flare
Bordatura tipo
Colet
Reborde

E

F

-

-

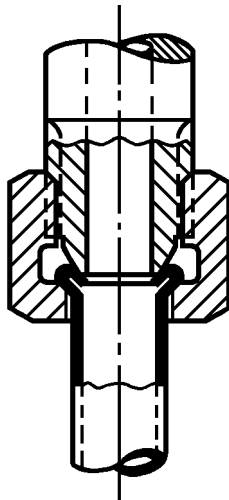

DIN 74233

Überwurfschraube
Union screw
Viti con risvolto
Vis chapeau
Tornillos de racor

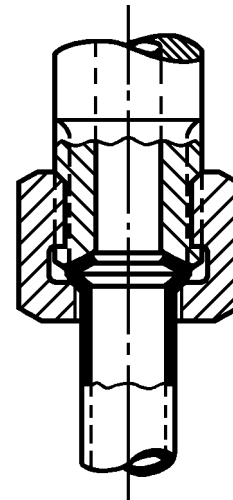

E





DIN 74234

Bördel
Flare
Bordatura tipo
Colet
Reborde

F

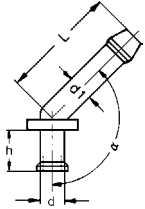

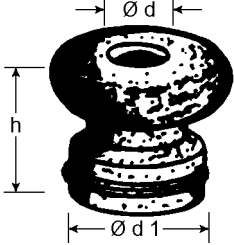
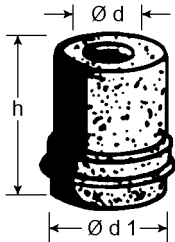
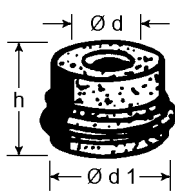
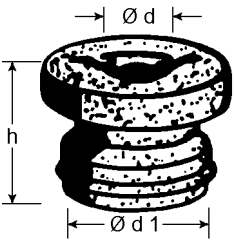
Armaturen

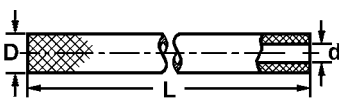
Fittings - Attrezzature - Composants et accessoires - Accesorios

Kniestücke Elbows Raccordi a gomito Raccord en équerre Piezas acodadas	Abmessungen - Dimensions - Dimensioni - Dimensions - Medidas [mm]					
	$\varnothing d$	$\varnothing d_1$	h	L	α	
	8,0	8,0	11,0	32,0	95°	03.3390-0055.1 390149
	8,0	8,0	11,0	32,0	105°	03.3390-0065.1 390150
	12,8	8,0	13,0	32,0	135°	03.3390-0130.1 390153
	12,8	8,0	13,0	32,0	105°	03.3390-0139.1 390154
Behälterstopfen Reservoir seal Tappi per serbatoio Bouchon de réservoir Taponés de depósitos	Abmessungen - Dimensions - Dimensioni - Dimensions - Medidas [mm]					
	$\varnothing d$	$\varnothing d_1$	h			Kautschuk ① 03.3304-0600.1 390081
	6,5	17,0	18,0	Kautschuk ①		03.3304-0700.1 390082
	6,5	17,0	10,5	Kautschuk ①		03.3304-1100.1 390084
	6,5	17,0	10,4	EPDM		03.3304-1102.1 390085
	7,3	17,0	13,5	Kautschuk ①		03.3304-1000.1 390083
	7,3	22,0	13,0	Kautschuk ①		03.3304-1400.1 390088
	12,3	22,0	13,0	EPDM		03.3304-2208.1 390090
	① Kautschuk India rubber Caucciù Caoutchouc Caucho					
Behälterschlauch Reservoir tube Flessibile per serbatoio Flexible réservoir Manguera del depósito	Abmessungen - Dimensions - Dimensioni - Dimensions - Medidas					
	$\varnothing D$ [mm]	$\varnothing d$ [mm]	L [m]			
	13,5	7,5	5,0	03.3538-0005.1 390414		
	13,5	7,5	20,0	03.3538-0020.1 390415		

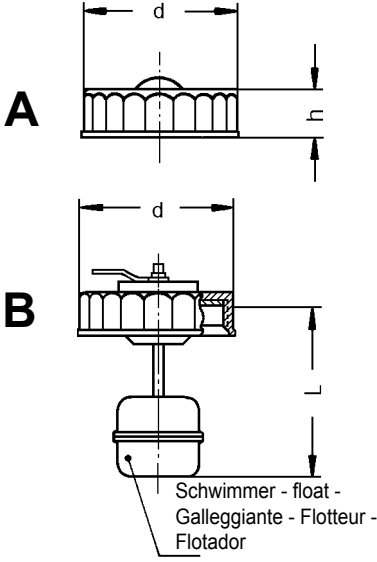

Armaturen

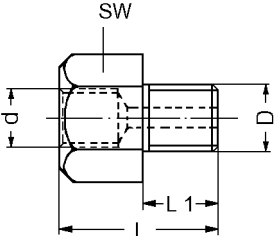
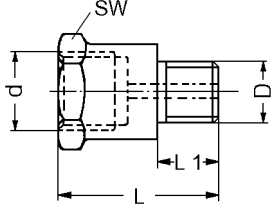
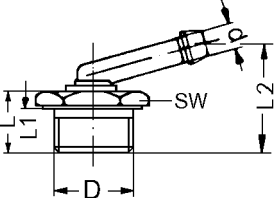
Fittings - Attrezzature - Composants et accessoires - Accesorios

Behälter Verschraubung Reservoir screw fitting Tappi filettato per serbatoio Couvercle de réservoir Fijación de depósito	Abmessungen - Dimensions - Dimensioni - Dimensions - Medidas [mm]							
Ausführung - Design - Esecuzione - Exécution - Ejecución	d	h	L					
	A	max. 51	14,0				03.3556-1065.2 390425	
		max. 51	14,0				03.3556-1141.2 390434	
		max. 51	14,5				03.3556-1147.2 390435 M	
		max. 51	14,0				03.3556-1164.2 390437	
	B	max. 51		45,5			03.3556-1094.2 390427	
		max. 51		51,2			03.3556-1113.2 390428	
		max. 51		83,0			03.3556-1115.2 390431	
		max. 51		54,0			03.3556-1124.2 390433	
		max. 51		40,5			03.3556-1199.2 390440	
		max. 51		40,5			03.3556-1199.2 390440	
M nur für Mineralöl only for mineral oil solo per olio minerale seulement pour huile minérale sólo para aceite mineral								
Schraubstutzen Screw adapters Raccordi filettati Raccord fileté Racores	Abmessungen - Dimensions - Dimensioni - Dimensions - Medidas [mm]							
D	d	Gewinde Ausführung - Thread design - Esecuzione filettata - Exécution filet - Ejecución de rosca	L	L₁	L₂	SW		
	M 10 x 1	M 10 x 1	A 2	21,0	8,0		17	03.3510-0100.1 390271
		M 12 x 1	A 1	24,0	8,0		17	03.3510-0300.1 390273
	M 12 x 1	M 10 x 1	A 2	20,5	8,0		17	03.3510-0054.1 390269 ①
		M 12 x 1	A 1	22,0	8,0		17	03.3510-0059.1 390270
	M 14 x 1,5	M 10 x 1	A 2	26,0	14,0		19	03.3510-4100.1 390279
		M 12 x 1	A 2	27,0	12,0		19	03.3510-0800.1 390275
① mit Drosselbohrung with throttle hole con foro calibrato di strozzamento avec d'étranglement con taladro estrangulador								
	M 10 x 1	M 10 x 1	A 2	32,0	8,0		17	03.3510-0200.1 390272
	M 22 x 1,5	Ø 10		16,5	12,0	30,0	27	03.3510-0026.2 390266



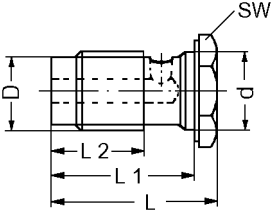
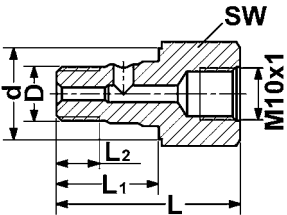

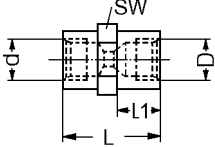
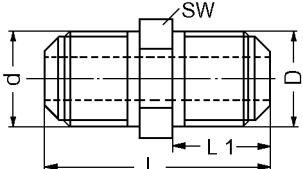
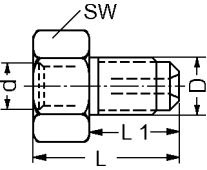
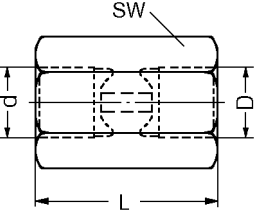
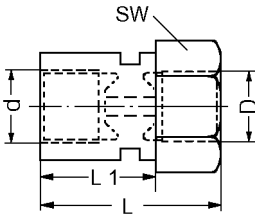
Armaturen

Fittings - Attrezzature - Composants et accessoires - Accesorios

Hohlschrauben Hollow screws Viti cave Vis creuse Tornillos huecos	Abmessungen - Dimensions - Dimensioni - Dimensions - Medidas [mm]								
	D	d	L	L ₁	L ₂	SW			
	M 10 x 1	12,1	24,5	19,5	8,5	17	03.3520-0302.1	390381	
		12,1	30,0	24,5	12,0	17	03.3520-0501.1	390382	
	M 12 x 1	14,1	28,0	22,5	10,0	17	03.3520-1003.1	390418	
	M 14 x 1,5	14,1	33,5	27,5	15,0	17	03.3520-2900.1	390390	
	M 10 x 1	12,1	34,0	19,0	8,0	17	03.3520-0600.1	390383	
Zwischenstücke Pipe adapters Raccordi intermedi Raccord intermédiaire Piezas intercaladas	Abmessungen - Dimensions - Dimensioni - Dimensions - Medidas [mm]								
	D	Gewinde Ausführung - Thread design - Esecuzione Filettata - Exécution filet - Ejecución de rosca	d	Gewinde Ausführung - Thread design - Esecuzione Filettata - Exécution filet - Ejecución de rosca	L	L ₁			SW
	M 10 x 1	A 2	M 10 x 1	A 2	24,0	8,5	14	03.3511-0800.1	390285 ①
	① In Sortimentbox 24.3516-0210.2 390553 enthalten. Included in collection 24.3516-0210.2 390553 . Contenuto nella scatola di assortimento 24.3516-0210.2 390553 . Include dans collection 24.3516-0210.2 390553 . Se incluye en caja de surtido 24.3516-0210.2 390553 .								
	M 12 x 1		M 12 x 1		35,0	15,0	12	03.3511-3800.1	390291
	M 12 x 1		M 10 x 1	A 2	28,0	15,3	17	03.3511-5200.1	390292
	M 12 x 1	A 1	M 12 x 1	A 1	29,0	-	17	03.3511-1000.1	390286
	M 12 x 1	A 1	M 12 x 1	A 1	29,0	19,0	19	03.3511-1100.1	390287

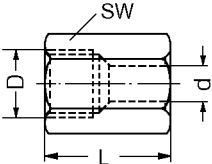
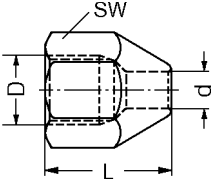

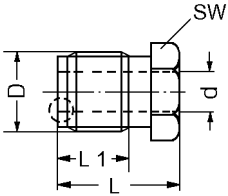
Armaturen

Fittings - Attrezzature - Composants et accessoires - Accesorios

Überwurfmutter Union nuts Dadi con risvolto Écrou-chapeau Tuerca de racor	Abmessungen - Dimensions - Dimensioni - Dimensions - Medidas [mm]						
	D	d	L	L ₁	für Bördel - for flare - bordatura tipo - pour colet - para reborde	SW	
	M 10 x 1	5,2	14,0		E	14	24.3516-0110.1 390549 ①
	<p>① In Sortimentbox 24.3516-0210.2 390553 enthalten. Included in collection 24.3516-0210.2 390553. Contenuto nella scatola di assortimento 24.3516-0210.2 390553. Incluse dans collection 24.3516-0210.2 390553. Se incluye en caja de surtido 24.3516-0210.2 390553.</p>						
	3/8" -24 UNF-2B	5,2	17,5		E	14	24.3516-0111.1 390550 ①
	<p>① In Sortimentbox 24.3516-0210.2 390553 enthalten. Included in collection 24.3516-0210.2 390553. Contenuto nella scatola di assortimento 24.3516-0210.2 390553. Incluse dans collection 24.3516-0210.2 390553. Se incluye en caja de surtido 24.3516-0210.2 390553.</p>						
Überwurfschrauben Union screws Viti con risvolto Vis chapeau Tornillos de racor	Abmessungen - Dimensions - Dimensioni - Dimensions - Medidas [mm]						
	D	d	L	L ₁	für Bördel - for flare - bordatura tipo - pour colet - para reborde	SW	
  E  F	M 10 x 1	4,75	17,0	11,0	E	10	03.3516-2300.1 390317
		5,2	16,7	9,5	E	10	24.3516-0020.1 390541 ②
		5,0	16,5	10,5	F	11	03.3516-3500.1 390318
		5,0	16,5	9,4	F	11	03.3516-0602.1 390412
		5,0	16,0	10,0	E	11	03.3516-0800.1 390313
		5,2	24,8	15,0	F	11	24.3516-0070.1 390546 ②
	M 10 x 1,25	5,2	19,5	13,5	F	10	24.3516-0050.1 390544 ②
		5,2	14,2	8,5	E	10	24.3516-0060.1 390545 ②
	M 12 x 1	6,0	18,0	11,4	E	12	24.3516-0080.1 390547
		5,0	20,0	13,0	F	12	24.3516-0090.1 390548
	3/8" -24 UNF-2A	5,2	18,0	12,0	E	10	24.3516-0040.1 390543 ②
		5,2	21,0	16,0	F	11	24.3516-0030.1 390542 ②
	<p>② In Sortimentbox 24.3516-0210.2 390553 enthalten. Included in collection 24.3516-0210.2 390553. Contenuto nella scatola di assortimento 24.3516-0210.2 390553. Incluse dans collection 24.3516-0210.2 390553. Se incluye en caja de surtido 24.3516-0210.2 390553.</p>						

Armaturen

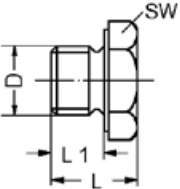
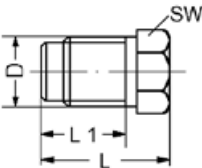
Fittings - Attrezzature - Composants et accessoires - Accesorios

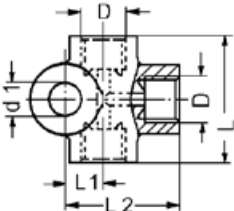
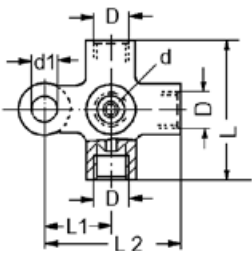
Verschlußstopfen Plugs Tappi Obturbateur Tapón de cierre	Abmessungen - Dimensions - Dimensioni - Dimensions - Medidas [mm]									
	D	d	L	L ₁	für Bördel - for flare - bordatura tipo - pour colet - para reborde	SW				
	M 10 x 1		12,5	7,5		14	03.3517-0100.1	390321		
	M 10 x 1		12,5	7,5		14	03.3517-0101.2	390322 ①		
① mit Dichtring (CU) with sealing ring (CU) avec joint d'étanchéité (CU) con anello di tenuta (CU) con junta (CU)										
	M 10 x 1		18,0	11,5	E + F	10	03.3517-5100.1	390326		
	M 12 x 1		20,0	13,0	E	12	03.3517-0300.1	390323		
Verteiler distributors ripartitore distributeur distribuidor	Abmessungen - Dimensions - Dimensioni - Dimensions - Medidas [mm]									
	D	Gewinde Ausführung - Thread design - Esecuzione Filettata - Exécution filet - Ejecución de rosca	d	Gewinde Ausführung - Thread design - Esecuzione Filettata - Exécution filet - Ejecución de rosca	L	L ₁	L ₂			d ₁
3 Anschlüsse - 3 Connections - 3 Attacchi - 3 Raccords - 3 Conexiones	M 10 x 1	A 2			30,0	8,0	23,0	7,1	03.3513-0200.1	390297
	M 10 x 1	A 2			30,0	8,0	23,0	8,4	03.3513-1000.1	390299
	M 10 x 1	A 1			36,0	9,0	27,0	8,4	03.3513-2700.1	390300
	M 12 x 1	A 1			36,0	10,0	31,5	8,3	03.3513-0300.1	390298
	M 10 x 1	A 2	M 10 x 1	A 2	32,0	17,0	33,0	8,4	03.3514-2600.1	390306
		A 2	M 10 x 1 ①	A 2	32,0	17,0	33,0	8,4	03.3514-2600.2	390307
① mit Entlüfterventil with bleeder valve con valvola di spurgo avec vis de purge con válvula de ventilador										
										

Armaturen

Fittings - Attrezzature - Composants et accessoires - Accesorios

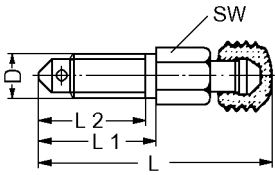
Entlüfterventil Bleeder valve Valvola di spurgo Vis de purge Válvula de ventilador	Abmessungen - Dimensions - Dimensioni - Dimensions - Medidas [mm]					
	D	L	L ₁	L ₂	SW	
 <p>Bestell-Nr. Staubkappe Part No. dust cap Codici ordinazione del parapolvere Référence capuchon de protection Referencia guardapolvo</p> <p>03.3590-0700.1 390456 03.3590-0701.1 390457 M</p>	M 6	31,5	16,0	12,0	7	03.3518-0100.2 390329
		31,5	16,0	12,0	7	03.3518-0102.2 390330 M
		41,0	22,0	12,0	7	03.3518-0200.2 390332
		29,0	13,5	12,0	7	03.3518-0300.2 390333
		29,0	13,5	12,0	7	03.3518-0302.2 390334 M
	M 7	33,0	16,5	15,0	7	03.3518-4200.2 390357
		41,0	22,0	15,5	7	03.3518-5900.2 390363
		22,5	12,5	11,0	7	03.3518-6800.2 390369 ①
		29,5	12,5	11,0	7	03.3518-6901.2 390370
	M 8	35,0	18,5	17,0	9	03.3518-0500.2 390337
		35,0	18,5	17,0	9	03.3518-0502.2 390339 M
		44,0	22,0	20,0	9	03.3518-0600.2 390340
		49,0	32,0	20,0	9	03.3518-0700.2 390342
		59,0	42,0	20,0	9	03.3518-0800.2 390343
		52,0	32,0	20,0	9	03.3518-6100.2 390364
		90,0	35,0	18,0	9	03.3518-8000.2 390373
	M 10 x 1	32,0	16,0	13,0	11	03.3518-0900.2 390345
		32,0	16,0	13,0	11	03.3518-0902.2 390346 M
		38,0	21,0	18,0	11	03.3518-1900.2 390354
		32,0	16,0	13,0	10	03.3518-5200.2 390358
M 12 x 1	31,5	15,5	13,0	12	03.3518-1501.2 390349 ②	
M 12 x 1,5	43,0	26,0	24,0	14	03.3518-1300.2 390347	
7/16"-20 UNF-2A	40,0	23,0	21,0	11	03.3518-1700.2 390352	

M nur für Mineralöl
only for mineral oil
solo per olio minerale
seulement pour huile minérale
sólo para aceite mineral

① mit Staubkappe **03.3590-0044.1 390455**
with dust cap **03.3590-0044.1 390455**
con parapolvere **03.3590-0044.1 390455**
avec capuchon de protection **03.3590-0044.1 390455**
con guardapolvo **03.3590-0044.1 390455**

② mit 60° Innenkegel
with 60° internal cone
con cono interno 60°
avec cône intérieur 60°
con cono interior 60°

Staubkappen
dust caps
parapolvere
capuchon de protection
guardapolvo

03.3590-0700.1 390456

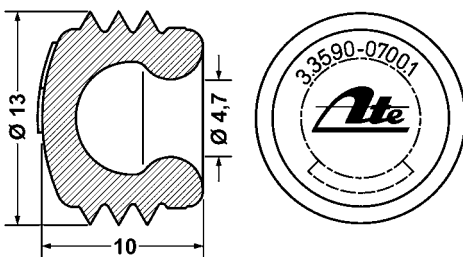

03.3590-0701.1 390457

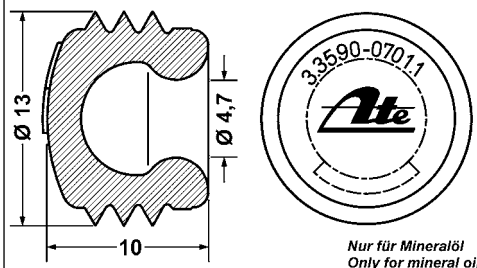



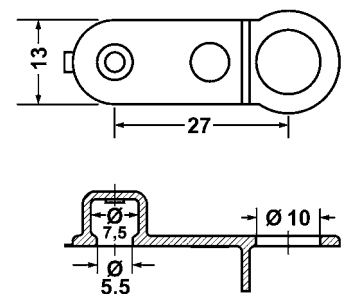

13.8190-0296.1 390409

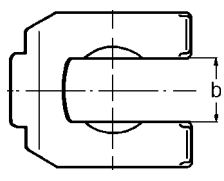
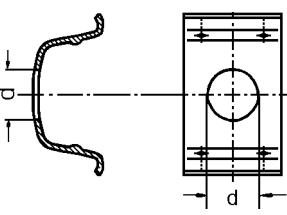
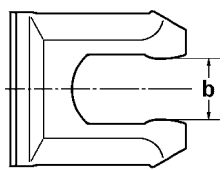

Armaturen

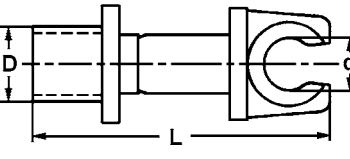
Fittings - Attrezzature - Composants et accessoires - Accesorios

Bremsschlauchhalter Hose spring-clamp Mollette per flessibile freni Ressort de retenue de flexible de frein Soporte manguera de freno	Abmessungen - Dimensions - Dimensioni - Dimensions - Medidas [mm]		
	b (d)	Blechstärke - Thickness of metal Spessore lamierino - Épaisseur de tôle - Espesor de chapa	
	14,0	1,00	03.5004-0101.1 990010
	14,0	1,75	03.5004-0401.1 990014
	12,0	1,00	24.5004-0001.1 390568 ②
	10,0	0,70	24.5004-0002.1 390569 ②
	11,0	1,00	24.5004-0003.1 390570 ②
② In Sortimentbox 24.3516-0230.2 390555 enthalten. Included in collection 24.3516-0230.2 390555. Contenuto nella scatola di assortimento 24.3516-0230.2 390555. Incluse dans collection 24.3516-0230.2 390555. Se incluye en caja de surtido 24.3516-0230.2 390555.			
Bremsrohrhalter Brake pipe line holder Supporto tubo freno Support de tuyau de freinage Soporte tubo de freno	Abmessungen - Dimensions - Dimensioni - Dimensions - Medidas [mm]		
	D	d	L
	6,3	4,7	28,0
24.3590-0002.1 390567 ②			
Rohrleitungen DIN 74234 Pipe line DIN 74234 Tubazioni DIN 74234 Conduite tube DIN 74234 Tuberías DIN 74234	Abmessungen - Dimensions - Dimensioni - Dimensions - Medidas		
	∅	L	
	4,75 mm	5,0 m	24.8134-0547.1 390571
	6,00 mm	5,0 m	24.8134-0560.1 390572
	8,00 mm	5,0 m	24.8134-0580.1 390573
	4,75 mm	31,5 m	24.8134-3147.1 390574

Armaturen

Fittings - Attrezzature - Composants et accessoires - Accesorios

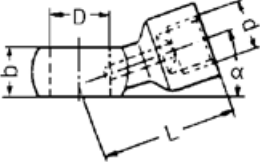
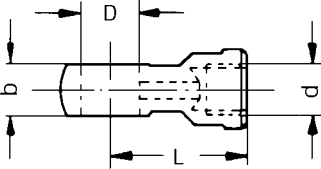
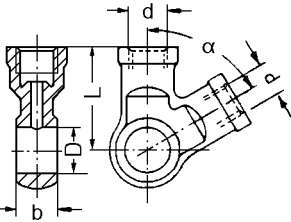
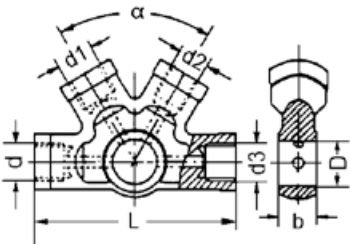
Ringstutzen Banjo fittings Raccordi anulari Manchon à oeillet Racores anulares	Abmessungen - Dimensions - Dimensioni - Dimensions - Medidas [mm]							
	D	d	Gewinde Ausführung - Thread design - Esecuzione filettata - Exécution filet - Ejecución de rosca	L	b	α		
1 Anschluss - 1 Connection - 1 Attaccho - 1 Raccord - 1 Conexión 	12,0	M 10 x 1	A 2	27,0	10,0	20°	03.3521-0100.1	390392
		M 10 x 1	A 2	30,0	10,0	30°	03.3521-0400.1	390394
	14,0	M 10 x 1	A 2	32,0	12,0	20°	03.3521-0800.1	390398
		M 12 x 1	A 1	32,0	12,0	20°	03.3521-0600.1	390395
1 Anschluss - 1 Connection - 1 Attaccho - 1 Raccord - 1 Conexión 	12,0	M 10 x 1	A 2	26,0	10,0		03.3521-0200.1	390393 ①
	① für Bremslichtschalter mit konischem Gewinde for stop-light switch with conical thread per interruttore luce di arresto con filettatura conica pour contacteur de stop avec filetage conique para interruptor de luz de freno con rosca cónica							
2 Anschlüsse - 2 Connections - 2 Attacchi - 2 Raccords - 2 Conexiones 	12,0	M 10 x 1	A 2	20,5	15,5	34°	03.3522-0200.1	390402
		M 12 x 1	A 1	32,0	12,0	60°	03.3522-0500.1	390403
	14,0	M 12 x 1	A 1	32,0	12,0	60°	03.3522-1100.1	390404
		M 10 x 1 ②	A 4					
② für Bremslichtschalter for stop-light switch per interruttore luce di arresto pour contacteur de stop para interruptor de luz de freno								
4 Anschlüsse - 4 Connections - 4 Attacchi - 4 Raccords - 4 Conexiones 	14,0	M 10 x 1	A 2	64,0	12,0	60°	03.3524-0300.1	390407

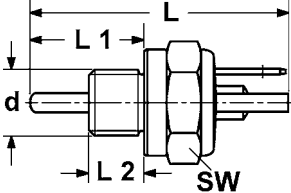
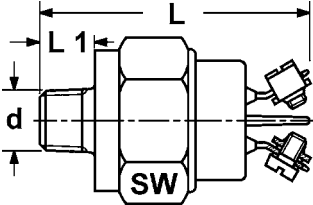
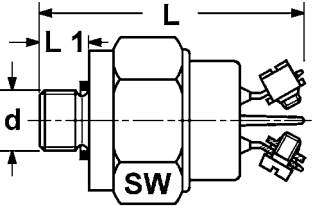
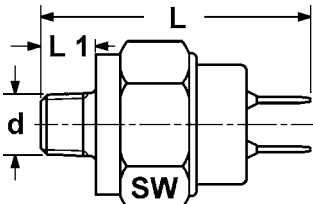
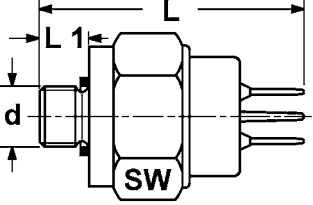
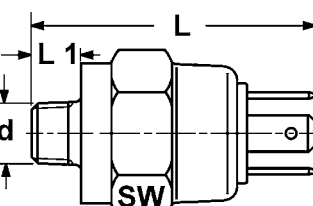

Armaturen

Fittings - Attrezzature - Composants et accessoires - Accesorios

Bremslichtschalter Stop-light switch Interruttore luce di arresto Contacteur de stop Interruptor de luz de freno	Abmessungen - Dimensions - Dimensioni - Dimensions - Medidas [mm]						
	Ausführung - Design - Esecuzione - Exécution - Ejecución	d	L	L ₁	L ₂		SW
	Steck-Anschluß Plug connection Attacco a spina Contact à fiches Enchufe de conexión	M 12 x 1	47,0	21,0	10,0	19	24.3525-9120.1 340015
	Klemm-Anschluß Clamp connection Collegamento a morsetto Borne de serrage Conexión por fijación	M 10 x 1	46,0	9,0		24	24.3526-0100.3 340017
		M 10 x 1	46,0	9,0		24	24.3526-0600.3 340027 M
	Klemm-Anschluß Clamp connection Collegamento a morsetto Borne de serrage Conexión por fijación	M 10 x 1	46,0	8,0		24	24.3526-0110.3 340018
		M 10 x 1	46,0	8,0		24	24.3526-0610.3 340030 M
	Steck-Anschluß Plug connection Attacco a spina Contact à fiches Enchufe de conexión	M 10 x 1	42,0	9,0		22	03.3526-2002.3 340010
	Steck-Anschluß Plug connection Attacco a spina Contact à fiches Enchufe de conexión	M 10 x 1	46,0	8,0		22	24.3526-0810.3 340037
	Steck-Anschluß Plug connection Attacco a spina Contact à fiches Enchufe de conexión	M 10 x 1	48,0	9,0		24	24.3526-0800.3 340033
		M 10 x 1	48,0	9,0		24	24.3526-1900.0 340038 M
		M 10 x 1	48,0	9,0		24	24.3526-2200.0 340039
	M nur für Mineralöl - only for mineral oil - solo per olio minerale seulement pour huile minérale - sólo para aceite mineral						



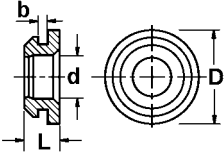
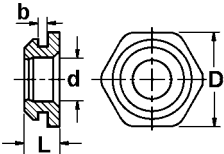

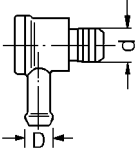
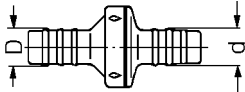



Armaturen

Fittings - Attrezzature - Composants et accessoires - Accesorios

Dichtung für Vakuum-Anschlußstück Hexagon for vacuum connection Guarnizione per pezzo di raccordo per depressione Hexagone pour raccord à dépression Retén para terminal de empalme al vacío	Abmessungen - Dimensions - Dimensioni - Dimensions - Medidas [mm]				
	L	b	D	d	
	9,5	1,5	28,0	13,0	03.7718-7203.1 390360
	9,5	2,5	28,0	13,0	03.7718-7202.1 390378
Vakuum-Rückschlagventil Vacuum check valve Valvola di non ritorno per depressione Soupape à dépression Válvula de retención al vacío	Abmessungen - Dimensions - Dimensioni - Dimensions - Medidas [mm]				
L	b	D	d		
			12,4	16,5	03.6118-7305.2 990032
			10,5	16,5	03.6718-9931.2 990002
			11,8	11,8	24.7718-7301.2 990024
			13,0	13,0	03.6118-7307.2 990033

Armaturen

Fittings - Attrezzature - Composants et accessoires - Accesorios

<p>Prüfanschlüsse Testing connectors attacchi di prova connexion d'essai conexiones de ensayo</p>	<p>Für den festen Einbau in die Bremsanlage (z.B. anstelle eines Verteilerstückes). Druckprüfgeräte können hier direkt über die Anschlußschlauchleitung verbunden werden, ohne die Bremsanlage nachträglich zu entlüften. For permanent installation in the braking system (e.g. in the place of a distributor piece). The pressure testing units can be connected here directly to the connection hose line without having to bleed the braking system afterwards. Per montaggio fisso nell'impianto di frenatura (p.e. al posto di un ripartitore a più vie). Apparecchi prova pressione possono essere collegati direttamente tramite il tubo di collegamento, senza dover spurgare l'impianto freni a posteriori. Pour installation permanente dans le système de freinage (par ex: à la place d' une pièce de distribution). Les appareils de vérification de la pression peuvent ici être directement reliés à la connexion. Le système de freinage n' a pas besoin d' être purgé par la suite. Para el montaje fijo en la instalación de frenos (p. ej. en lugar de un distribuidor). Los controladores de presión no pueden unirse aquí directamente a través de la línea de conexión sin tener que airear posteriormente la instalación de frenos.</p>			
	 03.9305-0501.3 390481	 03.9305-0510.3 390483	 03.9305-0520.3 390485	 03.9305-0530.3 390486
<p>Anzahl der Befestigungslaschen Number of mounting links Numero delle fascette Nombre de trous de fixation Número de las bridas de fijación</p>	1	1	2	2
<p>Anzahl der Anschlüsse Number of connections Numero di attacchi Nombre de raccordement Número de conexiones</p>	2	3	2	2
<p>Gewinde Ausführung Thread design Esecuzione filettata Exécution filet Ejecución de rosca</p>	M 12 x 1 A1	M 12 x 1 A1	M 10 x 1 A2	M 12 x 1 A1
<p>Richtung des Prüfanschlusses zur Befestigungslasche Direction of the testing connector to the mounting link Direzione del raccordo di prova alla fascetta di fissaggio Nens du raccord d' essai par rapport aux trous de fixation Dirección de la conexión de ensayo a la brida de fijación</p>	horizontal orizzontale	vertical verticale	vertical verticale	vertical verticale
	 03.9305-0570.3 390488	 03.9305-0590.3 390489	 03.9305-0700.3 390491	
<p>Anzahl der Befestigungslaschen Number of mounting links Numero delle fascette Nombre de trous de fixation Número de las bridas de fijación</p>	1	1	-	
<p>Anzahl der Anschlüsse Number of connections Numero di attacchi Nombre de raccordement Número de conexiones</p>	3	3	1	
<p>Gewinde Ausführung Thread design Esecuzione filettata Exécution filet Ejecución de rosca</p>	M 12 x 1 A1	M 10 x 1 A2	M 10 x 1	
<p>Richtung des Prüfanschlusses zur Befestigungslasche Direction of the testing connector to the mounting link Direzione del raccordo di prova alla fascetta di fissaggio Nens du raccord d' essai par rapport aux trous de fixation Dirección de la conexión de ensayo a la brida de fijación</p>	vertical verticale	horizontal orizzontale	-	
<p>Prüfanschlüsse - Einzelteile Testing connectors - individual parts Attacchi di prova - pezzi singoli Connexion d' essai - pièces détachées Piezas sueltas - conexión de ensayo</p>	<p>03.9305-0502.0 390482 Schraubverschlusskappe Screw-type sealing cap Calotta per tappo filettato Capuchon à vis Tapa roscable</p>	<p>03.9305-0501.1 390480 Verbindungskette Connecting chain catena di collegamento chaîne de raccordement cadena de unión</p>	<p>03.3501-0021.1 390242 Gummidichtung in der Verschlusskappe Rubber seal in the sealing cap guarnizione in gomma nella calotta joint dans le capuchon junta de goma en la tapa de cierre</p>	

Armaturen

Fittings - Attrezzature - Composants et accessoires - Accesorios

Sortimente
Assortments
Assortimenti
Assortiments
Surtidos

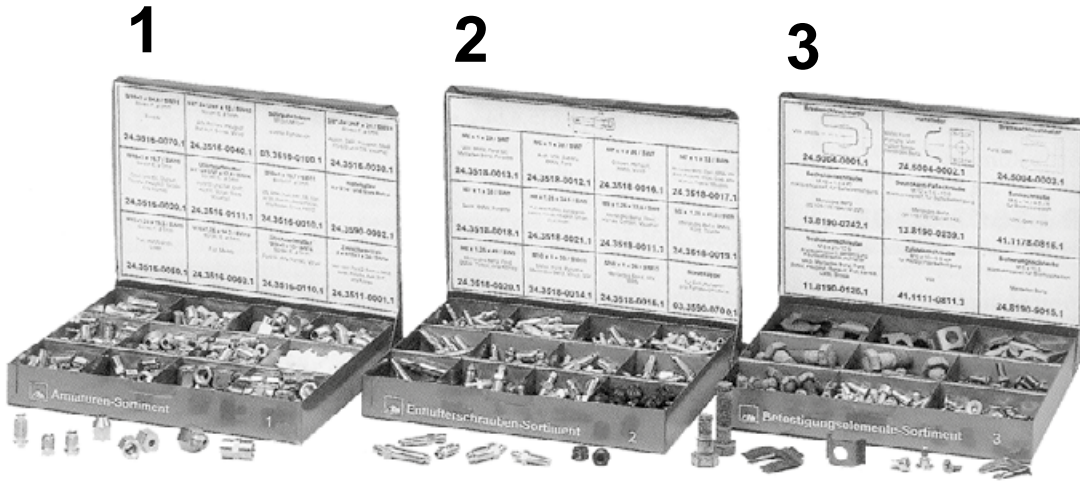

<p>① M10x1 x 24,8 / SW11 Bördel F, Ø5mm ● 24.3516-0070.1 390546</p>	<p>① 3/8"-24 UNF x 18/SW10 Bördel E, Ø5mm ● 24.3516-0040.1 390543</p>	<p>② Schraubstutzen M10x1/M10x1 ■ 03.3510-0100.1 390271</p>	<p>① 3/8"-24 UNF x 21/SW11 Bördel F, Ø5mm ● 24.3516-0030.1 390542</p>	<p>1 24.3516-0210.2 390553 Armaturen Sortiment Fittings collection Serie di accessori Armatures collection Surtido de accesorios</p>
<p>① M10x1 x 16,7 / SW10 Bördel E, Ø5mm ● 24.3516-0020.1 390541</p>	<p>③ Überwurfmutter 3/8"-24UNFx17,5/SW11/E, Ø5mm ● 24.3516-0111.1 390550</p>	<p>① M10x1 x 16,7 / SW11 Bördel F, Ø5mm ● 24.3516-0010.1 390540</p>	<p>Rohrhalter ④ für 3/16" und 5mm ● 24.3590-0002.1 390567</p>	
<p>① M10x1,25 x 10,5 / SW10 Bördel F, Ø5mm ● 24.3516-0050.1 390544</p>	<p>① M10x1,25 x 14,2 / SW10 Bördel E, Ø5mm ● 24.3516-0060.1 390545</p>	<p>③ Überwurfmutter M10x1 x 13 / SW14 / E, Ø5mm ● 24.3516-0110.1 390549</p>	<p>⑤ Zwischenstück 2 x M10x1 x 24 SW14 ● 03.3511-0800.1 390285</p>	
<p>M6 x 1 x 29 SW7 ● 24.3518-0013.1 390558</p>	<p>M6 x 1 x 38 SW7 ● 24.3518-0012.1 390557</p>	<p>M7 x 1 x 26 SW7 ● 24.3518-0016.1 390561</p>	<p>M7 x 1 x 33 SW9 ● 24.3518-0017.1 390562</p>	<p>2 24.3516-0220.2 390554 Entlüfterschrauben Sortiment Bleeder valve collection Viti di spurgo assortimento Vis de purge collection Surtido de tornillos de ventilador</p>
<p>M7 x 1 x 38 SW7 ● 24.3518-0018.1 390563</p>	<p>M8 x 1,25 x 24,5 SW8 ● 24.3518-0021.1 390566</p>	<p>M8 x 1,25 x 32,5 SW9 ● 24.3518-0011.1 390556</p>	<p>M8 x 1,25 x 41,5 SW9 ● 24.3518-0019.1 390564</p>	
<p>M8 x 1,25 x 49 SW9 ● 24.3518-0020.1 390565</p>	<p>M10 x 1 x 30 SW11 ● 24.3518-0014.1 390559</p>	<p>M10 x 1 x 36 SW11 ● 24.3518-0015.1 390560</p>	<p>⑥ Staubkappe ■ 03.3590-0700.1 390456</p>	
<p>⑦ Bremschlauchhalter ● 24.5004-0001.1 390568</p>	<p>⑧ Haltefeder ● 24.5004-0002.1 390569</p>	<p>⑦ Bremschlauchhalter ● 24.5004-0003.1 390570</p>	<p>3 24.3516-0230.2 390555 Befestigungselemente Sortiment Fittings Collection Pezzi di fissaggio assortimento Fixation collection Surtido de elementos de fijación</p>	
<p>⑨ Sechskantschraube M12 x 1,5 x 45 ■ 13.8190-0242.1 990124</p>	<p>⑩ Sechskant-Paßschraube M12 x 1,5 - 10.9 ■ 13.8190-0239.1 990122</p>	<p>⑪ Senkschraube M6 x 14 -4.8 - H ● 41.1178-0815.1 990137</p>		
<p>⑨ Sechskantschraube M8 x 21 - 10.9 ● 11.8190-0125.1 990054</p>	<p>⑫ Zylinderschraube M6 x 10 -8.8 ● 41.1111-0811.3 990136</p>	<p>⑬ Sicherungsschraube M6 x 15,5 ● 24.8190-9015.1 990133</p>		
<p>① Bördel Flare</p>	<p>② Schraubstutzen Screw adapters</p>	<p>③ Überwurfmutter Union nut</p>	<p>④ Rohrhalter Pipe holder</p>	<p>Reborde Racores</p>
<p>⑤ Zwischenstück Pipe adapter</p>	<p>⑥ Staubkappe Dust cap</p>	<p>⑦ Bremschlauchhalter Hose spring-clamp</p>	<p>⑧ Haltefeder Fixation spring</p>	<p>Tuerca de racor Soporte de tubo para 3/16" y 5mm</p>
<p>⑨ Sechskantschraube Hexagon screw</p>	<p>⑩ Sechskant-Paßschraube Hexagone-fitting screw</p>	<p>⑪ Senkschraube Boulon hexagonal</p>	<p>⑫ Zylinderschraube Cylinder screw</p>	<p>Piezas intercaladas Guardapolvo Soporte manguera de freno Resorte de retención</p>
<p>⑬ Sicherungsschraube Locking screw</p>	<p>⑭ Nachfüllbeutel 10 Stück Refillbag with 10 pieces</p>	<p>⑮ Einzelteil Single part</p>	<p>⑯ Sicherungsschraube Vite autobloccante</p>	<p>Tornillo hexagonal Tornillo calibrado hexagonal Tornillo cilíndrico Tornillo de seguridad Bolsa de relleno con 10 piezas Pieza suelta</p>
<p>⑰ Sicherungsschraube Locking screw</p>	<p>⑱ Nachfüllbeutel 10 Stück Refillbag with 10 pieces</p>	<p>⑲ Einzelteil Single part</p>	<p>⑳ Sicherungsschraube Vite autobloccante</p>	<p>Sacchetto di riassortimento 10 pezzi Sac de remplissage à 10 pièces</p>
<p>⑳ Sicherungsschraube Locking screw</p>	<p>㉑ Nachfüllbeutel 10 Stück Refillbag with 10 pieces</p>	<p>㉒ Einzelteil Single part</p>	<p>㉓ Sicherungsschraube Vite autobloccante</p>	<p>Pezzo singolo</p>





- D** Bremsgeräte komplett
- EN** Booster units complete
- FR** Servo-Freins complets
- IT** Servofreni completi
- ES** Servofreno completo
- NL** Complete remapparaten
- DA** Bremseenheder (kompl.)
- SV** Bromsapparater komplett
- HU** Teljes fékberendezés
- PT** Aparelho de travagem completo
- RU** Тормозные усилители в сборе
- CZ** Brzdová zařízení kompletní
- PL** Serwa hamulcowe kompletne
- EL** Μονάδες φρένων κομπλέ
- TR** Tüm fren cihazları
- ZH** 制动器总成
- JA** ブレーキ機器 全品
- AR** أنظمة المكابح بالكامل

K24-H

Bremsgeräte komplett

**Booster units complete - Servofreni completi -
Servo-freins complets - Servofreno completo**

● Die Nr. befindet sich auf dem im Fahrzeug eingebautem Aggregat.
the number is on the unit build in the car
il numero si trova sull'aggregato montato nella macchina
le numéro se trouve sur la pièce montée dans le véhicule
el n° se encuentra en el equipo montado en el vehículo



03.6121-0501.4	03.3508-0264.3	310009	Behälter
03.6122-0010.4	03.3508-8302.3	310046	Behälter
03.6122-0017.4	03.3508-8302.3	310046	Behälter
03.6122-0018.4	03.3508-8302.3	310046	Behälter
03.6122-0601.4	03.3508-8302.3	310046	Behälter
03.6122-1002.4	03.3508-8302.3	310046	Behälter
03.6122-1006.4	03.3508-8302.3	310046	Behälter
03.6122-1401.4	03.3508-8302.3	310046	Behälter
03.6122-2001.4	03.2119-6207.3	010060	THz 19,05
03.6122-2002.4	03.2119-6207.3	010060	THz 19,05
03.6122-2003.4	03.2119-6207.3	010060	THz 19,05
03.6122-2102.4	03.3508-8302.3	310046	Behälter
03.6122-2401.4	03.2119-0525.3	010046	THz 19,05 + Behälter
03.6122-2402.4	03.2120-0148.3	010070	THz 20,64 + Behälter
03.6122-2407.4	03.2120-0148.3	010070	THz 20,64 + Behälter
03.6127-0001.4	03.2123-6802.3	010186	THz 23,81
03.6127-0301.4	03.2123-6802.3	010186	THz 23,81
03.6127-0801.4	03.2122-0142.3 03.3558-0676.3	010128 310077	THz 22,20 Behälter + WE
03.6127-0804.4	03.3558-0676.3	310077	Behälter + WE
03.6132-0702.4	03.3508-8302.3	310046	Behälter
03.6132-1103.4	03.2120-0148.3	010070	THz 20,64 + Behälter
03.6132-1401.4	03.3508-8302.3	310046	Behälter
03.6132-1501.4	03.2122-0142.3 03.3558-0676.3	010128 310077	THz 22,20 Behälter + WE
03.6132-1502.4	03.2122-0142.3 03.3558-0676.3	010128 310077	THz 22,20 Behälter + WE
03.6132-1701.4	03.2123-1003.3	010175	THz 23,81
03.6132-1901.4	03.2120-5503.3	010124	THz 20,64 + Behälter
03.6132-2001.4	03.3508-8302.3	310046	Behälter
03.6132-2701.4	03.3508-7504.3	310045	Behälter
03.6132-2901.4	03.2120-0148.3	010070	THz 20,64 + Behälter

03.6132-3401.4	03.3508-8302.3	310046	Behälter
03.6132-3905.4	03.3508-7504.3	310045	Behälter
03.6132-3907.4	03.2120-1531.3 03.3508-7504.3	010092 310045	THz 20,64 Behälter
03.6132-3908.4	03.3508-7504.3	310045	Behälter
03.6132-3912.4	03.2120-1531.3	010092	THz 20,64
03.6132-4201.4	03.2120-0148.3	010070	THz 20,64 + Behälter
03.6132-4202.4	03.2120-0148.3	010070	THz 20,64 + Behälter
03.6132-4203.4	03.2120-0148.3	010070	THz 20,64 + Behälter
03.6132-4207.4	03.2120-0148.3	010070	THz 20,64 + Behälter
03.6132-4401.4	03.2120-5503.3	010124	THz 20,64 + Behälter
03.6132-4601.4	03.3508-7504.3	310045	Behälter
03.6132-4703.4	03.3508-8302.3	310046	Behälter
03.6132-4704.4	03.3508-8302.3	310046	Behälter
03.6132-4901.4	03.3508-7504.3	310045	Behälter
03.6132-5201.4	03.3508-7504.3	310045	Behälter
03.6132-5405.4	03.2120-0538.3	010077	THz 20,64
03.6132-5501.4	03.2120-1531.3 03.3508-7504.3	010092 310045	THz 20,64 Behälter
03.6132-5502.4	03.3508-7504.3	310045	Behälter
03.6132-5701.4	03.2120-1531.3	010092	THz 20,64
03.6132-5802.4	03.3508-7504.3	310045	Behälter
03.6132-6301.4	03.2120-2598.3	010116	THz 20,64
03.6132-6302.4	03.2120-2598.3	010116	THz 20,64
03.6132-6304.4	03.2120-2598.3	010116	THz 20,64
03.6132-6305.4	03.2120-2598.3	010116	THz 20,64
03.6132-6306.4	03.2120-2598.3	010116	THz 20,64
03.6132-6501.4	03.2120-1531.3	010092	THz 20,64
03.6132-6512.4	03.2120-1531.3	010092	THz 20,64
03.6132-6515.4	03.2120-1491.3	010089	THz 20,64 + WE
03.6132-6706.4	03.2120-1491.3	010089	THz 20,64 + WE
03.6142-0301.4	03.3508-8302.3	310046	Behälter



Bremsgeräte komplett

**Booster units complete - Servofreni completi -
Servo-freins complets - Servofreno completo**

● Die Nr. befindet sich auf dem im Fahrzeug eingebautem Aggregat.
the number is on the unit build in the car
il numero si trova sull'aggregato montato nella macchina
le numéro se trouve sur la pièce montée dans le véhicule
el n° se encuentra en el equipo montado en el vehículo



03.6142-0701.4	03.3508-8302.3	310046	Behälter	03.6142-4702.4	03.2122-4902.3	010144	THz 22,20
03.6142-1201.4	03.2123-2604.3	010178	THz 23,81 + WE	03.6142-4704.4	03.2122-4902.3	010144	THz 22,20
03.6142-1202.4	03.2123-2604.3	010178	THz 23,81 + WE	03.6142-4801.4	03.2123-6207.3	010185	THz 23,81
03.6142-1205.4	03.2123-2604.3	010178	THz 23,81 + WE		03.3508-7504.3	310045	Behälter
03.6142-1502.4	03.2122-2202.3	010140	THz 22,20	03.6142-4802.4	03.3508-7504.3	310045	Behälter
03.6142-1701.4	03.2119-6207.3	010060	THz 19,05	03.6142-4803.4	03.3508-7504.3	310045	Behälter
	03.3558-0676.3	310077	Behälter + WE	03.6142-5201.4	03.2123-6207.3	010185	THz 23,81
03.6142-1703.4	03.2120-4504.3	010123	THz 20,64		03.3508-7504.3	310045	Behälter
	03.3558-0676.3	310077	Behälter + WE	03.6142-5202.4	03.3508-7504.3	310045	Behälter
03.6142-1704.4	03.2120-4504.3	010123	THz 20,64	03.6142-5203.4	03.3508-7504.3	310045	Behälter
	03.3558-0676.3	310077	Behälter + WE	03.6142-5205.4	03.2123-4911.3	010182	THz 23,81
03.6142-2101.4	03.2122-2202.3	010140	THz 22,20	03.6142-5301.4	03.3508-8302.3	310046	Behälter
03.6142-2402.4	03.2123-6207.3	010185	THz 23,81	03.6142-5502.4	03.3508-7504.3	310045	Behälter
	03.3508-7504.3	310045	Behälter	03.6142-6803.4	03.2122-4902.3	010144	THz 22,20
03.6142-2403.4	03.3508-7504.3	310045	Behälter	03.6142-7203.4	03.2120-1491.3	010089	THz 20,64 + WE
03.6142-3001.4	03.2120-5503.3	010124	THz 20,64 + Behälter	03.6142-7204.4	03.2120-1491.3	010089	THz 20,64 + WE
03.6142-3201.4	03.6058-0301.3	320072	BR 25/5 (3)	03.6142-7205.4	03.2120-1491.3	010089	THz 20,64 + WE
03.6142-3203.4	03.6058-0301.3	320072	BR 25/5 (3)	03.6142-7301.4	03.2120-1491.3	010089	THz 20,64 + WE
03.6142-3204.4	03.6058-0301.3	320072	BR 25/5 (3)	03.6142-7302.4	03.2120-1491.3	010089	THz 20,64 + WE
03.6142-3205.4	03.6058-0301.3	320072	BR 25/5 (3)	03.6142-7303.4	03.2120-1491.3	010089	THz 20,64 + WE
03.6142-3301.4	03.2123-6207.3	010185	THz 23,81	03.6147-0401.4	03.2125-1102.3	010202	THz 25,40
	03.3508-7504.3	310045	Behälter		03.3508-3600.3	310030	Behälter
03.6142-3302.4	03.3508-7504.3	310045	Behälter	03.6147-0501.4	03.2125-1102.3	010202	THz 25,40
03.6142-4401.4	03.2123-2604.3	010178	THz 23,81 + WE	03.6147-1101.4	03.2125-1302.3	010203	THz 25,40
03.6142-4601.4	03.2122-0142.3	010128	THz 22,20	03.6147-1102.4	03.2125-1302.3	010203	THz 25,40
	03.3558-0676.3	310077	Behälter + WE	03.6147-1103.4	03.2125-1302.3	010203	THz 25,40
03.6142-4602.4	03.2122-0142.3	010128	THz 22,20	03.6147-1301.4	03.2123-6802.3	010186	THz 23,81
	03.3558-0676.3	310077	Behälter + WE	03.6147-1703.4	03.2125-1302.3	010203	THz 25,40
03.6142-4603.4	03.2122-0142.3	010128	THz 22,20	03.6147-2402.4	03.2123-8611.3	010195	THz 23,81
	03.3558-0676.3	310077	Behälter + WE	03.6152-0206.4	03.2123-3402.3	010181	THz 23,81
03.6142-4604.4	03.2122-0142.3	010128	THz 22,20		03.3508-8753.3	310049	Behälter + WE
	03.3558-0676.3	310077	Behälter + WE		03.6850-0202.4	300043	9"
03.6142-4605.4	03.2122-0142.3	010128	THz 22,20	03.6152-0209.4	03.2023-0166.3	010015	THz 23,81/19,05
	03.3558-0676.3	310077	Behälter + WE		03.6850-0202.4	300043	9"
03.6142-4701.4	03.2122-4902.3	010144	THz 22,20				

Bremsgeräte komplett

Booster units complete - Servofreni completi -
Servo-freins complets - Servofreno completo

● Die Nr. befindet sich auf dem im Fahrzeug eingebautem Aggregat.
the number is on the unit build in the car
il numero si trova sull'aggregato montato nella macchina
le numéro se trouve sur la pièce montée dans le véhicule
el n° se encuentra en el equipo montado en el vehículo



03.6152-0210.4	03.2023-0166.3 03.6850-0202.4	010015 300043	THz 23,81/19,05 9"
03.6152-0401.4	03.2122-6202.3	010148	THz 22,20
03.6152-0601.4	03.3508-8302.3	310046	Behälter
03.6152-0701.4	03.2123-6802.3	010186	THz 23,81
03.6152-0702.4	03.2122-6202.3	010148	THz 22,20
03.6152-0703.4	03.2122-6202.3	010148	THz 22,20
03.6152-0803.4	03.2123-6207.3 03.3508-7504.3	010185 310045	THz 23,81 Behälter
03.6152-1002.4	03.2123-3302.3	010180	THz 23,81
03.6152-1101.4	03.3508-8302.3	310046	Behälter
03.6152-1401.4	03.2123-6802.3	010186	THz 23,81
03.6152-1502.4	03.2123-3302.3	010180	THz 23,81
03.6152-1701.4	03.2123-6207.3 03.3508-7504.3	010185 310045	THz 23,81 Behälter
03.6152-1801.4	03.2122-0142.3 03.3558-0676.3	010128 310077	THz 22,20 Behälter + WE
03.6152-2001.4	03.2123-6207.3 03.3508-7504.3	010185 310045	THz 23,81 Behälter
03.6152-2002.4	03.3508-7504.3	310045	Behälter
03.6152-2003.4	03.2123-4911.3	010182	THz 23,81
03.6152-2101.4	03.3508-8302.3	310046	Behälter
03.6157-0201.4	03.3508-8302.3	310046	Behälter
03.6157-0301.4	03.2123-1003.3 03.3508-8753.3 03.6855-1202.4	010175 310049 300056	THz 23,81 Behälter + WE 9" Tandem
03.6157-0302.4	03.2123-1003.3 03.3508-8753.3 03.6855-1202.4	010175 310049 300056	THz 23,81 Behälter + WE 9" Tandem
03.6157-0303.4	03.2123-1003.3 03.3508-8753.3 03.6855-1202.4	010175 310049 300056	THz 23,81 Behälter + WE 9" Tandem
03.6157-0304.4	03.2123-3402.3 03.3508-8753.3 03.6855-1202.4	010181 310049 300056	THz 23,81 Behälter + WE 9" Tandem
03.6157-0305.4	03.2123-1003.3 03.3508-8753.3 03.6855-1202.4	010175 310049 300056	THz 23,81 Behälter + WE 9" Tandem

03.6157-0306.4	03.2123-3402.3 03.3508-8753.3 03.6855-1202.4	010181 310049 300056	THz 23,81 Behälter + WE 9" Tandem
03.6157-0307.4	03.2023-0112.3 03.6855-1202.4	010013 300056	THz 23,81/19,05 9" Tandem
03.6157-0308.4	03.2023-0166.3 03.6855-1202.4	010015 300056	THz 23,81/19,05 9" Tandem
03.6157-0309.4	03.2023-0112.3 03.6855-1202.4	010013 300056	THz 23,81/19,05 9" Tandem
03.6157-0310.4	03.2023-0166.3 03.6855-1202.4	010015 300056	THz 23,81/19,05 9" Tandem
03.6157-0501.4	03.2123-7002.3	010187	THz 23,81
03.6157-0503.4	03.2123-7002.3	010187	THz 23,81
03.6197-1501.4	03.3508-8302.3	310046	Behälter
03.6197-2101.4	03.3508-8302.3	310046	Behälter
03.6197-2201.4	03.3508-8302.3	310046	Behälter
03.6197-2202.4	03.3508-8302.3	310046	Behälter
03.6197-2203.4	03.3508-8302.3	310046	Behälter
03.6197-2204.4	03.3508-8302.3	310046	Behälter
03.6197-2801.4	03.3508-8302.3	310046	Behälter
03.6197-3301.4	03.3508-8302.3	310046	Behälter
03.6197-3302.4	03.3508-8302.3	310046	Behälter
03.6732-0101.4	03.2120-2031.3	010106	THz 20,64
03.6732-0201.4	03.2120-2031.3	010106	THz 20,64
03.6732-0203.4	03.2120-2031.3	010106	THz 20,64
03.6732-0401.4	03.2120-2031.3	010106	THz 20,64
03.6732-0503.4	03.2120-2598.3	010116	THz 20,64
03.6732-0504.4	03.2120-2598.3	010116	THz 20,64
03.6732-0601.4	03.2120-2031.3	010106	THz 20,64
03.6732-0901.4	03.2119-3389.3	010057	THz 19,05
03.6732-1001.4	03.2119-3389.3	010057	THz 19,05
03.6732-1101.4	03.2119-3389.3	010057	THz 19,05
03.6732-1103.4	03.2119-3389.3	010057	THz 19,05
03.6732-1201.4	03.2119-3389.3	010057	THz 19,05



Bremsgeräte komplett

**Booster units complete - Servofreni completi -
Servo-freins complets - Servofreno completo**

● Die Nr. befindet sich auf dem im Fahrzeug eingebautem Aggregat.
the number is on the unit build in the car
il numero si trova sull'aggregato montato nella macchina
le numéro se trouve sur la pièce montée dans le véhicule
el n° se encuentra en el equipo montado en el vehículo



03.6732-3301.4	03.2119-3389.3	010057	THz 19,05
03.6732-3501.4	03.2119-3389.3	010057	THz 19,05
03.6742-0101.4	03.2120-2598.3	010116	THz 20,64
03.6742-0102.4	03.2120-2598.3	010116	THz 20,64
03.6742-0103.4	03.2120-2598.3	010116	THz 20,64
03.6742-0104.4	03.2120-2598.3	010116	THz 20,64
03.6742-0105.4	03.2120-2598.3	010116	THz 20,64
03.6742-0106.4	03.2120-2598.3	010116	THz 20,64
03.6742-0107.4	03.2120-2598.3	010116	THz 20,64
03.6742-0108.4	03.2120-2598.3	010116	THz 20,64
03.6742-0109.4	03.2120-2598.3	010116	THz 20,64
03.6742-0110.4	03.2120-2598.3	010116	THz 20,64
03.6742-0111.4	03.2120-2598.3	010116	THz 20,64
03.6742-0112.4	03.2120-2598.3	010116	THz 20,64
03.6742-0113.4	03.2120-2598.3	010116	THz 20,64
03.6742-0114.4	03.2120-2598.3	010116	THz 20,64
03.6742-0115.4	03.2120-2598.3	010116	THz 20,64
03.6742-0116.4	03.2120-2598.3	010116	THz 20,64
03.6742-0117.4	03.2120-2598.3	010116	THz 20,64
03.6742-0118.4	03.2120-2598.3	010116	THz 20,64
03.6742-0119.4	03.2120-2597.3	010115	THz 20,64
03.6742-0120.4	03.2120-2597.3	010115	THz 20,64
03.6742-0121.4	03.2120-2597.3	010115	THz 20,64
03.6742-0122.4	03.2120-2597.3	010115	THz 20,64
03.6742-0123.4	03.2120-2597.3	010115	THz 20,64
03.6742-0124.4	03.2120-2597.3	010115	THz 20,64
03.6742-0201.4	03.2123-4911.3	010182	THz 23,81
03.6742-0202.4	03.2120-0538.3	010077	THz 20,64
03.6742-0203.4	03.2120-2598.3	010116	THz 20,64
03.6742-0204.4	03.2120-2598.3	010116	THz 20,64
03.6742-0301.4	03.2120-2598.3	010116	THz 20,64

03.6742-0302.4	03.2120-2598.3	010116	THz 20,64
03.6742-0401.4	03.2120-2598.3	010116	THz 20,64
03.6742-0402.4	03.2120-2598.3	010116	THz 20,64
03.6742-0404.4	03.2120-2598.3	010116	THz 20,64
03.6742-0406.4	03.2120-2598.3	010116	THz 20,64
03.6742-0407.4	03.2120-2598.3	010116	THz 20,64
03.6742-0409.4	03.2120-2597.3	010115	THz 20,64
03.6742-0410.4	03.2120-2597.3	010115	THz 20,64
03.6742-0411.4	03.2120-2597.3	010115	THz 20,64
03.6742-0412.4	03.2120-2597.3	010115	THz 20,64
03.6742-0413.4	03.2120-2597.3	010115	THz 20,64
03.6742-0414.4	03.2120-2597.3	010115	THz 20,64
03.6742-0415.4	03.2120-2597.3	010115	THz 20,64
03.6742-0416.4	03.2120-2597.3	010115	THz 20,64
03.6742-0419.4	03.2120-2597.3	010115	THz 20,64
03.6742-0420.4	03.2120-2597.3	010115	THz 20,64
03.6742-0421.4	03.2120-2597.3	010115	THz 20,64
03.6742-0422.4	03.2120-2597.3	010115	THz 20,64
03.6742-0423.4	03.2120-2597.3	010115	THz 20,64
03.6742-0601.4	03.2122-0142.3 03.3558-0676.3	010128 310077	THz 22,20 Behälter + WE
03.6742-0701.4	03.2119-3389.3	010057	THz 19,05
03.6742-1201.4	03.2119-3389.3	010057	THz 19,05
03.6742-1501.4	03.2120-2031.3	010106	THz 20,64
03.6742-1701.4	03.2120-2031.3	010106	THz 20,64
03.6742-1801.4	03.2119-3391.3	010058	THz 19,05
03.6742-2001.4	03.2120-1897.3	010103	THz 20,64
03.6752-0201.4	03.2120-2031.3 03.6750-0202.4	010106 300033	THz 20,64 9"
03.6752-0302.4	03.2120-2031.3	010106	THz 20,64
03.6752-0305.4	03.2120-2331.3	010110	THz 20,64
03.6752-0306.4	03.2120-2031.3	010106	THz 20,64

Bremsgeräte komplett

**Booster units complete - Servofreni completi -
Servo-freins complets - Servofreno completo**

● Die Nr. befindet sich auf dem im Fahrzeug eingebautem Aggregat.
the number is on the unit build in the car
il numero si trova sull'aggregato montato nella macchina
le numéro se trouve sur la pièce montée dans le véhicule
el n° se encuentra en el equipo montado en el vehículo



03.6752-0501.4	03.2120-2598.3	010116	THz 20,64
03.6752-0502.4	03.2120-2598.3	010116	THz 20,64
03.6752-0505.4	03.2120-2597.3	010115	THz 20,64
03.6752-0506.4	03.2120-2597.3	010115	THz 20,64
03.6752-0507.4	03.2120-2597.3	010115	THz 20,64
03.6752-0508.4	03.2120-2597.3	010115	THz 20,64
03.6752-0801.4	03.2122-9812.3	010161	THz 22,20
03.6752-0902.4	03.2120-2331.3	010110	THz 20,64
	03.7750-0302.4	300071	9"
03.6752-0903.4	03.7750-0302.4	300071	9"
03.6752-1002.4	03.2120-2682.3	010118	THz 20,64
03.6752-1101.4	03.2120-2331.3	010110	THz 20,64
03.6752-1102.4	03.2122-9612.3	010159	THz 22,20
03.6752-1201.4	03.2120-2331.3	010110	THz 20,64
03.6752-1301.4	03.2126-0512.3	010217	THz 26,99
03.6752-1401.4	03.2120-2331.3	010110	THz 20,64
03.6752-1607.4	03.2120-2597.3	010115	THz 20,64
03.6752-1608.4	03.2120-2597.3	010115	THz 20,64
03.6752-1609.4	03.2120-2597.3	010115	THz 20,64
03.6752-1610.4	03.2120-2597.3	010115	THz 20,64
03.6752-1611.4	03.2120-2597.3	010115	THz 20,64
03.6752-1703.4	03.2120-2597.3	010115	THz 20,64
03.6752-1704.4	03.2120-2597.3	010115	THz 20,64
03.6752-1901.4	03.2120-2031.3	010106	THz 20,64
03.6752-2101.4	03.2120-2682.3	010118	THz 20,64
03.6752-2502.4	03.2122-9631.3	010160	THz 22,20
03.6752-2601.4	03.2122-9631.3	010160	THz 22,20
03.6752-2901.4	03.6750-2902.4	300037	9"
03.6752-2902.4	03.2122-9631.3	010160	THz 22,20
	03.6750-2902.4	300037	9"
03.6752-2903.4	03.2120-2682.3	010118	THz 20,64
	03.6750-2902.4	300037	9"

03.6752-3103.4	03.2120-2682.3	010118	THz 20,64
03.6752-3201.4	03.2120-2031.3	010106	THz 20,64
03.6752-3501.4	03.2120-2682.3	010118	THz 20,64
03.6752-3601.4	03.2120-2682.3	010118	THz 20,64
03.6752-3701.4	03.2122-0626.3	010539	THz 22,20
03.6752-3702.4	03.2122-9631.3	010160	THz 22,20
03.6757-1004.4	03.2023-0166.3	010015	THz 23,81/19,05
	03.6855-1202.4	300056	9" Tandem
03.6762-0101.4	03.2123-8311.3	010192	THz 23,81
	03.7760-0902.4	300088	10"
03.6762-0102.4	03.2122-6911.3	010153	THz 22,20
	03.7760-0902.4	300088	10"
03.6762-0103.4	03.2122-6911.3	010153	THz 22,20
	03.7760-0902.4	300088	10"
03.6762-0104.4	03.7760-0902.4	300088	10"
03.6762-0105.4	03.2020-0402.3	010001	THz 20,64/19,05
	03.7760-0902.4	300088	10"
03.6762-0106.4	03.2123-8311.3	010192	THz 23,81
	03.7760-0902.4	300088	10"
03.6762-0107.4	03.7760-0902.4	300088	10"
03.6762-0108.4	03.2120-2082.3	010107	THz 20,64
	03.7760-0902.4	300088	10"
03.6762-0110.4	03.2120-1802.3	010099	THz 20,64
	03.7760-0902.4	300088	10"
03.6762-0111.4	03.2020-0402.3	010001	THz 20,64/19,05
	03.7760-0902.4	300088	10"
03.6762-0112.4	03.2120-1802.3	010099	THz 20,64
	03.7760-0902.4	300088	10"
03.6762-0114.4	03.2020-0402.3	010001	THz 20,64/19,05
	03.7760-0902.4	300088	10"
03.6762-0115.4	03.2120-2082.3	010107	THz 20,64
	03.7760-0902.4	300088	10"
03.6762-0116.4	03.2123-8311.3	010192	THz 23,81
	03.7760-0902.4	300088	10"
03.6762-0117.4	03.7760-0902.4	300088	10"
03.6762-0118.4	03.2123-8311.3	010192	THz 23,81
	03.7760-0902.4	300088	10"
03.6762-0312.4	03.7760-2702.4	300090	10"



Bremsgeräte komplett

Booster units complete - Servofreni completi - Servo-freins complets - Servofreno completo

● Die Nr. befindet sich auf dem im Fahrzeug eingebautem Aggregat.
the number is on the unit build in the car
il numero si trova sull'aggregato montato nella macchina
le numéro se trouve sur la pièce montée dans le véhicule
el n° se encuentra en el equipo montado en el vehículo



03.6762-0401.4	03.2023-0825.3 03.7760-2702.4	010028 300090	THz 23,81/19,05 10"	03.6842-0301.4	03.2120-0622.3	010079	THz 20,64
03.6762-0402.4	03.2023-0825.3 03.7760-2702.4	010028 300090	THz 23,81/19,05 10"	03.6842-0601.4	03.2120-0538.3	010077	THz 20,64
03.6762-0501.4	03.2022-0702.3	010007	THz 22,20/19,05	03.6842-0701.4	03.2120-0538.3	010077	THz 20,64
03.6762-0502.4	03.2022-0702.3	010007	THz 22,20/19,05	03.6842-0702.4	03.2120-0538.3	010077	THz 20,64
03.6762-0503.4	03.2022-0702.3	010007	THz 22,20/19,05	03.6842-0703.4	03.2123-4911.3	010182	THz 23,81
03.6762-0504.4	03.2022-1402.3	010010	THz 22,20/19,05	03.6842-0704.4	03.2120-0538.3	010077	THz 20,64
03.6762-0505.4	03.2022-1402.3	010010	THz 22,20/19,05	03.6842-1001.4	03.2123-0162.3	010162	THz 23,81 + WE
03.6762-0508.4	03.2022-1602.3	010011	THz 22,20/19,05	03.6842-1002.4	03.2120-2462.3	010113	THz 20,64 + WE
03.6762-0509.4	03.2022-1602.3	010011	THz 22,20/19,05	03.6842-1003.4	03.2123-0162.3	010162	THz 23,81 + WE
03.6762-0519.4	03.2022-1402.3	010010	THz 22,20/19,05	03.6842-1401.4	03.2120-0151.3	010071	THz 20,64
03.6762-0520.4	03.2022-1602.3	010011	THz 22,20/19,05	03.6842-1605.4	03.2120-2598.3	010116	THz 20,64
03.6762-0522.4	03.2022-0702.3	010007	THz 22,20/19,05	03.6842-1606.4	03.2120-2598.3	010116	THz 20,64
03.6762-0523.4	03.2022-1402.3	010010	THz 22,20/19,05	03.6842-1607.4	03.2120-2598.3	010116	THz 20,64
03.6762-0525.4	03.2022-1602.3	010011	THz 22,20/19,05	03.6842-1608.4	03.2120-2598.3	010116	THz 20,64
03.6762-0601.4	03.2020-0402.3 03.7760-0902.4	010001 300088	THz 20,64/19,05 10"	03.6842-1609.4	03.2120-2598.3	010116	THz 20,64
03.6762-0602.4	03.2120-1802.3 03.7760-0902.4	010099 300088	THz 20,64 10"	03.6842-1610.4	03.2120-2598.3	010116	THz 20,64
03.6832-0101.4	03.2120-3412.3	010121	THz 20,64	03.6842-1611.4	03.2120-2598.3	010116	THz 20,64
03.6832-0104.4	03.6058-0501.3	320074	BR 25/5 (4)	03.6842-1612.4	03.2120-2598.3	010116	THz 20,64
03.6832-0201.4	03.2120-1531.3	010092	THz 20,64	03.6842-1613.4	03.2120-2598.3	010116	THz 20,64
03.6832-0202.4	03.2120-1531.3	010092	THz 20,64	03.6842-1614.4	03.2120-2598.3	010116	THz 20,64
03.6832-0601.4	03.2120-0322.3	010074	THz 20,64 + WE	03.6842-3401.4	03.2123-0162.3	010162	THz 23,81 + WE
03.6832-0701.4	03.2120-2462.3	010113	THz 20,64 + WE	03.6852-0201.4	03.2123-1003.3 03.3508-8753.3 03.6850-0202.4	010175 310049 300043	THz 23,81 Behälter + WE 9"
03.6832-1001.4	03.2120-2462.3	010113	THz 20,64 + WE	03.6852-0202.4	03.2123-3402.3 03.3508-8753.3 03.6850-0202.4	010181 310049 300043	THz 23,81 Behälter + WE 9"
03.6832-1102.4	03.2120-0148.3	010070	THz 20,64 + Behälter	03.6852-0203.4	03.2123-1003.3 03.3508-8753.3 03.6850-0202.4	010175 310049 300043	THz 23,81 Behälter + WE 9"
03.6832-1301.4	03.2120-0151.3	010071	THz 20,64	03.6852-0204.4	03.2023-0112.3 03.6850-0202.4	010013 300043	THz 23,81/19,05 9"
03.6832-1505.4	03.2120-1531.3	010092	THz 20,64	03.6852-0205.4	03.2023-0166.3 03.6850-0202.4	010015 300043	THz 23,81/19,05 9"
03.6832-1704.4	03.2120-1531.3	010092	THz 20,64				
03.6832-1705.4	03.2120-1531.3	010092	THz 20,64				
03.6832-1706.4	03.2120-1531.3	010092	THz 20,64				

Bremsgeräte komplett

**Booster units complete - Servofreni completi -
Servo-freins complets - Servofreno completo**

● Die Nr. befindet sich auf dem im Fahrzeug eingebautem Aggregat.
the number is on the unit build in the car
il numero si trova sull'aggregato montato nella macchina
le numéro se trouve sur la pièce montée dans le véhicule
el n° se encuentra en el equipo montado en el vehículo



03.6852-0207.4	03.2023-0166.3 03.6850-0202.4	010015 300043	THz 23,81/19,05 9"
03.6852-0210.4	03.2023-0166.3 03.6850-0202.4	010015 300043	THz 23,81/19,05 9"
03.6852-0211.4	03.2023-0166.3 03.6850-0202.4	010015 300043	THz 23,81/19,05 9"
03.6852-0501.4	03.2123-2604.3 03.6850-0502.4	010178 300044	THz 23,81 + WE 9"
03.6852-0503.4	03.2123-2604.3 03.6850-0502.4	010178 300044	THz 23,81 + WE 9"
03.6852-1001.4	03.2123-5212.3 03.6850-5402.4	010183 300055	THz 23,81 9"
03.6852-1002.4	03.2123-5212.3 03.6850-5402.4	010183 300055	THz 23,81 9"
03.6852-1006.4	03.2123-0271.3 03.6850-5402.4	010164 300055	THz 23,81 + WE 9"
03.6852-1007.4	03.2123-0271.3 03.6850-5402.4	010164 300055	THz 23,81 + WE 9"
03.6852-1008.4	03.2123-0291.3 03.6850-5402.4	010165 300055	THz 23,81 9"
03.6852-1009.4	03.2123-0291.3 03.6850-5402.4	010165 300055	THz 23,81 9"
03.6852-1012.4	03.2123-0271.3 03.6850-5402.4	010164 300055	THz 23,81 + WE 9"
03.6852-1013.4	03.2123-0271.3 03.6850-5402.4	010164 300055	THz 23,81 + WE 9"
03.6852-1014.4	03.6850-5402.4	300055	9"
03.6852-1015.4	03.6850-5402.4	300055	9"
03.6852-1301.4	03.2123-6802.3	010186	THz 23,81
03.6852-1302.4	03.2123-6802.3	010186	THz 23,81
03.6852-1303.4	03.2123-6802.3	010186	THz 23,81
03.6852-1304.4	03.2122-6202.3	010148	THz 22,20
03.6852-1601.4	03.2123-6002.3 03.6850-2602.4	010184 300049	THz 23,81 9"
03.6852-1701.4	03.2123-9002.3	010198	THz 23,81 + WE
03.6852-1702.4	03.2123-9002.3	010198	THz 23,81 + WE
03.6852-1902.4	03.2123-4911.3	010182	THz 23,81
03.6852-1903.4	03.2123-6207.3	010185	THz 23,81

03.6852-2001.4	03.2123-6002.3 03.6850-2602.4	010184 300049	THz 23,81 9"
03.6852-2101.4	03.2120-0562.3	010078	THz 20,64
03.6852-2201.4	03.2123-4911.3	010182	THz 23,81
03.6852-2202.4	03.2123-6207.3	010185	THz 23,81
03.6852-2205.4	03.2120-0538.3	010077	THz 20,64
03.6852-2307.4	03.2120-1491.3	010089	THz 20,64 + WE
03.6852-2401.4	03.2120-0622.3	010079	THz 20,64
03.6852-2402.4	03.2120-0622.3	010079	THz 20,64
03.6852-2405.4	03.2120-0622.3	010079	THz 20,64
03.6852-3801.4	03.2120-1142.3	010085	THz 20,64
03.6852-4403.4	03.2122-8806.3	010157	THz 22,20
03.6852-4404.4	03.2122-8806.3	010157	THz 22,20
03.6852-4405.4	03.2122-8806.3	010157	THz 22,20
03.6852-4406.4	03.2122-8806.3	010157	THz 22,20
03.6852-4407.4	03.2122-8806.3	010157	THz 22,20
03.6852-4408.4	03.2122-8806.3	010157	THz 22,20
03.6852-4409.4	03.2122-8806.3	010157	THz 22,20
03.6852-4603.4	03.2123-7902.3 03.7750-5702.4	010191 300083	THz 23,81 + WE 9"
03.6852-4604.4	03.2123-8902.3 03.7750-5702.4	010197 300083	THz 23,81 9"
03.6852-4605.4	03.2023-0172.3 03.7750-5702.4	010016 300083	THz 23,81/19,05 9"
03.6852-4606.4	03.2023-0172.3 03.7750-5702.4	010016 300083	THz 23,81/19,05 9"
03.6852-4702.4	03.2123-7902.3	010191	THz 23,81 + WE
03.6852-4703.4	03.2123-8902.3	010197	THz 23,81
03.6852-5002.4	03.2120-1491.3	010089	THz 20,64 + WE
03.6852-5003.4	03.2120-1531.3	010092	THz 20,64
03.6852-5401.4	03.2123-5212.3 03.6850-5402.4	010183 300055	THz 23,81 9"
03.6852-5402.4	03.2123-5212.3 03.6850-5402.4	010183 300055	THz 23,81 9"



Bremsgeräte komplett

Booster units complete - Servofreni completi - Servo-freins complets - Servofreno completo

● Die Nr. befindet sich auf dem im Fahrzeug eingebautem Aggregat.
the number is on the unit build in the car
il numero si trova sull'aggregato montato nella macchina
le numéro se trouve sur la pièce montée dans le véhicule
el n° se encuentra en el equipo montado en el vehículo



03.6852-5403.4	03.2123-5212.3 03.6850-5402.4	010183 300055	THz 23,81 9"	03.6857-1204.4	03.2025-0111.3 03.6855-1202.4	010033 300056	THz 25,40/19,05 9" Tandem
03.6852-5404.4	03.2123-5212.3 03.6850-5402.4	010183 300055	THz 23,81 9"	03.6857-1205.4	03.2025-0111.3 03.6855-1202.4	010033 300056	THz 25,40/19,05 9" Tandem
03.6852-5902.4	03.2122-8012.3	010156	THz 22,20	03.6857-1401.4	03.2126-0512.3 03.6855-1402.4	010217 300057	THz 26,99 9" Tandem
03.6852-6202.4	03.2122-8012.3 03.6058-0301.3	010156 320072	THz 22,20 BR 25/5 (3)	03.6857-1402.4	03.2125-1902.3 03.6855-1402.4	010206 300057	THz 25,40 9" Tandem
03.6857-0101.4	03.2023-0166.3 03.6855-1202.4	010015 300056	THz 23,81/19,05 9" Tandem	03.6857-1403.4	03.2125-1902.3 03.6855-1402.4	010206 300057	THz 25,40 9" Tandem
03.6857-0102.4	03.2023-0112.3	010013	THz 23,81/19,05	03.6857-1404.4	03.2125-2102.3 03.6855-1402.4	010207 300057	THz 25,40 9" Tandem
03.6857-0104.4	03.2023-0112.3 03.6855-1202.4	010013 300056	THz 23,81/19,05 9" Tandem	03.6857-1405.4	03.6855-1402.4	300057	9" Tandem
03.6857-0105.4	03.2023-0166.3 03.6855-1202.4	010015 300056	THz 23,81/19,05 9" Tandem	03.6857-1406.4	03.6855-1402.4	300057	9" Tandem
03.6857-0108.4	03.2023-0166.3 03.6855-1202.4	010015 300056	THz 23,81/19,05 9" Tandem	03.6857-1407.4	03.6855-1402.4	300057	9" Tandem
03.6857-0303.4	03.2023-0166.3 03.6855-1202.4	010015 300056	THz 23,81/19,05 9" Tandem	03.6857-1408.4	03.6855-1402.4	300057	9" Tandem
03.6857-0304.4	03.2023-0166.3 03.6855-1202.4	010015 300056	THz 23,81/19,05 9" Tandem	03.6857-1409.4	03.6855-1402.4	300057	9" Tandem
03.6857-0501.4	03.2125-1712.3	010204	THz 25,40	03.6857-1410.4	03.6855-1402.4	300057	9" Tandem
03.6857-0502.4	03.2125-1712.3	010204	THz 25,40	03.6857-1411.4	03.6855-1402.4	300057	9" Tandem
03.6857-0503.4	03.2125-1712.3	010204	THz 25,40	03.6857-1413.4	03.6855-1402.4	300057	9" Tandem
03.6857-0504.4	03.2125-1712.3	010204	THz 25,40	03.6857-1416.4	03.6855-1402.4	300057	9" Tandem
03.6857-1001.4	03.2023-0166.3 03.6855-1202.4	010015 300056	THz 23,81/19,05 9" Tandem	03.6857-1417.4	03.6855-1402.4	300057	9" Tandem
03.6857-1002.4	03.2023-0166.3 03.6855-1202.4	010015 300056	THz 23,81/19,05 9" Tandem	03.6857-1420.4	03.6855-1402.4	300057	9" Tandem
03.6857-1003.4	03.2023-0166.3 03.6855-1202.4	010015 300056	THz 23,81/19,05 9" Tandem	03.6857-1421.4	03.6855-1402.4	300057	9" Tandem
03.6857-1106.4	03.2123-8512.3	010194	THz 23,81	03.6857-1422.4	03.6855-1402.4	300057	9" Tandem
03.6857-1201.4	03.2023-0166.3 03.6855-1202.4	010015 300056	THz 23,81/19,05 9" Tandem	03.6857-1423.4	03.6855-1402.4	300057	9" Tandem
03.6857-1202.4	03.2023-0166.3 03.6855-1202.4	010015 300056	THz 23,81/19,05 9" Tandem	03.6857-1424.4	03.6855-1402.4	300057	9" Tandem
03.6857-1203.4	03.2025-0111.3 03.6855-1202.4	010033 300056	THz 25,40/19,05 9" Tandem	03.6857-1425.4	03.6855-1402.4	300057	9" Tandem
				03.6857-1426.4	03.6855-1402.4	300057	9" Tandem
				03.6857-1501.4	03.2125-1712.3	010204	THz 25,40
				03.6857-1502.4	03.2125-1712.3	010204	THz 25,40
				03.6857-1503.4	03.2125-1712.3	010204	THz 25,40
				03.6857-1504.4	03.2125-1712.3	010204	THz 25,40

Bremsgeräte komplett

**Booster units complete - Servofreni completi -
Servo-freins complets - Servofreno completo**

● Die Nr. befindet sich auf dem im Fahrzeug eingebautem Aggregat.
the number is on the unit build in the car
il numero si trova sull'aggregato montato nella macchina
le numéro se trouve sur la pièce montée dans le véhicule
el n° se encuentra en el equipo montado en el vehículo



03.6857-1701.4	03.2123-6002.3 03.3558-0676.3	010184 310077	THz 23,81 Behälter + WE
03.6857-1801.4	03.2125-3801.3	010215	THz 25,40
03.6857-1901.4	03.6855-1902.4	300059	9" Tandem
03.6857-1902.4	03.6855-1902.4	300059	9" Tandem
03.6857-1905.4	03.6855-1902.4	300059	9" Tandem
03.6857-1906.4	03.2125-1902.3 03.6855-1902.4	010206 300059	THz 25,40 9" Tandem
03.6857-1907.4	03.6855-1902.4	300059	9" Tandem
03.6857-1910.4	03.6855-1902.4	300059	9" Tandem
03.6857-1911.4	03.6855-1902.4	300059	9" Tandem
03.6857-1912.4	03.6855-1902.4	300059	9" Tandem
03.6857-1913.4	03.2125-2102.3 03.6855-1902.4	010207 300059	THz 25,40 9" Tandem
03.6857-2101.4	03.2130-0102.3 03.6855-2202.4	010221 300061	THz 30,00 9" Tandem
03.6857-2103.4	03.2123-0522.3 03.6855-2202.4	010168 300061	THz 23,81 9" Tandem
03.6857-2201.4	03.2130-0102.3 03.6855-2202.4	010221 300061	THz 30,00 9" Tandem
03.6857-2202.4	03.2123-0522.3 03.6855-2202.4	010168 300061	THz 23,81 9" Tandem
03.6857-2203.4	03.6855-2202.4	300061	9" Tandem
03.6857-2204.4	03.6855-2202.4	300061	9" Tandem
03.6857-2205.4	03.2128-1203.3 03.6855-2202.4	010922 300061	THz 28,57 9" Tandem
03.6857-2301.4	03.2123-8512.3	010194	THz 23,81
03.6857-2401.4	03.2125-3801.3	010215	THz 25,40
03.6857-2402.4	03.2125-3701.3	010627	THz 25,40
03.6862.0904.4	03.7760-0902.4	300088	10"
03.6862-0201.4	03.2023-0166.3	010015	THz 23,81/19,05
03.6862-0202.4	03.2023-0166.3	010015	THz 23,81/19,05
03.6862-0203.4	03.2023-0166.3	010015	THz 23,81/19,05
03.6862-0204.4	03.2023-0166.3	010015	THz 23,81/19,05
03.6862-0301.4	03.2123-9002.3	010198	THz 23,81 + WE

03.6862-0501.4	03.2123-4911.3	010182	THz 23,81
03.6862-0502.4	03.2123-4911.3	010182	THz 23,81
03.6862-0505.4	03.2123-4911.3	010182	THz 23,81
03.6862-0506.4	03.2123-6207.3	010185	THz 23,81
03.6862-0507.4	03.2123-4911.3	010182	THz 23,81
03.6862-0508.4	03.2123-4911.3	010182	THz 23,81
03.6862-0801.4	03.2123-9002.3 03.7760-0402.4	010198 300087	THz 23,81 + WE 10"
03.6862-0802.4	03.2023-0183.3 03.7760-0402.4	010017 300087	THz 23,81/19,05 10"
03.6862-0803.4	03.7760-0402.4	300087	10"
03.6862-0901.4	03.2122-6911.3 03.7760-0902.4	010153 300088	THz 22,20 10"
03.6862-0902.4	03.2122-6911.3 03.7760-0902.4	010153 300088	THz 22,20 10"
03.6862-0903.4	03.2123-8311.3 03.7760-0902.4	010192 300088	THz 23,81 10"
03.6862-1101.4	03.2125-3801.3	010215	THz 25,40
03.6862-1105.4	03.2125-3801.3	010215	THz 25,40
03.6862-1201.4	03.2023-0262.3	010020	THz 23,81/20,64
03.6862-1303.4	03.2125-7002.3	010628	THz 25,40
03.6952-0201.4	03.2122-8012.3	010156	THz 22,20
03.6952-0202.4	03.2122-8012.3 03.6058-0301.3	010156 320072	THz 22,20 BR 25/5 (3)
03.6952-0301.4	03.2023-0172.3 03.7750-5702.4	010016 300083	THz 23,81/19,05 9"
03.6952-0302.4	03.2023-0172.3 03.7750-5702.4	010016 300083	THz 23,81/19,05 9"
03.6952-0401.4	03.2122-9612.3 03.7750-0302.4	010159 300071	THz 22,20 9"
03.6952-0501.4	03.2122-9612.3 03.7750-0302.4	010159 300071	THz 22,20 9"
03.6952-0601.4	03.2122-9612.3 03.7750-0302.4	010159 300071	THz 22,20 9"
03.6952-0701.4	03.2122-9612.3 03.7750-0302.4	010159 300071	THz 22,20 9"
03.7732-0201.4	03.2120-2031.3	010106	THz 20,64



Bremsgeräte komplett

Booster units complete - Servofreni completi -
Servo-freins complets - Servofreno completo

● Die Nr. befindet sich auf dem im Fahrzeug eingebautem Aggregat.
the number is on the unit build in the car
il numero si trova sull'aggregato montato nella macchina
le numéro se trouve sur la pièce montée dans le véhicule
el n° se encuentra en el equipo montado en el vehículo



03.7732-0401.4	03.2120-2031.3	010106	THz 20,64
03.7742-0801.4	03.2120-2031.3	010106	THz 20,64
03.7742-0901.4	03.2120-2031.3	010106	THz 20,64
03.7742-1402.4	03.7740-1402.4	300133	8"
03.7742-1403.4	03.7740-1402.4	300133	8"
03.7742-1404.4	03.2120-3943.3 03.7740-1402.4	010532 300133	THz 20,64 8"
03.7742-1405.4	03.7740-1402.4	300133	8"
03.7742-2001.4	03.2120-2031.3	010106	THz 20,64
03.7742-2101.4	03.2120-2031.3	010106	THz 20,64
03.7742-2501.4	03.2119-3391.3	010058	THz 19,05
03.7742-2601.4	03.2120-1897.3	010103	THz 20,64
03.7742-3301.4	03.2120-4166.3 03.7740-3302.4	010452 300107	THz 20,64 8"
03.7742-3501.4	03.2120-4166.3	010452	THz 20,64
03.7742-3601.4	03.2120-4166.3	010452	THz 20,64
03.7742-3701.4	03.2120-4166.3	010452	THz 20,64
03.7742-3802.4	03.2122-1184.3	010592	THz 22,20
03.7742-3806.4	03.2122-1184.3	010592	THz 22,20
03.7742-3808.4	03.2122-1184.3	010592	THz 22,20
03.7742-3901.4	03.2120-4241.3	010524	THz 20,64
03.7742-3902.4	03.2120-4246.3	010614	THz 20,64
03.7742-4001.4	03.2120-4221.3	010605	THz 20,64
03.7742-4401.4	03.2123-1484.3	010595	THz 23,81
03.7742-4402.4	03.2123-1484.3	010595	THz 23,81
03.7742-4601.4	03.2120-4321.3	010525	THz 20,64
03.7742-5401.4	03.2120-4321.3	010525	THz 20,64
03.7747-0601.4	03.2123-0921.3	010174	THz 23,81 (MKIV)
03.7747-0701.4	03.2123-0921.3	010174	THz 23,81 (MKIV)
03.7747-1301.4	03.2123-0921.3	010174	THz 23,81 (MKIV)
03.7747-1401.4	03.2123-0921.3	010174	THz 23,81 (MKIV)

03.7747-1501.4	03.2123-1622.3 03.7745-3003.4	010470 300157	THz 23,81 8/7" Tandem
03.7747-1502.4	03.2125-7402.3 03.7745-3003.4	010541 300157	THz 25,40 8/7" Tandem
03.7747-1503.4	03.2125-7402.3 03.7745-3003.4	010541 300157	THz 25,40 8/7" Tandem
03.7747-1602.4	03.2125-7502.3	010616	THz 25,40
03.7747-1603.4	03.2125-7502.3	010616	THz 25,40
03.7747-1604.4	03.2125-7502.3	010616	THz 25,40
03.7747-1631.4	03.7745-1632.4	300293	8/7" Tandem
03.7747-1831.4	03.7745-1832.4	300294	8/7" Tandem
03.7747-3201.4	03.2123-2221.3	010861	THz 23,81
03.7747-3401.4	03.2123-2221.3	010861	THz 23,81
03.7747-3601.4	03.2123-2774.3	010803	THz 23,81
03.7747-3602.4	03.2123-2774.3	010803	THz 23,81
03.7747-3605.4	03.2123-2774.3	010803	THz 23,81
03.7747-3901.4	03.2125-9901.3 03.7745-3902.4	010634 300129	THz 25,40 8/7" Tandem
03.7747-3902.4	03.2125-9901.3	010634	THz 25,40
03.7747-3903.4	03.2125-9911.3 03.7745-3902.4	010883 300129	THz 25,40 8/7" Tandem
03.7747-4301.4	03.2123-2221.3	010861	THz 23,81
03.7747-4401.4	03.2123-2221.3 03.7745-4402.4	010861 300295	THz 23,81 8/7" Tandem
03.7747-4402.4	03.7745-4402.4	300295	8/7" Tandem
03.7747-4600.4	03.2125-9901.3	010634	THz 25,40
03.7747-5802.4	03.2025-2301.3	010895	THz 25,40/22,20
03.7747-6301.4	03.2025-2301.3 03.7745-6302.4	010895 300261	THz 25,40/22,20 8"
03.7747-6302.4	03.7745-6302.4	300261	8"
03.7747-6501.4	03.7745-6502.4	300296	8"
03.7747-6502.4	03.7745-6502.4	300296	8"
03.7747-6503.4	03.7745-6502.4	300296	8"
03.7747-6504.4	03.7745-6502.4	300296	8"

Bremsgeräte komplett

**Booster units complete - Servofreni completi -
Servo-freins complets - Servofreno completo**

● Die Nr. befindet sich auf dem im Fahrzeug eingebautem Aggregat.
the number is on the unit build in the car
il numero si trova sull'aggregato montato nella macchina
le numéro se trouve sur la pièce montée dans le véhicule
el n° se encuentra en el equipo montado en el vehículo



03.7747-7101.4	03.2025-2301.3	010895	THz 25,40/22,20
03.7747-8501.4	03.4156-0073.3	010942	THz 26,99
03.7747-8901.4	03.2025-2301.3 03.7745-8902.4	010895 300297	THz 25,40/22,20 8"
03.7747-8902.4	03.2025-2301.3 03.7745-8902.4	010895 300297	THz 25,40/22,20 8"
03.7747-8903.4	03.7745-8902.4	300297	8"
03.7747-8904.4	03.7745-8902.4	300297	8"
03.7750-2333.4	03.2122-1588.3 03.7750-2332.4	010733 300113	THz 22,20 9"
03.7752-0101.4	03.2022-0602.3	010006	THz 22,20/19,05
03.7752-0102.4	03.2022-0602.3	010006	THz 22,20/19,05
03.7752-0104.4	03.2022-0602.3	010006	THz 22,20/19,05
03.7752-0132.4	03.2122-1421.3	010615	THz 22,20
03.7752-0201.4	03.2122-9612.3 03.7750-0302.4	010159 300071	THz 22,20 9"
03.7752-0204.4	03.2122-9612.3 03.7750-0302.4	010159 300071	THz 22,20 9"
03.7752-0232.4	03.2122-1461.3	010610	THz 22,20
03.7752-0241.4	03.4153-5287.4	010953	THz 23,81 + Behälter
03.7752-0302.4	03.2122-9612.3 03.7750-0302.4	010159 300071	THz 22,20 9"
03.7752-0341.4	03.2120-4611.3 03.2125-0493.3 03.2126-3144.3	010937 010940 010941	THz 20,64 THz 25,40 THz 26,99
03.7752-0342.4	03.2122-2031.3	010938	THz 22,20
03.7752-0401.4	03.2023-0562.3 03.7750-0302.4	010025 300071	THz 23,81/20,64 9"
03.7752-0402.4	03.2023-0542.3 03.7750-0302.4	010024 300071	THz 23,81/20,64 9"
03.7752-0404.4	03.7750-5702.4	300083	9"
03.7752-0405.4	03.2023-0542.3 03.7750-5702.4	010024 300083	THz 23,81/20,64 9"
03.7752-0442.4	03.2122-2031.3	010938	THz 22,20
03.7752-0443.4	03.2120-4611.3 03.2125-0493.3 03.2126-3144.3	010937 010940 010941	THz 20,64 THz 25,40 THz 26,99

03.7752-0501.4	03.2122-9612.3 03.7750-0302.4	010159 300071	THz 22,20 9"
03.7752-0532.4	03.2120-4321.3 03.7750-0532.4	010525 300110	THz 20,64 9"
03.7752-0541.4	03.2120-4611.3 03.2125-0493.3 03.2126-3144.3	010937 010940 010941	THz 20,64 THz 25,40 THz 26,99
03.7752-0707.4	03.2122-0264.3	010129	THz 22,20
03.7752-0708.4	03.2122-0264.3	010129	THz 22,20
03.7752-0709.4	03.2122-0264.3	010129	THz 22,20
03.7752-0710.4	03.2122-0282.3	010130	THz 22,20
03.7752-0713.4	03.2122-0264.3	010129	THz 22,20
03.7752-0714.4	03.2122-0264.3	010129	THz 22,20
03.7752-0715.4	03.2122-0264.3	010129	THz 22,20
03.7752-0716.4	03.2122-0264.3	010129	THz 22,20
03.7752-0717.4	03.2122-0264.3	010129	THz 22,20
03.7752-0718.4	03.2122-0264.3	010129	THz 22,20
03.7752-0722.4	03.2122-0264.3	010129	THz 22,20
03.7752-0723.4	03.2123-1121.3	010176	THz 23,81
03.7752-0808.4	03.2122-0264.3	010129	THz 22,20
03.7752-0809.4	03.2122-0264.3	010129	THz 22,20
03.7752-0810.4	03.2122-0282.3	010130	THz 22,20
03.7752-0813.4	03.2122-0264.3	010129	THz 22,20
03.7752-0814.4	03.2122-0264.3	010129	THz 22,20
03.7752-0815.4	03.2122-0264.3	010129	THz 22,20
03.7752-0816.4	03.2122-0264.3	010129	THz 22,20
03.7752-0819.4	03.2122-0264.3	010129	THz 22,20
03.7752-0820.4	03.2123-1121.3	010176	THz 23,81
03.7752-0831.4	03.2122-1691.3	010918	THz 22,20
03.7752-0901.4	03.2122-1042.3 03.7750-4302.4	010137 300076	THz 22,20 9"
03.7752-0902.4	03.2120-3943.3 03.7750-4302.4	010532 300076	THz 20,64 9"
03.7752-1001.4	03.7750-7402.4	300084	9"



Bremsgeräte komplett

Booster units complete - Servofreni completi -
Servo-freins complets - Servofreno completo

● Die Nr. befindet sich auf dem im Fahrzeug eingebautem Aggregat.
the number is on the unit build in the car
il numero si trova sull'aggregato montato nella macchina
le numéro se trouve sur la pièce montée dans le véhicule
el n° se encuentra en el equipo montado en el vehículo



03.7752-1005.4	03.2122-0646.3	010133	THz 22,20
	03.7750-7402.4	300084	9"
03.7752-1006.4	03.2122-0646.3	010133	THz 22,20
	03.7750-7402.4	300084	9"
03.7752-1031.4	03.2123-1484.3	010595	THz 23,81
03.7752-1201.4	03.2122-1042.3	010137	THz 22,20
	03.7750-4902.4	300079	9"
03.7752-1202.4	03.2120-3943.3	010532	THz 20,64
	03.7750-4902.4	300079	9"
03.7752-1204.4	03.2120-3943.3	010532	THz 20,64
	03.7750-4902.4	300079	9"
03.7752-1331.4	03.2120-4381.3	010526	THz 20,64
	03.7750-1332.4	300155	9"
03.7752-1332.4	03.2120-4461.3	010571	THz 20,64
	03.7750-1332.4	300155	9"
03.7752-1831.4	03.2122-1356.3	010529	THz 22,20
	03.7750-1832.4	300111	9"
03.7752-1832.4	03.2122-1351.3	010528	THz 22,20
	03.7750-1832.4	300111	9"
03.7752-1833.4	03.2122-1351.3	010528	THz 22,20
	03.7750-1832.4	300111	9"
03.7752-1834.4	03.2122-1356.3	010529	THz 22,20
	03.7750-1832.4	300111	9"
03.7752-2041.4	03.2120-4611.3	010937	THz 20,64
	03.2125-0493.3	010940	THz 25,40
	03.2126-3144.3	010941	THz 26,99
03.7752-2042.4	03.2122-2031.3	010938	THz 22,20
03.7752-2142.4	03.2122-2031.3	010938	THz 22,20
03.7752-2231.4	03.4122-0031.3	010611	THz 22,20
	03.7750-2232.4	300112	9"
03.7752-2232.4	03.4122-0041.3	010612	THz 22,20
	03.7750-2232.4	300112	9"
03.7752-2331.4	03.2122-1564.3	010594	THz 22,20
	03.7750-2332.4	300113	9"
03.7752-2332.4	03.7750-2332.4	300113	9"
03.7752-2333.4	03.2122-1588.3	010733	THz 22,20
	03.7750-2332.4	300113	9"
03.7752-2334.4	03.2123-2243.3	010748	THz 23,81
	03.7750-2332.4	300113	9"
03.7752-2335.4	03.7750-2332.4	300113	9"

03.7752-2336.4	03.7750-2332.4	300113	9"
03.7752-2402.4	03.2122-0621.3	010131	THz 22,20
03.7752-2431.4	03.2122-1564.3	010594	THz 22,20
03.7752-2433.4	03.2122-1588.3	010733	THz 22,20
03.7752-2434.4	03.2123-2243.3	010748	THz 23,81
03.7752-2601.4	03.0101-0025.2	320014	BRES 3/35
	03.2120-3943.3	010532	THz 20,64
	03.7750-5502.4	300081	9"
03.7752-2603.4	03.2120-3943.3	010532	THz 20,64
	03.7750-5502.4	300081	9"
03.7752-2604.4	03.0101-0025.2	320014	BRES 3/35
	03.2120-3943.3	010532	THz 20,64
	03.7750-5502.4	300081	9"
03.7752-2607.4	03.2120-3943.3	010532	THz 20,64
	03.7750-5502.4	300081	9"
03.7752-2608.4	03.2120-3943.3	010532	THz 20,64
	03.7750-5502.4	300081	9"
03.7752-2631.4	03.2122-1691.3	010918	THz 22,20
03.7752-2632.4	03.2122-1691.3	010918	THz 22,20
03.7752-2701.4	03.2120-3943.3	010532	THz 20,64
03.7752-2731.4	03.2122-1691.3	010918	THz 22,20
03.7752-2732.4	03.2122-1691.3	010918	THz 22,20
03.7752-2801.4	03.2122-0264.3	010129	THz 22,20
03.7752-2931.4	03.2123-1626.3	010727	THz 23,81
	03.7750-2932.4	300175	9"
03.7752-3031.4	03.2123-1626.3	010727	THz 23,81
03.7752-3101.4	03.2120-3943.3	010532	THz 20,64
03.7752-3103.4	03.2120-3943.3	010532	THz 20,64
03.7752-3131.4	03.2122-1184.3	010592	THz 22,20
03.7752-3231.4	03.4153-0015.3	011005	THz 23,81 - Behälter
	03.7750-8732.4	300199	9"
03.7752-3232.4	03.4153-5287.4	010953	THz 23,81 + Behälter
	03.7750-8732.4	300199	9"
03.7752-3233.4	03.7750-8732.4	300199	9"
03.7752-3234.4	03.7750-8732.4	300199	9"
03.7752-3401.4	03.2122-0264.3	010129	THz 22,20

Bremsgeräte komplett

**Booster units complete - Servofreni completi -
Servo-freins complets - Servofreno completo**

● Die Nr. befindet sich auf dem im Fahrzeug eingebautem Aggregat.
the number is on the unit build in the car
il numero si trova sull'aggregato montato nella macchina
le numéro se trouve sur la pièce montée dans le véhicule
el n° se encuentra en el equipo montado en el vehículo



03.7752-3402.4	03.2122-0282.3	010130	THz 22,20
03.7752-3403.4	03.2123-1121.3	010176	THz 23,81
03.7752-3405.4	03.2122-0282.3	010130	THz 22,20
03.7752-3501.4	03.2122-0264.3	010129	THz 22,20
03.7752-3502.4	03.2122-0282.3	010130	THz 22,20
03.7752-3504.4	03.2123-1121.3	010176	THz 23,81
03.7752-3510.4	03.2122-0282.3	010130	THz 22,20
03.7752-3531.4	03.2123-2781.3	010631	THz 23,81
03.7752-3532.4	03.2123-2781.3	010631	THz 23,81
03.7752-3534.4	03.2123-2781.3	010631	THz 23,81
03.7752-3731.4	03.2122-1184.3	010592	THz 22,20
03.7752-3831.4	03.2123-1484.3	010595	THz 23,81
03.7752-4231.4	03.2123-2781.3	010631	THz 23,81
03.7752-4232.4	03.2123-2781.3	010631	THz 23,81
03.7752-4233.4	03.2123-2781.3	010631	THz 23,81
03.7752-4302.4	03.2122-1042.3 03.7750-4302.4	010137 300076	THz 22,20 9"
03.7752-4401.4	03.2123-1121.3	010176	THz 23,81
03.7752-4402.4	03.2123-1121.3	010176	THz 23,81
03.7752-4431.4	03.2122-1926.3	010916	THz 22,20
03.7752-4501.4	03.2123-1121.3	010176	THz 23,81
03.7752-4503.4	03.2123-1121.3	010176	THz 23,81
03.7752-4531.4	03.2123-2781.3	010631	THz 23,81
03.7752-4532.4	03.2123-2781.3	010631	THz 23,81
03.7752-4701.4	03.2120-2031.3	010106	THz 20,64
03.7752-4703.4	03.2120-4441.3	010510	THz 20,64
03.7752-4901.4	03.2122-1042.3 03.7750-4902.4	010137 300079	THz 22,20 9"
03.7752-5431.4	03.7750-5432.4	300248	9"
03.7752-5432.4	03.7750-5432.4	300248	9"
03.7752-5433.4	03.7750-5432.4	300248	9"
03.7752-5509.4	03.7750-5502.4	300081	9"

03.7752-5510.4	03.7750-5502.4	300081	9"
03.7752-5511.4	03.7750-5502.4	300081	9"
03.7752-5512.4	03.7750-5502.4	300081	9"
03.7752-5513.4	03.7750-5502.4	300081	9"
03.7752-5514.4	03.7750-5502.4	300081	9"
03.7752-5631.4	03.2123-2243.3	010748	THz 23,81
03.7752-5731.4	03.4153-0015.3 03.7750-8732.4	011005 300199	THz 23,81 - Behälter 9"
03.7752-5732.4	03.4153-5287.4 03.7750-8732.4	010953 300199	THz 23,81 + Behälter 9"
03.7752-5733.4	03.7750-8732.4	300199	9"
03.7752-5734.4	03.7750-8732.4	300199	9"
03.7752-5739.4	03.4153-0015.3 03.7750-8732.4	011005 300199	THz 23,81 - Behälter 9"
03.7752-5740.4	03.4153-5287.4 03.7750-8732.4	010953 300199	THz 23,81 + Behälter 9"
03.7752-5741.4	03.7750-8732.4	300199	9"
03.7752-5742.4	03.7750-8732.4	300199	9"
03.7752-6001.4	03.7750-6002.4	300134	9"
03.7752-6002.4	03.7750-6002.4	300134	9"
03.7752-6003.4	03.2122-1184.3 03.7750-6002.4	010592 300134	THz 22,20 9"
03.7752-6102.4	03.2122-1042.3	010137	THz 22,20
03.7752-6104.4	03.2122-1042.3	010137	THz 22,20
03.7752-6131.4	03.2120-4321.3	010525	THz 20,64
03.7752-6132.4	03.2120-4321.3	010525	THz 20,64
03.7752-6231.4	03.2122-1356.3 03.7750-6232.4	010529 300215	THz 22,20 9"
03.7752-6232.4	03.2122-1356.3 03.7750-6232.4	010529 300215	THz 22,20 9"
03.7752-6301.4	03.7750-6302.4	300161	9"
03.7752-6302.4	03.7750-6302.4	300161	9"
03.7752-6303.4	03.7750-6302.4	300161	9"
03.7752-6304.4	03.7750-6302.4	300161	9"



Bremsgeräte komplett

Booster units complete - Servofreni completi - Servo-freins complets - Servofreno completo

● Die Nr. befindet sich auf dem im Fahrzeug eingebautem Aggregat.
the number is on the unit build in the car
il numero si trova sull'aggregato montato nella macchina
le numéro se trouve sur la pièce montée dans le véhicule
el n° se encuentra en el equipo montado en el vehículo



03.7752-6305.4	03.7750-6302.4	300161	9"
03.7752-6306.4	03.7750-6302.4	300161	9"
03.7752-6331.4	03.4122-0031.3	010611	THz 22,20
	03.7750-6332.4	300226	9"
03.7752-6403.4	03.2122-1184.3	010592	THz 22,20
03.7752-6404.4	03.2123-1484.3	010595	THz 23,81
03.7752-6802.4	03.2123-1484.3	010595	THz 23,81
03.7752-6902.4	03.2123-1484.3	010595	THz 23,81
03.7752-6903.4	03.2123-1484.3	010595	THz 23,81
03.7752-7131.4	03.4152-0158.3	011007	THz 22,20 - Behälter
	03.7750-7132.4	300255	9"
03.7752-7132.4	03.4152-0158.3	011007	THz 22,20 - Behälter
	03.7750-7132.4	300255	9"
03.7752-7332.4	03.2120-4641.3	010932	THz 20,64
	03.7750-7332.4	300298	9"
03.7752-7401.4	03.2122-1042.3	010137	THz 22,20
	03.7750-7402.4	300084	9"
03.7752-7431.4	03.4153-5287.4	010953	THz 23,81 + Behälter
03.7752-7435.4	03.4153-5287.4	010953	THz 23,81 + Behälter
03.7752-8105.4	03.2122-1331.3	010607	THz 22,20
03.7752-8108.4	03.2122-1331.3	010607	THz 22,20
03.7752-8432.4	03.2120-4611.3	010937	THz 20,64
	03.2125-0493.3	010940	THz 25,40
	03.2126-3144.3	010941	THz 26,99
03.7752-8437.4	03.2120-4611.3	010937	THz 20,64
	03.2125-0493.3	010940	THz 25,40
	03.2126-3144.3	010941	THz 26,99
03.7752-8533.4	03.7750-8532.4	300264	9"
03.7752-8534.4	03.2120-4611.3	010937	THz 20,64
	03.2125-0493.3	010940	THz 25,40
	03.2126-3144.3	010941	THz 26,99
	03.7750-8532.4	300264	9"
03.7752-8535.4	03.2122-2031.3	010938	THz 22,20
	03.7750-8532.4	300264	9"
03.7752-8536.4	03.2120-4611.3	010937	THz 20,64
	03.2125-0493.3	010940	THz 25,40
	03.2126-3144.3	010941	THz 26,99
	03.7750-8532.4	300264	9"

03.7752-8537.4	03.2122-2031.3	010938	THz 22,20
	03.7750-8532.4	300264	9"
03.7752-8631.4	03.2120-4611.3	010937	THz 20,64
	03.2125-0493.3	010940	THz 25,40
	03.2126-3144.3	010941	THz 26,99
03.7752-8632.4	03.2125-0493.3	010940	THz 25,40
	03.2126-3144.3	010941	THz 26,99
03.7752-8633.4	03.2122-2031.3	010938	THz 22,20
03.7752-8731.4	03.4153-0015.3	011005	THz 23,81 - Behälter
	03.7750-8732.4	300199	9"
03.7752-8732.4	03.7750-8732.4	300199	9"
03.7752-8733.4	03.4153-5287.4	010953	THz 23,81 + Behälter
	03.7750-8732.4	300199	9"
03.7752-8734.4	03.7750-8732.4	300199	9"
03.7752-8735.4	03.4153-0015.3	011005	THz 23,81 - Behälter
	03.7750-8732.4	300199	9"
03.7752-8831.4	03.7750-8832.4	300299	9"
03.7752-9001.4	03.2123-1581.3	010487	THz 23,81 (MKIV)
03.7752-9101.4	03.2123-1581.3	010487	THz 23,81 (MKIV)
03.7752-9231.4	03.2120-4611.3	010937	THz 20,64
	03.2125-0493.3	010940	THz 25,40
	03.2126-3144.3	010941	THz 26,99
03.7752-9233.4	03.2122-2031.3	010938	THz 22,20
03.7752-9301.4	03.2120-4321.3	010525	THz 20,64
	03.7750-9302.4	300116	9"
03.7752-9302.4	03.2122-1356.3	010529	THz 22,20
	03.7750-9302.4	300116	9"
03.7752-9303.4	03.2120-4321.3	010525	THz 20,64
	03.7750-9302.4	300116	9"
03.7752-9304.4	03.2122-1356.3	010529	THz 22,20
	03.7750-9302.4	300116	9"
03.7752-9305.4	03.2120-4321.3	010525	THz 20,64
	03.7750-9302.4	300116	9"
03.7752-9306.4	03.2122-1356.3	010529	THz 22,20
	03.7750-9302.4	300116	9"
03.7752-9307.4	03.2122-1351.3	010528	THz 22,20
	03.7750-9302.4	300116	9"
03.7752-9308.4	03.2122-1351.3	010528	THz 22,20
	03.7750-9302.4	300116	9"

Bremsgeräte komplett

**Booster units complete - Servofreni completi -
Servo-freins complets - Servofreno completo**

● Die Nr. befindet sich auf dem im Fahrzeug eingebautem Aggregat.
the number is on the unit build in the car
il numero si trova sull'aggregato montato nella macchina
le numéro se trouve sur la pièce montée dans le véhicule
el n° se encuentra en el equipo montado en el vehículo



03.7752-9309.4	03.2122-1356.3	010529	THz 22,20
	03.7750-9302.4	300116	9"
03.7752-9310.4	03.2122-1351.3	010528	THz 22,20
	03.7750-9302.4	300116	9"
03.7752-9331.4	03.4152-0158.3	011007	THz 22,20 - Behälter
03.7752-9401.4	03.2122-1351.3	010528	THz 22,20
	03.7750-9402.4	300117	9"
03.7752-9402.4	03.2122-1351.3	010528	THz 22,20
	03.7750-9402.4	300117	9"
03.7752-9403.4	03.2122-1351.3	010528	THz 22,20
	03.7750-9402.4	300117	9"
03.7752-9532.4	03.2122-2031.3	010938	THz 22,20
03.7752-9702.4	03.2123-2221.3	010861	THz 23,81
03.7752-9703.4	03.2123-2221.3	010861	THz 23,81
03.7752-9704.4	03.2123-2221.3	010861	THz 23,81
03.7752-9705.4	03.2123-2221.3	010861	THz 23,81
03.7752-9706.4	03.2123-2221.3	010861	THz 23,81
03.7752-9802.4	03.2123-2221.3	010861	THz 23,81
	03.7750-2532.4	300225	9"
03.7752-9803.4	03.2123-2221.3	010861	THz 23,81
	03.7750-2532.4	300225	9"
03.7752-9804.4	03.2123-2221.3	010861	THz 23,81
	03.7750-2532.4	300225	9"
03.7752-9805.4	03.2123-2221.3	010861	THz 23,81
	03.7750-2532.4	300225	9"
03.7752-9806.4	03.2123-2221.3	010861	THz 23,81
	03.7750-2532.4	300225	9"
03.7757-0101.4	03.2023-0230.3	010019	THz 23,81/19,05
03.7757-0102.4	03.2023-0825.3	010028	THz 23,81/19,05
03.7757-0131.4	03.7755-0132.4	300265	9/8" Tandem
03.7757-0201.4	03.2025-0211.3	010034	THz 25,40/19,05
03.7757-0203.4	03.7750-0302.4	300071	9"
03.7757-0204.4	03.7750-0302.4	300071	9"
03.7757-0231.4	03.4156-0073.3	010942	THz 26,99
03.7757-0314.4	03.2023-0642.3	010026	THz 23,81/20,64
03.7757-0319.4	03.2023-0642.3	010026	THz 23,81/20,64

03.7757-0321.4	03.2023-0642.3	010026	THz 23,81/20,64
03.7757-0324.4	03.2023-0642.3	010026	THz 23,81/20,64
03.7757-0631.4	03.2125-0651.3	010935	THz 25,40
03.7757-0632.4	03.2125-0651.3	010935	THz 25,40
03.7757-0633.4	03.2125-0651.3	010935	THz 25,40
03.7757-0801.4	03.2123-1526.3	010477	THz 23,81
	03.7755-4202.4	300164	9/8" Tandem
03.7757-0802.4	03.2123-1526.3	010477	THz 23,81
	03.7755-4202.4	300164	9/8" Tandem
03.7757-0803.4	03.2123-1548.3	010478	THz 23,81
	03.7755-4202.4	300164	9/8" Tandem
03.7757-0804.4	03.2123-1548.3	010478	THz 23,81
	03.7755-4202.4	300164	9/8" Tandem
03.7757-0805.4	03.2125-8111.3	010479	THz 25,40
	03.7755-4202.4	300164	9/8" Tandem
03.7757-0806.4	03.2125-8111.3	010479	THz 25,40
	03.7755-4202.4	300164	9/8" Tandem
03.7757-0901.4	03.2123-1486.3	010488	THz 23,81
03.7757-0902.4	03.2123-1741.3	010537	THz 23,81
03.7757-1001.4	03.2123-1486.3	010488	THz 23,81
03.7757-1002.4	03.2123-1741.3	010537	THz 23,81
03.7757-1031.4	03.2125-0651.3	010935	THz 25,40
03.7757-1032.4	03.2125-0651.3	010935	THz 25,40
03.7757-1033.4	03.2125-0651.3	010935	THz 25,40
03.7757-1034.4	03.2125-0651.3	010935	THz 25,40
03.7757-1201.4	03.7755-3402.4	300189	9/8" Tandem
03.7757-1202.4	03.7755-3402.4	300189	9/8" Tandem
03.7757-1203.4	03.7755-3402.4	300189	9/8" Tandem
03.7757-1204.4	03.7755-3402.4	300189	9/8" Tandem
03.7757-1205.4	03.7755-3402.4	300189	9/8" Tandem
03.7757-1206.4	03.7755-3402.4	300189	9/8" Tandem
03.7757-1207.4	03.2125-7637.3	010707	THz 25,40
	03.7755-3402.4	300189	9/8" Tandem
03.7757-1208.4	03.2125-7743.3	010921	THz 25,40
	03.7755-3402.4	300189	9/8" Tandem



Bremsgeräte komplett

**Booster units complete - Servofreni completi -
Servo-freins complets - Servofreno completo**

● Die Nr. befindet sich auf dem im Fahrzeug eingebautem Aggregat.
the number is on the unit build in the car
il numero si trova sull'aggregato montato nella macchina
le numéro se trouve sur la pièce montée dans le véhicule
el n° se encuentra en el equipo montado en el vehículo



03.7757-1209.4	03.2125-7638.3	010738	THz 25,40
	03.7755-3402.4	300189	9/8" Tandem
03.7757-1210.4	03.2125-7743.3	010921	THz 25,40
	03.7755-3402.4	300189	9/8" Tandem
03.7757-1231.4	03.7755-1232.4	300260	9/8" Tandem
03.7757-1431.4	03.7755-1432.4	300300	9/8" Tandem
03.7757-1501.4	03.2125-8404.3	010583	THz 25,40
	03.7755-1902.4	300138	9/8" Tandem
03.7757-1601.4	03.2125-8404.3	010583	THz 25,40
03.7757-1902.4	03.2125-0332.3	010952	THz 25,40
	03.7755-1902.4	300138	9/8" Tandem
03.7757-1903.4	03.2125-0332.3	010952	THz 25,40
	03.7755-1902.4	300138	9/8" Tandem
03.7757-2002.4	03.2125-0332.3	010952	THz 25,40
03.7757-2004.4	03.2125-0332.3	010952	THz 25,40
03.7757-2201.4	03.2125-9704.3	010603	THz 25,40
	03.7755-4302.4	300165	9/8" Tandem
03.7757-2202.4	03.2125-9704.3	010603	THz 25,40
	03.7755-4302.4	300165	9/8" Tandem
03.7757-2203.4	03.2125-9704.3	010603	THz 25,40
	03.7755-4302.4	300165	9/8" Tandem
03.7757-2501.4	03.2123-1486.3	010488	THz 23,81
03.7757-2503.4	03.2123-2621.3	010701	THz 23,81
03.7757-2601.4	03.2123-1486.3	010488	THz 23,81
03.7757-2603.4	03.2123-2621.3	010701	THz 23,81
03.7757-2801.4	03.2125-0332.3	010952	THz 25,40
	03.7755-6302.4	300221	9/8" Tandem
03.7757-2802.4	03.2125-0332.3	010952	THz 25,40
	03.7755-6302.4	300221	9/8" Tandem
03.7757-2803.4	03.2125-0332.3	010952	THz 25,40
	03.7755-6302.4	300221	9/8" Tandem
03.7757-2804.4	03.2125-0332.3	010952	THz 25,40
	03.7755-6302.4	300221	9/8" Tandem
03.7757-2805.4	03.2125-0332.3	010952	THz 25,40
	03.7755-6302.4	300221	9/8" Tandem
03.7757-2806.4	03.2125-0332.3	010952	THz 25,40
	03.7755-6302.4	300221	9/8" Tandem

03.7757-2807.4	03.2125-0332.3	010952	THz 25,40
	03.7755-6302.4	300221	9/8" Tandem
03.7757-2808.4	03.2125-0332.3	010952	THz 25,40
	03.7755-6302.4	300221	9/8" Tandem
03.7757-2811.4	03.2125-0332.3	010952	THz 25,40
	03.7755-6302.4	300221	9/8" Tandem
03.7757-2812.4	03.2125-0332.3	010952	THz 25,40
	03.7755-6302.4	300221	9/8" Tandem
03.7757-2931.4	03.2125-0651.3	010935	THz 25,40
03.7757-3201.4	03.2123-1526.3	010477	THz 23,81
	03.7755-4202.4	300164	9/8" Tandem
03.7757-3202.4	03.2123-1526.3	010477	THz 23,81
	03.7755-4202.4	300164	9/8" Tandem
03.7757-3203.4	03.2123-1548.3	010478	THz 23,81
	03.7755-4202.4	300164	9/8" Tandem
03.7757-3204.4	03.2123-1548.3	010478	THz 23,81
	03.7755-4202.4	300164	9/8" Tandem
03.7757-3205.4	03.2125-8111.3	010479	THz 25,40
	03.7755-4202.4	300164	9/8" Tandem
03.7757-3206.4	03.2125-8111.3	010479	THz 25,40
	03.7755-4202.4	300164	9/8" Tandem
03.7757-3301.4	03.2125-9704.3	010603	THz 25,40
	03.7755-4302.4	300165	9/8" Tandem
03.7757-3302.4	03.2125-9704.3	010603	THz 25,40
	03.7755-4302.4	300165	9/8" Tandem
03.7757-3303.4	03.2125-9704.3	010603	THz 25,40
	03.7755-4302.4	300165	9/8" Tandem
03.7757-3401.4	03.2125-7743.3	010921	THz 25,40
	03.7755-3402.4	300189	9/8" Tandem
03.7757-3402.4	03.2125-7638.3	010738	THz 25,40
	03.7755-3402.4	300189	9/8" Tandem
03.7757-3501.4	03.2123-2621.3	010701	THz 23,81
03.7757-3531.4	03.2125-0651.3	010935	THz 25,40
03.7757-3601.4	03.2123-2621.3	010701	THz 23,81
03.7757-3701.4	03.2125-7743.3	010921	THz 25,40
	03.7755-4702.4	300224	9/8" Tandem
03.7757-3702.4	03.2125-7638.3	010738	THz 25,40
	03.7755-4702.4	300224	9/8" Tandem
03.7757-3801.4	03.2125-7638.3	010738	THz 25,40

Bremsgeräte komplett

**Booster units complete - Servofreni completi -
Servo-freins complets - Servofreno completo**

● Die Nr. befindet sich auf dem im Fahrzeug eingebautem Aggregat.
the number is on the unit build in the car
il numero si trova sull'aggregato montato nella macchina
le numéro se trouve sur la pièce montée dans le véhicule
el n° se encuentra en el equipo montado en el vehículo



03.7757-4501.4	03.2125-7743.3	010921	THz 25,40
03.7757-4601.4	03.2125-7638.3	010738	THz 25,40
03.7757-4701.4	03.2125-7743.3 03.7755-4702.4	010921 300224	THz 25,40 9/8" Tandem
03.7757-4702.4	03.2125-7637.3 03.2125-7638.3 03.7755-4702.4	010707 010738 300224	THz 25,40 THz 25,40 9/8" Tandem
03.7757-4703.4	03.2125-7743.3 03.7755-4702.4	010921 300224	THz 25,40 9/8" Tandem
03.7757-4704.4	03.2125-7638.3 03.7755-4702.4	010738 300224	THz 25,40 9/8" Tandem
03.7757-4705.4	03.2125-7743.3 03.7755-4702.4	010921 300224	THz 25,40 9/8" Tandem
03.7757-4706.4	03.2125-7638.3 03.7755-4702.4	010738 300224	THz 25,40 9/8" Tandem
03.7757-4707.4	03.2125-7743.3 03.7755-4702.4	010921 300224	THz 25,40 9/8" Tandem
03.7757-4708.4	03.2125-7638.3 03.7755-4702.4	010738 300224	THz 25,40 9/8" Tandem
03.7757-4807.4	03.2125-0161.3	010920	THz 25,40
03.7757-4808.4	03.2125-0531.3	010945	THz 25,40
03.7757-4813.4	03.2125-0161.3	010920	THz 25,40
03.7757-5001.4	03.2125-7743.3	010921	THz 25,40
03.7757-5002.4	03.2125-7638.3	010738	THz 25,40
03.7757-5301.4	03.7755-1432.4	300300	9/8" Tandem
03.7757-5501.4	03.7755-9703.4	300239	9/8" Tandem
03.7757-5502.4	03.7755-9703.4	300239	9/8" Tandem
03.7757-6101.4	03.7755-1232.4	300260	9/8" Tandem
03.7757-6102.4	03.7755-1232.4	300260	9/8" Tandem
03.7757-6201.4	03.7755-1432.4	300300	9/8" Tandem
03.7757-6202.4	03.7755-1432.4	300300	9/8" Tandem
03.7757-6301.4	03.7755-6302.4	300221	9/8" Tandem
03.7757-6302.4	03.7755-6302.4	300221	9/8" Tandem
03.7757-6303.4	03.2125-0332.3 03.7755-6302.4	010952 300221	THz 25,40 9/8" Tandem
03.7757-6401.4	03.7755-1432.4	300300	9/8" Tandem

03.7757-6402.4	03.7755-1432.4	300300	9/8" Tandem
03.7757-6404.4	03.7755-1432.4	300300	9/8" Tandem
03.7757-6405.4	03.7755-1432.4	300300	9/8" Tandem
03.7757-7301.4	03.2025-2301.3	010895	THz 25,40/22,20
03.7757-7501.4	03.7755-7703.4	300247	9/8" Tandem
03.7757-7601.4	03.7755-0132.4	300265	9/8" Tandem
03.7757-7701.4	03.2125-0651.3 03.7755-7703.4	010935 300247	THz 25,40 9/8" Tandem
03.7757-7702.4	03.2125-0651.3 03.7755-7703.4	010935 300247	THz 25,40 9/8" Tandem
03.7757-8201.4	03.2126-3196.3 03.7755-8202.4	010968 300301	THz 26,99 9/8" Tandem
03.7757-8801.4	03.4156-0073.3	010942	THz 26,99
03.7757-9001.4	03.2126-3196.3	010968	THz 26,99
03.7757-9002.4	03.2126-3196.3	010968	THz 26,99
03.7757-9301.4	03.7755-1232.4	300260	9/8" Tandem
03.7757-9401.4	03.7755-1432.4	300300	9/8" Tandem
03.7757-9402.4	03.7755-1432.4	300300	9/8" Tandem
03.7757-9501.4	03.7755-1432.4	300300	9/8" Tandem
03.7757-9601.4	03.7755-1432.4	300300	9/8" Tandem
03.7757-9701.4	03.7755-9703.4	300239	9/8" Tandem
03.7762-0101.4	03.2123-8311.3 03.7760-0902.4	010192 300088	THz 23,81 10"
03.7762-0102.4	03.2122-6911.3 03.7760-0902.4	010153 300088	THz 22,20 10"
03.7762-0103.4	03.2122-6911.3 03.7760-0902.4	010153 300088	THz 22,20 10"
03.7762-0104.4	03.7760-0902.4	300088	10"
03.7762-0108.4	03.2120-2082.3 03.7760-0902.4	010107 300088	THz 20,64 10"
03.7762-0110.4	03.2120-1802.3 03.7760-0902.4	010099 300088	THz 20,64 10"
03.7762-0112.4	03.2120-1802.3 03.7760-0902.4	010099 300088	THz 20,64 10"
03.7762-0114.4	03.2020-0402.3 03.7760-0902.4	010001 300088	THz 20,64/19,05 10"



Bremsgeräte komplett

Booster units complete - Servofreni completi - Servo-freins complets - Servofreno completo

● Die Nr. befindet sich auf dem im Fahrzeug eingebautem Aggregat.
the number is on the unit build in the car
il numero si trova sull'aggregato montato nella macchina
le numéro se trouve sur la pièce montée dans le véhicule
el n° se encuentra en el equipo montado en el vehículo



03.7762-0115.4	03.2120-2082.3 03.7760-0902.4	010107 300088	THz 20,64 10"	03.7762-0504.4	03.2120-1802.3 03.7760-0902.4	010099 300088	THz 20,64 10"
03.7762-0116.4	03.2123-8311.3 03.7760-0902.4	010192 300088	THz 23,81 10"	03.7762-0505.4	03.2120-2082.3 03.7760-0902.4	010107 300088	THz 20,64 10"
03.7762-0117.4	03.7760-0902.4	300088	10"	03.7762-0506.4	03.7760-0902.4	300088	10"
03.7762-0118.4	03.2123-8311.3 03.7760-0902.4	010192 300088	THz 23,81 10"	03.7762-0631.4	03.2125-0483.3 03.7760-2232.4	010783 300266	THz 25,40 10"
03.7762-0119.4	03.2120-2082.3 03.7760-0902.4	010107 300088	THz 20,64 10"	03.7762-0632.4	03.2125-0483.3 03.7760-2232.4	010783 300266	THz 25,40 10"
03.7762-0120.4	03.2120-2082.3 03.7760-0902.4	010107 300088	THz 20,64 10"	03.7762-0701.4	03.2022-1201.3 03.7760-0902.4	010009 300088	THz 22,20/17,46 10"
03.7762-0121.4	03.2120-1802.3 03.7760-0902.4	010099 300088	THz 20,64 10"	03.7762-0702.4	03.2022-1201.3 03.7760-0902.4	010009 300088	THz 22,20/17,46 10"
03.7762-0122.4	03.2120-1802.3 03.7760-0902.4	010099 300088	THz 20,64 10"	03.7762-0703.4	03.2022-1201.3 03.7760-0902.4	010009 300088	THz 22,20/17,46 10"
03.7762-0123.4	03.2020-0402.3 03.7760-0902.4	010001 300088	THz 20,64/19,05 10"	03.7762-0704.4	03.2022-1201.3 03.7760-0902.4	010009 300088	THz 22,20/17,46 10"
03.7762-0124.4	03.7760-0902.4	300088	10"	03.7762-0705.4	03.2022-1201.3 03.7760-0902.4	010009 300088	THz 22,20/17,46 10"
03.7762-0201.4	03.2020-0402.3 03.7760-0902.4	010001 300088	THz 20,64/19,05 10"	03.7762-0731.4	03.2123-2821.3	010944	THz 23,81
03.7762-0202.4	03.2120-1802.3 03.7760-0902.4	010099 300088	THz 20,64 10"	03.7762-0801.4	03.2022-1201.3 03.7760-0902.4	010009 300088	THz 22,20/17,46 10"
03.7762-0204.4	03.2120-2082.3 03.7760-0902.4	010107 300088	THz 20,64 10"	03.7762-0802.4	03.2022-1201.3 03.7760-0902.4	010009 300088	THz 22,20/17,46 10"
03.7762-0301.4	03.2023-0825.3 03.7760-2702.4	010028 300090	THz 23,81/19,05 10"	03.7762-0901.4	03.2022-1201.3 03.7760-0902.4	010009 300088	THz 22,20/17,46 10"
03.7762-0302.4	03.2023-0825.3 03.7760-2702.4	010028 300090	THz 23,81/19,05 10"	03.7762-0902.4	03.2022-1201.3 03.7760-0902.4	010009 300088	THz 22,20/17,46 10"
03.7762-0312.4	03.2023-0825.3 03.7760-2702.4	010028 300090	THz 23,81/19,05 10"	03.7762-1001.4	03.2125-3011.3	010211	THz 25,40
03.7762-0313.4	03.2023-0825.3 03.7760-2702.4	010028 300090	THz 23,81/19,05 10"	03.7762-1002.4	03.2125-3011.3	010211	THz 25,40
03.7762-0401.4	03.2023-0262.3 03.7760-0402.4	010020 300087	THz 23,81/20,64 10"	03.7762-1032.4	03.2123-3041.3 03.7760-2332.4	010887 300267	THz 23,81 10"
03.7762-0402.4	03.7760-0402.4	300087	10"	03.7762-1203.4	03.2125-3011.3	010211	THz 25,40
03.7762-0501.4	03.2120-1802.3 03.7760-0902.4	010099 300088	THz 20,64 10"	03.7762-1204.4	03.2125-3011.3	010211	THz 25,40
03.7762-0502.4	03.2120-2082.3 03.7760-0902.4	010107 300088	THz 20,64 10"	03.7762-1801.4	03.2125-3011.3	010211	THz 25,40
03.7762-0503.4	03.7760-0902.4	300088	10"	03.7762-1802.4	03.2125-3011.3	010211	THz 25,40
				03.7762-1901.4	03.2125-3011.3	010211	THz 25,40
				03.7762-1902.4	03.2125-3011.3	010211	THz 25,40

Bremsgeräte komplett

**Booster units complete - Servofreni completi -
Servo-freins complets - Servofreno completo**

● Die Nr. befindet sich auf dem im Fahrzeug eingebautem Aggregat.
the number is on the unit build in the car
il numero si trova sull'aggregato montato nella macchina
le numéro se trouve sur la pièce montée dans le véhicule
el n° se encuentra en el equipo montado en el vehículo



03.7762-2001.4	03.2125-3011.3	010211	THz 25,40
03.7762-2002.4	03.2125-3011.3	010211	THz 25,40
03.7762-2031.4	03.2125-0483.3	010783	THz 25,40
03.7762-2032.4	03.2125-0483.3	010783	THz 25,40
03.7762-2033.4	03.2125-0661.3	010917	THz 25,40
03.7762-2034.4	03.2125-0661.3	010917	THz 25,40
03.7762-2231.4	03.2125-0661.3 03.7760-2232.4	010917 300266	THz 25,40 10"
03.7762-2232.4	03.2125-0661.3 03.7760-2232.4	010917 300266	THz 25,40 10"
03.7762-2233.4	03.2125-0661.3 03.7760-2232.4	010917 300266	THz 25,40 10"
03.7762-2234.4	03.7760-2232.4	300266	10"
03.7762-2331.4	03.2123-3041.3 03.7760-2332.4	010887 300267	THz 23,81 10"
03.7762-2332.4	03.7760-2332.4	300267	10"
03.7762-2333.4	03.2123-3041.3 03.7760-2332.4	010887 300267	THz 23,81 10"
03.7762-2334.4	03.7760-2332.4	300267	10"
03.7762-2402.4	03.2023-0987.3	010473	THz 23,81/20,64
03.7762-2701.4	03.2023-0825.3 03.7760-2702.4	010028 300090	THz 23,81/19,05 10"
03.7762-3102.4	03.2023-0987.3 03.7760-3102.4	010473 300139	THz 23,81/20,64 10"
03.7762-3103.4	03.2023-0987.3 03.7760-3102.4	010473 300139	THz 23,81/20,64 10"
03.7762-3109.4	03.2023-0987.3 03.7760-3102.4	010473 300139	THz 23,81/20,64 10"
03.7762-3110.4	03.2023-1904.3 03.7760-3102.4	010724 300139	THz 23,81/20,64 10"
03.7762-3111.4	03.2023-1904.3 03.7760-3102.4	010724 300139	THz 23,81/20,64 10"
03.7762-3120.4	03.2023-1949.3 03.7760-3102.4	010725 300139	THz 23,81/20,64 10"
03.7762-3121.4	03.2023-1949.3 03.7760-3102.4	010725 300139	THz 23,81/20,64 10"
03.7762-3606.4	03.2023-1084.3 03.7760-3602.4	010591 300176	THz 23,81/20,64 10"

03.7762-3607.4	03.2023-1044.3 03.7760-3602.4	010590 300176	THz 23,81/20,64 10"
03.7762-3706.4	03.2023-1084.3	010591	THz 23,81/20,64
03.7762-3707.4	03.2023-1044.3	010590	THz 23,81/20,64
03.7762-4101.4	03.2023-1066.3 03.7760-4102.4	010032 300091	THz 23,81/19,05 10"
03.7762-4102.4	03.2023-1066.3 03.7760-4102.4	010032 300091	THz 23,81/19,05 10"
03.7762-4203.4	03.2123-1486.3	010488	THz 23,81
03.7762-4204.4	03.2123-1546.3	010536	THz 23,81
03.7762-4301.4	03.2123-1486.3	010488	THz 23,81
03.7762-4302.4	03.2123-1546.3	010536	THz 23,81
03.7762-4603.4	03.2123-2164.3	010599	THz 23,81
03.7762-4803.4	03.2123-2164.3	010599	THz 23,81
03.7762-4903.4	03.2123-2164.3	010599	THz 23,81
03.7762-5003.4	03.2123-2164.3	010599	THz 23,81
03.7762-5101.4	03.2123-2146.3 03.7760-5102.4	010572 300140	THz 23,81 10"
03.7762-5102.4	03.2123-1551.3 03.7760-5102.4	010512 300140	THz 23,81 10"
03.7762-5103.4	03.7760-5102.4	300140	10"
03.7762-5104.4	03.7760-5102.4	300140	10"
03.7762-5202.4	03.2120-4441.3	010510	THz 20,64
03.7762-5301.4	03.2122-1351.3	010528	THz 22,20
03.7762-5401.4	03.2123-2146.3 03.7760-5102.4	010572 300140	THz 23,81 10"
03.7762-5501.4	03.2122-1521.3 03.7760-5502.4	010494 300151	THz 22,20 10"
03.7762-5503.4	03.2122-1541.3 03.7760-5502.4	010511 300151	THz 22,20 10"
03.7762-5602.4	03.2123-1551.3 03.7760-5602.4	010512 300121	THz 23,81 10"
03.7762-5603.4	03.2122-1541.3 03.7760-5602.4	010511 300121	THz 22,20 10"
03.7762-6201.4	03.2123-2164.3	010599	THz 23,81
03.7762-6301.4	03.2123-2164.3	010599	THz 23,81



Bremsgeräte komplett

**Booster units complete - Servofreni completi -
Servo-freins complets - Servofreno completo**

● Die Nr. befindet sich auf dem im Fahrzeug eingebautem Aggregat.
the number is on the unit build in the car
il numero si trova sull'aggregato montato nella macchina
le numéro se trouve sur la pièce montée dans le véhicule
el n° se encuentra en el equipo montado en el vehículo



03.7762-6901.4	03.2123-2821.3	010944	THz 23,81
03.7762-7110.4	03.2123-3041.3 03.7760-2332.4	010887 300267	THz 23,81 10"
03.7762-7111.4	03.2123-3041.3 03.7760-2332.4	010887 300267	THz 23,81 10"
03.7762-7114.4	03.2123-3041.3 03.7760-2332.4	010887 300267	THz 23,81 10"
03.7762-7631.4	03.2123-2821.3	010944	THz 23,81
03.7762-8101.4	03.2123-3103.3 03.7760-8103.4	010781 300240	THz 23,81 10"
03.7762-8102.4	03.2123-3103.3 03.7760-8103.4	010781 300240	THz 23,81 10"
03.7762-8104.4	03.2123-3103.3 03.7760-8103.4	010781 300240	THz 23,81 10"
03.7762-8105.4	03.2123-3103.3 03.7760-8103.4	010781 300240	THz 23,81 10"
03.7762-9101.4	03.2123-3103.3	010781	THz 23,81
03.7762-9601.4	03.2125-0483.3 03.7760-2232.4	010783 300266	THz 25,40 10"
03.7762-9602.4	03.2125-0483.3 03.7760-2232.4	010783 300266	THz 25,40 10"
03.7762-9801.4	03.2123-3041.3 03.7760-2332.4	010887 300267	THz 23,81 10"
03.7767-0101.4	03.2026-0462.3	010728	THz 26,99/25,40
03.7767-0102.4	03.2026-0462.3	010728	THz 26,99/25,40
03.7767-0103.4	03.2026-0512.3	010038	THz 26,99/25,40
03.7767-0104.4	03.2026-0512.3	010038	THz 26,99/25,40
03.7767-0105.4	03.2026-0462.3	010728	THz 26,99/25,40
03.7767-0106.4	03.2026-0562.3	010729	THz 26,99/25,40
03.7767-0107.4	03.2026-0462.3	010728	THz 26,99/25,40
03.7767-0108.4	03.2026-0562.3	010729	THz 26,99/25,40
03.7767-0502.4	03.2126-3014.3 03.7765-1002.4	010811 300246	THz 26,99 10/9" Tandem
03.7767-1001.4	03.2126-3014.3 03.7765-1002.4	010811 300246	THz 26,99 10/9" Tandem
03.7767-1302.4	03.2126-3144.3	010941	THz 26,99
03.7767-1303.4	03.2126-3144.3	010941	THz 26,99

03.7767-1401.4	03.2126-3144.3	010941	THz 26,99
03.7847-0101.4	03.2025-1904.3 03.7845-0103.4	010797 300268	THz 25,40/22,20 8"
03.7847-0102.4	03.7845-0103.4	300268	8"
03.7847-0103.4	03.2025-1904.3 03.7845-0103.4	010797 300268	THz 25,40/22,20 8"
03.7847-0104.4	03.7845-0103.4	300268	8"
03.7847-0401.4	03.2023-2407.3	010796	THz 23,81/22,20
03.7847-0501.4	03.2025-1904.3	010797	THz 25,40/22,20
03.7847-0601.4	03.2025-1904.3	010797	THz 25,40/22,20
03.7849-0101.4	03.2123-2064.3	010598	THz 23,81
03.7849-0201.4	03.2023-1741.3 03.7848-2002.4	010703 300166	THz 23,81/20,64 7/8" Tandem
03.7849-0202.4	03.2025-1741.3 03.7848-2002.4	010705 300166	THz 25,40/20,64 7/8" Tandem
03.7849-0203.4	03.7848-2002.4	300166	7/8" Tandem
03.7849-0204.4	03.7848-2002.4	300166	7/8" Tandem
03.7849-0901.4	03.2025-1741.3	010705	THz 25,40/20,64
03.7849-0902.4	03.2025-1741.3	010705	THz 25,40/20,64
03.7849-1201.4	03.2123-2064.3	010598	THz 23,81
03.7849-2001.4	03.7848-2002.4	300166	7/8" Tandem
03.7849-2002.4	03.7848-2002.4	300166	7/8" Tandem
03.7849-3001.4	03.7848-9402.4	300227	7/8" Tandem
03.7849-3301.4	03.4125-0032.3	010955	THz 25,40
03.7849-4001.4	03.2023-2407.3 03.7848-4003.4	010796 300235	THz 23,81/22,20 8"
03.7849-4002.4	03.7848-4003.4	300235	8"
03.7849-4005.4	03.2023-2407.3 03.7848-4003.4	010796 300235	THz 23,81/22,20 8"
03.7849-4006.4	03.7848-4003.4	300235	8"
03.7849-5001.4	03.2025-1904.3 03.7848-5003.4	010797 300236	THz 25,40/22,20 8"
03.7849-5002.4	03.7848-5003.4	300236	8"
03.7849-5005.4	03.2025-1904.3 03.7848-5003.4	010797 300236	THz 25,40/22,20 8"

Bremsgeräte komplett

**Booster units complete - Servofreni completi -
Servo-freins complets - Servofreno completo**

● Die Nr. befindet sich auf dem im Fahrzeug eingebautem Aggregat.
the number is on the unit build in the car
il numero si trova sull'aggregato montato nella macchina
le numéro se trouve sur la pièce montée dans le véhicule
el n° se encuentra en el equipo montado en el vehículo



03.7849-5006.4	03.7848-5003.4	300236	8"
03.7849-6201.4	03.7848-9402.4	300227	7/8" Tandem
03.7849-9401.4	03.7848-9402.4	300227	7/8" Tandem
03.7852-0102.4	03.2122-1883.3 03.7850-0102.4	010735 300180	THz 22,20 9"
03.7852-0103.4	03.2122-1888.3 03.7850-0102.4	010736 300180	THz 22,20 9"
03.7854-0101.4	03.7853-0102.4	300252	9"
03.7854-0102.4	03.7853-0102.4	300252	9"
03.7854-0201.4	03.7853-0202.4	300181	9"
03.7854-0202.4	03.7853-0202.4	300181	9"
03.7854-0701.4	03.7853-0702.4	300195	9"
03.7854-0702.4	03.7853-0702.4	300195	9"
03.7854-0901.4	03.7853-0902.4	300150	9"
03.7854-0902.4	03.7853-0902.4	300150	9"
03.7854-0903.4	03.7853-0902.4	300150	9"
03.7854-0904.4	03.7853-0902.4	300150	9"
03.7854-0905.4	03.7853-0902.4	300150	9"
03.7854-0906.4	03.7853-0902.4	300150	9"
03.7854-0907.4	03.7853-0902.4	300150	9"
03.7854-0908.4	03.7853-0902.4	300150	9"
03.7854-1501.4	03.2120-4461.3 03.7853-1502.4	010571 300200	THz 20,64 9"
03.7854-1502.4	03.7853-1502.4	300200	9"
03.7854-1601.4	03.2122-1351.3 03.7853-1602.4	010528 300167	THz 22,20 9"
03.7854-1602.4	03.2122-1942.3	010700	THz 22,20
03.7854-1603.4	03.2122-1351.3	010528	THz 22,20
03.7854-1604.4	03.2122-1942.3	010700	THz 22,20
03.7854-1701.4	03.4122-0041.3	010612	THz 22,20
03.7854-1703.4	03.4122-0041.3	010612	THz 22,20
03.7854-2101.4	03.7853-2102.4	300201	9"
03.7854-2102.4	03.7853-2102.4	300201	9"

03.7854-2103.4	03.7853-2102.4	300201	9"
03.7854-2104.4	03.7853-2102.4	300201	9"
03.7854-2105.4	03.7853-2102.4	300201	9"
03.7854-2106.4	03.7853-2102.4	300201	9"
03.7854-2107.4	03.7853-2102.4	300201	9"
03.7854-2108.4	03.7853-2102.4	300201	9"
03.7854-2109.4	03.7853-2102.4	300201	9"
03.7854-2110.4	03.7853-2102.4	300201	9"
03.7854-2111.4	03.7853-2102.4	300201	9"
03.7854-2112.4	03.7853-2102.4	300201	9"
03.7854-2113.4	03.7853-2102.4	300201	9"
03.7854-2114.4	03.7853-2102.4	300201	9"
03.7854-2115.4	03.7853-2102.4	300201	9"
03.7854-2116.4	03.7853-2102.4	300201	9"
03.7854-2601.4	03.7853-2602.4	300196	9"
03.7854-2602.4	03.7853-2602.4	300196	9"
03.7854-2701.4	03.7853-2702.4	300269	9"
03.7854-2702.4	03.7853-2702.4	300269	9"
03.7854-3901.4	03.7853-3902.4	300270	9"
03.7854-4101.4	03.2120-4611.3 03.2125-0493.3 03.2126-3144.3 03.7853-4102.4	010937 010940 010941 300271	THz 20,64 THz 25,40 THz 26,99 9"
03.7854-4103.4	03.2122-2031.3 03.7853-4102.4	010938 300271	THz 22,20 9"
03.7854-4105.4	03.2120-4611.3 03.2125-0493.3 03.2126-3144.3 03.7853-4102.4	010937 010940 010941 300271	THz 20,64 THz 25,40 THz 26,99 9"
03.7854-4106.4	03.2120-4611.3 03.2125-0493.3 03.2126-3144.3 03.7853-4102.4	010937 010940 010941 300271	THz 20,64 THz 25,40 THz 26,99 9"
03.7854-4108.4	03.7853-4102.4	300271	9"
03.7854-4501.4	03.2120-4611.3 03.2125-0493.3 03.2126-3144.3	010937 010940 010941	THz 20,64 THz 25,40 THz 26,99



Bremsgeräte komplett

Booster units complete - Servofreni completi -
Servo-freins complets - Servofreno completo

● Die Nr. befindet sich auf dem im Fahrzeug eingebautem Aggregat.
the number is on the unit build in the car
il numero si trova sull'aggregato montato nella macchina
le numéro se trouve sur la pièce montée dans le véhicule
el n° se encuentra en el equipo montado en el vehículo



03.7854-4502.4	03.2122-2031.3	010938	THz 22,20
03.7854-4601.4	03.2120-4611.3	010937	THz 20,64
	03.2125-0493.3	010940	THz 25,40
	03.2126-3144.3	010941	THz 26,99
	03.7853-4602.4	300302	9"
03.7854-4602.4	03.2122-2031.3	010938	THz 22,20
	03.7853-4602.4	300302	9"
03.7854-4603.4	03.7853-4602.4	300302	9"
03.7854-4701.4	03.2120-4611.3	010937	THz 20,64
	03.2125-0493.3	010940	THz 25,40
	03.2126-3144.3	010941	THz 26,99
03.7854-4702.4	03.2122-2031.3	010938	THz 22,20
03.7854-5401.4	03.2120-4611.3	010937	THz 20,64
	03.2125-0493.3	010940	THz 25,40
	03.2126-3144.3	010941	THz 26,99
03.7854-5402.4	03.2122-2031.3	010938	THz 22,20
03.7854-5404.4	03.2122-2031.3	010938	THz 22,20
03.7854-5406.4	03.2120-4611.3	010937	THz 20,64
	03.2125-0493.3	010940	THz 25,40
	03.2126-3144.3	010941	THz 26,99
03.7854-5501.4	03.2120-4611.3	010937	THz 20,64
	03.2125-0493.3	010940	THz 25,40
	03.2126-3144.3	010941	THz 26,99
03.7854-5502.4	03.2122-2031.3	010938	THz 22,20
03.7854-6001.4	03.2122-2031.3	010938	THz 22,20
03.7857-0301.4	03.2125-0421.3	010934	THz 25,40
03.7859-0101.4	03.7858-0102.4	300262	9/8" Tandem
03.7859-0103.4	03.7858-0102.4	300262	9/8" Tandem
03.7859-0731.4	03.7858-0732.4	300272	9/8" Tandem
03.7859-0732.4	03.2125-0421.3	010934	THz 25,40
	03.7858-0732.4	300272	9/8" Tandem
03.7859-0932.4	03.2125-0421.3	010934	THz 25,40
03.7859-0933.4	03.2125-0421.3	010934	THz 25,40
03.7859-1231.4	03.2125-0493.3	010940	THz 25,40
03.7859-1931.4	03.7858-1932.4	300263	9/8" Tandem
03.7859-2801.4	03.7858-2802.4	300303	9/8" Tandem
03.7859-2802.4	03.7858-2802.4	300303	9/8" Tandem

03.7859-3301.4	03.2125-9604.3	010581	THz 25,40
	03.7858-3302.4	300122	9/8" Tandem
03.7859-3302.4	03.2125-9604.3	010581	THz 25,40
	03.7858-3302.4	300122	9/8" Tandem
03.7859-3631.4	03.7858-3632.4	300234	9/8" Tandem
03.7859-4001.4	03.7858-3532.4	300233	9/8" Tandem
03.7859-4002.4	03.7858-3532.4	300233	9/8" Tandem
03.7859-4431.4	03.7858-4432.4	300304	9/8" Tandem
03.7859-4502.4	03.7858-4502.4	300202	9/8" Tandem
03.7859-4631.4	03.2125-0493.3	010940	THz 25,40
	03.7858-4632.4	300273	9/8" Tandem
03.7859-4632.4	03.7858-4632.4	300273	9/8" Tandem
03.7859-4831.4	03.7858-4832.4	300274	9/8" Tandem
03.7859-5031.4	03.7858-5032.4	300275	9/8" Tandem
03.7859-5131.4	03.7858-5132.4	300276	9/8" Tandem
03.7859-5232.4	03.2125-0421.3	010934	THz 25,40
03.7859-5233.4	03.2125-0421.3	010934	THz 25,40
03.7859-5234.4	03.2125-0421.3	010934	THz 25,40
03.7859-5331.4	03.2125-0421.3	010934	THz 25,40
03.7859-6001.4	03.7858-3532.4	300233	9/8" Tandem
03.7859-6002.4	03.7858-3532.4	300233	9/8" Tandem
03.7859-6101.4	03.7858-3632.4	300234	9/8" Tandem
03.7859-6102.4	03.7858-3632.4	300234	9/8" Tandem
03.7859-6103.4	03.7858-3632.4	300234	9/8" Tandem
03.7859-7601.4	03.7858-7602.4	300277	9/8" Tandem
03.7862-0101.4	03.2022-2624.3	010588	THz 22,20/20,64
	03.7860-0702.4	300123	10"
03.7862-0601.4	03.7860-0602.4	300141	10"
03.7862-0602.4	03.7860-0602.4	300141	10"
03.7862-0603.4	03.7860-0602.4	300141	10"
03.7862-0604.4	03.7860-0602.4	300141	10"
03.7862-0605.4	03.7860-0602.4	300141	10"
03.7862-0606.4	03.7860-0602.4	300141	10"

Bremsgeräte komplett

**Booster units complete - Servofreni completi -
Servo-freins complets - Servofreno completo**

● Die Nr. befindet sich auf dem im Fahrzeug eingebautem Aggregat.
the number is on the unit build in the car
il numero si trova sull'aggregato montato nella macchina
le numéro se trouve sur la pièce montée dans le véhicule
el n° se encuentra en el equipo montado en el vehículo



03.7862-1201.4	03.7860-1202.4	300187	10"
03.7862-1403.4	03.7860-1402.4	300228	10"
03.7862-1405.4	03.7860-1402.4	300228	10"
03.7862-1406.4	03.7860-1402.4	300228	10"
03.7862-2801.4	03.2123-3421.3	010933	THz 23,81
03.7862-3301.4	03.2123-3421.3	010933	THz 23,81
03.7862-3701.4	03.7860-3702.4	300305	9"
03.7862-3901.4	03.7860-8802.4	300291	10"
03.7862-3902.4	03.7860-8802.4	300291	10"
03.7862-3903.4	03.7860-8802.4	300291	10"
03.7862-4301.4	03.2122-2163.3	010800	THz 22,20
	03.7860-4302.4	300231	10"
03.7862-4701.4	03.2123-3421.3	010933	THz 23,81
03.7862-4801.4	03.2123-3421.3	010933	THz 23,81
03.7862-5301.4	03.2123-3421.3	010933	THz 23,81
03.7862-5701.4	03.7860-5702.4	300279	10"
03.7862-5801.4	03.7860-3732.4	300306	10"
03.7862-7801.4	03.7860-7802.4	300280	10"
03.7862-8601.4	03.2123-3421.3	010933	THz 23,81
03.7864-0331.4	03.7863-0332.4	300203	10"
03.7864-0332.4	03.7863-0332.4	300203	10"
03.7864-0401.4	03.2123-2024.3	010597	THz 23,81
	03.7863-0402.4	300124	10"
03.7864-0402.4	03.2123-2024.3	010597	THz 23,81
	03.7863-0402.4	300124	10"
03.7864-0730.4	03.7863-3932.4	300288	10"
03.7864-0731.4	03.7863-3932.4	300288	10"
03.7864-0831.4	03.2123-3593.3	010919	THz 23,81
	03.7863-4832.4	300289	10"
03.7864-0901.4	03.7863-0903.4	300244	10"
03.7864-0902.4	03.7863-0903.4	300244	10"
03.7864-1101.4	03.2023-2004.3	010788	THz 23,81/19,05
	03.7863-0903.4	300244	10"

03.7864-1102.4	03.7863-0903.4	300244	10"
03.7864-2001.4	03.2123-2146.3	010572	THz 23,81
	03.7863-2002.4	300126	10"
03.7864-2003.4	03.2123-2621.3	010701	THz 23,81
	03.7863-2002.4	300126	10"
03.7864-2101.4	03.2122-1521.3	010494	THz 22,20
	03.7863-2002.4	300126	10"
03.7864-2201.4	03.2123-2581.3	010613	THz 23,81
	03.7863-2202.4	300127	10"
03.7864-2301.4	03.2123-2581.3	010613	THz 23,81
03.7864-2801.4	03.2123-2561.3	010629	THz 23,81
	03.7863-2802.4	300188	10"
03.7864-3001.4	03.7863-3002.4	300223	10"
03.7864-3233.4	03.7863-3232.4	300307	10"
03.7864-3234.4	03.7863-3232.4	300307	10"
03.7864-3235.4	03.7863-3232.4	300307	10"
03.7864-3236.4	03.7863-3232.4	300307	10"
03.7864-3237.4	03.7863-3232.4	300307	10"
03.7864-3331.4	03.7863-3332.4	300308	10"
03.7864-3332.4	03.7863-3332.4	300308	10"
03.7864-3503.4	03.2123-2715.3	010802	THz 23,81
	03.7863-3502.4	300128	10"
03.7864-3504.4	03.2123-2715.3	010802	THz 23,81
	03.7863-3502.4	300128	10"
03.7864-3601.4	03.2122-2129.3	010799	THz 22,20
	03.7873-4302.4	300312	11"
03.7864-3602.4	03.2122-2129.3	010799	THz 22,20
	03.7873-4302.4	300312	11"
03.7864-4401.4	03.2122-1351.3	010528	THz 22,20
03.7864-4402.4	03.2122-1942.3	010700	THz 22,20
03.7864-4501.4	03.7863-4502.4	300230	10"
03.7864-4502.4	03.2123-3493.3	010792	THz 23,81
	03.7863-4502.4	300230	10"
03.7864-5001.4	03.2122-1351.3	010528	THz 22,20
03.7864-5002.4	03.2122-1942.3	010700	THz 22,20
03.7864-5003.4	03.2122-1351.3	010528	THz 22,20



Bremsgeräte komplett

Booster units complete - Servofreni completi -
Servo-freins complets - Servofreno completo

● Die Nr. befindet sich auf dem im Fahrzeug eingebautem Aggregat.
the number is on the unit build in the car
il numero si trova sull'aggregato montato nella macchina
le numéro se trouve sur la pièce montée dans le véhicule
el n° se encuentra en el equipo montado en el vehículo



03.7864-5004.4	03.2122-1942.3	010700	THz 22,20
03.7864-5301.4	03.2122-2129.3	010799	THz 22,20
03.7864-5302.4	03.2122-2129.3	010799	THz 22,20
03.7864-6001.4	03.7863-6002.4	300249	10"
03.7864-6002.4	03.7863-6002.4	300249	10"
03.7864-6302.4	03.2122-2129.3	010799	THz 22,20
03.7864-7801.4	03.7863-7803.4	300237	10"
03.7864-7802.4	03.7863-7803.4	300237	10"
03.7864-7803.4	03.4155-0153.3	010927	THz 25,40
	03.7863-7803.4	300237	10"
03.7864-7804.4	03.4155-0156.3	010862	THz 25,40
	03.7863-7803.4	300237	10"
03.7864-8501.4	03.7863-3932.4	300288	10"
03.7864-8502.4	03.7863-3932.4	300288	10"
03.7864-9501.4	03.7863-3232.4	300307	10"
03.7864-9502.4	03.7863-3232.4	300307	10"
03.7864-9801.4	03.7863-9802.4	300281	10"
03.7869-4101.4	03.7868-4102.4	300250	10/8" Tandem
03.7869-4701.4	03.7868-4702.4	300253	10/8" Tandem
03.7869-4702.4	03.7868-4702.4	300253	10/8" Tandem
03.7869-4703.4	03.7868-4702.4	300253	10/8" Tandem
03.7869-5201.4	03.7868-5202.4	300309	10"
03.7869-5301.4	03.7868-5302.4	300251	10/8" Tandem
03.7872-0607.4	03.7870-0602.4	300310	11"
03.7872-0608.4	03.7870-0602.4	300310	11"
03.7872-1101.4	03.2123-3421.3	010933	THz 23,81
03.7872-1201.4	03.2123-3421.3	010933	THz 23,81
03.7872-1601.4	03.2123-3421.3	010933	THz 23,81
	03.7870-1602.4	300311	11"
03.7874-1201.4	03.7873-1202.4	300197	11"
03.7874-1202.4	03.7873-1202.4	300197	11"
03.7874-1205.4	03.4153-0063.3	010773	THz 23,81
	03.7873-1202.4	300197	11"

03.7874-1305.4	03.4153-0063.3	010773	THz 23,81
03.7874-1801.4	03.2122-2129.3	010799	THz 22,20
03.7874-2601.4	03.4153-0063.3	010773	THz 23,81
03.7874-2701.4	03.4153-0063.3	010773	THz 23,81
03.7874-3001.4	03.2122-2129.3	010799	THz 22,20
03.7874-3701.4	03.7873-3702.4	300283	11"
03.7874-3702.4	03.7873-3702.4	300283	11"
03.7874-3901.4	03.7873-3902.4	300254	11"
03.7874-3902.4	03.7873-3902.4	300254	11"
03.7874-4304.4	03.7873-4302.4	300312	11"
03.7874-4305.4	03.7873-4302.4	300312	11"
03.7874-4501.4	03.7873-4502.4	300284	11"
03.7874-4502.4	03.7873-4502.4	300284	11"
03.7874-4503.4	03.7873-4502.4	300284	11"
03.7874-4504.4	03.7873-4502.4	300284	11"
03.7874-4505.4	03.7873-4502.4	300284	11"
03.7874-4506.4	03.7873-4502.4	300284	11"
10.6350-2002.4	10.6123-0522.3	010633	THz 23,81
10.6352-2901.4	10.6350-3902.4	300213	9"
10.6352-2902.4	10.6350-3902.4	300213	9"
10.6352-4001.4	03.2122-1421.3	010615	THz 22,20
	10.6350-4002.4	300285	9"
10.6353-2901.4	10.6350-3902.4	300213	9"
10.6353-2902.4	10.6350-3902.4	300213	9"
10.6353-4001.4	03.2122-1421.3	010615	THz 22,20
	10.6350-4002.4	300285	9"
10.6362-0403.4	10.6360-1903.4	300093	10" (MKIV)
10.6362-0501.4	10.6360-1003.4	300156	10"
10.6362-0502.4	10.6360-1003.4	300156	10"
10.6362-0503.4	10.6360-1003.4	300156	10"
10.6362-0504.4	10.6360-1003.4	300156	10"
10.6362-1001.4	10.6360-1003.4	300156	10"

Bremsgeräte komplett

Booster units complete - Servofreni completi -
Servo-freins complets - Servofreno completo

● Die Nr. befindet sich auf dem im Fahrzeug eingebautem Aggregat.
the number is on the unit build in the car
il numero si trova sull'aggregato montato nella macchina
le numéro se trouve sur la pièce montée dans le véhicule
el n° se encuentra en el equipo montado en el vehículo



10.6362-1002.4 **10.6360-1003.4** 300156 10"

10.6362-1003.4 **10.6360-1003.4** 300156 10"

10.6362-1004.4 **10.6360-1003.4** 300156 10"

10.6362-1301.4 **10.6360-1302.4** 300286 10"

10.6362-1302.4 **10.6360-1302.4** 300286 10"

10.6362-1905.4 **10.6360-1903.4** 300093 10" (MKIV)

10.6362-2001.4 **10.6360-2002.4** 300143 10"

10.6362-2002.4 **10.6360-2002.4** 300143 10"











- D** Reparatursätze
- EN** Repair kits
- FR** Kits de réparation
- IT** Corredi riparazione
- ES** Juegos de reparación
- NL** Reparatiesets
- DA** Reparationssæt
- SV** Reparationssatser
- HU** Javítókészletek
- PT** Kit de reparação
- RU** Ремонтные комплекты
- CZ** Sady pro opravu
- PL** Zestawy naprawcze
- EL** ΣΕΤ ΕΠΙΣΚΕΥΗΣ
- TR** Tamir takımları
- ZH** 维修组
- JA** リペアキット
- AR** طواقم التصليح

K24-H







Reparatursätze

Repair kits - Corredi riparazione - Nécessaires de réparation - Juegos de reparación

					
03.2122-2202.3 010140	03.0370-3922.2 053922	THz Reparatursatz	03.3508-3600.3 310030	03.3556-1164.2 390437	Verschraubung
03.2122-4902.3 010144	03.0370-3922.2 053922	THz Reparatursatz	03.3508-5201.3 310037	03.3556-1164.2 390437	Verschraubung
03.2415-0512.3 030001	03.0350-1508.2 071508	Gz Reparatursatz	03.3508-5851.3 310039	03.3556-1164.2 390437	Verschraubung
03.2415-0514.3 030002	03.0350-1508.2 071508	Gz Reparatursatz	03.3508-5951.3 310041	03.3556-1164.2 390437	Verschraubung
03.2415-0515.3 030003	03.0350-1508.2 071508	Gz Reparatursatz	03.3508-8302.3 310046	03.3556-1164.2 390437	Verschraubung
03.2419-3307.3 030014	03.0350-1906.2 071906	Gz Reparatursatz	03.3508-8326.3 310047	03.3556-1164.2 390437	Verschraubung
03.2419-7800.3 030016	03.0350-1919.2 071919	Gz Reparatursatz	03.3508-8753.3 310049	03.3556-1164.2 390437	Verschraubung
03.2419-9000.3 030025	03.0350-1919.2 071919	Gz Reparatursatz	03.3508-8801.3 310050	03.3556-1164.2 390437	Verschraubung
03.2515-1101.3 040001	03.0450-1502.2 081502	Nz Reparatursatz	03.3508-8802.3 310051	03.3556-1094.2 390427	Verschraubung + WE
03.2520-1201.3 040011	03.0450-2006.2 082006	Nz Reparatursatz	03.3508-8901.3 310054	03.3556-1164.2 390437	Verschraubung
03.2523-0811.3 040019	03.0450-2311.2 082311	Nz Reparatursatz	03.3508-8902.3 310055	03.3556-1094.2 390427	Verschraubung + WE
03.2525-1802.3 040025	03.0450-2509.2 082509	Nz Reparatursatz	03.3509-0100.3 310057	03.3556-1164.2 390437	Verschraubung
03.2525-2602.3 040029	03.0450-2510.2 082510	Nz Reparatursatz	03.3509-0218.3 310062	03.3506-0016.2 390255	Ausgleichskappe
03.2525-2711.3 040030	03.0450-2510.2 082510	Nz Reparatursatz	03.3509-0600.3 310065	03.3556-1164.2 390437	Verschraubung
03.2528-1301.3 040032	03.0450-2805.2 082805	Nz Reparatursatz	03.3509-1000.3 310066	03.3556-1164.2 390437	Verschraubung
03.2538-0102.3 040033	03.0450-3801.2 083801	Nz Reparatursatz	03.3558-0606.3 310075	03.3556-1113.2 390428	Verschraubung + WE
03.2538-0104.3 040035	03.0450-3801.2 083801	Nz Reparatursatz	03.3558-0704.3 310078	03.3556-1094.2 390427	Verschraubung + WE
03.2728-2101.3 020008	03.0402-1128.2 060027	Rz Reparatursatz	03.3558-0706.3 310079	03.3556-1113.2 390428	Verschraubung + WE
03.2728-2201.3 020009	03.0402-1128.2 060027	Rz Reparatursatz	03.7755-3402.4 300189	03.0655-0004.2 370004	Wegsensor
03.3128-1401.3 010295	03.0370-1828.2 051828	Hz Reparatursatz	03.7755-4702.4 300224	03.0655-0001.2 370001	Wegsensor
03.3131-2201.3 010300	03.0370-1131.2 051131	Hz Reparatursatz	03.7848-2002.4 300166	03.0655-0007.2 370007	Wegsensor
03.3131-2401.3 010303	03.0370-1131.2 051131	Hz Reparatursatz	03.7848-9402.4 300227	03.0655-0007.2 370007	Wegsensor
03.3138-2001.3 010310 010310	03.0370-1038.2 051038 03.0370-9998.2 059998	Hz Reparatursatz Hz Rep. Satz,-Kolben	03.7858-1932.4 300263	03.0655-0007.2 370007	Wegsensor
03.3219-0102.3 020036	03.0470-2619.2 060051	Rz Dichtungssatz	03.7858-3032.4 300257	03.0655-0001.2 370001	Wegsensor
03.3219-0411.3 020038	03.0470-2619.2 060051	Rz Dichtungssatz	03.7858-3532.4 300233	03.0655-0001.2 370001	Wegsensor
03.3231-3401.3 020120	03.0401-2031.2 052031	Rz Reparatursatz	03.7858-3632.4 300234	03.0655-0001.2 370001	Wegsensor
03.3241-1801.3 020130	03.0403-0341.2 060031	Rz Reparatursatz	03.7858-9502.4 300205	03.0655-0006.2 370006	Wegsensor
03.3241-1802.3 020131	03.0403-0341.2 060031	Rz Reparatursatz	03.7863-0832.4 300229	03.0655-0007.2 370007	Wegsensor
03.3508-0100.3 310002	03.3556-1164.2 390437	Verschraubung	03.7863-0903.4 300244	03.0655-0007.2 370007	Wegsensor
03.3508-0264.3 310009	03.3556-1164.2 390437	Verschraubung	03.7863-4132.4 300259	03.0655-0007.2 370007	Wegsensor
03.3508-0401.3 310014	03.3556-1164.2 390437	Verschraubung	03.7868-4702.4 300253	03.0655-0006.2 370006	Wegsensor
03.3508-0500.3 310016	03.3556-1164.2 390437	Verschraubung	03.7873-0202.4 300152	03.0655-0007.2 370007	Wegsensor
03.3508-0501.3 310017	03.3556-1164.2 390437	Verschraubung	11.1361-0004.2 200001	11.0441-3601.2 250007	Dichtungssatz
03.3508-0801.3 310023	03.3556-1164.2 390437	Verschraubung	11.1441-8035.2 200002	11.0441-4402.2 250014	Dichtungssatz
			11.1441-8036.2 200003	11.0441-4402.2 250014	Dichtungssatz



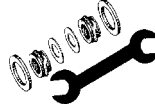



Reparatursätze

Repair kits - Corredi riparazione - Nécessaires de réparation - Juegos de reparación

					
11.1541-0013.2 200005	11.0441-5401.2 250027	Dichtungssatz	11.3361-8503.2 220016	11.0101-5402.2 260009	Hülsensatz
11.3331-0033.2 220001	11.0441-3305.2 250006	Dichtungssatz	220016	11.0441-3602.2 250008	Dichtungssatz
11.3331-0034.2 220002	11.0441-3305.2 250006	Dichtungssatz	220016	11.8116-0066.1 390577	Haltefeder
11.3331-0037.2 220395	11.0441-3305.2 250006	Dichtungssatz	220016	11.8171-0008.1 990049	Führungsbolzen
11.3331-0038.2 220396	11.0441-3305.2 250006	Dichtungssatz	11.3361-8504.2 220017	11.0101-5402.2 260009	Hülsensatz
11.3331-0039.2 220387	11.0441-3305.2 250006	Dichtungssatz	220017	11.0441-3602.2 250008	Dichtungssatz
11.3331-0040.2 220388	11.0441-3305.2 250006	Dichtungssatz	220017	11.8116-0066.1 390577	Haltefeder
11.3331-8016.2 220003	11.0101-5402.2 260009	Hülsensatz	220017	11.8171-0008.1 990049	Führungsbolzen
220003	11.0441-3302.2 250004	Dichtungssatz	11.3361-8505.2 220024	11.0101-5402.2 260009	Hülsensatz
220003	11.8171-0008.1 990049	Führungsbolzen	220024	11.0441-3602.2 250008	Dichtungssatz
11.3331-8501.2 220004	11.0101-5402.2 260009	Hülsensatz	220024	11.8116-0185.1 390592	Haltefeder
220004	11.0441-3302.2 250004	Dichtungssatz	220024	11.8171-0008.1 990049	Führungsbolzen
220004	11.8116-0015.1 390492	Haltefeder	11.3361-8506.2 220025	11.0101-5402.2 260009	Hülsensatz
220004	11.8171-0008.1 990049	Führungsbolzen	220025	11.0441-3602.2 250008	Dichtungssatz
11.3331-8502.2 220005	11.0101-5402.2 260009	Hülsensatz	220025	11.8116-0185.1 390592	Haltefeder
220005	11.0441-3302.2 250004	Dichtungssatz	220025	11.8171-0008.1 990049	Führungsbolzen
220005	11.8116-0015.1 390492	Haltefeder	11.3361-9975.2 220281	11.0101-5407.2 260011	Hülsensatz
220005	11.8171-0008.1 990049	Führungsbolzen	220281	11.0441-3602.2 250008	Dichtungssatz
11.3334-8001.2 220006	11.0101-5407.2 260011	Hülsensatz	220281	11.8116-0073.1 390498	Haltefeder
220006	11.0441-3302.2 250004	Dichtungssatz	220281	11.8171-0008.1 990049	Führungsbolzen
220006	11.8171-0008.1 990049	Führungsbolzen	11.3361-9976.2 220282	11.0101-5407.2 260011	Hülsensatz
11.3334-8002.2 220007	11.0101-5407.2 260011	Hülsensatz	220282	11.0441-3602.2 250008	Dichtungssatz
220007	11.0441-3302.2 250004	Dichtungssatz	220282	11.8116-0073.1 390498	Haltefeder
220007	11.8171-0008.1 990049	Führungsbolzen	220282	11.8171-0008.1 990049	Führungsbolzen
11.3334-9995.2 220008	11.0101-5402.2 260009	Hülsensatz	11.3381-8501.2 220018	11.0101-5402.2 260009	Hülsensatz
220008	11.0441-3303.2 250005	Dichtungssatz	220018	11.0441-3802.2 250009	Dichtungssatz
220008	11.8171-0008.1 990049	Führungsbolzen	220018	11.8116-0066.1 390577	Haltefeder
11.3334-9996.2 220009	11.0101-5402.2 260009	Hülsensatz	220018	11.8171-0008.1 990049	Führungsbolzen
220009	11.0441-3303.2 250005	Dichtungssatz	11.3381-8502.2 220019	11.0101-5402.2 260009	Hülsensatz
220009	11.8171-0008.1 990049	Führungsbolzen	220019	11.0441-3802.2 250009	Dichtungssatz
11.3341-8501.2 220010	11.0101-5402.2 260009	Hülsensatz	220019	11.8116-0066.1 390577	Haltefeder
220010	11.0441-3401.2 250151	Dichtungssatz	220019	11.8171-0008.1 990049	Führungsbolzen
220010	11.8116-0066.1 390577	Haltefeder	11.3381-8503.2 220020	11.0101-5402.2 260009	Hülsensatz
220010	11.8171-0008.1 990049	Führungsbolzen	220020	11.0441-3803.2 250010	Dichtungssatz
11.3341-8502.2 220011	11.0101-5402.2 260009	Hülsensatz	220020	11.8116-0066.1 390577	Haltefeder
220011	11.0441-3401.2 250151	Dichtungssatz	220020	11.8171-0008.1 990049	Führungsbolzen
220011	11.8116-0066.1 390577	Haltefeder	11.3381-8504.2 220021	11.0101-5402.2 260009	Hülsensatz
220011	11.8171-0008.1 990049	Führungsbolzen	220021	11.0441-3803.2 250010	Dichtungssatz
11.3351-8501.2 220012	11.0101-5402.2 260009	Hülsensatz	220021	11.8116-0066.1 390577	Haltefeder
220012	11.8116-0015.1 390492	Haltefeder	220021	11.8171-0008.1 990049	Führungsbolzen
220012	11.8171-0008.1 990049	Führungsbolzen	11.3381-8505.2 220022	11.0101-5402.2 260009	Hülsensatz
11.3351-8502.2 220013	11.0101-5402.2 260009	Hülsensatz	220022	11.0441-3802.2 250009	Dichtungssatz
220013	11.8116-0015.1 390492	Haltefeder	220022	11.8116-0066.1 390577	Haltefeder
220013	11.8171-0008.1 990049	Führungsbolzen	220022	11.8171-0008.1 990049	Führungsbolzen
11.3351-8503.2 220014	11.0101-5402.2 260009	Hülsensatz	11.3381-8506.2 220023	11.0101-5402.2 260009	Hülsensatz
220014	11.8116-0015.1 390492	Haltefeder	220023	11.0441-3802.2 250009	Dichtungssatz
220014	11.8171-0008.1 990049	Führungsbolzen	220023	11.8116-0066.1 390577	Haltefeder
11.3351-8504.2 220015	11.0101-5402.2 260009	Hülsensatz	220023	11.8171-0008.1 990049	Führungsbolzen
220015	11.8116-0015.1 390492	Haltefeder	11.3401-0055.2 220519	11.0101-5407.2 260011	Hülsensatz
220015	11.8171-0008.1 990049	Führungsbolzen	220519	11.8116-0143.1 390513	Haltefeder
			220519	11.8171-0008.1 990049	Führungsbolzen
			11.3401-0056.2 220520	11.0101-5407.2 260011	Hülsensatz
			220520	11.8116-0143.1 390513	Haltefeder
			220520	11.8171-0008.1 990049	Führungsbolzen

Reparatursätze







Repair kits - Corredi riparazione - Nécessaires de réparation - Juegos de reparación

  				  			
11.3401-8501.2	220028	11.0101-5402.2	260009 Hülsensatz	11.3451-8501.2	220389	11.0101-5407.2	260011 Hülsensatz
	220028	11.0441-4002.2	250011 Dichtungssatz		220389	11.0101-5409.2	260035 Hülsensatz
	220028	11.8116-0066.1	390577 Haltefeder		220389	11.0441-4502.2	250143 Dichtungssatz
	220028	11.8171-0008.1	990049 Führungsbolzen		220389	11.8116-0172.1	390500 Haltefeder
					220389	11.8171-0008.1	990049 Führungsbolzen
11.3401-8502.2	220029	11.0101-5402.2	260009 Hülsensatz	11.3451-8502.2	220390	11.0101-5407.2	260011 Hülsensatz
	220029	11.0441-4002.2	250011 Dichtungssatz		220390	11.0101-5409.2	260035 Hülsensatz
	220029	11.8116-0066.1	390577 Haltefeder		220390	11.0441-4502.2	250143 Dichtungssatz
	220029	11.8171-0008.1	990049 Führungsbolzen		220390	11.8116-0172.1	390500 Haltefeder
					220390	11.8171-0008.1	990049 Führungsbolzen
11.3401-8503.2	220030	11.0101-5402.2	260009 Hülsensatz	11.3456-8003.2	220038	11.0441-4501.2	250015 Dichtungssatz
	220030	11.0441-4002.2	250011 Dichtungssatz				
	220030	11.8116-0066.1	390577 Haltefeder				
	220030	11.8171-0008.1	990049 Führungsbolzen				
11.3401-8504.2	220031	11.0101-5402.2	260009 Hülsensatz	11.3456-8004.2	220039	11.0441-4501.2	250015 Dichtungssatz
	220031	11.0441-4002.2	250011 Dichtungssatz				
	220031	11.8116-0066.1	390577 Haltefeder				
	220031	11.8171-0008.1	990049 Führungsbolzen				
11.3401-8505.2	220032	11.0101-5402.2	260009 Hülsensatz	11.3481-0106.2	220040	11.0101-4802.2	260007 Hülsensatz
	220032	11.0441-4002.2	250011 Dichtungssatz		220040	11.0441-4810.2	250023 Dichtungssatz
	220032	11.8116-0094.1	390504 Haltefeder				
	220032	11.8171-0008.1	990049 Führungsbolzen				
11.3401-8506.2	220033	11.0101-5402.2	260009 Hülsensatz	11.3481-0107.2	220041	11.0101-4802.2	260007 Hülsensatz
	220033	11.0441-4002.2	250011 Dichtungssatz				
	220033	11.8116-0094.1	390504 Haltefeder				
	220033	11.8171-0008.1	990049 Führungsbolzen				
11.3401-8507.2	220034	11.0101-5402.2	260009 Hülsensatz	11.3481-0108.2	220042	11.0101-4802.2	260007 Hülsensatz
	220034	11.0441-4002.2	250011 Dichtungssatz				
	220034	11.8116-0296.1	390445 Haltefeder				
	220034	11.8171-0008.1	990049 Führungsbolzen				
11.3401-8508.2	220035	11.0101-5402.2	260009 Hülsensatz	11.3481-0167.2	220285	11.0101-5407.2	260011 Hülsensatz
	220035	11.0441-4002.2	250011 Dichtungssatz		220285	11.0441-4811.2	250024 Dichtungssatz
	220035	11.8116-0296.1	390445 Haltefeder				
	220035	11.8171-0008.1	990049 Führungsbolzen				
11.3401-8511.2	220026	11.0101-5402.2	260009 Hülsensatz	11.3481-0168.2	220286	11.0101-5407.2	260011 Hülsensatz
	220026	11.0441-4002.2	250011 Dichtungssatz		220286	11.0441-4811.2	250024 Dichtungssatz
	220026	11.8116-0296.1	390445 Haltefeder				
	220026	11.8171-0008.1	990049 Führungsbolzen				
11.3401-8512.2	220027	11.0101-5402.2	260009 Hülsensatz	11.3481-8014.2	220045	11.0101-4802.2	260007 Hülsensatz
	220027	11.0441-4002.2	250011 Dichtungssatz		220045	11.0441-4803.2	250018 Dichtungssatz
	220027	11.8116-0296.1	390445 Haltefeder				
	220027	11.8171-0008.1	990049 Führungsbolzen				
11.3401-8513.2	220036	11.0101-5402.2	260009 Hülsensatz	11.3481-8015.2	220046	11.0101-4802.2	260007 Hülsensatz
	220036	11.0441-4002.2	250011 Dichtungssatz		220046	11.0441-4803.2	250018 Dichtungssatz
	220036	11.8116-0315.2	390447 Haltefeder				
	220036	11.8171-0008.1	990049 Führungsbolzen				
11.3401-8514.2	220037	11.0101-5402.2	260009 Hülsensatz	11.3481-8016.2	220047	11.0101-4802.2	260007 Hülsensatz
	220037	11.0441-4002.2	250011 Dichtungssatz		220047	11.0441-4803.2	250018 Dichtungssatz
	220037	11.8116-0315.2	390447 Haltefeder				
	220037	11.8171-0008.1	990049 Führungsbolzen				
11.3421-8501.2	220405	11.0101-6004.2	260014 Hülsensatz	11.3481-8029.2	220048	11.0101-4802.2	260007 Hülsensatz
	220405	11.8116-0133.1	390511 Haltefeder		220048	11.0441-4803.2	250018 Dichtungssatz
	220405	11.8171-0008.1	990049 Führungsbolzen				
11.3421-8502.2	220406	11.0101-6004.2	260014 Hülsensatz	11.3481-8030.2	220049	11.0101-4802.2	260007 Hülsensatz
	220406	11.8116-0133.1	390511 Haltefeder		220049	11.0441-4803.2	250018 Dichtungssatz
	220406	11.8171-0008.1	990049 Führungsbolzen				
				11.3481-8037.2	220050	11.0101-5407.2	260011 Hülsensatz
					220050	11.0441-4805.2	250020 Dichtungssatz
					220050	11.8171-0008.1	990049 Führungsbolzen
				11.3481-8038.2	220051	11.0101-5407.2	260011 Hülsensatz
					220051	11.0441-4805.2	250020 Dichtungssatz
					220051	11.8171-0008.1	990049 Führungsbolzen
				11.3481-8075.2	220053	11.0101-5407.2	260011 Hülsensatz
					220053	11.0441-4811.2	250024 Dichtungssatz
					220053	11.8171-0008.1	990049 Führungsbolzen
				11.3481-8076.2	220054	11.0101-5407.2	260011 Hülsensatz
					220054	11.0441-4811.2	250024 Dichtungssatz
					220054	11.8171-0008.1	990049 Führungsbolzen
				11.3481-8083.2	220057	11.0101-5407.2	260011 Hülsensatz
					220057	11.0441-4811.2	250024 Dichtungssatz
					220057	11.8116-0129.1	390591 Haltefeder
					220057	11.8171-0008.1	990049 Führungsbolzen
				11.3481-8084.2	220058	11.0101-5407.2	260011 Hülsensatz
					220058	11.0441-4811.2	250024 Dichtungssatz
					220058	11.8116-0129.1	390591 Haltefeder
					220058	11.8171-0008.1	990049 Führungsbolzen





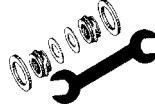



Reparatursätze

Repair kits - Corredi riparazione - Nécessaires de réparation - Juegos de reparación

  				  			
11.3481-8085.2	220059	11.0101-5407.2 260011	Hülsensatz	11.3481-8516.2	220366	11.0101-5407.2 260011	Hülsensatz
	220059	11.0441-4811.2 250024	Dichtungssatz		220366	11.8116-0264.1 390594	Haltefeder
	220059	11.8116-0129.1 390591	Haltefeder		220366	11.8171-0008.1 990049	Führungsbolzen
	220059	11.8171-0008.1 990049	Führungsbolzen				
11.3481-8086.2	220060	11.0101-5407.2 260011	Hülsensatz	11.3481-9833.2	220561	11.0101-5407.2 260011	Hülsensatz
	220060	11.0441-4811.2 250024	Dichtungssatz		220561	11.0441-4811.2 250024	Dichtungssatz
	220060	11.8116-0129.1 390591	Haltefeder		220561	11.8116-0129.1 390591	Haltefeder
	220060	11.8171-0008.1 990049	Führungsbolzen		220561	11.8171-0008.1 990049	Führungsbolzen
11.3481-8503.2	220061	11.0101-4801.2 260006	Hülsensatz	11.3481-9834.2	220562	11.0101-5407.2 260011	Hülsensatz
	220061	11.0441-4804.2 250019	Dichts.a.(+Sich.Ring)		220562	11.0441-4811.2 250024	Dichtungssatz
	220061	11.0441-4808.2 250022	Dichtungssatz		220562	11.8116-0129.1 390591	Haltefeder
	220061	24.0102-4801.2 260085	Hülsensatz+Schrauben		220562	11.8171-0008.1 990049	Führungsbolzen
11.3481-8504.2	220062	11.0101-4801.2 260006	Hülsensatz	11.3521-8003.2	220070	11.0101-4802.2 260007	Hülsensatz
	220062	11.0441-4804.2 250019	Dichts.a.(+Sich.Ring)	11.3521-8004.2	220071	11.0101-4802.2 260007	Hülsensatz
	220062	11.0441-4808.2 250022	Dichtungssatz	11.3521-8011.2	220072	11.0441-5202.2 250026	Dichtungssatz
	220062	24.0102-4801.2 260085	Hülsensatz+Schrauben	11.3521-8012.2	220073	11.0441-5202.2 250026	Dichtungssatz
11.3481-8505.2	220063	11.0101-5407.2 260011	Hülsensatz	11.3521-8501.2	220391	11.0101-5407.2 260011	Hülsensatz
	220063	11.0441-4805.2 250020	Dichtungssatz		220391	11.0101-5409.2 260035	Hülsensatz
	220063	11.8171-0008.1 990049	Führungsbolzen		220391	11.0441-5203.2 250144	Dichtungssatz
11.3481-8506.2	220064	11.0101-5407.2 260011	Hülsensatz		220391	11.8116-0191.1 390522	Haltefeder
	220064	11.0441-4805.2 250020	Dichtungssatz		220391	11.8171-0008.1 990049	Führungsbolzen
	220064	11.8171-0008.1 990049	Führungsbolzen	11.3521-8502.2	220392	11.0101-5407.2 260011	Hülsensatz
11.3481-8507.2	220065	11.0101-5402.2 260009	Hülsensatz		220392	11.0101-5409.2 260035	Hülsensatz
	220065	11.0441-4810.2 250023	Dichtungssatz		220392	11.0441-5203.2 250144	Dichtungssatz
	220065	11.8171-0008.1 990049	Führungsbolzen		220392	11.8116-0191.1 390522	Haltefeder
11.3481-8508.2	220066	11.0101-5402.2 260009	Hülsensatz		220392	11.8171-0008.1 990049	Führungsbolzen
	220066	11.0441-4810.2 250023	Dichtungssatz	11.3541-0257.2	220074	11.0101-5407.2 260011	Hülsensatz
	220066	11.8171-0008.1 990049	Führungsbolzen		220074	11.8171-0008.1 990049	Führungsbolzen
11.3481-8509.2	220329	11.0101-4801.2 260006	Hülsensatz	11.3541-0258.2	220075	11.0101-5407.2 260011	Hülsensatz
	220329	11.0441-4808.2 250022	Dichtungssatz		220075	11.8171-0008.1 990049	Führungsbolzen
	220329	24.0102-4801.2 260085	Hülsensatz+Schrauben	11.3541-8017.2	220076	11.0101-5407.2 260011	Hülsensatz
11.3481-8510.2	220330	11.0101-4801.2 260006	Hülsensatz		220076	11.0441-5402.2 250028	Dichtungssatz
	220330	11.0441-4808.2 250022	Dichtungssatz		220076	11.8171-0008.1 990049	Führungsbolzen
	220330	24.0102-4801.2 260085	Hülsensatz+Schrauben	11.3541-8018.2	220077	11.0101-5407.2 260011	Hülsensatz
11.3481-8511.2	220337	11.0101-5407.2 260011	Hülsensatz		220077	11.0441-5402.2 250028	Dichtungssatz
	220337	11.0441-4805.2 250020	Dichtungssatz		220077	11.8171-0008.1 990049	Führungsbolzen
	220337	11.8171-0008.1 990049	Führungsbolzen	11.3541-8039.2	220078	11.0441-5404.2 250029	Dichtungssatz
11.3481-8512.2	220338	11.0101-5407.2 260011	Hülsensatz	11.3541-8040.2	220079	11.0441-5404.2 250029	Dichtungssatz
	220338	11.0441-4805.2 250020	Dichtungssatz	11.3541-8045.2	220080	11.0101-5407.2 260011	Hülsensatz
	220338	11.8171-0008.1 990049	Führungsbolzen		220080	11.0441-5405.2 250030	Dichtungssatz
11.3481-8513.2	220335	11.0101-5407.2 260011	Hülsensatz		220080	11.8171-0008.1 990049	Führungsbolzen
	220335	11.0230-0687.1 260106	Halter	11.3541-8061.2	220081	11.0101-5407.2 260011	Hülsensatz
	220335	11.0441-4805.2 250020	Dichtungssatz		220081	11.0441-5402.2 250028	Dichtungssatz
	220335	11.8116-0264.1 390594	Haltefeder		220081	11.8171-0008.1 990049	Führungsbolzen
	220335	11.8171-0008.1 990049	Führungsbolzen	11.3541-8062.2	220082	11.0101-5407.2 260011	Hülsensatz
11.3481-8514.2	220336	11.0101-5407.2 260011	Hülsensatz		220082	11.0441-5402.2 250028	Dichtungssatz
	220336	11.0230-0687.1 260106	Halter		220082	11.8171-0008.1 990049	Führungsbolzen
	220336	11.0441-4805.2 250020	Dichtungssatz	11.3541-8065.2	220083	11.0441-5404.2 250029	Dichtungssatz
	220336	11.8116-0264.1 390594	Haltefeder		220084	11.0441-5404.2 250029	Dichtungssatz
	220336	11.8171-0008.1 990049	Führungsbolzen	11.3541-8066.2	220084	11.0441-5404.2 250029	Dichtungssatz
11.3481-8515.2	220365	11.0101-5407.2 260011	Hülsensatz				
	220365	11.8116-0264.1 390594	Haltefeder				
	220365	11.8171-0008.1 990049	Führungsbolzen				

Reparatursätze







Repair kits - Corredi riparazione - Nécessaires de réparation - Juegos de reparación

  				  			
11.3541-8067.2	220085 220085	11.0101-5407.2 260011 11.0441-5405.2 250030	Hülssensatz Dichtungssatz	11.3541-8504.2	220096 220096 220096	11.0101-5409.2 260035 11.0441-5405.2 250030 11.8171-0008.1 990049	Hülssensatz Dichtungssatz Führungsbolzen
11.3541-8068.2	220086 220086	11.0101-5407.2 260011 11.0441-5405.2 250030	Hülssensatz Dichtungssatz	11.3541-8505.2	220097 220097 220097	11.0101-5407.2 260011 11.0441-5402.2 250028 11.8171-0008.1 990049	Hülssensatz Dichtungssatz Führungsbolzen
11.3541-8083.2	220241 220241 220241	11.0101-5407.2 260011 11.8116-0292.1 390521 11.8171-0008.1 990049	Hülssensatz Haltefeder Führungsbolzen	11.3541-8506.2	220098 220098 220098	11.0101-5407.2 260011 11.0441-5402.2 250028 11.8171-0008.1 990049	Hülssensatz Dichtungssatz Führungsbolzen
11.3541-8084.2	220242 220242 220242	11.0101-5407.2 260011 11.8116-0292.1 390521 11.8171-0008.1 990049	Hülssensatz Haltefeder Führungsbolzen	11.3541-8507.2	220099 220099 220099	11.0101-5407.2 260011 11.0441-5402.2 250028 11.8171-0008.1 990049	Hülssensatz Dichtungssatz Führungsbolzen
11.3541-8085.2	220287 220287 220287 220287	11.0101-5407.2 260011 11.8116-0129.1 390591 11.8116-0292.1 390521 11.8171-0008.1 990049	Hülssensatz Haltefeder Haltefeder Führungsbolzen	11.3541-8508.2	220100 220100 220100	11.0101-5407.2 260011 11.0441-5402.2 250028 11.8171-0008.1 990049	Hülssensatz Dichtungssatz Führungsbolzen
11.3541-8086.2	220288 220288 220288 220288	11.0101-5407.2 260011 11.8116-0129.1 390591 11.8116-0292.1 390521 11.8171-0008.1 990049	Hülssensatz Haltefeder Haltefeder Führungsbolzen	11.3541-8509.2	220101 220101 220101	11.0101-5407.2 260011 11.0441-5402.2 250028 11.8171-0008.1 990049	Hülssensatz Dichtungssatz Führungsbolzen
11.3541-8089.2	220087 220087 220087	11.0101-5407.2 260011 11.0441-5402.2 250028 11.8171-0008.1 990049	Hülssensatz Dichtungssatz Führungsbolzen	11.3541-8510.2	220102 220102 220102	11.0101-5407.2 260011 11.0441-5402.2 250028 11.8171-0008.1 990049	Hülssensatz Dichtungssatz Führungsbolzen
11.3541-8090.2	220088 220088 220088	11.0101-5407.2 260011 11.0441-5402.2 250028 11.8171-0008.1 990049	Hülssensatz Dichtungssatz Führungsbolzen	11.3541-8511.2	220103 220103 220103 220103	11.0101-5402.2 260009 11.0441-5402.2 250028 11.8116-0091.1 390502 11.8171-0008.1 990049	Hülssensatz Dichtungssatz Haltefeder Führungsbolzen
11.3541-8091.2	220089 220089 220089	11.0101-5407.2 260011 11.0441-5402.2 250028 11.8171-0008.1 990049	Hülssensatz Dichtungssatz Führungsbolzen	11.3541-8512.2	220104 220104 220104 220104	11.0101-5402.2 260009 11.0441-5402.2 250028 11.8116-0091.1 390502 11.8171-0008.1 990049	Hülssensatz Dichtungssatz Haltefeder Führungsbolzen
11.3541-8092.2	220090 220090 220090	11.0101-5407.2 260011 11.0441-5402.2 250028 11.8171-0008.1 990049	Hülssensatz Dichtungssatz Führungsbolzen	11.3541-8513.2	220105 220105 220105 220105	11.0101-5402.2 260009 11.0441-5402.2 250028 11.8170-0729.1 260107 11.8171-0008.1 990049	Hülssensatz Dichtungssatz Haltefeder Führungsbolzen
11.3541-8101.2	220091 220091 220091 220091	11.0101-5407.2 260011 11.0441-5402.2 250028 11.8116-0097.1 390590 11.8171-0008.1 990049	Hülssensatz Dichtungssatz Haltefeder Führungsbolzen	11.3541-8514.2	220106 220106 220106 220106	11.0101-5402.2 260009 11.0441-5402.2 250028 11.8170-0729.1 260107 11.8171-0008.1 990049	Hülssensatz Dichtungssatz Haltefeder Führungsbolzen
11.3541-8102.2	220092 220092 220092 220092	11.0101-5407.2 260011 11.0441-5402.2 250028 11.8116-0097.1 390590 11.8171-0008.1 990049	Hülssensatz Dichtungssatz Haltefeder Führungsbolzen	11.3541-8515.2	220107 220107 220107	11.0101-5402.2 260009 11.0441-5402.2 250028 11.8171-0008.1 990049	Hülssensatz Dichtungssatz Führungsbolzen
11.3541-8105.2	220339 220339	11.0101-5407.2 260011 11.8171-0008.1 990049	Hülssensatz Führungsbolzen	11.3541-8516.2	220108 220108 220108	11.0101-5402.2 260009 11.0441-5402.2 250028 11.8171-0008.1 990049	Hülssensatz Dichtungssatz Führungsbolzen
11.3541-8106.2	220340 220340	11.0101-5407.2 260011 11.8171-0008.1 990049	Hülssensatz Führungsbolzen	11.3541-8517.2	220109 220109 220109 220109	11.0101-5402.2 260009 11.0441-5402.2 250028 11.8116-0091.1 390502 11.8171-0008.1 990049	Hülssensatz Dichtungssatz Haltefeder Führungsbolzen
11.3541-8501.2	220093 220093 220093	11.0101-5409.2 260035 11.0441-5405.2 250030 11.8171-0008.1 990049	Hülssensatz Dichtungssatz Führungsbolzen	11.3541-8518.2	220110 220110 220110 220110	11.0101-5402.2 260009 11.0441-5402.2 250028 11.8116-0091.1 390502 11.8171-0008.1 990049	Hülssensatz Dichtungssatz Haltefeder Führungsbolzen
11.3541-8502.2	220094 220094 220094	11.0101-5409.2 260035 11.0441-5405.2 250030 11.8171-0008.1 990049	Hülssensatz Dichtungssatz Führungsbolzen	11.3541-8519.2	220111 220111	11.0101-5409.2 260035 11.0441-5405.2 250030	Hülssensatz Dichtungssatz





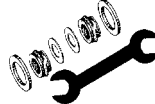



Reparatursätze

Repair kits - Corredi riparazione - Nécessaires de réparation - Juegos de reparación

  				  			
11.3541-8520.2	220112	11.0101-5409.2	260035 Hülsensatz	11.3571-8503.2	220123	11.0101-5402.2	260009 Hülsensatz
	220112	11.0441-5405.2	250030 Dichtungssatz		220123	11.0441-5702.2	250033 Dichtungssatz
					220123	11.8116-0091.1	390502 Haltefeder
					220123	11.8171-0008.1	990049 Führungsbolzen
11.3541-8521.2	220113	11.0101-5409.2	260035 Hülsensatz	11.3571-8504.2	220124	11.0101-5402.2	260009 Hülsensatz
	220113	11.0441-5405.2	250030 Dichtungssatz		220124	11.0441-5702.2	250033 Dichtungssatz
					220124	11.8116-0091.1	390502 Haltefeder
					220124	11.8171-0008.1	990049 Führungsbolzen
11.3541-8522.2	220114	11.0101-5409.2	260035 Hülsensatz	11.3571-8505.2	220125	11.0101-5409.2	260035 Hülsensatz
	220114	11.0441-5405.2	250030 Dichtungssatz		220125	11.0441-5704.2	250034 Dichtungssatz
					220125	11.8116-0143.1	390513 Haltefeder
					220125	11.8170-0306.1	260102 Halter
					220125	11.8171-0008.1	990049 Führungsbolzen
11.3541-8523.2	220115	11.0101-5409.2	260035 Hülsensatz	11.3571-8506.2	220126	11.0101-5409.2	260035 Hülsensatz
	220115	11.0441-5409.2	250031 Dichtungssatz		220126	11.0441-5704.2	250034 Dichtungssatz
	220115	11.8116-0143.1	390513 Haltefeder		220126	11.8116-0143.1	390513 Haltefeder
	220115	11.8170-0306.1	260102 Halter		220126	11.8171-0008.1	990049 Führungsbolzen
	220115	11.8171-0008.1	990049 Führungsbolzen				
11.3541-8524.2	220116	11.0101-5409.2	260035 Hülsensatz	11.3571-8507.2	220127	11.0101-5409.2	260035 Hülsensatz
	220116	11.0441-5409.2	250031 Dichtungssatz		220127	11.0441-5704.2	250034 Dichtungssatz
	220116	11.8116-0143.1	390513 Haltefeder		220127	11.8116-0143.1	390513 Haltefeder
	220116	11.8170-0306.1	260102 Halter		220127	11.8170-0306.1	260102 Halter
	220116	11.8171-0008.1	990049 Führungsbolzen		220127	11.8171-0008.1	990049 Führungsbolzen
11.3541-8529.2	220341	11.0101-5407.2	260011 Hülsensatz	11.3571-8508.2	220128	11.0101-5409.2	260035 Hülsensatz
	220341	11.0441-5402.2	250028 Dichtungssatz		220128	11.0441-5704.2	250034 Dichtungssatz
	220341	11.8116-0264.1	390594 Haltefeder		220128	11.8116-0143.1	390513 Haltefeder
	220341	11.8171-0008.1	990049 Führungsbolzen		220128	11.8170-0306.1	260102 Halter
					220128	11.8171-0008.1	990049 Führungsbolzen
11.3541-8530.2	220342	11.0101-5407.2	260011 Hülsensatz	11.3571-8509.2	220313	11.0101-5407.2	260011 Hülsensatz
	220342	11.0441-5402.2	250028 Dichtungssatz		220313	11.0441-5703.2	250145 Dichtungssatz
	220342	11.8116-0264.1	390594 Haltefeder		220313	11.8116-0253.1	390512 Haltefeder
	220342	11.8171-0008.1	990049 Führungsbolzen		220313	11.8171-0008.1	990049 Führungsbolzen
11.3541-8531.2	220367	11.0101-5407.2	260011 Hülsensatz	11.3571-8510.2	220314	11.0101-5407.2	260011 Hülsensatz
	220367	11.8116-0264.1	390594 Haltefeder		220314	11.0441-5703.2	250145 Dichtungssatz
	220367	11.8116-0356.1	390586 Haltefeder		220314	11.8116-0253.1	390512 Haltefeder
	220367	11.8171-0008.1	990049 Führungsbolzen		220314	11.8171-0008.1	990049 Führungsbolzen
11.3541-8532.2	220368	11.0101-5407.2	260011 Hülsensatz	11.3571-8511.2	220315	11.0101-5407.2	260011 Hülsensatz
	220368	11.8116-0264.1	390594 Haltefeder		220315	11.0441-5703.2	250145 Dichtungssatz
	220368	11.8116-0356.1	390586 Haltefeder		220315	11.8116-0253.1	390512 Haltefeder
	220368	11.8171-0008.1	990049 Führungsbolzen		220315	11.8170-0401.1	260103 Halter
					220315	11.8171-0008.1	990049 Führungsbolzen
11.3571-8007.2	220117	11.0101-5407.2	260011 Hülsensatz	11.3571-8512.2	220316	11.0101-5407.2	260011 Hülsensatz
	220117	11.0441-5702.2	250033 Dichtungssatz		220316	11.0441-5703.2	250145 Dichtungssatz
	220117	11.8116-0073.1	390498 Haltefeder		220316	11.8116-0253.1	390512 Haltefeder
	220117	11.8171-0008.1	990049 Führungsbolzen		220316	11.8170-0401.1	260103 Halter
					220316	11.8171-0008.1	990049 Führungsbolzen
11.3571-8008.2	220118	11.0101-5407.2	260011 Hülsensatz	11.3571-8009.2	220119	11.0101-5407.2	260011 Hülsensatz
	220118	11.0441-5702.2	250033 Dichtungssatz		220119	11.0441-5702.2	250033 Dichtungssatz
	220118	11.8116-0073.1	390498 Haltefeder				
	220118	11.8171-0008.1	990049 Führungsbolzen				
11.3571-8009.2	220119	11.0101-5407.2	260011 Hülsensatz	11.3571-8010.2	220120	11.0101-5407.2	260011 Hülsensatz
	220119	11.0441-5702.2	250033 Dichtungssatz		220120	11.0441-5702.2	250033 Dichtungssatz
11.3571-8010.2	220120	11.0101-5407.2	260011 Hülsensatz	11.3571-8501.2	220121	11.0101-5402.2	260009 Hülsensatz
	220120	11.0441-5702.2	250033 Dichtungssatz		220121	11.0101-5407.2	260011 Hülsensatz
					220121	11.0441-5702.2	250033 Dichtungssatz
					220121	11.8116-0091.1	390502 Haltefeder
					220121	11.8171-0008.1	990049 Führungsbolzen
11.3571-8501.2	220121	11.0101-5402.2	260009 Hülsensatz	11.3571-8502.2	220122	11.0101-5402.2	260009 Hülsensatz
	220121	11.0101-5407.2	260011 Hülsensatz		220122	11.0101-5407.2	260011 Hülsensatz
	220121	11.0441-5702.2	250033 Dichtungssatz		220122	11.0441-5702.2	250033 Dichtungssatz
	220121	11.8116-0091.1	390502 Haltefeder		220122	11.8116-0091.1	390502 Haltefeder
	220121	11.8171-0008.1	990049 Führungsbolzen		220122	11.8171-0008.1	990049 Führungsbolzen
11.3571-8502.2	220122	11.0101-5402.2	260009 Hülsensatz	11.3571-8515.2	220333	11.0101-5409.2	260035 Hülsensatz
	220122	11.0101-5407.2	260011 Hülsensatz		220333	11.0441-5704.2	250034 Dichtungssatz
	220122	11.0441-5702.2	250033 Dichtungssatz		220333	11.8116-0237.1	390509 Haltefeder
	220122	11.8116-0091.1	390502 Haltefeder		220333	11.8171-0008.1	990049 Führungsbolzen
	220122	11.8171-0008.1	990049 Führungsbolzen	11.3571-8516.2	220334	11.0101-5409.2	260035 Hülsensatz
					220334	11.0441-5704.2	250034 Dichtungssatz
					220334	11.8116-0237.1	390509 Haltefeder
					220334	11.8171-0008.1	990049 Führungsbolzen
11.3571-8502.2	220122	11.0101-5402.2	260009 Hülsensatz	11.3571-8517.2	220321	11.0101-5409.2	260035 Hülsensatz
	220122	11.0101-5407.2	260011 Hülsensatz		220321	11.0441-5704.2	250034 Dichtungssatz
	220122	11.0441-5702.2	250033 Dichtungssatz		220321	11.8116-0143.1	390513 Haltefeder
	220122	11.8116-0091.1	390502 Haltefeder		220321	11.8171-0008.1	990049 Führungsbolzen
	220122	11.8171-0008.1	990049 Führungsbolzen				

Reparatursätze







Repair kits - Corredi riparazione - Nécessaires de réparation - Juegos de reparación

  				  			
11.3571-8518.2	220322	11.0101-5409.2 260035	Hülsensatz	11.3601-8063.2	220135	11.0101-5407.2 260011	Hülsensatz
	220322	11.0441-5704.2 250034	Dichtungssatz		220135	11.0441-6007.2 250146	Dichtungssatz
	220322	11.8116-0143.1 390513	Haltefeder		220135	11.8116-0073.1 390498	Haltefeder
	220322	11.8171-0008.1 990049	Führungsbolzen		220135	11.8171-0008.1 990049	Führungsbolzen
11.3571-8521.2	220319	11.0101-5409.2 260035	Hülsensatz	11.3601-8064.2	220136	11.0101-5407.2 260011	Hülsensatz
	220319	11.0441-5704.2 250034	Dichtungssatz		220136	11.0441-6007.2 250146	Dichtungssatz
	220319	11.8116-0143.1 390513	Haltefeder		220136	11.8116-0073.1 390498	Haltefeder
	220319	11.8170-0306.1 260102	Halter		220136	11.8171-0008.1 990049	Führungsbolzen
	220319	11.8171-0008.1 990049	Führungsbolzen				
11.3571-8522.2	220320	11.0101-5409.2 260035	Hülsensatz	11.3601-8065.2	220137	11.0101-5407.2 260011	Hülsensatz
	220320	11.0441-5704.2 250034	Dichtungssatz		220137	11.0441-6003.2 250037	Dichtungssatz
	220320	11.8116-0143.1 390513	Haltefeder		220137	11.8171-0008.1 990049	Führungsbolzen
	220320	11.8170-0306.1 260102	Halter				
	220320	11.8171-0008.1 990049	Führungsbolzen	11.3601-8066.2	220138	11.0101-5407.2 260011	Hülsensatz
					220138	11.0441-6003.2 250037	Dichtungssatz
					220138	11.8171-0008.1 990049	Führungsbolzen
11.3571-8523.2	220343	11.0101-5407.2 260011	Hülsensatz	11.3601-8067.2	220139	11.0101-5407.2 260011	Hülsensatz
	220343	11.0101-5409.2 260035	Hülsensatz		220139	11.0441-6007.2 250146	Dichtungssatz
	220343	11.0441-5704.2 250034	Dichtungssatz		220139	11.8171-0008.1 990049	Führungsbolzen
	220343	11.8116-0143.1 390513	Haltefeder				
	220343	11.8171-0008.1 990049	Führungsbolzen				
11.3571-8524.2	220344	11.0101-5407.2 260011	Hülsensatz	11.3601-8068.2	220140	11.0101-5407.2 260011	Hülsensatz
	220344	11.0101-5409.2 260035	Hülsensatz		220140	11.0441-6007.2 250146	Dichtungssatz
	220344	11.0441-5704.2 250034	Dichtungssatz		220140	11.8171-0008.1 990049	Führungsbolzen
	220344	11.8116-0143.1 390513	Haltefeder				
	220344	11.8171-0008.1 990049	Führungsbolzen	11.3601-8071.2	220141	11.0101-5407.2 260011	Hülsensatz
					220141	11.0441-6007.2 250146	Dichtungssatz
					220141	11.8171-0008.1 990049	Führungsbolzen
11.3571-8525.2	220363	11.0101-5407.2 260011	Hülsensatz	11.3601-8072.2	220142	11.0101-5407.2 260011	Hülsensatz
	220363	11.0441-5704.2 250034	Dichtungssatz		220142	11.0441-6007.2 250146	Dichtungssatz
	220363	11.8116-0292.1 390521	Haltefeder		220142	11.8171-0008.1 990049	Führungsbolzen
	220363	11.8171-0008.1 990049	Führungsbolzen				
11.3571-8526.2	220364	11.0101-5407.2 260011	Hülsensatz	11.3601-8073.2	220143	11.0101-5407.2 260011	Hülsensatz
	220364	11.0441-5704.2 250034	Dichtungssatz		220143	11.0441-6007.2 250146	Dichtungssatz
	220364	11.8116-0292.1 390521	Haltefeder		220143	11.8171-0008.1 990049	Führungsbolzen
	220364	11.8171-0008.1 990049	Führungsbolzen				
11.3601-0011.2	220129	11.0101-5407.2 260011	Hülsensatz	11.3601-8074.2	220144	11.0101-5407.2 260011	Hülsensatz
	220129	11.0441-6003.2 250037	Dichtungssatz		220144	11.0441-6007.2 250146	Dichtungssatz
	220129	11.8171-0008.1 990049	Führungsbolzen		220144	11.8171-0008.1 990049	Führungsbolzen
11.3601-0012.2	220130	11.0101-5407.2 260011	Hülsensatz	11.3601-8501.2	220145	11.0101-5402.2 260009	Hülsensatz
	220130	11.0441-6003.2 250037	Dichtungssatz		220145	11.0230-0020.2 260023	Haltefeder
	220130	11.8171-0008.1 990049	Führungsbolzen		220145	11.0441-6003.2 250037	Dichtungssatz
					220145	11.8116-0083.1 390501	Haltefeder
					220145	11.8171-0008.1 990049	Führungsbolzen
11.3601-0073.2	220131	11.0101-5407.2 260011	Hülsensatz	11.3601-8502.2	220146	11.0101-5402.2 260009	Hülsensatz
	220131	11.0441-6003.2 250037	Dichtungssatz		220146	11.0230-0020.2 260023	Haltefeder
	220131	11.8171-0008.1 990049	Führungsbolzen		220146	11.0441-6003.2 250037	Dichtungssatz
					220146	11.8116-0083.1 390501	Haltefeder
					220146	11.8171-0008.1 990049	Führungsbolzen
11.3601-0074.2	220132	11.0101-5407.2 260011	Hülsensatz	11.3601-8503.2	220147	11.0101-5402.2 260009	Hülsensatz
	220132	11.0441-6003.2 250037	Dichtungssatz		220147	11.0441-6003.2 250037	Dichtungssatz
	220132	11.8171-0008.1 990049	Führungsbolzen		220147	11.8116-0083.1 390501	Haltefeder
					220147	11.8171-0008.1 990049	Führungsbolzen
11.3601-8001.2	220133	11.0101-5407.2 260011	Hülsensatz	11.3601-8504.2	220148	11.0101-5402.2 260009	Hülsensatz
	220133	11.0441-6003.2 250037	Dichtungssatz		220148	11.0441-6003.2 250037	Dichtungssatz
	220133	11.8116-0052.1 390496	Haltefeder		220148	11.8116-0083.1 390501	Haltefeder
	220133	11.8171-0008.1 990049	Führungsbolzen		220148	11.8171-0008.1 990049	Führungsbolzen
11.3601-8002.2	220134	11.0101-5407.2 260011	Hülsensatz	11.3601-8505.2	220149	11.0101-5402.2 260009	Hülsensatz
	220134	11.0441-6003.2 250037	Dichtungssatz		220149	11.0441-6003.2 250037	Dichtungssatz
	220134	11.8116-0052.1 390496	Haltefeder		220149	11.8116-0083.1 390501	Haltefeder
	220134	11.8171-0008.1 990049	Führungsbolzen		220149	11.8171-0008.1 990049	Führungsbolzen
11.3601-8049.3	220327	11.0441-6007.2 250146	Dichtungssatz				
11.3601-8050.3	220328	11.0441-6007.2 250146	Dichtungssatz				





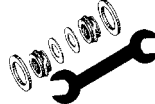



Reparatursätze

Repair kits - Corredi riparazione - Nécessaires de réparation - Juegos de reparación

  				  			
11.3601-8506.2	220150	11.0101-5402.2	260009 Hülsensatz	11.3601-8522.2	220348	11.0101-5407.2	260011 Hülsensatz
	220150	11.0441-6003.2	250037 Dichtungssatz		220348	11.0441-6003.2	250037 Dichtungssatz
	220150	11.8116-0083.1	390501 Haltefeder		220348	11.8116-0052.1	390496 Haltefeder
	220150	11.8171-0008.1	990049 Führungsbolzen		220348	11.8171-0008.1	990049 Führungsbolzen
11.3601-8507.2	220151	11.0101-5407.2	260011 Hülsensatz	11.3601-8523.2	220349	11.0101-5407.2	260011 Hülsensatz
	220151	11.0441-6003.2	250037 Dichtungssatz		220349	11.0441-6007.2	250146 Dichtungssatz
	220151	11.8116-0052.1	390496 Haltefeder		220349	11.8116-0073.1	390498 Haltefeder
	220151	11.8171-0008.1	990049 Führungsbolzen		220349	11.8171-0008.1	990049 Führungsbolzen
11.3601-8508.2	220152	11.0101-5407.2	260011 Hülsensatz	11.3601-8524.2	220350	11.0101-5407.2	260011 Hülsensatz
	220152	11.0441-6003.2	250037 Dichtungssatz		220350	11.0441-6007.2	250146 Dichtungssatz
	220152	11.8116-0052.1	390496 Haltefeder		220350	11.8116-0073.1	390498 Haltefeder
	220152	11.8171-0008.1	990049 Führungsbolzen		220350	11.8171-0008.1	990049 Führungsbolzen
11.3601-8509.2	220153	11.0101-6004.2	260014 Hülsensatz	11.3601-8525.2	220351	11.0101-5407.2	260011 Hülsensatz
	220153	11.0441-6003.2	250037 Dichtungssatz		220351	11.0441-6007.2	250146 Dichtungssatz
					220351	11.8116-0143.1	390513 Haltefeder
					220351	11.8171-0008.1	990049 Führungsbolzen
11.3601-8510.2	220154	11.0101-6004.2	260014 Hülsensatz	11.3601-8526.2	220352	11.0101-5407.2	260011 Hülsensatz
	220154	11.0441-6003.2	250037 Dichtungssatz		220352	11.0441-6007.2	250146 Dichtungssatz
					220352	11.8116-0143.1	390513 Haltefeder
					220352	11.8171-0008.1	990049 Führungsbolzen
11.3601-8511.2	220155	11.0101-5402.2	260009 Hülsensatz	11.3601-8527.2	220353	11.0101-5407.2	260011 Hülsensatz
	220155	11.0441-6003.2	250037 Dichtungssatz		220353	11.0441-6007.2	250146 Dichtungssatz
	220155	11.8116-0092.1	390503 Haltefeder		220353	11.8116-0301.1	390610 Haltefeder
	220155	11.8171-0008.1	990049 Führungsbolzen		220353	11.8171-0008.1	990049 Führungsbolzen
11.3601-8512.2	220156	11.0101-5402.2	260009 Hülsensatz	11.3601-8528.2	220354	11.0101-5407.2	260011 Hülsensatz
	220156	11.0441-6003.2	250037 Dichtungssatz		220354	11.0441-6007.2	250146 Dichtungssatz
	220156	11.8116-0092.1	390503 Haltefeder		220354	11.8116-0301.1	390610 Haltefeder
	220156	11.8171-0008.1	990049 Führungsbolzen		220354	11.8171-0008.1	990049 Führungsbolzen
11.3601-8513.2	220393	11.0101-5704.2	260095 Hülsensatz	11.3601-8529.2	220355	11.0101-5407.2	260011 Hülsensatz
	220393	11.0441-6007.2	250146 Dichtungssatz		220355	11.0441-6007.2	250146 Dichtungssatz
	220393	11.8116-0200.1	390505 Haltefeder		220355	11.8171-0008.1	990049 Führungsbolzen
	220393	11.8171-0008.1	990049 Führungsbolzen				
11.3601-8514.2	220394	11.0101-5704.2	260095 Hülsensatz	11.3601-8530.2	220356	11.0101-5407.2	260011 Hülsensatz
	220394	11.0441-6007.2	250146 Dichtungssatz		220356	11.0441-6007.2	250146 Dichtungssatz
	220394	11.8116-0200.1	390505 Haltefeder		220356	11.8171-0008.1	990049 Führungsbolzen
	220394	11.8171-0008.1	990049 Führungsbolzen				
11.3601-8515.2	220323	11.0101-5402.2	260009 Hülsensatz	11.4601-8001.3	220157	11.0441-6002.2	250036 Dichtungssatz
	220323	11.0441-6003.2	250037 Dichtungssatz				
	220323	11.8116-0083.1	390501 Haltefeder				
	220323	11.8171-0008.1	990049 Führungsbolzen				
11.3601-8516.2	220324	11.0101-5402.2	260009 Hülsensatz	11.4601-8002.3	220158	11.0441-6002.2	250036 Dichtungssatz
	220324	11.0441-6003.2	250037 Dichtungssatz				
	220324	11.8116-0083.1	390501 Haltefeder	11.4601-8003.3	220159	11.0441-6002.2	250036 Dichtungssatz
	220324	11.8171-0008.1	990049 Führungsbolzen				
11.3601-8519.2	220345	11.0101-5407.2	260011 Hülsensatz	11.4601-8004.3	220160	11.0441-6002.2	250036 Dichtungssatz
	220345	11.0441-6007.2	250146 Dichtungssatz				
	220345	11.8116-0073.1	390498 Haltefeder	11.9341-9991.2	220407	11.0101-5402.2	260009 Hülsensatz
	220345	11.8171-0008.1	990049 Führungsbolzen		220407	11.0441-3401.2	250151 Dichtungssatz
					220407	11.8116-0185.1	390592 Haltefeder
					220407	11.8171-0008.1	990049 Führungsbolzen
11.3601-8520.2	220346	11.0101-5407.2	260011 Hülsensatz	11.9341-9992.2	220408	11.0101-5402.2	260009 Hülsensatz
	220346	11.0441-6007.2	250146 Dichtungssatz		220408	11.0441-3401.2	250151 Dichtungssatz
	220346	11.8116-0073.1	390498 Haltefeder		220408	11.8116-0185.1	390592 Haltefeder
	220346	11.8171-0008.1	990049 Führungsbolzen		220408	11.8171-0008.1	990049 Führungsbolzen
11.3601-8521.2	220347	11.0101-5407.2	260011 Hülsensatz	11.9347-7001.2	220473	11.0101-5407.2	260011 Hülsensatz
	220347	11.0441-6003.2	250037 Dichtungssatz		220473	11.8170-0584.1	260105 Halter
	220347	11.8116-0052.1	390496 Haltefeder		220473	11.8171-0008.1	990049 Führungsbolzen
	220347	11.8171-0008.1	990049 Führungsbolzen				
				11.9347-7002.2	220474	11.0101-5407.2	260011 Hülsensatz
					220474	11.8170-0584.1	260105 Halter
					220474	11.8171-0008.1	990049 Führungsbolzen

Reparatursätze





Repair kits - Corredi riparazione - Nécessaires de réparation - Juegos de reparación

  				  					
11.9347-7003.2	220565	11.0101-5407.2	260011	Hülsensatz	11.9387-7003.2	220567	11.0101-5407.2	260011	Hülsensatz
	220565	11.8116-0340.1	390595	Haltefeder		220567	11.8116-0340.1	390595	Haltefeder
	220565	11.8170-0584.1	260105	Halter		220567	11.8170-0633.1	260117	Halter
	220565	11.8171-0008.1	990049	Führungsbolzen		220567	11.8171-0008.1	990049	Führungsbolzen
11.9347-7004.2	220566	11.0101-5407.2	260011	Hülsensatz	11.9387-7004.2	220568	11.0101-5407.2	260011	Hülsensatz
	220566	11.8116-0340.1	390595	Haltefeder		220568	11.8116-0340.1	390595	Haltefeder
	220566	11.8170-0584.1	260105	Halter		220568	11.8170-0633.1	260117	Halter
	220566	11.8171-0008.1	990049	Führungsbolzen		220568	11.8171-0008.1	990049	Führungsbolzen
11.9347-7005.2	220643	11.0101-5407.2	260011	Hülsensatz	11.9387-7005.2	220569	11.0101-5407.2	260011	Hülsensatz
	220643	11.8116-0340.1	390595	Haltefeder		220569	11.8116-0340.1	390595	Haltefeder
	220643	11.8171-0008.1	990049	Führungsbolzen		220569	11.8171-0008.1	990049	Führungsbolzen
11.9347-7006.2	220644	11.0101-5407.2	260011	Hülsensatz	11.9387-7006.2	220570	11.0101-5407.2	260011	Hülsensatz
	220644	11.8116-0340.1	390595	Haltefeder		220570	11.8116-0340.1	390595	Haltefeder
	220644	11.8171-0008.1	990049	Führungsbolzen		220570	11.8171-0008.1	990049	Führungsbolzen
11.9367-7001.2	220733	11.0101-5407.2	260011	Hülsensatz	11.9387-7015.2	220627	11.0101-5407.2	260011	Hülsensatz
	220733	11.8116-0340.1	390595	Haltefeder		220627	11.0230-0698.2	260091	Halter
	220733	11.8171-0008.1	990049	Führungsbolzen		220627	11.8116-0340.1	390595	Haltefeder
						220627	11.8171-0008.1	990049	Führungsbolzen
11.9367-7002.2	220734	11.0101-5407.2	260011	Hülsensatz	11.9387-7016.2	220628	11.0101-5407.2	260011	Hülsensatz
	220734	11.8116-0340.1	390595	Haltefeder		220628	11.0230-0698.2	260091	Halter
	220734	11.8171-0008.1	990049	Führungsbolzen		220628	11.8116-0340.1	390595	Haltefeder
						220628	11.8171-0008.1	990049	Führungsbolzen
11.9381-9957.2	220661	11.0101-5407.2	260011	Hülsensatz	11.9387-7021.2	220629	11.0101-5407.2	260011	Hülsensatz
	220661	11.8116-0143.1	390513	Haltefeder		220629	11.8116-0340.1	390595	Haltefeder
	220661	11.8171-0008.1	990049	Führungsbolzen		220629	11.8171-0008.1	990049	Führungsbolzen
11.9381-9958.2	220662	11.0101-5407.2	260011	Hülsensatz	11.9387-7022.2	220630	11.0101-5407.2	260011	Hülsensatz
	220662	11.8116-0143.1	390513	Haltefeder		220630	11.8116-0340.1	390595	Haltefeder
	220662	11.8171-0008.1	990049	Führungsbolzen		220630	11.8171-0008.1	990049	Führungsbolzen
11.9381-9959.2	220433	11.0101-5402.2	260009	Hülsensatz	11.9387-7045.2	220797	11.0101-5407.2	260011	Hülsensatz
	220433	11.0441-3803.2	250010	Dichtungssatz		220797	11.0230-0698.2	260091	Halter
	220433	11.8116-0066.1	390577	Haltefeder		220797	11.8116-0340.1	390595	Haltefeder
	220433	11.8171-0008.1	990049	Führungsbolzen		220797	11.8171-0008.1	990049	Führungsbolzen
11.9381-9960.2	220434	11.0101-5402.2	260009	Hülsensatz	11.9387-7046.2	220798	11.0101-5407.2	260011	Hülsensatz
	220434	11.0441-3803.2	250010	Dichtungssatz		220798	11.0230-0698.2	260091	Halter
	220434	11.8116-0066.1	390577	Haltefeder		220798	11.8116-0340.1	390595	Haltefeder
	220434	11.8171-0008.1	990049	Führungsbolzen		220798	11.8171-0008.1	990049	Führungsbolzen
11.9381-9961.2	220435	11.0101-5402.2	260009	Hülsensatz	11.9401-9951.2	220463	11.0101-5402.2	260009	Hülsensatz
	220435	11.0441-3803.2	250010	Dichtungssatz		220463	11.8116-0296.1	390445	Haltefeder
	220435	11.8116-0066.1	390577	Haltefeder		220463	11.8171-0008.1	990049	Führungsbolzen
	220435	11.8171-0008.1	990049	Führungsbolzen					
11.9381-9962.2	220436	11.0101-5402.2	260009	Hülsensatz	11.9401-9952.2	220464	11.0101-5402.2	260009	Hülsensatz
	220436	11.0441-3803.2	250010	Dichtungssatz		220464	11.8116-0296.1	390445	Haltefeder
	220436	11.8116-0066.1	390577	Haltefeder		220464	11.8171-0008.1	990049	Führungsbolzen
	220436	11.8171-0008.1	990049	Führungsbolzen					
11.9382-7003.2	220891	11.0103-0001.2	250156	Bremssattel-Zubehör	11.9401-9959.2	220833	11.0101-5402.2	260009	Hülsensatz
11.9382-7004.2	220892	11.0103-0001.2	250156	Bremssattel-Zubehör		220833	11.0441-4002.2	250011	Dichtungssatz
						220833	11.8171-0008.1	990049	Führungsbolzen
11.9387-7001.2	220397	11.0101-5407.2	260011	Hülsensatz	11.9401-9960.2	220834	11.0101-5402.2	260009	Hülsensatz
	220397	11.8116-0340.1	390595	Haltefeder		220834	11.0441-4002.2	250011	Dichtungssatz
	220397	11.8171-0008.1	990049	Führungsbolzen		220834	11.8171-0008.1	990049	Führungsbolzen
11.9387-7002.2	220398	11.0101-5407.2	260011	Hülsensatz	11.9401-9975.2	220495	11.0101-5402.2	260009	Hülsensatz
	220398	11.8116-0340.1	390595	Haltefeder		220495	11.0441-4003.2	250001	Dichtungssatz
	220398	11.8171-0008.1	990049	Führungsbolzen		220495	11.8116-0094.1	390504	Haltefeder
						220495	11.8171-0008.1	990049	Führungsbolzen



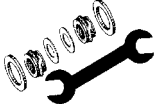

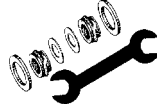



Reparatursätze

Repair kits - Corredi riparazione - Nécessaires de réparation - Juegos de reparación

  				  			
11.9401-9976.2	220496	11.0101-5402.2	260009 Hülsensatz	11.9421-9964.2	220466	11.0101-5402.2	260009 Hülsensatz
	220496	11.0441-4003.2	250001 Dichtungssatz		220466	11.0230-0119.2	260089 Haltersatz
	220496	11.8116-0094.1	390504 Haltefeder		220466	11.8116-0296.1	390445 Haltefeder
	220496	11.8171-0008.1	990049 Führungsbolzen		220466	11.8171-0008.1	990049 Führungsbolzen
11.9401-9977.2	220439	11.0101-5402.2	260009 Hülsensatz	11.9421-9965.2	220799	11.0101-5407.2	260011 Hülsensatz
	220439	11.0441-4003.2	250001 Dichtungssatz		220799	11.8116-0323.1	390459 Haltefeder
	220439	11.8116-0094.1	390504 Haltefeder		220799	11.8171-0008.1	990049 Führungsbolzen
	220439	11.8171-0008.1	990049 Führungsbolzen	11.9421-9966.2	220800	11.0101-5407.2	260011 Hülsensatz
11.9401-9978.2	220440	11.0101-5402.2	260009 Hülsensatz		220800	11.8116-0323.1	390459 Haltefeder
	220440	11.0441-4003.2	250001 Dichtungssatz		220800	11.8171-0008.1	990049 Führungsbolzen
	220440	11.8116-0094.1	390504 Haltefeder	11.9421-9979.2	220497	11.0101-5407.2	260011 Hülsensatz
	220440	11.8171-0008.1	990049 Führungsbolzen		220497	11.8116-0236.1	390507 Haltefeder
11.9406-9993.2	220413	11.0101-5402.2	260009 Hülsensatz		220497	11.8171-0008.1	990049 Führungsbolzen
	220413	11.0441-4004.2	250012 Dichtungssatz	11.9421-9980.2	220498	11.0101-5407.2	260011 Hülsensatz
	220413	11.8116-0168.1	390499 Haltefeder		220498	11.8116-0236.1	390507 Haltefeder
	220413	11.8171-0008.1	990049 Führungsbolzen		220498	11.8171-0008.1	990049 Führungsbolzen
11.9406-9994.2	220414	11.0101-5402.2	260009 Hülsensatz	11.9426-9957.2	220895	11.0101-5402.2	260009 Hülsensatz
	220414	11.0441-4004.2	250012 Dichtungssatz		220895	11.0441-4203.2	250013 Dichtungssatz
	220414	11.8116-0168.1	390499 Haltefeder		220895	11.8116-0330.1	390472 Haltefeder
	220414	11.8171-0008.1	990049 Führungsbolzen		220895	11.8171-0008.1	990049 Führungsbolzen
11.9406-9995.2	220415	11.0101-5402.2	260009 Hülsensatz	11.9426-9958.2	220896	11.0101-5402.2	260009 Hülsensatz
	220415	11.0441-4004.2	250012 Dichtungssatz		220896	11.0441-4203.2	250013 Dichtungssatz
	220415	11.8116-0168.1	390499 Haltefeder		220896	11.8116-0330.1	390472 Haltefeder
	220415	11.8171-0008.1	990049 Führungsbolzen		220896	11.8171-0008.1	990049 Führungsbolzen
11.9406-9996.2	220416	11.0101-5402.2	260009 Hülsensatz	11.9426-9959.2	220801	11.0101-5407.2	260011 Hülsensatz
	220416	11.0441-4004.2	250012 Dichtungssatz		220801	11.8116-0323.1	390459 Haltefeder
	220416	11.8116-0168.1	390499 Haltefeder		220801	11.8171-0008.1	990049 Führungsbolzen
	220416	11.8171-0008.1	990049 Führungsbolzen	11.9426-9960.2	220802	11.0101-5407.2	260011 Hülsensatz
11.9407-7001.2	220573	11.0101-5407.2	260011 Hülsensatz		220802	11.8116-0323.1	390459 Haltefeder
	220573	11.8116-0340.1	390595 Haltefeder		220802	11.8171-0008.1	990049 Führungsbolzen
	220573	11.8170-0633.1	260117 Halter	11.9426-9977.2	220897	11.0101-5402.2	260009 Hülsensatz
	220573	11.8171-0008.1	990049 Führungsbolzen		220897	11.0441-4203.2	250013 Dichtungssatz
11.9407-7002.2	220574	11.0101-5407.2	260011 Hülsensatz		220897	11.8116-0330.1	390472 Haltefeder
	220574	11.8116-0340.1	390595 Haltefeder		220897	11.8171-0008.1	990049 Führungsbolzen
	220574	11.8170-0633.1	260117 Halter	11.9426-9989.2	220639	11.0441-4203.2	250013 Dichtungssatz
	220574	11.8171-0008.1	990049 Führungsbolzen		220639	11.8116-0323.1	390459 Haltefeder
11.9407-7005.2	220637	11.0101-5407.2	260011 Hülsensatz	11.9426-9990.2	220640	11.0441-4203.2	250013 Dichtungssatz
	220637	11.8116-0340.1	390595 Haltefeder		220640	11.8116-0323.1	390459 Haltefeder
	220637	11.8170-0633.1	260117 Halter	11.9426-9991.2	220641	11.0441-4203.2	250013 Dichtungssatz
	220637	11.8171-0008.1	990049 Führungsbolzen		220641	11.8116-0323.1	390459 Haltefeder
11.9407-7006.2	220638	11.0101-5407.2	260011 Hülsensatz	11.9426-9992.2	220642	11.0441-4203.2	250013 Dichtungssatz
	220638	11.8116-0340.1	390595 Haltefeder		220642	11.8116-0323.1	390459 Haltefeder
	220638	11.8170-0633.1	260117 Halter	11.9426-9993.2	220443	11.0101-5402.2	260009 Hülsensatz
	220638	11.8171-0008.1	990049 Führungsbolzen		220443	11.0441-4203.2	250013 Dichtungssatz
11.9421-9911.2	220825	11.0101-5402.2	260009 Hülsensatz		220443	11.8116-0168.1	390499 Haltefeder
	220825	11.8116-0066.1	390577 Haltefeder		220443	11.8171-0008.1	990049 Führungsbolzen
	220825	11.8171-0008.1	990049 Führungsbolzen	11.9426-9994.2	220444	11.0101-5402.2	260009 Hülsensatz
11.9421-9912.2	220826	11.0101-5402.2	260009 Hülsensatz		220444	11.0441-4203.2	250013 Dichtungssatz
	220826	11.8116-0066.1	390577 Haltefeder		220444	11.8116-0168.1	390499 Haltefeder
	220826	11.8171-0008.1	990049 Führungsbolzen		220444	11.8171-0008.1	990049 Führungsbolzen
11.9421-9963.2	220465	11.0101-5402.2	260009 Hülsensatz	11.9441-9949.2	220803	11.0101-5409.2	260035 Hülsensatz
	220465	11.0230-0119.2	260089 Haltersatz		220803	11.8116-0310.1	390611 Haltefeder
	220465	11.8116-0296.1	390445 Haltefeder		220803	11.8171-0008.1	990049 Führungsbolzen
	220465	11.8171-0008.1	990049 Führungsbolzen				

Reparatursätze





Repair kits - Corredi riparazione - Nécessaires de réparation - Juegos de reparación

  				  			
11.9441-9950.2	220804	11.0101-5409.2	260035 Hülsensatz	11.9521-7001.2	220499	11.0101-5407.2	260011 Hülsensatz
	220804	11.8116-0310.1	390611 Haltefeder		220499	11.8171-0008.1	990049 Führungsbolzen
	220804	11.8171-0008.1	990049 Führungsbolzen				
11.9441-9955.2	220805	11.8116-0133.1	390511 Haltefeder	11.9521-7002.2	220500	11.0101-5407.2	260011 Hülsensatz
	220805	11.8171-0096.1	250155 Führungsbolzen		220500	11.8171-0008.1	990049 Führungsbolzen
11.9441-9956.2	220806	11.8116-0133.1	390511 Haltefeder	11.9541-9543.2	220645	11.0101-5407.2	260011 Hülsensatz
	220806	11.8171-0096.1	250155 Führungsbolzen		220645	11.8116-0301.1	390610 Haltefeder
					220645	11.8171-0008.1	990049 Führungsbolzen
11.9441-9957.2	220827	11.0101-5402.2	260009 Hülsensatz	11.9541-9544.2	220646	11.0101-5407.2	260011 Hülsensatz
	220827	11.8116-0296.1	390445 Haltefeder		220646	11.8116-0301.1	390610 Haltefeder
	220827	11.8171-0008.1	990049 Führungsbolzen		220646	11.8171-0008.1	990049 Führungsbolzen
11.9441-9958.2	220828	11.0101-5402.2	260009 Hülsensatz	11.9541-9545.2	220625	11.0101-5407.2	260011 Hülsensatz
	220828	11.8116-0296.1	390445 Haltefeder		220625	11.8116-0301.1	390610 Haltefeder
	220828	11.8171-0008.1	990049 Führungsbolzen		220625	11.8171-0008.1	990049 Führungsbolzen
11.9441-9967.2	220807	11.0101-5409.2	260035 Hülsensatz	11.9541-9546.2	220626	11.0101-5407.2	260011 Hülsensatz
	220807	11.8116-0310.1	390611 Haltefeder		220626	11.8116-0301.1	390610 Haltefeder
	220807	11.8171-0008.1	990049 Führungsbolzen		220626	11.8171-0008.1	990049 Führungsbolzen
11.9441-9968.2	220808	11.0101-5409.2	260035 Hülsensatz	11.9541-9549.2	220575	11.0101-5409.2	260035 Hülsensatz
	220808	11.8116-0310.1	390611 Haltefeder		220575	11.0441-5409.2	250031 Dichtungssatz
	220808	11.8171-0008.1	990049 Führungsbolzen		220575	11.8171-0069.1	250152 Führungsbolzen
11.9441-9971.2	220839	11.0101-7003.2	260124 Hülsensatz	11.9541-9550.2	220576	11.0101-5409.2	260035 Hülsensatz
					220576	11.0441-5409.2	250031 Dichtungssatz
11.9441-9972.2	220840	11.0101-7003.2	260124 Hülsensatz		220576	11.8171-0069.1	250152 Führungsbolzen
11.9461-9981.2	220899	11.0101-5402.2	260009 Hülsensatz	11.9541-9553.2	220563	11.0101-5409.2	260035 Hülsensatz
	220899	11.8116-0296.1	390445 Haltefeder		220563	11.8116-0351.1	390538 Haltefeder
	220899	11.8171-0008.1	990049 Führungsbolzen		220563	11.8171-0008.1	990049 Führungsbolzen
11.9461-9982.2	220900	11.0101-5402.2	260009 Hülsensatz	11.9541-9554.2	220564	11.0101-5409.2	260035 Hülsensatz
	220900	11.8116-0296.1	390445 Haltefeder		220564	11.8116-0351.1	390538 Haltefeder
	220900	11.8171-0008.1	990049 Führungsbolzen		220564	11.8171-0008.1	990049 Führungsbolzen
11.9461-9983.2	220467	11.0101-5402.2	260009 Hülsensatz	11.9541-9569.2	220725	11.0101-5407.2	260011 Hülsensatz
	220467	11.0230-0176.2	260088 Haltersatz		220725	11.8116-0264.1	390594 Haltefeder
	220467	11.0441-4203.2	250013 Dichtungssatz		220725	11.8171-0008.1	990049 Führungsbolzen
	220467	11.8116-0296.1	390445 Haltefeder				
	220467	11.8171-0008.1	990049 Führungsbolzen	11.9541-9570.2	220726	11.0101-5407.2	260011 Hülsensatz
11.9461-9984.2	220468	11.0101-5402.2	260009 Hülsensatz		220726	11.8116-0264.1	390594 Haltefeder
	220468	11.0230-0176.2	260088 Haltersatz		220726	11.8171-0008.1	990049 Führungsbolzen
	220468	11.0441-4203.2	250013 Dichtungssatz	11.9541-9575.2	220829	11.0101-5402.2	260009 Hülsensatz
	220468	11.8116-0296.1	390445 Haltefeder		220829	11.8116-0206.1	390593 Haltefeder
	220468	11.8171-0008.1	990049 Führungsbolzen		220829	11.8171-0008.1	990049 Führungsbolzen
11.9481-9811.2	220445	11.0101-5407.2	260011 Hülsensatz	11.9541-9576.2	220830	11.0101-5402.2	260009 Hülsensatz
	220445	11.8116-0274.1	390516 Haltefeder		220830	11.8116-0206.1	390593 Haltefeder
	220445	11.8171-0008.1	990049 Führungsbolzen		220830	11.8171-0008.1	990049 Führungsbolzen
11.9481-9812.2	220446	11.0101-5407.2	260011 Hülsensatz	11.9541-9587.2	220419	11.0101-5402.2	260009 Hülsensatz
	220446	11.8116-0274.1	390516 Haltefeder		220419	11.0441-5402.2	250028 Dichtungssatz
	220446	11.8171-0008.1	990049 Führungsbolzen		220419	11.8116-0109.1	390495 Haltefeder
11.9481-9871.2	220681	11.0101-5407.2	260011 Hülsensatz		220419	11.8116-0206.1	390593 Haltefeder
	220681	11.0441-4811.2	250024 Dichtungssatz		220419	11.8170-0729.1	260107 Halter
	220681	11.8116-0129.1	390591 Haltefeder		220419	11.8170-0730.1	260108 Halter
	220681	11.8171-0008.1	990049 Führungsbolzen		220419	11.8171-0008.1	990049 Führungsbolzen
11.9481-9872.2	220682	11.0101-5407.2	260011 Hülsensatz	11.9541-9588.2	220420	11.0101-5402.2	260009 Hülsensatz
	220682	11.0441-4811.2	250024 Dichtungssatz		220420	11.0441-5402.2	250028 Dichtungssatz
	220682	11.8116-0129.1	390591 Haltefeder		220420	11.8116-0109.1	390495 Haltefeder
	220682	11.8171-0008.1	990049 Führungsbolzen		220420	11.8116-0206.1	390593 Haltefeder
					220420	11.8170-0729.1	260107 Halter
					220420	11.8170-0730.1	260108 Halter
					220420	11.8171-0008.1	990049 Führungsbolzen



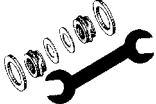

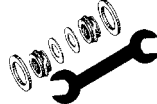



Reparatursätze

Repair kits - Corredi riparazione - Nécessaires de réparation - Juegos de reparación

  				  			
11.9541-9595.2	220501	11.0101-5409.2	260035 Hülsensatz	11.9571-9785.2	220595	11.0101-5407.2	260011 Hülsensatz
	220501	11.0441-5409.2	250031 Dichtungssatz		220595	11.8116-0356.1	390586 Haltefeder
	220501	11.8116-0143.1	390513 Haltefeder		220595	11.8171-0008.1	990049 Führungsbolzen
	220501	11.8171-0008.1	990049 Führungsbolzen				
11.9541-9596.2	220502	11.0101-5409.2	260035 Hülsensatz	11.9571-9786.2	220596	11.0101-5407.2	260011 Hülsensatz
	220502	11.0441-5409.2	250031 Dichtungssatz		220596	11.8116-0356.1	390586 Haltefeder
	220502	11.8116-0143.1	390513 Haltefeder		220596	11.8171-0008.1	990049 Führungsbolzen
	220502	11.8171-0008.1	990049 Führungsbolzen				
11.9541-9667.2	220421	11.0101-5402.2	260009 Hülsensatz	11.9571-9793.2	220665	11.8116-0351.1	390538 Haltefeder
	220421	11.0230-0444.1	260104 Halter				
	220421	11.0441-5402.2	250028 Dichtungssatz	11.9571-9794.2	220666	11.8116-0351.1	390538 Haltefeder
	220421	11.8116-0109.1	390495 Haltefeder				
	220421	11.8116-0206.1	390593 Haltefeder	11.9571-9801.2	220577	11.0101-5407.2	260011 Hülsensatz
	220421	11.8171-0008.1	990049 Führungsbolzen		220577	11.8171-0008.1	990049 Führungsbolzen
11.9541-9668.2	220422	11.0101-5402.2	260009 Hülsensatz	11.9571-9802.2	220578	11.0101-5407.2	260011 Hülsensatz
	220422	11.0230-0444.1	260104 Halter		220578	11.8171-0008.1	990049 Führungsbolzen
	220422	11.0441-5402.2	250028 Dichtungssatz				
	220422	11.8116-0109.1	390495 Haltefeder	11.9571-9811.2	220485	11.0101-5407.2	260011 Hülsensatz
	220422	11.8116-0206.1	390593 Haltefeder		220485	11.0101-5706.2	260097 Hülsensatz
	220422	11.8171-0008.1	990049 Führungsbolzen		220485	11.0441-5704.2	250034 Dichtungssatz
11.9541-9805.2	220503	11.0101-5407.2	260011 Hülsensatz		220485	11.8116-0326.1	390471 Haltefeder
	220503	11.8116-0073.1	390498 Haltefeder		220485	11.8171-0008.1	990049 Führungsbolzen
	220503	11.8171-0008.1	990049 Führungsbolzen		220485	11.8171-0067.1	250153 Führungsbolzen
11.9541-9806.2	220504	11.0101-5407.2	260011 Hülsensatz	11.9571-9812.2	220486	11.0101-5407.2	260011 Hülsensatz
	220504	11.8116-0073.1	390498 Haltefeder		220486	11.0101-5706.2	260097 Hülsensatz
	220504	11.8171-0008.1	990049 Führungsbolzen		220486	11.0441-5704.2	250034 Dichtungssatz
11.9541-9950.2	220843	11.8170-0002.1	260110 Halter		220486	11.8116-0326.1	390471 Haltefeder
11.9541-9951.2	220844	11.8170-0002.1	260110 Halter		220486	11.8171-0008.1	990049 Führungsbolzen
11.9546-9997.2	220399	11.0101-5407.2	260011 Hülsensatz		220486	11.8171-0067.1	250153 Führungsbolzen
11.9546-9998.2	220400	11.0101-5407.2	260011 Hülsensatz	11.9571-9813.2	220647	11.0101-5407.2	260011 Hülsensatz
11.9571-9757.2	220857	11.8116-0301.1	390610 Haltefeder		220647	11.8116-0356.1	390586 Haltefeder
11.9571-9758.2	220858	11.8116-0301.1	390610 Haltefeder		220647	11.8171-0008.1	990049 Führungsbolzen
11.9571-9765.2	220663	11.0101-5704.2	260095 Hülsensatz	11.9571-9814.2	220648	11.0101-5407.2	260011 Hülsensatz
	220663	11.8116-0351.1	390538 Haltefeder		220648	11.8116-0356.1	390586 Haltefeder
	220663	11.8171-0008.1	990049 Führungsbolzen		220648	11.8171-0008.1	990049 Führungsbolzen
11.9571-9766.2	220664	11.0101-5704.2	260095 Hülsensatz	11.9571-9819.2	220469	11.0101-5705.2	260096 Hülsensatz
	220664	11.8116-0351.1	390538 Haltefeder		220469	11.0441-5704.2	250034 Dichtungssatz
	220664	11.8171-0008.1	990049 Führungsbolzen		220469	11.8116-0326.1	390471 Haltefeder
11.9571-9779.2	220657	11.0101-5407.2	260011 Hülsensatz		220469	11.8171-0067.1	250153 Führungsbolzen
	220657	11.8116-0356.1	390586 Haltefeder	11.9571-9820.2	220470	11.0101-5705.2	260096 Hülsensatz
	220657	11.8171-0008.1	990049 Führungsbolzen		220470	11.0441-5704.2	250034 Dichtungssatz
11.9571-9780.2	220658	11.0101-5407.2	260011 Hülsensatz		220470	11.8116-0326.1	390471 Haltefeder
	220658	11.8116-0356.1	390586 Haltefeder		220470	11.8171-0067.1	250153 Führungsbolzen
	220658	11.8171-0008.1	990049 Führungsbolzen	11.9571-9821.2	220579	11.0101-5407.2	260011 Hülsensatz
11.9571-9781.2	220659	11.0101-5407.2	260011 Hülsensatz		220579	11.8171-0008.1	990049 Führungsbolzen
	220659	11.8116-0295.2	390524 Haltefeder	11.9571-9822.2	220580	11.0101-5407.2	260011 Hülsensatz
	220659	11.8116-0356.1	390586 Haltefeder		220580	11.8171-0008.1	990049 Führungsbolzen
	220659	11.8171-0008.1	990049 Führungsbolzen	11.9571-9823.2	220471	11.0101-5407.2	260011 Hülsensatz
11.9571-9782.2	220660	11.0101-5407.2	260011 Hülsensatz		220471	11.0441-5704.2	250034 Dichtungssatz
	220660	11.8116-0295.2	390524 Haltefeder		220471	11.8116-0292.1	390521 Haltefeder
	220660	11.8116-0356.1	390586 Haltefeder		220471	11.8171-0008.1	990049 Führungsbolzen
	220660	11.8171-0008.1	990049 Führungsbolzen	11.9571-9824.2	220472	11.0101-5407.2	260011 Hülsensatz
					220472	11.0441-5704.2	250034 Dichtungssatz
					220472	11.8116-0292.1	390521 Haltefeder
					220472	11.8171-0008.1	990049 Führungsbolzen

Reparatursätze

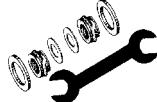



Repair kits - Corredi riparazione - Nécessaires de réparation - Juegos de reparación

  			  		
11.9571-9835.2	220427	11.0101-5409.2 260035 Hülsensatz	11.9571-9972.2	220606	11.0101-5407.2 260011 Hülsensatz
	220427	11.0441-5704.2 250034 Dichtungssatz		220606	11.0441-5702.2 250033 Dichtungssatz
	220427	11.8116-0143.1 390513 Haltefeder		220606	11.8116-0073.1 390498 Haltefeder
	220427	11.8116-0347.2 390535 Haltefeder		220606	11.8171-0008.1 990049 Führungsbolzen
	220427	11.8171-0008.1 990049 Führungsbolzen			
11.9571-9836.2	220428	11.0101-5409.2 260035 Hülsensatz	11.9576-9947.2	220809	11.0101-5409.2 260035 Hülsensatz
	220428	11.0441-5704.2 250034 Dichtungssatz		220809	11.8116-0410.2 390589 Haltefeder
	220428	11.8116-0143.1 390513 Haltefeder		220809	11.8171-0008.1 990049 Führungsbolzen
	220428	11.8116-0347.2 390535 Haltefeder			
	220428	11.8171-0008.1 990049 Führungsbolzen			
11.9571-9841.2	220401	11.0101-5407.2 260011 Hülsensatz	11.9576-9948.2	220810	11.0101-5409.2 260035 Hülsensatz
	220401	11.8116-0301.1 390610 Haltefeder		220810	11.8116-0410.2 390589 Haltefeder
	220401	11.8171-0008.1 990049 Führungsbolzen		220810	11.8171-0008.1 990049 Führungsbolzen
11.9571-9842.2	220402	11.0101-5407.2 260011 Hülsensatz	11.9576-9975.2	220649	11.0101-5407.2 260011 Hülsensatz
	220402	11.8116-0301.1 390610 Haltefeder		220649	11.8116-0345.2 390596 Haltefeder
	220402	11.8171-0008.1 990049 Führungsbolzen		220649	11.8116-0410.2 390589 Haltefeder
11.9571-9847.2	220487	11.0101-5407.2 260011 Hülsensatz		220649	11.8171-0008.1 990049 Führungsbolzen
	220487	11.0101-5409.2 260035 Hülsensatz			
	220487	11.0441-5704.2 250034 Dichtungssatz			
	220487	11.8116-0143.1 390513 Haltefeder			
	220487	11.8171-0008.1 990049 Führungsbolzen			
11.9571-9848.2	220488	11.0101-5407.2 260011 Hülsensatz	11.9576-9976.2	220650	11.0101-5407.2 260011 Hülsensatz
	220488	11.0101-5409.2 260035 Hülsensatz		220650	11.8116-0345.2 390596 Haltefeder
	220488	11.0441-5704.2 250034 Dichtungssatz		220650	11.8116-0410.2 390589 Haltefeder
	220488	11.8116-0143.1 390513 Haltefeder		220650	11.8171-0008.1 990049 Führungsbolzen
	220488	11.8171-0008.1 990049 Führungsbolzen			
11.9571-9861.2	220403	11.0101-5407.2 260011 Hülsensatz	11.9576-9995.2	220651	11.0101-5409.2 260035 Hülsensatz
	220403	11.8116-0301.1 390610 Haltefeder		220651	11.8116-0410.2 390589 Haltefeder
	220403	11.8171-0008.1 990049 Führungsbolzen		220651	11.8171-0008.1 990049 Führungsbolzen
11.9571-9862.2	220404	11.0101-5407.2 260011 Hülsensatz	11.9576-9996.2	220652	11.0101-5409.2 260035 Hülsensatz
	220404	11.8116-0301.1 390610 Haltefeder		220652	11.8116-0410.2 390589 Haltefeder
	220404	11.8171-0008.1 990049 Führungsbolzen		220652	11.8171-0008.1 990049 Führungsbolzen
11.9571-9863.2	220513	11.0101-5407.2 260011 Hülsensatz	11.9601-2601.2	220913	11.0103-0002.2 250157 Bremssattel-Zubehör
	220513	11.8116-0366.2 390587 Haltefeder	11.9601-2602.2	220914	11.0103-0002.2 250157 Bremssattel-Zubehör
	220513	11.8171-0008.1 990049 Führungsbolzen	11.9601-2603.2	220915	11.0103-0002.2 250157 Bremssattel-Zubehör
	220513	11.8171-0067.1 250153 Führungsbolzen	11.9601-2604.2	220916	11.0103-0002.2 250157 Bremssattel-Zubehör
11.9571-9864.2	220514	11.0101-5407.2 260011 Hülsensatz	11.9601-8501.2	220593	11.0101-5706.2 260097 Hülsensatz
	220514	11.8116-0366.2 390587 Haltefeder		220593	11.0441-6008.2 250038 Dichtungssatz
	220514	11.8171-0008.1 990049 Führungsbolzen		220593	11.8116-0237.1 390509 Haltefeder
	220514	11.8171-0067.1 250153 Führungsbolzen		220593	11.8171-0067.1 250153 Führungsbolzen
11.9571-9867.2	220423	11.0101-5704.2 260095 Hülsensatz	11.9601-8502.2	220594	11.0101-5706.2 260097 Hülsensatz
	220423	11.0441-5704.2 250034 Dichtungssatz		220594	11.0441-6008.2 250038 Dichtungssatz
	220423	11.8171-0008.1 990049 Führungsbolzen		220594	11.8116-0237.1 390509 Haltefeder
11.9571-9868.2	220424	11.0101-5704.2 260095 Hülsensatz		220594	11.8171-0067.1 250153 Führungsbolzen
	220424	11.0441-5704.2 250034 Dichtungssatz	11.9601-9711.2	220873	11.0441-6008.2 250038 Dichtungssatz
	220424	11.8171-0008.1 990049 Führungsbolzen	11.9601-9712.2	220874	11.0441-6008.2 250038 Dichtungssatz
11.9571-9871.2	220425	11.0101-5407.2 260011 Hülsensatz	11.9601-9717.2	220901	11.0441-6008.2 250038 Dichtungssatz
	220425	11.8171-0008.1 990049 Führungsbolzen	11.9601-9718.2	220902	11.0441-6008.2 250038 Dichtungssatz
11.9571-9872.2	220426	11.0101-5407.2 260011 Hülsensatz	11.9601-9721.2	220875	11.8116-0367.1 390600 Haltefeder
	220426	11.8171-0008.1 990049 Führungsbolzen	11.9601-9722.2	220876	11.8116-0367.1 390600 Haltefeder
11.9571-9872.2	220426	11.0101-5407.2 260011 Hülsensatz	11.9601-9731.2	220853	11.0441-6008.2 250038 Dichtungssatz
	220426	11.8171-0008.1 990049 Führungsbolzen	11.9601-9732.2	220854	11.0441-6008.2 250038 Dichtungssatz
11.9571-9971.2	220605	11.0101-5407.2 260011 Hülsensatz	11.9601-9745.2	220653	11.0101-5407.2 260011 Hülsensatz
	220605	11.0441-5702.2 250033 Dichtungssatz		220653	11.8116-0206.1 390593 Haltefeder
	220605	11.8116-0073.1 390498 Haltefeder		220653	11.8171-0008.1 990049 Führungsbolzen
	220605	11.8171-0008.1 990049 Führungsbolzen			



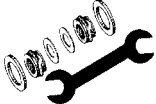

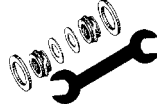



Reparatursätze

Repair kits - Corredi riparazione - Nécessaires de réparation - Juegos de reparación

  				  					
11.9601-9746.2	220654	11.0101-5407.2	260011	Hülsensatz	11.9606-9953.2	220587	11.0101-5409.2	260035	Hülsensatz
	220654	11.8116-0206.1	390593	Haltefeder		220587	11.0441-6008.2	250038	Dichtungssatz
	220654	11.8171-0008.1	990049	Führungsbolzen		220587	11.8116-0347.2	390535	Haltefeder
						220587	11.8116-0410.2	390589	Haltefeder
						220587	11.8171-0008.1	990049	Führungsbolzen
11.9601-9759.2	220811	11.0101-5704.2	260095	Hülsensatz	11.9606-9954.2	220588	11.0101-5409.2	260035	Hülsensatz
	220811	11.8116-0356.1	390586	Haltefeder		220588	11.0441-6008.2	250038	Dichtungssatz
	220811	11.8171-0008.1	990049	Führungsbolzen		220588	11.8116-0347.2	390535	Haltefeder
11.9601-9760.2	220812	11.0101-5704.2	260095	Hülsensatz		220588	11.8116-0410.2	390589	Haltefeder
	220812	11.8116-0356.1	390586	Haltefeder		220588	11.8171-0008.1	990049	Führungsbolzen
	220812	11.8171-0008.1	990049	Führungsbolzen	11.9606-9957.2	220815	11.0101-5409.2	260035	Hülsensatz
11.9601-9765.2	220813	11.0101-5407.2	260011	Hülsensatz		220815	11.0441-6008.2	250038	Dichtungssatz
	220813	11.8116-0237.1	390509	Haltefeder		220815	11.8116-0410.2	390589	Haltefeder
	220813	11.8171-0008.1	990049	Führungsbolzen		220815	11.8171-0008.1	990049	Führungsbolzen
11.9601-9766.2	220814	11.0101-5407.2	260011	Hülsensatz	11.9606-9958.2	220816	11.0101-5409.2	260035	Hülsensatz
	220814	11.8116-0237.1	390509	Haltefeder		220816	11.0441-6008.2	250038	Dichtungssatz
	220814	11.8171-0008.1	990049	Führungsbolzen		220816	11.8116-0410.2	390589	Haltefeder
11.9601-9771.2	220583	11.0101-5706.2	260097	Hülsensatz		220816	11.8171-0008.1	990049	Führungsbolzen
	220583	11.0441-6008.2	250038	Dichtungssatz	11.9606-9959.2	220729	11.0101-6006.2	260098	Hülsensatz
	220583	11.8116-0237.1	390509	Haltefeder		220729	11.8116-0366.2	390587	Haltefeder
	220583	11.8171-0067.1	250153	Führungsbolzen		220729	11.8171-0008.1	990049	Führungsbolzen
						220729	11.8171-0067.1	250153	Führungsbolzen
11.9601-9772.2	220584	11.0101-5706.2	260097	Hülsensatz	11.9606-9960.2	220730	11.0101-6006.2	260098	Hülsensatz
	220584	11.0441-6008.2	250038	Dichtungssatz		220730	11.8116-0366.2	390587	Haltefeder
	220584	11.8116-0237.1	390509	Haltefeder		220730	11.8171-0008.1	990049	Führungsbolzen
	220584	11.8171-0067.1	250153	Führungsbolzen		220730	11.8171-0067.1	250153	Führungsbolzen
11.9601-9787.2	220585	11.0101-5407.2	260011	Hülsensatz	11.9606-9961.2	220655	11.0101-5409.2	260035	Hülsensatz
	220585	11.0441-6008.2	250038	Dichtungssatz		220655	11.0441-6008.2	250038	Dichtungssatz
	220585	11.8116-0301.1	390610	Haltefeder		220655	11.8116-0410.2	390589	Haltefeder
	220585	11.8171-0008.1	990049	Führungsbolzen		220655	11.8171-0008.1	990049	Führungsbolzen
11.9601-9788.2	220586	11.0101-5407.2	260011	Hülsensatz	11.9606-9962.2	220656	11.0101-5409.2	260035	Hülsensatz
	220586	11.0441-6008.2	250038	Dichtungssatz		220656	11.0441-6008.2	250038	Dichtungssatz
	220586	11.8116-0301.1	390610	Haltefeder		220656	11.8116-0410.2	390589	Haltefeder
	220586	11.8171-0008.1	990049	Führungsbolzen		220656	11.8171-0008.1	990049	Führungsbolzen
11.9601-9823.2	220849	11.0101-5402.2	260009	Hülsensatz	11.9606-9965.2	220817	11.0101-5409.2	260035	Hülsensatz
	220849	11.0441-6003.2	250037	Dichtungssatz		220817	11.0101-5704.2	260095	Hülsensatz
11.9601-9824.2	220850	11.0101-5402.2	260009	Hülsensatz		220817	11.0441-6008.2	250038	Dichtungssatz
	220850	11.0441-6003.2	250037	Dichtungssatz		220817	11.8116-0299.1	390446	Haltefeder
11.9601-9829.2	220505	11.0101-5407.2	260011	Hülsensatz		220817	11.8116-0327.1	390599	Haltefeder
	220505	11.8116-0366.2	390587	Haltefeder		220817	11.8171-0008.1	990049	Führungsbolzen
	220505	11.8171-0008.1	990049	Führungsbolzen	11.9606-9966.2	220818	11.0101-5409.2	260035	Hülsensatz
	220505	11.8171-0067.1	250153	Führungsbolzen		220818	11.0101-5704.2	260095	Hülsensatz
11.9601-9830.2	220506	11.0101-5407.2	260011	Hülsensatz		220818	11.0441-6008.2	250038	Dichtungssatz
	220506	11.8116-0366.2	390587	Haltefeder		220818	11.8116-0299.1	390446	Haltefeder
	220506	11.8171-0008.1	990049	Führungsbolzen		220818	11.8116-0327.1	390599	Haltefeder
	220506	11.8171-0067.1	250153	Führungsbolzen		220818	11.8171-0008.1	990049	Führungsbolzen
11.9601-9883.2	220917	11.0441-6008.2	250038	Dichtungssatz	11.9606-9967.2	220905	11.0101-5402.2	260009	Hülsensatz
11.9601-9884.2	220918	11.0441-6008.2	250038	Dichtungssatz		220905	11.0441-6008.2	250038	Dichtungssatz
11.9606-9945.2	220727	11.0101-5704.2	260095	Hülsensatz		220905	11.8116-0339.2	390528	Haltefeder
	220727	11.8116-0388.2	390588	Haltefeder		220905	11.8171-0008.1	990049	Führungsbolzen
	220727	11.8171-0008.1	990049	Führungsbolzen	11.9606-9968.2	220906	11.0101-5402.2	260009	Hülsensatz
11.9606-9946.2	220728	11.0101-5704.2	260095	Hülsensatz		220906	11.0441-6008.2	250038	Dichtungssatz
	220728	11.8116-0388.2	390588	Haltefeder		220906	11.8116-0339.2	390528	Haltefeder
	220728	11.8171-0008.1	990049	Führungsbolzen		220906	11.8171-0008.1	990049	Führungsbolzen

Reparatursätze







Repair kits - Corredi riparazione - Nécessaires de réparation - Juegos de reparación

  				  			
11.9606-9969.2	220731	11.0101-6006.2	260098 Hülsensatz	13.2351-8005.2	210014	13.0441-3505.2	2250051 Dichtungssatz
	220731	11.8116-0366.2	390587 Haltefeder	13.2351-8006.2	210015	13.0441-3505.2	2250051 Dichtungssatz
	220731	11.8171-0008.1	990049 Führungsbolzen	13.2351-8019.2	210139	13.0441-3507.2	2250053 Dichtungssatz
	220731	11.8171-0067.1	250153 Führungsbolzen	13.2351-8020.2	210140	13.0441-3507.2	2250053 Dichtungssatz
11.9606-9970.2	220732	11.0101-6006.2	260098 Hülsensatz	13.2353-8003.2	210016	13.0441-3504.2	2250050 Dichtungssatz
	220732	11.8116-0366.2	390587 Haltefeder	13.2353-8004.2	210017	13.0441-3504.2	2250050 Dichtungssatz
	220732	11.8171-0008.1	990049 Führungsbolzen	13.2361-8001.2	210214	13.0441-3606.2	2250147 Dichtungssatz
	220732	11.8171-0067.1	250153 Führungsbolzen	13.2361-8002.2	210215	13.0441-3606.2	2250147 Dichtungssatz
11.9606-9971.2	220589	11.0101-5407.2	260011 Hülsensatz	13.2361-8003.2	210220	13.0441-3609.2	2250057 Dichtungssatz
	220589	11.0441-6008.2	250038 Dichtungssatz	13.2361-8004.2	210221	13.0441-3609.2	2250057 Dichtungssatz
	220589	11.8116-0345.2	390596 Haltefeder	13.2361-8005.2	210237	13.0441-3609.2	2250057 Dichtungssatz
	220589	11.8171-0008.1	990049 Führungsbolzen	13.2361-8006.2	210238	13.0441-3609.2	2250057 Dichtungssatz
11.9606-9972.2	220590	11.0101-5407.2	260011 Hülsensatz	13.2381-0039.2	210020	13.0441-3812.2	2250068 Dichtungssatz
	220590	11.0441-6008.2	250038 Dichtungssatz	13.2381-0040.2	210021	13.0441-3812.2	2250068 Dichtungssatz
	220590	11.8116-0345.2	390596 Haltefeder	13.2381-0067.2	210024	13.0441-3815.2	2250069 Dichtungssatz
	220590	11.8171-0008.1	990049 Führungsbolzen	13.2381-0068.2	210025	13.0441-3815.2	2250069 Dichtungssatz
11.9606-9979.2	220907	11.0101-6006.2	260098 Hülsensatz	13.2381-0083.2	210026	13.0441-3819.2	2250072 Dichtungssatz
	220907	11.0441-6008.2	250038 Dichtungssatz	13.2381-0084.2	210027	13.0441-3819.2	2250072 Dichtungssatz
	220907	11.8116-0315.2	390447 Haltefeder	13.2381-0085.2	210028	13.0441-3819.2	2250072 Dichtungssatz
	220907	11.8171-0008.1	990049 Führungsbolzen	13.2381-0086.2	210029	13.0441-3819.2	2250072 Dichtungssatz
	220907	11.8171-0067.1	250153 Führungsbolzen	13.2381-0087.2	210149	13.0441-3819.2	2250072 Dichtungssatz
11.9606-9980.2	220908	11.0101-6006.2	260098 Hülsensatz	13.2381-0088.2	210150	13.0441-3819.2	2250072 Dichtungssatz
	220908	11.0441-6008.2	250038 Dichtungssatz	13.2381-8027.2	210033	13.0441-3811.2	2250067 Dichtungssatz
	220908	11.8116-0315.2	390447 Haltefeder	13.2381-8028.2	210034	13.0441-3811.2	2250067 Dichtungssatz
	220908	11.8171-0008.1	990049 Führungsbolzen	13.2381-8029.2	210035	13.0441-3811.2	2250067 Dichtungssatz
	220908	11.8171-0067.1	250153 Führungsbolzen	13.2381-8030.2	210036	13.0441-3811.2	2250067 Dichtungssatz
11.9606-9981.2	220591	11.0101-5407.2	260011 Hülsensatz	13.2381-8033.2	210222	13.0441-3817.2	2250071 Dichtungssatz
	220591	11.8116-0325.2	390461 Haltefeder	13.2381-8034.2	210223	13.0441-3817.2	2250071 Dichtungssatz
	220591	11.8171-0008.1	990049 Führungsbolzen	13.2381-8035.2	210037	13.0441-3817.2	2250071 Dichtungssatz
11.9606-9982.2	220592	11.0101-5407.2	260011 Hülsensatz	13.2381-8036.2	210038	13.0441-3817.2	2250071 Dichtungssatz
	220592	11.8116-0325.2	390461 Haltefeder	13.2381-9996.2	210039	13.0441-3801.2	2250058 Dichtungssatz
	220592	11.8171-0008.1	990049 Führungsbolzen	13.2381-9997.2	210040	13.0441-3801.2	2250058 Dichtungssatz
11.9606-9991.2	220429	11.0101-5402.2	260009 Hülsensatz	13.2383-0001.2	210041	13.0441-3803.2	2250060 Dichtungssatz
	220429	11.0441-6008.2	250038 Dichtungssatz	13.2383-0002.2	210042	13.0441-3803.2	2250060 Dichtungssatz
	220429	11.8116-0239.2	390510 Haltefeder	13.2384-0013.2	210043	13.0441-3810.2	2250066 Dichtungssatz
	220429	11.8171-0008.1	990049 Führungsbolzen				
11.9606-9992.2	220430	11.0101-5402.2	260009 Hülsensatz				
	220430	11.0441-6008.2	250038 Dichtungssatz				
	220430	11.8116-0239.2	390510 Haltefeder				
	220430	11.8171-0008.1	990049 Führungsbolzen				
13.2351-0011.2	210008	13.0441-3506.2	2250052 Dichtungssatz				
13.2351-0012.2	210009	13.0441-3506.2	2250052 Dichtungssatz				
13.2351-0013.2	210010	13.0441-3506.2	2250052 Dichtungssatz				
13.2351-0014.2	210011	13.0441-3506.2	2250052 Dichtungssatz				
13.2351-0017.2	210012	13.0441-3506.2	2250052 Dichtungssatz				
13.2351-0018.2	210013	13.0441-3506.2	2250052 Dichtungssatz				
13.2351-0025.2	210210	13.0441-3506.2	2250052 Dichtungssatz				
13.2351-0026.2	210211	13.0441-3506.2	2250052 Dichtungssatz				
13.2351-0051.2	210180	13.0441-3507.2	2250053 Dichtungssatz				
13.2351-0052.2	210181	13.0441-3507.2	2250053 Dichtungssatz				





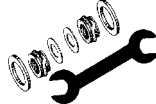



Reparatursätze

Repair kits - Corredi riparazione - Nécessaires de réparation - Juegos de reparación

					
13.2384-0014.2 210044	13.0441-3810.2 250066	Dichtungssatz	13.2481-0034.2 210077	13.0441-4819.2 250104	Dichtungssatz
13.2401-0025.2 210224	13.0441-4022.2 250149	Dichtungssatz	13.2481-0057.2 210078	13.0441-4819.2 250104	Dichtungssatz
13.2401-0026.2 210225	13.0441-4022.2 250149	Dichtungssatz	13.2481-0073.2 210079	13.0441-4819.2 250104	Dichtungssatz
13.2401-0027.2 210045	13.0441-4014.2 250079	Dichtungssatz	13.2481-0074.2 210080	13.0441-4819.2 250104	Dichtungssatz
13.2401-0028.2 210046	13.0441-4014.2 250079	Dichtungssatz	13.2481-0075.2 210081	13.0441-4819.2 250104	Dichtungssatz
13.2401-0039.2 210153	13.0441-4022.2 250149	Dichtungssatz	13.2481-0076.2 210082	13.0441-4819.2 250104	Dichtungssatz
13.2401-0040.2 210154	13.0441-4022.2 250149	Dichtungssatz	13.2481-2311.3 210085	13.0441-4819.2 250104	Dichtungssatz
13.2401-8007.2 210047	13.0441-4002.2 250074	Dichtungssatz	13.2481-2411.3 210086	13.0441-4819.2 250104	Dichtungssatz
210047	13.0441-4008.2 250076	Dichtungssatz	13.2481-7404.3 210089	13.0441-4819.2 250104	Dichtungssatz
13.2401-8008.2 210048	13.0441-4002.2 250074	Dichtungssatz	13.2481-8007.2 210090	13.0441-4825.2 250107	Dichtungssatz
210048	13.0441-4008.2 250076	Dichtungssatz	13.2481-8008.2 210091	13.0441-4825.2 250107	Dichtungssatz
13.2401-8013.2 210051	13.0441-4020.2 250084	Dichtungssatz	13.2481-8011.2 210092	13.0441-4825.2 250107	Dichtungssatz
13.2401-8014.2 210052	13.0441-4020.2 250084	Dichtungssatz	13.2481-8012.2 210093	13.0441-4825.2 250107	Dichtungssatz
13.2421-0025.2 210145	13.0441-4206.2 250087	Dichtungssatz	13.2481-8013.2 210094	13.0441-4825.2 250107	Dichtungssatz
13.2421-0026.2 210146	13.0441-4206.2 250087	Dichtungssatz	13.2481-8014.2 210095	13.0441-4825.2 250107	Dichtungssatz
13.2421-0043.2 210193	13.0441-4216.2 250093	Dichtungssatz	13.2481-8057.2 210096	13.0441-4825.2 250107	Dichtungssatz
13.2421-0044.2 210194	13.0441-4216.2 250093	Dichtungssatz	13.2481-8058.2 210097	13.0441-4825.2 250107	Dichtungssatz
13.2421-8005.2 210053	13.0441-4205.2 250086	Dichtungssatz	13.2481-8067.2 210098	13.0441-4819.2 250104	Dichtungssatz
13.2421-8006.2 210054	13.0441-4205.2 250086	Dichtungssatz	13.2481-8068.2 210099	13.0441-4819.2 250104	Dichtungssatz
13.2421-8007.2 210055	13.0441-4205.2 250086	Dichtungssatz	13.2481-9992.2 210100	13.0441-4819.2 250104	Dichtungssatz
13.2421-8008.2 210056	13.0441-4205.2 250086	Dichtungssatz	13.2481-9993.2 210101	13.0441-4819.2 250104	Dichtungssatz
13.2421-8021.2 210057	13.0441-4206.2 250087	Dichtungssatz	13.2481-9998.2 210102	13.0441-4815.2 250102	Dichtungssatz
13.2421-8022.2 210058	13.0441-4206.2 250087	Dichtungssatz	13.2481-9999.2 210103	13.0441-4815.2 250102	Dichtungssatz
13.2421-8025.2 210061	13.0441-4216.2 250093	Dichtungssatz	13.2483-8001.2 210104	13.0441-4825.2 250107	Dichtungssatz
13.2421-8026.2 210062	13.0441-4216.2 250093	Dichtungssatz	13.2483-8002.2 210105	13.0441-4825.2 250107	Dichtungssatz
13.2423-8009.2 210063	13.0441-4206.2 250087	Dichtungssatz	13.2541-8001.2 210110	13.0441-5416.2 250117	Dichtungssatz
13.2423-8010.2 210064	13.0441-4206.2 250087	Dichtungssatz	13.2541-8002.2 210111	13.0441-5416.2 250117	Dichtungssatz
13.2424-0009.2 210065	13.0441-4212.2 250089	Dichtungssatz	13.2541-8008.2 210112	13.0441-5411.2 250114	Dichtungssatz
13.2424-0010.2 210066	13.0441-4212.2 250089	Dichtungssatz	13.2541-9998.2 210113	13.0441-5409.2 250112	Dichtungssatz
13.2424-8001.2 210072	13.0441-4212.2 250089	Dichtungssatz	13.2541-9999.2 210114	13.0441-5409.2 250112	Dichtungssatz
13.2424-8002.2 210073	13.0441-4212.2 250089	Dichtungssatz	13.2544-8001.2 210115	13.0441-5417.2 250118	Dichtungssatz
13.2461-8001.2 210226	13.0441-4601.2 250099	Dichtungssatz	210115	13.0471-5405.2 250136	Rep.Satz Nachstellung
13.2461-8002.2 210227	13.0441-4601.2 250099	Dichtungssatz	210115	13.0471-5407.2 250137	Verbindungsschrauben
13.2481-0024.2 210074	13.0441-4819.2 250104	Dichtungssatz	210115	13.0471-5408.2 250138	Rep.Satz Rückstellwelle
13.2481-0026.2 210075	13.0441-4825.2 250107	Dichtungssatz	210115	13.0471-5409.2 250139	Rep.Satz Bremshebel
13.2481-0033.2 210076	13.0441-4819.2 250104	Dichtungssatz	210115	13.8158-0020.1 990113	Handbremshebel
			210115	13.8158-0021.1 990114	Handbremshebel







Reparatursätze

Repair kits - Corredi riparazione - Nécessaires de réparation - Juegos de reparación

  			  		
13.2544-8002.2	210116	13.0441-5417.2 250118 Dichtungssatz	13.2601-8035.2	210167	03.3518-6100.2 390364 Entlüfterventil
	210116	13.0471-5405.2 250136 Rep.Satz Nachstellung		210167	03.3518-8000.2 390373 Entlüfterventil
	210116	13.0471-5407.2 250137 Verbindungsschrauben		210167	13.0441-6012.2 250133 Dichtungssatz
	210116	13.0471-5408.2 250138 Rep.Satz Rückstellwelle	13.2601-8036.2	210168	03.3518-6100.2 390364 Entlüfterventil
	210116	13.0471-5409.2 250139 Rep.Satz Bremshebel		210168	03.3518-8000.2 390373 Entlüfterventil
	210116	13.8158-0020.1 990113 Handbremshebel		210168	13.0441-6012.2 250133 Dichtungssatz
	210116	13.8158-0021.1 990114 Handbremshebel			
13.2571-8011.2	210121	13.0441-5718.2 250120 Dichtungssatz	13.2601-8037.2	210169	03.3518-6100.2 390364 Entlüfterventil
				210169	03.3518-8000.2 390373 Entlüfterventil
				210169	13.0441-6012.2 250133 Dichtungssatz
13.2571-8012.2	210122	13.0441-5718.2 250120 Dichtungssatz			
13.2571-8013.2	210123	13.0441-5718.2 250120 Dichtungssatz	13.2601-8038.2	210170	03.3518-6100.2 390364 Entlüfterventil
				210170	03.3518-8000.2 390373 Entlüfterventil
				210170	13.0441-6012.2 250133 Dichtungssatz
13.2571-8014.2	210124	13.0441-5718.2 250120 Dichtungssatz			
13.2571-8015.2	210125	13.0441-5720.2 250122 Dichtungssatz	13.2601-9996.2	210176	13.0441-6001.2 250126 Dichtungssatz
13.2571-8016.2	210126	13.0441-5720.2 250122 Dichtungssatz	13.2601-9997.2	210177	13.0441-6001.2 250126 Dichtungssatz
13.2571-8023.2	210127	13.0441-5724.2 250125 Dichtungssatz	13.4341-8001.2	210151	13.0441-3401.2 250044 Dichtungssatz
13.2571-8024.2	210128	13.0441-5724.2 250125 Dichtungssatz	13.4341-8002.2	210152	13.0441-3401.2 250044 Dichtungssatz
13.2571-8027.2	210129	13.0441-5720.2 250122 Dichtungssatz	13.4401-8005.2	210182	13.0441-4018.2 250083 Dichtungssatz
13.2571-8028.2	210130	13.0441-5720.2 250122 Dichtungssatz	13.4401-8006.2	210183	13.0441-4018.2 250083 Dichtungssatz
13.2571-9994.2	210131	13.0441-5720.2 250122 Dichtungssatz	13.4401-8009.2	210184	13.0441-4018.2 250083 Dichtungssatz
13.2571-9995.2	210132	13.0441-5720.2 250122 Dichtungssatz	13.4401-8010.2	210185	13.0441-4018.2 250083 Dichtungssatz
13.2571-9998.2	210133	13.0441-5718.2 250120 Dichtungssatz	13.4401-8018.2	210186	13.0441-4018.2 250083 Dichtungssatz
13.2571-9999.2	210134	13.0441-5718.2 250120 Dichtungssatz	13.4401-8019.2	210187	13.0441-4018.2 250083 Dichtungssatz
13.2601-0179.3	210141	13.0441-6012.2 250133 Dichtungssatz	13.4401-8020.2	210188	13.0441-4018.2 250083 Dichtungssatz
13.2601-0180.3	210142	13.0441-6012.2 250133 Dichtungssatz	13.4401-8021.2	210189	13.0441-4018.2 250083 Dichtungssatz
13.2601-7015.2	210230	03.3518-6100.2 390364 Entlüfterventil	13.4401-8022.2	210190	13.0441-4018.2 250083 Dichtungssatz
	210230	03.3518-8000.2 390373 Entlüfterventil			
	210230	13.0441-6012.2 250133 Dichtungssatz	13.4401-8027.2	210191	13.0441-4016.2 250081 Dichtungssatz
13.2601-7016.2	210231	03.3518-6100.2 390364 Entlüfterventil	13.4401-8028.2	210192	13.0441-4016.2 250081 Dichtungssatz
	210231	03.3518-8000.2 390373 Entlüfterventil			
	210231	13.0441-6012.2 250133 Dichtungssatz	13.4421-8003.2	210197	13.0441-4214.2 250091 Dichtungssatz
13.2601-8025.2	210157	13.0441-6001.2 250126 Dichtungssatz	13.4421-8004.2	210198	13.0441-4214.2 250091 Dichtungssatz
13.2601-8026.2	210158	13.0441-6001.2 250126 Dichtungssatz	13.4421-8007.2	210235	13.0441-4214.2 250091 Dichtungssatz
13.2601-8027.2	210159	13.0441-6001.2 250126 Dichtungssatz	13.4421-8008.2	210236	13.0441-4214.2 250091 Dichtungssatz
13.2601-8028.2	210160	13.0441-6001.2 250126 Dichtungssatz	13.4421-8009.2	210228	13.0441-4214.2 250091 Dichtungssatz
13.2601-8029.2	210161	13.0441-6003.2 250128 Dichtungssatz	13.4421-8010.2	210229	13.0441-4214.2 250091 Dichtungssatz
13.2601-8030.2	210162	13.0441-6003.2 250128 Dichtungssatz	13.4441-8011.3	210216	13.0441-4408.2 250096 Dichtungssatz
13.2601-8031.2	210163	13.0441-6003.2 250128 Dichtungssatz	13.4441-8012.3	210217	13.0441-4408.2 250096 Dichtungssatz
13.2601-8032.2	210164	13.0441-6003.2 250128 Dichtungssatz	13.4441-8013.3	210199	13.0441-4408.2 250096 Dichtungssatz
13.2601-8033.2	210165	13.0441-6003.2 250128 Dichtungssatz	13.4441-8014.3	210200	13.0441-4408.2 250096 Dichtungssatz
13.2601-8034.2	210166	13.0441-6003.2 250128 Dichtungssatz	13.4441-8015.3	210201	13.0441-4408.2 250096 Dichtungssatz



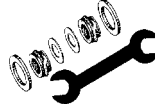



Reparatursätze

Repair kits - Corredi riparazione - Nécessaires de réparation - Juegos de reparación

					
13.4441-8016.3 210202	13.0441-4408.2 250096	Dichtungssatz	24.3304-1708.5 240098	24.0101-3001.2 260039	Bremssattel-Zubehör
13.4441-8017.3 210203	13.0441-4408.2 250096	Dichtungssatz	24.3331-0037.5 240547	11.0441-3305.2 250006	Dichtungssatz
13.4441-8018.3 210204	13.0441-4408.2 250096	Dichtungssatz	24.3331-0038.5 240548	11.0441-3305.2 250006	Dichtungssatz
13.4571-0019.3 210249	13.0441-5721.2 250123	Dichtungssatz	24.3331-8501.5 240509	11.0101-5402.2 260009	Hülsensatz
13.4571-0020.3 210250	13.0441-5721.2 250123	Dichtungssatz	240509	11.0441-3302.2 250004	Dichtungssatz
13.4571-8005.3 210205	13.0441-5721.2 250123	Dichtungssatz	240509	11.8116-0015.1 390492	Haltefeder
13.4571-8006.3 210206	13.0441-5721.2 250123	Dichtungssatz	240509	11.8171-0008.1 990049	Führungsbolzen
13.4574-8005.3 210207	13.0441-5721.2 250123	Dichtungssatz	24.3331-8502.5 240510	11.0101-5402.2 260009	Hülsensatz
210207	24.8190-0029.2 990156	Handbremsbetätigung	240510	11.0441-3302.2 250004	Dichtungssatz
13.4574-8006.3 210208	13.0441-5721.2 250123	Dichtungssatz	240510	11.8116-0015.1 390492	Haltefeder
210208	24.8190-0030.2 990157	Handbremsbetätigung	240510	11.8171-0008.1 990049	Führungsbolzen
13.9361-0023.2 210241	13.0441-3609.2 250057	Dichtungssatz	24.3341-9991.5 240511	11.0101-5402.2 260009	Hülsensatz
13.9361-0024.2 210242	13.0441-3609.2 250057	Dichtungssatz	240511	11.0441-3401.2 250151	Dichtungssatz
13.9361-0029.2 210243	13.0441-3609.2 250057	Dichtungssatz	240511	11.8116-0185.1 390592	Haltefeder
13.9361-0030.2 210244	13.0441-3609.2 250057	Dichtungssatz	240511	11.8171-0008.1 990049	Führungsbolzen
13.9361-0035.2 210253	13.0441-3609.2 250057	Dichtungssatz	24.3341-9992.5 240512	11.0101-5402.2 260009	Hülsensatz
13.9361-0036.2 210254	13.0441-3609.2 250057	Dichtungssatz	240512	11.0441-3401.2 250151	Dichtungssatz
13.9544-0021.2 210257	13.0441-5417.2 250118	Dichtungssatz	240512	11.8116-0185.1 390592	Haltefeder
210257	13.0471-5405.2 250136	Rep.Satz Nachstellung	240512	11.8171-0008.1 990049	Führungsbolzen
210257	13.0471-5407.2 250137	Verbindungsschrauben	24.3344-1701.5 240087	24.0101-3401.2 260043	Bremssattel-Zubehör
210257	13.0471-5408.2 250138	Rep.Satz Rückstellwelle	24.3344-1702.5 240088	24.0101-3401.2 260043	Bremssattel-Zubehör
210257	13.0471-5409.2 250139	Rep.Satz Bremshebel	24.3344-1703.5 240117	24.0101-3601.2 260044	Bremssattel-Zubehör
210257	13.8158-0020.1 990113	Handbremshebel	24.3344-1704.5 240118	24.0101-3601.2 260044	Bremssattel-Zubehör
210257	13.8158-0021.1 990114	Handbremshebel	24.3347-1703.7 220685	24.0101-3803.2 260101	Bremssattel-Zubehör
13.9544-0022.2 210258	13.0441-5417.2 250118	Dichtungssatz	24.3347-1704.7 220686	24.0101-3803.2 260101	Bremssattel-Zubehör
210258	13.0471-5405.2 250136	Rep.Satz Nachstellung	24.3347-1705.7 220751	24.0101-3803.2 260101	Bremssattel-Zubehör
210258	13.0471-5407.2 250137	Verbindungsschrauben	24.3347-1706.7 220752	24.0101-3803.2 260101	Bremssattel-Zubehör
210258	13.0471-5408.2 250138	Rep.Satz Rückstellwelle	24.3361-8503.5 240513	11.0101-5402.2 260009	Hülsensatz
210258	13.0471-5409.2 250139	Rep.Satz Bremshebel	240513	11.0441-3602.2 250008	Dichtungssatz
210258	13.8158-0020.1 990113	Handbremshebel	240513	11.8116-0066.1 390577	Haltefeder
210258	13.8158-0021.1 990114	Handbremshebel	240513	11.8171-0008.1 990049	Führungsbolzen
24.0530-3801.3 220161	24.0101-3601.2 260044	Bremssattel-Zubehör	24.3361-8504.5 240514	11.0101-5402.2 260009	Hülsensatz
24.1441-1701.5 239001	11.0441-4402.2 250014	Dichtungssatz	240514	11.0441-3602.2 250008	Dichtungssatz
24.1441-1702.5 239002	11.0441-4402.2 250014	Dichtungssatz	240514	11.8116-0066.1 390577	Haltefeder
24.3301-1703.7 220683	24.0101-3802.2 260100	Bremssattel-Zubehör	240514	11.8171-0008.1 990049	Führungsbolzen
24.3301-1704.7 220684	24.0101-3802.2 260100	Bremssattel-Zubehör	24.3361-9975.5 240541	11.0101-5407.2 260011	Hülsensatz
24.3304-1701.5 240113	24.0101-3004.2 260042	Bremssattel-Zubehör	240541	11.0441-3602.2 250008	Dichtungssatz
24.3304-1702.5 240114	24.0101-3004.2 260042	Bremssattel-Zubehör	240541	11.8116-0073.1 390498	Haltefeder
24.3304-1703.5 240091	24.0101-3004.2 260042	Bremssattel-Zubehör	240541	11.8171-0008.1 990049	Führungsbolzen
24.3304-1704.5 240092	24.0101-3004.2 260042	Bremssattel-Zubehör	24.3361-9976.5 240542	11.0101-5407.2 260011	Hülsensatz
24.3304-1707.5 240097	24.0101-3001.2 260039	Bremssattel-Zubehör	240542	11.0441-3602.2 250008	Dichtungssatz
			240542	11.8116-0073.1 390498	Haltefeder
			240542	11.8171-0008.1 990049	Führungsbolzen
			24.3364-1603.5 240009	24.0101-3601.2 260044	Bremssattel-Zubehör
			24.3364-1604.5 240010	24.0101-3601.2 260044	Bremssattel-Zubehör
			24.3364-1605.5 240011	11.0101-5403.2 260010	Faltenbalgsatz
			240011	24.0101-3601.2 260044	Bremssattel-Zubehör

Reparatursätze







Repair kits - Corredi riparazione - Nécessaires de réparation - Juegos de reparación

					
24.3364-1606.5 240012 240012	11.0101-5403.2 260010 24.0101-3601.2 260044	Faltenbalsatz Bremsattel-Zubehör	24.3384-1770.7 220792	24.0101-3802.2 260100	Bremsattel-Zubehör
24.3364-1701.5 240053	24.0101-3601.2 260044	Bremsattel-Zubehör	24.3387-1707.7 220701	24.0101-3803.2 260101	Bremsattel-Zubehör
24.3364-1702.5 240054	24.0101-3601.2 260044	Bremsattel-Zubehör	24.3387-1708.7 220702	24.0101-3803.2 260101	Bremsattel-Zubehör
24.3367-1711.7 220753	24.0101-3803.2 260101	Bremsattel-Zubehör	24.3387-1717.7 220757	24.0101-3803.2 260101	Bremsattel-Zubehör
24.3367-1712.7 220754	24.0101-3803.2 260101	Bremsattel-Zubehör	24.3387-1718.7 220758	24.0101-3803.2 260101	Bremsattel-Zubehör
24.3381-1701.5 240071	24.0101-3801.2 260045	Bremsattel-Zubehör	24.3387-1719.7 220773	24.0101-3803.2 260101	Bremsattel-Zubehör
24.3381-1702.5 240072	24.0101-3801.2 260045	Bremsattel-Zubehör	24.3387-1720.7 220774	24.0101-3803.2 260101	Bremsattel-Zubehör
24.3381-8503.5 240515 240515 240515 240515	11.0101-5402.2 260009 11.0441-3803.2 250010 11.8116-0066.1 390577 11.8171-0008.1 990049	Hülsensatz Dichtungssatz Haltefeder Führungsbolzen	24.3401-1601.5 240173 24.3401-1602.5 240174	24.0101-3401.2 260043 24.0101-3401.2 260043	Bremsattel-Zubehör Bremsattel-Zubehör
24.3381-8504.5 240516 240516 240516 240516	11.0101-5402.2 260009 11.0441-3803.2 250010 11.8116-0066.1 390577 11.8171-0008.1 990049	Hülsensatz Dichtungssatz Haltefeder Führungsbolzen	24.3401-1603.5 240017 240017	24.0101-3401.2 260043 24.0101-3601.2 260044	Bremsattel-Zubehör Bremsattel-Zubehör
24.3381-9959.5 240517 240517 240517 240517	11.0101-5402.2 260009 11.0441-3803.2 250010 11.8116-0066.1 390577 11.8171-0008.1 990049	Hülsensatz Dichtungssatz Haltefeder Führungsbolzen	24.3401-1604.5 240018 240018	24.0101-3401.2 260043 24.0101-3601.2 260044	Bremsattel-Zubehör Bremsattel-Zubehör
24.3381-9960.5 240518 240518 240518 240518	11.0101-5402.2 260009 11.0441-3803.2 250010 11.8116-0066.1 390577 11.8171-0008.1 990049	Hülsensatz Dichtungssatz Haltefeder Führungsbolzen	24.3401-1703.5 240351 240351 240351 240351	11.0101-5402.2 260009 11.0441-4002.2 250011 11.8116-0066.1 390577 11.8171-0008.1 990049	Hülsensatz Dichtungssatz Haltefeder Führungsbolzen
24.3381-9961.5 240519 240519 240519 240519	11.0101-5402.2 260009 11.0441-3803.2 250010 11.8116-0066.1 390577 11.8171-0008.1 990049	Hülsensatz Dichtungssatz Haltefeder Führungsbolzen	24.3401-1704.5 240352 240352 240352 240352	11.0101-5402.2 260009 11.0441-4002.2 250011 11.8116-0066.1 390577 11.8171-0008.1 990049	Hülsensatz Dichtungssatz Haltefeder Führungsbolzen
24.3381-9962.5 240520 240520 240520 240520	11.0101-5402.2 260009 11.0441-3803.2 250010 11.8116-0066.1 390577 11.8171-0008.1 990049	Hülsensatz Dichtungssatz Haltefeder Führungsbolzen	24.3401-1705.5 240423 240423 240423 240423	11.0101-5402.2 260009 11.0441-4002.2 250011 11.8116-0066.1 390577 11.8171-0008.1 990049	Hülsensatz Dichtungssatz Haltefeder Führungsbolzen
24.3384-1601.5 240013	24.0101-3601.2 260044	Bremsattel-Zubehör	24.3401-1706.5 240424 240424 240424 240424	11.0101-5402.2 260009 11.0441-4002.2 250011 11.8116-0066.1 390577 11.8171-0008.1 990049	Hülsensatz Dichtungssatz Haltefeder Führungsbolzen
24.3384-1602.5 240014	24.0101-3601.2 260044	Bremsattel-Zubehör	24.3401-8503.5 240521 240521 240521 240521	11.0101-5402.2 260009 11.0441-4002.2 250011 11.8116-0066.1 390577 11.8171-0008.1 990049	Hülsensatz Dichtungssatz Haltefeder Führungsbolzen
24.3384-1603.5 240015	24.0101-3601.2 260044	Bremsattel-Zubehör	24.3401-8504.5 240522 240522 240522 240522	11.0101-5402.2 260009 11.0441-4002.2 250011 11.8116-0066.1 390577 11.8171-0008.1 990049	Hülsensatz Dichtungssatz Haltefeder Führungsbolzen
24.3384-1604.5 240016	24.0101-3601.2 260044	Bremsattel-Zubehör	24.3401-9977.5 240523 240523 240523 240523	11.0101-5402.2 260009 11.0441-4003.2 250001 11.8116-0094.1 390504 11.8171-0008.1 990049	Hülsensatz Dichtungssatz Haltefeder Führungsbolzen
24.3384-1703.5 240055	24.0101-3601.2 260044	Bremsattel-Zubehör	24.3401-9978.5 240524 240524 240524 240524	11.0101-5402.2 260009 11.0441-4003.2 250001 11.8116-0094.1 390504 11.8171-0008.1 990049	Hülsensatz Dichtungssatz Haltefeder Führungsbolzen
24.3384-1704.5 240056	24.0101-3601.2 260044	Bremsattel-Zubehör	24.3417-1703.7 220759	24.0101-3803.2 260101	Bremsattel-Zubehör
24.3384-1705.5 240063	24.0101-3601.2 260044	Bremsattel-Zubehör	24.3417-1704.7 220760	24.0101-3803.2 260101	Bremsattel-Zubehör
24.3384-1706.5 240064	24.0101-3601.2 260044	Bremsattel-Zubehör			
24.3384-1707.5 240171 240171	11.0101-5403.2 260010 24.0101-3601.2 260044	Faltenbalsatz Bremsattel-Zubehör			
24.3384-1708.5 240172 240172	11.0101-5403.2 260010 24.0101-3601.2 260044	Faltenbalsatz Bremsattel-Zubehör			
24.3384-1769.7 220791	24.0101-3802.2 260100	Bremsattel-Zubehör			





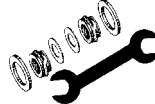



Reparatursätze

Repair kits - Corredi riparazione - Nécessaires de réparation - Juegos de reparación

					
24.3421-1705.5 240353	11.0101-5402.2 260009	Hülsensatz	24.3481-1708.5 240074	24.0101-3601.2 260044	Bremssattel-Zubehör
240353	11.8116-0296.1 390445	Haltefeder	24.3481-1709.5 240065	24.0101-4804.2 260050	Bremssattel-Zubehör
240353	11.8171-0008.1 990049	Führungsbolzen	24.3481-1710.5 240066	24.0101-4804.2 260050	Bremssattel-Zubehör
24.3421-1706.5 240354	11.0101-5402.2 260009	Hülsensatz	24.3481-1710.5 240066	24.0101-4804.2 260050	Bremssattel-Zubehör
240354	11.8116-0296.1 390445	Haltefeder	24.3481-1731.5 240209	11.0101-5407.2 260011	Hülsensatz
240354	11.8171-0008.1 990049	Führungsbolzen	240209	11.0441-4805.2 250020	Dichtungssatz
24.3421-9979.5 240475	11.0101-5407.2 260011	Hülsensatz	240209	11.8171-0008.1 990049	Führungsbolzen
240475	11.8116-0236.1 390507	Haltefeder	24.3481-1732.5 240210	11.0101-5407.2 260011	Hülsensatz
240475	11.8171-0008.1 990049	Führungsbolzen	240210	11.0441-4805.2 250020	Dichtungssatz
24.3421-9980.5 240476	11.0101-5407.2 260011	Hülsensatz	240210	11.8171-0008.1 990049	Führungsbolzen
240476	11.8116-0236.1 390507	Haltefeder	24.3481-1733.5 240213	11.0101-5407.2 260011	Hülsensatz
240476	11.8171-0008.1 990049	Führungsbolzen	240213	11.0441-4811.2 250024	Dichtungssatz
24.3434-1601.5 240019	24.0101-4301.2 260047	Bremssattel-Zubehör	240213	11.8116-0129.1 390591	Haltefeder
24.3434-1602.5 240020	24.0101-4301.2 260047	Bremssattel-Zubehör	240213	11.8171-0008.1 990049	Führungsbolzen
24.3434-1701.5 240357	11.0101-5403.2 260010	Faltenbalgsatz	24.3481-1734.5 240214	11.0101-5407.2 260011	Hülsensatz
24.3434-1702.5 240358	11.0101-5403.2 260010	Faltenbalgsatz	240214	11.0441-4811.2 250024	Dichtungssatz
24.3451-1703.5 240059	11.0101-5403.2 260010	Faltenbalgsatz	240214	11.8116-0129.1 390591	Haltefeder
240059	24.0101-3401.2 260043	Bremssattel-Zubehör	240214	11.8171-0008.1 990049	Führungsbolzen
24.3451-1704.5 240060	11.0101-5403.2 260010	Faltenbalgsatz	24.3481-1735.5 240283	11.0101-4801.2 260006	Hülsensatz
240060	24.0101-3401.2 260043	Bremssattel-Zubehör	240283	11.0441-4808.2 250022	Dichtungssatz
24.3481-0705.5 240021	24.0101-4801.2 990131	Bremssattel-Zubehör	240283	24.0102-4801.2 260085	Hülsensatz+Schrauben
24.3481-0706.5 240022	24.0101-4801.2 990131	Bremssattel-Zubehör	24.3481-1736.5 240284	11.0101-4801.2 260006	Hülsensatz
24.3481-0707.5 240023	24.0101-4801.2 990131	Bremssattel-Zubehör	240284	11.0441-4808.2 250022	Dichtungssatz
24.3481-0708.5 240024	24.0101-4801.2 990131	Bremssattel-Zubehör	240284	24.0102-4801.2 260085	Hülsensatz+Schrauben
24.3481-0711.5 240025	24.0101-4801.2 990131	Bremssattel-Zubehör	24.3481-1745.5 240277	11.0101-4803.2 260008	Hülsensatz
24.3481-0712.5 240026	24.0101-4801.2 990131	Bremssattel-Zubehör	240277	11.0441-4808.2 250022	Dichtungssatz
24.3481-0713.5 240027	24.0101-4801.2 990131	Bremssattel-Zubehör	240277	24.0102-4803.2 260086	Hülsensatz+Schrauben
24.3481-0714.5 240028	24.0101-4801.2 990131	Bremssattel-Zubehör	24.3481-1746.5 240278	11.0101-4803.2 260008	Hülsensatz
24.3481-1505.5 240047	24.0101-4803.2 260049	Bremssattel-Zubehör	240278	11.0441-4808.2 250022	Dichtungssatz
24.3481-1506.5 240048	24.0101-4803.2 260049	Bremssattel-Zubehör	240278	24.0102-4803.2 260086	Hülsensatz+Schrauben
24.3481-1611.5 240029	24.0101-4807.2 260053	Bremssattel-Zubehör	24.3481-1747.5 240279	11.0101-4803.2 260008	Hülsensatz
24.3481-1612.5 240030	24.0101-4807.2 260053	Bremssattel-Zubehör	240279	11.0441-4808.2 250022	Dichtungssatz
24.3481-1615.5 240031	24.0101-4806.2 260052	Bremssattel-Zubehör	240279	24.0102-4803.2 260086	Hülsensatz+Schrauben
24.3481-1616.5 240032	24.0101-4806.2 260052	Bremssattel-Zubehör	24.3481-1748.5 240280	11.0101-4803.2 260008	Hülsensatz
24.3481-1617.5 240115	24.0101-3601.2 260044	Bremssattel-Zubehör	240280	11.0441-4808.2 250022	Dichtungssatz
24.3481-1618.5 240116	24.0101-3601.2 260044	Bremssattel-Zubehör	240280	24.0102-4803.2 260086	Hülsensatz+Schrauben
24.3481-1703.5 240051	24.0101-4301.2 260047	Bremssattel-Zubehör	24.3481-1749.5 240281	11.0101-4801.2 260006	Hülsensatz
24.3481-1704.5 240052	24.0101-4301.2 260047	Bremssattel-Zubehör	240281	11.0441-4808.2 250022	Dichtungssatz
24.3481-1707.5 240073	24.0101-3601.2 260044	Bremssattel-Zubehör	240281	24.0102-4801.2 260085	Hülsensatz+Schrauben
			24.3481-1750.5 240282	11.0101-4801.2 260006	Hülsensatz
			240282	11.0441-4808.2 250022	Dichtungssatz
			240282	24.0102-4801.2 260085	Hülsensatz+Schrauben
			24.3481-1753.5 240287	11.0101-4803.2 260008	Hülsensatz
			240287	11.0441-4808.2 250022	Dichtungssatz
			240287	24.0102-4803.2 260086	Hülsensatz+Schrauben
			24.3481-1754.5 240288	11.0101-4803.2 260008	Hülsensatz
			240288	11.0441-4808.2 250022	Dichtungssatz
			240288	24.0102-4803.2 260086	Hülsensatz+Schrauben
			24.3481-1805.7 220765	24.0101-3802.2 260100	Bremssattel-Zubehör
			24.3481-1806.7 220766	24.0101-3802.2 260100	Bremssattel-Zubehör

Reparatursätze







Repair kits - Corredi riparazione - Nécessaires de réparation - Juegos de reparación

  			  		
24.3481-8515.5	240477	11.0101-5407.2 260011 Hülsensatz 240477 11.8116-0264.1 390594 Haltefeder 240477 11.8171-0008.1 990049 Führungsbolzen	24.3541-1631.7	220325 220325	11.0101-5403.2 260010 Faltenbalgsatz 11.0441-5404.2 250029 Dichtungssatz
24.3481-8516.5	240478	11.0101-5407.2 260011 Hülsensatz 240478 11.8116-0264.1 390594 Haltefeder 240478 11.8171-0008.1 990049 Führungsbolzen	24.3541-1632.7	220326 220326	11.0101-5403.2 260010 Faltenbalgsatz 11.0441-5404.2 250029 Dichtungssatz
24.3481-9833.5	240479	11.0101-5407.2 260011 Hülsensatz 240479 11.0441-4811.2 250024 Dichtungssatz 240479 11.8116-0129.1 390591 Haltefeder 240479 11.8171-0008.1 990049 Führungsbolzen	24.3541-1701.5	240005 240005 240005	11.0101-5407.2 260011 Hülsensatz 11.0441-5402.2 250028 Dichtungssatz 11.8171-0008.1 990049 Führungsbolzen
24.3481-9834.5	240480	11.0101-5407.2 260011 Hülsensatz 240480 11.0441-4811.2 250024 Dichtungssatz 240480 11.8116-0129.1 390591 Haltefeder 240480 11.8171-0008.1 990049 Führungsbolzen	24.3541-1702.5	240006 240006 240006	11.0101-5407.2 260011 Hülsensatz 11.0441-5402.2 250028 Dichtungssatz 11.8171-0008.1 990049 Führungsbolzen
24.3511-1701.5	240101	24.0101-5102.2 260056 Bremssattel-Zubehör	24.3541-1705.5	240111	24.0101-5405.2 260063 Bremssattel-Zubehör
24.3511-1702.5	240102	24.0101-5102.2 260056 Bremssattel-Zubehör	24.3541-1706.5	240112	24.0101-5405.2 260063 Bremssattel-Zubehör
24.3521-0701.7	220209	24.0101-4801.2 990131 Bremssattel-Zubehör	24.3541-1707.5	240067	24.0101-5401.2 260059 Bremssattel-Zubehör
24.3521-0702.7	220210	24.0101-4801.2 990131 Bremssattel-Zubehör	24.3541-1708.5	240068	24.0101-5401.2 260059 Bremssattel-Zubehör
24.3521-0705.5	240033	24.0101-4801.2 990131 Bremssattel-Zubehör	24.3541-1711.5	240107	24.0101-5102.2 260056 Bremssattel-Zubehör
24.3521-0706.5	240034	24.0101-4801.2 990131 Bremssattel-Zubehör	24.3541-1712.5	240108	24.0101-5102.2 260056 Bremssattel-Zubehör
24.3521-1701.5	240001	11.0101-5407.2 260011 Hülsensatz 240001 11.0441-5202.2 250026 Dichtungssatz 240001 11.8116-0097.1 390590 Haltefeder 240001 11.8171-0008.1 990049 Führungsbolzen	24.3541-1717.5	240121	24.0101-3601.2 260044 Bremssattel-Zubehör
24.3521-1702.5	240002	11.0101-5407.2 260011 Hülsensatz 240002 11.0441-5202.2 250026 Dichtungssatz 240002 11.8116-0097.1 390590 Haltefeder 240002 11.8171-0008.1 990049 Führungsbolzen	24.3541-1718.5	240122	24.0101-3601.2 260044 Bremssattel-Zubehör
24.3521-7001.5	240481	11.0101-5407.2 260011 Hülsensatz 240481 11.8171-0008.1 990049 Führungsbolzen	24.3541-1719.5	240057 240057 240057	11.0101-5403.2 260010 Faltenbalgsatz 11.0101-5409.2 260035 Hülsensatz 24.0101-4301.2 260047 Bremssattel-Zubehör
24.3521-7002.5	240482	11.0101-5407.2 260011 Hülsensatz 240482 11.8171-0008.1 990049 Führungsbolzen	24.3541-1720.5	240058 240058 240058	11.0101-5403.2 260010 Faltenbalgsatz 11.0101-5409.2 260035 Hülsensatz 24.0101-4301.2 260047 Bremssattel-Zubehör
24.3541-0701.5	240035	24.0101-4801.2 990131 Bremssattel-Zubehör	24.3541-1721.5	240075	24.0101-3601.2 260044 Bremssattel-Zubehör
24.3541-0702.5	240036	24.0101-4801.2 990131 Bremssattel-Zubehör	24.3541-1722.5	240076	24.0101-3601.2 260044 Bremssattel-Zubehör
24.3541-1603.5	240037	24.0101-3601.2 260044 Bremssattel-Zubehör	24.3541-1723.5	240077	24.0101-3601.2 260044 Bremssattel-Zubehör
24.3541-1604.5	240038	24.0101-3601.2 260044 Bremssattel-Zubehör	24.3541-1724.5	240078	24.0101-3601.2 260044 Bremssattel-Zubehör
24.3541-1609.5	240039	11.0101-5403.2 260010 Faltenbalgsatz 240039 11.0101-5409.2 260035 Hülsensatz 240039 24.0101-4301.2 260047 Bremssattel-Zubehör	24.3541-1725.5	240003 240003	11.0101-5403.2 260010 Faltenbalgsatz 11.0441-5404.2 250029 Dichtungssatz
24.3541-1610.5	240040	11.0101-5403.2 260010 Faltenbalgsatz 240040 11.0101-5409.2 260035 Hülsensatz 240040 24.0101-4301.2 260047 Bremssattel-Zubehör	24.3541-1726.5	240004 240004	11.0101-5403.2 260010 Faltenbalgsatz 11.0441-5404.2 250029 Dichtungssatz
24.3541-1611.5	240041	24.0101-3401.2 260043 Bremssattel-Zubehör	24.3541-1731.5	240061	24.0101-4301.2 260047 Bremssattel-Zubehör
24.3541-1612.5	240042	24.0101-3401.2 260043 Bremssattel-Zubehör	24.3541-1732.5	240062	24.0101-4301.2 260047 Bremssattel-Zubehör
24.3541-1619.5	240043	24.0101-3601.2 260044 Bremssattel-Zubehör	24.3541-1739.5	240223	11.0101-5403.2 260010 Faltenbalgsatz
24.3541-1620.5	240044	24.0101-3601.2 260044 Bremssattel-Zubehör	24.3541-1740.5	240224	11.0101-5403.2 260010 Faltenbalgsatz
			24.3541-1773.7	220527 220527	11.0101-5403.2 260010 Faltenbalgsatz 24.0101-3401.2 260043 Bremssattel-Zubehör
			24.3541-1774.7	220528 220528	11.0101-5403.2 260010 Faltenbalgsatz 24.0101-3401.2 260043 Bremssattel-Zubehör
			24.3541-1779.5	240249	11.0101-5403.2 260010 Faltenbalgsatz
			24.3541-1780.5	240250	11.0101-5403.2 260010 Faltenbalgsatz





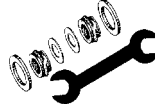



Reparatursätze

Repair kits - Corredi riparazione - Nécessaires de réparation - Juegos de reparación

  			  				
24.3541-1821.7	220695	24.0101-3802.2 260100	Bremssattel-Zubehör	24.3541-9588.5	240528	11.0101-5402.2 260009	Hülsensatz
					240528	11.0441-5402.2 250028	Dichtungssatz
24.3541-1822.7	220696	24.0101-3802.2 260100	Bremssattel-Zubehör		240528	11.8116-0109.1 390495	Haltefeder
					240528	11.8116-0206.1 390593	Haltefeder
24.3541-8083.5	240483	11.0101-5407.2 260011	Hülsensatz		240528	11.8170-0729.1 260107	Halter
	240483	11.8116-0292.1 390521	Haltefeder		240528	11.8170-0730.1 260108	Halter
	240483	11.8171-0008.1 990049	Führungsbolzen		240528	11.8171-0008.1 990049	Führungsbolzen
24.3541-8084.5	240484	11.0101-5407.2 260011	Hülsensatz	24.3541-9667.5	240529	11.0101-5402.2 260009	Hülsensatz
	240484	11.8116-0292.1 390521	Haltefeder		240529	11.0230-0444.1 260104	Halter
	240484	11.8171-0008.1 990049	Führungsbolzen		240529	11.0441-5402.2 250028	Dichtungssatz
					240529	11.8116-0109.1 390495	Haltefeder
24.3541-8085.5	240525	11.0101-5407.2 260011	Hülsensatz		240529	11.8116-0206.1 390593	Haltefeder
	240525	11.8116-0129.1 390591	Haltefeder		240529	11.8171-0008.1 990049	Führungsbolzen
	240525	11.8116-0292.1 390521	Haltefeder				
	240525	11.8171-0008.1 990049	Führungsbolzen	24.3541-9668.5	240530	11.0101-5402.2 260009	Hülsensatz
24.3541-8086.5	240526	11.0101-5407.2 260011	Hülsensatz		240530	11.0230-0444.1 260104	Halter
	240526	11.8116-0129.1 390591	Haltefeder		240530	11.0441-5402.2 250028	Dichtungssatz
	240526	11.8116-0292.1 390521	Haltefeder		240530	11.8116-0109.1 390495	Haltefeder
	240526	11.8171-0008.1 990049	Führungsbolzen		240530	11.8116-0206.1 390593	Haltefeder
					240530	11.8171-0008.1 990049	Führungsbolzen
24.3541-8105.5	240485	11.0101-5407.2 260011	Hülsensatz	24.3546-1707.7	220597	11.0101-5407.2 260011	Hülsensatz
	240485	11.8171-0008.1 990049	Führungsbolzen				
24.3541-8106.5	240486	11.0101-5407.2 260011	Hülsensatz	24.3546-1708.7	220598	11.0101-5407.2 260011	Hülsensatz
	240486	11.8171-0008.1 990049	Führungsbolzen				
24.3541-8521.5	240487	11.0101-5409.2 260035	Hülsensatz	24.3571-1703.5	240099	24.0101-5701.2 260065	Bremssattel-Zubehör
	240487	11.0441-5405.2 250030	Dichtungssatz	24.3571-1704.5	240100	24.0101-5701.2 260065	Bremssattel-Zubehör
24.3541-8522.5	240488	11.0101-5409.2 260035	Hülsensatz	24.3571-1705.5	240069	24.0101-3401.2 260043	Bremssattel-Zubehör
	240488	11.0441-5405.2 250030	Dichtungssatz	24.3571-1706.5	240070	24.0101-3401.2 260043	Bremssattel-Zubehör
24.3541-8523.5	240551	11.0101-5409.2 260035	Hülsensatz	24.3571-1707.5	240079	24.0101-3601.2 260044	Bremssattel-Zubehör
	240551	11.0441-5409.2 250031	Dichtungssatz				
	240551	11.8116-0143.1 390513	Haltefeder	24.3571-1708.5	240080	24.0101-3601.2 260044	Bremssattel-Zubehör
	240551	11.8170-0306.1 260102	Halter				
	240551	11.8171-0008.1 990049	Führungsbolzen	24.3571-1725.5	240313	11.0101-5407.2 260011	Hülsensatz
24.3541-8524.5	240552	11.0101-5409.2 260035	Hülsensatz		240313	11.0441-5704.2 250034	Dichtungssatz
	240552	11.0441-5409.2 250031	Dichtungssatz		240313	11.8116-0292.1 390521	Haltefeder
	240552	11.8116-0143.1 390513	Haltefeder		240313	11.8171-0008.1 990049	Führungsbolzen
	240552	11.8170-0306.1 260102	Halter	24.3571-1726.5	240314	11.0101-5407.2 260011	Hülsensatz
	240552	11.8171-0008.1 990049	Führungsbolzen		240314	11.0441-5704.2 250034	Dichtungssatz
24.3541-8529.5	240553	11.0101-5407.2 260011	Hülsensatz		240314	11.8116-0292.1 390521	Haltefeder
	240553	11.0441-5402.2 250028	Dichtungssatz		240314	11.8171-0008.1 990049	Führungsbolzen
	240553	11.8116-0264.1 390594	Haltefeder	24.3571-1733.5	240349	11.0101-5402.2 260009	Hülsensatz
	240553	11.8171-0008.1 990049	Führungsbolzen		240349	11.8116-0273.1 390515	Haltefeder
24.3541-8530.5	240554	11.0101-5407.2 260011	Hülsensatz		240349	11.8171-0008.1 990049	Führungsbolzen
	240554	11.0441-5402.2 250028	Dichtungssatz	24.3571-1734.5	240350	11.0101-5402.2 260009	Hülsensatz
	240554	11.8116-0264.1 390594	Haltefeder		240350	11.8116-0273.1 390515	Haltefeder
	240554	11.8171-0008.1 990049	Führungsbolzen		240350	11.8171-0008.1 990049	Führungsbolzen
24.3541-9587.5	240527	11.0101-5402.2 260009	Hülsensatz	24.3571-1739.7	220667	24.0101-3803.2 260101	Bremssattel-Zubehör
	240527	11.0441-5402.2 250028	Dichtungssatz				
	240527	11.8116-0109.1 390495	Haltefeder	24.3571-1740.7	220668	24.0101-3803.2 260101	Bremssattel-Zubehör
	240527	11.8116-0206.1 390593	Haltefeder				
	240527	11.8170-0729.1 260107	Halter	24.3571-1743.7	220687	24.0101-3803.2 260101	Bremssattel-Zubehör
	240527	11.8170-0730.1 260108	Halter				
	240527	11.8171-0008.1 990049	Führungsbolzen	24.3571-1744.7	220688	24.0101-3803.2 260101	Bremssattel-Zubehör
				24.3571-1745.7	220689	24.0101-3802.2 260100	Bremssattel-Zubehör
				24.3571-1746.7	220690	24.0101-3802.2 260100	Bremssattel-Zubehör
				24.3571-1747.7	220691	24.0101-3802.2 260100	Bremssattel-Zubehör

Reparatursätze

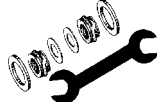





Repair kits - Corredi riparazione - Nécessaires de réparation - Juegos de reparación

					
24.3571-1748.7	220692	24.0101-3802.2	260100	Bremssattel-Zubehör	
24.3571-1749.7	220693	24.0101-3802.2	260100	Bremssattel-Zubehör	
24.3571-1750.7	220694	24.0101-3802.2	260100	Bremssattel-Zubehör	
24.3571-1761.5	240461	11.0101-5407.2	260011	Hülsensatz	
	240461	11.0441-5704.2	250034	Dichtungssatz	
	240461	11.8116-0292.1	390521	Haltefeder	
	240461	11.8171-0008.1	990049	Führungsbolzen	
24.3571-1762.5	240462	11.0101-5407.2	260011	Hülsensatz	
	240462	11.0441-5704.2	250034	Dichtungssatz	
	240462	11.8116-0292.1	390521	Haltefeder	
	240462	11.8171-0008.1	990049	Führungsbolzen	
24.3571-8505.5	240489	11.0101-5409.2	260035	Hülsensatz	
	240489	11.0441-5704.2	250034	Dichtungssatz	
	240489	11.8116-0143.1	390513	Haltefeder	
	240489	11.8171-0008.1	990049	Führungsbolzen	
24.3571-8506.5	240490	11.0101-5409.2	260035	Hülsensatz	
	240490	11.0441-5704.2	250034	Dichtungssatz	
	240490	11.8116-0143.1	390513	Haltefeder	
	240490	11.8171-0008.1	990049	Führungsbolzen	
24.3571-8507.5	240555	11.8170-0306.1	260102	Halter	
24.3571-8508.5	240556	11.8170-0306.1	260102	Halter	
24.3571-8511.5	240491	11.0101-5407.2	260011	Hülsensatz	
	240491	11.0441-5703.2	250145	Dichtungssatz	
	240491	11.8116-0253.1	390512	Haltefeder	
	240491	11.8170-0401.1	260103	Halter	
	240491	11.8171-0008.1	990049	Führungsbolzen	
24.3571-8512.5	240492	11.0101-5407.2	260011	Hülsensatz	
	240492	11.0441-5703.2	250145	Dichtungssatz	
	240492	11.8116-0253.1	390512	Haltefeder	
	240492	11.8170-0401.1	260103	Halter	
	240492	11.8171-0008.1	990049	Führungsbolzen	
24.3571-8517.5	240493	11.0101-5409.2	260035	Hülsensatz	
	240493	11.0441-5704.2	250034	Dichtungssatz	
	240493	11.8116-0143.1	390513	Haltefeder	
	240493	11.8171-0008.1	990049	Führungsbolzen	
24.3571-8518.5	240494	11.0101-5409.2	260035	Hülsensatz	
	240494	11.0441-5704.2	250034	Dichtungssatz	
	240494	11.8116-0143.1	390513	Haltefeder	
	240494	11.8171-0008.1	990049	Führungsbolzen	
24.3571-8521.5	240495	11.0101-5409.2	260035	Hülsensatz	
	240495	11.0441-5704.2	250034	Dichtungssatz	
	240495	11.8116-0143.1	390513	Haltefeder	
	240495	11.8170-0306.1	260102	Halter	
	240495	11.8171-0008.1	990049	Führungsbolzen	
24.3571-8522.5	240496	11.0101-5409.2	260035	Hülsensatz	
	240496	11.0441-5704.2	250034	Dichtungssatz	
	240496	11.8116-0143.1	390513	Haltefeder	
	240496	11.8170-0306.1	260102	Halter	
	240496	11.8171-0008.1	990049	Führungsbolzen	
24.3571-9801.5	240497	11.0101-5407.2	260011	Hülsensatz	
	240497	11.8171-0008.1	990049	Führungsbolzen	
24.3571-9802.5	240498	11.0101-5407.2	260011	Hülsensatz	
	240498	11.8171-0008.1	990049	Führungsbolzen	
24.3571-9811.5	240531	11.0101-5407.2	260011	Hülsensatz	
	240531	11.0101-5706.2	260097	Hülsensatz	
	240531	11.0441-5704.2	250034	Dichtungssatz	
	240531	11.8116-0326.1	390471	Haltefeder	
	240531	11.8171-0008.1	990049	Führungsbolzen	
	240531	11.8171-0067.1	250153	Führungsbolzen	
24.3571-9812.5	240532	11.0101-5407.2	260011	Hülsensatz	
	240532	11.0101-5706.2	260097	Hülsensatz	
	240532	11.0441-5704.2	250034	Dichtungssatz	
	240532	11.8116-0326.1	390471	Haltefeder	
	240532	11.8171-0008.1	990049	Führungsbolzen	
	240532	11.8171-0067.1	250153	Führungsbolzen	
24.3571-9813.5	240557	11.0101-5407.2	260011	Hülsensatz	
	240557	11.8116-0356.1	390586	Haltefeder	
	240557	11.8171-0008.1	990049	Führungsbolzen	
24.3571-9814.5	240558	11.0101-5407.2	260011	Hülsensatz	
	240558	11.8116-0356.1	390586	Haltefeder	
	240558	11.8171-0008.1	990049	Führungsbolzen	
24.3571-9823.5	240499	11.0101-5407.2	260011	Hülsensatz	
	240499	11.0441-5704.2	250034	Dichtungssatz	
	240499	11.8116-0292.1	390521	Haltefeder	
	240499	11.8171-0008.1	990049	Führungsbolzen	
24.3571-9824.5	240500	11.0101-5407.2	260011	Hülsensatz	
	240500	11.0441-5704.2	250034	Dichtungssatz	
	240500	11.8116-0292.1	390521	Haltefeder	
	240500	11.8171-0008.1	990049	Führungsbolzen	
24.3571-9841.5	240501	11.0101-5407.2	260011	Hülsensatz	
	240501	11.8171-0008.1	990049	Führungsbolzen	
24.3571-9842.5	240502	11.0101-5407.2	260011	Hülsensatz	
	240502	11.8171-0008.1	990049	Führungsbolzen	
24.3601-1601.5	240203	11.0101-5403.2	260010	Faltenbalgsatz	
24.3601-1602.5	240204	11.0101-5403.2	260010	Faltenbalgsatz	
24.3601-1701.5	240007	11.0101-5407.2	260011	Hülsensatz	
	240007	11.0441-6003.2	250037	Dichtungssatz	
	240007	11.8171-0008.1	990049	Führungsbolzen	
24.3601-1702.5	240008	11.0101-5407.2	260011	Hülsensatz	
	240008	11.0441-6003.2	250037	Dichtungssatz	
	240008	11.8171-0008.1	990049	Führungsbolzen	
24.3601-1709.5	240275	11.0101-6004.2	260014	Hülsensatz	
	240275	11.0441-6003.2	250037	Dichtungssatz	
24.3601-1710.5	240276	11.0101-6004.2	260014	Hülsensatz	
	240276	11.0441-6003.2	250037	Dichtungssatz	
24.3601-1713.5	240355	11.0101-5402.2	260009	Hülsensatz	
	240355	11.0441-6003.2	250037	Dichtungssatz	
	240355	11.8116-0197.1	390523	Haltefeder	
	240355	11.8116-0290.2	390520	Haltefeder	
	240355	11.8170-0530.1	260115	Halter	
	240355	11.8171-0008.1	990049	Führungsbolzen	
24.3601-1714.5	240356	11.0101-5402.2	260009	Hülsensatz	
	240356	11.0441-6003.2	250037	Dichtungssatz	
	240356	11.8116-0197.1	390523	Haltefeder	
	240356	11.8116-0290.2	390520	Haltefeder	
	240356	11.8170-0530.1	260115	Halter	
	240356	11.8171-0008.1	990049	Führungsbolzen	

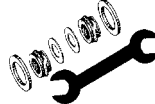

Reparatursätze

Repair kits - Corredi riparazione - Nécessaires de réparation - Juegos de reparación

  				  					
24.3601-8501.5	240533	11.0101-5402.2	260009	Hülsensatz	24.3601-9829.5	240507	11.0101-5407.2	260011	Hülsensatz
	240533	11.0230-0020.2	260023	Haltersatz		240507	11.8116-0366.2	390587	Haltefeder
	240533	11.0441-6003.2	250037	Dichtungssatz		240507	11.8171-0008.1	990049	Führungsbolzen
	240533	11.8116-0083.1	390501	Haltefeder		240507	11.8171-0067.1	250153	Führungsbolzen
	240533	11.8171-0008.1	990049	Führungsbolzen	24.3601-9830.5	240508	11.0101-5407.2	260011	Hülsensatz
24.3601-8502.5	240534	11.0101-5402.2	260009	Hülsensatz		240508	11.8116-0366.2	390587	Haltefeder
	240534	11.0230-0020.2	260023	Haltersatz		240508	11.8171-0008.1	990049	Führungsbolzen
	240534	11.0441-6003.2	250037	Dichtungssatz		240508	11.8171-0067.1	250153	Führungsbolzen
	240534	11.8116-0083.1	390501	Haltefeder	24.9235-0013.5	230001	13.0441-3506.2	2250052	Dichtungssatz
	240534	11.8171-0008.1	990049	Führungsbolzen	24.9235-0014.5	230002	13.0441-3506.2	2250052	Dichtungssatz
24.3601-8503.5	240535	11.0101-5402.2	260009	Hülsensatz	24.9235-0051.5	230003	13.0441-3507.2	2250053	Dichtungssatz
	240535	11.0441-6003.2	250037	Dichtungssatz	24.9235-0052.5	230004	13.0441-3507.2	2250053	Dichtungssatz
	240535	11.8116-0083.1	390501	Haltefeder	24.9235-8005.5	230023	13.0441-3505.2	2250051	Dichtungssatz
	240535	11.8171-0008.1	990049	Führungsbolzen	24.9235-8006.5	230024	13.0441-3505.2	2250051	Dichtungssatz
24.3601-8504.5	240536	11.0101-5402.2	260009	Hülsensatz	24.9236-8001.5	230007	13.0441-3606.2	2250147	Dichtungssatz
	240536	11.0441-6003.2	250037	Dichtungssatz	24.9236-8002.5	230008	13.0441-3606.2	2250147	Dichtungssatz
	240536	11.8116-0083.1	390501	Haltefeder	24.9236-8003.5	230009	13.0441-3609.2	2250057	Dichtungssatz
	240536	11.8171-0008.1	990049	Führungsbolzen	24.9236-8004.5	230010	13.0441-3609.2	2250057	Dichtungssatz
24.3601-8505.5	240537	11.0101-5402.2	260009	Hülsensatz	24.9238-0087.5	230035	13.0441-3819.2	2250072	Dichtungssatz
	240537	11.0441-6003.2	250037	Dichtungssatz	24.9238-0088.5	230036	13.0441-3819.2	2250072	Dichtungssatz
	240537	11.8116-0083.1	390501	Haltefeder	24.9238-8027.5	230011	13.0441-3811.2	2250067	Dichtungssatz
	240537	11.8171-0008.1	990049	Führungsbolzen	24.9238-8028.5	230012	13.0441-3811.2	2250067	Dichtungssatz
24.3601-8506.5	240538	11.0101-5402.2	260009	Hülsensatz	24.9238-8029.5	230013	13.0441-3811.2	2250067	Dichtungssatz
	240538	11.0441-6003.2	250037	Dichtungssatz	24.9238-8030.5	230014	13.0441-3811.2	2250067	Dichtungssatz
	240538	11.8116-0083.1	390501	Haltefeder	24.9238-8033.5	230015	13.0441-3817.2	2250071	Dichtungssatz
	240538	11.8171-0008.1	990049	Führungsbolzen	24.9238-8034.5	230016	13.0441-3817.2	2250071	Dichtungssatz
24.3601-8511.5	240539	11.0101-5402.2	260009	Hülsensatz	24.9238-8035.5	230025	13.0441-3817.2	2250071	Dichtungssatz
	240539	11.0441-6003.2	250037	Dichtungssatz	24.9238-8036.5	230026	13.0441-3817.2	2250071	Dichtungssatz
	240539	11.8116-0092.1	390503	Haltefeder	24.9240-0027.5	230017	13.0441-4014.2	2250079	Dichtungssatz
	240539	11.8171-0008.1	990049	Führungsbolzen	24.9240-0028.5	230018	13.0441-4014.2	2250079	Dichtungssatz
24.3601-8512.5	240540	11.0101-5402.2	260009	Hülsensatz	24.9240-0039.5	230055	13.0441-4022.2	2250149	Dichtungssatz
	240540	11.0441-6003.2	250037	Dichtungssatz	24.9240-0040.5	230056	13.0441-4022.2	2250149	Dichtungssatz
	240540	11.8116-0092.1	390503	Haltefeder	24.9240-8013.5	230019	13.0441-4020.2	2250084	Dichtungssatz
	240540	11.8171-0008.1	990049	Führungsbolzen	24.9240-8014.5	230020	13.0441-4020.2	2250084	Dichtungssatz
24.3601-8527.5	240503	11.0101-5407.2	260011	Hülsensatz	24.9242-8005.5	230027	13.0441-4205.2	2250086	Dichtungssatz
	240503	11.0441-6007.2	250146	Dichtungssatz	24.9242-8006.5	230028	13.0441-4205.2	2250086	Dichtungssatz
	240503	11.8116-0301.1	390610	Haltefeder	24.9242-8007.5	230029	13.0441-4205.2	2250086	Dichtungssatz
	240503	11.8171-0008.1	990049	Führungsbolzen	24.9242-8008.5	230030	13.0441-4205.2	2250086	Dichtungssatz
24.3601-8528.5	240504	11.0101-5407.2	260011	Hülsensatz					
	240504	11.0441-6007.2	250146	Dichtungssatz					
	240504	11.8116-0301.1	390610	Haltefeder					
	240504	11.8171-0008.1	990049	Führungsbolzen					
24.3601-9785.5	240545	11.0101-5706.2	260097	Hülsensatz					
	240545	11.0441-6008.2	250038	Dichtungssatz					
	240545	11.8116-0237.1	390509	Haltefeder					
	240545	11.8171-0067.1	250153	Führungsbolzen					
24.3601-9786.5	240546	11.0101-5706.2	260097	Hülsensatz					
	240546	11.0441-6008.2	250038	Dichtungssatz					
	240546	11.8116-0237.1	390509	Haltefeder					
	240546	11.8171-0067.1	250153	Führungsbolzen					
24.3601-9787.5	240505	11.0101-5407.2	260011	Hülsensatz					
	240505	11.0441-6008.2	250038	Dichtungssatz					
	240505	11.8171-0008.1	990049	Führungsbolzen					
24.3601-9788.5	240506	11.0101-5407.2	260011	Hülsensatz					
	240506	11.0441-6008.2	250038	Dichtungssatz					
	240506	11.8171-0008.1	990049	Führungsbolzen					

Reparatursätze

Repair kits - Corredi riparazione - Nécessaires de réparation - Juegos de reparación

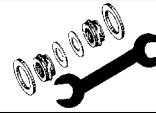
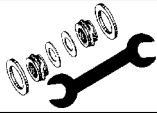

24.9242-8021.5	230031	13.0441-4206.2250087	Dichtungssatz
24.9242-8022.5	230032	13.0441-4206.2250087	Dichtungssatz
24.9246-8001.5	230021	13.0441-4601.2250099	Dichtungssatz
24.9246-8002.5	230022	13.0441-4601.2250099	Dichtungssatz
24.9257-8023.5	230033	13.0441-5724.2250125	Dichtungssatz
24.9257-8024.5	230034	13.0441-5724.2250125	Dichtungssatz
24.9257-8027.5	230039	13.0441-5720.2250122	Dichtungssatz
24.9257-8028.5	230040	13.0441-5720.2250122	Dichtungssatz
24.9260-8025.5	230041	13.0441-6001.2250126	Dichtungssatz
24.9260-8026.5	230042	13.0441-6001.2250126	Dichtungssatz
24.9260-8029.5	230043	13.0441-6003.2250128	Dichtungssatz
24.9260-8030.5	230044	13.0441-6003.2250128	Dichtungssatz
24.9260-8031.5	230045	13.0441-6003.2250128	Dichtungssatz
24.9260-8032.5	230046	13.0441-6003.2250128	Dichtungssatz
24.9440-8027.5	230051	13.0441-4016.2250081	Dichtungssatz
24.9440-8028.5	230052	13.0441-4016.2250081	Dichtungssatz
24.9442-8003.5	230053	13.0441-4214.2250091	Dichtungssatz
24.9442-8004.5	230054	13.0441-4214.2250091	Dichtungssatz
24.9936-0035.5	230047	13.0441-3609.2250057	Dichtungssatz
24.9936-0036.5	230048	13.0441-3609.2250057	Dichtungssatz





- D** Abbildungen Bremssättel
- EN** Illustrations brake calipers
- FR** Illustrations étriers de frein
- IT** Illustrazioni pinze freno
- ES** Ilustraciones pinzas de freno
- NL** Afbeeldingen remzadel
- DA** Tegning bremsecaliper
- SV** Avbildningar bromssade
- HU** Ábrák féknyereg
- PT** Figuras pinças de travões
- RU** Изображение суппортов дисковых тормозных механизмов
- CZ** Zobrazení třmenů kotoučové brzdy
- PL** Rysunki gniazda hamulcowe
- EL** Εικόνες διχάλων φρένων
- TR** Fren kaliperi resimleri
- ZH** 制动钳的图示
- JA** 図: ブレーキキャリパ
- AR** لم ار فصل لة كفل ات ايل آل الكشأ

K24-H

Abbildungen Bremssättel

Illustrations brake calipers - Illustrazioni pinze de freno - Illustrations Étriers de frein -
 Ilustraciones pinzas de freno

11.3331-0037.2 220395 
 11.3331-0038.2 220396 



PEUGEOT

406 Limousine (95-04)
 406 Kombi (96-04)
 406 Coupe (97-05)



11.0441-3305.2 250006

Dichtungssatz
 gasket set

11.3331-0039.2 220387 
 11.3331-0040.2 220388 





MERCEDES BENZ

V-Klasse (BM638) (96-03)
 VITO (BM638) (96-03)



11.0441-3305.2 250006

Dichtungssatz
 gasket set

11.3331-8501.2 220004 
 11.3331-8502.2 220005 



BMW

3er Reihe/E30 (82-93)
 5er Reihe/E28 (81-87)
 6er Reihe/E24 (76-89)
 7er Reihe/E23 (77-86)



11.0441-3302.2 250004 11.0101-5402.2 260009 11.8171-0008.1 990049

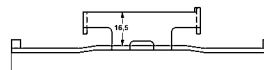

Dichtungssatz - gasket set

11.8116-0015.1 390492



Abbildungen Bremssättel

Illustrations brake calipers - Illustrazioni pinze de freno - Illustrations Étriers de frein -
 Ilustraciones pinzas de freno

11.3334-8001.2 220006 
 11.3334-8002.2 220007 



ATE



SAAB

900 (79-93)
 9000 (85-93)
 9000 (94-98)



11.0441-3302.2 250004
 Dichtungssatz - gasket set
 11.8116-0047.1 390494

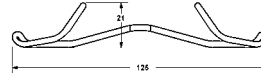



11.0101-5407.2 260011



11.8171-0008.1 990049



11.3361-8503.2 220016 
 11.3361-8504.2 220017 



ATE



BMW

3er Reihe/E36 Limousine (90-98)
 3er Reihe/E36 Coupe (92-99)
 3er Reihe/E36 Cabrio (93-99)
 Z1 (88-91)



11.0441-3602.2 250008
 Dichtungssatz - gasket set
 11.8116-0066.1 390557

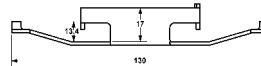



11.0101-5402.2 260009



11.8171-0008.1 990049



11.3361-8505.2 220024 
 11.3361-8506.2 220025 



ATE



BMW

Z3/E36 (95-02)



11.0441-3602.2 250008
 Dichtungssatz - gasket set
 11.8116-0185.1 390592

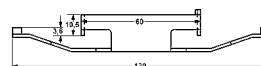

11.0101-5402.2 260009



11.8171-0008.1 990049



Abbildungen Bremssättel

Illustrations brake calipers - Illustrazioni pinze de freno - Illustrations Étriers de frein -
 Ilustraciones pinzas de freno

11.3361-9975.2 220281 
 11.3361-9976.2 220282 



ATE



Ø 36



CITROEN

EVASION (94-02)

FIAT

ULYSSE (94-02)

LANCIA

ZETA (94-02)

PEUGEOT

806 (94-02)



11.0441-3602.2 250008
 Dichtungssatz - gasket set

11.8116-0073.1 390498

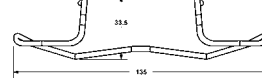



11.0101-5407.2 260011



11.8171-0008.1 990049



11.3381-8501.2 220018 
 11.3381-8502.2 220019 



ATE



Ø 38



BMW

3er Reihe/E30 (82-93)

7er Reihe/E32 (86-94)



11.0441-3802.2 250009
 Dichtungssatz - gasket set

11.8116-0066.1 390557

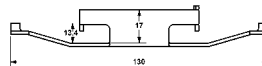



11.0101-5402.2 260009



11.8171-0008.1 990049



11.3381-8503.2 220020 
 11.3381-8504.2 220021 



ATE



Ø 38



BMW

5er Reihe/E34 (88-96)

7er Reihe/E32 (86-94)



11.0441-3803.2 250010
 Dichtungssatz - gasket set

11.8116-0066.1 390557

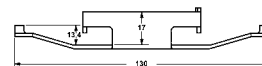

11.0101-5402.2 260009



11.8171-0008.1 990049



Abbildungen Bremssättel

Illustrations brake calipers - Illustrazioni pinze de freno - Illustrations Étriers de frein -
 Ilustraciones pinzas de freno

11.3401-0055.2 220519 
 11.3401-0056.2 220520 





SAAB

9-5 Limousine (YS3E) (97-10)
 9-5 Kombi (YS3E) (98-10)

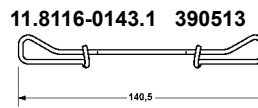

11.0441-3803.2 250010 11.0101-5407.2 260011 11.8171-0008.1 990049



11.3401-8503.2 220030 
 11.3401-8504.2 220031 





BMW

5er Reihe/E34 (88-96)

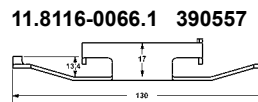

11.0441-4002.2 250011 11.0101-5402.2 260009 11.8171-0008.1 990049
 Dichtungssatz - gasket set



11.3451-8501.2 220389 
 11.3451-8502.2 220390 



MERCEDES BENZ

Transporter (BM 901/902) SPRINTER (95-06)

VOLKSWAGEN

LT/- 4x4 (96-06)



11.0441-4502.2 250143 11.0101-5407.2 260011 11.8171-0008.1 990049
 Dichtungssatz - gasket set

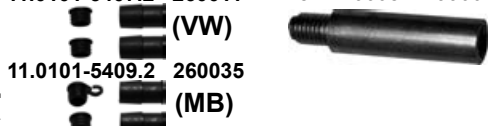
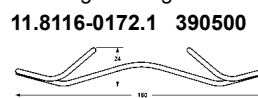

Abbildungen Bremssättel

Illustrations brake calipers - Illustrazioni pinze de freno - Illustrations Étriers de frein -
 Ilustraciones pinzas de freno

11.3481-8511.2 220337 

11.3481-8512.2 220338 



FORD

FIESTA III (89-96)



11.0441-4805.2 250020

Dichtungssatz
gasket set

11.0101-5407.2 260011



11.8171-0008.1 990049



11.3481-8513.2 220335 

11.3481-8514.2 220336 



FORD

FIESTA III (89-96)
 FIESTA IV (96-02)
 KA I (96-08)

MAZDA

121 (96-03)



11.0441-4805.2 250020
 Dichtungssatz - gasket set

11.8116-0264.1 390594

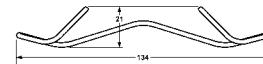

11.0101-5407.2 260011



11.8171-0008.1 990049



11.0230-0165.2 260073
 Haltersatz - anchor set

11.3481-8515.2 220365 

11.3481-8516.2 220366 



FORD

FIESTA IV (96-02)
 KA I (96-08)

MAZDA

121 (96-03)



11.8116-0264.1 390594

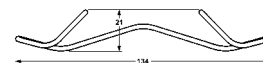

11.0101-5407.2 260011



11.8171-0008.1 990049



Abbildungen Bremssättel

Illustrations brake calipers - Illustrazioni pinze de freno - Illustrations Étriers de frein - Ilustraciones pinzas de freno

11.3481-9833.2 220561 
 11.3481-9834.2 220562 



CITROEN

SAXO (96-04)
 XSARA (N1) Limousine (97-05)
 XSARA (N2) Kombi (97-05)
 XSARA (N0) Coupe (97-05)

PEUGEOT

106 (91-96)
 106 (96-04)
 205 (91-98)
 306 Lim. (3/5-türig) (93-01)
 306 Lim. (4-türig) (94-01)
 306 Cabriolet (94-03)
 306 Kombi (97-02)



11.0441-4811.2 250024
 Dichtungssatz - gasket set

11.8116-0129.1 390591

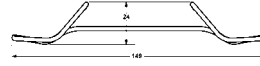



11.0101-5407.2 260011



11.8171-0008.1 990049



11.0230-0081.2 260038

11.3521-8501.2 220391 
 11.3521-8502.2 220392 



MERCEDES BENZ

Transporter (BM 901/902) SPRINTER (95-06)
 Transporter (BM 903/904) SPRINTER (95-06)

VOLKSWAGEN

LT/- 4x4 (96-06)



11.0441-5203.2 250144
 Dichtungssatz - gasket set

11.8116-0191.1 390522

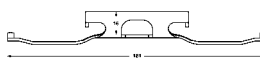

11.0101-5407.2 260011



(VW)

(MB)

11.8171-0008.1 990049



11.3541-8085.2 220287 
 11.3541-8086.2 220288 



OPEL

CALIBRA / Vauxhall Calibra (89-97)
 VECTRA A / Vauxhall Cavalier (89-95)

SAAB

900 (94-98)



11.8116-0129.1 390591

11.8116-0292.1 390521

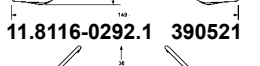

11.0101-5407.2 260011



260011





11.8171-0008.1 990049



Abbildungen Bremssättel

Illustrations brake calipers - Illustrazioni pinze de freno - Illustrations Étriers de frein -
 Ilustraciones pinzas de freno

11.3541-8521.2 220113 
 11.3541-8522.2 220114 



AUDI

80 (87-91)
 80 Quattro (87-91)
 90 (87-91)
 90 Quattro (87-91)

AUDI

100 (83-90)
 CABRIO (91-00)
 COUPE (89-96)
 COUPE Quattro (87-96)



11.0441-5405.2 250030
 Dichtungssatz
 gasket set

11.0101-5409.2 260035



11.3541-8523.2 220115 
 11.3541-8524.2 220116 



AUDI

A3 (96-03)

SEAT

LEON I (1M1) (99-05)
 TOLEDO II (1M2) (98-04)

SKODA

OCTAVIA I (1U) (97-10)

VOLKSWAGEN

BORA (98-04)
 GOLF III (92-97)
 GOLF III Variant (93-99)
 GOLF IV (98-05)
 GOLF IV Variant (99-06)
 NEW BEETLE (98-10)
 NEW BEETLE Cabriolet (03-10)
 PASSAT (94-96)
 VENTO (92-98)



11.0441-5409.2 250031
 Dichtungssatz - gasket set

11.8116-0143.1 390513

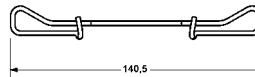



11.0101-5409.2 260035



11.8171-0008.1 990049



11.0230-0042.2 260027
 Haltersatz - anchor set

11.3541-8529.2 220341 
 11.3541-8530.2 220342 



FORD

FIESTA III (89-96)
 FIESTA IV (96-02)
 PUMA (97-01)

MAZDA

121 (96-03)



11.0441-5402.2 250028
 Dichtungssatz - gasket set

11.8116-0264.1 390594

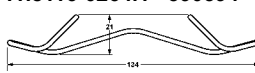

11.0101-5407.2 260011





11.8171-0008.1 990049



Abbildungen Bremssättel

Illustrations brake calipers - Illustrazioni pinze de freno - Illustrations Étriers de frein - Ilustraciones pinzas de freno

11.3541-8531.2 220367 

11.3541-8532.2 220368 



FORD

FIESTA IV (96-02)
FIESTA V (02-08)
FUSION (02-12)
KA I (96-08)
PUMA (97-01)
STREET KA (03-06)

MAZDA

121 (96-03)
2 (DY) (03-07)



11.8116-0356.1 390586

11.0101-5407.2 260011

11.8171-0008.1 990049

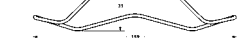

11.8116-0264.1 390594

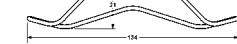

11.3571-8507.2 220127 

11.3571-8508.2 220128 



AUDI

100 (91-94)
100 Quattro (91-94)
A6 / A6 Avant (4A/C4) (94-97)



11.0441-5704.2 250034
Dichtungssatz - gasket set

11.0101-5407.2 260011

11.8171-0008.1 990049

11.8116-0143.1 390513

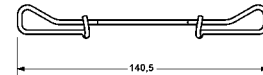

11.0101-5409.2 260035

11.0230-0042.2 260027
Haltersatz - anchor set

11.3571-8509.2 220313 

11.3571-8510.2 220314 



MERCEDES BENZ

CLK-Klasse (C208) Coupe (97-02)
CLK-Klasse (A208) Cabrio (98-03)
E-Klasse (W210) Limousine (95-02)
E-Klasse (S210) Kombi (96-03)
SLK-Klasse (R170) (96-04)



11.0441-5703.2 250145
Dichtungssatz gasket set

11.0101-5407.2 260011

11.8171-0008.1 990049

11.8116-0253.1 390512

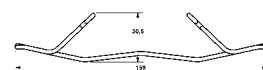

Abbildungen Bremssättel

Illustrations brake calipers - Illustrazioni pinze de freno - Illustrations Étriers de frein -
 Ilustraciones pinzas de freno

11.3571-8511.2 220315 

11.3571-8512.2 220316 



MERCEDES BENZ

C-Klasse (W202) Limousine (93-00)
 C-Klasse (S202) Kombi (96-01)
 CLK-Klasse (C208) Coupe (97-02)
 CLK-Klasse (A208) Cabrio (98-03)
 E-Klasse (W210) Limousine (95-02)
 E-Klasse (S210) Kombi (96-03)
 SLK-Klasse (R170) (96-04)



11.0441-5703.2 250145

Dichtungssatz gasket set

11.8116-0253.1 390512

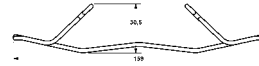

11.0101-5407.2 260011



11.8171-0008.1 990049



11.0230-0096.2 260033
 Haltersatz - anchor set

11.3571-8518.2 220322 

11.3571-8517.2 220321 



AUDI

A4 (B5) (95-01)



11.0441-5704.2 250034

Dichtungssatz - gasket set

11.8116-0143.1 390513

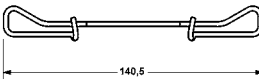

11.0101-5407.2 260011



11.8171-0008.1 990049



11.3601-8501.2 220145 

11.3601-8502.2 220146 



BMW

5er Reihe/E34 (88-96)



11.0441-6003.2 250037

Dichtungssatz - gasket set

11.8116-0083.1 390501

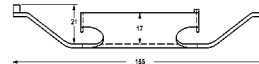

11.0101-5402.2 260009





11.8171-0008.1 990049



11.0230-0020.2 260023
 Haltersatz - anchor set

Abbildungen Bremssättel

Illustrations brake calipers - Illustrazioni pinze de freno - Illustrations Étriers de frein -
 Ilustraciones pinzas de freno

11.3601-8505.2 220149 
 11.3601-8506.2 220150 



BMW

5er Reihe/E34 (88-96)
 7er Reihe/E32 (86-94)



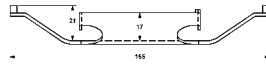

11.0441-6003.2 250037
 Dichtungssatz - gasket set

11.8116-0083.1 390501



11.0230-0009.2 260018
 Haltersatz - anchor set

11.3601-8511.2 220155 
 11.3601-8512.2 220156 



BMW



8er Reihe/E31 (90-99)

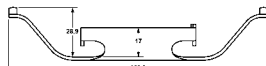

11.0441-6003.2 250037
 Dichtungssatz - gasket set

11.8116-0092.1 390503



11.3601-8515.2 220323 
 11.3601-8516.2 220324 



BMW

3er Reihe/E36 Limousine (90-98)
 3er Reihe/E36 Coupe (92-99)
 3er Reihe/E36 Cabrio (93-99)
 Z3 (95-02)



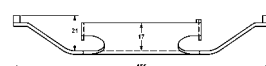

11.0441-6003.2 250037
 Dichtungssatz - gasket set

11.8116-0083.1 390501



Abbildungen Bremssättel

Illustrations brake calipers - Illustrazioni pinze de freno - Illustrations Étriers de frein -
 Ilustraciones pinzas de freno

11.9347-7001.2 220473 
 11.9347-7002.2 220474 



MINI
 R50 / R53 (00-06)



11.0230-0162.2 260090
 Haltersatz - anchor set



11.9347-7003.2 220565 
 11.9347-7004.2 220566 





MINI
 R50 / R53 (00-06)
 R52 Cabrio (04-08)

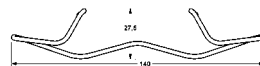

11.0230-0162.2 260090
 Haltersatz - anchor set

11.8116-0340.1 390595



11.9347-7005.2 220643 
 11.9347-7006.2 220644 



DAIHATSU
 CHARADE (11-13)

TOYOTA
 YARIS (06-11)
 YARIS (11-)



11.8116-0340.1 390595

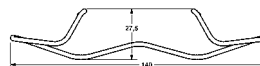

Abbildungen Bremssättel

Illustrations brake calipers - Illustrazioni pinze de freno - Illustrations Étriers de frein -
 Ilustraciones pinzas de freno

11.9381-9957.2 220661 
 11.9381-9958.2 220662 



SAAB

9-5 Limousine (YS3E) (97-10)
 9-5 Kombi (YS3E) (98-10)

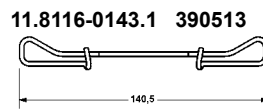

11.0101-5407.2 260011 11.8171-0008.1 990049



11.9381-9959.2 220433 
 11.9381-9960.2 220434 



BMW

3er Reihe/E36 Limousine (90-98)
 3er Reihe/E36 Touring (95-99)
 3er Reihe/E36 Coupe (92-99)
 3er Reihe/E36 Cabrio (93-99)

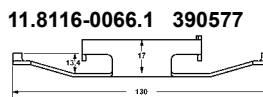

11.0441-3803.2 250010 11.0101-5402.2 260009 11.8171-0008.1 990049
 Dichtungssatz - gasket set



11.9381-9961.2 220435 
 11.9381-9962.2 220436 



BMW

3er Reihe/E36 Touring (95-99)
 3er Reihe/E36 Cabrio (93-99)





11.0441-3803.2 250010 11.0101-5402.2 260009 11.8171-0008.1 990049
 Dichtungssatz - gasket set



Abbildungen Bremssättel

Illustrations brake calipers - Illustrazioni pinze de freno - Illustrations Étriers de frein -
 Ilustraciones pinzas de freno

11.9387-7001.2 220397 
 11.9387-7002.2 220398 



RENAULT

ESPACE IV (JK_) (02-)
 LAGUNA II Limousine (BG_) (01-07)
 LAGUNA II Grandtour (KG_) (01-07)
 MEGANE II Limousine 3/5-türig (BM/CM_) (02-08)
 MEGANE II Limousine 4-türig (LM_) (03-08)
 VEL SATIS (BJ0_) (02-09)

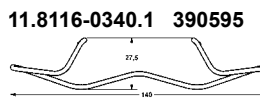

11.8116-0340.1 390595

11.0101-5407.2 260011 11.8171-0008.1 990049



11.9387-7003.2 220567 
 11.9387-7004.2 220568 



OPEL

VECTRA C (F68,F69) (02-08)
 Vauxhall Vectra MK II (02-08)

SAAB

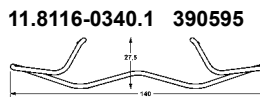

9-3 Limousine (YS3F) (03-12)
 9-3 Sport Combi (05-12)
 9-3 Cabriolet (YS3F) (03-12)
 9-3 X (09-12)



11.8116-0340.1 390595

11.0101-5407.2 260011 11.8171-0008.1 990049



11.9387-7005.2 220569 
 11.9387-7006.2 220570 



OPEL

VECTRA C (F68,F69) (02-08)
 Vauxhall Vectra MK II (02-08)

SAAB

9-3 Limousine (YS3F) (03-12)
 9-3 Sport Combi (05-12)
 9-3 Cabriolet (YS3F) (03-12)
 9-3 X (09-12)

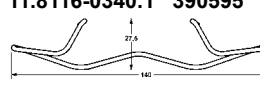



11.8116-0340.1 390595

11.0101-5407.2 260011 11.8171-0008.1 990049



Abbildungen Bremssättel

Illustrations brake calipers - Illustrazioni pinze de freno - Illustrations Étriers de frein -
 Ilustraciones pinzas de freno

11.9387-7015.2 220627 
 11.9387-7016.2 220628 



FORD

C-MAX (07-10)
 FOCUS II (05-11)
 FOCUS C-MAX (03-07)



MAZDA

3 (BK) (03-09)

VOLVO

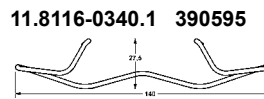
C30 Coupe (06-12)
 C70 II Cabrio (06-13)
 S40 II (04-12)
 V50 (04-12)



11.9387-7021.2 220629 
 11.9387-7022.2 220630 



NISSAN

PRIMERA (P12E) Limousine (02-08)
 PRIMERA (W12) Kombi (02-08)

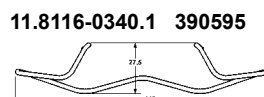

11.9401-9951.2 220463 
 11.9401-9952.2 220464 



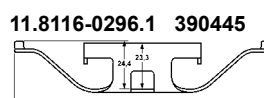

BMW

3er Reihe/E46 Limousine (98-05)
 3er Reihe/E46 Touring (99-05)



Abbildungen Bremssättel

Illustrations brake calipers - Illustrazioni pinze de freno - Illustrations Étriers de frein -
 Ilustraciones pinzas de freno

11.9406-9995.2 220415 
 11.9406-9996.2 220416 





BMW
 5er Reihe/E39 (96-03)

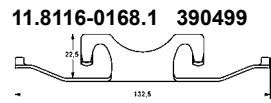

11.0441-4004.2 250012 11.0101-5402.2 260009 11.8171-0008.1 990049
 Dichtungssatz - gasket set



11.9407-7001.2 220573 
 11.9407-7002.2 220574 





OPEL
 SIGNUM / Vauxhall Signum (03-08)
 VECTRA C Caravan (F35) / Vauxhall MK II (03-08)

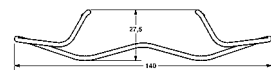

11.0101-5407.2 260011 11.8171-0008.1 990049
 11.8116-0340.1 390595



11.9407-7005.2 220637 
 11.9407-7006.2 220638 



OPEL
 SIGNUM / Vauxhall Signum (03-08)
 VECTRA C Caravan (F35) / Vauxhall MK II (03-08)



11.0101-5407.2 260011 11.8171-0008.1 990049
 11.8116-0340.1 390595

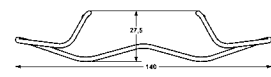

Abbildungen Bremssättel

Illustrations brake calipers - Illustrazioni pinze de freno - Illustrations Étriers de frein -
 Ilustraciones pinzas de freno

11.9421-9963.2 220465 
 11.9421-9964.2 220466 





BMW
 X5/E53 (00-07)

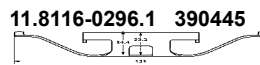

11.0101-5402.2 260009 11.8171-0008.1 990049



11.9421-9979.2 220497 
 11.9421-9980.2 220498 





VOLVO
 S60 I (00-09)
 S80 I (98-06)
 V70 II (00-07)
 XC70 I CROSS COUNTRY (00-07)

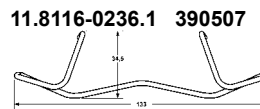

11.0101-5407.2 260011 11.8171-0008.1 990049



11.9481-9811.2 220445 
 11.9481-9812.2 220446 



MINI
 R50 / R53 (00-06)
 R52 Cabrio (04-08)



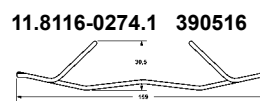

11.0101-5407.2 260011 11.8171-0008.1 990049



Abbildungen Bremssättel

Illustrations brake calipers - Illustrazioni pinze de freno - Illustrations Étriers de frein -
Ilustraciones pinzas de freno

11.9541-9545.2 220625 

11.9541-9546.2 220626 



ATE



Ø 54



RENAULT

CLIO III (BR_/CR_) (05-12)
MEGANE II Limousine 3/5-türig (BM/CM_) (02-08)
MEGANE II Limousine 4-türig (LM_) (03-08)
MEGANE II Coupe/Cabrio (EM_) (03-10)
MEGANE II Grandtour (KM_) (03-08)
SCENIC II (JM_) (03-09)

11.9541-9549.2 220575 

11.9541-9550.2 220576 



ATE



Ø 54



AUDI

A1 (10-) / A2 (00-05) / A3 (96-13)
A3 / A3 Sportback (03-13)
A3 Cabrio (08-13)

SEAT

ALTEA (5P1) ALTEA XL (5P5)
CORDOBA III (6L2)
IBIZA IV / V
LEON I / II (05-12) / Mii (12-)
TOLEDO II / III / IV (KG3) (12-)



SKODA

CITIGO (12-) / FABIA I / II / OCTAVIA I / II
RAPID / RAPID Spaceback (12-)
ROOMSTER (5J) (06-15) / YETI (09-)

VOLKSWAGEN

BORA / CADDY III / FOX (05-)
GOLF IV (98-05) / GOLF V (03-08)
GOLF VI (08-)
JETTA V (05-10) / JETTA VI (11-)
NEW BEETLE (98-10) / BEETLE (11-)/ Cabriolet (12-)
POLO IV (02-09) / POLO V (09-)
up (11-)

11.0441-5409.2 250031 11.0101-5409.2 260035 11.8171-0008.1 990049
Dichtungssatz - gasket set



11.9541-9553.2 220563 

11.9541-9554.2 220564 



ATE



Ø 54



AUDI

A1 (10-)
A3 (03-13) / A3 Cabrio (08-13)
TT Coupe (06-14)
TT Roadster (07-14)

SEAT

ALTEA (5P1) / ALTEA XL (5P5)
LEON II (1P1) (05-12)
TOLEDO III (5P2) (05-09)
TOLEDO IV (KG3) (12-)



SKODA

FABIA III (NJ) (14-)
OCTAVIA II (1Z) (04-13) RAPID (12-)
ROOMSTER (5J) (06-15) / SUPERB II (08-)
SUPERB Kombi (09-) / YETI (09-)

VOLKSWAGEN

CADDY III (04-15)
CC COUPE (11-) / EOS (06-)
GOLF V / GOLF VI / GOLF Plus (05-14)
JETTA V (05-10) / JETTA VI (11-) / BEETLE (11-)
PASSAT (05-10) / PASSAT (10-14)
PASSAT CC (08-11) / PASSAT ALLTRACK (12-)
POLO V (09-) / SCIROCCO (08-) / TOURAN (03-15)

11.8116-0351.1 390538

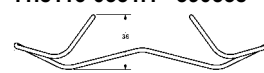

11.0101-5409.2 260035 11.8171-0008.1 990049



Abbildungen Bremssättel

Illustrations brake calipers - Illustrazioni pinze de freno - Illustrations Étriers de frein -
 Ilustraciones pinzas de freno

11.9541-9587.2 220419 

11.9541-9588.2 220420 



BMW

3er Reihe/E36 Limousine (90-98)
 3er Reihe/E36 Touring (95-99)
 3er Reihe/E36 Coupe (92-99)
 3er Reihe/E36 Cabrio (93-99)
 3er Reihe/E36 Compact (94-00)
 3er Reihe/E46 Limousine (98-05)

BMW

3er Reihe/E46 Touring (99-05)
 3er Reihe/E46 Coupe (99-06)
 3er Reihe/E46 Cabrio (00-06)
 3er Reihe/E46 Compact (01-05)
 Z3/E36 (95-02)
 Z4 Roadster/E85 (03-08)



11.0441-5402.2 250028
 Dichtungssatz gasket set
 11.8116-0109.1 390495

11.0101-5402.2 260009

11.8171-0008.1 990049

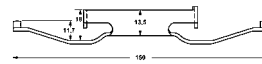

11.9541-9595.2 220501 

11.9541-9596.2 220502 



AUDI

A3 (96-03)
 TT Coupe (98-06)
 TT Roadster (99-06)

SKODA

OCTAVIA I (1U) (97-10)

SEAT

IBIZA IV (6L1) (02-10)
 LEON I (1M1) (99-05)
 TOLEDO II (1M2) (98-04)

VOLKSWAGEN

BORA (98-04)
 GOLF IV (98-03)
 GOLF IV Variant (99-06)
 NEW BEETLE (98-10)
 POLO IV (02-09)



11.0441-5409.2 250031
 Dichtungssatz - gasket set
 11.8116-0143.1 390513

11.0101-5409.2 260035

11.8171-0008.1 990049

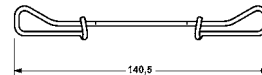

11.9541-9667.2 220421 

11.9541-9668.2 220422 



BMW

3er Reihe/E36 Limousine (90-98)
 3er Reihe/E36 Touring (95-99)
 3er Reihe/E36 Coupe (92-99)
 3er Reihe/E36 Cabrio (93-99)
 3er Reihe/E36 Compact (94-00)
 Z3/E36 (95-02)



11.8116-0109.1 390495
 11.8116-0206.1 390593

11.0101-5402.2 260009

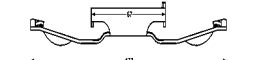

11.8171-0008.1 990049



11.0441-5402.2 250028
 Dichtungssatz - gasket set
 11.0230-0097.2 260092
 Haltersatz - anchor set

Abbildungen Bremssättel

Illustrations brake calipers - Illustrazioni pinze de freno - Illustrations Étriers de frein -
 Ilustraciones pinzas de freno



11.9541-9805.2 220503 
 11.9541-9806.2 220504 

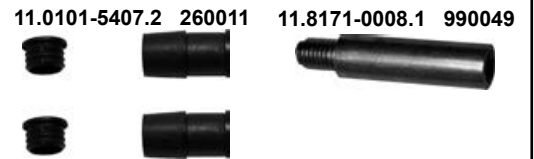

VOLVO

440 (88-96)
 460 (88-96)
 480 (86-96)



11.9571-9779.2 220657 
 11.9571-9780.2 220658 



OPEL

SIGNUM (03-08)
 Vauxhall Signum (03-08)
 VECTRA C (F68,F69) (02-08)
 Vauxhall Vectra MK II (02-08)
 VECTRA C Caravan (F35) (02-08)
 Vauxhall MK II (03-08)

SAAB

9-3 Limousine (YS3F) (03-12)
 9-3 Sport Combi (05-12)
 9-3 Cabriolet (YS3F) (03-12)
 9-3 X (09-12)



11.8116-0356.1 390586

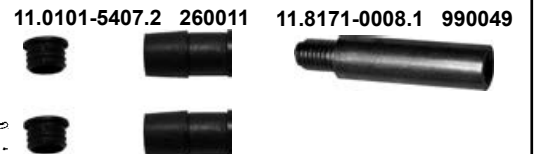
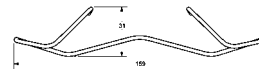

11.9571-9785.2 220595 
 11.9571-9786.2 220596 



MAZDA

3 (BK) (03-09)
 3 (BL) (09-)
 5 (CR) (05-10)
 5 (CW) (10-)
 PREMACY (CR) (05-10)



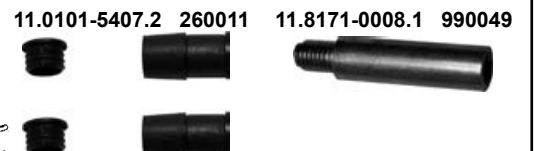
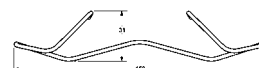

11.8116-0356.1 390586



Abbildungen Bremssättel



Illustrations brake calipers - Illustrazioni pinze de freno - Illustrations Étriers de frein -
 Ilustraciones pinzas de freno

11.9571-9801.2 220577 
 11.9571-9802.2 220578 

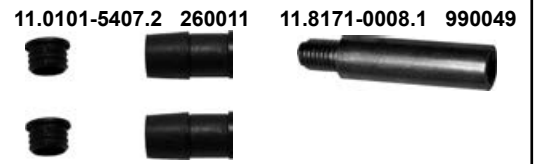

TOYOTA
 AVENSIS (97-03)



11.9571-9811.2 220485 
 11.9571-9812.2 220486 





FORD
 GALAXY I (95-06)

VOLKSWAGEN
 SHARAN I (95-10)

SEAT
 ALHAMBRA I (96-10)



11.9571-9819.2 220469 
 11.9571-9820.2 220470 



FORD
 GALAXY I (95-06)

VOLKSWAGEN
 SHARAN I (95-10)
 TRANSPORTER (T4) (90-03)

SEAT
 ALHAMBRA I (96-10)

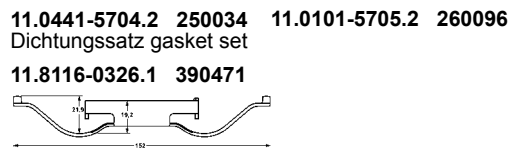

Abbildungen Bremssättel

Illustrations brake calipers - Illustrazioni pinze de freno - Illustrations Étriers de frein - Ilustraciones pinzas de freno

11.9571-9821.2 220579 

11.9571-9822.2 220580 



TOYOTA

AVENSIS (97-03)

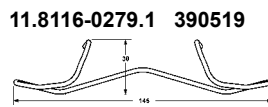

11.0101-5407.2 260011 11.8171-0008.1 990049



11.9571-9823.2 220471 

11.9571-9824.2 220472 



OPEL

ADAM (13-)/ASTRA G (98-04)
Vauxhall Astra MKIV (98-04)
ASTRA H / GTC (04-10)
Vauxhall Astra Mk V (04-10)
ASTRA H Caravan (04-10)
Vauhall Astra MKV Estate (04-10)
ASTRA TWIN TOP (06-10)

OPEL

COMBO / Vaux.Combo (01-11)
CORSA C (00-06)
CORSA D (06-)
CORSA E (14-)
Vauxhall Corsa MK III (06-)
MERIVA A/ Vaux. Meriva A (03-10)
MERIVA B (10-)
ZAFIRA I / Vauxhall Zafira I (99-05)
ZAFIRA II / Vauxhall Zafira II (05-)

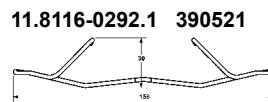

11.0441-5704.2 250034 11.0101-5407.2 260011 11.8171-0008.1 990049

Dichtungssatz gasket set

11.8116-0292.1 390521



11.9571-9836.2 220428 

11.9571-9835.2 220427 



AUDI

A4 (B6/B7) (01-08)
A4 Cabrio (02-08)
A6 / A6 Avant (4B/C5) (97-05)
A6 (4F2/C6) Limousine (04-11)
A6 (4F5/C6) Avant (05-11)

SEAT

EXEO / ST (09-13)

SKODA

SUPERB I (02-08)

VOLKSWAGEN

PASSAT (97-05)

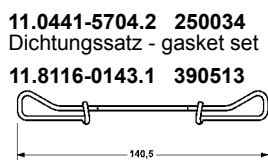

11.0441-5704.2 250034 11.0101-5409.2 260035 11.8171-0008.1 990049



Dichtungssatz - gasket set

11.8116-0143.1 390513



Abbildungen Bremssättel

Illustrations brake calipers - Illustrazioni pinze de freno - Illustrations Étriers de frein -
 Ilustraciones pinzas de freno

11.9571-9841.2 220401 
 11.9571-9842.2 220402 



RENAULT

LAGUNA II Limousine (BG_) (01-07)
 LAGUNA II Grandtour (KG_) (01-07)
 SCENIC I (JA_) (99-03)



11.9571-9861.2 220403 
 11.9571-9862.2 220404 



RENAULT

LAGUNA II Limousine (BG_) (01-07)
 LAGUNA II Grandtour (KG_) (01-07)



11.9571-9863.2 220513 
 11.9571-9864.2 220514 





VOLVO

S60 (00-09)
 S80 I (98-06)
 V70 II (00-07)
 XC70 I CROSS COUNTRY (00-07)



Abbildungen Bremssättel

Illustrations brake calipers - Illustrazioni pinze de freno - Illustrations Étriers de frein -
 Ilustraciones pinzas de freno

11.9571-9871.2 220425 
 11.9571-9872.2 220426 





MG

ZT Limousine (01-05)
 ZT-T Kombi (01-05)

ROVER

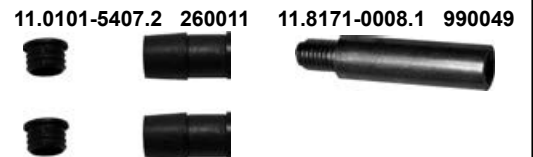
75-Serie (RJ) (99-04)
 75 Serie (RX) (04-05)



11.9571-9971.2 220605 
 11.9571-9972.2 220606 



VOLVO

850 Limousine (91-96)
 850 Kombi (92-96)
 C70 Coupe (97-02)
 C70 I Cabrio (98-06)
 S70 (97-00)
 V70 I (97-00)



11.9576-9995.2 220651 
 11.9576-9996.2 220652 



AUDI

A3 / A3 Sportback (03-13)

SEAT

LEON II (1P1) (05-12)

SKODA

SUPERB II (08-15)
 SUPERB Combi (09-15)



VOLKSWAGEN

EOS (06-)
 GOLF V (03-08)
 GOLF VI (08-)
 PASSAT Limousine (05-10)
 PASSAT Variant (05-10)
 PASSAT CC (08-11)

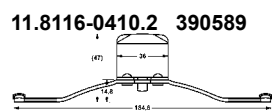

Abbildungen Bremssättel

Illustrations brake calipers - Illustrazioni pinze de freno - Illustrations Étriers de frein -
 Ilustraciones pinzas de freno

11.9601-9787.2 220585 
 11.9601-9788.2 220586 



RENAULT

ESPACE IV (JK_) (02-)
 LAGUNA II Limousine (BG_) (01-07)
 LAGUNA II Grandtour (KG_) (01-07)
 VEL SATIS (BJ0_) (02-09)



11.0101-5403.2 260010 11.0101-5407.2 260011 11.8171-0008.1 990049



11.9606-9953.2 220587 
 11.9606-9954.2 220588 



AUDI

A4 (B6/B7) (01-08)
 A6 (4F2/C6) Limousine (04-11)
 A6 (4F5/C6) Avant (05-11)
 A6 Allroad (06-11)
 A8 (03-09)

SEAT

EXEO / ST (09-13)



11.8116-0410.2 390589

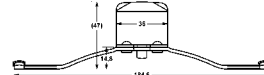

11.0101-5409.2 260035 11.8171-0008.1 990049



11.9606-9961.2 220655 
 11.9606-9962.2 220656 



AUDI

A4 (B6/B7) (01-08)
 A4 Cabrio (02-08)
 A6 (4F2/C6) Limousine (04-11)
 A6 (4F5/C6) Avant (05-11)
 A6 Allroad (06-11)



11.8116-0410.2 390589

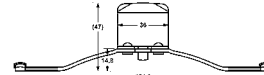

11.0101-5409.2 260035 11.8171-0008.1 990049



Abbildungen Bremssättel

Illustrations brake calipers - Illustrazioni pinze de freno - Illustrations Étriers de frein -
 Ilustraciones pinzas de freno

11.9606-9971.2 220589 

11.9606-9972.2 220590 



OPEL

SIGNUM (03-08)
 Vauxhall Signum (03-08)
 VECTRA C (F68,F69) (02-08)
 Vauxhall Vectra MK II (02-08)
 VECTRA C Caravan (F35) (03-08)
 Vauxhall MK II (03-08)

SAAB

9-3 Limousine (YS3F) (03-12)
 9-3 Sport Combi (05-12)
 9-3 Cabriolet (YS3F) (03-12)
 9-3 X (09-12)

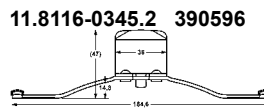

11.0101-5407.2 260011 11.8171-0008.1 990049



13.2351-0013.2 210010 

13.2351-0014.2 210011 



OPEL

ASTRA F (91-01)
 Vauxhall Astra MKIII (91-01)
 CALIBRA (89-97)
 Vauxhall Calibra (89-97)
 KADETT E / Vauxhall Astra E/Belmont (84-93)
 VECTRA A / Vauxhall Cavalier (89-95)

SAAB

900 (94-98)



13.0441-3506.2 250052

Dichtungssatz
 gasket set

13.2351-0025.2 210210 

13.2351-0026.2 210211 



OPEL

VECTRA B (96-02)
 Vauxhall Vectra (96-02)

SAAB

9-3 (YS3D) (98-02)
 9-3 Cabriolet (YS3D) (98-03)
 900 (94-98)



13.0441-3506.2 250052

Dichtungssatz
 gasket set



Abbildungen Bremssättel

Illustrations brake calipers - Illustrazioni pinze de freno - Illustrations Étriers de frein -
Ilustraciones pinzas de freno

13.2351-0051.2 210180 

13.2351-0052.2 210181 



ATE



OPEL

VECTRA B / Vauxhall Vectra (96-02)



13.0441-3507.2 250053

Dichtungssatz
gasket set

13.2351-8005.2 210014 

13.2351-8006.2 210015 



ATE



MERCEDES BENZ

(W124) E-Klasse (85-93)
(W201) 190-190 E 2,6 (82-93)
C-Klasse (W202) Limousine (93-00)
E-Klasse (W124) Limousine (93-95)
E-Klasse (C124) Coupe (93-97)



13.0441-3505.2 250051

Dichtungssatz
gasket set

13.2351-8019.2 210139 

13.2351-8020.2 210140 



ATE



MERCEDES BENZ

C-Klasse (W202) Limousine (93-00)



13.0441-3507.2 250053

Dichtungssatz
gasket set

Abbildungen Bremssättel

Illustrations brake calipers - Illustrazioni pinze de freno - Illustrations Étriers de frein -
Ilustraciones pinzas de freno

13.2353-8003.2 210016 

13.2353-8004.2 210017 



ATE



MERCEDES BENZ

(W108) 250 S-300 SEb (65-72)

(W109) 300 SEL (65-72)

(W111) 220-280 (59-71)



13.0441-3504.2 250050

Dichtungssatz
gasket set

13.2361-8001.2 210214 

13.2361-8002.2 210215 



ATE



MERCEDES BENZ

C-Klasse (W202) Limousine (93-00)

CLK-Klasse (C208) Coupe (97-02)

CLK-Klasse (A208) Cabrio (98-03)

E-Klasse (W210) Limousine (95-02)

SL-Klasse (R129) (93-01)



13.0441-3606.2 250147

Dichtungssatz
gasket set

13.2361-8003.2 210220 

13.2361-8004.2 210221 



ATE



MERCEDES BENZ

C-Klasse (W202) Limousine (93-00)

C-Klasse (S202) Kombi (96-01)

CLK-Klasse (C208) Coupe (97-02)

CLK-Klasse (A208) Cabrio (98-03)

E-Klasse (W210) Limousine (95-02)

SLK-Klasse (R170) (96-04)



13.0441-3609.2 250057

Dichtungssatz
gasket set

Abbildungen Bremssättel

Illustrations brake calipers - Illustrazioni pinze de freno - Illustrations Étriers de frein -
Ilustraciones pinzas de freno

13.2361-8005.2 210237 

13.2361-8006.2 210238 



MERCEDES BENZ

E-Klasse (W210) Limousine (95-02)



13.0441-3609.2 250057

Dichtungssatz
gasket set

13.2381-0039.2 210020 

13.2381-0040.2 210021 



VOLVO

240 Limousine (74-93)
240 Kombi (74-93)
260 Limousine (74-82)
260 Kombi (75-82)
260 Coupe (77-78)



13.0441-3812.2 250068

Dichtungssatz
gasket set

13.2381-0097.2 210239 

13.2381-0098.2 210240 





VOLVO

850 Limousine (91-96)
850 Kombi (92-96)
C70 Coupe (97-02)
C70 I Cabrio (98-06)
S70 (97-00)
V70 I (97-00)

Abbildungen Bremssättel

Illustrations brake calipers - Illustrazioni pinze de freno - Illustrations Étriers de frein -
Ilustraciones pinzas de freno

13.2381-8027.2 210033 

13.2381-8028.2 210034 



MERCEDES BENZ

(R107) 280 SL-560 SL (71-89)
(W114) 230.6-280 CE (67-76)
(W115) 200-240 D 3,0 (67-76)
(W116) 280 S-450 SEL 6,9 (72-80)
(W123) 200-300 TD Turbo (76-85)
(W126) 260 SE-560 SEC (80-91)



13.0441-3811.2 250067

Dichtungssatz
gasket set

13.2381-8029.2 210035 

13.2381-8030.2 210036 



MERCEDES BENZ

(R107) 280 SL-560 SL (71-89)
(W114) 230.6-280 CE (67-76)
(W115) 200-240 D 3,0 (67-76)
(W116) 280 S-450 SEL 6,9 (72-80)
(W126) 260 SE-560 SEC (80-91)



13.0441-3811.2 250067

Dichtungssatz
gasket set

13.2381-8033.2 210222 

13.2381-8034.2 210223 



MERCEDES BENZ

(W124) E-Klasse (85-93)
C-Klasse (W202) Limousine (93-00)
E-Klasse (W124) Limousine (93-95)
SL-Klasse (R129) (93-01)



13.0441-3817.2 250071

Dichtungssatz
gasket set

Abbildungen Bremssättel

Illustrations brake calipers - Illustrazioni pinze de freno - Illustrations Étriers de frein -
 Ilustraciones pinzas de freno

13.2381-8035.2 210037 

13.2381-8036.2 210038 



ATE



Ø 38



MERCEDES BENZ

(R129) SL-Klasse (89-93)
 (W124) E-Klasse (85-93)
 (W201) 190-190 E 2,6 (82-93)
 C-Klasse (W202) Limousine (93-00)
 C-Klasse (S202) Kombi (96-01)
 CLK-Klasse (C208) Coupe (97-02)

MERCEDES BENZ

E-Klasse (W124) Limousine (93-95)
 E-Klasse (S124) Kombi (93-96)
 E-Klasse (C124) Coupe (93-97)
 E-Klasse (A124) Cabrio (93-98)
 E-Klasse (W210) Limousine (95-02)
 SL-Klasse (R129) (93-01)
 SLK-Klasse (R170) (96-04)



13.0441-3817.2 250071

Dichtungssatz
 gasket set

13.2381-9996.2 210039 

13.2381-9997.2 210040 



ATE



Ø 38



PORSCHE

911 (63-90)



13.0441-3801.2 250058

Dichtungssatz
 gasket set

13.2401-0027.2 210045 

13.2401-0028.2 210046 



ATE



Ø 40



VOLVO

740 Limousine (83-92)
 740 Kombi (85-92)
 760 Limousine (82-92)
 760 Kombi (82-92)

VOLVO

940 I Limousine (90-95)
 940 I Kombi (90-95)
 940 II Limousine (95-98)
 940 II Kombi (95-98)
 960 I Limousine (90-94)
 960 I Kombi (90-94)
 960 II Limousine (94-96)
 960 II Kombi (94-96)

Abbildungen Bremssättel

Illustrations brake calipers - Illustrazioni pinze de freno - Illustrations Étriers de frein -
Ilustraciones pinzas de freno

13.2401-0039.2 210153 

13.2401-0040.2 210154 



OPEL

OMEGA B / Vauxhall Omega (94-03)



13.0441-4022.2 250149

Dichtungssatz
gasket set

13.2401-8007.2 210047 

13.2401-8008.2 210048 



VOLKSWAGEN

KÄFER (TYP 1) (49-03)



13.0441-4002.2 250074 bis 07.72 verwenden - reuse up to 07.72
Dichtungssatz
gasket set

13.0441-4008.2 250076 ab 08.72 verwenden - reuse from 08.72
Dichtungssatz
gasket set

13.2401-8013.2 210051 

13.2401-8014.2 210052 



MERCEDES BENZ

E-Klasse (S210) Kombi (96-03)

S-Klasse (W140) (91-93)

S-Klasse (W140) (93-98)



13.0441-4020.2 250084

Dichtungssatz
gasket set

Abbildungen Bremssättel

Illustrations brake calipers - Illustrazioni pinze de freno - Illustrations Étriers de frein -
Ilustraciones pinzas de freno

13.2421-0026.2 210146 

13.2421-0025.2 210145 



ATE



Ø 42



PORSCHE

911 (63-90)



13.0441-4206.2 250087

Dichtungssatz
gasket set

13.2421-0043.2 210193 

13.2421-0044.2 210194 



ATE



Ø 42



OPEL

OMEGA B / Vauxhall Omega (94-03)



13.0441-4216.2 250093

Dichtungssatz
gasket set

13.2421-8005.2 210053 

13.2421-8006.2 210054 



ATE



Ø 42



BMW

2,5/2,8/3,0/3,3 (68-77)

5er Reihe/E12 (72-81)



13.0441-4205.2 250086

Dichtungssatz
gasket set

Abbildungen Bremssättel

Illustrations brake calipers - Illustrazioni pinze de freno - Illustrations Étriers de frein -
 Ilustraciones pinzas de freno

13.2421-8021.2 210057 

13.2421-8022.2 210058 



MERCEDES BENZ

(W123) 200-300 TD Turbo (76-85)



13.0441-4206.2 250087

Dichtungssatz
gasket set

13.2421-8025.2 210061 

13.2421-8026.2 210062 



MERCEDES BENZ

(R129) SL-Klasse (89-93)
 (W124) E-Klasse (85-93)
 C-Klasse (W202) Limousine (93-00)
 C-Klasse (S202) Kombi (96-01)
 C-Klasse (S203) Kombi (01-07)
 CLK-Klasse (C208) Coupe (97-02)
 CLK-Klasse (A208) Cabrio (98-03)

MERCEDES BENZ

E-Klasse (W124) Limousine (93-95)
 E-Klasse (W210) Limousine (95-02)
 SL-Klasse (R129) (93-01)
 SLK-Klasse (R170) (96-04)



13.0441-4216.2 250093

Dichtungssatz
gasket set

13.2423-8009.2 210063 

13.2423-8010.2 210064 



MERCEDES BENZ

(R113) 230 SL-280 SL (63-71)
 (W108) 250 S-300 SEb (65-72)
 (W109) 300 SEL (65-72)
 (W111) 220-280 (59-71)





13.0441-4206.2 250087

Dichtungssatz
gasket set

Abbildungen Bremssättel

Illustrations brake calipers - Illustrazioni pinze de freno - Illustrations Étriers de frein -
Ilustraciones pinzas de freno

13.2461-8001.2 210226 

13.2461-8002.2 210227 



ATE



Ø 46



MERCEDES BENZ

CL-Klasse (C140) Coupe (96-99)

E-Klasse (S210) Kombi (96-03)

S-Klasse (W140) (91-93)

S-Klasse (W140) (93-98)

S-Klasse (W220) (98-06)



13.0441-4601.2 250099

Dichtungssatz
gasket set

13.2481-0075.2 210081 

13.2481-0076.2 210082 



ATE



Ø 48



PORSCHE

911 (63-90)



13.0441-4819.2 250104

Dichtungssatz
gasket set

13.2481-8011.2 210092 

13.2481-8012.2 210093 



ATE



Ø 48



BMW

3er Reihe/E21 (75-83)



13.0441-4825.2 250107

Dichtungssatz
gasket set

Abbildungen Bremssättel

Illustrations brake calipers - Illustrazioni pinze de freno - Illustrations Étriers de frein -
Ilustraciones pinzas de freno

13.2481-8067.2 210098 

13.2481-8068.2 210099 



ATE



PORSCHE

911 (63-90)



13.0441-4819.2 250104

Dichtungssatz
gasket set

13.2481-9999.2 210103 

13.2481-9998.2 210102 



ATE



PORSCHE

911 (63-90)
914/6 (70-73)



13.0441-4815.2 250102

Dichtungssatz
gasket set

13.2541-8002.2 210111 

13.2541-8001.2 210110 



ATE



VOLKSWAGEN

TRANSPORTER (Typ 2) (60-79)
TRANSPORTER (Typ 2) (79-92)





13.0441-5416.2 250117

Dichtungssatz
gasket set

Abbildungen Bremssättel

Illustrations brake calipers - Illustrazioni pinze de freno - Illustrations Étriers de frein -
Ilustraciones pinzas de freno

13.2544-0019.2 210251 

13.2544-0020.2 210252 



MERCEDES BENZ

UNIMOG (BM 427) 1000-1650
UNIMOG (BM 437) 1350-2450
UNIMOG 20 (BM 405.050) (07-)
UNIMOG 3000-5000 (BM 437.4) (02-)

13.2571-8011.2 210121 

13.2571-8012.2 210122 



MERCEDES BENZ

(W108) 250 S-300 SEb (65-72)
(W109) 300 SEL (65-72)
(W111) 220-280 (59-71)



13.0441-5718.2 250120

Dichtungssatz
gasket set

13.2571-8013.2 210123 

13.2571-8014.2 210124 



MERCEDES BENZ

(R107) 280 SL-560 SL (71-89)



13.0441-5718.2 250120

Dichtungssatz
gasket set

Abbildungen Bremssättel

Illustrations brake calipers - Illustrazioni pinze de freno - Illustrations Étriers de frein -
Ilustraciones pinzas de freno

13.2571-8023.2 210127 

13.2571-8024.2 210128 



MERCEDES BENZ

(W126) 260 SE-560 SEC (80-91)



13.0441-5724.2 250125

Dichtungssatz
gasket set

13.2571-9998.2 210133 

13.2571-9999.2 210134 



MERCEDES BENZ

(R113) 230 SL-280 SL (63-71)
(W108) 250 S-300 SEb (65-72)
(W109) 300 SEL (65-72)
(W110) 190 c-230 (61-68)
(W111) 220-280 (59-71)
(W114) 230.6-280 CE (67-76)
(W115) 200-240 D 3,0 (67-76)



13.0441-5718.2 250120

Dichtungssatz
gasket set

13.2601-0145.2 210247 

13.2601-0146.2 210248 



MERCEDES BENZ

UNIMOG (BM 427) 1000-1650
UNIMOG (BM 437) 1350-2450
UNIMOG 20 (BM 405.050) (07-)
UNIMOG 3000-5000 (BM 437.4) (02-)
UNIMOG 300-400 (BM 405.1) (00-)

Abbildungen Bremssättel

Illustrations brake calipers - Illustrazioni pinze de freno - Illustrations Étriers de frein -
Ilustraciones pinzas de freno

13.2601-7015.2 210230 

13.2601-7016.2 210231 



ATE



MERCEDES BENZ

MB-TRAC (BM 441) 1000
UNIMOG (BM 403) 54/66/72/800
UNIMOG (BM 406) 65/70/80/84/900
UNIMOG (BM 413) 72/80/800 L
UNIMOG (BM 416) 80/90/100/110/1100/1100 L
UNIMOG (BM 417) 800-1150
UNIMOG (BM 424) 1000/1200
UNIMOG (BM 427) 1000-1650
UNIMOG (BM 435) 435/1300 L/1700/1700 L

MERCEDES BENZ

UNIMOG (BM 436) 1300/1700
UNIMOG (BM 437) 1350-2450



13.0441-6012.2 250133 03.3518-6100.2 390364 03.3518-8000.2 390373

Dichtungssatz
gasket set

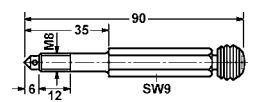
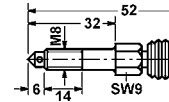

13.2601-8027.2 210159 

13.2601-8028.2 210160 



ATE



MERCEDES BENZ

(R107) 280 SL-560 SL (71-89)



13.0441-6001.2 250126

Dichtungssatz
gasket set

13.2601-8034.2 210166 

13.2601-8033.2 210165 



ATE



MERCEDES BENZ

(R107) 280 SL-560 SL (71-89)



13.0441-6003.2 250128

Dichtungssatz
gasket set

Abbildungen Bremssättel

Illustrations brake calipers - Illustrazioni pinze de freno - Illustrations Étriers de frein -
 Ilustraciones pinzas de freno

13.2601-8035.2 210167 

13.2601-8036.2 210168 



ATE



Ø 60



MERCEDES BENZ

MB-TRAC (BM 440) 65/70/700/800/900
 MB-TRAC (BM 441) 1000
 UNIMOG (BM 403) 54/66/72/800
 UNIMOG (BM 406) 65/70/80/84/900
 UNIMOG (BM 413) 72/80/800 L
 UNIMOG (BM 416) 80/90/100/110/1100/1100 L
 UNIMOG (BM 417) 800-1150
 UNIMOG (BM 424) 1000/1200
 UNIMOG (BM 427) 1000-1650

MERCEDES BENZ

UNIMOG (BM 435) 435/1300
 L/1700/1700 L
 UNIMOG (BM 436) 1300/1700
 UNIMOG (BM 437) 1350-2450



13.0441-6012.2 250133 03.3518-6100.2 390364 03.3518-8000.2 390373

Dichtungssatz
 gasket set

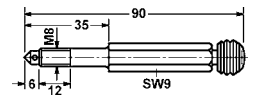
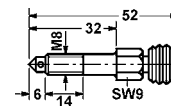

13.2601-8037.2 210169 

13.2601-8038.2 210170 



ATE



Ø 60



MERCEDES BENZ

MB-TRAC (BM 440) 65/70/700/800/900
 MB-TRAC (BM 441) 1000
 UNIMOG (BM 403) 54/66/72/800
 UNIMOG (BM 406) 65/70/80/84/900
 UNIMOG (BM 413) 72/80/800 L
 UNIMOG (BM 416) 80/90/100/110/1100/1100 L
 UNIMOG (BM 417) 800-1150 / UNIMOG (BM 424) 1000/1200
 UNIMOG (BM 427) 1000-1650
 UNIMOG (BM 435) 435/1300 L/1700/1700 L

MERCEDES BENZ

UNIMOG (BM 436) 1300/1700
 UNIMOG (BM 437) 1350-2450



13.0441-6012.2 250133 03.3518-6100.2 390364 03.3518-8000.2 390373

Dichtungssatz
 gasket set

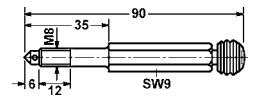
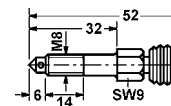

13.2601-9996.2 210176 

13.2601-9997.2 210177 



ATE



Ø 60



MERCEDES BENZ

(W114) 230.6-280 CE (67-76)
 (W115) 200-240 D 3,0 (67-76)





13.0441-6001.2 250126

Dichtungssatz
 gasket set

Abbildungen Bremssättel

Illustrations brake calipers - Illustrazioni pinze de freno - Illustrations Étriers de frein -
Ilustraciones pinzas de freno

13.4341-8002.2 210152 

13.4341-8001.2 210151 



BMW

1502 - 2002 (65-77)



13.0441-3401.2 250044

Dichtungssatz
gasket set

13.4401-8021.2 210189 

13.4401-8022.2 210190 



BMW

1502 - 2002 (65-77)
2,5/2,8/3,0/3,3 (68-77)
5er Reihe/E12 (72-81)



13.0441-4018.2 250083

Dichtungssatz
gasket set

13.4421-8009.2 210228 

13.4421-8010.2 210229 



MERCEDES BENZ

C-Klasse (W202) Limousine (93-00)
CLK-Klasse (C208) Coupe (97-02)
E-Klasse (W210) Limousine (95-02)
E-Klasse (S210) Kombi (96-03)



13.0441-4214.2 250091

Dichtungssatz
gasket set

Abbildungen Bremssättel

Illustrations brake calipers - Illustrazioni pinze de freno - Illustrations Étriers de frein -
 Ilustraciones pinzas de freno

13.4571-8005.3 210205 

13.4571-8006.3 210206 

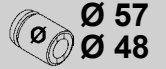

MERCEDES BENZ

UNIMOG (BM 425) 120/150/1300/1500
 UNIMOG (BM 435) 435/1300 L/1700/1700 L



13.0441-5721.2 250123

Dichtungssatz
 gasket set

13.9361-0023.2 210241 

13.9361-0024.2 210242 



MERCEDES BENZ

C-Klasse (W203) Limousine (00-07)
 C-Klasse (S203) Kombi (01-07)
 C-Klasse (CL203) Sportcoupe (01-08)
 C-Klasse (CLC203) Coupe (08-10)
 CLK-Klasse (C209) Coupe (02-09)
 CLK-Klasse (A209) Cabrio (03-09) / SLK-Klasse (R171) (04-11)



13.0441-3609.2 250057

Dichtungssatz
 gasket set

13.9361-0035.2 210253 

13.9361-0036.2 210254 



MERCEDES BENZ

C-Klasse (W203) Limousine (00-07)
 C-Klasse (S203) Kombi (01-07)
 C-Klasse (CL203) Sportcoupe (01-08)
 C-Klasse (CLC203) Coupe (08-10)
 CLK-Klasse (C209) Coupe (02-09)
 CLK-Klasse (A209) Cabrio (03-09) / SLK-Klasse (R171) (04-11)



13.0441-3609.2 250057

Dichtungssatz
 gasket set

Abbildungen Bremssättel

Illustrations brake calipers - Illustrazioni pinze de freno - Illustrations Étriers de frein -
Ilustraciones pinzas de freno

24.3301-1703.7 220683 

24.3301-1704.7 220684 



TRW



Ø 30



MERCEDES BENZ

A-Klasse (W169) (04-11)

B-Klasse (W245) (05-11)

24.3331-0037.5 240547 

24.3331-0038.5 240548 



ATE



Ø 33



PEUGEOT

406 Limousine (95-04)

406 Kombi (96-04)

406 Coupe (97-05)



11.0441-3305.2 250006

Dichtungssatz
gasket set

24.3331-1701.5 240543 

24.3331-1702.5 240544 



BOS



Ø 33



MERCEDES BENZ

V-Klasse (BM638) (96-03)

VITO (BM638) (96-03)

Abbildungen Bremssättel

Illustrations brake calipers - Illustrazioni pinze de freno - Illustrations Étriers de frein -
Ilustraciones pinzas de freno

24.3331-8501.5 240509 

24.3331-8502.5 240510 





BMW

3er Reihe/E30 (82-93)
5er Reihe/E28 (81-87)
6er Reihe/E24 (76-89)
7er Reihe/E23 (77-86)

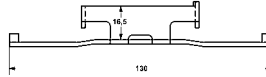

11.0441-3302.2 250004 11.0101-5402.2 260009 11.8171-0008.1 990049
Dichtungssatz - gasket set
11.8116-0015.1 390492



24.3344-1703.5 240117 

24.3344-1704.5 240118 



ALFA ROMEO

145 (94-01) / 146 (94-01)
155 (92-97) / SPIDER (95-05)

FIAT

BARCETTA (95-04)



24.0101-3601.2 260044



FIAT

BRAVO (95-01) / COUPE (94-00)
TEMPRA (90-93) / TEMPRA (93-96)
TIPO (88-93) / TIPO (93-95)

LANCIA

DEDRA (90-93) / DEDRA (94-99)
DELTA (94-99)

24.3344-1705.5 240273 

24.3344-1706.5 240274 



FORD

FOCUS I (98-04)

Abbildungen Bremssättel

Illustrations brake calipers - Illustrazioni pinze de freno - Illustrations Étriers de frein -
Ilustraciones pinzas de freno

24.3344-1707.7 220531 

24.3344-1708.7 220532 



TRW



Ø 34



RENAULT

MEGANE I Grandtour (KA_) (98-03)
MEGANE SCENIC (JA_) (96-99)
SCENIC I (JA_) (99-03)

24.3344-1709.7 220537 

24.3344-1710.7 220538 



TRW



Ø 34



AUDI

A2 (00-05)

SEAT

CORDOBA III (6L2) (02-09)
IBIZA IV (6L1) (02-10)
IBIZA V / ST / SPORTCOUPE (08-)

VOLKSWAGEN

POLO IV (02-09)

24.3344-1711.7 220539 

24.3344-1712.7 220540 



TRW



Ø 34



SEAT

AROSA (6H) (97-05)
CORDOBA I (93-99)
IBIZA III (6K1) (99-02)

VOLKSWAGEN

LUPO (98-05)
POLO III (95-01)
POLO Classic (96-01)

Abbildungen Bremssättel

Illustrations brake calipers - Illustrazioni pinze de freno - Illustrations Étriers de frein -
Ilustraciones pinzas de freno

24.3344-1713.7 220559 

24.3344-1714.7 220560 



TRW



Ø 34

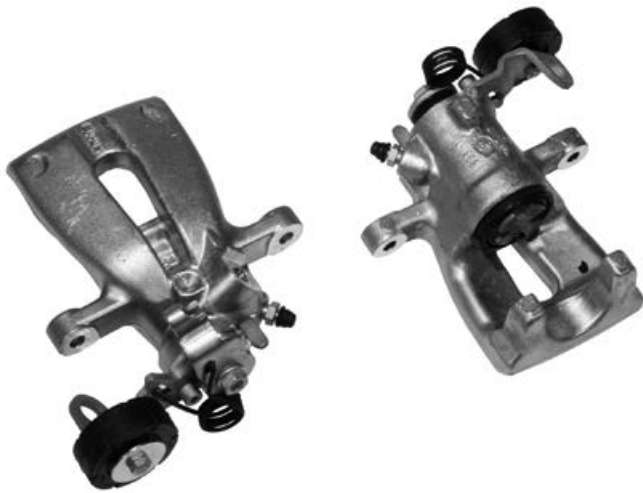

OPEL

ASTRA G / Vauxhall Astra MKIV (98-05)

24.3344-1715.5 240327 

24.3344-1716.5 240328 



TRW



Ø 34



ALFA ROMEO

145 (94-01)

146 (94-01)

FIAT

MAREA (96-02)

24.3344-1717.5 240341 

24.3344-1718.5 240342 



TRW



Ø 34

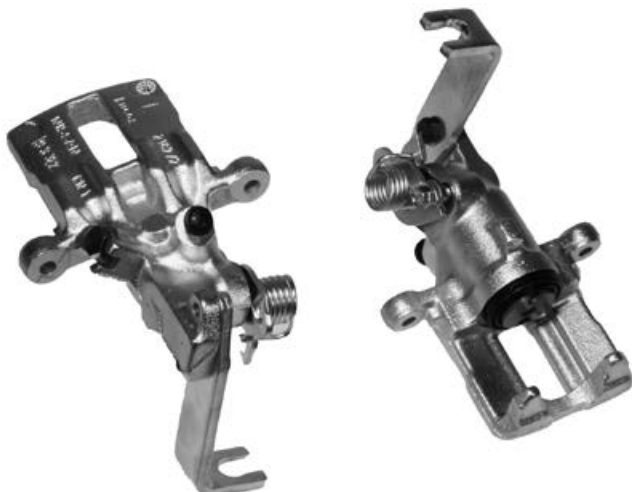

NISSAN

ALMERA (N16) (00-06)

PRIMERA (P11E) Limousine (96-02)

Abbildungen Bremssättel

Illustrations brake calipers - Illustrazioni pinze de freno - Illustrations Étriers de frein -
Ilustraciones pinzas de freno

24.3344-1719.5 240343 

24.3344-1720.5 240344 



NISSAN

ALMERA (N15) (95-00)

ALMERA (N16) (00-06)

24.3347-1703.7 220685 

24.3347-1704.7 220686 



TRW





RENAULT

CLIO III (BR_/CR_) (05-12)

CLIO III Grandtour (KR_) (08-12)

MODUS/GRAND MODUS (JP0_) (04-13)

24.3354-1701.5 240347 

24.3354-1702.5 240348 



AKE



MAZDA

323 Limousine/323 F/323 P/323 S (98-03)

626 Kombi (98-02)

PREMACY (99-05)

Abbildungen Bremssättel

Illustrations brake calipers - Illustrazioni pinze de freno - Illustrations Étriers de frein - Ilustraciones pinzas de freno

24.3361-8503.5 240513 
 24.3361-8504.5 240514 



BMW

3er Reihe/E36 Limousine (90-98)
 3er Reihe/E36 Coupe (92-99)
 3er Reihe/E36 Cabrio (93-99)
 Z1 (88-91)



11.0441-3602.2 250008 11.0101-5402.2 260009 11.8171-0008.1 990049
 Dichtungssatz - gasket set

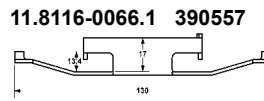

24.3361-9975.5 240541 
 24.3361-9976.5 240542 



CITROEN

EVASION (94-02)

LANCIA

ZETA (94-02)

FIAT

ULYSSE (94-02)



PEUGEOT

806 (94-02)

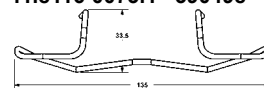

11.0441-3602.2 250008 11.0101-5407.2 260011 11.8171-0008.1 990049
 Dichtungssatz - gasket set



24.3364-1605.5 240011 
 24.3364-1606.5 240012 



VOLKSWAGEN

GOLF II (84-93)
 JETTA II (84-92)

VOLKSWAGEN

PASSAT Limousine (85-88)
 PASSAT Variant (85-88)
 SCIROCCO II (84-92)



24.0101-3601.2 260044



Abbildungen Bremssättel

Illustrations brake calipers - Illustrazioni pinze de freno - Illustrations Étriers de frein -
 Ilustraciones pinzas de freno

24.3367-1707.7 220669 

24.3367-1708.7 220670 



OPEL

ASTRA H / GTC / Vauxhall Astra Mk V (04-10)
 ASTRA H Caravan/Vau. Astra MKV Estate (04-10)
 ASTRA TWIN TOP (06-10)
 MERIVA A / Vauxhall Meriva A (03-10)

24.3381-8503.5 240515 

24.3381-8504.5 240516 





BMW

5er Reihe/E34 (88-96)
 7er Reihe/E32 (86-94)

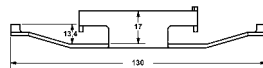

11.0441-3803.2 250010 11.0101-5402.2 260009 11.8171-0008.1 990049
 Dichtungssatz - gasket set
 11.8116-0066.1 390557



24.3384-1601.5 240013 

24.3384-1602.5 240014 



AUDI

80 (87-91)
 90 (87-91)

AUDI

100 (83-90)
 100 (91-94)
 CABRIO (91-00)
 COUPE (89-96)



24.0101-3601.2 260044



Abbildungen Bremssättel

Illustrations brake calipers - Illustrazioni pinze de freno - Illustrations Étriers de frein -
 Ilustraciones pinzas de freno

24.3384-1603.5 240015 

24.3384-1604.5 240016 



TRW



Ø 38



AUDI

200 (84-91)



24.0101-3601.2 260044





SEAT

CORDOBA I (93-99)
 IBIZA II (93-99)
 TOLEDO I (1L) (91-98)

VOLKSWAGEN

CORRADO (88-95)
 GOLF II (84-93)
 GOLF III (92-97)
 JETTA II (84-92)
 PASSAT Variant (85-88)
 PASSAT (88-93)
 VENTO (92-98)

24.3384-1605.5 240295 

24.3384-1606.5 240296 



TRW





Ø 38



PEUGEOT

405 (87-92)
 405 (93-95)

24.3384-1701.5 240169 

24.3384-1702.5 240170 



TRW



Ø 38





AUDI

80 (91-95)

Abbildungen Bremssättel

Illustrations brake calipers - Illustrazioni pinze de freno - Illustrations Étriers de frein - Ilustraciones pinzas de freno

24.3384-1703.5 240055 

24.3384-1704.5 240056 



AUDI

80 Quattro (87-91)
90 Quattro (87-91)



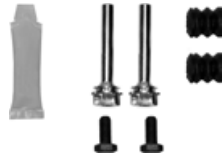

24.0101-3601.2 260044



AUDI

100 Quattro (85-90)
100 Quattro (91-94)
200 Quattro (85-91)
A6 / A6 Avant (4A/C4) (94-97)
A8 (94-02)
COUPE Quattro (87-96)

24.3384-1707.5 240171 

24.3384-1708.5 240172 



FORD

GALAXY I (95-06)

SEAT

ALHAMBRA I (96-10)
CORDOBA I (93-99)



24.0101-3601.2 260044





SEAT

IBIZA II (93-99)
TOLEDO I (1L) (91-98)

VOLKSWAGEN

CORRADO (88-95)
GOLF III (92-97)
GOLF III Variant (93-99)
GOLF III Cabriolet (94-02)
PASSAT (88-93)
PASSAT (94-96)
SHARAN I (95-10)
VENTO (92-98)

24.3384-1709.5 240257 

24.3384-1710.5 240258 



AUDI

100 (91-94)
A6 / A6 Avant (4A/C4) (94-97)
CABRIO (91-00)
COUPE (89-96)

Abbildungen Bremssättel

Illustrations brake calipers - Illustrazioni pinze de freno - Illustrations Étriers de frein -
Ilustraciones pinzas de freno

24.3384-1713.5 240431 

24.3384-1714.5 240432 



BOS





Ø 38



FORD

MONDEO III (00-07)

24.3384-1715.5 240265 

24.3384-1716.5 240266 



TRW



Ø 38



FORD

GALAXY I (95-06)

SEAT

ALHAMBRA I (96-10)

VOLKSWAGEN

SHARAN I (95-10)

TRANSPORTER (T4) (90-03)

24.3384-1717.5 240267 

24.3384-1718.5 240268 



TRW



Ø 38



VOLKSWAGEN

TRANSPORTER (T4) (90-03)

Abbildungen Bremssättel

Illustrations brake calipers - Illustrazioni pinze de freno - Illustrations Étriers de frein -
Ilustraciones pinzas de freno

24.3384-1719.5 240259 

24.3384-1720.5 240260 



AUDI

A4 (B5) (95-01)

24.3384-1721.5 240255 

24.3384-1722.5 240256 



VOLVO

S40 I (95-03)

V40 (95-04)

24.3384-1723.7 220523 

24.3384-1724.7 220524 



AUDI

A3 (96-03)

TT Coupe (98-06)

TT Roadster (99-06)

SEAT

CORDOBA I (93-99)

CORDOBA II (6K2) (99-02)

IBIZA II (93-99)

IBIZA III (6K1) (99-02)

TOLEDO II (1M2) (98-04)

SKODA

OCTAVIA I (1U) (97-10)

VOLKSWAGEN

GOLF III Cabriolet (94-02)

GOLF IV (98-03)

NEW BEETLE (98-10)

POLO Variant (97-01)

Abbildungen Bremssättel

Illustrations brake calipers - Illustrazioni pinze de freno - Illustrations Étriers de frein -
Ilustraciones pinzas de freno

24.3384-1725.5 240261 

24.3384-1726.5 240262 



TRW



Ø 38



AUDI

A4 (B5) (95-01)

24.3384-1729.7 220541 

24.3384-1730.7 220542 



TRW



Ø 38



AUDI

A3 (96-03)
TT Coupe (98-06)
TT Roadster (99-06)

SKODA

FABIA I (6Y) (99-07)
FABIA II (5J) (07-14)
ROOMSTER (5J) (06-15)

SEAT

CORDOBA III (6L2) (02-09)
IBIZA IV (6L1) (02-10)
LEON I (1M1) (99-05)
TOLEDO II (1M2) (98-04)

VOLKSWAGEN

GOLF IV (98-03)
NEW BEETLE (98-10)
NEW BEETLE Cabriolet (03-10)
POLO IV (02-09)

24.3384-1731.7 220543 

24.3384-1732.7 220544 



TRW



Ø 38



AUDI

A4 (B5) (95-01)
A6 / A6 Avant (4B/C5) (97-05)

SKODA

SUPERB I (02-08)

VOLKSWAGEN

PASSAT (97-05)

Abbildungen Bremssättel

Illustrations brake calipers - Illustrazioni pinze de freno - Illustrations Étriers de frein -
Ilustraciones pinzas de freno

24.3384-1733.7 220545 

24.3384-1734.7 220546 



TRW



AUDI

A6 / A6 Avant (4B/C5) (97-05)
A6 Allroad (00-05)

VOLKSWAGEN

PASSAT (97-05)

24.3384-1735.7 220547 

24.3384-1736.7 220548 



TRW



AUDI

A4 (B6/B7) (01-08)
A4 Cabrio (02-08)

SEAT

EXEO / ST (09-13)

24.3384-1737.5 240301 

24.3384-1738.5 240302 



TRW



SEAT

CORDOBA I (93-99)
IBIZA II (93-99)

VOLKSWAGEN

POLO III (95-01)
POLO Classic (96-01)

Abbildungen Bremssättel

Illustrations brake calipers - Illustrazioni pinze de freno - Illustrations Étriers de frein -
Ilustraciones pinzas de freno

24.3384-1741.7 220599 

24.3384-1742.7 220600 



ALFA ROMEO

147 (01-10)

156 (97-05)

GT (04-10)

FIAT

LINEA (07-11)

LANCIA

LYBRA (99-05)

24.3384-1743.5 240319 

24.3384-1744.5 240320 



MITSUBISHI

CARISMA (95-06)

SPACE STAR (98-06)

VOLVO

S40 I (95-03)

V40 (95-04)

24.3384-1745.7 220609 

24.3384-1746.7 220610 



AUDI

A3 (96-03)

TT Coupe (98-06)

TT Roadster (99-06)

SEAT

LEON I (1M1) (99-05)

TOLEDO II (1M2) (98-04)

VOLKSWAGEN

BORA (98-04)

GOLF IV (98-03)

GOLF IV Variant (99-06)

NEW BEETLE (98-10)

Abbildungen Bremssättel

Illustrations brake calipers - Illustrazioni pinze de freno - Illustrations Étriers de frein -
Ilustraciones pinzas de freno

24.3384-1753.7 220633 

24.3384-1754.7 220634 



TRW



Ø 38



OPEL

ASTRA G / Vauxhall Astra MKIV (98-05)
MERIVA A / Vauxhall Meriva Mk I (03-10)
ZAFIRA I / Vauxhall Zafira I (99-05)

24.3384-1755.7 220635 

24.3384-1756.7 220636 



TRW



Ø 38

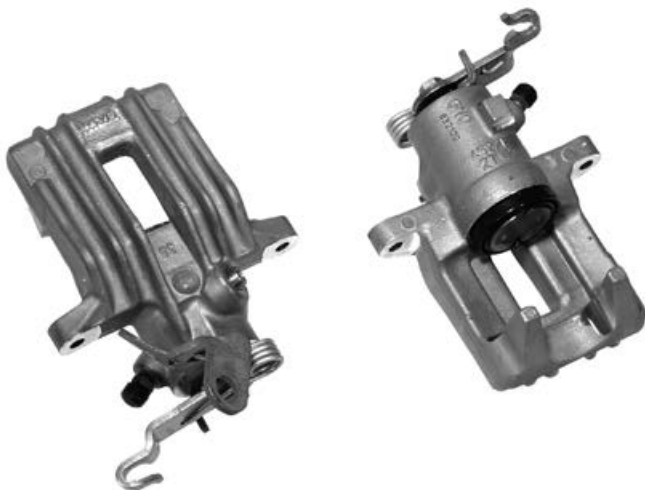

AUDI

A3 / A3 Sportback (03-13)
A3 Cabrio (08-13)

SEAT

ALTEA (5P1) (04-)
ALTEA XL (5P5) (06-)
LEON II (1P1) (05-12)
TOLEDO III (5P2) (05-09)

SKODA

OCTAVIA II (1Z) (04-13)
YETI (09-)

VOLKSWAGEN

EOS (06-)
GOLF V (03-08)
GOLF VI (08-)
GOLF VI Cabriolet (11-)
GOLF Plus (05-14)
SCIROCCO (08-)
JETTA VI (11-)
BEETLE (11-)
BEETLE Cabriolet (12-)
SCIROCCO (08-)

24.3384-1761.7 220671 

24.3384-1762.7 220672 



TRW



Ø 38



CITROEN

C8 (02-14)

FIAT

ULYSSE (02-11)

LANCIA

PHEDRA (02-10)

PEUGEOT

807 (02-14)

Abbildungen Bremssättel

Illustrations brake calipers - Illustrazioni pinze de freno - Illustrations Étriers de frein -
Ilustraciones pinzas de freno

24.3387-1701.7 220673 

24.3387-1702.7 220674 



TRW



Ø 38



OPEL

ASTRA H / GTC / Vauxhall Astra Mk V (04-10)
ASTRA H Caravan/Vauxhall Astra MKV Estate (04-10)
ASTRA TWIN TOP (06-10)
COMBO / Vauxhall Combo (01-11)
MERIVA A / Vauxhall Meriva A (03-10)

24.3387-1705.7 220675 

24.3387-1706.7 220676 



TRW



Ø 38

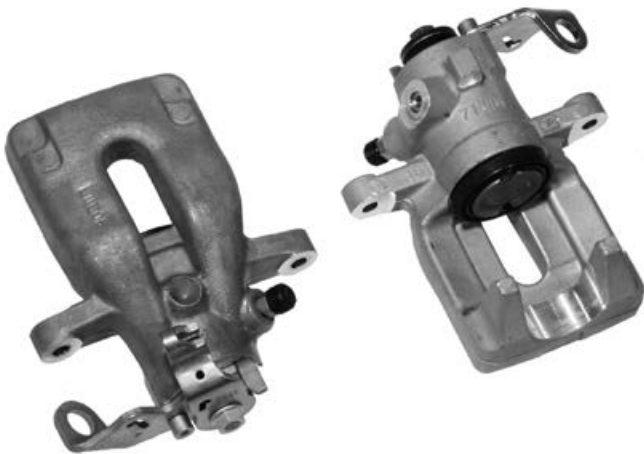

CITROEN

C2 (03-09)
C3 (02-09)
C3 II (09-)
C3 Pluriel (03-10)

PEUGEOT

1007 (05-11)

24.3401-8503.5 240521 

24.3401-8504.5 240522 



ATE



Ø 40



BMW

5er Reihe/E34 (88-96)



11.0441-4002.2 250011 11.0101-5402.2 260009 11.8171-0008.1 990049

Dichtungssatz - gasket set

11.8116-0066.1 390557

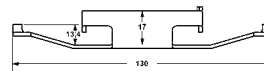

Abbildungen Bremssättel

Illustrations brake calipers - Illustrazioni pinze de freno - Illustrations Étriers de frein -
Ilustraciones pinzas de freno

24.3401-9977.5 240523 
24.3401-9978.5 240524 



BMW



7er Reihe/E38 (93-01)

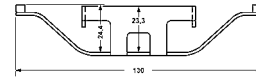

11.0441-4003.2 250001
Dichtungssatz - gasket set

11.8116-0094.1 390504



24.3411-1701.5 240361 
24.3411-1702.5 240362 

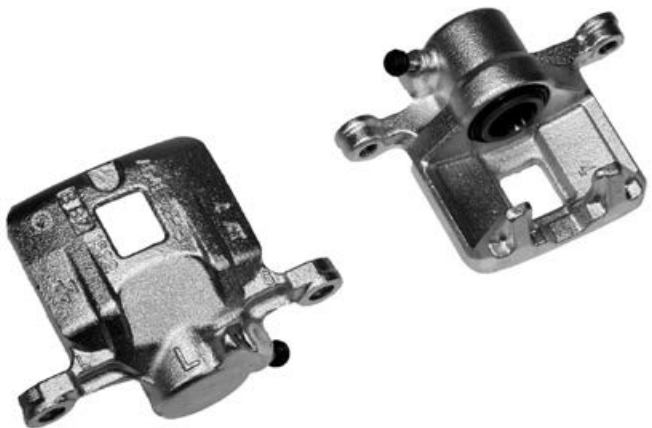

OPEL

FRONTERA A (92-98)
FRONTERA B (98-04)
MONTEREY (92-98)
MONTEREY (98-99)

24.3414-1703.7 220535 
24.3414-1704.7 220536 

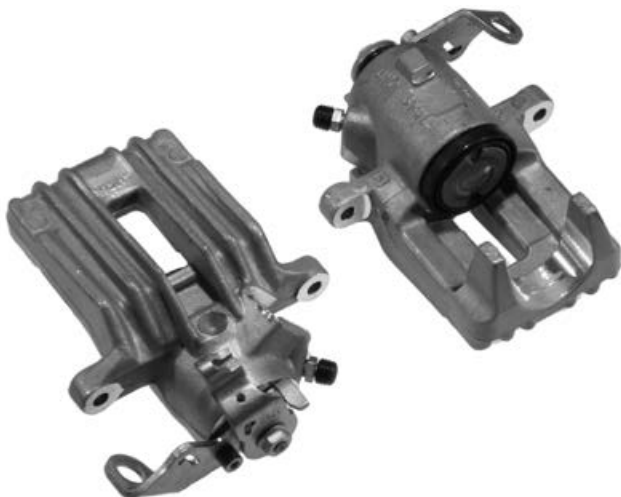

SEAT

TOLEDO II (1M2) (98-04)

SKODA

OCTAVIA I (1U) (97-10)

VOLKSWAGEN

BORA (98-04)
GOLF IV Variant (99-06)

Abbildungen Bremssättel

Illustrations brake calipers - Illustrazioni pinze de freno - Illustrations Étriers de frein -
Ilustraciones pinzas de freno

24.3414-1705.7 220549 

24.3414-1706.7 220550 



TRW



Ø 41



AUDI

A3 (96-03)
TT Coupe (98-06)
TT Roadster (99-06)

VOLKSWAGEN

BORA (98-04)
GOLF IV (98-03)
GOLF IV Variant (99-06)

SEAT

LEON I (1M1) (99-05)
TOLEDO II (1M2) (98-04)

SKODA

OCTAVIA I (1U) (97-10)

24.3414-1711.7 220677 

24.3414-1712.7 220678 



TRW



Ø 41



VOLKSWAGEN

TRANSPORTER (T5) BUS / MULTIVAN / KASTEN (03-)
TRANSPORTER (T5) PRITSCHKE / FAHRGESTELL (03-)
TRANSPORTER (T6) (15-)

24.3417-1701.7 220679 

24.3417-1702.7 220680 



TRW



Ø 41



VOLKSWAGEN

CADDY III (04-15)

Abbildungen Bremssättel

Illustrations brake calipers - Illustrazioni pinze de freno - Illustrations Étriers de frein - Ilustraciones pinzas de freno

24.3421-9979.5 240475 
24.3421-9980.5 240476 



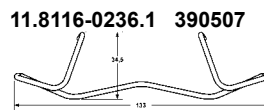

VOLVO

S60 (00-09)
S80 I (98-06)
V70 II (00-07)
XC70 I CROSS COUNTRY (00-07)



11.0101-5407.2 260011 11.8171-0008.1 990049



24.3424-1701.5 240561 
24.3424-1702.5 240562 



NISSAN



INTERSTAR (X70) (02-10)

OPEL

MOVANO A (98-10)

RENAULT

MASTER II Bus (JD/ND_) (98-06)
MASTER II Kasten (FD_) (98-06)
MASTER II Pritsche/Fahrgestell (ED/HD/UD_) (98-06)
MASTER III Bus (JD_) (06-10)
MASTER III Kasten (FD_) (06-10)
MASTER III Pritsche/Fahrgestell (ED/HD/UD_) (06-10)

24.3431-1705.5 240365 
24.3431-1706.5 240366 

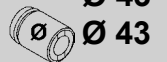

HYUNDAI

GALLOPER (98-03)

MITSUBISHI

L 200 (92-96)
L 200 (96-06)
L 400 (96-02)
PAJERO (90-00)
PAJERO SPORT / MONTERO (USA) (98-09)
SPACE GEAR (95-02)

Abbildungen Bremssättel

Illustrations brake calipers - Illustrazioni pinze de freno - Illustrations Étriers de frein -
Ilustraciones pinzas de freno

24.3434-1601.5 240019 

24.3434-1602.5 240020 



TRW



Ø 43

FORD

SCORPIO / GRANADA (GB) (85-91)
SCORPIO / GRANADA (GB) (95-98)
SIERRA (82-86)
SIERRA (87-92)



24.0101-4301.2 260047



24.3434-1701.5 240357 

24.3434-1702.5 240358 



TRW



Ø 43

AUDI

100 (83-90)
100 Quattro (85-90)
100 Quattro (91-94)
200 Quattro (85-91)
A6 / A6 Avant (4A/C4) (94-97)
QUATTRO (80-91)
V8 (88-94)



24.3441-1701.5 240331 

24.3441-1702.5 240332 



PER





Ø 44

Ø 44

MERCEDES BENZ

Transporter (BM 901/902) SPRINTER (95-06) 

Transporter (BM 903/904) SPRINTER (95-06) 

Transporter (BM 905) SPRINTER (01-06) 

VOLKSWAGEN

LT/- 4x4 (96-06) 



Abbildungen Bremssättel

Illustrations brake calipers - Illustrazioni pinze de freno - Illustrations Étriers de frein -
 Ilustraciones pinzas de freno

24.3451-1501.5 240263 

24.3451-1502.5 240264 



BDX



Ø 45



RENAULT

CLIO I Limousine (B/C 57_) (90-98)
 CLIO I Kasten (S 57_) (91-98)
 EXPRESS/RAPID (F40_) (85-98)
 R5 SUPER (85-96)

24.3451-1711.5 240251 

24.3451-1712.5 240252 



BDX





Ø 45



RENAULT

TWINGO I Limousine (C06_) (93-07)
 TWINGO I Kasten (S06_) (93-07)

24.3481-0705.5 240021 

24.3481-0706.5 240022 



DEL



Ø 48



OPEL

CORSA A / Vauxhall Nova (83-92)
 KADETT D / Vauxhall Astra D (79-84)
 KADETT E / Vauxhall Astra E/Belmont (84-93)



24.0101-4801.2 990131



Abbildungen Bremssättel

Illustrations brake calipers - Illustrazioni pinze de freno - Illustrations Étriers de frein -
 Ilustraciones pinzas de freno

24.3481-0707.5 240023 

24.3481-0708.5 240024 



DEL



OPEL

ASCONA C / Vauxhall Cavalier (82-88)
 CORSA A / Vauxhall Nova (83-92)
 KADETT D / Vauxhall Astra D (79-84)
 KADETT E / Vauxhall Astra E/Belmont (84-93)



24.0101-4801.2 990131



24.3481-1505.5 240047 

24.3481-1506.5 240048 



BDX



RENAULT

CLIO I Limousine (B/C 57_) (90-98)
 CLIO I Kasten (S 57_) (91-98)
 EXPRESS/RAPID (F40_) (85-98) / R5 SUPER (85-96)
 R19 (3/5-türig) (B53/C53/S53_) (88-95)
 R19 CHAMADE (L53_) (89-95)



24.0101-4803.2 260049



24.3481-1607.5 240211 

24.3481-1608.5 240212 



TRW



BMW

3er Reihe/E30 (82-93)
 Z1 (88-91)



Abbildungen Bremssättel

Illustrations brake calipers - Illustrazioni pinze de freno - Illustrations Étriers de frein - Ilustraciones pinzas de freno

24.3481-1609.7 220197 

24.3481-1610.7 220198 



CITROEN

C15 (84-)
VISA (78-89)
ZX (N2) Limousine (91-97)

PEUGEOT

205 (83-90)
205 (91-98)
309 (85-93)

24.3481-1611.5 240029 

24.3481-1612.5 240030 



DACIA

LOGAN Limousine (LS_) (04-13)
SANDERO (08-13)





24.0101-4807.2 260053



RENAULT

CLIO I (90-98) / CLIO II (98-)
EXPRESS/RAPID (F40_) (85-98)
LOGAN (LS_) (04-13)
LOGAN Kombi (KS_) (04-13)
MEGANE I (96-02)
R5 SUPER(85-96) /R9(82-89) /R11(83-89)
R19 (3/5-türig) (B53/C53/S53_) (88-95)
R19 CHAMADE (L53_) (89-95)
R21 Limousine (B48/L48_) (86-93)
SANDERO (BS0_) (07-)
THALIA I (LB_) (98-)
THALIA II / SYMBOL (LU_) (08-)
TWINGO I Limousine (C06_) (93-06)
TWINGO I Kasten (S06_) (93-07)
TWINGO II (CNO_) (07-14)

24.3481-1615.5 240031 

24.3481-1616.5 240032 



CITROEN

ZX (N2) Limousine (91-97)
ZX (N2) Kombi (93-98)

DACIA

LOGAN Limousine (LS_) (04-13)
LOGAN MCV Kombi (KS_) (07-13)
SANDERO (08-13)



24.0101-4806.2 260052



PEUGEOT

205 (83-98) / 309 (85-93)

RENAULT

CLIO I Limousine (B/C 57_) (90-98) / CLIO I Kasten (S 57_) (91-98)
CLIO II Limousine (BB_/CB_) (98-05) / CLIO II Kasten (SB_) (98-05)
LOGAN (LS_) (04-)
LOGAN Kombi (KS_) (04-)
MEGANE I Limousine 3/5-türig (BA/SA_) (96-02)
MEGANE I Classic (LA_) (96-02) / MEGANE I Coach (DA_) (95-03)
MEGANE I Cabrio (EA_) (96-03) / MEGANE I Grandtour (KA_) (98-03)
MEGANE SCENIC (JA_) (96-99)
R5 SUPER (85-96) / R9 (82-89) / R11 (83-89) / R19 (88-95)
R19 Cabriolet (D53_) (91-96) / R21 Limousine (B48/L48_) (86-93)
R21 NEVADA (K48_) (86-95) / SANDERO (BS0_) (07-)
THALIA I (LB_) (98-)
THALIA II / SYMBOL (LU_) (08-)
TWINGO I Limousine (C06_) (93-06)
TWINGO II (CNO_) (07-14)

Abbildungen Bremssättel

Illustrations brake calipers - Illustrazioni pinze de freno - Illustrations Étriers de frein -
 Ilustraciones pinzas de freno

24.3481-1703.5 240051 

24.3481-1704.5 240052 



FIAT

PUNTO (93-00)
 TEMPRA (90-93)
 TIPO (88-93)
 UNO (90-95)

LANCIA

Y (96-03)



24.0101-4301.2 260047



24.3481-1707.5 240073 

24.3481-1708.5 240074 



PEUGEOT

405 (87-92)
 405 (93-95)



24.0101-3601.2 260044



24.3481-1725.5 240187 

24.3481-1726.5 240188 



NISSAN

100 NX (B13) (90-94)
 SUNNY (N14) Limousine (90-95)

Abbildungen Bremssättel

Illustrations brake calipers - Illustrazioni pinze de freno - Illustrations Étriers de frein -
 Ilustraciones pinzas de freno

24.3481-1733.5 240213 
 24.3481-1734.5 240214 



OPEL

ASTRA F / Vauxhall Astra MKIII (91-01)
 ASTRA F CLASSIC (98-02)
 CORSA A / Vauxhall Nova (83-92)
 ASTRA F CLASSIC Caravan (98-05)
 CORSA B / Vauxhall Corsa (93-00)



11.0441-4811.2 250024 11.0101-5407.2 260011 11.8171-0008.1 990049
 Dichtungssatz - gasket set
 11.8116-0129.1 390591

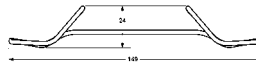

24.3481-1735.5 240283 
 24.3481-1736.5 240284 



SEAT

AROSA (6H) (97-05)

SKODA

FABIA I (6Y) (99-07)
 FABIA II (5J) (07-14)

VOLKSWAGEN

FOX (05-11)
 LUPO (98-05)
 POLO III (95-01)
 POLO IV (02-09)



11.0441-4808.2 250022 11.0101-4801.2 260006 24.0102-4801.2 260085
 Dichtungssatz
 gasket set

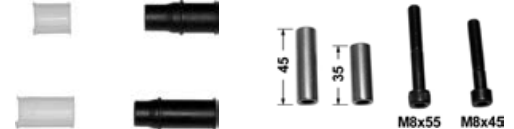

24.3481-1739.5 240243 
 24.3481-1740.5 240244 





PEUGEOT

206 Limousine (98-09)

Abbildungen Bremssättel

Illustrations brake calipers - Illustrazioni pinze de freno - Illustrations Étriers de frein -
 Ilustraciones pinzas de freno

24.3481-1741.5 240245 

24.3481-1742.5 240246 



BOS



Ø 48





CITROEN

XSARA (N1) Limousine (97-05)
 XSARA (N0) Coupe (97-05)

PEUGEOT

206 Limousine (98-09)
 306 Limousine (3/5-türig) (93-01)
 306 Limousine (4-türig) (94-01)

24.3481-1743.5 240305 

24.3481-1744.5 240306 



BDX



Ø 48



FIAT

CINQUECENTO (92-98)
 PANDA (03-13)
 PUNTO (93-00)
 PUNTO (00-03)
 SEICENTO (98-08)

LANCIA

Y (96-03)

24.3481-1745.5 240277 

24.3481-1746.5 240278 



ATE



Ø 48



SEAT

CORDOBA I (93-99)
 IBIZA II (93-99)
 IBIZA III (6K1) (99-02)

VOLKSWAGEN

DERBY/POLO Stufenheck (77-88)
 GOLF II (84-93)
 JETTA II (84-92)
 POLO II (81-94)
 POLO Classic (96-01)
 POLO Variant (97-01)



11.0441-4808.2 250022 11.0101-4803.2 260008 24.0102-4803.2 260086

Dichtungssatz - gasket set



35

35

M8x45

M8x45

Abbildungen Bremssättel

Illustrations brake calipers - Illustrazioni pinze de freno - Illustrations Étriers de frein -
 Ilustraciones pinzas de freno

24.3481-1749.5 240281 

24.3481-1750.5 240282 

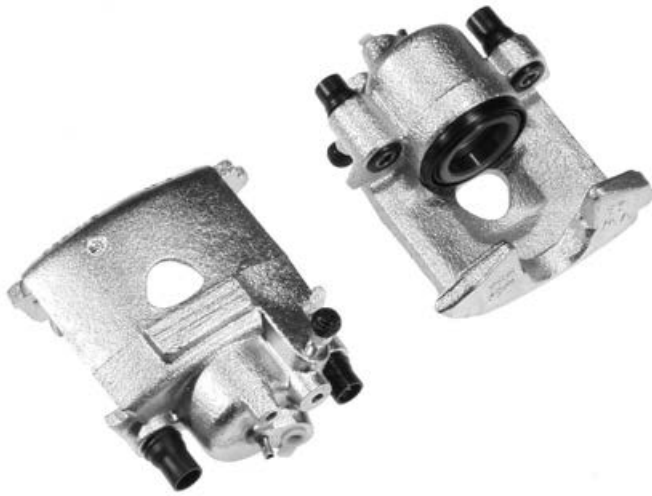

VOLKSWAGEN

POLO III (95-01)



11.0441-4808.2 250022 11.0101-4801.2 260006 24.0102-4801.2 260085
 Dichtungssatz - gasket set



24.3481-1751.5 240285 

24.3481-1752.5 240286 



FIAT

PUNTO (93-00)
 PUNTO (00-03)
 PUNTO (03-06)

LANCIA

Y (96-03)

24.3481-1757.5 240325 

24.3481-1758.5 240326 



OPEL

AGILA / Vauxhall Agila Mk I (00-07)

SUZUKI

WAGON R+ (00-08)

Abbildungen Bremssättel

Illustrations brake calipers - Illustrazioni pinze de freno - Illustrations Étriers de frein -
Ilustraciones pinzas de freno

24.3481-1759.5 240339 

24.3481-1759.5 240339 

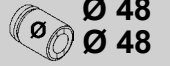

MERCEDES BENZ

Transporter (BM 631) MB 100 D (87-96)

24.3481-1761.5 240393 

24.3481-1762.5 240394 



CITROEN

C2 (03-09)

C3 (02-09)

24.3481-1763.5 240367 

24.3481-1764.5 240368 



NISSAN

MICRA (K11E) (92-02)

Abbildungen Bremssättel

Illustrations brake calipers - Illustrazioni pinze de freno - Illustrations Étriers de frein -
Ilustraciones pinzas de freno

24.3481-1765.5 240369 

24.3481-1766.5 240370 



TRW



Ø 48



OPEL

CORSA C / Vauxhall Corsa MK II (00-06)

24.3481-1767.5 240371 

24.3481-1768.5 240372 



TRW



Ø 48



OPEL

CORSA C / Vauxhall Corsa MK II (00-06)

24.3481-1769.5 240373 

24.3481-1770.5 240374 



BOS



Ø 48



PEUGEOT

206 Limousine (98-09)

206 SW (02-07)

206 PLUS (09-13)

Abbildungen Bremssättel

Illustrations brake calipers - Illustrazioni pinze de freno - Illustrations Étriers de frein -
Ilustraciones pinzas de freno

24.3481-1771.5 240375 

24.3481-1772.5 240376 



BOS

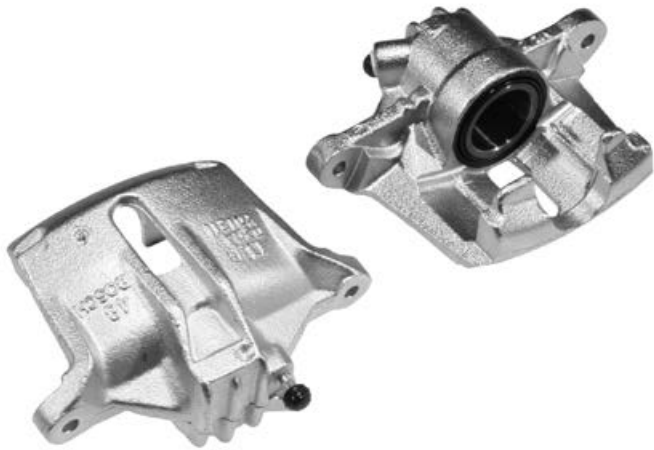

PEUGEOT

206 Limousine (98-09)

206 SW (02-07)

206 PLUS (09-13)

24.3481-1773.5 240377 

24.3481-1774.5 240378 



CHEVROLET

MATIZ (05-)

SPARK (05-10)

DAEWOO

MATIZ (98-05)

24.3481-8515.5 240477 

24.3481-8516.5 240478 



ATE



FORD

FIESTA IV (96-02)

KA I (96-08)

MAZDA

121 (96-03)



11.8116-0264.1 390594

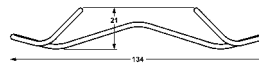

11.0101-5407.2 260011





11.8171-0008.1 990049



Abbildungen Bremssättel

Illustrations brake calipers - Illustrazioni pinze de freno - Illustrations Étriers de frein -
Ilustraciones pinzas de freno

24.3481-9833.5 240479 

24.3481-9834.5 240480 



CITROEN

SAXO (96-04)
XSARA (N1) Limousine (97-05)
XSARA (N2) Kombi (97-05)
XSARA (N0) Coupe (97-05)

PEUGEOT

106 (91-96)
106 (96-04)
205 (91-98)
306 Lim. (3/5-türig) (93-01)
306 Lim. (4-türig) (94-01)
306 Cabriolet (94-03)
306 Kombi (97-02)



11.0441-4811.2 250024
Dichtungssatz - gasket set

11.8116-0129.1 390591

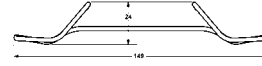

11.0101-5407.2 260011



11.8171-0008.1 990049



11.0230-0081.2 260038

24.3511-1709.5 240333 

24.3511-1710.5 240334 

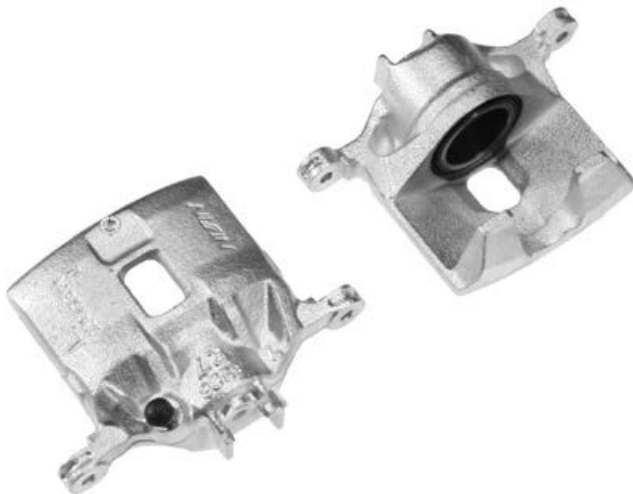

HONDA

CIVIC (3/4-türig) (95-01)
CIVIC COUPE (96-01)
LOGO (99-02)

24.3511-1711.5 240379 

24.3511-1712.5 240380 



TOYOTA

YARIS (99-05)
YARIS VERSO (99-05)

Abbildungen Bremssättel

Illustrations brake calipers - Illustrazioni pinze de freno - Illustrations Étriers de frein -
 Ilustraciones pinzas de freno

24.3521-1701.5 240001 

24.3521-1702.5 240002 



ATE



Ø 52



CHEVROLET

LANOS (05-10)

DAEWOO

ESPERO (95-99)
 LANOS (97-02)
 NEXIA / RACER (95-08)

OPEL

ASCONA C / Vauxhall Cavalier (82-88)
 ASTRA F / Vauxhall Astra MKIII (91-01)
 CALIBRA / Vauxhall Calibra (89-97)
 KADETT E / Vauxhall Astra E/Belmont (84-93)
 VECTRA A / Vauxhall Cavalier (89-95)
 VECTRA B / Vauxhall Vectra (96-02)



11.0441-5202.2 250026
 Dichtungssatz gasket set

11.8116-0097.1 390590

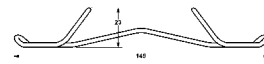



11.0101-5407.2 260011



11.8171-0008.1 990049



24.3521-1707.5 240471 

24.3521-1708.5 240472 



BOS



Ø 52



MERCEDES BENZ

Transporter (BM 901/902) SPRINTER (95-06)
 Transporter (BM 903/904) SPRINTER (95-06)

VOLKSWAGEN

LT/LT 4x4 (96-06)



24.3521-7001.5 240481 

24.3521-7002.5 240482 



ATE



Ø 52



OPEL

ASTRA G / Vauxhall Astra MKIV (98-05)



11.0101-5407.2 260011



11.8171-0008.1 990049



Abbildungen Bremssättel

Illustrations brake calipers - Illustrazioni pinze de freno - Illustrations Étriers de frein - Ilustraciones pinzas de freno

24.3541-1603.5 240037 

24.3541-1604.5 240038 



TRW



Ø 54



MERCEDES BENZ

(W124) E-Klasse (85-93)
(W201) 190-190 E, 2,6 (82-93)

MERCEDES BENZ

E-Klasse (W124) Limousine (93-95)
E-Klasse (S124) Kombi (93-96)
E-Klasse (C124) Coupe (93-97)
E-Klasse (A124) Cabrio (93-98)



24.0101-3601.2 260044



24.3541-1609.5 240039 

24.3541-1610.5 240040 



TRW



Ø 54



AUDI

80 (87-95) / 80 Quattro (78-91)
90 (85-91) / 90 Quattro (84-87)
100 (83-90)
COUPE (81-96) / COUPE Quattro (85-87)

SEAT

CORDOBA I (93-99)
CORDOBA II (6K2) (99-02)
IBIZA II (93-99) / IBIZA III (6K1) (99-02)
INCA (6K9) (96-03)
TOLEDO I (1L) (91-98)

VOLKSWAGEN

CADDY II (96-03) / CORRADO (88-95)
GOLF II (84-93) / GOLF III (92-97)
GOLF III Variant (93-99)
GOLF III Cabriolet (94-02)
JETTA II (84-92)
PASSAT Limousine (85-88)
PASSAT Variant (85-88)
PASSAT (88-96)
POLO Classic (96-01)
POLO Variant (97-01)
SCIROCCO II (84-92)
VENTO (92-98)



24.0101-4301.2 260047



24.3541-1625.5 240045 

24.3541-1626.5 240046 



TRW



Ø 54



RENAULT

ESPACE I (J/S 11_) (84-90)
ESPACE II (J/S 63_) (91-96)
FUEGO (80-85)

RENAULT

R18 Limousine (78-86)
R18 Variable (79-86)
R20 (76-84)
R21 Limousine (B48/L48_) (86-93)
R21 NEVADA (K48_) (86-95)
R25 (84-92)
R30 (75-84)



24.0101-5404.2 260062



Abbildungen Bremssättel

Illustrations brake calipers - Illustrazioni pinze de freno - Illustrations Étriers de frein -
 Ilustraciones pinzas de freno

24.3541-1631.5 240413 
 24.3541-1632.5 240414 





MERCEDES BENZ

(W201) 190-190 E 2,6 (82-93)



11.0441-5404.2 250029 11.0101-5403.2 260010
 Dichtungssatz - gasket set



24.3541-1701.5 240005 
 24.3541-1702.5 240006 



FORD

FIESTA (76-89)
 FIESTA III (89-96)



11.0441-5402.2 250028 11.0101-5407.2 260011 11.8171-0008.1 990049
 Dichtungssatz
 gasket set



24.3541-1705.5 240111 
 24.3541-1706.5 240112 



TOYOTA

COROLLA (92-97)





24.0101-5405.2 260063



Abbildungen Bremssättel

Illustrations brake calipers - Illustrazioni pinze de freno - Illustrations Étriers de frein -
Ilustraciones pinzas de freno

24.3541-1707.5 240067 

24.3541-1708.5 240068 



BDX



FORD

ESCORT / ORION (91-94)
ESCORT VII (95-00)



24.0101-5401.2 260059



24.3541-1725.5 240003 

24.3541-1726.5 240004 



TRW





MERCEDES BENZ

(W124) E-Klasse (85-93)
E-Klasse (W124) Limousine (93-95)
E-Klasse (S124) Kombi (93-96)

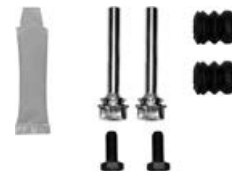

24.0101-3601.2 260044



24.3541-1731.5 240061 

24.3541-1732.5 240062 



TRW



SEAT

CORDOBA I (93-99)
CORDOBA II (6K2) (99-02)
IBIZA III (6K1) (99-02)
TOLEDO I (1L) (91-98)



24.0101-4301.2 260047





VOLKSWAGEN

CORRADO (88-95)
GOLF II (84-93)
GOLF III (92-97)
PASSAT (88-93)
PASSAT (94-96)
VENTO (92-98)

Abbildungen Bremssättel

Illustrations brake calipers - Illustrazioni pinze de freno - Illustrations Étriers de frein -
Ilustraciones pinzas de freno

24.3541-1737.5 240197 

24.3541-1738.5 240198 



TRW



Ø 54

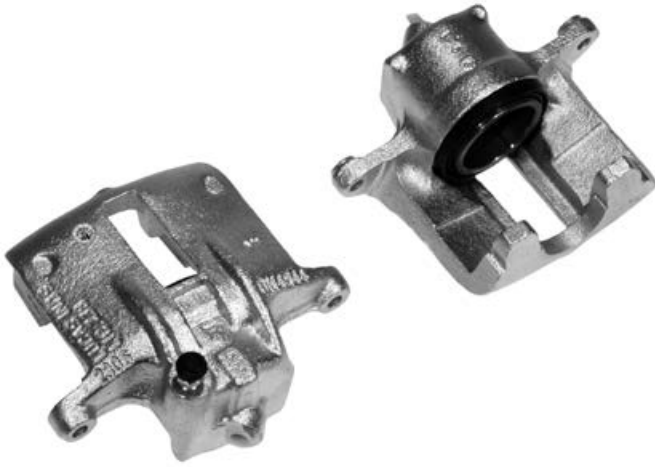



SKODA

FELICIA I (791/795) (95-97)
FELICIA II (6U) (98-01)
FELICIA PICK-UP (797) (97-00)

VOLKSWAGEN

CADDY Pickup (97-02)

24.3541-1739.5 240223 

24.3541-1740.5 240224 



TRW





Ø 54



VOLKSWAGEN

GOLF III (92-97)
GOLF III Variant (93-99)
GOLF III Cabriolet (94-02)
VENTO (92-98)

24.3541-1741.5 240215 

24.3541-1742.5 240216 



TRW



Ø 54





RENAULT

LAGUNA I Limousine (B56/556_) (93-00)
LAGUNA I Grandtour (K56_) (95-00)
MEGANE I Limousine 3/5-türig (BA/SA_) (96-02)
MEGANE I Coach (DA_) (95-03)
MEGANE I Cabrio (EA_) (96-03)
MEGANE SCENIC (JA_) (96-99)
SAFRANE (B54_) (92-00)

Abbildungen Bremssättel

Illustrations brake calipers - Illustrazioni pinze de freno - Illustrations Étriers de frein -
Ilustraciones pinzas de freno

24.3541-1743.5 240219 

24.3541-1744.5 240220 



AUDI

80 (91-95)

24.3541-1745.5 240217 

24.3541-1746.5 240218 



AUDI

A4 (B5) (95-01)

24.3541-1749.5 240427 

24.3541-1750.5 240428 



RENAULT

CLIO II Limousine (BB_/CB_) (98-05)
ESPACE III (JE_) (96-02)
LAGUNA I Limousine (B56/556_) (93-00)
LAGUNA I Grandtour (K56_) (95-00)
MEGANE I Limousine 3/5-türig (BA/SA_) (96-02)
MEGANE I Classic (LA_) (96-02)
MEGANE I Coach (DA_) (95-03)
MEGANE I Cabrio (EA_) (96-03)
MEGANE I Grandtour (KA_) (98-03)
MEGANE SCENIC (JA_) (96-99)
SCENIC I (JA_) (99-03)

Abbildungen Bremssättel

Illustrations brake calipers - Illustrazioni pinze de freno - Illustrations Étriers de frein -
Ilustraciones pinzas de freno

24.3541-1751.7 220477 

24.3541-1752.7 220478 



TRW



MERCEDES BENZ

C-Klasse (W202) Limousine (93-00)

C-Klasse (S202) Kombi (96-01)

24.3541-1753.7 220479 

24.3541-1754.7 220480 



TRW



MERCEDES BENZ

A-Klasse (W168) (97-04)

24.3541-1755.7 220481 

24.3541-1756.7 220482 



TRW

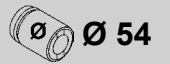

MERCEDES BENZ

C-Klasse (W202) Limousine (93-00)

Abbildungen Bremssättel

Illustrations brake calipers - Illustrazioni pinze de freno - Illustrations Étriers de frein -
Ilustraciones pinzas de freno

24.3541-1757.7 220483 

24.3541-1758.7 220484 



TRW



Ø 54



CITROEN

BERLINGO (MF) Kombi (96-08)
BERLINGO (M_) Kasten (96-08)
XSARA (N1) Limousine (97-05)
XSARA (N2) Kombi (97-05)
XSARA (N0) Coupe (97-05)
XSARA Picasso (N68) (00-10)

PEUGEOT

306 Cabriolet (94-03)
306 Kombi (97-02)
PARTNER Kombi (96-08)
PARTNER Kasten (96-08)

PEUGEOT

306 Limousine (3/5-türig) (93-01)
306 Limousine (4-türig) (94-01)

24.3541-1759.7 220491 

24.3541-1760.7 220492 



TRW





Ø 54



MERCEDES BENZ

A-Klasse (W168) (97-04)

24.3541-1761.5 240233 

24.3541-1762.5 240234 



BOS



Ø 54



CITROEN

BERLINGO (MF) Kombi (96-08)
C3 (02-09)
C4 I Limousine (LC_) (04-10)
C4 I Coupe (04-10)
XSARA (N1) Limousine (97-05)
XSARA (N2) Kombi (97-05)
XSARA (N0) Coupe (97-05)
XSARA Picasso (N68) (00-10)

PEUGEOT

207 Limousine (06-12)
207 CC (07-)
207 SW (07-13)
307 Limousine (00-07)
307 Break (02-08)
307 CC (03-09)
307 SW (02-08)
1007 (05-01)
PARTNER Kombi (96-08)
PARTNER Kasten (96-08)

Abbildungen Bremssättel

Illustrations brake calipers - Illustrazioni pinze de freno - Illustrations Étriers de frein -
Ilustraciones pinzas de freno

24.3541-1763.5 240231 

24.3541-1764.5 240232 



TRW



Ø 54



AUDI

A4 (B5) (95-01)
A4 (B6/B7) (01-08)

SEAT

EXEO / ST (09-13)

VOLKSWAGEN

PASSAT (97-05)

24.3541-1765.5 240235 

24.3541-1766.5 240236 



BOS



Ø 54



NISSAN

KUBISTAR (X76) Kombi (03-09)

RENAULT

KANGOO I (KC_) (98-07)
KANGOO Express/Rapid (FC_) (98-07)

24.3541-1767.5 240237 

24.3541-1768.5 240238 



BOS



Ø 54



CITROEN

XSARA (N1) Limousine (97-05)
XSARA (N2) Kombi (97-05)
XSARA (N0) Coupe (97-05)

PEUGEOT

206 Limousine (98-09)
206 CC (00-07)
306 Limousine (3/5-türig) (93-01)
306 Limousine (4-türig) (94-01)
306 Cabriolet (94-03)
306 Kombi (97-02)

Abbildungen Bremssättel

Illustrations brake calipers - Illustrazioni pinze de freno - Illustrations Étriers de frein -
Ilustraciones pinzas de freno

24.3541-1771.5 240239 

24.3541-1772.5 240240 



BOS



Ø 54



CITROEN

BERLINGO (MF) Kombi (96-08)
BERLINGO (M_) Kasten (96-08)
C2 (03-09)
C3 (02-09)
C3 II (09-)
C3 Picasso (09-)
C4 I Limousine (LC_) (04-10)
C4 I Coupe (04-10)/ C4 CACTUS (14-)
C-ELYSEE (12-) / DS 3 (09-)
XSARA (N1) Limousine (97-05)
XSARA (N2) Kombi (97-05)
XSARA (N0) Coupe (97-05)
XSARA Picasso (N68) (00-10)

PEUGEOT

206 Limousine (98-09)
206 CC (00-07)
206 SW (02-07)
207 Limousine (06-12)
207 SW (07-13)
208 (12-) / 301 (12-)
307 Limousine (00-07)
307 Break (02-08)
307 SW (02-08)
1007 (05-11) / 2008 (13-)
PARTNER Kombi (96-08)
PARTNER Kasten (96-08)

24.3541-1775.7 220529 

24.3541-1776.7 220530 



TRW



Ø 54



VOLKSWAGEN

TRANSPORTER (T4) (90-03)

24.3541-1777.5 240247 

24.3541-1778.5 240248 



TRW



Ø 54



CITROEN

BERLINGO (MF) Kombi (96-08)
BERLINGO (M_) Kasten (96-08)

PEUGEOT

PARTNER Kombi (96-08)
PARTNER Kasten (96-08)

Abbildungen Bremssättel

Illustrations brake calipers - Illustrazioni pinze de freno - Illustrations Étriers de frein -
Ilustraciones pinzas de freno

24.3541-1779.5 240249 

24.3541-1780.5 240250 



TRW



Ø 54



SEAT

AROSA (6H) (97-05)

VOLKSWAGEN

LUPO (98-05)

POLO III (95-01)

24.3541-1783.5 240269 

24.3541-1784.5 240270 



TRW



Ø 54



MITSUBISHI

CARISMA (95-06)

SPACE STAR (98-06)

VOLVO

S40 I (95-03)

V40 (95-04)

24.3541-1785.5 240271 

24.3541-1786.5 240272 



TRW



Ø 54



MITSUBISHI

CARISMA (95-06)

VOLVO

S40 I (95-03)

V40 (95-04)

Abbildungen Bremssättel

Illustrations brake calipers - Illustrazioni pinze de freno - Illustrations Étriers de frein -
Ilustraciones pinzas de freno

24.3541-1787.5 240289 

24.3541-1788.5 240290 



FIAT

BRAVA (95-01)
BRAVO (95-01)
MAREA (96-02)
PUNTO (00-03)
PUNTO (03-06)

24.3541-1789.5 240291 

24.3541-1790.5 240292 



ALFA ROMEO

145 (94-01)
146 (94-01)

FIAT

BARCETTA (95-04)
BRAVA (95-01)
BRAVO (95-01)
MAREA (96-02)
PUNTO (00-03)
PUNTO (03-06)

24.3541-1795.7 220551 

24.3541-1796.7 220552 



OPEL

COMBO / Vauxhall Combo (01-11)
CORSA C / Vauxhall Corsa MK II (00-06)
MERIVA A / Vauxhall Meriva A (03-10)
TIGRA TWIN TOP / Vauxhall Tigra Twin Top (04-09)

Abbildungen Bremssättel

Illustrations brake calipers - Illustrazioni pinze de freno - Illustrations Étriers de frein -
Ilustraciones pinzas de freno

24.3541-1797.7 220553 

24.3541-1798.7 220554 



TRW



SEAT

CORDOBA III (6L2) (02-09)
IBIZA IV (6L1) (02-10)
IBIZA V / ST / SC (08-)

SKODA

FABIA I (6Y) (99-07)
FABIA II (5J) (07-14)
ROOMSTER (5J) (06-15)

VOLKSWAGEN

POLO IV (02-09)

24.3541-1803.7 220603 

24.3541-1804.7 220604 





TRW



CITROEN

C2 (03-09)
C3 (02-09)
C3 Pluriel (03-10)

24.3541-1805.5 240323 

24.3541-1806.5 240324 



HONDA

CIVIC (3/4-türig) (95-01)
CIVIC COUPE (96-01)
CRX (92-98)

Abbildungen Bremssättel

Illustrations brake calipers - Illustrazioni pinze de freno - Illustrations Étriers de frein -
Ilustraciones pinzas de freno

24.3541-1807.5 240335 

24.3541-1808.5 240336 



AKE



Ø 54



HYUNDAI

ACCENT II (00-05)
GETZ (02-09)
LANTRA/ELANTRA (90-95)
PONY/EXCEL (89-94)
S-COUPE (90-96)

24.3541-1809.7 220613 

24.3541-1810.7 220614 



BOS



Ø 54



FIAT

BRAVO (07-)
STILO / STILO Multi Wagon (01-08)

24.3541-1811.5 240429 

24.3541-1812.5 240430 



BOS



Ø 54



FIAT

BRAVO (07-)
IDEA (04-12)
STILO / STILO Multi Wagon (01-08)

LANCIA

MUSA (04-12)

Abbildungen Bremssättel

Illustrations brake calipers - Illustrazioni pinze de freno - Illustrations Étriers de frein -
Ilustraciones pinzas de freno

24.3541-1813.5 240381 

24.3541-1814.5 240382 



TRW



Ø 54





HONDA

CIVIC (5-türig) (94-96)
CIVIC AERODECK (98-01)
CONCERTO (90-95)

ROVER

200 II-Serie (RF) (96-00)
200-Serie (XW) (90-95)
400-Serie (RT) (95-00)
400-Serie (XW) (90-95)
45-Serie (RT) (00-05)
STREETWISE (03-05)

24.3541-1815.5 240383 

24.3541-1816.5 240384 



SUM





Ø 54



MITSUBISHI

GALANT (4-türig) (87-92)
GALANT (5-türig) (88-92)
SANTAMO (99-04)
SPACE RUNNER (91-99)
SPACE WAGON (91-98)

24.3541-8085.5 240525 

24.3541-8086.5 240526 



ATE



Ø 54



OPEL

CALIBRA / Vauxhall Calibra (89-97)
VECTRA A / Vauxhall Cavalier (89-95)

SAAB

900 (94-98)

Abbildungen Bremssättel

Illustrations brake calipers - Illustrazioni pinze de freno - Illustrations Étriers de frein - Ilustraciones pinzas de freno

24.3541-8105.5 240485 
 24.3541-8106.5 240486 



FORD
 FOCUS I (98-04)

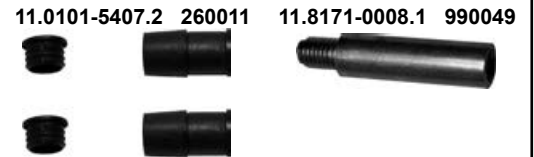

24.3541-8523.5 240551 
 24.3541-8524.5 240552 



AUDI
 A3 (96-03)
SEAT
 LEON I (1M1) (99-05)
 TOLEDO II (1M2) (98-04)
SKODA
 OCTAVIA I (1U) (97-10)

VOLKSWAGEN
 BORA (98-04)
 GOLF III (92-97)
 GOLF III Variant (93-99)
 GOLF IV (98-05)
 GOLF IV Variant (99-06)
 NEW BEETLE (98-10)
 NEW BEETLE Cabriolet (03-10)
 PASSAT (94-96)
 VENTO (92-98)



24.3541-8529.5 240553 
 24.3541-8530.5 240554 



FORD
 FIESTA III (89-96)
 FIESTA IV (96-02)
 PUMA (97-01)



Abbildungen Bremssättel

Illustrations brake calipers - Illustrazioni pinze de freno - Illustrations Étriers de frein - Ilustraciones pinzas de freno

24.3541-9587.5 240527 
 24.3541-9588.5 240528 





BMW

3er Reihe/E36 Limousine (90-98) 3er Reihe/E46 Touring (99-05)
 3er Reihe/E36 Touring (95-99) 3er Reihe/E46 Coupe (99-06)
 3er Reihe/E36 Coupe (92-99) 3er Reihe/E46 Cabrio (00-06)
 3er Reihe/E36 Cabrio (93-99) 3er Reihe/E46 Compact (01-05)
 3er Reihe/E36 Compact (94-00) Z3/E36 (95-02)
 3er Reihe/E46 Limousine (98-05) Z4 Roadster/E85 (03-08)

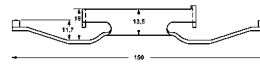

11.0441-5402.2 250028 11.0101-5402.2 260009 11.8171-0008.1 990049
 Dichtungssatz gasket set
 11.8116-0109.1 390495



24.3541-9667.5 240529 
 24.3541-9668.5 240530 



BMW

3er Reihe/E36 Limousine (90-98)
 3er Reihe/E36 Touring (95-99)
 3er Reihe/E36 Coupe (92-99)
 3er Reihe/E36 Cabrio (93-99)
 3er Reihe/E36 Compact (94-00)
 Z3 (95-02)



11.8116-0109.1 390495 11.0101-5402.2 260009 11.8171-0008.1 990049



11.8116-0206.1 390593

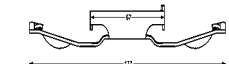

24.3571-1703.5 240099 
 24.3571-1704.5 240100 



MAZDA

626 (GE) (91-97)
 626 (GF) (97-02)
 MX-6 (91-97)
 XEDOS 6 (92-00)



24.0101-5701.2 260065



Abbildungen Bremssättel

Illustrations brake calipers - Illustrazioni pinze de freno - Illustrations Étriers de frein -
Ilustraciones pinzas de freno

24.3571-1705.5 240069 

24.3571-1706.5 240070 



TRW



Ø 57



OPEL

OMEGA A / Vauxhall Carlton (87-93)
OMEGA B / Vauxhall Omega (94-03)
SENATOR B / Vauxhall Royal (88-93)



24.0101-3401.2 260043



24.3571-1707.5 240079 

24.3571-1708.5 240080 



TRW



Ø 57



VOLVO

740 Limousine (83-92)
740 Kombi (85-92)



24.0101-3601.2 260044



VOLVO

940 I Limousine (90-95)
940 I Kombi (90-95)
940 II Limousine (95-98)
940 II Kombi (95-98)
960 I Limousine (90-94)
960 I Kombi (90-94)
960 II Limousine (94-96)
960 II Kombi (94-96)
S90 (97-98)
V90 (97-98)

24.3571-1709.5 240153 

24.3571-1710.5 240154 



TRW



Ø 57



CITROEN

EVASION (94-02)
JUMPY Kombi (95-06)
JUMPY Kasten (95-06)
JUMPY Pritsche/Fahrgestell (99-06)

FIAT

SCUDO (95-06)
ULYSSE (94-02)

LANCIA

ZETA (94-02)

PEUGEOT

806 (94-02)
EXPERT Kombi (95-06)
EXPERT Kasten (95-06)
EXPERT Pritsche/Fahrgestell (95-06)

Abbildungen Bremssättel

Illustrations brake calipers - Illustrazioni pinze de freno - Illustrations Étriers de frein -
Ilustraciones pinzas de freno

24.3571-1713.5 240201 

24.3571-1714.5 240202 





SUM



TOYOTA

CARINA E (92-97)
CELICA (93-99)

24.3571-1715.5 240225 

24.3571-1716.5 240226 





TRW



PEUGEOT

406 Limousine (95-04)
406 Kombi (96-04)
406 Coupe (97-05)

24.3571-1717.5 240227 

24.3571-1718.5 240228 



TRW



PEUGEOT

406 Limousine (95-04)
406 Kombi (96-04)

Abbildungen Bremssättel

Illustrations brake calipers - Illustrazioni pinze de freno - Illustrations Étriers de frein -
Ilustraciones pinzas de freno

24.3571-1719.5 240303 

24.3571-1720.5 240304 



ATE



ALFA ROMEO

166 (98-07)

LANCIA

KAPPA (95-01)

24.3571-1721.7 220555 

24.3571-1722.7 220556 



TRW



MERCEDES BENZ

C-Klasse (W203) Limousine (00-07)

C-Klasse (S203) Kombi (01-07)

C-Klasse (CL203) Sportcoupe (01-08)

C-Klasse (CLC203) Coupe (08-10)

CLK-Klasse (C209) Coupe (02-09)

CLK-Klasse (A209) Cabrio (03-09)

SLK-Klasse (R171) (04-11)

24.3571-1727.7 220601 

24.3571-1728.7 220602 



TRW





PEUGEOT

607 (00-10)

Abbildungen Bremssättel

Illustrations brake calipers - Illustrazioni pinze de freno - Illustrations Étriers de frein -
Ilustraciones pinzas de freno

24.3571-1731.5 240321 

24.3571-1732.5 240322 





TRW



NISSAN

ALMERA (N16) (00-06)
PRIMERA (P11E) Limousine (96-02)
PRIMERA (W11) Kombi (98-02)

24.3571-1735.5 240385 

24.3571-1736.5 240386 



BOS





FORD

MONDEO III (01-07)

JAGUAR

X-Type (CF1) Limousine (01-09)
X-Type (CF1) Kombi (03-09)

24.3571-1737.5 240387 

24.3571-1738.5 240388 



MITSUBISHI

L 200 (86-96)
L 300 (86-94)
L 300 (94-00) (Kabine und Chassis)

Abbildungen Bremssättel

Illustrations brake calipers - Illustrazioni pinze de freno - Illustrations Étriers de frein -
Ilustraciones pinzas de freno

24.3571-1739.7 220667 

24.3571-1740.7 220668 



TRW



Ø 57



MERCEDES BENZ

C-Klasse (W203) Limousine (00-07)
C-Klasse (S203) Kombi (01-07)
C-Klasse (CL203) Sportcoupe (01-08)
C-Klasse (CLC203) Coupe (08-10)
CLK-Klasse (C209) Coupe (02-09)
CLK-Klasse (A209) Cabrio (03-09)
SLK-Klasse (R171) (04-11)

24.3571-1743.7 220687 

24.3571-1744.7 220688 



TRW



Ø 57



MERCEDES BENZ

VANEO (BM414) (02-05)

24.3571-1745.7 220689 

24.3571-1746.7 220690 



TRW



Ø 57

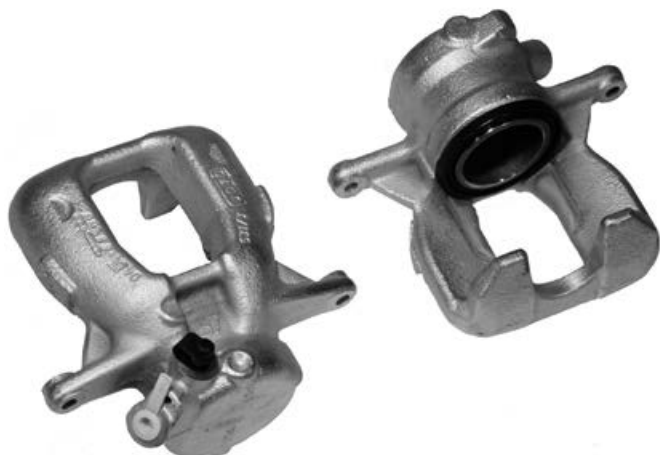

PEUGEOT

407 Limousine (04-11)

Abbildungen Bremssättel

Illustrations brake calipers - Illustrazioni pinze de freno - Illustrations Étriers de frein -
Ilustraciones pinzas de freno

24.3571-1747.7 220691 

24.3571-1748.7 220692 



MERCEDES BENZ

A-Klasse (W169) (04-11)
B-Klasse (W245) (05-11)

24.3571-8505.5 240489 

24.3571-8506.5 240490 

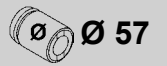

AUDI

100 (91-94)
100 Quattro (91-94)
A6 / A6 Avant (4A/C4) (94-97)



11.0441-5704.2 250034 11.0101-5409.2 260035 11.8171-0008.1 990049
Dichtungssatz - gasket set

11.8116-0143.1 390513

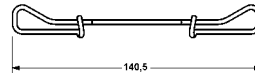

24.3571-8511.5 240491 

24.3571-8512.5 240492 



MERCEDES BENZ

C-Klasse (W202) Limousine (93-00)
C-Klasse (S202) Kombi (96-01)
CLK-Klasse (C208) Coupe (97-02)
CLK-Klasse (A208) Cabrio (98-03)
E-Klasse (W210) Limousine (95-02)
E-Klasse (S210) Kombi (96-03)
SLK-Klasse (R170) (96-04)



11.0441-5703.2 250145 11.0101-5407.2 260011 11.8171-0008.1 990049
Dichtungssatz gasket set

11.8116-0253.1 390512

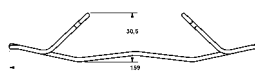

11.0230-0096.2 260033
Haltersatz - anchor set

Abbildungen Bremssättel

Illustrations brake calipers - Illustrazioni pinze de freno - Illustrations Étriers de frein -
 Ilustraciones pinzas de freno

24.3571-8518.2 240494 

24.3571-8517.2 240493 



AUDI

A4 (B5) (95-01)



11.0441-5704.2 250034
 Dichtungssatz - gasket set

11.8116-0143.1 390513

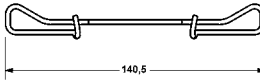



11.0101-5407.2 260011



11.8171-0008.1 990049



24.3571-8522.5 240496 

24.3571-8521.5 240495 



AUDI

A4 (B5) (95-01)
 A4 (B6/B7) (01-08)
 A4 Cabrio (02-08)
 A6 / A6 Avant (4B/C5) (97-05)

SEAT

EXEO / ST (09-13)

SKODA

SUPERB I (02-08)

VOLKSWAGEN

PASSAT (97-05)



11.0441-5704.2 250034
 Dichtungssatz - gasket set

11.8116-0143.1 390513

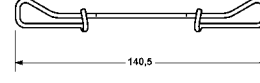

11.0101-5409.2 260035



11.8171-0008.1 990049



11.0230-0042.2 260027
 Haltersatz - anchor set

24.3571-9801.5 240497 

24.3571-9802.5 240498 



TOYOTA

AVENSIS (97-03)



11.0101-5407.2 260011





11.8171-0008.1 990049



Abbildungen Bremssättel

Illustrations brake calipers - Illustrazioni pinze de freno - Illustrations Étriers de frein -
Ilustraciones pinzas de freno

24.3571-9823.5 240499 

24.3571-9824.5 240500 



ATE



Ø 57



OPEL

ASTRA G (98-05)
Vauxhall Astra MKIV (98-04)
ASTRA H / GTC (04-10)
Vauxhall Astra Mk V (04-10)
ASTRA H Caravan (04-10)
Vauxhall Astra MKV Estate (04-10)
ASTRA TWIN TOP (06-10)



11.0441-5704.2 250034
Dichtungssatz gasket set

11.8116-0292.1 390521

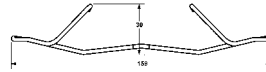

OPEL

COMBO / Vaux.Combo (01-11)
CORSA C (00-06)
Vauxhall Corsa MK II (00-06)
CORSA D (06-)
Vauxhall Corsa MK III (06-)
MERIVA A / Vaux. Meriva A (03-10)
MERIVA B (10-)
ZAFIRA I / Vauxhall Zafira I (99-05)
ZAFIRA II / Vauxhall Zafira II (05-11)

11.0101-5407.2 260011

11.8171-0008.1 990049



24.3571-9841.5 240501 

24.3571-9842.5 240502 



ATE



Ø 57



RENAULT

LAGUNA II Limousine (BG_) (01-07)
LAGUNA II Grandtour (KG_) (01-07)
SCENIC I (JA_) (99-03)





11.0101-5403.2 260010

11.0101-5407.2 260011

11.8171-0008.1 990049



24.3601-1601.5 240203 

24.3601-1602.5 240204 



TRW



Ø 60



VOLKSWAGEN

TRANSPORTER (Typ 2) (79-92)

Abbildungen Bremssättel

Illustrations brake calipers - Illustrazioni pinze de freno - Illustrations Étriers de frein -
Ilustraciones pinzas de freno

24.3601-1707.5 240229 

24.3601-1708.5 240230 



TRW





Ø 60



RENAULT

ESPACE III (JE_) (96-02)
LAGUNA I Limousine (B56/556_) (93-00)
LAGUNA I Grandtour (K56_) (95-00)
MEGANE I Coach (DA_) (95-03)
MEGANE I Cabrio (EA_) (96-03)
MEGANE SCENIC (JA_) (96-99)
SAFRANE (B54_) (92-00)

24.3601-1709.5 240275 

24.3601-1710.5 240276 



TRW



Ø 60



VOLKSWAGEN

TRANSPORTER (Typ 2) (79-92)

24.3601-1711.7 220607 

24.3601-1712.7 220608 



TRW



Ø 60



CITROEN

C8 (02-04)
JUMPY Kombi (95-06)
JUMPY Kasten (95-06)
JUMPY Pritsche/Fahrgestell(99-06)

FIAT

SCUDO (95-06)
ULYSSE (02-11)

LANCIA

PHEDRA (02-10)

PEUGEOT

807 (02-)
EXPERT Kombi (95-06)
EXPERT Kasten (95-06)
EXPERT Pritsche/Fahrgestell
(95-06)

Abbildungen Bremssättel

Illustrations brake calipers - Illustrazioni pinze de freno - Illustrations Étriers de frein -
 Ilustraciones pinzas de freno

24.3601-1717.5 240391 
 24.3601-1718.5 240392 

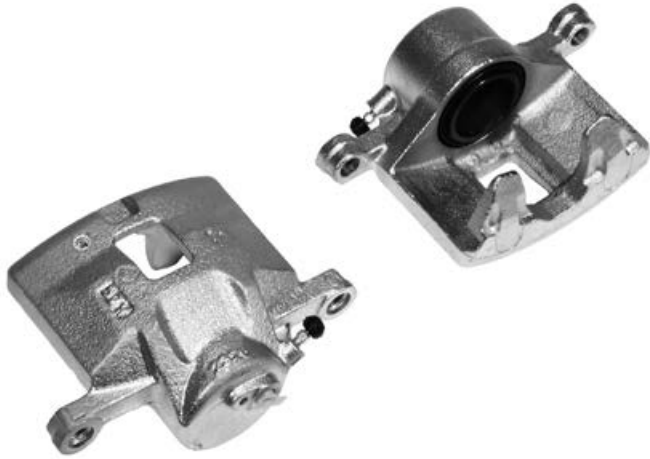

OPEL

FRONTERA A (92-98)
 FRONTERA B (98-04)
 MONTEREY (92-98)
 MONTEREY (98-99)

24.3601-8501.5 240533 
 24.3601-8502.5 240534 



BMW

5er Reihe/E34 (88-96)



11.0441-6003.2 250037
 Dichtungssatz - gasket set

11.8116-0083.1 390501

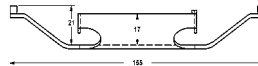

11.0101-5402.2 260009



11.8171-0008.1 990049



11.0230-0020.2 260023
 Haltersatz - anchor set

24.3601-8503.5 240535 
 24.3601-8504.5 240536 



BMW

5er Reihe/E34 (88-96)
 7er Reihe/E32 (86-94)



11.0441-6003.2 250037
 Dichtungssatz - gasket set

11.8116-0083.1 390501

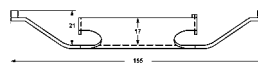

11.0101-5402.2 260009



11.8171-0008.1 990049



Abbildungen Bremssättel

Illustrations brake calipers - Illustrazioni pinze de freno - Illustrations Étriers de frein -
 Ilustraciones pinzas de freno

24.3601-8505.5 240537 
 24.3601-8506.5 240538 



BMW

5er Reihe/E34 (88-96)
 7er Reihe/E32 (86-94)



11.0441-6003.2 250037
 Dichtungssatz - gasket set

11.8116-0083.1 390501

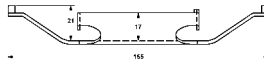

11.0101-5402.2 260009



11.8171-0008.1 990049



11.0230-0009.2 260018
 Haltersatz - anchor set

24.3601-8527.5 240503 
 24.3601-8528.5 240504 



FORD

COUGAR (98-00)
 MONDEO I (93-96)
 MONDEO II (96-00)
 SCORPIO / GRANADA (GB) (95-98)



11.0441-6005.2 250150
 Dichtungssatz - gasket set

11.8116-0118.1 390508

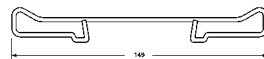

11.0101-5407.2 260011



11.8171-0008.1 990049



11.0230-0170.2 260078
 Haltersatz - anchor set

24.3601-9787.5 240505 
 24.3601-9788.5 240506 



RENAULT

ESPACE IV (JK_) (02-)
 LAGUNA II Limousine (BG_) (01-07)
 LAGUNA II Grandtour (KG_) (01-07)
 VEL SATIS (BJ0_) (02-09)



11.0101-5403.2 260010



11.0101-5407.2 260011





11.8171-0008.1 990049



Abbildungen Bremssättel

Illustrations brake calipers - Illustrazioni pinze de freno - Illustrations Étriers de frein -
 Ilustraciones pinzas de freno

24.3601-9829.5 240507 

24.3601-9830.5 240508 



ATE



Ø 60



VOLVO

S60 (00-09)
 S80 I (98-06)
 V70 II (00-07)
 XC70 I CROSS COUNTRY (00-07)



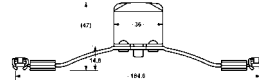

11.8116-0366.2 390587



11.0101-5407.2 260011 11.8171-0008.1 990049



24.3601-9947.5 240597 

24.3601-9948.5 240598 



ATE



Ø 60



VOLKSWAGEN

TOUAREG I (03-10)
 TRANSPORTER (T5) BUS / MULTIVAN / KASTEN (03-)
 TRANSPORTER (T5) PRITSCHEN / FAHRGESTELL (03-)
 TRANSPORTER (T6) (15-)



24.9235-0013.5 230001 

24.9235-0014.5 230002 



ATE



Ø 35



OPEL

ASTRA F (91-01)
 Vauxhall Astra MKIII (91-01)
 CALIBRA (89-97)
 Vauxhall Calibra (89-97)
 KADETT E / Vauxhall Astra E/Belmont (84-93)
 VECTRA A / Vauxhall Cavalier (89-95)

SAAB

900 (94-98)



13.0441-3506.2 250052

Dichtungssatz
 gasket set



Abbildungen Bremssättel

Illustrations brake calipers - Illustrazioni pinze de freno - Illustrations Étriers de frein -
Ilustraciones pinzas de freno

24.9235-0051.5 230003 

24.9235-0052.5 230004 



OPEL

VECTRA B / Vauxhall Vectra (96-02)



13.0441-3507.2 250053

Dichtungssatz
gasket set

24.9235-8005.5 230023 

24.9235-8006.5 230024 



MERCEDES BENZ

(W124) E-Klasse (85-93)
(W201) 190-190 E 2,6 (82-93)
C-Klasse (W202) Limousine (93-00)
E-Klasse (W124) Limousine (93-95)
E-Klasse (C124) Coupe (93-97)



13.0441-3505.2 250051

Dichtungssatz
gasket set

24.9236-0001.5 230005 

24.9236-0002.5 230006 





VOLVO

740 Limousine (83-92)
740 Kombi (85-92)
760 Limousine (82-92)
760 Kombi (82-92)

Abbildungen Bremssättel

Illustrations brake calipers - Illustrazioni pinze de freno - Illustrations Étriers de frein -
Ilustraciones pinzas de freno

24.9236-8001.5 230007 

24.9236-8002.5 230008 



ATE



MERCEDES BENZ

C-Klasse (W202) Limousine (93-00)
CLK-Klasse (C208) Coupe (97-02)
CLK-Klasse (A208) Cabrio (98-03)
E-Klasse (W210) Limousine (95-02)
SL-Klasse (R129) (93-01)



13.0441-3606.2 250147

Dichtungssatz
gasket set

24.9238-0087.5 230035 

24.9238-0088.5 230036 



ATE



VOLVO

740 Limousine (83-92)
740 Kombi (85-92)
760 Limousine (82-92)
760 Kombi (82-92)





13.0441-3819.2 250072

Dichtungssatz
gasket set

VOLVO

940 I Limousine (90-95)
940 I Kombi (90-95)
940 II Limousine (95-98)
940 II Kombi (95-98)
960 I Limousine (90-94)
960 I Kombi (90-94)

24.9238-0097.5 230037 

24.9238-0098.5 230038 



ATE





VOLVO

850 Limousine (91-96)
850 Kombi (92-96)
C70 Coupe (97-02)
C70 I Cabrio (98-06)
S70 (97-00)
V70 I (97-00)

Abbildungen Bremssättel

Illustrations brake calipers - Illustrazioni pinze de freno - Illustrations Étriers de frein -
Ilustraciones pinzas de freno

24.9238-8033.5 230015 

24.9238-8034.5 230016 



MERCEDES BENZ

(W124) E-Klasse (85-93)
C-Klasse (W202) Limousine (93-00)
E-Klasse (W124) Limousine (93-95)
SL-Klasse (R129) (93-01)



13.0441-3817.2 250071

Dichtungssatz
gasket set

24.9238-8035.5 230025 

24.9238-8036.5 230026 



MERCEDES BENZ

(R129) SL-Klasse (89-93)
(W124) E-Klasse (85-93)
(W201) 190-190 E 2,6 (82-93)
C-Klasse (W202) Limousine (93-00)
C-Klasse (S202) Kombi (96-01)
E-Klasse (W124) Limousine (93-95)
E-Klasse (S124) Kombi (93-96)





13.0441-3817.2 250071

Dichtungssatz
gasket set

MERCEDES BENZ

E-Klasse (A124) Cabrio (93-98)
SL-Klasse (R129) (93-01)
SLK-Klasse (R170) (96-04)

24.9240-0027.5 230017 

24.9240-0028.5 230018 



VOLVO

740 Limousine (83-92)
740 Kombi (85-92)
760 Limousine (82-92)
760 Kombi (82-92)

VOLVO

940 I Limousine (90-95)
940 I Kombi (90-95)
940 II Limousine (95-98)
940 II Kombi (95-98)
960 I Limousine (90-94)
960 I Kombi (90-94)
960 II Limousine (94-96)
960 II Kombi (94-96)

Abbildungen Bremssättel

Illustrations brake calipers - Illustrazioni pinze de freno - Illustrations Étriers de frein -
Ilustraciones pinzas de freno

24.9240-0039.5 230055 

24.9240-0040.5 230056 



OPEL

OMEGA B / Vauxhall Omega (94-03)



13.0441-4022.2 250149

Dichtungssatz
gasket set

24.9240-8013.5 230019 

24.9240-8014.5 230020 



MERCEDES BENZ

E-Klasse (S210) Kombi (96-03)

S-Klasse (W140) (91-93)

S-Klasse (W140) (93-98)



13.0441-4020.2 250084

Dichtungssatz
gasket set

24.9242-8005.5 230027 

24.9242-8006.5 230028 



BMW

2,5/2,8/3,0/3,3 (68-77)

5er Reihe/E12 (72-81)



13.0441-4205.2 250086

Dichtungssatz
gasket set

Abbildungen Bremssättel

Illustrations brake calipers - Illustrazioni pinze de freno - Illustrations Étriers de frein -
Ilustraciones pinzas de freno

24.9242-8007.5 230029 

24.9242-8008.5 230030 



ATE



Ø 42



BMW

2,5/2,8/3,0/3,3 (68-77)

6er Reihe/E24 (76-89)



13.0441-4205.2 250086

Dichtungssatz
gasket set

24.9242-8021.5 230031 

24.9242-8022.5 230032 



ATE



Ø 42



MERCEDES BENZ

(W123) 200-300 TD Turbo (76-85)



13.0441-4206.2 250087

Dichtungssatz
gasket set

24.9246-8001.5 230021 

24.9246-8002.5 230022 



ATE



Ø 46



MERCEDES BENZ

CL-Klasse (C140) Coupe (96-99)

E-Klasse (S210) Kombi (96-03)

S-Klasse (W140) (91-93)

S-Klasse (W140) (93-98)

S-Klasse (W220) (98-06)





13.0441-4601.2 250099

Dichtungssatz
gasket set

Abbildungen Bremssättel

Illustrations brake calipers - Illustrazioni pinze de freno - Illustrations Étriers de frein -
Ilustraciones pinzas de freno

24.9257-8027.5 230039 

24.9257-8028.5 230040 



ATE



Ø 57



VOLKSWAGEN

LT/- 4x4 (75-96)



13.0441-5720.2 250122

Dichtungssatz
gasket set

24.9260-8025.5 230041 

24.9260-8026.5 230042 



ATE



Ø 60



MERCEDES BENZ

(W116) 280 S-450 SEL 6,9 (72-80)



13.0441-6001.2 250126

Dichtungssatz
gasket set

24.9260-8029.5 230043 

24.9260-8030.5 230044 



ATE



Ø 60



MERCEDES BENZ

(W123) 200-300 TD Turbo (76-85)





13.0441-6003.2 250128

Dichtungssatz
gasket set

Abbildungen Bremssättel

Illustrations brake calipers - Illustrazioni pinze de freno - Illustrations Étriers de frein -
Ilustraciones pinzas de freno

24.9260-8031.5 230045 

24.9260-8032.5 230046 



MERCEDES BENZ

(W126) 260 SE-560 SEC (80-91)



13.0441-6003.2 250128

Dichtungssatz
gasket set

24.9440-8027.5 230051 

24.9440-8028.5 230052 



MERCEDES BENZ

(R107) 280 SL-560 SL (71-89)



13.0441-4016.2 250081

Dichtungssatz
gasket set

24.9442-8003.5 230053 

24.9442-8004.5 230054 

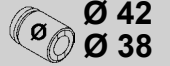

MERCEDES BENZ

(R129) SL-Klasse (89-93)
(W124) E-Klasse (85-93)
(W201) 190-190 E 2,6 (82-93)
E-Klasse (W124) Limousine (93-95)
SL-Klasse (R129) (93-01)



13.0441-4214.2 250091

Dichtungssatz
gasket set



- D** Abbildungen Bremsschläuche
- EN** Illustrations brake hoses
- FR** Illustrations flexibles de frein
- IT** Illustrazioni flessibile freno
- ES** Ilustraciones tubos flexible de freno
- NL** Afbeeldingen remslangen
- DA** Tegning bremseslange
- SV** Avbildningar bromsslang
- HU** Ábrák féktömlő
- PT** Figuras tubos de travão
- RU** Изображение Тормозной шланг
- CZ** hadice brzdy
- PL** Rysunki Przewód hamulcowy giętki
- EL** Εικόνες Εύκαμπτος σωλήνας φρένου
- TR** Fren hortumu resimleri
- ZH** 制动器软管图
- JA** 図：ブレーキホース
- AR** خرطوم المكبح لالكشأ

K24-H

Abbildungen Bremsschläuche, Kupplungsschläuche

Illustrations brake hoses, clutch hoses - Illustrations fessibilli freno, fessibilli frizione - Illustrations Flexible de frein, Flexibles d'embrayages - Ilustraciones flexibles de freno, flexibles d'embrague

24.1253-0010.3 331066

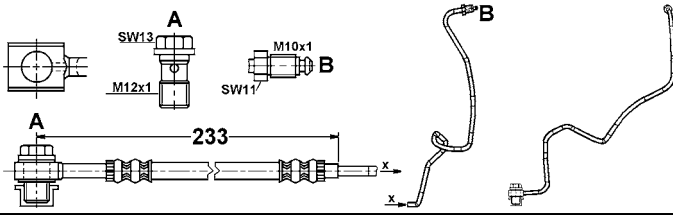

24.1253-0020.3 331067

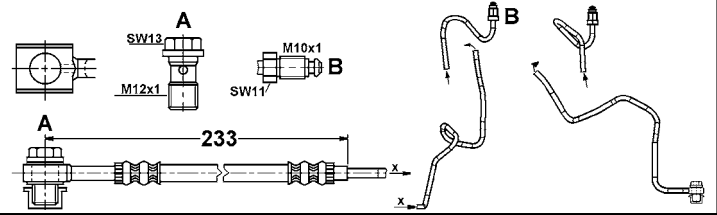

24.1253-0030.3 331126

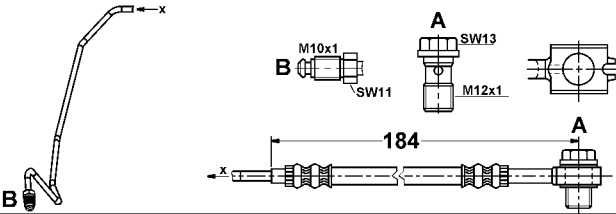

24.1253-0040.3 331127

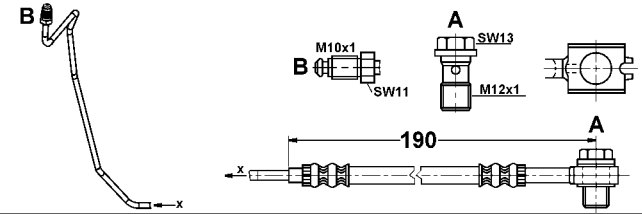

24.1253-0050.3 331148

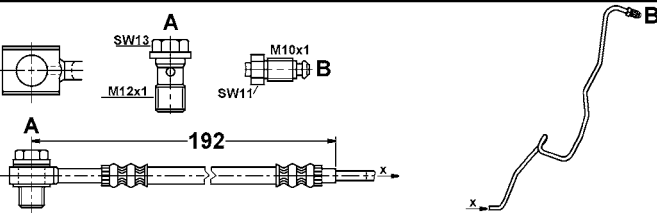

24.1253-0060.3 331149

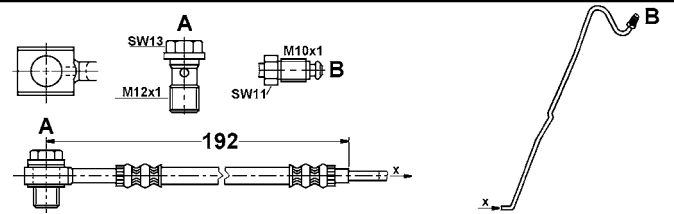

24.1294-0010.3 331253

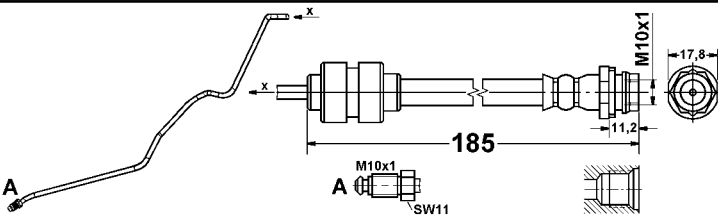

24.1294-0011.3 331254

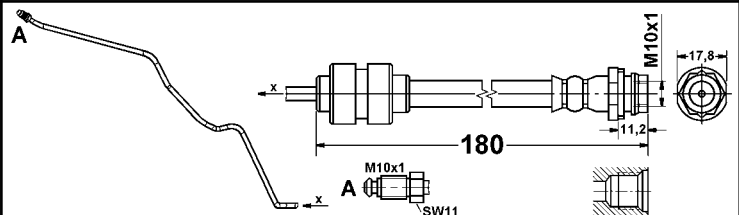

24.1294-0014.3 331448

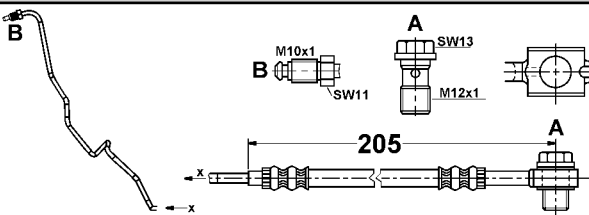

24.1294-0015.3 331449

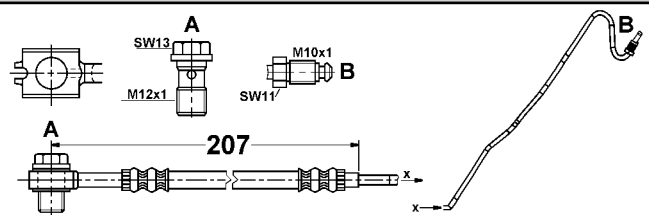

24.5101-0346.3 331406

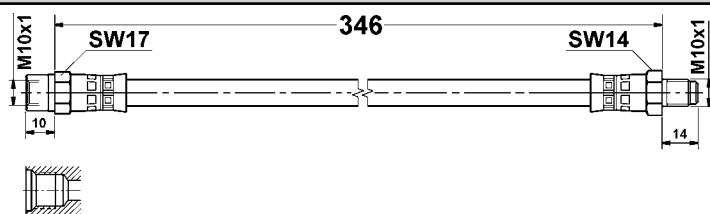

24.5102-0304.3 331407

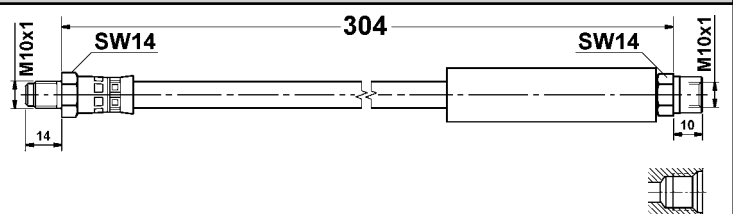

24.5103-0430.3 331408

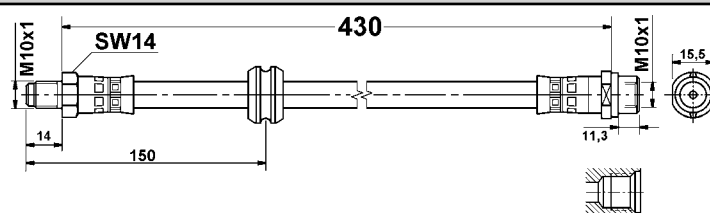

24.5105-0139.3 331216



Abbildungen Bremsschläuche, Kupplungsschläuche

Illustrations brake hoses, clutch hoses - Illustrations fessibilli freno, fessibilli frizione - Illustrations Flexible de frein, Flexibles d'embrayages - Ilustraciones flexibles de freno, flexibles d'embrague

24.5105-0442.3 331432

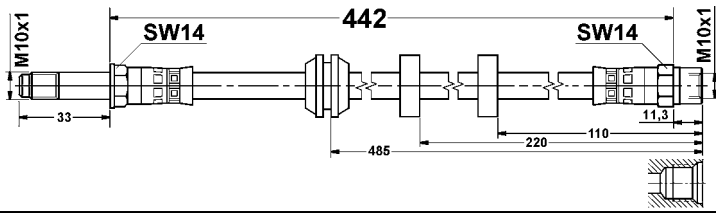

24.5108-0266.3 330038

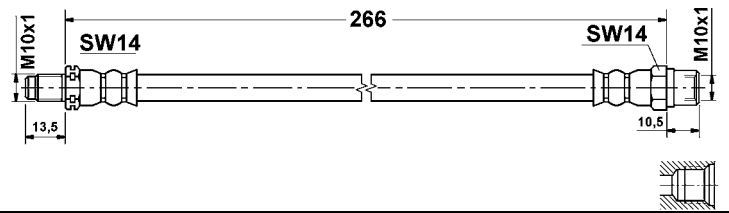

24.5110-0155.3 330040

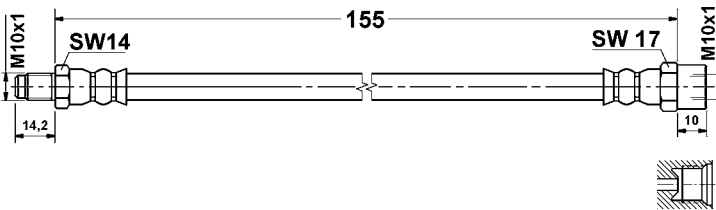

24.5111-0150.3 330497

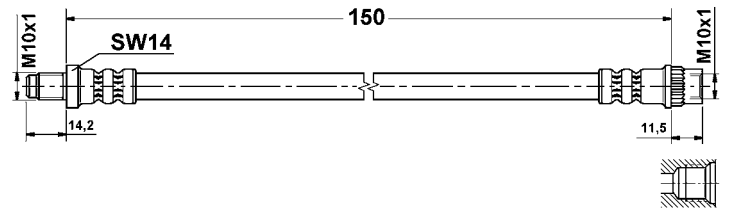

24.5111-0201.3 330498

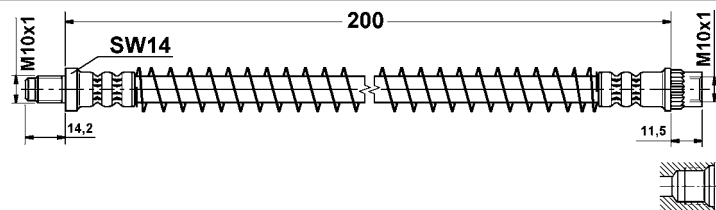

24.5111-0221.3 330818

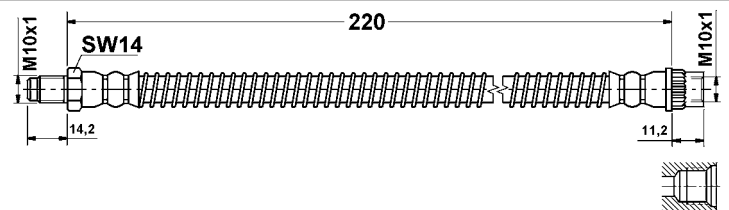

24.5111-0235.3 330477

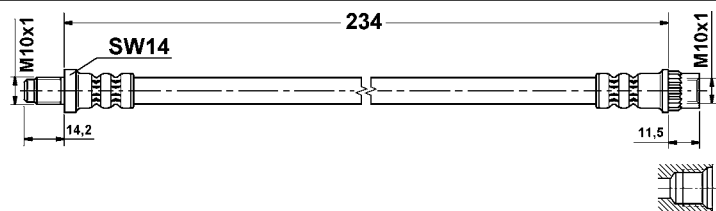

24.5111-0241.3 330680

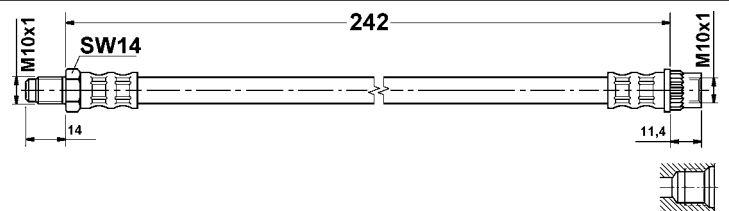

24.5111-0260.3 330408

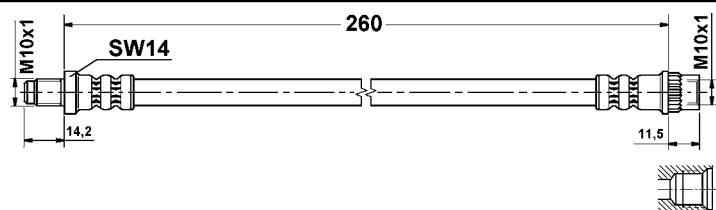

24.5111-0280.3 330389

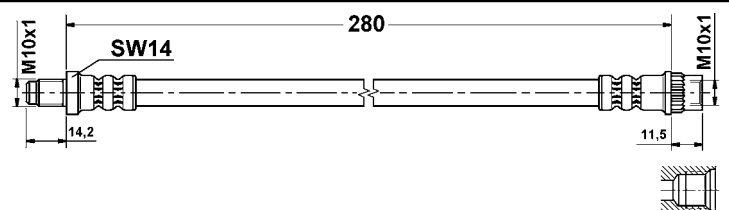

24.5111-0285.3 330608

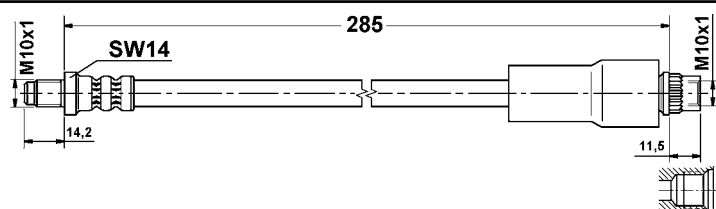

24.5111-0290.3 330108

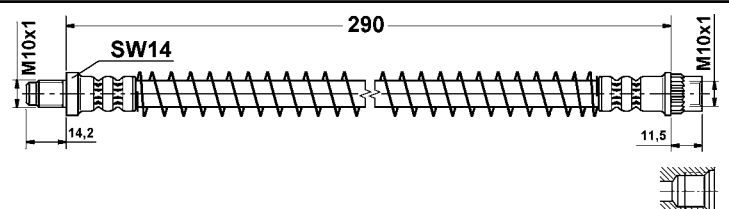

24.5111-0300.3 330407

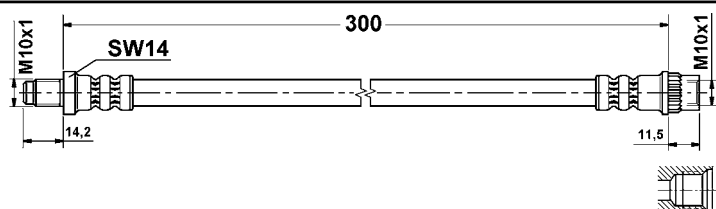

24.5111-0301.3 330499

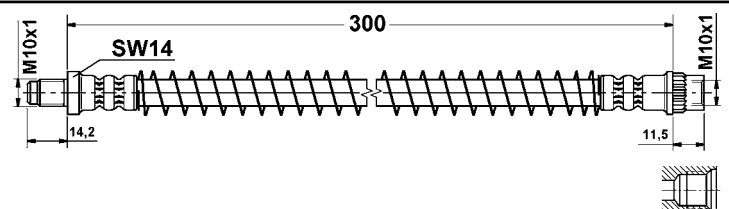

Abbildungen Bremsschläuche, Kupplungsschläuche

Illustrations brake hoses, clutch hoses - Illustrations fessibilli freno, fessibilli frizione - Illustrations Flexible de frein, Flexibles d'embrayages - Ilustraciones flexibles de freno, flexibles d'embrague

<p>24.5111-0306.3 330596</p>	<p>24.5111-0310.3 331393</p>
<p>24.5111-0317.3 330501</p>	<p>24.5111-0320.3 330487</p>
<p>24.5111-0321.3 330597</p>	<p>24.5111-0326.3 330766</p>
<p>24.5111-0330.3 330160</p>	<p>24.5111-0335.3 330778</p>
<p>24.5111-0336.3 330570</p>	<p>24.5111-0345.3 330406</p>
<p>24.5111-0355.3 330757</p> <p>NUR FÜR MINERALÖL ONLY FOR MINERAL OIL</p>	<p>24.5111-0375.3 331128</p>
<p>24.5111-0386.3 330503</p>	<p>24.5111-0390.3 330566</p>

Abbildungen Bremsschläuche, Kupplungsschläuche

Illustrations brake hoses, clutch hoses - Illustrations fessibilli freno, fessibilli frizione - Illustrations Flexible de frein, Flexibles d'embrayages - Ilustraciones flexibles de freno, flexibles d'embrague

24.5111-0396.3 330609

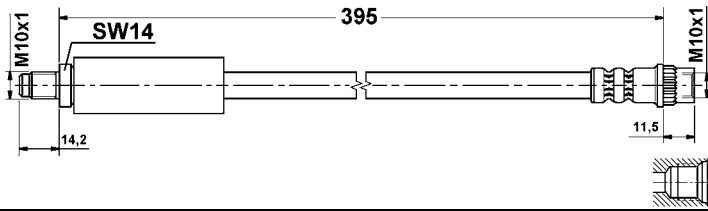

24.5111-0405.3 330410

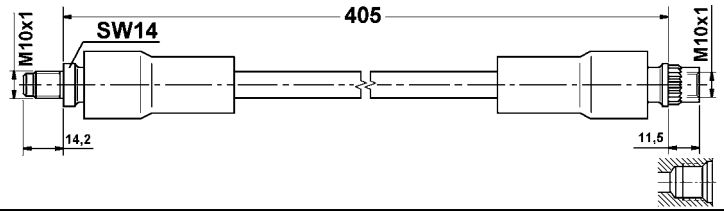

24.5111-0411.3 331394

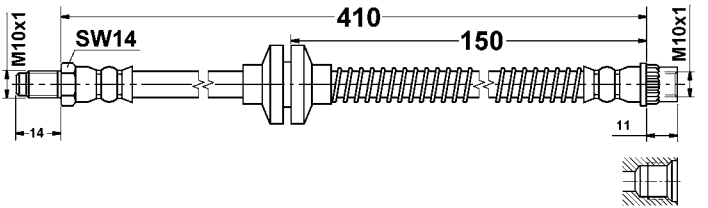

24.5111-0420.3 330682

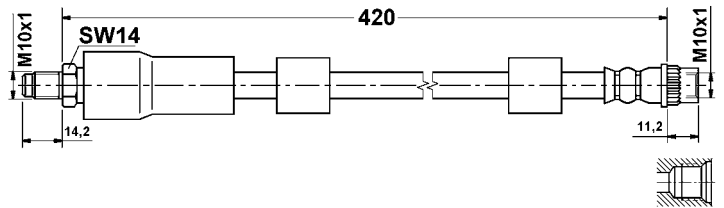

24.5111-0424.3 331014

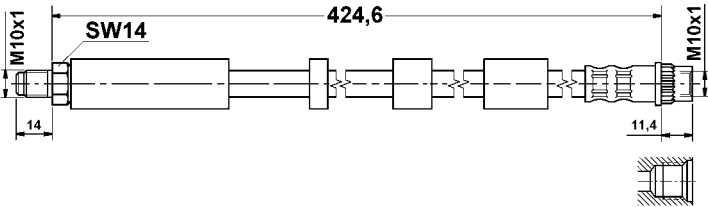

24.5111-0425.3 330278

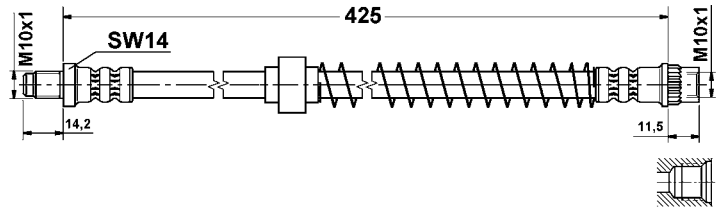

24.5111-0426.3 331347

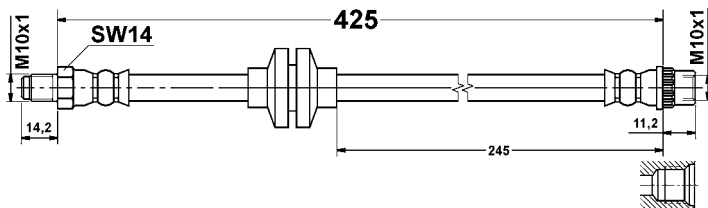

24.5111-0429.3 331015

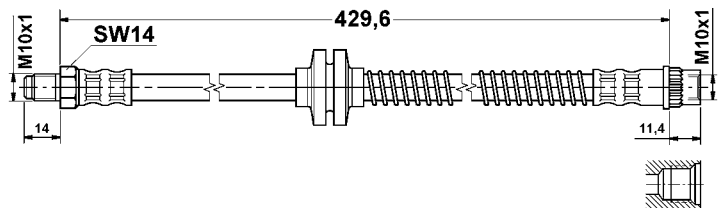

24.5111-0438.3 330568

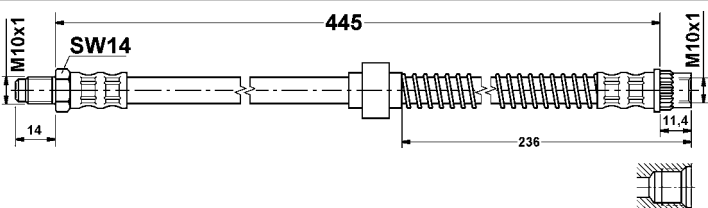

24.5111-0445.3 330504

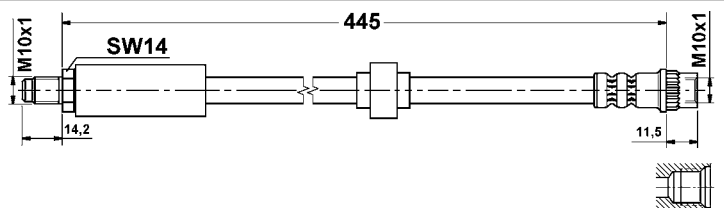

24.5111-0446.3 331055

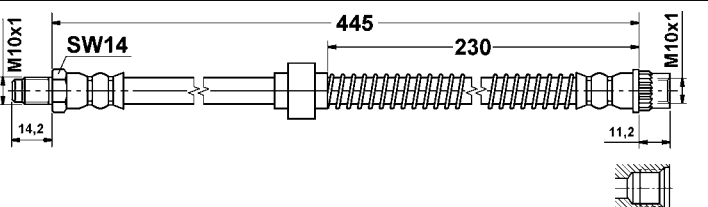

24.5111-0455.3 330914

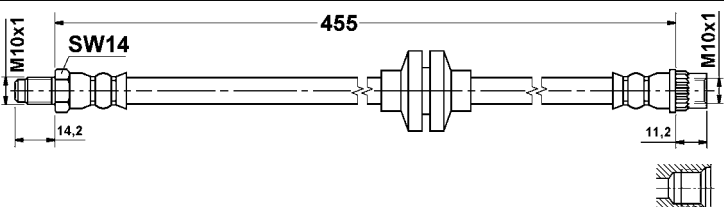

24.5111-0460.3 330603

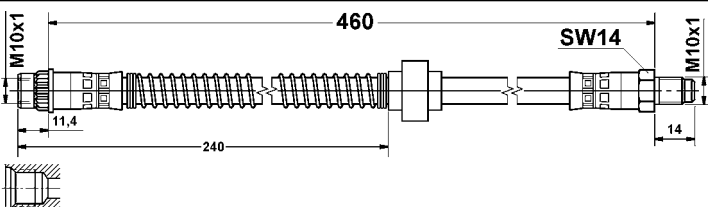

24.5111-0462.3 330555

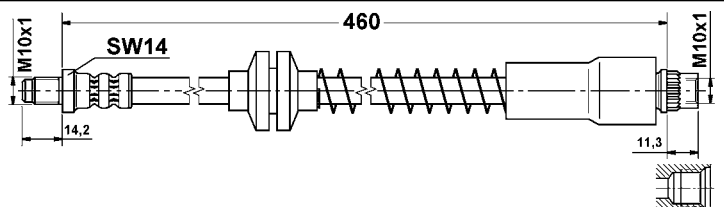

Abbildungen Bremsschläuche, Kupplungsschläuche

Illustrations brake hoses, clutch hoses - Illustrations fessibili freno, fessibili frizione - Illustrations Flexible de frein, Flexibles d'embrayages - Ilustraciones flexibles de freno, flexibles d'embrague

<p>24.5111-0485.3 331370</p>	<p>24.5111-0490.3 330598</p>
<p>24.5111-0495.3 330505</p>	<p>24.5111-0496.3 331371</p>
<p>24.5111-0510.3 330819</p>	<p>24.5111-0520.3 330506</p>
<p>24.5111-0535.3 330684</p>	<p>24.5111-0550.3 330665</p>
<p>24.5111-0595.3 331495</p>	<p>24.5112-0142.3 331016</p>
<p>24.5112-0155.3 330507</p>	<p>24.5112-0160.3 330612</p>
<p>24.5112-0185.3 330654</p>	<p>24.5112-0187.3 331150</p>

Abbildungen Bremsschläuche, Kupplungsschläuche

Illustrations brake hoses, clutch hoses - Illustrations fessibilli freno, fessibilli frizione - Illustrations Flexible de frein, Flexibles d'embrayages - Ilustraciones flexibles de freno, flexibles d'embrague

24.5112-0220.3 330613

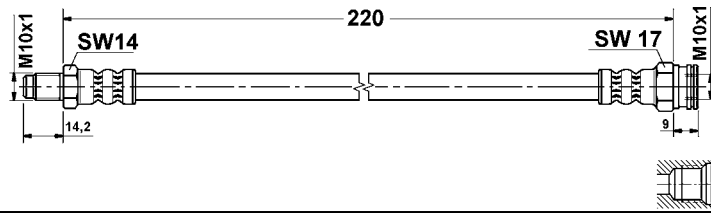

24.5112-0230.3 330508

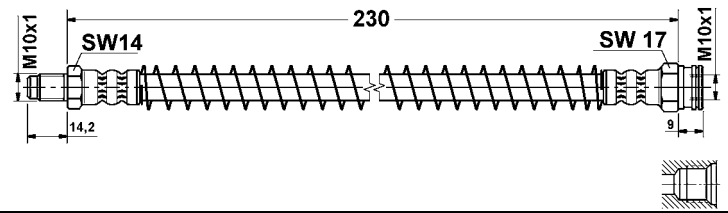

24.5112-0260.3 330577

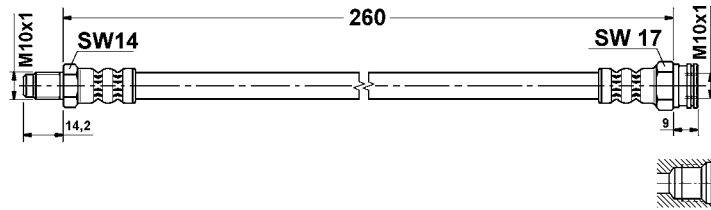

24.5112-0280.3 331200

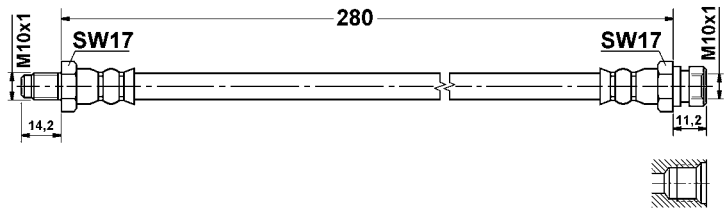

24.5112-0285.3 330604

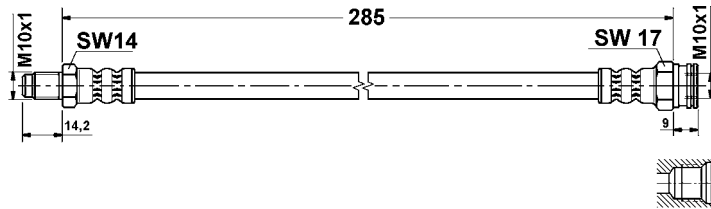

24.5112-0295.3 330907

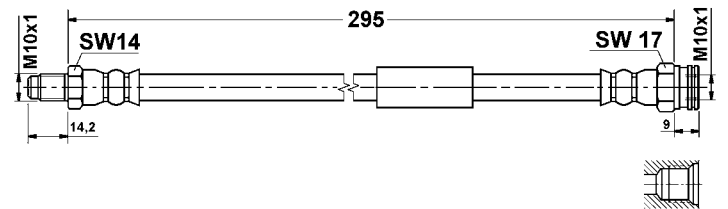

24.5112-0300.3 330696

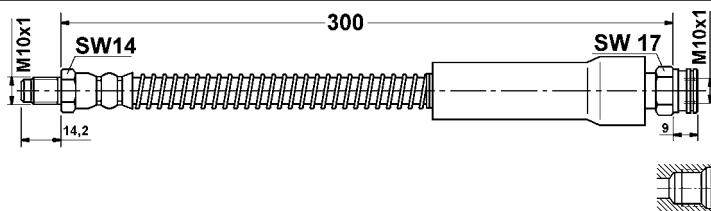

24.5112-0315.3 330509

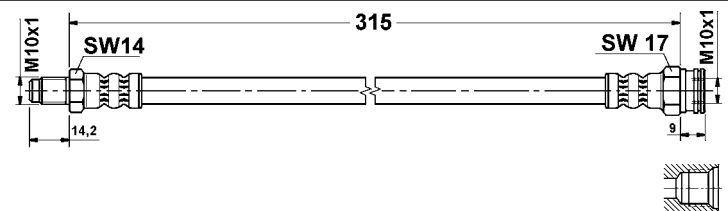

24.5112-0325.3 330415

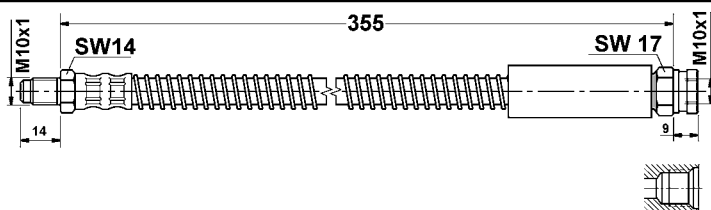

24.5112-0327.3 330417

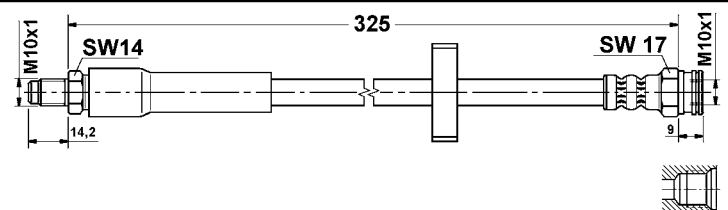

24.5112-0339.3 330771

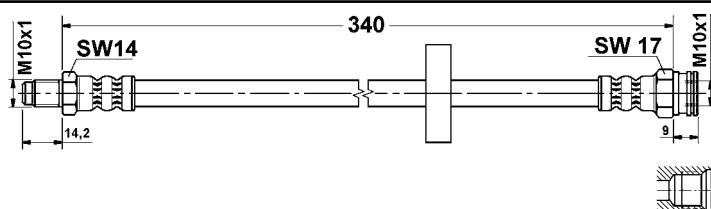

24.5112-0340.3 330511

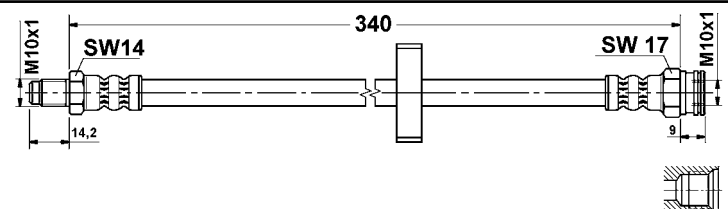

24.5112-0341.3 330655

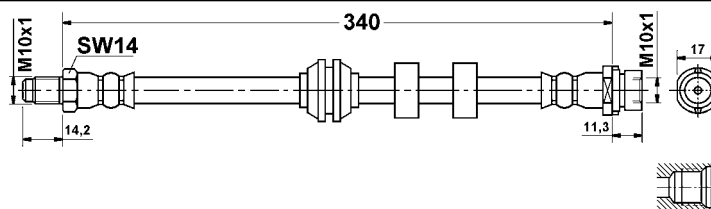

24.5112-0355.3 330758

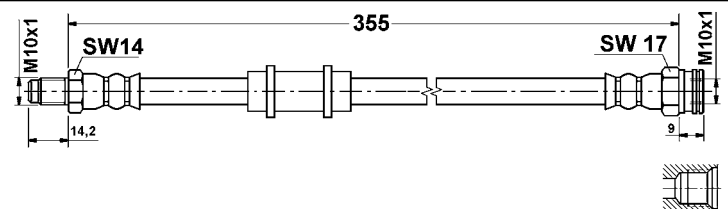

Abbildungen Bremsschläuche, Kupplungsschläuche

Illustrations brake hoses, clutch hoses - Illustrations fessibili freno, fessibili frizione - Illustrations Flexible de frein, Flexibles d'embrayages - Ilustraciones flexibles de freno, flexibles d'embrague

<p>24.5112-0356.3 331129</p>	<p>24.5112-0360.3 330513</p>
<p>24.5112-0361.3 330649</p>	<p>24.5112-0362.3 330512</p>
<p>24.5112-0370.3 330515</p>	<p>24.5112-0376.3 330514</p>
<p>24.5112-0381.3 330711</p>	<p>24.5112-0384.3 330651</p>
<p>24.5112-0385.3 330392</p>	<p>24.5112-0386.3 330516</p>
<p>24.5112-0387.3 330519</p>	<p>24.5112-0388.3 330518</p>
<p>24.5112-0390.3 330517</p>	<p>24.5112-0395.3 330521</p>

Abbildungen Bremsschläuche, Kupplungsschläuche

Illustrations brake hoses, clutch hoses - Illustrations fessibilli freno, fessibilli frizione - Illustrations Flexible de frein, Flexibles d'embrayages - Ilustraciones flexibles de freno, flexibles d'embrague

24.5112-0396.3 330520

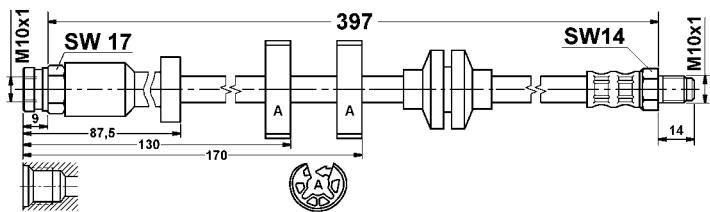

24.5112-0397.3 330666

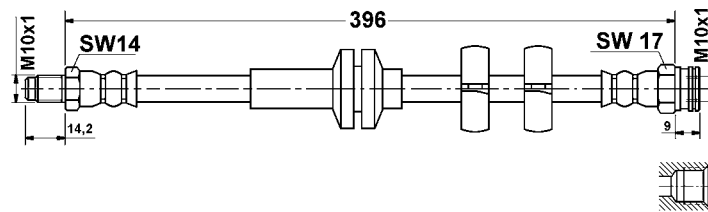

24.5112-0402.3 331297

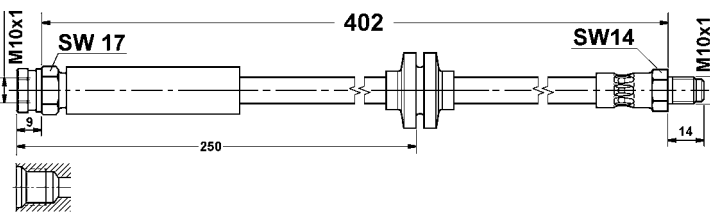

24.5112-0405.3 330428

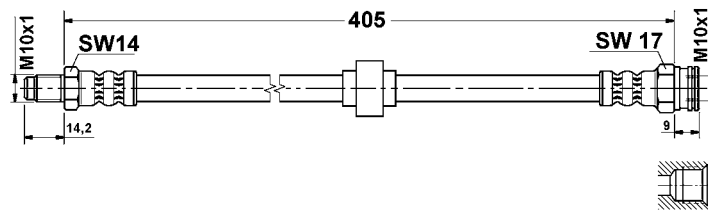

24.5112-0406.3 331496

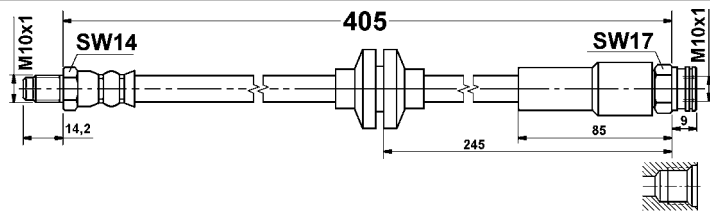

24.5112-0408.3 330667

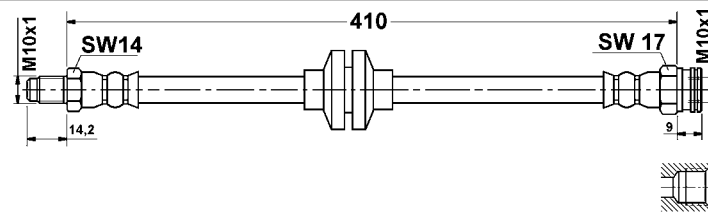

24.5112-0410.3 330494

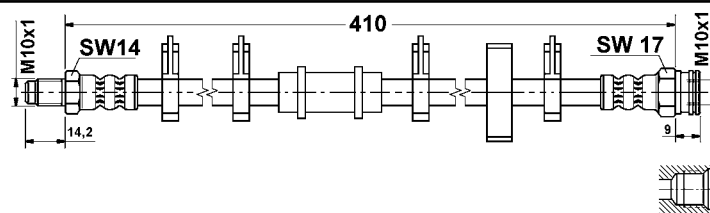

24.5112-0412.3 330569

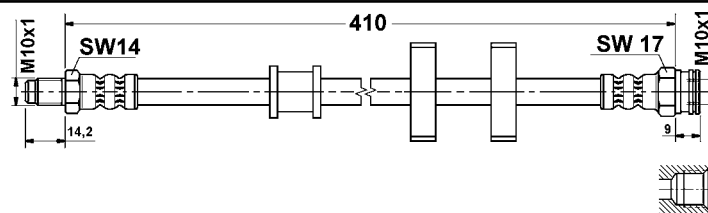

24.5112-0413.3 331151

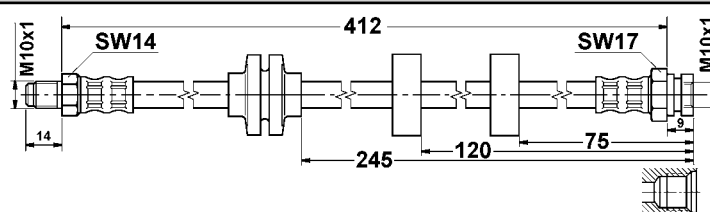

24.5112-0414.3 331453

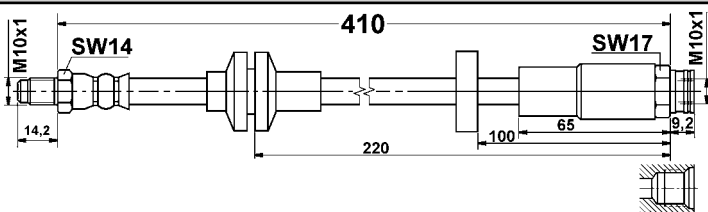

24.5112-0417.3 331298

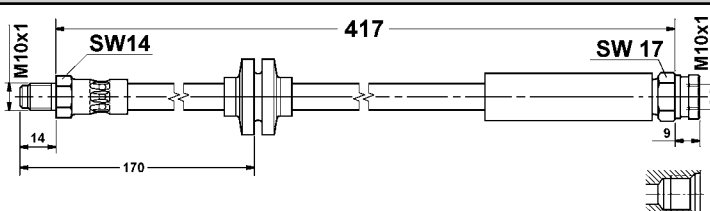

24.5112-0430.3 330615

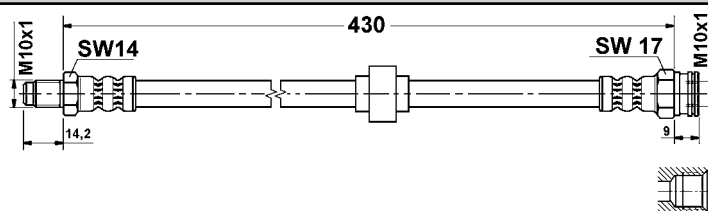

24.5112-0433.3 330522

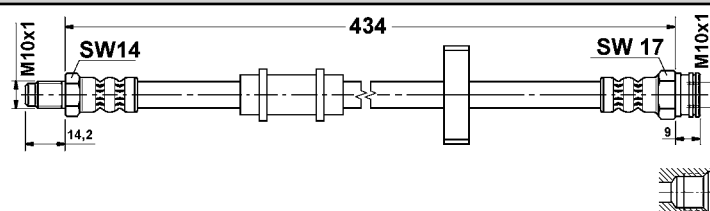

24.5112-0435.3 330524

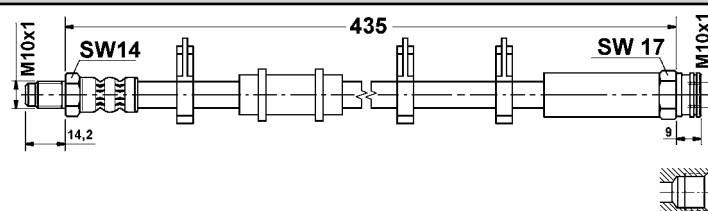

Abbildungen Bremsschläuche, Kupplungsschläuche

Illustrations brake hoses, clutch hoses - Illustrations fessibili freno, fessibili frizione - Illustrations Flexible de frein, Flexibles d'embrayages - Ilustraciones flexibles de freno, flexibles d'embrague

<p>24.5112-0436.3 330574</p>	<p>24.5112-0437.3 330886</p>
<p>24.5112-0440.3 330887</p>	<p>24.5112-0445.3 330564</p>
<p>24.5112-0454.3 331360</p>	<p>24.5112-0455.3 330527</p>
<p>24.5112-0456.3 330875</p>	<p>24.5112-0460.3 330599</p>
<p>24.5112-0461.3 330616</p>	<p>24.5112-0465.3 330526</p>
<p>24.5112-0466.3 330579</p>	<p>24.5112-0470.3 331460</p>
<p>24.5112-0475.3 330698</p>	<p>24.5112-0477.3 331299</p>

Abbildungen Bremsschläuche, Kupplungsschläuche

Illustrations brake hoses, clutch hoses - Illustrations fessibilli freno, fessibilli frizione - Illustrations Flexible de frein, Flexibles d'embrayages - Ilustraciones flexibles de freno, flexibles d'embrague

24.5112-0490.3 330876

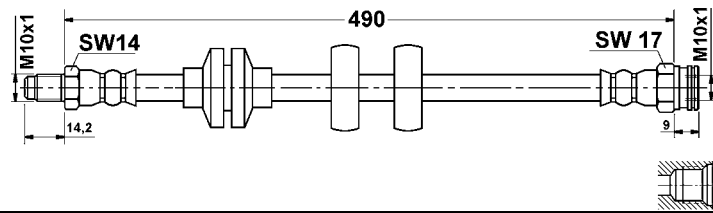

24.5112-0492.3 331217

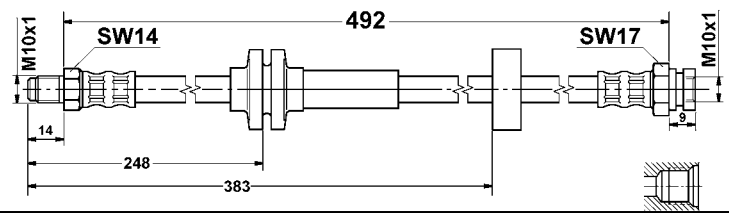

24.5113-0209.3 331300

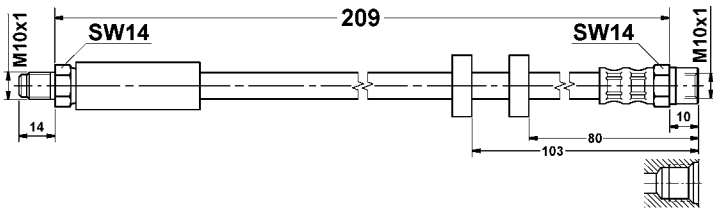

24.5113-0220.3 331318

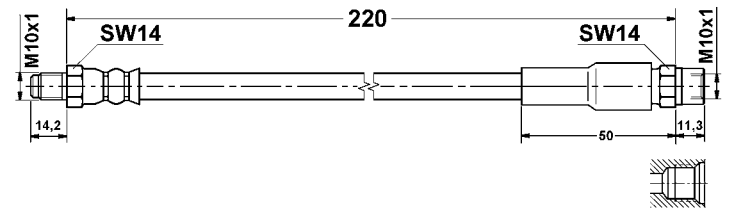

24.5113-0275.3 330653

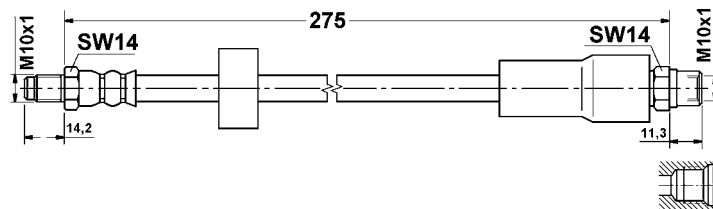

24.5113-0280.3 330393

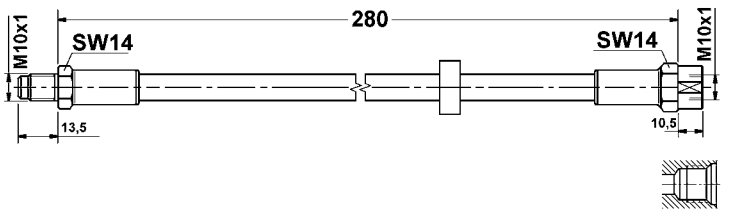

24.5113-0283.3 331395

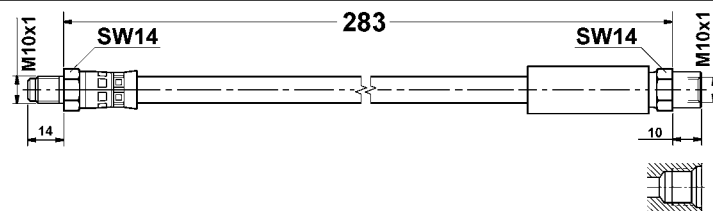

24.5113-0380.3 331344

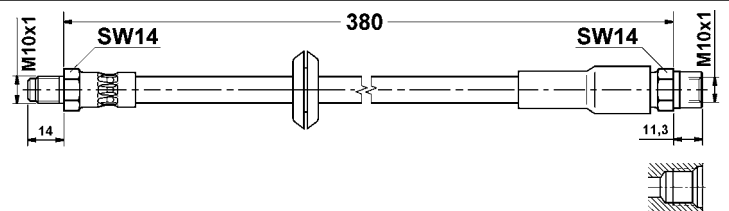

24.5113-0423.3 331396

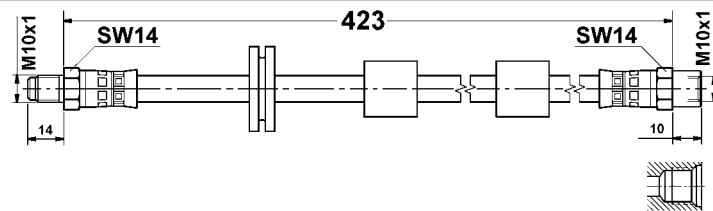

24.5113-0440.3 331239

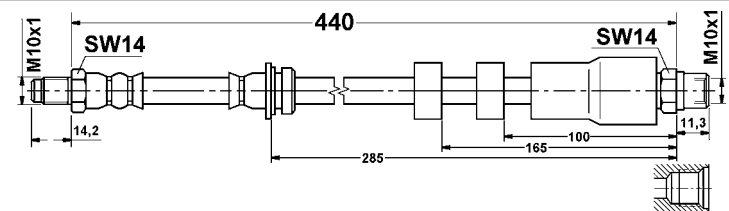

24.5113-0483.3 331397

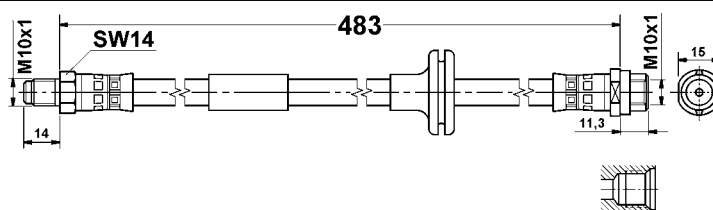

24.5113-0515.3 330668

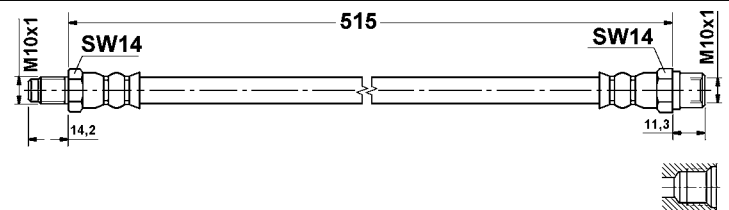

24.5113-0540.3 331301

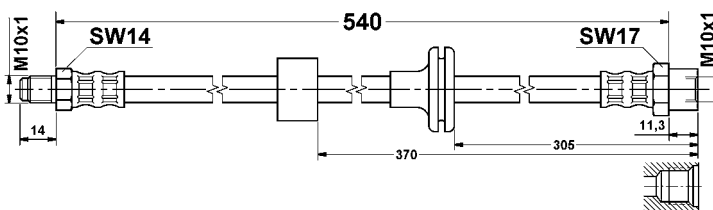

24.5115-0400.3 330413

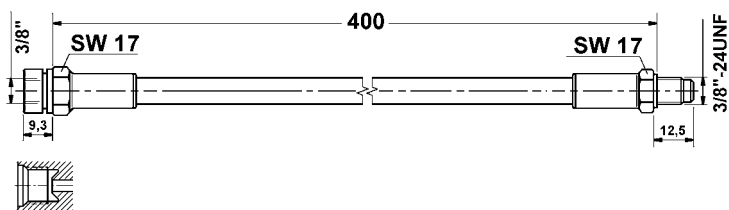

Abbildungen Bremsschläuche, Kupplungsschläuche

Illustrations brake hoses, clutch hoses - Illustrations fessibilli freno, fessibilli frizione - Illustrations Flexible de frein, Flexibles d'embrayages - Ilustraciones flexibles de freno, flexibles d'embrague

<p>24.5117-0195.3 330565</p>	<p>24.5117-0205.3 330669</p>
<p>24.5118-0420.3 330444</p>	<p>24.5118-0470.3 330462</p>
<p>24.5118-0471.3 330528</p>	<p>24.5118-0520.3 330600</p>
<p>24.5118-0688.3 331419</p>	<p>24.5119-0435.3 330472</p>
<p>24.5119-0447.3 330990</p>	<p>24.5119-0477.3 330991</p>
<p>24.5120-0435.3 330488</p>	<p>24.5122-0460.3 330493</p>
<p>24.5123-0240.3 330759</p>	<p>24.5123-0281.3 330877</p>

Abbildungen Bremsschläuche, Kupplungsschläuche

Illustrations brake hoses, clutch hoses - Illustrations fessibilli freno, fessibilli frizione - Illustrations Flexible de frein, Flexibles d'embrayages - Ilustraciones flexibles de freno, flexibles d'embrague

24.5123-0295.3 330820

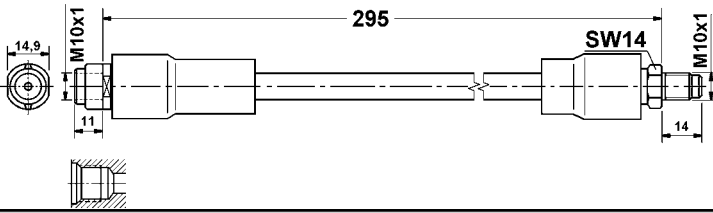

24.5123-0328.3 330910

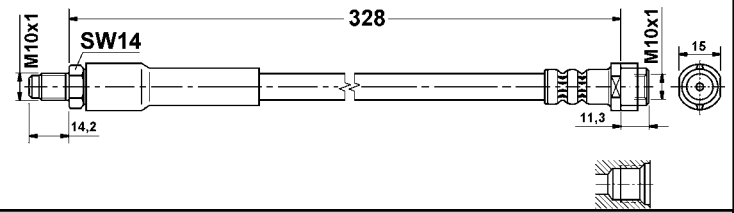

24.5123-0350.3 330963

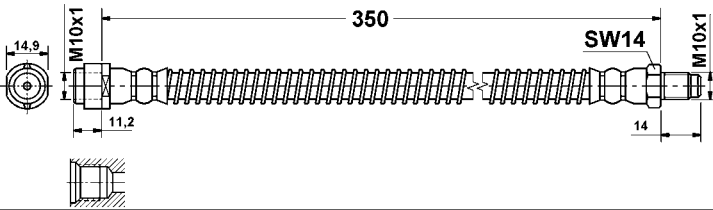

24.5123-0380.3 331256

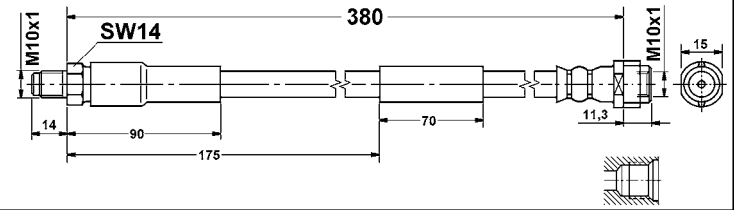

24.5123-0545.3 331240

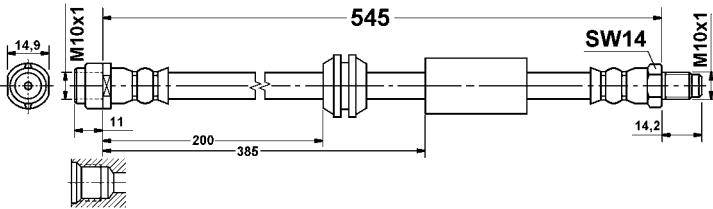

24.5123-0610.3 331241

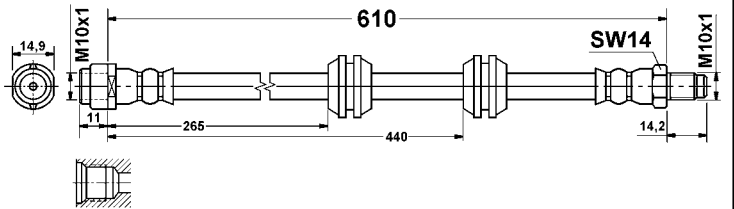

24.5124-0252.3 331218

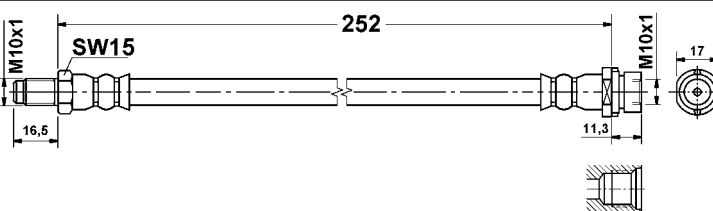

24.5124-0410.3 330760

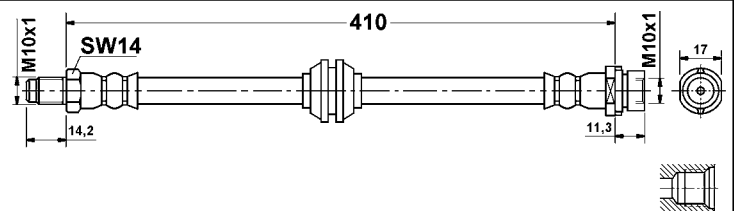

24.5124-0411.3 330774

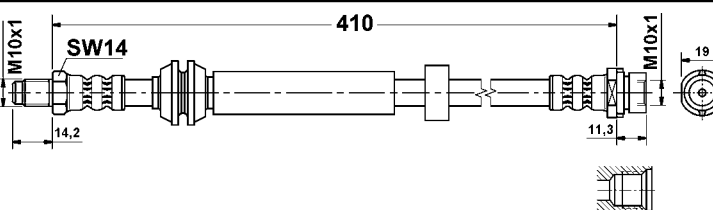

24.5124-0420.3 331276

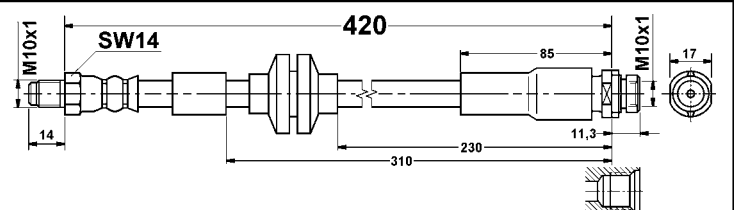

24.5125-0230.3 331277

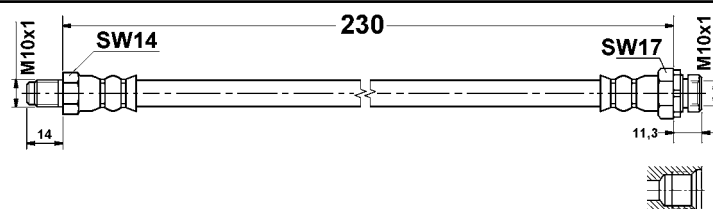

24.5125-0323.3 330911

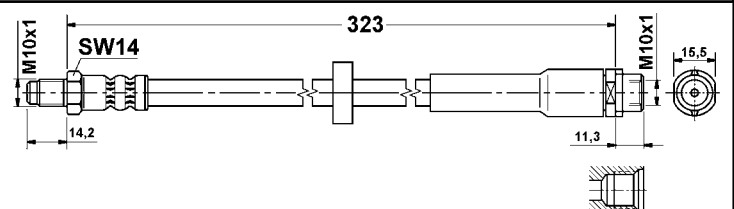

24.5125-0555.3 331348

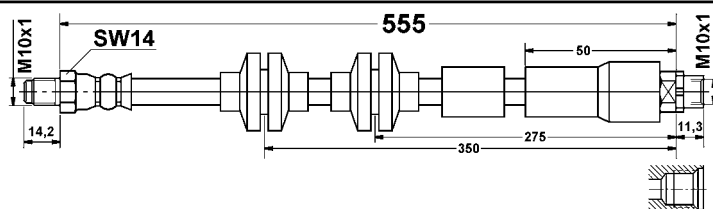

24.5126-0474.3 331017

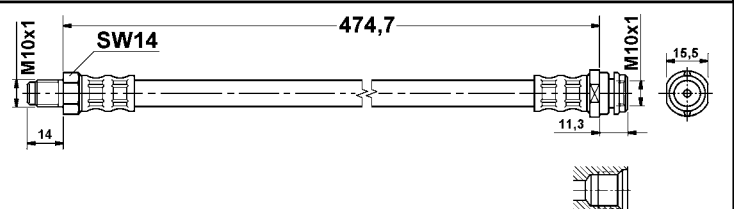

Abbildungen Bremsschläuche, Kupplungsschläuche

Illustrations brake hoses, clutch hoses - Illustrations fessibili freno, fessibili frizione - Illustrations Flexible de frein, Flexibles d'embrayages - Ilustraciones flexibles de freno, flexibles d'embrague

<p>24.5127-0305.3 330578</p>	<p>24.5129-0395.3 330582</p>
<p>24.5129-0396.3 330583</p>	<p>24.5130-0526.3 330584</p>
<p>24.5130-0527.3 330585</p>	<p>24.5131-0415.3 331238</p>
<p>24.5131-0495.3 330677</p>	<p>24.5133-0310.3 331197</p>
<p>24.5133-0311.3 331198</p>	<p>24.5134-0457.3 330752</p>
<p>24.5134-0468.3 330704</p>	<p>24.5134-0518.3 330705</p>
<p>24.5134-0562.3 330706</p>	<p>24.5135-0280.3 330775</p>

Abbildungen Bremsschläuche, Kupplungsschläuche

Illustrations brake hoses, clutch hoses - Illustrations fessibilli freno, fessibilli frizione - Illustrations Flexible de frein, Flexibles d'embrayages - Ilustraciones flexibles de freno, flexibles d'embrague

<p>24.5137-0190.3 330878</p>	<p>24.5137-0221.3 331302</p>
<p>24.5137-0365.3 331130</p>	<p>24.5137-0385.3 331089</p>
<p>24.5137-0455.3 331131</p>	<p>24.5137-0470.3 331090</p>
<p>24.5137-0490.3 330964</p>	<p>24.5137-0495.3 331132</p>
<p>24.5138-0263.3 330885</p>	<p>24.5140-0194.3 331383</p>
<p>24.5140-0240.3 330947</p>	<p>24.5140-0241.3 330948</p>
<p>24.5140-0256.3 331445</p>	<p>24.5140-0396.3 331372</p>

Abbildungen Bremsschläuche, Kupplungsschläuche

Illustrations brake hoses, clutch hoses - Illustrations fessibili freno, fessibili frizione - Illustrations Flexible de frein, Flexibles d'embrayages - Ilustraciones flexibles de freno, flexibles d'embrague

24.5140-0495.3 331446

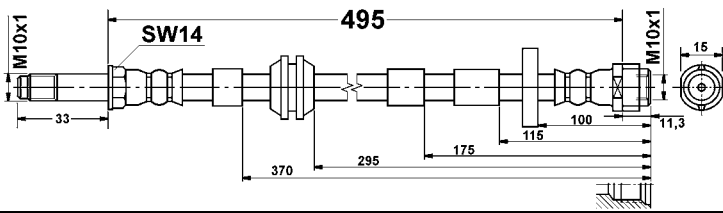

24.5140-0498.3 330912

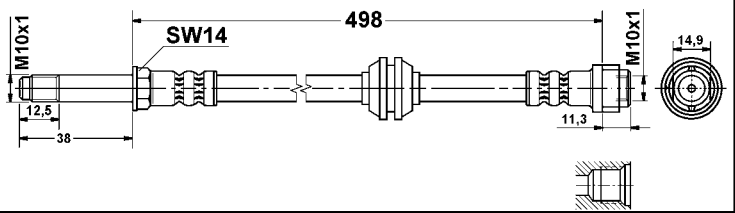

24.5140-0514.3 331290

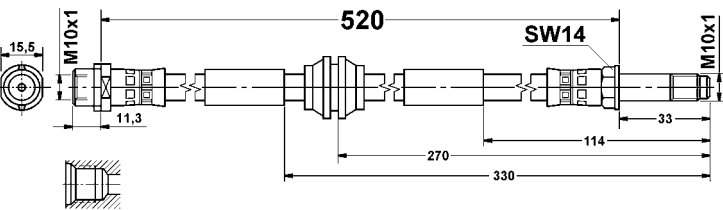

24.5140-0650.3 331500

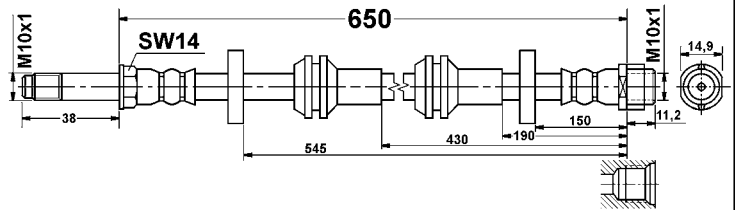

24.5140-0670.3 331501

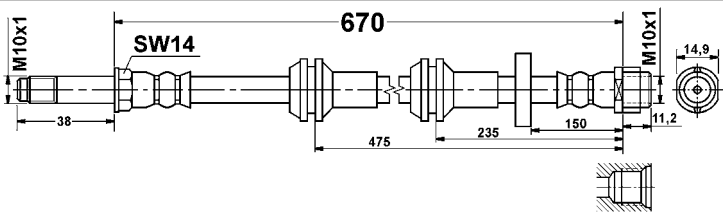

24.5141-0320.3 330949

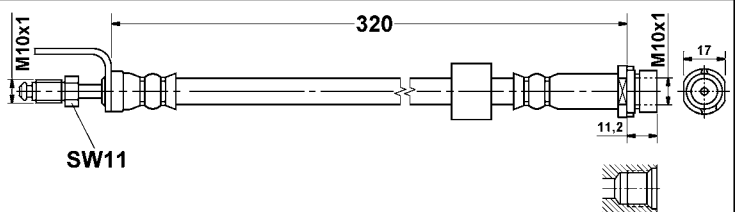

24.5141-0473.3 331303

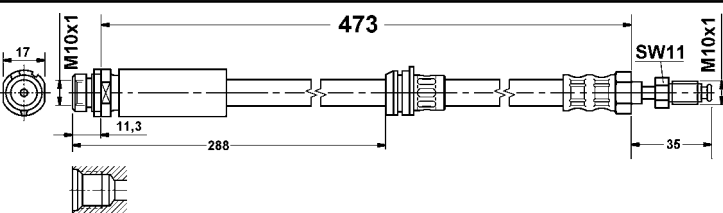

24.5142-0290.3 330950

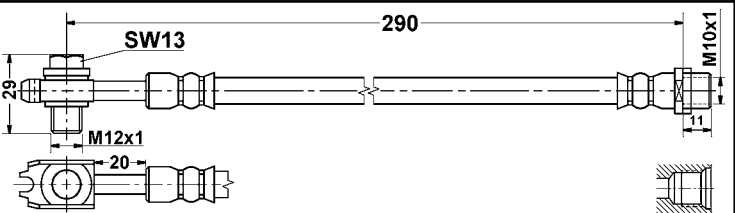

24.5143-0257.3 331167

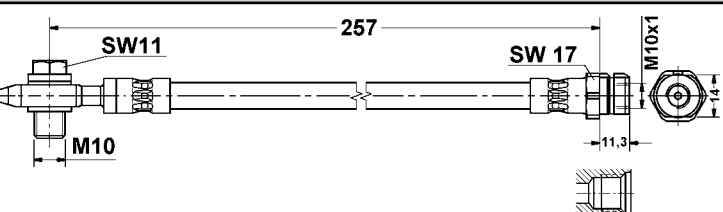

24.5143-0439.3 331411

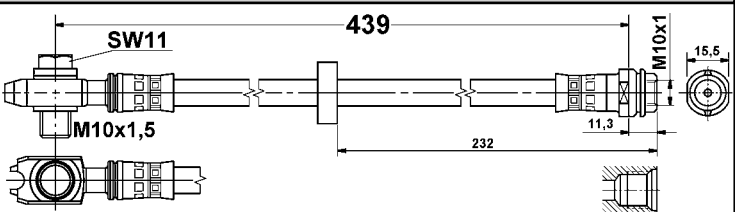

24.5143-0544.3 331420

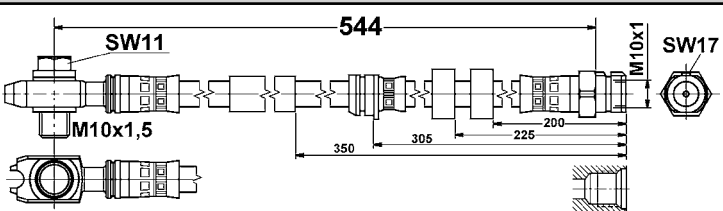

24.5143-0564.3 331433

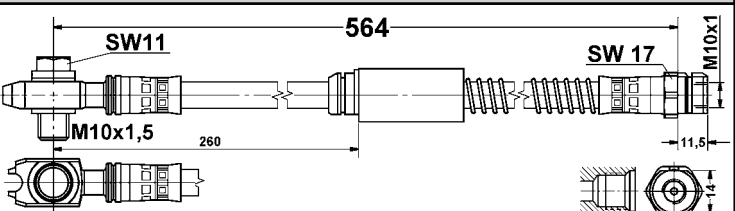

24.5143-0569.3 331398

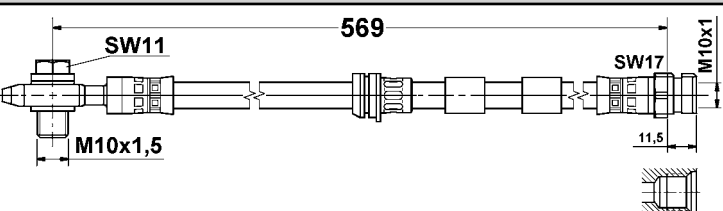

24.5143-0578.3 331168

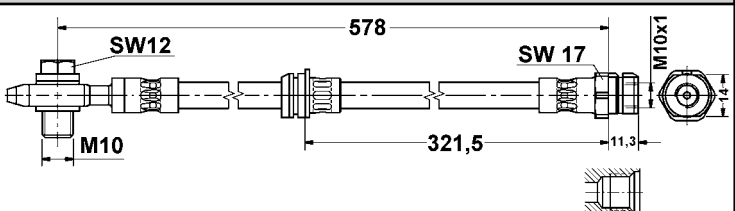

Abbildungen Bremsschläuche, Kupplungsschläuche

Illustrations brake hoses, clutch hoses - Illustrations fessibilli freno, fessibilli frizione - Illustrations Flexible de frein, Flexibles d'embrayages - Ilustraciones flexibles de freno, flexibles d'embrague

24.5144-0410.3 331242

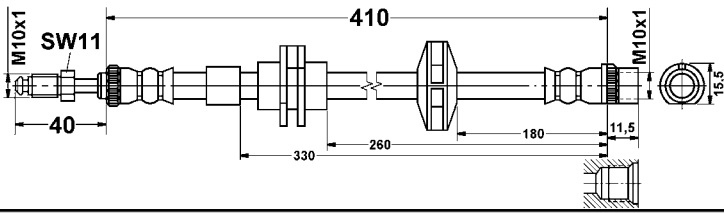

24.5144-0455.3 331201

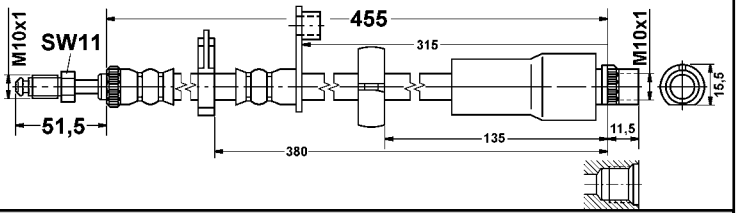

24.5144-0480.3 330961

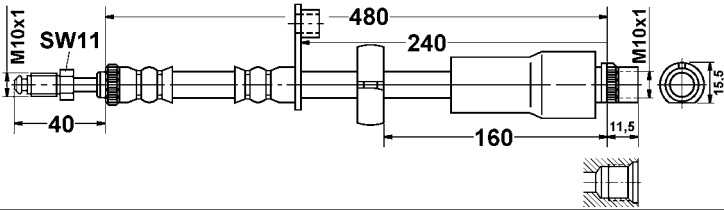

24.5144-0500.3 331169

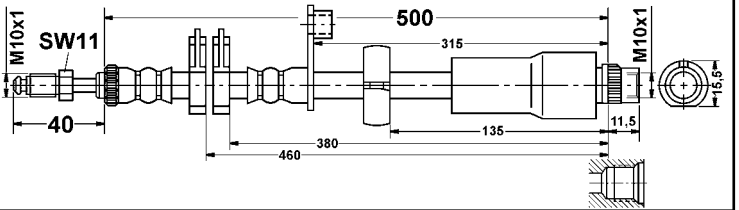

24.5145-0176.3 330965

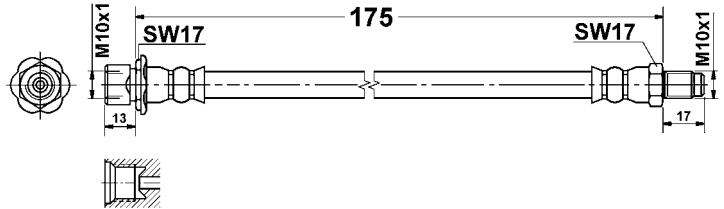

24.5146-0330.3 330973

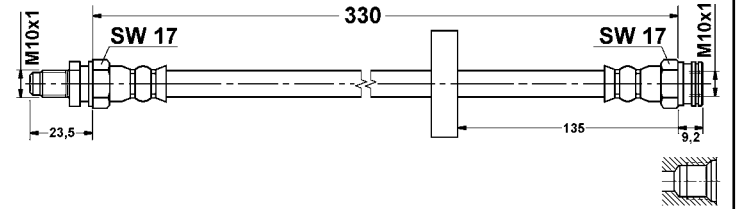

24.5147-0385.3 331427

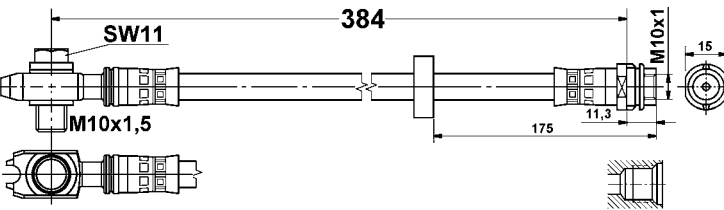

24.5148-0319.3 331421

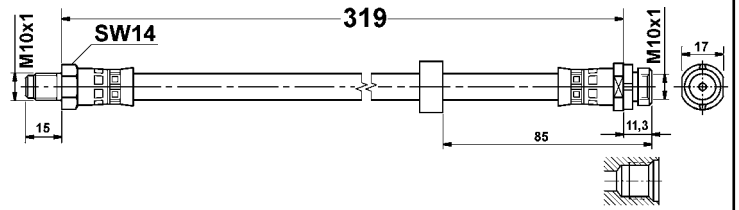

24.5148-0354.3 330992

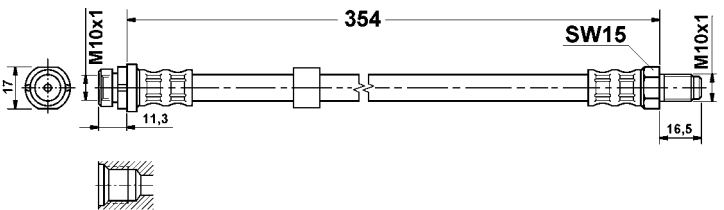

24.5148-0406.3 331478

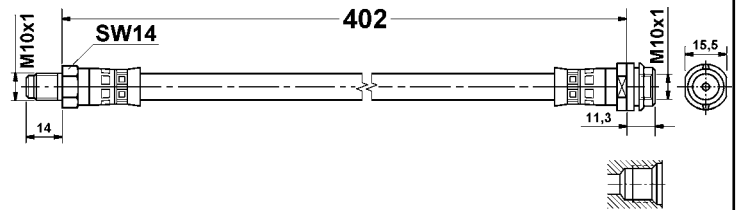

24.5149-0431.3 330993

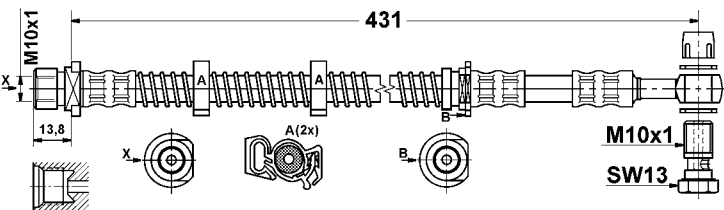

24.5150-0459.3 331018

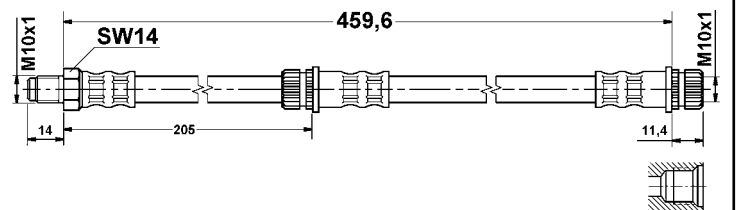

24.5151-0583.3 331019

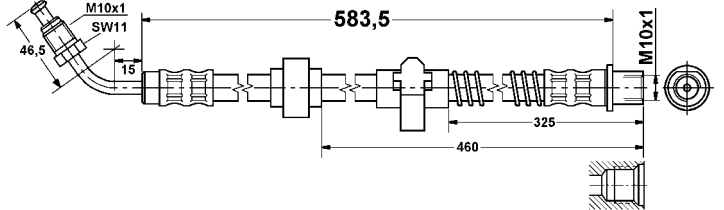

24.5151-0584.3 331020

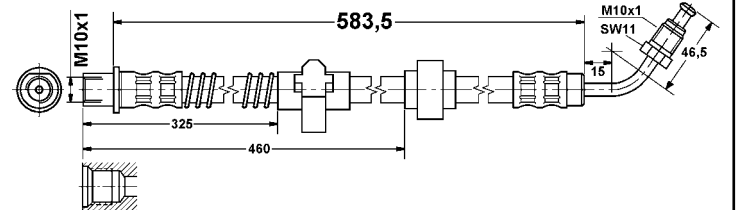

Abbildungen Bremsschläuche, Kupplungsschläuche

Illustrations brake hoses, clutch hoses - Illustrations fessibili freno, fessibili frizione - Illustrations Flexible de frein, Flexibles d'embrayages - Ilustraciones flexibles de freno, flexibles d'embrague

24.5151-0638.3 331141

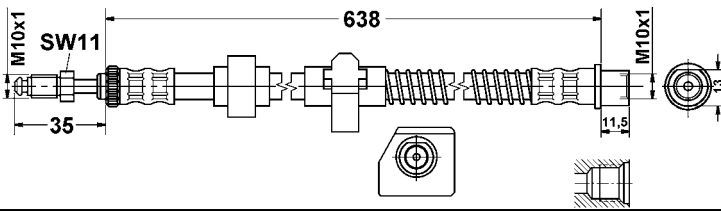

24.5151-0639.3 331142

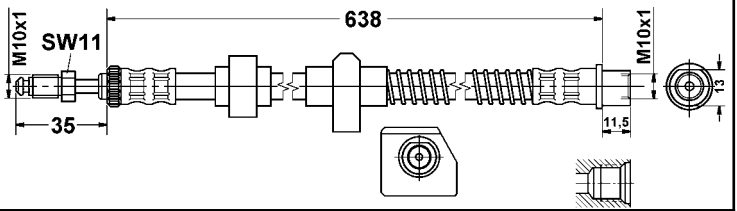

24.5152-0218.3 331042

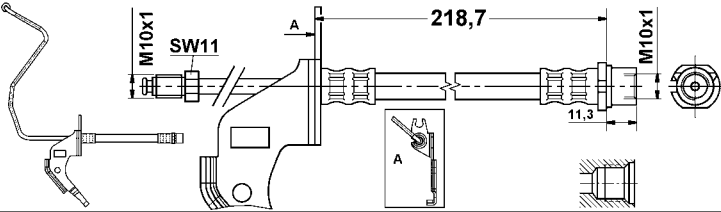

24.5152-0219.3 331043

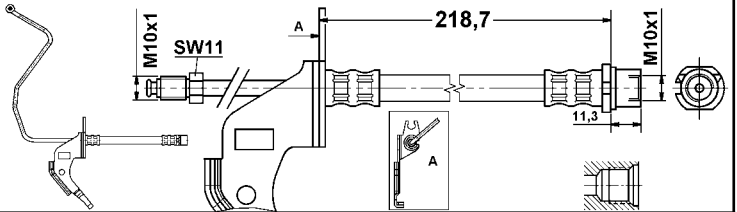

24.5153-0380.3 331044

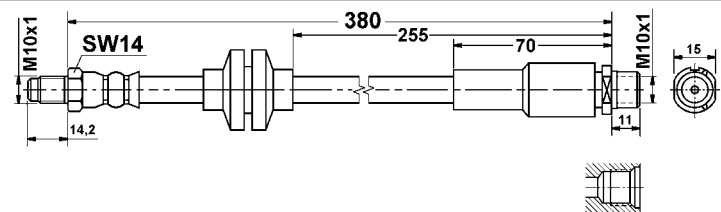

24.5154-0190.3 331056

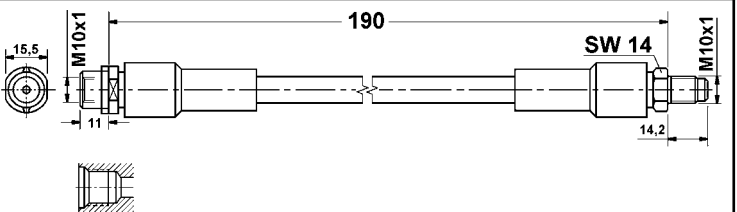

24.5155-0445.3 331057

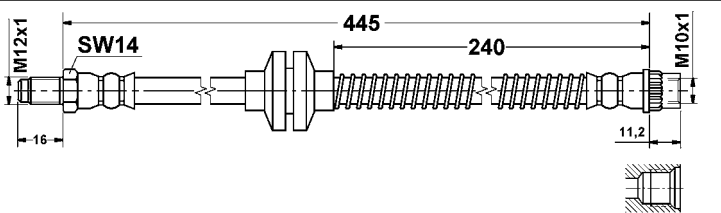

24.5157-0218.3 331095

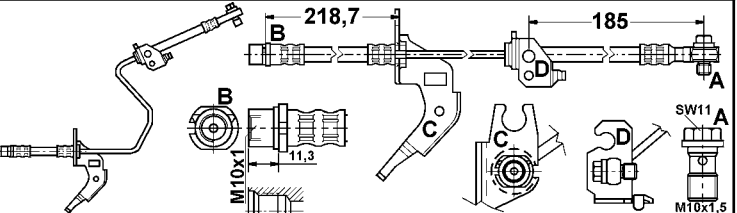

24.5157-0219.3 331096

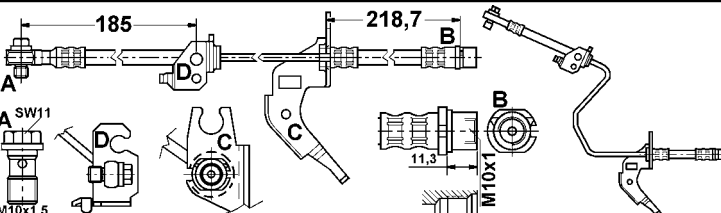

24.5157-0272.3 331304

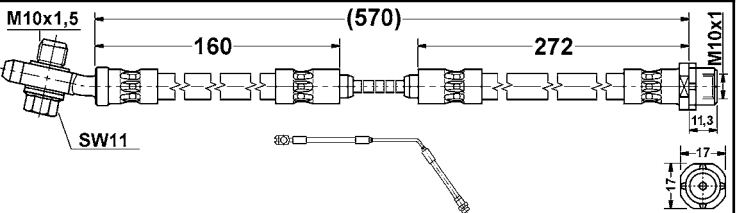

24.5157-0273.3 331305

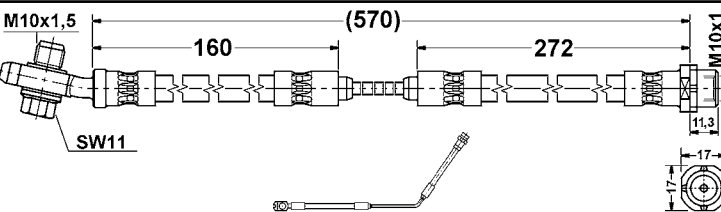

24.5158-0164.3 331152

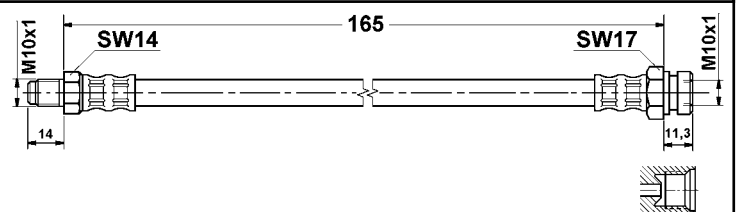

24.5159-0195.3 331153

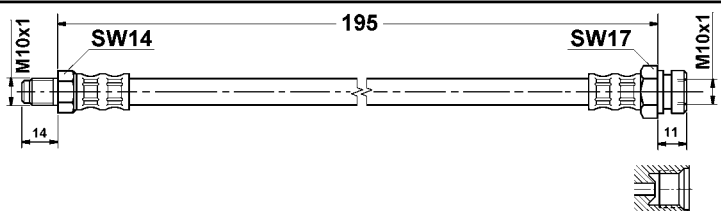

24.5160-0215.3 331154

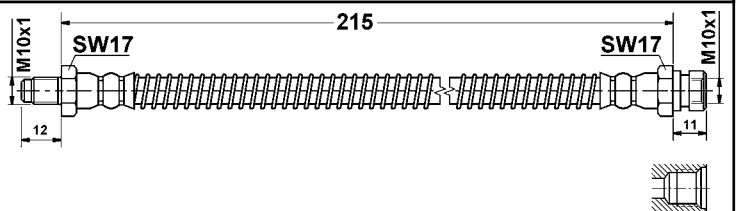

Abbildungen Bremsschläuche, Kupplungsschläuche

Illustrations brake hoses, clutch hoses - Illustrations fessibili freno, fessibili frizione - Illustrations Flexible de frein, Flexibles d'embrayages - Ilustraciones flexibles de freno, flexibles d'embrague

24.5161-0313.3 331219

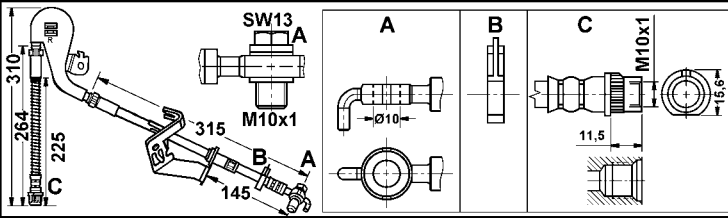

24.5161-0314.3 331220

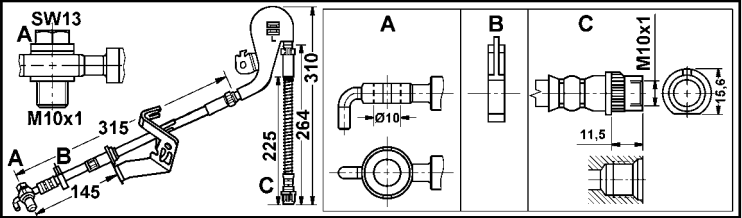

24.5161-0315.3 331186

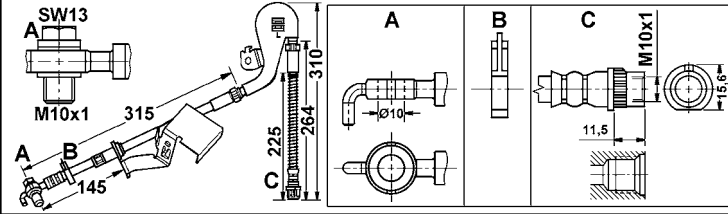

24.5161-0316.3 331187

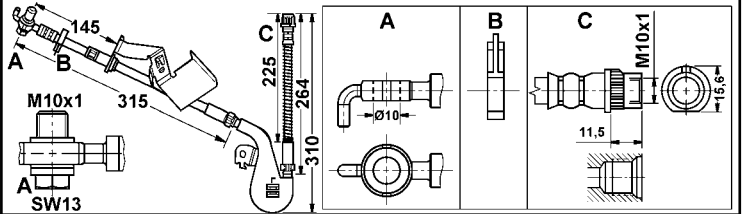

24.5161-0775.3 331412

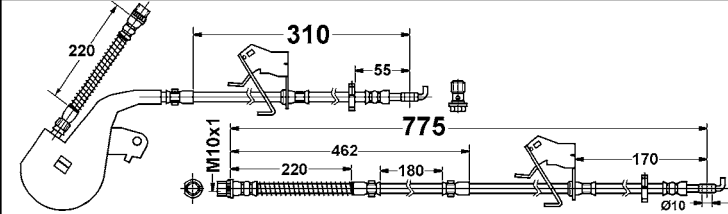

24.5161-0776.3 331413

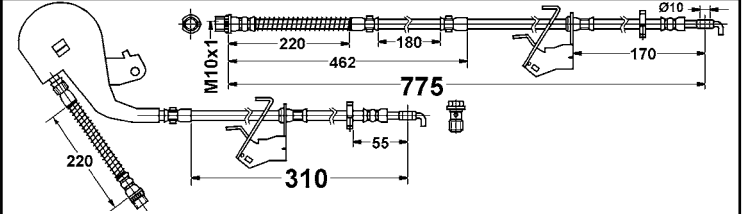

24.5162-0185.3 331202

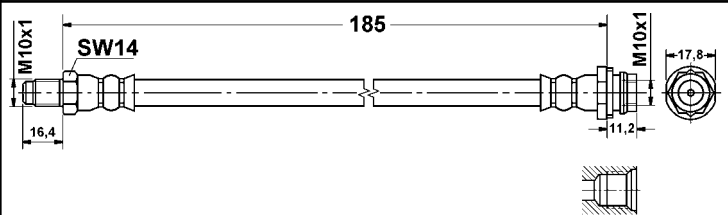

24.5162-0375.3 331203

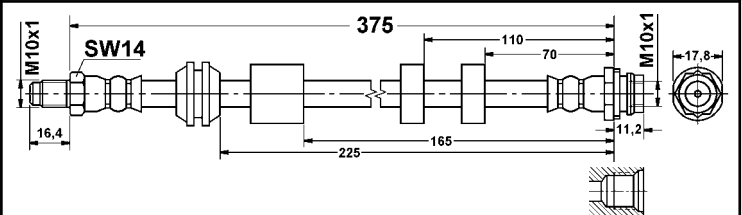

24.5162-0390.3 331199

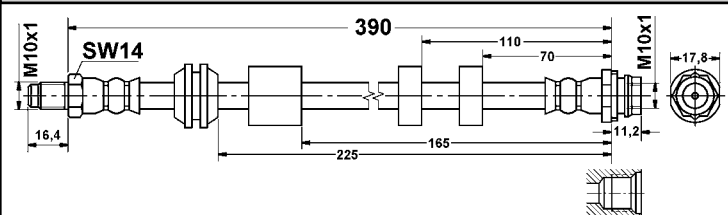

24.5162-0405.3 331194

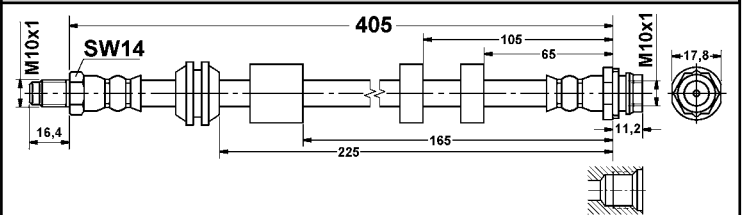

24.5163-0155.3 331204

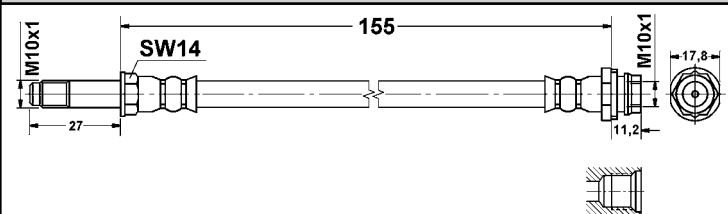

24.5164-0315.3 331209

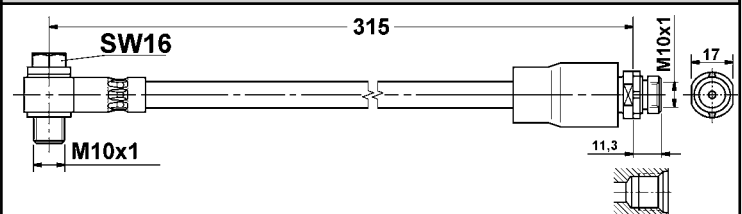

24.5164-0316.3 331210

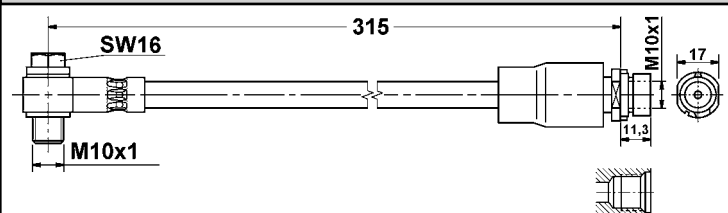

24.5164-0317.3 331211

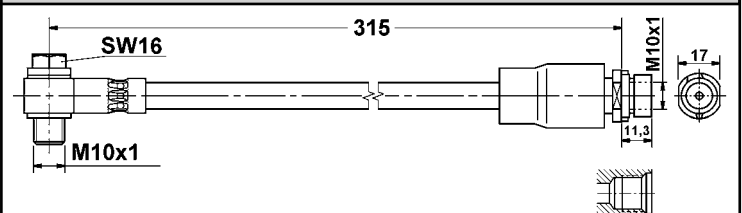

Abbildungen Bremsschläuche, Kupplungsschläuche

Illustrations brake hoses, clutch hoses - Illustrations fessibilli freno, fessibilli frizione - Illustrations Flexible de frein, Flexibles d'embrayages - Ilustraciones flexibles de freno, flexibles d'embrague

<p>24.5165-0215.3 331319</p>	<p>24.5165-0350.3 331257</p>
<p>24.5165-0415.3 331320</p>	<p>24.5165-0425.3 331258</p>
<p>24.5165-0450.3 331259</p>	<p>24.5166-0325.3 331293</p>
<p>24.5166-0454.3 331306</p>	<p>24.5167-0420.3 331278</p>
<p>24.5169-0355.3 331307</p>	<p>24.5169-0458.3 331429</p>
<p>24.5169-0475.3 331497</p>	<p>24.5169-0590.3 331422</p>
<p>24.5170-0161.3 331308</p>	<p>24.5170-0315.3 331309</p>

Abbildungen Bremsschläuche, Kupplungsschläuche

Illustrations brake hoses, clutch hoses - Illustrations fessibilli freno, fessibilli frizione - Illustrations Flexible de frein, Flexibles d'embrayages - Ilustraciones flexibles de freno, flexibles d'embrague

24.5170-0361.3 331310

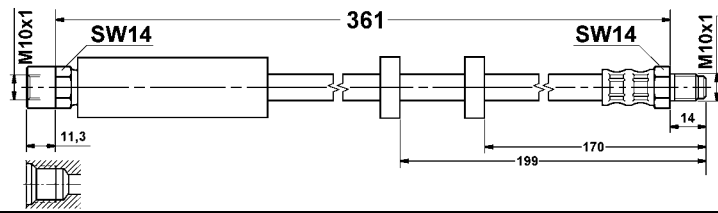

24.5170-0426.3 331452

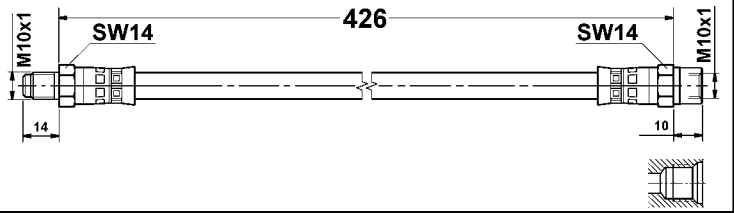

24.5170-0465.3 331331

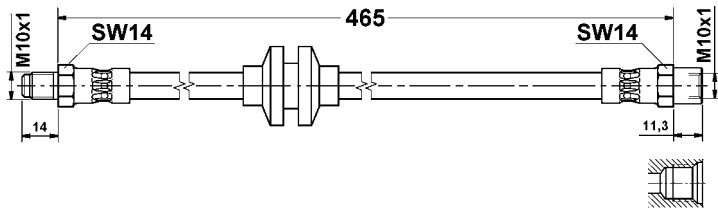

24.5172-0305.3 331312

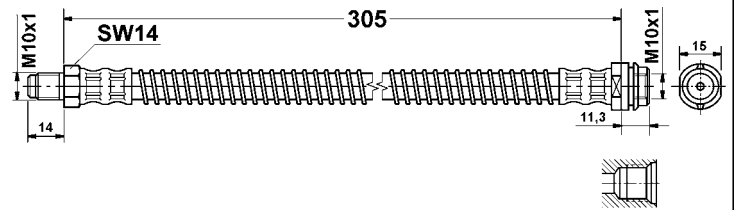

24.5171-0393.3 331311

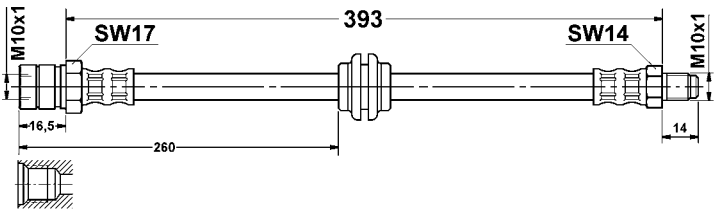

24.5173-0435.3 331363

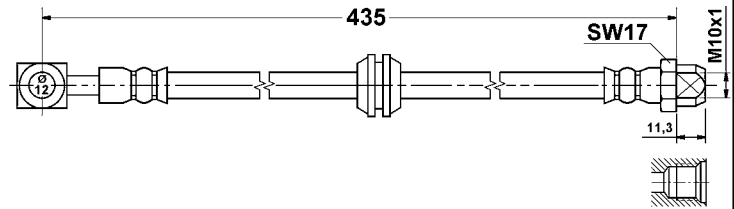

24.5173-0570.3 331364

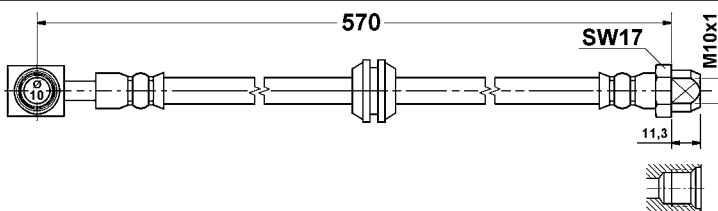

24.5174-0526.3 331365

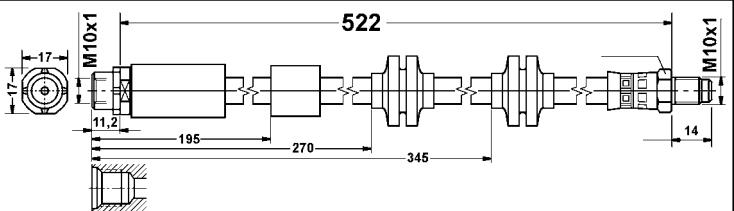

24.5174-0527.3 331390

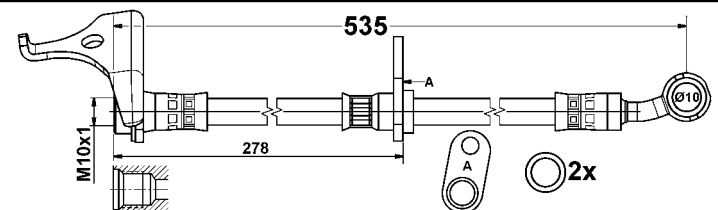

24.5175-0528.3 331391

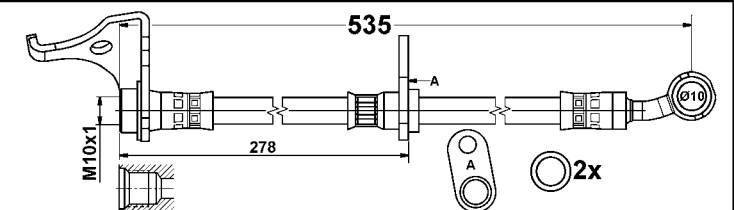

24.5176-0384.3 331373

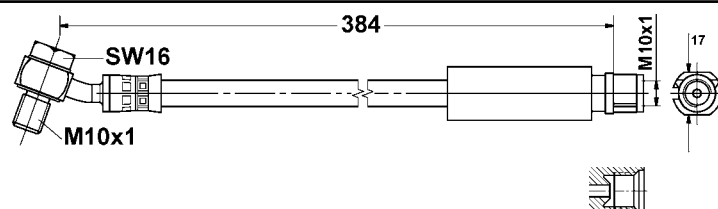

24.5176-0400.3 331492

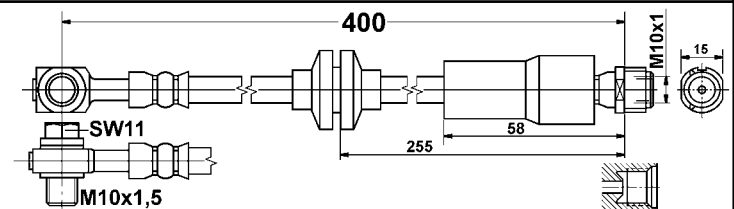

24.5176-0494.3 331447

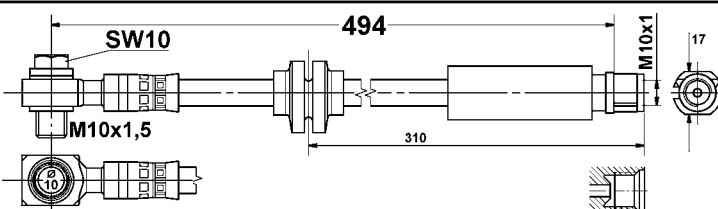

24.5201-0135.3 331399

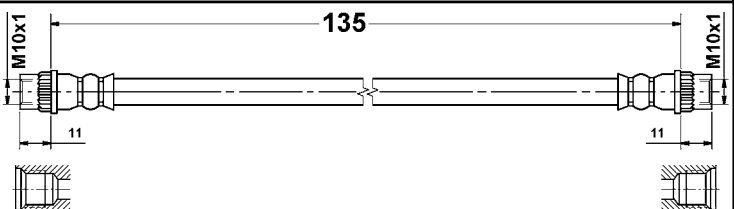

Abbildungen Bremsschläuche, Kupplungsschläuche

Illustrations brake hoses, clutch hoses - Illustrations fessibili freno, fessibili frizione - Illustrations Flexible de frein, Flexibles d'embrayages - Ilustraciones flexibles de freno, flexibles d'embrague

<p>24.5201-0164.3 331414</p>	<p>24.5201-0180.3 331498</p>
<p>24.5201-0204.3 331400</p>	<p>24.5201-0220.3 331272</p>
<p>24.5201-0290.3 331401</p>	<p>24.5201-0474.3 331434</p>
<p>24.5202-0204.3 331402</p>	<p>24.5203-0135.3 331403</p>
<p>24.5204-0200.3 331499</p>	<p>24.5204-0233.3 331430</p>
<p>24.5204-0260.3 331423</p>	<p>24.5205-0205.3 330780</p>
<p>24.5207-0205.3 330042</p>	<p>24.5209-0250.3 330043</p>

Abbildungen Bremsschläuche, Kupplungsschläuche

Illustrations brake hoses, clutch hoses - Illustrations fessibilli freno, fessibilli frizione - Illustrations Flexible de frein, Flexibles d'embrayages - Ilustraciones flexibles de freno, flexibles d'embrague

<p>24.5209-0280.3 330044</p>	<p>24.5209-0353.3 330046</p>
<p>24.5223-0294.3 330576</p>	<p>24.5224-0240.3 331260</p>
<p>24.5224-0295.3 331261</p>	<p>24.5224-0299.3 331262</p>
<p>24.5224-0330.3 331263</p>	<p>24.5224-0440.3 331378</p>
<p>24.5224-0460.3 331264</p>	<p>24.5225-0160.3 331366</p>
<p>24.5225-0240.3 331321</p>	<p>24.5225-0300.3 331266</p>
<p>24.5225-0370.3 331379</p>	<p>24.5226-0485.3 331048</p>

Abbildungen Bremsschläuche, Kupplungsschläuche

Illustrations brake hoses, clutch hoses - Illustrations fessibili freno, fessibili frizione - Illustrations Flexible de frein, Flexibles d'embrayages - Ilustraciones flexibles de freno, flexibles d'embrague

24.5226-0489.3 331049

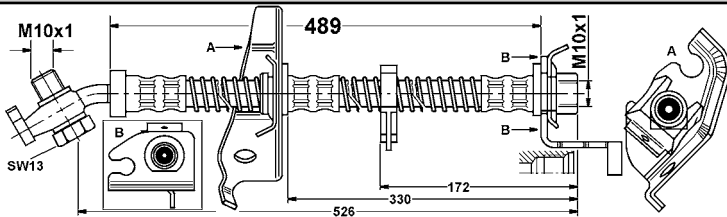

24.5228-0165.3 330879

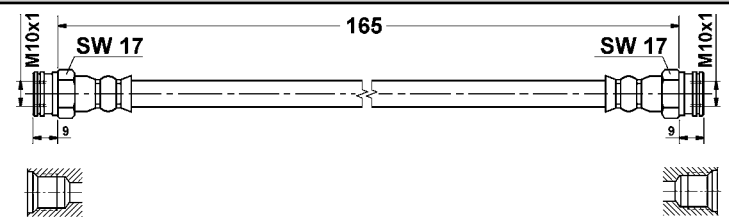

24.5228-0180.3 330761

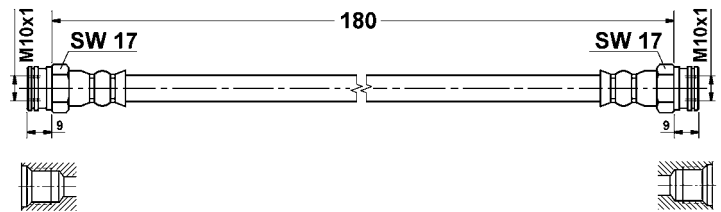

24.5228-0181.3 331279

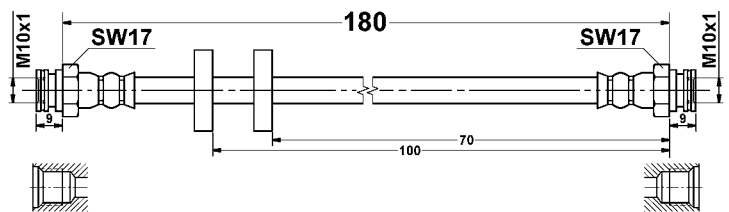

24.5228-0185.3 330107

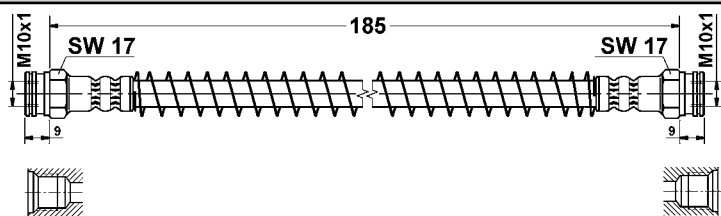

24.5228-0195.3 330469

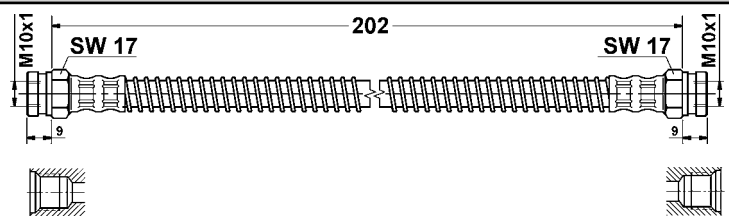

24.5228-0196.3 330656

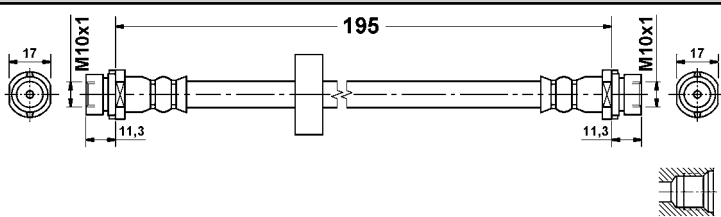

24.5228-0200.3 330470

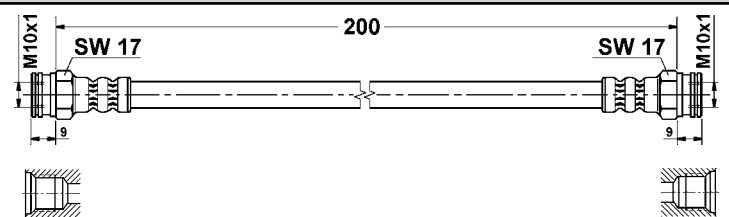

24.5228-0216.3 330908

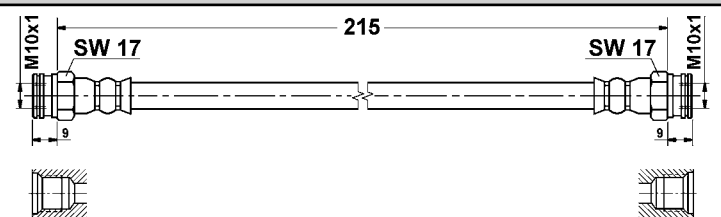

24.5228-0223.3 330530

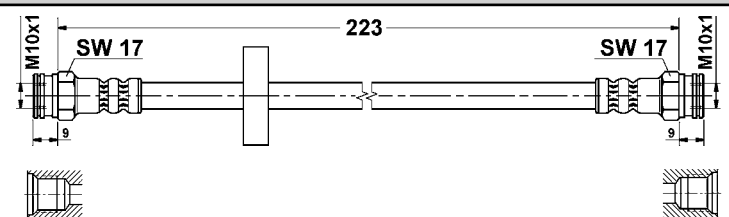

24.5228-0235.3 330395

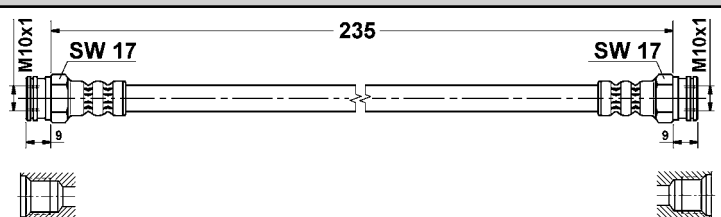

24.5228-0245.3 330531

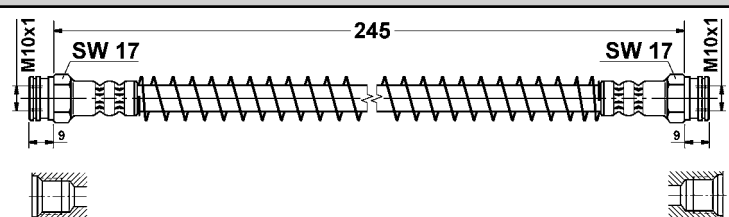

24.5228-0255.3 330409

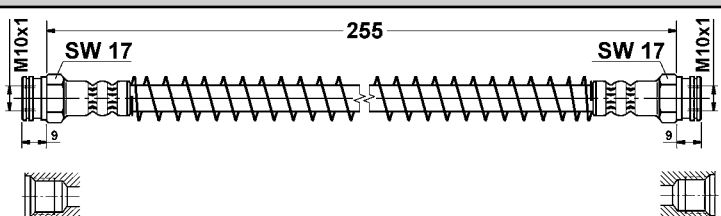

24.5228-0275.3 330035

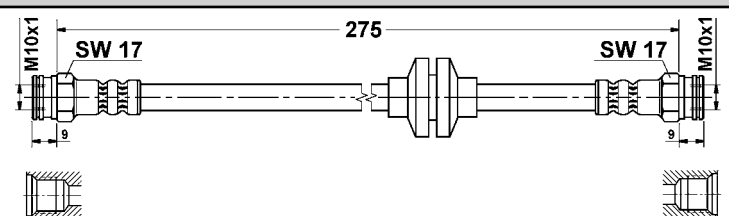

Abbildungen Bremsschläuche, Kupplungsschläuche

Illustrations brake hoses, clutch hoses - Illustrations fessibilli freno, fessibilli frizione - Illustrations Flexible de frein, Flexibles d'embrayages - Ilustraciones flexibles de freno, flexibles d'embrague

24.5228-0280.3 330532

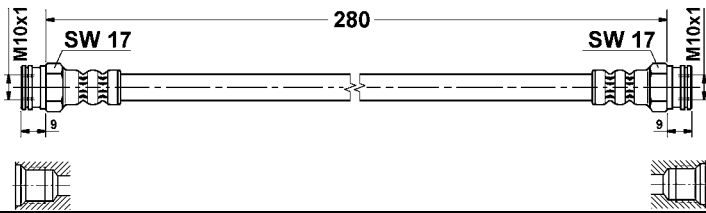

24.5228-0350.3 330396

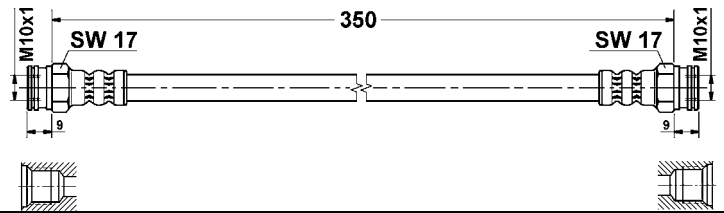

24.5228-0375.3 330699

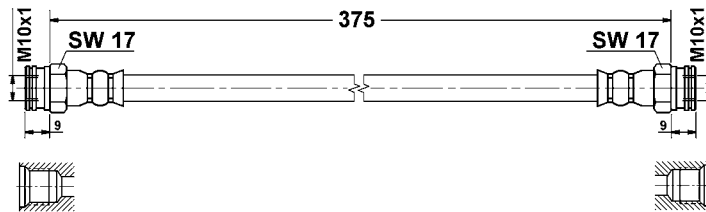

24.5229-0181.3 330533

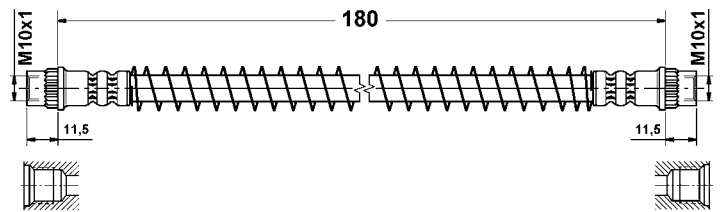

24.5229-0185.3 330397

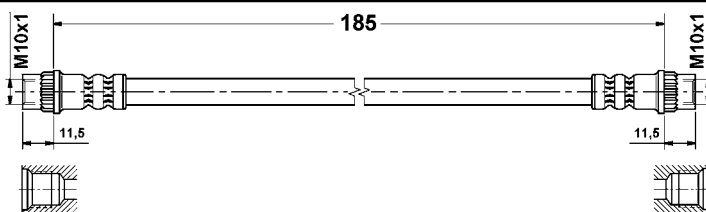

24.5229-0193.3 330571

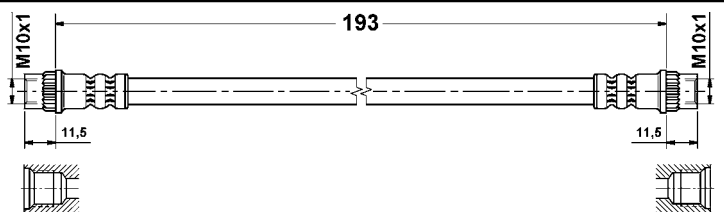

24.5229-0199.3 330534

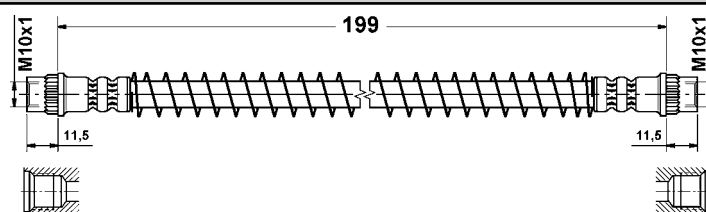

24.5229-0200.3 330572

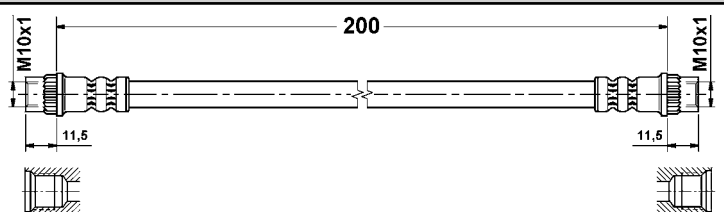

24.5229-0209.3 330670

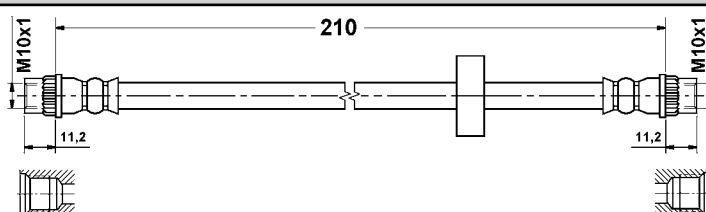

24.5229-0211.3 330573

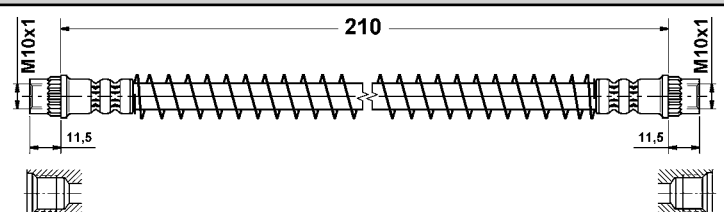

24.5229-0220.3 330399

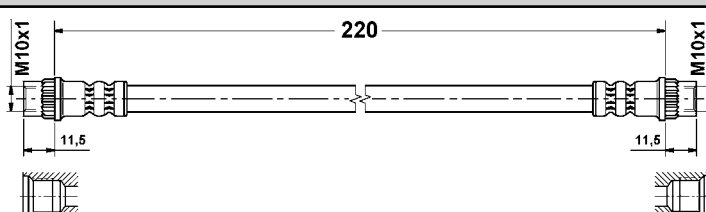

24.5229-0240.3 330400

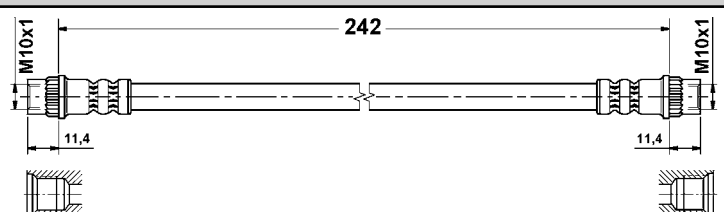

24.5229-0251.3 330535

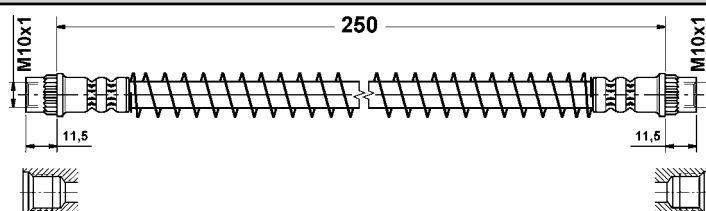

24.5229-0255.3 330581

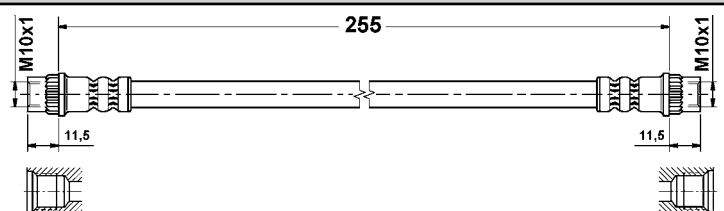

Abbildungen Bremsschläuche, Kupplungsschläuche

Illustrations brake hoses, clutch hoses - Illustrations fessibili freno, fessibili frizione - Illustrations Flexible de frein, Flexibles d'embrayages - Ilustraciones flexibles de freno, flexibles d'embrague

24.5229-0265.3 330540

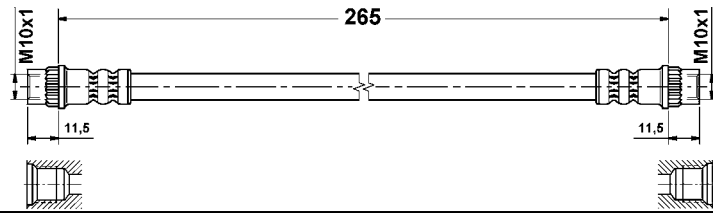

24.5229-0285.3 330032

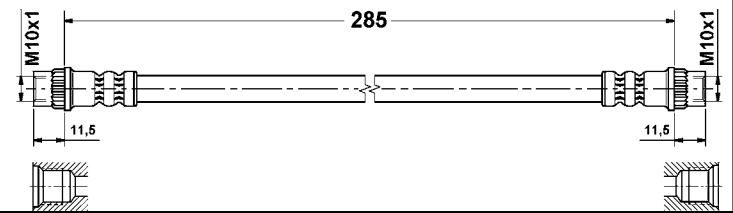

24.5230-0143.3 330402

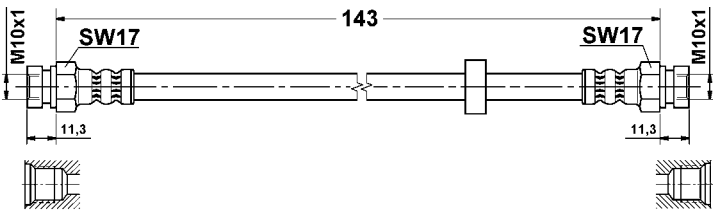

24.5230-0243.3 331155

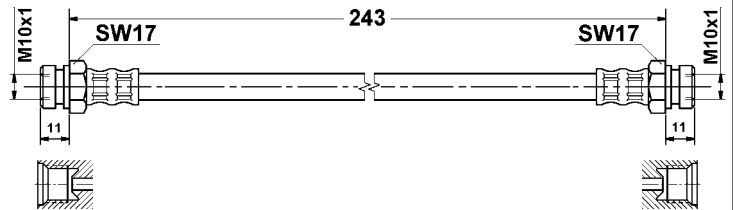

24.5230-0285.3 331322

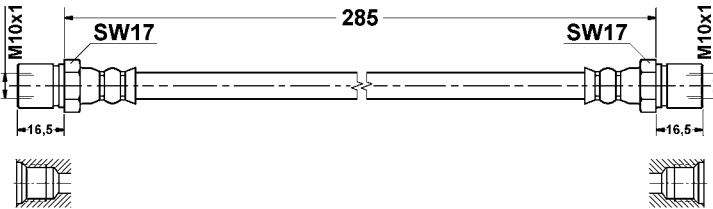

24.5231-0320.3 330496

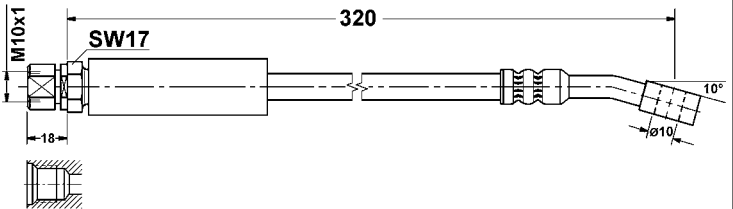

24.5231-0391.3 331424

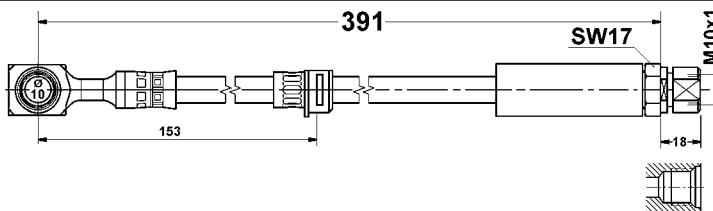

24.5231-0426.3 331313

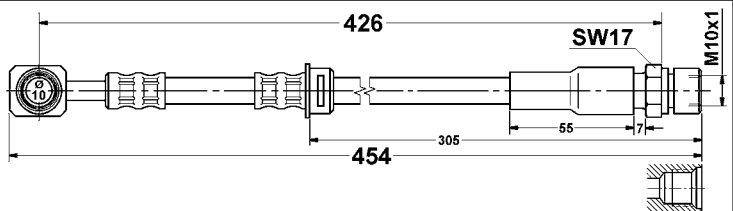

24.5232-0283.3 331323

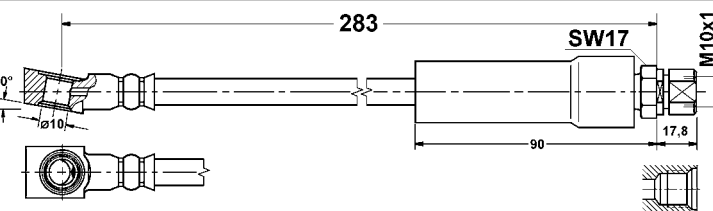

24.5232-0388.3 330580

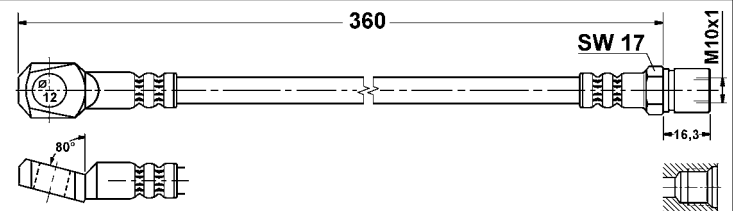

24.5233-0180.3 330888

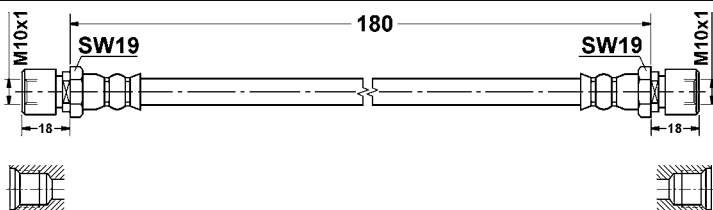

24.5233-0200.3 330425

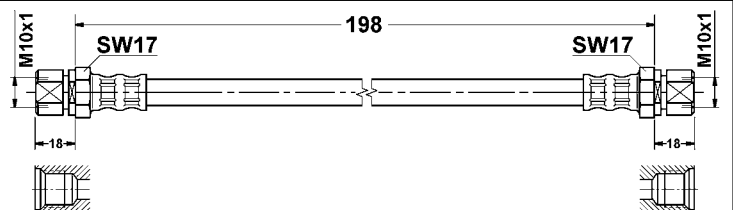

24.5235-0128.3 331324

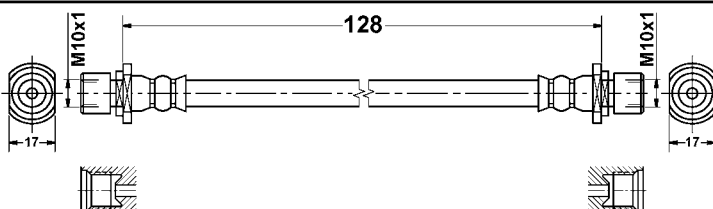

24.5235-0160.3 331325

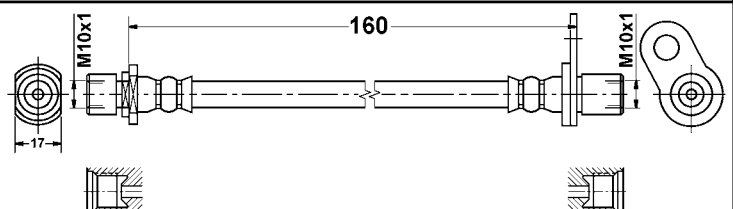

Abbildungen Bremsschläuche, Kupplungsschläuche

Illustrations brake hoses, clutch hoses - Illustrations fessibilli freno, fessibilli frizione - Illustrations Flexible de frein, Flexibles d'embrayages - Ilustraciones flexibles de freno, flexibles d'embrague

24.5235-0190.3 330916

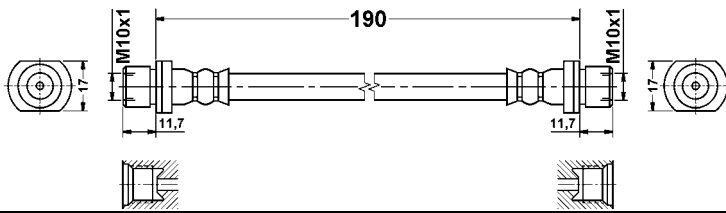

24.5235-0200.3 331280

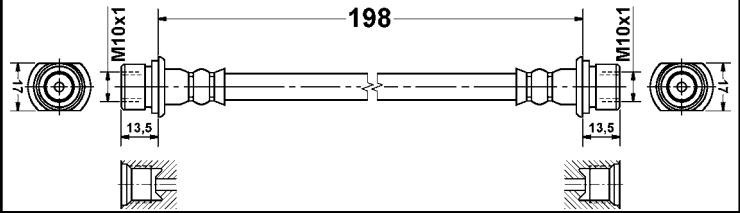

24.5235-0205.3 331093

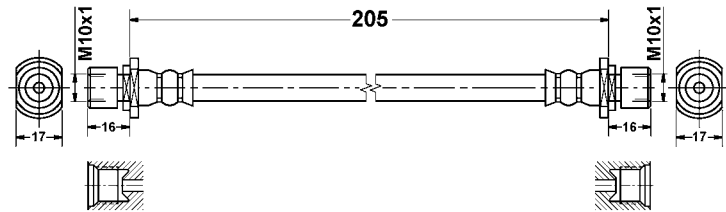

24.5235-0250.3 330917

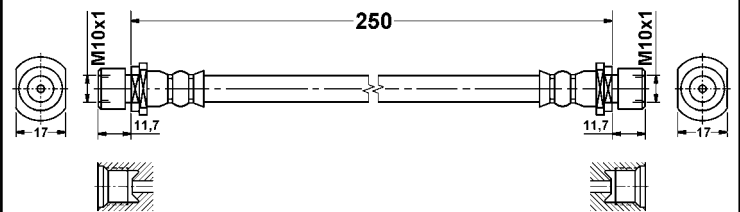

24.5235-0275.3 331179

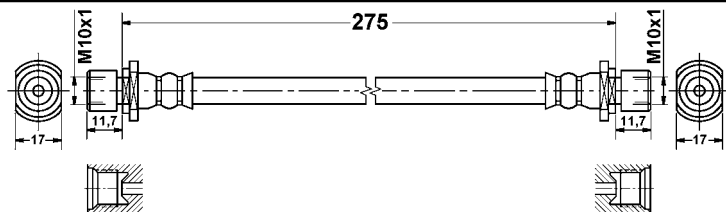

24.5236-0429.3 330586

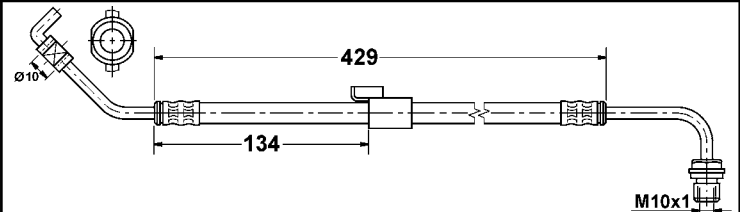

24.5236-0430.3 330587

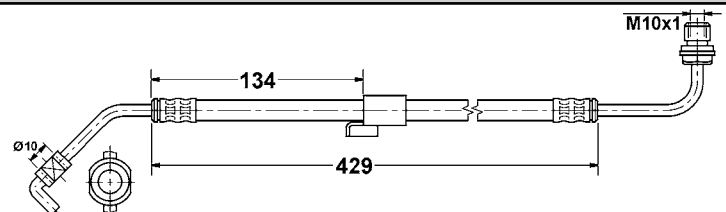

24.5237-0183.3 331454

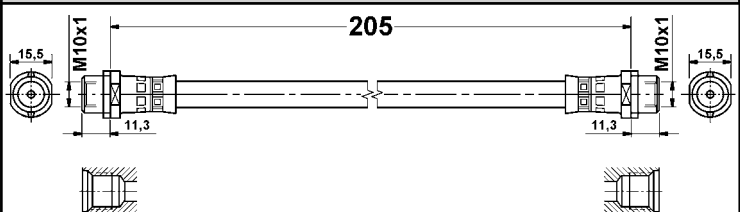

24.5237-0235.3 330781

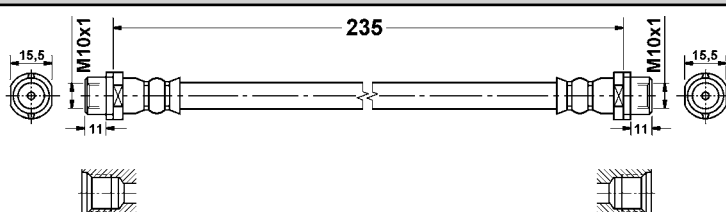

24.5237-0250.3 330880

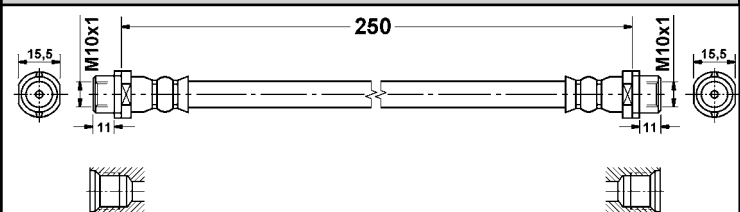

24.5237-0273.3 331444

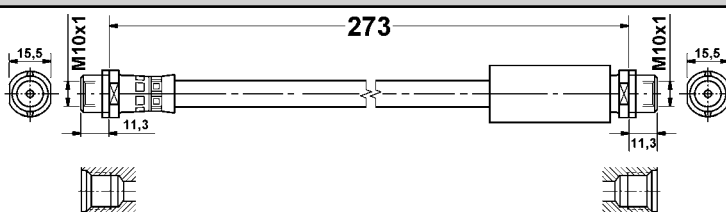

24.5237-0288.3 331442

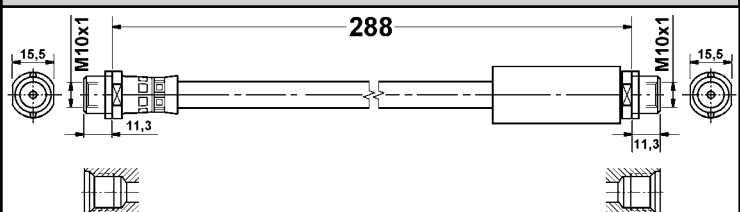

24.5237-0308.3 331435

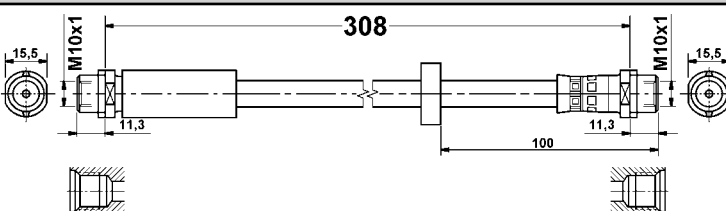

24.5237-0333.3 331425

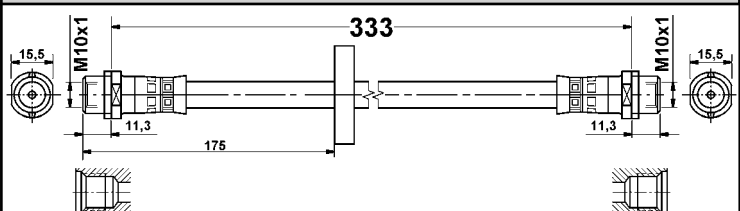

Abbildungen Bremsschläuche, Kupplungsschläuche

Illustrations brake hoses, clutch hoses - Illustrations fessibili freno, fessibili frizione - Illustrations Flexible de frein, Flexibles d'embrayages - Ilustraciones flexibles de freno, flexibles d'embrague

24.5237-0334.3 331443

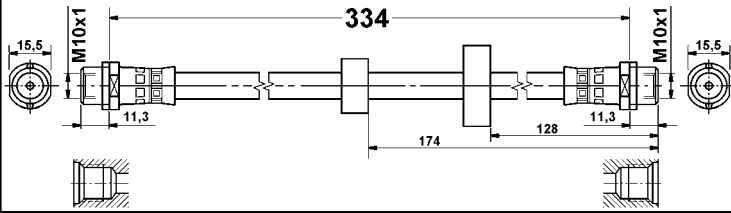

24.5237-0342.3 331404

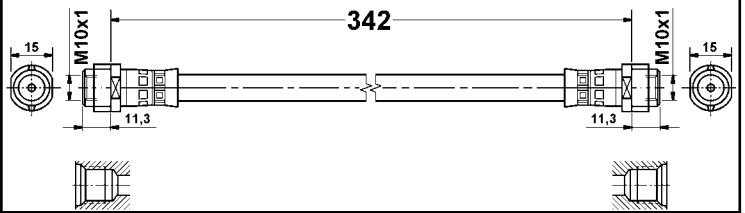

24.5237-0345.3 331367

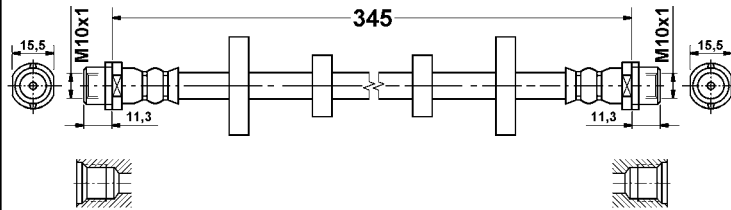

24.5237-0360.3 331212

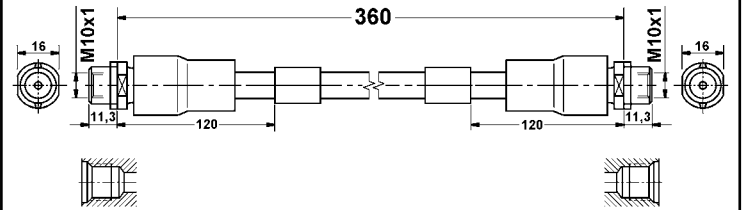

24.5237-0490.3 330672

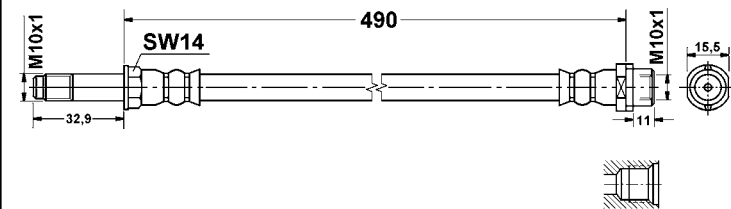

24.5237-0515.3 331463

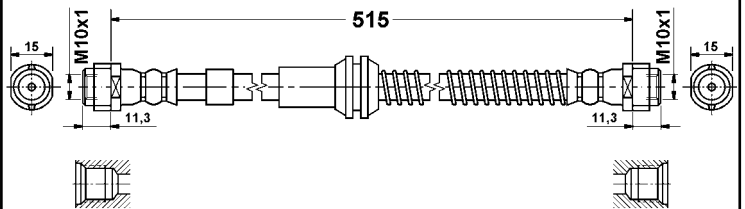

24.5238-0230.3 330673

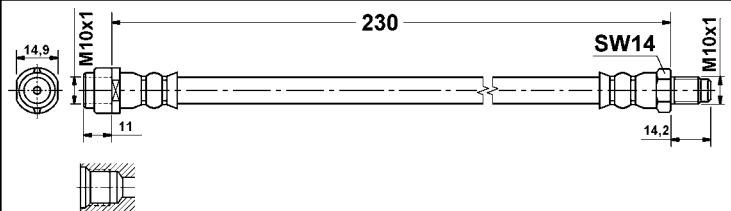

24.5238-0255.3 330674

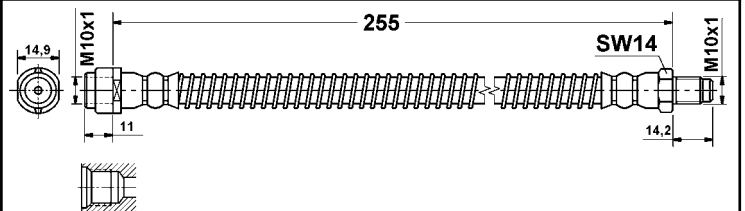

24.5239-0165.3 330606

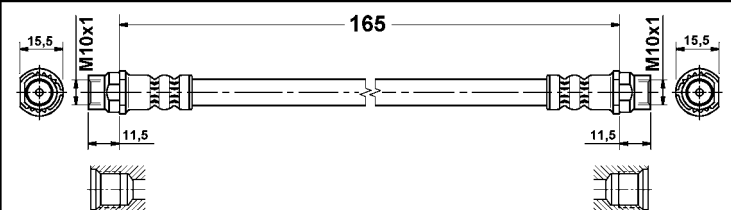

24.5239-0180.3 331464

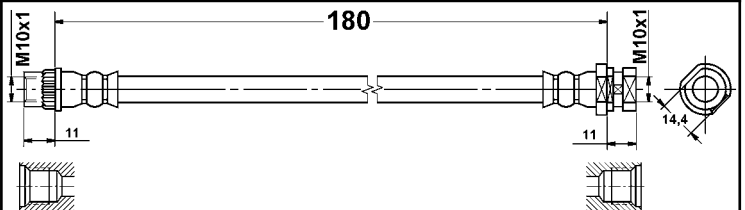

24.5239-0190.3 330966

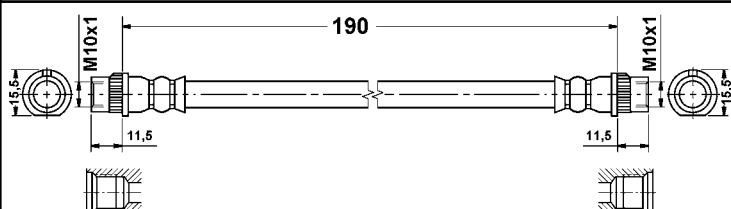

24.5239-0240.3 331170

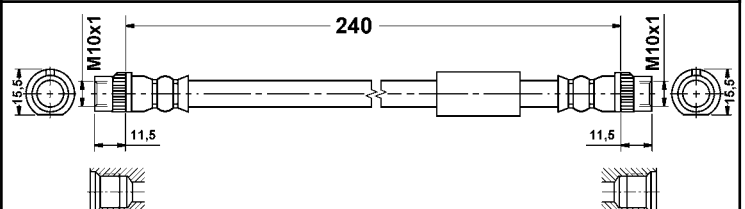

24.5239-0260.3 331171

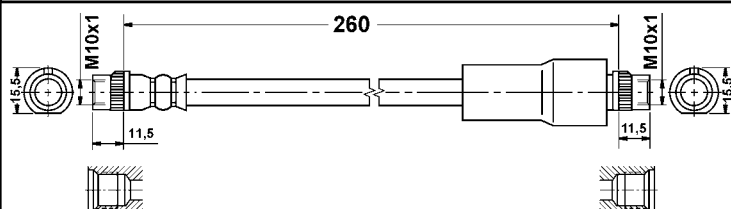

24.5239-0355.3 331243

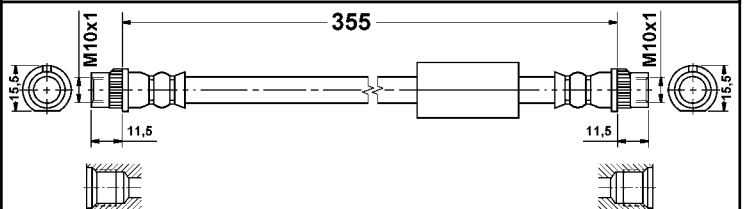

Abbildungen Bremsschläuche, Kupplungsschläuche

Illustrations brake hoses, clutch hoses - Illustrations fessibilli freno, fessibilli frizione - Illustrations Flexible de frein, Flexibles d'embrayages - Ilustraciones flexibles de freno, flexibles d'embrague

<p>24.5239-0365.3 331281</p>	<p>24.5240-0195.3 330753</p>
<p>24.5240-0220.3 330619</p>	<p>24.5241-0200.3 330620</p>
<p>24.5241-0396.3 331380</p>	<p>24.5241-0401.3 331021</p>
<p>24.5241-0429.3 331381</p>	<p>24.5241-0720.3 331415</p>
<p>24.5241-0721.3 331416</p>	<p>24.5242-0190.3 330675</p>
<p>24.5243-0190.3 330678</p>	<p>24.5243-0310.3 330755</p>
<p>24.5244-0240.3 330679</p>	<p>24.5245-0398.3 331188</p>

Abbildungen Bremsschläuche, Kupplungsschläuche

Illustrations brake hoses, clutch hoses - Illustrations fessibili freno, fessibili frizione - Illustrations Flexible de frein, Flexibles d'embrayages - Ilustraciones flexibles de freno, flexibles d'embrague

<p>24.5245-0405.3 330686</p>	<p>24.5246-0185.3 330881</p>
<p>24.5246-0190.3 330697</p>	<p>24.5246-0216.3 331022</p>
<p>24.5246-0260.3 330782</p>	<p>24.5247-0190.3 331385</p>
<p>24.5247-0191.3 331386</p>	<p>24.5247-0195.3 330919</p>
<p>24.5247-0205.3 331094</p>	<p>24.5247-0210.3 331023</p>
<p>24.5247-0235.3 331374</p>	<p>24.5247-0236.3 331417</p>
<p>24.5247-0237.3 331418</p>	<p>24.5247-0275.3 331244</p>

Abbildungen Bremsschläuche, Kupplungsschläuche

Illustrations brake hoses, clutch hoses - Illustrations fessibilli freno, fessibilli frizione - Illustrations Flexible de frein, Flexibles d'embrayages - Ilustraciones flexibles de freno, flexibles d'embrague

24.5247-0276.3 331245

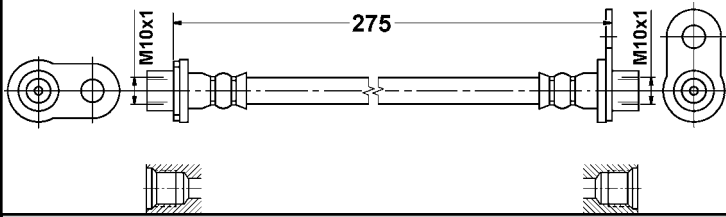

24.5247-0280.3 330700

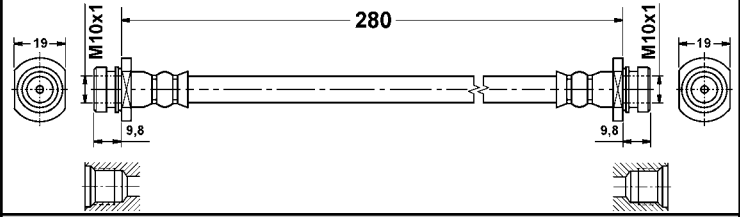

24.5247-0281.3 330967

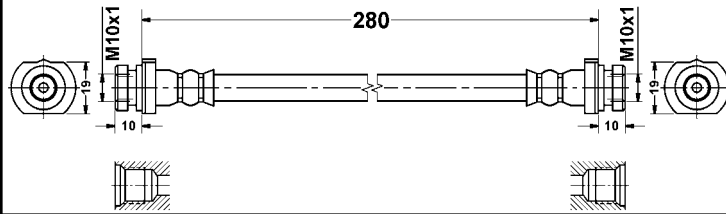

24.5247-0310.3 330951

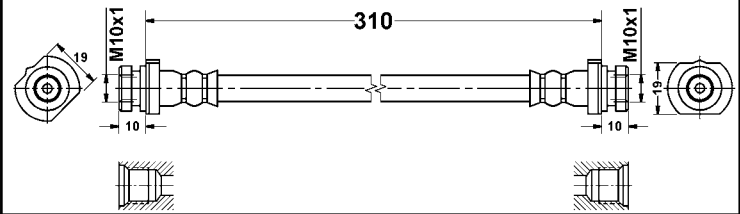

24.5248-0461.3 330707

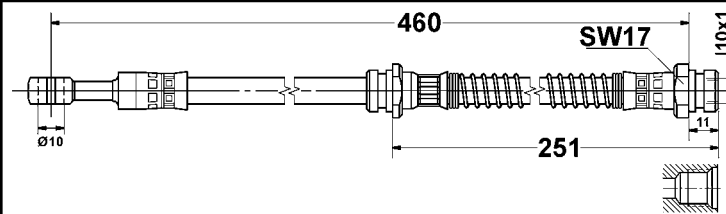

24.5248-0466.3 330920

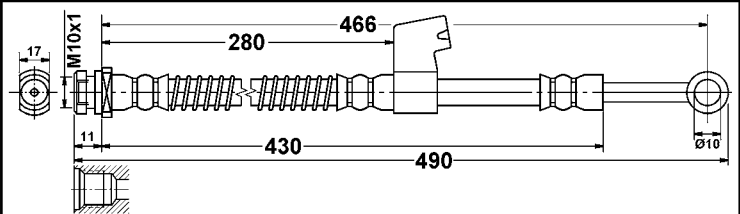

24.5248-0467.3 330921

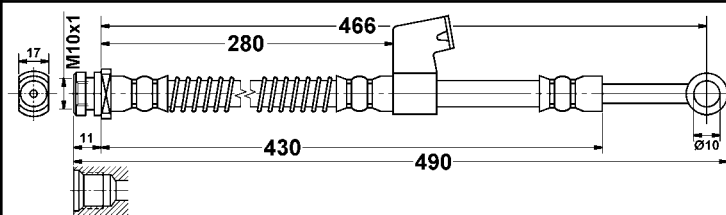

24.5249-0416.3 330708

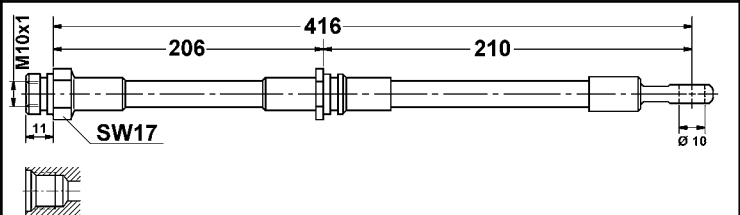

24.5251-0185.3 330701

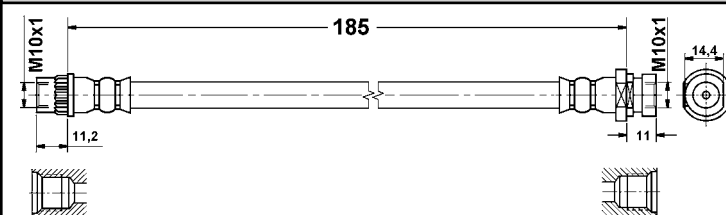

24.5251-0465.3 330822

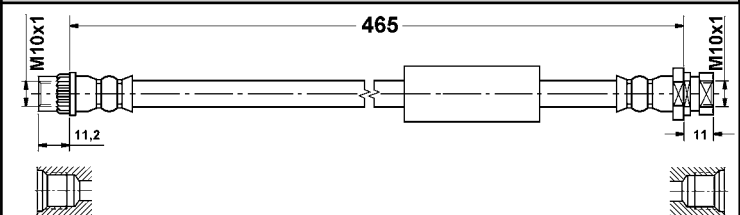

24.5252-0390.3 330702

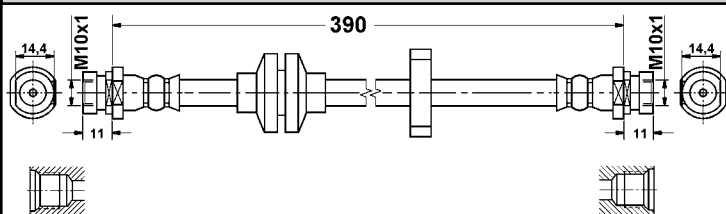

24.5256-0298.3 330756



24.5256-0318.3 331426

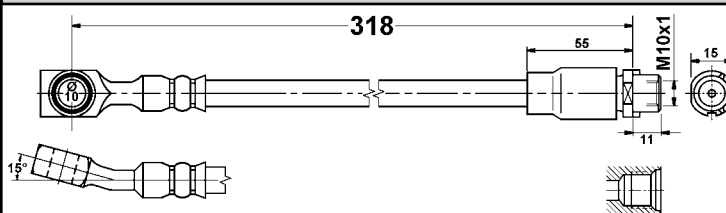

24.5258-0450.3 330824

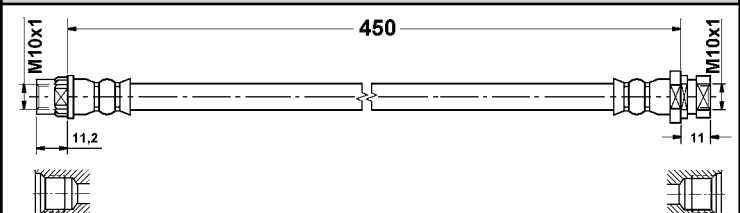

Abbildungen Bremsschläuche, Kupplungsschläuche

Illustrations brake hoses, clutch hoses - Illustrations fessibili freno, fessibili frizione - Illustrations Flexible de frein, Flexibles d'embrayages - Ilustraciones flexibles de freno, flexibles d'embrague

<p>24.5259-0315.3 330882</p>	<p>24.5260-0155.3 331156</p>
<p>24.5260-0280.3 330883</p>	<p>24.5261-0130.3 331387</p>
<p>24.5261-0195.3 331077</p>	<p>24.5261-0225.3 330909</p>
<p>24.5261-0255.3 331078</p>	<p>24.5261-0256.3 331246</p>
<p>24.5261-0291.3 330994</p>	<p>24.5262-0180.3 331180</p>
<p>24.5262-0501.3 331025</p>	<p>24.5262-0520.3 331349</p>
<p>24.5262-0521.3 331350</p>	<p>24.5262-0575.3 330922</p>

Abbildungen Bremsschläuche, Kupplungsschläuche

Illustrations brake hoses, clutch hoses - Illustrations fessibilli freno, fessibilli frizione - Illustrations Flexible de frein, Flexibles d'embrayages - Ilustraciones flexibles de freno, flexibles d'embrague

24.5262-0576.3 330923

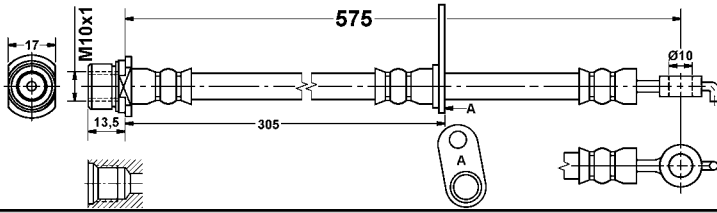

24.5263-0440.3 331282

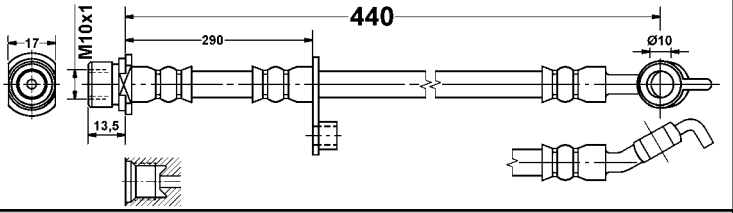

24.5263-0441.3 331283

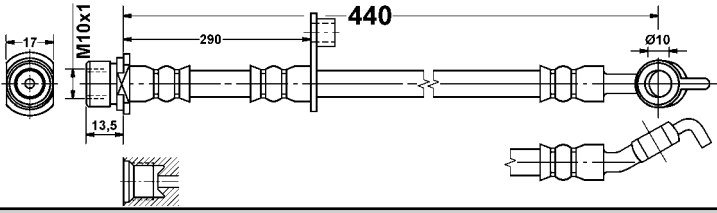

24.5263-0575.3 330924

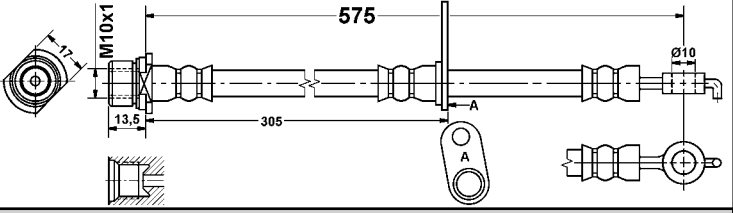

24.5263-0576.3 330925

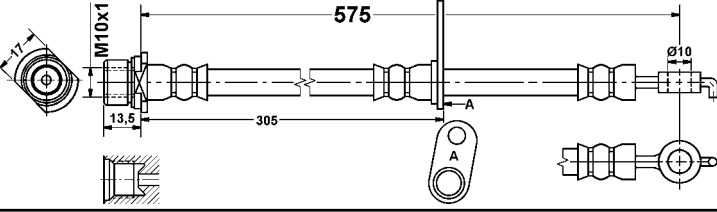

24.5263-0592.3 331284

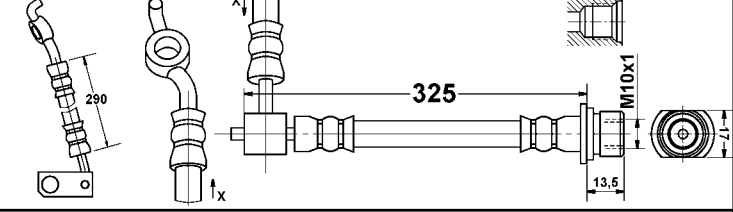

24.5263-0593.3 331285

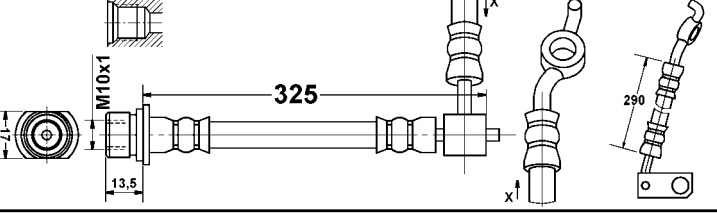

24.5263-0594.3 331286

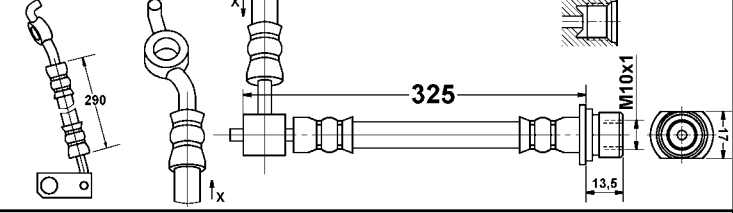

24.5263-0595.3 331287

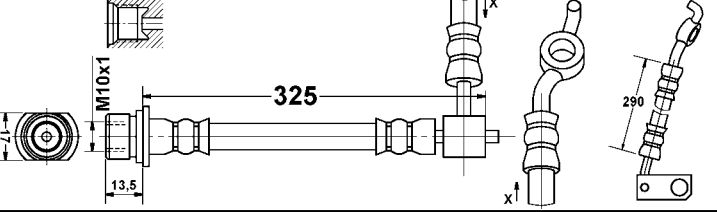

24.5264-0205.3 331059

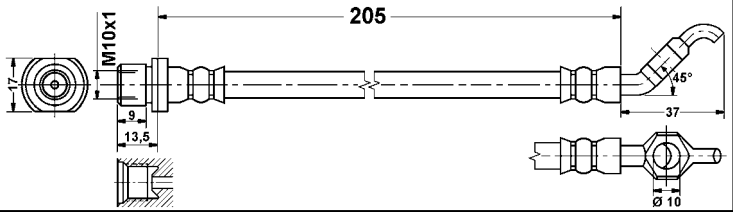

24.5264-0221.3 330995

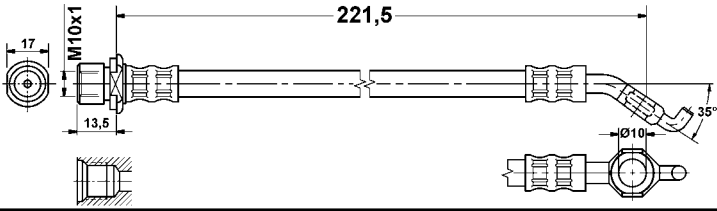

24.5264-0245.3 331133

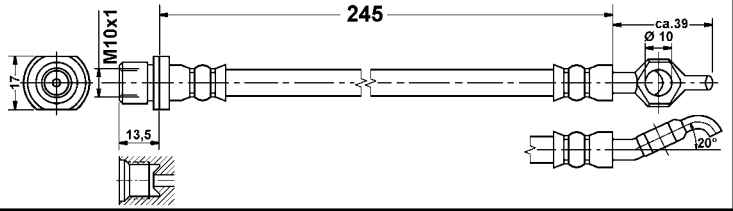

24.5264-0525.3 330926

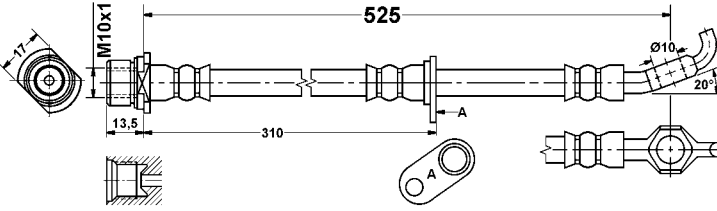

24.5264-0526.3 330927

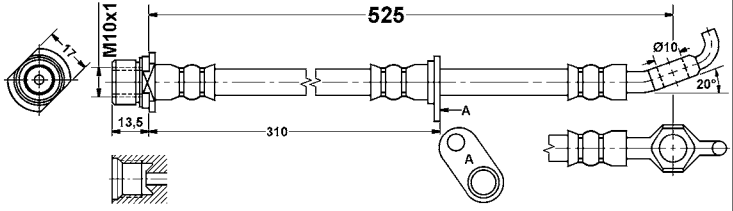

Abbildungen Bremsschläuche, Kupplungsschläuche

Illustrations brake hoses, clutch hoses - Illustrations fessibilli freno, fessibilli frizione - Illustrations Flexible de frein, Flexibles d'embrayages - Ilustraciones flexibles de freno, flexibles d'embrague

24.5265-0263.3 331157

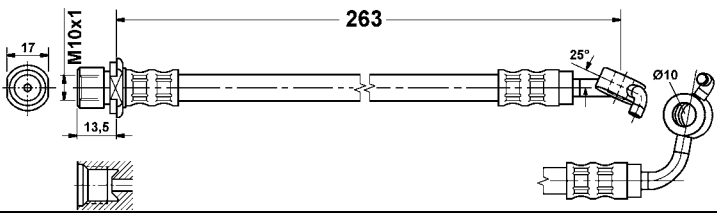

24.5265-0264.3 331158

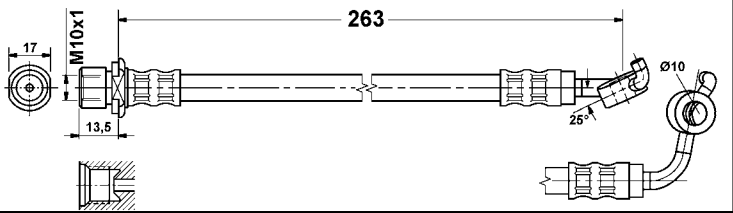

24.5265-0275.3 331069

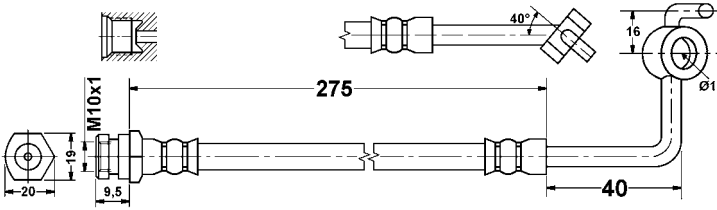

24.5265-0335.3 331070

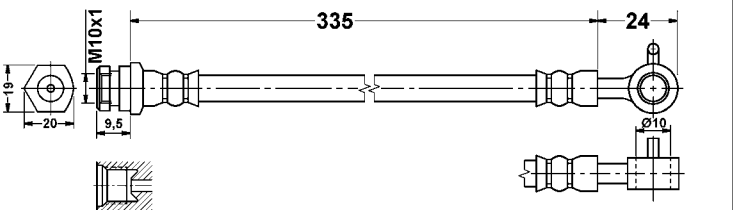

24.5265-0345.3 331091

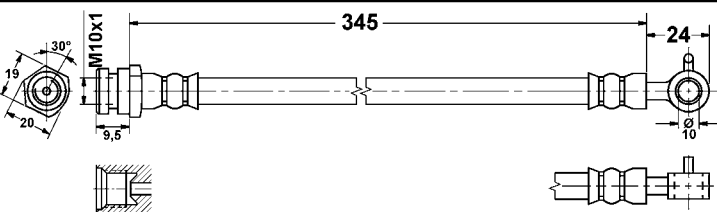

24.5265-0346.3 331092

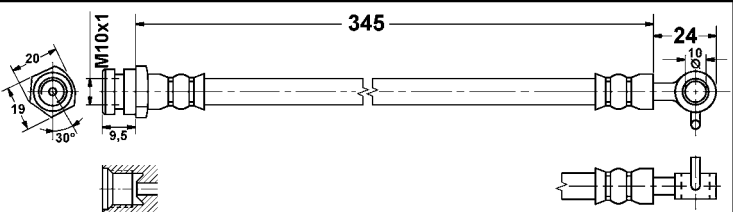

24.5265-0347.3 331405

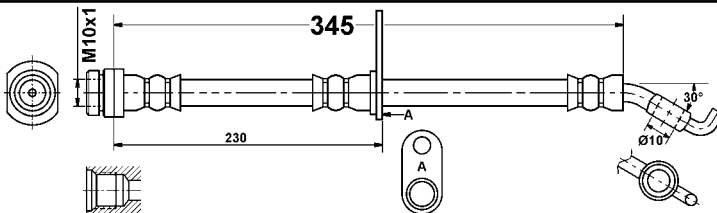

24.5265-0365.3 331159

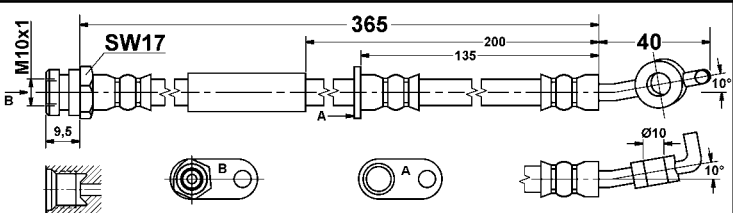

24.5265-0366.3 331160

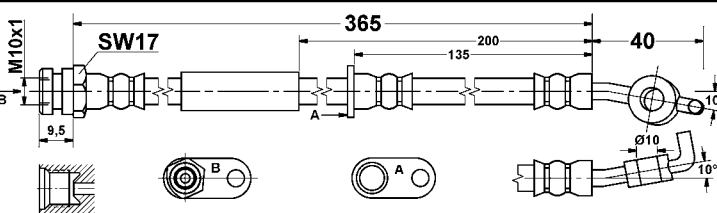

24.5265-0440.3 331351

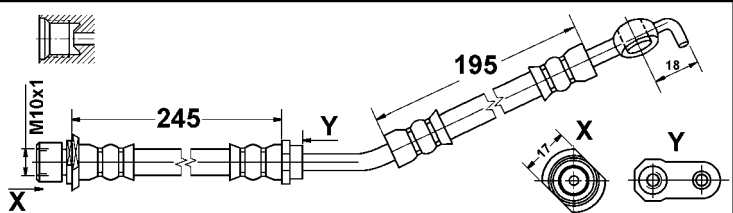

24.5265-0441.3 331352

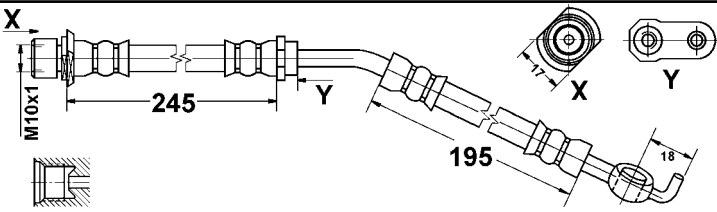

24.5265-0557.3 330928

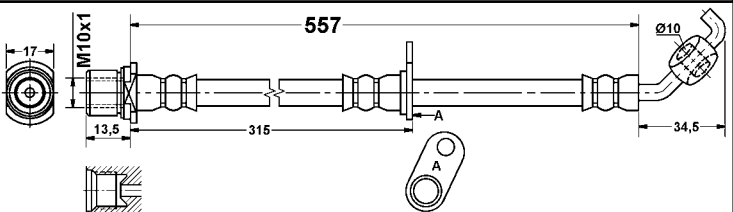

24.5265-0558.3 330929

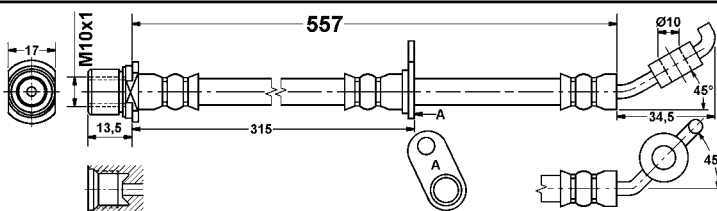

24.5266-0452.3 330930

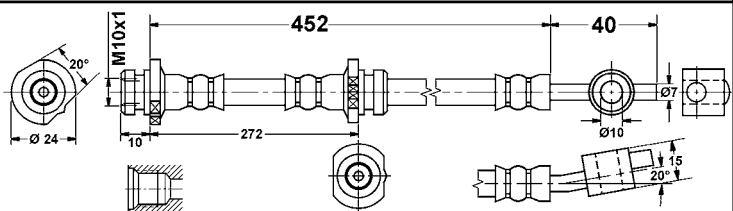

Abbildungen Bremsschläuche, Kupplungsschläuche

Illustrations brake hoses, clutch hoses - Illustrations fessibilli freno, fessibilli frizione - Illustrations Flexible de frein, Flexibles d'embrayages - Ilustraciones flexibles de freno, flexibles d'embrague

24.5266-0453.3 330931

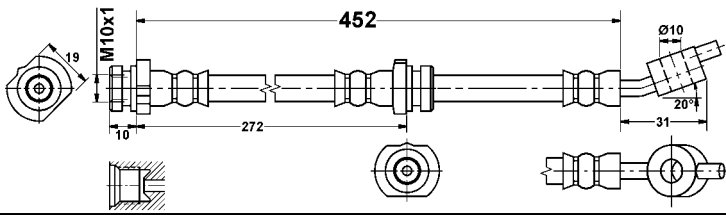

24.5266-0475.3 331139

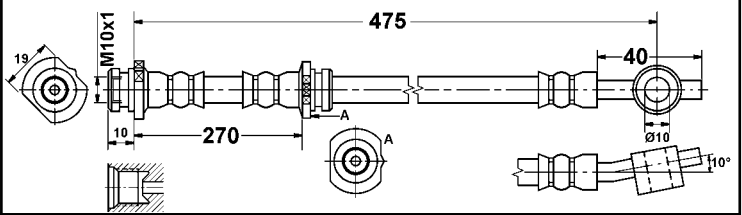

24.5266-0476.3 331140

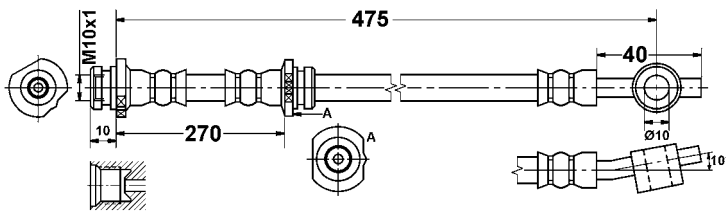

24.5266-0600.3 331161

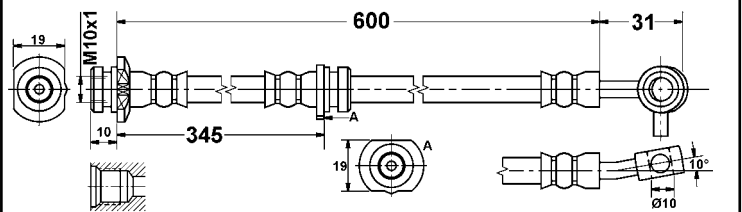

24.5266-0601.3 331162

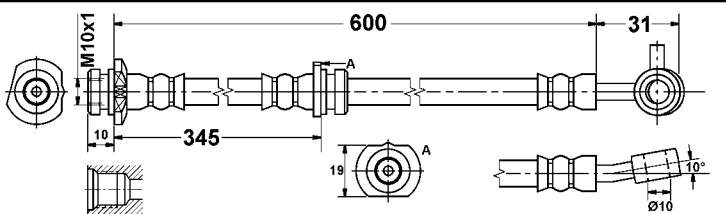

24.5267-0390.3 330932

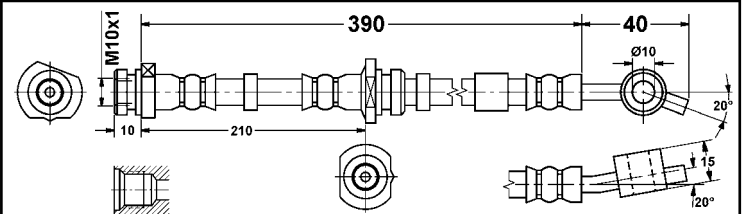

24.5267-0391.3 330974

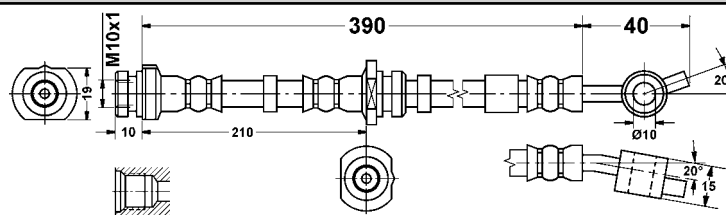

24.5267-0625.3 331332

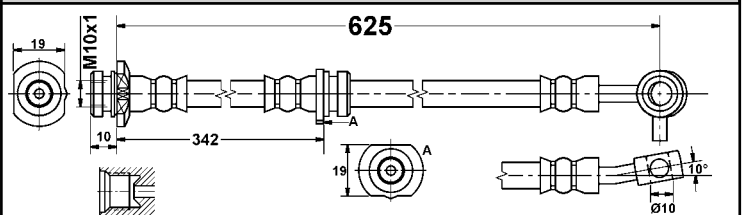

24.5267-0626.3 331333

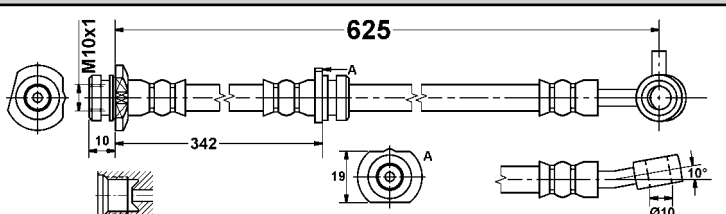

24.5268-0270.3 331072

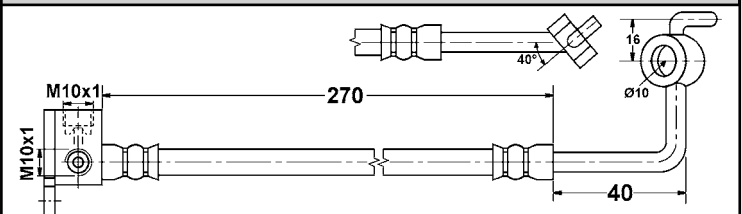

24.5268-0495.3 330933

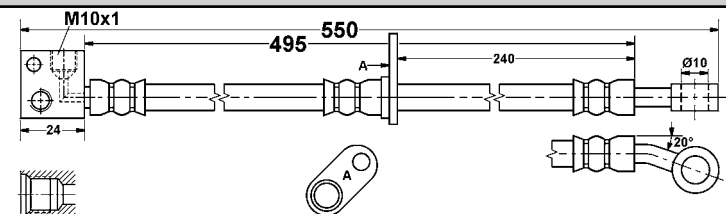

24.5268-0496.3 330934

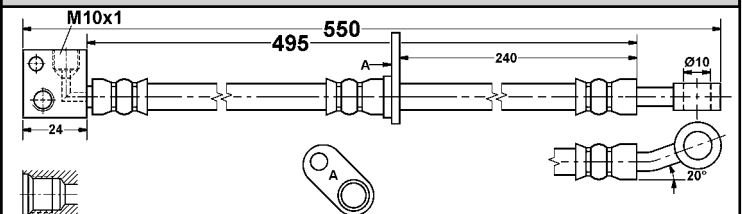

24.5268-0510.3 331143

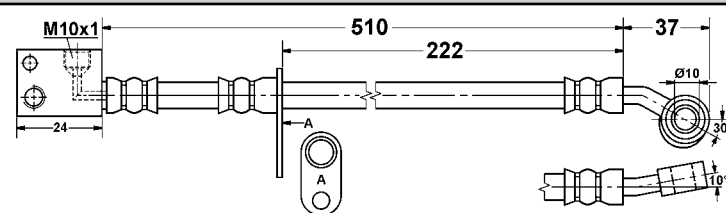

24.5268-0511.3 331144

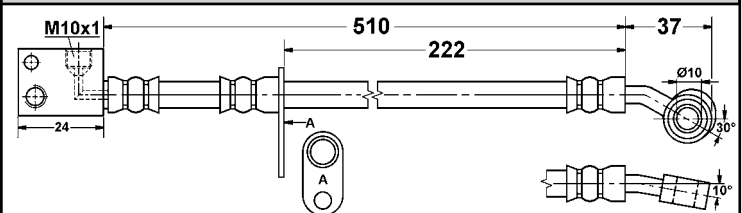

Abbildungen Bremsschläuche, Kupplungsschläuche

Illustrations brake hoses, clutch hoses - Illustrations fessibili freno, fessibili frizione - Illustrations Flexible de frein, Flexibles d'embrayages - Ilustraciones flexibles de freno, flexibles d'embrague

24.5268-0560.3 331345

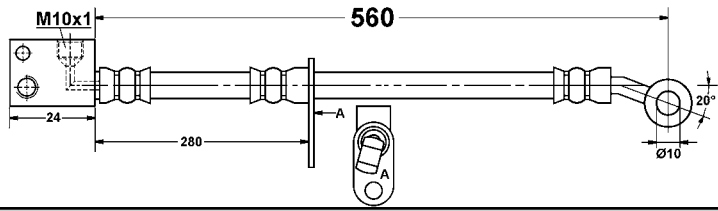

24.5268-0561.3 331346

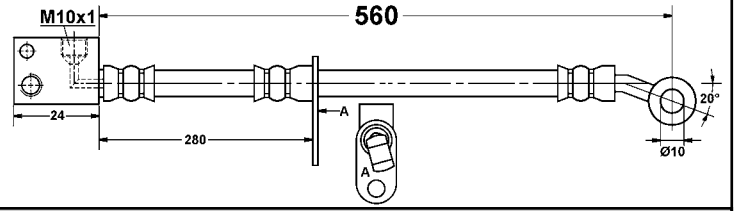

24.5269-0195.3 330935

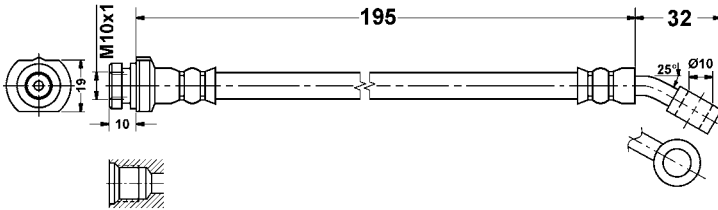

24.5269-0460.3 331026

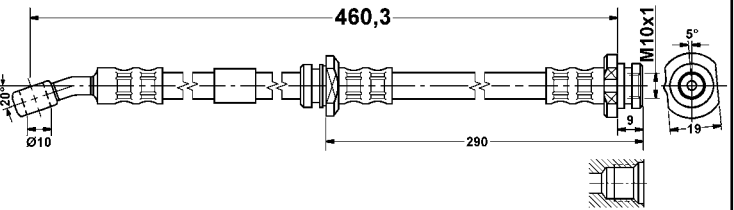

24.5269-0462.3 331027

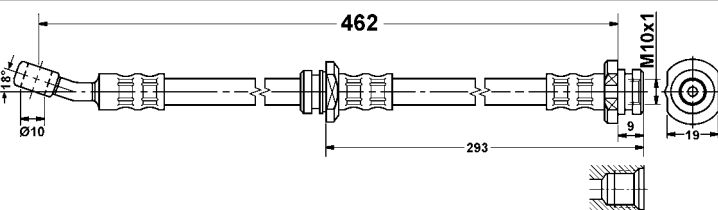

24.5270-0200.3 331247

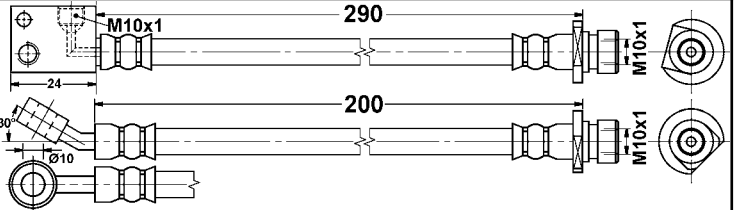

24.5270-0201.3 331248

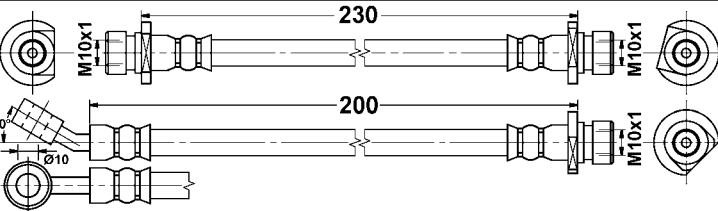

24.5270-0410.3 331181

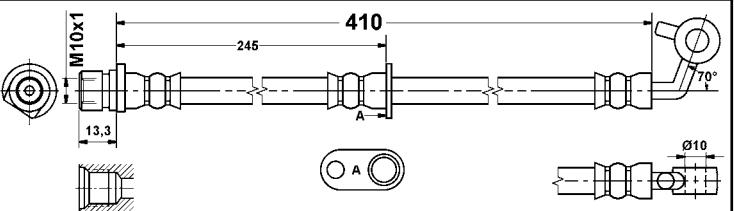

24.5270-0411.3 331182

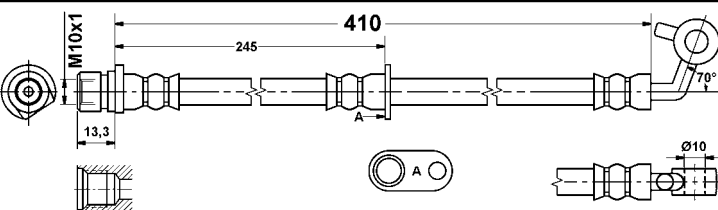

24.5270-0435.3 331134

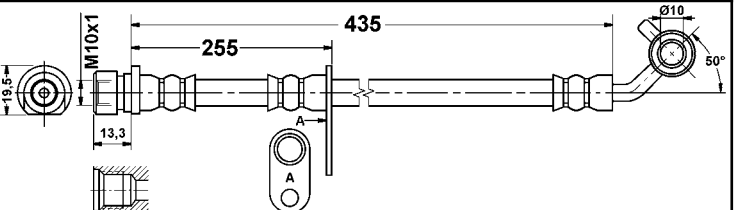

24.5270-0450.3 331183

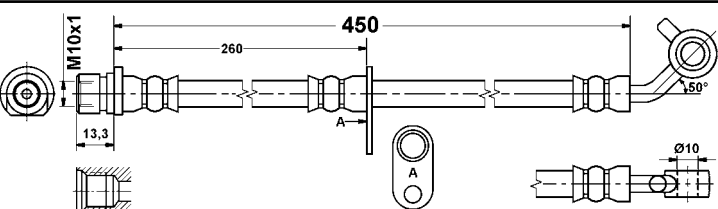

24.5270-0456.3 330996

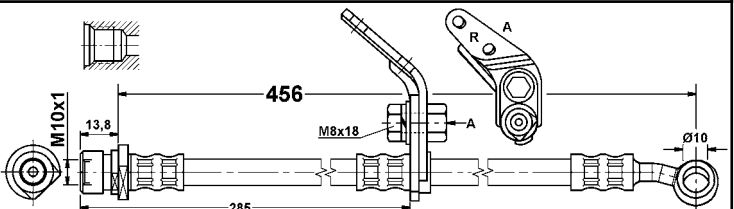

24.5270-0457.3 330997

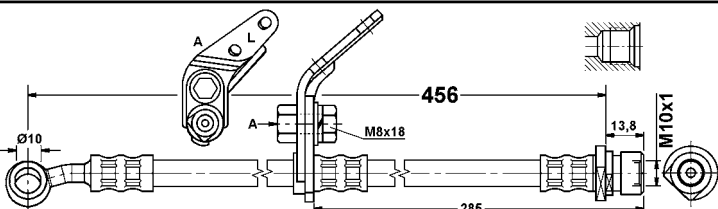

24.5270-0461.3 330998

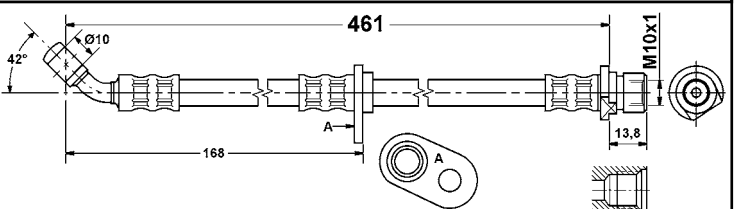

Abbildungen Bremsschläuche, Kupplungsschläuche

Illustrations brake hoses, clutch hoses - Illustrations fessibilli freno, fessibilli frizione - Illustrations Flexible de frein, Flexibles d'embrayages - Ilustraciones flexibles de freno, flexibles d'embrague

24.5270-0462.3 330999

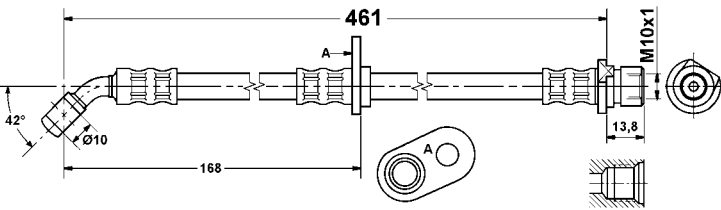

24.5270-0475.3 331467

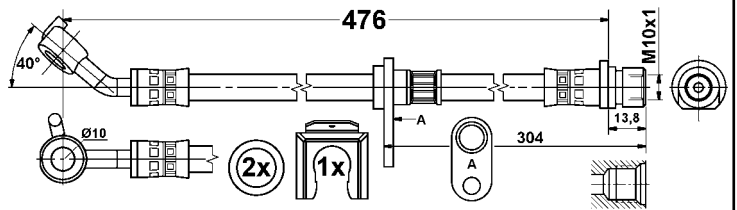

24.5270-0476.3 331468

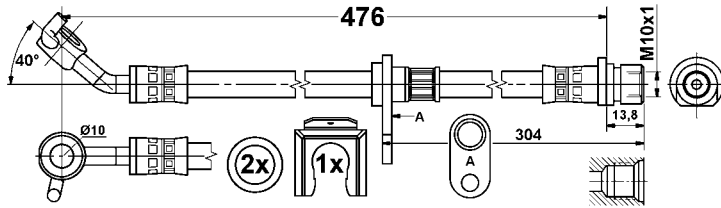

24.5270-0490.3 331079

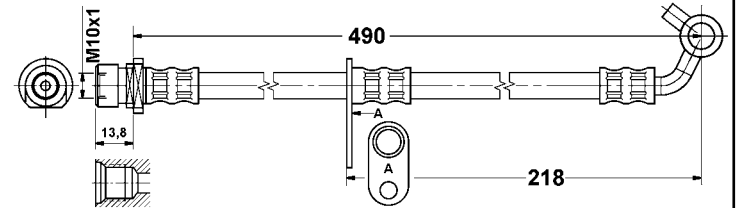

24.5270-0496.3 331469

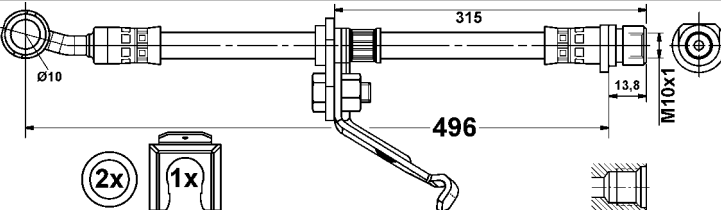

24.5270-0497.3 331470

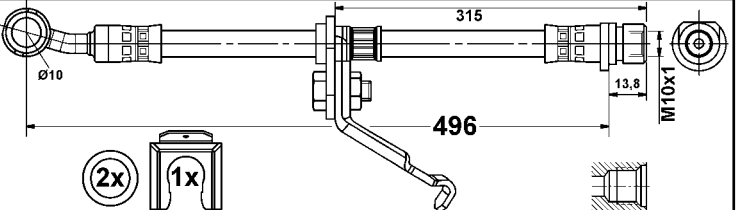

24.5270-0515.3 331145

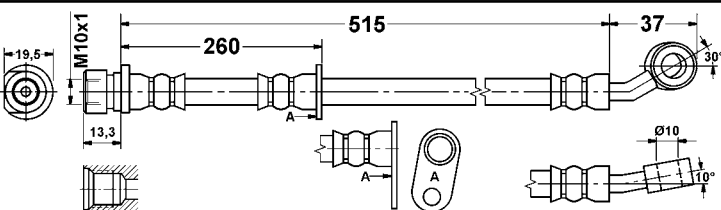

24.5270-0516.3 331146

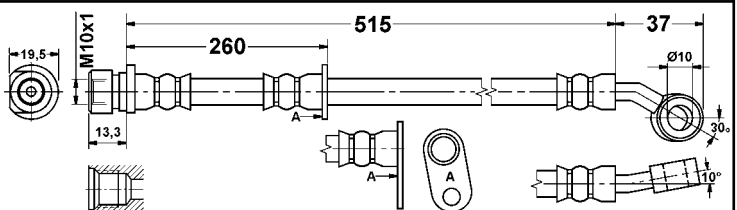

24.5270-0581.3 331000

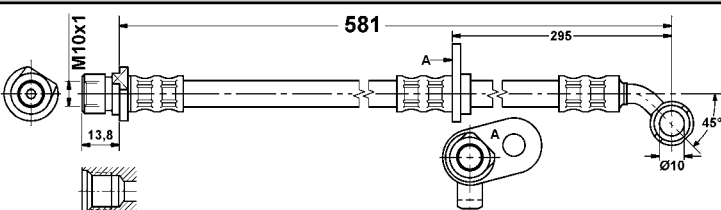

24.5270-0582.3 331001

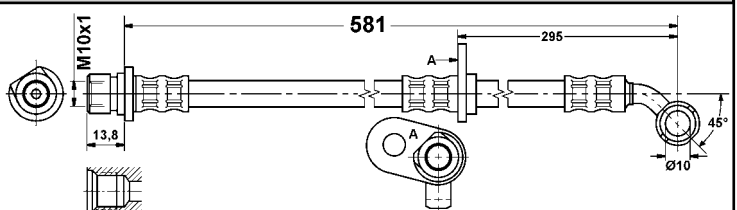

24.5272-0205.3 330975

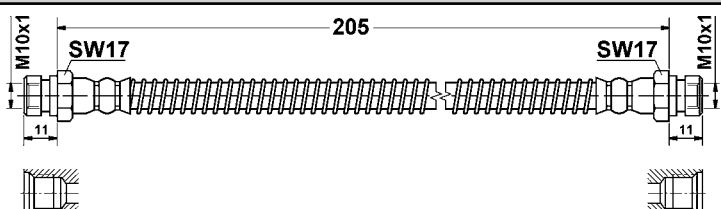

24.5272-0258.3 330939

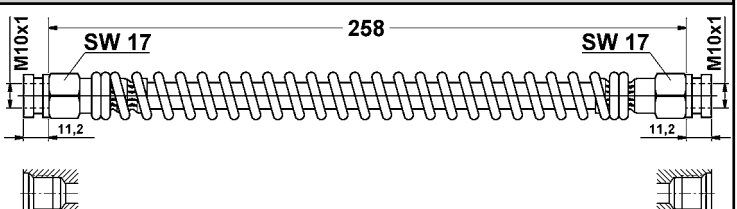

24.5273-0375.3 331147

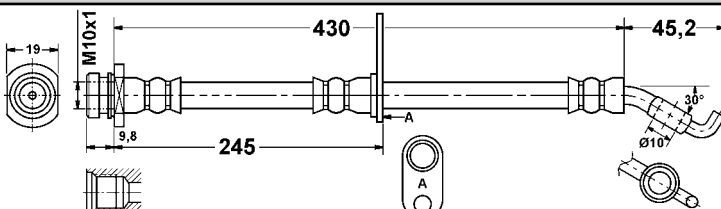

24.5273-0490.3 330940

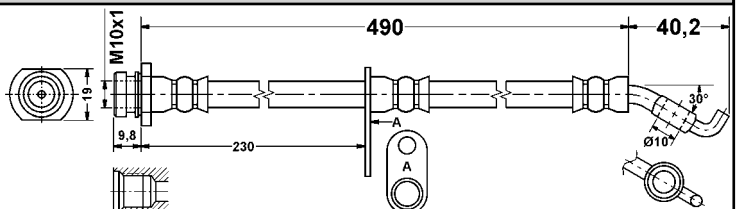

Abbildungen Bremsschläuche, Kupplungsschläuche

Illustrations brake hoses, clutch hoses - Illustrations fessibilli freno, fessibilli frizione - Illustrations Flexible de frein, Flexibles d'embrayages - Ilustraciones flexibles de freno, flexibles d'embrague

<p>24.5274-0180.3 330941</p>	<p>24.5275-0200.3 330942</p>
<p>24.5276-0240.3 330943</p>	<p>24.5277-0420.3 330944</p>
<p>24.5277-0530.3 331002</p>	<p>24.5277-0531.3 331003</p>
<p>24.5278-0335.3 330945</p>	<p>24.5278-0467.3 331073</p>
<p>24.5278-0652.3 331189</p>	<p>24.5278-0661.3 331190</p>
<p>24.5279-0180.3 331465</p>	<p>24.5279-0225.3 331163</p>
<p>24.5279-0300.3 331135</p>	<p>24.5279-0305.3 330946</p>



Abbildungen Bremsschläuche, Kupplungsschläuche

Illustrations brake hoses, clutch hoses - Illustrations fessibilli freno, fessibilli frizione - Illustrations

Flexible de frein, Flexibles d'embrayages - Ilustraciones flexibles de freno, flexibles d'embrague

24.5279-0360.3 331045

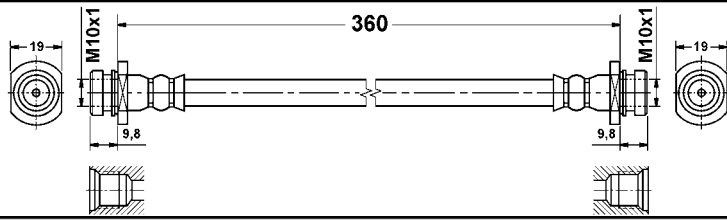

24.5281-0452.3 331436

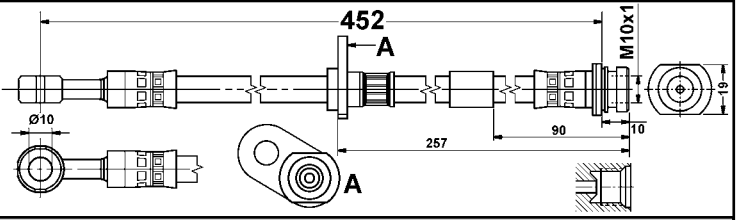

24.5281-0453.3 331437

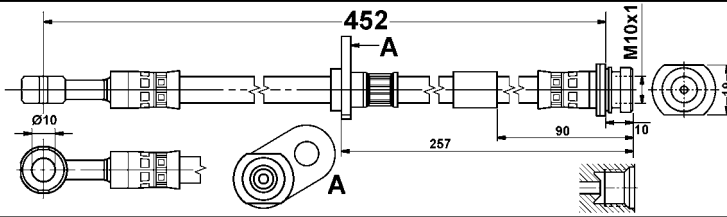

24.5281-0553.3 331004

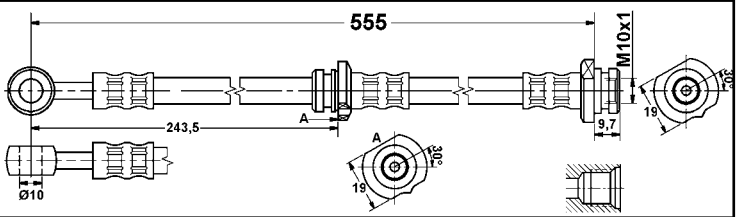

24.5281-0554.3 331005

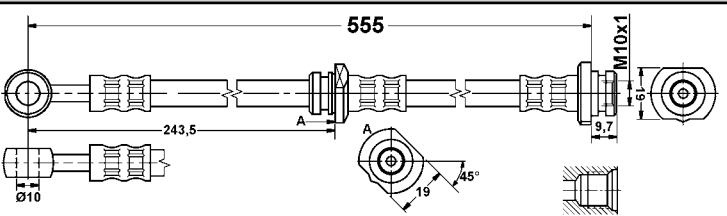

24.5281-0556.3 330955

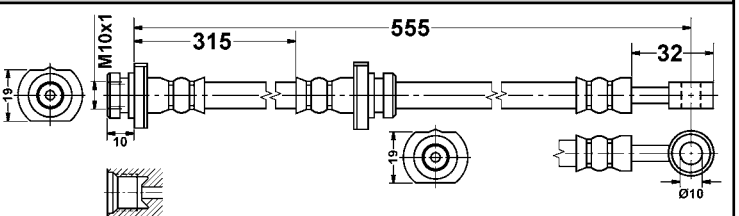

24.5281-0557.3 330956

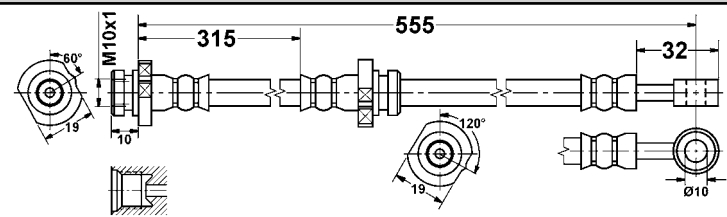

24.5281-0580.3 331006

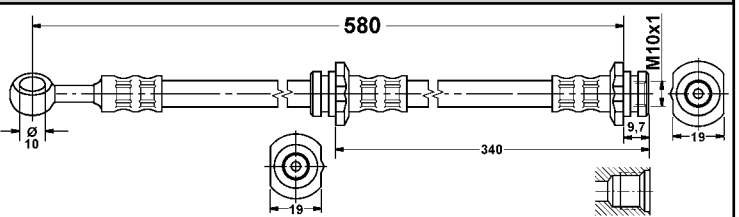

24.5281-0585.3 331007

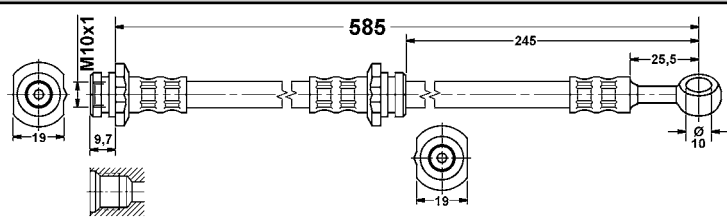

24.5281-0640.3 330968

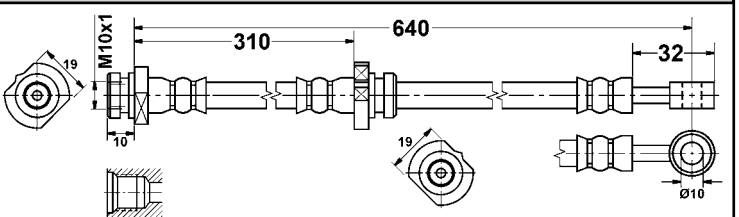

24.5281-0641.3 330969

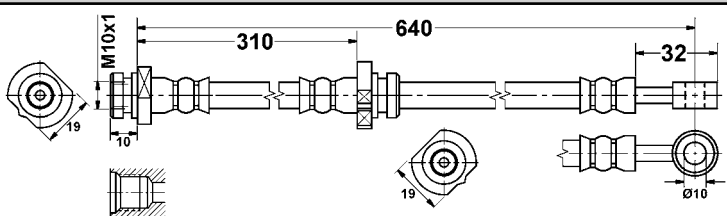

24.5283-0403.3 331136

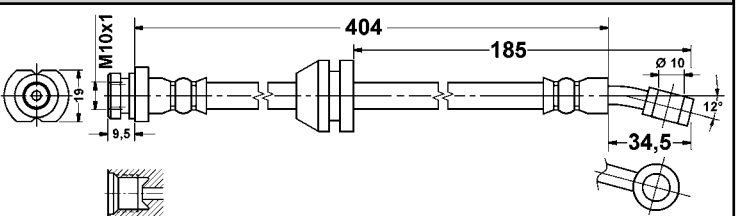

24.5283-0470.3 330959

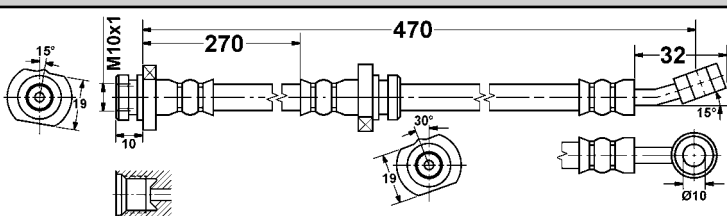

24.5283-0471.3 330960

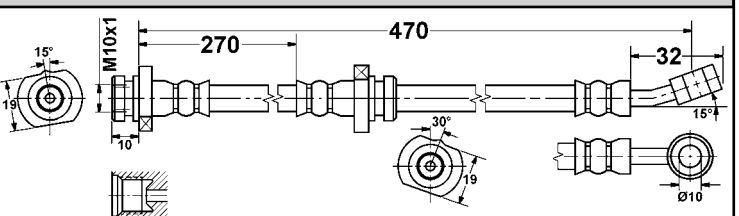

Abbildungen Bremsschläuche, Kupplungsschläuche

Illustrations brake hoses, clutch hoses - Illustrations fessibili freno, fessibili frizione - Illustrations Flexible de frein, Flexibles d'embrayages - Ilustraciones flexibles de freno, flexibles d'embrague

<p>24.5284-0220.3 330970</p>	<p>24.5284-0283.3 331080</p>
<p>24.5284-0400.3 331060</p>	<p>24.5285-0240.3 330976</p>
<p>24.5285-0265.3 331184</p>	<p>24.5285-0269.3 331137</p>
<p>24.5286-0265.3 331046</p>	<p>24.5286-0340.3 330977</p>
<p>24.5286-0341.3 330989</p>	<p>24.5286-0342.3 331138</p>
<p>24.5286-0400.3 331375</p>	<p>24.5286-0401.3 331376</p>
<p>24.5286-0405.3 331061</p>	<p>24.5286-0485.3 331172</p>

Abbildungen Bremsschläuche, Kupplungsschläuche

Illustrations brake hoses, clutch hoses - Illustrations fessibilli freno, fessibilli frizione - Illustrations Flexible de frein, Flexibles d'embrayages - Ilustraciones flexibles de freno, flexibles d'embrague

24.5286-0488.3 331221

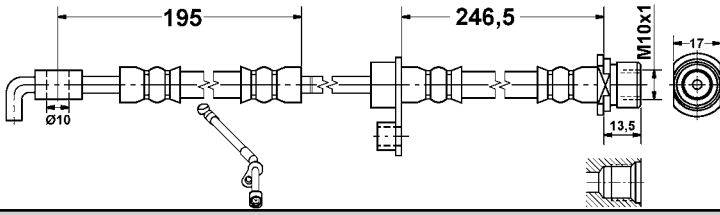

24.5286-0489.3 331222

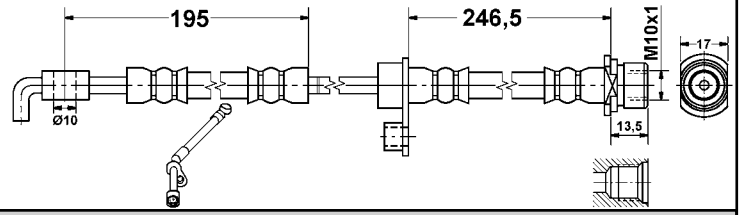

24.5286-0524.3 331223

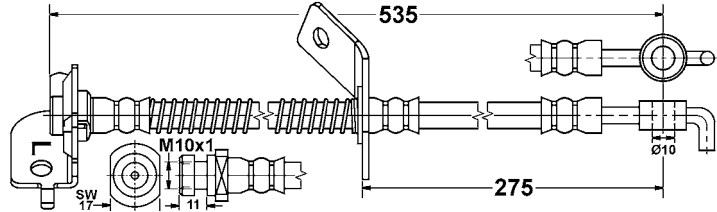

24.5286-0525.3 331224

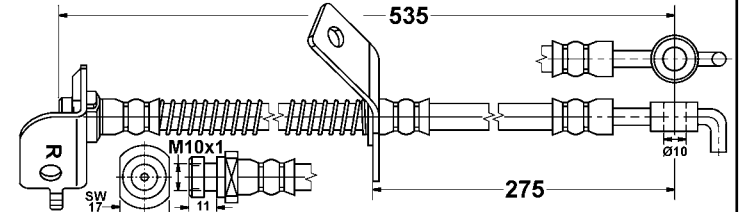

24.5286-0540.3 331249

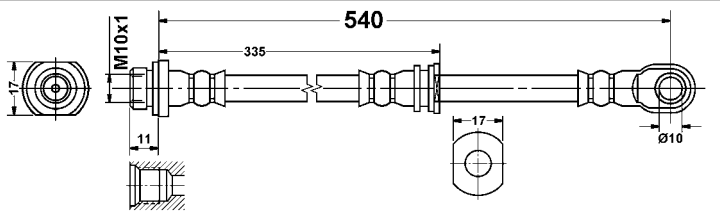

24.5286-0545.3 331250

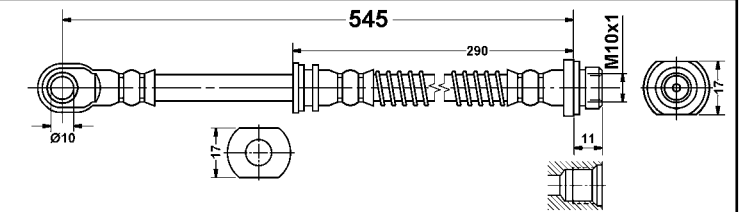

24.5286-0556.3 331251

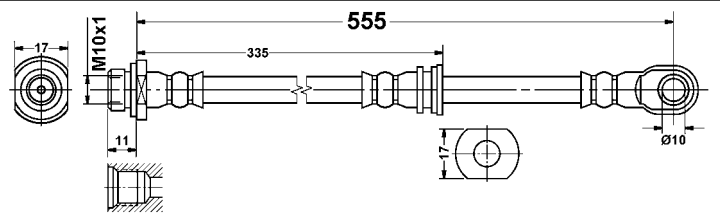

24.5286-0600.3 331173

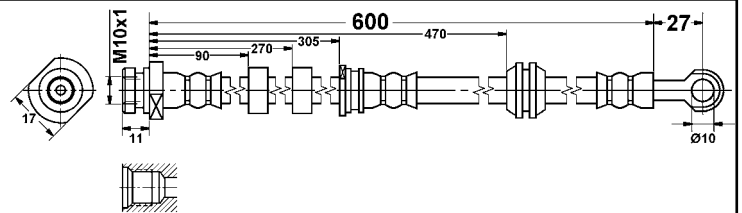

24.5286-0601.3 331174

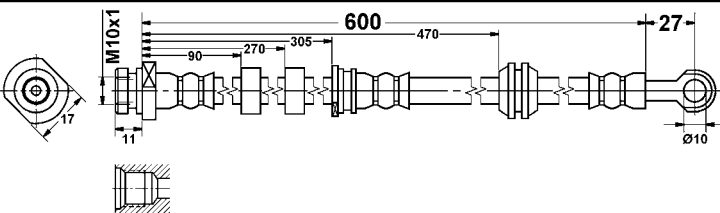

24.5286-0615.3 331493

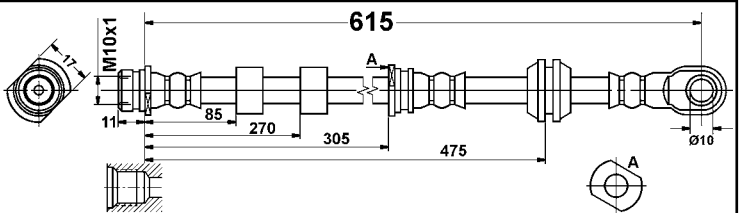

24.5286-0660.3 331252

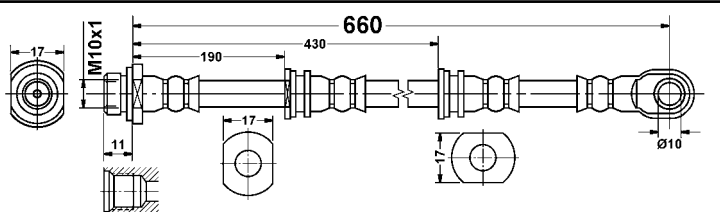

24.5287-0441.3 331008

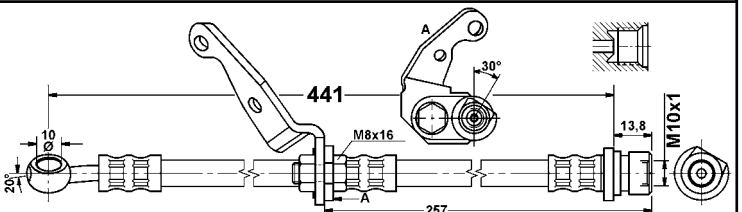

24.5287-0442.3 331009

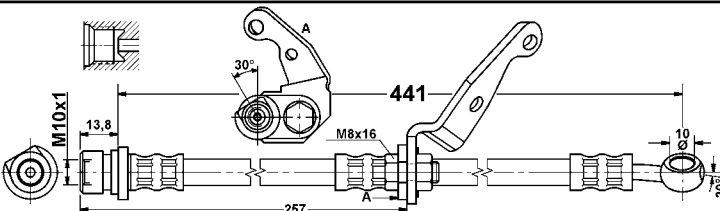

24.5287-0451.3 331010

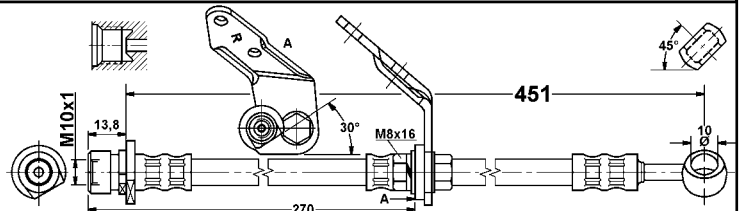

Abbildungen Bremsschläuche, Kupplungsschläuche

Illustrations brake hoses, clutch hoses - Illustrations fessibili freno, fessibili frizione - Illustrations Flexible de frein, Flexibles d'embrayages - Ilustraciones flexibles de freno, flexibles d'embrague

24.5287-0452.3 331011

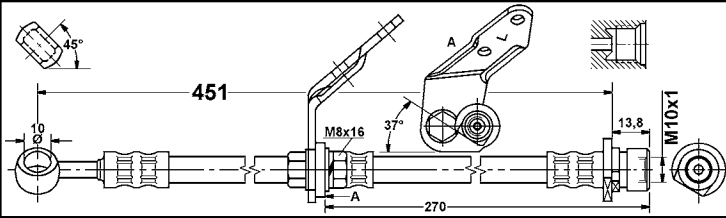

24.5288-0265.3 331062

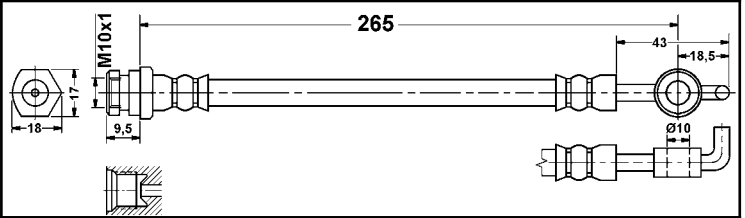

24.5288-0270.3 331227

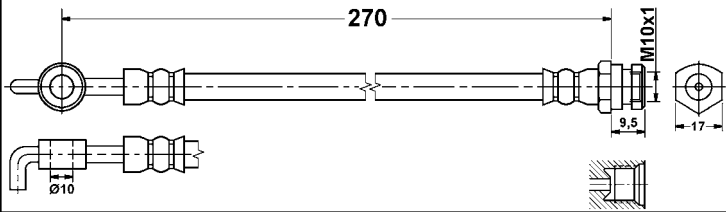

24.5288-0295.3 331185

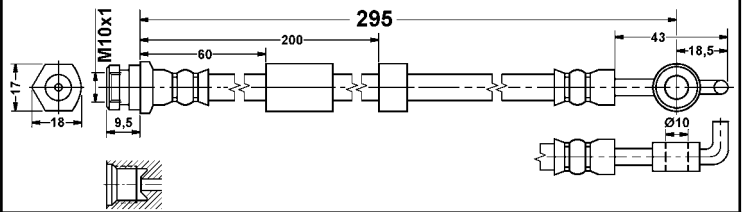

24.5288-0375.3 331012

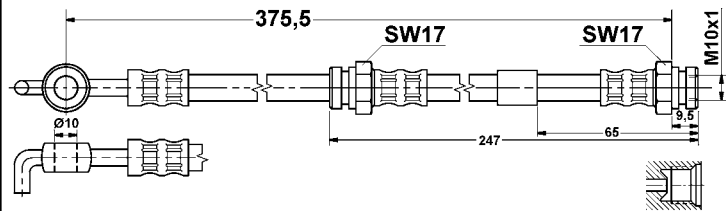

24.5289-0277.3 331013

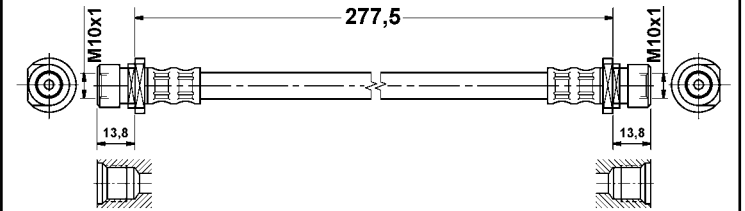

24.5289-0425.3 331388

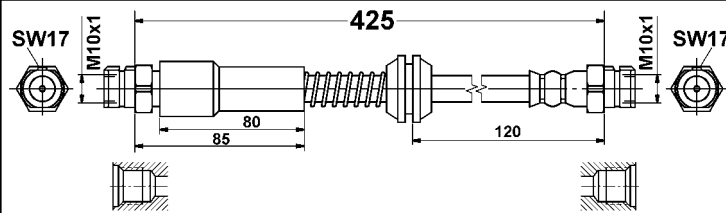

24.5289-0432.3 331377

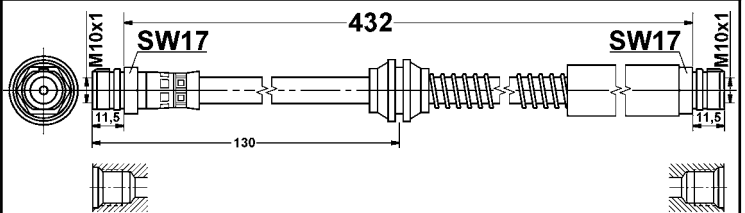

24.5289-0490.3 331389

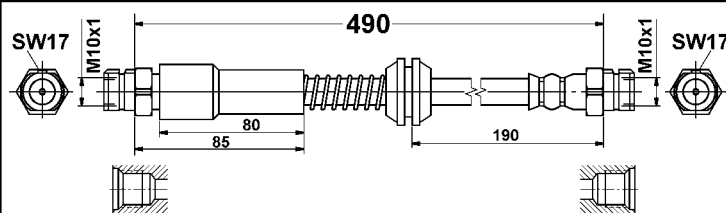

24.5289-0495.3 331457

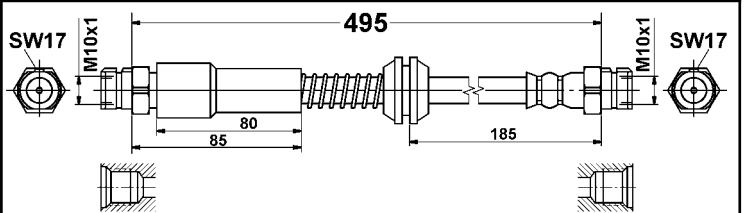

24.5290-0180.3 331028

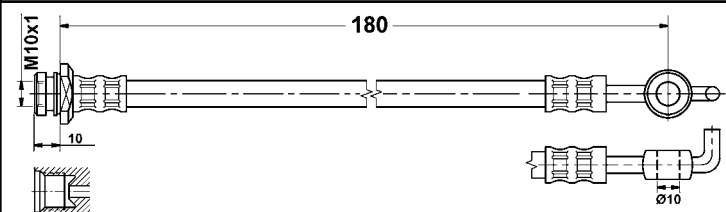

24.5290-0240.3 331334

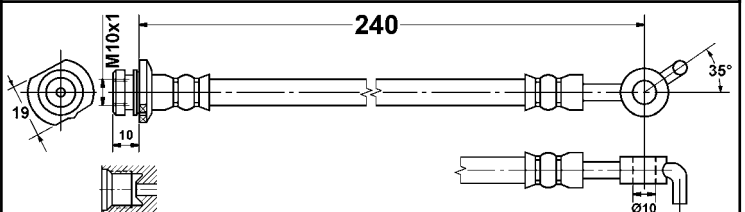

24.5290-0241.3 331335

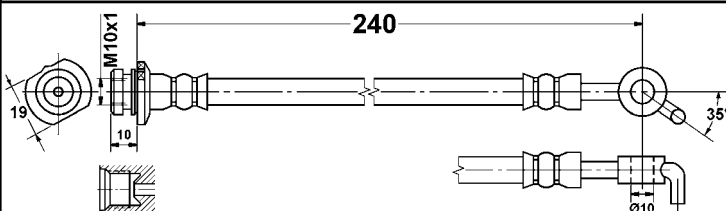

24.5290-0410.3 331081

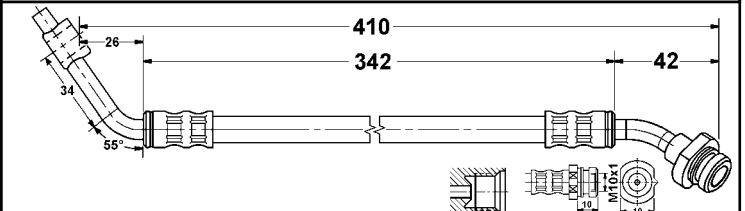

Abbildungen Bremsschläuche, Kupplungsschläuche

Illustrations brake hoses, clutch hoses - Illustrations fessibilli freno, fessibilli frizione - Illustrations Flexible de frein, Flexibles d'embrayages - Ilustraciones flexibles de freno, flexibles d'embrague

24.5290-0414.3 331175

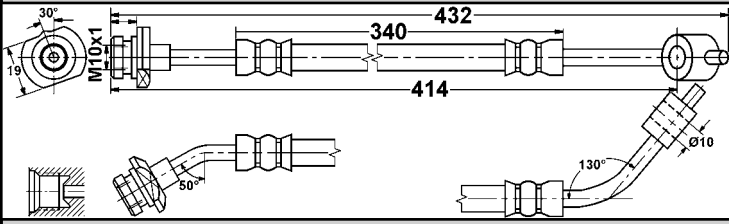

24.5290-0439.3 331176

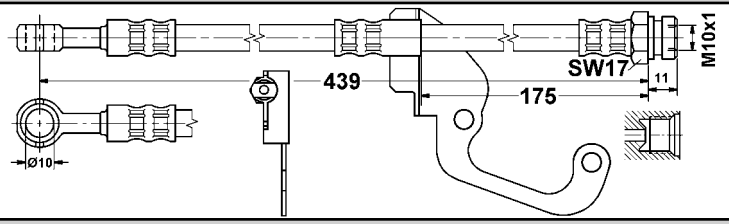

24.5290-0440.3 331177

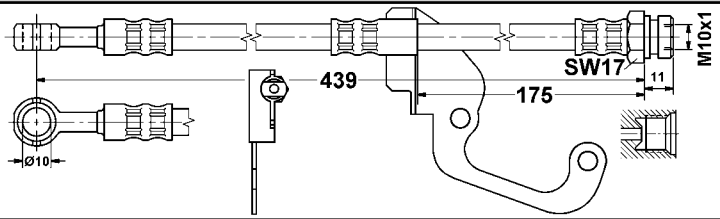

24.5290-0485.3 331082

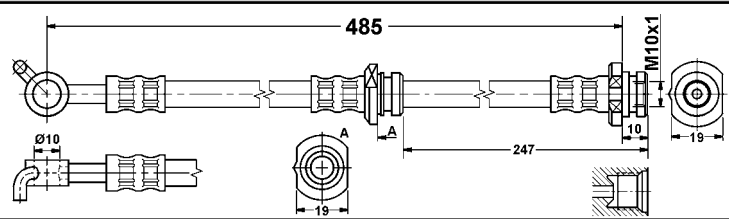

24.5290-0486.3 331178

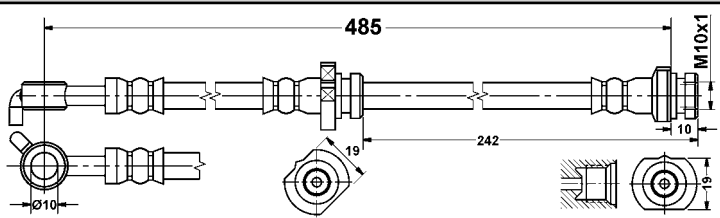

24.5290-0502.3 331164

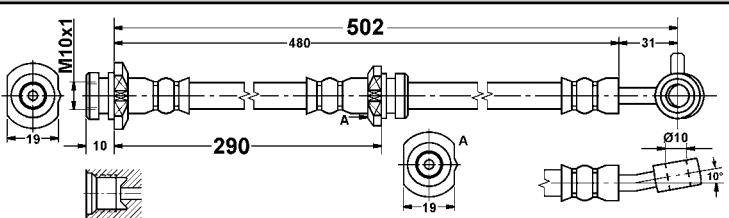

24.5290-0505.3 331083

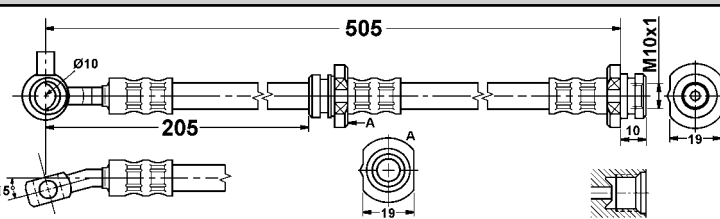

24.5290-0545.3 331063

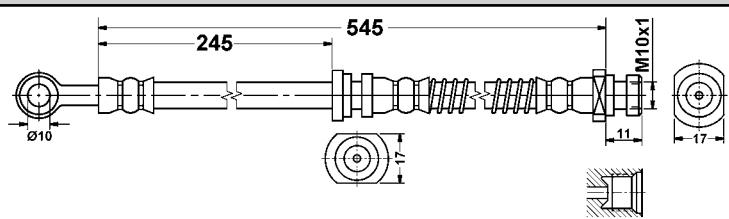

24.5291-0345.3 331165

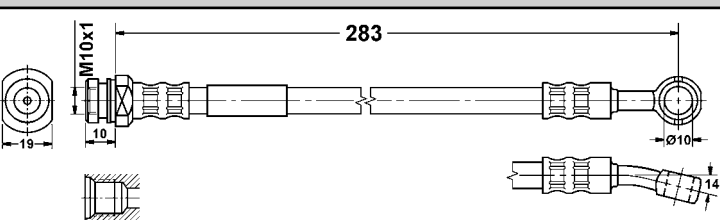

24.5291-0425.3 331029

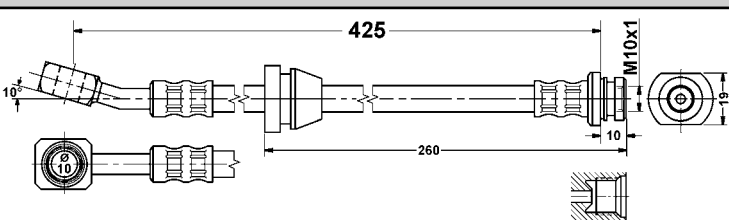

24.5291-0430.3 331084

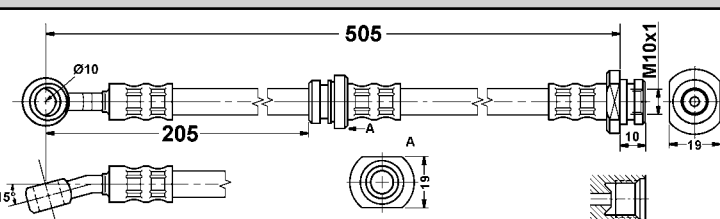

24.5291-0508.3 331085

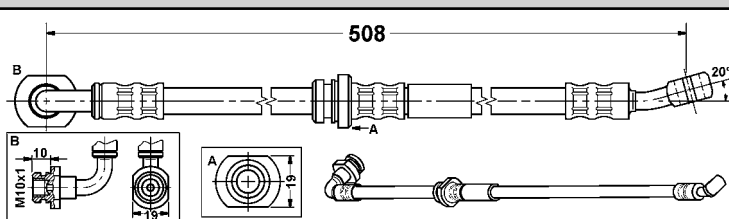

24.5291-0755.3 331195

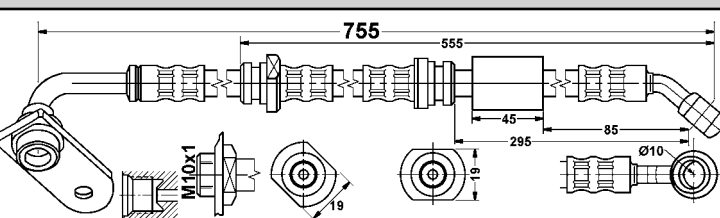

24.5291-0756.3 331196

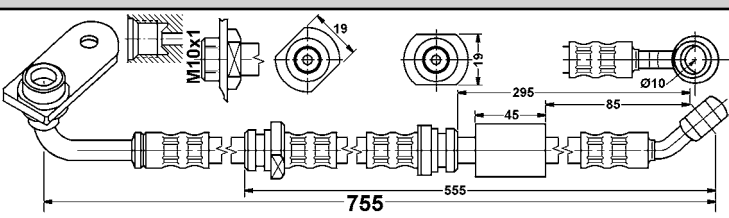

Abbildungen Bremsschläuche, Kupplungsschläuche

Illustrations brake hoses, clutch hoses - Illustrations fessibili freno, fessibili frizione - Illustrations Flexible de frein, Flexibles d'embrayages - Ilustraciones flexibles de freno, flexibles d'embrague

24.5292-0240.3 331225

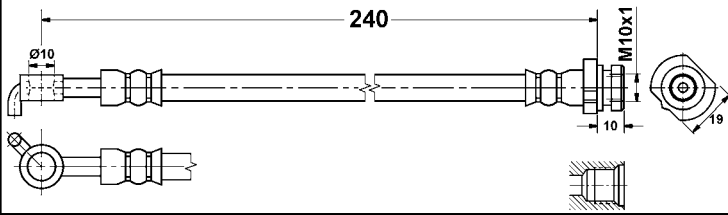

24.5292-0241.3 331226

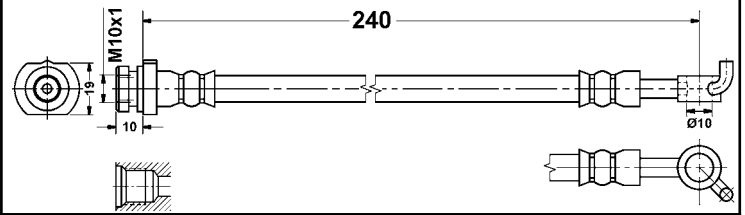

24.5292-0605.3 331030

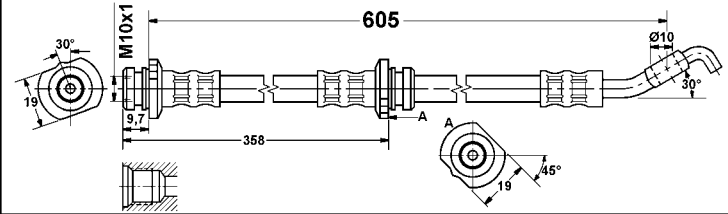

24.5293-0567.3 331438

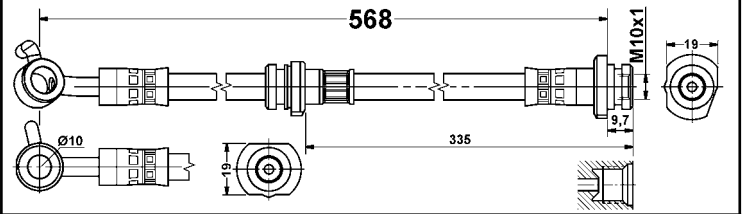

24.5293-0605.3 331031

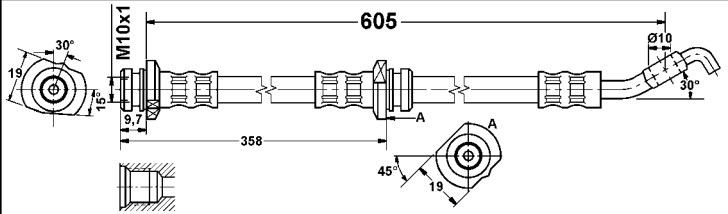

24.5293-0635.3 331440

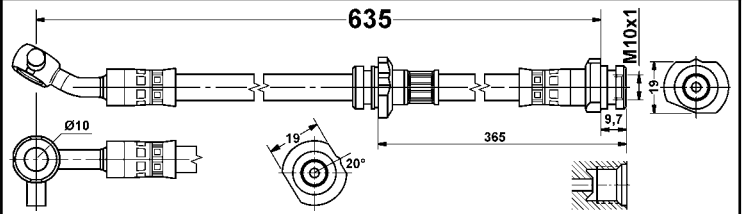

24.5293-0636.3 331441

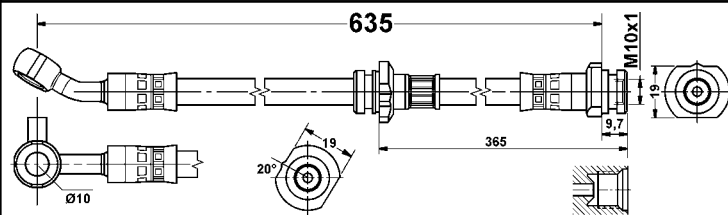

24.5294-0463.3 331032

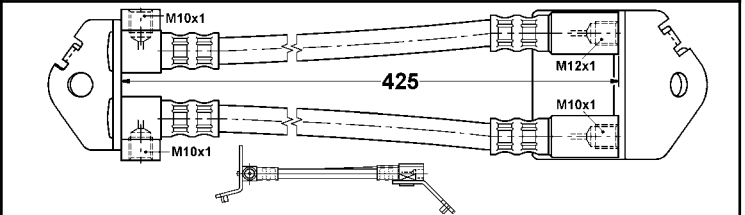

24.5295-0496.3 331033

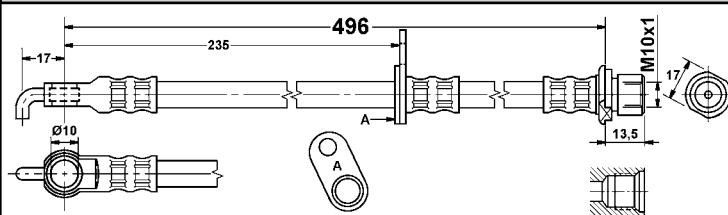

24.5295-0525.3 331353

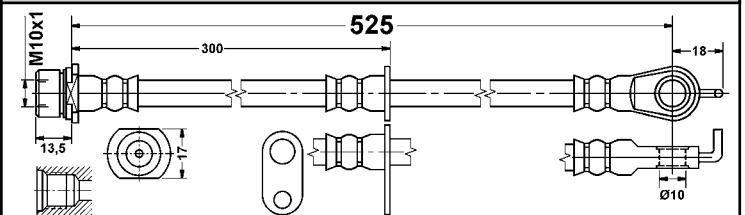

24.5295-0526.3 331354

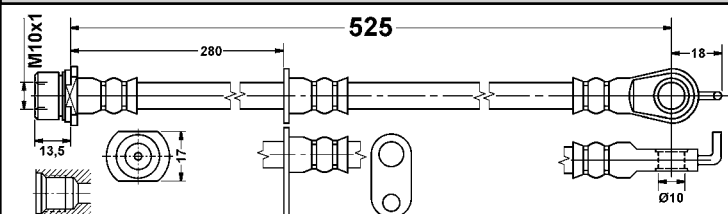

24.5295-0680.3 331355

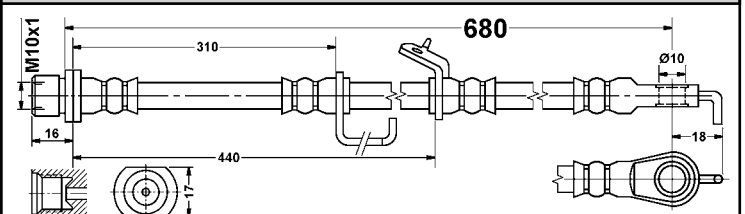

24.5295-0681.3 331356

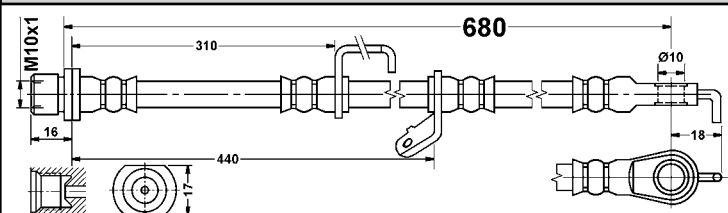

24.5296-0280.3 331034

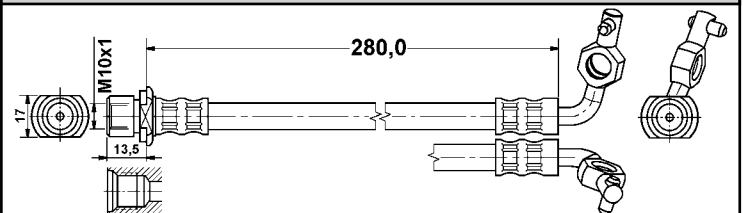

Abbildungen Bremsschläuche, Kupplungsschläuche

Illustrations brake hoses, clutch hoses - Illustrations fessibilli freno, fessibilli frizione - Illustrations Flexible de frein, Flexibles d'embrayages - Ilustraciones flexibles de freno, flexibles d'embrague

24.5296-0281.3 331035

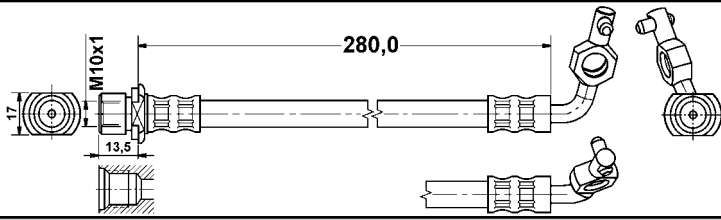

24.5296-0563.3 331483

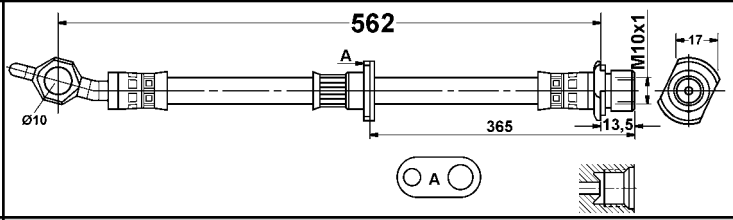

24.5296-0720.3 331494

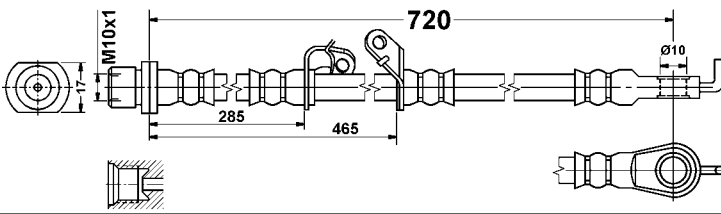

24.5297-0272.3 331036

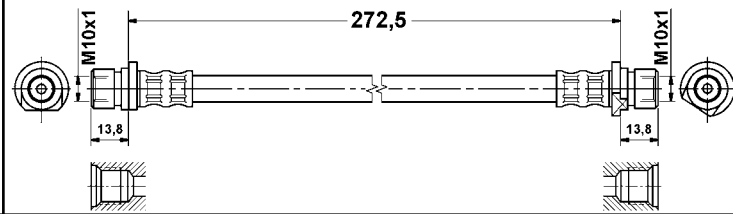

24.5297-0332.3 331037

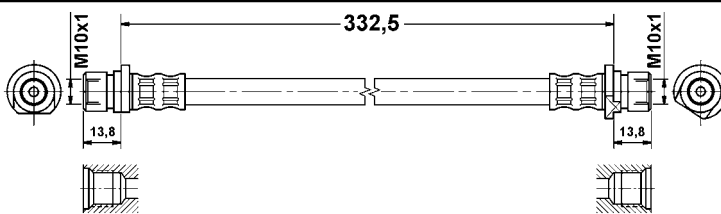

24.5297-0385.3 331047

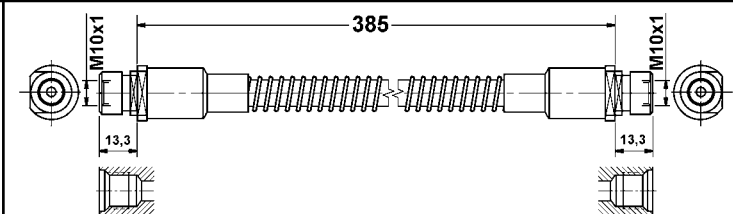

24.5298-0270.3 331086

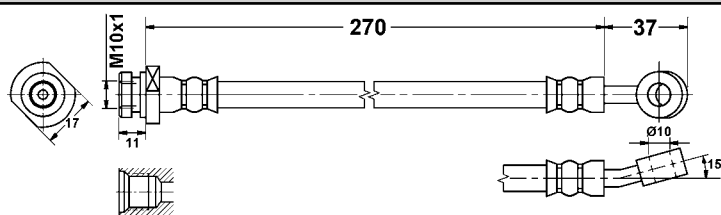

24.5298-0271.3 331087

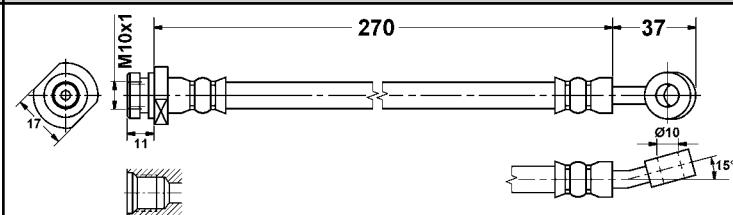

24.5298-0322.3 331314

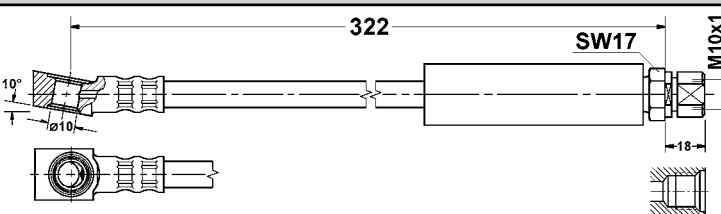

24.5298-0464.3 331358

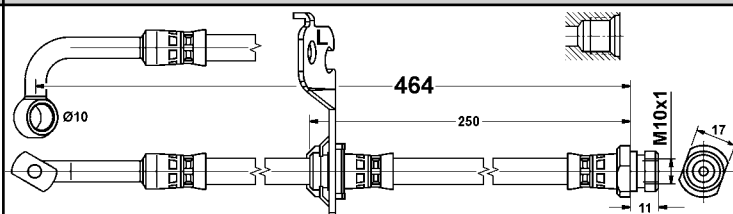

24.5298-0465.3 331359

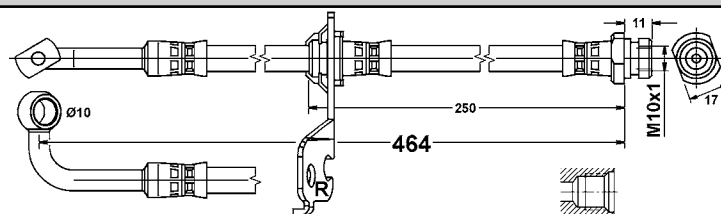

24.5298-0469.3 331191

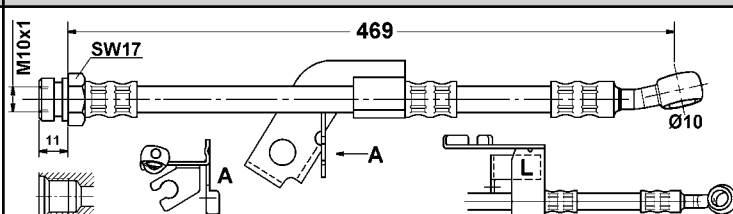

24.5298-0470.3 331192

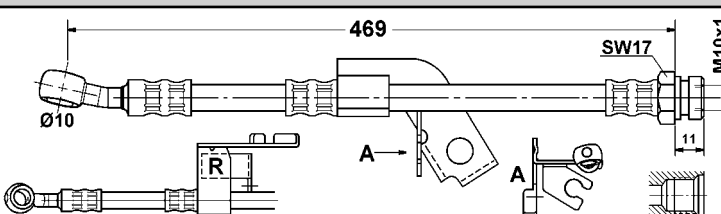

24.5298-0475.3 331255

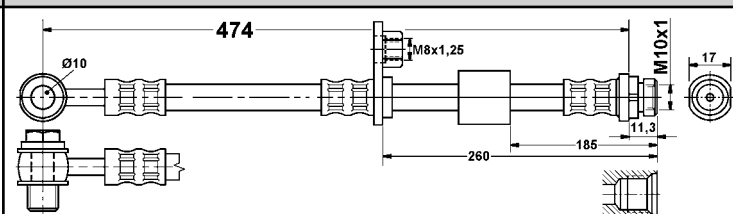

Abbildungen Bremsschläuche, Kupplungsschläuche

Illustrations brake hoses, clutch hoses - Illustrations fessibili freno, fessibili frizione - Illustrations Flexible de frein, Flexibles d'embrayages - Ilustraciones flexibles de freno, flexibles d'embrague

24.5298-0514.3 331088

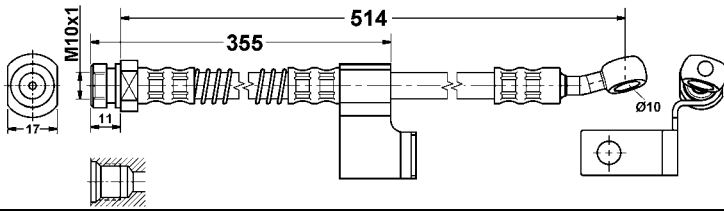

24.5298-0515.3 331166

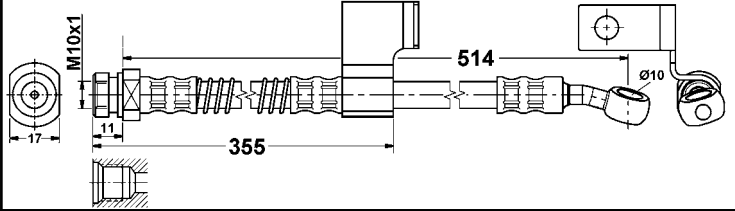

24.5299-0309.3 331315

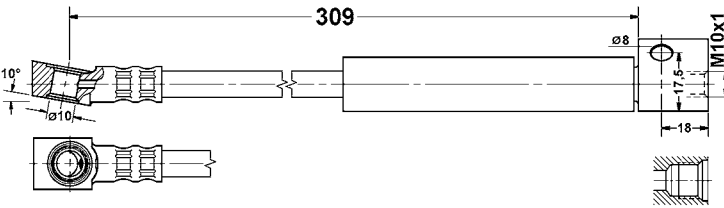

24.5299-0449.3 331039

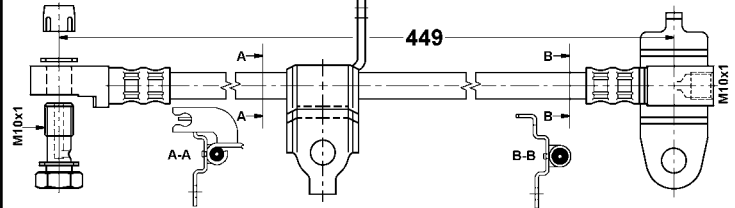

24.5299-0452.3 331040

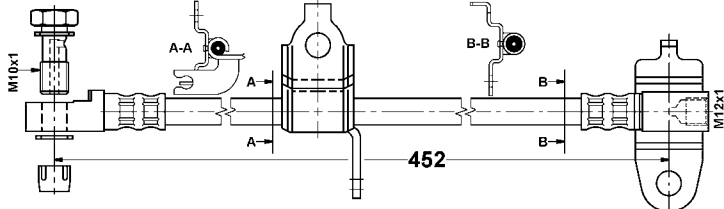

24.5302-0295.3 330403

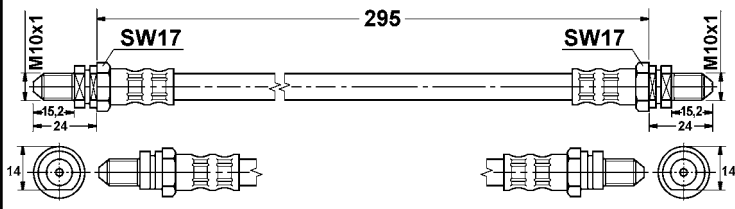

24.5302-0296.3 330476

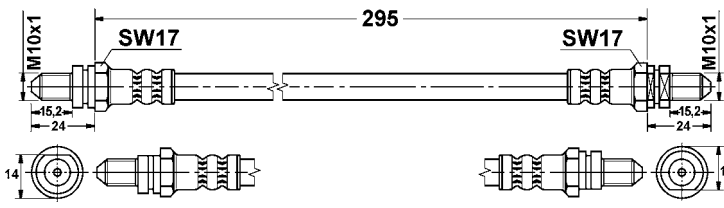

24.5303-0275.3 331213

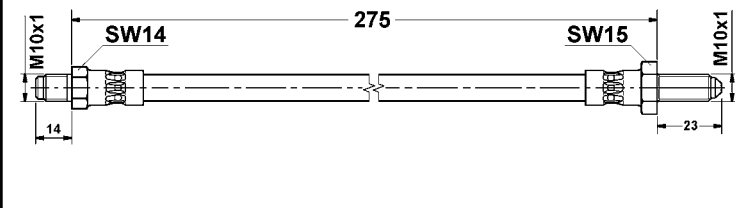

24.5303-0400.3 330404

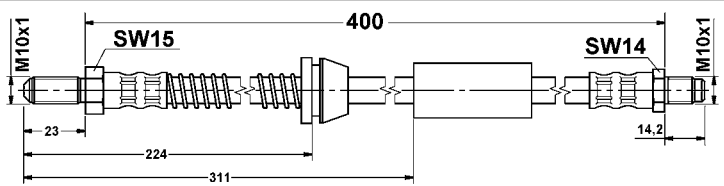

24.5303-0455.3 330588

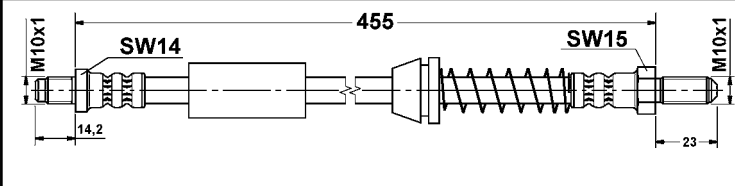

24.5304-0280.3 330589

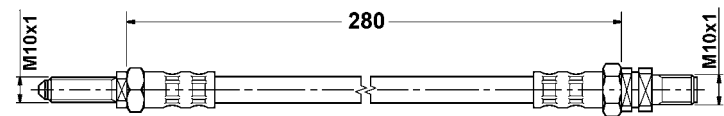

24.5305-0295.3 330657

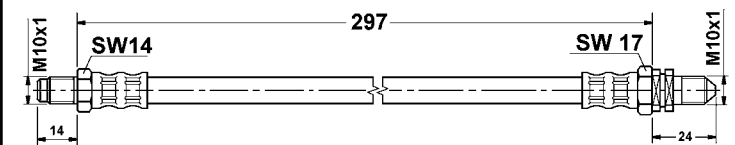

24.5305-0300.3 330658

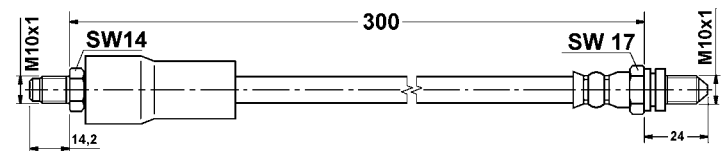

24.5305-0310.3 331326

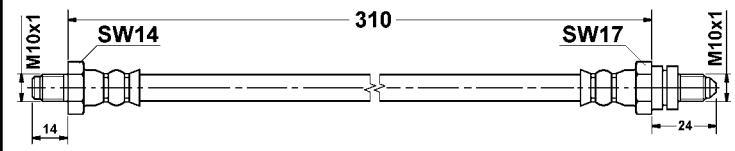

Abbildungen Bremsschläuche, Kupplungsschläuche

Illustrations brake hoses, clutch hoses - Illustrations fessibilli freno, fessibilli frizione - Illustrations Flexible de frein, Flexibles d'embrayages - Ilustraciones flexibles de freno, flexibles d'embrague

24.5305-0320.3 330764

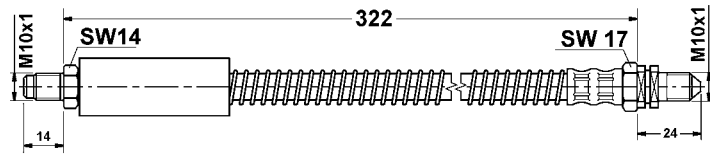

24.5305-0340.3 330659

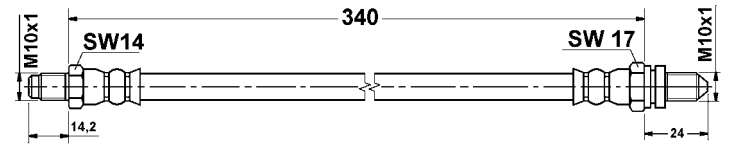

24.5305-0350.3 330660

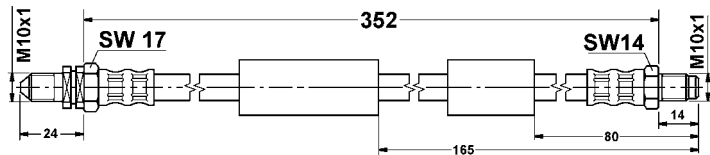

24.5305-0351.3 330687

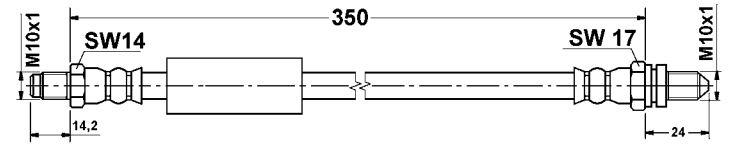

24.5305-0355.3 330688

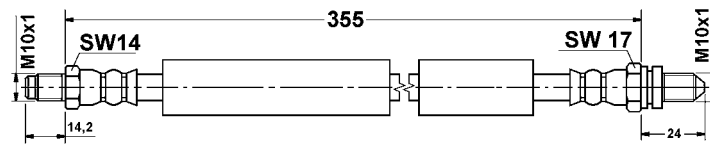

24.5305-0370.3 331392

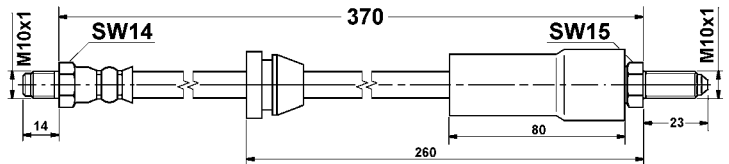

24.5305-0420.3 330661

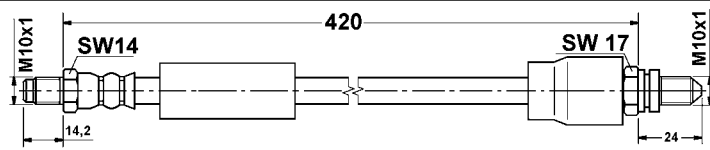

24.5306-0295.3 330662

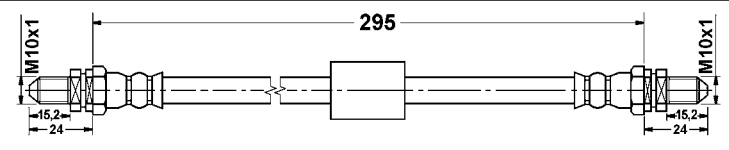

24.5307-0320.3 330703

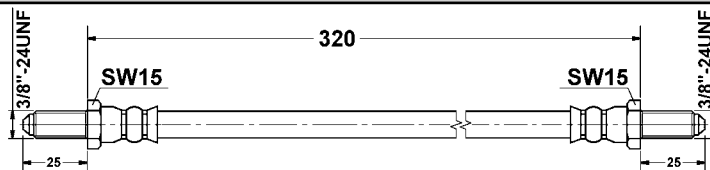

24.5308-0488.3 330776

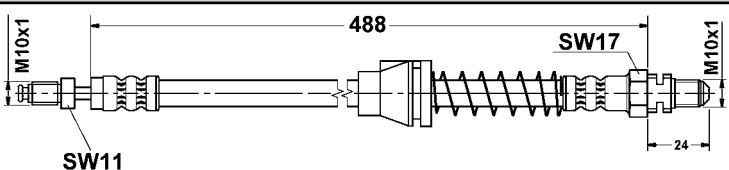

24.5308-0489.3 330777

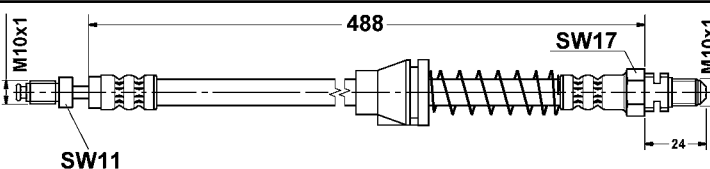

24.5309-0540.3 331368

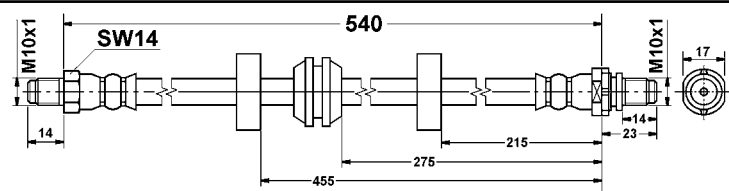

24.5310-0270.3 331369

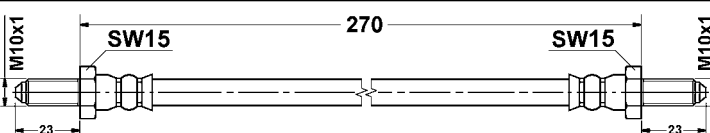

24.5411-0550.3 330567

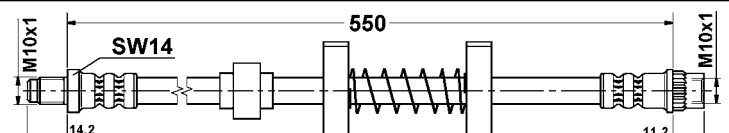

NUR FÜR MINERALÖL ONLY FOR MINERAL OIL



Abbildungen Bremsschläuche, Kupplungsschläuche

Illustrations brake hoses, clutch hoses - Illustrations fessibili freno, fessibili frizione - Illustrations Flexible de frein, Flexibles d'embrayages - Ilustraciones flexibles de freno, flexibles d'embrague

24.5802-0320.3 330050

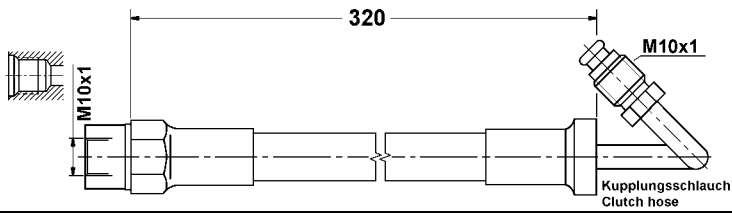

24.5803-0325.3 330051

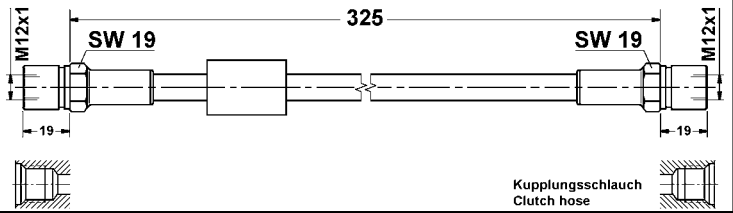

24.5901-0225.3 331288

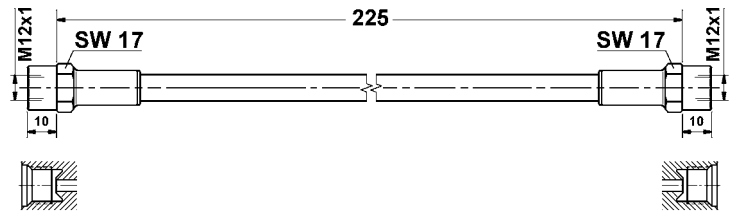

24.5901-0517.3 330054

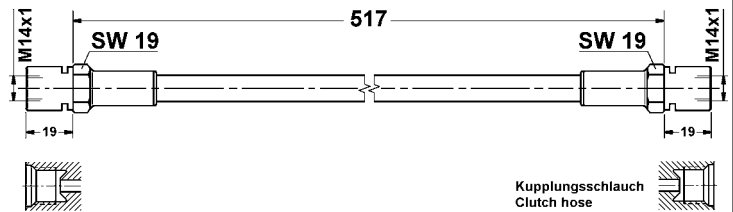

24.5905-0320.3 330058

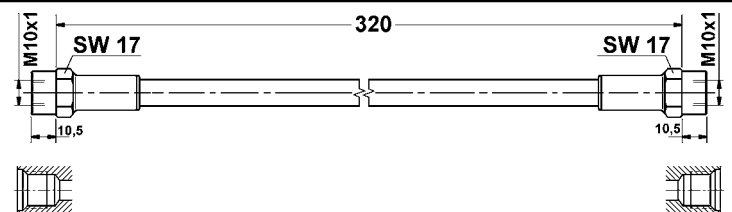

83.1094-0070.3 331228

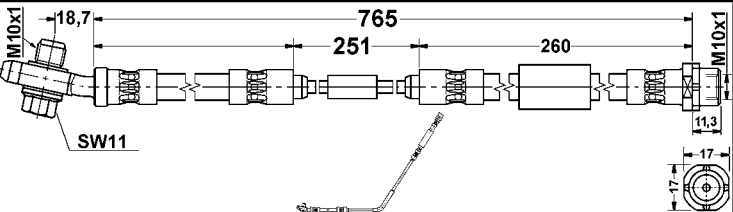

83.1294-0250.3 331267

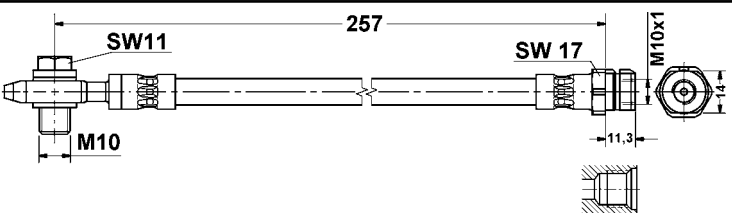

83.1294-0260.3 331268

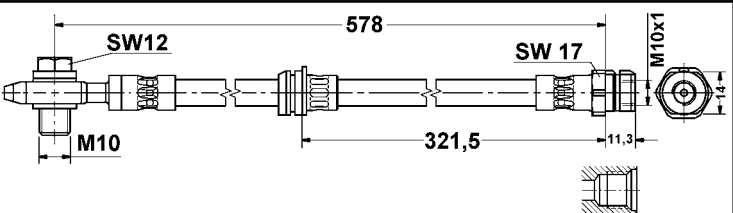

83.5301-0700.3 330165

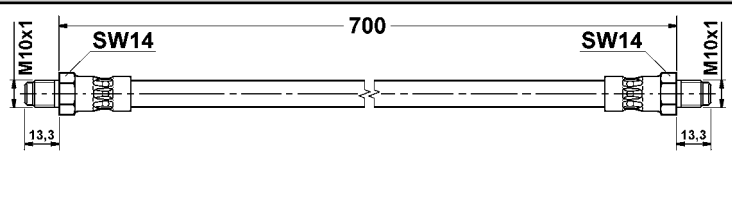

83.6101-0240.3 330202

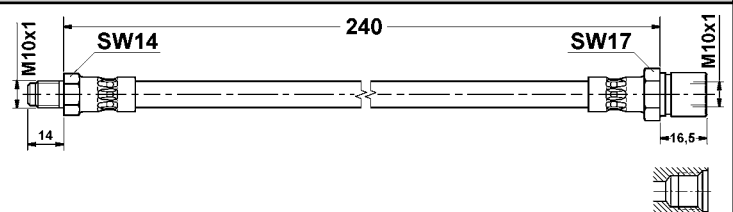

83.6101-0250.3 330203

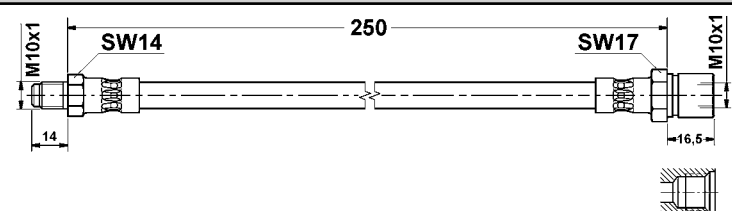

83.6101-0270.3 330204

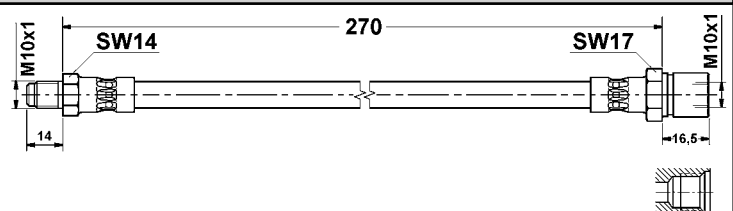

83.6101-0295.3 330205



83.6101-0325.3 330206

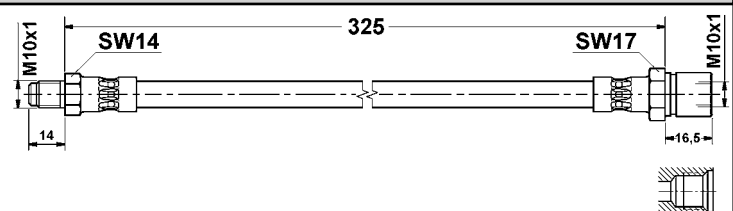

Abbildungen Bremsschläuche, Kupplungsschläuche

Illustrations brake hoses, clutch hoses - Illustrations fessibilli freno, fessibilli frizione - Illustrations Flexible de frein, Flexibles d'embrayages - Ilustraciones flexibles de freno, flexibles d'embrague

83.6101-0380.3 330208

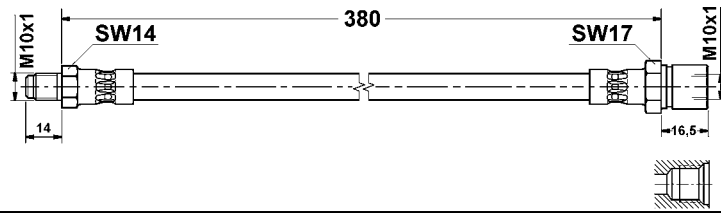

83.6101-0412.3 330212

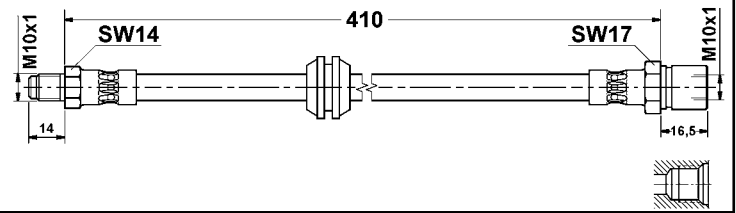

83.6101-0520.3 330215

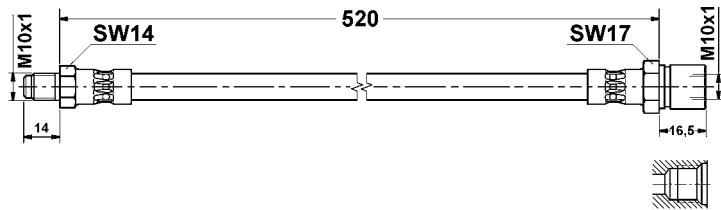

83.6101-0600.3 330216

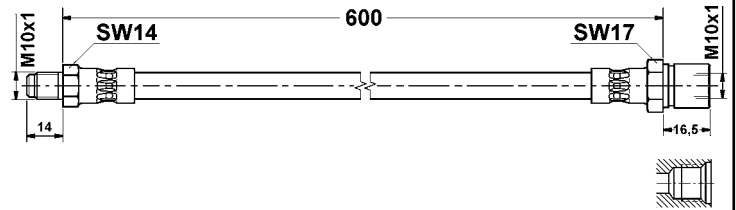

83.6101-0650.3 330217

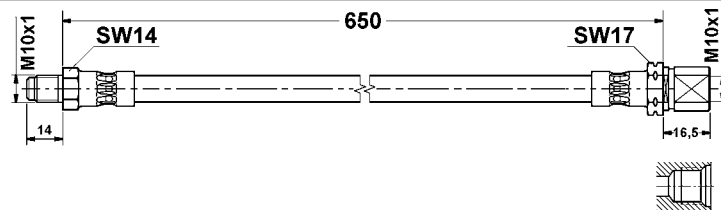

83.6102-0320.3 330376

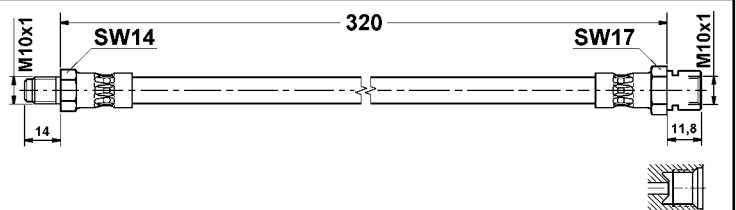

83.6103-0190.3 330218

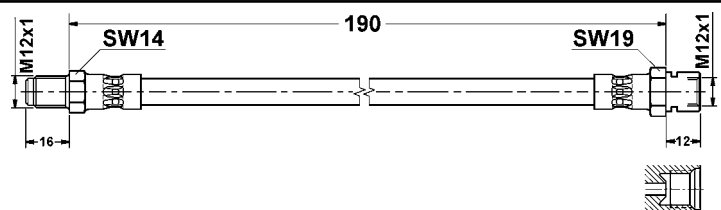

83.6103-0200.3 330219

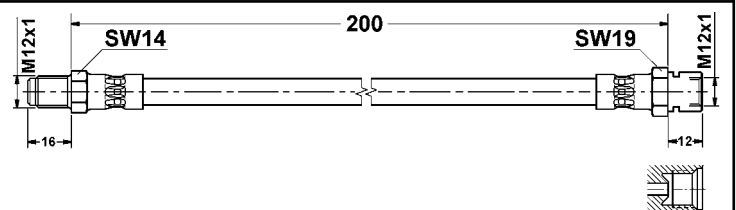

83.6103-0240.3 330220

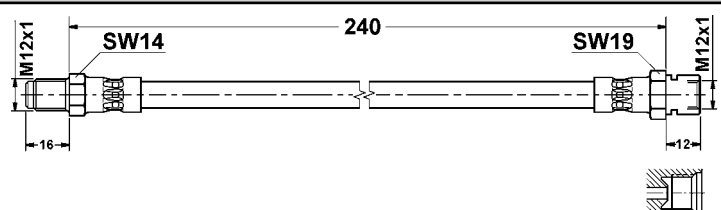

83.6103-0260.3 330221

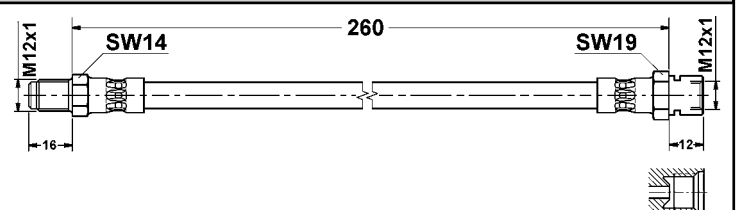

83.6103-0300.3 330223

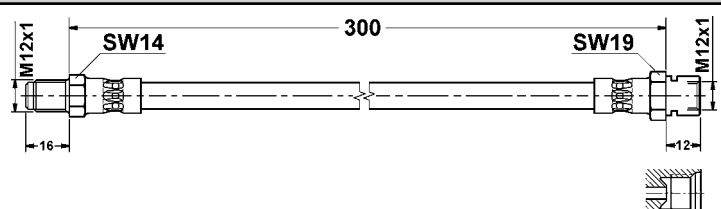

83.6103-0320.3 330224

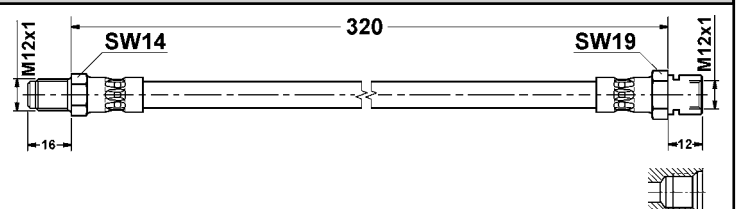

83.6103-0350.3 330225

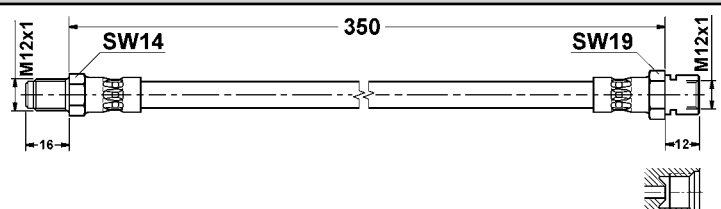

83.6103-0400.3 330226

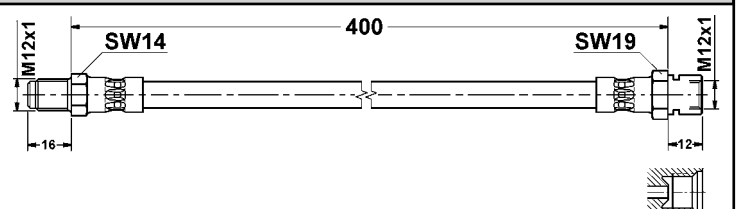

Abbildungen Bremsschläuche, Kupplungsschläuche

Illustrations brake hoses, clutch hoses - Illustrations fessibilli freno, fessibilli frizione - Illustrations Flexible de frein, Flexibles d'embrayages - Ilustraciones flexibles de freno, flexibles d'embrague

83.6103-0420.3 330227

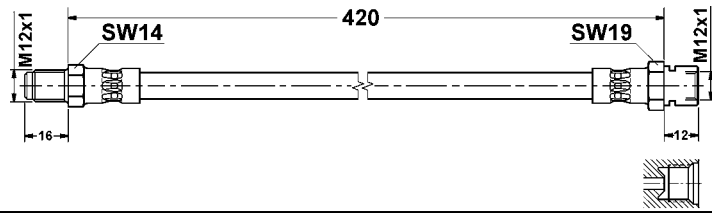

83.6103-0450.3 330228

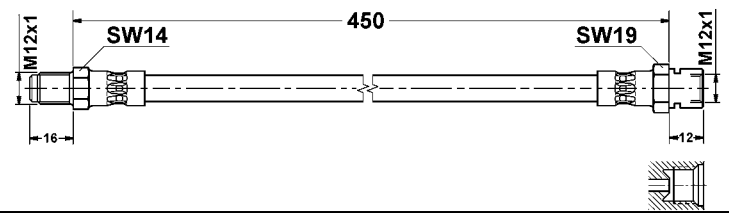

83.6103-0470.3 330229

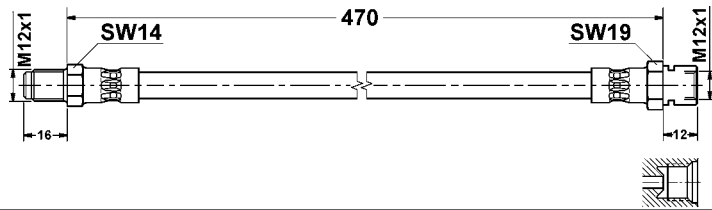

83.6103-0500.3 330230

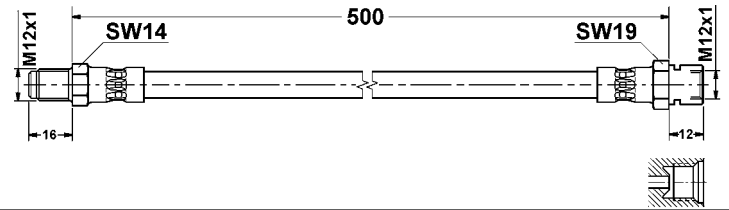

83.6103-0550.3 330231

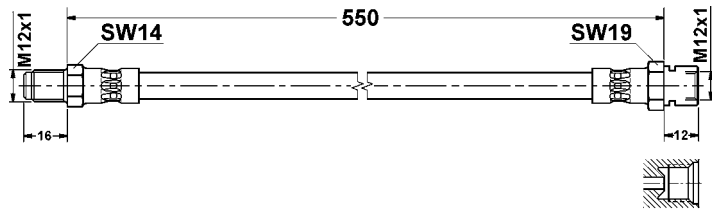

83.6103-0600.3 330233

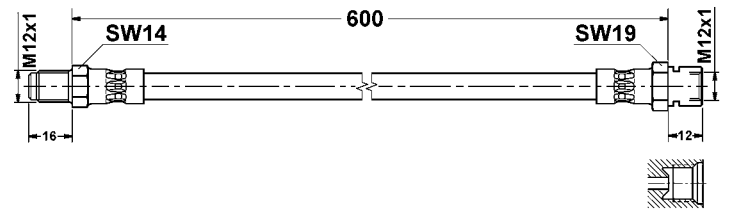

83.6103-0620.3 330234

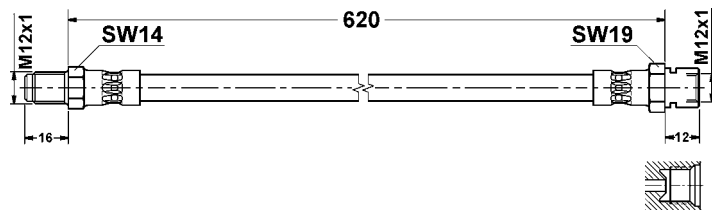

83.6103-0650.3 330235

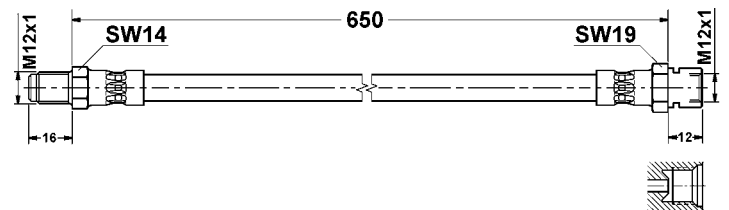

83.6103-0700.3 330236

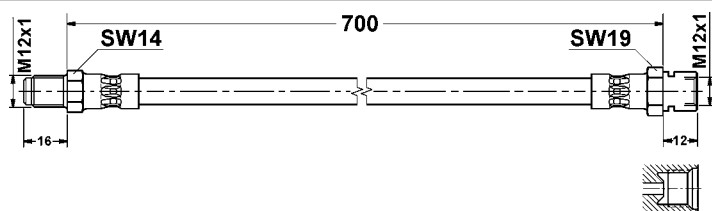

83.6103-0800.3 330237

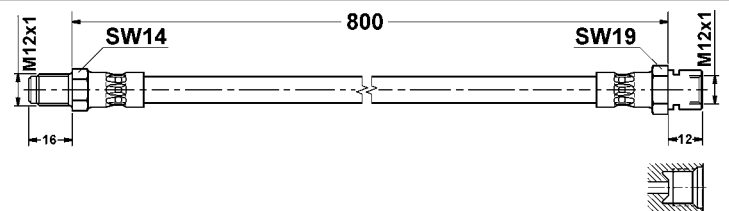

83.6104-0180.3 330510

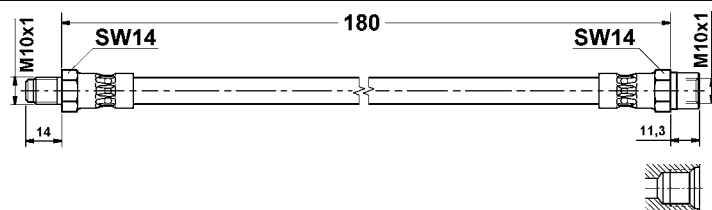

83.6104-0210.3 330473

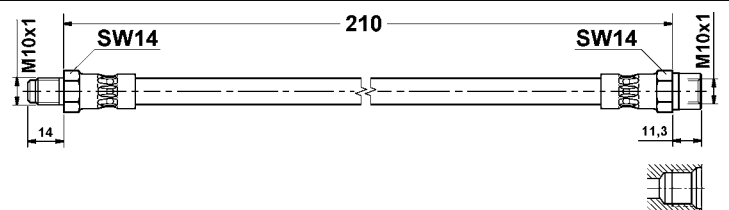

83.6104-0220.3 330474

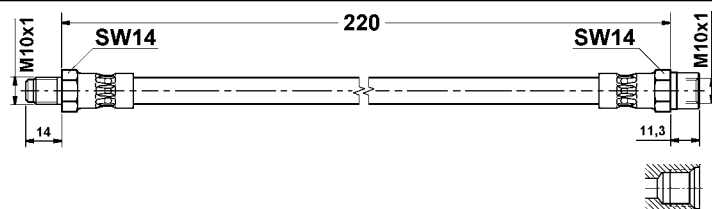

83.6104-0241.3 330731

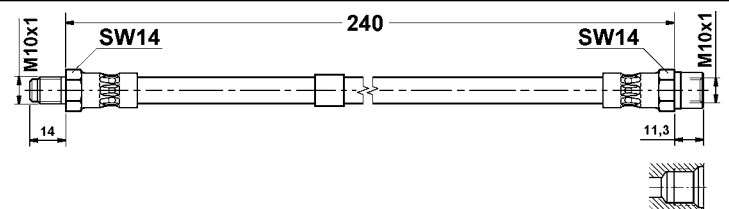

Abbildungen Bremsschläuche, Kupplungsschläuche

Illustrations brake hoses, clutch hoses - Illustrations fessibilli freno, fessibilli frizione - Illustrations Flexible de frein, Flexibles d'embrayages - Ilustraciones flexibles de freno, flexibles d'embrague

83.6104-0245.3 330525

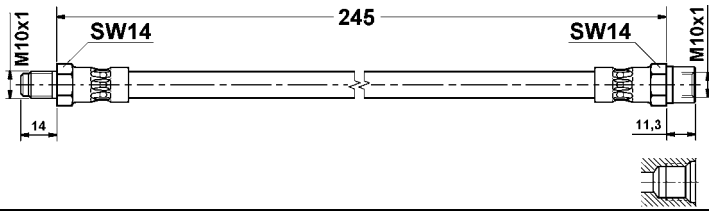

83.6104-0250.3 330720

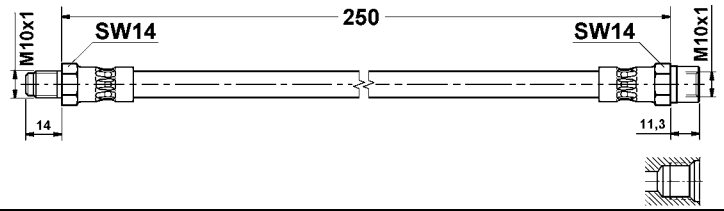

83.6104-0295.3 330244

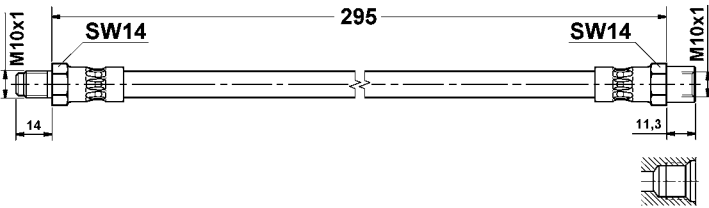

83.6101-0315.3 330889

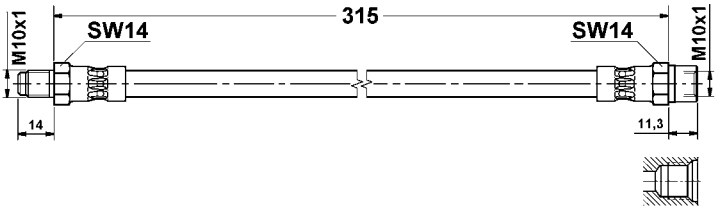

83.6104-0325.3 330246

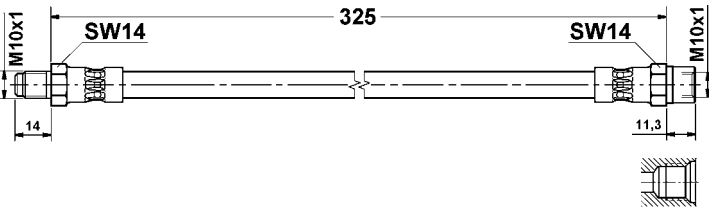

83.6104-0336.3 330451

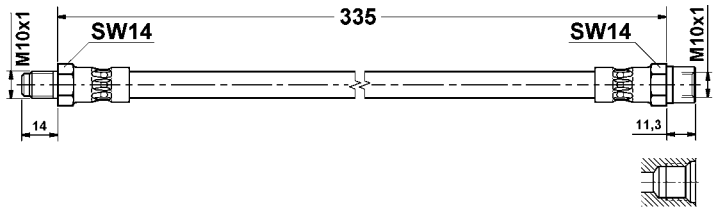

83.6104-0360.3 330475

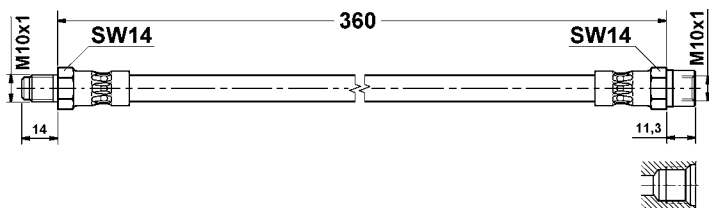

83.6104-0400.3 330249

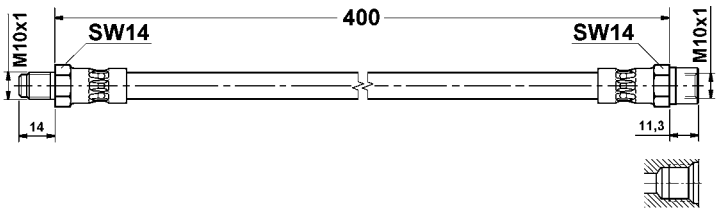

83.6104-0440.3 330714

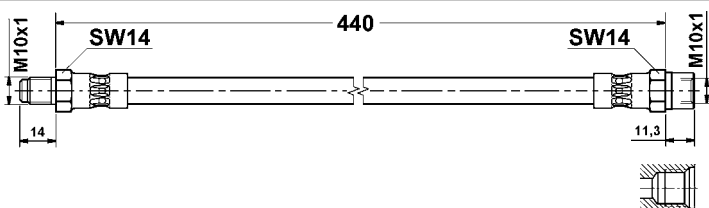

83.6104-0450.3 330251

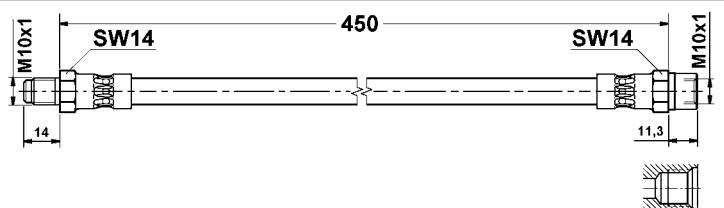

83.6104-0470.3 330253

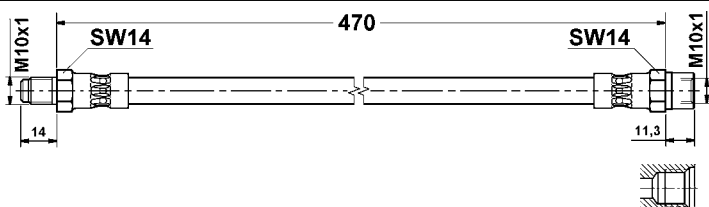

83.6105-0200.3 330453

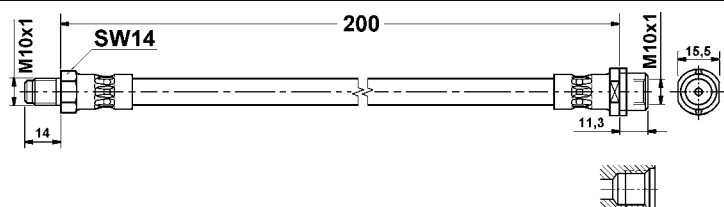

83.6105-0300.3 330537

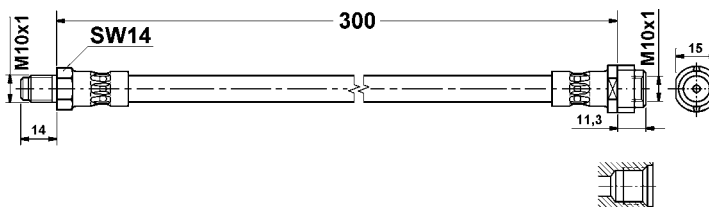

83.6105-0360.3 330635

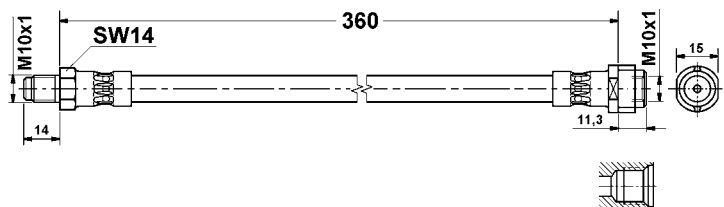

Abbildungen Bremsschläuche, Kupplungsschläuche

Illustrations brake hoses, clutch hoses - Illustrations fessibilli freno, fessibilli frizione - Illustrations Flexible de frein, Flexibles d'embrayages - Ilustraciones flexibles de freno, flexibles d'embrague

83.6105-0510.3 330622

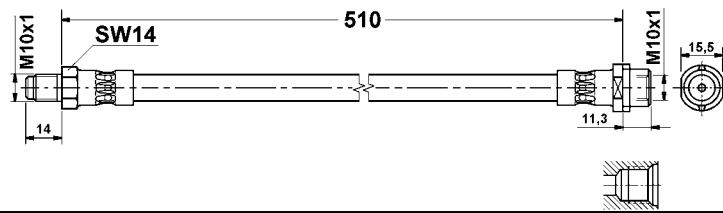

83.6113-0140.3 330482

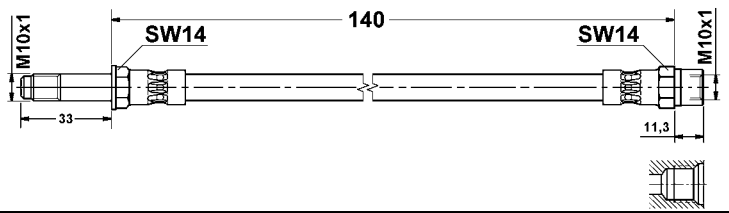

83.6113-0276.3 330538

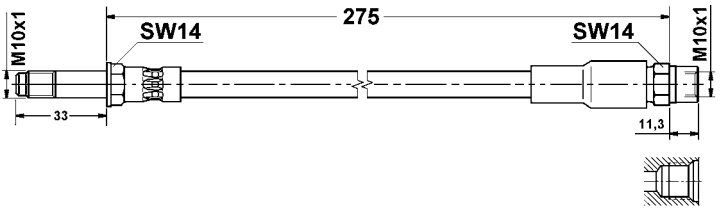

83.6113-0321.3 330621

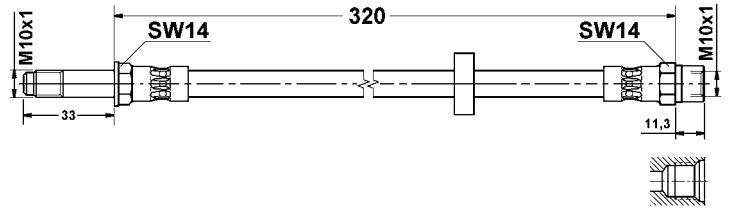

83.6113-0331.3 330982

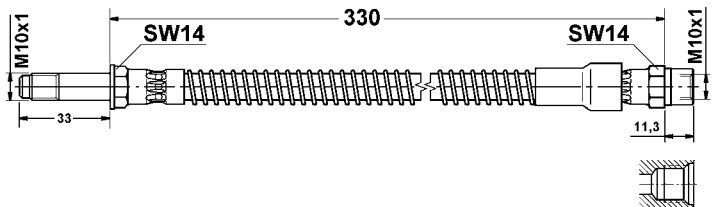

83.6113-0552.3 330864

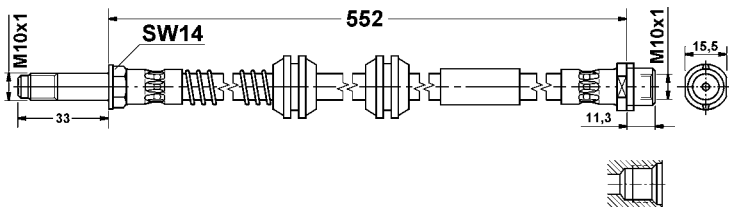

83.6114-0300.3 330258

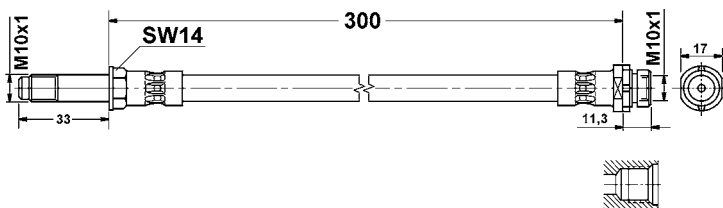

83.6116-0226.3 330454

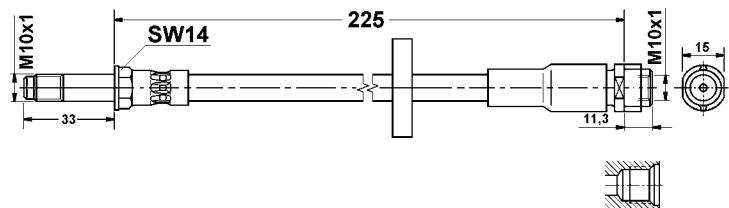

83.6118-0281.3 330483

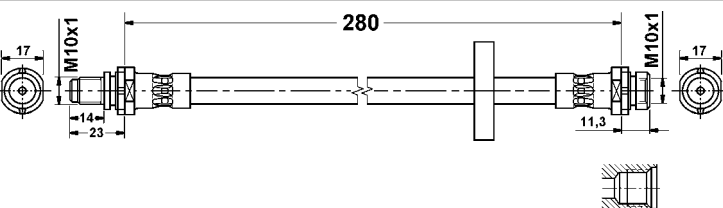

83.6121-0250.3 330260

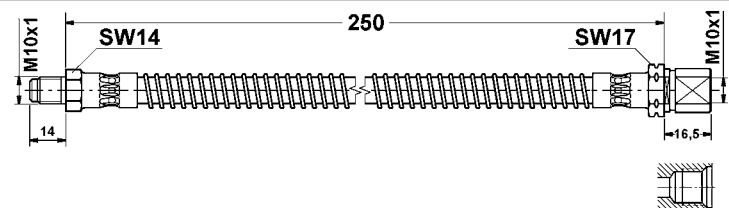

83.6121-0340.3 330261

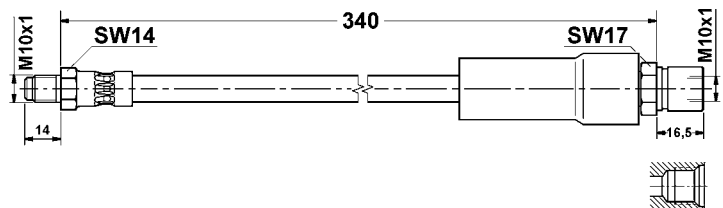

83.6123-0381.3 330262

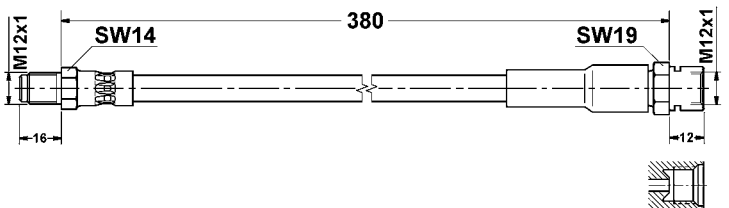

83.6123-0465.3 330379

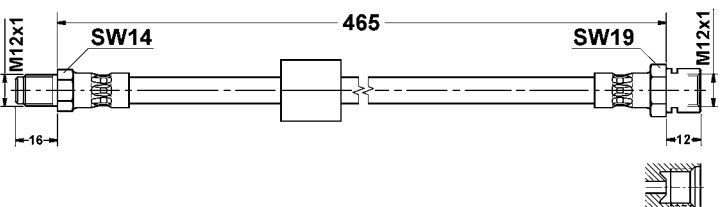

83.6123-0471.3 330263

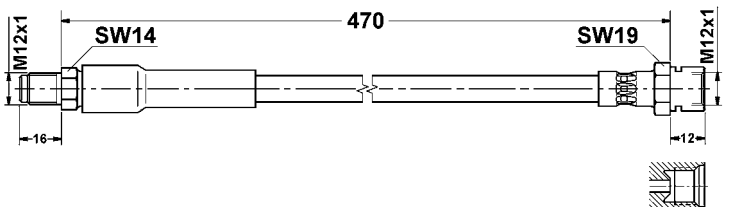

Abbildungen Bremsschläuche, Kupplungsschläuche

Illustrations brake hoses, clutch hoses - Illustrations fessibilli freno, fessibilli frizione - Illustrations Flexible de frein, Flexibles d'embrayages - Ilustraciones flexibles de freno, flexibles d'embrague

83.6124-0218.3 330455

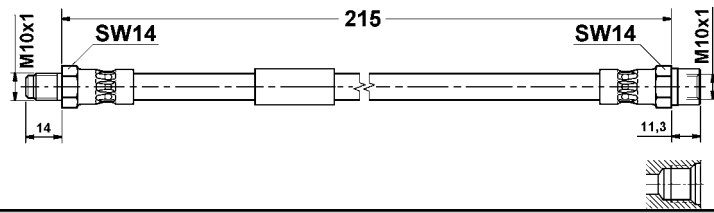

83.6124-0252.3 330456

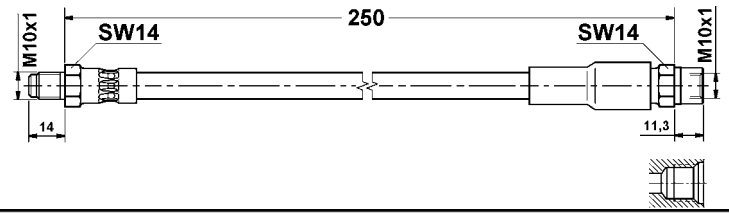

83.6124-0282.3 330490

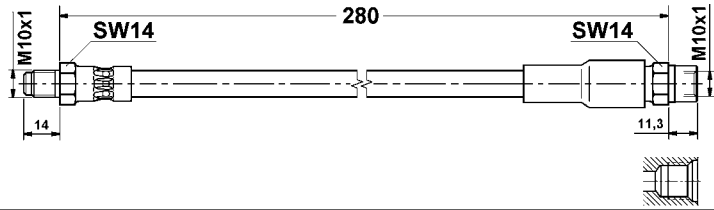

83.6124-0285.3 330722

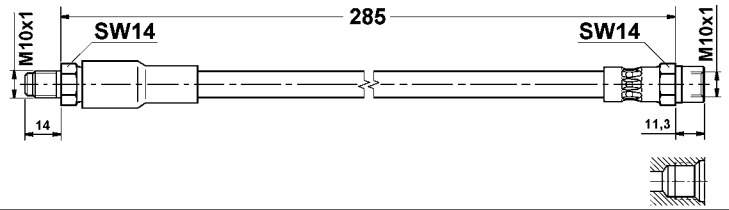

83.6124-0304.3 330983

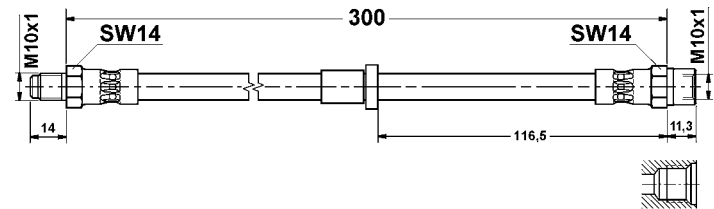

83.6124-0305.3 330723

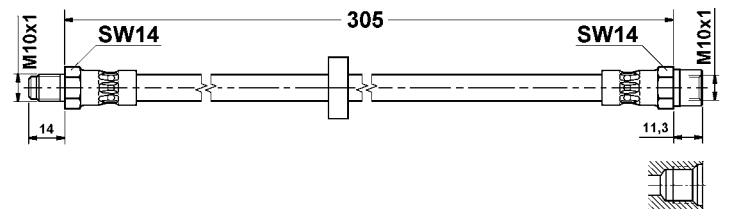

83.6124-0331.3 330267

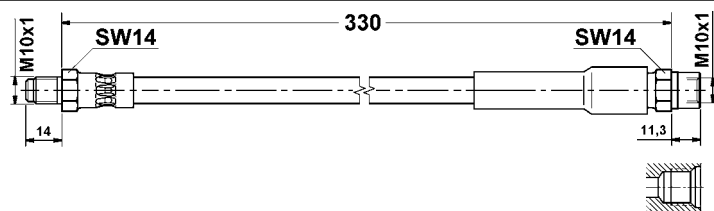

83.6124-0362.3 330715

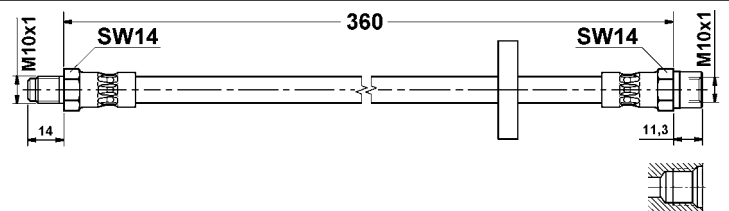

83.6124-0380.3 330268

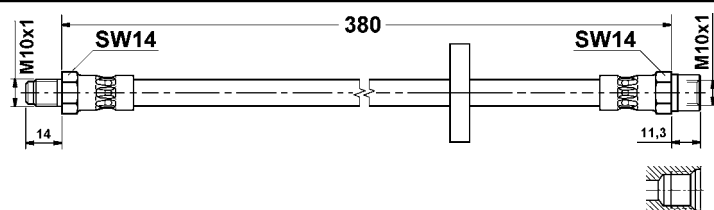

83.6124-0422.3 330269

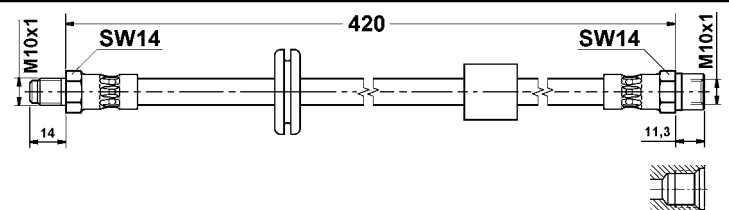

83.6133-0500.3 330272

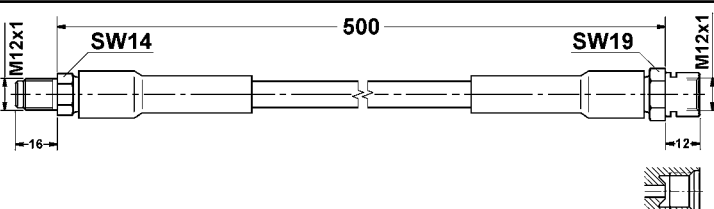

83.6133-0551.3 330273

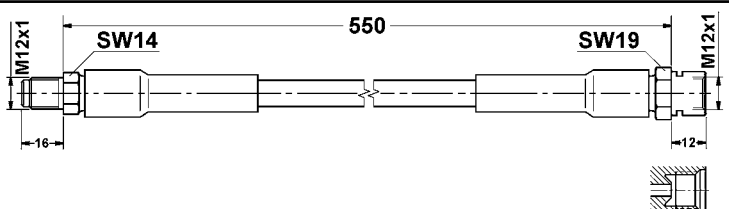

83.6133-0651.3 330274

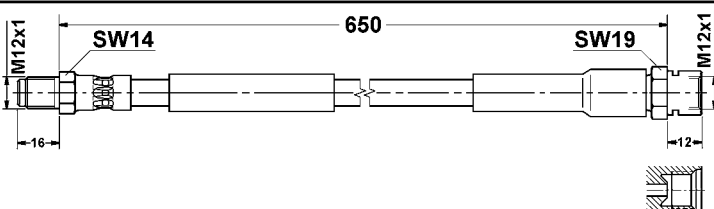

83.6134-0270.3 330779

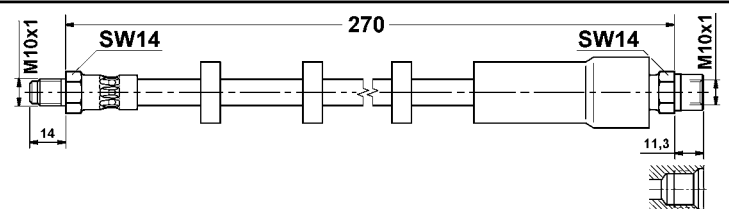

Abbildungen Bremsschläuche, Kupplungsschläuche

Illustrations brake hoses, clutch hoses - Illustrations fessibilli freno, fessibilli frizione - Illustrations Flexible de frein, Flexibles d'embrayages - Ilustraciones flexibles de freno, flexibles d'embrague

<p>83.6134-0300.3 330725</p>	<p>83.6134-0332.3 330716</p>
<p>83.6134-0335.3 330277</p>	<p>83.6150-0206.3 330978</p>
<p>83.6150-0436.3 330890</p>	<p>83.6150-0451.3 330283</p>
<p>83.6150-0481.3 330542</p>	<p>83.6150-0556.3 330712</p>
<p>83.6151-0411.3 330461</p>	<p>83.6151-0552.3 330857</p>
<p>83.6151-0602.3 330893</p>	<p>83.6152-0406.3 330789</p>
<p>83.6154-0526.3 330285</p>	<p>83.6155-0160.3 330717</p>

Abbildungen Bremsschläuche, Kupplungsschläuche

Illustrations brake hoses, clutch hoses - Illustrations fessibilli freno, fessibilli frizione - Illustrations Flexible de frein, Flexibles d'embrayages - Ilustraciones flexibles de freno, flexibles d'embrague

83.6155-0327.3 330287

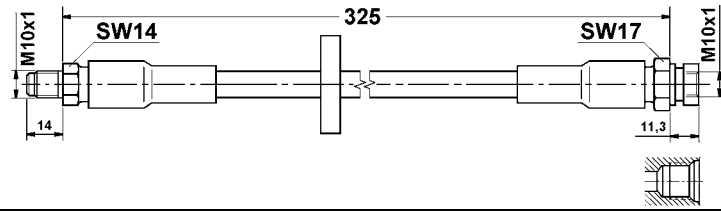

83.6169-0325.3 330546

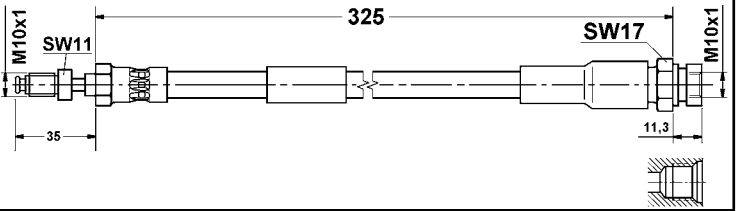

83.6169-0418.3 330894

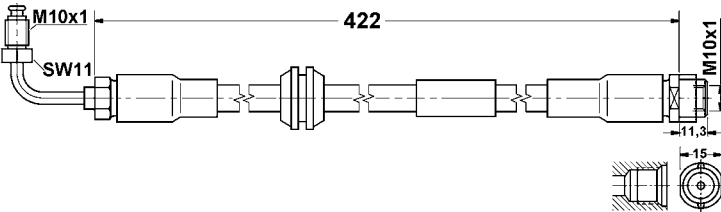

83.6169-0505.3 330288

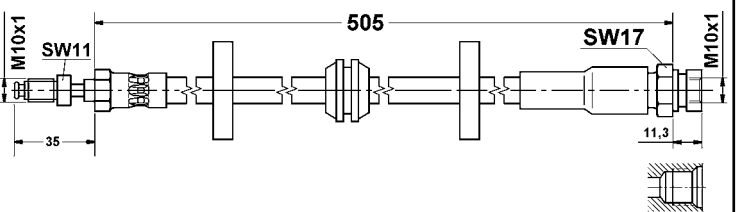

83.6169-0685.3 330984

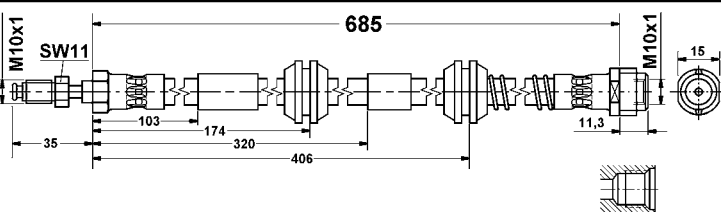

83.6188-0311.3 330291

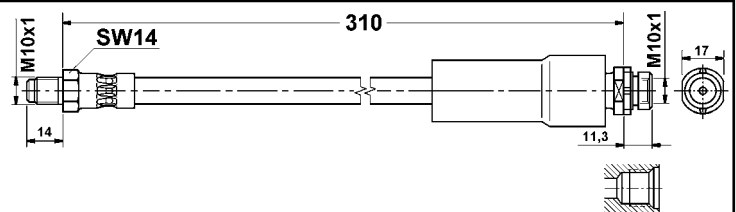

83.6192-0250.3 330726

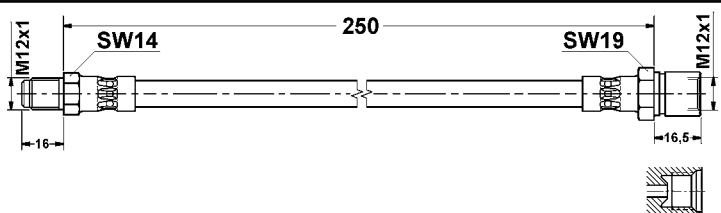

83.6196-0325.3 330727

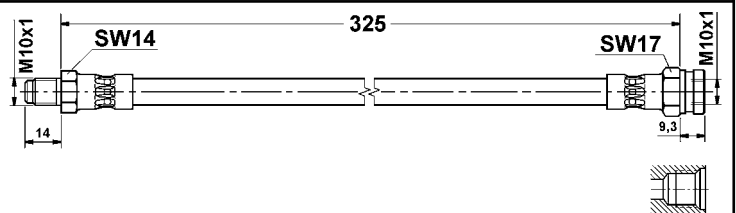

83.6201-0175.3 330663

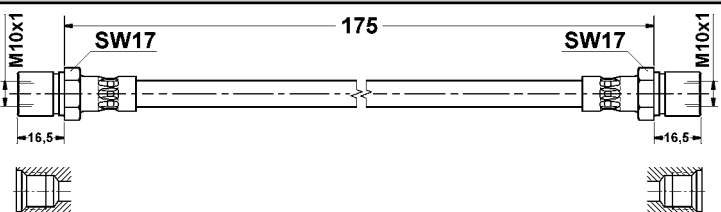

83.6201-0500.3 330297

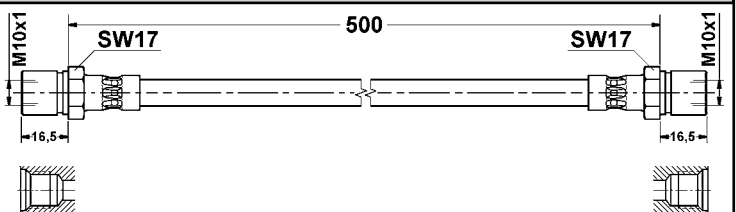

83.6203-0200.3 330298

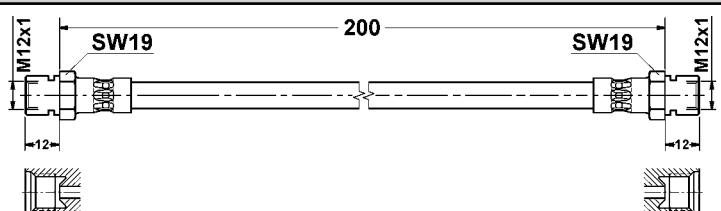

83.6203-0250.3 330299

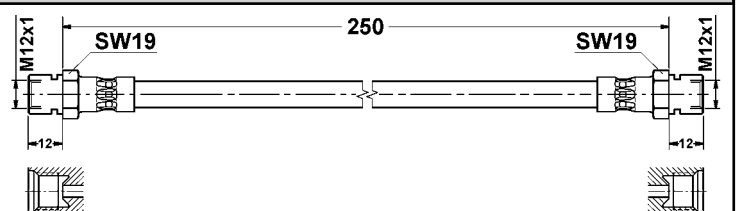

83.6203-0260.3 330300

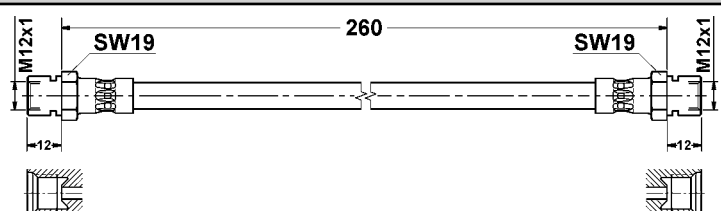

83.6203-0300.3 330386

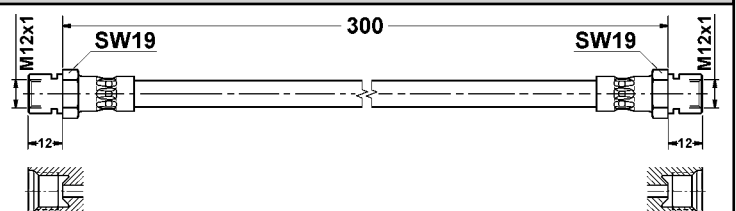

Abbildungen Bremsschläuche, Kupplungsschläuche

Illustrations brake hoses, clutch hoses - Illustrations fessibili freno, fessibili frizione - Illustrations Flexible de frein, Flexibles d'embrayages - Ilustraciones flexibles de freno, flexibles d'embrague

<p>83.6203-0400.3 330302</p>	<p>83.6203-0540.3 330303</p>
<p>83.6204-0100.3 330441</p>	<p>83.6204-0143.3 330304</p>
<p>83.6204-0180.3 330547</p>	<p>83.6204-0220.3 330308</p>
<p>83.6204-0240.3 330718</p>	<p>83.6204-0280.3 330732</p>
<p>83.6204-0282.3 330309</p>	<p>83.6204-0286.3 330733</p>
<p>83.6204-0300.3 330548</p>	<p>83.6204-0350.3 330382</p>
<p>83.6204-0400.3 330311</p>	<p>83.6204-0500.3 330313</p>

Abbildungen Bremsschläuche, Kupplungsschläuche

Illustrations brake hoses, clutch hoses - Illustrations fessibili freno, fessibili frizione - Illustrations Flexible de frein, Flexibles d'embrayages - Ilustraciones flexibles de freno, flexibles d'embrague

83.6205-0252.3 330315

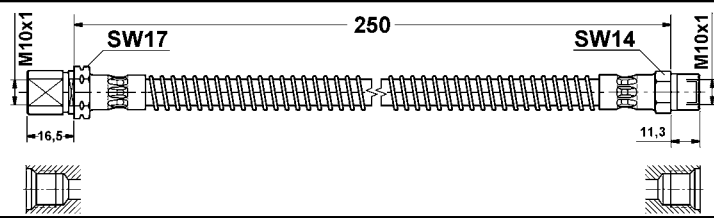

83.6211-0531.3 330551

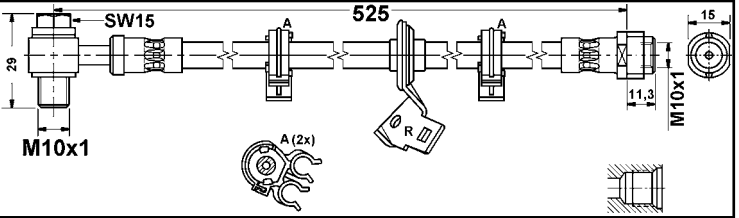

83.6211-0532.3 330552

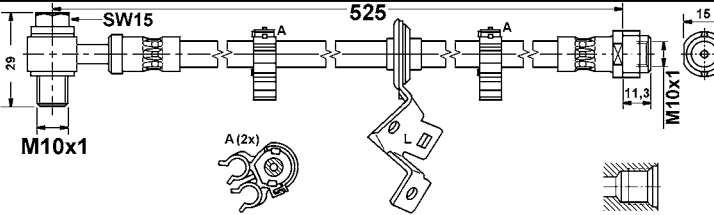

83.6211-0535.3 330627

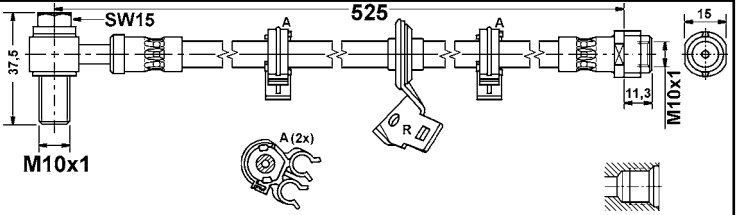

83.6211-0536.3 330628

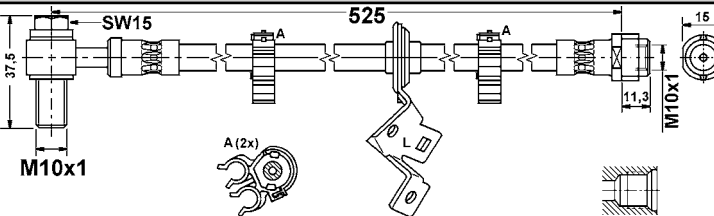

83.6212-0160.3 330318

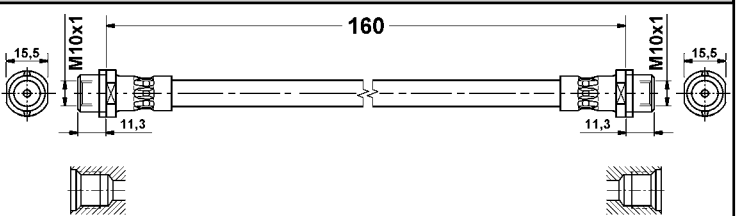

83.6212-0170.3 330625

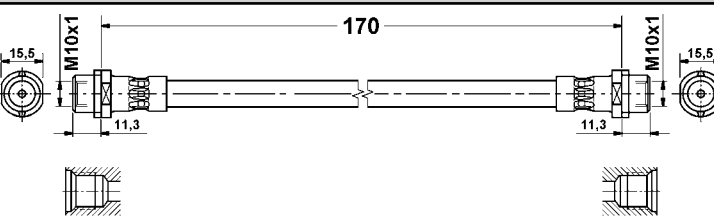

83.6213-0335.3 330459

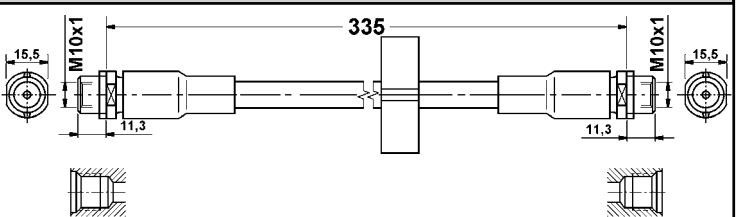

83.6215-0330.3 330322

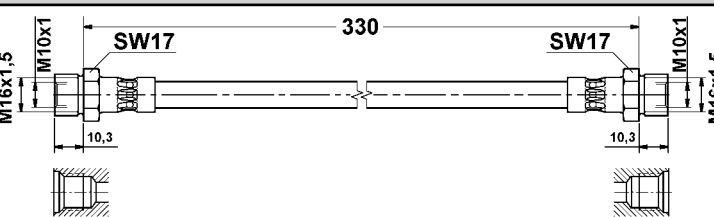

83.6215-0400.3 330323

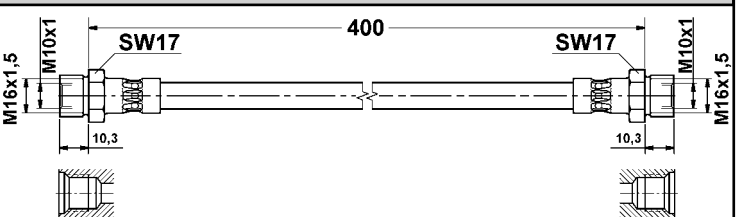

83.6219-0455.3 330592

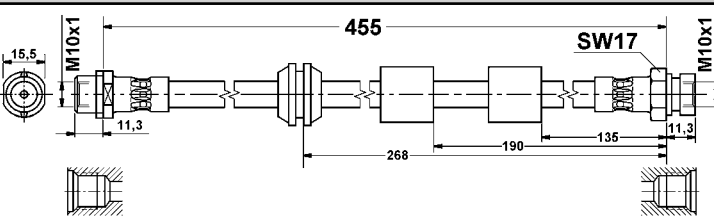

83.6220-0296.3 330324

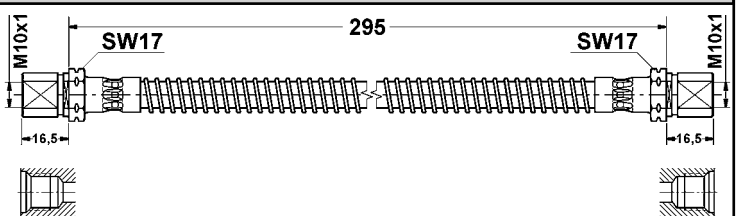

83.6224-0200.3 330729

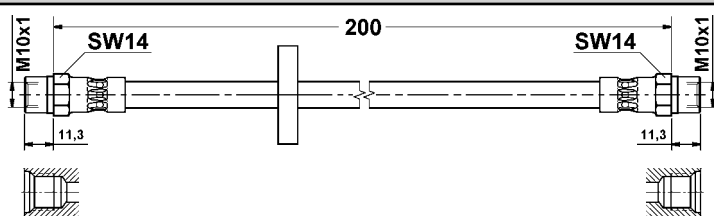

83.6224-0300.3 330730

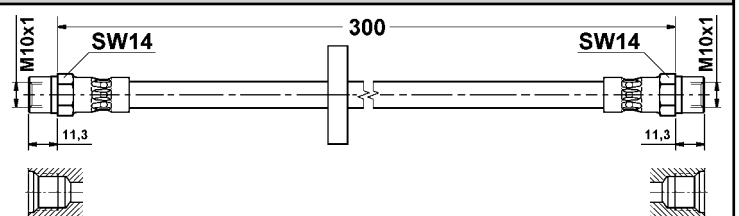

Abbildungen Bremsschläuche, Kupplungsschläuche

Illustrations brake hoses, clutch hoses - Illustrations fessibili freno, fessibili frizione - Illustrations Flexible de frein, Flexibles d'embrayages - Ilustraciones flexibles de freno, flexibles d'embrague

83.6225-0287.3 330735

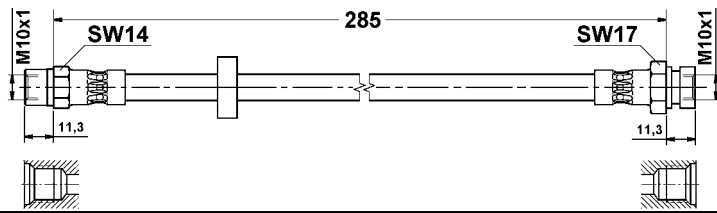

83.6227-0281.3 330424

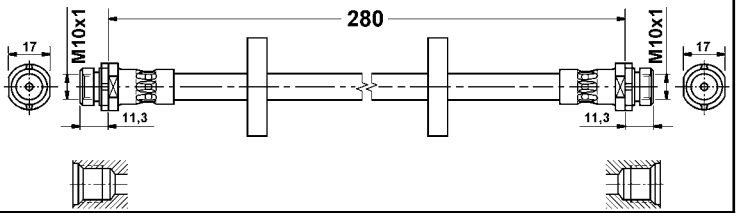

83.6232-0465.3 330736

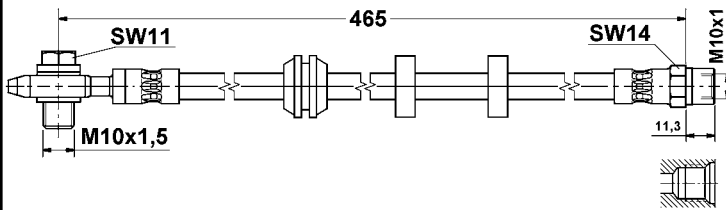

83.6235-0100.3 330463

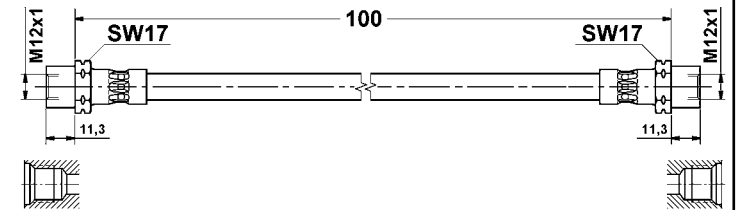

83.6236-0175.3 330710

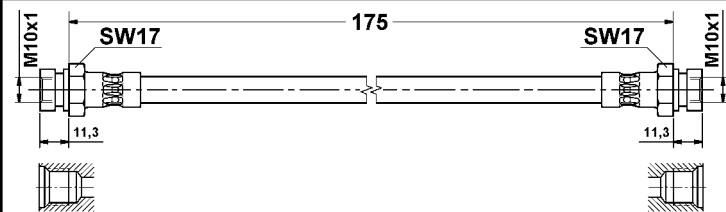

83.6236-0402.3 330464

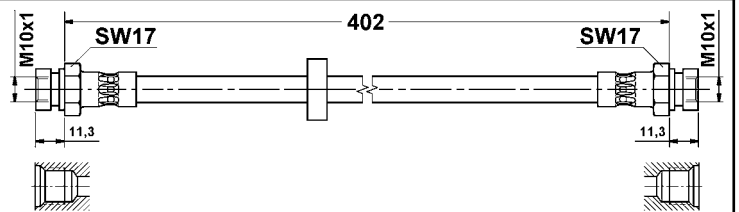

83.6238-0408.3 330895

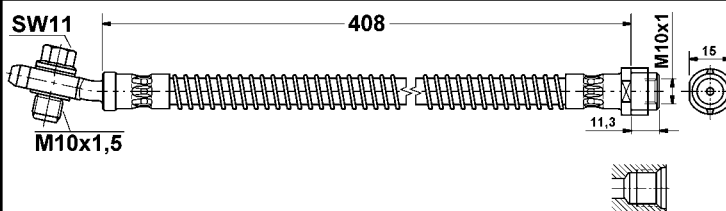

83.6238-0508.3 330631

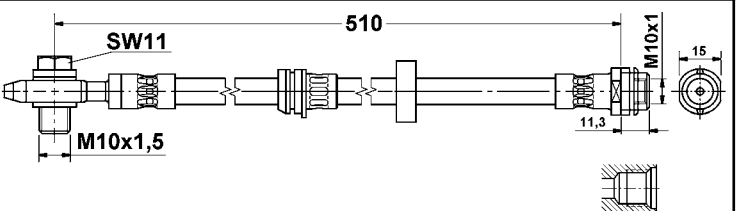

83.6239-0297.3 330643

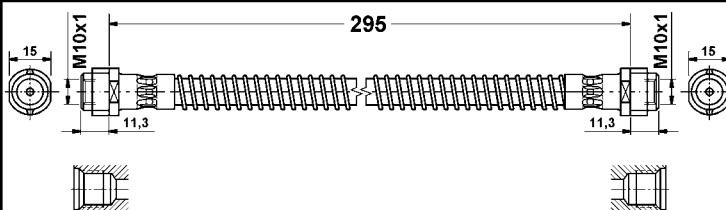

83.6240-0220.3 330465

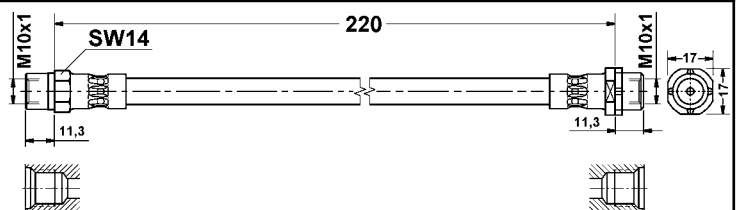

83.6243-0385.3 330632

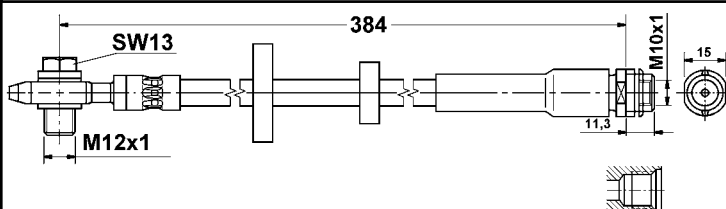

83.6243-0393.3 330629

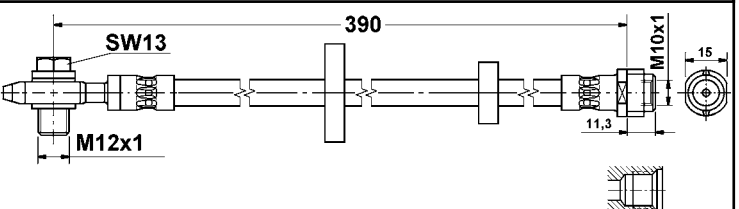

83.6247-0522.3 330595

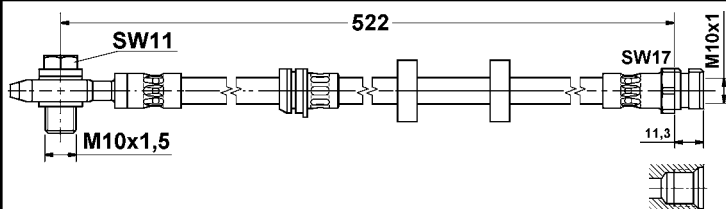

83.6251-0301.3 330556

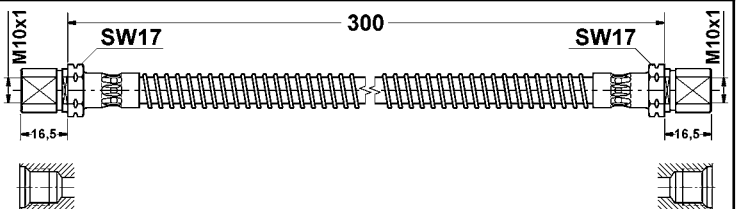

Abbildungen Bremsschläuche, Kupplungsschläuche

Illustrations brake hoses, clutch hoses - Illustrations fessibilli freno, fessibilli frizione - Illustrations Flexible de frein, Flexibles d'embrayages - Ilustraciones flexibles de freno, flexibles d'embrague

83.6252-0560.3 330557

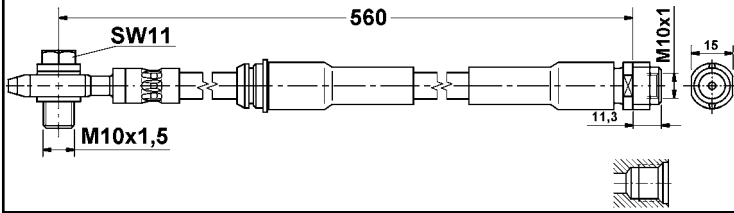

83.6255-0200.3 330896

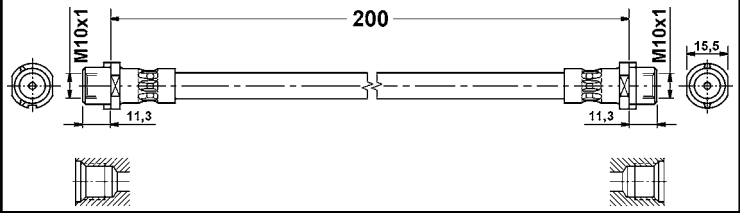

83.6255-0337.3 330744

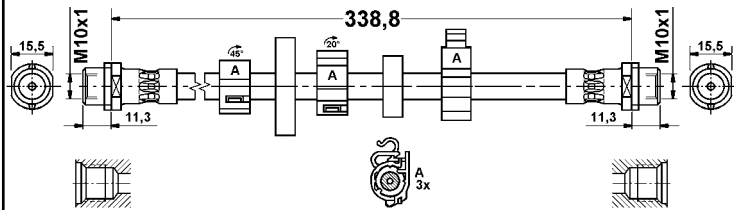

83.6255-0340.3 330745

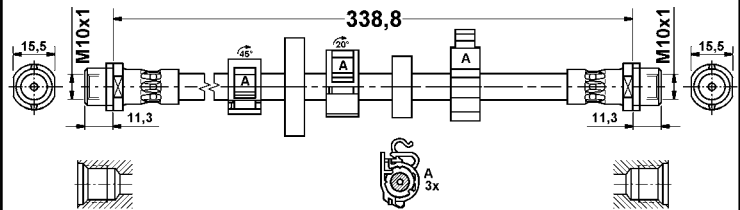

83.6255-0353.3 330481

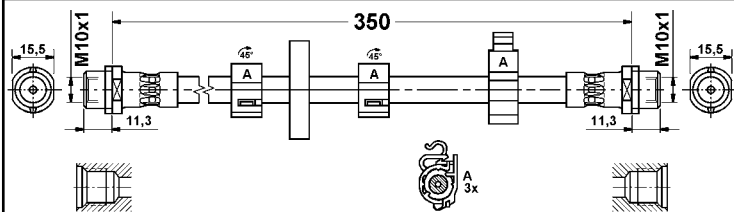

83.6267-0195.3 330737

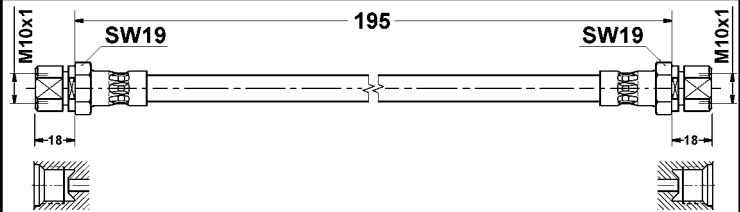

83.6267-0285.3 330332

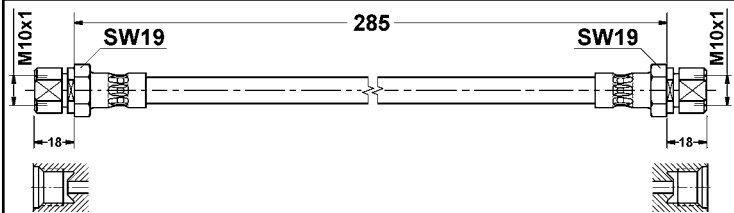

83.6267-0330.3 330333

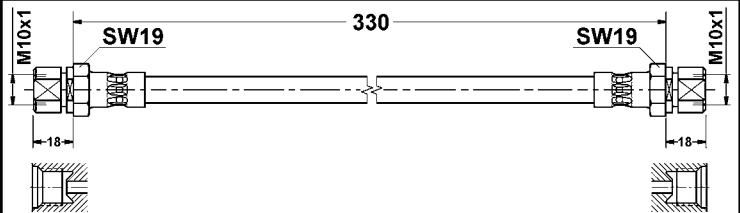

83.6288-0280.3 330336

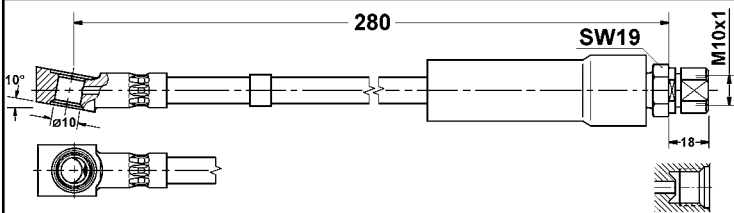

83.6288-0314.3 330338

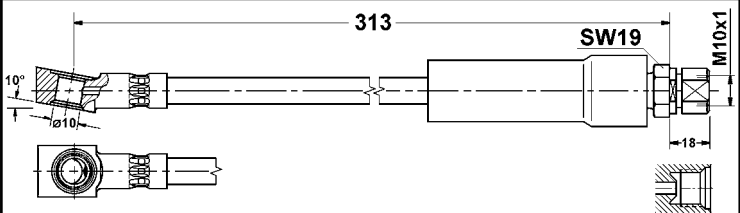

83.6289-0391.3 330341

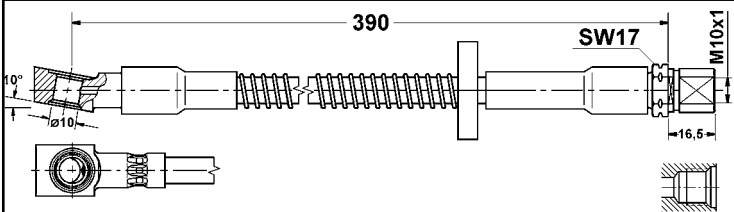

83.6294-0315.3 330738

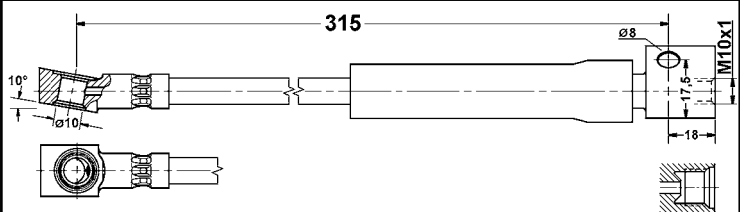

83.6299-0807.3 330901

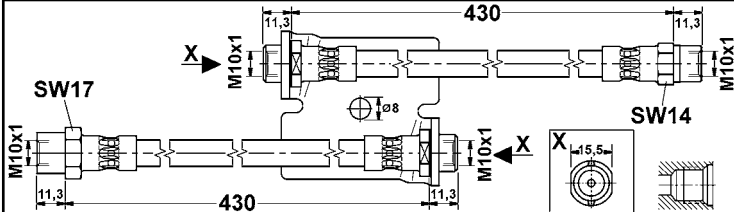

83.6301-0150.3 330342

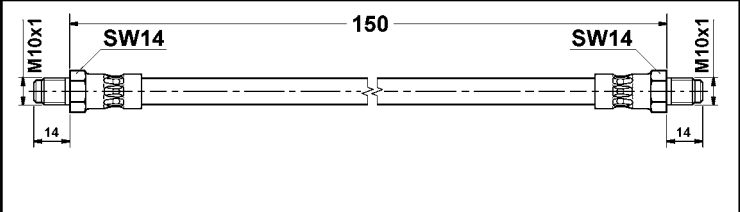

Abbildungen Bremsschläuche, Kupplungsschläuche

Illustrations brake hoses, clutch hoses - Illustrations fessibilli freno, fessibilli frizione - Illustrations Flexible de frein, Flexibles d'embrayages - Ilustraciones flexibles de freno, flexibles d'embrague

83.6301-0355.3 330343

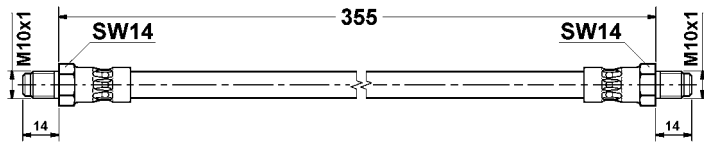

83.6301-0380.3 330344

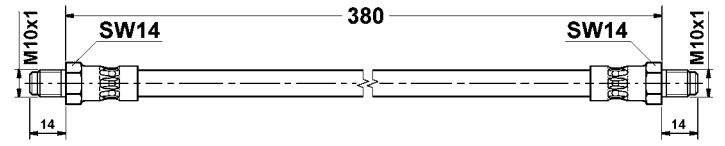

83.6303-0501.3 330348

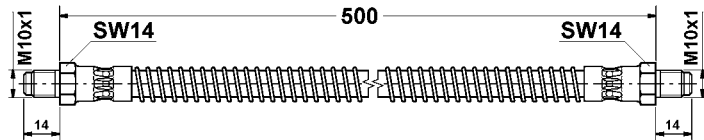

83.6314-0375.3 330558

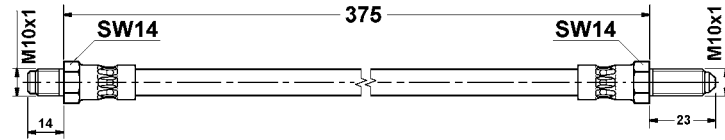

83.6327-0180.3 330740

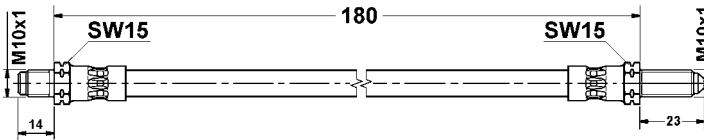

83.6339-0228.3 330361

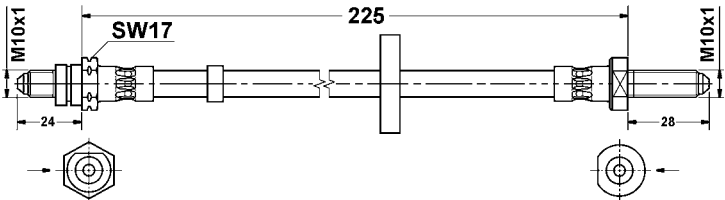

83.6339-0253.3 330362

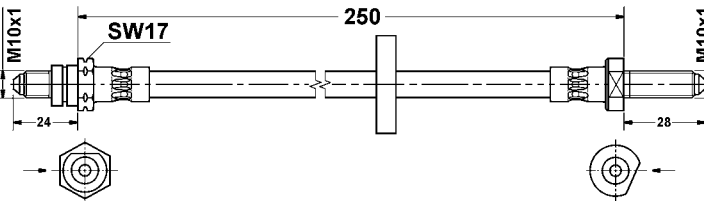

83.6383-0300.3 330371

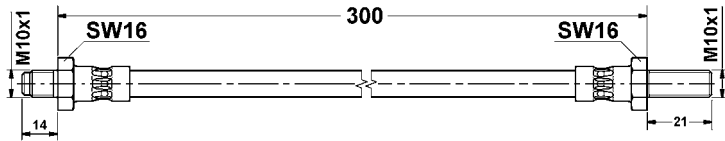

83.6401-0159.3 330746

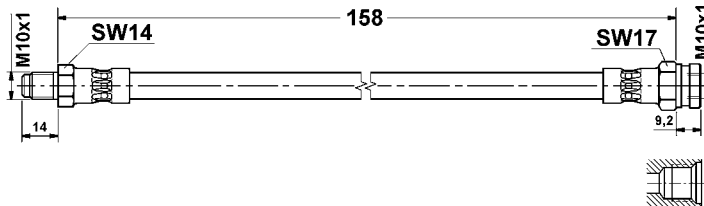

83.6401-0413.3 330748

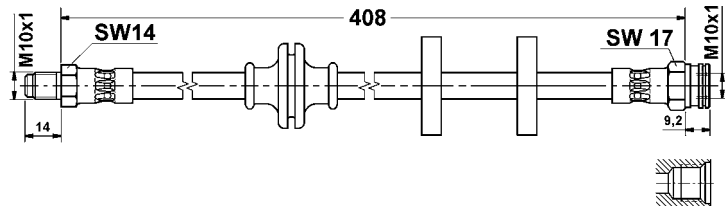

83.6501-0282.3 330769

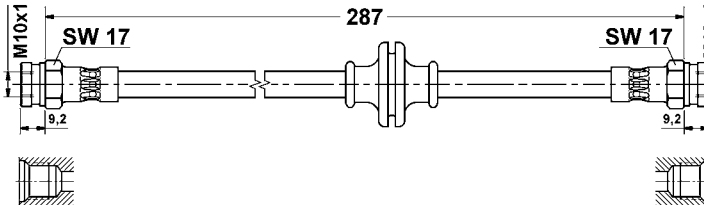

83.7101-9219.3 330903

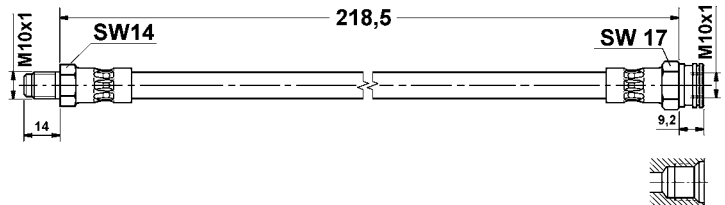

83.7101-9399.3 330904

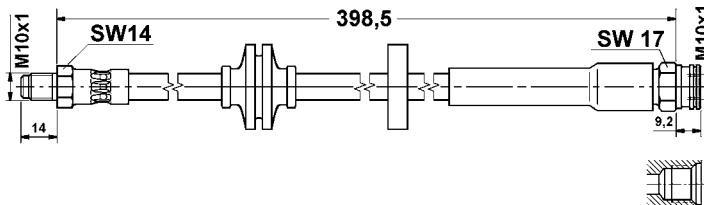

83.7101-9489.3 330906

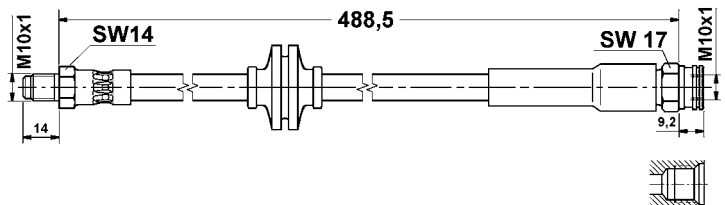

Abbildungen Bremsschläuche, Kupplungsschläuche

Illustrations brake hoses, clutch hoses - Illustrations fessibilli freno, fessibilli frizione - Illustrations Flexible de frein, Flexibles d'embrayages - Ilustraciones flexibles de freno, flexibles d'embrague

83.7101-9504.3 330898

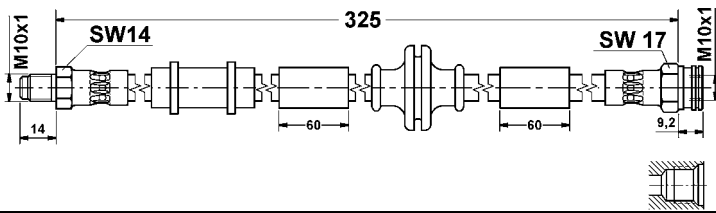

83.7114-0376.3 330373

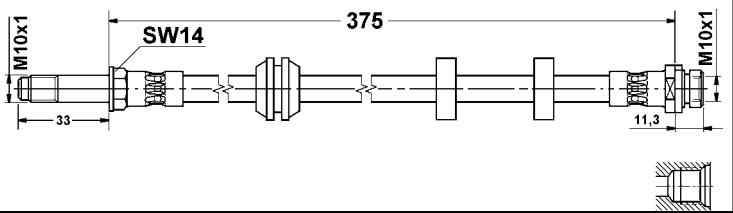

83.7119-0180.3 330634

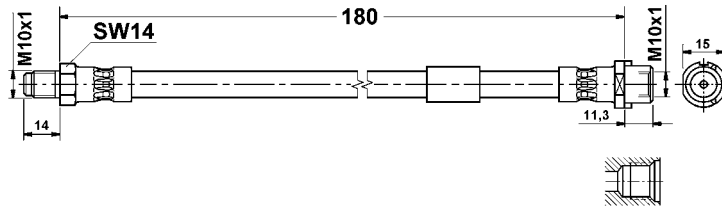

83.7188-0446.3 330664

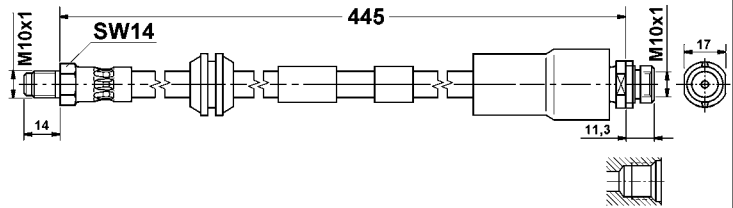

83.7201-9173.3 330868

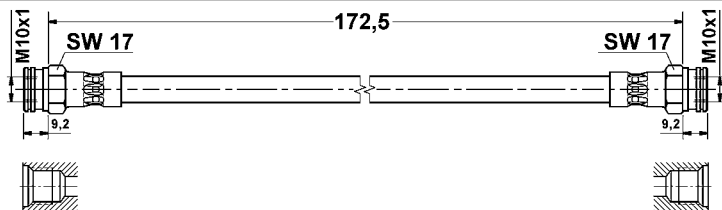

83.7216-0404.3 330374

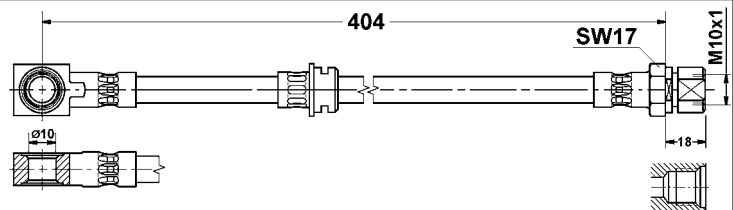

83.7247-0603.3 330899

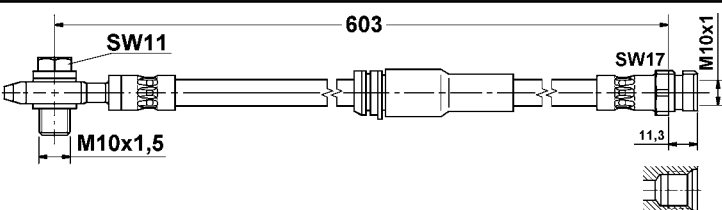

83.7249-0536.3 330900

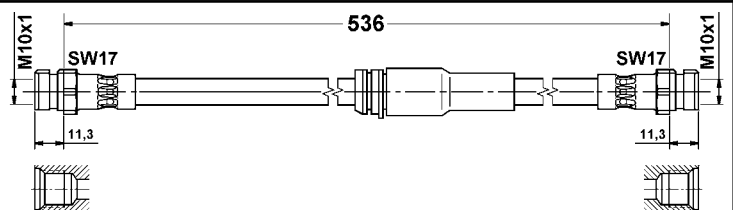

83.7704-0200.3 330825

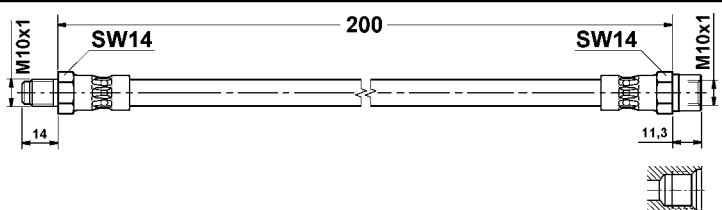

83.7704-0266.3 330979

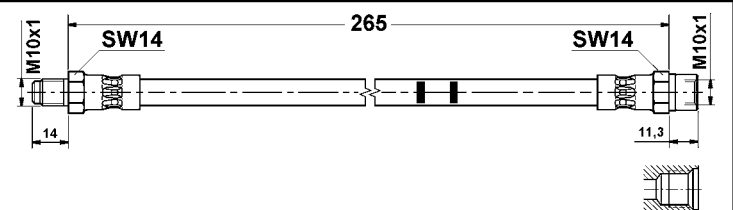

83.7704-0281.3 330804

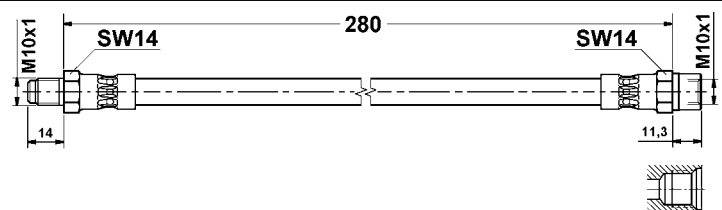

83.7704-0290.3 330826

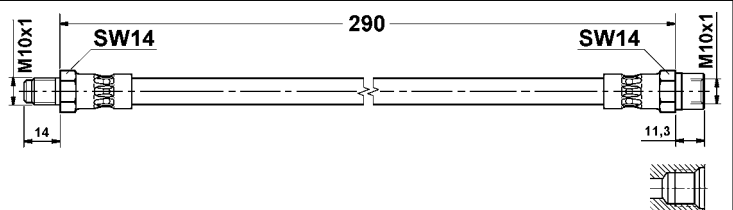

83.7704-0320.3 330851

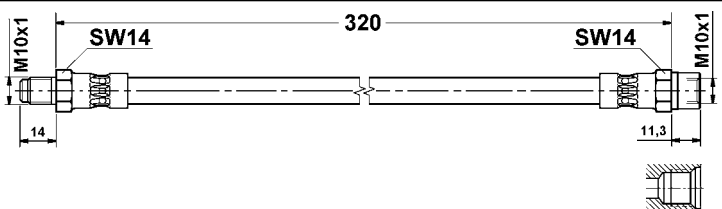

83.7705-0342.3 331273

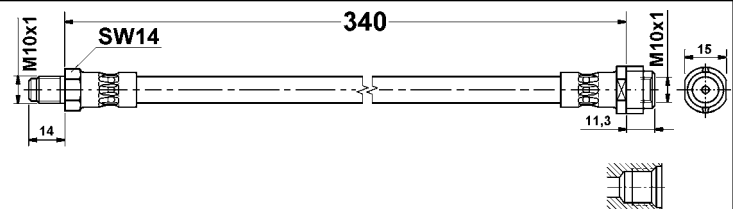

Abbildungen Bremsschläuche, Kupplungsschläuche

Illustrations brake hoses, clutch hoses - Illustrations fessibili freno, fessibili frizione - Illustrations Flexible de frein, Flexibles d'embrayages - Ilustraciones flexibles de freno, flexibles d'embrague

83.7705-0386.3 330828

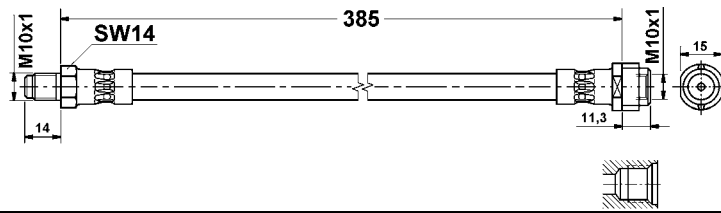

83.7713-0347.3 330986

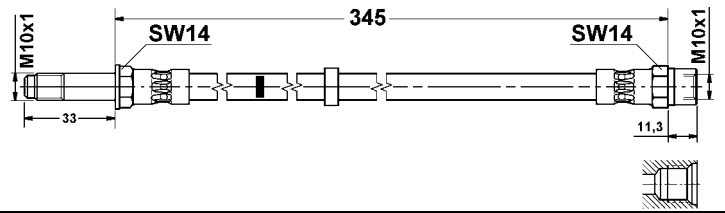

83.7713-0366.3 331100

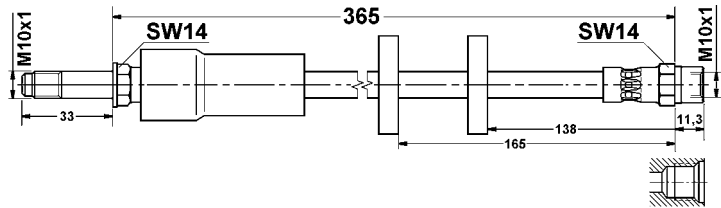

83.7713-0476.3 331116

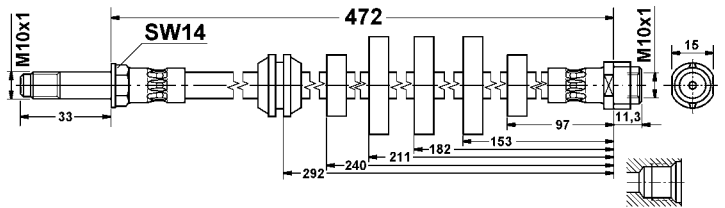

83.7713-0483.3 331229

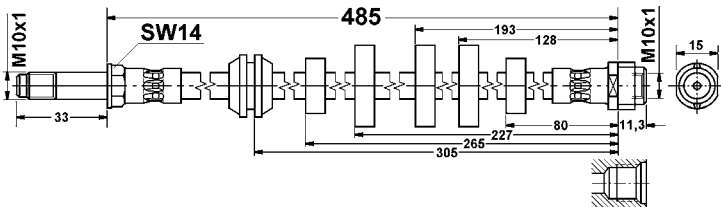

83.7713-0487.3 331342

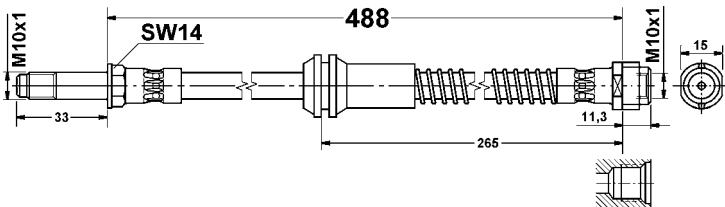

83.7714-0391.3 330980

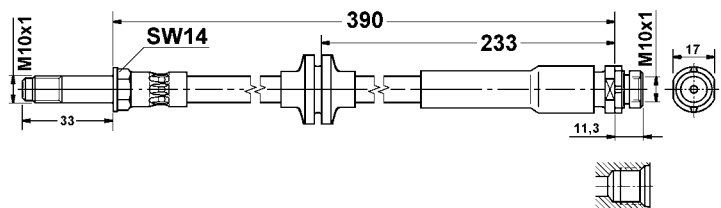

83.7715-0380.3 331269

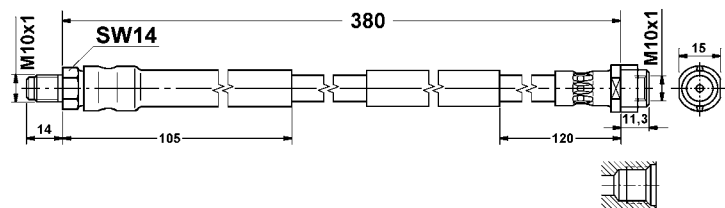

83.7716-0363.3 330829

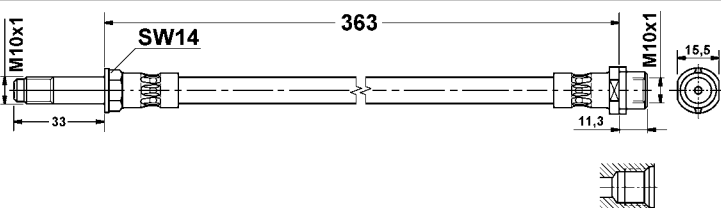

83.7716-0397.3 330790

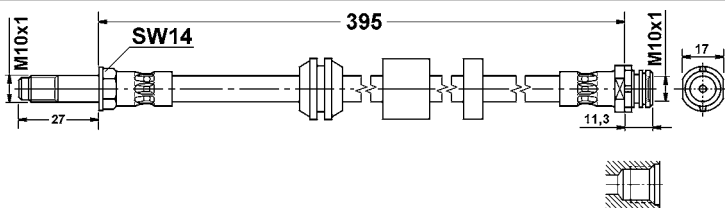

83.7716-0398.3 330987

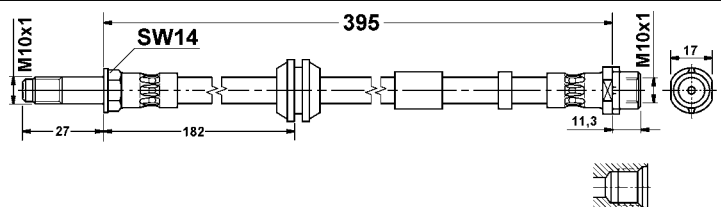

83.7724-0202.3 330852

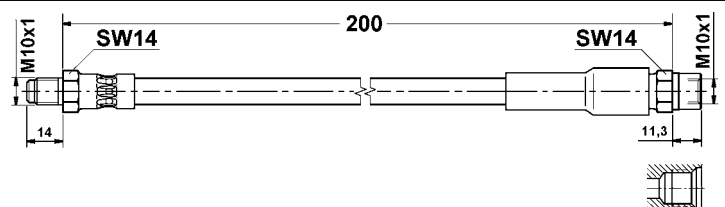

83.7724-0204.3 331206

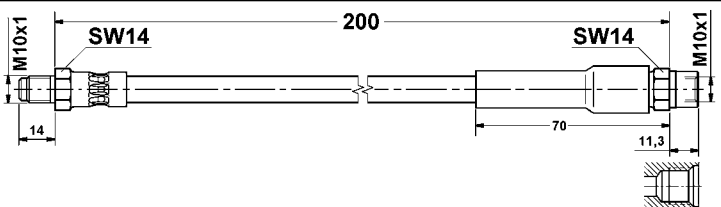

83.7724-0268.3 331076

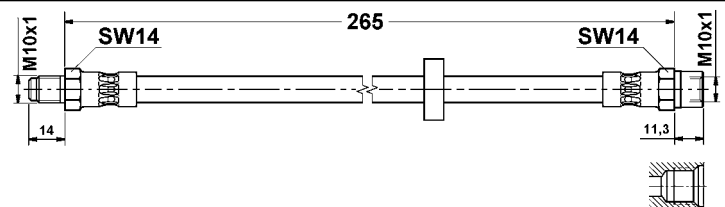

Abbildungen Bremsschläuche, Kupplungsschläuche

Illustrations brake hoses, clutch hoses - Illustrations fessibilli freno, fessibilli frizione - Illustrations Flexible de frein, Flexibles d'embrayages - Ilustraciones flexibles de freno, flexibles d'embrague

83.7724-0467.3 331274

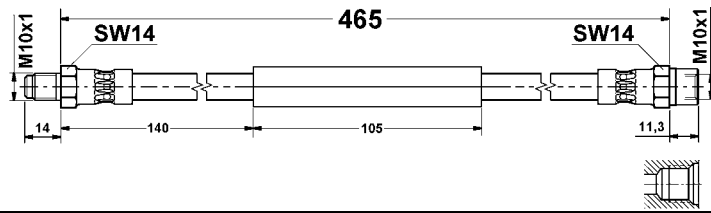

83.7734-0290.3 330809

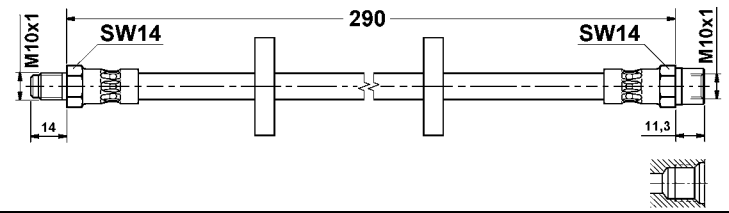

83.7750-0482.3 331270

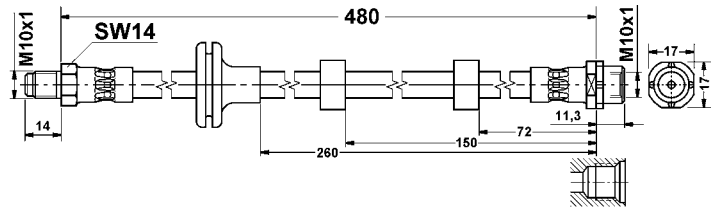

83.7750-0513.3 331051

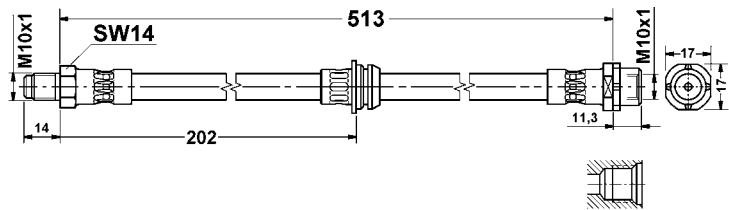

83.7750-0524.3 331230

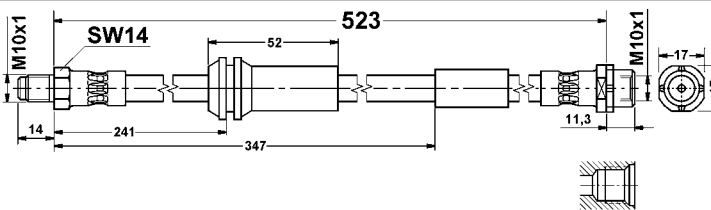

83.7751-0417.3 331102

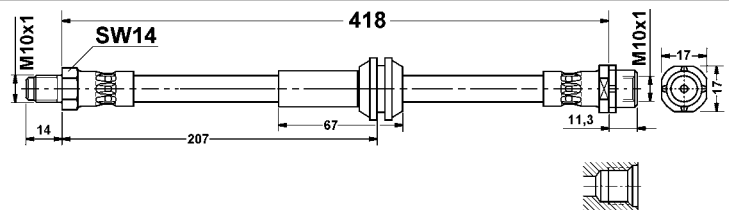

83.7751-0425.3 331271

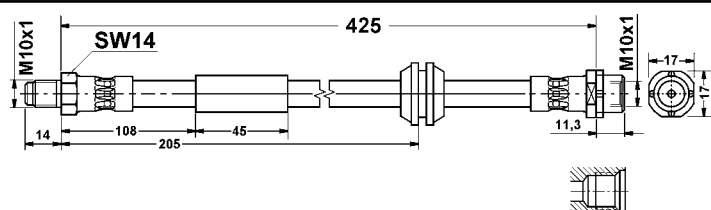

83.7751-0495.3 331104

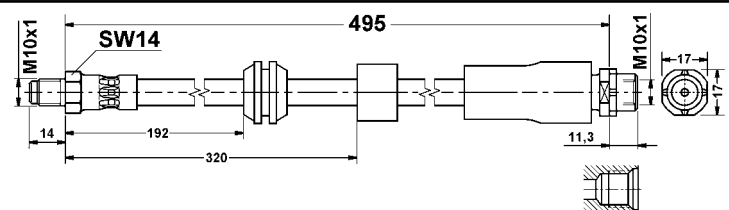

83.7751-0502.3 331109

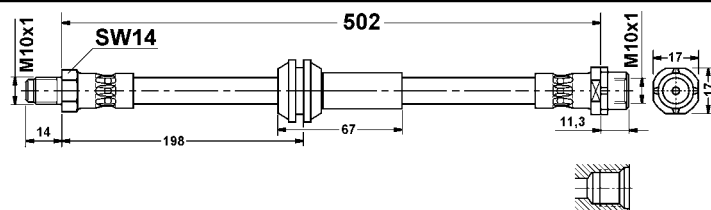

83.7751-0520.3 331052

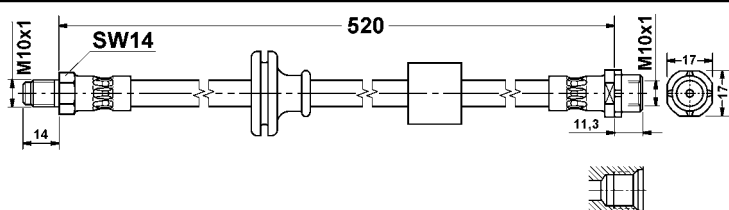

83.7751-0553.3 331103

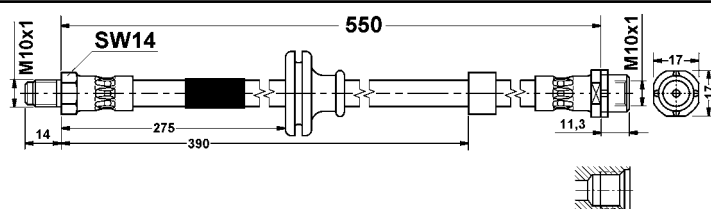

83.7752-0236.3 331118

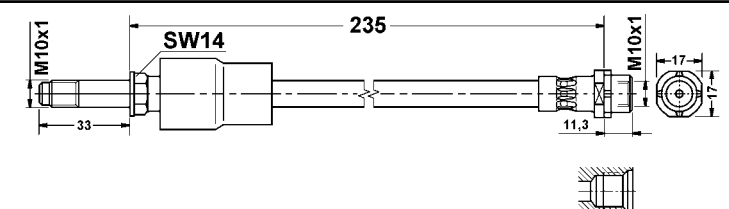

83.7769-0275.3 331207

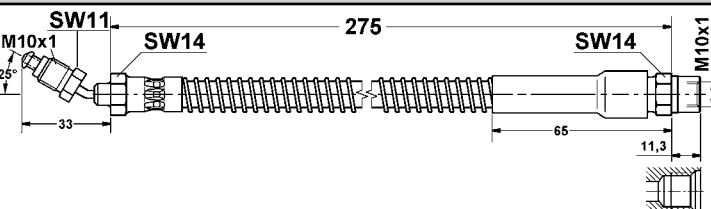

83.7769-0493.3 330861

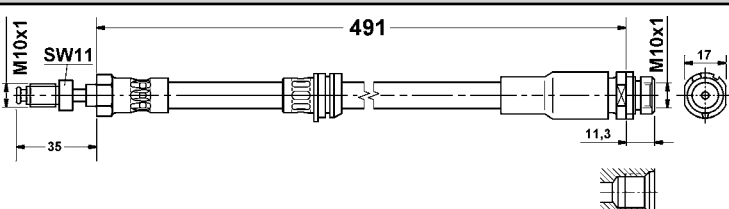

Abbildungen Bremsschläuche, Kupplungsschläuche

Illustrations brake hoses, clutch hoses - Illustrations fessibilli freno, fessibilli frizione - Illustrations Flexible de frein, Flexibles d'embrayages - Ilustraciones flexibles de freno, flexibles d'embrague

83.7769-0561.3 331105

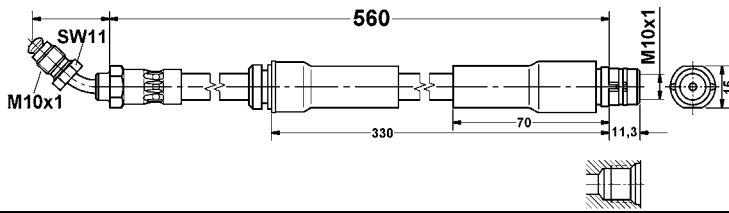

83.7769-0713.3 331097

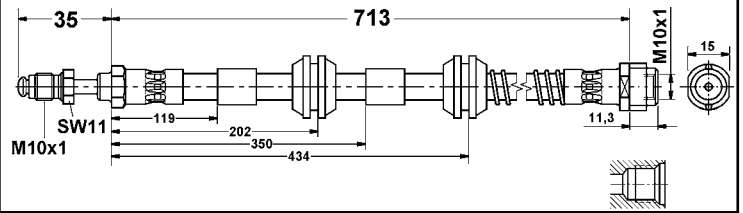

83.7788-0280.3 330836

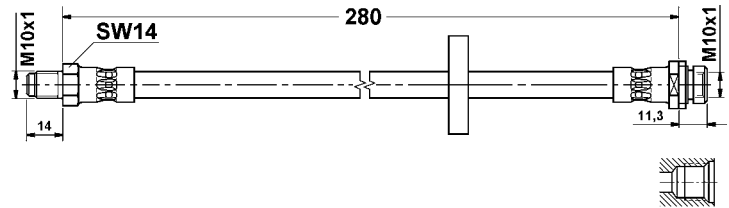

83.7788-0382.3 330971

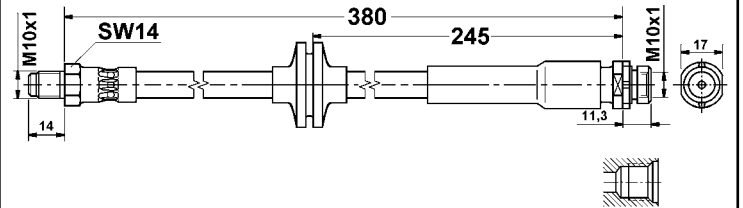

83.7788-0383.3 330972

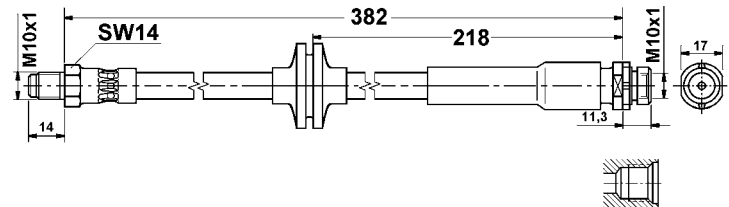

83.7788-0386.3 331231

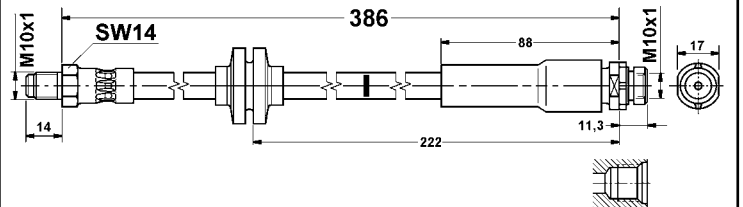

83.7788-0409.3 330981

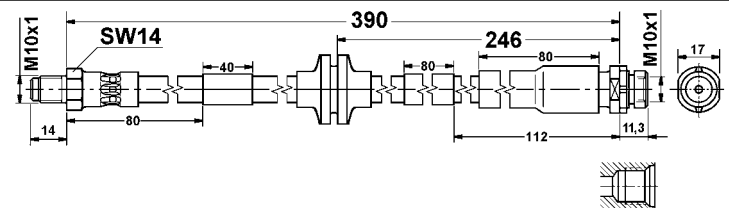

83.7788-0414.3 330988

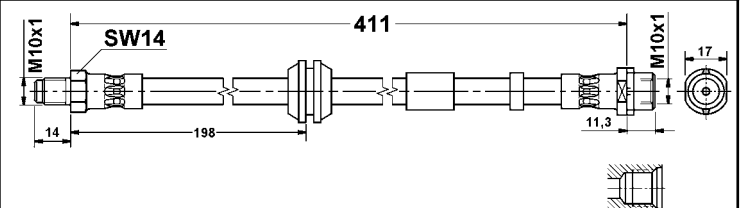

83.7788-0425.3 331232

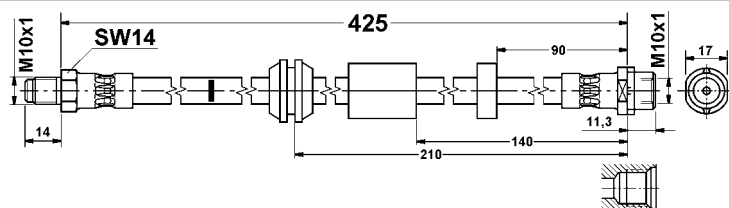

83.7788-0435.3 331119

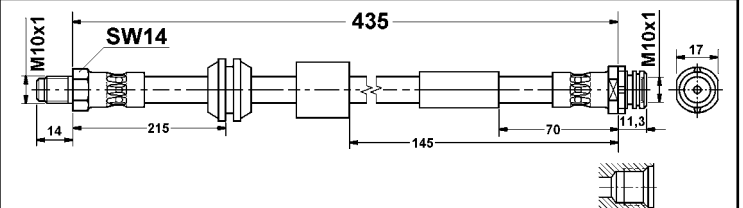

83.7788-0472.3 331120

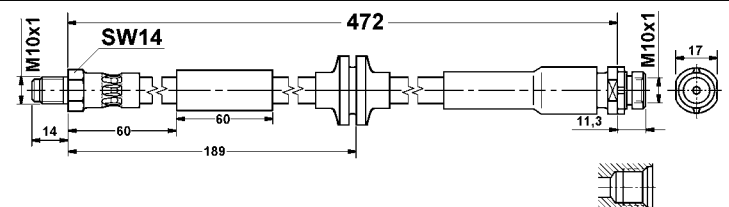

83.7804-0150.3 330853

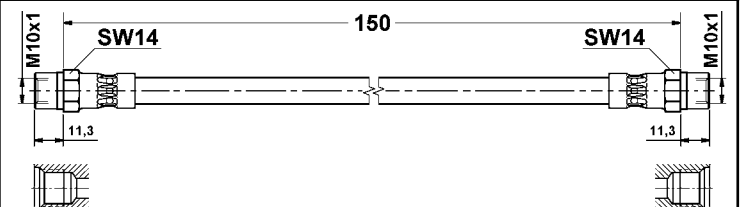

83.7807-0412.3 331098

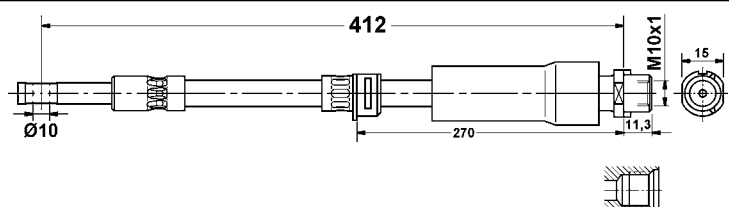

83.7812-0200.3 330846

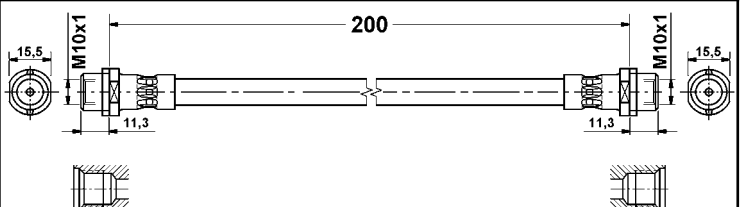

Abbildungen Bremsschläuche, Kupplungsschläuche

Illustrations brake hoses, clutch hoses - Illustrations fessibilli freno, fessibilli frizione - Illustrations Flexible de frein, Flexibles d'embrayages - Ilustraciones flexibles de freno, flexibles d'embrague

83.7812-0400.3 331214

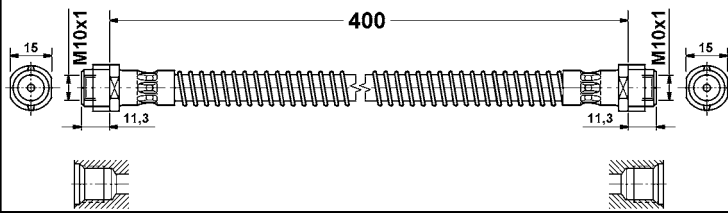

83.7813-0252.3 330796

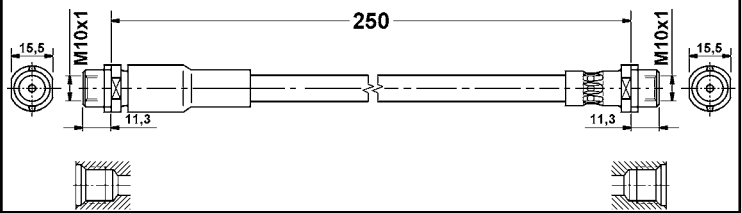

83.7813-0295.3 330799

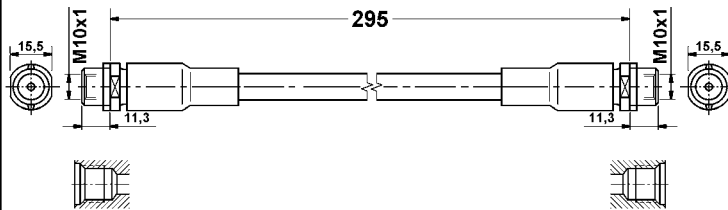

83.7813-0315.3 330870

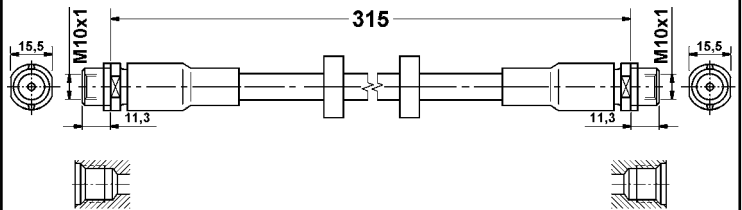

83.7824-0180.3 330812

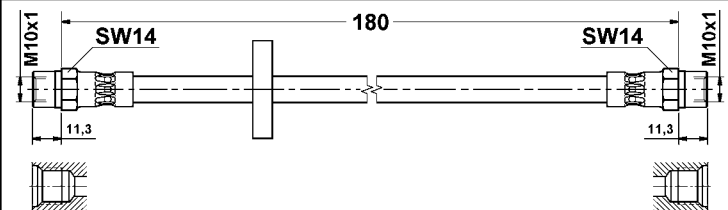

83.7824-0383.3 330856

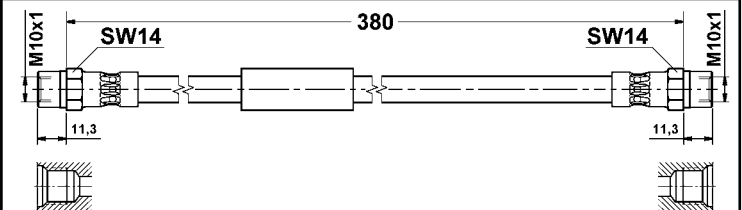

83.7827-0245.3 331113

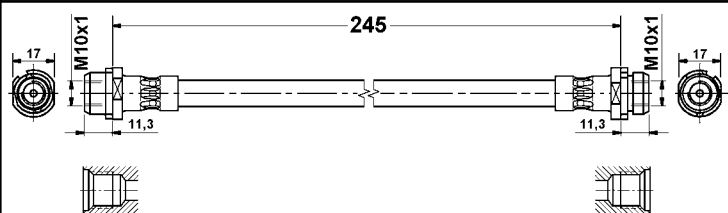

83.7827-0263.3 331193

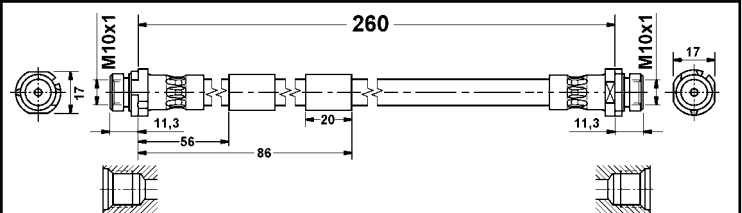

83.7827-0300.3 330902

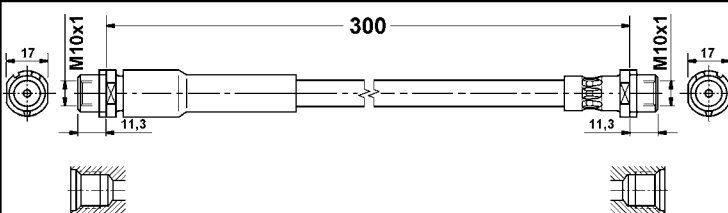

83.7827-0321.3 330862

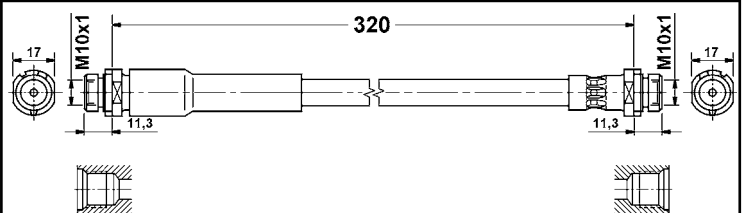

83.7835-0412.3 331275

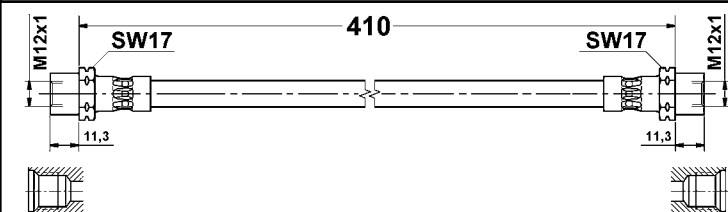

83.7836-0135.3 330816

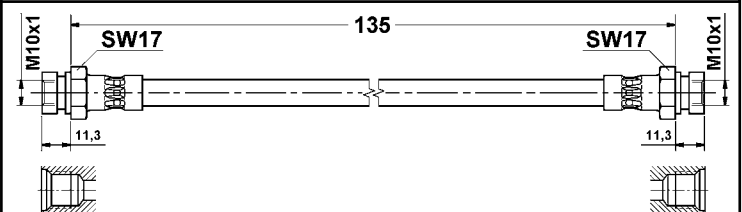

83.7838-0370.3 331122

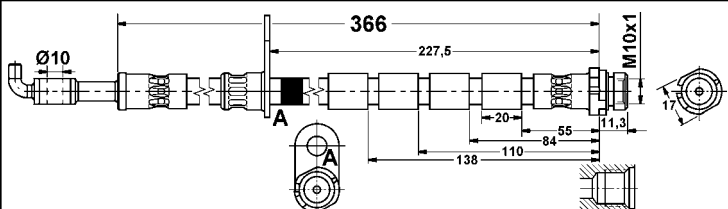

83.7838-0371.3 331123

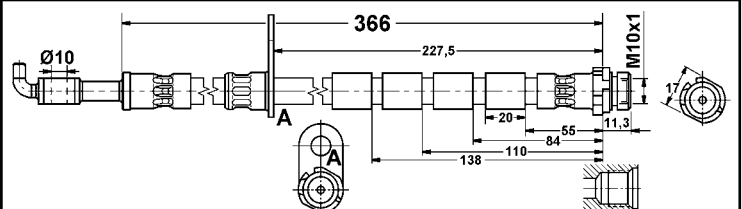

Abbildungen Bremsschläuche, Kupplungsschläuche

Illustrations brake hoses, clutch hoses - Illustrations fessibili freno, fessibili frizione - Illustrations Flexible de frein, Flexibles d'embrayages - Ilustraciones flexibles de freno, flexibles d'embrague

<p>83.7847-0254.3 331233</p>	<p>83.7847-0257.3 331234</p>
<p>83.7847-0620.3 331110</p>	<p>83.7849-0145.3 331106</p>
<p>83.7849-0236.3 330873</p>	<p>83.7849-0243.3 331099</p>
<p>83.7849-0250.3 331111</p>	<p>83.7849-0419.3 331114</p>
<p>83.7849-0426.3 331235</p>	<p>83.7849-0502.3 331125</p>
<p>83.7849-0554.3 331112</p>	<p>83.7850-0180.3 331054</p>
<p>83.7850-0205.3 331115</p>	<p>83.7855-0354.3 331236</p>

Abbildungen Bremsschläuche, Kupplungsschläuche

Illustrations brake hoses, clutch hoses - Illustrations fessibilli freno, fessibilli frizione - Illustrations Flexible de frein, Flexibles d'embrayages - Ilustraciones flexibles de freno, flexibles d'embrague

83.7856-0369.3 331237

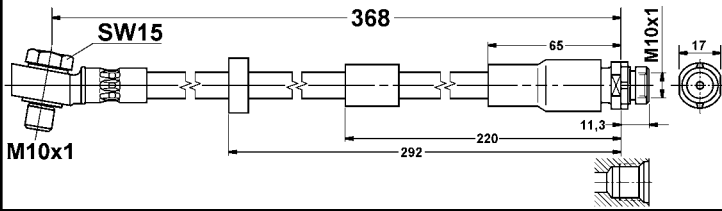

83.7858-0140.3 330837

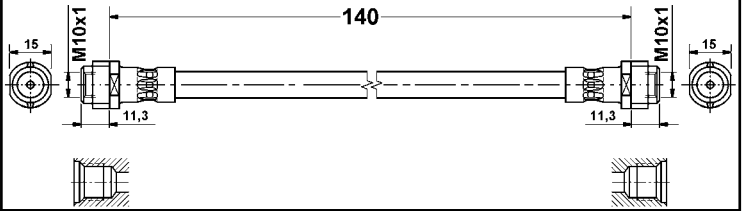

83.7858-0165.3 331107

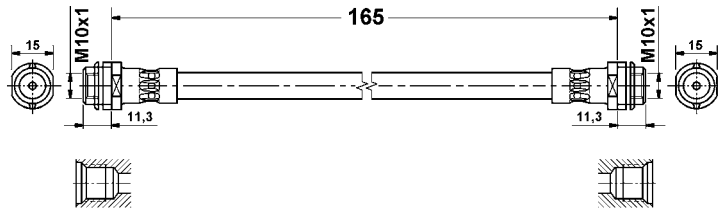



- D** Technische Übersetzungen
- EN** Technical translations
- FR** Traductions techniques
- IT** Traduzioni tecniche
- ES** Traducciones técnicas
- NL** Technische vertalingen
- DA** Tekniske oversættelser
- SV** Tekniska översättningar
- HU** Műszaki fordítás
- PT** Glossário técnico
- RU** Перевод технических терминов
- CZ** Technické překlady
- PL** Tłumaczenia techniczne
- EL** Τεχνικές μεταφράσεις
- TR** Teknik çeviriler
- ZH** 技术翻译
- JA** テクニカルトランスミッション
- AR** الترجمات التقنية

K24-H

1-Kammer-Druckluftbremse	single-chamber air brake	frein pneumatique à 1 chambre
1-Kolbensattel D=xx	single-piston caliper D=xx	étrier à 1 piston D=xx
2-Kolbensattel D=xx	2-piston caliper D=xx	étrier à 2 pistons D=xx
4-Kolbensattel	4-piston caliper	étrier à 4 pistons
1-Kreis-Bremse	single-circuit brake	frein à 1 circuit
2-Kreis-Bremse	two-circuit-brake	frein à deux circuits
1-Kreis-Sättel	single-circuit caliper	étriers frein à 1 circuit
2-Kreis-Sättel	two-circuit-caliper	étriers frein à 2 circuits
1. Hinterachse	first rear axle	1. essieu arrière
1. und 2. Hinterachse	first and second rear axle	1. et 2. essieu arrière
4-Loch-Bremsscheibe	4-bore brake disc	disques de frein à 4 trous
6-Loch-Bremsscheibe	6-bore brake disc	disques de frein à 6 trous
3-Loch-Felge	3-bore wheel rim	jante à 3 trous
4-Loch-Felge	4-bore wheel rim	jante à 4 trous
5-Loch-Felge	5-bore wheel rim	jante à 5 trous
6kt-Schraube	hexagon head screw	vis hex.
6kt-Schraube (innen)	hexagon socket screw	vis hex. (intérieure)
6“-Tandem	6“-tandem	6“-tandem
8“-Tandem mit Gabelkopf	8“-tandem with yoke	8“-tandem avec chape
8“-Tandem ohne Gabelkopf	8“-tandem without yoke	8“-tandem sauf chape
ABS	ABS (anti-lock brake system)	ABS (système anti-blocage)
ABS-Dichtungssatz	ABS-gasket kit	jeu de joints de ABS
Achtung: Kolbenstellung ändern !	attention: change piston position !	attention: position du piston à changer !
Adapter für Bördel E	adapter for bead type E	adapteur pour colet E
alle Typen	all types	tous types
Alu-Pumpe	alu-pump	pompe en alu
Alu-Sättel	alu-calipers	étriers en alu
am Bremssattel	on the brake caliper	sur l'étrier de frein
am Hauptzylinder	on the master cylinder	sur le maître-cylindre
A-Motor	A engine	moteur A
Anschlagschraube oben	stop screw, top	vis de butée en haut
Anschluß/Anschlüsse	connection/connections	raccordement/raccordements
Anti-Noise-Blech	shim	tôle anti-bruit
ASC (Automatische Stabilitäts Control)	ASC (automatic stability control)	ASC (contrôle de stabilité)
ASR (Antriebsschlupfregelsystem)	ASR (traction control system TCS)	ASR (anti-patinage)
ATE nur über VAG erhältlich	ATE only available through VAG	ATE (Teves) en vente chez VAG seulement
auf Typenschild	on identification plate	sur plaque d'identification
aufgeschraubt	screwed on	vissé
Auslaß seitlich links	outlet lateral left-hand	échappement latéral gauche
Auslaß seitlich rechts	outlet lateral right-hand	échappement latéral droit
außen	outer	mâle
automatische Nachstellung	automatic adjustment	ajustage automatique
Behälter	reservoir	réservoir
Behälter Doppel-WE	reservoir with double warning device	réservoir avec témoin d'usure double
Behälterbefestigung	reservoir fastening	fixation réservoir
Behälterstopfen	reservoir plug	bouchon de réservoir
Behälterverschraubung	reservoir cap	vissage de réservoir
Behörde	authority cars	véhicule communal
Beläge	brake pads	plaquettes de frein
belüftete Scheiben	ventilated discs	disques ventilés
Betätigungseinheit	actuation unit	unité de commande
blau	blue	bleu
Bodenventil	residual pressure center valve	soupape de pression résiduelle
Bodenventile tauschen	change residual pressure center valve	soupape de pression résiduelle à changer
Bördel x	flare type x	colet x
braun	brown	marron
breite Ausführung	wide design	exécution large
Bremse	brake	frein
Bremsgerät	booster unit	servo-frein
Bremskraftregler	brake pressure regulator	correcteur de freinage
Bremsleitungen erneuern !	renew brake lines !	conduits de frein à renouveler !
Bremslichtschalter	stop-light switch	contacteur stop
Bremsscheiben	brake discs	disques de frein
Bremsschlauch beachten !	notice brake hose !	faire attention flexible de frein !
Buchse + Ausgleichbügel	bushing + compensating clip	douille + étrier de compensation
Bus	bus (van)	autobus/car
Bypassregler	by-pass regulator	régulateur à by-pass
Citroen-Bremse	Citroen-brake	freins Citroen
D (Durchmesser) =	D (diameter) =	D (diamètre) =
Dichtring	sealing ring	rondelle d'étanchéité
Dichtung	seal	joint
Dichtungssatz	gasket kit	jeu de joints
Differentialsperre	differential lock	blocage de différentiel
Differenzdruckschalter	differential-pressure switch	interrupteur à pression différentielle
Differenzdruckventil	differential pressure valve	pression différentielle de soupape
diverse Typen	various types	types diverses
Doppelbereifung	twin tyres	pneu double



freno pneumatico a camera singola	freno de aire de 1 cámara	geluiddempende plaat
pinza freno a un pistoncino D = xx	mordaza de freno D=xx	1-zuigerklauw D=xx
pinza freno a 2 pistoncini D=xx	mordaza con dos pistones D=xx	2-zuigerklauw D=xx
pinza freno a 4 pistoncini	mordaza con 4 pistones	4-zuigerklauw
impianto frenante circuito semplice	freno de 1 circuito	enkel remcircuit
impianto frenante doppio circuito	freno de 2 circuitos	gescheiden remcircuit
pinza freno a 1 circuito	pinza de 1 circuito	remklauwen voor enkel remcircuit
pinza freno a 2 circuiti	pinza de 2 circuitos	remklauwen voor gescheiden remcircuit
primo assale posteriore	1. eje trasero	1e achteras
primo e secondo assale posteriore	1. + 2. eje trasero	1e en 2e achteras
disco freno 4 fori	disco freno con 4 taladros	4-gats remschijf
disco freno 6 fori	disco freno con 6 taladros	6-gats remschijf
cerchione a 3 fori	Llantas de 3 taladros	3-gats velg
cerchione a 4 fori	Llantas de 4 taladros	4-gats velg
cerchione a 5 fori	Llantas de 5 taladros	5-gats velg
vite testa esagonale	tornillo hexagonal	zeskantbout
brugola	tornillo hexagonal (interior)	zeskantbout (binnen)
tandem 6"	6"-tándem	6"-tandem
tandem 8" con testa a forcella	8"-tándem con cabeza de horquilla	8"-tandem met gaffel
tandem 8" senza testa a forcella	8"-tándem sin cabeza de horquilla	8"-tandem zonder gaffel
ABS (sistema antibloccaggio in frenata)	ABS (sistema de frenado antibloqueo)	ABS
serie guarnizioni ABS	juego de reparación de juntas ABS	ABS-pakkingset
attenzione: cambiare posizione pistone !	atención: cambiar posición pistón !	Attentie: positie zuiger wijzigen !
adattatore per bordatura E	adaptador para rebordes E	adapter voor felsrand E
tutti tipi	todos tipo	alle typen
pompa in alluminio	bomba de aluminio	alu-pomp
pinza in alluminio	mordaza de freno de aluminio	alu-klauwen
sulla pinza freno	a la pinza de freno	op de remklauw
sulla pompa freno	a la bomba principal de freno	op de hoofdremscilinder
motore A	motor de A	A-motor
vite di fermo in alto	tornillo de tope arriba	aanslagschroef boven
attacco / attacchi	conexion/conexiones	aansluiting/aansluitingen
lamierino antirumore	placa anti-ruidos	geluiddempende plaat
ASC (controllo automatico stabilità)	ASC (control automático de estabilidad)	ASC (Automatische Stabiiliteits Controle)
ASR (sistema antislittamento in accelerata)	ASR (sistemas antiderrapaje)	ASR (tractieregelingssysteem)
ATE distribuito esclusivamente da VAG	ATE solamente através de VAG	ATE alleen verkrijgbaar via VAG
vedi targhetta di identificazione	placa de identificación	op typeplaatje
avvitato	fijado	opgeschroefd
scarico laterale sinistro	salida lateral izquierda	uitlaat opzij links
scarico laterale destro	salida lateral derecha	uitlaat opzij rechts
esterno	exterior	buiten
correzione automatica	reajuste automatico	automatische bijstelling
serbatoio	recipiente	reservoir
serbatoio con doppia spia	recipiente con doble aparato de aviso	reservoir dubbele noodknipperlichtinstallatie
fissaggio serbatoio	recipiente de fijación	bevestiging reservoir
tappo serbatoio	tapon	plug reservoir
tappo filettato serbatoio	fijación depósito	schroefkoppeling reservoir
enti statali	vehiculos oficiales	overheid
pastiglie freno	pastillas de freno	voeringen
dischi ventilati	disco ventilado	geventileerde schijven
unità di comando	unidad de accionamiento	bedieningseenheid
blu	azul	blauw
valvola di fondo	válvula de fondo	bodemventiel
sostituire valvola di fondo	cambiar válvula de fondo	bodemventielen vervangen
bordatura tipo x	reborde x	felsrand x
marrone	marron	bruin
versione larga	variante ancha	brede uitvoering
freno	freno	rem
servofreno	servofreno	remapparaat
correttore di frenata	corrector de frenado	remdrukregelaar
sostituire tubi freni !	renovar latiguillos de freno !	remleidingen vernieuwen !
interruttore luce stop	interruptor de luz de freno	remlichtschakelaar
dischi freno	discos de freno	remschijven
attenzione ai flessibili freni !	atención al latiguillo de freno !	let op de remslang !
bussola + staffa di compensazione	casquillo + estribo de compensación	bus + expansiebeugel
autobus	autobus	bus
regolatore by-pass	regulador de by-pass	bypassregelaar
freno Citroen	freno Citroen	citroen-rem
D (diametro) =	D (diámetro) =	D (diameter) =
guarnizione anulare	reten	afdichtring
guarnizione	junta	pakking
serie guarnizioni	juego de reparación de juntas	pakkingset
differenziale autobloccante	bloqueo diferencial	differentieelslot
interruttore pressione differenziale	interruptor de presión diferencial	verschilddrukschakelaar
valvola pressione differenziale	válvula de presión diferencial	verschilddrukklep
vari tipi	diversos tipo	diverse typen
ruote gemellate	cubierta doble	dubbele banden

Doppelkabine	double cab	cabine double
Druckbegrenzungsventil	pressure limiting valve	soupape à réglage de pression
Druckbolzen	tappet	boulon de pression
Druckbolzen (kurz)	tappet (short)	boulon de pression (court)
Druckbolzen (lang)	tappet (long)	boulon de pression (long)
Druckluftbremse	air brake	frein à pneumatique
Druckluftleitung	compressed-air line	conduite pneumatique
Druckluftunterstützung	air brake assistance	assistance à pneumatique
Druckluftverstärker	air brake booster	amplificateur à pneumatique
Druck-Warnschalter	pressure warning switch	avertisseur d'alerte de pression
DS-Regler	DS-valve	correcteur de DS
EDS	EDS (electronic differential lock)	EDS (blocage de différentiel électronique)
EDS-Ventilblock	EDS-valve block	EDS-bloc de vannes
EG-Vorschrift	accordance with EC regulation	aux prescriptions CEE
Einbau hinter der Achse	installation aft of axle	montage derrière l'essieu
Einbau vor der Achse	installation forward of axle	montage devant l'essieu
Einbausatz	installation kit	lot de montage
Einfachbereifung	single tyre	pneu simple
Einknöpfmaß xx mm	button-in dimension xx mm	mesure à boutonner xx mm
Einlaß D=xx mm	inlet diameter=xx mm	admission diamètre=xx mm
Einlaß mit Gummistopfen	inlet with rubber plug	admission avec bouchon de caoutchouc
Einschraubregler	screw-in proportioning valve	compensateurs à visser
elektr. Vergaser	electr. carburetor	carburateur électrique
Entlüfteranschluß	bleeding connection	raccordement de purge
Entlüfterventil	bleeder valve	soupape de purge
erhöhte Zuladung	increased payload	charge utile augmentée
Ersatz für Sättel D=xx	replacement for calipers D=xx	remplacement pour étriers D=xx
ETS	ETS (electronic trac control system)	ETS (contrôle trajectoire)
Europa	Europe	Europe
Export	Export	Export
Fahrschule	driving school	auto-école
Faltenbalsatz	bellow seal set	jeu de joints-soufflets
Faustsättel	fist-type calipers	étriers à griffe
Fenster	window	fenêtre
Festsättel	fixed calipers	étriers fixes
Flanschdicke x mm	flange thickness x mm	épaisseur de la bride x mmm
Flanschmaß = xx,x	flange dimension = xx,x	dimension de la bride = xx,x
Fuller-Getriebe	fuller-gearbox	boîte à vitesse fuller
für Belagsätze ohne Zubehör	for brake pads without accessories	pour garnitures de frein sauf accessoire
für Bremssättel/Vorgänger	for calipers/predecessor	pour étriers de frein/prédécesseur
für Doppelmembran-Gerät	for twin diaphragm booster	pour appareil à double membrane
Gabelkopfsatz	yoke kit	jeu de chape
Gehäuse L=	housing L=	corps L=
gelb	yellow	jaune
gepanzerte Fahrzeuge	armoured vehicles	véhicule blindé
Getriebe	gearbox	boîte de vitesse
Getriebe-Nr.	gearbox-no.	no. boîte de vitesse
GG-Pumpe	cast-iron-pump	pompe en fonte
GG-Sättel	cast iron-caliper	étriers en fonte
GG-THz/Vorgänger	cast-iron-TMC/predecessor	MCT fonte/prédécesseur
Golf-Staaten	Gulf States	pays du Golfe Persique
Gz mit senkrechtem Flansch	CC with vertical flange	émetteur d'embrayage avec bride
Gz (Geberzylinder)	CC (clutch cylinder)	EE (émetteur d'embrayage)
Gz-Reparaturset	CC-repair kit	néc. de réparation EE
HA (Hinterachse)	RA (rear axle)	AR (essieu arrière)
Haltefeder	retaining spring	ressort à retenu
Halter	anchor	support
Haltersatz	anchor set	jeu de support
Halterschraube	anchor screw	vis de support
Handbremsbetätigung	hand brake actuation	frein à main
Handbremshebel	handbrake lever	levier de frein à main
HA-Scheibenbremse	rear axle disc brake	frein à disque essieu AR
HA-Trommelbremse	rear axle drum brake	frein à tambour essieu AR
Hebel	lever	levier
Hochdach	high roof	toit surélevé
Hohlschraube	hollow screw	vis creuse
Hosei-Bremse	Hosei brake	freins Hosei
Hub	stroke	course
Hülsensatz	sleeve kit	jeu de douilles
Hydraulikspeicher	hydraulic accumulator	accumulateur hydraulique
Hydraulikverstärker	hydraulic booster	amplificateur hydraulique
Hydraulikzylinder	hydraulic cylinder	cylindre de hydraulique
Hydr. Steuereinheit	hydraulic unit	modulateur
Hz (Hauptzylinder)	MC (master cylinder)	MC (maître cylindre)
Hz-Reparaturset	MC-repair kit	néc. de réparation MC
im Fahrerhaus	in cab	dans la cabine du conducteur
im Motorraum	in engine compartment	dans compartiment moteur



cabina doppia	cabina doble	dubbele cabine
valvola limitatrice pressione	valvula de limitación de presión	drukregelaar
perno pressione (oliva)	perno de presión	drukpen
perno pressione (corto) (oliva)	perno de presión (corto)	drukpen (kort)
perno pressione (lungo) (oliva)	perno de presión (largo)	drukpen (lang)
freno pneumatico	freno de aire comprimido	pneumatische rem
tubo aria compressa	aire comprimido de flexible	pneumatische leiding
comando aria compressa	freno de aire auxiliár	luchtdrukbekrachtiging
servofreno pneumatico	servo de aire a presión	luchtdrukbekrachtiger
interruttore spia pressione	interruptor de aviso de presión	druk-waarschuwingsschakelaar
regolatore flusso pressione	regulador DS	DS-regelaar
EDS (bloccaggio elettronico differenziale)	EDS (bloqueo diferencial electrónico)	EDS
gruppo valvole EDS	EDS válvula de bloqueo	EDS-kleppenblok
normativa CE	según normativa CEE	EG-voorschrift
montaggio dietro l'assale	instalación despues del eje	montage achter de as
montaggio davanti l'assale	instalación antes del eje	montage vóór de as
serie di montaggio	juego de montaje	inbouwset
ruota singola	cubierta simple	enkele banden
misura alloggiamento xx mm	medida de alojamiento xx mm	inknoopmaat xx mm
diametro mandata = xx mm	admision diámetro = xx mm	inlaat D=xx mm
mandata con tappo in gomma	admision con tapon de goma	inlaat met rubberen plug
regolatore a vite	regulador roscado	inschroefregelaar
carburatore elettronico	carburador eléctrico	elektr. carburateur
attacco per spurgo	conexion de purga	ontluchtingsaansluiting
valvola di spurgo	válvula de purga	ontluchtingsventiel
carico utile maggiorato	incremento de carga	verhoogd laadvermogen
ricambio per pinza freno D=xx	sustitución para pinzas D=xx	reserve voor remklauwen D=xx
ETS (controllo elettronico della trazione)	ETS (sistema de control electr. de tracción)	ETS
Europa	Europa	Europa
export	Exportación	export
scuola guida	escuela de conducción	rijsschool
serie soffiati	juego de reparac. de suspension neumatica	rolbalgset
pinza freno flottante	pinza de puno	zwevende remklauwen
finestralla	ventana	venster
pinza freno fissa	pinza de fija	vaste remklauwen
spessore flangia x mm	grosor de la brida x mm	flensdikte x mm
misura flangia = xx,x	medida de brida = xx,x	flensmaat = xx,x
scatola cambio Fuller	Fuller caja de cambios	Fuller-transmissie
per pastiglie freno senza accessori	para juego de pastilla sin accesorios	voor remvoeringsets zonder toebehoren
per pinze freno / precedente	para pinza/avisador	voor remklauwen/voorlopers
per servofreno a doppia membrana	para servo freno con doble membrana	voor dubbel-membraantoestel
serie forcelle	juego de cabeza de horquilla	gaffelset
carcassa L =	carcasa L=	huis L=
giallo	amarillo	geel
veicoli blindati	vehículo blindado	gepantserde voertuigen
scatola cambio	caja de cambios	transmissie
scatola cambio n.	número de caja de cambios	transmissie-nr.
pompa in ghisa	bomba de fundición de gris	GG-pomp
pinza in ghisa	pinza de fundición de gris	GG-klauwen
pompa tandem in ghisa / precedente	cil. principal de fundición de gris/avisador	GG-tandemhoofdcilinder/voorloper
Stati del Golfo	estados del Golfo Pérsico	Golfstaten
pompa frizione con flangia verticale	cilindro distribuidor con brida vertical	hoofdcilinder met verticale flens
cilindro di comando	CTR (cilindro distribuidor)	hoofdcilinder
serie riparazione cilindro di comando	juego de reparación de juntas CTR	reparatieset hoofdcilinder
P (asse posteriore)	HA (eje trasero)	achteras
molla di ritegno	muelle de sujeción	klemveer
supporto	soporte	houder
serie di supporti	juego de soporte	houderset
vite supporto	tomillo de soporte	houderschroef
azionamento freno a mano	activación de freno de mano	bediening handrem
leva freno a mano	palanca freno de mano	handremhendel
dischi freno asse posteriore	eje trasero disco de freno	schijfrem achteras
tamburi freno asse posteriore	eje trasero tambores de freno	trommelrem achteras
leva	palanca	hendel
tetto sopraelevato	techo sobrealzado	hoog dak
vite cava	tomillo hueco	holle bout
freni Hosei	freno de Hosei	Hosei-rem
corsa	elevación	slag
serie boccole	juego de vaina	doppenset
accumulatore idraulico	acumulador de hidráulico	hydraulisch reservoir
servofreno idraulico	servo hidráulico	hydraulische versterker
cilindro idraulico	cilindro de hidráulico	hydraulische cilinder
modulatore idraulico	modulador de hidráulico	hydr. regelenheid
pompa freno	CM (cilindro maestro)	hoofdcilinder
serie riparazione pompa freno	juego de reparación CM	reparatieset hoofdcilinder
in cabina	en cabina	in de stuurcabine
nel vano motore	en compartimento de motor	in de motorruimte

innen	inside	intérieur
Innengewinde	inner thread	tarudage intérieure
Kastenwagen	van	fourgonnette
Katalysator	catalytic converter	catalyseur
Kennzeichen: xx	registration number: xx	indice: xx
Kerbe am Flansch	notch on flange	entaille sur la bride
Klasse	class	classe
Kleinbus	minibus	petit autobus
Klimaanlage	air conditioning	air conditionné
Kolbenstange D=	piston rod diameter=	tige de commande diamètre=
Kolbenstange L=	piston rod length=	tige de commande longueur=
Kombiwagen	station wagon	voiture familière
Kompakt THz	compact TMC	MCT compact
Krankenwagen	ambulance	véhicule à ambulance
Kupplung	clutch	embrayage
Kupplungsabgang	outlet port for clutch connection	sortie d'embrayage
Kupplungsverstärker	clutch booster	amplificateur d'embrayage
kurzer Radstand	short wheel base	empattement court
kurzes Bremsgerät	short brake booster	servo-frein court
L (Länge) =	L (length) =	L (longueur) =
langer Radstand	long wheel base	empattement long
Leckageanzeige	leakage indicator	avertissement de fuite
lieferbar	available	disponible
links oben und rechts unten	upper left and lower right	à gauche, en haut et à droite, en bas
links vor und rechts hinter der Achse	left in front and right behind axle	à gauche devant essieu et à droite derrière essieu
Linklenker	left hand drive	direction à gauche
Luftfederung	pneumatic suspension	suspension pneumatique
luftgekühlt	air-cooled	refroidir par air
M8-Führungsbolzen	M8-guide pin	boulon de guidage M8
MA-Getriebe	MA gearbox	boîte de vitesse MA
mit 1 Haltestift	with 1 retaining pin	avec 1 bouchon d'arrêt
mit 2 Haltestiften	with 2 retaining pins	avec 2 bouchon d'arrêts
mit Alufelgen	with alu wheel rim	avec jante en alu
mit angegossenem Behälter	with cast-on reservoir	réservoir en fonte commun
mit geregeltm Katalysator	with controlled catalytic converter	avec cataliseur réglé
mit Laschen	with straps	avec collier
mit Leichtmetallrädern	with light alloy rims	avec jantes en aluminium
MKII-Aggregat kpl.	MKII complete unit	agrégat MKII complet
Mod. (Modell)	Mod. (model)	Mod. (modèle)
Motor	engine	moteur
Motor-Nr.	engine number	numéro de moteur
Motor-Pumpen-Aggregat	motor pump unit	agrégat moteur pompe
Multi-Link-Achse	multi-link axle	essieu multi-link
m.Z. (mit Zubehör)	m.Z. (with accessories)	m.Z. (avec accessoire)
Nachstellteile-Satz	adjuster parts set	jeu de pièces d'ajustage
ND-Schlauch	ND low pressure hose	flexible de ND
Nebenabtrieb	power take-off	propulsion secondaire
Niveauregulierung	suspension level-control	correcteur d'assiette
Nz (Nehmerzylinder)	SC (slave cylinder)	RE (récepteur d'embrayage)
Nz-Reparatursatz	SC-repair kit	néc. de réparation RE
ohne Alufelgen	without alu wheel rim	sauf jante en alu
ohne geregelten Katalysator	uncontrolled catalytic converter	sauf cataliseur réglé
ohne Laschen	without straps	sans collier
ohne Leichtmetallräder	without light alloy rim	sauf jantes en aluminium
O-Ring	O-ring	joint torique
Pedal Feststeller	lockable pedal	fixation des pédales
Polizei	Police	Police
Rad	wheel	roue
Radsensor	wheel sensor	capteur de roue
Radstand xxxx mm	wheel base xxxx mm	empattement xxxx mm
rechts oben und links unten	upper right and lower left	à droite, en haut et à gauche, en bas
Rechtslenker	right hand drive	direction à droite
Regler	regulator	régulateur
Reihenmotor	R engine	moteur en ligne
Reisebus/Hochdecker	tourist bus/high decker	autobus/car avec cabine élevée
Reparatursatz	repair kit	néc. de réparation
Ringstutzen-Satz	ring type nipple set	jeux de raccord annulaire
Rohrleitung	pipe line	conduite tube
rot	red	rouge
roter Sattel	red caliper	étrier rouge
Rückschlagventil	non-return valve	clapet antiretour
Rückstellwellen-Satz	resetting shaft set	jeu d'arbres de rappel
Rz (Radzylinder)	WC (wheel cylinder)	CR (cylindre roue)
Rz-Dichtungssatz	WC-seal kit	jeu de joints CR
Rz-Reparatursatz	WC-repair kit	néc. de réparation CR
Salisbury-Achse	Salisbury axle	essieu Salisbury
Sattel mit 1 Haltestift	caliper with 1 retaining pin	étrier avec 1 bouchon d'arrêt



interno	interior	binnen
filettatura interna	rosca interior	binnendraad
furgone	furgon	bestelwagen
catalizzatore	catalizador	katalysator
sigla: xx	distintivo: xx	kenmerk: xx
centraggio su flangia	muesca en brida	kerf in de flens
classe	classe	klasse
minibus	mini-bus	kleine bus
aria condizionata	aire acondicionado	airconditioning
biella D=	varilla de pistón diámetro =	zuigerstang D=
biella L=	varilla de pistón largo=	zuigerstang L=
station wagon	break (familiar)	stationwagen
pompa freno tandem compatta	cilindro maestro tandem compacto	compacte tandemhoofdcilinder
ambulanza	ambulancia	ziekenwagen
frizione	embrague	koppeling
uscita per frizione	salida conexión embrague	koppelingsuitlaat
servofrizione	refuerzo embrague	koppelingsbekrachtiger
passo corto	distancia corta entre ejes	korte wielbasis
servofreno corto	servofreno corto	kort remapparaat
L (lunghezza) =	L (largo) =	L (lengte) =
passo lungo	distancia larga entre ejes	lange wielbasis
spia perdite	indicador pérdida líquido de freno	lekkagedetector
disponibile	suministrable	leverbaar
a sinistra in alto e a destra in basso	izquierda arriba + derecha abajo	links boven en rechts onder
davanti a sinistra e dietro a destra dell'assale	izquierda adelante+derecha atrás de eje	links voor en rechts achter de as
guida a sinistra	volante a la izquierda	auto met stuur links
sospensione pneumatica	suspensión neumática	luchtvering
raffreddato ad aria	refrigeración por aire	luchtgekoeld
perni di guida M8	perno de guía M8	M8-geleidingspen
scatola cambio MA	caja de cambios MA	MA-transmissie
con 1 spina di fissaggio	con 1 pasador	met 1 borgstift
con 2 spine di fissaggio	con 2 pasadores	met 2 borgstiften
con cerchioni in alluminio	con Llantas de aluminio	met aluminium velgen
con serbatoio stampato	con depósito anadido	met aangegoten reservoir
con catalizzatore regolato	con catalizador regulado	met geregelde katalysator
con coprigiunto	con brida	met verbindingselementen
con ruote in lega leggera	con Llantas de aluminio	met lichtmetalen wielen
gruppo completo MKII	MKII sistema completo	MKII-aggregaat compl.
mod. (modello)	Mod. (modelo)	mod. (model)
motore	motor	motor
motore n.	número de motor	motornr.
gruppo motore-pompa	systema motor-bomba	motor-pomp-aggregaat
assale Multi-link	eje Multi-Link	multi-link-as
con acc. (con accessori)	m.Z. (con accesorios)	met toebehoren (met toebehoren)
serie parti registrazione	juego de acoplamiento	set stelonderdelen
flessibile bassa pressione	ND flexible	ND-slang
attacco di forza	potencia adicional	pto
correttore d'assetto	regulación de altura de suspensión	niveauregeling
cilindro ricevitore	CRE (cilindro receptor)	werkcilinder
serie riparazione cilindro ricevitore	juego de reparación de juntas CRE	reparatieset werkcilinder
cerchioni in alluminio	sin Llantas de aluminio	zonder aluminium velgen
senza catalizzatore regolato	sin catalizador regulado	zonder geregelde katalysator
senza coprigiunto	sin brida	zonder verbindingselementen
senza ruote in lega leggera	sin Llantas de aluminio	zonder lichtmetalen wielen
O-Ring	junta torica	O-ring
blocca-pedale	eje pedal	pedaalvastzetter
Polizia	Police	politie
ruota	rueda	wiel
sensore ruota	sensor de rueda	wielsensor
passo xxxx mm	distancia entre rueda xxxx mm	wielbasis xxxx mm
a destra in alto e a sinistra in basso	derecha arriba + izquierda abajo	rechts boven en links onder
guida a destra	volante a la derecha	auto met het stuur rechts
correttore di frenata	regulador	regelaar
motore in linea	motor de R	lijnmotor
pullman / pianale alto	autobús	Reisbus/hoogdekker
serie di riparazione	juego de reparación	reparatieset
serie raccordi anulari	juego de tubuladura anular	set ringaansluitingen
tubazione	latiguillo	pijpleiding
rosso	rojo	rood
pinza rossa	pinza roja	rood zadel
valvola di non ritorno	valvula de retención	terugslagklep
serie alberi di richiamo	juego de onda de retroceso	set terugstelasjes
cil. ruota (cilindretto ruota)	CR (cilindro de rueda)	wielcilinder
serie guarnizioni cil. ruota	juego de reparación de juntas CR	pakkingset wielcilinder
serie riparazione cil. ruota	juego de reparación CR	reparatieset wielcilinder
assale Salisbury	Salisbury eje	Salisbury-as
pinza con una spina di fissaggio	pinza con 1 pasador	klauw met 1 borgstift

Sattel mit 2 Haltestiften	caliper with 2 retaining pins	étrier avec 2 bouchon d'arrêt
Sättel mit Gussnoppen	calipers with cast-naps	étriers avec nopas en fonte
Sattelschraube	caliper screw	vis d'étrier
Scheibenbremse	disc brake	disques de frein
Scheibenkupplung	disc clutch	embrayage du disque
Scheibenschraube	disc screw	disque vis
Schlauchleitung	line hose	conduite flexible
Schraubstutzen	screw neck	raccordement à vis
schwarz	black	noir
Schwimmsättel	floating caliper	étrier flottant
Schwingblech WE	sheet metal warning device	tôle oscillante dispositif d'avertissement
SCS	SCS (stop control system)	SCS (système de contrôle stop)
separater Behälter	separate reservoir	réservoir séparé
separates Druckstück/Vorgänger	separate thrust member/predecessor	pièce d'appui/prédécesseur
Servolenkung	power steering	direction assistée
Skandinavien	Scandinavia	Scandinavie
Sitzplätze	seats	sièges
Sonderfahrzeuge	special vehicle	véhicule spécial
Spezialaufbau	special body	carrosserie spéciale
Sportfahrwerk	sports suspension	châssis sport
Spur	track	voie
Standard-Bremsgerät	standard booster unit	servo-frein standard
Standard-THz	standard tandem master cylinder	MC-tandem standard
staubfeste Ausführung	dustproof design	exécution anti poussière
Stufenheck	saloon	à coffre
T50-Reparaturatz	T50-repair kit	néc. de réparation T50
Tandemregler	tandem proportioning valve	compensateur tandem
THz mit 3 Anschlüssen	TMC with 3 connections	MCT avec 3 raccords
THz mit Anschlagsschraube	TMC with stop screw	MCT avec vis de butée
THz (Tandemhauptzylinder)	TMC (tandem master cylinder)	MCT (maître cylindre tandem)
THz-Reparaturatz	TMC-repair kit	néc. de réparation MCT
THz-RS (Montagehülse)	TMC-repair kit (assembly sleeve)	néc. de réparation MCT (douille d'assemblage)
Timken-Achse	Timken axle	essieu Timken
Topfmanschette	pot seal	coupelle
Tragbolzensatz	supporting bolt set	jeu de boulons de suspension
Transporter	transporters	transporter
Triebkopf	drive head	tête de propulsion
Trommelbremse	drum brake	frein à tambour
TBB (Trommelbremsbacken)	DBS (drum brake shoes)	SGT (mâchoires de frein à tambour)
Umbau 1-teilig auf 2-teilig	reconstruction 1-piece to 2-piece	reconstruction 1 partie sur 2 parties
Unterdruckverstärker	vacuum booster	amplificateur à dépression
ursprüngl. verschraubte Beläge	initial screwed pads	à l'origine garnitures vissés
VA (Vorderachse)	FA (front axle)	VA (essieu avant)
VA-Girling-Bremse	front axle girling-brake	frein à girling essieu avant
VA-Scheibenbremse	front axle disc brake	frein à disque essieu avant
VA-Trommelbremse	front axle brake drums	tambours de frein essieu avant
Ventilblock	valve block	bloc de vanes
Ventilblock kpl.	valve block complete	bloc de vanes complet
Verbindungsschrauben	connection screws	vis de raccordement
Verschlußschraube	screw plug	vis de fermeture
Verschraubung	screw fitting	couvercle
Verschraubung kpl.	screw fitting cpl.	couvercle complet
verstärkte Bremse	heavy-duty brake	frein renforcé
verstärkte Stoßdämpfer	reinforced dampers (shock absorber)	amortisseurs renforcés
verstärktes Fahrwerk	reinforced suspension	châssis renforcé
Verteilerstück wiederverwenden	reuse distributor piece	distributeur à remettre
V-Motor	V engine	moteur en V
Vorder- und Hinterachse	front and rear axle	essieu avant et essieu arrière
Vorderachse	front axle	essieu avant
Vorderachse und 2. Hinterachse	front axle and second rear axle	essieu avant et 2. essieu arrière
Vordruckventil	residual pressure valve	soupape pression d'admission
Vorgänger	predecessor	prédécesseur
Vorgänger / Abschirmkappe	predecessor / deflector cap	prédécesseur/défecteur
Vorgänger-THz, Einlaß D=xx	predecessor-TMC, inlet diameter=xx	MCT prédécesseur, admission diamètre=xx
Vorspannzylinder	pre-loaded cylinder	cylindre relais
WK (Warnkontakt)	WI (wear indicator)	TU (témoin d'usure)
Warnkontakt 1-polig	wear indicator single connector	témoin d'usure 1-borne
Warnkontakt 2-polig	wear indicator twin connector	témoin d'usure 2-bornes
Warnschalter	warning switch	interrupteur d'avertissement
WE (Warneinrichtung)	WD (warning device)	DA (dispositif d'avertissement)
WE-Befestigung	WD fixture	fixation de DA
Wegsensor	travel sensor	capteur de course
weiß	white	blanc
Zylinderschraube	cylinder screw	vis cylindre



pinza con due spine di fissaggio	pinza con 2 pasadores	klauw met 2 borgstiften
pinze freno con borchie fuse	pinzas con protuberancias de fundición	klauwen met aangegoten noppen
vite pinza	tornillo de pinza	klauwbouten
freni a disco	disco de freno	schijfrem
frizione a disco	disco de embrague	plaatkoppeling
viti disco freno	tornillo de disco	schijfbout
flessibile (tubo flessibile)	latiguillo flexible	slangleiding
raccordo filettato	tornillo de fijación	schroefaansluiting
nero	negro	zwart
pinza freno flottante	pinza flotante	zwevende klauwen
spia a lamierino vibrante	chapa para avisador de desgaste	trilplaat
SCS (sistema controllo frenata)	SCS (sistema de control de frenada)	SCS
serbatoio separato	depósito independiente	apart reservoir
pezzo di pressione separato / precedente	tubería de presión independiente/avisador	apart drukstuk/voorloper
servosterzo	dirección asistida	stuurbekrachting
Scandinavia	Escandinavia	Scandinavië
posti a sedere	plazas	zitplaatsen
veicolo speciale	vehículos especial	speciale voertuigen
carrozzeria speciale	construcción carrocería especial	speciale opbouw
assetto sportivo	suspensión deportiva	sportonderstel
carreggiata	distancia entre ruedas	spoor
servofreno standard	servo freno standard	standaard remapparaat
pompa freno tandem standard	cilindro tándem standard	standaard tandemhoofdcilinder
versione antipolvere	version antipolución	stofvaste uitvoering
a 3 volumi	parte trasera escalonada	notch-back
serie riparazione T50	juego de reparación T50	T50-reparatieset
regolatore tandem	tándem regulador	tandemregelaar
pompa freno tandem con 3 attacchi	cilindro tándem con 3 conexions	tandemhoofdcilinder met 3 aansluitingen
pompa freno tandem con vite di fermo	cilindro tándem con tornillo de tope	tandemhoofdcilinder met aanslagbout
pompa freno tandem	CMT (cilindro tándem)	tandemhoofdcilinder
serie riparazione pompa freno tandem	juego de reparación CMT	reparatieset tandemhoofdcilinder
serie rip. pompa freno tandem (bussola montaggio)	juego de reparación CMT (vainas de montaje)	tandemhoofdcilinder RS (montagehuls)
assale Timken	Timken eje	Timken-as
guarnizione a tazza	retén	cupmanchet
serie perni di supporto	juego de tornillo de soporte	set draagpennen
furgoncino	furgoneta	transporter
motrice con sola cabina (telaio nudo)	grupo motriz	aandrijfkop
freni a tamburo	tambores de freno	trommelrem
ganasce freno	ZDF (zapatas de freno)	trommelremschoenen
modifica da 1 a 2 sezioni	reconstrucción de 1 a 2 piezas	ombouw 1-delig naar 2-delig
servofreno a depressione	amplificador de depresion	onderdrukbekrachtiger
pastiglie freno avvitare in origine	pastillas inicialmente montadas	oorspr. vastgeschroefde remvoeringen
A (asse anteriore)	VA (eje delantero)	vooras
asse anteriore con impianto Girling	eje delantero - Girling freno	Girling-rem vooras
dischi freno asse anteriore	eje delantero - disco de freno	schijfrem vooras
tamburi freno asse anteriore	eje delantero - tambores de freno	trommelrem vooras
blocco valvole	válvula de bloqueo	kleppenblok
blocco valvole completo	bloque de valvulas completo	kleppenblok compl.
viti di collegamento	tornillo de conexión	verbindingsschroeven
vite di chiusura	tornillo de cierre	schroefop
attacco filettato	tornillo de fijación	schroefkoppeling
attacco filettato completo	fijación completa	schroefkoppeling compl.
freno rinforzato	freno reforzado	bekrachtigde rem
ammortizzatori rinforzati	amortiguadores reforzados	versterkte schokdemper
autotelaio rinforzato	suspensión reforzada	versterkt onderstel
riutilizzare il distributore	distribuidor de reemplazo	verdeelblok opnieuw gebruiken
motore a V	motor de V	V-motor
assi anteriore e posteriore	eje delantero + eje trasero	voor- en achteras
asse anteriore	eje delantero	vooras
asse anteriore e secondo asse posteriore	eje delantero + 2. eje trasero	vooras en 2e achteras
valvola anticipo pressione	válvula de presión previa	restdrukklep
precedente	predecesor	voorloper
precedente / calotta di protezione	predecesor / tapa deflector	voorloper / verdelerkap
pompa freno tandem precedente, D mandata = xx	predecesor cilindro principal, admision D=xx	voorloper tandemhoofdcilinder, inlaat D=xx
convertitore di pressione	cilindro preajustado	voorspancilinder
RU (rilevatore usura)	CD (contacto de desgaste)	contact noodknipperlichtinstallatie
rivelatore usura unipolare	contacto de desgaste con 1 conexión	contact noodknipperlichtinstallatie 1-polig
rivelatore usura bipolare	contacto de desgaste con 2 conexiones	contact noodknipperlichtinstallatie 2-polig
interuttore spia	interruptor de desgaste	schakelaar noodknipperlichtinstallatie
DS disp. spia (dispositivo spia)	DD (dispositivo de desgaste)	noodknipperlichtinstallatie
fissaggio dispositivo spia	fijación del dispositivo de desgaste	bevestiging noodknipperlichtinstallatie
sensore di corsa	sensor de ruta	wegsensor
bianco	blanco	wit
vite cilindrica	tornillo cilíndrico	cilinderkoppbout

1-Kammer-Druckluftbremse	pneumatisk bremse med et kammer	enkammartryckluftsbroms
1-Kolbensattel D=xx	1-bremseåg Ø=xx	1-kolvsock d=xx
2-Kolbensattel D=xx	2-bremseåg Ø=xx	2-kolvsock d=xx
4-Kolbensattel	4-bremseåg	4-kolvsock
1-Kreis-Bremse	1-kreds-bremse	1-krets broms
2-Kreis-Bremse	2-kreds-bremse	2-krets broms
1-Kreis-Sättel	1-kreds-bremseåg	1-krets bromsok
2-Kreis-Sättel	2-kreds-bremseåg	2-krets bromsok
1. Hinterachse	1. bagaksel	1:a bakaxeln
1. und 2. Hinterachse	1. og 2. bagaksel	1:a och 2:a bakaxeln
4-Loch-Bremsscheibe	4-hul-bremsskive	4-håls bromsskiva
6-Loch-Bremsscheibe	6-hul-bremsskive	6-håls bromsskiva
3-Loch-Felge	3-hul-fælg	3-håls fälg
4-Loch-Felge	4-hul-fælg	4-håls fälg
5-Loch-Felge	5-hul-fælg	5-håls fälg
6kt-Schraube	6-kant skrue	sekskantsskrub
6kt-Schraube (innen)	6-kant skrue (indvendigt)	sekskanthåls skrue
6"-Tandem	6"-tandem	6"-tandem
8"-Tandem mit Gabelkopf	8"-tandem med gaffelhoved	8"-tandem med gaffelhuvud
8"-Tandem ohne Gabelkopf	8"-tandem uden gaffelhoved	8"-tandem utan gaffelhuvud
ABS	ABS	ABS (låsningsfria bromsar)
ABS-Dichtungssatz	ABS-pakningssæt	ABS packningssats
Achtung: Kolbenstellung ändern !	Bemærk: Stempelstilling skal ændres!	OBS! Ändra kolvläge !
Adapter für Bördel E	adapter til krave E	adapter för fläns E
alle Typen	alle typer	alla typer
Alu-Pumpe	alu-pumpe	aluminiumpump
Alu-Sättel	alu-åg	aluminium-ok
am Bremssattel	på bremseåg	på bromsoket
am Hauptzylinder	på hovedcylindren	på huvudcylindern
A-Motor	A-motor	A-motor
Anschlagschraube oben	stoppskrue oppe	stoppskrue upptill
Anschluß/Anschlüsse	tilslutning/tilslutninger	anslutning/anslutningar
Anti-Noise-Blech	Anti-Noise-plade	anti-noise-plåt
ASC (Automatische Stabilitäts Control)	ASC (automatisk stabilitetskontrol)	ASC (automatisk stabilitetskontroll)
ASR (Antriebsschlupfregelsystem)	ASR (traktionskontrolsystem)	ASR (antispinnreglering)
ATE nur über VAG erhältlich	ATE kan kun leveres via VAG	ATE erhålls endast via VAG
auf Typenschild	på typeskiltet	på typskylten
aufgeschraubt	skruet på	påskruvad
Auslaß seitlich links	udløb i siden til venstre	utlopp vänster sida
Auslaß seitlich rechts	udløb i siden til højre	utlopp höger sida
außen	udvendigt	yttre
automatische Nachstellung	automatisk justering	automatisk efterjustering
Behälter	beholder	behållare
Behälter Doppel-WE	beholder dobbelt advarselsudstyr	behållare med dubbel varningsanordning
Behälterbefestigung	beholderfastgørelse	behållarinfastning
Behälterstopfen	beholderprop	behållareplugg
Behälterverschraubung	beholderforskruing	behållarförskruvning
Behörde	myndighed	myndighet
Beläge	belægninger	belägg
belüftete Scheiben	ventilerede skiver	ventilerade skivor
Betätigungseinheit	aktiveringsenhed	manövreringsenhet
blau	blå	blå
Bodenventil	bundventil	bottenventil
Bodenventile tauschen	udskift bundventilerne	byta bottenventil
Bördel x	krave x	fläns typ x
braun	brun	brun
breite Ausführung	bred udførelse	brett utförande
Bremse	bremse	broms
Bremserät	bremseenhed	bromsenhet
Bremskraftregler	bremsekraftregulator	bromskraftregulator
Bremisleitungen erneuern !	Udskift bremseledninger!	förnya bromsledningarna !
Bremslightschalter	bremselygtekontakt	bromsljusomkopplare
Bremsscheiben	bremsseskiver	bromsskivor
Bremsschlauch beachten !	Bemærk bromseslange!	Observera bromsslängen !
Buchse + Ausgleichbügel	bøsning + udligningsbøjle	bussning med utjämningsbygel
Bus	bus	buss
Bypassregler	bypass-regulator	bypassregulator
Citroen-Bremse	Citroen-bremse	Citroen-broms
D (Durchmesser) =	Ø (diameter) =	D (diameter) =
Dichtring	pakring	packningsring
Dichtung	pakning	packning
Dichtungssatz	pakningssæt	packningssats
Differentialsperre	differentialspærre	differentialspärr
Differenzdruckschalter	differenstrykkontakt	omkopplare för differenstryck
Differenzdruckventil	differenstrykventil	differenstrycksventil
diverse Typen	diverse typer	diverse typer
Doppelbereifung	dobbelte dæk	dubbeldäck



travão pneumático de 1 câmara	1-kamrás sűrített levegős fék	однокамерный пневматический тормоз
pinça de travão de 1 pistão D=xx	1-dugattyús nyereg D=xx	однопоршневой суппорт D=xx
pinça de travão de 2 pistões D=xx	2-dugattyús nyereg D=xx	двухпоршневой суппорт D=xx
pinça de travão de 4 pistões	4-dugattyús nyereg	четырёхпоршневой суппорт
travão mono-circuito	1 fékkörös fék	одноконтурная тормозная система
travão de circuito duplo	2 fékkörös fék	двухконтурная тормозная система
pinça de travão mono-circuito	1 körös nyereg	одноконтурные суппорта
pinça de travão de circuito duplo	2 körös nyereg	двухконтурные суппорта
1º eixo traseiro	1. hátsó tengely	1-й задний мост
1º e 2º eixos traseiros	1. és 2. hátsó tengely	1-й и 2-й задний мост
disco de travão com 4 furos	4 lyukas féktárcsa	тормозной диск с 4 отверстиями
disco de travão com 6 furos	6 lyukas féktárcsa	тормозной диск с 6 отверстиями
jante de 3 furos	3 lyukas keréktárcsa	колесный обод с 3 отверстиями
jante de 4 furos	4 lyukas keréktárcsa	колесный обод с 4 отверстиями
jante de 5 furos	5 lyukas keréktárcsa	колесный обод с 5 отверстиями
parafuso hexagonal	Hatlapfejű csavar	болт с шестигранной головкой
parafuso hexagonal (interior)	Belső hatlapfejű csavar	болт с шестигранной головкой (внутренней)
6" - tandem	6"-tandem	тандем 6"
8" - tandem com cabeça de garfo	8"-tandem villafejvel	тандем 8" с вильчатой головкой
8" - tandem sem cabeça de garfo	8"-tandem villafej nélkül	тандем 8" без вильчатой головки
ABS - sistema de travagem anti-bloqueio	ABS	ABS (антиблокировочная система)
ABS - jogo de juntas	ABS-tömítéskészlet	комплект прокладок для ABS
atenção: mudar a posição do pistão !	Figyelem: a dugattyúk helyzetét meg kell változtatni!	Внимание: изменить положение поршня!
adaptador para rebordo E	Adapter az „E” peremhez	адаптер для бортика типа E
todos os tipos	valamennyi típus	все типы
bomba em alumínio	Alumíniumszivattyú	алюминиевый насос
pinça de travão em alumínio	Alumíniumnyereg	алюминиевые суппорта
no pinça de travão	a féknyergen	на суппорте тормоза
na bomba central de travões	a főfékhengeren	на главном цилиндре
motor em A	A-motor	двигатель типа A
parafuso limitador de curso, em cima	felső útközőcsavar	упорный винт сверху
ligação / ligações	Csatlakozás/csatlakozások	подключение/подключения
placa anti-ruído	Zajcsökkentő lemez	противопопыховый экран
ASC (controlo automático de estabilidade)	ASC (automata stabilitás-ellenőző rendszer)	ASC (автоматическая система курсовой устойчивости)
ASR (sistema de controlo de tracção)	ASR (hajítás csúszásszabályozó rendszer)	ASR (противобуксовочная система)
ATE só disponível através da VAG	Az ATE csak a VAG-nál kapható	Приобрести продукцию ATE можно только через компанию VAG
na placa de identificação	a típustáblára	на заводской табличке с обозначением модели
aparafusado	felcsavarozva	на винтах
escape lateral esquerdo	Bal kieresztőnyílás	выпускное отверстие сбоку слева
escape lateral direito	Jobb kieresztőnyílás	выпускное отверстие сбоку справа
macho	kívül	снаружи
ajuste automático	automatikus utánállítás	автоматическая подстройка (регулировка)
depósito	Tartály	емкость (бачок)
depósito com sistema de avisador duplo	Tartály, kettős WE	емкость с двойным сигнальным устройством
fixação do depósito	Tartályrögztítés	крепление емкости
bujão do depósito	Tartálydugó	пробка емкости
tampa do depósito	Tartály csavarkötés	винтовое крепление емкости
oficial	Hivatal	автомобили для госслужб
pastilhas de travão de disco	Féktételek	тормозные накладки (колодки)
discos ventilados	Hűtött tárcsák	вентилируемые диски
unidade de accionamento	Kezelő egység	блок включения
azul	kék	синий
válvula de pressão residual	Fenékszelep	клапан избыточного давления главного тормозного цилиндра
mudar válvula de pressão residual	Fenékszelep kicserélése	Заменить клапаны избыточного давления
rebordo tipo X	Perem x	фланец x
castanho	barna	коричневый
modelo largo	Széles kivitel	широкая модификация
travão	Fék	тормоз
servo-assistida	Fékberendezés	тормозное устройство
regulador da força de travagem	Fékerőszabályzó	регулятор тормозного усилия
substituir tubagem do sistema de travagem	Cserélje ki a fékvezetékeket !	Заменить тормозные шланги !
interruptor da luz de stop	Féklámpa kapcsoló	выключатель сигнала торможения
discos de travão	Féktárcsák	тормозные диски
atenção ao tubo de travão !	Ügyeljen a féktömlőre !	Обратить внимание на тормозной шланг!
bucha + cabo de compensação	Hüvely + kiegyenlítő kengyel	втулка + компенсационная скоба
autocarro	Busz	автобус
regulador by-pass	Bypass szabályozó	байпасный регулятор
travão Citroen	Citroen-fék	тормоз „Ситроен“
D (diâmetro) =	D (átmérő) =	D (диаметр) =
retentor	Tömítőgyűrű	уплотнительное кольцо
junta	Tömítés	прокладка уплотнительная
jogo de juntas	Tömítéskészlet	комплект прокладок
bloqueio do diferencial	Differenciálzár	блокировка дифференциала
interruptor do diferencial de pressão	Nyomáskülönbség kapcsoló	дифференциальное реле давления
válvula do diferencial de pressão	Nyomáskülönbség szelep	дифференциальный регулирующий клапан
diversos tipos	Különböző típusok	различные типы
pneu duplo	Dupla kerékkészlet	сдвоенные шины

Doppelkabine	dobbelt kabine	dubbelhytt
Druckbegrenzungsventil	trykbegrænsningsventil	tryckbegrænsningsventil
Druckbolzen	trykbolt	tryckbolt
Druckbolzen (kurz)	trykbolt (kort)	tryckbolt (kort)
Druckbolzen (lang)	trykbolt (lang)	tryckbolt (lång)
Druckluftbremse	trykluftbremse	tryckluftsbroms
Druckluftleitung	trykluftledning	tryckluftsledning
Druckluftunterstützung	trykluftunderstøttet	tryckluftsstöd
Druckluftverstärker	trykluftforstærker	tryckluftsförstärkare
Druck-Warnschalter	tryk-advarselskontakt	tryck-varningsomkopplare
DS-Regler	DS-regulator	DS regulator
EDS	EDS	EDS (elektronisk differential spærr)
EDS-Ventilblock	EDS-ventilblok	EDS ventilblock
EG-Vorschrift	EF-forskrift	EG direktiv
Einbau hinter der Achse	indbygning bagved akslen	inmontering bakom axeln
Einbau vor der Achse	indbygning foran akslen	inmontering framför axeln
Einbausatz	indbygningssæt	monteringssats
Einfachbereifung	enkelt dæk	enkeldäck
Einknopfmaß xx mm	indknæpningsmål xx mm	inknåppningsmått xx mm
Einlaß D=xx mm	indløb Ø=xx mm	inlopp D=xx mm
Einlaß mit Gummistopfen	indløb med gummiprop	inlopp med gummiplugg
Einschraubregler	indskruningsregulator	insskruv-utjæmningsventil
elektr. Vergaser	elektr. karburator	elektrisk förgasare
Entlüfteranschluß	udluftningstilslutning	avlutningsanslutning
Entlüfterventil	udluftningsventil	avlutningsventil
erhöhte Zuladung	øget last	förhöjd tillsatsvikt
Ersatz für Sättel D=xx	erstatning for åg Ø=xx	ersättning för ok D=xx
ETS	ETS (elektronisk traktionssystem)	ETS antispinningsystem
Europa	Europa	Europa
Export	eksport	export
Fahrschule	køreskole	körskola
Faltenbaldsatz	foldebælgssæt	bælgsats
Faustsättel	håndåg	flytande bromsok
Fenster	vindue	fönster
Festsättel	faste åg	fasta ok
Flanschdicke x mm	flangetykkelse x mm	flånstjocklek x mm
Flanschmaß = xx,x	flangemål = xx,x	flånsmått = xx,x
Fuller-Getriebe	Fuller-gear	Fuller växellåda
für Belagsätze ohne Zubehör	til belægningssæt uden tilbehør	för beläggsatser utan tillbehör
für Bremssättel/Vorgänger	til bremseåg/forgænger	för bromsok/förgångare
für Doppelmembran-Gerät	til dobbeltmembran-enhed	för dubbelmembran-enhet
Gabelkopfsatz	gaffelhovedsæt	gaffelhuvudsats
Gehäuse L=	hus L=	hus L=
gelb	gul	gul
gepanzerte Fahrzeuge	pansrede køretøjer	bepansrade fordon
Getriebe	gear	væxellåda
Getriebe-Nr.	gear-nr.	væxellåds-nr.
GG-Pumpe	støbejerns-pumpe	pump av grått gjutjärn
GG-Sättel	støbejerns-åg	ok av grått gjutjärn
GG-THz/Vorgänger	støbejerns-TMC/forgænger	Thc av grått gjutjärn/förgångare
Golf-Staaten	Golfstaterne	Golfstaterna
Gz mit senkrechtem Flansch	givercylinder med lodret flange	givarcylinder med vertikal flåns
Gz (Geberzylinder)	givercylinder	Gc (givarcylinder)
Gz-Reparaturatz	givercylinder-reparationssæt	Gc-reparationssats
HA (Hinterachse)	BA (bagaksel)	BA (bakaxel)
Haltefeder	holdefeder	spærrfjæder
Halter	holder	hållare
Haltersatz	holdesæt	hållaresats
Halterschraube	holderskrue	hållareskruv
Handbremsbetätigung	aktivering af håndbremse	handbromsmanövrering
Handbremshebel	håndbremsestang	handbromsspak
HA-Scheibenbremse	BA-skivebremse	BA skivbroms
HA-Trommelbremse	BA-tromlebremse	BA trumbroms
Hebel	håndtag	spak
Hochdach	højt tag	högt tak
Hohlschraube	hulskrue	ihålig skruv
Hosei-Bremse	Hosei-bremse	Hosei-broms
Hub	slag	slag
Hülsensatz	bøsningesæt	hylssats
Hydraulikspeicher	hydraulikkumulator	hydraulackumulator
Hydraulikverstärker	hydraulikforstærker	hydraulförstärkare
Hydraulikzylinder	hydraulikcylinder	hydraulicylinder
Hydr. Steuereinheit	hydraulisk styreenhed	hydr. styrenhet
HZ (Hauptzylinder)	hovedcylinder	Hc (huvudcylinder)
HZ-Reparaturatz	hovedcylinder-reparationssæt	Hc-reparationssats
im Fahrerhaus	i førerhuset	i förarhytten
im Motorraum	i motorrummet	i motorrummet



cabina dupla	Dupla vezetőfülke	двойная кабина
válvula limitadora de pressão	Nyomáskorlátozó szelep	редукционный клапан
perno de pressão	Nyomócsap	зажимный болт
perno de pressão (curto)	Nyomócsap (rövid)	зажимный болт (короткий)
perno de pressão (longo)	Nyomócsap (hosszú)	зажимный болт (длинный)
travão pneumático	Sűrített levegős fék	пневматический тормоз
conduta pneumática	Sűrített levegő vezeték	трубопровод сжатого воздуха
assistência pneumática	Sűrített levegő segítség	поддержка сжатым воздухом
servofreio pneumático	Sűrített levegő erősítő	пневматический усилитель (бустер)
interruptor de aviso de pressão	Nyomás figyelmeztető kapcsoló	сигнальное реле давления
regulador DS	DS-szabályozó	DS-регулятор
EDS (bloqueio electrónico do diferencial)	EDS-szelepblokk	EDS (электронная блокировка дифференциала)
EDS-válvula de bloqueio	EG-előírás	клапанный блок EDS
de acordo com as normas da CE	Beszerezés a tengely mögött	Соответствует предписаниям Европейского Сообщества
instalação atrás do eixo	Beszerezés a tengely előtt	установка позади оси
instalação à frente do eixo	Beszerező készlet	установка перед осью
jogo de montagem	Egyszeres kerékkészlet	монтажный комплект
pneu simples	Begombolási méret xx mm	одинарные шины
medida p/ instalar botão xx mm	Bemenőnyílás D=xx mm	размер закрепления xx мм
diâmetro de admissão = xx mm	Becsavarható szabályozó	впускное отверстие D=xx мм
admissão com ficha de borracha	Elektr. porlasztó	впускное отверстие с резиновой пробкой
regulador de parafuso	Légtelenítő csatlakozó	ввинчиваемый регулятор
carburador eléctrico	Légtelenítő szelep	электр. карбюратор
ligação de purga	Megnövelt rakomány	подсоединение устройства для удаления воздуха
válvula de purga	Nyeregptítés D=xx	клапан сапуна
carga útil aumentada	ETS	повышенная полезная нагрузка
sobressalente para pinça de travão D=xx	Európa	замена по суппортам D=xx
ETS (sistema electrónico da tracção)	Export	ETS (электронная система контроля тягового усилия)
Europa	Járművezető iskola	Европа
exportação	Harmonika-készlet	экспорт
escola de condução	Mozgó nyergek	автошкола
jogo de foles	Ablak	комплект гофрированных чехлов
pinça de travão tipo „Faust“	Rögzített nyereg	тормозной механизм с плавающей скобой
janela	Karimavastagság x mm	окно
pinça de travão fixa	Karimaméret = xx,x	фиксированная скоба дискового тормоза
espessura da flange x mm	Fuller-sebességváltó	толщина фланца x мм
medida da flange = xx,x	Fékbetétkészletekhez tartozék nélkül	размер фланца=xx,x
caixa de velocidades Fuller	Féknyergekhez/előző kivitel	коробка передач Фуллера
para pastilhas de travão sem acessórios	Kétmembrános berendezéshez	для комплектов колодок без принадлежностей
para pinças de travão / anterior	Villafekészlet	для тормозных суппортов / предшественники
para servofreio de dupla membrana	Ház L=	для устройства с двойной мембраной
jogo de cabeça de garfo	sárga	комплект вильчатых головок
caixa L =	Páncélozott járművek	корпус L=
amarelo	Sebességváltó	желтый
veículos blindados	Sebességváltó száma	бронированные автомобили
caixa de velocidades	GG-szivattyú	коробка передач
caixa de velocidades nr.	GG-nyergek	номер коробки передач
caixa de velocidades nr.	GG-tandem főfékhenger/előző kivitel	насос из серого чугуна
bomba em ferro fundido	Öbölmenti országok	суппорта из серого чугуна
pinça de travão em ferro fundido	Munkahenger függőleges karimával	двулопостной главный тормозной цилиндр из серого чугуна/предшественник
bomba central tandem em ferro fundido / anterior	Gz (munkahenger)	государства Персидского залива
países do Golfo Pérsico	Munkahenger-javítókészlet	главный цилиндр сцепления с вертикальным фланцем
bomba central de embraiagem com flange vertical	HA (hátsó tengely)	Gz (главный цилиндр привода сцепления)
BCE (bomba central de embraiagem)	Tartórugó	ремкомплект главного цилиндра привода сцепления
BCE-jogo de reparação	Tartó	HA (задний мост)
ET (eixo traseiro)	Tartókészlet	стопорная пружина
mola de retenção	Tartócsavar	держатель, крепление
suporte	Kézifék működtetés	комплект крепления
jogo de suportes	Kézifékkar	болт крепления
parafuso de suporte	Hátsó tengely tárcsafék	устройство включения ручного тормоза
actuação do travão de mão	Hátsó tengely dobéfék	рычаг ручного тормоза
alavanca do travão de mão	Kar	дисковый тормоз задней оси
disco de travão do eixo traseiro	Magas tető	барабанный тормоз задней оси
tambor do eixo traseiro	Üreges csavar	рычаг
alavanca	Hosei-fék	высокая крыша
tejadilho alto	Lökét	полый болт
parafuso oco	Hüvelykészlet	тормоз Хосай
travões Hosei	Hidraulikai tároló	ход поршня
curso	Hidraulikus erősítő	комплект втулок
jogo de guias	Hidraulikus henger	гидравлический аккумулятор
acumulador hidráulico	Hidr. vezérlőegység	гидравлический усилитель
servofreio hidráulico	Ház (főfékhenger)	гидравлический цилиндр
cilindro hidráulico	Főfékhenger javítókészlet	гидравлический блок управления
unidade hidráulica	a vezetőfülkében	Hz (главный цилиндр)
BCT (bomba central de travões)	a motortérben	ремкомплект главного цилиндра
BCT-jogo de reparação		в кабине водителя
na cabina		в моторном отделении
no compartimento do motor		

innen	indvendigt	inuti
Innengewinde	indvendigt gevind	innergånga
Kastenwagen	kassevogn	skåpvagn
Katalysator	katalysator	katalysator
Kennzeichen: xx	indregistreringsnr.: xx	registreringsnummer: xx
Kerbe am Flansch	kærv på flangen	hack i flånsen
Klasse	klasse	klasse
Kleinbus	minibus	minibuss
Klimaanlage	klimaanlæg	luftkonditionering
Kolbenstange D=	stempelstang Ø=	kolvstång D=
Kolbenstange L=	stempelstang L=	kolvstång L=
Kombiwagen	stationcar	kombibil
Kompakt THz	kompakt TMC	kompakt THC
Krankenwagen	ambulance	ambulans
Kupplung	kobling	koppling
Kupplungsabgang	koblingsudgang	kopplingsutlopp
Kupplungsverstärker	koblingsforstærker	kopplingsforstærkere
kurzer Radstand	kort hjulafstand	kort hjulbas
kurzes Bremsgerät	kort bremseenhed	kort bromsenhet
L (Länge) =	L (længde) =	L (längd) =
langer Radstand	lang hjulafstand	lång hjulbas
Leckageanzeige	lækage-indikator	läckageindikator
lieferbar	kan leveres	tillgänglig
links oben und rechts unten	oppe til venstre og nede til højre	vänster upptill och höger nedtill
links vor und rechts hinter der Achse	til venstre foran og til højre bagved akslen	vänster framför och höger bakom axeln
Linklenker	venstrestyret	vänsterstyrt fordon
Luftfederung	luftaffjedring	luftfjædring
luftgekühlt	luftkølet	luftkyld
M8-Führungsbolzen	M8-styrebolt	M8-styrbult
MA-Getriebe	MA-gear	MA-væxellåda
mit 1 Haltestift	med 1 holdetap	med 1 insatspinne
mit 2 Haltestiften	med 2 holdetapper	med 2 insatspinnar
mit Alufelgen	med alu-fælg	med aluminiumfælger
mit angegossenem Behälter	med påstøbt beholder	med pågjuten behållare
mit regeltem Katalysator	med reguleret katalysator	med reglerad katalysator
mit Laschen	med lasker	med stroppar/flikar/länkar
mit Leichtmetallrädern	med letmetalhjul	med lättmetalhjul
MKII-Aggregat kpl.	MKII-aggregat kpl.	MKII-aggregat kompl.
Mod. (Modell)	mod. (model)	mod. (modell)
Motor	motor	motor
Motor-Nr.	motor-nr.	motor-nr.
Motor-Pumpen-Aggregat	motor-pumpe-aggregat	motor-pump-aggregat
Multi-Link-Achse	multi-link-aksel	multilänkaxel
m.Z. (mit Zubehör)	m.t. (med tilbehør)	m.t. (med tillbehör)
Nachstellteile-Satz	sæt justeringsdele	sats med efterjusteringsdelar
ND-Schlauch	lavtryksslange	LT-slang (lågtrycks-)
Nebenabtrieb	sekundært kraftudtag	extra drivning
Niveauregulierung	niveauregulering	nivåreglering
Nz (Nehmerzylinder)	slavecylinder	SC slavcylinder
Nz-Reparatursatz	slavecylinder-reparationssæt	SC reparationssats
ohne Alufelgen	uden alu-fælg	utan aluminiumfælger
ohne regeltem Katalysator	uden reguleret katalysator	utan reglerad katalysator
ohne Laschen	uden lasker	utan stroppar/flikar/länkar
ohne Leichtmetallräder	uden letmetalhjul	utan lättmetalhjul
O-Ring	O-ring	O-ring
Pedal Feststeller	pedal lås	pedallås
Polizei	politi	polis
Rad	hjul	hjul
Radsensor	hjulsensor	hjulsensor
Radstand xxxx mm	hjulafstand xxxx mm	hjulbas xxxx mm
rechts oben und links unten	oppe til højre og nede til venstre	höger upptill och vänster nedtill
Rechtslenker	højrestyret	högerstyrt fordon
Regler	regulator	regulator
Reihenmotor	seriemotor	radmotor
Reisebus/Hochdecker	rejsebus/høj bus	turistbuss/ hög buss
Reparatursatz	reparationssæt	reparationssats
Ringstutzen-Satz	ringstuds-sæt	ringstuts-sats
Rohrleitung	rørledning	rörledning
rot	rød	röd
roter Sattel	rødt åg	rött ok
Rückschlagventil	kontraventil	backventil
Rückstellwellen-Satz	sæt tilbagesstillingsaksel	återställningsaxel-sats
Rz (Radzylinder)	hjulcylinder	Hc (hjulcylinder)
Rz-Dichtungssatz	hjulcylinder-pakningssæt	Hc-O268pakningssats
Rz-Reparatursatz	hjulcylinder-reparationssæt	Hc-reparationssats
Salisbury-Achse	Salisbury-aksel	Salisbury-axel
Sattel mit 1 Haltestift	åg med 1 holdetap	ok med 1 insatspinne



interior	belül	внутри
rosca interior	Belső menet	внутренняя резьба
furgão	Szekrényes kocsi	автомобиль-фургон
catalisador	Katalizátor	катализатор
identificação: xx	Rendszám: xx	номер: xx
corte na flange	Bemetszés a karimán	насечка на фланце
classe	Osztály	класс
mini-autocarro	Kisbusz	микроавтобус
ar condicionado	Klímaberendezés	кондиционер
biela D=	Dugattyúrúd D=	поршневой шток D=
biela L=	Dugattyúrúd L=	поршневой шток L=
carrinha station	Kombikocsi	автомобиль-универсал (пикап)
bomba central tandem compacta	Kompakt tandem-főfékhenger	компактный двухполостной главный тормозной цилиндр
ambulância	Betegszállító kocsi	санитарный автомобиль
embraiagem	Tengelykapcsoló	сцепление
saída p/ ligação da embraiagem	Tengelykapcsoló kivezetés	выходное отверстие муфты
servo-embraiagem	Tengelykapcsoló erősítő	усилитель сцепления
distância curta entre eixos	Rövid tengelytávolság	короткая колесная база
servofreio curto	Rövid fékberendezés	короткое тормозное устройство
L (comprimento) =	L (hosszúság) =	L (длина) =
distância longa entre eixos	Hosszú kerék bázis	длинная колесная база
indicador de fuga	Szivárgásjelző	сигнализация утечки
disponível	szállítható	может быть поставлено
em cima à esquerda e em baixo à direita	a bal oldalon fent és a jobb oldalon lent	слева сверху и справа внизу
à esquerda à frente e à direita atrás do eixo	a baloldalon a tengely előtt és a jobb oldalon a tengely mögött	слева перед осью и справа позади оси
volante à esquerda	Balkormányos	леворульный автомобиль
suspensão pneumática	Pneumatikus felfüggesztés	пневматическая подвеска
refrigerado por ar	léghűtéses	с воздушным охлаждением
perno-guia M8	M8-vezetőcsap	направляющий болт M8
caixa de velocidades MA	MA-sebességváltó	коробка передач MA
com 1 perno retentor	1 tartócsappal	с 1 упорным болтом
com 2 pernos retentores	2 tartócsappal	с двумя упорными болтами
com jante em alumínio	alumínium keréktárcsákkal	с алюминиевые колесными дисками (ободами)
com reservatório fundido	öntött tartállyal	с резервуаром, выполненным литьем
com catalizador regulável	szabályozott katalizátorral	с регулируемым катализатором
com encaixes	hevederekkel	с накладками
com jantes em liga	könnyűfém kerekkel	с колесами из легкого сплава
unidade completa MKII	Komplett MKII-aggregát	агрегат MKII в сборе
Mod. (Modelo)	Mod. (modell)	мод. (модель)
motor	Motor	двигатель
nr. do motor	Motor-szám	номер двигателя
sistema bomba-motor	Motor-szivattyú aggregát	агрегат двигатель-помпа
eixo multi-link	Multi-Link tengely	ось „мульти-линк“
com acessórios	m.Z. (tartozékokkal)	m.Z. (с принадлежностями)
jogo de peças de afinação	Utánállító alkatrész-készlet	комплект деталей для регулировки
tubo ND	Alacsony nyomású tömlő	шланг низкого давления
propulsão secundária	Melléklehajtás	вспомогательный привод
regulação nível	Magasság szabályozó modul	регулировка высоты дорожного просвета
BAE-bomba auxiliar de embraiagem	Nz (vezérelt henger)	NZ (рабочий цилиндр привода выключения сцепления)
BAE-jogo de reparação	Nz-javítókészlet	ремкомплект рабочего цилиндра сцепления
sem jante em alumínio	Alumínium keréktárcsák nélkül	без алюминиевых ободов
sem catalizador regulável	Szabályozott katalizátor nélkül	без регулируемого катализатора
sem encaixes	Hevederek nélkül	без накладок
sem jantes em liga leve	Könnyűfém kerek nélkül	без колес из легкого сплава
vedante / O-ring	Körkeresztmetszetű gyűrű	кольцо круглого сечения
pedal com bloqueio	Padárlögzítő	фиксатор педали
Polícia	Rendőrség	полиция
roda	Kerék	колесо
sensor da roda	Kerékérzékelő	датчик колеса
distância entre eixos xxxx mm	Tengelytávolság xxxx mm	колесная база автомобиля xxxx мм
à direita em cima e à esquerda em baixo	a jobb oldalon fent és a bal oldalon lent	справа сверху и слева внизу
volante à direita	Jobbkormányos	праворульный автомобиль
regulador	Szabályozó	регулятор
motor em linha	Soros motor	рядный двигатель
autocarro de turismo / cabina alta	Autóbusz/emeletes busz	междугородный автобус/туристский автобус с высоко расположенным пассажирским помещением
jogo de reparação	Javító készlet	ремкомплект
jogo de suportes / anilhas	Gyűrűs talpkészlet	комплект кольцевых патрубков
tubagem	Csővezeték	трубопровод
vermelho	Piros	красный
pinça de travão vermelha	Piros nyereg	красный суппорт
válvula de sentido único	Visszacsapó szelep	обратный клапан
jogo para reset de árvores	Visszaállító tengely-készlet	комплект валов возврата в исходное положение
CR (cilindro de roda)	Rz (kerékfékhenger)	Rz (колесный тормозной цилиндр)
CR-jogo de juntas	Kerékfékhenger tömítőkészlet	комплект прокладок колесного тормозного цилиндра
CR-jogo de reparação	Kerékfékhenger javítókészlet	ремкомплект колесного тормозного цилиндра
eixo Salisbury	Salisbury-tengely	ось Солсбери
pinça de travão com 1 perno retentor	Nyereg 1 tartócsappal	суппорт с 1 штифтовым ограничителем

Sattel mit 2 Haltestiften	åg med 2 holdetapper	ok med 2 insatspinnar
Sättel mit Gussnoppen	åg med støbte nopper	ok med gjutna noppor
Sattelschraube	ågskrue	okskrue
Scheibenbremse	skivebremse	skivbroms
Scheibenkupplung	skivekobling	skivkoppling
Scheibenschraube	skiveskrue	skivskrue
Schlauchleitung	slangeledning	slangedning
Schraubstutzen	skruestuds	skruerstuds
schwarz	sort	svart
Schwimmsättel	flydeåg	flytande ok
Schwingblech WE	svingplade advarselsudstyr	svängplåt VA (varningsanordning)
SCS	SCS (stopp kontrolsystem)	SCS (stopp kontroll system)
separater Behälter	separat beholder	separat behållare
separates Druckstück/Vorgänger	separat trykstykke/forgænger	separat trykstykke/föregångare
Servolenkung	servostyring	servostyrning
Skandinavien	Skandinavien	Skandinavien
Sitzplätze	siddelpladser	sittplatser
Sonderfahrzeuge	specialkøretøj	speciella fordon
Spezialaufbau	specialopbygning	speciell oppbyggnad
Sportfahrwerk	sportkøretøj	sportchassi
Spur	spor	spår
Standard-Bremsgerät	standard-bremseenhed	standard bromsenhet
Standard-THz	standard-TMC	standard Thc
staubfeste Ausführung	støvfast udførelse	dammsäkert utförande
Stufenheck	sedan	sedan-bakdel
T50-Reparaturatz	T50-reparationssæt	T50-reparationssats
Tandemregler	tandemregulator	tandemregulator
THz mit 3 Anschlüssen	TMC med 3 tilslutninger	Thc med 3 anslutningar
THz mit Anschlagsschraube	TMC med stoppskrue	Thc med anslagskrue
THz (Tandemhauptzylinder)	TMC (tandemhovedcylinder)	Thc (tandemhovedcylinder)
THz-Reparaturatz	TMC-reparationssæt	Thc-reparationssats
THz-RS (Montagehülse)	TMC-reparationssæt (montagebøsning)	Thc-RS (monteringshylsa)
Timken-Achse	Timken-aksel	Timken-axel
Topfmanschette	kopmanchet	övergångshylsa
Tragbolzensatz	sæt bærebolte	bærskruvsats
Transporter	transporter	transportfordon
Triebkopf	drivhoved	drivhuvud
Trommelbremse	tromlebremse	trumbroms
TBB (Trommelbremsbacken)	TBB (tromlebremsebakker)	TBB (trumbromsbackar)
Umbau 1-teilig auf 2-teilig	ombygning fra 1 del til 2 dele	ombyggnad 1-delad till 2-delad
Unterdruckverstärker	undertryksforstærker	undertrycksförstärkare
ursprüngl. verschraubte Beläge	oprind. fastskruede belægninger	ursprungl. förskruvade belägg
VA (Vorderachse)	FA (foraksel)	FA (framaxel)
VA-Girling-Bremse	FA-Girling-bremse	FA-Girling-broms
VA-Scheibenbremse	FA-skivebremse	FA-skivbroms
VA-Trommelbremse	FA-tromlebremse	FA-trumbroms
Ventilblock	ventilblok	ventilblock
Ventilblock kpl.	ventilblok komplet	ventilblock kompl.
Verbindungsschrauben	forbindelsesskruer	kopplingsskruevar
Verschlußschraube	låseskrue	låsplugg
Verschraubung	forskruning	förskruvning
Verschraubung kpl.	forskruning komplet	förskruvning kompl.
verstärkte Bremse	forstærket bremse	förstärkt broms
verstärkte Stoßdämpfer	forstærket støddæmper	förstärkta stötdämpare
verstärktes Fahrwerk	forstærket chassis	förstärkt chassi
Verteilerstück wiederverwenden	genbrug fordelerstykke	återanvänd fördelarstycket
V-Motor	V-motor	V-motor
Vorder- und Hinterachse	for- og bagaksel	fram- och bakaxel
Vorderachse	foraksel	framaxel
Vorderachse und 2. Hinterachse	foraksel og 2. bagaksel	framaxel och 2:a bakaxeln
Vordruckventil	fortryksventil	förtrycksventil
Vorgänger	forgænger	föregångare
Vorgänger / Abschirmkappe	forgænger / afskærmningshætte	föregångare / avskärmningskåpa
Vorgänger-THz, Einlaß D=xx	forgænger-TMC, indløb Ø=xx	föregångare-Thc, inlopp D=xx
Vorspannzylinder	forspændecylinder	förspännencylinder
WK (Warnkontakt)	advarselskontakt	VK (varningskontakt)
Warnkontakt 1-polig	1-polet advarselskontakt	varningskontakt 1-polig
Warnkontakt 2-polig	2-polet advarselskontakt	varningskontakt 2-polig
Warnschalter	advarselskontakt	varningsbrytare
WE (Warneinrichtung)	advarselsanordning	VA (varningsanordning)
WE-Befestigung	fastgøring advarselsanordning	infästning för varningsanordning
Wegsensor	vejsensor	vägsensor
weiß	hvid	vit
Zylinderschraube	cylinderskrue	cylinderskrue



pinça de travão com 2 pernos retentores	Nyereg 2 tartócsappal	суппорт с 2 штифтовым ограничителем
pinças de travão c/ saliências fundidas	Nyergek öntött szemcsékkel	суппорта с литыми утолщениями
parafuso da pinça de travão	Nyeregcsavar	болт суппорта
discos de travão	Tárcsafék	дисковый тормоз
discos de embraiagem	Tárcsás tengelykapcsoló	дисковая муфта, сцепление
parafuso do disco	Tárcsacsavar	болт диска
tubo	Tömlővezeték	шланг
terminal roscado	Csavarcsomók	горловина под резьбовую пробку
preto	Fekete	черный
pinça de travão oscilante	Úszónyereg	плавающие скобы (суппорта)
avisador em chapa oscilante	Rezgőlemez WE	металлический лист сигнального устройства
SCS (sistema de controlo de stop)	SCS	система SCS (stop control system)
reservatório isolado	Külön tartály	отдельный резервуар
peça de pressão / anterior	Külön nyomóidom/előző kivétel	отдельный упор/предшественник
direcção assistida	Szervokormány	рулевое управление с сервоприводом
Escandinávia	Skandinávia	Скандинавия
assentos	Ülőhelyek	сидячие места
veículo especial	Különleges gépkocsik	специальные автомобили
carroçaria especial	Különleges felépítmény	специальный кузов
suspensão desportiva	Sportos futómű	спортивная ходовая часть
via	Nyom	полоса движения
servofreio standard	Standard fékberendezés	стандартное тормозное устройство
bomba central tandem standard	Standard tandem főfékhenger	стандартный двухполостной главный тормозной цилиндр
construção anti-poeiras	Porvédett kivétel	пыленепроницаемая модификация
3 volumes	Lépcsőshátú	задняя часть кузова с углом между стеклом задка и багажником
jogo de reparação T50	T50-javítókészlet	ремкомплект T50
regulador tandem	Tandemszabályozó	двухполостной ограничитель давления
BCT com 3 ligações	THz 3 csatlakozóval	двухполостной главный тормозной цилиндр с 3 подключениями
BCT com parafuso de retenção	Tandem főfékhenger ütközőcsavarral	двухполостной главный тормозной цилиндр с упорным винтом
BCT-bomba central tandem	THz (tandem főfékhenger)	THz (двухполостной главный тормозной цилиндр)
BCT-jogo de reparação	Tandem főfékhenger javítókészlet	ремкомплект двухполостного главного тормозного цилиндра
BCT-invólucro de montagem	Tandem főfékhenger-RS (szerelőhüvely)	ремкомплект двухполостного главного тормозного цилиндра (монтажная гильза)
eixo Timken	Timken-tengely	ось Тимкена
vedante	Edénytömítőgallér	пыльник стакана
jogo de pernos de suporte	Tartócsapkészlet	комплект опорных болтов
furgoneta	Szállítókosci	автомобиль-фургон малой грузоподъемности
cabeça de propulsão	Hajtófej	приводной агрегат
travão de tambor	Dobfék	барабанный тормоз
MTT (Maxilas de Travão de Tambor)	TBB (dobfékpofák)	ТВВ (колодки барабанного тормоза)
reconstrução de 1 peça a partir de 2 peças	Átéptés 1-részesről 2-részesre	переоборудование с 1 части на 2 части
servofreio de vácuo	VÁkuum erősítő	вакуумный усилитель
pastilhas aparafusadas de origem	eredetileg felcsavarozott fékbetétek	первоначально прикручиваемые колодки
ED (eixo dianteiro)	VA (első tengely)	VA (передний мост)
travões Girling do eixo dianteiro	Első tengely Girling-fék	передний тормоз Гирлинга
travão de disco do eixo dianteiro	Első tengely tárcsafék	передний дисковый тормоз
travão de tambor do eixo dianteiro	Első tengely dobfék	передний барабанный тормоз
válvula de bloqueio	Szelepblokk	клапанный блок
válvula de bloqueio - completa	Komplett szelepblokk	клапанный блок в сборе
parafusos de união	Összekötő csavarok	соединительные болты
parafuso de fecho	Zárócsavar	навинчивающаяся крышка
aparafusamento	Csavarkötés	резьбовое соединение
aparafusamento completo	Komplett csavarkötés	резьбовое соединение в сборе
travão reforçado	Megerősített fék	усиленные тормоза
amortecedor reforçado	Megerősített lengéscsillapító	усиленный амортизаторы
suspensão reforçada	Megerősített futómű	усиленная ходовая часть
reutilizar peça de distribuição	Az elosztóidomot újra fel kell használni	использовать снова распределитель
motor em V	V-motor	V-образный двигатель
eixos dianteiro e traseiro	Első és hátsó tengely	передний и задний мост
eixo dianteiro	Első tengely	передний мост
eixo dianteiro e 2º eixo traseiro	Első tengely és 2. hátsó tengely	передний мост и 2-й задний мост
válvula de pressão dianteira	Előnyomásszelep	подпорный клапан
anterior	Előző kivétel	предшественник
anterior / capa de protecção	Előző kivétel / árnyékoló sapka	предшественник/ экранирующая головка
anterior bomba central tandem, Ø entrada = xx	Előző kivétel - tandem főfékhenger, bemenőnyílás D=xx	предшествовавший двухполостной главный тормозной цилиндр, вход D=xx
cilindro pré-tensionado	Előfeszítő henger	предварительный цилиндр
AD (avisador de desgaste)	WK (figyelmeztető érintkező)	сигнальный контакт
AD c/ 1 terminal	1-pólusú kopásfigyelmeztető érintkező	сигнальный контакт 1-полюсный
AD c/ 2 terminais	2-pólusú kopásfigyelmeztető érintkező	сигнальный контакт 2-полюсный
interruptor de aviso	Figyelmeztető kapcsoló	сигнальное реле
DA (dispositivo de aviso)	WE (figyelmeztető berendezés)	WE (сигнальное устройство)
fixação do dispositivo de aviso	Figyelmeztető berendezés rögzítés	крепление сигнального устройства
sensor de curso	Útérzékelő	датчик скорости автомобиля
branco	fehér	белый
parafuso do cilindro	Hengeres fejű csavar	болт головки блока цилиндров

1-Kammer-Druckluftbremse	1komorová pneumatická brzda	1 - komorowy hamulec pneumatyczny
1-Kolbensattel D=xx	1pístový třmen D=xx	zacisk z jednym tłoczkiem D=xx
2-Kolbensattel D=xx	2pístový třmen D=xx	zacisk z dwoma tłoczkami D=xx
4-Kolbensattel	4pístový třmen	zacisk z 4 tłoczkami
1-Kreis-Bremse	jednookruhová brzda	hamulec jednoobwodowy
2-Kreis-Bremse	dvouokruhová brzda	hamulec dwuobwodowy
1-Kreis-Sättel	jednookruhový třmen	zaciski jednoobwodowe
2-Kreis-Sättel	dvouokruhový třmen	zaciski dwuobwodowe
1. Hinterachse	1. zadní náprava	pierwsza oś tylna
1. und 2. Hinterachse	1. a 2. zadní náprava	pierwsza i druga oś tylna
4-Loch-Bremsscheibe	brzdový kotouč se 4 otvory	tarcza hamulca z 4 otworami
6-Loch-Bremsscheibe	brzdový kotouč se 6 otvory	tarcza hamulca z 6 otworami
3-Loch-Felge	ráfek se 3 otvory	obřezč kola z 3 otvorami
4-Loch-Felge	ráfek se 4 otvory	obřezč kola z 4 otvorami
5-Loch-Felge	ráfek s 5 otvory	obřezč kola z 5 otvorami
6kt-Schraube	šroub se 6hrannou hlavou	šruba z 6hrannou hlavou
6kt-Schraube (innen)	šroub se 6hrannou hlavou (vnitřní)	šruba z 6hrannou hlavou (wewnątrz)
6"-Tandem	6" tandem	tandem 6"
8"-Tandem mit Gabelkopf	8" tandem s vidlicovou hlavou	tandem 8" z główką rozwidloną
8"-Tandem ohne Gabelkopf	8" tandem bez vidlicové hlavy	tandem 8" bez główki rozwidłonej
ABS	ABS	ABS
ABS-Dichtungssatz	sada těsnění pro ABS	komplet uszczelniający do ABS
Achtung: Kolbenstellung ändern !	Pozor! Změnit polohu pístu!	Uwaga: zmienić położenie tłoka!
Adapter für Bördel E	Adaptér pro obrubu typu E	adapter do zwinienia obwodowego typu E
alle Typen	všechny typy	wszystkie typy
Alu-Pumpe	hliníkové čerpadlo	pompa aluminiowa
Alu-Sättel	hliníkové třmeny	zaciski aluminiowe
am Bremssattel	u třmenu kotoučové brzdy	na zacisku aluminiowym
am Hauptzylinder	u hlavního válce	na pompie hamulca
A-Motor	A motor	silnik A
Anschlagschraube oben	dorazový šroub nahoře	wkręt zderzakowy, góra
Anschluß/Anschlüsse	přípoj/přípoje	przyłącze / przylączca
Anti-Noise-Blech	vymezovací podložka	blacha tłumiąca hałas
ASC (Automatische Stabilitäts Control)	ASC (automatická kontrola stability)	ASC (automatyczny system kontroli stabilności jazdy)
ASR (Antriebsschlupfregelsystem)	ASR (systém pro protismykovou regulaci)	ASR (układ antypoślizgowej stabilizacji napędu)
ATE nur über VAG erhältlich	ATE lze obdržet jen přes VAG	ATE dostępne tylko przez VAG
auf Typenschild	na typovém štítku	na tabliczce znamionowej
aufgeschraubt	našroubováno	nakręcone
Auslaß seitlich links	výfuk na straně vlevo	wylot z lewej strony z boku
Auslaß seitlich rechts	výfuk na straně vpravo	wylot z prawej strony z boku
außen	vně	na zewnątrz
automatische Nachstellung	automatické seřizování	automatyczna regulacja
Behälter	nádržka	zbiorniczek
Behälter Doppel-WE	dvojité VZ nádržky	zbiorniczek z podwójnym urządzeniem ostrzegawczym
Behälterbefestigung	upevnění nádržky	mocowanie zbiorniczka
Behälterstopfen	zátká nádržky	korek zbiorniczka
Behälterverschraubung	šroubení nádržky	zakrętka zbiorniczka
Behörde	úřad	urząd
Beläge	obložení	okładziny hamulcowe
belüftete Scheiben	větrané kotouče	tarcze wentylowane
Betätigungseinheit	ovládací jednotka	jednostka obsługowa
blau	modrý	niebieski
Bodenventil	dnový ventil	zawór denny
Bodenventile tauschen	vyměnit dnové ventily	wymienić zawory denne
Bördel x	obrubá x	zawinięcie obwodowe x
braun	hnědý	brązowy
breite Ausführung	široké provedení	typ szeroki
Bremse	brzda	hamulec
Bremsgerät	brzdové zařízení	urządzenie hamulcowe
Bremskraftregler	regulátor brzdné síly	regulátor siły hamowania
Bremsleitungen erneuern !	vyměnit brzdová vedení!	Wymienić przewody hamulcowe!
Bremslichtschalter	spínač brzdového světla	włącznik światła stopu
Bremsscheiben	brzdové kotouče	tarcze hamulcowe
Bremsschlauch beachten !	Dbejte na brzdovou hadici!	Zwrócić uwagę na przewód hamulcowy!
Buchse + Ausgleichbügel	pouzdro + vyrovnávací třmen	tuleja + kabłąk wyrównawczy
Bus	autobus	bus (van)
Bypassregler	obtokový regulátor	regulátor obejściowy
Citroen-Bremse	brzda Citroenu	hamulec Citroen'a
D (Durchmesser) =	D (průměr) =	D (średnica) =
Dichtring	těsnící kroužek	pierścień uszczelniający
Dichtung	těsnění	uszczelka
Dichtungssatz	sada těsnění	zestaw uszczelniający
Differentialsperr	uzávěrka diferenciálu	blokada układu różnicowego
Differenzdruckschalter	diferenční tlakový spínač	włącznik różnicy ciśnień
Differenzdruckventil	diferenční tlakový ventil	zawór różnicy ciśnień
diverse Typen	různé typy	różne typy
Doppelbereifung	dvojí pneumatiky	podwójne ogumienie



Φρένο πεπιεσμένου αέρα 1 θαλάμου	tek odalı havalı fren	抗噪音板
Δίχαλο πέδησης 1 εμβόλου D=xx	1 pistonlu kaliper D=xx	1活塞制动钳 D=xx
Δίχαλο πέδησης 2 εμβόλων D=xx	2 pistonlu kaliper D=xx	2活塞制动钳 D=xx
Δίχαλο πέδησης 4 εμβόλων	4 pistonlu kaliper	4活塞制动钳
Φρένο 1 κυκλώματος	1 devreli fren	1回路制动器
Φρένο 2 κυκλωμάτων	2 devreli fren	2回路制动器
Δίχαλα πέδησης 1 κυκλώματος	1 devreli kaliperler	1回路制动钳
Δίχαλα πέδησης 2 κυκλωμάτων	2 devreli kaliperler	2回路制动钳
1ος πίσω άξονας	1. arka aks	第1后桥
1ος και 2ος πίσω άξονας	1. ve 2. arka aks	第1和第2后桥
Δίσκος φρένου 4 οπών	4 delikli fren diskı	4孔式制动圆盘
Δίσκος φρένου 6 οπών	6 delikli fren diskı	6孔式制动圆盘
Ζάντα 3 οπών	3 delikli jant	3孔式轮辋
Ζάντα 4 οπών	4 delikli jant	4孔式轮辋
Ζάντα 5 οπών	5 delikli jant	5孔式轮辋
Βίδα εξαγωνικής κεφαλής	6 köşeli civata	六角螺栓
Βίδα κεφαλής κοίλου εξαγώνου	6 köşeli civata (iç)	内六角螺栓
Δίδυμος 6"	6 inç tandem	6英寸串联制动液缸
Δίδυμος 8" με διχαλωτή κεφαλή	8 inç tandem, çatal başlıklı	8英寸串联制动液缸带有叉头
Δίδυμος 8" χωρίς διχαλωτή κεφαλή	8 inç tandem, çatal başlıksız	8英寸串联制动液缸不带叉头
Σύστημα ανιμπλοκαρίσματος (ABS)	ABS (anti blokaj sistemi)	防抱死制动系统
Σε στεγανοποίησης συστήματος ανιμπλοκαρίσματος (ABS)	ABS conta takımı	防抱死制动系统密封套件
Προσοχή: Αλλαγή της θέσης του εμβόλου !	Dikkat: Piston pozisyonunu değiştirin !	注意: 活塞位置变更 !
Προσαρμογέας για περιχέλιωση τύπου E	havşa E için adaptör	用于卷边E的适配件
όλοι οι τύποι	tüm tipler	所有型号
Αλουμινένια αντλία	alüminyum pompa	铝制泵
Αλουμινένια δίχαλα πέδησης	alüminyum kaliperler	铝制制动钳
στο δίχαλο πέδησης	fren kaliperinde	制动钳旁
στον κεντρικό κύλινδρο	ana merkez silindirinde	主液缸旁
Κινητήρας A	A motor	A发动机
Κοχλίας αναστολής επάνω	üst dayanak civatası	上限位螺钉
Σύνδεση/Συνδέσεις	bağlantı/bağlantılar	接口/连接
Ηχομωνωτική λαμαρίνα	susturucu	抗噪音板
ASC (Αυτόματος Έλεγχος Ευστάθειας)	ASC (Otomatik Stabilite Kontrolü)	ASC (汽车稳定性自动控制装置)
ASR (Διάταξη Ρύθμισης Έλξης και Ολίσθησης)	ASR (Anti Patınaj Sistemi)	ASR (防侧滑调节系统)
ATE διατίθεται μόνο μέσω VAG	ATE sadece VAG üzerinden temin edilebilir	只能通过VAG购置ATE
πάνω στην πινακίδα τύπου	tip levhası üzerinde	在铭牌上
βιδωμένο	vidalanmış	拧上
Εξαγωγή πλάγια αριστερά	çıkış yeri sol yan taraf	左侧排气
Εξαγωγή πλάγια δεξιά	çıkış yeri sağ yan taraf	右侧排气
εξωτερικά	dış	外部
Αυτόματη επαναρύθμιση	otomatik ayarlama	自动调整
Δοχείο	hazne	容器
Δοχείο με διπλή διάταξη προειδοποίησης (ΔΠ)	çift ikaz sistemli hazne	双层WE的容器
Στήριξη δοχείου	hazne tespitleme	容器的固定
Τάπα δοχείου	hazne tapası	容器堵头
Πώμα δοχείου	hazne vida bağlantısı	容器螺帽
Υψηρεσία	resmi araç	政府机关
Τακάκια φρένων	fren balataları	摩擦片
Αεριζόμενοι δίσκοι	havalandırılmalı diskler	通风的制动盘
Μονάδα χειρισμού	çalıştırma ünitesi	操纵单元
μπλε	mavi	蓝色
Βαλβίδα πυθμένα	taban valfi	底阀
Αντικατάσταση βαλβίδων πυθμένα	taban valflerini değiştirin	更换底阀
Περιχέλιωση x	havşa x	卷边 x
καφέ	kahverengi	棕色
Πλατιά έκδοση	geniş model	宽结构形式
Φρένο	fren	制动器
Μονάδα πέδησης	fren cihazı	制动器
Ρυθμιστής δύναμης πέδησης	fren regülatörü	制动力调节器
Αντικατάσταση σωλήνων φρένων !	fren hatlarını yenileyin !	更新制动管路 !
Διακόπτης φώτων φρένων	fren lambası şalteri	制动灯开关
Δίσκοι φρένων	fren diskleri	制动圆盘
Προσοχή στον εύκαμπο σωλήνα φρένου !	fren hortumunu dikkate alın !	注意制动软管 !
Δακτύλιος + Κλιπ εξισορρόπηση	buç + dengeleme elemanı	轴套 + 补偿卡箍
Λεωφορείο	otobüs	大客车
Ρυθμιστής παράκαμψης	bypass regülatörü	旁路调节器
Φρένο Citroen	Citroen freni	雪铁龙制动器
D (Διάμετρος) =	Ç (Çap) =	D (直径) =
Στεγανοποιητικός δακτύλιος	conta halkası	密封圈
Στεγανοποίηση	conta	密封
Σε στεγανοποίησης	conta takımı	密封套件
Εμπλοκέας διαφορικού	diferansiyal kilidi	差动锁止机构
Διακόπτης διαφοράς πίεσης	fark basınç şalteri	差动压力开关
Βαλβίδα διαφοράς πίεσης	fark basınç valfi	差动压力阀
διάφοροι τύποι	muhtelif tipler	各种型号
Διπλά ελαστικά	çift lastik	双轮胎

Doppelkabine	dvojitá kabina	kabina podwójna
Druckbegrenzungsventil	tlakový omezovací ventil	zawór ograniczenia ciśnienia
Druckbolzen	tlakový čep	trzcierń naciskowy
Druckbolzen (kurz)	tlakový čep (krátký)	trzcierń naciskowy (krótki)
Druckbolzen (lang)	tlakový čep (dlouhý)	trzcierń naciskowy (długi)
Druckluftbremse	vzduchová brzda	hamulec pneumatyczny
Druckluftleitung	tlakovzdušné vedení	przewód sprężonego powietrza
Druckluftunterstützung	tlakovzdušná podpora	wspomaganie sprężonym powietrzem
Druckluftverstärker	tlakovzdušný zesilovač	wspomaganie pneumatyczne
Druck-Warnschalter	výstražný spínač tlaku	ciśnieniowy włącznik ostrzegawczy
DS-Regler	regulátor DS	regulator DS
EDS	EDS	EDS (elektronická blokada układu różnicowego)
EDS-Ventilblock	blok ventilů EDS	EDS - blok zaworůw
EG-Vorschrift	předpis ES	przepis EC (unijný)
Einbau hinter der Achse	montáž za nápravou	montaż za osią
Einbau vor der Achse	montáž před nápravou	montaż przed osią
Einbausatz	montážní sada	komplet montażowy
Einfachbereifung	jedna sada pneumatik	pojedyncze ogumienie
Einknöpfmaß xx mm	rozměr zapínání xx mm	wymiar zapięcia na guzik xx mm
Einlaß D=xx mm	sání D=xx mm	wlot D=xx mm
Einlaß mit Gummistopfen	sání s pryžovou zátkou	wlot z korkiem gumowym
Einschraubregler	regulátor k zašroubování	regulator wkręcany
elektr. Vergaser	elektr. karburátor	gaźnik elektroniczny
Entlüfteranschluß	připoj odvodušňovače	przyłącze odpowietrzacza
Entlüfterventil	odvodušňovací ventil	zawór odpowietrzacza
erhöhte Zuladung	zvýšené užitečné zatížení	zwiększone doładowanie
Ersatz für Sättel D=xx	náhrada za třmeny D=xx	zastępczo za zaciski D=xx
ETS	ETS	ETS (elektronický systém kontroli trakci)
Europa	Evropa	Europa
Export	export	eksport
Fahrschule	autoškola	nauka jazdy
Faltenbalsatz	sada vlnovců	komplet mieszków
Faustsättel	plovoucí třmeny	zaciski ruchome
Fenster	okno	szyba
Festsättel	pevné třmeny	zaciski stałe
Flanschdicke x mm	tloušťka příruby x mm	grubość kołnierza x mm
Flanschmaß = xx,x	rozměr příruby = xx,x	wymiar kołnierza = xx,x
Fuller-Getriebe	převodovka fuller	przekładnia Fullera
für Belagsätze ohne Zubehör	pro sady obložení bez příslušenství	do kompletu klockůw hamulcowych bez osprzętu
für Bremssättel/Vorgänger	pro třmeny kotoučové brzdy/předchůdce	do zaciskůw hamulcůw / poprzednicy
für Doppelmembran-Gerät	pro zařízení s dvojitou membránou	do urządzienia z podwójną membraną
Gabelkopfsatz	sada vidlicových hlav	zestaw główek rozwidloných
Gehäuse L=	plášť L=	obudowa L=
gelb	žlutý	żółty
gepanzerte Fahrzeuge	obrněná vozidla	pojazdy opancerzone
Getriebe	převodovka	skrzynia biegów
Getriebe-Nr.	čís. převodovky	nr skrzyni biegów
GG-Pumpe	čerpadlo z šedé litiny	pompa z żeliwa szarego
GG-Sättel	třmeny z šedé litiny	zaciski z żeliwa szarego
GG-THz/Vorgänger	THV ze šedé litiny/předchůdce	pompa hamulca typu tandem z želiwa szarego / poprzednik
Golf-Staaten	Golfské státy	państwa Zatoki Perskiej
Gz mit senkrechtem Flansch	válec vysílače se svislou přírubou	pompa sprzęgła z prostopadłym kołnierzem
Gz (Geberzylinder)	VV (válec vysílače)	pompa sprzęgła
Gz-Reparaturatz	sada dílů pro opravu VV	zestaw naprawczy do pompy sprzęgła
HA (Hinterachse)	ZN (zadní náprava)	oś tylna
Haltefeder	přídružná pružina	sprężyna mocująca
Halter	držák	uchwyt
Haltersatz	sada držáků	komplet uchwytůw
Halterschraube	šroub držáků	šruba uchwytu
Handbremsbetätigung	ovládání ruční brzdy	uruchomienie hamulca ręcznego
Handbremshebel	páka ruční brzdy	dźwignia hamulca ręcznego
HA-Scheibenbremse	kotoučová brzda ZN	hamulec tarczowy na osi tylnéj
HA-Trommelbremse	bubnová brzda ZN	hamulec bębnowy na osi tylnéj
Hebel	páka	dźwignia
Hochdach	vysoká střecha	wysoki dach
Hohlschraube	dutý šroub	šruba wydrážona
Hosei-Bremse	brzda Hosei	hamulec Hosei
Hub	zdvih	skok
Hülsensatz	sada pouzder	komplet tulejek
Hydraulikspeicher	hydraulický zásobník	akumulátor hydraulický
Hydraulikverstärker	hydraulický posilovač	hydraulický sílownik wspomagající
Hydraulikzylinder	hydraulický válec	cylinder hydraulický
Hydr. Steuereinheit	hydraulická řídící jednotka	hydraulický blok sterující
Hv (Hauptzylinder)	HV (hlavní válec)	PH (pompa hamulcowa)
Hv-Reparaturatz	sada dílů pro opravu HV	zestaw naprawczy do pompy hamulcovej
im Fahrerhaus	v kabině řidiče	w kabinie
im Motorraum	v motorovém prostoru	w maszynowni



Διπλός θάλαμος	çift kabin	双驾驶室
Βαλβίδα περιορισμού της πίεσης	basınç sınırlama valfi	限压阀
Πείρος πίεσης	baskı pimi	压力销
Πείρος πίεσης (κοντός)	baskı pimi (kısa)	压力销 (短)
Πείρος πίεσης (μακρύς)	baskı pimi (uzun)	压力销 (长)
Φρένο πεπιεσμένου αέρα	havalı fren	压缩空气制动器
Σωλήνες πεπιεσμένου αέρα	basınçlı hava hattı	压缩空气管路
Υποστήριξη πεπιεσμένου αέρα	basınçlı hava desteği	压缩空气支承
Ενισχυτής πεπιεσμένου αέρα	basınçlı hava amplifikatörü	压缩空气放大器
Διακόπτης προειδοποίησης πίεσης	basınç ikaz şalteri	压力报警开关
Ρυθμιστής DS	DS regülatörü	DS差动锁止装置调节器
EDS (ηλεκτρονικό κλειδίωμα διαφορικού)	EDS	EDS电动差动锁止装置
Μπλοκ βαλβιδών EDS	EDS valf bloğu	EDS阀块
Προδιαγραφή EK	AB direktifi	EG欧盟规定
Τοποθέτηση πίσω από τον άξονα	aksın arkasına montaj	装在轴后
Τοποθέτηση μπροστά από τον άξονα	aksın önüne montaj	装在轴前
Σετ τοποθέτησης	montaj seti	安装套件
Μονά ελαστικά	tek lastik	单轮胎
Διάσταση μπουτόν xx mm	düğümleme ölçüsü xx mm	按钮尺寸 xx mm
Εισαγωγή D=xx mm	giriş Ç=xx mm	进气口 D=xx mm
Εισαγωγή με λαστιχένια πώματα	lastik tapalı giriş	带有橡胶堵头的进气口
Βιδωτός ρυθμιστής	vidalanarak montajlı regülatör	拧进调节器
Ηλεκτρικό καρμπυρατέρ	elektrikli karbüratör	电气化器
Σύνδεση εξαερισμού	hava boşaltma bağlantısı	排气接口
Βαλβίδα εξαέρωσης	hava boşaltma valfi	排气阀
Αυξημένο πρόσθετο φορτίο	fazla yüklemeye	增大的载重
Αντικατάσταση για δίχαρα πέδησης D=xx	kaliperler için yedek D=xx	用于制动钳 D=xx
ETS	ETS	ETS
Ευρώπη	Avrupa	欧洲
Εξαγωγή	export	出口
Σχολή οδηγών	sürücü kursu	驾驶学校
Σετ φούσκας	körük takımı	波纹管组
Ολισθαίνοντα δίχαρα πέδησης	yumruk tip kaliperler	浮式制动钳
Παράθυρο	pencere	车窗
Σταθερά δίχαρα πέδησης	sabit kaliperler	固定式制动钳
Πάχος φλάντζας x mm	flaş kalınlığı x mm	法兰厚度 x mm
Διάσταση φλάντζας = xx,x	flaş ölçüsü = xx,x	法兰尺寸 = xx, x
Κιβώτιο ταχυτήτων Fuller	Fuller şanzıman	变速箱
για σετ τακακιών χωρίς εξαρτήματα	aksesuarsız balata takımları için	用于不带辅件的刹车片组
για δίχαρα πέδησης/προηγούμενος τύπος	fren kaliperleri için/önceki	用于制动钳/牵引车
για συσκευή διπλής μεμβράνης	çift diyaframlı cihaz için	用于双膜片装置
Σετ διχαλωτής κεφαλής	çatal başlık takımı	叉头套件
Περίβλημα L=	gövde L=	壳体 L=
κίτρινο	sarı	黄色
Θωρακισμένα οχήματα	zırhlı araçlar	装甲车辆
Κιβώτιο ταχυτήτων	şanzıman	变速箱
Αριθ. κιβωτίου ταχυτήτων	şanzıman no.	变速箱编号
Χυτοσιδηρή αντλία	gri dökme demir pompa	灰铸铁泵
Χυτοσιδηρά δίχαρα πέδησης	gri dökme demir kaliperler	灰铸铁制动钳
Χυτοσιδηρός δίδυμος κύριος κύλινδρος πέδησης/προηγούμενος τύπος	gri dökme demir tandem ana merkez silindiri/önceki	灰铸铁串联式主液缸/牵引车
Χώρες περσικού κόλπου	Körfez Ülkeleri	海湾国家
Εντολοδότης κύλινδρος με κάθετη φλάντζα	Dikey flaşlı kumanda silindiri	带有垂直法兰的传感器缸
Εντολοδότης κύλινδρος	KS (kumanda silindiri)	Gz (传感器缸)
Σετ επισκευής εντολοδότη κυλίνδρου	KS onarım seti	传感器缸维修组件
ΠΑ (πίσω άξονας)	AA (arka aks)	HA (后桥)
Ελατήριο συγκράτησης	tutma yayı	保持弹簧
Στήριγμα	tutucu	保持器
Σετ στήριξης	tutucu seti	保持器组件
Βίδα στήριξης	ankraj civatası	保持螺钉
Χειρισμός χειρόφρενου	el freni kumandası	手刹车
Μοχλός χειρόφρενου	el freni kolu	手刹车杆
Δισκόφρενο ΠΑ	AA diskli fren	后桥盘式制动器
Ταμπουρόφρενο ΠΑ	AA kampanalı fren	后桥鼓式制动器
Μοχλός	kol	摇杆
Ψηλή οροφή	yüksek tavan	高顶蓬
Κοίλος κοχλίας	içi oyuk vida	空心螺钉
Φρένα Hosei	Hosei freni	Hosei制动器
Διαδρομή εμβόλου	strok	行程
Σετ χιτωνίων	kovan takımı	套筒组
Υδραυλικό πιεστικό δοχείο	hidrolik akümülatör	液压蓄能器
Υδραυλικός ενισχυτής	hidrolik amplifikatör	液压放大器
Υδραυλικός κύλινδρος	hidrolik silindiri	液压缸
Υδραυλική μονάδα ελέγχου	hidr. kumanda ünitesi	液压控制单元
Κεντρικός κύλινδρος	AMS (ana merkez silindiri)	H _z (主液缸)
Σετ επισκευής κεντρικού κυλίνδρου	AMS onarım seti	主液缸维修套件
στην καμπίνα του οδηγού	sürücü kabini içinde	在驾驶室
στο χώρο του κινητήρα	motor bölümü içinde	在发动机舱

innen	uvnitř	wewnątrz
Innengewinde	vnitřní závit	gwint wewnętrzny
Kastenwagen	skříňový automobil	furgon
Katalysator	katalyzátor	katalizator
Kennzeichen: xx	registrační značka: xx	numery rejestracyjne: xx
Kerbe am Flansch	zářez na přírubě	nacięcie w kołnierzu
Klasse	třída	klasa
Kleinbus	mikrobus	mini bus
Klimaanlage	klimatizační zařízení	klimatyzacja
Kolbenstange D=	pístnice D=	łoczysko, średnica D=
Kolbenstange L=	pístnice L=	łoczysko, długość L=
Kombiwagen	kombi	kombi
Kompakt THz	kompaktní THV	kompaktowa tandemowa pompa hamulcowa
Krankenwagen	sanitní vůz	karetka pogotowia
Kupplung	spojka	sprzęgło
Kupplungsabgang	výstup spojky	odprowadzenie sprzęgła
Kupplungsverstärker	zesilovač spojky	układ wspomagania sprzęgła
kurzer Radstand	krátký rozvor kol	krótki rozstaw osi
kurzes Bremsgerät	krátké brzdové zařízení	krótkie urządzenie hamujące
L (Länge) =	L (délka)	L (długość) =
langer Radstand	douhý rozvor kol	duży rozstaw osi
Leckageanzeige	indikátor průsaku	wskaźnik wycieku
lieferbar	k dodání	dostępny
links oben und rechts unten	vlevo nahoře a vpravo dole	z lewej strony u góry oraz z prawej strony na dole
links vor und rechts hinter der Achse	vlevo před a vpravo za nápravou	z lewej strony z przodu i z prawej strony za osią
Linkslenker	volant vlevo	układ kierowniczy z kierownicą z lewej strony
Luftfederung	vzduchové odpružení	zawieszenie pneumatyczne
luftgekühlt	chlazené vzduchem	chłodzone powietrzem
M8-Führungsbolzen	vodící čep M8	M8 - bolce prowadzące
MA-Getriebe	MA-převodovka	skrzynia biegów MA
mit 1 Haltestift	s 1 přídržným kolíkem	z 1 przpieniem ustalajícím
mit 2 Haltestiften	se 2 přídržnými kolíky	z 2 trzpieniami ustalającymi
mit Alufelgen	s hliníkovými ráfky	z aluminiowymi obręczami kół
mit angegossenem Behälter	s nalitou nádrží	z odlanym zbiorniczkiem
mit geregeltm Katalysator	s řízeným katalyzátorem	z katalizatorem regulowanym
mit Laschen	s lamelami	z wypustkami
mit Leichtmetallrädern	s koly z lehkého kovu	z kołami z metali lekkich
MKII-Aggregat kpl.	MKII kompletní jednotka	MKII - kompletny agregat
Mod. (Modell)	Mod. (model)	mod. (model)
Motor	Motor	silnik
Motor-Nr.	čís. motoru	nr silnika
Motor-Pumpen-Aggregat	agregát motorového čerpadla	silnik-pompy-agregat
Multi-Link-Achse	náprava multi-link	oś multi - link
m.Z. (mit Zubehör)	m.Z. (s příslušenstvím)	z o. (z osprzętem)
Nachstellteile-Satz	sada seřizovacích dílů	komplet części regulacyjnych
ND-Schlauch	nízkotlaká hadice	przewód n.c. (niskiego ciśnienia)
Nebenabtrieb	vedlejší výstupní člen	dodatkowy odbiornik napędu
Niveauregulierung	regulace hladiny	regulacja poziomu
Nz (Nehmerzylinder)	VS (válec snímače)	SW (silownik wysprężlający)
Nz-Reparatursatz	sada dílů pro opravu VS	zestaw naprawczy SW
ohne Alufelgen	bez hliníkových ráfků	bez aluminiowych obręczy kół
ohne geregelten Katalysator	bez řízeného katalyzátoru	bez katalizatora regulowanego
ohne Laschen	bez lamel	bez wypustek
ohne Leichtmetallräder	bez kol z lehkého kovu	bez kół z metali lekkich
O-Ring	kroužek O	O -ring
Pedal Feststeller	zajištění pedálu	ustalacz pedálu
Polizei	Policie	Policja
Rad	kolo	koło
Radsensor	senzor kola	czujnik koła
Radstand xxxx mm	rozvor kol xxxx mm	rozstaw osi xxxx mm
rechts oben und links unten	vpravo nahoře a vlevo dole	z prawej strony u góry i z lewej na dole
Rechtslenker	volant vpravo	układ kierowniczy z kierownicą z prawej strony
Regler	regulátor	regulator
Reihenmotor	řadový motor	silnik jednorzędowy
Reisebus/Hochdecker	autokar/autobus s vysokou střechou	autobus wycieczkowy / wysokopokładowy
Reparatursatz	sada dílů pro opravu	zestaw naprawczy
Ringstutzen-Satz	sada kruhových hrdel	komplet króćców pierścieniowych
Rohrleitung	potrubí	rurociąg
rot	červený	czerwony
roter Sattel	červený třmen	czerwony zacisk
Rückschlagventil	zpětný ventil	zawór jednokierunkowy
Rückstellwellen-Satz	sada vratných hřídelů	walki zwrotne
Rz (Radzylinder)	KV (kolový váleček)	CHK (cylinděrki hamulcowe koła)
Rz-Dichtungssatz	sada těsnění KV	zestaw uszczelniający CHK
Rz-Reparatursatz	sada dílů pro opravu KV	zestaw naprawczy CHK
Salisbury-Achse	náprava Salisbury	oś Salisbury
Sattel mit 1 Haltestift	třmen s 1 přídržným kolíkem	zacisk z 1 kolíkiem ustalajícím



εσωτερικά	iç	内部
εσωτερικό σπείρωμα	iç vida dışı	内螺纹
Κλούβα	kapalı kasa araç	厢式汽车
Καταλυτικός μετατροπέας	katalitik konvertör	催化器
Πινάκιδα αριθμού κυκλοφορίας: xx	plaka no: xx	车牌: xx
Εγκοπές στη φλάντζα	flanştaki çentik	法兰上的刻痕
Κατηγορία	sınıf	等级
Μικρό λεωφορείο	minibüs	小巴
Κλιματιστικό	klima sistemi	空调装置
Στέλεχος εμβόλου D=	piston kolu Ç=	活塞杆D=
Στέλεχος εμβόλου L=	piston kolu U=	活塞杆L=
Στέισον βάγκον	station wagon	客货两用车
Κομπάκτ διδυμος κύριος κύλινδρος πέδησης	kompakt tandem ana merkez silindiri	紧凑型串联式主液缸
Ασθενοφόρο αυτοκίνητο	ambulans	救护车
Συμπλέκτης	debriyaj	离合器
Έξοδος συμπλέκτη	debriyaj çıkışı	离合器输出端
Ενισχυτής συμπλέκτη	debriyaj güçlendirici	离合放大器
μικρό μεταξόνιο	kısa aks aralığı	短轴距
κοντή μονάδα πέδησης	kısa fren cihazı	短制动器
L (μήκος) =	U (Uzunluk) =	L(长)=
μεγάλο μεταξόνιο	uzun aks aralığı	长轴距
Ένδειξη διαρροής	sızıntı göstergesi	泄漏显示
διαθέσιμο	stokta var	可供货
αριστερά επάνω και δεξιά κάτω	sol üst ve sağ alt	左上和右下
αριστερά μπροστά και δεξιά πίσω από τον άξονα	solda önde ve sağda aksın arkasında	轴的左前和右后
Αριστεροτίμονα οχήματα	soldan direksiyonlu	左侧驾驶的汽车
Σύστημα ανάρτησης πεπιεσμένου αέρα	havalı süspansiyon	空气弹簧
Αερόψυκτο	hava soğutmalı	风冷
Πείρος οδηγός M8	M8 kılavuz pim	M8导向螺纹销
Κιβώτιο ταχυτήτων MA	MA şanzıman	MA变速箱
με 1 πείρο στήριξης	1 tutucu pim ile	带有1个固定销
με 2 πείρους στήριξης	2 tutucu pim ile	带有2个固定销
με ζάντες αλουμινίου	alüminyum jantlı	带有铝制轮辋
με χυτό δοχείο	dökme hazneli	带有铸造容器
με ρυθμιζόμενο καταλυτικό μετατροπέα	kontrollü katalitik konvertörlü	带有可调节的催化器
με ελάσματα	bağlantı kulakları ile	带有连接板
με ζάντες κράματος ελαφρού μετάλλου	hafif metal	带有轻金属车轮
MKII συγκρότημα πλήρες	MKII ünitesi komple	整套MKII装置
Μοντ. (μοντέλο)	mod. (model)	Mod. (车型)
Κινητήρας	motor	发动机
Αριθμός κινητήρα	motor no.	发动机号码
Συγκρότημα κινητήρα-αντλίας	motor-pompa ünitesi	发动机泵组
Άξονας Multi-Link	multi-link aks	多连接轴
με εξαρτ. (με εξαρτήματα)	aksesuarları ile	带有Z. (带有辅件)
Σετ τεμαχίων ρύθμισης	ayarlama parçaları takımı	调整套件
ND εύκαμπτου σωλήνα	ND hortum	低压软管
Βοηθητικός μηχανισμός κίνησης	yavru şanzıman	辅助驱动
Σύστημα οριζοντιώσεως	seviye ayarlama sistemi	水平位调节
Εντολοδόχος κύλινδρος	AS (alıcı silindir)	Nz (输出缸)
Σετ επισκευής εντολοδόχου κυλίνδρου	AS onarım seti	输出缸维修组件
χωρίς ζάντες αλουμινίου	alüminyum jantsız	不带铝制轮辋
χωρίς ρυθμιζόμενο καταλυτικό μετατροπέα	kontrollü katalitik konvertörsüz	不带可调节的催化器
χωρίς λωρίδες	kulaksız	不带连接板
χωρίς ζάντες κράματος ελαφρού μετάλλου	hafif metal jantsız	不带轻金属车轮
Δακτύλιος O	O-ring	O型圈
Διάταξη ακινητοποίησης πεντάλ	pedal sabitleyici	踏板限位器
Αστυνομία	Polis	警察
Τροχός	tekerlek	车轮
Αισθητήρας τροχού	tekerlek sensörü	车轮传感器
Μεταξόνιο xxxx mm	aks aralığı xxxx mm	轴距 xxxx mm
δεξιά επάνω και αριστερά κάτω	sağ üst ve sol alt	右上和左下
Δεξιότιμονα οχήματα	sağdan direksiyonlu	右侧驾驶的汽车
Ρυθμιστής	regülatör	调节器
Κινητήρας σειράς	sıra motor	直列式发动机
Υπερασπτικό λεωφορείο/Υπερωρυμένο	şehirlerarası otobüs/yüksek tavanlı otobüs	长途客车/高顶盖车
Σετ επισκευής	onarım seti	维修套件
Σετ στρογγυλού στομίου	yüzüklü rakor takımı	环形管接头组件
Σωλήνωση	boru hattı	管道
κόκκινο	kırmızı	红色
Κόκκινο δίχало πέδησης	kırmızı kaliper	红色制动钳
Βαλβίδα αντεπιστροφής	çekvalf	单向阀
Σετ άξονα επαναφοράς	sıfırlama mili takımı	复位轴组件
Κύλινδρος τροχού	TFM (tekerlek fren merkezi)	Rz (车轮制动缸)
Σετ στεγανοποίησης κυλίνδρου τροχού	TFM conta takımı	车轮制动缸密封套件
Σετ επισκευής κυλίνδρου τροχού	TFM onarım seti	车轮制动缸维修套件
Άξονας Salisbury	Salisbury aks	索尔兹伯里轴
Δίχало πέδησης με 1 πείρο στήριξης	1 tutucu pimli kaliper	制动钳带有1个固定销

Sattel mit 2 Haltestiften	třmen se 2 přídržnými kolíky	zaciśki z 2 kołkami ustalajúcymi
Sättel mit Gussnoppen	třmen s litými nopkami	zaciśki z odlewanými vypustkami
Sattelschraube	šroub třmenu	šruba zacisku
Scheibenbremse	kotoučová brzda	hamulec tarczowy
Scheibenkupplung	kotoučová spojka	sprzęgło tarczowe
Scheibenschraube	kotoučový šroub	šruba tarczy
Schlauchleitung	hadicové vedení	przewód giętki
Schraubstutzen	šroubovací hrdlo	króciec śrubowy
schwarz	černý	czarny
Schwimmsättel	plovoucí třmeny	zaciśki pływające
Schwingblech WE	kov výstražného zařízení	urządzenie ostrzegawcze z blachy wahlivej
SCS	SCS	SCS (system kontroli stopu)
separater Behälter	samostatná nádrž	oddzielny zbiornik
separates Druckstück/Vorgänger	samostatný tlačný element/předchůdce	oddzielny element dociskowy / poprzednik
Servolenkung	servořízení	wspomagany układ kierowniczy
Skandinavien	Skandinávie	Skandynawia
Sitzplätze	místa k sezení	miejsca siedzące
Sonderfahrzeuge	speciální vozidla	pojazdy specjalne
Spezialaufbau	speciální karosérie	specjalne nadwozie
Sportfahrwerk	sportovní podvozek	podwozie sportowe
Spur	stopa	rozstaw kół
Standard-Bremsgerät	standardní posilovač brzd	standardowe urządzenie hamulcowe
Standard-THz	standardní tandemový hlavní válec	standardowa pompa hamulcowa typu tandem
staubfeste Ausführung	provedení odolné proti prachu	wykonanie odporne na kurz
Stufenheck	stupňovitá záď	tył kaskadowy
T50-Reparaturatz	T50 sada dílů pro opravu	zestaw naprawczy T50
Tandemregler	tandemový regulátor	regulator tandemowy
THz mit 3 Anschlüssen	THV se 3 přípoji	pompa hamulcowa tandemowa z 3 przyłączami
THz mit Anschlagsschraube	THV s dorazovým šroubem	PHT z wkrętem zderzakowym
THz (Tandemhauptzylinder)	THV (tandemový hlavní válec)	PHT (pompa hamulcowa typu tandem)
THz-Reparaturatz	sada dílů pro opravu THV	PHT - zestaw naprawczy
THz-RS (Montagehülse)	sada dílů pro opravu THV (montážní pouzdro)	PHT - zestaw naprawczy (tuleja montażowa)
Timken-Achse	náprava Timken	oś Timkena
Topfmanschette	hrcová manžeta	pierścień samouszczelniający garnkowy
Tragbolzensatz	sada nosných čepů	komplet trzpieni nośnych
Transporter	dodávkové vozidlo	furgonetka
Triebkopf	pohonná jednotka	głowica napędowa
Trommelbremse	bubnová brzda	hamulec bębnowy
TBB (Trommelbremsbacken)	ČBB (čelisti bubnové brzdy)	SHB (szczęki hamulca bębnowego)
Umbau 1-teilig auf 2-teilig	přestavba z 1dílného na 2dílné	przebudowa z 1 - częściowej na 2 - częściową
Unterdruckverstärker	podtlakový posilovač	wspomaganie podciśnieniowe
ursprüngl. verschraubte Beläge	původně našroubovaná obložení	pierwotnie przykręcone okładziny
VA (Vorderachse)	PN (přední náprava)	OP (oś przednia)
VA-Girling-Bremse	brzda Girling PN	hamulec Girlinga osi przedniej
VA-Scheibenbremse	kotoučová brzda PN	hamulec tarczowy osi przedniej
VA-Trommelbremse	bubnová brzda PN	hamulec bębnowy osi przedniej
Ventilblock	ventilový blok	blok zaworów
Ventilblock kpl.	ventilový blok kompl.	blok zaworów kompletny
Verbindungsschrauben	spojovací šrouby	śruby połączeniowe
Verschlußschraube	závěrný šroub	śruby zamykające
Verschraubung	šroubení	połączenie śrubowe
Verschraubung kpl.	šroubení kompl.	połączenie śrubowe kompletne
verstärkte Bremse	zesílená brzda	wzmocniony hamulec
verstärkte Stoßdämpfer	zesílený tlumič nárazů	wzmocnione amortyzatory
verstärktes Fahrwerk	zesílený podvozek	wzmocniony układ jezdny
Verteilerstück wiederverwenden	opět použít díl rozdělovače	ponowne użycie rozdzielacza
V-Motor	V motor	silnik w układzie V
Vorder- und Hinterachse	přední a zadní náprava	oś przednia i tylna
Vorderachse	přední náprava	oś przednia
Vorderachse und 2. Hinterachse	přední náprava a 2. zadní náprava	oś przednia i druga oś tylna
Vordruckventil	ventil zabraňující vniku vzduchu do brzd. okruhu	zawór ciśnienia wstępnego
Vorgänger	předchůdce	poprzednik
Vorgänger / Abschirmkappe	předchůdce / stínicí čepička	poprzednik / pokrywa ekranująca
Vorgänger-THz, Einlaß D=xx	předchůdce THV, sání D=xx	poprzednik - PHT, wlot D=xx
Vorspannzylinder	předpinací válec	cylinder naprężenia pierwotnego
WK (Warnkontakt)	VK (výstražný kontakt)	SO (styk ostrzegawczy)
Warnkontakt 1-polig	výstražný kontakt 1pólový	styk ostrzegawczy 1 - biegunowy
Warnkontakt 2-polig	výstražný kontakt 2pólový	styk ostrzegawczy 2 - biegunowy
Warnschalter	výstražný spínač	włącznik ostrzegawczy
WE (Warneinrichtung)	VZ (výstražné zařízení)	UO (urządzenie ostrzegawcze)
WE-Befestigung	připevnění VZ	mocowanie UO
Wegsensor	dráhový senzor	sensor drogi
weiß	bílý	biały
Zylinderschraube	válcový šroub	śruba cylindra



Δίχαλο πέδησης με 2 πείρους στήριξης	2 tutucu pimli kaliper	制动钳带有2个固定销
Δίχαλα πέδησης με μεγάλα κομβία	dökme pimli kaliperler	制动钳带有铸造轴头
Βίδα δίχαλου πέδησης	kaliper civatası	制动钳螺钉
Δισκόφρενο	diskli fren	盘式制动器
Συμπλέκτης δίσκων	diskli debriyaj	盘式离合器
Βίδα δίσκου	disk civatası	盘式螺钉
Εύκαμπος σωλήνας	hortum hattı	软管
Βιδωτά στόμια	vidalı rakor	丝堵
μαύρο	siyah	黑色
Πλωτά δίχαλα πέδησης	hareketli kaliperler	浮动制动钳
Έλασμα ταλάντωσης ΔΠ	İS titreşim sacı	平衡板 WE
SCS (σύστημα ελέγχου στοπ)	SCS	SCS停车控制系统
Ξεχωριστό δοχείο	ayrı hazne	单独的容器
Ξεχωριστό τεμάχιο πίεσης/προηγούμενος τύπος	ayrı baskı parçası/önceki	单独的压力件/牵引车
Σερβομηχανισμός διεύθυνσης	havali direksiyon	转向助力机构
Σκανδιναβία	İskandinavya	斯堪地维亚
Καθίσματα	koltuk sayısı	座位
Ειδικά οχήματα	özel araçlar	专用车辆
Ειδική κατασκευή	özel üst yapı	特殊结构
Σπορ ανάρτηση	spor yürüyen aksam	运动型底盘
Ίχνος	iz	轮距
Στάνταρ μονάδα πέδησης	standart fren	标准制动器
Στάνταρ δίδυμος κύριος κύλινδρος πέδησης	standard tandam ana merkez silindiri	标准串联式主液缸
Έκδοση ανθεκτική στη σκόνη	toz geçirmez model	除尘型
Σεντάν	limuzin	阶背车尾
Σετ επισκευής T50	T50 onarım seti	T50维修套件
Δίδυμος ρυθμιστής	tandem regülatörü	串联式主液缸调节器
Δίδυμος κύριος κύλινδρος πέδησης με 3 συνδέσεις	3 bağlantılı tandem ana merkez silindiri	带有3个接口的串联式主液缸
Δίδυμος κύριος κύλινδρος πέδησης με κοχλία αναστολής	dayanak civatalı tandem ana merkez silindiri	带有限位螺钉的串联式主液缸
Δίδυμος κύριος κύλινδρος πέδησης	tandem ana merkez silindiri	串联式主液缸
Σετ επισκευής δίδυμου κύριου κυλίνδρου πέδησης	tandem ana merkez silindiri onarım seti	串联式主液缸维修套件
Σετ επισκευής δίδυμου κύριου κυλίνδρου πέδησης (χιτώνιο συναρμολόγησης)	tandem ana merkez silindiri onarım seti (montaj kovani)	串联式主液缸维修套件 (安装轴套)
Άξονας Timken	Timken aks	泰姆肯轴
Δισκοειδής μανσέτα	çanak conta	固定鼓涨圈
Σετ πείρων στήριξης	tutucu pim takımı	支承螺栓组件
Μεταφορικό όχημα	transporter	运输车
Κεφαλή κίνησης	tahrik kafası	牵引车
Ταμπουράφρενο	kampanalı fren	鼓式制动器
ΣΤΠ (σιαγόνες τυμπάνου πέδησης)	KFP (kampanalı fren pabuçları)	TBB (鼓式制动爪)
Μετατροπή 1 τεμαχίου σε 2 τεμάχια	1 parçalıdan 2 parçalıya tadilat	从一体改装为两体
Ενισχυτής υποπίεσης	vakumlu güçlendirici	负压放大器
Αρχ. βιδωνόμενα τακάκια φρένων	orijinal vidalanan balatalar	原有螺丝连接的刹车片
ΜΑ (μπροστινός άξονας)	ÖA (Ön Aks)	前桥
Φρένο ΜΑ Girling	ÖA girling fren	前桥Girling制动器
Δισκόφρενο ΜΑ	ÖA diskli fren	前桥盘式制动器
Ταμπουράφρενο ΜΑ	ÖA kampanalı fren	前桥鼓式制动器
Συγκρότημα βαλβίδων	valf bloğu	阀块
Συγκρότημα βαλβίδων πλήρες	komple valf bloğu	阀块整体
Κοχλίες σύνδεσης	bağlantı civataları	连接螺丝
Κοχλίας φραγής	kör tapa	封闭螺帽
Κοχλιοσύνδεση	vidalı bağlantı	螺纹连接
Κοχλιοσύνδεση πλήρες	vidalı bağlantı komple	螺纹连接整体
Ενισχυμένα φρένα	güçlendirilmiş fren	增强的制动器
Ενισχυμένα αμορτισέρ	güçlendirilmiş amortisör	增强的减震器
Ενισχυμένο σύστημα ανάρτησης	güçlendirilmiş yürüyen aksam	增强的底盘
Επαναχρησιμοποιήστε το εξάρτημα διανομέα	dağıtıcı parçayı tekrar kullanın	重新利用分配件
Κινητήρας V	V motor	V型发动机
Μπροστινός και πίσω άξονας	ön ve arka aks	前桥和后桥
Μπροστινός άξονας	ön aks	前桥
Μπροστινός άξονας και 2ος πίσω άξονας	ön aks ve 2. arka aks	前桥和第2后桥
Βαλβίδα προπίεσης	ön basınç valfi	预压力阀
Προηγούμενος τύπος	önceki	牵引车
Προηγούμενος τύπος / πώμα θωράκισης	önceki / deflektör	牵引车 / 屏蔽盖
Προηγούμενος τύπος δίδυμου κύριου κυλίνδρου πέδησης, εισαγωγή D=xx	önceki tandem ana merkez silindiri, giriş Ç=xx	牵引车串联式主液缸, 进口 D=xx
Κύλινδρος προέντασης	ön yüklemeli silindir	预夹紧缸
ΕΠ (επαφή προειδοποίησης)	İK (İkaz Kontaklı)	WK (警示触点)
Επαφή προειδοποίησης 1-πολική	1 kutuplu ikaz kontaklı	1极警示触点
Επαφή προειδοποίησης 2-πολική	2 kutuplu ikaz kontaklı	2极警示触点
Διακόπτης προειδοποίησης	ikaz şalteri	警示开关
ΔΠ (διάταξη προειδοποίησης)	İS (İkaz Sistemi)	WE (警示装置)
Στερέωση ΔΠ	İS tespitleme	警示装置的固定
Αισθητήρας διαδρομής	hareket sensörü	行程传感器
λευκό	beyaz	白色
Βίδα κυλινδρικής κεφαλής	silindirik civata	圆柱头螺钉

1-Kammer-Druckluftbremse	جيجضليل عنام جاص حول	防音プレート(シングルチャンバ・エアブレーキ)
1-Kolbensattel D=xx	D=xx دحو سابلب ةيلف ةيلا	1ピストンキャリパ D=xx
2-Kolbensattel D=xx	D=xx تاسابلل ةجوزم ةيلف ةيلا	2ピストンキャリパ D=xx
4-Kolbensattel	تاسابلل ةيعلبر ةيلف ةيلا	4ピストンキャリパ
1-Kreis-Bremse	دحو ةيبرك ةرياب ظمرف	1サイクルブレーキ
2-Kreis-Bremse	نيتيبرك نيترياب ظمرف	2サイクルブレーキ
1-Kreis-Sättel	ةيبرك ةرياب ةيلف ةيلا	1サイクルキャリパ
2-Kreis-Sättel	نيتيبرك نيترياب ةيلف ةيلا	2サイクルキャリパ
1. Hinterachse	لوالا يفلخا روحلا	1番目のリアシャフト
1. und 2. Hinterachse	يناشل لوالا يفلخا روحلا	1番目と2番目のリアシャフト
4-Loch-Bremsscheibe	بوقثلا يعلبر يلحرف صرق	4穴ブレーキディスク
6-Loch-Bremsscheibe	بوقثلا يسلس يلحرف صرق	6穴ブレーキディスク
3-Loch-Felge	تاحتف تالشب طن ج	3穴ホイール
4-Loch-Felge	تاحتف عبراب طن ج	4穴ホイール
5-Loch-Felge	تاحتف سمخب طن ج	5穴ホイール
6kt-Schraube	معلقلا ةيسلس سارب رامسم	6角ネジ
6kt-Schraube (innen)	(لخادل نم) معلقلا ةيسلس سارب رامسم	6角ネジ(内側)
6"-Tandem	صروب 6 ساقم ةيفدارت ةن اوطنأ	6面タンデム
8"-Tandem mit Gabelkopf	يفرط نرقمب فوزم صروب 8 ساقم ةيفدارت ةن اوطنأ	ヨーク付8面タンデム
8"-Tandem ohne Gabelkopf	يفرط نرقمب فوزم ريغ صروب 8 ساقم ةيفدارت ةن اوطنأ	ヨークなし8面タンデム
ABS	ABS ةقال غزالل عنالما لم ارفلما ماظن	ABS(アンチロックブレーキシステム)
ABS-Dichtungssatz	ABS ةقال غزالل عنالما لم ارفلما ماظنل مكحال مقاط	ABSガスケットキット
Achtung: Kolbenstellung ändern !	سابلبل ةيخسول ليذعتب مق :هيبنت	注意:ピストンポジション変更 !
Adapter für Bördel E	E عوزلا نم ةرخل ئيام	ビードタイプE用アダプター
alle Typen	عوزلا اعيم ج	全タイプ
Alu-Pumpe	مويجولال نم ةخضم	アルミポンプ
Alu-Sättel	مويجولال نم ةيلف ةيلا	アルミキャリパ
am Bremsattel	ظمرفلل ةيلف ةيلا ةل ع	ブレーキキャリパ上に
am Hauptzylinder	ةيس يوزلا ةن اوطنأ ةل ع	マスターシリンダー上に
A-Motor	A ةئيي ةل ع لفرح	Aエンジン
Anschlagschraube oben	ةل ع ب قنز رامسم	ストップネジ、上側
Anschluß/Anschlüsse	تالصر/لصر	接続/コネクション
Anti-Noise-Blech	جيجضليل عنام جاص حول	防音プレート
ASC (Automatische Stabilitäts Control)	(نارتالا يف ليكي تاوتوالا مكحتل ماظن) ASC ماظن	ASC(アクエプスタビリティコントロール)
ASR (Antriebschlupfregelsystem)	(رچلا ةردق يف مكحتل ماظن) ASR ماظن	ASR(トラクションコントロールシステム)
ATE nur über VAG erhältlich	VAG ةرورل ل غ نم ATE يلهي تاوتوالا مرخدا ةريجت ةل ع لوصخا نامي ل	ATEはVAGを通じてのみ入手可能
auf Typenschild	(غصرا) فير عتلا ةحول ةل ع	車種認識プレート上
aufgeschraubt	لئوكفم	ネジ止め
Auslaß seitlich links	عرس يلا ةهچلا ةل ع يبناج جورخ نفنم	左側面の出口
Auslaß seitlich rechts	نم يلا ةهچلا ةل ع يبناج جورخ نفنم	右側面の出口
außen	جراخا نم	外側
automatische Nachstellung	يتاوتوالا لكشب ةئيي هتو طبض دواع	自動調節(アジャストメント)
Behälter	نازخ ءءءو ءءءو	容器(タンク)
Behälter Doppel-WE	ريذيت يتزيهچتب دوزم نازخ	ダブルウォーニングデバイス付容器(タンク)
Behälterbefestigung	نازخا تيبثت	容器(タンク)固定
Behälterstopfen	نازخا قلس	容器(タンク)プラグ
Behälterverschraubung	ريمسب نازخا تيبثت	容器(タンク)ネジ式キャップ
Behörde	ظلسب ةلوعم ءءءو ءئيي	省庁、オーソリティーカー
Beläge	لم ارفلال لي	ブレーキパッド
belüftete Scheiben	لوم صراقأ	換気付ディスク
Betätigungseinheit	لي ءئييت دءءو	アクチュエーターユニット
blau	قرزا	青色
Bodenventil	عاقلا مامص	残留圧センターバルブ
Bodenventile tauschen	عاقلا تامامص ليذيت	残留圧センターバルブ交換
Bördel x	x ةرد ةرورخ	フレアタイプx
braun	رچسأ -يوزب	茶色
breite Ausführung	ضيرع ميمصت	ワイドデザイン(ワイドバージョン)
Bremse	ظمرف	ブレーキ
Bremsgerät	لم ارفلال زيذعت دءءو	ブースターユニット
Bremskraftregler	ةيلحرفلا ةوقلا مظنم	ブレーキ圧調節器
Bremsleitungen erneuern !	ةيلحرفلا تالصرولا ديذيت	ブレーキ管刷新 !
Bremslichtschalter	لم ارفلال عوض خلتفم	ブレーキランプスイッチ
Bremsscheiben	لم ارفلال صراقأ	ブレーキディスク
Bremsschlauch beachten !	لم ارفلال موطرخل هبتنا	ブレーキチューブに注意 !
Buchse + Ausgleichbügel	قداجم ءوسللق + قبل ج	ジャック+バランスクリップ
Bus	ظفاح	バス
Bypassregler	رورملا نفنم مظنم	バイパス調節器
Citroen-Bremse	نيورتس ظمرف	シトロエンブレーキ
D (Durchmesser) =	D (رطق) =	D(直径) =
Dichtring	مكحال ةقح	密閉リング
Dichtung	مكحال ةيشح ءءءو	密閉(シーリング)
Dichtungssatz	مكحال مقاط	ガスケットキット
Differentialsperre	يلضافت لفق	デフエルンシャルロック
Differenzdruckschalter	يلضافتل طمخزلل خلتفم	デフエルンシャル圧スイッチ
Differenzdruckventil	يلضافتل طمخزلل مامص	デフエルンシャル圧バルブ
diverse Typen	ةمونتم تازارط	様々な種類(タイプ)
Doppelbereifung	ةجوزم تاراطا	ツインタイヤ



Doppelkabine	تجويزم قروصقم، قن ييباك	ダブルキャブ
Druckbegrenzungsventil	ط غضنلا مي جحت مامص	圧力制限バルブ
Druckbolzen	تيطا غنننا (روباخ) قرام غ	タペット
Druckbolzen (kurz)	(قريصق) تيطا غنننا (روباخ) قرام غ	タペット(ショート)
Druckbolzen (lang)	(قريوط) تيطا غنننا (روباخ) قرام غ	タペット(ロング)
Druckluftbremse	طو غنننلا ءاوطاب لم عت ظمرف	エアブレーキ
Druckluftleitung	طو غنننلا ءاوطاب لاصرو	圧縮エア管
Druckluftunterstützung	طو غنننلا ءاوطاب ظم اعل اظمرفلا مي عت	エアブレーキアシスト
Druckluftverstärker	طو غنننلا ءاوطاب ظم اعل اظمرفلا ززم	エアブレーキブースター
Druck-Warnschalter	ط غنننلا اب صاخ ريذحت حاتمغم	圧力警告スイッチ
DS-Regler	DS، مظنم	DSバルブ
EDS	يظلم افننلا لغولا يف ينورتكللا مكحتلا مظن EDS، مظن	EDS(電子式ディフェレンシャルロック)
EDS-Ventilblock	EDS، مظن تام لامص ةموم جم	EDS/バルブブロック
EG-Vorschrift	تيروروال ةموم جملا تام يل عت ةحئال	EGヨーロッパ共同体規則
Einbau hinter der Achse	روحنلا فلخ ب يلفرننلا	シャフト後部への設置
Einbau vor der Achse	روحنلا امام ا ب يلفرننلا	シャフト前部への設置
Einbausatz	ب يلفرت م قاط	インストールキット
Einfachbereifung	درفم راطا	一重タイヤ
Einknopfmaß xx mm	م xx (ظصولا) ظببرلا ةعطق (سايقم) دعب	ボタンイン寸法xxmm
Einlaß D=xx mm	م D=xx لوخ ذفنم	吸入直径 =xxmm
Einlaß mit Gummistopfen	تيطلمم كدانسب بوزم لوخ ذفنم	ゴムプラグ付吸気部
Einschraubregler	ظببرلا فوق مظنم	ネジ式調節バルブ
elektr. Vergaser	يبرك نبركفم	電子式キャリブレター
Entlüfteranschluß	(س يفتن) تيووت ظمرو	排気コネクタ
Entlüfterventil	(س يفتن) تيووت مامص	排気バルブ
erhöhte Zuladung	دئاز ليم جت بن حش	高くなったペイロード(負荷)
Ersatz für Sättel D=xx	D=XX تيفننلا تايلا ل ليدبت	キャリバーD=xxの代用パーツ
ETS	راسنلا يف ينورتكللا مكحتلا مظن	ETS(電子式トラクションコントロールシステム)
Europa	ايوروا	ヨーロッパ
Export	ريصت	輸出
Fahrschule	عايقلا ميل عت صبرم	自動車学校
Faltenbalsatz	ب يرسننل غنام ح ي فانم قاط	シールセット
Faustsättel	تضباق تيفن تايلا	げんこつ型キャピラ
Fenster	قنن	窓
Festsättel	تعبث تيفن تايلا	固定式キャピラ
Flanschdicke x mm	م x موئنلا فرط كمص	フランジ厚xmm
Flanschmaß = xx,x	م xx,x موئنلا فرط داعبا	フランジ寸法=xxx
Fuller-Getriebe	رلوف سور قونص	フラー式ギアボックス
für Belagsätze ohne Zubehör	تيل يفت تاق حلم زونب لم ارفلا ليتب صاخ	付属品のないブレーキパッド用
für Bremsättel/Vorgänger	قباسن الام ارفلل تيفننلا تايلا اب صاخ	ブレーキキャピラー/従前モデル用
für Doppelmembran-Gerät	تقورلا تيش غلا ةئ يانث زي زعتلا كدوب صاخ	2重皮膜ブースター用
Gabelkopfsatz	تيفرظ نراقم ةموم جم	ヨークキット
Gehäuse L=	L= قبل ع تبيم	ハウジングL=
gelb	رفصا	黄色
gepanzerte Fahrzeuge	ةعدم تابلفرم	防弾武装車両
Getriebe	سورت قونص	ギアボックス
Getriebe-Nr.	سورتنلا قونص مقدر	ギアボックス番号
GG-Pumpe	بصللا ديدخل نم ةمومصم ةخضم	鑄鉄ポンプ
GG-Sättel	بصللا ديدخل نم ةمومصم تيفن تايلا	鑄鉄キャピラ
GG-THz/Vorgänger	قباسن الام ارفلل ديدخل نم ةمومصم تيفننلا تايلا قن اوطن	鑄鉄THz(タンデムマスターシリンダー) / 従前モデル
Golf-Staaten	ج يل غلا لود	湾岸諸国
Gz mit senkrechtem Flansch	يذوم ع فرطب موزم تضباق قن اوطن	垂直フランジ付クラッチシリンダー
Gz (Geberzylinder)	تضباق قن اوطن	Gzクラッチシリンダー
Gz-Reparaturset	تضباق قن اوطن ا حلصا قاط	Gzクラッチシリンダー修理キット
HA (Hinterachse)	يفل خلا روحنلا	HA(リアシャフト)
Haltefeder	ت يبتت تضبان	固定用スプリング
Halter	ت يبتت وضع	アンカー
Haltersatz	ت يبتت قاط	アンカーセット
Halterschraube	ت يبتت رامسم	アンカーネジ
Handbremsbetätigung	تيدويلا ظمرفلا لي غنث	サイドブレーキ稼動
Handbremshebel	تيدويلا ظمرفلا عازد	サイドブレーキレバー
HA-Scheibenbremse	يفل خلا روحنلا تيصروق ظمرف	リアシャフトディスクブレーキ
HA-Trommelbremse	يفل خلا روحنلا تين اوطن ا ظمرف	リアシャフトドラムブレーキ
Hebel	ةعفار، عازد	レバー
Hochdach	لا ع فقن	ハイルーフ
Hohlschraube	فومج بلول، رامسم	空洞ネジ
Hosei-Bremse	ياسروه ظمرف	豊生ブレーキ
Hub	راوشم، طوش	ストローク
Hülsensatz	بل ج قاط	スリーブキット
Hydraulikspeicher	تيلوردي قن زاخ	油圧アキュムレーター(蓄圧器)
Hydraulikverstärker	تيلوردي ززم	油圧ブースター
Hydraulikzylinder	تيلوردي قن اوطن	油圧シリンダー
Hydr. Steuereinheit	تيلوردي مك جت كدو	油圧制御ユニット
Hz (Hauptzylinder)	تيس يئولا قن اوطن	Hz(マスターシリンダー)
Hz-Reparaturset	تيس يئولا قن اوطن ا حلصا قاط	マスターシリンダー修理キット
im Fahrerhaus	قئاسنلا قروصقم يف	キャブ内
im Motorraum	لقرننلا زي ح يف	エンジンルーム

innen	ل داخل نم	内側
Innengewinde	يل داخل ببلول	内側スレッド
Kastenwagen	تقوونص قبلقم	ワンボックスカー
Katalysator	يزفح لوح	触媒
Kennzeichen: xx	تريهم قمالع	車番: xx
Kerbe am Flansch	(طقن لفل) هفشلا يلع قملث	フランジ上のノッチ
Klasse	قتبترم هجرد	等級
Kleinbus	ري نخس سي بيوتوا صاب ينيم	ミニバス
Klimaanlage	ءاوه فيلقم	エアコン
Kolbenstange D=	D= س لبلفل عارذ	ピストンロッド径 D=
Kolbenstange L=	L= س لبلفل عارذ	ピストンロッド長 L=
Kombiwagen	(يبيموك) رافسا قرايس	ステーションワゴン
Kompakt THz	ة جهيم تيفدارت فيس يئر قن اوطنأ	コンパクトタデムマスターシリンダー
Krankenwagen	فاحس ا قبلقم	救急車
Kupplung	ضباقلل	クラッチ
Kupplungsabgang	ضباقلل لقصو جرحم	クラッチ接続用出力ポート
Kupplungsverstärker	ضباقلل ام عجم	クラッチブースター
kurzer Radstand	قري صيق تال ج ع قذعاق	短いホイールベース
kurzes Bremsgerät	قري نخس لم لرف زيذعت قذجو	短いブレーキブースター
L (Länge) =	L (لوطنل) =	L(長さ) =
langer Radstand	قل يوط تال ج ع قذعاق	長いホイールベース
Leckageanzeige	بوس تلال نايب بن ييم	漏えいインジケーター
lieferbar	مديروت نلقم ، حابتم	納品可能
links oben und rechts unten	لفسا ا ول ا نيم يلا هجو ول ع ا ول ا رلس يلا هج	左上と右下
links vor und rechts hinter der Achse	روح لال لفسا ا ن ييم مام ا رلس ي	シャフトの左前部と右後部
Linkslenker	يرلس ي هي جوت	左ハンドル
Luftfederung	ي ي اوه ق يلق عت	エアスプリング
luftgekühlt	اي ي اوه دربم	空冷式
M8-Führungsbolzen	M8, يل يلد روباخ	M8ガイドピン
MA-Getriebe	سورت قونص	MAギアボックス
mit 1 Haltestift	قنز روباخ بوزم	固定ピン1本で
mit 2 Haltestiften	قنز يروباخ بوزم	固定ピン2本で
mit Alufelgen	جوي هول ا طنون جب بوزم	アルミホイール付
mit angegossenem Behälter	ببص ناز جب بوزم	キャストオンタンク付
mit regeltem Katalysator	جوك جم يزفاح لوحب بوزم	制御式触媒付
mit Laschen	(فاساط) يش او ح بوزم	ストラップ付
mit Leichtmetallrädern	في فح نذ نم ة موصنصم تال ج ع بوزم	軽金属ホイール付
MKII-Aggregat kpl.	قلم الكلا MKII قذجو	MKIIユニット 全体
Mod. (Modell)	ل يوم	モデル(年式)
Motor	ل جرحم	エンジン
Motor-Nr.	ل جرحل ا مقور	エンジン番号
Motor-Pumpen-Aggregat	ل جرحل ا هضم قذجو	エンジンポンプユニット
Multi-Link-Achse	تال صول ا دد عتم روحم	マルチリンクシャフト
m.Z. (mit Zubehör)	قيل يلمت تفاق لجم بوزم	m.Z.(付属品付)
Nachstellteile-Satz	قئ ي امل طبضل ا اعز ج ا قاط	アジャスターパーツセット
ND-Schlauch	ND, ضف خن ل ا ط غنضل ا مو طرخ	ND低圧チューブ(ホース)
Nebenabtrieb	ي جراح عند	パワーテイクオフ
Niveauregulierung	قيل عتل ا يوتسم يف مك حتل ا ملظن	サスペンションレベルコントロール
Nz (Nehmerzylinder)	ة عبات قن اوطنأ	Nz(スレイブシリンダー)
Nz-Reparaturatz	ة عباتل ا قن اوطنأ ل حالص ا قاط	スレイブシリンダー修理キット
ohne Alufelgen	جوي هول ا طنون ج بوب	アルミホイールなし
ohne geregelten Katalysator	جوك جم يزفح لوحم بوب	制御式触媒なし
ohne Laschen	(فاساط) يش او ح بوب	ストラップなし
ohne Leichtmetallräder	في فح نذ نم ة موصنصم تال ج ع بوب	軽金属ホイールなし
O-Ring	O قئ يه يل ع ققل ح	Oリング
Pedal Feststeller	قن اول ا تبتتم	ロックが可能なペダル
Polizei	قطرشلا	警察
Rad	قل ج ع	車輪
Radsensor	قل ج ع ل س ل س ح	ホイールセンサー
Radstand xxxx mm	مم XXXX تال ج ع ا قذعاق	ホイールベースxxxxmm
rechts oben und links unten	لفسا ا ول ا رلس يلا هجو ول ع ا ول ا نيم يلا هج	右上と左下
Rechtslenker	ين يمي هي جوت	右ハンドル
Regler	مظنم	レギュレーター
Reihenmotor	ميقنصم ل جرحم	直列型エンジン Rエンジン
Reisebus/Hochdecker	ة عتترم بلكر قروص قجب ا تال ج ع ل فاح	旅行用バス/ハイルーフ型
Reparaturatz	حلص ا قاط	修理キット
Ringstutzen-Satz	قيل ق ل ح تام ا ع ة موم جم	リング型ニツベルセット
Rohrleitung	ي بوبن ا طخ	パイプライン
rot	رم ح ا	赤色
roter Sattel	ءارم ة قئ ل ف قئ ل ا	レッド キャピラ
Rückschlagventil	ي ع ج ر ل ءاوه لمص	逆行防止バルブ
Rückstellwellen-Satz	طبضل ا كعاع ا عتم ع ا موم جم	リセットシャフトセット
Rz (Radzylinder)	قل ج ع ا قن اوطنأ	Rz(ホイールシリンダー)
Rz-Dichtungsatz	قل ج ع ا قن اوطنأ مك ح ا قاط	ホイールシリンダー密閉キット
Rz-Reparaturatz	قل ج ع ا قن اوطنأ ل حالص ا قاط	ホイールシリンダー修理キット
Salisbury-Achse	يروبس يلس روحم	ソールズベリー型シャフト
Sattel mit 1 Haltestift	قنز وباخ بوزم قئ ل ف قئ ل ا	固定ピン1つのキャピラ









Sattel mit 2 Haltestiften	قنز يروباخب قوزم قيفف قفلا	固定ピン2つのキャピラ
Sättel mit Gussnoppen	بصلال ديدل انم قيفق ع تاظل غت اب قيفف تايفلا	鑄造ナット付キャリパー
Sattelschraube	قففقلل قفلا رابم	キャリパーネジ
Scheibenbremse	قفصرق ظرف	ディスクブレーキ
Scheibenkupplung	قفصرق ضرباق	ディスククラッチ
Scheibenschraube	صروقلا رابم	ディスクネジ
Schlauchleitung	(قفوطرخ) قفطخ تالصر	ホース(チューブ)配管
Schraubstützen	قفبلول تام ع	ネジネック(スクリューネック)
schwarz	دوسا	黒色
Schwimmsättel	قم ع قيفف تايفلا	フローティング キャリパー
Schwingblech WE	حجر لقم جولب ريذحت قريه جت	シートメタル型警告デバイス
SCS	(فقوشلا قيف مكحتلا ماطن) SCS, ماطن	SCS(ストップコントロールシステム)
separater Behälter	لصرفنم نازخ	セパレータータンク
separates Druckstück/Vorgänger	قباسل الصرفنم يطاغفننا وضع	セパレーター圧カピース/従前モデル
Servolenkung	دقوشلا قفز لوم قفلا	パワーステアリング
Skandinavier	ايفن ين الفس!	スカンジナビア
Sitzplätze	سولج نكام	座席 シート
Sonderfahrzeuge	قصاخ تافص او بب تالبكرم	特別車
Spezialaufbau	صاخ لكيفه	特別車体
Sportfahrwerk	قفضايفر قفيل عت ةموم جم	スポーツ仕様サスペンション
Spur	رامم	軌跡
Standard-Bremsgerät	قفس ايفق لمارف زيذعت كدحو	標準ブースターユニット
Standard-THz	قفراي عم قيفدارت قفيس قفيل قن او طسا	標準タンデムマスターシリンダー
staubfeste Ausführung	راب غلا مكارتل موام م قفصرت	埃に強い仕様
Stufenheck	(نلديس) ةمتم قونص اب قرايس قرحوم	セダン(サルーン)
T50-Reparaturatz	T50 حلصل م قاط	T50修理キット
Tandemregler	قفدارت مظنم	タンデム比率調節バルブ
THz mit 3 Anschlüssen	تالصر تالشب قيفدارت قفيس قفيل قن او طسا	コネクタが3つあるタンデムマスターシリンダー
THz mit Anschlagsschraube	قنز رابم ب قوزم قيفدارت قفيس قفيل قن او طسا	ストップネジが付いたタンデムマスターシリンダー
THz (Tandemhauptzylinder)	قفدارت قفيس قفيل قن او طسا	タンデムマスターシリンダー
THz-Reparaturatz	قفدارتلا قفيس قفيل قن او طسا لل حلصل م قاط	タンデムマスターシリンダー修理キット
THz-RS (Montagehülse)	(ب قيفرت قبل ج) قيفدارتلا قفيس قفيل قن او طسا لل حلصل م قاط	タンデムマスターシリンダー修理キット(組み立てスリーブ)
Timken-Achse	نكسم يت روم	ティムケン社シャフト
Topfmanschette	قفئاو بيرسيت ةم نام	ボットシール
Tragbolzensatz	قم ع (ريم لسم) ريب او خ ةموم جم	補助ボルトセット
Transporter	لاقن وضع	輸送車
Triebkopf	(ل قفيل تايفلا) ع قفلا سار	ドライブヘッド
Trommelbremse	قفن او طسا ظرف	ドラムブレーキ
TBB (Trommelbremsbacken)	قفن او طسا ال لمارفلا (قفذخ) تاموقل	TBB(ドラムブレーキパッド)
Umbau 1-teilig auf 2-teilig	نيت عطق اول كدحو ةعطق نم لكيفه قداع!	1部ものを2部ものへ改造
Unterdruckverstärker	غيفرفقلل طمخض زرع	負圧(真空)ブースター
ursprüngl. verschraubte Beläge	ريم بس بب تيبتم قفلا لوي	もとはねじ止めされていたパッド
VA (Vorderachse)	قفا مال او حجل	VA(フロントシャフト)
VA-Girling-Bremse	قفا مال او حجل جن قفلا ريج ظرف	フロントシャフト・ガールングブレーキ
VA-Scheibenbremse	قفا مال او حجل قفصرق ظرف	フロントシャフトディスクブレーキ
VA-Trommelbremse	قفا مال او حجل قفن او طسا ظرف	フロントシャフトドラムブレーキ
Ventilblock	تامامص ةموم جم	バルブブロック
Ventilblock kpl.	ظم لك تامامص ةموم جم	バルブブロック 全体
Verbindungsschrauben	ظبير ريم بس	接続ネジ
Verschlußschraube	قفبلول قداص	密閉ネジ (スクリュープラグ)
Verschraubung	رابم جلا ظبير مك ج!	ネジ止め (スクリューフィッティング)
Verschraubung kpl.	رابم جلا ظبيرل مانتلا مك ج!	ネジ止め 全部
verstärkte Bremse	قم عم لمارف	強化ブレーキ
verstärkte Stoßdämpfer	م عم تاممص صام	強化ショックアブソーバー(強化ダンパー)
verstärktes Fahrwerk	قم عم قفيل عت ةموم جم	強化サスペンション
Verteilerstück wiederverwenden	ةمزولما ةعطقلا ماذختسا قداع!	ディストリビューターパーツの再利用
V-Motor	V قففيه قلع كرحم	V字型エンジン
Vorder- und Hinterachse	قفنل قلاو قفا مال ن قفرو حجل	フロント&リアシャフト
Vorderachse	قفا مال او حجل	フロントシャフト
Vorderachse und 2. Hinterachse	قفا مال او حجل او قفا مال او حجل	フロントシャフトと2番目のリアシャフト
Vordruckventil	ص قفلا طمخضل مامص	残留圧バルブ
Vorgänger	قباسل	従前モデル
Vorgänger / Abschirmkappe	(قصر) ع ج قوننلق / قباسل	従前モデル/シールドキャップ
Vorgänger-THz, Einlaß D=xx	D=xx لوخ قفم (قفيلو لا مامل) قفبل قفدارتلا قفيس قفيل قن او طسا	従前モデル-タンデムマスターシリンダー、吸気部径D=xx
Vorspannzylinder	قفلو لا ن حثلا قن او طسا	事前負荷をかけられたシリンダー(プリロードシリンダー)
WK (Warnkontakt)	لكانتلا نم ريذحتلا رشوم	WK(ウェアインジケーター)
Warnkontakt 1-polig	دحو قفرب ريذحت رشوم	ウェアインジケーター 1相
Warnkontakt 2-polig	فارطلال ايئانث ريذحت رشوم	ウェアインジケーター 2相
Warnschalter	ريذحتلا حلتمفم	警告スイッチ
WE (Warneinrichtung)	ريذحتلا قريه جت	WE(警告デバイス)
WE-Befestigung	ريذحتلا قريه جت تيبتم	WE(警告デバイス)固定
Wegsensor	تافسل جلا سايفق سا سح	トラベルセンサー
weiß	ص قفا	白色
Zylinderschraube	قن او طسا لل رابم	シリンダーネジ

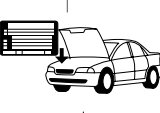

- D** So benutzen Sie den K24-H
- EN** How to use the K24-H
- FR** Utilisation du catalogue K24-H
- IT** Come consultare il catalogo K24-H
- ES** Use así el K24-H
- NL** Zo gebruikt u de K24-H
- DA** Sådan anvendes K24-H
- SV** Så använder du K24-H
- HU** How to use the K24-H
- PT** Como utilizar o K24-H
- RU** Как пользоваться каталогом K24-H
- CZ** Jak používat K24-H
- PL** Tak należy korzystać z K24-H
- EL** Έτσι χρησιμοποιείτε τον K24-H
- TR** K24-H'ı Broşürünü Nasıl Kullanacaksınız
- ZH** 这样使用 K24-H
- JA** カタログNo.24-Hのご利用法
- AR** No.24-H طريقة استعمال الكatalog

K24-H



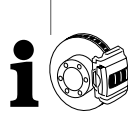
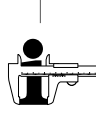
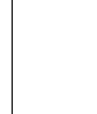









How to use the K24-H

Product groups		Type of vehicle		Installation period (from/to)		ATE number		Remark (spare part)	
Front/rear axle	Chassis number	Remark (car)		Short number		Definition			
kW									
AUDI A4 CABRIO (02-)									
									
1,8 T	120	8E-55-99999	04.02	PR: 1LB,1LE	11.3571-8522.2	220320	<input type="checkbox"/> + ESP	D=57, - Halter	ATE
1,8 T Quattro	120		05.03	PR: 1LB,1LE	11.3571-8521.2	220319	<input type="checkbox"/> + ESP	D=57, - Halter	ATE
2,0	96		05.04	PR: 1LB,1LE	11.0441-5704.2	250034		Dichtungssatz	ATE
2,0 TFSI	120	8E-55-400001	08.06	PR: 1LB,1LE	11.0101-5409.2	260035		Hülsensatz	ATE

*

**

*Product groups

	Booster unit		Handbrake cable
	Master cylinder		Brake pressure regulator
	Reservoir		Clutch cylinder
	Brake caliper		Slave cylinder
	Brake hose		Clutch hose
	Wheel cylinder		Clutch cable

**Hand drive

- Left hand drive
- Right hand drive

****Manufacturer

ADV	Advics
ATE	Continental Teves (ATE)
AKE	Akebono
AIS	Aisin
AP	AP Lockheed
BDX	Bendix
BOS	Bosch
BRE	Brembo
CIT	Citroën
DEL	Delco
FI	Fiat
FTE	FTE Automotive
MAN	Mando
NIS	Nissin
PER	Perrot
SUM	Sumitomo
TOK	Tokico
TRW	Lucas (LUC)
VW	Volkswagen

***Installation Position















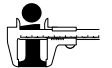



<input type="checkbox"/>	front
<input type="checkbox"/>	rear
<input type="checkbox"/>	left
<input type="checkbox"/>	right
<input type="checkbox"/>	upper left
<input type="checkbox"/>	lower left
<input type="checkbox"/>	upper right
<input type="checkbox"/>	lower right
<input type="checkbox"/>	center
<input type="checkbox"/>	top
<input type="checkbox"/>	bottom
<input type="checkbox"/>	front axle
<input type="checkbox"/>	front left
<input type="checkbox"/>	front right
<input type="checkbox"/>	rear axle
<input type="checkbox"/>	rear left
<input type="checkbox"/>	rear right

All position details are based on vehicle facing forwards.

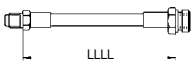
Abbreviations

-	Without / not	HEB	Lever	WE	Warning device	Coupe
+	With / only / for	HZ	Master cylinder	WK	Wear indicator	Convertible
AUT	Automatic adjustment	L	Alloyed / highly carburized	Zub	Accessories	Bus
B	Coated	L=	Length	Brake hose + pipe line	2-door	Van / Panel van
BG	Brake force limiter	Nz	Slave cylinder	3-door	4-door	Fastback / Hatchback
BR	Brake pressure regulator	PD	PowerDisc	5-door	Saloon / Sedan	Pickup/Chassis Platform truck/ chassis
BRE	Screw-in regulator	Rz	Wheel cylinder	Estate / Station wagon	Series	DKW master class/special class/ universal
BRES	Screw-in regulator set	RzR	Wheel cylinder with built-in corrector		FAUN powered cart (Kraka)	Transporter / Van
BRL	Brake pressure regulator, load sensitive	S	Fixing screw / caliper screw			
D=	Diameter	THz	Tandem master cylinder			
Gz	Clutch cylinder	V	Ventilated			

Parts information

		SHORT NUMBER				SHORT NUMBER	
	03.6199-xxxx.4 → 03.61dy-xxxx.4 → 03.67dy-xxxx.4 → 03.68dy-xxxx.4 → 03.69dy-xxxx.4 → 03.77dy-xxxx.4 → 03.78dy-xxxx.4 → 03.78dy-xxxx.4 → 03.78dy-xxxx.4 → 03.78dy-xxxx.4 → 03.78dy-xxxx.4 → 03.78dy-xxxx.4 →	30nnnn 30nnnn 30nnnn 30nnnn 30nnnn 30nnnn 30nnnn 30nnnn 30nnnn 30nnnn 30nnnn	Brake booster T50 T51 T52/3 T52 T53 T52/4 T52/4 T52/4Z T52/5 T52/5Z T55/1 T55/1Z	  	 ▲ 03.27dd-xxxx.3 → ▲ 03.32dd-xxxx.3 → 03.040x-xxdd.2 → 03.0470-xxdd.2 → 24.3727-xxxx.2 → ■ 83.5yxx-LLLL.3 → ■ 83.5yxx-LLLL.3 → ■ 83.6yxx-LLLL.3 → ■ 83.7yxx-LLLL.3 →	02nnnn 02nnnn 06nnnn 06nnnn 58xxxx 33nnnn 33nnnn 33nnnn 33nnnn	Single piston wheel cylinder Wheel cylinder Repair kit (with pistons) Gasket kit (without pistons) Handbrake cable Brake hose + pipe line Brake/clutch hose Brake/clutch hose Brake/clutch hose
	▲ 03.20dd-xxxx.3 → ▲ 03.21dd-xxxx.3 → ▲ 03.23dd-xxxx.3 → ▲ 03.31dd-xxxx.3 → 03.0370-xxdd.2 →	01nnnn 01nnnn 01nnnn 01nnnn 05xxdd	Step-bore tandem master cylinder Tandem master cylinder Step-bore master cylinder Master cylinder (e.g. 03.2122-: Ø=22,20) Repair kit	 	 LLLL 03.60xx-xxxx.3 → 03.65xx-xxxx.3 → 03.0101-xxxx.2 →	32nnnn 32nnnn 32nnnn	y = 1: Thread 1 × inner/1 × outer y = 2: Thread 2 × inner y = 3: Thread 2 × outer Brake pressure regulator (BR) Brake force limiter (BG) Screw-in regulator (BRE) Brake pressure regulator, load-sensitive (BRL) Screw-in regulator set (BRES)
	03.3508-xxxx.x → 03.3509-xxxx.x → 03.3558-xxxx.x → 03.0101-xxxx.2 →	31nnnn 31nnnn 31nnnn 39nnnn	Reservoir Reservoir Reservoir Repair kit		35/3 braun (4)		Markings, coloured markings (number of connections)
	▲ 11.3ddx-xxxx.2 → 11.9ddx-xxxx.2 → ▲ 13.2ddx-xxxx.2 → ▲ 13.4ddx-xxxx.2 → 13.9ddx-xxxx.2 → 24.3ddx-xxxx.5 → 11.0441-ddxx.2 → 13.0441-ddxx.2 → 11.0230-xxxx.2 → 24.0101-xxxx.2 → ▲ 11.0101-xxxx.2 → 11.8116-xxxx.1 →	22nnnn 22nnnn 21nnnn 21nnnn 21nnnn 24nnnn 25nnnn 25nnnn 26nnnn 26nnnn 26nnnn 39nnnn	Fist-type caliper Fist-type caliper 2 cyl. fixed caliper 4 cyl. fixed caliper Fixed caliper Remanufactured fist-type caliper Gasket kit Gasket kit Fist caliper holder set (holder, sliding sleeve set, guide pins) Installation kit (sliding sleeve set, guide pins) Sliding sleeve set Retaining spring	  	▲ 03.24dd-xxxx.3 → 03.0350-ddxx.2 → ▲ 03.25dd-xxxx.3 → 03.0450-ddxx.2 → 24.3728-xxxx.2 →	03nnnn 07ddxx 04nnnn 08ddxx 59xxxx	Clutch cylinder (e.g. 03.2419-: Ø=19,05) Gasket kit Slave cylinder (e.g. 03.2525-: Ø=25,40) Gasket kit Clutch cable

d	y
0	0 = Single unit
5	5 = Tandem unit
2 = 6"	0 = Single unit
3 = 7"	3 = Single unit BA
4 = 8"	5 = Single unit
5 = 9"	8 = Single unit BA
6 = 10"	BA = Electronic brake actuator
	Z = Tension bolt brake booster

nnnn = The last four digits correspond to a running number.

dd = Nominal dimension

- ▲ 24. also possible using same numbering system.
- and 03., 24. and 83. also possible using same numbering system.

Complete copies or extracts of this catalog only by permission. Damage claims on the basis of data in this catalog cannot be recognized. The right of modification in construction or design is reserved. As far as we refer in our documents to part numbers of the vehicle makers, this is for comparison purposes only. The use of such information on invoices to the vehicle owner is not admissible.

The multitude of car models and spare parts from numerous vehicle manufacturers do not always allow an exact allocation. Therefore please pay attention to the corresponding remarks and spare part descriptions.

Utilisation du catalogue K24-H

Groupes de produit		Type de véhicule	Date de montage (du/au)		Référence ATE	Remarque (référence)			
Essieu avant/arrière	No. de châssis (du/au) kW	Remarque (véhicule)	Référence Courte	Indication					
AUDI A4 CABRIO (02-)									
	1,8 T 1,8 T Quattro 2,0 2,0 TFSI	◀ 120 ◀ 120 ▲ 96 ◀ 120	8E-55-999999 8E-55-400001	04.02 05.03 08.06 08.06	PR: 1LB,1LE PR: 1LB,1LE PR: 1LB,1LE PR: 1LB,1LE	11.3571-8522.2 11.3571-8521.2 11.0441-5704.2 11.0101-5409.2	220320 220319 250034 260035	<input type="checkbox"/> + ESP <input type="checkbox"/> + ESP D=57, - Halter D=57, - Halter Dichtungssatz Hülsensatz	ATE ATE ATE ATE
*	**		***		****				

*Groupes de produit



Servo-frein



Câble de
frein à main



Maître cylindre



Correcteur
de freinage



Réservoir



Emetteur
d'embrayage



Etrier de frein



Récepteur
d'embrayage



Flexible de frein



Flexible
d'embrayage



Cylindre de roue



Câble
d'embrayage

**Direction

◀ Conduite à gauche

▶ Conduite à droite

****Fabricant

ADV	Advics
ATE	Continental Teves (ATE)
AKE	Akebono
AIS	Aisin
AP	AP Lockheed
BDX	Bendix
BOS	Bosch
BRE	Brembo
CIT	Citroën
DEL	Delco
FI	Fiat
FTE	FTE Automotive
MAN	Mando
NIS	Nissin
PER	Perrot
SUM	Sumitomo
TOK	Tokico
TRW	Lucas (LUC)
VW	Volkswagen

***Positionnement















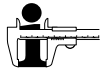



<input type="checkbox"/>	avant
<input type="checkbox"/>	arrière
<input type="checkbox"/>	gauche
<input type="checkbox"/>	droite
<input type="checkbox"/>	avant gauche
<input type="checkbox"/>	arrière gauche
<input type="checkbox"/>	avant droite
<input type="checkbox"/>	arrière droite
<input type="checkbox"/>	milieu
<input type="checkbox"/>	en haut
<input type="checkbox"/>	en bas
<input type="checkbox"/>	essieu avant
<input type="checkbox"/>	essieu avant gauche
<input type="checkbox"/>	essieu avant droite
<input type="checkbox"/>	essieu arrière
<input type="checkbox"/>	essieu arrière gauche
<input type="checkbox"/>	essieu arrière droite

Toutes positions vues en
position de conduite

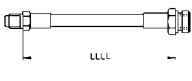
Abréviations

-	Sauf / sans	HEB	Levier	WE	Dispositif d'avertissement	Break
+	Avec / seulement / pour	HZ	Maître cylindre	WK	Témoin d'usure	Coupé
AUT	Ajustage Automatique	L	Allié / carbonise	Zub	Accessoires	Décapotable
B	Revêtu	L =	Longueur			Autobus/car
BG	Limiteur de freinage	Nz	Récepteur d'embrayage			Fourgon
BR	Correcteur de freinage	PD	PowerDisc			Arrière profilé
BRE	Correcteur à visser	Rz	Cylindre de roue		Flexible de frein + conduite	Camion-plateau/Châssis
BRES	Jeu de correcteur à visser	RzR	Cylindre de roue avec correcteur intégré		2 portes	Série
BRL	Correcteur de freinage asservi à la charge	S	Vis d'étrier / vis de fixation		3 portes	DKW Classe supérieure/Classe spéciale/Universel
D =	Diamètre	THz	Maître cylindre tandem		4 portes	FAUN Chariot motorisé (Kraka)
Gz	Emetteur 'embrayage	V	Ventilé		5 portes	Camionnette
					Berline	

Explications des références

		RÉF. COURTE				RÉF. COURTE	
	03.6199-xxxx.4 → 03.61dy-xxxx.4 → 03.67dy-xxxx.4 → 03.68dy-xxxx.4 → 03.69dy-xxxx.4 → 03.77dy-xxxx.4 → 03.78dy-xxxx.4 → 03.78dy-xxxx.4 → 03.78dy-xxxx.4 → 03.78dy-xxxx.4 → 03.78dy-xxxx.4 → 03.78dy-xxxx.4 →	30nnnn 30nnnn 30nnnn 30nnnn 30nnnn 30nnnn 30nnnn 30nnnn 30nnnn 30nnnn 30nnnn 30nnnn	Servo-frein T50 T51 T52/3 T52 T53 T52/4 T52/4 T52/4Z T52/5 T52/5Z T55/1 T55/1Z	  	 ▲ 03.27dd-xxxx.3 → ▲ 03.32dd-xxxx.3 → 03.040x-xxdd.2 → 03.0470-xxdd.2 → 24.3727-xxxx.2 → ■ 83.1xxx-xxxx.3 → ■ 83.5yxx-LLLL.3 → ■ 83.6yxx-LLLL.3 → ■ 83.7yxx-LLLL.3 →	02nnnn 02nnnn 06nnnn 06nnnn 58xxxx 33nnnn 33nnnn 33nnnn 33nnnn	Cylindre de roue borgne Cylindre de roue Néc. de réparation (avec pistons) Jeu de joints (sans pistons) Câble de frein à main Flexible de frein + conduite Flexible de frein-/d'embrayages Flexible de frein-/d'embrayages Flexible de frein-/d'embrayages
	▲ 03.20dd-xxxx.3 → ▲ 03.21dd-xxxx.3 → ▲ 03.23dd-xxxx.3 → ▲ 03.31dd-xxxx.3 → 03.0370-xxdd.2 →	01nnnn 01nnnn 01nnnn 01nnnn 05xxdd	Maître cylindre tandem étagé Maître cylindre tandem Maître cylindre étagé Maître cylindre simple circuit (p.ex. 03.2122-: Ø=22,20) Néc. de réparation	 	 03.60xx-xxxx.3 → 03.65xx-xxxx.3 → 03.0101-xxxx.2 →	32nnnn 32nnnn 32nnnn	y = 1: Raccordement 1x femelle/1x mâle y = 2: Raccordement 2x femelle y = 3: Raccordement 2x mâle Correcteur de freinage (BR) Limiteur de freinage (BG) Correcteur à visser (BRE) Correcteur de freinage asservi à la charge (BRL) Jeu de correcteur à visser (BRES)
	03.3508-xxxx.x → 03.3509-xxxx.x → 03.3558-xxxx.x → 03.0101-xxxx.2 →	31nnnn 31nnnn 31nnnn 39nnnn	Réservoir Réservoir Réservoir Néc. de réparation		35/3 braun (4)		Indice, repère de couleur (nombre de raccords)
	▲ 11.3ddx-xxxx.2 → 11.9ddx-xxxx.2 → ▲ 13.2ddx-xxxx.2 → ▲ 13.4ddx-xxxx.2 → 13.9ddx-xxxx.2 → 24.3ddx-xxxx.5 → 11.0441-ddxx.2 → 13.0441-ddxx.2 → 11.0230-xxxx.2 → 24.0101-xxxx.2 → ▲ 11.0101-xxxx.2 → 11.8116-xxxx.1 →	22nnnn 22nnnn 21nnnn 21nnnn 21nnnn 24nnnn 25nnnn 25nnnn 26nnnn 26nnnn 26nnnn 39nnnn	Etrier à griffe Etrier à griffe Etrier à 2 pistons Etrier à 4 pistons Etrier fixe Etrier à griffe de réchange Jeu de joints Jeu de joints Jeu de supports d'étriers à griffe (support, jeu de douilles de guidage, boulon de guidage) Lot de montage (jeu de douilles de guidage, boulon de guidage) Jeu de douilles de guidage Ressort à retenu	  	▲ 03.24dd-xxxx.3 → 03.0350-ddxx.2 → ▲ 03.25dd-xxxx.3 → 03.0450-ddxx.2 → 24.3728-xxxx.2 →	03nnnn 07ddxx 04nnnn 08ddxx 59xxxx	Emetteur d'embrayage (p. ex. 03.2419-: Ø=19,05) Jeu de joints Récepteur d'embrayage (e.g. 03.2525-: Ø=25,40) Jeu de joints Câble d'embrayage

d	y
0	Appareil simple
5	Appareil tandem
2 = 6"	0 = Appareil simple
3 = 7"	3 = Appareil simple BA
4 = 8"	5 = Appareil simple
5 = 9"	8 = Appareil simple BA
6 = 10"	BA = Assistance de freinage avec AFU
	Z = Servo-frein à tirant

nnnn = Les quatre derniers chiffres correspondent à un ordre numérique.

dd = Dimension nominale

▲ Le préfixe de ces familles de produit peut également être 24.

■ Le préfixe de ces familles de produit peut également être 03., 24. ou 83.

Toute reproduction totale ou partielle de ce catalogue est interdite sauf notre autorisation préalable. Une demande de dommages et intérêts qui se baserait ou aurait pour objet un renseignement donné par le présent catalogue ne saurait être retenue. Nous nous réservons le droit de modifier les spécifications de nos produits sans préavis et, si cela est nécessaire, pour assurer les performances optimales de nos gammes de produits. Les références constructeurs fournies dans le présent catalogue sont données seulement à titre indicatif. L'utilisation de telles informations dans les factures d'un détenteur de véhicule n'est pas admise.

La diversité des modèles et des pièces de rechange ne permet pas toujours une affectation correcte. Par conséquent nous vous prions de bien vouloir tenir compte des observations et des descriptions contenues dans ce catalogue.

Come consultare il catalogo K24-H

Gruppi prodotto		Veicolo		Anno di produzione veicolo		Codice lungo		Altri dettagli ricambio			
Asse anteriore/posteriore		Numero telaio		Altri dettagli veicolo		Codice breve		Altre informazioni			
kW											
AUDI A4 CABRIO (02-)											
	1,8 T 1,8 T Quattro 2,0 2,0 TFSI	◀ 120 ▶ 120 ▶ 96 ▶ 120	8E-55-999999 8E-55-400001	04.02 05.03 05.04	08.06 08.06 08.06	PR: 1LB,1LE PR: 1LB,1LE PR: 1LB,1LE PR: 1LB,1LE	11.3571-8522.2 11.3571-8521.2 11.0441-5704.2 11.0101-5409.2	220320 220319 250034 260035	<input type="checkbox"/> + ESP <input type="checkbox"/> + ESP	D=57, - Halter D=57, - Halter Dichtungssatz Hülsensatz	ATE ATE ATE ATE
*		**						***		****	

*Gruppi prodotto

	Servofreno		Cavi freno a mano
	Pompa freno		Correttore frenata
	Serbatoio compensazione		Cilindro comando
	Pinza freno		Cilindro ricevitore
	Flessibile freno		Flessibile frizione
	Cilindretto ruota		Cavi frizione

**Guida

- ◀ Guida sinistra
- ▶ Guida destra

****Produttore

ADV	Advics
ATE	Continental Teves (ATE)
AKE	Akebono
AIS	Aisin
AP	AP Lockheed
BDX	Bendix
BOS	Bosch
BRE	Brembo
CIT	Citroën
DEL	Delco
FI	Fiat
FTE	FTE Automotive
MAN	Mando
NIS	Nissin
PER	Perrot
SUM	Sumitomo
TOK	Tokico
TRW	Lucas (LUC)
VW	Volkswagen

***Posizione di montaggio















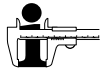









	davanti
	dietro
	a sinistra
	a destra
	davanti a sinistra
	dietro a sinistra
	davanti a destra
	dietro a destra
	al centro
	in alto
	in basso
	asse anteriore
	asse anteriore a sinistra
	asse anteriore a destra
	asse posteriore
	asse posteriore a sinistra
	asse posteriore a destra

Le indicazioni dei simboli si riferiscono alla direzione di marcia.

Abbreviazioni

-	Senza / non	HEB	Leva	V	Ventilato	Station Wagon
+	Con / solo / per	HZ	Pompa freno	WE	Rilevatore usura incollato	Coupé
AUT	Regolazione automatica	L	In lega / lega di carbonio	WK	Rilevatore usura a clip	Cabriolet
B	Rivestito	L =	Lunghezza	Zub	Accessori	Autobus
BG	Limitatore potenza freno	Nz	Cilindro ricevitore frizione			Furgone
BR	Correttore di frenata	PD	PowerDisc			Coda spiovente
BRE	Correttore avvitabile	Rz	Cilindretto ruota			Autocarro cassonato/Autotelaio
BRES	Correttore (da avvitare)	RzR	Cilindretto ruota con correttore			Serie
BRL	Correttore di frenata, dipendente dal carico	S	Viti fissaggio pinza / viti di fissaggio			DKW Classe superiore/Classe spec./Universale
D =	Diametro	THz	Pompa freno tandem			FAUN Motocarri (Kraka)
Gz	Pompa frizione					Furgoncino

Informazioni sugli articoli

		CODICE BREVE				CODICE BREVE	
	03.6199-xxxx.4 → 03.61dy-xxxx.4 → 03.67dy-xxxx.4 → 03.68dy-xxxx.4 → 03.69dy-xxxx.4 → 03.77dy-xxxx.4 → 03.78dy-xxxx.4 → 03.78dy-xxxx.4 → 03.78dy-xxxx.4 → 03.78dy-xxxx.4 → 03.78dy-xxxx.4 → 03.78dy-xxxx.4 →	30nnnn 30nnnn 30nnnn 30nnnn 30nnnn 30nnnn 30nnnn 30nnnn 30nnnn 30nnnn 30nnnn 30nnnn	Servofreno T50 T51 T52/3 T52 T53 T52/4 T52/4 T52/4Z T52/5 T52/5Z T55/1 T55/1Z	         	▲ 03.27dd-xxxx.3 → ▲ 03.32dd-xxxx.3 → 03.040x-xxdd.2 → 03.0470-xxdd.2 → 24.3727-xxxx.2 → ■ 83.1xxx-xxxx.3 → ■ 83.5yxx-LLLL.3 → ■ 83.6yxx-LLLL.3 → ■ 83.7yxx-LLLL.3 →	02nnnn 02nnnn 06nnnn 06nnnn 58xxxx 33nnnn 33nnnn 33nnnn 33nnnn	Cilindretto ruota a un pistone Cilindretto ruota Serie di riparazione (con pistoni) Serie di guarnizioni (senza pistoni) Cavi freno a mano Flessibile del freno + tubazione Flessibile freno/frizione Flessibile freno/frizione Flessibile freno/frizione
	▲ 03.20dd-xxxx.3 → ▲ 03.21dd-xxxx.3 → ▲ 03.23dd-xxxx.3 → ▲ 03.31dd-xxxx.3 → 03.0370-xxdd.2 →	01nnnn 01nnnn 01nnnn 01nnnn 05xxdd	Pompa freno tandem a stadi Pompa freno tandem Pompa freno a stadi Pompa freno (p. ej. 03.2122-: Ø=22,20) Serie di riparazione	  	LLLL 03.60xx-xxxx.3 → 03.65xx-xxxx.3 → 03.0101-xxxx.2 → 35/3 marrone (4)	32nnnn 32nnnn 32nnnn	y = 1: Raccordo 1 × interno/1 × esterno y = 2: Raccordo 2 × interno y = 3: Raccordo 2 × esterno Correttore frenata (BR) Limitatore potenza freno (BG) Regolatore a vite (BRE) Correttore frenata dipendente dal carico (BRL) Mini / regolatore (da avvitare) (BRES)
	03.3508-xxxx.x → 03.3509-xxxx.x → 03.3558-xxxx.x → 03.0101-xxxx.2 →	31nnnn 31nnnn 31nnnn 39nnnn	Serbatoio compensazione Serbatoio compensazione Serbatoio compensazione Serie di riparazioni				
	▲ 11.3ddx-xxxx.2 → 11.9ddx-xxxx.2 → ▲ 13.2ddx-xxxx.2 → ▲ 13.4ddx-xxxx.2 → 13.9ddx-xxxx.2 → 24.3ddx-xxxx.5 → 11.0441-ddxx.2 → 13.0441-ddxx.2 → 11.0230-xxxx.2 → 24.0101-xxxx.2 → ▲ 11.0101-xxxx.2 → 11.8116-xxxx.1 →	22nnnn 22nnnn 21nnnn 21nnnn 21nnnn 24nnnn 25nnnn 25nnnn 26nnnn 26nnnn 26nnnn 39nnnn	Pinza freno flottante Pinza freno flottante Pinza a 2 pistoncini Pinza a 4 pistoncini Pinza a 4 pistoncini Pinza freno flottante di sostituzione Serie di guarnizioni Serie di guarnizioni Serie staffe per pinze flottanti (supporto, serie di guarnizioni, guide scorrimento) Serie di montaggio (serie di guarnizioni, guide scorrimento) Serie di guarnizioni Molla di ritegno	  	▲ 03.24dd-xxxx.3 → 03.0350-ddxx.2 → ▲ 03.24dd-xxxx.3 → 03.0350-ddxx.2 → 24.3728-xxxx.2 →	03nnnn 07ddxx 03nnnn 07ddxx 59xxxx	Cilindro comando (p.es. 03.2419-: Ø=19,05) Serie guarnizioni Cilindro comando (p.es. 03.2419-: Ø=19,05) Serie guarnizioni Cavi frizione

d	y
0	Dispositivo singolo
5	Dispositivo tandem
2 = 6"	
3 = 7"	
4 = 8"	0 = Dispositivo singolo
5 = 9"	3 = Dispositivo singolo BA
6 = 10"	5 = Dispositivo singolo
	8 = Dispositivo singolo
	BA = Assistente di frenata
	Z = Apparecchi per freni con tirante

nnnn = Nessun riferimento a codice ATE (esteso).

dd = Dimensione nominale

▲ E' possibile anche 24. con un sistema di numerazione uguale.

■ E' possibile anche 03., 24. e 83. con un sistema di numerazione uguale.

La ristampa anche parziale di questo catalogo può essere effettuata solo con nostro permesso. Richieste di sostituzione in base ai dati di questo catalogo non possono essere accettate. Salvo modifiche. Un riferimento nei nostri documenti ai numeri dei particolari di ricambio del produttore dell'autovettura viene fatto esclusivamente a scopo comparativo. L'utilizzo di questi dati in fatture al proprietario dell'autovettura non è ammissibile.

La molteplicità dei modelli e delle parti di ricambio di alcuni costruttori di autoveicoli non sempre consente una correlazione esatta. Si consiglia quindi di fare particolare attenzione alle osservazioni riportate nel catalogo ed alle descrizioni delle parti di ricambio.

Use así el K24-H

Grupos producto		Veículo	Anno di produzione veicolo		Codice lungo	Altri dettagli ricambio	
Asse anteriore/posteriore		Numero telaio	Altri dettagli veicolo		Codice breve	Altre informazioni	
kW							
AUDI A4 CABRIO (02-)							
	1,8 T 1,8 T Quattro 2,0 2,0 TFSI	◀ 120 ◀ 120 ◀ 96 ◀ 120	8E-55-99999 8E-55-40001	04.02 05.03 05.04	08.06 08.06 08.06	PR: 1LB,1LE PR: 1LB,1LE PR: 1LB,1LE PR: 1LB,1LE	11.3571-8522.2 11.3571-8521.2 11.0441-5704.2 11.0101-5409.2
						220320 220319 250034 260035	<input type="checkbox"/> + ESP <input type="checkbox"/> + ESP
							D=57, - Halter D=57, - Halter Dichtungssatz Hülsensatz
							ATE ATE ATE ATE
*		**				***	****

*Grupo de producto

	Servofreno		Cable de freno de mano
	Cilindro maestro		Corrector de frenado
	Depósito		Cilindro transmisor de embrague
	Pinza de freno		Cilindro receptor de embrague
	Tubo flexible de freno		Tubo flexible de embrague
	Cilindro de rueda		Cable de embrague

**Dirección

- ◀ Volante a la izquierda
- ▶ Volante a la derecha

****Fabricante

ADV	Advics
ATE	Continental Teves (ATE)
AKE	Akebono
AIS	Aisin
AP	AP Lockheed
BDX	Bendix
BOS	Bosch
BRE	Brembo
CIT	Citroën
DEL	Delco
FI	Fiat
FTE	FTE Automotive
MAN	Mando
NIS	Nissin
PER	Perrot
SUM	Sumitomo
TOK	Tokico
TRW	Lucas (LUC)
VW	Volkswagen

***Posición de montaje





















	adelante
	atrás
	izquierda
	derecha
	izquierda arriba
	izquierda abajo
	derecha arriba
	derecha abajo
	medio
	arriba
	abajo
	eje delantero
	izquierda adelante
	derecha adelante
	eje trasero
	izquierda atrás
	derecha atrás

Todas las indicaciones de posición se refieren siempre al sentido de la marcha.

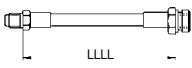
Abreviaturas

-	Sin / no	Gz	Cilindro transmisor de embrague	S	Tornillo para pinza/tornillo querfija	Break
+	Con / solo / para			THz	Cilindro maestro tándem	Coupé
AUT	Reajuste automático	HEB	Palanca	V	Ventilado	Cabriolé
B	Recubierto	HZ	Cilindro maestro	WE	Dispositivo de desgaste	Autobús
BG	Limitador de frenado	L	Aleación especial	WK	Contacto de desgaste	Furgón
BR	Corrector de frenado	L =	Largo	Zub	Accesorios	Portón trasero alargado
BRE	Regulador de rosca	Nz	Cilindro receptor de embrague	Latiguillo + tubería		Camión con plataforma/Chasis
BRES	Juego regulador de rosca			2-puertas		Serie
BRL	Corrector de frenado dependiente de carga	PD	PowerDisc	3-puertas		DKW Clase maestra/Clase especial/Universal
D =	Diámetro	Rz	Cilindro de rueda	4-puertas		FAUN carretilla (Kraka)
		RzR	Cilindro de rueda con regulador integrado	5-puertas		Furgoneta
				Berlina		

Información artículos

		REF. CORTA				REF. CORTA																			
	03.6199-xxxx.4 → 03.61dy-xxxx.4 → 03.67dy-xxxx.4 → 03.68dy-xxxx.4 → 03.69dy-xxxx.4 → 03.77dy-xxxx.4 →	30nnnn 30nnnn 30nnnn 30nnnn 30nnnn 30nnnn	Refuerzo de la presión de frenada T50 T51 T52/3 T52 T53 T52/4		 ▲ 03.27dd-xxxx.3 → ▲ 03.32dd-xxxx.3 → 03.040x-xxdd.2 → 03.0470-xxdd.2 →	02nnnn 02nnnn 06nnnn 06nnnn	Cilindro de rueda de un pistón Cilindro de rueda Juego de reparación (con pistón) Juego de reparación de juntas (sin pistón)																		
	03.78dy-xxxx.4 → 03.78dy-xxxx.4 → 03.78dy-xxxx.4 → 03.78dy-xxxx.4 → 03.78dy-xxxx.4 → 03.78dy-xxxx.4 →	30nnnn 30nnnn 30nnnn 30nnnn 30nnnn 30nnnn	T52/4 T52/4Z T52/5 T52/5Z T55/1 T55/1Z	 	 24.3727-xxxx.2 →	58xxxx	Cable de freno mano																		
			<table border="1"> <thead> <tr> <th>d</th> <th>y</th> </tr> </thead> <tbody> <tr> <td>2 = 6"</td> <td>0 = Simple</td> </tr> <tr> <td>3 = 7"</td> <td>5 = Tandem</td> </tr> <tr> <td>4 = 8"</td> <td>0 = Simple</td> </tr> <tr> <td>5 = 9"</td> <td>3 = Simple BA</td> </tr> <tr> <td>6 = 10"</td> <td>5 = Simple</td> </tr> <tr> <td></td> <td>8 = Simple BA</td> </tr> <tr> <td></td> <td>BA = Asistente de frenado</td> </tr> <tr> <td></td> <td>Z = Aparato de freno por tirante</td> </tr> </tbody> </table>	d	y	2 = 6"	0 = Simple	3 = 7"	5 = Tandem	4 = 8"	0 = Simple	5 = 9"	3 = Simple BA	6 = 10"	5 = Simple		8 = Simple BA		BA = Asistente de frenado		Z = Aparato de freno por tirante		■ 83.1xxx-xxxx.3 → ■ 83.5yxx-LLLL.3 → ■ 83.6yxx-LLLL.3 → ■ 83.7yxx-LLLL.3 →	33nnnn 33nnnn 33nnnn 33nnnn	Latiguillo + tubería Tubo flexible de freno-/embrague Tubo flexible de freno-/embrague Tubo flexible de freno-/embrague
d	y																								
2 = 6"	0 = Simple																								
3 = 7"	5 = Tandem																								
4 = 8"	0 = Simple																								
5 = 9"	3 = Simple BA																								
6 = 10"	5 = Simple																								
	8 = Simple BA																								
	BA = Asistente de frenado																								
	Z = Aparato de freno por tirante																								
	▲ 03.20dd-xxxx.3 → ▲ 03.21dd-xxxx.3 → ▲ 03.23dd-xxxx.3 → ▲ 03.31dd-xxxx.3 → 03.0370-xxdd.2 →	01nnnn 01nnnn 01nnnn 01nnnn 05xxdd	Cilindro maestro escalonado tandem Cilindro maestro tandem Cilindro escalonado maestro Cilindro maestro (p. ej. 03.2122-: Ø=22,20) Juego de reparación	 	 LLLL		y = 1: Roscas 1× interior/1× exterior y = 2: Roscas 2× interior y = 3: Roscas 2× exterior																		
	03.3508-xxxx.x → 03.3509-xxxx.x → 03.3558-xxxx.x → 03.0101-xxxx.2 →	31nnnn 31nnnn 31nnnn 39nnnn	Depósito Depósito Depósito Juego de reparación		03.60xx-xxxx.3 → 03.65xx-xxxx.3 → 03.0101-xxxx.2 →	32nnnn 32nnnn 32nnnn	Corrector de frenado (BR) Limitador de frenado (BG) Regulador de rosca (BRE) Corrector de frenado dependiente de la carga (BRL) Juego de reguladores de rosca (BRES)																		
					35/3 marrón (4)		Característica / marcación de color (número de conexiones)																		
	▲ 11.3ddx-xxxx.2 → 11.9ddx-xxxx.2 → ▲ 13.2ddx-xxxx.2 → ▲ 13.4ddx-xxxx.2 → 13.9ddx-xxxx.2 → 24.3ddx-xxxx.5 → 11.0441-ddxx.2 → 13.0441-ddxx.2 → 11.0230-xxxx.2 → 24.0101-xxxx.2 → ▲ 11.0101-xxxx.2 → 11.8116-xxxx.1 →	22nnnn 22nnnn 21nnnn 21nnnn 21nnnn 24nnnn 25nnnn 25nnnn 26nnnn 26nnnn 26nnnn 39nnnn	Pinza de puño Pinza de puño Pinza fija 2-cilindros Pinza fija 4-cilindros Pinza fija Pinza de puño refabricada Juego de reparación de juntas Juego de reparación de juntas Juego de soportes de pinza de puño (soporte, juego de casquillos corredizos, perno de guía) Juego de montaje (juego de casquillos corredizos, perno de guía) Juego casquillos corredizos Muelle de sujeción	  	▲ 03.24dd-xxxx.3 → 03.0350-ddxx.2 →	03nnnn 07ddxx	Cilindro transmisor de embrague (p.ej. 03.2419-: Ø=19,05) Juego de reparación de juntas																		
					▲ 03.25dd-xxxx.3 → 03.0450-ddxx.2 →	04nnnn 08ddxx	Cilindro receptor de embrague (e.ej. 03.2525-: Ø=25,40) Juego de reparación de juntas																		
					24.3728-xxxx.2 →	59xxxx	Cable de embrague																		

nnnn = Las cuatro últimas cifras son números correlativos.

dd = Medida nominal





















▲ También posible el 24. en caso del mismo sistema de numeración.

■ También posible el 03., 24. y 83. en caso del mismo sistema de numeración.

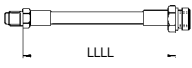
Sólo se permite la reproducción total o parcial con nuestra autorización. No se atenderán reclamaciones motivadas por los datos contenidos en este catálogo. Quedan reservados los derechos de modificaciones en la construcción. Si en nuestros documentos hacemos referencia a números de piezas de recambio de los constructores de vehículos, esto únicamente es para establecer una comparación. No está permitido el uso de datos de este tipo en las facturas emitidas al propietario del vehículo.

La variedad de modelos y de piezas de recambio de algunos constructores de vehículos no permite siempre una distribución exacta. Por este motivo, por favor fíjese atentamente en las observaciones y descripciones de las piezas de recambio detalladas en el catálogo.

Artikelinformatie

		VERKORT NUMMER				VERKORT NUMMER	
	03.6199-xxxx.4 → 03.61dy-xxxx.4 → 03.67dy-xxxx.4 → 03.68dy-xxxx.4 → 03.69dy-xxxx.4 → 03.77dy-xxxx.4 → 03.78dy-xxxx.4 → 03.78dy-xxxx.4 → 03.78dy-xxxx.4 → 03.78dy-xxxx.4 → 03.78dy-xxxx.4 → 03.78dy-xxxx.4 →	30nnnn 30nnnn 30nnnn 30nnnn 30nnnn 30nnnn 30nnnn 30nnnn 30nnnn 30nnnn 30nnnn 30nnnn	Rembekrachtiger T50 T51 T52/3 T52 T53 T52/4 T52/4 T52/4Z T52/5 T52/5Z T55/1 T55/1Z	  	 ▲ 03.27dd-xxxx.3 → ▲ 03.32dd-xxxx.3 → 03.040x-xxdd.2 → 03.0470-xxdd.2 → 24.3727-xxxx.2 → ■ 83.1xxx-xxxx.3 → ■ 83.5yxx-LLLL.3 → ■ 83.6yxx-LLLL.3 → ■ 83.7yxx-LLLL.3 →	02nnnn 02nnnn 06nnnn 06nnnn 58xxxx 33nnnn 33nnnn 33nnnn 33nnnn	enkelzijdig werkende wielremcilinder Wielremcilinder Reparatieset (met zuiger) Pakkingset (zonder zuiger) Handremkabel Remslang + pijpleiding Rem-/koppelingslang Rem-/koppelingslangh Rem-/koppelingslang
	▲ 03.20dd-xxxx.3 → ▲ 03.21dd-xxxx.3 → ▲ 03.23dd-xxxx.3 → ▲ 03.31dd-xxxx.3 → 03.0370-xxdd.2 →	01nnnn 01nnnn 01nnnn 01nnnn 05xxdd	Tandem-hoofdcilinder trapsgewijs Tandem-hoofdcilinder Hoofdremcilinder trapsgewijs Hoofdremcilinder (bijv. 03.2122-: Ø=22,20) Reparatieset	 	 LLLL 03.60xx-xxxx.3 → 03.65xx-xxxx.3 → 03.0101-xxxx.2 →	32nnnn 32nnnn 32nnnn	y = 1: schroefdraad 1× binnen/1× buiten y = 2: schroefdraad 2× binnen y = 3: schroefdraad 2× binnen Remkrachtregelaar (BR) Remkrachtbegrenzer (BG) Inschroefregelaar (BRE) Lastafhankelijke Remkrachtregelaar (BRL) Inschroefregelaar-set (BRES)
	03.3508-xxxx.x → 03.3509-xxxx.x → 03.3558-xxxx.x → 03.0101-xxxx.2 →	31nnnn 31nnnn 31nnnn 39nnnn	Remvloestofreservoir Remvloestofreservoir Remvloestofreservoir Reparatieset		35/3 bruin (4)		Kenmerk, kleurmarkering (aantal aansluitingen)
	▲ 11.3ddx-xxxx.2 → 11.9ddx-xxxx.2 → ▲ 13.2ddx-xxxx.2 → ▲ 13.4ddx-xxxx.2 → 13.9ddx-xxxx.2 → 24.3ddx-xxxx.5 → 11.0441-ddxx.2 → 13.0441-ddxx.2 → 11.0230-xxxx.2 → 24.0101-xxxx.2 → ▲ 11.0101-xxxx.2 → 11.8116-xxxx.1 →	22nnnn 22nnnn 21nnnn 21nnnn 21nnnn 24nnnn 25nnnn 25nnnn 26nnnn 26nnnn 26nnnn 39nnnn	Vuistzadel Vuistzadel 2-cil. vast remzadel 4-cil. vast remzadel Vast remzadel Ruilzadel vuistzadel Pakkingset Pakkingset Vuistzadelhouder -set (houder, centreerstift) Inbouwset (geleidebussen set, geleidbouten) Geleidebussen set Bevestigingsveer	  	▲ 03.24dd-xxxx.3 → 03.0350-ddxx.2 → ▲ 03.25dd-xxxx.3 → 03.0450-ddxx.2 → 24.3728-xxxx.2 →	03nnnn 07ddxx 04nnnn 08ddxx 59xxxx	Koppelingshoofdcilinder (bijv. 03.2419-: Ø=19,05) Pakkingset Koppelingshoofdcilinder (bijv. 03.2419-: Ø=19,05) Pakkingset Koppelingshoofdcilinder (bijv. 03.3219-: Ø=19,08) Pakkingset

d	y
0	Enkelvoudig apparaat
5	Tandem apparaat
2 = 6"	
3 = 7"	
4 = 8"	0 = Enkelvoudig apparaat
5 = 9"	3 = Enkelvoudig apparaat BA
6 = 10"	5 = Enkelvoudig apparaat
	8 = Enkelvoudig apparaat BA
	BA = Remassistent
	Z = Trekankerremapparaten

nnnn = de laatste vier cijfers houden een tellernummer in.

dd = Standaard Maat





▲ Ook 24. met hetzelfde volgnummer mogelijk

■ Ook 03., 24. en 83. met hetzelfde volgnummer mogelijk.

Het nadrukken ook gedeeltelijk, is alleen met onze toestemming toegestaan. Schadeclaims op basis van informatie in deze catalogus kunnen niet worden aanvaard. Constructiewijzigingen voorbehouden. Voor zover wij in onze documentatie refereren naar onderdeelnummers van de voertuigfabrikant, dienen die slechts om te vergelijken. Een gebruik van dergelijke gegevens in rekeningen aan de voertuigeigenaar is niet geoorloofd.

De verschillen in modellen en onderdelen van enige voertuigfabrikanten maken niet altijd een nauwkeurige indeling mogelijk. Let daarom vooral op de in de catalogus vermelde opmerkingen en onderdeelbeschrijvingen.

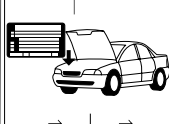
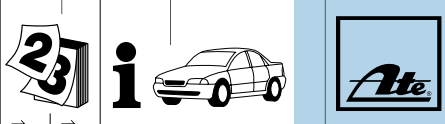
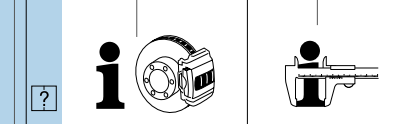
Sådan anvendes K24-H

Produktgruppe	Køretøjtper	Montageperiode (fra/til)	ATE-artikelnummer (langt)	Bemærkning (artikel)																																							
For-/bagaksel	Stelnummer (fra/til) kW	Bemærkning (køretøj)	ATE-artikelnummer (kort)	Artikel																																							
																																											
AUDI A4 CABRIO (02-)																																											
	1,8 T 1,8 T Quattro 2,0 2,0 TFSI	<table border="0"> <tr><td>◀ 120</td><td>8E-55-99999</td><td>04.02</td><td>PR: 1LB,1LE</td><td>11.3571-8522.2</td><td>220320</td><td><input type="checkbox"/> + ESP</td><td>D=57, - Halter</td><td>ATE</td></tr> <tr><td>◀ 120</td><td></td><td>05.03</td><td>PR: 1LB,1LE</td><td>11.3571-8521.2</td><td>220319</td><td><input type="checkbox"/> + ESP</td><td>D=57, - Halter</td><td>ATE</td></tr> <tr><td>◀ 96</td><td></td><td>05.04</td><td>PR: 1LB,1LE</td><td>11.0441-5704.2</td><td>250034</td><td></td><td>Dichtungssatz</td><td>ATE</td></tr> <tr><td>◀ 120</td><td>8E-55-40001</td><td>08.06</td><td>PR: 1LB,1LE</td><td>11.0101-5409.2</td><td>260035</td><td></td><td>Hülsensatz</td><td>ATE</td></tr> </table>	◀ 120	8E-55-99999	04.02	PR: 1LB,1LE	11.3571-8522.2	220320	<input type="checkbox"/> + ESP	D=57, - Halter	ATE	◀ 120		05.03	PR: 1LB,1LE	11.3571-8521.2	220319	<input type="checkbox"/> + ESP	D=57, - Halter	ATE	◀ 96		05.04	PR: 1LB,1LE	11.0441-5704.2	250034		Dichtungssatz	ATE	◀ 120	8E-55-40001	08.06	PR: 1LB,1LE	11.0101-5409.2	260035		Hülsensatz	ATE					
◀ 120	8E-55-99999	04.02	PR: 1LB,1LE	11.3571-8522.2	220320	<input type="checkbox"/> + ESP	D=57, - Halter	ATE																																			
◀ 120		05.03	PR: 1LB,1LE	11.3571-8521.2	220319	<input type="checkbox"/> + ESP	D=57, - Halter	ATE																																			
◀ 96		05.04	PR: 1LB,1LE	11.0441-5704.2	250034		Dichtungssatz	ATE																																			
◀ 120	8E-55-40001	08.06	PR: 1LB,1LE	11.0101-5409.2	260035		Hülsensatz	ATE																																			
*	**			***	****																																						

*Produktgruppen

	Bremseforstærker		Håndbremsekabel
	Hovedbremsecylinder		Bremsekraftfordeler
	Ekspansionsbeholder		Koblings- mastercylinder
	Bremsecaliper		Koblings- slavecylinder
	Bremseslange		Koblingslange
	Hjulcylinder		Koblingskabel





**Styring

- ◀ Venstrestyring
▶ Højrestyring

****Producentkode

ADV	Advics
ATE	Continental Teves (ATE)
AKE	Akebono
AIS	Aisin
AP	AP Lockheed
BDX	Bendix
BOS	Bosch
BRE	Brembo
CIT	Citroën
DEL	Delco
FI	Fiat
FTE	FTE Automotive
MAN	Mando
NIS	Nissin
PER	Perrot
SUM	Sumitomo
TOK	Tokico
TRW	Lucas (LUC)
VW	Volkswagen

***Monteringssted























	for
	bag
	venstre
	højre
	foran til venstre
	bagved til venstre
	foran til højre
	bagved til højre
<input type="checkbox"/>	midt
	oppe
	nede
	Foraksel
	Venstre foraksel
	Højre foraksel
	Bagaksel
	Venstre bagaksel
	Højre bagaksel

Samtlige monteringssteder er altid i relation til kørselsretningen.

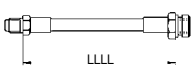
Forkortelser

-	Uden / ikke	HEB	Arm	V	Ventileret	Kombination
+	Med / kun / til	HZ	Hovedcylinder	WE	Advarselsanordning	Coupé
AUT	Automatisk indstilling	L	Legeret / højt kulstofindhold	WK	Advarselskontakt	Cabriolet
B	Coated	L =	Længde	Zub	Tilbehør	bus
BG	Bremsekraftbegrænser	Nz	Slavecylinder			kassevogn
BR	Bremsekraftfordeler	PD	PowerDisc			Hatchback
BRE	Iskruningsregulator	Rz	Hjulcylinder			Lad/chassis
BRES	Iskruningsregulatorsæt	RzR	Hjulcylinder med integreret regulator			Serie
BRL	Bremsekraftfordeler lastafhængig	S	Fastgøringsskrue / caliperskrue			DKW mesterklasse/særklasse/ universal
D =	Diameter	THz	Tandem-hovedcylinder			FAUN Kraka
Gz	Mastercylinder					Transporter

Artikelinformation

		KORT NUMMER				KORT NUMMER	
	03.6199-xxxx.4 → 03.61dy-xxxx.4 → 03.67dy-xxxx.4 → 03.68dy-xxxx.4 → 03.69dy-xxxx.4 → 03.77dy-xxxx.4 → 03.78dy-xxxx.4 → 03.78dy-xxxx.4 → 03.78dy-xxxx.4 → 03.78dy-xxxx.4 → 03.78dy-xxxx.4 →	30nnnn 30nnnn 30nnnn 30nnnn 30nnnn 30nnnn 30nnnn 30nnnn 30nnnn 30nnnn 30nnnn	Bremseforstærker T50 T51 T52/3 T52 T53 T52/4 T52/4 T52/4Z T52/5 T52/5Z T55/1 T55/1Z	    	 03.27dd-xxxx.3 → 03.32dd-xxxx.3 → 03.040x-xxdd.2 → 03.0470-xxdd.2 → 24.3727-xxxx.2 → 83.5yxx-LLLL.3 → 83.1xxx-xxxx.3 → 83.6yxx-LLLL.3 → 83.7yxx-LLLL.3 →	02nnnn 02nnnn 06nnnn 06nnnn 58xxxx 33nnnn 33nnnn 33nnnn 33nnnn	Ensidig virkende hjulcylinder Hjulcylinder Reparationssæt (med stempel) Pakningssæt (uden stempel) Håndbremsekabel Bremseslange + rørledning Bremse-/Koblingslange Bremse-/Koblingslange Bremse-/Koblingslange y = 1: Gevind 1× indvendig/1× udvendig y = 2: Gevind 2× indvendig y = 3: Gevind 2× udvendig Bremsekraftfordeler (BR) Bremsekraftbegrænser (BG) Iskruningsregulator (BRE) Bremsekraftfordeler lastafhængig (BRL) Iskruningsregulator-sæt (BRES)
	▲ 03.20dd-xxxx.3 → ▲ 03.21dd-xxxx.3 → ▲ 03.23dd-xxxx.3 → ▲ 03.31dd-xxxx.3 → 03.0370-xxdd.2 →	01nnnn 01nnnn 01nnnn 01nnnn 05xxdd	Tandem-hovedcylinder trindelt Tandem-hovedcylinder Trin-hovedcylinder Hovedcylinder (F.eks. 03.2122-: Ø=22,20) Reparationssæt	 	 LLLL	32nnnn 32nnnn 32nnnn	y = 1: Gevind 1× indvendig/1× udvendig y = 2: Gevind 2× indvendig y = 3: Gevind 2× udvendig Bremsekraftfordeler (BR) Bremsekraftbegrænser (BG) Iskruningsregulator (BRE) Bremsekraftfordeler lastafhængig (BRL) Iskruningsregulator-sæt (BRES)
	03.3508-xxxx.x → 03.3509-xxxx.x → 03.3558-xxxx.x → 03.0101-xxxx.2 →	31nnnn 31nnnn 31nnnn 39nnnn	Ekspansionsbeholder Ekspansionsbeholder Ekspansionsbeholder Reparationssæt		35/3 brun (4)		Kendetegn, farvemærkning (Antal tilslutninger)
	▲ 11.3ddx-xxxx.2 → 11.9ddx-xxxx.2 → ▲ 13.2ddx-xxxx.2 → ▲ 13.4ddx-xxxx.2 → 13.9ddx-xxxx.2 → 24.3ddx-xxxx.5 → 11.0441-ddxx.2 → 13.0441-ddxx.2 → 11.0230-xxxx.2 → 24.0101-xxxx.2 → ▲ 11.0101-xxxx.2 → 11.8116-xxxx.1 →	22nnnn 22nnnn 21nnnn 21nnnn 21nnnn 24nnnn 25nnnn 25nnnn 26nnnn 26nnnn 26nnnn 39nnnn	Flydende bremsecaliper Flydende bremsecaliper 2-cyl. Fast bremsecaliper 4-cyl. Fast bremsecaliper Fast bremsecaliper Udskiftningsscaliper Flydende bremsecaliper Pakningssæt Pakningssæt Flydende bremsesattelholder-sæt (holder, glidemuffesæt, styrebolte) Monteringssæt (glidemuffesæt, styrebolte) Glidemuffesæt Holdefjeder	  	▲ 03.24dd-xxxx.3 → 03.0350-ddxx.2 → ▲ 03.25dd-xxxx.3 → 03.0450-ddxx.2 → 24.3728-xxxx.2 →	03nnnn 07ddxx 04nnnn 08ddxx 59xxxx	Koblings-mastercylinder (F.eks. 03.2419-: Ø=19,05) Pakningssæt Koblings-slavecylinder ((F.eks. 03.2525-: Ø=25,40) Pakningssæt Koblingskabel

d	y
0	Enkeltkreds enhed
5	Tandemenhed
2 = 6"	
3 = 7"	
4 = 8"	0 = Enkeltkreds enhed
5 = 9"	3 = Enkeltkreds enhed BA
6 = 10"	5 = Enkeltkreds enhed BA
	8 = Enkeltkreds enhed BA
	BA = Bremseassistent
	Z = Bremseenheder til ækanker trækanker

nnnn = De sidste fire cifre svarer til et aritmetiknummer.

dd = Nominelt mål















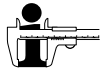

▲ Også 24. mulig ved samme nummersystem.

■ Også 03., 24. og 83. mulig ved samme nummersystem.

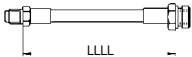
Eftertryk, også i uddrag, er kun tilladt efter vores godkendelse. Erstatningskrav som følge af angivelser i dette katalog godkendes ikke. Forbehold for konstruktionsændringer. Så vidt vi refererer til køretøjproducentens reservedelsnummer i vores bilag, bør disse kun anvendes til sammenligningsformål. En anvendelse af sådanne angivelser på fakturaer til ejeren af køretøjet er ikke tilladt.

Køretøjproducenterne har mange modeller og reservedele. Derfor er en nøjagtig angivelse ikke altid mulig. Vær derfor specielt opmærksom på de angivne bemærkninger og reservedelsbeskrivelser i kataloget.

Produktinformationer

		KORTNUMMER				KORTNUMMER																			
	03.6199-xxxx.4 → 03.61dy-xxxx.4 → 03.67dy-xxxx.4 → 03.68dy-xxxx.4 → 03.69dy-xxxx.4 → 03.77dy-xxxx.4 → 03.78dy-xxxx.4 → 03.78dy-xxxx.4 → 03.78dy-xxxx.4 → 03.78dy-xxxx.4 → 03.78dy-xxxx.4 → 03.78dy-xxxx.4 →	30nnnn 30nnnn 30nnnn 30nnnn 30nnnn 30nnnn 30nnnn 30nnnn 30nnnn 30nnnn 30nnnn 30nnnn	Bromskraftförstärkare T50 T51 T52/3 T52 T53 T52/4 T52/4 T52/4Z T52/5 T52/5Z T55/1 T55/1Z	  	▲ 03.27dd-xxxx.3 → ▲ 03.32dd-xxxx.3 → 03.040x-xxdd.2 → 03.0470-xxdd.2 → 24.3727-xxxx.2 →	02nnnn 02nnnn 06nnnn 06nnnn 58xxxx	Ensidigt verkande hjulcylander Hjulcylander Reparationssats (med kolv) Tätningssats (utan kolv) Handbromslina																		
			<table border="1"> <tr> <td>d</td> <td>y</td> </tr> <tr> <td></td> <td>0 = enkel apparat</td> </tr> <tr> <td></td> <td>5 = tandemapparat</td> </tr> <tr> <td>2 = 6"</td> <td>0 = enkel apparat</td> </tr> <tr> <td>3 = 7"</td> <td>3 = enkel apparat BA</td> </tr> <tr> <td>4 = 8"</td> <td>5 = enkel apparat</td> </tr> <tr> <td>5 = 9"</td> <td>8 = enkel apparat BA</td> </tr> <tr> <td>6 = 10"</td> <td>BA = bromsassistent</td> </tr> <tr> <td></td> <td>Z = bromsapparater med</td> </tr> </table>	d	y		0 = enkel apparat		5 = tandemapparat	2 = 6"	0 = enkel apparat	3 = 7"	3 = enkel apparat BA	4 = 8"	5 = enkel apparat	5 = 9"	8 = enkel apparat BA	6 = 10"	BA = bromsassistent		Z = bromsapparater med		■ 83.1xxx-xxxx.3 → ■ 83.5yxx-LLLL.3 → ■ 83.6yxx-LLLL.3 → ■ 83.7yxx-LLLL.3 →	33nnnn 33nnnn 33nnnn 33nnnn	Bromssläng + rörledning Broms-/kopplingsläng Broms-/kopplingsläng Broms-/kopplingsläng
d	y																								
	0 = enkel apparat																								
	5 = tandemapparat																								
2 = 6"	0 = enkel apparat																								
3 = 7"	3 = enkel apparat BA																								
4 = 8"	5 = enkel apparat																								
5 = 9"	8 = enkel apparat BA																								
6 = 10"	BA = bromsassistent																								
	Z = bromsapparater med																								
	▲ 03.20dd-xxxx.3 → ▲ 03.21dd-xxxx.3 → ▲ 03.23dd-xxxx.3 → ▲ 03.31dd-xxxx.3 → 03.0370-xxdd.2 →	01nnnn 01nnnn 01nnnn 01nnnn 05xxdd	Tandemhuvudcylander stegad Tandemhuvudcylander Steghuvudcylander Huvudcylander (t. ex. 03.2122-: Ø=22,20) Reparationssats	 			y = 1: gänga 1× inner/1× ytter y = 2: gänga 2× inner y = 3: gänga 2× ytter																		
	03.3508-xxxx.x → 03.3509-xxxx.x → 03.3558-xxxx.x → 03.0101-xxxx.2 →	31nnnn 31nnnn 31nnnn 39nnnn	Utjämningsbehållare Utjämningsbehållare Utjämningsbehållare Reparationssats			03.60xx-xxxx.3 → 03.65xx-xxxx.3 → 03.0101-xxxx.2 →	32nnnn 32nnnn 32nnnn	Bromskraftregulator (BR) Bromskraftbegränsare (BG) Inskruvningsregulator (BRE) Bromskraftregulator lastavhängig (BRL) Inskruvningsregulatorsats (BRES)																	
						35/3 braun (4)	märkning, färgmarkering (antal anslutningar)																		
	▲ 11.3ddx-xxxx.2 → 11.9ddx-xxxx.2 → ▲ 13.2ddx-xxxx.2 → ▲ 13.4ddx-xxxx.2 → 13.9ddx-xxxx.2 → 24.3ddx-xxxx.5 → 11.0441-ddxx.2 → 13.0441-ddxx.2 → 11.0230-xxxx.2 → 24.0101-xxxx.2 → ▲ 11.0101-xxxx.2 → 11.8116-xxxx.1 →	22nnnn 22nnnn 21nnnn 21nnnn 21nnnn 24nnnn 25nnnn 25nnnn 26nnnn 26nnnn 26nnnn 39nnnn	Flytande bromsok Flytande bromsok Fast bromsok 4-cyl. fast bromsok Fast bromsok Utbytessadel flytande bromsok Tätningssats Tätningssats Fäste flytande bromsok (fäste, sats skjuthylsor, styrbult) Inbyggnadssats (sats skjuthylsor, styrbult) Sats skjuthylsor Klämfjäder	  	▲ 03.24dd-xxxx.3 → 03.0350-ddxx.2 → ▲ 03.25dd-xxxx.3 → 03.0450-ddxx.2 → 24.3728-xxxx.2 →	03nnnn 07ddxx 04nnnn 08ddxx 59xxxx	Kopplingshuvudcylander (t. ex. 03.2419-: Ø=19,05) Tätningssats Kopplingslavcylander (t. ex. 03.2525-: Ø=25,40) Tätningssats Kopplingslina																		

nnnn = De sista fyra siffrorna motsvarar ett räknenummer.

dd = nominellt mått





▲ Även 24. möjlig vid samma nummertilldelningssystem.

■ Även 03., 24. och 83. möjlig vid samma nummertilldelningssystem.

Eftertryck – även delvis – är förbjudet utan vårt medgivande. Ersättningsanspråk pga uppgifterna i denna katalog godkänns ej. Konstruktionsändringar förbehålles. När vi hänvisar till fordonstillverkarens reservdelsnummer i våra underlag, så är det bara för jämförelsens skull. Dyliga uppgifter får inte anges på fakturor till fordonets ägare.

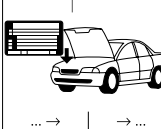
Fordonstillverkarna har många modeller och reservdelar. Därför är en exakt tillämpning inte alltid möjlig. Beakta därför de i katalogen anförda kommentarerna och reservdelsbeskrivningarna.

Como utilizar o K24-H

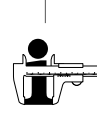
Grupos de Produto	Marca e Modelo	período de montagem (de/até)		Referência ATE	Info adicional peça			
Eixo dianteiro-/traseiro	Número de chassis (de/até)	Info adicional Veículo		Referência curta ATE	Especificações Técnicas			
	kW							
AUDI A4 CABRIO (02-)								
								
1,8 T 1,8 T Quattro 2,0 2,0 TFSI	◀ 120 ◀ 120 ◀ 96 ◀ 120	8E-55-99999 04.02 05.03 05.04	08.06 08.06 08.06	PR: 1LB,1LE PR: 1LB,1LE PR: 1LB,1LE PR: 1LB,1LE	11.3571-8522.2 11.3571-8521.2 11.0441-5704.2 11.0101-5409.2	220320 220319 250034 260035	<input type="checkbox"/> + ESP <input type="checkbox"/> + ESP	D=57, - Halter ATE D=57, - Halter ATE Dichtungssatz ATE Hülsensatz ATE
*	**			***	****			

*Grupos de Produto

	Servofreio		Cabo do travão de mão
	Bomba Central de Travões		Regulador de Travagem
	Depósito		Bomba Central de Embraiagem
	Pinça de travão		Bomba Auxiliar de Embraiagem
	Tubo de Travão		Mangueira da embraiagem
	Cilindro de Roda		Cabo de Embraiagem

**Direção

- ◀ Volante à esquerda
- ▶ Volante à direita

****Fabricante

ADV	Advics
ATE	Continental Teves (ATE)
AKE	Akebono
AIS	Aisin
AP	AP Lockheed
BDX	Bendix
BOS	Bosch
BRE	Brembo
CIT	Citroën
DEL	Delco
FI	Fiat
FTE	FTE Automotive
MAN	Mando
NIS	Nissin
PER	Perrot
SUM	Sumitomo
TOK	Tokico
TRW	Lucas (LUC)
VW	Volkswagen

***Posição de Montagem















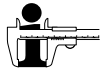

- à frente
- atrás
- esquerda
- direita
- esquerda à frente
- esquerda atrás
- direita à frente
- direita atrás
- centro
- em cima
- em baixo
- eixo dianteiro
- eixo dianteiro do lado esquerdo
- eixo dianteiro do lado direito
- eixo traseiro
- eixo traseiro esquerdo
- eixo traseiro direito

Todas as indicações de posição referem-se ao lado de condução.

Abreviaturas

-	Salvo / sem		embraiagem	THz	Bomba central de travões tandem	Carrinha
+	Com / apenas / para	HEB	Alavanca	V	Ventilado	Coupé
AUT	Regulação automática	HZ	Bomba central de travões	WE	Dispositivo de Aviso	Cabrio
B	Revestido	L	Liga de Carbono	WK	Avisador de Desgaste	Autocarro
BG	Limitador de travagem	Nz	Bomba auxiliar de embraiagem	Zub	Acessórios	Furgão
BR	Regulador de travagem					Hatchback
BRE	Regulador de parafuso	PD	PowerDisc			Pick-Up/Chassis
BRES	Jogo de reguladores de parafuso	Rz	Cilindro de roda			Série
BRL	Regulador de travagem dependente da carga	RzR	Cilindro de roda com regulador incorporado			DKW Meisterklasse/Sonderklasse/Universal (classe mestre/classe especial/universal)
D =	Diâmetro	S	Parafuso de fixação / parafuso da maxila			FAUN Veículo tractor (Kraka)
Gz	Bomba central de					Furgoneta

Informações sobre artigos

		REF. CURTA				REF. CURTA																			
	03.6199-xxxx.4 → 03.61dy-xxxx.4 → 03.67dy-xxxx.4 → 03.68dy-xxxx.4 → 03.69dy-xxxx.4 → 03.77dy-xxxx.4 →	30nnnn 30nnnn 30nnnn 30nnnn 30nnnn 30nnnn	Servofreio T50 T51 T52/3 T52 T53 T52/4		▲ 03.27dd-xxxx.3 → ▲ 03.32dd-xxxx.3 → 03.040x-xxdd.2 → 03.0470-xxdd.2 →	02nnnn 02nnnn 06nnnn 06nnnn	Cilindro de Roda de 1 pistón Cilindro da Roda Kit de Reparação (com pistons) Jogo de Juntas (sem pistons)																		
	03.78dy-xxxx.4 → 03.78dy-xxxx.4 → 03.78dy-xxxx.4 → 03.78dy-xxxx.4 → 03.78dy-xxxx.4 → 03.78dy-xxxx.4 →	30nnnn 30nnnn 30nnnn 30nnnn 30nnnn 30nnnn	T52/4 T52/4Z T52/5 T52/5Z T55/1 T55/1Z	 	24.3727-xxxx.2 →	58xxxx	Cabo do Travão de Mão																		
			<table border="1"> <tr> <td>d</td> <td>y</td> </tr> <tr> <td>0 = aparelho simples</td> <td>0 = aparelho simples</td> </tr> <tr> <td>5 = aparelho Tandem</td> <td>3 = aparelho simples BA</td> </tr> <tr> <td></td> <td>5 = aparelho simples</td> </tr> <tr> <td>2 = 6"</td> <td>8 = aparelho simples BA</td> </tr> <tr> <td>3 = 7"</td> <td>BA = assistente de travagem</td> </tr> <tr> <td>4 = 8"</td> <td>Z = aparelhos de</td> </tr> <tr> <td>5 = 9"</td> <td>travagem com tirante</td> </tr> <tr> <td>6 = 10"</td> <td>de ancoragem</td> </tr> </table>	d	y	0 = aparelho simples	0 = aparelho simples	5 = aparelho Tandem	3 = aparelho simples BA		5 = aparelho simples	2 = 6"	8 = aparelho simples BA	3 = 7"	BA = assistente de travagem	4 = 8"	Z = aparelhos de	5 = 9"	travagem com tirante	6 = 10"	de ancoragem		■ 83.1xxx-xxxx.3 → ■ 83.5yxx-LLLL.3 → ■ 83.6yxx-LLLL.3 → ■ 83.7yxx-LLLL.3 →	33nnnn 33nnnn 33nnnn 33nnnn	Mangueira de travão + tubagem Tubo de Travão / Embraiagem Tubo de Travão / Embraiagem Tubo de Travão / Embraiagem
d	y																								
0 = aparelho simples	0 = aparelho simples																								
5 = aparelho Tandem	3 = aparelho simples BA																								
	5 = aparelho simples																								
2 = 6"	8 = aparelho simples BA																								
3 = 7"	BA = assistente de travagem																								
4 = 8"	Z = aparelhos de																								
5 = 9"	travagem com tirante																								
6 = 10"	de ancoragem																								
	▲ 03.20dd-xxxx.3 → ▲ 03.21dd-xxxx.3 → ▲ 03.23dd-xxxx.3 → ▲ 03.31dd-xxxx.3 → 03.0370-xxdd.2 →	01nnnn 01nnnn 01nnnn 01nnnn 05xxdd	Bomba Central de Travões Tandem Escalonada Bomba Central de Travões Tandem Bomba Central de Travões Escalonada Bomba Central de Travões (por ex. 03.2122-: Ø=22,20) Kit de Reparação	 	LLLL	y = 1: Roscas 1× interior/1× externa y = 2: Roscas 2× interior y = 3: Roscas 2× exterior																			
	03.3508-xxxx.x → 03.3509-xxxx.x → 03.3558-xxxx.x → 03.0101-xxxx.2 →	31nnnn 31nnnn 31nnnn 39nnnn	Depósito Depósito Depósito Kit de Reparação		03.60xx-xxxx.3 → 03.65xx-xxxx.3 → 03.0101-xxxx.2 → 35/3 castanho (4)	32nnnn 32nnnn 32nnnn	Regulador de travagem (BR) Limitador de travagem (BG) Regulador de parafuso (BRE) Regulador de travagem dependente da carga (BRL) Jogo reguladores de parafuso (BRES) Característica / marca de cor (no. de ligações)																		
	▲ 11.3ddx-xxxx.2 → 11.9ddx-xxxx.2 → ▲ 13.2ddx-xxxx.2 → ▲ 13.4ddx-xxxx.2 → 13.9ddx-xxxx.2 → 24.3ddx-xxxx.5 → 11.0441-ddxx.2 → 13.0441-ddxx.2 → 11.0230-xxxx.2 → 24.0101-xxxx.2 → ▲ 11.0101-xxxx.2 → 11.8116-xxxx.1 →	22nnnn 22nnnn 21nnnn 21nnnn 21nnnn 24nnnn 25nnnn 25nnnn 26nnnn 26nnnn 26nnnn 39nnnn	Pinça de Travão Pinça de Travão Pinça de Travão Fixa c/ 2 pistons Pinça de Travão Fixa c/ 4 pistón Pinça de Travão Fixa Pinça de Travão Recondicionada Jogo de juntas Jogo de juntas Jogo Suporte da Pinça de Travão (suporte, jogo de guias, perno guia) Kit de Montagem (jogo de guias, perno guia) Jogo de Guias Mola de Retenção	  	▲ 03.24dd-xxxx.3 → 03.0350-ddxx.2 → ▲ 03.25dd-xxxx.3 → 03.0450-ddxx.2 → 24.3728-xxxx.2 →	03nnnn 07ddxx 04nnnn 08ddxx 59xxxx	Bomba Central de Embraiagem (por ex. 03.2419-: Ø=19,05) Jogo de juntas Bomba auxiliar de embraiagem (por ex. 03.2525-: Ø=25,40) Jogo de juntas Cabo da embraiagem																		

nnnn = Os quatro últimos dígitos são números sequenciais

dd = Medida nominal

▲ o prefixo desta famílias de produto pode também ser 24.

■ o prefixo desta famílias de produto pode também ser 03., 24. ou 83.

Cópias integrais ou parciais deste catálogo estão interditas salvo autorização prévia. Reclamações motivadas por informação constante neste catálogo não serão aceites. Reservamo-nos ao direito de proceder a alterações de construção ou desenho sem aviso prévio. Quando indicamos a referência de origem, tal destina-se apenas para efeito de comparação. Não é permitido utilizar essa informação nas facturas emitadas ao proprietário do veículo.

A diversidade de modelos de viaturas e de peças de substituição nem sempre permite uma conversão exacta. Por esta razão agradecemos que leia atentamente as correspondentes notas e descrições indicadas neste catálogo.

Как пользоваться каталогом K24-N

Группы продукции Тип автомобиля период монтажа (от/до) Номер артикула ATE Ссылка (артикул)

Передний мост/ задний мост	Тип автомобиля	период монтажа (от/до)	Номер артикула ATE	Ссылка (артикул)	Короткий номер	Ссылка (артикул)			
AUDI A4 CABRIO (02-)									
	1,8 T 1,8 T Quattro 2,0 2,0 TFSI	120 120 96 120	8E-55-99999 04.02 05.03 08.06 05.04 08.06 08.06	PR: 1LB,1LE PR: 1LB,1LE PR: 1LB,1LE PR: 1LB,1LE	11.3571-8522.2 11.3571-8521.2 11.0441-5704.2 11.0101-5409.2	220320 220319 250034 260035	<input type="checkbox"/> + ESP <input type="checkbox"/> + ESP	D=57, - Halter D=57, - Halter Dichtungssatz Hülsensatz	ATE ATE ATE ATE

*

**

*Группы продукции



Усилитель тормозного привода



Трос ручного тормоза



Главный тормозной цилиндр



Регулятор тормозного усилия



Компенсационный бачок



Главный цилиндр привода сцепления



Тормозной суппорт (скоба)



Рабочий цилиндр привода выключения сцепления



Тормозной шланг



Тормозной шланг



Колесный тормозной цилиндр



Трос сцепления

**Вид рулевого управления

◀ Автомобиль с левым рулем

▶ Автомобиль с правым рулем

****Производитель

ADV	Advics
ATE	Continental Teves (ATE)
AKE	Akebono
AIS	Aisin
AP	AP Lockheed
BDX	Bendix
BOS	Bosch
BRE	Brembo
CIT	Citroën
DEL	Delco
FI	Fiat
FTE	FTE Automotive
MAN	Mando
NIS	Nissin
PER	Perrot
SUM	Sumitomo
TOK	Tokico
TRW	Lucas (LUC)
VW	Volkswagen

***Место установки

спереди

сзади

слева

справа

слева спереди

слева снизу

справа спереди

справа внизу

в середине

сверху

снизу

передняя ось

передняя ось слева

передняя ось справа

задняя ось

задняя ось слева

задняя ось справа

Все данные расположения всегда относятся к направлению движения















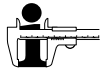



Сокращения

-	без/не	D =	диаметр	S	винт фиксирующий / болтом суппорта	5-дверный
+	с/только/для	Gz	Цилиндр датчик	THz	Двуполостной главный тормозной цилиндр	седан
AUT	автоматической регулировкой	HEB	рычагом	V	вентилируемый	универсал
B	покрытое	HZ	Главный цилиндр	WE	Сигнальное устройство	купе
BG	Ограничитель тормозных сил	L	легированный / высокоуглеродистый	WK	сигнальным контактом	кабриолет
BR	Регулятор тормозного сил	L	легированный / высокоуглеродистый	Zub	принадлежностями	автобус
BRE	Вкручивающийся регулятор	L =	Длина			фургон
BRES	Набор вкручивающихся регуляторов	Nz	Принимающий цилиндр			хетчбэк
BRL	Регулятор тормозных сил, зависимый от нагрузки	PD	PowerDisc			платформа/шасси
		Rz	Колесный тормозной цилиндр			серия
		RzR	Колесный тормозной цилиндр со встроенным регулятором			DKW мастер класс/ специальный/ универсальный
						FAUN электрокар (Kraka)
						грузовой автомобиль

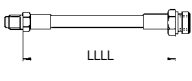
RU



Информация об изделиях

		КОРОТКИЙ НОМЕР				КОРОТКИЙ НОМЕР																	
	03.6199-xxxx.4 → 03.61dy-xxxx.4 → 03.67dy-xxxx.4 → 03.68dy-xxxx.4 → 03.69dy-xxxx.4 → 03.77dy-xxxx.4 →	30nnnn 30nnnn 30nnnn 30nnnn 30nnnn 30nnnn	Усилитель тормозного привода T50 T51 T52/3 T52 T53 T52/4		▲ 03.27dd-xxxx.3 → ▲ 03.32dd-xxxx.3 → 03.040x-xxdd.2 → 03.0470-xxdd.2 →	02nnnn 02nnnn 06nnnn 06nnnn	Односторонне работающий колесный тормозной цилиндр Колесный тормозной цилиндр Ремонтный комплект (с поршнем) Комплект прокладок (без поршня)																
	03.78dy-xxxx.4 → 03.78dy-xxxx.4 → 03.78dy-xxxx.4 → 03.78dy-xxxx.4 → 03.78dy-xxxx.4 → 03.78dy-xxxx.4 →	30nnnn 30nnnn 30nnnn 30nnnn 30nnnn 30nnnn	T52/4 T52/4Z T52/5 T52/5Z T55/1 T55/1Z	 	24.3727-xxxx.2 →	58xxxx	Трос ручного тормоза																
			<table border="1"> <thead> <tr> <th>d</th> <th>y</th> </tr> </thead> <tbody> <tr> <td>0 = 6"</td> <td>0 = Однополостное устройство</td> </tr> <tr> <td>3 = 7"</td> <td>5 = Двухполостное устройство</td> </tr> <tr> <td>4 = 8"</td> <td>0 = Однополостное устройство</td> </tr> <tr> <td>5 = 9"</td> <td>3 = Однополостное устройство BA</td> </tr> <tr> <td>6 = 10"</td> <td>5 = Однополостное устройство</td> </tr> <tr> <td></td> <td>8 = Однополостное устройство BA</td> </tr> <tr> <td></td> <td>BA = устройство „ассистент при торможении“</td> </tr> </tbody> </table>	d	y	0 = 6"	0 = Однополостное устройство	3 = 7"	5 = Двухполостное устройство	4 = 8"	0 = Однополостное устройство	5 = 9"	3 = Однополостное устройство BA	6 = 10"	5 = Однополостное устройство		8 = Однополостное устройство BA		BA = устройство „ассистент при торможении“		■ 83.1xxx-xxxx.3 → ■ 83.5yxx-LLLL.3 → ■ 83.6yxx-LLLL.3 → ■ 83.7yxx-LLLL.3 →	33nnnn 33nnnn 33nnnn 33nnnn	тормозной шланг + трубопровод Шланг тормоза/сцепления Шланг тормоза/сцепления Шланг тормоза/сцепления
d	y																						
0 = 6"	0 = Однополостное устройство																						
3 = 7"	5 = Двухполостное устройство																						
4 = 8"	0 = Однополостное устройство																						
5 = 9"	3 = Однополостное устройство BA																						
6 = 10"	5 = Однополостное устройство																						
	8 = Однополостное устройство BA																						
	BA = устройство „ассистент при торможении“																						
	▲ 03.20dd-xxxx.3 → ▲ 03.21dd-xxxx.3 → ▲ 03.23dd-xxxx.3 → ▲ 03.31dd-xxxx.3 → 03.0370-xxdd.2 →	01nnnn 01nnnn 01nnnn 01nnnn 05xxdd	ступенчатый Двухполостной вный тормозной цилиндр Двухполостной главный тормозной цилиндр Ступенчатый главный тормозной цилиндр Главный тормозной цилиндр (напр., 03.2122-: Ø=22,20) Ремкомплект	 	 LLLL		y = 1: резьба 1× внутр/1× наружн y = 2: резьба 2× внутр y = 3: резьба 2× наружн																
	03.3508-xxxx.x → 03.3509-xxxx.x → 03.3558-xxxx.x → 03.0101-xxxx.2 →	31nnnn 31nnnn 31nnnn 39nnnn	Компенсационный бачок Компенсационный бачок Компенсационный бачок Ремкомплект		03.60xx-xxxx.3 → 03.65xx-xxxx.3 → 03.0101-xxxx.2 →	32nnnn 32nnnn 32nnnn	Регулятор тормозных сил (BR) Ограничитель тормозных сил (BG) тормозных сил регулятор (BRE) Регулятор тормозных сил в зависимости от загрузки автомобиля (BRL) Комплект вкручиваемого регулятора (BRES)																
					35/3 brown (4)		Обозначение, цветная маркировка (количество подсоединений)																
					▲ 03.24dd-xxxx.3 → 03.0350-ddxx.2 →	03nnnn 07ddxx	Главный цилиндр привода сцепления (напр., 03.2419-: Ø=19,05) Комплект прокладок																
	▲ 11.3ddx-xxxx.2 → 11.9ddx-xxxx.2 → ▲ 13.2ddx-xxxx.2 → ▲ 13.4ddx-xxxx.2 → 13.9ddx-xxxx.2 → 24.3ddx-xxxx.5 → 11.0441-ddxx.2 → 13.0441-ddxx.2 → 11.0230-xxxx.2 → 24.0101-xxxx.2 → ▲ 11.0101-xxxx.2 → 11.8116-xxxx.1 →	22nnnn 22nnnn 21nnnn 21nnnn 21nnnn 24nnnn 25nnnn 25nnnn 26nnnn 26nnnn 26nnnn 39nnnn	Плавающая скоба (суппорт) Плавающая скоба (суппорт) 2-цил. фиксированный суппорт 4-цил. фиксированный суппорт Фиксированная скоба Восстановленный суппорт, плавающий суппорт Комплект прокладок Комплект прокладок Комплект крепежа для плавающего суппорта (держатель, комплект подвижных втулок, направляющие болты) Монтажный комплект (комплект подвижных втулок, направляющие болты) Комплект подвижных втулок Прижимная пружина	 	▲ 03.25dd-xxxx.3 → 03.0450-ddxx.2 →	04nnnn 08ddxx	Рабочий цилиндр привода сцепления (напр., 03.2525-: Ø=25,40) Комплект прокладок																
					24.3728-xxxx.2 →	59xxxx	Трос сцепления																

nnnn = последние четыре цифры соответствуют номеру по порядку

dd = номинальный размер









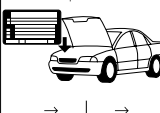

▲ При такой же системе нумерации возможен также и номер 24.

■ ри такой же системе нумерации возможны также и номера 03, 24 и 83

Воспроизведение данного издания, в том числе частичное, допускается только с нашего разрешения. Претензии на возмещение ущерба на основании приводимых в данном каталоге сведений не признаются. Сохраняем за собой право на изменение конструкции. Если в нашей документации содержится ссылка на номера запасных частей какого-либо производителя автомобилей, то это служит только для сравнения. Использование такого рода сведений в счетах, адресованных производителям автомобилей, не допускается.

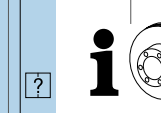
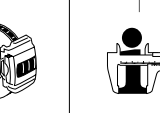
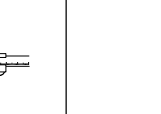
Вследствие того, что некоторые производители автомобилей предлагают широкий спектр моделей и запасных частей, их не всегда можно точно сочетать. Просим Вас в связи с этим обращать особое внимание на примечания и описания заменяемых деталей, содержащиеся в данном каталоге.

Jak používat K24-H

Skupiny produktů	Typ vozidla	Doba vestavby (od/do)	Katalogové číslo ATE	Upozornění (díl)					
Přední/zadní náprava	Číslo podvozku	Upozornění (vozidlo)	Zkratkové číslo	Definice					
	kW								
									
									
AUDI A4 CABRIO (02-)									
	1,8 T 1,8 T Quattro 2,0 2,0 TFSI	◀ 120 ◀ 120 ▲ 96 ▲ 120	8E-55-999999 04.02 05.03 05.04	PR: 1LB,1LE PR: 1LB,1LE PR: 1LB,1LE PR: 1LB,1LE	11.3571-8522.2 11.3571-8521.2 11.0441-5704.2 11.0101-5409.2	220320 220319 250034 260035	 + ESP  + ESP	D=57, - Halter D=57, - Halter Dichtungssatz Hülsensatz	ATE ATE ATE ATE
*	**			***	****				

*Skupiny výrobků

	Posilovač brzdného účinku		Lano ruční brzdny
	Hlavní brzdový válec		Regulátor brzdné síly
	Vyrovňovací nádržka		Válec vysílače spojky
	Třmen kotoučové brzdny		Válec snímače spojky
	Hadice brzdny		Hadice spojky
	Kolový váleček		Lano spojky

**Druh řízení

- ◀ Volant vlevo
- ▶ Volant vpravo

****Označení výrobce

ADV	Advics
ATE	Continental Teves (ATE)
AKE	Akebono
AIS	Aisin
AP	AP Lockheed
BDX	Bendix
BOS	Bosch
BRE	Brembo
CIT	Citroën
DEL	Delco
FI	Fiat
FTE	FTE Automotive
MAN	Mando
NIS	Nissin
PER	Perrot
SUM	Sumitomo
TOK	Tokico
TRW	Lucas (LUC)
VW	Volkswagen

***Montážní poloha





















-  vpředu
-  vzadu
-  vlevo
-  vpravo
-  vlevo nahoře
-  vlevo dole
-  vpravo nahoře
-  vpravo dole
-  uprostřed
-  nahoře
-  dole
-  nahoře
-  vlevo nahoře
-  vpravo nahoře
-  dole
-  vlevo dole
-  vpravo dole

Veškeré údaje o pozicích jsou vždy vztaženy na směr jízdy.

Zkratky

-	Bez / ne	HEB	Pákou	V	Větráný	Kombi
+	S / jen / pro	Hz	Hlavní válec	WE	Výstražné zařízení	Kupé
AUT	Automatickým seřizováním	L	Legovaný/vysoce nauhličený	WK	Výstražným kontaktem	Kabriolet
B	Opatřený povlakem	L =	Délka	Žub	Příslušenstvím	Autobus
BG	Omezovač brzdné síly	Nz	Válec snímače			Skříňová dodávka
BR	Regulátor brzdné síly	PD	PowerDisc			Splyňavá záď
BRE	Regulátor k zašroubování	Rz	Kolový váleček			Pick-up/podvozek
BRES	Sada regulátorů k zašroubování	RzR	Kolový váleček s integrovaným regulátorem			Série
BRL	regulátor brzdné síly závislý na zátěži	S	Upevňovací šroub / šroubem třmenu			DKW mistrovská třída/speciální třída/univerzální třída
D =	Průměr	THz	Tandemový hlavní válec			FAUN čtyřkolka (Kraka)
Gz	Válec vysílače			Brzdová hadice + potrubí		Dodávkový automobil
				2dvěřový		
				3dvěřový		
				4dvěřový		
				5dvěřový		
				Sedan		

Informace o výrobku

		ZKRATKOVÉ ČÍSLO				ZKRATKOVÉ ČÍSLO	
	03.6199-xxxx.4 → 03.61dy-xxxx.4 → 03.67dy-xxxx.4 → 03.68dy-xxxx.4 → 03.69dy-xxxx.4 → 03.77dy-xxxx.4 → 03.78dy-xxxx.4 → 03.78dy-xxxx.4 → 03.78dy-xxxx.4 → 03.78dy-xxxx.4 → 03.78dy-xxxx.4 → 03.78dy-xxxx.4 →	30nnnn 30nnnn 30nnnn 30nnnn 30nnnn 30nnnn 30nnnn 30nnnn 30nnnn 30nnnn 30nnnn 30nnnn	Posilovač brzdného účinku T50 T51 T52/3 T52 T53 T52/4 T52/4 T52/4Z T52/5 T52/5Z T55/1 T55/1Z	   	 ▲ 03.27dd-xxxx.3 → ▲ 03.32dd-xxxx.3 → 03.040x-xxdd.2 → 03.0470-xxdd.2 → 24.3727-xxxx.2 → 83.1xxx-xxxx.3 → 83.5yxx-LLLL.3 → 83.6yxx-LLLL.3 → 83.7yxx-LLLL.3 →	02nnnn 02nnnn 06nnnn 06nnnn 58xxxx 33nnnn 33nnnn 33nnnn 33nnnn	jednostranně působící kolový váleček Kolový váleček Sada dílů pro opravu (s pístem) Sada těsnění (bez pístu) Lano ruční brzdy brzdová hadice + potrubí Brzdová / spojková hadice Brzdová / spojková hadice Brzdová / spojková hadice
	▲ 03.20dd-xxxx.3 → ▲ 03.21dd-xxxx.3 → ▲ 03.23dd-xxxx.3 → ▲ 03.31dd-xxxx.3 → 03.0370-xxdd.2 →	01nnnn 01nnnn 01nnnn 01nnnn 05xxdd	Tandemový hlavní válec stupňový Tandemový hlavní válec Stupňový hlavní válec Hlavní válec (nap. 03.2122-: Ø=22,20) Sada dílů pro opravu	 	 LLLL 03.60xx-xxxx.3 → 03.65xx-xxxx.3 → 03.0101-xxxx.2 → 35/3 brown (4) ▲ 03.24dd-xxxx.3 → 03.0350-ddxx.2 →	32nnnn 32nnnn 32nnnn 32nnnn 03nnnn 07ddxx	y = 1: závit 1 × vnitřní/1 × vnější y = 2: závit 2 × vnitřní y = 3: závit 2 × vnější Regulator brzdné síly (BR) Omezovač brzdné síly (BG) Regulator k zašroubování (BRE) Regulator brzdné síly závislý na zatížení (BRL) Sada regulátorů k zašroubování (BRES) Značka, barevné značení (počet přípojů) Válec vysilače spojky (nap. 03.2419-: Ø=19,05) Sada těsnění
	03.3508-xxxx.x → 03.3509-xxxx.x → 03.3558-xxxx.x → 03.0101-xxxx.2 →	31nnnn 31nnnn 31nnnn 39nnnn	Vyrovnávací nádržka Vyrovnávací nádržka Vyrovnávací nádržka Sada dílů pro opravu				
	▲ 11.3ddx-xxxx.2 → 11.9ddx-xxxx.2 → ▲ 13.2ddx-xxxx.2 → ▲ 13.4ddx-xxxx.2 → 13.9ddx-xxxx.2 → 24.3ddx-xxxx.5 → 11.0441-ddxx.2 → 13.0441-ddxx.2 → 11.0230-xxxx.2 → 24.0101-xxxx.2 → ▲ 11.0101-xxxx.2 → 11.8116-xxxx.1 →	22nnnn 22nnnn 21nnnn 21nnnn 21nnnn 24nnnn 25nnnn 25nnnn 26nnnn 26nnnn 26nnnn 39nnnn	Plovoucí třmen Plovoucí třmen 2válc. pevný třmen 4válc. pevný třmen Pevný třmen Výměnný třmen plovoucí třmen Sada těsnění Sada těsnění Sada držáků plovoucího třmenu (držák, sada posuvných pouzder, vodící čep) Montážní sada (sada posuvných pouzder, vodící čep) Sada posuvných pouzder Přidrzná pružina	  	▲ 03.25dd-xxxx.3 → 03.0450-ddxx.2 → 24.3728-xxxx.2 →	04nnnn 08ddxx 59xxxx	Válec snímače spojky (nap. 03.2525-: Ø=25,40) Sada těsnění Spojková hadice

nnnn = Poslední čtyři čísla odpovídají počtu

dd = jmenovitý rozměr









▲ Rovněž 24. při stejné systematice pojmenování možné

■ Rovněž 03., 24. a 83 při stejné systematice pojmenování možné

Rozmnožování, i jen jednotlivých částí, je dovoleno jen s naším souhlasem. Nároky na náhradu na základě údajů v tomto katalogu nemohou být uznávány. Změny konstrukce vyhrazeny. Pokud se v našich podkladech odvoláváme na číslo náhradního dílu výrobce vozidla, slouží to jen pro účely porovnání. Používání takovýchto údajů ve fakturách vystavovaných majitelům vozidel není přípustné.

Rozmanitost modelů a náhradních dílů některých výrobců vozidel nedovoluje vždy přesné přiřazení. Věnujte proto prosím zvláštní pozornost poznámkám a popisům náhradních dílů uvedeným v katalogu.

Tak należy korzystać z K24-H

Grupy produktów	Typ pojazdu	Czas montażu (od/do)		Numer artykułu ATE		Uwaga (artykuł)			
Oś tylna / przednia	Numer podwozia	Uwaga (pojazd)		Numer skrócony		Definicja			
	kW								
AUDI A4 CABRIO (02-)									
	1,8 T 1,8 T Quattro 2,0 2,0 TFSI	◀ 120 ◀ 120 ◀ 96 ◀ 120	8E-55-99999 04.02 05.03 08.06 05.04 08.06 08.06	PR: 1LB,1LE PR: 1LB,1LE PR: 1LB,1LE PR: 1LB,1LE	11.3571-8522.2 11.3571-8521.2 11.0441-5704.2 11.0101-5409.2	220320 220319 250034 260035	 + ESP  + ESP	D=57, - Halter D=57, - Halter Dichtungssatz Hülsensatz	ATE ATE ATE ATE
*		**				***	****		

*Grupy produktów



Wspomaganie hamulca



Linka hamulca ręcznego



Pompa hamulcowa



Regulator siły hamowania



Zbiornik wyrównawczy



Pompa sprzęgła



Zacisk hamulca



Siłownik wysprzęglający



Przewód hamulcowy giętki



Przewód sprzęgła giętki



Cylinder hamulcowy koła



Linka sprzęgła

**Rodzaj układu kierowniczego

















◀ z kierownicą z lewej strony

▶ z kierownicą z prawej strony

****Producent

ADV	Advics
ATE	Continental Teves (ATE)
AKE	Akebono
AIS	Aisin
AP	AP Lockheed
BDX	Bendix
BOS	Bosch
BRE	Brembo
CIT	Citroën
DEL	Delco
FI	Fiat
FTE	FTE Automotive
MAN	Mando
NIS	Nissin
PER	Perrot
SUM	Sumitomo
TOK	Tokico
TRW	Lucas (LUC)
VW	Volkswagen

*** Pozycja montażu















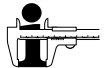



	z przodu
	z tyłu
	z lewej strony
	z prawej strony
	z lewej strony u góry
	z lewej strony na dole
	z prawej strony u góry
	z prawej strony na dole
	po środku
	u góry
	na dole
	Oś przednia
	z lewej strony z przodu
	z prawej strony z przodu
	Oś tylna
	z lewej strony z tyłu
	z prawej strony z tyłu

Poszczególne pozycje zawsze w odniesieniu do kierunku jazdy.

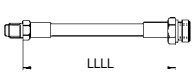
Skróty

-	Bez / nie	Gz	Pompa sprzęgła	S	Śruba łącząca / śrubą zacisku hamulca	Limuzyna
+	Z / tylko / do	HEB	Dźwignią	THz	Pompa hamulcowa typu tandem	Kombi
AUT	Automatyczną regulacją	HZ	Pompa hamulcowa	V	Wentylowane	Coupe
B	Powlekane	L	Stopowe / z dużą zawartością węgla	WE	Urządzenie ostrzegawcze	Cabriolet
BG	Ogranicznik siły hamowania	L =	Długość	WK	Stykem ostrzegawczym	Bus
BR	Regulator siły hamowania	Nz	Siłownik wysprzęglający	Zub	Osprzętem	Van
BRE	Regulator wkręcany	PD	PowerDisc		Przewód hamulcowy + rurociąg Dwudrzwiowy	Hatchback
BRES	Zestaw regulatorów wkręcanych	Rz	Cylinder hamulcowy koła		Trzydrzwiowy	Pickup/podwozie
BRL	Regulator siły hamowania w zależności obciążenia	RzR	Cylinder hamulcowy koła ze zintegrowanym regulatorem		Czterodrzwiowy	Seria
D =	Średnica				Pięciodrzwiowy	DKW klasa master/klasa specjalna/klasa uniwersalna
						FAUN quad
						Transporter

Informacje o artykułach

		NUMER SKRÓCONY				NUMER SKRÓCONY	
	03.6199-xxxx.4 → 03.61dy-xxxx.4 → 03.67dy-xxxx.4 → 03.68dy-xxxx.4 → 03.69dy-xxxx.4 → 03.77dy-xxxx.4 → 03.78dy-xxxx.4 → 03.78dy-xxxx.4 → 03.78dy-xxxx.4 → 03.78dy-xxxx.4 → 03.78dy-xxxx.4 → 03.78dy-xxxx.4 →	30nnnn 30nnnn 30nnnn 30nnnn 30nnnn 30nnnn 30nnnn 30nnnn 30nnnn 30nnnn 30nnnn 30nnnn	wspomaganie hamulca T50 T51 T52/3 T52 T53 T52/4 T52/4 T52/4Z T52/5 T52/5Z T55/1 T55/1Z	  	 ▲ 03.27dd-xxxx.3 → ▲ 03.32dd-xxxx.3 → 03.040x-xxdd.2 → 03.0470-xxdd.2 → 24.3727-xxxx.2 → ■ 83.1xxx-xxxx.3 → ■ 83.5yxx-LLLL.3 → ■ 83.6yxx-LLLL.3 → ■ 83.7yxx-LLLL.3 →	02nnnn 02nnnn 06nnnn 06nnnn 58xxxx 33nnnn 33nnnn 33nnnn 33nnnn	jednostronnie działający cylinder hamulcowy cylinder hamulcowy koła zestaw naprawczy (z tłoczkiem) zestaw uszczelniający (bez tłoczka) linka hamulca ręcznego przewód hamulcowy + rurociąg przewód hamulcowy/sprzęgła giętki przewód hamulcowy/sprzęgła giętki przewód hamulcowy/sprzęgła giętki przewód hamulcowy/sprzęgła giętki
	▲ 03.20dd-xxxx.3 → ▲ 03.21dd-xxxx.3 → ▲ 03.23dd-xxxx.3 → ▲ 03.31dd-xxxx.3 → 03.0370-xxdd.2 →	01nnnn 01nnnn 01nnnn 01nnnn 05xxdd	tandem- wielostopniowa pompa hamulcowa tandem- pompa hamulcowa wielostopniowa pompa hamulcowa pompa hamulcowa (np. 03.2122-: Ø=22,20) zestaw naprawczy	 	 LLLL 03.60xx-xxxx.3 → 03.65xx-xxxx.3 → 03.0101-xxxx.2 →	32nnnn 32nnnn 32nnnn	regulator siły hamowania (BR) ogranicznik siły hamowania (BG) regulator wkręcany (BRE) regulator siły hamowania w zależności od obciążenia (BRL) zestaw regulatorów wkręcanych (BRES)
	03.3508-xxxx.x → 03.3509-xxxx.x → 03.3558-xxxx.x → 03.0101-xxxx.2 →	31nnnn 31nnnn 31nnnn 39nnnn	zbiornik wyrównawczy zbiornik wyrównawczy zbiornik wyrównawczy zestaw naprawczy		35/3 brown (4)		znaki, oznakowanie barwne (liczba przyłączy)
	▲ 11.3ddx-xxxx.2 → 11.9ddx-xxxx.2 → ▲ 13.2ddx-xxxx.2 → ▲ 13.4ddx-xxxx.2 → 13.9ddx-xxxx.2 → 24.3ddx-xxxx.5 → 11.0441-ddxx.2 → 13.0441-ddxx.2 → 11.0230-xxxx.2 → 24.0101-xxxx.2 → ▲ 11.0101-xxxx.2 → 11.8116-xxxx.1 →	22nnnn 22nnnn 21nnnn 21nnnn 21nnnn 24nnnn 25nnnn 25nnnn 26nnnn 26nnnn 26nnnn 39nnnn	zacisk ruchomy zacisk ruchomy zacisk stały z 2 cylinderkami zacisk stały z 4 cylinderkami Zacisk stały zacisk wymienny - ruchomy komplet uszczelniający komplet uszczelniający uchwyt zacisku ruchomego - komplet (uchwyt, komplet tulei przesuwnych, bolce prowadzące) komplet montażowy (komplet tulei przesuwnych, bolce prowadzące) komplet tulei przesuwnych sprężyna mocująca	  	▲ 03.24dd-xxxx.3 → 03.0350-ddxx.2 → ▲ 03.25dd-xxxx.3 → 03.0450-ddxx.2 → 24.3728-xxxx.2 →	03nnnn 07ddxx 04nnnn 08ddxx 59xxxx	pompa sprzęgła (np. 03.2419-: Ø=19,05) komplet uszczelniający siłownik wysprzęglający (np. 03.2525-: Ø=25,40) komplet uszczelniający linka sprzęgła

nnnn = ostatnie cztery cyfry odpowiadają kolejnemu numerowi.

dd = wymiary

▲ Dla tego samego systemu oznaczania numerowego możliwe jest również oznaczenie 24.

■ Dla tego samego systemu oznaczania numerowego możliwe jest również oznaczenie 03., 24. i 83.

Drukowanie, również fragmentami, dozwolone jest wyłącznie za naszą zgodą. Roszczenia odszkodowawcze wynikające z informacji zawartych w niniejszym katalogu nie będą uznawane. Zastrzega się możliwość zmian konstrukcyjnych. O ile w naszej dokumentacji odnosimy się do numeru części zamiennego producenta pojazdu, to służy to wyłącznie celom porównawczym. Stosowanie tego rodzaju informacji w rachunkach wystawianych posiadaczom pojazdów nie jest dozwolone.

Wielość modeli i części zamiennych kilku producentów pojazdów nie zawsze pozwala na dokładne przyporządkowanie. Z tego względu prosimy o zwracanie szczególnej uwagi na podane w katalogu uwagi i opisy części zamiennych.

Έτσι χρησιμοποιείτε τον K24-H

Ομάδες προϊόντων	Τύπος αυτοκινήτου	Χρονικό διάστημα τοποθέτησης (από/έως)	Αριθμός προϊόντος ATE	Υπόδειξη (προϊόν)
Μπροστινός άξονας/πίσω άξονας	Αριθμός πλαισίου kW	Υπόδειξη (όχημα)	Σύντομος κωδικός	Ορισμός
AUDI A4 CABRIO (02-)				
1,8 T 1,8 T Quattro 2,0 2,0 TFSI	◀ 120 ▶ 120 ▶ 96 ▶ 120	8E-55-99999 04.02 05.03 08.06 08.06 08.06	PR: 1LB,1LE PR: 1LB,1LE PR: 1LB,1LE PR: 1LB,1LE	11.3571-8522.2 11.3571-8521.2 11.0441-5704.2 11.0101-5409.2
	8E-55-400001			220320 220319 250034 260035
				+ ESP + ESP
				D=57, - Halter D=57, - Halter Dichtungssatz Hülsensatz
				ATE ATE ATE ATE

*Μπροστινόςω



Σερβόφρενο



Συρματόσχοινο χειρόφρενου



Κεντρικός κύλινδρος πέδησης



Ρυθμιστής δύναμης πέδησης



Δοχείο διαστολής



Εντολοδότης κύλινδρος συμπλέκτη



Δίχαλο πέδησης



Εντολοδόχος κύλινδρος συμπλέκτη



Εύκαμπτος σωλήνας φρένου



Εύκαμπτος σωλήνας σύνδεσης



Κύλινδρος τροχού



Ντίζα συμπλέκτη

**Τρόπος διεύθυνσης

◀ Αριστεροτίμονα οχήματα

▶ Δεξιοτίμονα οχήματα

****Κατασκευαστής

ADV	Advics
ATE	Continental Teves (ATE)
AKE	Akebono
AIS	Aisin
AP	AP Lockheed
BDX	Bendix
BOS	Bosch
BRE	Brembo
CIT	Citroën
DEL	Delco
FI	Fiat
FTE	FTE Automotive
MAN	Mando
NIS	Nissin
PER	Perrot
SUM	Sumitomo
TOK	Tokico
TRW	Lucas (LUC)
VW	Volkswagen

***Θέση τοποθέτησης















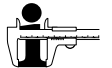



	μπροστά
	πίσω
	αριστερά
	δεξιά
	αριστερά επάνω
	αριστερά κάτω
	δεξιά επάνω
	δεξιά κάτω
	μέση
	επάνω
	κάτω
	Μπροστινός άξονας
	αριστερά μπροστά
	δεξιά μπροστά
	Πίσω άξονας
	αριστερά πίσω
	δεξιά πίσω

Όλες οι ενδείξεις θέσεως ανταποκρίνονται πάντα στην κατεύθυνση οδήγησης

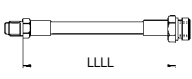
Βραχυγραφίες

-	χωρίς / εκτός	D =	Διάμετρος	S	Βίδα στερέωσης / βίδα δίχαλου πέδησης	Λιμουζίνα
+	με / μόνο / για	Gz	Εντολοδότης κύλινδρος	THz	Διπλός κεντρικός κύλινδρος	Στέισον
AUT	αυτόματη επαναρρύθμιση	HEB	μοχλό	V	αεριζόμενο	Κουπέ
B	επικαλυμμένος	Hz	Κεντρικός κύλινδρος	WE	Διάταξη προειδοποίησης	Κάμπριο
BG	Διάταξη περιορισμού δύναμης πέδησης	L	χαλυβόκρομα / υψηλή ανθράκωση	WK	επαφή προειδοποίησης	Λεωφορείο
BR	Ρυθμιστής δύναμης πέδησης	L =	Μήκος	Zub	εξαρτήματα	Κλούβα
BRE	Βιδωτός ρυθμιστής	Nz	Εντολοδόχος κύλινδρος	Εύκαμπτος σωλήνας πέδησης + σωλήνωση		Λίφτμπακ
BRES	Σετ βιδωτού ρυθμιστή	PD	PowerDisc	2-πορτο		Ανοιχτό φορτηγάκι/Πλαίσιο
BRL	Ρυθμιστής δύναμης πέδησης ανάλογα της φόρτισης	Rz	Κύλινδρος τροχού	3-πορτο		Σειρά
		RzR	Κύλινδρο τροχού με ενσωματωμένο ρυθμιστή	4-πορτο		DKW Κύρια κατηγορία/Ειδική κατηγορία/Γενικής χρήσης
				5-πορτο		FAUN Αυτοκίνητο όχημα (Kraka)
						Μικρό φορτηγό

Πληροφορίες προϊόντος

		ΣΥΝΤΟΜΟΣ ΚΩΔΙΚΟΣ				ΣΥΝΤΟΜΟΣ ΚΩΔΙΚΟΣ																			
	03.6199-xxxx.4 → 03.61dy-xxxx.4 → 03.67dy-xxxx.4 → 03.68dy-xxxx.4 → 03.69dy-xxxx.4 → 03.77dy-xxxx.4 →	30nnnn 30nnnn 30nnnn 30nnnn 30nnnn 30nnnn	Σερβόφρενο T50 T51 T52/3 T52 T53 T52/4		▲ 03.27dd-xxxx.3 → ▲ 03.32dd-xxxx.3 → 03.040x-xxdd.2 → 03.0470-xxdd.2 →	02nnnn 02nnnn 06nnnn 06nnnn	Μονόπλευρα ενεργός κύλινδρος Κύλινδρος τροχού Σετ επισκευής (με έμβολο) Σετ στεγανοποίησης (χωρίς έμβολο)																		
	03.78dy-xxxx.4 → 03.78dy-xxxx.4 → 03.78dy-xxxx.4 → 03.78dy-xxxx.4 → 03.78dy-xxxx.4 → 03.78dy-xxxx.4 →	30nnnn 30nnnn 30nnnn 30nnnn 30nnnn 30nnnn	T52/4 T52/4Z T52/5 T52/5Z T55/1 T55/1Z	 	24.3727-xxxx.2 →	58xxxx	Συρματόσχοινο χειρόφρενου																		
			<table border="1"> <thead> <tr> <th>d</th> <th>y</th> </tr> </thead> <tbody> <tr> <td>2 = 6"</td> <td>0 = Απλή συσκευή</td> </tr> <tr> <td>3 = 7"</td> <td>5 = Διπλή συσκευή</td> </tr> <tr> <td>4 = 8"</td> <td>0 = Απλή συσκευή</td> </tr> <tr> <td>5 = 9"</td> <td>3 = Απλή συσκευή ΥΠ</td> </tr> <tr> <td>6 = 10"</td> <td>5 = Απλή συσκευή</td> </tr> <tr> <td></td> <td>8 = Απλή συσκευή ΥΠ</td> </tr> <tr> <td></td> <td>ΥΠ = υποβοήθηση πέδησης</td> </tr> <tr> <td></td> <td>Z = συσκευές πέδησης αγκύρωσης</td> </tr> </tbody> </table>	d	y	2 = 6"	0 = Απλή συσκευή	3 = 7"	5 = Διπλή συσκευή	4 = 8"	0 = Απλή συσκευή	5 = 9"	3 = Απλή συσκευή ΥΠ	6 = 10"	5 = Απλή συσκευή		8 = Απλή συσκευή ΥΠ		ΥΠ = υποβοήθηση πέδησης		Z = συσκευές πέδησης αγκύρωσης		■ 83.1xxx-xxxx.3 → ■ 83.5γxx-LLLL.3 → ■ 83.6γxx-LLLL.3 → ■ 83.7γxx-LLLL.3 →	33nnnn 33nnnn 33nnnn 33nnnn	Εύκαμπτος σωλήνας πέδησης + σωλήνωση Εύκαμπτος σωλήνας φρένου/συμπλέκτη Εύκαμπτος σωλήνας φρένου/συμπλέκτη Εύκαμπτος σωλήνας φρένου/συμπλέκτη
d	y																								
2 = 6"	0 = Απλή συσκευή																								
3 = 7"	5 = Διπλή συσκευή																								
4 = 8"	0 = Απλή συσκευή																								
5 = 9"	3 = Απλή συσκευή ΥΠ																								
6 = 10"	5 = Απλή συσκευή																								
	8 = Απλή συσκευή ΥΠ																								
	ΥΠ = υποβοήθηση πέδησης																								
	Z = συσκευές πέδησης αγκύρωσης																								
	▲ 03.20dd-xxxx.3 → ▲ 03.21dd-xxxx.3 → ▲ 03.23dd-xxxx.3 → ▲ 03.31dd-xxxx.3 → 03.0370-xxdd.2 →	01nnnn 01nnnn 01nnnn 01nnnn 05xxdd	Βαθμιδωτός διπλός κεντρικός κύλινδρος Διπλός κεντρικός κύλινδρος Βαθμιδωτός κεντρικός κύλινδρος Κεντρικός κύλινδρος (π.χ 03.2122-: Ø=22,20) Σετ επισκευής	 	 LLLL		y = 1: Σπείρωμα 1× εσωτερικά / 1× εξωτερικά y = 2: Σπείρωμα 2× εσωτερικά y = 3: Σπείρωμα 2× εξωτερικά																		
	03.3508-xxxx.x → 03.3509-xxxx.x → 03.3558-xxxx.x → 03.0101-xxxx.2 →	31nnnn 31nnnn 31nnnn 39nnnn	Δοχείο διαστολής Δοχείο διαστολής Δοχείο διαστολής Σετ επισκευής		03.60xx-xxxx.3 → 03.65xx-xxxx.3 → 03.0101-xxxx.2 →	32nnnn 32nnnn 32nnnn	Ρυθμιστής δύναμης πέδησης (ΡΠ) Διάταξη περιορισμού δύναμης πέδησης (ΠΠ) Βιδωτός ρυθμιστής (ΒΡ) Ρυθμιστής δύναμης πέδησης ανάλογα του φορτίου (ΡΠΦ) Σετ βιδωτού ρυθμιστή (ΣΒΡ)																		
	03.3508-xxxx.x → 03.3509-xxxx.x → 03.3558-xxxx.x → 03.0101-xxxx.2 →	31nnnn 31nnnn 31nnnn 39nnnn	Δοχείο διαστολής Δοχείο διαστολής Δοχείο διαστολής Σετ επισκευής		35/3 brown (4)		Χαρακτηριστικό, έγχρωμο μαρκάρισμα (αριθμός συνδέσεων)																		
	▲ 11.3ddx-xxxx.2 → 11.9ddx-xxxx.2 → ▲ 13.2ddx-xxxx.2 → ▲ 13.4ddx-xxxx.2 → 13.9ddx-xxxx.2 → 24.3ddx-xxxx.5 → 11.0441-ddxx.2 → 13.0441-ddxx.2 → 11.0230-xxxx.2 → 24.0101-xxxx.2 → ▲ 11.0101-xxxx.2 → 11.8116-xxxx.1 →	22nnnn 22nnnn 21nnnn 21nnnn 21nnnn 24nnnn 25nnnn 25nnnn 26nnnn 26nnnn 26nnnn 39nnnn	Ολισθαίνον δίχαλο πέδησης Ολισθαίνον δίχαλο πέδησης 2-κύλινδρο σταθερό δίχαλο πέδησης 4-κύλινδρο σταθερό δίχαλο πέδησης σταθερή δαγκάνα Αντικαθιστούμενο ολισθαίνον δίχαλο πέδησης Σετ στεγανοποίησης Σετ στεγανοποίησης Σετ σπρίνγκας ολισθαίνοντος δίχαλου πέδησης (στήριγμα, σετ ολισθαίνοντος χιτωνίου, πείρος οδηγός) Σετ τοποθέτησης (σετ ολισθαίνοντος χιτωνίου, πείρος οδηγός) Σετ ολισθαίνοντος χιτωνίου Ελατήριο συγκράτησης	  	▲ 03.24dd-xxxx.3 → 03.0350-ddxx.2 →	03nnnn 07ddxx	Εντολοδότης κύλινδρος συμπλέκτη (π.χ. 03.2419-: Ø=19,05) Σετ στεγανοποίησης																		
					▲ 03.25dd-xxxx.3 → 03.0450-ddxx.2 →	04nnnn 08ddxx	Εντολοδόχος κύλινδρος συμπλέκτη (π.χ. 03.2525-: Ø=25,40) Σετ στεγανοποίησης																		
					24.3728-xxxx.2 →	59xxxx	Ντίζα συμπλέκτη																		

nnnn = Τα τελευταία τέσσερα ψηφία αντιστοιχούν σε έναν αριθμό αρίθμησης.

dd = Ονομαστική διάσταση

▲ Επίσης δυνατό και το 24. σε περίπτωση ίδιου συστήματος αρίθμησης.

■ Επίσης δυνατό και το 03., 24. και 83. σε περίπτωση ίδιου συστήματος αρίθμησης.

Η επανεκτύπωση, επίσης και αποσπασματικά, επιτρέπεται μόνο με την έγκρισή μας. Οι αξιώσεις αντικατάστασης βάσει των στοιχείων αυτού του καταλόγου δεν μπορούν να αναγνωριστούν. Διατηρούμε το δικαίωμα των κατασκευαστικών αλλαγών. Στο βαθμό που αναφερόμαστε στα έγγραφα μας στους αριθμούς ανταλλακτικών του κατασκευαστή του οχήματος, χρησιμεύει μόνο για λόγους σύγκρισης. Μια χρήση αυτών των στοιχείων σε λογαριασμούς που απευθύνονται στον ιδιοκτήτη του οχήματος δεν επιτρέπεται.

Ο μεγάλος αριθμός μοντέλων και ανταλλακτικών μερικών κατασκευαστών οχημάτων δεν επιτρέπει πάντοτε ένα ακριβή καταμερισμό. Προσέξτε παρακαλώ γι' αυτό ιδιαίτερα τις σχετικές παρατηρήσεις σ' αυτόν τον κατάλογο και τις περιγραφές των ανταλλακτικών εξαρτημάτων.

K24-H'i Broşürünü Nasıl Kullanacaksınız

Ürün grubu	Araç tipleri	Montaj süresi (tarih aralığı)	ATE-Ürün numarası (uzun)	Tanım (Ürün)
Ön-/Arka aks	Araç şasi numarası (tarih aralığı)	Tanım (Araç)	ATE-Ürün numarası (kısa)	Ürün
	kW			
AUDI A4 CABRIO (02-)				
	1,8 T 1,8 T Quattro 2,0 2,0 TFSI	120 120 96 120	8E-55-99999 04.02 05.03 08.06 05.04 08.06 08.06	PR: 1LB,1LE PR: 1LB,1LE PR: 1LB,1LE PR: 1LB,1LE
			11.3571-8522.2 11.3571-8521.2 11.0441-5704.2 11.0101-5409.2	220320 220319 250034 260035
				+ ESP + ESP
				D=57, - Halter D=57, - Halter Dichtungssatz Hülzensatz
				ATE ATE ATE ATE
*	**		***	****

**Ürün grupları

	Booster		El Freni Teli
	Fren Merkez Silindiri		Fren Basınç Regülatörü
	Fren Hidroliği Haznesi		Debriyaj Silindiri
	Fren Kaliperi		Debriyaj Yardımcı Silindiri
	Fren hortumu		Debriyaj Hortumu
	Hidrolik Fren Silindiri		Debriyaj Teli

**Direksiyon türü

- ◀ Soldan Direksiyonlu araçlar
- ▶ Sağ direksiyon araçlar

****Üretici firma tanımı

ADV	Advics
ATE	Continental Teves (ATE)
AKE	Akebono
AIS	Aisin
AP	AP Lockheed
BDX	Bendix
BOS	Bosch
BRE	Brembo
CIT	Citroën
DEL	Delco
FI	Fiat
FTE	FTE Automotive
MAN	Mando
NIS	Nissin
PER	Perrot
SUM	Sumitomo
TOK	Tokico
TRW	Lucas (LUC)
VW	Volkswagen

***Montaj pozisyonu



















	ön
	arka
	sol
	sağ
	sol ön
	sol arka
	sağ ön
	sağ arka
	orta
	üst
	alt
	ön aks
	sol ön aks
	sağ ön aks
	arka aks
	sol arka aks
	sağ arka aks

Tüm pozisyon verileri sürüş yönüne göre dir.

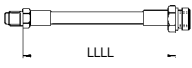
Kısaltmalar

-	Hariç / değil	HEB	Levyeli	THz	Tandem Merkezi	Sedan
+	İle / sadece / için	HZ	Fren Merkez Silindiri		Fren Hidrolik Silindiri	Station wagon
AUT	Otomatik boşluk ayarlayıcı	L	Alaşımli / karbonlanmış	V	Havalandırmalı	Coupe
B	Kaplamalı	L =	Uzunluk	WE	İkaz mekanizması	Cabrio
BG	Fren Güç Regülatörü	Nz	Alıcı silindir	WK	Balata aşınma sensörlü	Otobüs
BR	Fren Basınç Regülatörü	PD	PowerDisc	Zub	Aksesuarlı	Kapalı kasa kamyonet
BRE	Vidalı tip Regülatör	Rz	Hidrolik Fren Silindiri			Hatchback
BRES	Vidalı Tip Regülatör Seti	RzR	Entegre Fren Düzeltme sistemi			Açık kasa kamyonet/Şasi
BRL	Ağırlığa duyarlı Fren Basınç Regülatörü	S	Sabitleme civatası / Kaliper civatalı			Seri
D =	Çap					DKW master sınıf/özel sınıf/üniversal
Gz	Verici Silindir Debriyaj Silindiri					FAUN motorlu araç (Kraka)
						Transporter

Ürün bilgileri

		KISA NUMARA				KISA NUMARA																			
	03.6199-xxxx.4 → 03.61dy-xxxx.4 → 03.67dy-xxxx.4 → 03.68dy-xxxx.4 → 03.69dy-xxxx.4 → 03.77dy-xxxx.4 →	30nnnn 30nnnn 30nnnn 30nnnn 30nnnn 30nnnn	Booster T50 T51 T52/3 T52 T53 T52/4		▲ 03.27dd-xxxx.3 → ▲ 03.32dd-xxxx.3 → 03.040x-xxdd.2 → 03.0470-xxdd.2 →	02nnnn 02nnnn 06nnnn 06nnnn	pistonlu Fren hidrolik Silindiri Fren Hidrolik Silindiri Tamir Takımı (pistonları ile birlikte) Conta Takımı (pistonsuz)																		
	03.78dy-xxxx.4 → 03.78dy-xxxx.4 → 03.78dy-xxxx.4 → 03.78dy-xxxx.4 → 03.78dy-xxxx.4 → 03.78dy-xxxx.4 →	30nnnn 30nnnn 30nnnn 30nnnn 30nnnn 30nnnn	T52/4 T52/4Z T52/5 T52/5Z T55/1 T55/1Z		24.3727-xxxx.2 →	58xxxx	El Freni teli																		
			<table border="1"> <thead> <tr> <th>d</th> <th>y</th> </tr> </thead> <tbody> <tr> <td>2 = 6"</td> <td>0 = Tekli Ünite</td> </tr> <tr> <td>3 = 7"</td> <td>5 = Tandem, çiftli ünite</td> </tr> <tr> <td>4 = 8"</td> <td>0 = Tekli Ünite</td> </tr> <tr> <td>5 = 9"</td> <td>3 = Tekli Ünite BA</td> </tr> <tr> <td>6 = 10"</td> <td>5 = Tekli Ünite</td> </tr> <tr> <td></td> <td>8 = Tekli Ünite BA</td> </tr> <tr> <td></td> <td>BA = Elektronik Fren Ayan</td> </tr> <tr> <td></td> <td>Z = Gerilim Cıvatalı Fren Boosteri</td> </tr> </tbody> </table>	d	y	2 = 6"	0 = Tekli Ünite	3 = 7"	5 = Tandem, çiftli ünite	4 = 8"	0 = Tekli Ünite	5 = 9"	3 = Tekli Ünite BA	6 = 10"	5 = Tekli Ünite		8 = Tekli Ünite BA		BA = Elektronik Fren Ayan		Z = Gerilim Cıvatalı Fren Boosteri		■ 83.1xxx-xxxx.3 → ■ 83.5yxx-LLLL.3 → ■ 83.6yxx-LLLL.3 → ■ 83.7yxx-LLLL.3 →	33nnnn 33nnnn 33nnnn 33nnnn	Fren hortumu + boru hattı Fren/Debriyaj hortumu Fren/Debriyaj hortumu Fren/Debriyaj hortumu
d	y																								
2 = 6"	0 = Tekli Ünite																								
3 = 7"	5 = Tandem, çiftli ünite																								
4 = 8"	0 = Tekli Ünite																								
5 = 9"	3 = Tekli Ünite BA																								
6 = 10"	5 = Tekli Ünite																								
	8 = Tekli Ünite BA																								
	BA = Elektronik Fren Ayan																								
	Z = Gerilim Cıvatalı Fren Boosteri																								
	▲ 03.20dd-xxxx.3 → ▲ 03.21dd-xxxx.3 → ▲ 03.23dd-xxxx.3 → ▲ 03.31dd-xxxx.3 → 03.0370-xxdd.2 →	01nnnn 01nnnn 01nnnn 01nnnn 05xxdd	Kademeli delinmiş çiftli merkezi silindir Çiftli merkezi silindir Kademeli delinmiş merkezi silindir Merkezi silindir (Örnek. 03.2122-: Ø=22,20) Tamir Takımı				y = 1: Dış 1 × iç/1 × dış y = 2: Dış 2 × iç y = 3: Dış 2 × dış																		
	03.3508-xxxx.x → 03.3509-xxxx.x → 03.3558-xxxx.x → 03.0101-xxxx.2 →	31nnnn 31nnnn 31nnnn 39nnnn	Fren Hidroliği Haznesi Fren Hidroliği Haznesi Fren Hidroliği Haznesi Tamir Takımı		03.60xx-xxxx.3 → 03.65xx-xxxx.3 → 03.0101-xxxx.2 →	32nnnn 32nnnn 32nnnn	Fren basınç regülatörü (BR) Fren Güç kısıtlandırıcısı (BG) Vidalı tip Regülatör (BRE) Yüke duyarlı fren basınç regülatörü (BRL) Vidalı tip regülatör seti (BRES)																		
	▲ 11.3ddx-xxxx.2 → 11.9ddx-xxxx.2 → ▲ 13.2ddx-xxxx.2 → ▲ 13.4ddx-xxxx.2 → 13.9ddx-xxxx.2 → 24.3ddx-xxxx.5 → 11.0441-ddxx.2 → 13.0441-ddxx.2 → 11.0230-xxxx.2 → 24.0101-xxxx.2 → ▲ 11.0101-xxxx.2 → 11.8116-xxxx.1 →	22nnnn 22nnnn 21nnnn 21nnnn 21nnnn 24nnnn 25nnnn 25nnnn 26nnnn 26nnnn 26nnnn 39nnnn	Basit Kaliper Basit Kaliper Çift Silindirli Sabit Kaliper Dört Silindirli Sabit Kaliper Sabit kaliper Tamir edilmiş Basit Kaliper Conta Takımı Conta Takımı Kaliper Tutucu Seti (Tutucu gövde, kayar, gömlek seti, kayıt pimleri) Montaj Takımı (Kayar Gömlek seti, kayıt pimleri) Kayar Gömlek Seti Geri Getirme Yayı		▲ 03.24dd-xxxx.3 → 03.0350-ddxx.2 →	03nnnn 07ddxx	Debriyaj Silindiri (Örneğin. 03.2419-: Ø=19,05) Conta Tamir Takımı																		
					▲ 03.25dd-xxxx.3 → 03.0450-ddxx.2 →	04nnnn 08ddxx	Debriyaj Yardımcı Silindiri (Örneğin 03.2525-: Ø=25,40) Conta Tamir Takımı																		
					24.3728-xxxx.2 →	59xxxx	Debriyaj Teli																		

nnnn = Son dört rakam mevcut bir numaraya karşılıktır.

dd = Nominal çap



















▲ 24. aynı numaralama sistemini kullanmak mümkündür

■ 03., 24. ve 83. aynı numaralama sistemini kullanmak mümkündür.

Bu kataloğun içeriği ve kopyaları yalnız müsaade alınarak kullanılabilir. Bu kataloğtaki bilgileri baz alarak kullanılan parçalar yüzünden zarara uğranılması durumunda mesuliyet kullanıcıya aittir. Dizayn ve montaj değişiklikleri hakkı saklıdır. Dökümanımızda kullanılan araç üreticilerinin verdikleri parça numaraları sadece karşılaştırma içindir. Faturalarda araç üreticilerinin parça numaralarının kullanılmasına müsaade edilmez.

Otomobil modellerindeki ve üretici firmaların çokluğu ve çeşitliliği her zaman her yedek parçanın tam olarak kullanılmasına imkan vermeyebilir. Bu nedenle notlara ve yedek parça talimatlarının içeriğine dikkat ediniz.

零件信息

		编号				编号	
	03.6199-xxxx.4 → 03.61dy-xxxx.4 → 03.67dy-xxxx.4 → 03.68dy-xxxx.4 → 03.69dy-xxxx.4 → 03.77dy-xxxx.4 →	30nnnn 30nnnn 30nnnn 30nnnn 30nnnn 30nnnn	制动力放大器 T50 T51 T52/3 T52 T53 T52/4		▲ 03.27dd-xxxx.3 → ▲ 03.32dd-xxxx.3 → 03.040x-xxdd.2 → 03.0470-xxdd.2 →	02nnnn 02nnnn 06nnnn 06nnnn	一侧有效的车轮制动缸 车轮制动缸 维修组 (带活塞) 密封组 (不带活塞)
	03.78dy-xxxx.4 → 03.78dy-xxxx.4 → 03.78dy-xxxx.4 → 03.78dy-xxxx.4 → 03.78dy-xxxx.4 → 03.78dy-xxxx.4 →	30nnnn 30nnnn 30nnnn 30nnnn 30nnnn 30nnnn	T52/4 T52/4Z T52/5 T52/5Z T55/1 T55/1Z	 	24.3727-xxxx.2 → ■ 83.1xxx-xxxx.3 → ■ 83.5yxx-LLLL.3 → ■ 83.6yxx-LLLL.3 → ■ 83.7yxx-LLLL.3 →	58xxxx 33nnnn 33nnnn 33nnnn 33nnnn	手制动拉索 制动软管 + 管道 制动-/连接软管 制动-/连接软管 制动-/连接软管
	▲ 03.20dd-xxxx.3 → ▲ 03.21dd-xxxx.3 → ▲ 03.23dd-xxxx.3 → ▲ 03.31dd-xxxx.3 → 03.0370-xxdd.2 →	01nnnn 01nnnn 01nnnn 01nnnn 05xxdd	串联-主缸 分级 串联-主缸 分级-H主缸 主缸 (如. 03.2122-: 厚度=22,20) 维修组	 	LLL 03.60xx-xxxx.3 → 03.65xx-xxxx.3 → 03.0101-xxxx.2 →	32nnnn 32nnnn 32nnnn	y = 1: 螺纹 1× 内部/1× 外部 y = 2: 螺纹 2× 内部 y = 3: 螺纹 2× 外部 制动力调节器 (BR) 制动力限制器 (BG) 旋入调节器 (BRE) 与载荷相关的制动力调节器 (BRL) 旋入调节器-组 (BRES)
	03.3508-xxxx.x → 03.3509-xxxx.x → 03.3558-xxxx.x → 03.0101-xxxx.2 →	31nnnn 31nnnn 31nnnn 39nnnn	平衡罐 平衡罐 平衡罐 维修组		35/3 灰色 (4)		名称, 颜色标记 (连接的数量)
	▲ 11.3ddx-xxxx.2 → 11.9ddx-xxxx.2 → ▲ 13.2ddx-xxxx.2 → ▲ 13.4ddx-xxxx.2 → 13.9ddx-xxxx.2 → 24.3ddx-xxxx.5 → 11.0441-ddxx.2 → 13.0441-ddxx.2 → 11.0230-xxxx.2 → 24.0101-xxxx.2 → ▲ 11.0101-xxxx.2 → 11.8116-xxxx.1 →	22nnnn 22nnnn 21nnnn 21nnnn 21nnnn 24nnnn 25nnnn 25nnnn 26nnnn 26nnnn 26nnnn 39nnnn	浮式制动钳 浮式制动钳 卡式制动钳 四缸卡式制动钳 卡式制动钳 交换钳 浮式制动钳 密封组 密封组 浮式制动钳支架-组 (支架, 滑套组, 导向销) 安装组 (滑套组, 导向销) 滑套组 止动弹簧	  	▲ 03.24dd-xxxx.3 → 03.0350-ddxx.2 → ▲ 03.25dd-xxxx.3 → 03.0450-ddxx.2 → 24.3728-xxxx.2 →	03nnnn 07ddxx 04nnnn 08ddxx 59xxxx	离合器-输出缸 (如. 03.2419-: 厚度=19,05) 密封组 离合器-输出缸 (如. 03.2525-: 厚度=25,40) 密封组 连接拉索

d	y
2 = 6"	0 = 简单设备
3 = 7"	5 = 串联设备
4 = 8"	0 = 简单设备
5 = 9"	3 = 简单设备 BA
6 = 10"	5 = 简单设备
	8 = 简单设备 BA
	BA = 制动辅助
	Z = 拉杆制动器

nnnn =最后四位数字是顺序号。

dd = 额定尺寸

▲ 可以在相同的编号系统中实现第 24. 位编号。

■ 可以在相同的编号系统中实现第 03., 24. 和 83. 的编号

简要的强调一下, 就是说必须经过我们的许可。基于该目录说明的替换要求没有进行说明。保留更改结构的权利。

只要我们在我们的资料中提到了整车制造商的替代件编号, 只能用于比较。

不允许在给用户的帐单中使用同样类型的说明。

整车制造商多样化的车型和替代件不可能做到精确的划分。所以, 请您注意目录中的说明和替代件描述。

カタログK24-Hのご利用法

製品グループ	車種	取り付け期間 (から/まで)	ATE商品番号(長)	情報(商品)
前車軸/後車軸	車台番号(から/まで)	情報(車両)	ATE商品番号(短)	商品
	kW			
AUDI A4 CABRIO (02-)				
	1,8 T 1,8 T Quattro 2,0 2,0 TFSI	◀ 120 ◀ 120 ◀ 96 ◀ 120	8E-55-999999 04.02 05.03 08.06 05.04 08.06 08.06	PR: 1LB,1LE PR: 1LB,1LE PR: 1LB,1LE PR: 1LB,1LE
			11.3571-8522.2 11.3571-8521.2 11.0441-5704.2 11.0101-5409.2	220320 220319 250034 260035
		8E-55-400001		☑ + ESP ☑ + ESP
				D=57, - Halter D=57, - Halter Dichtungssatz Hülzensatz
				ATE ATE ATE ATE

*製品グループ

	ブレーキブースター		サイドブレーキワイヤー
	マスターブレーキシリンダー		ブレーキプレッシャーレギュレーター
	ブレーキフルードタンク		クラッチマスターシリンダー
	ブレーキキャリパー		クラッチスレーブシリンダー
	ブレーキホース		クラッチホース
	ホイールシリンダー		クラッチワイヤー

**ステアリング

- ◀ 左ハンドル
- ▶ 右ハンドル

****メーカー略号

ADV	Advics
ATE	Continental Teves (ATE)
AKE	Akebono
AIS	Aisin
AP	AP Lockheed
BDX	Bendix
BOS	Bosch
BRE	Brembo
CIT	Citroën
DEL	Delco
FI	Fiat
FTE	FTE Automotive
MAN	Mando
NIS	Nissin
PER	Perrot
SUM	Sumitomo
TOK	Tokico
TRW	Lucas (LUC)
VW	Volkswagen

***取り付け位置















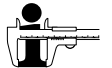



	前
	後ろ
	左
	右
	左前方
	右前方
	左後方
	右後方
	中央
	上
	下
	前車軸
	前車軸 左
	前車軸 右
	後車軸
	後車軸 左
	後車軸 右

位置表示は全て車の進行方向に即しています。

略語

-	の付いていない/なし	D =	直径	THz	タンデムマスターシリンダー	セダン
+	の付いた/のみ/~用の	Gz	マスターシリンダー	V	通気機能	ステーションワゴン
AUT	自動調整機能付き	HEB	レバー付き	WE	警告装置	クーペ
B	コーティング仕上げ	Hz	マスターシリンダー	WK	ウォーニングコンタクト付き	カブリオ
BG	ブレーキプレッシャーリデュース	L	合金/炭素繊維強化	Zub	付属品付き	バス
BR	ブレーキプレッシャーレギュレーター	L =	長さ			バン
BRE	スクリュウインコントローラー	Nz	スレーブシリンダー			ハッチバック
BRES	スクリュウインコントローラーキット	PD	PowerDisc			ピックアップ/シャシー
BRL	ブレーキプレッシャーレギュレーター 負荷により変化	Rz	ホイールシリンダー			シリーズ
		RzR	調整器組み込みホイールシリンダー			DKW マスタークラス/ スペシャルクラス/ユニバーサル
		S	固定するネジ/キャリパーネジ付き			FAUN パワーカート(Kraka)
						トランスポーター

商品情報

		略番				略番															
	03.6199-xxxx.4 → 03.61dy-xxxx.4 → 03.67dy-xxxx.4 → 03.68dy-xxxx.4 → 03.69dy-xxxx.4 → 03.77dy-xxxx.4 →	30nnnn 30nnnn 30nnnn 30nnnn 30nnnn 30nnnn	ブレーキブースター T50 T51 T52/3 T52 T53 T52/4		▲ 03.27dd-xxxx.3 → ▲ 03.32dd-xxxx.3 → 03.040x-xxdd.2 → 03.0470-xxdd.2 →	02nnnn 02nnnn 06nnnn 06nnnn	片側に作用するホイールシリンダー ホイールシリンダー リペアキット(ピストン付き) シールキット(ピストンなし)														
	03.78dy-xxxx.4 → 03.78dy-xxxx.4 → 03.78dy-xxxx.4 → 03.78dy-xxxx.4 → 03.78dy-xxxx.4 → 03.78dy-xxxx.4 →	30nnnn 30nnnn 30nnnn 30nnnn 30nnnn 30nnnn	T52/4 T52/4Z T52/5 T52/5Z T55/1 T55/1Z		24.3727-xxxx.2 →	58xxxx	サイドブレーキワイヤー														
			<table border="1"> <tr> <td>d</td> <td>y</td> </tr> <tr> <td></td> <td>0 = シングルタイプ 5 = タンデムタイプ</td> </tr> <tr> <td>2 = 6"</td> <td>0 = シングルタイプ</td> </tr> <tr> <td>3 = 7"</td> <td>3 = シングルタイプ BA</td> </tr> <tr> <td>4 = 8"</td> <td>5 = シングルタイプ</td> </tr> <tr> <td>5 = 9"</td> <td>8 = シングルタイプ BA</td> </tr> <tr> <td>6 = 10"</td> <td>BA = ブレーキアシスト Z = タイロッドブレーキングユニット</td> </tr> </table>	d	y		0 = シングルタイプ 5 = タンデムタイプ	2 = 6"	0 = シングルタイプ	3 = 7"	3 = シングルタイプ BA	4 = 8"	5 = シングルタイプ	5 = 9"	8 = シングルタイプ BA	6 = 10"	BA = ブレーキアシスト Z = タイロッドブレーキングユニット		■ 83.1xxx-xxxx.3 → ■ 83.5yxx-LLLL.3 → ■ 83.6yxx-LLLL.3 → ■ 83.7yxx-LLLL.3 →	33nnnn 33nnnn 33nnnn 33nnnn	ブレーキチューブ + パイプライン ブレーキホース/クラッチホース ブレーキホース/クラッチホース ブレーキホース/クラッチホース
d	y																				
	0 = シングルタイプ 5 = タンデムタイプ																				
2 = 6"	0 = シングルタイプ																				
3 = 7"	3 = シングルタイプ BA																				
4 = 8"	5 = シングルタイプ																				
5 = 9"	8 = シングルタイプ BA																				
6 = 10"	BA = ブレーキアシスト Z = タイロッドブレーキングユニット																				
	▲ 03.20dd-xxxx.3 → ▲ 03.21dd-xxxx.3 → ▲ 03.23dd-xxxx.3 → ▲ 03.31dd-xxxx.3 → 03.0370-xxdd.2 →	01nnnn 01nnnn 01nnnn 01nnnn 05xxdd	ステップタンデムマスターシリンダー タンデムマスターシリンダー ステップマスターシリンダー マスターシリンダー (例 03.2122-: Ø=22,20) リペアキット				y = 1: ネジ 1× 内側/1× 外側 y = 2: ネジ 2× 内側 y = 3: ネジ 2× 外側														
	03.3508-xxxx.x → 03.3509-xxxx.x → 03.3558. xxxx.x → 03.0101-xxxx.2 →	31nnnn 31nnnn 31nnnn 39nnnn	ブレーキフルードタンク ブレーキフルードタンク ブレーキフルードタンク リペアキット		03.60xx-xxxx.3 → 03.65xx-xxxx.3 → 03.0101-xxxx.2 →	32nnnn 32nnnn 32nnnn	ブレーキプレッシャーレギュレーター (BR) ブレーキプレッシャーリデューサー (BG) スクリュウインコントローラー (BRE) ブレーキプレッシャーレギュレーター 負荷により変化 (BRL) スクリュウインコントローラーキット (BRES)														
					35/3 茶 (4)		記号、カラー標識 (接続箇所数)														
	▲ 11.3ddx-xxxx.2 → 11.9ddx-xxxx.2 → ▲ 13.2ddx-xxxx.2 → ▲ 13.4ddx-xxxx.2 → 13.9ddx-xxxx.2 → 24.3ddx-xxxx.5 → 11.0441-ddxx.2 → 13.0441-ddxx.2 → 11.0230-xxxx.2 → 24.0101-xxxx.2 → ▲ 11.0101-xxxx.2 → 11.8116-xxxx.1 →	22nnnn 22nnnn 21nnnn 21nnnn 21nnnn 24nnnn 25nnnn 25nnnn 26nnnn 26nnnn 26nnnn 39nnnn	フィストキャリパー フィストキャリパー 2シリンダー フィックスキャリパー 4シリンダーフィックスキャリパー フィックスキャリパー 交換キャリパー フィストキャリパー シールキット シールキット フィストキャリパーホルダーキット(ホルダー、スライディングスリーブキット、ガイドピン) 組み込みキット (スライディングスリーブキット、ガイドピン) スライディングスリーブキット リテーニングスプリング		▲ 03.24dd-xxxx.3 → 03.0350-ddxx.2 →	03nnnn 07ddxx	クラッチマスターシリンダー (例 03.2419-: Ø=19,05) シールキット														
					▲ 03.25dd-xxxx.3 → 03.0450-ddxx.2 →	04nnnn 08ddxx	クラッチスレーブシリンダー (例 03.2525-: Ø=25,40) シールキット														
					24.3728-xxxx.2 →	59xxxx	クラッチワイヤー														

nnnn = 最後の4つの数字はカウントナンバーです。

dd = 名目寸法

▲この印の項目は、24にもそれ以外の番号は同じものがあります。

■この印の項目は、03、24、および 83にもそれ以外の番号は同じものがあります。

複製は、たとえ一部であっても、必ず当社の許可が必要です。当カタログの記述内容に基づく賠償請求権は認められません。構成の変更に関しては、これを保留します。当社がその資料の中で車両メーカーの交換部品番号に触れる限りにおいては、これは単に比較目的によるものです。このような記述内容を車両所有者あての計算書の中で用いることは許されません。

車両メーカーの数は多種多様なモデルや交換部品を持つため、厳密な分類法を守ることが不可能な場合があります。従って当カタログ中に記載された内容と部品情報には特にご注意ください。部品情報には特にご注意ください。

مجموعة المنتجات	موديلات العربات	فترة التركيب (من / إلى)	الرقم الكامل للمنتجات	ملاحظة (المنتجات)
المحور الأمامي / الخلفي	العدد الترتيبي بالمصنع (من / إلى)	ملاحظة (العربة)	الرقم المختصر للمنتجات	المنتجات
AUDI A4 CABRIO (02-)				
1,8 T 1,8 T Quattro 2,0 2,0 TFSI	▲ 120 ▲ 120 ▲ 96 ▲ 120	8E-55-999999 04.02 05.03 05.04 08.06 08.06 08.06	PR: 1LB,1LE PR: 1LB,1LE PR: 1LB,1LE PR: 1LB,1LE	11.3571-8522.2 11.3571-8521.2 11.0441-5704.2 11.0101-5409.2
	8E-55-400001			22032 220319 250034 260035
				+ ESP + ESP
				D=57,- Halter ATE D=57,- Halter ATE Dichtungssatz ATE Hülsensatz ATE

مجموعات المنتجات*

	مضخم قوّة الفرملة		كبل المكبح اليدوي
	أسطوانة المكابح الرئيسية		معدّل قوّة الفرملة
	خزان تعديل المنسوب		الأسطوانة الضاغطة للواصل
	سرج الفرامل		الأسطوانة المضغوطة للواصل
	خرطوم المكبح		خرطوم الواصل
	إسطوانة العجلة		كبل الواصل

نوع المقود**

- ◀ مقود على اليسار
- ▶ مقود على اليمين

شفرة التعريف للمصنعين***

ADV	Advics
ATE	Continental Teves (ATE)
AKE	Akebono
AIS	Aisin
AP	AP Lockheed
BDX	Bendix
BOS	Bosch
BRE	Brembo
CIT	Citroën
DEL	Delco
FI	Fiat
FTE	FTE Automotive
MAN	Mando
NIS	Nissin
PER	Perrot
SUM	Sumitomo
TOK	Tokico
TRW	Lucas (LUC)
VW	Volkswagen

موضع التركيب***



















▲	أمام
▼	خلف
◀	وسط
▶	يمين
▲	أمام على اليسار
▼	خلف على اليسار
▶	أمام على اليمين
◀	خلف على اليمين
■	وسط
▲	فوق
▼	تحت
■	المحور الأمامي
■	المحور الأمامي على اليسار
■	المحور الأمامي على اليمين
■	المحور الخلفي
■	المحور الخلفي على اليسار
■	المحور الخلفي على اليمين

المذكورة أعلاه حدّدت حسب اتجاه سير العربة المواضع

اختصارات

-	بدون / لا	HEB	بعثلة	V	ميرّد بالهواء	صالون
+	مع / إلا / ل	Hz	الأسطوانة الرئيسية	WE	جهاز إنذار	استيشن
AUT	بضبط أوتوماتيكي	L	الطول	WK	مجهز بنمّاس لجهاز الإنذار	كوبويه
B	نظّم	L=	الطول	Zub	بتجهيزات إضافية	كأبريو
BG	معدّد قوّة الفرملة	Nz	الأسطوانة المضغوطة			حافلة
BR	معدّل قوّة الفرملة	PD	ATE PowerDisc قرص المكبح			نأقلّة صن دوقية
BRE	معدّل ملولب	Rz	أسطوانة العجلة مع			هاتش باك
BRES	طقم تعديل ملولب	RzR	أسطوانة العجلة مع			نأقلّة مسطحه/شاسيه
BRL	معدّل قوّة الفرملة حسب الحمل		معدّل مدمج			الفئّة
D=	قرئ ادل رطق	S	بلولم تيبثت رامم			ألفاخرة/الفئّة الخاصة/الشاملة
Gz	الأسطوانة الضاغطة	THz	أسطوانة رئيسية مزدوجة			سيارّة DKW من الفئّة
						عربة مكشوفة FAUN
						نأقلّة

خط أنبوبوي + خرطوم المكابح
ثنائية الأبواب
ثلاثية الأبواب
رباعية الأبواب
خماسية الأبواب

		الرقم المختصر				الرقم المختصر	
	03.6199-xxxx.4 → 03.61dy-xxxx.4 → 03.67dy-xxxx.4 → 03.68dy-xxxx.4 → 03.69dy-xxxx.4 → 03.77dy-xxxx.4 → 03.78dy-xxxx.4 → 03.78dy-xxxx.4 → 03.78dy-xxxx.4 → 03.78dy-xxxx.4 → 03.78dy-xxxx.4 → 03.78dy-xxxx.4 →	30 nnnnn 30 nnnnn 30 nnnnn 30 nnnnn 30 nnnnn 30 nnnnn 30 nnnnn 30 nnnnn 30 nnnnn 30 nnnnn 30 nnnnn 30 nnnnn	مضخم قوة الفرملة T50 T51 T52/3 T52 T53 T52/4 T52/4 T52/4Z T52/5 T52/5Z T55/1 T55/1Z	  	▲ 03.27dd-xxxx.3 → ▲ 03.32dd-xxxx.3 → 03.040x-xxdd.2 → 03.0470-xxdd.2 → 24.3727-xxxx.2 → ■ 83.1xxx-xxxx.3 → ■ 83.5yxx-LLLL.3 → ■ 83.6yxx-LLLL.3 → ■ 83.7yxx-LLLL.3 →	02 nnnn 02 nnnn 06 nnnn 06 nnnn 58 xxxx 33 nnnn 33 nnnn 33 nnnn 33 nnnn	أسطوانة تعمل على جانب واحد اسطوانة العجلة طقم تصليح (مع بستون) طقم منع التسرب (بدون بستون) كبل المكبح اليدوي خط أنبوبى + خرطوم المكابح خرطوم المكبح / الواصل خرطوم المكبح / الواصل خرطوم المكبح / الواصل
	▲ 03.20dd-xxxx.3 → ▲ 03.21dd-xxxx.3 → ▲ 03.23dd-xxxx.3 → ▲ 03.31dd-xxxx.3 → 03.0370-xxdd.2 →	01 nnnn 01 nnnn 01 nnnn 01 nnnn 05 xxdd	أسطوانة رئيسية مزدوجة ومدرجة أسطوانة رئيسية مزدوجة أسطوانة رئيسية مدرجة على سبيل المثال (z. B. 03.2122-: Ø=22,20) طقم للتصليح	 	1 = جز اللولب × داخلي / 1 × خارجي 2 = جز اللولب × داخلي 3 = جز اللولب × خارجي 03.60xx-xxxx.3 → 03.65xx-xxxx.3 → 03.0101-xxxx.2 →	32 nnnn 32 nnnn 32 nnnn	معدل قوة الفرملة (BR) معدل قوة الفرملة (BG) معدل ملولب (BRE) معدل قوة الفرملة حسب الحمل (BRL) طقم معدل قوة الفرملة ملولب (BRES)
	03.3508-xxxx.x → 03.3509-xxxx.x → 03.3558-xxxx.x → 03.0101-xxxx.2 →	31 nnnn 31 nnnn 31 nnnn 39 nnnn	خزّان لتعديل المنسوب خزّان لتعديل المنسوب خزّان لتعديل المنسوب طقم للتصليح		3/35 بتّي (4)	31 nnnn 31 nnnn 31 nnnn 39 nnnn	العلامة المميزة، اللون المميز (عدد التوصيلات)
	▲ 11.3ddx-xxxx.2 → 11.9ddx-xxxx.2 → ▲ 13.2ddx-xxxx.2 → ▲ 13.4ddx-xxxx.2 → 13.9ddx-xxxx.2 → 24.3ddx-xxxx.5 → 11.0441-ddxx.2 → 13.0441-ddxx.2 → 11.0230-xxxx.2 → 24.0101-xxxx.2 → ▲ 11.0101-xxxx.2 → 11.8116-xxxx.1 →	22 nnnn 22 nnnn 21 nnnn 21 nnnn 21 nnnn 24 nnnn 25 nnnn 25 nnnn 26 nnnn 26 nnnn 26 nnnn 39 nnnn	سرج بقبضة سرج بقبضة سرج ثابت سرج ثابت بأربع أسطوانات سرج ثابت سرج للتغيير سرج بقبضة طقم لمنع التسرب طقم لمنع التسرب طقم ماسك لسرج بقبضة (ماسك) طقم لدواة مدفوعة، مسمار تثبيت طقم للتركيب (طقم لدواة مدفوعة، مسمار تثبيت) طقم لدواة مدفوعة ز'دبُرْك للتثبيت	  	▲ 03.24dd-xxxx.3 → 03.0350-ddxx.2 → ▲ 03.25dd-xxxx.3 → 03.0450-ddxx.2 → 24.3728-xxxx.2 →	03 nnnn 07 ddx 04 nnnn 08 ddx 59 xxxx	الواصل - الأسطوانة المضغوطة على سبيل المثال (03.2419-: Ø=19,05) طقم منع التسرب الواصل - الأسطوانة المضغوطة على سبيل المثال (03.2525-: Ø=25,40) طقم منع التسرب كبل الواصل

ö	wy
0	0 = جهاز فردي
5	5 = جهاز مزدوج
6 = 2	0 = جهاز فردي
7 = 3	3 = BA = جهاز فردي
8 = 4	5 = جهاز فردي
9 = 5	8 = BA = جهاز فردي
10 = 6	BA = مساعد الفرملة
	Z = أجهزة الفرملة ذات مرسة للجانب

nnnn = الأرقام الأخيرة تمثل العدد الترتيبي

dd = المقاييس العادية

▲ رقم 24 جازز أيضا حسب نفس منهجية الترقيم
 ■ الأرقام 03، 24، و 83 جائزة أيضا حسب نفس منهجية الترقيم

لا يجوز إعادة طبع أو نسخ هذه الوثيقة ولو جزئيا إلا بترخيص مباشر من طرفنا. لا نعتبر بائية طلبات لتعويض أضرار أو خسائر قد تلحق من جراء استعمال البيانات والمعلومات المنصوص عليها بهذا الكتالوج. نحفظ بحق إجراء تعديلات على تصاميمنا. أرقام قطع الغيار لمصنعي السيارات الآتي ذكرها في هذه الوثيقة هي لغرض المقارنة فقط لا يجوز استعمال مثل هذه البيانات في إصدار الفواتير لأصحاب العربات.

نظرا لتعدد موديلات العربات و قطع الغيار فإنه ليس بالإمكان دائما الربط الدقيق بين المنتجات والأرقام. ولذلك فالرجاء الانتباه بالخصوص للملاحظات والبيانات التوضيحية الخاصة بقطع الغيار والمنصوص عليها في الكتالوج.

ATE – A Trademark of the
Continental Corporation

Continental Aftermarket GmbH

Guerickestraße 7
D-60488 Frankfurt am Main
Tel. +49 (0) 69 7603-1
Fax +49 (0) 69 761061

www.ate.de

**Continental Automotive Trading
Italia S.r.l.**

Divisione ATE
Via Matteotti, 62
I-20092 Cinisello Balsamo (MI)
Tel. +39 02 35680 1
Fax +39 02 35680 325
E-Mail: info.consumatori@continental-corporation.com

www.ate-freni.it

Continental AutomotiveFrance SAS

Parc Ariane Bâtiment Vénus
Rue Hélène Boucher
F-78280 Guyancourt
Tél. +33 (0)1 39 44 10 30
Fax +33 (0)1 39 44 10 40
E-Mail: 07GYFMAte-technique@continental-corporation.com

www.ate-freinage.fr

Continental Automotive Spain, S.A.

C/ Sepúlveda, 11
E-28108 Alcobendas (Madrid)
Phone +34 (0) 657 21 21
Fax +34 (0)91 657 21 49

www.frenos-ate.es