



Nuovi particolari a magazzino

secondo applicazioni veicolo

03/2017

www.ate.de





Descrizione

Codici OE -
Codice ATE

Pre-codice / varie

AUDI

A4 (B8) Avant (08-)	1,8 FSI	post.dx	04.2008		24.6243-1722.5	240783	Pinza freno posteriore	8K0 615 404 C	
	1,8 TFSI	post.dx	01.2012		24.6243-1722.5	240783	Pinza freno posteriore	8K0 615 404 C	
		post.dx	04.2008		24.6243-1722.5	240783	Pinza freno posteriore	8K0 615 404 C	
	1,8 TFSI quattro	post.dx	01.2012		24.6243-1722.5	240783	Pinza freno posteriore	8K0 615 404 C	
		post.dx	09.2008		24.6243-1722.5	240783	Pinza freno posteriore	8K0 615 404 C	
	2,0 TDI	post.dx	09.2013		24.6243-1722.5	240783	Pinza freno posteriore	8K0 615 404 C	
		post.dx	04.2008		24.6243-1722.5	240783	Pinza freno posteriore	8K0 615 404 C	
		post.dx	06.2008		24.6243-1722.5	240783	Pinza freno posteriore	8K0 615 404 C	
		post.dx	11.2011		24.6243-1722.5	240783	Pinza freno posteriore	8K0 615 404 C	
		post.dx	05.2013		24.6243-1722.5	240783	Pinza freno posteriore	8K0 615 404 C	
	2,0 TDI quattro	post.dx	04.2008		24.6243-1722.5	240783	Pinza freno posteriore	8K0 615 404 C	
		post.dx	05.2013		24.6243-1722.5	240783	Pinza freno posteriore	8K0 615 404 C	
		post.dx	08.2008		24.6243-1722.5	240783	Pinza freno posteriore	8K0 615 404 C	
		post.dx	09.2013		24.6243-1722.5	240783	Pinza freno posteriore	8K0 615 404 C	
		post.dx	11.2011		24.6243-1722.5	240783	Pinza freno posteriore	8K0 615 404 C	
	2,0 TFSI	post.dx	04.2008		24.6243-1722.5	240783	Pinza freno posteriore	8K0 615 404 C	
		post.dx	05.2013		24.6243-1722.5	240783	Pinza freno posteriore	8K0 615 404 C	
		post.dx	06.2008		24.6243-1722.5	240783	Pinza freno posteriore	8K0 615 404 C	
	2,0 TFSI quattro	post.dx	11.2009		24.6243-1722.5	240783	Pinza freno posteriore	8K0 615 404 C	
		post.dx	05.2013		24.6243-1722.5	240783	Pinza freno posteriore	8K0 615 404 C	
		post.dx	04.2008		24.6243-1722.5	240783	Pinza freno posteriore	8K0 615 404 C	



Descrizione

Codici OE -
Codice ATE

Pre-codice / varie

AUDI

A4 (B8) Avant (08-)	2,7 TDI	post.dx	06.2008		24.6243-1722.5	240783	Pinza freno posteriore	8K0 615 404 C	
	3,0 TDI	post.dx	11.2011		24.6243-1722.5	240783	Pinza freno posteriore	8K0 615 404 C	
	3,0 TDI quattro	post.dx	04.2008		24.6243-1722.5	240783	Pinza freno posteriore	8K0 615 404 C	
		post.dx	06.2008		24.6243-1722.5	240783	Pinza freno posteriore	8K0 615 404 C	
		post.dx	11.2011		24.6243-1722.5	240783	Pinza freno posteriore	8K0 615 404 C	
	3,0 TFSI quattro	post.dx	02.2012		24.6243-1722.5	240783	Pinza freno posteriore	8K0 615 404 C	
	3,2 FSI	post.dx	09.2008		24.6243-1722.5	240783	Pinza freno posteriore	8K0 615 404 C	
	3,2 FSI quattro	post.dx	04.2008		24.6243-1722.5	240783	Pinza freno posteriore	8K0 615 404 C	
A4 (B8) Berlina (07-)	1,8 TFSI	post.dx	01.2008		24.6243-1722.5	240783	Pinza freno posteriore	8K0 615 404 C	
		post.dx	01.2012		24.6243-1722.5	240783	Pinza freno posteriore	8K0 615 404 C	
		post.dx	11.2007		24.6243-1722.5	240783	Pinza freno posteriore	8K0 615 404 C	
	1,8 TFSI quattro	post.dx	09.2008		24.6243-1722.5	240783	Pinza freno posteriore	8K0 615 404 C	
		post.dx	01.2012		24.6243-1722.5	240783	Pinza freno posteriore	8K0 615 404 C	
	2,0 TDI	post.dx	01.2008		24.6243-1722.5	240783	Pinza freno posteriore	8K0 615 404 C	
		post.dx	06.2008		24.6243-1722.5	240783	Pinza freno posteriore	8K0 615 404 C	
		post.dx	08.2008		24.6243-1722.5	240783	Pinza freno posteriore	8K0 615 404 C	
		post.dx	09.2013		24.6243-1722.5	240783	Pinza freno posteriore	8K0 615 404 C	
		post.dx	11.2007		24.6243-1722.5	240783	Pinza freno posteriore	8K0 615 404 C	
		post.dx	11.2011		24.6243-1722.5	240783	Pinza freno posteriore	8K0 615 404 C	
		post.dx	05.2013		24.6243-1722.5	240783	Pinza freno posteriore	8K0 615 404 C	
	2,0 TDI quattro	post.dx	11.2011		24.6243-1722.5	240783	Pinza freno posteriore	8K0 615 404 C	



Descrizione

Codici OE -
Codice ATE

Pre-codice / varie

AUDI

A4 (B8) Berlina (07-)	2,0 TDI quattro	post.dx	09.2013		24.6243-1722.5	240783	Pinza freno posteriore	8K0 615 404 C	
		post.dx	05.2013		24.6243-1722.5	240783	Pinza freno posteriore	8K0 615 404 C	
		post.dx	01.2008		24.6243-1722.5	240783	Pinza freno posteriore	8K0 615 404 C	
	2,0 TFSI	post.dx	06.2008		24.6243-1722.5	240783	Pinza freno posteriore	8K0 615 404 C	
		post.dx	05.2013		24.6243-1722.5	240783	Pinza freno posteriore	8K0 615 404 C	
	2,0 TFSI quattro	post.dx	11.2009		24.6243-1722.5	240783	Pinza freno posteriore	8K0 615 404 C	
		post.dx	06.2008		24.6243-1722.5	240783	Pinza freno posteriore	8K0 615 404 C	
		post.dx	05.2013		24.6243-1722.5	240783	Pinza freno posteriore	8K0 615 404 C	
	2,7 TDI	post.dx	11.2007		24.6243-1722.5	240783	Pinza freno posteriore	8K0 615 404 C	
	3,0 TDI	post.dx	11.2011		24.6243-1722.5	240783	Pinza freno posteriore	8K0 615 404 C	
	3,0 TDI quattro	post.dx	11.2007		24.6243-1722.5	240783	Pinza freno posteriore	8K0 615 404 C	
		post.dx	11.2011		24.6243-1722.5	240783	Pinza freno posteriore	8K0 615 404 C	
		post.dx	06.2008		24.6243-1722.5	240783	Pinza freno posteriore	8K0 615 404 C	
	3,0 TFSI quattro	post.dx	02.2012		24.6243-1722.5	240783	Pinza freno posteriore	8K0 615 404 C	
	3,2 FSI	post.dx	09.2008		24.6243-1722.5	240783	Pinza freno posteriore	8K0 615 404 C	
	3,2 FSI quattro	post.dx	11.2007		24.6243-1722.5	240783	Pinza freno posteriore	8K0 615 404 C	
A5 / A5 Sportback (07-16)	1,8 TFSI	post.dx	06.2014		24.6243-1722.5	240783	Pinza freno posteriore	8K0 615 404 C	
		post.dx	10.2007		24.6243-1722.5	240783	Pinza freno posteriore	8K0 615 404 C	
		post.dx	05.2015		24.6243-1722.5	240783	Pinza freno posteriore	8K0 615 404 C	
		post.dx	05.2009		24.6243-1722.5	240783	Pinza freno posteriore	8K0 615 404 C	
	2,0 TDI	post.dx	08.2008		24.6243-1722.5	240783	Pinza freno posteriore	8K0 615 404 C	



Descrizione

Codici OE -
Codice ATE

Pre-codice / varie

AUDI

A5 / A5 Sportback (07-16)	2,0 TDI	post.dx	10.2008		24.6243-1722.5	240783	Pinza freno posteriore	8K0 615 404 C	
		post.dx	05.2013		24.6243-1722.5	240783	Pinza freno posteriore	8K0 615 404 C	
		post.dx	09.2009		24.6243-1722.5	240783	Pinza freno posteriore	8K0 615 404 C	
		post.dx	07.2011		24.6243-1722.5	240783	Pinza freno posteriore	8K0 615 404 C	
		post.dx	09.2013		24.6243-1722.5	240783	Pinza freno posteriore	8K0 615 404 C	
	2,0 TDI quattro	post.dx	12.2011		24.6243-1722.5	240783	Pinza freno posteriore	8K0 615 404 C	
		post.dx	08.2008		24.6243-1722.5	240783	Pinza freno posteriore	8K0 615 404 C	
		post.dx	09.2013		24.6243-1722.5	240783	Pinza freno posteriore	8K0 615 404 C	
	2,0 TFSI	post.dx	11.2008		24.6243-1722.5	240783	Pinza freno posteriore	8K0 615 404 C	
		post.dx	08.2015		24.6243-1722.5	240783	Pinza freno posteriore	8K0 615 404 C	
		post.dx	06.2008		24.6243-1722.5	240783	Pinza freno posteriore	8K0 615 404 C	
		post.dx	05.2013		24.6243-1722.5	240783	Pinza freno posteriore	8K0 615 404 C	
	2,0 TFSI quattro	post.dx	05.2013		24.6243-1722.5	240783	Pinza freno posteriore	8K0 615 404 C	
		post.dx	06.2008		24.6243-1722.5	240783	Pinza freno posteriore	8K0 615 404 C	
		post.dx	08.2015		24.6243-1722.5	240783	Pinza freno posteriore	8K0 615 404 C	
	2,7 TDI	post.dx	09.2007		24.6243-1722.5	240783	Pinza freno posteriore	8K0 615 404 C	
		post.dx	05.2007		24.6243-1722.5	240783	Pinza freno posteriore	8K0 615 404 C	
	3,0 TDI	post.dx	07.2011		24.6243-1722.5	240783	Pinza freno posteriore	8K0 615 404 C	
	3,0 TDI quattro	post.dx	05.2015		24.6243-1722.5	240783	Pinza freno posteriore	8K0 615 404 C	
		post.dx	03.2008		24.6243-1722.5	240783	Pinza freno posteriore	8K0 615 404 C	
		post.dx	05.2007		24.6243-1722.5	240783	Pinza freno posteriore	8K0 615 404 C	



Descrizione

Codici OE -
Codice ATE

Pre-codice / varie

AUDI

A5 / A5 Sportback (07-16)	3,0 TDI quattro	post.dx	07.2011		24.6243-1722.5	240783	Pinza freno posteriore	8K0 615 404 C	
	3,0 TFSI quattro	post.dx	12.2011		24.6243-1722.5	240783	Pinza freno posteriore	8K0 615 404 C	
	3,2 FSI	post.dx	05.2007		24.6243-1722.5	240783	Pinza freno posteriore	8K0 615 404 C	
	3,2 FSI quattro	post.dx	05.2007		24.6243-1722.5	240783	Pinza freno posteriore	8K0 615 404 C	
	RS 5	post.dx	03.2010		24.6243-1722.5	240783	Pinza freno posteriore	8K0 615 404 C	
	S5	post.dx	05.2007		24.6243-1722.5	240783	Pinza freno posteriore	8K0 615 404 C	
		post.dx	01.2010		24.6243-1722.5	240783	Pinza freno posteriore	8K0 615 404 C	
A5 Cabrio (09-16)	1,8 TFSI	post.dx	07.2011		24.6243-1722.5	240783	Pinza freno posteriore	8K0 615 404 C	
		post.dx	05.2015		24.6243-1722.5	240783	Pinza freno posteriore	8K0 615 404 C	
		post.dx	09.2009		24.6243-1722.5	240783	Pinza freno posteriore	8K0 615 404 C	
	2,0 TDI	post.dx	05.2009		24.6243-1722.5	240783	Pinza freno posteriore	8K0 615 404 C	
		post.dx	05.2013		24.6243-1722.5	240783	Pinza freno posteriore	8K0 615 404 C	
		post.dx	07.2011		24.6243-1722.5	240783	Pinza freno posteriore	8K0 615 404 C	
		post.dx	09.2013		24.6243-1722.5	240783	Pinza freno posteriore	8K0 615 404 C	
		post.dx	11.2011		24.6243-1722.5	240783	Pinza freno posteriore	8K0 615 404 C	
	2,0 TDI quattro	post.dx	09.2013		24.6243-1722.5	240783	Pinza freno posteriore	8K0 615 404 C	
		post.dx	01.2012		24.6243-1722.5	240783	Pinza freno posteriore	8K0 615 404 C	
	2,0 TFSI	post.dx	08.2015		24.6243-1722.5	240783	Pinza freno posteriore	8K0 615 404 C	
		post.dx	05.2013		24.6243-1722.5	240783	Pinza freno posteriore	8K0 615 404 C	
		post.dx	03.2009		24.6243-1722.5	240783	Pinza freno posteriore	8K0 615 404 C	
	2,0 TFSI quattro	post.dx	05.2013		24.6243-1722.5	240783	Pinza freno posteriore	8K0 615 404 C	



Descrizione

Codici OE -
Codice ATE

Pre-codice / varie

AUDI

A5 Cabrio (09-16)	2,0 TFSI quattro	post.dx	08.2015		24.6243-1722.5	240783	Pinza freno posteriore	8K0 615 404 C	
		post.dx	03.2009		24.6243-1722.5	240783	Pinza freno posteriore	8K0 615 404 C	
	2,7 TDI	post.dx	03.2009		24.6243-1722.5	240783	Pinza freno posteriore	8K0 615 404 C	
		post.dx	05.2009		24.6243-1722.5	240783	Pinza freno posteriore	8K0 615 404 C	
	3,0 TDI	post.dx	07.2011		24.6243-1722.5	240783	Pinza freno posteriore	8K0 615 404 C	
	3,0 TDI quattro	post.dx	05.2015		24.6243-1722.5	240783	Pinza freno posteriore	8K0 615 404 C	
		post.dx	03.2009		24.6243-1722.5	240783	Pinza freno posteriore	8K0 615 404 C	
		post.dx	07.2011		24.6243-1722.5	240783	Pinza freno posteriore	8K0 615 404 C	
	3,0 TFSI quattro	post.dx	11.2011		24.6243-1722.5	240783	Pinza freno posteriore	8K0 615 404 C	
	3,2 FSI	post.dx	03.2009		24.6243-1722.5	240783	Pinza freno posteriore	8K0 615 404 C	
	3,2 FSI quattro	post.dx	03.2009		24.6243-1722.5	240783	Pinza freno posteriore	8K0 615 404 C	
	S5	post.dx	04.2009		24.6243-1722.5	240783	Pinza freno posteriore	8K0 615 404 C	
A6 (4G2/C7) Limousine (11-)	1,8 TFSI	post.dx	09.2014		24.6243-1724.5	240799	Pinza freno posteriore	4G0 615 404 A	
	2,0 TDI	post.dx	01.2012		24.6243-1724.5	240799	Pinza freno posteriore	4G0 615 404 A	
		post.dx	09.2014		24.6243-1724.5	240799	Pinza freno posteriore	4G0 615 404 A	
		post.dx	04.2011		24.6243-1724.5	240799	Pinza freno posteriore	4G0 615 404 A	
	2,0 TDI quattro	post.dx	04.2015		24.6243-1724.5	240799	Pinza freno posteriore	4G0 615 404 A	
	2,0 TDI ultra	post.dx	11.2013		24.6243-1724.5	240799	Pinza freno posteriore	4G0 615 404 A	
	2,0 TFSI	post.dx	04.2011		24.6243-1724.5	240799	Pinza freno posteriore	4G0 615 404 A	
		post.dx	05.2013		24.6243-1724.5	240799	Pinza freno posteriore	4G0 615 404 A	
		post.dx	09.2014		24.6243-1724.5	240799	Pinza freno posteriore	4G0 615 404 A	



Descrizione

Codici OE -
Codice ATE

Pre-codice / varie

AUDI

A6 (4G2/C7) Limousine (11-)	2,0 TFSI hybrid	post.dx	11.2011		24.6243-1724.5	240799	Pinza freno posteriore	4G0 615 404 A	
	2,0 TFSI quattro	post.dx	05.2014		24.6243-1724.5	240799	Pinza freno posteriore	4G0 615 404 A	
		post.dx	05.2012		24.6243-1724.5	240799	Pinza freno posteriore	4G0 615 404 A	
		post.dx	05.2013		24.6243-1724.5	240799	Pinza freno posteriore	4G0 615 404 A	
	2,8 FSI	post.dx	04.2011		24.6243-1724.5	240799	Pinza freno posteriore	4G0 615 404 A	
	2,8 FSI quattro	post.dx	04.2011		24.6243-1724.5	240799	Pinza freno posteriore	4G0 615 404 A	
		post.dx	09.2014		24.6243-1724.5	240799	Pinza freno posteriore	4G0 615 404 A	
	3,0 TDI	post.dx	09.2014		24.6243-1724.5	240799	Pinza freno posteriore	4G0 615 404 A	
		post.dx	04.2011		24.6243-1724.5	240799	Pinza freno posteriore	4G0 615 404 A	
	3,0 TDI quattro	post.dx	05.2013		24.6243-1724.5	240799	Pinza freno posteriore	4G0 615 404 A	
		post.dx	09.2014		24.6243-1724.5	240799	Pinza freno posteriore	4G0 615 404 A	
		post.dx	12.2011		24.6243-1724.5	240799	Pinza freno posteriore	4G0 615 404 A	
		post.dx	04.2011		24.6243-1724.5	240799	Pinza freno posteriore	4G0 615 404 A	
	3,0 TFSI quattro	post.dx	04.2011		24.6243-1724.5	240799	Pinza freno posteriore	4G0 615 404 A	
		post.dx	09.2014		24.6243-1724.5	240799	Pinza freno posteriore	4G0 615 404 A	
	S6	post.dx	04.2012		24.6243-1724.5	240799	Pinza freno posteriore	4G0 615 404 A	
		post.dx	10.2014		24.6243-1724.5	240799	Pinza freno posteriore	4G0 615 404 A	
A6 (4G5/C7) Avant (11-)	1,8 TFSI	post.dx	09.2014		24.6243-1724.5	240799	Pinza freno posteriore	4G0 615 404 A	
	2,0 TDI	post.dx	09.2014		24.6243-1724.5	240799	Pinza freno posteriore	4G0 615 404 A	
		post.dx	01.2012		24.6243-1724.5	240799	Pinza freno posteriore	4G0 615 404 A	
		post.dx	09.2011		24.6243-1724.5	240799	Pinza freno posteriore	4G0 615 404 A	



Descrizione

Codici OE -
Codice ATE

Pre-codice / varie

AUDI

A6 (4G5/C7) Avant (11-)	2,0 TDI quattro	post.dx	04.2015		24.6243-1724.5	240799	Pinza freno posteriore	4G0 615 404 A	
	2,0 TDI ultra	post.dx	11.2013		24.6243-1724.5	240799	Pinza freno posteriore	4G0 615 404 A	
	2,0 TFSI	post.dx	06.2011		24.6243-1724.5	240799	Pinza freno posteriore	4G0 615 404 A	
		post.dx	09.2014		24.6243-1724.5	240799	Pinza freno posteriore	4G0 615 404 A	
	2,0 TFSI quattro	post.dx	05.2015		24.6243-1724.5	240799	Pinza freno posteriore	4G0 615 404 A	
	2,8 FSI	post.dx	09.2011		24.6243-1724.5	240799	Pinza freno posteriore	4G0 615 404 A	
	2,8 FSI quattro	post.dx	09.2011		24.6243-1724.5	240799	Pinza freno posteriore	4G0 615 404 A	
		post.dx	09.2014		24.6243-1724.5	240799	Pinza freno posteriore	4G0 615 404 A	
	3,0 TDI	post.dx	09.2011		24.6243-1724.5	240799	Pinza freno posteriore	4G0 615 404 A	
		post.dx	09.2014		24.6243-1724.5	240799	Pinza freno posteriore	4G0 615 404 A	
	3,0 TDI quattro	post.dx	09.2011		24.6243-1724.5	240799	Pinza freno posteriore	4G0 615 404 A	
		post.dx	09.2014		24.6243-1724.5	240799	Pinza freno posteriore	4G0 615 404 A	
		post.dx	12.2011		24.6243-1724.5	240799	Pinza freno posteriore	4G0 615 404 A	
	3,0 TFSI quattro	post.dx	09.2011		24.6243-1724.5	240799	Pinza freno posteriore	4G0 615 404 A	
		post.dx	09.2014		24.6243-1724.5	240799	Pinza freno posteriore	4G0 615 404 A	
	S6	post.dx	04.2012		24.6243-1724.5	240799	Pinza freno posteriore	4G0 615 404 A	
		post.dx	09.2014		24.6243-1724.5	240799	Pinza freno posteriore	4G0 615 404 A	
A6 Allroad (12-)	3,0 TDI quattro	post.dx	01.2012		24.6243-1724.5	240799	Pinza freno posteriore	4G0 615 404 A	
		post.dx	09.2014		24.6243-1724.5	240799	Pinza freno posteriore	4G0 615 404 A	
		post.dx	11.2015		24.6243-1724.5	240799	Pinza freno posteriore	4G0 615 404 A	
	3,0 TFSI quattro	post.dx	09.2014		24.6243-1724.5	240799	Pinza freno posteriore	4G0 615 404 A	



Descrizione

Codici OE -
Codice ATE

Pre-codice / varie

AUDI

A6 Allroad (12-)	3,0 TFSI quattro	post.dx	01.2012		24.6243-1724.5	240799	Pinza freno posteriore	4G0 615 404 A	
A7 Sportback (10-)	1,8 TFSI	post.dx	04.2015		24.6243-1724.5	240799	Pinza freno posteriore	4G0 615 404 A	
	2,0 TFSI	post.dx	09.2014		24.6243-1724.5	240799	Pinza freno posteriore	4G0 615 404 A	
	2,0 TFSI quattro	post.dx	05.2015		24.6243-1724.5	240799	Pinza freno posteriore	4G0 615 404 A	
	2,8 FSI	post.dx	05.2011		24.6243-1724.5	240799	Pinza freno posteriore	4G0 615 404 A	
	2,8 FSI quattro	post.dx	07.2010		24.6243-1724.5	240799	Pinza freno posteriore	4G0 615 404 A	
	3,0 TDI	post.dx	11.2015		24.6243-1724.5	240799	Pinza freno posteriore	4G0 615 404 A	
		post.dx	11.2010		24.6243-1724.5	240799	Pinza freno posteriore	4G0 615 404 A	
	3,0 TDI quattro	post.dx	05.2013		24.6243-1724.5	240799	Pinza freno posteriore	4G0 615 404 A	
		post.dx	07.2010		24.6243-1724.5	240799	Pinza freno posteriore	4G0 615 404 A	
		post.dx	08.2014		24.6243-1724.5	240799	Pinza freno posteriore	4G0 615 404 A	
		post.dx	11.2011		24.6243-1724.5	240799	Pinza freno posteriore	4G0 615 404 A	
		post.dx	11.2015		24.6243-1724.5	240799	Pinza freno posteriore	4G0 615 404 A	
		post.dx	05.2014		24.6243-1724.5	240799	Pinza freno posteriore	4G0 615 404 A	
	3,0 TDI ultra	post.dx	05.2014		24.6243-1724.5	240799	Pinza freno posteriore	4G0 615 404 A	
	3,0 TFSI quattro	post.dx	05.2014		24.6243-1724.5	240799	Pinza freno posteriore	4G0 615 404 A	
		post.dx	07.2010		24.6243-1724.5	240799	Pinza freno posteriore	4G0 615 404 A	
	S7	post.dx	10.2011		24.6243-1724.5	240799	Pinza freno posteriore	4G0 615 404 A	
		post.dx	05.2014		24.6243-1724.5	240799	Pinza freno posteriore	4G0 615 404 A	
A8 (09-)	2,0 TFSI hybrid	post.sx	05.2012		24.6243-1713.5	240715	Pinza freno posteriore	4H0 615 403	
	2,0 TFSI quattro	post.sx	09.2016		24.6243-1713.5	240715	Pinza freno posteriore	4H0 615 403	



Descrizione

Codici OE -
Codice ATE

Pre-codice / varie

AUDI

A8 (09-)	2,5 TFSI	post.sx	07.2012		24.6243-1713.5	240715	Pinza freno posteriore	4H0 615 403	
	3,0 TDI	post.sx	09.2011		24.6243-1713.5	240715	Pinza freno posteriore	4H0 615 403	
	3,0 TDI quattro	post.sx	07.2010		24.6243-1713.5	240715	Pinza freno posteriore	4H0 615 403	
		post.sx	09.2013		24.6243-1713.5	240715	Pinza freno posteriore	4H0 615 403	
	3,0 TFSI quattro	post.sx	07.2010		24.6243-1713.5	240715	Pinza freno posteriore	4H0 615 403	
	4,0 TFSI quattro	post.sx	09.2013		24.6243-1713.5	240715	Pinza freno posteriore	4H0 615 403	
		post.sx	03.2012		24.6243-1713.5	240715	Pinza freno posteriore	4H0 615 403	
	4,2 FSI quattro	post.sx	11.2009		24.6243-1713.5	240715	Pinza freno posteriore	4H0 615 403	
	4,2 TDI quattro	post.sx	11.2009		24.6243-1713.5	240715	Pinza freno posteriore	4H0 615 403	
		post.sx	09.2013		24.6243-1713.5	240715	Pinza freno posteriore	4H0 615 403	
	6,3 W12 quattro	post.sx	01.2011		24.6243-1713.5	240715	Pinza freno posteriore	4H0 615 403	
	S8	post.sx	04.2012		24.6243-1713.5	240715	Pinza freno posteriore	4H0 615 403	
A8 (94-02)	2,5 TDI quattro		06.1997	09.1998	24.5102-0250.3	331477	Tubo flessibile posteriore	4D0 611 775 B	83.6124-0252.3
	2,8 30V quattro		04.1996	09.1998	24.5102-0250.3	331477	Tubo flessibile posteriore	4D0 611 775 B	83.6124-0252.3
	2,8 quattro		07.1995	03.1996	24.5102-0250.3	331477	Tubo flessibile posteriore	4D0 611 775 B	83.6124-0252.3
			06.1994	03.1996	24.5102-0250.3	331477	Tubo flessibile posteriore	4D0 611 775 B	83.6124-0252.3
	3,7		07.1995	09.1998	24.5102-0250.3	331477	Tubo flessibile posteriore	4D0 611 775 B	83.6124-0252.3
	3,7 quattro		10.1995	09.1998	24.5102-0250.3	331477	Tubo flessibile posteriore	4D0 611 775 B	83.6124-0252.3
	4,2 quattro		06.1994	09.1998	24.5102-0250.3	331477	Tubo flessibile posteriore	4D0 611 775 B	83.6124-0252.3
	S8		06.1996	09.1998	24.5102-0250.3	331477	Tubo flessibile posteriore	4D0 611 775 B	83.6124-0252.3
Q5 (08-16)	2,0 TDI	post.dx	01.2013		24.6243-1722.5	240783	Pinza freno posteriore	8K0 615 404 C	



Descrizione

Codici OE -
Codice ATE

Pre-codice / varie

AUDI

Q5 (08-16)	2,0 TDI	post.dx	05.2013		24.6243-1722.5	240783	Pinza freno posteriore	8K0 615 404 C	
		post.dx	09.2015		24.6243-1722.5	240783	Pinza freno posteriore	8K0 615 404 C	
	2,0 TDI quattro	post.dx	01.2013		24.6243-1722.5	240783	Pinza freno posteriore	8K0 615 404 C	
		post.dx	05.2013		24.6243-1722.5	240783	Pinza freno posteriore	8K0 615 404 C	
	2,0 TFSI hybr,quattro	post.dx	01.2013		24.6243-1722.5	240783	Pinza freno posteriore	8K0 615 404 C	
	2,0 TFSI quattro	post.dx	01.2013		24.6243-1722.5	240783	Pinza freno posteriore	8K0 615 404 C	
		post.dx	05.2013		24.6243-1722.5	240783	Pinza freno posteriore	8K0 615 404 C	
		post.dx	08.2015		24.6243-1722.5	240783	Pinza freno posteriore	8K0 615 404 C	
	3,0 TDI quattro	post.dx	11.2013		24.6243-1722.5	240783	Pinza freno posteriore	8K0 615 404 C	
		post.dx	01.2013		24.6243-1722.5	240783	Pinza freno posteriore	8K0 615 404 C	
	3,0 TFSI quattro	post.dx	01.2013		24.6243-1722.5	240783	Pinza freno posteriore	8K0 615 404 C	
	3,2 FSI quattro	post.dx	01.2013		24.6243-1722.5	240783	Pinza freno posteriore	8K0 615 404 C	



Descrizione

Codici OE -
Codice ATE

Pre-codice / varie

BMW

1er Reihe/E81/E87 Limousine (04-11)	118 d	post.sx	09.2004	03.2007	24.3401-9933.5	240727	Pinza freno posteriore	34 21 6 768 693	
		post.dx	09.2004	03.2007	24.3401-9934.5	240728	Pinza freno posteriore	34 21 6 768 694	
		post.sx	04.2007	05.2011	24.3401-9933.5	240727	Pinza freno posteriore	34 21 6 768 693	
		post.dx	04.2007	05.2011	24.3401-9934.5	240728	Pinza freno posteriore	34 21 6 768 694	
	120 d	post.sx	03.2007	05.2011	24.3401-9933.5	240727	Pinza freno posteriore	34 21 6 768 693	
		post.sx	09.2004	02.2007	24.3401-9933.5	240727	Pinza freno posteriore	34 21 6 768 693	
		post.dx	03.2007	05.2011	24.3401-9934.5	240728	Pinza freno posteriore	34 21 6 768 694	
		post.dx	09.2004	02.2007	24.3401-9934.5	240728	Pinza freno posteriore	34 21 6 768 694	
1er Reihe/E82 Coupe (07-13)	118 d	post.dx	09.2009	10.2013	24.3401-9934.5	240728	Pinza freno posteriore	34 21 6 768 694	
		post.sx	09.2009	10.2013	24.3401-9933.5	240727	Pinza freno posteriore	34 21 6 768 693	
	120 d	post.sx	10.2007	10.2013	24.3401-9933.5	240727	Pinza freno posteriore	34 21 6 768 693	
		post.dx	10.2007	10.2013	24.3401-9934.5	240728	Pinza freno posteriore	34 21 6 768 694	
	120 i	post.dx	09.2009	10.2013	24.3401-9934.5	240728	Pinza freno posteriore	34 21 6 768 694	
		post.sx	09.2009	10.2013	24.3401-9933.5	240727	Pinza freno posteriore	34 21 6 768 693	
	125 i	post.dx	03.2008	10.2013	24.3401-9934.5	240728	Pinza freno posteriore	34 21 6 768 694	
		post.sx	03.2008	10.2013	24.3401-9933.5	240727	Pinza freno posteriore	34 21 6 768 693	
1er Reihe/E88 Cabrio (08-13)	118 d	post.dx	09.2008	10.2013	24.3401-9934.5	240728	Pinza freno posteriore	34 21 6 768 694	
		post.sx	09.2008	10.2013	24.3401-9933.5	240727	Pinza freno posteriore	34 21 6 768 693	
	118 i	post.dx	03.2008	10.2013	24.3401-9934.5	240728	Pinza freno posteriore	34 21 6 768 694	
		post.sx	03.2008	10.2013	24.3401-9933.5	240727	Pinza freno posteriore	34 21 6 768 693	
	120 d	post.dx	03.2008	10.2013	24.3401-9934.5	240728	Pinza freno posteriore	34 21 6 768 694	









						Descrizione	Codici OE - Codice ATE		Pre-codice / varie
---	---	---	--	---	--	--------------------	-----------------------------------	---	---------------------------

BMW

1er Reihe/E88 Cabrio (08-13)	120 d	post.sx	03.2008	10.2013	24.3401-9933.5	240727	Pinza freno posteriore	34 21 6 768 693	
	120 i	post.dx	03.2008	10.2013	24.3401-9934.5	240728	Pinza freno posteriore	34 21 6 768 694	
		post.sx	03.2008	10.2013	24.3401-9933.5	240727	Pinza freno posteriore	34 21 6 768 693	
	125 i	post.dx	03.2008	10.2013	24.3401-9934.5	240728	Pinza freno posteriore	34 21 6 768 694	
		post.sx	03.2008	10.2013	24.3401-9933.5	240727	Pinza freno posteriore	34 21 6 768 693	
	128 i	post.dx	03.2008	10.2013	24.3401-9934.5	240728	Pinza freno posteriore	34 21 6 768 694	
		post.sx	03.2008	10.2013	24.3401-9933.5	240727	Pinza freno posteriore	34 21 6 768 693	
2er Reihe/F22 Coupe (13-)	228 i		07.2014		24.0124-0248.1	424248	Discofreno ant.	34 11 6 792 221	
	230 i		09.2015		24.0124-0248.1	424248	Discofreno ant.	34 11 6 792 221	
2er Reihe/F23 Cabrio (14-)	228 i		11.2014		24.0124-0248.1	424248	Discofreno ant.	34 11 6 792 221	
	230 i		09.2015		24.0124-0248.1	424248	Discofreno ant.	34 11 6 792 221	
3er Reihe/F30 Limousine (11-)	325 d		04.2013		24.0124-0248.1	424248	Discofreno ant.	34 11 6 792 221	
			03.2016		24.0124-0248.1	424248	Discofreno ant.	34 11 6 792 221	
	328 i		02.2012		24.0124-0248.1	424248	Discofreno ant.	34 11 6 792 221	
	328 i xDrive		02.2012		24.0124-0248.1	424248	Discofreno ant.	34 11 6 792 221	
	330 d		09.2015		24.0124-0248.1	424248	Discofreno ant.	34 11 6 792 221	
			07.2012		24.0124-0248.1	424248	Discofreno ant.	34 11 6 792 221	
	330 d xDrive		09.2015		24.0124-0248.1	424248	Discofreno ant.	34 11 6 792 221	
			03.2013		24.0124-0248.1	424248	Discofreno ant.	34 11 6 792 221	
	330 i		07.2015		24.0124-0248.1	424248	Discofreno ant.	34 11 6 792 221	
	330 i xDrive		07.2015		24.0124-0248.1	424248	Discofreno ant.	34 11 6 792 221	



					Descrizione	Codici OE - Codice ATE	 Pre-codice / varie
---	---	---	--	---	--------------------	-----------------------------------	--

BMW

3er Reihe/F31 Touring (12-)	325 d		04.2013		24.0124-0248.1	424248	Discofreno ant.	34 11 6 792 221	
			03.2016		24.0124-0248.1	424248	Discofreno ant.	34 11 6 792 221	
	328 i		05.2012		24.0124-0248.1	424248	Discofreno ant.	34 11 6 792 221	
	328 i xDrive		03.2013		24.0124-0248.1	424248	Discofreno ant.	34 11 6 792 221	
	330 d		05.2012		24.0124-0248.1	424248	Discofreno ant.	34 11 6 792 221	
			09.2015		24.0124-0248.1	424248	Discofreno ant.	34 11 6 792 221	
	330 d xDrive		03.2013		24.0124-0248.1	424248	Discofreno ant.	34 11 6 792 221	
			09.2015		24.0124-0248.1	424248	Discofreno ant.	34 11 6 792 221	
	330 i		07.2015		24.0124-0248.1	424248	Discofreno ant.	34 11 6 792 221	
	330 i xDrive		07.2015		24.0124-0248.1	424248	Discofreno ant.	34 11 6 792 221	
3er Reihe/F34 GT (13-)	325 d		03.2013		24.0124-0248.1	424248	Discofreno ant.	34 11 6 792 221	
			07.2016		24.0124-0248.1	424248	Discofreno ant.	34 11 6 792 221	
	328 i		03.2013		24.0124-0248.1	424248	Discofreno ant.	34 11 6 792 221	
	328 i xDrive		03.2013		24.0124-0248.1	424248	Discofreno ant.	34 11 6 792 221	
	330 d		09.2015		24.0124-0248.1	424248	Discofreno ant.	34 11 6 792 221	
			03.2014		24.0124-0248.1	424248	Discofreno ant.	34 11 6 792 221	
	330 d xDrive		03.2014		24.0124-0248.1	424248	Discofreno ant.	34 11 6 792 221	
			09.2015		24.0124-0248.1	424248	Discofreno ant.	34 11 6 792 221	
	330 i		10.2015		24.0124-0248.1	424248	Discofreno ant.	34 11 6 792 221	
	330 i xDrive		10.2015		24.0124-0248.1	424248	Discofreno ant.	34 11 6 792 221	
	335 d xDrive		03.2014		24.0124-0248.1	424248	Discofreno ant.	34 11 6 792 221	



Descrizione

Codici OE -
Codice ATE

Pre-codice / varie

BMW

4er Reihe/F32 Coupe (13-)	425 d		03.2016		24.0124-0248.1	424248	Discofreno ant.	34 11 6 792 221	
			03.2014		24.0124-0248.1	424248	Discofreno ant.	34 11 6 792 221	
	428 i		07.2013		24.0124-0248.1	424248	Discofreno ant.	34 11 6 792 221	
	428 i xDrive		07.2013		24.0124-0248.1	424248	Discofreno ant.	34 11 6 792 221	
	430 d		07.2013		24.0124-0248.1	424248	Discofreno ant.	34 11 6 792 221	
	430 d xDrive		03.2014		24.0124-0248.1	424248	Discofreno ant.	34 11 6 792 221	
	430 i		03.2016		24.0124-0248.1	424248	Discofreno ant.	34 11 6 792 221	
	430 i xDrive		03.2016		24.0124-0248.1	424248	Discofreno ant.	34 11 6 792 221	
4er Reihe/F33 Cabrio (14-)	425 d		07.2014		24.0124-0248.1	424248	Discofreno ant.	34 11 6 792 221	
			03.2016		24.0124-0248.1	424248	Discofreno ant.	34 11 6 792 221	
	428 i		10.2013		24.0124-0248.1	424248	Discofreno ant.	34 11 6 792 221	
	428 i xDrive		10.2013		24.0124-0248.1	424248	Discofreno ant.	34 11 6 792 221	
	430 d		07.2014		24.0124-0248.1	424248	Discofreno ant.	34 11 6 792 221	
	430 i		03.2016		24.0124-0248.1	424248	Discofreno ant.	34 11 6 792 221	
	430 i xDrive		03.2016		24.0124-0248.1	424248	Discofreno ant.	34 11 6 792 221	
4er Reihe/F36 Gran Coupe (14-)	425 d		03.2016		24.0124-0248.1	424248	Discofreno ant.	34 11 6 792 221	
	428 i		03.2014		24.0124-0248.1	424248	Discofreno ant.	34 11 6 792 221	
	428 i xDrive		03.2014		24.0124-0248.1	424248	Discofreno ant.	34 11 6 792 221	
	430 d		07.2014		24.0124-0248.1	424248	Discofreno ant.	34 11 6 792 221	
	430 d xDrive		07.2014		24.0124-0248.1	424248	Discofreno ant.	34 11 6 792 221	
	430 i		03.2016		24.0124-0248.1	424248	Discofreno ant.	34 11 6 792 221	



Descrizione

Codici OE -
Codice ATE

Pre-codice / varie

BMW

4er Reihe/F36 Gran Coupe (14-)	430 i xDrive		03.2016		24.0124-0248.1	424248	Discofreno ant.	34 11 6 792 221	
5er Reihe/F10 Limousine (10-17)	518 d	post.dx	01.2013		24.6244-1704.5	240797	Pinza freno posteriore	34 21 6 793 042	
		post.dx	07.2014		24.6244-1704.5	240797	Pinza freno posteriore	34 21 6 793 042	
	520 d	post.dx	03.2010		24.6244-1704.5	240797	Pinza freno posteriore	34 21 6 793 042	
		post.dx	07.2014		24.6244-1704.5	240797	Pinza freno posteriore	34 21 6 793 042	
		post.dx	01.2013		24.6244-1704.5	240797	Pinza freno posteriore	34 21 6 793 042	
	520 d xDrive	post.dx	02.2013		24.6244-1704.5	240797	Pinza freno posteriore	34 21 6 793 042	
		post.dx	07.2014		24.6244-1704.5	240797	Pinza freno posteriore	34 21 6 793 042	
		post.dx	01.2013		24.6244-1704.5	240797	Pinza freno posteriore	34 21 6 793 042	
	520 i	post.dx	09.2011		24.6244-1704.5	240797	Pinza freno posteriore	34 21 6 793 042	
	523 i	post.dx	03.2010		24.6244-1704.5	240797	Pinza freno posteriore	34 21 6 793 042	
	525 d	post.dx	03.2010		24.6244-1704.5	240797	Pinza freno posteriore	34 21 6 793 042	
		post.dx	09.2011		24.6244-1704.5	240797	Pinza freno posteriore	34 21 6 793 042	
	525 d xDrive	post.dx	09.2011		24.6244-1704.5	240797	Pinza freno posteriore	34 21 6 793 042	
	528 i	post.dx	09.2011		24.6244-1704.5	240797	Pinza freno posteriore	34 21 6 793 042	
		post.dx	03.2010		24.6244-1704.5	240797	Pinza freno posteriore	34 21 6 793 042	
	528 i xDrive	post.dx	09.2011		24.6244-1704.5	240797	Pinza freno posteriore	34 21 6 793 042	
	530 d	post.dx	03.2010		24.6244-1704.5	240797	Pinza freno posteriore	34 21 6 793 042	
		post.dx	09.2011		24.6244-1704.5	240797	Pinza freno posteriore	34 21 6 793 042	
		post.dx	10.2015		24.6244-1704.5	240797	Pinza freno posteriore	34 21 6 793 042	
	530 d xDrive	post.dx	03.2011		24.6244-1704.5	240797	Pinza freno posteriore	34 21 6 793 042	



Descrizione







Codici OE -
Codice ATE

Pre-codice / varie

BMW

5er Reihe/F10 Limousine (10-17)	530 d xDrive	post.dx	10.2015		24.6244-1704.5	240797	Pinza freno posteriore	34 21 6 793 042	
	530 i	post.dx	09.2011		24.6244-1704.5	240797	Pinza freno posteriore	34 21 6 793 042	
5er Reihe/F11 Touring (10-)	518 d	post.dx	01.2013		24.6244-1704.5	240797	Pinza freno posteriore	34 21 6 793 042	
		post.dx	05.2014		24.6244-1704.5	240797	Pinza freno posteriore	34 21 6 793 042	
	520 d	post.dx	09.2010		24.6244-1704.5	240797	Pinza freno posteriore	34 21 6 793 042	
		post.dx	05.2014		24.6244-1704.5	240797	Pinza freno posteriore	34 21 6 793 042	
	520 d xDrive	post.dx	02.2013		24.6244-1704.5	240797	Pinza freno posteriore	34 21 6 793 042	
		post.dx	05.2014		24.6244-1704.5	240797	Pinza freno posteriore	34 21 6 793 042	
	520 i	post.dx	09.2011		24.6244-1704.5	240797	Pinza freno posteriore	34 21 6 793 042	
	523 i	post.dx	09.2010		24.6244-1704.5	240797	Pinza freno posteriore	34 21 6 793 042	
	525 d	post.dx	09.2010		24.6244-1704.5	240797	Pinza freno posteriore	34 21 6 793 042	
		post.dx	09.2011		24.6244-1704.5	240797	Pinza freno posteriore	34 21 6 793 042	
	525 d xDrive	post.dx	09.2011		24.6244-1704.5	240797	Pinza freno posteriore	34 21 6 793 042	
	528 i	post.dx	09.2010		24.6244-1704.5	240797	Pinza freno posteriore	34 21 6 793 042	
		post.dx	09.2011		24.6244-1704.5	240797	Pinza freno posteriore	34 21 6 793 042	
	528 i xDrive	post.dx	09.2011		24.6244-1704.5	240797	Pinza freno posteriore	34 21 6 793 042	
	530 d	post.dx	10.2015		24.6244-1704.5	240797	Pinza freno posteriore	34 21 6 793 042	
		post.dx	09.2010		24.6244-1704.5	240797	Pinza freno posteriore	34 21 6 793 042	
		post.dx	09.2011		24.6244-1704.5	240797	Pinza freno posteriore	34 21 6 793 042	
	530 i	post.dx	09.2011		24.6244-1704.5	240797	Pinza freno posteriore	34 21 6 793 042	









					Descrizione	Codici OE - Codice ATE	 Pre-codice / varie
---	---	---	--	---	-------------	---------------------------	---

CHEVROLET

AVEO (T300) (11-)	1,2 16V		03.2011	12.2011	24.3727-2903.2	582903	Cavi per freno a mano	95301023 , 95930035	
	1,3 D		07.2011	12.2011	24.3727-2903.2	582903	Cavi per freno a mano	95301023 , 95930035	
	1,4 16V		03.2011	12.2011	24.3727-2903.2	582903	Cavi per freno a mano	95301023 , 95930035	
	1,6 16V		03.2011	12.2011	24.3727-2903.2	582903	Cavi per freno a mano	95301023 , 95930035	
			06.2011	12.2011	24.3727-2903.2	582903	Cavi per freno a mano	95301023 , 95930035	
REZZO (05-09)	1,6 i 16V		08.2005	05.2009	24.3220-1747.3	020583	Cil.ruota posteriore	431335 , 93740568	
			03.2005	05.2009	24.3220-1747.3	020583	Cil.ruota posteriore	431335 , 93740568	
	2,0 i 16V		03.2005	05.2009	24.3220-1747.3	020583	Cil.ruota posteriore	431335 , 93740568	
			08.2005	05.2009	24.3220-1747.3	020583	Cil.ruota posteriore	431335 , 93740568	



					Descrizione	Codici OE - Codice ATE	 Pre-codice / varie
---	---	---	--	---	--------------------	-----------------------------------	--

Classic PKW

CHRYSLER VOYAGER (ES) (90-95)	2,5 i		08.1990	12.1995	24.3220-1748.3	020584	Cil.ruota posteriore	0 5252 617 , 0 4423 601 , 4423 601 , 5252 617	
	2,5 TD		01.1992	12.1995	24.3220-1748.3	020584	Cil.ruota posteriore	0 5252 617 , 0 4423 601 , 4423 601 , 5252 617	
	3,0 i		10.1990	12.1995	24.3220-1748.3	020584	Cil.ruota posteriore	0 5252 617 , 0 4423 601 , 4423 601 , 5252 617	
	3,3 i		08.1990	12.1995	24.3220-1748.3	020584	Cil.ruota posteriore	0 5252 617 , 0 4423 601 , 4423 601 , 5252 617	
FERRARI	308 GTB/GTS		04.1981	08.1985	83.7758-0381.3	331485	Tubo flessibile anteriore		
	Mondial		04.1981		83.7758-0381.3	331485	Tubo flessibile anteriore		
MERCEDES BENZ (R107) 280 SL-560 SL (71-89)	280 SL			07.1985	24.2523-1210.3	040105	Cilindro frizione	A 201 290 03 11 , A 201 290 01 11 , A 201 290 00 11 , A 001 295 61 07 , A 001 295 30 07 , A 001 295 29 07 , A 001 295 27 07 , A 001 295 14 07 , A 001 295 13 07 , 201 290 03 11 , 201 290 01 11 , 201 290 00 11 , 001 295 61 07 , 001 295 30 07 , 001 295 29 07	03.2523-1210.3
	300 SL		09.1985	08.1989	24.2523-1210.3	040105	Cilindro frizione	A 201 290 03 11 , A 201 290 01 11 , A 201 290 00 11 , A 001 295 61 07 , A 001 295 30 07 , A 001 295 29 07 , A 001 295 27 07 , A 001 295 14 07 , A 001 295 13 07 , 201 290 03 11 , 201 290 01 11 , 201 290 00 11 , 001 295 61 07 , 001 295 30 07 , 001 295 29 07	03.2523-1210.3



Descrizione

Codici OE -
Codice ATE

Pre-codice / varie

Classic PKW

MERCEDES BENZ (W123) 200-300 TD Turbo (76-85)	200		03.1980	09.1985	24.2523-1210.3	040105	Cilindro frizione	A 201 290 03 11 , A 201 290 01 11 , A 201 290 00 11 , A 001 295 61 07 , A 001 295 30 07 , A 001 295 29 07 , A 001 295 27 07 , A 001 295 14 07 , A 001 295 13 07 , 201 290 03 11 , 201 290 01 11 , 201 290 00 11 , 001 295 61 07 , 001 295 30 07 , 001 295 29 07	03.2523-1210.3
	200 D			03.1985	24.2523-1210.3	040105	Cilindro frizione	A 201 290 03 11 , A 201 290 01 11 , A 201 290 00 11 , A 001 295 61 07 , A 001 295 30 07 , A 001 295 29 07 , A 001 295 27 07 , A 001 295 14 07 , A 001 295 13 07 , 201 290 03 11 , 201 290 01 11 , 201 290 00 11 , 001 295 61 07 , 001 295 30 07 , 001 295 29 07	03.2523-1210.3
	200 T		11.1980	12.1985	24.2523-1210.3	040105	Cilindro frizione	A 201 290 03 11 , A 201 290 01 11 , A 201 290 00 11 , A 001 295 61 07 , A 001 295 30 07 , A 001 295 29 07 , A 001 295 27 07 , A 001 295 14 07 , A 001 295 13 07 , 201 290 03 11 , 201 290 01 11 , 201 290 00 11 , 001 295 61 07 , 001 295 30 07 , 001 295 29 07	03.2523-1210.3
	230 CE		06.1980	07.1985	24.2523-1210.3	040105	Cilindro frizione	A 201 290 03 11 , A 201 290 01 11 , A 201 290 00 11 , A 001 295 61 07 , A 001 295 30 07 , A 001 295 29 07 , A 001 295 27 07 , A 001 295 14 07 , A 001 295 13 07 , 201 290 03 11 , 201 290 01 11 , 201 290 00 11 , 001 295 61 07 , 001 295 30 07 , 001 295 29 07	03.2523-1210.3



Descrizione

Codici OE -
Codice ATE

Pre-codice / varie

Classic PKW

MERCEDES BENZ (W123) 200-300 TD Turbo (76-85)	230 E		06.1980	09.1985	24.2523-1210.3	040105	Cilindro frizione	A 201 290 03 11 , A 201 290 01 11 , A 201 290 00 11 , A 001 295 61 07 , A 001 295 30 07 , A 001 295 29 07 , A 001 295 27 07 , A 001 295 14 07 , A 001 295 13 07 , 201 290 03 11 , 201 290 01 11 , 201 290 00 11 , 001 295 61 07 , 001 295 30 07 , 001 295 29 07	03.2523-1210.3
	230 TE		06.1980	12.1985	24.2523-1210.3	040105	Cilindro frizione	A 201 290 03 11 , A 201 290 01 11 , A 201 290 00 11 , A 001 295 61 07 , A 001 295 30 07 , A 001 295 29 07 , A 001 295 27 07 , A 001 295 14 07 , A 001 295 13 07 , 201 290 03 11 , 201 290 01 11 , 201 290 00 11 , 001 295 61 07 , 001 295 30 07 , 001 295 29 07	03.2523-1210.3
	240 D			07.1985	24.2523-1210.3	040105	Cilindro frizione	A 201 290 03 11 , A 201 290 01 11 , A 201 290 00 11 , A 001 295 61 07 , A 001 295 30 07 , A 001 295 29 07 , A 001 295 27 07 , A 001 295 14 07 , A 001 295 13 07 , 201 290 03 11 , 201 290 01 11 , 201 290 00 11 , 001 295 61 07 , 001 295 30 07 , 001 295 29 07	03.2523-1210.3
	240 TD			12.1985	24.2523-1210.3	040105	Cilindro frizione	A 201 290 03 11 , A 201 290 01 11 , A 201 290 00 11 , A 001 295 61 07 , A 001 295 30 07 , A 001 295 29 07 , A 001 295 27 07 , A 001 295 14 07 , A 001 295 13 07 , 201 290 03 11 , 201 290 01 11 , 201 290 00 11 , 001 295 61 07 , 001 295 30 07 , 001 295 29 07	03.2523-1210.3



Descrizione

Codici OE -
Codice ATE

Pre-codice / varie

Classic PKW

MERCEDES BENZ (W124) Classe E (85-93)	200		01.1985	02.1990	24.2523-1210.3	040105	Cilindro frizione	A 201 290 03 11 , A 201 290 01 11 , A 201 290 00 11 , A 001 295 61 07 , A 001 295 30 07 , A 001 295 29 07 , A 001 295 27 07 , A 001 295 14 07 , A 001 295 13 07 , 201 290 03 11 , 201 290 01 11 , 201 290 00 11 , 001 295 61 07 , 001 295 30 07 , 001 295 29 07	03.2523-1210.3
	200 CE		04.1990	06.1993	24.2523-1210.3	040105	Cilindro frizione	A 201 290 03 11 , A 201 290 01 11 , A 201 290 00 11 , A 001 295 61 07 , A 001 295 30 07 , A 001 295 29 07 , A 001 295 27 07 , A 001 295 14 07 , A 001 295 13 07 , 201 290 03 11 , 201 290 01 11 , 201 290 00 11 , 001 295 61 07 , 001 295 30 07 , 001 295 29 07	03.2523-1210.3
	200 D		01.1985	06.1993	24.2523-1210.3	040105	Cilindro frizione	A 201 290 03 11 , A 201 290 01 11 , A 201 290 00 11 , A 001 295 61 07 , A 001 295 30 07 , A 001 295 29 07 , A 001 295 27 07 , A 001 295 14 07 , A 001 295 13 07 , 201 290 03 11 , 201 290 01 11 , 201 290 00 11 , 001 295 61 07 , 001 295 30 07 , 001 295 29 07	03.2523-1210.3
	200 E		01.1985	06.1993	24.2523-1210.3	040105	Cilindro frizione	A 201 290 03 11 , A 201 290 01 11 , A 201 290 00 11 , A 001 295 61 07 , A 001 295 30 07 , A 001 295 29 07 , A 001 295 27 07 , A 001 295 14 07 , A 001 295 13 07 , 201 290 03 11 , 201 290 01 11 , 201 290 00 11 , 001 295 61 07 , 001 295 30 07 , 001 295 29 07	03.2523-1210.3



Descrizione

Codici OE -
Codice ATE

Pre-codice / varie

Classic PKW

MERCEDES BENZ (W124) Classe E (85-93)	200 T		10.1985	02.1990	24.2523-1210.3	040105	Cilindro frizione	A 201 290 03 11 , A 201 290 01 11 , A 201 290 00 11 , A 001 295 61 07 , A 001 295 30 07 , A 001 295 29 07 , A 001 295 27 07 , A 001 295 14 07 , A 001 295 13 07 , 201 290 03 11 , 201 290 01 11 , 201 290 00 11 , 001 295 61 07 , 001 295 30 07 , 001 295 29 07	03.2523-1210.3
	200 TD		10.1985	08.1991	24.2523-1210.3	040105	Cilindro frizione	A 201 290 03 11 , A 201 290 01 11 , A 201 290 00 11 , A 001 295 61 07 , A 001 295 30 07 , A 001 295 29 07 , A 001 295 27 07 , A 001 295 14 07 , A 001 295 13 07 , 201 290 03 11 , 201 290 01 11 , 201 290 00 11 , 001 295 61 07 , 001 295 30 07 , 001 295 29 07	03.2523-1210.3
	200 TE		10.1988	06.1993	24.2523-1210.3	040105	Cilindro frizione	A 201 290 03 11 , A 201 290 01 11 , A 201 290 00 11 , A 001 295 61 07 , A 001 295 30 07 , A 001 295 29 07 , A 001 295 27 07 , A 001 295 14 07 , A 001 295 13 07 , 201 290 03 11 , 201 290 01 11 , 201 290 00 11 , 001 295 61 07 , 001 295 30 07 , 001 295 29 07	03.2523-1210.3
	230 CE		05.1987	08.1989	24.2523-1210.3	040105	Cilindro frizione	A 201 290 03 11 , A 201 290 01 11 , A 201 290 00 11 , A 001 295 61 07 , A 001 295 30 07 , A 001 295 29 07 , A 001 295 27 07 , A 001 295 14 07 , A 001 295 13 07 , 201 290 03 11 , 201 290 01 11 , 201 290 00 11 , 001 295 61 07 , 001 295 30 07 , 001 295 29 07	03.2523-1210.3



Descrizione

Codici OE -
Codice ATE

Pre-codice / varie

Classic PKW

MERCEDES BENZ (W124) Classe E (85-93)	230 E		01.1985	08.1989	24.2523-1210.3	040105	Cilindro frizione	A 201 290 03 11 , A 201 290 01 11 , A 201 290 00 11 , A 001 295 61 07 , A 001 295 30 07 , A 001 295 29 07 , A 001 295 27 07 , A 001 295 14 07 , A 001 295 13 07 , 201 290 03 11 , 201 290 01 11 , 201 290 00 11 , 001 295 61 07 , 001 295 30 07 , 001 295 29 07	03.2523-1210.3
	230 TE		10.1985	08.1989	24.2523-1210.3	040105	Cilindro frizione	A 201 290 03 11 , A 201 290 01 11 , A 201 290 00 11 , A 001 295 61 07 , A 001 295 30 07 , A 001 295 29 07 , A 001 295 27 07 , A 001 295 14 07 , A 001 295 13 07 , 201 290 03 11 , 201 290 01 11 , 201 290 00 11 , 001 295 61 07 , 001 295 30 07 , 001 295 29 07	03.2523-1210.3
	250 D		01.1985	08.1989	24.2523-1210.3	040105	Cilindro frizione	A 201 290 03 11 , A 201 290 01 11 , A 201 290 00 11 , A 001 295 61 07 , A 001 295 30 07 , A 001 295 29 07 , A 001 295 27 07 , A 001 295 14 07 , A 001 295 13 07 , 201 290 03 11 , 201 290 01 11 , 201 290 00 11 , 001 295 61 07 , 001 295 30 07 , 001 295 29 07	03.2523-1210.3
	250 TD		10.1985	08.1989	24.2523-1210.3	040105	Cilindro frizione	A 201 290 03 11 , A 201 290 01 11 , A 201 290 00 11 , A 001 295 61 07 , A 001 295 30 07 , A 001 295 29 07 , A 001 295 27 07 , A 001 295 14 07 , A 001 295 13 07 , 201 290 03 11 , 201 290 01 11 , 201 290 00 11 , 001 295 61 07 , 001 295 30 07 , 001 295 29 07	03.2523-1210.3



Descrizione

Codici OE -
Codice ATE

Pre-codice / varie

Classic PKW

MERCEDES BENZ (W124) Classe E (85-93)	260 E		01.1985	08.1989	24.2523-1210.3	040105	Cilindro frizione	A 201 290 03 11 , A 201 290 01 11 , A 201 290 00 11 , A 001 295 61 07 , A 001 295 30 07 , A 001 295 29 07 , A 001 295 27 07 , A 001 295 14 07 , A 001 295 13 07 , 201 290 03 11 , 201 290 01 11 , 201 290 00 11 , 001 295 61 07 , 001 295 30 07 , 001 295 29 07	03.2523-1210.3
	260 E 4-Matic		05.1985	08.1989	24.2523-1210.3	040105	Cilindro frizione	A 201 290 03 11 , A 201 290 01 11 , A 201 290 00 11 , A 001 295 61 07 , A 001 295 30 07 , A 001 295 29 07 , A 001 295 27 07 , A 001 295 14 07 , A 001 295 13 07 , 201 290 03 11 , 201 290 01 11 , 201 290 00 11 , 001 295 61 07 , 001 295 30 07 , 001 295 29 07	03.2523-1210.3
	300 CE		05.1987	08.1989	24.2523-1210.3	040105	Cilindro frizione	A 201 290 03 11 , A 201 290 01 11 , A 201 290 00 11 , A 001 295 61 07 , A 001 295 30 07 , A 001 295 29 07 , A 001 295 27 07 , A 001 295 14 07 , A 001 295 13 07 , 201 290 03 11 , 201 290 01 11 , 201 290 00 11 , 001 295 61 07 , 001 295 30 07 , 001 295 29 07	03.2523-1210.3
	300 D		01.1985	08.1989	24.2523-1210.3	040105	Cilindro frizione	A 201 290 03 11 , A 201 290 01 11 , A 201 290 00 11 , A 001 295 61 07 , A 001 295 30 07 , A 001 295 29 07 , A 001 295 27 07 , A 001 295 14 07 , A 001 295 13 07 , 201 290 03 11 , 201 290 01 11 , 201 290 00 11 , 001 295 61 07 , 001 295 30 07 , 001 295 29 07	03.2523-1210.3



Descrizione

Codici OE -
Codice ATE

Pre-codice / varie

Classic PKW

MERCEDES BENZ (W124) Classe E (85-93)	300 E		01.1985	08.1989	24.2523-1210.3	040105	Cilindro frizione	A 201 290 03 11 , A 201 290 01 11 , A 201 290 00 11 , A 001 295 61 07 , A 001 295 30 07 , A 001 295 29 07 , A 001 295 27 07 , A 001 295 14 07 , A 001 295 13 07 , 201 290 03 11 , 201 290 01 11 , 201 290 00 11 , 001 295 61 07 , 001 295 30 07 , 001 295 29 07	03.2523-1210.3
	300 E 4-Matic		11.1986	08.1989	24.2523-1210.3	040105	Cilindro frizione	A 201 290 03 11 , A 201 290 01 11 , A 201 290 00 11 , A 001 295 61 07 , A 001 295 30 07 , A 001 295 29 07 , A 001 295 27 07 , A 001 295 14 07 , A 001 295 13 07 , 201 290 03 11 , 201 290 01 11 , 201 290 00 11 , 001 295 61 07 , 001 295 30 07 , 001 295 29 07	03.2523-1210.3
	300 TD		04.1986	08.1989	24.2523-1210.3	040105	Cilindro frizione	A 201 290 03 11 , A 201 290 01 11 , A 201 290 00 11 , A 001 295 61 07 , A 001 295 30 07 , A 001 295 29 07 , A 001 295 27 07 , A 001 295 14 07 , A 001 295 13 07 , 201 290 03 11 , 201 290 01 11 , 201 290 00 11 , 001 295 61 07 , 001 295 30 07 , 001 295 29 07	03.2523-1210.3
	300 TE		10.1985	08.1989	24.2523-1210.3	040105	Cilindro frizione	A 201 290 03 11 , A 201 290 01 11 , A 201 290 00 11 , A 001 295 61 07 , A 001 295 30 07 , A 001 295 29 07 , A 001 295 27 07 , A 001 295 14 07 , A 001 295 13 07 , 201 290 03 11 , 201 290 01 11 , 201 290 00 11 , 001 295 61 07 , 001 295 30 07 , 001 295 29 07	03.2523-1210.3



Descrizione

Codici OE -
Codice ATE

Pre-codice / varie

Classic PKW

MERCEDES BENZ (W124) Classe E (85-93)	300 TE 4-Matic		11.1986	08.1989	24.2523-1210.3	040105	Cilindro frizione	A 201 290 03 11 , A 201 290 01 11 , A 201 290 00 11 , A 001 295 61 07 , A 001 295 30 07 , A 001 295 29 07 , A 001 295 27 07 , A 001 295 14 07 , A 001 295 13 07 , 201 290 03 11 , 201 290 01 11 , 201 290 00 11 , 001 295 61 07 , 001 295 30 07 , 001 295 29 07	03.2523-1210.3
MERCEDES BENZ (W126) 260 SE-560 SEC (80-91)	260 SE		09.1985	03.1991	24.2523-1210.3	040105	Cilindro frizione	A 201 290 03 11 , A 201 290 01 11 , A 201 290 00 11 , A 001 295 61 07 , A 001 295 30 07 , A 001 295 29 07 , A 001 295 27 07 , A 001 295 14 07 , A 001 295 13 07 , 201 290 03 11 , 201 290 01 11 , 201 290 00 11 , 001 295 61 07 , 001 295 30 07 , 001 295 29 07	03.2523-1210.3
	300 SE		09.1985	03.1991	24.2523-1210.3	040105	Cilindro frizione	A 201 290 03 11 , A 201 290 01 11 , A 201 290 00 11 , A 001 295 61 07 , A 001 295 30 07 , A 001 295 29 07 , A 001 295 27 07 , A 001 295 14 07 , A 001 295 13 07 , 201 290 03 11 , 201 290 01 11 , 201 290 00 11 , 001 295 61 07 , 001 295 30 07 , 001 295 29 07	03.2523-1210.3
	300 SEL		09.1985	03.1991	24.2523-1210.3	040105	Cilindro frizione	A 201 290 03 11 , A 201 290 01 11 , A 201 290 00 11 , A 001 295 61 07 , A 001 295 30 07 , A 001 295 29 07 , A 001 295 27 07 , A 001 295 14 07 , A 001 295 13 07 , 201 290 03 11 , 201 290 01 11 , 201 290 00 11 , 001 295 61 07 , 001 295 30 07 , 001 295 29 07	03.2523-1210.3



Descrizione

Codici OE -
Codice ATE

Pre-codice / varie

Classic PKW

MERCEDES BENZ (W201) 190-190 E 2,6 (82-93)	190		04.1982	02.1990	24.2523-1210.3	040105	Cilindro frizione	A 201 290 03 11 , A 201 290 01 11 , A 201 290 00 11 , A 001 295 61 07 , A 001 295 30 07 , A 001 295 29 07 , A 001 295 27 07 , A 001 295 14 07 , A 001 295 13 07 , 201 290 03 11 , 201 290 01 11 , 201 290 00 11 , 001 295 61 07 , 001 295 30 07 , 001 295 29 07	03.2523-1210.3
	190 D		09.1983	05.1993	24.2523-1210.3	040105	Cilindro frizione	A 201 290 03 11 , A 201 290 01 11 , A 201 290 00 11 , A 001 295 61 07 , A 001 295 30 07 , A 001 295 29 07 , A 001 295 27 07 , A 001 295 14 07 , A 001 295 13 07 , 201 290 03 11 , 201 290 01 11 , 201 290 00 11 , 001 295 61 07 , 001 295 30 07 , 001 295 29 07	03.2523-1210.3
	190 D 2,2		09.1983	09.1985	24.2523-1210.3	040105	Cilindro frizione	A 201 290 03 11 , A 201 290 01 11 , A 201 290 00 11 , A 001 295 61 07 , A 001 295 30 07 , A 001 295 29 07 , A 001 295 27 07 , A 001 295 14 07 , A 001 295 13 07 , 201 290 03 11 , 201 290 01 11 , 201 290 00 11 , 001 295 61 07 , 001 295 30 07 , 001 295 29 07	03.2523-1210.3
	190 D 2,5		05.1985	05.1993	24.2523-1210.3	040105	Cilindro frizione	A 201 290 03 11 , A 201 290 01 11 , A 201 290 00 11 , A 001 295 61 07 , A 001 295 30 07 , A 001 295 29 07 , A 001 295 27 07 , A 001 295 14 07 , A 001 295 13 07 , 201 290 03 11 , 201 290 01 11 , 201 290 00 11 , 001 295 61 07 , 001 295 30 07 , 001 295 29 07	03.2523-1210.3



Descrizione

Codici OE -
Codice ATE

Pre-codice / varie

Classic PKW

MERCEDES BENZ (W201) 190-190 E 2,6 (82-93)	190 E 1,8		03.1990	05.1993	24.2523-1210.3	040105	Cilindro frizione	A 201 290 03 11 , A 201 290 01 11 , A 201 290 00 11 , A 001 295 61 07 , A 001 295 30 07 , A 001 295 29 07 , A 001 295 27 07 , A 001 295 14 07 , A 001 295 13 07 , 201 290 03 11 , 201 290 01 11 , 201 290 00 11 , 001 295 61 07 , 001 295 30 07 , 001 295 29 07	03.2523-1210.3
	190 E 2,0		04.1982	05.1993	24.2523-1210.3	040105	Cilindro frizione	A 201 290 03 11 , A 201 290 01 11 , A 201 290 00 11 , A 001 295 61 07 , A 001 295 30 07 , A 001 295 29 07 , A 001 295 27 07 , A 001 295 14 07 , A 001 295 13 07 , 201 290 03 11 , 201 290 01 11 , 201 290 00 11 , 001 295 61 07 , 001 295 30 07 , 001 295 29 07	03.2523-1210.3
	190 E 2,3		09.1983	05.1993	24.2523-1210.3	040105	Cilindro frizione	A 201 290 03 11 , A 201 290 01 11 , A 201 290 00 11 , A 001 295 61 07 , A 001 295 30 07 , A 001 295 29 07 , A 001 295 27 07 , A 001 295 14 07 , A 001 295 13 07 , 201 290 03 11 , 201 290 01 11 , 201 290 00 11 , 001 295 61 07 , 001 295 30 07 , 001 295 29 07	03.2523-1210.3
	190 E 2,3 16V		07.1984	08.1988	24.2523-1210.3	040105	Cilindro frizione	A 201 290 03 11 , A 201 290 01 11 , A 201 290 00 11 , A 001 295 61 07 , A 001 295 30 07 , A 001 295 29 07 , A 001 295 27 07 , A 001 295 14 07 , A 001 295 13 07 , 201 290 03 11 , 201 290 01 11 , 201 290 00 11 , 001 295 61 07 , 001 295 30 07 , 001 295 29 07	03.2523-1210.3



Descrizione

Codici OE -
Codice ATE

Pre-codice / varie

Classic PKW

MERCEDES BENZ (W201) 190-190 E 2,6 (82-93)	190 E 2,5 16V		09.1988	05.1993	24.2523-1210.3	040105	Cilindro frizione	A 201 290 03 11 , A 201 290 01 11 , A 201 290 00 11 , A 001 295 61 07 , A 001 295 30 07 , A 001 295 29 07 , A 001 295 27 07 , A 001 295 14 07 , A 001 295 13 07 , 201 290 03 11 , 201 290 01 11 , 201 290 00 11 , 001 295 61 07 , 001 295 30 07 , 001 295 29 07	03.2523-1210.3
	190 E 2,5 16V Evolut,		03.1989	05.1993	24.2523-1210.3	040105	Cilindro frizione	A 201 290 03 11 , A 201 290 01 11 , A 201 290 00 11 , A 001 295 61 07 , A 001 295 30 07 , A 001 295 29 07 , A 001 295 27 07 , A 001 295 14 07 , A 001 295 13 07 , 201 290 03 11 , 201 290 01 11 , 201 290 00 11 , 001 295 61 07 , 001 295 30 07 , 001 295 29 07	03.2523-1210.3
	190 E 2,6		04.1986		24.2523-1210.3	040105	Cilindro frizione	A 201 290 03 11 , A 201 290 01 11 , A 201 290 00 11 , A 001 295 61 07 , A 001 295 30 07 , A 001 295 29 07 , A 001 295 27 07 , A 001 295 14 07 , A 001 295 13 07 , 201 290 03 11 , 201 290 01 11 , 201 290 00 11 , 001 295 61 07 , 001 295 30 07 , 001 295 29 07	03.2523-1210.3
MERCEDES BENZ E-Klasse (W124) Limousine (93-95)	E 200		06.1993	06.1995	24.2523-1210.3	040105	Cilindro frizione	A 201 290 03 11 , A 201 290 01 11 , A 201 290 00 11 , A 001 295 61 07 , A 001 295 30 07 , A 001 295 29 07 , A 001 295 27 07 , A 001 295 14 07 , A 001 295 13 07 , 201 290 03 11 , 201 290 01 11 , 201 290 00 11 , 001 295 61 07 , 001 295 30 07 , 001 295 29 07	03.2523-1210.3



Descrizione

Codici OE -
Codice ATE

Pre-codice / varie

Classic PKW

MERCEDES BENZ E-Klasse (W124) Limousine (93-95)	E 200 D		06.1993	06.1995	24.2523-1210.3	040105	Cilindro frizione	A 201 290 03 11 , A 201 290 01 11 , A 201 290 00 11 , A 001 295 61 07 , A 001 295 30 07 , A 001 295 29 07 , A 001 295 27 07 , A 001 295 14 07 , A 001 295 13 07 , 201 290 03 11 , 201 290 01 11 , 201 290 00 11 , 001 295 61 07 , 001 295 30 07 , 001 295 29 07	03.2523-1210.3
MERCEDES BENZ G Classe (W460) (79-93)	230 GE		04.1982	07.1993	24.2523-1210.3	040105	Cilindro frizione	A 201 290 03 11 , A 201 290 01 11 , A 201 290 00 11 , A 001 295 61 07 , A 001 295 30 07 , A 001 295 29 07 , A 001 295 27 07 , A 001 295 14 07 , A 001 295 13 07 , 201 290 03 11 , 201 290 01 11 , 201 290 00 11 , 001 295 61 07 , 001 295 30 07 , 001 295 29 07	03.2523-1210.3
	250 GD		08.1987	07.1993	24.2523-1210.3	040105	Cilindro frizione	A 201 290 03 11 , A 201 290 01 11 , A 201 290 00 11 , A 001 295 61 07 , A 001 295 30 07 , A 001 295 29 07 , A 001 295 27 07 , A 001 295 14 07 , A 001 295 13 07 , 201 290 03 11 , 201 290 01 11 , 201 290 00 11 , 001 295 61 07 , 001 295 30 07 , 001 295 29 07	03.2523-1210.3
MERCEDES BENZ G-Klasse (W461) (90-)			02.1990		24.2523-1210.3	040105	Cilindro frizione	A 201 290 03 11 , A 201 290 01 11 , A 201 290 00 11 , A 001 295 61 07 , A 001 295 30 07 , A 001 295 29 07 , A 001 295 27 07 , A 001 295 14 07 , A 001 295 13 07 , 201 290 03 11 , 201 290 01 11 , 201 290 00 11 , 001 295 61 07 , 001 295 30 07 , 001 295 29 07	03.2523-1210.3



Descrizione

Codici OE -
Codice ATE

Pre-codice / varie

Classic PKW

MERCEDES BENZ G-Klasse (W461) (90-)	290 GD		04.1992		24.2523-1210.3	040105	Cilindro frizione	A 201 290 03 11 , A 201 290 01 11 , A 201 290 00 11 , A 001 295 61 07 , A 001 295 30 07 , A 001 295 29 07 , A 001 295 27 07 , A 001 295 14 07 , A 001 295 13 07 , 201 290 03 11 , 201 290 01 11 , 201 290 00 11 , 001 295 61 07 , 001 295 30 07 , 001 295 29 07	03.2523-1210.3
	G 290 TD		07.1997		24.2523-1210.3	040105	Cilindro frizione	A 201 290 03 11 , A 201 290 01 11 , A 201 290 00 11 , A 001 295 61 07 , A 001 295 30 07 , A 001 295 29 07 , A 001 295 27 07 , A 001 295 14 07 , A 001 295 13 07 , 201 290 03 11 , 201 290 01 11 , 201 290 00 11 , 001 295 61 07 , 001 295 30 07 , 001 295 29 07	03.2523-1210.3



Descrizione

Codici OE -
Codice ATE

Pre-codice / varie

DACIA

DUSTER (HS_) (10-)	1,2 TCe 125 4x4		06.2015		03.0520-8019.3	698019	Topkit Originale Ate posteriori	44 0A 036 57R	
			06.2015		03.0137-0507.2	650507	Serie qanasce posteriori	44 06 074 93R	
	1,5 dCi 4x4		10.2010		03.0520-8019.3	698019	Topkit Originale Ate posteriori	44 0A 036 57R	
			06.2010		03.0520-8019.3	698019	Topkit Originale Ate posteriori	44 0A 036 57R	
			08.2013		03.0520-8019.3	698019	Topkit Originale Ate posteriori	44 0A 036 57R	
			10.2010		03.0137-0507.2	650507	Serie qanasce posteriori	44 06 074 93R	
			06.2010		03.0137-0507.2	650507	Serie qanasce posteriori	44 06 074 93R	
			08.2013		03.0137-0507.2	650507	Serie qanasce posteriori	44 06 074 93R	
	1,6 16V 4x4		06.2010		03.0520-8019.3	698019	Topkit Originale Ate posteriori	44 0A 036 57R	
			06.2010		03.0137-0507.2	650507	Serie qanasce posteriori	44 06 074 93R	
	1,6 SCe 115 4x4		06.2015		03.0520-8019.3	698019	Topkit Originale Ate posteriori	44 0A 036 57R	
			06.2015		03.0137-0507.2	650507	Serie qanasce posteriori	44 06 074 93R	

DAEWOO

REZZO (00-05)	1,6 i 16V		09.2000	08.2005	24.3220-1747.3	020583	Cil.ruota posteriore	431335 , 93740568	
	1,8 i		09.2000	08.2005	24.3220-1747.3	020583	Cil.ruota posteriore	431335 , 93740568	
	2,0 i 16V		09.2000	08.2005	24.3220-1747.3	020583	Cil.ruota posteriore	431335 , 93740568	

FIAT

500 L Kombi (12-)	1,4		01.2014		13.0460-7302.2	607302	Serie pastiglie anteriore	77366915	v. foto
	1,6 D Multijet		09.2013		13.0460-7302.2	607302	Serie pastiglie anteriore	77366915	v. foto



Descrizione

Codici OE -
Codice ATE

Pre-codice / varie

FORD

C-MAX II (10-)	1,0 EcoBoost		09.2012		24.5140-0420.3	331503	Tubo flessibile posteriore	AV61-2282-AC , 1681131	
	1,5 EcoBoost		03.2015		24.5140-0420.3	331503	Tubo flessibile posteriore	AV61-2282-AC , 1681131	
	1,5 TDCi		03.2015		24.5140-0420.3	331503	Tubo flessibile posteriore	AV61-2282-AC , 1681131	
	1,5 TDCi ECOnetic		03.2015		24.5140-0420.3	331503	Tubo flessibile posteriore	AV61-2282-AC , 1681131	
	1,6 CNG		01.2013		24.5140-0420.3	331503	Tubo flessibile posteriore	AV61-2282-AC , 1681131	
	1,6 EcoBoost		12.2010		24.5140-0420.3	331503	Tubo flessibile posteriore	AV61-2282-AC , 1681131	
	1,6 Flexifuel		02.2011		24.5140-0420.3	331503	Tubo flessibile posteriore	AV61-2282-AC , 1681131	
	1,6 LPG		02.2012		24.5140-0420.3	331503	Tubo flessibile posteriore	AV61-2282-AC , 1681131	
	1,6 TDCi		12.2010		24.5140-0420.3	331503	Tubo flessibile posteriore	AV61-2282-AC , 1681131	
	1,6 Ti-VCT		02.2012		24.5140-0420.3	331503	Tubo flessibile posteriore	AV61-2282-AC , 1681131	
			12.2010		24.5140-0420.3	331503	Tubo flessibile posteriore	AV61-2282-AC , 1681131	
	2,0 Energi Hybrid		01.2015		24.5140-0420.3	331503	Tubo flessibile posteriore	AV61-2282-AC , 1681131	
	2,0 TDCi		02.2011		24.5140-0420.3	331503	Tubo flessibile posteriore	AV61-2282-AC , 1681131	
			03.2015		24.5140-0420.3	331503	Tubo flessibile posteriore	AV61-2282-AC , 1681131	
			12.2010		24.5140-0420.3	331503	Tubo flessibile posteriore	AV61-2282-AC , 1681131	
FOCUS III (11-)	1,0 EcoBoost		02.2012		24.5140-0420.3	331503	Tubo flessibile posteriore	AV61-2282-AC , 1681131	
	1,5 EcoBoost		09.2014		24.5140-0420.3	331503	Tubo flessibile posteriore	AV61-2282-AC , 1681131	
	1,5 TDCi		09.2014		24.5140-0420.3	331503	Tubo flessibile posteriore	AV61-2282-AC , 1681131	
	1,5 TDCi ECOnetic		09.2014		24.5140-0420.3	331503	Tubo flessibile posteriore	AV61-2282-AC , 1681131	
	1,6 EcoBoost		03.2011		24.5140-0420.3	331503	Tubo flessibile posteriore	AV61-2282-AC , 1681131	
	1,6 Flexifuel		07.2013		24.5140-0420.3	331503	Tubo flessibile posteriore	AV61-2282-AC , 1681131	



Descrizione





Codici OE -
Codice ATE

Pre-codice / varie

FORD

FOCUS III (11-)	1,6 LPG		02.2012		24.5140-0420.3	331503	Tubo flessibile posteriore	AV61-2282-AC , 1681131	
	1,6 TDCi		03.2011		24.5140-0420.3	331503	Tubo flessibile posteriore	AV61-2282-AC , 1681131	
	1,6 TDCi ECOnetic		04.2012		24.5140-0420.3	331503	Tubo flessibile posteriore	AV61-2282-AC , 1681131	
	1,6 Ti-VCT		02.2012		24.5140-0420.3	331503	Tubo flessibile posteriore	AV61-2282-AC , 1681131	
			03.2011		24.5140-0420.3	331503	Tubo flessibile posteriore	AV61-2282-AC , 1681131	
			08.2011		24.5140-0420.3	331503	Tubo flessibile posteriore	AV61-2282-AC , 1681131	
	1,6 Ti-VCT Flexifuel		03.2011		24.5140-0420.3	331503	Tubo flessibile posteriore	AV61-2282-AC , 1681131	
	2		10.2013		24.5140-0420.3	331503	Tubo flessibile posteriore	AV61-2282-AC , 1681131	
	2,0 EcoBoost ST		06.2012		24.5140-0420.3	331503	Tubo flessibile posteriore	AV61-2282-AC , 1681131	
	2,0 TDCi		03.2011		24.5140-0420.3	331503	Tubo flessibile posteriore	AV61-2282-AC , 1681131	
			11.2014		24.5140-0420.3	331503	Tubo flessibile posteriore	AV61-2282-AC , 1681131	
	2,0 Ti-GDi		08.2011		24.5140-0420.3	331503	Tubo flessibile posteriore	AV61-2282-AC , 1681131	
	2,3 RS				24.5140-0420.3	331503	Tubo flessibile posteriore	AV61-2282-AC , 1681131	
	Electric		07.2013		24.5140-0420.3	331503	Tubo flessibile posteriore	AV61-2282-AC , 1681131	
GRAND C-MAX (10-)	1,0 EcoBoost		09.2012		24.5140-0420.3	331503	Tubo flessibile posteriore	AV61-2282-AC , 1681131	
	1,5 EcoBoost		03.2015		24.5140-0420.3	331503	Tubo flessibile posteriore	AV61-2282-AC , 1681131	
	1,5 TDCi		03.2015		24.5140-0420.3	331503	Tubo flessibile posteriore	AV61-2282-AC , 1681131	
	1,6 EcoBoost		12.2010		24.5140-0420.3	331503	Tubo flessibile posteriore	AV61-2282-AC , 1681131	
	1,6 Flexifuel		02.2011		24.5140-0420.3	331503	Tubo flessibile posteriore	AV61-2282-AC , 1681131	
	1,6 LPG		02.2012		24.5140-0420.3	331503	Tubo flessibile posteriore	AV61-2282-AC , 1681131	
	1,6 TDCi		12.2010		24.5140-0420.3	331503	Tubo flessibile posteriore	AV61-2282-AC , 1681131	



				Descrizione	Codici OE - Codice ATE	 Pre-codice / varie
---	---	--	---	--------------------	-----------------------------------	---

FORD

GRAND C-MAX (10-)	1,6 Ti-VCT		12.2010		24.5140-0420.3	331503	Tubo flessibile posteriore	AV61-2282-AC , 1681131	
	2,0 TDCi		03.2015		24.5140-0420.3	331503	Tubo flessibile posteriore	AV61-2282-AC , 1681131	
			12.2010		24.5140-0420.3	331503	Tubo flessibile posteriore	AV61-2282-AC , 1681131	



Descrizione

Codici OE -
Codice ATE

Pre-codice / varie

JAGUAR

TIPO S (CCX) (99-08)	4,2 V8			10.2007	13.0460-7292.2	607292	Serie pastiglie anteriore	C2C 39929 , C2C 27290 , C2C 35612	v. foto
XF (CC9) (08-)	2,0 16V		06.2012		13.0460-7292.2	607292	Serie pastiglie anteriore	C2C 39929 , C2C 27290 , C2C 35612	v. foto
	2,2 D		04.2011		13.0460-7292.2	607292	Serie pastiglie anteriore	C2C 39929 , C2C 27290 , C2C 35612	v. foto
			05.2011		13.0460-7292.2	607292	Serie pastiglie anteriore	C2C 39929 , C2C 27290 , C2C 35612	v. foto
			03.2012		13.0460-7292.2	607292	Serie pastiglie anteriore	C2C 39929 , C2C 27290 , C2C 35612	v. foto
	2,7 D		03.2008		13.0460-7292.2	607292	Serie pastiglie anteriore	C2C 39929 , C2C 27290 , C2C 35612	v. foto
	3,0 D		03.2009		13.0460-7292.2	607292	Serie pastiglie anteriore	C2C 39929 , C2C 27290 , C2C 35612	v. foto
	3,0 V6		03.2008		13.0460-7292.2	607292	Serie pastiglie anteriore	C2C 39929 , C2C 27290 , C2C 35612	v. foto
	4,2 V8		03.2008		13.0460-7292.2	607292	Serie pastiglie anteriore	C2C 39929 , C2C 27290 , C2C 35612	v. foto
XF Sportbrake (CC9) (12-)	2,2 D		09.2012		13.0460-7292.2	607292	Serie pastiglie anteriore	C2C 39929 , C2C 27290 , C2C 35612	v. foto
	3,0 D		09.2012		13.0460-7292.2	607292	Serie pastiglie anteriore	C2C 39929 , C2C 27290 , C2C 35612	v. foto
XJ (X350,X358) (03-09)	XJ6 2,7 D		10.2005		13.0460-7292.2	607292	Serie pastiglie anteriore	C2C 39929 , C2C 27290 , C2C 35612	v. foto
XK8 CABRIOLET (06-)	3,6 V8		10.2007		13.0460-7292.2	607292	Serie pastiglie anteriore	C2C 39929 , C2C 27290 , C2C 35612	v. foto
	4,2		09.2007		13.0460-7292.2	607292	Serie pastiglie anteriore	C2C 39929 , C2C 27290 , C2C 35612	v. foto



Descrizione

Codici OE -
Codice ATE

Pre-codice / varie

JAGUAR

XK8 CABRIOLET (06-)	4,2 XK8		03.2006		13.0460-7292.2	607292	Serie pastiglie anteriore	C2C 39929 , C2C 27290 , C2C 35612	v. foto
	4,2 XKR		03.2006		13.0460-7292.2	607292	Serie pastiglie anteriore	C2C 39929 , C2C 27290 , C2C 35612	v. foto
			08.2006		13.0460-7292.2	607292	Serie pastiglie anteriore	C2C 39929 , C2C 27290 , C2C 35612	v. foto
	5,0 V8		01.2009		13.0460-7292.2	607292	Serie pastiglie anteriore	C2C 39929 , C2C 27290 , C2C 35612	v. foto
XK Coupe (06-)	3,5 XK		07.2007		13.0460-7292.2	607292	Serie pastiglie anteriore	C2C 39929 , C2C 27290 , C2C 35612	v. foto
	4,2 XK8		03.2006		13.0460-7292.2	607292	Serie pastiglie anteriore	C2C 39929 , C2C 27290 , C2C 35612	v. foto
	4,2 XKR		03.2006		13.0460-7292.2	607292	Serie pastiglie anteriore	C2C 39929 , C2C 27290 , C2C 35612	v. foto
			08.2006		13.0460-7292.2	607292	Serie pastiglie anteriore	C2C 39929 , C2C 27290 , C2C 35612	v. foto
	5,0 V8		01.2009		13.0460-7292.2	607292	Serie pastiglie anteriore	C2C 39929 , C2C 27290 , C2C 35612	v. foto



Descrizione

Codici OE -
Codice ATE

Pre-codice / varie

JEEP

CHEROKEE (XJ) (95-01)	2,5 i 4x4		10.1996	09.2001	24.3220-1748.3	020584	Cil.ruota posteriore	0 5252 617 , 0 4423 601 , 4423 601 , 5252 617	
	2,5 TDi 4x4		10.1996	09.2001	24.3220-1748.3	020584	Cil.ruota posteriore	0 5252 617 , 0 4423 601 , 4423 601 , 5252 617	
	4,0 i 4x4		01.1995	09.2001	24.3220-1748.3	020584	Cil.ruota posteriore	0 5252 617 , 0 4423 601 , 4423 601 , 5252 617	
WRANGLER II (TJ) (96-07)	2,4		11.2002	04.2007	24.3220-1748.3	020584	Cil.ruota posteriore	0 5252 617 , 0 4423 601 , 4423 601 , 5252 617	
	2,5		08.1996	04.2007	24.3220-1748.3	020584	Cil.ruota posteriore	0 5252 617 , 0 4423 601 , 4423 601 , 5252 617	
	3,8		02.2006	04.2007	24.3220-1748.3	020584	Cil.ruota posteriore	0 5252 617 , 0 4423 601 , 4423 601 , 5252 617	
	4		06.1998	04.2007	24.3220-1748.3	020584	Cil.ruota posteriore	0 5252 617 , 0 4423 601 , 4423 601 , 5252 617	
			08.1996	04.2007	24.3220-1748.3	020584	Cil.ruota posteriore	0 5252 617 , 0 4423 601 , 4423 601 , 5252 617	
			06.1998	03.2006	24.3220-1748.3	020584	Cil.ruota posteriore	0 5252 617 , 0 4423 601 , 4423 601 , 5252 617	
	4,0 Rubicon		08.2003	04.2007	24.3220-1748.3	020584	Cil.ruota posteriore	0 5252 617 , 0 4423 601 , 4423 601 , 5252 617	

LEXUS

ES 350 (06-12)	3,5 V6	post.dx	01.2007	06.2012	24.5296-0562.3	331482	Tube flessibile posteriore	90947-02F60	
----------------	--------	---------	---------	---------	----------------	--------	----------------------------	-------------	--



				Descrizione	Codici OE - Codice ATE		Pre-codice / varie
--	--	--	--	-------------	---------------------------	--	--------------------

MAZDA

3 (BM) (13-)	1,5 Skyaktiv-D 105		02.2016		13.0460-5658.2	605658	Serie pastiglie anteriore	BHY1-33-28ZA	v. foto
	1,5 Skyaktiv-G 100		09.2013		13.0460-5658.2	605658	Serie pastiglie anteriore	BHY1-33-28ZA	v. foto
	1,6 Skyaktiv-G 105		09.2013		13.0460-5658.2	605658	Serie pastiglie anteriore	BHY1-33-28ZA	v. foto
	2,0 Skyaktiv-G 120		09.2013		13.0460-5658.2	605658	Serie pastiglie anteriore	BHY1-33-28ZA	v. foto
	2,0 Skyaktiv-G 150		09.2013		13.0460-5658.2	605658	Serie pastiglie anteriore	BHY1-33-28ZA	v. foto
	2,0 Skyaktiv-G 165		09.2013		13.0460-5658.2	605658	Serie pastiglie anteriore	BHY1-33-28ZA	v. foto
	2,2 Skyaktiv-D 150		09.2013		13.0460-5658.2	605658	Serie pastiglie anteriore	BHY1-33-28ZA	v. foto
CX-3 (15-)	1,5 D		01.2015		13.0460-5658.2	605658	Serie pastiglie anteriore	BHY1-33-28ZA	v. foto
	1,5 D AWD		01.2015		13.0460-5658.2	605658	Serie pastiglie anteriore	BHY1-33-28ZA	v. foto
	2		05.2015		13.0460-5658.2	605658	Serie pastiglie anteriore	BHY1-33-28ZA	v. foto
	2,0 AWD		05.2015		13.0460-5658.2	605658	Serie pastiglie anteriore	BHY1-33-28ZA	v. foto



					Descrizione	Codici OE - Codice ATE		Pre-codice / varie
--	--	--	--	--	--------------------	-----------------------------------	--	---------------------------

MERCEDES BENZ

A-Klasse (W176) (12-)	A 160		07.2015		24.4123-1718.3	011016	Pompa freno	A 246 430 03 01 , A 246 430 00 01 , 246 430 03 01 , 246 430 00 01	
	A 160 CDI		06.2013		24.4123-1718.3	011016	Pompa freno	A 246 430 03 01 , A 246 430 00 01 , 246 430 03 01 , 246 430 00 01	
	A 180		06.2012		24.4123-1718.3	011016	Pompa freno	A 246 430 03 01 , A 246 430 00 01 , 246 430 03 01 , 246 430 00 01	
	A 180 CDI		06.2012		24.4123-1718.3	011016	Pompa freno	A 246 430 03 01 , A 246 430 00 01 , 246 430 03 01 , 246 430 00 01	
	A 200		06.2012		24.4123-1718.3	011016	Pompa freno	A 246 430 03 01 , A 246 430 00 01 , 246 430 03 01 , 246 430 00 01	
	A 200 CDI		02.2014		24.4123-1718.3	011016	Pompa freno	A 246 430 03 01 , A 246 430 00 01 , 246 430 03 01 , 246 430 00 01	
			06.2012	02.2014	24.4123-1718.3	011016	Pompa freno	A 246 430 03 01 , A 246 430 00 01 , 246 430 03 01 , 246 430 00 01	
	A 200 CDI 4-Matic		02.2014		24.4123-1718.3	011016	Pompa freno	A 246 430 03 01 , A 246 430 00 01 , 246 430 03 01 , 246 430 00 01	
	A 220 4-matic		05.2014		24.4123-1718.3	011016	Pompa freno	A 246 430 03 01 , A 246 430 00 01 , 246 430 03 01 , 246 430 00 01	
	A 220 CDI		06.2012		24.4123-1718.3	011016	Pompa freno	A 246 430 03 01 , A 246 430 00 01 , 246 430 03 01 , 246 430 00 01	
	A 220 CDI 4-Matic		09.2012		24.4123-1718.3	011016	Pompa freno	A 246 430 03 01 , A 246 430 00 01 , 246 430 03 01 , 246 430 00 01	



Descrizione

Codici OE -
Codice ATE

Pre-codice / varie

MERCEDES BENZ

A-Klasse (W176) (12-)	A 220 d		07.2015		24.4123-1718.3	011016	Pompa freno	A 246 430 03 01 , A 246 430 00 01 , 246 430 03 01 , 246 430 00 01	
	A 220 d 4-matic		07.2015		24.4123-1718.3	011016	Pompa freno	A 246 430 03 01 , A 246 430 00 01 , 246 430 03 01 , 246 430 00 01	
	A 250		06.2012		24.4123-1718.3	011016	Pompa freno	A 246 430 03 01 , A 246 430 00 01 , 246 430 03 01 , 246 430 00 01	
			07.2015		24.4123-1718.3	011016	Pompa freno	A 246 430 03 01 , A 246 430 00 01 , 246 430 03 01 , 246 430 00 01	
	A 250 4-matic		07.2015		24.4123-1718.3	011016	Pompa freno	A 246 430 03 01 , A 246 430 00 01 , 246 430 03 01 , 246 430 00 01	
			06.2013		24.4123-1718.3	011016	Pompa freno	A 246 430 03 01 , A 246 430 00 01 , 246 430 03 01 , 246 430 00 01	
	A 45 AMG		06.2013		24.4123-1718.3	011016	Pompa freno	A 246 430 03 01 , A 246 430 00 01 , 246 430 03 01 , 246 430 00 01	
B-Klasse (W246/W242) (11-)	B 160		07.2015		24.4123-1718.3	011016	Pompa freno	A 246 430 03 01 , A 246 430 00 01 , 246 430 03 01 , 246 430 00 01	
	B 160 CDI		05.2013		24.4123-1718.3	011016	Pompa freno	A 246 430 03 01 , A 246 430 00 01 , 246 430 03 01 , 246 430 00 01	
	B 180		11.2011		24.4123-1718.3	011016	Pompa freno	A 246 430 03 01 , A 246 430 00 01 , 246 430 03 01 , 246 430 00 01	
	B 180 CDI		11.2011		24.4123-1718.3	011016	Pompa freno	A 246 430 03 01 , A 246 430 00 01 , 246 430 03 01 , 246 430 00 01	



Descrizione

Codici OE -
Codice ATE

Pre-codice / varie

MERCEDES BENZ

B-Klasse (W246/W242) (11-)	B 200 CDI		08.2014		24.4123-1718.3	011016	Pompa freno	A 246 430 03 01 , A 246 430 00 01 , 246 430 03 01 , 246 430 00 01	
			11.2011		24.4123-1718.3	011016	Pompa freno	A 246 430 03 01 , A 246 430 00 01 , 246 430 03 01 , 246 430 00 01	
	B 200 CDI 4-matic		08.2014		24.4123-1718.3	011016	Pompa freno	A 246 430 03 01 , A 246 430 00 01 , 246 430 03 01 , 246 430 00 01	
	B 200 CGI		11.2011		24.4123-1718.3	011016	Pompa freno	A 246 430 03 01 , A 246 430 00 01 , 246 430 03 01 , 246 430 00 01	
	B 200 Natural Gas		11.2012		24.4123-1718.3	011016	Pompa freno	A 246 430 03 01 , A 246 430 00 01 , 246 430 03 01 , 246 430 00 01	
	B 220 4-matic		09.2014		24.4123-1718.3	011016	Pompa freno	A 246 430 03 01 , A 246 430 00 01 , 246 430 03 01 , 246 430 00 01	
			05.2013		24.4123-1718.3	011016	Pompa freno	A 246 430 03 01 , A 246 430 00 01 , 246 430 03 01 , 246 430 00 01	
	B 220 CDI		09.2014		24.4123-1718.3	011016	Pompa freno	A 246 430 03 01 , A 246 430 00 01 , 246 430 03 01 , 246 430 00 01	
			12.2012		24.4123-1718.3	011016	Pompa freno	A 246 430 03 01 , A 246 430 00 01 , 246 430 03 01 , 246 430 00 01	
	B 250		09.2012		24.4123-1718.3	011016	Pompa freno	A 246 430 03 01 , A 246 430 00 01 , 246 430 03 01 , 246 430 00 01	
	B 250 4-matic		08.2014		24.4123-1718.3	011016	Pompa freno	A 246 430 03 01 , A 246 430 00 01 , 246 430 03 01 , 246 430 00 01	



Descrizione

Codici OE -
Codice ATE

Pre-codice / varie

MERCEDES BENZ

C-Klasse (C204) Coupe (11-)	C 200 CGI		06.2011		24.0328-0155.1	528155	Discofreno ant.	A 212 421 13 12 , A 204 421 25 12 , A 204 421 07 12 , 204 421 25 12 , 212 421 13 12 , 204 421 07 12	
	C 220 CDI		06.2011		24.0328-0155.1	528155	Discofreno ant.	A 212 421 13 12 , A 204 421 25 12 , A 204 421 07 12 , 204 421 25 12 , 212 421 13 12 , 204 421 07 12	
	C 250 CDI		06.2011		24.0328-0155.1	528155	Discofreno ant.	A 212 421 13 12 , A 204 421 25 12 , A 204 421 07 12 , 204 421 25 12 , 212 421 13 12 , 204 421 07 12	
	C 250 CGI		06.2011		24.0328-0155.1	528155	Discofreno ant.	A 212 421 13 12 , A 204 421 25 12 , A 204 421 07 12 , 204 421 25 12 , 212 421 13 12 , 204 421 07 12	
C Classe (CL203) Sportcoupé (01-08)	C 160 Kompressor		04.2005	05.2008	24.2536-5001.3	090014	Cilindro frizione	0B8 141 671 , A 000 254 28 08 , A 000 254 17 08 , 000 254 28 08 , 000 254 17 08	
	C 180		03.2001	05.2008	24.2536-5001.3	090014	Cilindro frizione	0B8 141 671 , A 000 254 28 08 , A 000 254 17 08 , 000 254 28 08 , 000 254 17 08	
	C 180 Kompressor		05.2002	05.2008	24.2536-5001.3	090014	Cilindro frizione	0B8 141 671 , A 000 254 28 08 , A 000 254 17 08 , 000 254 28 08 , 000 254 17 08	
	C 200 CDI		07.2003	05.2008	24.2536-5001.3	090014	Cilindro frizione	0B8 141 671 , A 000 254 28 08 , A 000 254 17 08 , 000 254 28 08 , 000 254 17 08	
	C 200 CGI Kompressor		07.2003	05.2008	24.2536-5001.3	090014	Cilindro frizione	0B8 141 671 , A 000 254 28 08 , A 000 254 17 08 , 000 254 28 08 , 000 254 17 08	
	C 200 Kompressor		03.2001	05.2008	24.2536-5001.3	090014	Cilindro frizione	0B8 141 671 , A 000 254 28 08 , A 000 254 17 08 , 000 254 28 08 , 000 254 17 08	



Descrizione







Codici OE -
Codice ATE

Pre-codice / varie

MERCEDES BENZ

C Classe (CL203) Sportcoupé (01-08)	C 220		05.2002	05.2008	24.2536-5001.3	090014	Cilindro frizione	0B8 141 671 , A 000 254 28 08 , A 000 254 17 08 , 000 254 28 08 , 000 254 17 08	
	C 220 CDI		03.2001	05.2008	24.2536-5001.3	090014	Cilindro frizione	0B8 141 671 , A 000 254 28 08 , A 000 254 17 08 , 000 254 28 08 , 000 254 17 08	
	C 230		06.2005	05.2008	24.2536-5001.3	090014	Cilindro frizione	0B8 141 671 , A 000 254 28 08 , A 000 254 17 08 , 000 254 28 08 , 000 254 17 08	
	C 230 Kompressor		03.2001	05.2008	24.2536-5001.3	090014	Cilindro frizione	0B8 141 671 , A 000 254 28 08 , A 000 254 17 08 , 000 254 28 08 , 000 254 17 08	
	C 320		09.2002	05.2008	24.2536-5001.3	090014	Cilindro frizione	0B8 141 671 , A 000 254 28 08 , A 000 254 17 08 , 000 254 28 08 , 000 254 17 08	
C Classe (S203) Station Wagon (01-07)	C 180		03.2001	09.2007	24.2536-5001.3	090014	Cilindro frizione	0B8 141 671 , A 000 254 28 08 , A 000 254 17 08 , 000 254 28 08 , 000 254 17 08	
	C 180 Kompressor		05.2002	09.2007	24.2536-5001.3	090014	Cilindro frizione	0B8 141 671 , A 000 254 28 08 , A 000 254 17 08 , 000 254 28 08 , 000 254 17 08	
	C 200 CDI		03.2001	09.2007	24.2536-5001.3	090014	Cilindro frizione	0B8 141 671 , A 000 254 28 08 , A 000 254 17 08 , 000 254 28 08 , 000 254 17 08	
			04.2003	09.2007	24.2536-5001.3	090014	Cilindro frizione	0B8 141 671 , A 000 254 28 08 , A 000 254 17 08 , 000 254 28 08 , 000 254 17 08	
	C 200 CGI Kompressor		07.2003	09.2007	24.2536-5001.3	090014	Cilindro frizione	0B8 141 671 , A 000 254 28 08 , A 000 254 17 08 , 000 254 28 08 , 000 254 17 08	
	C 200 Kompressor		03.2001	04.2002	24.2536-5001.3	090014	Cilindro frizione	0B8 141 671 , A 000 254 28 08 , A 000 254 17 08 , 000 254 28 08 , 000 254 17 08	



					Descrizione	Codici OE - Codice ATE		Pre-codice / varie
---	---	---	--	---	-------------	---------------------------	---	--------------------

MERCEDES BENZ

C Classe (S203) Station Wagon (01-07)	C 200 Kompressor		05.2002	09.2007	24.2536-5001.3	090014	Cilindro frizione	0B8 141 671 , A 000 254 28 08 , A 000 254 17 08 , 000 254 28 08 , 000 254 17 08	
	C 220 CDI		03.2001	09.2007	24.2536-5001.3	090014	Cilindro frizione	0B8 141 671 , A 000 254 28 08 , A 000 254 17 08 , 000 254 28 08 , 000 254 17 08	
			02.2004	09.2007	24.2536-5001.3	090014	Cilindro frizione	0B8 141 671 , A 000 254 28 08 , A 000 254 17 08 , 000 254 28 08 , 000 254 17 08	
	C 230		06.2005	09.2007	24.2536-5001.3	090014	Cilindro frizione	0B8 141 671 , A 000 254 28 08 , A 000 254 17 08 , 000 254 28 08 , 000 254 17 08	
	C 230 Kompressor		02.2004	09.2007	24.2536-5001.3	090014	Cilindro frizione	0B8 141 671 , A 000 254 28 08 , A 000 254 17 08 , 000 254 28 08 , 000 254 17 08	
	C 240		03.2001	09.2007	24.2536-5001.3	090014	Cilindro frizione	0B8 141 671 , A 000 254 28 08 , A 000 254 17 08 , 000 254 28 08 , 000 254 17 08	
	C 270 CDI		03.2001	09.2007	24.2536-5001.3	090014	Cilindro frizione	0B8 141 671 , A 000 254 28 08 , A 000 254 17 08 , 000 254 28 08 , 000 254 17 08	
	C 280		06.2005	09.2007	24.2536-5001.3	090014	Cilindro frizione	0B8 141 671 , A 000 254 28 08 , A 000 254 17 08 , 000 254 28 08 , 000 254 17 08	
	C 320		03.2001	09.2007	24.2536-5001.3	090014	Cilindro frizione	0B8 141 671 , A 000 254 28 08 , A 000 254 17 08 , 000 254 28 08 , 000 254 17 08	
	C 320 CDI		02.2005	09.2007	24.2536-5001.3	090014	Cilindro frizione	0B8 141 671 , A 000 254 28 08 , A 000 254 17 08 , 000 254 28 08 , 000 254 17 08	
C-Klasse (S204) Kombi (07-14)	C 200 CDI		09.2007	08.2014	24.0328-0155.1	528155	Discofreno ant.	A 212 421 13 12 , A 204 421 25 12 , A 204 421 07 12 , 204 421 25 12 , 212 421 13 12 , 204 421 07 12	



Descrizione

Codici OE -
Codice ATE

Pre-codice / varie

MERCEDES BENZ

C-Klasse (S204) Kombi (07-14)	C 200 CGI		04.2009	08.2014	24.0328-0155.1	528155	Discofreno ant.	A 212 421 13 12 , A 204 421 25 12 , A 204 421 07 12 , 204 421 25 12 , 212 421 13 12 , 204 421 07 12	
	C 200 Kompressor		09.2007	08.2014	24.0328-0155.1	528155	Discofreno ant.	A 212 421 13 12 , A 204 421 25 12 , A 204 421 07 12 , 204 421 25 12 , 212 421 13 12 , 204 421 07 12	
	C 220 CDI		01.2007	08.2014	24.0328-0155.1	528155	Discofreno ant.	A 212 421 13 12 , A 204 421 25 12 , A 204 421 07 12 , 204 421 25 12 , 212 421 13 12 , 204 421 07 12	
			09.2007	08.2014	24.0328-0155.1	528155	Discofreno ant.	A 212 421 13 12 , A 204 421 25 12 , A 204 421 07 12 , 204 421 25 12 , 212 421 13 12 , 204 421 07 12	
			12.2008	08.2014	24.0328-0155.1	528155	Discofreno ant.	A 212 421 13 12 , A 204 421 25 12 , A 204 421 07 12 , 204 421 25 12 , 212 421 13 12 , 204 421 07 12	
	C 220 CDI 4-matic		02.2013	08.2014	24.0328-0155.1	528155	Discofreno ant.	A 212 421 13 12 , A 204 421 25 12 , A 204 421 07 12 , 204 421 25 12 , 212 421 13 12 , 204 421 07 12	
	C 230		09.2007	08.2014	24.0328-0155.1	528155	Discofreno ant.	A 212 421 13 12 , A 204 421 25 12 , A 204 421 07 12 , 204 421 25 12 , 212 421 13 12 , 204 421 07 12	
	C 250 CDI		04.2009	08.2014	24.0328-0155.1	528155	Discofreno ant.	A 212 421 13 12 , A 204 421 25 12 , A 204 421 07 12 , 204 421 25 12 , 212 421 13 12 , 204 421 07 12	
	C 250 CDI 4matic		04.2009	08.2014	24.0328-0155.1	528155	Discofreno ant.	A 212 421 13 12 , A 204 421 25 12 , A 204 421 07 12 , 204 421 25 12 , 212 421 13 12 , 204 421 07 12	



					Descrizione	Codici OE - Codice ATE		Pre-codice / varie
--	--	--	--	--	-------------	---------------------------	--	--------------------

MERCEDES BENZ

C-Klasse (S204) Kombi (07-14)	C 250 CGI		04.2009	08.2014	24.0328-0155.1	528155	Discofreno ant.	A 212 421 13 12 , A 204 421 25 12 , A 204 421 07 12 , 204 421 25 12 , 212 421 13 12 , 204 421 07 12	
	C 280		09.2007	08.2014	24.0328-0155.1	528155	Discofreno ant.	A 212 421 13 12 , A 204 421 25 12 , A 204 421 07 12 , 204 421 25 12 , 212 421 13 12 , 204 421 07 12	
	C 300		08.2007	08.2014	24.0328-0155.1	528155	Discofreno ant.	A 212 421 13 12 , A 204 421 25 12 , A 204 421 07 12 , 204 421 25 12 , 212 421 13 12 , 204 421 07 12	
C Classe (W203) Berlina (00-07)	C 180		04.2000	04.2007	24.2536-5001.3	090014	Cilindro frizione	0B8 141 671 , A 000 254 28 08 , A 000 254 17 08 , 000 254 28 08 , 000 254 17 08	
	C 180 Kompressor		05.2002	04.2007	24.2536-5001.3	090014	Cilindro frizione	0B8 141 671 , A 000 254 28 08 , A 000 254 17 08 , 000 254 28 08 , 000 254 17 08	
	C 200 CDI		04.2003	04.2007	24.2536-5001.3	090014	Cilindro frizione	0B8 141 671 , A 000 254 28 08 , A 000 254 17 08 , 000 254 28 08 , 000 254 17 08	
			04.2000	04.2007	24.2536-5001.3	090014	Cilindro frizione	0B8 141 671 , A 000 254 28 08 , A 000 254 17 08 , 000 254 28 08 , 000 254 17 08	
	C 200 CGI Kompressor		07.2003	04.2007	24.2536-5001.3	090014	Cilindro frizione	0B8 141 671 , A 000 254 28 08 , A 000 254 17 08 , 000 254 28 08 , 000 254 17 08	
	C 200 Kompressor		04.2000	04.2007	24.2536-5001.3	090014	Cilindro frizione	0B8 141 671 , A 000 254 28 08 , A 000 254 17 08 , 000 254 28 08 , 000 254 17 08	
			05.2000	05.2002	24.2536-5001.3	090014	Cilindro frizione	0B8 141 671 , A 000 254 28 08 , A 000 254 17 08 , 000 254 28 08 , 000 254 17 08	



Descrizione

Codici OE -
Codice ATE

Pre-codice / varie

MERCEDES BENZ

C Classe (W203) Berlina (00-07)	C 220 CDI		04.2000	04.2007	24.2536-5001.3	090014	Cilindro frizione	0B8 141 671 , A 000 254 28 08 , A 000 254 17 08 , 000 254 28 08 , 000 254 17 08	
			02.2004	04.2007	24.2536-5001.3	090014	Cilindro frizione	0B8 141 671 , A 000 254 28 08 , A 000 254 17 08 , 000 254 28 08 , 000 254 17 08	
	C 230		06.2005	04.2007	24.2536-5001.3	090014	Cilindro frizione	0B8 141 671 , A 000 254 28 08 , A 000 254 17 08 , 000 254 28 08 , 000 254 17 08	
	C 230 Kompressor		02.2004	04.2007	24.2536-5001.3	090014	Cilindro frizione	0B8 141 671 , A 000 254 28 08 , A 000 254 17 08 , 000 254 28 08 , 000 254 17 08	
	C 240		04.2000	04.2007	24.2536-5001.3	090014	Cilindro frizione	0B8 141 671 , A 000 254 28 08 , A 000 254 17 08 , 000 254 28 08 , 000 254 17 08	
	C 270 CDI		08.2000	04.2007	24.2536-5001.3	090014	Cilindro frizione	0B8 141 671 , A 000 254 28 08 , A 000 254 17 08 , 000 254 28 08 , 000 254 17 08	
	C 320		04.2000	04.2007	24.2536-5001.3	090014	Cilindro frizione	0B8 141 671 , A 000 254 28 08 , A 000 254 17 08 , 000 254 28 08 , 000 254 17 08	
	C 320 CDI		02.2005	04.2007	24.2536-5001.3	090014	Cilindro frizione	0B8 141 671 , A 000 254 28 08 , A 000 254 17 08 , 000 254 28 08 , 000 254 17 08	
C-Klasse (W204) Limousine (07-14)	C 200		05.2011	01.2014	24.0328-0155.1	528155	Discofreno ant.	A 212 421 13 12 , A 204 421 25 12 , A 204 421 07 12 , 204 421 25 12 , 212 421 13 12 , 204 421 07 12	
	C 200 CGI		04.2009	01.2014	24.0328-0155.1	528155	Discofreno ant.	A 212 421 13 12 , A 204 421 25 12 , A 204 421 07 12 , 204 421 25 12 , 212 421 13 12 , 204 421 07 12	



Descrizione







Codici OE -
Codice ATE

Pre-codice / varie

MERCEDES BENZ

C-Klasse (W204) Limousine (07-14)	C 200 Kompressor		03.2007	01.2014	24.0328-0155.1	528155	Discofreno ant.	A 212 421 13 12 , A 204 421 25 12 , A 204 421 07 12 , 204 421 25 12 , 212 421 13 12 , 204 421 07 12	
	C 220 CDI		12.2008	01.2014	24.0328-0155.1	528155	Discofreno ant.	A 212 421 13 12 , A 204 421 25 12 , A 204 421 07 12 , 204 421 25 12 , 212 421 13 12 , 204 421 07 12	
			03.2007	01.2014	24.0328-0155.1	528155	Discofreno ant.	A 212 421 13 12 , A 204 421 25 12 , A 204 421 07 12 , 204 421 25 12 , 212 421 13 12 , 204 421 07 12	
	C 220 CDI 4-matic		02.2013	01.2014	24.0328-0155.1	528155	Discofreno ant.	A 212 421 13 12 , A 204 421 25 12 , A 204 421 07 12 , 204 421 25 12 , 212 421 13 12 , 204 421 07 12	
	C 230		03.2007	01.2014	24.0328-0155.1	528155	Discofreno ant.	A 212 421 13 12 , A 204 421 25 12 , A 204 421 07 12 , 204 421 25 12 , 212 421 13 12 , 204 421 07 12	
	C 230 4-matic		07.2007	01.2014	24.0328-0155.1	528155	Discofreno ant.	A 212 421 13 12 , A 204 421 25 12 , A 204 421 07 12 , 204 421 25 12 , 212 421 13 12 , 204 421 07 12	
	C 250 CDI		08.2008	01.2014	24.0328-0155.1	528155	Discofreno ant.	A 212 421 13 12 , A 204 421 25 12 , A 204 421 07 12 , 204 421 25 12 , 212 421 13 12 , 204 421 07 12	
	C 250 CDI 4-matic		01.2011	01.2014	24.0328-0155.1	528155	Discofreno ant.	A 212 421 13 12 , A 204 421 25 12 , A 204 421 07 12 , 204 421 25 12 , 212 421 13 12 , 204 421 07 12	
	C 250 CGI		04.2009	01.2014	24.0328-0155.1	528155	Discofreno ant.	A 212 421 13 12 , A 204 421 25 12 , A 204 421 07 12 , 204 421 25 12 , 212 421 13 12 , 204 421 07 12	



					Descrizione	Codici OE - Codice ATE	 Pre-codice / varie
---	---	---	--	---	-------------	---------------------------	---

MERCEDES BENZ

C-Klasse (W204) Limousine (07-14)	C 280		03.2007	01.2014	24.0328-0155.1	528155	Discofreno ant.	A 212 421 13 12 , A 204 421 25 12 , A 204 421 07 12 , 204 421 25 12 , 212 421 13 12 , 204 421 07 12	
	C 280 4-matic		07.2007	01.2014	24.0328-0155.1	528155	Discofreno ant.	A 212 421 13 12 , A 204 421 25 12 , A 204 421 07 12 , 204 421 25 12 , 212 421 13 12 , 204 421 07 12	
	C 300		07.2009	01.2014	24.0328-0155.1	528155	Discofreno ant.	A 212 421 13 12 , A 204 421 25 12 , A 204 421 07 12 , 204 421 25 12 , 212 421 13 12 , 204 421 07 12	
	C 300 4-matic		04.2009	01.2014	24.0328-0155.1	528155	Discofreno ant.	A 212 421 13 12 , A 204 421 25 12 , A 204 421 07 12 , 204 421 25 12 , 212 421 13 12 , 204 421 07 12	
CLA-Klasse (C117) Coupe (13-)	CLA 180		01.2013		24.4123-1718.3	011016	Pompa freno	A 246 430 03 01 , A 246 430 00 01 , 246 430 03 01 , 246 430 00 01	
	CLA 180 BE		01.2013		24.4123-1718.3	011016	Pompa freno	A 246 430 03 01 , A 246 430 00 01 , 246 430 03 01 , 246 430 00 01	
	CLA 180 CDI		10.2013		24.4123-1718.3	011016	Pompa freno	A 246 430 03 01 , A 246 430 00 01 , 246 430 03 01 , 246 430 00 01	
	CLA 200		01.2013		24.4123-1718.3	011016	Pompa freno	A 246 430 03 01 , A 246 430 00 01 , 246 430 03 01 , 246 430 00 01	
	CLA 200 CDI		06.2013		24.4123-1718.3	011016	Pompa freno	A 246 430 03 01 , A 246 430 00 01 , 246 430 03 01 , 246 430 00 01	
			07.2014		24.4123-1718.3	011016	Pompa freno	A 246 430 03 01 , A 246 430 00 01 , 246 430 03 01 , 246 430 00 01	



Descrizione

Codici OE -
Codice ATE

Pre-codice / varie

MERCEDES BENZ

CLA-Klasse (C117) Coupe (13-)	CLA 200 CDI 4-matic		07.2014		24.4123-1718.3	011016	Pompa freno	A 246 430 03 01 , A 246 430 00 01 , 246 430 03 01 , 246 430 00 01	
	CLA 220 4-matic		04.2016		24.4123-1718.3	011016	Pompa freno	A 246 430 03 01 , A 246 430 00 01 , 246 430 03 01 , 246 430 00 01	
	CLA 220 CDI		09.2014		24.4123-1718.3	011016	Pompa freno	A 246 430 03 01 , A 246 430 00 01 , 246 430 03 01 , 246 430 00 01	
			01.2013		24.4123-1718.3	011016	Pompa freno	A 246 430 03 01 , A 246 430 00 01 , 246 430 03 01 , 246 430 00 01	
	CLA 220 CDI 4-matic		07.2014		24.4123-1718.3	011016	Pompa freno	A 246 430 03 01 , A 246 430 00 01 , 246 430 03 01 , 246 430 00 01	
			09.2014		24.4123-1718.3	011016	Pompa freno	A 246 430 03 01 , A 246 430 00 01 , 246 430 03 01 , 246 430 00 01	
	CLA 250		01.2013		24.4123-1718.3	011016	Pompa freno	A 246 430 03 01 , A 246 430 00 01 , 246 430 03 01 , 246 430 00 01	
			07.2015		24.4123-1718.3	011016	Pompa freno	A 246 430 03 01 , A 246 430 00 01 , 246 430 03 01 , 246 430 00 01	
	CLA 250 4-Matic		07.2013		24.4123-1718.3	011016	Pompa freno	A 246 430 03 01 , A 246 430 00 01 , 246 430 03 01 , 246 430 00 01	
			07.2015		24.4123-1718.3	011016	Pompa freno	A 246 430 03 01 , A 246 430 00 01 , 246 430 03 01 , 246 430 00 01	
	CLA 45 AMG 4-Matic		07.2013		24.4123-1718.3	011016	Pompa freno	A 246 430 03 01 , A 246 430 00 01 , 246 430 03 01 , 246 430 00 01	









					Descrizione	Codici OE - Codice ATE	 Pre-codice / varie
---	---	---	--	---	--------------------	-----------------------------------	--

MERCEDES BENZ

CLA-Klasse (X117) Shooting Brake (15-)	CLA 180		01.2015		24.4123-1718.3	011016	Pompa freno	A 246 430 03 01 , A 246 430 00 01 , 246 430 03 01 , 246 430 00 01	
	CLA 180 d		07.2015		24.4123-1718.3	011016	Pompa freno	A 246 430 03 01 , A 246 430 00 01 , 246 430 03 01 , 246 430 00 01	
	CLA 200		01.2015		24.4123-1718.3	011016	Pompa freno	A 246 430 03 01 , A 246 430 00 01 , 246 430 03 01 , 246 430 00 01	
	CLA 200 CDI		01.2015		24.4123-1718.3	011016	Pompa freno	A 246 430 03 01 , A 246 430 00 01 , 246 430 03 01 , 246 430 00 01	
	CLA 200 CDI 4-matic		01.2015		24.4123-1718.3	011016	Pompa freno	A 246 430 03 01 , A 246 430 00 01 , 246 430 03 01 , 246 430 00 01	
	CLA 220 4-matic		04.2016		24.4123-1718.3	011016	Pompa freno	A 246 430 03 01 , A 246 430 00 01 , 246 430 03 01 , 246 430 00 01	
	CLA 220 CDI		01.2015		24.4123-1718.3	011016	Pompa freno	A 246 430 03 01 , A 246 430 00 01 , 246 430 03 01 , 246 430 00 01	
	CLA 220 CDI 4-matic		01.2015		24.4123-1718.3	011016	Pompa freno	A 246 430 03 01 , A 246 430 00 01 , 246 430 03 01 , 246 430 00 01	
	CLA 220 d		01.2015		24.4123-1718.3	011016	Pompa freno	A 246 430 03 01 , A 246 430 00 01 , 246 430 03 01 , 246 430 00 01	
	CLA 220 d 4-matic		09.2015		24.4123-1718.3	011016	Pompa freno	A 246 430 03 01 , A 246 430 00 01 , 246 430 03 01 , 246 430 00 01	
	CLA 250		01.2015		24.4123-1718.3	011016	Pompa freno	A 246 430 03 01 , A 246 430 00 01 , 246 430 03 01 , 246 430 00 01	



					Descrizione	Codici OE - Codice ATE	 Pre-codice / varie
---	---	---	--	---	--------------------	-----------------------------------	--

MERCEDES BENZ

CLA-Klasse (X117) Shooting Brake (15-)	CLA 250 4-matic		01.2015		24.4123-1718.3	011016	Pompa freno	A 246 430 03 01 , A 246 430 00 01 , 246 430 03 01 , 246 430 00 01	
			07.2015		24.4123-1718.3	011016	Pompa freno	A 246 430 03 01 , A 246 430 00 01 , 246 430 03 01 , 246 430 00 01	
	CLA 45 AMG 4-matic		01.2015		24.4123-1718.3	011016	Pompa freno	A 246 430 03 01 , A 246 430 00 01 , 246 430 03 01 , 246 430 00 01	
CLK Klasse (A208) Cabriolet (98-03)	CLK 200 Kompressor		06.2000	06.2003	24.2536-5001.3	090014	Cilindro frizione	0B8 141 671 , A 000 254 28 08 , A 000 254 17 08 , 000 254 28 08 , 000 254 17 08	
	CLK 230 Kompressor		06.2000	06.2003	24.2536-5001.3	090014	Cilindro frizione	0B8 141 671 , A 000 254 28 08 , A 000 254 17 08 , 000 254 28 08 , 000 254 17 08	
CLK Klasse (A209) Cabriolet (03-09)	CLK 200 Kompressor		05.2003	12.2009	24.2536-5001.3	090014	Cilindro frizione	0B8 141 671 , A 000 254 28 08 , A 000 254 17 08 , 000 254 28 08 , 000 254 17 08	
			10.2006	12.2009	24.2536-5001.3	090014	Cilindro frizione	0B8 141 671 , A 000 254 28 08 , A 000 254 17 08 , 000 254 28 08 , 000 254 17 08	
	CLK 240		05.2003	12.2009	24.2536-5001.3	090014	Cilindro frizione	0B8 141 671 , A 000 254 28 08 , A 000 254 17 08 , 000 254 28 08 , 000 254 17 08	
	CLK 320 CDI		05.2005	12.2009	24.2536-5001.3	090014	Cilindro frizione	0B8 141 671 , A 000 254 28 08 , A 000 254 17 08 , 000 254 28 08 , 000 254 17 08	
CLK Klasse (C208) Coupé (97-02)	CLK 200 Kompressor		06.2000	06.2002	24.2536-5001.3	090014	Cilindro frizione	0B8 141 671 , A 000 254 28 08 , A 000 254 17 08 , 000 254 28 08 , 000 254 17 08	
	CLK 230 Kompressor		06.2000	06.2002	24.2536-5001.3	090014	Cilindro frizione	0B8 141 671 , A 000 254 28 08 , A 000 254 17 08 , 000 254 28 08 , 000 254 17 08	



Descrizione

Codici OE -
Codice ATE

Pre-codice / varie

MERCEDES BENZ

CLK Classe (C209) Coupe (02-09)	CLK 200 CGI		09.2002	04.2009	24.2536-5001.3	090014	Cilindro frizione	0B8 141 671 , A 000 254 28 08 , A 000 254 17 08 , 000 254 28 08 , 000 254 17 08	
	CLK 200 Kompressor		10.2006	04.2009	24.2536-5001.3	090014	Cilindro frizione	0B8 141 671 , A 000 254 28 08 , A 000 254 17 08 , 000 254 28 08 , 000 254 17 08	
			09.2002	04.2009	24.2536-5001.3	090014	Cilindro frizione	0B8 141 671 , A 000 254 28 08 , A 000 254 17 08 , 000 254 28 08 , 000 254 17 08	
	CLK 220 CDI		05.2005	04.2009	24.2536-5001.3	090014	Cilindro frizione	0B8 141 671 , A 000 254 28 08 , A 000 254 17 08 , 000 254 28 08 , 000 254 17 08	
	CLK 240		05.2002	04.2009	24.2536-5001.3	090014	Cilindro frizione	0B8 141 671 , A 000 254 28 08 , A 000 254 17 08 , 000 254 28 08 , 000 254 17 08	
	CLK 270 CDI		10.2002	04.2009	24.2536-5001.3	090014	Cilindro frizione	0B8 141 671 , A 000 254 28 08 , A 000 254 17 08 , 000 254 28 08 , 000 254 17 08	
	CLK 280		05.2005	04.2009	24.2536-5001.3	090014	Cilindro frizione	0B8 141 671 , A 000 254 28 08 , A 000 254 17 08 , 000 254 28 08 , 000 254 17 08	
	CLK 320		05.2002	04.2009	24.2536-5001.3	090014	Cilindro frizione	0B8 141 671 , A 000 254 28 08 , A 000 254 17 08 , 000 254 28 08 , 000 254 17 08	
	CLK 320 CDI		05.2005	04.2009	24.2536-5001.3	090014	Cilindro frizione	0B8 141 671 , A 000 254 28 08 , A 000 254 17 08 , 000 254 28 08 , 000 254 17 08	



Descrizione

Codici OE -
Codice ATE

Pre-codice / varie

MERCEDES BENZ

E-Klasse (A124) Cabrio (93-98)	E 200		06.1993	03.1998	24.2523-1210.3	040105	Cilindro frizione	A 201 290 03 11 , A 201 290 01 11 , A 201 290 00 11 , A 001 295 61 07 , A 001 295 30 07 , A 001 295 29 07 , A 001 295 27 07 , A 001 295 14 07 , A 001 295 13 07 , 201 290 03 11 , 201 290 01 11 , 201 290 00 11 , 001 295 61 07 , 001 295 30 07 , 001 295 29 07	03.2523-1210.3
E-Klasse (A207) Cabrio (10-)	E 200 CGI		03.2010		24.0328-0155.1	528155	Discofreno ant.	A 212 421 13 12 , A 204 421 25 12 , A 204 421 07 12 , 204 421 25 12 , 212 421 13 12 , 204 421 07 12	
	E 220 BlueTec		05.2014		24.0328-0155.1	528155	Discofreno ant.	A 212 421 13 12 , A 204 421 25 12 , A 204 421 07 12 , 204 421 25 12 , 212 421 13 12 , 204 421 07 12	
	E 220 CDI		03.2010		24.0328-0155.1	528155	Discofreno ant.	A 212 421 13 12 , A 204 421 25 12 , A 204 421 07 12 , 204 421 25 12 , 212 421 13 12 , 204 421 07 12	
	E 250 CGI		03.2010		24.0328-0155.1	528155	Discofreno ant.	A 212 421 13 12 , A 204 421 25 12 , A 204 421 07 12 , 204 421 25 12 , 212 421 13 12 , 204 421 07 12	
E-Klasse (C124) Coupe (93-97)	E 200		06.1993	06.1997	24.2523-1210.3	040105	Cilindro frizione	A 201 290 03 11 , A 201 290 01 11 , A 201 290 00 11 , A 001 295 61 07 , A 001 295 30 07 , A 001 295 29 07 , A 001 295 27 07 , A 001 295 14 07 , A 001 295 13 07 , 201 290 03 11 , 201 290 01 11 , 201 290 00 11 , 001 295 61 07 , 001 295 30 07 , 001 295 29 07	03.2523-1210.3



Descrizione

Codici OE -
Codice ATE

Pre-codice / varie

MERCEDES BENZ

E Classe (W212) Coupé (09-)	E 200 CGI		09.2009		24.0328-0155.1	528155	Discofreno ant.	A 212 421 13 12 , A 204 421 25 12 , A 204 421 07 12 , 204 421 25 12 , 212 421 13 12 , 204 421 07 12	
	E 220 BlueTec		05.2014		24.0328-0155.1	528155	Discofreno ant.	A 212 421 13 12 , A 204 421 25 12 , A 204 421 07 12 , 204 421 25 12 , 212 421 13 12 , 204 421 07 12	
	E 220 CDI		05.2009		24.0328-0155.1	528155	Discofreno ant.	A 212 421 13 12 , A 204 421 25 12 , A 204 421 07 12 , 204 421 25 12 , 212 421 13 12 , 204 421 07 12	
			07.2014		24.0328-0155.1	528155	Discofreno ant.	A 212 421 13 12 , A 204 421 25 12 , A 204 421 07 12 , 204 421 25 12 , 212 421 13 12 , 204 421 07 12	
	E 250 CGI		05.2009		24.0328-0155.1	528155	Discofreno ant.	A 212 421 13 12 , A 204 421 25 12 , A 204 421 07 12 , 204 421 25 12 , 212 421 13 12 , 204 421 07 12	
E Classe (S210) Station Wagon (96-03)	E 200		07.1999	04.2003	24.2536-5001.3	090014	Cilindro frizione	0B8 141 671 , A 000 254 28 08 , A 000 254 17 08 , 000 254 28 08 , 000 254 17 08	
	E 200 Kompressor		07.1999	04.2003	24.2536-5001.3	090014	Cilindro frizione	0B8 141 671 , A 000 254 28 08 , A 000 254 17 08 , 000 254 28 08 , 000 254 17 08	
	E 220 CDI		07.1999	04.2003	24.2536-5001.3	090014	Cilindro frizione	0B8 141 671 , A 000 254 28 08 , A 000 254 17 08 , 000 254 28 08 , 000 254 17 08	
	E 240		07.1999	04.2003	24.2536-5001.3	090014	Cilindro frizione	0B8 141 671 , A 000 254 28 08 , A 000 254 17 08 , 000 254 28 08 , 000 254 17 08	
	E 270 CDI		07.1999	04.2003	24.2536-5001.3	090014	Cilindro frizione	0B8 141 671 , A 000 254 28 08 , A 000 254 17 08 , 000 254 28 08 , 000 254 17 08	









				Descrizione	Codici OE - Codice ATE		Pre-codice / varie
--	--	--	--	-------------	---------------------------	--	--------------------

MERCEDES BENZ

E Classe (S210) Station Wagon (96-03)	E 280		07.1999	04.2003	24.2536-5001.3	090014	Cilindro frizione	0B8 141 671 , A 000 254 28 08 , A 000 254 17 08 , 000 254 28 08 , 000 254 17 08	
E Classe (S211) Station Wagon (03-09)	E 200 CDI		04.2006	10.2009	24.2536-5001.3	090014	Cilindro frizione	0B8 141 671 , A 000 254 28 08 , A 000 254 17 08 , 000 254 28 08 , 000 254 17 08	
	E 200 Kompressor		04.2006	10.2009	24.2536-5001.3	090014	Cilindro frizione	0B8 141 671 , A 000 254 28 08 , A 000 254 17 08 , 000 254 28 08 , 000 254 17 08	
			03.2003	10.2009	24.2536-5001.3	090014	Cilindro frizione	0B8 141 671 , A 000 254 28 08 , A 000 254 17 08 , 000 254 28 08 , 000 254 17 08	
	E 220 CDI		03.2003	10.2009	24.2536-5001.3	090014	Cilindro frizione	0B8 141 671 , A 000 254 28 08 , A 000 254 17 08 , 000 254 28 08 , 000 254 17 08	
			04.2006	10.2009	24.2536-5001.3	090014	Cilindro frizione	0B8 141 671 , A 000 254 28 08 , A 000 254 17 08 , 000 254 28 08 , 000 254 17 08	
	E 240		03.2003	10.2009	24.2536-5001.3	090014	Cilindro frizione	0B8 141 671 , A 000 254 28 08 , A 000 254 17 08 , 000 254 28 08 , 000 254 17 08	
	E 270 CDI		03.2003	10.2009	24.2536-5001.3	090014	Cilindro frizione	0B8 141 671 , A 000 254 28 08 , A 000 254 17 08 , 000 254 28 08 , 000 254 17 08	
	E 280		05.2005	10.2009	24.2536-5001.3	090014	Cilindro frizione	0B8 141 671 , A 000 254 28 08 , A 000 254 17 08 , 000 254 28 08 , 000 254 17 08	
	E 280 CDI		03.2005	10.2009	24.2536-5001.3	090014	Cilindro frizione	0B8 141 671 , A 000 254 28 08 , A 000 254 17 08 , 000 254 28 08 , 000 254 17 08	
E Classe (S212) Station Wagon (09-)	E 200		03.2013		24.0328-0155.1	528155	Discofreno ant.	A 212 421 13 12 , A 204 421 25 12 , A 204 421 07 12 , 204 421 25 12 , 212 421 13 12 , 204 421 07 12	



					Descrizione	Codici OE - Codice ATE	 Pre-codice / varie
---	---	---	--	---	-------------	---------------------------	---

MERCEDES BENZ

E Classe (S212) Station Wagon (09-)	E 200 CDI		11.2009		24.0328-0155.1	528155	Discofreno ant.	A 212 421 13 12 , A 204 421 25 12 , A 204 421 07 12 , 204 421 25 12 , 212 421 13 12 , 204 421 07 12	
	E 200 CGI		11.2009		24.0328-0155.1	528155	Discofreno ant.	A 212 421 13 12 , A 204 421 25 12 , A 204 421 07 12 , 204 421 25 12 , 212 421 13 12 , 204 421 07 12	
	E 220 BlueTec		05.2015		24.0328-0155.1	528155	Discofreno ant.	A 212 421 13 12 , A 204 421 25 12 , A 204 421 07 12 , 204 421 25 12 , 212 421 13 12 , 204 421 07 12	
	E 220 CDI		11.2009		24.0328-0155.1	528155	Discofreno ant.	A 212 421 13 12 , A 204 421 25 12 , A 204 421 07 12 , 204 421 25 12 , 212 421 13 12 , 204 421 07 12	
E Classe (W210) Berlina (95-02)	E 200		07.1999	04.2002	24.2536-5001.3	090014	Cilindro frizione	0B8 141 671 , A 000 254 28 08 , A 000 254 17 08 , 000 254 28 08 , 000 254 17 08	
			06.1995	04.2002	24.2523-1210.3	040105	Cilindro frizione	A 201 290 03 11 , A 201 290 01 11 , A 201 290 00 11 , A 001 295 61 07 , A 001 295 30 07 , A 001 295 29 07 , A 001 295 27 07 , A 001 295 14 07 , A 001 295 13 07 , 201 290 03 11 , 201 290 01 11 , 201 290 00 11 , 001 295 61 07 , 001 295 30 07 , 001 295 29 07	03.2523-1210.3
	E 200 CDI		07.1999	04.2002	24.2536-5001.3	090014	Cilindro frizione	0B8 141 671 , A 000 254 28 08 , A 000 254 17 08 , 000 254 28 08 , 000 254 17 08	



Descrizione

Codici OE -
Codice ATE

Pre-codice / varie

MERCEDES BENZ

E Classe (W210) Berlina (95-02)	E 200 CDI		07.1998	04.2002	24.2523-1210.3	040105	Cilindro frizione	A 201 290 03 11 , A 201 290 01 11 , A 201 290 00 11 , A 001 295 61 07 , A 001 295 30 07 , A 001 295 29 07 , A 001 295 27 07 , A 001 295 14 07 , A 001 295 13 07 , 201 290 03 11 , 201 290 01 11 , 201 290 00 11 , 001 295 61 07 , 001 295 30 07 , 001 295 29 07	03.2523-1210.3
	E 200 D		07.1999	04.2002	24.2536-5001.3	090014	Cilindro frizione	0B8 141 671 , A 000 254 28 08 , A 000 254 17 08 , 000 254 28 08 , 000 254 17 08	
			10.1996	04.2002	24.2523-1210.3	040105	Cilindro frizione	A 201 290 03 11 , A 201 290 01 11 , A 201 290 00 11 , A 001 295 61 07 , A 001 295 30 07 , A 001 295 29 07 , A 001 295 27 07 , A 001 295 14 07 , A 001 295 13 07 , 201 290 03 11 , 201 290 01 11 , 201 290 00 11 , 001 295 61 07 , 001 295 30 07 , 001 295 29 07	03.2523-1210.3
	E 200 Kompressor		07.1999	04.2002	24.2536-5001.3	090014	Cilindro frizione	0B8 141 671 , A 000 254 28 08 , A 000 254 17 08 , 000 254 28 08 , 000 254 17 08	
			08.2000	04.2002	24.2536-5001.3	090014	Cilindro frizione	0B8 141 671 , A 000 254 28 08 , A 000 254 17 08 , 000 254 28 08 , 000 254 17 08	
			09.1997	04.2002	24.2523-1210.3	040105	Cilindro frizione	A 201 290 03 11 , A 201 290 01 11 , A 201 290 00 11 , A 001 295 61 07 , A 001 295 30 07 , A 001 295 29 07 , A 001 295 27 07 , A 001 295 14 07 , A 001 295 13 07 , 201 290 03 11 , 201 290 01 11 , 201 290 00 11 , 001 295 61 07 , 001 295 30 07 , 001 295 29 07	03.2523-1210.3



Descrizione

Codici OE -
Codice ATE

Pre-codice / varie

MERCEDES BENZ

E Classe (W210) Berlina (95-02)	E 200 Kompressor		08.2000	04.2002	24.2523-1210.3	040105	Cilindro frizione	A 201 290 03 11 , A 201 290 01 11 , A 201 290 00 11 , A 001 295 61 07 , A 001 295 30 07 , A 001 295 29 07 , A 001 295 27 07 , A 001 295 14 07 , A 001 295 13 07 , 201 290 03 11 , 201 290 01 11 , 201 290 00 11 , 001 295 61 07 , 001 295 30 07 , 001 295 29 07	03.2523-1210.3
	E 220 CDI		07.1999	04.2002	24.2536-5001.3	090014	Cilindro frizione	0B8 141 671 , A 000 254 28 08 , A 000 254 17 08 , 000 254 28 08 , 000 254 17 08	
			07.1998	04.2002	24.2523-1210.3	040105	Cilindro frizione	A 201 290 03 11 , A 201 290 01 11 , A 201 290 00 11 , A 001 295 61 07 , A 001 295 30 07 , A 001 295 29 07 , A 001 295 27 07 , A 001 295 14 07 , A 001 295 13 07 , 201 290 03 11 , 201 290 01 11 , 201 290 00 11 , 001 295 61 07 , 001 295 30 07 , 001 295 29 07	03.2523-1210.3
	E 220 D		07.1999	04.2002	24.2536-5001.3	090014	Cilindro frizione	0B8 141 671 , A 000 254 28 08 , A 000 254 17 08 , 000 254 28 08 , 000 254 17 08	
			06.1995	06.1998	24.2523-1210.3	040105	Cilindro frizione	A 201 290 03 11 , A 201 290 01 11 , A 201 290 00 11 , A 001 295 61 07 , A 001 295 30 07 , A 001 295 29 07 , A 001 295 27 07 , A 001 295 14 07 , A 001 295 13 07 , 201 290 03 11 , 201 290 01 11 , 201 290 00 11 , 001 295 61 07 , 001 295 30 07 , 001 295 29 07	03.2523-1210.3



Descrizione

Codici OE -
Codice ATE

Pre-codice / varie

MERCEDES BENZ

E Classe (W210) Berlina (95-02)	E 230		06.1995	08.1997	24.2523-1210.3	040105	Cilindro frizione	A 201 290 03 11 , A 201 290 01 11 , A 201 290 00 11 , A 001 295 61 07 , A 001 295 30 07 , A 001 295 29 07 , A 001 295 27 07 , A 001 295 14 07 , A 001 295 13 07 , 201 290 03 11 , 201 290 01 11 , 201 290 00 11 , 001 295 61 07 , 001 295 30 07 , 001 295 29 07	03.2523-1210.3
	E 240		07.1999	04.2002	24.2536-5001.3	090014	Cilindro frizione	0B8 141 671 , A 000 254 28 08 , A 000 254 17 08 , 000 254 28 08 , 000 254 17 08	
			09.1997	04.2002	24.2523-1210.3	040105	Cilindro frizione	A 201 290 03 11 , A 201 290 01 11 , A 201 290 00 11 , A 001 295 61 07 , A 001 295 30 07 , A 001 295 29 07 , A 001 295 27 07 , A 001 295 14 07 , A 001 295 13 07 , 201 290 03 11 , 201 290 01 11 , 201 290 00 11 , 001 295 61 07 , 001 295 30 07 , 001 295 29 07	03.2523-1210.3
	E 250 D		06.1995	04.2002	24.2523-1210.3	040105	Cilindro frizione	A 201 290 03 11 , A 201 290 01 11 , A 201 290 00 11 , A 001 295 61 07 , A 001 295 30 07 , A 001 295 29 07 , A 001 295 27 07 , A 001 295 14 07 , A 001 295 13 07 , 201 290 03 11 , 201 290 01 11 , 201 290 00 11 , 001 295 61 07 , 001 295 30 07 , 001 295 29 07	03.2523-1210.3



Descrizione

Codici OE -
Codice ATE

Pre-codice / varie

MERCEDES BENZ

E Classe (W210) Berlina (95-02)	E 250 TD		09.1997	04.2002	24.2523-1210.3	040105	Cilindro frizione	A 201 290 03 11 , A 201 290 01 11 , A 201 290 00 11 , A 001 295 61 07 , A 001 295 30 07 , A 001 295 29 07 , A 001 295 27 07 , A 001 295 14 07 , A 001 295 13 07 , 201 290 03 11 , 201 290 01 11 , 201 290 00 11 , 001 295 61 07 , 001 295 30 07 , 001 295 29 07	03.2523-1210.3
	E 270 CDI		07.1999	04.2002	24.2536-5001.3	090014	Cilindro frizione	0B8 141 671 , A 000 254 28 08 , A 000 254 17 08 , 000 254 28 08 , 000 254 17 08	
			07.1999	04.2002	24.2523-1210.3	040105	Cilindro frizione	A 201 290 03 11 , A 201 290 01 11 , A 201 290 00 11 , A 001 295 61 07 , A 001 295 30 07 , A 001 295 29 07 , A 001 295 27 07 , A 001 295 14 07 , A 001 295 13 07 , 201 290 03 11 , 201 290 01 11 , 201 290 00 11 , 001 295 61 07 , 001 295 30 07 , 001 295 29 07	03.2523-1210.3
	E 280		07.1999	04.2002	24.2536-5001.3	090014	Cilindro frizione	0B8 141 671 , A 000 254 28 08 , A 000 254 17 08 , 000 254 28 08 , 000 254 17 08	
			01.1996	04.2002	24.2523-1210.3	040105	Cilindro frizione	A 201 290 03 11 , A 201 290 01 11 , A 201 290 00 11 , A 001 295 61 07 , A 001 295 30 07 , A 001 295 29 07 , A 001 295 27 07 , A 001 295 14 07 , A 001 295 13 07 , 201 290 03 11 , 201 290 01 11 , 201 290 00 11 , 001 295 61 07 , 001 295 30 07 , 001 295 29 07	03.2523-1210.3



Descrizione

Codici OE -
Codice ATE

Pre-codice / varie

MERCEDES BENZ

E Classe (W210) Berlina (95-02)	E 290 TD		01.1996	04.2002	24.2523-1210.3	040105	Cilindro frizione	A 201 290 03 11 , A 201 290 01 11 , A 201 290 00 11 , A 001 295 61 07 , A 001 295 30 07 , A 001 295 29 07 , A 001 295 27 07 , A 001 295 14 07 , A 001 295 13 07 , 201 290 03 11 , 201 290 01 11 , 201 290 00 11 , 001 295 61 07 , 001 295 30 07 , 001 295 29 07	03.2523-1210.3
	E 300 D		06.1995	04.2002	24.2523-1210.3	040105	Cilindro frizione	A 201 290 03 11 , A 201 290 01 11 , A 201 290 00 11 , A 001 295 61 07 , A 001 295 30 07 , A 001 295 29 07 , A 001 295 27 07 , A 001 295 14 07 , A 001 295 13 07 , 201 290 03 11 , 201 290 01 11 , 201 290 00 11 , 001 295 61 07 , 001 295 30 07 , 001 295 29 07	03.2523-1210.3
	E 320 CDI		07.1999	04.2002	24.2523-1210.3	040105	Cilindro frizione	A 201 290 03 11 , A 201 290 01 11 , A 201 290 00 11 , A 001 295 61 07 , A 001 295 30 07 , A 001 295 29 07 , A 001 295 27 07 , A 001 295 14 07 , A 001 295 13 07 , 201 290 03 11 , 201 290 01 11 , 201 290 00 11 , 001 295 61 07 , 001 295 30 07 , 001 295 29 07	03.2523-1210.3
E Classe (W211) Berlina (02-09)	E 200 CDI		04.2006	02.2009	24.2536-5001.3	090014	Cilindro frizione	0B8 141 671 , A 000 254 28 08 , A 000 254 17 08 , 000 254 28 08 , 000 254 17 08	
			05.2002	02.2009	24.2536-5001.3	090014	Cilindro frizione	0B8 141 671 , A 000 254 28 08 , A 000 254 17 08 , 000 254 28 08 , 000 254 17 08	
	E 200 Kompressor		04.2006	02.2009	24.2536-5001.3	090014	Cilindro frizione	0B8 141 671 , A 000 254 28 08 , A 000 254 17 08 , 000 254 28 08 , 000 254 17 08	



Descrizione

Codici OE -
Codice ATE

Pre-codice / varie

MERCEDES BENZ

E Classe (W211) Berlina (02-09)	E 200 Kompressor		05.2002	02.2009	24.2536-5001.3	090014	Cilindro frizione	0B8 141 671 , A 000 254 28 08 , A 000 254 17 08 , 000 254 28 08 , 000 254 17 08	
	E 200 NGT		03.2004	02.2009	24.2536-5001.3	090014	Cilindro frizione	0B8 141 671 , A 000 254 28 08 , A 000 254 17 08 , 000 254 28 08 , 000 254 17 08	
	E 220 CDI		03.2003	02.2009	24.2536-5001.3	090014	Cilindro frizione	0B8 141 671 , A 000 254 28 08 , A 000 254 17 08 , 000 254 28 08 , 000 254 17 08	
			03.2002	02.2009	24.2536-5001.3	090014	Cilindro frizione	0B8 141 671 , A 000 254 28 08 , A 000 254 17 08 , 000 254 28 08 , 000 254 17 08	
			04.2006	02.2009	24.2536-5001.3	090014	Cilindro frizione	0B8 141 671 , A 000 254 28 08 , A 000 254 17 08 , 000 254 28 08 , 000 254 17 08	
	E 230		04.2006	02.2009	24.2536-5001.3	090014	Cilindro frizione	0B8 141 671 , A 000 254 28 08 , A 000 254 17 08 , 000 254 28 08 , 000 254 17 08	
	E 240		03.2002	02.2009	24.2536-5001.3	090014	Cilindro frizione	0B8 141 671 , A 000 254 28 08 , A 000 254 17 08 , 000 254 28 08 , 000 254 17 08	
	E 250 CDI		08.2008	02.2009	24.2536-5001.3	090014	Cilindro frizione	0B8 141 671 , A 000 254 28 08 , A 000 254 17 08 , 000 254 28 08 , 000 254 17 08	
	E 270 CDI		03.2002	02.2009	24.2536-5001.3	090014	Cilindro frizione	0B8 141 671 , A 000 254 28 08 , A 000 254 17 08 , 000 254 28 08 , 000 254 17 08	
	E 280		05.2005	02.2009	24.2536-5001.3	090014	Cilindro frizione	0B8 141 671 , A 000 254 28 08 , A 000 254 17 08 , 000 254 28 08 , 000 254 17 08	
	E 280 CDI		03.2005	02.2009	24.2536-5001.3	090014	Cilindro frizione	0B8 141 671 , A 000 254 28 08 , A 000 254 17 08 , 000 254 28 08 , 000 254 17 08	



Descrizione

Codici OE -
Codice ATE

Pre-codice / varie

MERCEDES BENZ

E Classe (W212) Berlina (09-)	E 200		01.2013		24.0328-0155.1	528155	Discofreno ant.	A 212 421 13 12 , A 204 421 25 12 , A 204 421 07 12 , 204 421 25 12 , 212 421 13 12 , 204 421 07 12	
	E 200 CDI		03.2009		24.0328-0155.1	528155	Discofreno ant.	A 212 421 13 12 , A 204 421 25 12 , A 204 421 07 12 , 204 421 25 12 , 212 421 13 12 , 204 421 07 12	
	E 200 CGI		08.2009		24.0328-0155.1	528155	Discofreno ant.	A 212 421 13 12 , A 204 421 25 12 , A 204 421 07 12 , 204 421 25 12 , 212 421 13 12 , 204 421 07 12	
	E 200 NGT		07.2013		24.0328-0155.1	528155	Discofreno ant.	A 212 421 13 12 , A 204 421 25 12 , A 204 421 07 12 , 204 421 25 12 , 212 421 13 12 , 204 421 07 12	
			03.2009		24.0328-0155.1	528155	Discofreno ant.	A 212 421 13 12 , A 204 421 25 12 , A 204 421 07 12 , 204 421 25 12 , 212 421 13 12 , 204 421 07 12	
	E 220 BlueTec		05.2014		24.0328-0155.1	528155	Discofreno ant.	A 212 421 13 12 , A 204 421 25 12 , A 204 421 07 12 , 204 421 25 12 , 212 421 13 12 , 204 421 07 12	
	E 220 CDI		03.2009		24.0328-0155.1	528155	Discofreno ant.	A 212 421 13 12 , A 204 421 25 12 , A 204 421 07 12 , 204 421 25 12 , 212 421 13 12 , 204 421 07 12	
	E 250		03.2009		24.0328-0155.1	528155	Discofreno ant.	A 212 421 13 12 , A 204 421 25 12 , A 204 421 07 12 , 204 421 25 12 , 212 421 13 12 , 204 421 07 12	
	E 250 CDI		03.2009		24.0328-0155.1	528155	Discofreno ant.	A 212 421 13 12 , A 204 421 25 12 , A 204 421 07 12 , 204 421 25 12 , 212 421 13 12 , 204 421 07 12	



Descrizione

Codici OE -
Codice ATE

Pre-codice / varie

MERCEDES BENZ

G Classe (W463) (90-)	250 GD		06.1990		24.2523-1210.3	040105	Cilindro frizione	A 201 290 03 11 , A 201 290 01 11 , A 201 290 00 11 , A 001 295 61 07 , A 001 295 30 07 , A 001 295 29 07 , A 001 295 27 07 , A 001 295 14 07 , A 001 295 13 07 , 201 290 03 11 , 201 290 01 11 , 201 290 00 11 , 001 295 61 07 , 001 295 30 07 , 001 295 29 07	03.2523-1210.3
	300 GD		09.1989		24.2523-1210.3	040105	Cilindro frizione	A 201 290 03 11 , A 201 290 01 11 , A 201 290 00 11 , A 001 295 61 07 , A 001 295 30 07 , A 001 295 29 07 , A 001 295 27 07 , A 001 295 14 07 , A 001 295 13 07 , 201 290 03 11 , 201 290 01 11 , 201 290 00 11 , 001 295 61 07 , 001 295 30 07 , 001 295 29 07	03.2523-1210.3
	300 GE		06.1990		24.2523-1210.3	040105	Cilindro frizione	A 201 290 03 11 , A 201 290 01 11 , A 201 290 00 11 , A 001 295 61 07 , A 001 295 30 07 , A 001 295 29 07 , A 001 295 27 07 , A 001 295 14 07 , A 001 295 13 07 , 201 290 03 11 , 201 290 01 11 , 201 290 00 11 , 001 295 61 07 , 001 295 30 07 , 001 295 29 07	03.2523-1210.3
	350 G Turbo		09.1991		24.2523-1210.3	040105	Cilindro frizione	A 201 290 03 11 , A 201 290 01 11 , A 201 290 00 11 , A 001 295 61 07 , A 001 295 30 07 , A 001 295 29 07 , A 001 295 27 07 , A 001 295 14 07 , A 001 295 13 07 , 201 290 03 11 , 201 290 01 11 , 201 290 00 11 , 001 295 61 07 , 001 295 30 07 , 001 295 29 07	03.2523-1210.3



Descrizione

Codici OE -
Codice ATE

Pre-codice / varie

MERCEDES BENZ

G Classe (W463) Cabriolet (90-)	300 GD		12.1990		24.2523-1210.3	040105	Cilindro frizione	A 201 290 03 11 , A 201 290 01 11 , A 201 290 00 11 , A 001 295 61 07 , A 001 295 30 07 , A 001 295 29 07 , A 001 295 27 07 , A 001 295 14 07 , A 001 295 13 07 , 201 290 03 11 , 201 290 01 11 , 201 290 00 11 , 001 295 61 07 , 001 295 30 07 , 001 295 29 07	03.2523-1210.3
	300 GE		09.1989		24.2523-1210.3	040105	Cilindro frizione	A 201 290 03 11 , A 201 290 01 11 , A 201 290 00 11 , A 001 295 61 07 , A 001 295 30 07 , A 001 295 29 07 , A 001 295 27 07 , A 001 295 14 07 , A 001 295 13 07 , 201 290 03 11 , 201 290 01 11 , 201 290 00 11 , 001 295 61 07 , 001 295 30 07 , 001 295 29 07	03.2523-1210.3
	320 GE		09.1994		24.2523-1210.3	040105	Cilindro frizione	A 201 290 03 11 , A 201 290 01 11 , A 201 290 00 11 , A 001 295 61 07 , A 001 295 30 07 , A 001 295 29 07 , A 001 295 27 07 , A 001 295 14 07 , A 001 295 13 07 , 201 290 03 11 , 201 290 01 11 , 201 290 00 11 , 001 295 61 07 , 001 295 30 07 , 001 295 29 07	03.2523-1210.3
	350 G Turbo		09.1991		24.2523-1210.3	040105	Cilindro frizione	A 201 290 03 11 , A 201 290 01 11 , A 201 290 00 11 , A 001 295 61 07 , A 001 295 30 07 , A 001 295 29 07 , A 001 295 27 07 , A 001 295 14 07 , A 001 295 13 07 , 201 290 03 11 , 201 290 01 11 , 201 290 00 11 , 001 295 61 07 , 001 295 30 07 , 001 295 29 07	03.2523-1210.3



Descrizione

Codici OE -
Codice ATE

Pre-codice / varie

MERCEDES BENZ

GLA-Klasse (X156) (13-)	GLA 180		02.2015		24.4123-1718.3	011016	Pompa freno	A 246 430 03 01 , A 246 430 00 01 , 246 430 03 01 , 246 430 00 01	
	GLA 180 CDI		07.2014		24.4123-1718.3	011016	Pompa freno	A 246 430 03 01 , A 246 430 00 01 , 246 430 03 01 , 246 430 00 01	
	GLA 200		12.2013		24.4123-1718.3	011016	Pompa freno	A 246 430 03 01 , A 246 430 00 01 , 246 430 03 01 , 246 430 00 01	
	GLA 200 CDI		12.2013		24.4123-1718.3	011016	Pompa freno	A 246 430 03 01 , A 246 430 00 01 , 246 430 03 01 , 246 430 00 01	
	GLA 200 CDI 4-matic		12.2013		24.4123-1718.3	011016	Pompa freno	A 246 430 03 01 , A 246 430 00 01 , 246 430 03 01 , 246 430 00 01	
	GLA 220 CDI		12.2013		24.4123-1718.3	011016	Pompa freno	A 246 430 03 01 , A 246 430 00 01 , 246 430 03 01 , 246 430 00 01	
	GLA 220 CDI 4-matic		12.2013		24.4123-1718.3	011016	Pompa freno	A 246 430 03 01 , A 246 430 00 01 , 246 430 03 01 , 246 430 00 01	
	GLA 220 d		07.2015		24.4123-1718.3	011016	Pompa freno	A 246 430 03 01 , A 246 430 00 01 , 246 430 03 01 , 246 430 00 01	
	GLA 220 d 4-matic		07.2015		24.4123-1718.3	011016	Pompa freno	A 246 430 03 01 , A 246 430 00 01 , 246 430 03 01 , 246 430 00 01	
	GLA 250		12.2013		24.4123-1718.3	011016	Pompa freno	A 246 430 03 01 , A 246 430 00 01 , 246 430 03 01 , 246 430 00 01	
	GLA 250 4-matic		12.2013		24.4123-1718.3	011016	Pompa freno	A 246 430 03 01 , A 246 430 00 01 , 246 430 03 01 , 246 430 00 01	



Descrizione

Codici OE -
Codice ATE

Pre-codice / varie

MERCEDES BENZ

GLA-Klasse (X156) (13-)	GLA 45 AMG		05.2014		24.4123-1718.3	011016	Pompa freno	A 246 430 03 01 , A 246 430 00 01 , 246 430 03 01 , 246 430 00 01	
M Classe (W163) (98-05)	ML 230	ant.sx	03.1998	08.2000	24.5143-0535.3	331491	Tubo flessibile anteriore	A 163 420 22 48 , A 163 420 20 48 , A 163 420 18 48 , A 163 420 15 48 , A 163 420 11 48 , A 163 420 08 48 , 163 420 20 48 , 163 420 22 48 , 163 420 18 48 , 163 420 15 48 , 163 420 11 48 , 163 420 08 48	83.6211-0532.3
	ML 270 CDI	ant.sx	09.1999	08.2000	24.5143-0535.3	331491	Tubo flessibile anteriore	A 163 420 22 48 , A 163 420 20 48 , A 163 420 18 48 , A 163 420 15 48 , A 163 420 11 48 , A 163 420 08 48 , 163 420 20 48 , 163 420 22 48 , 163 420 18 48 , 163 420 15 48 , 163 420 11 48 , 163 420 08 48	83.6211-0532.3
			09.1999	06.2005	24.2536-5001.3	090014	Cilindro frizione	0B8 141 671 , A 000 254 28 08 , A 000 254 17 08 , 000 254 28 08 , 000 254 17 08	
	ML 320	ant.sx	03.1998	08.2000	24.5143-0535.3	331491	Tubo flessibile anteriore	A 163 420 22 48 , A 163 420 20 48 , A 163 420 18 48 , A 163 420 15 48 , A 163 420 11 48 , A 163 420 08 48 , 163 420 20 48 , 163 420 22 48 , 163 420 18 48 , 163 420 15 48 , 163 420 11 48 , 163 420 08 48	83.6211-0532.3
	ML 430	ant.sx	09.1998	08.2000	24.5143-0535.3	331491	Tubo flessibile anteriore	A 163 420 22 48 , A 163 420 20 48 , A 163 420 18 48 , A 163 420 15 48 , A 163 420 11 48 , A 163 420 08 48 , 163 420 20 48 , 163 420 22 48 , 163 420 18 48 , 163 420 15 48 , 163 420 11 48 , 163 420 08 48	83.6211-0532.3



Descrizione

Codici OE -
Codice ATE

Pre-codice / varie

MERCEDES BENZ

M Classe (W163) (98-05)	ML 55 AMG	ant.sx	09.1999	08.2000	24.5143-0535.3	331491	Tubo flessibile anteriore	A 163 420 22 48 , A 163 420 20 48 , A 163 420 18 48 , A 163 420 15 48 , A 163 420 11 48 , A 163 420 08 48 , 163 420 20 48 , 163 420 22 48 , 163 420 18 48 , 163 420 15 48 , 163 420 11 48 , 163 420 08 48	83.6211-0532.3
SLK Classe (R170) (96-04)	SLK 200 Kompressor		03.2000	03.2004	24.2536-5001.3	090014	Cilindro frizione	0B8 141 671 , A 000 254 28 08 , A 000 254 17 08 , 000 254 28 08 , 000 254 17 08	
	SLK 230 Kompressor		03.2000	03.2004	24.2536-5001.3	090014	Cilindro frizione	0B8 141 671 , A 000 254 28 08 , A 000 254 17 08 , 000 254 28 08 , 000 254 17 08	
	SLK 320		04.2000	03.2004	24.2536-5001.3	090014	Cilindro frizione	0B8 141 671 , A 000 254 28 08 , A 000 254 17 08 , 000 254 28 08 , 000 254 17 08	
SLK-Klasse (R171) (04-11)	SLK 200 Kompressor		03.2004	01.2011	24.2536-5001.3	090014	Cilindro frizione	0B8 141 671 , A 000 254 28 08 , A 000 254 17 08 , 000 254 28 08 , 000 254 17 08	
	SLK 280		04.2005	01.2011	24.2536-5001.3	090014	Cilindro frizione	0B8 141 671 , A 000 254 28 08 , A 000 254 17 08 , 000 254 28 08 , 000 254 17 08	
	SLK 300		03.2009	01.2011	24.2536-5001.3	090014	Cilindro frizione	0B8 141 671 , A 000 254 28 08 , A 000 254 17 08 , 000 254 28 08 , 000 254 17 08	
	SLK 350		03.2004	01.2011	24.2536-5001.3	090014	Cilindro frizione	0B8 141 671 , A 000 254 28 08 , A 000 254 17 08 , 000 254 28 08 , 000 254 17 08	
SLK-Klasse / SLC-Klasse (R172) (11-)	SLC 180		01.2016		24.0328-0155.1	528155	Discofreno ant.	A 212 421 13 12 , A 204 421 25 12 , A 204 421 07 12 , 204 421 25 12 , 212 421 13 12 , 204 421 07 12	



Descrizione

Codici OE -
Codice ATE

Pre-codice / varie

MERCEDES BENZ

SL-Klasse (R230) (01-11)	SL 350		02.2003	11.2011	24.2536-5001.3	090014	Cilindro frizione	0B8 141 671 , A 000 254 28 08 , A 000 254 17 08 , 000 254 28 08 , 000 254 17 08	
Furgoncino (BM 901/902) SPRINTER (95-)	208 CDI		04.2000	05.2006	24.2536-5001.3	090014	Cilindro frizione	0B8 141 671 , A 000 254 28 08 , A 000 254 17 08 , 000 254 28 08 , 000 254 17 08	
	208 D		04.2000	05.2006	24.2536-5001.3	090014	Cilindro frizione	0B8 141 671 , A 000 254 28 08 , A 000 254 17 08 , 000 254 28 08 , 000 254 17 08	
	210 D		04.2000	05.2006	24.2536-5001.3	090014	Cilindro frizione	0B8 141 671 , A 000 254 28 08 , A 000 254 17 08 , 000 254 28 08 , 000 254 17 08	
	211 CDI		04.2000	05.2006	24.2536-5001.3	090014	Cilindro frizione	0B8 141 671 , A 000 254 28 08 , A 000 254 17 08 , 000 254 28 08 , 000 254 17 08	
	212 D		04.2000	05.2006	24.2536-5001.3	090014	Cilindro frizione	0B8 141 671 , A 000 254 28 08 , A 000 254 17 08 , 000 254 28 08 , 000 254 17 08	
	213 CDI		04.2000	05.2006	24.2536-5001.3	090014	Cilindro frizione	0B8 141 671 , A 000 254 28 08 , A 000 254 17 08 , 000 254 28 08 , 000 254 17 08	
	214		04.2000	05.2006	24.2536-5001.3	090014	Cilindro frizione	0B8 141 671 , A 000 254 28 08 , A 000 254 17 08 , 000 254 28 08 , 000 254 17 08	
	216 CDI		04.2000	05.2006	24.2536-5001.3	090014	Cilindro frizione	0B8 141 671 , A 000 254 28 08 , A 000 254 17 08 , 000 254 28 08 , 000 254 17 08	
Furgoncino (BM 903/904) SPRINTER (95-)	308 CDI		04.2000	05.2006	24.2536-5001.3	090014	Cilindro frizione	0B8 141 671 , A 000 254 28 08 , A 000 254 17 08 , 000 254 28 08 , 000 254 17 08	
	308 D		04.2000	05.2006	24.2536-5001.3	090014	Cilindro frizione	0B8 141 671 , A 000 254 28 08 , A 000 254 17 08 , 000 254 28 08 , 000 254 17 08	



Descrizione







Codici OE -
Codice ATE

Pre-codice / varie

MERCEDES BENZ

Furgoncino (BM 903/904) SPRINTER (95-)	310 D		04.2000	05.2006	24.2536-5001.3	090014	Cilindro frizione	0B8 141 671 , A 000 254 28 08 , A 000 254 17 08 , 000 254 28 08 , 000 254 17 08	
	311 CDI		04.2000	05.2006	24.2536-5001.3	090014	Cilindro frizione	0B8 141 671 , A 000 254 28 08 , A 000 254 17 08 , 000 254 28 08 , 000 254 17 08	
	312 D		04.2000	05.2006	24.2536-5001.3	090014	Cilindro frizione	0B8 141 671 , A 000 254 28 08 , A 000 254 17 08 , 000 254 28 08 , 000 254 17 08	
	313 CDI		04.2000	05.2006	24.2536-5001.3	090014	Cilindro frizione	0B8 141 671 , A 000 254 28 08 , A 000 254 17 08 , 000 254 28 08 , 000 254 17 08	
	314		04.2000	05.2006	24.2536-5001.3	090014	Cilindro frizione	0B8 141 671 , A 000 254 28 08 , A 000 254 17 08 , 000 254 28 08 , 000 254 17 08	
	316 CDI		04.2000	05.2006	24.2536-5001.3	090014	Cilindro frizione	0B8 141 671 , A 000 254 28 08 , A 000 254 17 08 , 000 254 28 08 , 000 254 17 08	
	408 CDI		04.2000	05.2006	24.2536-5001.3	090014	Cilindro frizione	0B8 141 671 , A 000 254 28 08 , A 000 254 17 08 , 000 254 28 08 , 000 254 17 08	
	408 D		04.2000	05.2006	24.2536-5001.3	090014	Cilindro frizione	0B8 141 671 , A 000 254 28 08 , A 000 254 17 08 , 000 254 28 08 , 000 254 17 08	
	410 D		04.2000	05.2006	24.2536-5001.3	090014	Cilindro frizione	0B8 141 671 , A 000 254 28 08 , A 000 254 17 08 , 000 254 28 08 , 000 254 17 08	
	411 CDI		04.2000	05.2006	24.2536-5001.3	090014	Cilindro frizione	0B8 141 671 , A 000 254 28 08 , A 000 254 17 08 , 000 254 28 08 , 000 254 17 08	
	412 D		04.2000	05.2006	24.2536-5001.3	090014	Cilindro frizione	0B8 141 671 , A 000 254 28 08 , A 000 254 17 08 , 000 254 28 08 , 000 254 17 08	



					Descrizione	Codici OE - Codice ATE	 Pre-codice / varie
---	---	---	--	---	--------------------	-----------------------------------	--

MERCEDES BENZ

Furgoncino (BM 903/904) SPRINTER (95-)	413 CDI		04.2000	05.2006	24.2536-5001.3	090014	Cilindro frizione	0B8 141 671 , A 000 254 28 08 , A 000 254 17 08 , 000 254 28 08 , 000 254 17 08	
	414		04.2000	05.2006	24.2536-5001.3	090014	Cilindro frizione	0B8 141 671 , A 000 254 28 08 , A 000 254 17 08 , 000 254 28 08 , 000 254 17 08	
	416 CDI		04.2000	05.2006	24.2536-5001.3	090014	Cilindro frizione	0B8 141 671 , A 000 254 28 08 , A 000 254 17 08 , 000 254 28 08 , 000 254 17 08	



Descrizione

Codici OE -
Codice ATE

Pre-codice / varie

MINI

F55 (14-)	Cooper		10.2014		13.0460-2797.2	602797	Serie pastiglie posteriori	34 21 6 871 300 , 34 21 6 864 488 , 34 21 6 861 641	v. foto
	Cooper D		10.2014		13.0460-2797.2	602797	Serie pastiglie posteriori	34 21 6 871 300 , 34 21 6 864 488 , 34 21 6 861 641	v. foto
	Cooper S		10.2014		13.0460-2797.2	602797	Serie pastiglie posteriori	34 21 6 871 300 , 34 21 6 864 488 , 34 21 6 861 641	v. foto
	Cooper SD		10.2014		13.0460-2797.2	602797	Serie pastiglie posteriori	34 21 6 871 300 , 34 21 6 864 488 , 34 21 6 861 641	v. foto
	John Cooper Works		09.2015		13.0460-2797.2	602797	Serie pastiglie posteriori	34 21 6 871 300 , 34 21 6 864 488 , 34 21 6 861 641	v. foto
	One		10.2014		13.0460-2797.2	602797	Serie pastiglie posteriori	34 21 6 871 300 , 34 21 6 864 488 , 34 21 6 861 641	v. foto
	One D		10.2014		13.0460-2797.2	602797	Serie pastiglie posteriori	34 21 6 871 300 , 34 21 6 864 488 , 34 21 6 861 641	v. foto
	One First		03.2015		13.0460-2797.2	602797	Serie pastiglie posteriori	34 21 6 871 300 , 34 21 6 864 488 , 34 21 6 861 641	v. foto
F56 (13-)	Cooper		11.2013		13.0460-2797.2	602797	Serie pastiglie posteriori	34 21 6 871 300 , 34 21 6 864 488 , 34 21 6 861 641	v. foto
	Cooper D		11.2013		13.0460-2797.2	602797	Serie pastiglie posteriori	34 21 6 871 300 , 34 21 6 864 488 , 34 21 6 861 641	v. foto
	Cooper S		11.2013		13.0460-2797.2	602797	Serie pastiglie posteriori	34 21 6 871 300 , 34 21 6 864 488 , 34 21 6 861 641	v. foto
			11.2014		13.0460-2797.2	602797	Serie pastiglie posteriori	34 21 6 871 300 , 34 21 6 864 488 , 34 21 6 861 641	v. foto
	Cooper SD		06.2014		13.0460-2797.2	602797	Serie pastiglie posteriori	34 21 6 871 300 , 34 21 6 864 488 , 34 21 6 861 641	v. foto
	John Cooper Works		03.2015		13.0460-2797.2	602797	Serie pastiglie posteriori	34 21 6 871 300 , 34 21 6 864 488 , 34 21 6 861 641	v. foto



Descrizione

Codici OE -
Codice ATE

Pre-codice / varie

MINI

F56 (13-)	One		06.2014		13.0460-2797.2	602797	Serie pastiglie posteriori	34 21 6 871 300 , 34 21 6 864 488 , 34 21 6 861 641	v. foto
			11.2013		13.0460-2797.2	602797	Serie pastiglie posteriori	34 21 6 871 300 , 34 21 6 864 488 , 34 21 6 861 641	v. foto
	One D		11.2013		13.0460-2797.2	602797	Serie pastiglie posteriori	34 21 6 871 300 , 34 21 6 864 488 , 34 21 6 861 641	v. foto
F57 Cabrio (15-)	Cooper		11.2015		13.0460-2797.2	602797	Serie pastiglie posteriori	34 21 6 871 300 , 34 21 6 864 488 , 34 21 6 861 641	v. foto
	Cooper D		11.2015		13.0460-2797.2	602797	Serie pastiglie posteriori	34 21 6 871 300 , 34 21 6 864 488 , 34 21 6 861 641	v. foto
	Cooper S		11.2015		13.0460-2797.2	602797	Serie pastiglie posteriori	34 21 6 871 300 , 34 21 6 864 488 , 34 21 6 861 641	v. foto
	Cooper SD		03.2016		13.0460-2797.2	602797	Serie pastiglie posteriori	34 21 6 871 300 , 34 21 6 864 488 , 34 21 6 861 641	v. foto
	John Cooper Works		03.2016		13.0460-2797.2	602797	Serie pastiglie posteriori	34 21 6 871 300 , 34 21 6 864 488 , 34 21 6 861 641	v. foto
	One		03.2016		13.0460-2797.2	602797	Serie pastiglie posteriori	34 21 6 871 300 , 34 21 6 864 488 , 34 21 6 861 641	v. foto



					Descrizione	Codici OE - Codice ATE		Pre-codice / varie
--	--	--	--	--	-------------	---------------------------	--	--------------------

NISSAN

QASHQAI (J11E) (14-)	1,2 DIG-T		02.2014		13.0460-5652.2	605652	Serie pastiglie anteriore	D1 06 04E A0A , D1060-4EA0A	v. foto
	1,5 dCi		02.2014		13.0460-5652.2	605652	Serie pastiglie anteriore	D1 06 04E A0A , D1060-4EA0A	v. foto
	1,6 dCi		02.2014		13.0460-5652.2	605652	Serie pastiglie anteriore	D1 06 04E A0A , D1060-4EA0A	v. foto
	1,6 dCi 4x4		02.2014		13.0460-5652.2	605652	Serie pastiglie anteriore	D1 06 04E A0A , D1060-4EA0A	v. foto
	1,6 DIG-T		10.2014		13.0460-5652.2	605652	Serie pastiglie anteriore	D1 06 04E A0A , D1060-4EA0A	v. foto
	2		12.2013		13.0460-5652.2	605652	Serie pastiglie anteriore	D1 06 04E A0A , D1060-4EA0A	v. foto
	2,0 4x4 (J11R)		10.2015		13.0460-5652.2	605652	Serie pastiglie anteriore	D1 06 04E A0A , D1060-4EA0A	v. foto



Descrizione

Codici OE -
Codice ATE

Pre-codice / varie

OPEL

ASTRA G / Vauxhall Astra MKIV (98-05)	1,4 16V				24.2531-5002.3	090004	Cilindro frizione	93172628 , 56 79 335 , 9126238 , 56 79 331	
	1,4 Caravan		09.2007		24.2531-5002.3	090004	Cilindro frizione	93172628 , 56 79 335 , 9126238 , 56 79 331	
	1,4 Limousine		09.2007		24.2531-5002.3	090004	Cilindro frizione	93172628 , 56 79 335 , 9126238 , 56 79 331	
ASTRA H / GTC / Vauxhall Astra Mk V (04-10)	1,2		08.2005	11.2010	24.2531-5002.3	090004	Cilindro frizione	93172628 , 56 79 335 , 9126238 , 56 79 331	
	1,3 CDTI		08.2005	11.2010	24.2531-5002.3	090004	Cilindro frizione	93172628 , 56 79 335 , 9126238 , 56 79 331	
	1,4		01.2004	11.2010	24.2531-5002.3	090004	Cilindro frizione	93172628 , 56 79 335 , 9126238 , 56 79 331	
	1,6		01.2007	11.2010	24.2531-5002.3	090004	Cilindro frizione	93172628 , 56 79 335 , 9126238 , 56 79 331	
			01.2004	11.2010	24.2531-5002.3	090004	Cilindro frizione	93172628 , 56 79 335 , 9126238 , 56 79 331	
	1,6 Turbo		01.2007	11.2010	24.2531-5002.3	090004	Cilindro frizione	93172628 , 56 79 335 , 9126238 , 56 79 331	
	1,7 CDTI		04.2007	11.2010	24.2531-5002.3	090004	Cilindro frizione	93172628 , 56 79 335 , 9126238 , 56 79 331	
			01.2004	11.2010	24.2531-5002.3	090004	Cilindro frizione	93172628 , 56 79 335 , 9126238 , 56 79 331	
	1,8		01.2006	11.2010	24.2531-5002.3	090004	Cilindro frizione	93172628 , 56 79 335 , 9126238 , 56 79 331	
			01.2004	11.2010	24.2531-5002.3	090004	Cilindro frizione	93172628 , 56 79 335 , 9126238 , 56 79 331	
	1,9 CDTI		09.2005	11.2010	24.2531-5002.3	090004	Cilindro frizione	93172628 , 56 79 335 , 9126238 , 56 79 331	



Descrizione

Codici OE -
Codice ATE

Pre-codice / varie

OPEL

ASTRA H / GTC / Vauxhall Astra Mk V (04-10)	1,9 CDTI		09.2004	11.2010	24.2531-5002.3	090004	Cilindro frizione	93172628 , 56 79 335 , 9126238 , 56 79 331	
	2,0 Turbo		09.2004	11.2010	24.2531-5002.3	090004	Cilindro frizione	93172628 , 56 79 335 , 9126238 , 56 79 331	
			01.2004	11.2010	24.2531-5002.3	090004	Cilindro frizione	93172628 , 56 79 335 , 9126238 , 56 79 331	
	2,0 Turbo OPC		03.2005	11.2010	24.2531-5002.3	090004	Cilindro frizione	93172628 , 56 79 335 , 9126238 , 56 79 331	
ASTRA H Caravan/Vau. Astra MKV Estate (04-10)	1,2		08.2005	11.2010	24.2531-5002.3	090004	Cilindro frizione	93172628 , 56 79 335 , 9126238 , 56 79 331	
	1,3 CDTI		08.2005	11.2010	24.2531-5002.3	090004	Cilindro frizione	93172628 , 56 79 335 , 9126238 , 56 79 331	
	1,4		08.2004	11.2010	24.2531-5002.3	090004	Cilindro frizione	93172628 , 56 79 335 , 9126238 , 56 79 331	
	1,6		01.2007	11.2010	24.2531-5002.3	090004	Cilindro frizione	93172628 , 56 79 335 , 9126238 , 56 79 331	
			08.2004	11.2010	24.2531-5002.3	090004	Cilindro frizione	93172628 , 56 79 335 , 9126238 , 56 79 331	
	1,6 LPG		08.2009	11.2010	24.2531-5002.3	090004	Cilindro frizione	93172628 , 56 79 335 , 9126238 , 56 79 331	
	1,6 Turbo		01.2007	11.2010	24.2531-5002.3	090004	Cilindro frizione	93172628 , 56 79 335 , 9126238 , 56 79 331	
	1,7 CDTI		04.2007	11.2010	24.2531-5002.3	090004	Cilindro frizione	93172628 , 56 79 335 , 9126238 , 56 79 331	
			08.2004	11.2010	24.2531-5002.3	090004	Cilindro frizione	93172628 , 56 79 335 , 9126238 , 56 79 331	
	1,7 TD		08.2004	11.2010	24.2531-5002.3	090004	Cilindro frizione	93172628 , 56 79 335 , 9126238 , 56 79 331	



Descrizione

Codici OE -
Codice ATE

Pre-codice / varie

OPEL

ASTRA H Caravan/Vau. Astra MKV Estate (04-10)	1,8		08.2005	11.2010	24.2531-5002.3	090004	Cilindro frizione	93172628 , 56 79 335 , 9126238 , 56 79 331	
			09.2004	11.2010	24.2531-5002.3	090004	Cilindro frizione	93172628 , 56 79 335 , 9126238 , 56 79 331	
	1,9 CDTI		09.2004	11.2010	24.2531-5002.3	090004	Cilindro frizione	93172628 , 56 79 335 , 9126238 , 56 79 331	
			08.2004	11.2010	24.2531-5002.3	090004	Cilindro frizione	93172628 , 56 79 335 , 9126238 , 56 79 331	
			09.2005	11.2010	24.2531-5002.3	090004	Cilindro frizione	93172628 , 56 79 335 , 9126238 , 56 79 331	
	2,0 Turbo		08.2004	11.2010	24.2531-5002.3	090004	Cilindro frizione	93172628 , 56 79 335 , 9126238 , 56 79 331	
			09.2004	11.2010	24.2531-5002.3	090004	Cilindro frizione	93172628 , 56 79 335 , 9126238 , 56 79 331	
ASTRA H TwinTop (06-10)	1,6		12.2006	11.2010	24.2531-5002.3	090004	Cilindro frizione	93172628 , 56 79 335 , 9126238 , 56 79 331	
			03.2006	11.2010	24.2531-5002.3	090004	Cilindro frizione	93172628 , 56 79 335 , 9126238 , 56 79 331	
	1,6 Turbo		02.2007	11.2010	24.2531-5002.3	090004	Cilindro frizione	93172628 , 56 79 335 , 9126238 , 56 79 331	
	1,8		03.2006	11.2010	24.2531-5002.3	090004	Cilindro frizione	93172628 , 56 79 335 , 9126238 , 56 79 331	
	1,9 CDTI		03.2006	11.2010	24.2531-5002.3	090004	Cilindro frizione	93172628 , 56 79 335 , 9126238 , 56 79 331	
	2,0 Turbo		03.2006	11.2010	24.2531-5002.3	090004	Cilindro frizione	93172628 , 56 79 335 , 9126238 , 56 79 331	
ASTRA J / GTC / Vauxhall Astra MK VI (09-)	2,0 OPC				13.0460-7309.2	607309	Serie pastiglie posteriori	13473429 , 16 05 295	v. foto
COMBO / Vauxhall Combo (01-11)	1,4 16V		10.2001	10.2011	24.2531-5002.3	090004	Cilindro frizione	93172628 , 56 79 335 , 9126238 , 56 79 331	



Descrizione

Codici OE -
Codice ATE

Pre-codice / varie

OPEL

COMBO / Vauxhall Combo (01-11)	1,7 DTI 16V		10.2001	10.2011	24.2531-5002.3	090004	Cilindro frizione	93172628 , 56 79 335 , 9126238 , 56 79 331	
CORSA C / Vauxhall Corsa MK II (00-06)	1,0 12V		09.2000	09.2006	24.2531-5002.3	090004	Cilindro frizione	93172628 , 56 79 335 , 9126238 , 56 79 331	
	1,2 16V		09.2000	09.2006	24.2531-5002.3	090004	Cilindro frizione	93172628 , 56 79 335 , 9126238 , 56 79 331	
	1,4 16V		09.2000	09.2006	24.2531-5002.3	090004	Cilindro frizione	93172628 , 56 79 335 , 9126238 , 56 79 331	
	1,7 DTI 16V		09.2000	09.2006	24.2531-5002.3	090004	Cilindro frizione	93172628 , 56 79 335 , 9126238 , 56 79 331	
CORSA D / Vauxhall Corsa MK III (06-)	1,0 i		10.2006		24.2531-5002.3	090004	Cilindro frizione	93172628 , 56 79 335 , 9126238 , 56 79 331	
	1,2		06.2010		24.2531-5002.3	090004	Cilindro frizione	93172628 , 56 79 335 , 9126238 , 56 79 331	
	1,2 i 16V		10.2006		24.2531-5002.3	090004	Cilindro frizione	93172628 , 56 79 335 , 9126238 , 56 79 331	
	1,2 LPG		09.2009		24.2531-5002.3	090004	Cilindro frizione	93172628 , 56 79 335 , 9126238 , 56 79 331	
	1,3 CDTI		10.2006		24.2531-5002.3	090004	Cilindro frizione	93172628 , 56 79 335 , 9126238 , 56 79 331	
			06.2010		24.2531-5002.3	090004	Cilindro frizione	93172628 , 56 79 335 , 9126238 , 56 79 331	
	1,4		09.2009		24.2531-5002.3	090004	Cilindro frizione	93172628 , 56 79 335 , 9126238 , 56 79 331	
			06.2010		24.2531-5002.3	090004	Cilindro frizione	93172628 , 56 79 335 , 9126238 , 56 79 331	
	1,4 i 16V		10.2006		24.2531-5002.3	090004	Cilindro frizione	93172628 , 56 79 335 , 9126238 , 56 79 331	



Descrizione

Codici OE -
Codice ATE

Pre-codice / varie

OPEL

CORSA D / Vauxhall Corsa MK III (06-)	1,4 Turbo ecoFLEX		06.2012		24.2531-5002.3	090004	Cilindro frizione	93172628 , 56 79 335 , 9126238 , 56 79 331	
	1,7 CDTi		06.2010		24.2531-5002.3	090004	Cilindro frizione	93172628 , 56 79 335 , 9126238 , 56 79 331	
			10.2006		24.2531-5002.3	090004	Cilindro frizione	93172628 , 56 79 335 , 9126238 , 56 79 331	
MERIVA A / Vauxhall Meriva Mk I (03-10)	1,6		05.2003	05.2010	24.2531-5002.3	090004	Cilindro frizione	93172628 , 56 79 335 , 9126238 , 56 79 331	
TIGRA TWIN TOP / Vau. Tigra Twin Top (04-09)	1,4		06.2004	08.2009	24.2531-5002.3	090004	Cilindro frizione	93172628 , 56 79 335 , 9126238 , 56 79 331	
ZAFIRA III Tourer / Vauxhall Zafira III Tourer (11-)	1,4 T				13.0460-7309.2	607309	Serie pastiglie posteriori	13473429 , 16 05 295	v. foto
	1,4 T LPG				13.0460-7309.2	607309	Serie pastiglie posteriori	13473429 , 16 05 295	v. foto
	1,6 CDTi ecoFLEX				13.0460-7309.2	607309	Serie pastiglie posteriori	13473429 , 16 05 295	v. foto
			07.2014		13.0460-7309.2	607309	Serie pastiglie posteriori	13473429 , 16 05 295	v. foto
	1,6 SIDI				13.0460-7309.2	607309	Serie pastiglie posteriori	13473429 , 16 05 295	v. foto
	1,6 T CNG				13.0460-7309.2	607309	Serie pastiglie posteriori	13473429 , 16 05 295	v. foto
	1,8				13.0460-7309.2	607309	Serie pastiglie posteriori	13473429 , 16 05 295	v. foto
	1,8 LPG				13.0460-7309.2	607309	Serie pastiglie posteriori	13473429 , 16 05 295	v. foto
	2,0 CDTi				13.0460-7309.2	607309	Serie pastiglie posteriori	13473429 , 16 05 295	v. foto
			01.2015		13.0460-7309.2	607309	Serie pastiglie posteriori	13473429 , 16 05 295	v. foto
	2,0 CDTi BiTurbo				13.0460-7309.2	607309	Serie pastiglie posteriori	13473429 , 16 05 295	v. foto



Descrizione

Codici OE -
Codice ATE

Pre-codice / varie

RENAULT

DUSTER (HS-) (11-)	1,5 dCi 4x4		06.2011		03.0520-8019.3	698019	Topkit Originale Ate posteriori	44 0A 036 57R	
			06.2011		03.0137-0507.2	650507	Serie qanasce posteriori	44 06 074 93R	
	1,6 16V 4x4		06.2011		03.0520-8019.3	698019	Topkit Originale Ate posteriori	44 0A 036 57R	
			06.2011		03.0137-0507.2	650507	Serie qanasce posteriori	44 06 074 93R	
	2,0 4x4		02.2012		03.0520-8019.3	698019	Topkit Originale Ate posteriori	44 0A 036 57R	
			02.2012		03.0137-0507.2	650507	Serie qanasce posteriori	44 06 074 93R	
KADJAR (HFE) (15-)	1,2 TCe 130		06.2015		13.0460-5652.2	605652	Serie pastiglie anteriore	D1 06 04E A0A , D1060-4EA0A	v. foto
	1,5 dCi 110		06.2015		13.0460-5652.2	605652	Serie pastiglie anteriore	D1 06 04E A0A , D1060-4EA0A	v. foto
	1,6 dCi 130		06.2015		13.0460-5652.2	605652	Serie pastiglie anteriore	D1 06 04E A0A , D1060-4EA0A	v. foto
	1,6 dCi 130 4x4		06.2015		13.0460-5652.2	605652	Serie pastiglie anteriore	D1 06 04E A0A , D1060-4EA0A	v. foto
MEGANE III Coupé (DZ0_) (08-)	2,0 TCe 250		05.2009		24.0111-0186.2	411186	Disco freno post.	43 20 200 21R	

SUZUKI

VITARA (89-98)	1,6	post.dx	01.1989	01.1993	24.3223-1715.3	020586	Cil.ruota posteriore	53401-60A00	
		post.sx	01.1989	01.1993	24.3223-1714.3	020585	Cil.ruota posteriore	53402-60A00	
	1,6 Cabrio	post.dx	01.1989	01.1993	24.3223-1715.3	020586	Cil.ruota posteriore	53401-60A00	
		post.sx	01.1989	01.1993	24.3223-1714.3	020585	Cil.ruota posteriore	53402-60A00	
	1,6 i 16V	post.sx	02.1991	01.1993	24.3223-1714.3	020585	Cil.ruota posteriore	53402-60A00	
		post.dx	02.1991	01.1993	24.3223-1715.3	020586	Cil.ruota posteriore	53401-60A00	



Descrizione

Codici OE -
Codice ATE

Pre-codice / varie

TOYOTA

CAMRY (06-11)	2,0 VVT-i	post.dx	02.2007	08.2011	24.5296-0562.3	331482	Tubo flessibile posteriore	90947-02F60	
	2,4 VVT-i	post.dx	02.2007	08.2011	24.5296-0562.3	331482	Tubo flessibile posteriore	90947-02F60	
	2,4 VVT-i Hybrid	post.dx	02.2007	08.2011	24.5296-0562.3	331482	Tubo flessibile posteriore	90947-02F60	
	3,5 VVT-i	post.dx	02.2007	08.2011	24.5296-0562.3	331482	Tubo flessibile posteriore	90947-02F60	
		post.dx	01.2008	08.2011	24.5296-0562.3	331482	Tubo flessibile posteriore	90947-02F60	
RAV4 III (05-)	2,0 16V	post.sx	12.2008		24.5275-0287.3	331481	Tubo flessibile posteriore	90947-02F52	
	2,0 16V 4WD	post.sx	12.2008		24.5275-0287.3	331481	Tubo flessibile posteriore	90947-02F52	
	2,0 VVT-i	post.sx	03.2009		24.5275-0287.3	331481	Tubo flessibile posteriore	90947-02F52	
	2,0 VVT-i 4WD	post.sx	02.2007		24.5275-0287.3	331481	Tubo flessibile posteriore	90947-02F52	
		post.sx	03.2009		24.5275-0287.3	331481	Tubo flessibile posteriore	90947-02F52	
	2,2 D-4D	post.sx	12.2008		24.5275-0287.3	331481	Tubo flessibile posteriore	90947-02F52	
	2,2 D-4D 4WD	post.sx	02.2007		24.5275-0287.3	331481	Tubo flessibile posteriore	90947-02F52	
		post.sx	12.2008		24.5275-0287.3	331481	Tubo flessibile posteriore	90947-02F52	
	2,2 D-CAT 4WD	post.sx	02.2007		24.5275-0287.3	331481	Tubo flessibile posteriore	90947-02F52	
	2,4 VVT-i	post.sx	02.2007		24.5275-0287.3	331481	Tubo flessibile posteriore	90947-02F52	
	2,4 VVT-i 4WD	post.sx	02.2007		24.5275-0287.3	331481	Tubo flessibile posteriore	90947-02F52	
	3,5 VVT-i 4WD	post.sx	08.2007		24.5275-0287.3	331481	Tubo flessibile posteriore	90947-02F52	
		post.sx	02.2007		24.5275-0287.3	331481	Tubo flessibile posteriore	90947-02F52	



Descrizione

Codici OE -
Codice ATE

Pre-codice / varie

VOLKSWAGEN

CRAFTER (06-)	2,0 TDI		11.2015		24.2536-5001.3	090014	Cilindro frizione	0B8 141 671 , A 000 254 28 08 , A 000 254 17 08 , 000 254 28 08 , 000 254 17 08	
	2,0 TDI 4motion		11.2011		24.2536-5001.3	090014	Cilindro frizione	0B8 141 671 , A 000 254 28 08 , A 000 254 17 08 , 000 254 28 08 , 000 254 17 08	
	2,0 TDI BlueMotion		07.2011		24.2536-5001.3	090014	Cilindro frizione	0B8 141 671 , A 000 254 28 08 , A 000 254 17 08 , 000 254 28 08 , 000 254 17 08	
	2,5 TDI		04.2006		24.2536-5001.3	090014	Cilindro frizione	0B8 141 671 , A 000 254 28 08 , A 000 254 17 08 , 000 254 28 08 , 000 254 17 08	

13.0460-7309.2 607309

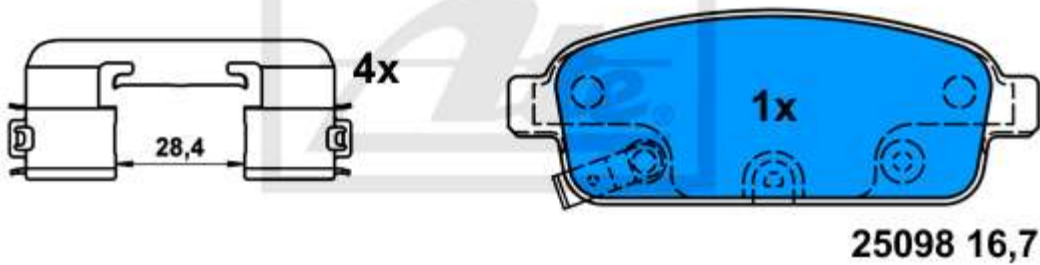
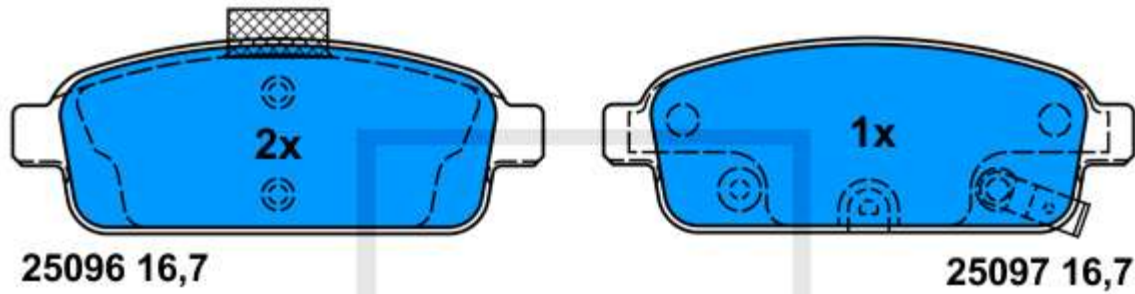

116,5 x 42,7

Applicazioni:

OPEL ASTRA J / GTC / Vauxhall Astra MK VI (09-)
OPEL ZAFIRA III Tourer / Vauxhall Zafira III Tourer (11-)

13.0460-7292.2 607292

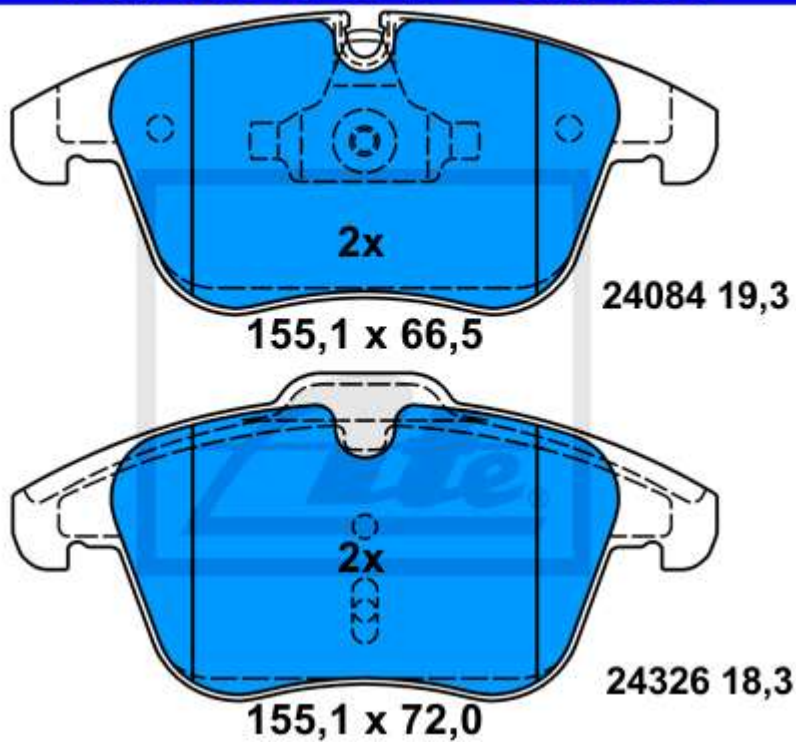

Applicazioni:

- JAGUAR TIPO S (CCX) (99-08)
- JAGUAR XF (CC9) (08-)
- JAGUAR XF Sportbrake (CC9) (12-)
- JAGUAR XJ (X350,X358) (03-09)
- JAGUAR XK8 CABRIOLET (06-)
- JAGUAR XK Coupe (06-)

13.0460-7302.2 607302

Applicazioni:
FIAT 500 L Kombi (12-)

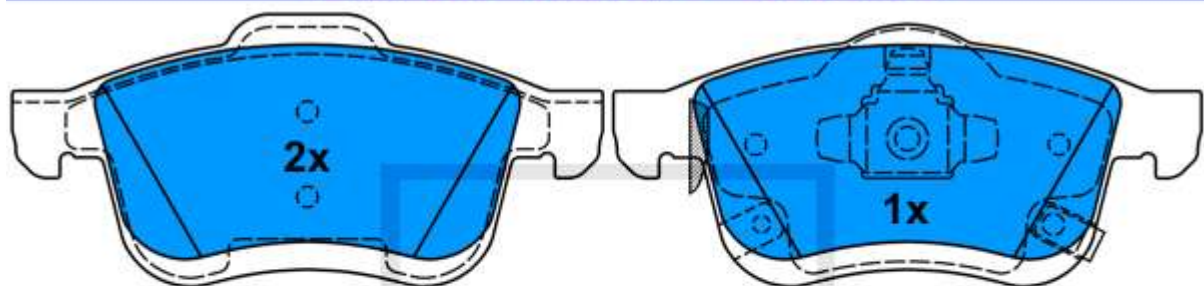

24727 20,7
156,3 x 71,5

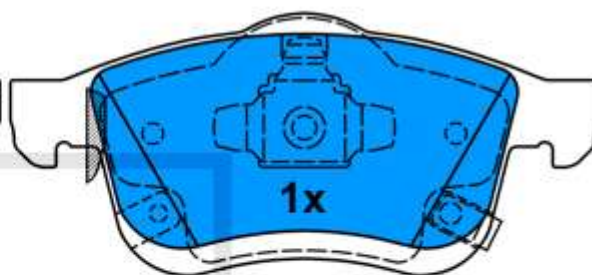

25906 20,7
155,1 x 69,0

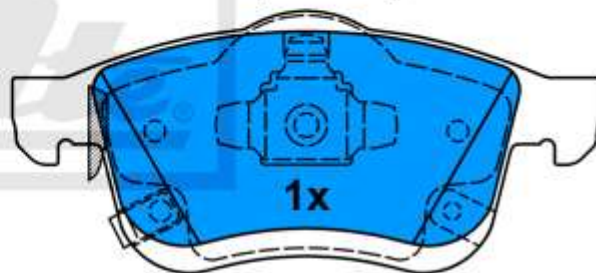

25907 20,7
155,1 x 69,0

13.0460-2797.2 602797

Applicazioni:

MINI F55 (14-)
MINI F56 (13-)
MINI F57 Cabrio (15-)

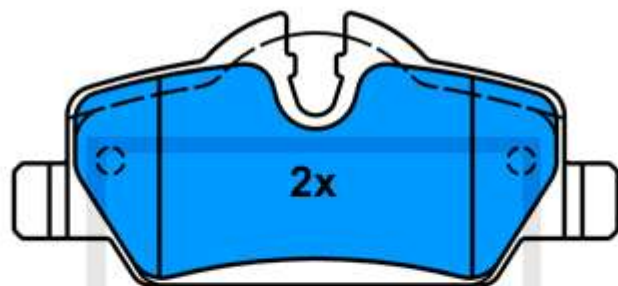
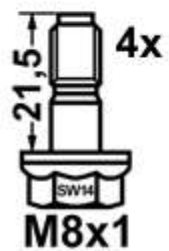
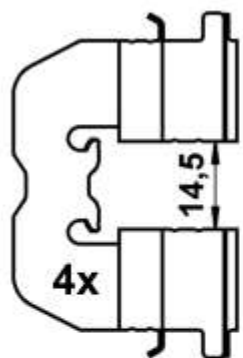

25980 16,8

99,6 x 44,7

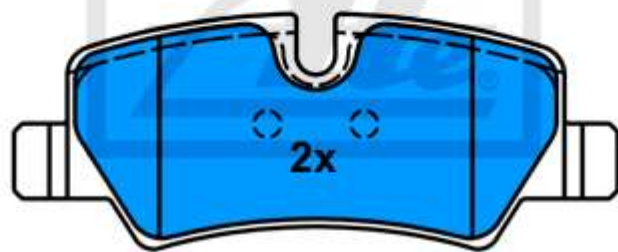

25981 16,8

99,5 x 38,8

13.0460-5658.2 605658

Applicazioni:
MAZDA 3 (BM) (13-)
MAZDA CX-3 (15-)

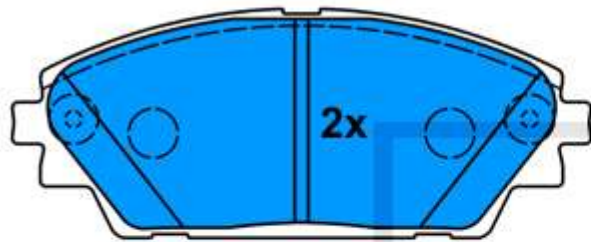

25875 15,9

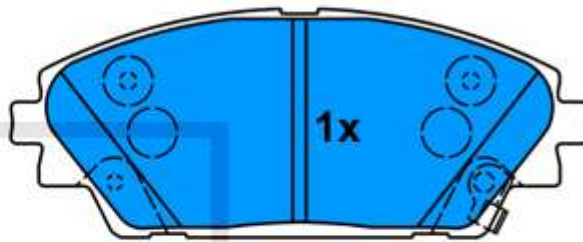

25876 15,9

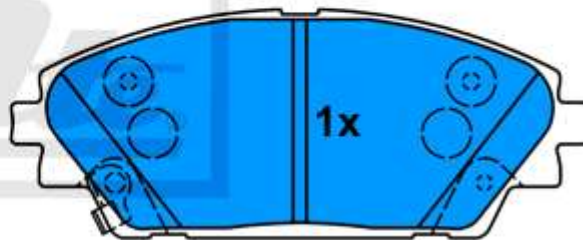

28877 15,9

141,0 x 55,8

13.0460-5652.2 605652

Applicazioni:

RENAULT KADJAR (HFE) (15-)
NISSAN QASHQAI (J11E) (14-)

