

Freni a tamburo

Drum Brake Kits

2017

CB5-I

Bremsen-Ersatzteilprogramm

Brake Parts Program



Brakethrough Technology



- D** Fahrzeugregister
- EN** Index of vehicles
- FR** Liste des véhicules
- IT** Indice autovetture
- ES** Índice de vehículos
- NL** Voertuigregister
- DA** Køretøjsregister
- SV** Fordonsregister
- HU** Járműlista
- PT** Registo automóvel
- RU** Перечень автомобилей
- CZ** Rejstřík vozidel
- PL** Indeks pojazdów
- EL** Κατάλογος οχημάτων
- TR** Araç kaydı
- ZH** 汽吹登璦翻
- JA** 然画索引
- AR** سجل العربفة

CB5-I





AUTOBIANCHI

Y10 4

CITROEN

Jumper 4

Nemo 4

FIAT

500 4

500 C Cabrio 4

500L 5

Brava 4

Bravo 4

Doblò 2001 → 5

Doblò Restyling 5

Doblò 2009 → 5

Ducato 10/14 q.l 5

Ducato 18 q.l 5

Ducato mod. 2006 5

Fiorino 5

Fiorino mod. 2008 6

Fiorino Minicargo 6

Grande Punto 7

Grande Punto EVO 7

Idea 6

Linea 6

Marea Berlina 6

Marea Weekend 6

Marengo 6

Multipla 6

Palio 6

Palio Weekend 6

Panda 1993 → 7

Panda 2003 → 7

Panda 2012 → 7

Punto 1993 → 7

Punto 1999 → 7

Punto Restyling 7

Punto Van 1999 → 7

Punto Van Restyling 7

Qubo 8

Tipo 3 Volumi 8

Uno 8

FORD

Fiesta 8

Focus 2005 8

Fusion 8

Ka 8

Ka II 8

Puma 8

Sportka 8

Streetka 8

Ranger 9

Transit Tourneo Connect 9

INNOCENTI

Minitre 9

Turbo de Tomaso 9

LADA

Vesta 9

LANCIA

Delta 9

Musa 9

Y 9

Ypsilon 9

New Ypsilon 9

LAND ROVER

Discovery 3 10

Discovery 4 10

Range Rover Sport 10

MASERATI

Ghibli 10

Quattroporte 10

MAZDA

Mazda 2 10

NISSAN

Micra 10

Note 10

OPEL

Adam 10

Astra 10

Combo 10

Corsa 11

PEUGEOT

Boxer 11

PIAGGIO

Porter 11

Porter Maxxi 11

RENAULT

Clio II 11

Clio III 11

Clio Sportour 11

Grand Modus 11

Modus 11

New Modus 11

Twingo II 11

Twingo III 11

SEAT

Marbella 12

Toledo 12

SKODA

Rapid 12

Roomster 12

SMART

Forfour 12

Fortwo 12

TOYOTA

Yaris 12

Yaris mod. 2012 12



- D** Fahrzeugverwendungen
- EN** Applications of vehicles
- FR** Applications
- IT** Applicazioni autoveicoli
- ES** Aplicaciones
- NL** Voertuigtoepassingen
- DA** Køretøjsanvendelser
- SV** Fordonsavändningar
- HU** Járműalkalmazások
- PT** Utilizações do veículo
- RU** Применение в автомобилях
- CZ** Použití vozidel
- PL** Zastosowania pojazdów
- EL** Χρήσεις οχημάτων
- TR** Araç kullanımları
- ZH** 汽车用户
- JA** 車両利用方法
- AR** إستعمالات العربة

CB5-I



	 		 			
AUTOBIANCHI						
 Y10	Tutti i modelli escluso 4x4	93→	185 x 30	sx/dx	FK185103 (*) (kit freno)	AP
	4x4	93→	185 x 30	sx/dx	FK185104 (*) (kit freno)	AP
CITROEN						
 JUMPER	2.0 i, 2.0 HDi, 2.2 HDi, 2.8 HDi, 2.8 HDi 4x4 (senza ABS)	2002→	254 x 57	sx	FC254017	AP
			254 x 57	dx	FC254018	AP
	2.0 i, 2.0 HDi, 2.2 HDi, 2.8 HDi, 2.8 HDi 4x4 (con ABS)	2002→	254 x 57	sx	FC254019	AP
			254 x 57	dx	FC254020	AP
	Tutti i modelli escl. 4x4 (freno di stazionamento)	2002→	172 x 40	sx	FC172001	AP
			172 x 40	dx	FC172002	AP
4x4 (freno di stazionamento)	2002→	172 x 40	sx/dx	FK172003 (kit freno)	AP	
Tutti i modelli (freno di stazionamento)	2006→	172 x 40	sx	FC172005	AP	
		172 x 40	dx	FC172006	AP	
 NEMO	1.4 i	1/2008→	203 x 38	sx/dx	FC203114	AP
	1.4 HDi	1/2008→	228 x 40	sx/dx	FC228115	AP
FIAT						
 BRAVA	1.2 i 16V, 1.4 i 12V senza ABS	95→	180 x 30	sx/dx	FC180102	AP
	1.2 i 16V, 1.4 i 12V con ABS (foro Ø 13)	95→	203 x 38	sx/dx	FC203105	AP
	1.6 i 16V, 1.8 i 16V con ABS (foro Ø 21)	95→	203 x 38	sx/dx	FC203106	AP
	1.6 i 16V, 1.8 i 16V base e ABS (foro Ø 13)	98→	203 x 38	sx/dx	FC203105	AP
	1.9 D senza ABS	95→	180 x 30	sx/dx	FC180102	AP
	1.9 TD base e ABS (foro Ø 13)	95→	203 x 38	sx/dx	FC203105	AP
	1.9 TD con ABS (foro Ø 21)	95→	203 x 38	sx/dx	FC203106	AP
	1.9 JTD base e ABS (foro Ø 13)	95→	203 x 38	sx/dx	FC203105	AP
 BRAVO	1.2 i 16V, 1.4 i 12V senza ABS	95→	180 x 30	sx/dx	FC180102	AP
	1.2 i 16V, 1.4 i 12V con ABS (foro Ø 13)	95→	203 x 38	sx/dx	FC203105	AP
	1.6 i 16V, 1.8 i 16V con ABS (foro Ø 21)	95→	203 x 38	sx/dx	FC203106	AP
	1.6 i 16V, 1.8 i 16V base e ABS (foro Ø 13)	98→	203 x 38	sx/dx	FC203105	AP
	1.9 D senza ABS	95→	180 x 30	sx/dx	FC180102	AP
	1.9 TD base e ABS (foro Ø 13)	95→	203 x 38	sx/dx	FC203105	AP
	1.9 TD con ABS (foro Ø 21)	95→	203 x 38	sx/dx	FC203106	AP
	1.9 JTD base e ABS (foro Ø 13)	95→	203 x 38	sx/dx	FC203105	AP
 500	0.9, 1.2 i, 1.2 LPG, 1.3 D Multijet	2010→	180 x 30	sx/dx	FC180119	AP
 500 C CABRIO	0.9, 1.2, 1.3 D Multijet	2010→	180 x 30	sx/dx	FC180119	AP

Tutti i modelli s'intende come tutti i modelli con freni a tamburo

(*) = ad esaurimento scorte

						
FIAT						
 500L	900 bicilindrico 1.3 JTD 1.4 benzina	2014->	228 x 42	sx/dx	FC228122	ATE
 DOBLÒ 2001 ->	1.3 D Multijet, 1.3 JTD 1.4 i 1.6 i 16V, 1.6 Natural Power 1.9 D Multijet, 1.9 JTD	2001->	228 x 40	sx/dx	FC228111	AP/ATE
 DOBLÒ RESTYLING	Tutti i modelli	1/2006->	228 x 40	sx/dx	FC228113	AP
 DOBLÒ 2009 ->	1.3 Cargo passo corto 7 q.li	11/2009->	228 x 40	sx/dx	FC228120	AP
	1.3 Combi passo corto 7 q.li Panorama 5 P	11/2009->	254 x 57	sx	FC254021	AP
			254 x 57	dx	FC254022	AP
	1.3 Cargo 10 q.li Combi 10 q.li, Panorama 7 P	11/2009->	254 x 57	sx	FC254023	AP
			254 x 57	dx	FC254024	AP
	1.4 Tutti i modelli	11/2009->	254 x 57	sx	FC254023	AP
			254 x 57	dx	FC254024	AP
	1.6 1.6 MTA Cargo passo corto 7 q.li	11/2009->	228 x 40	sx/dx	FC228120	AP
	1.6 1.6 MTA Combi passo corto 7 q.li Panorama 5 P	11/2009->	254 x 57	sx	FC254021	AP
			254 x 57	dx	FC254022	AP
1.6 1.6 MTA Cargo 10 q.li Combi 10 q.li	11/2009->	254 x 57	sx	FC254023	AP	
		254 x 57	dx	FC254024	AP	
2.0	11/2009->	254 x 57	sx	FC254023	AP	
		254 x 57	dx	FC254024	AP	
 DUCATO 10/14 q.l	Tutti i modelli senza ABS (cil. Ø 25,4)	94-2001	254 x 57	sx	FC254015	Lucas
			254 x 57	dx	FC254016	Lucas
	2.0 i, 2.0 JTD, 2.3 JTD, 2.8 JTD, 2.8 JTD 4x4 (senza ABS)	2002->	254 x 57	sx	FC254017	AP
			254 x 57	dx	FC254018	AP
	2.0 i, 2.0 JTD, 2.3 JTD, 2.8 JTD, 2.8 JTD 4x4 (con ABS)	2002->	254 x 57	sx	FC254019	AP
			254 x 57	dx	FC254020	AP
Tutti i modelli escl. 4x4 (freno di stazionamento)	2002->	172 x 40	sx	FC172001	AP	
		172 x 40	dx	FC172002	AP	
4x4 (freno di stazionamento)	2002->	172 x 40	sx/dx	FK172003 (kit freno)	AP	
DUCATO 18 q.li	Tutti i modelli escl. 4x4 (freno di stazionamento)	10/2001->	172 x 40	sx	FC172001	AP
			172 x 40	dx	FC172002	AP
	4x4 (freno di stazionamento)	10/2001->	172 x 40	sx/dx	FK172003 (kit freno)	AP
 DUCATO mod.2006	Tutti i modelli (freno di stazionamento)	2006->	172 x 40	sx	FC172005	AP
			172 x 40	dx	FC172006	AP
 FIORINO	Tutti i modelli	88-93	185 x 30	sx/dx	FK185103 (*) (kit freno)	FIAT/ AP

*Tutti i modelli" s'intende come tutti i modelli con freni a tamburo

(*) = ad esaurimento scorte

	 		 			
FIAT						
 FIORINO mod. 2008	1.3 MPI, 1.4 8V	1/2008->	203 x 38	sx/dx	FC203114	AP
	1.3 D Multijet 1.4 Fire Natural Power	1/2008->	228 x 40	sx/dx	FC228115	AP
 FIORINO Minicargo	A portata maggiorata	2017->	228 x 40	sx/dx	FC228124	ATE
 IDEA	1.2 i 16V 1.3 JTD 1.4, 1.4 LPG, 1.4 16V	10/2003->	203 x 38	sx/dx	FC203112	AP
	1.3 D Multijet, 1.9 JTD	10/2003->	228 x 40	sx/dx	FC228112	AP
 LINEA	1.3 multijet 1.4	2007->	203 x 38	sx/dx	FC228114	AP
 MAREA BERLINA	1.6 i 16V senza ABS	96->	203 x 38	sx/dx	FC203105	AP
	1.6 i 16V con ABS (foro Ø 21)	96->	203 x 38	sx/dx	FC203106	AP
	1.6 i 16V con ABS (foro Ø 13)	96->	203 x 38	sx/dx	FC203105	AP
	1.8 i 16V senza ABS	96->	203 x 38	sx/dx	FC203105	AP
	1.8 i 16V con ABS (foro Ø 21)	96->	203 x 38	sx/dx	FC203106	AP
	1.8 i 16V con ABS (foro Ø 13)	96->	203 x 38	sx/dx	FC203105	AP
	1.9 TD senza ABS	96->	203 x 38	sx/dx	FC203105	AP
	1.9 TD con ABS (foro Ø 21)	96->	203 x 38	sx/dx	FC203106	AP
	1.9 TD con ABS (foro Ø 13)	96->	203 x 38	sx/dx	FC203105	AP
1.9 JTD	96->	203 x 38	sx/dx	FC203105	AP	
 MAREA WEEKEND	1.6 senza ABS 1.8 senza ABS	98->	228 x 40	sx/dx	FC228108	AP
	1.6 con ABS (foro Ø 21) 1.8 con ABS (foro Ø 21)	98->	228 x 40	sx/dx	FC228109	AP
	1.6 con ABS (foro Ø 13) 1.8 con ABS (foro Ø 13)	98->	228 x 40	sx/dx	FC228108	AP
	1.9 TD senza ABS	98->	228 x 40	sx/dx	FC228108	AP
	1.9 TD con ABS (foro Ø 21)	98->	228 x 40	sx/dx	FC228109	AP
	1.9 TD con ABS (foro Ø 13)	98->	228 x 40	sx/dx	FC228108	AP
	1.9 JTD base e ABS (foro Ø 13)	98->	228 x 40	sx/dx	FC228108	AP
 MARENGO	Tutti i modelli senza ABS	98->	228 x 40	sx/dx	FC228108	AP
	Tutti i modelli con ABS (foro Ø 21)	98->	228 x 40	sx/dx	FC228109	AP
	Tutti i modelli con ABS (foro Ø 13)	98->	228 x 40	sx/dx	FC228108	AP
 MULTIPLA	1.6, 1.6 16V, 1.6 16V Bluepower 1.6 16V Bipower base e ABS (foro Ø 13) 1.9 JTD base e ABS (foro Ø 13)	98->	228 x 40	sx/dx	FC228108	AP
 PALIO PALIO WEEKEND	1.0, 1.2 senza ABS	96->	228 x 40	sx/dx	FC228108	AP
	1.0, 1.2 con ABS (foro Ø 21)	96->	228 x 40	sx/dx	FC228109	AP
	1.5, 1.6 i 16V senza ABS	96->	228 x 40	sx/dx	FC228108	AP
	1.5, 1.6 i 16V con ABS (foro Ø 21)	96->	228 x 40	sx/dx	FC228109	AP
	1.7 TD, 1.9D, 1.9 JTD senza ABS	96->	228 x 40	sx/dx	FC228108	AP
	1.7 TD, 1.9D, 1.9 JTD con ABS (foro Ø 21)	96->	228 x 40	sx/dx	FC228109	AP

"Tutti i modelli" s'intende come tutti i modelli con freni a tamburo

	 		 			
FIAT						
 PANDA 1993 →	Tutti i modelli escluso 4x4	93→	185 x 30	sx/dx	FK185103 (*) (kit freno)	FIAT/AP
	4x4	93→	185 x 30	sx/dx	FK185104 (*) (kit freno)	FIAT/AP
 PANDA 2003 → escluso 4x4	1.1 Mpi 8V senza ABS	2003→	180 x 30	sx/dx	FC180117	AP
	1.1, 1.2	2010→	180 x 30	sx/dx	FC180119	AP
	1.2 Natural Power, 1.2 LPG	2003→	203 x 38	sx/dx	FC203114	AP
	1.3 D Multijet, 1.3 JTD	2010→	180 x 30	sx/dx	FC180119	AP
	1.4 Natural Power	2003→	203 x 38	sx/dx	FC203114	AP
 PANDA 2012→	Tutti i modelli (escluso 4x4)	2012→	203 x 38	sx/dx	FC203121	ATE
 PUNTO 1993 →	1.1 i (55), 1.2 i (60/75) Berlina, 1.2 i (60) Cabrio, 1.2 i 16V (85) Berlina e Cabrio, 1.6 i (90) Berlina e Cabrio, 1.7D, 1.7TD	93→	180 x 30	sx/dx	FC180101	AP
 PUNTO 1999 →	1.2, 1.2 16V Cambio manuale senza ABS	99→	180 x 30	sx/dx	FC180111	AP
	1.2, 1.2 16V Cambio manuale con ABS	99→	180 x 30	sx/dx	FC180112	AP
	1.2 16V Cambio Automatico senza ABS	99→	180 x 30	sx/dx	FC180113	AP
	1.2 16V Cambio Automatico con ABS	99→	180 x 30	sx/dx	FC180114	AP
	1.9 D, 1.9 JTD senza ABS	99→	180 x 30	sx/dx	FC180113	AP
	1.9 D, 1.9 JTD con ABS	99→	180 x 30	sx/dx	FC180114	AP
 PUNTO VAN 1999 →	1.2 MPI F3 8V senza ABS	9/2000→	180 x 30	sx/dx	FC180115	AP
	1.2 MPI con ABS	9/2000→	180 x 30	sx/dx	FC180112	AP
	1.9 D, 1.9 JTD senza ABS	99→	180 x 30	sx/dx	FC180113	AP
	1.9 D, 1.9 JTD con ABS	99→	180 x 30	sx/dx	FC180114	AP
 PUNTO RESTYLING	1.2, 1.2 16V senza ABS	2003→	180 x 30	sx/dx	FC180111	AP
	1.2, 1.2 16V con ABS	2003→	180 x 30	sx/dx	FC180112	AP
	1.3 JTD 16V senza ABS	2003→	180 x 30	sx/dx	FC180113	AP
	1.3 JTD 16V con ABS	2003→	180 x 30	sx/dx	FC180114	AP
	1.4 16V	2003→	203 x 38	sx/dx	FC203111	AP
	1.9 JTD senza ABS	2003→	180 x 30	sx/dx	FC180113	AP
	1.9 JTD con ABS	2003→	180 x 30	sx/dx	FC180114	AP
 PUNTO VAN RESTYLING	1.3 JTD 16V senza ABS	4/2003→	180 x 30	sx/dx	FC180113	AP
	1.3 JTD 16V con ABS	4/2003→	180 x 30	sx/dx	FC180114	AP
 GRANDE PUNTO GRANDE PUNTO EVO Escluso Sporting	1.2	9/2005→	203 x 38	sx/dx	FC203114	AP
	1.3 Multijet 1.4, 1.4 LPG, 1.4 16V, 1.4 Natural Power	9/2005→	228 x 40	sx/dx	FC228114	AP

Tutti i modelli s'intende come tutti i modelli con freni a tamburo

(*) = ad esaurimento scorte

	 		 			
FIAT						
 QUBO	1.3 MPI, 1.4 8V	1/2008->	203 x 38	sx/dx	FC203114	AP
	1.3 D Multijet, 1.4 Fire Natural Power	1/2008->	228 x 40	sx/dx	FC228115	AP
 TIPO 3 volumi	1.3 Multijet, 1.4, 1.6 E-torQ	2016->	228 x 40	sx/dx	FC228123	ATE
 UNO	Tutti i modelli	93->	185 x 30	sx/dx	FK185103 (*) (kit freno)	AP
FORD						
 FIESTA	1.0 i, 1.2 i 16V, 1.3 i Berlina, 1.4, 1.8 D Berlina, 1.8 DI Berlina senza ABS	2000-2/2002	180 x 30	sx/dx	FC180201	AP
	con ABS	2000-2/2002	203 x 38	sx/dx	FC203202 (*)	AP
	1.2 i 16V, 1.3 i, 1.4 i 16V, 1.4 TDCi 1.6 i 16V, 1.6 TDCi	3/2002-2008	203 x 38	sx/dx	FC203203	AP
 FOCUS 2005	Tutti i modelli	2005-2013	228 x 40	sx/dx	FC228206	AP
 FUSION	1.25 i 16V 1.4 i 16V, 1.4 TDCi 1.6 i 16V, 1.6 TDCi	10/2002->	203 x 38	sx/dx	FC203203	AP
 KA	1.0 i, 1.3 i	2000->	180 x 30	sx/dx	FC180201	AP
 KA II	1.2 i 16V 1.3 TDCi	2010->	180 x 30	sx/dx	FC180119	AP
 PUMA	Tutti i modelli con ABS	2000-8/2002	203 x 38	sx/dx	FC203202 (*)	AP
 SPORTKA	Tutti i modelli	2003->	203 x 38	sx/dx	FC203202 (*)	AP
 STREETKA	Tutti i modelli	2003->	203 x 38	sx/dx	FC203202 (*)	AP

"Tutti i modelli" s'intende come tutti i modelli con freni a tamburo

(*) = ad esaurimento scorte

	 		 			
FORD						
 RANGER	2.5L DurATEc benzina 2.2L Duratorq TDCi 3.2L Duratorq TDCi senza ABS	2011->	270 x 56	sx	FC270209	ATE/Nisshimbo
			270 x 56	dx	FC270210	ATE/Nisshimbo
	con ABS	2011->	270 x 56	sx	FC270207	ATE/Nisshimbo
			270 x 56	dx	FC270208	ATE/Nisshimbo
	2.5L DurATEc benzina 2.2L Duratorq TDCi 3.2L Duratorq TDCi 4x4 senza ABS	2011->	295 x 56	sx	FC295213	ATE/Nisshimbo
			295 x 56	dx	FC295214	ATE/Nisshimbo
con ABS	2011->	295 x 56	sx	FC295211	ATE/Nisshimbo	
		295 x 56	dx	FC295212	ATE/Nisshimbo	
 TRANSIT TOURNEO CONNECT	1.8i, 1.8TDCi	2002->	228 x 57	sx/dx	FK228205 (kit freno)	AP
INNOCENTI						
 MINITRE	Tutti i modelli	82-90	185 x 30	sx/dx	FK185103 (*) (kit freno)	AP
 TURBO DE TOMASO	Tutti i modelli	82-90	185 x 30	sx/dx	FK185103 (*) (kit freno)	AP
LADA						
 VESTA	1.6L Diesel	2015->	203 x 38	sx/dx	FC203801	ATE
LANCIA						
 DELTA	1.3, 1.5	86-90	185 x 30	sx/dx	FK185103 (*) (kit freno)	AP
	Turbo DS	86-90	185 x 30	sx/dx	FK185103 (*) (kit freno)	AP
 MUSA	1.3 D Multijet 70CV	2004->	203 x 38	sx/dx	FC203112	AP
	1.3 D Multijet 90-95CV	2004->	228 x 40	sx/dx	FC228112	AP
	1.4	2004->	203 x 38	sx/dx	FC203112	AP
	1.9 D Multijet	2004->	228 x 40	sx/dx	FC228112	AP
 Y	1.1 i 1.2 i, 1.2 i 16V 1.4 i	93->	180 x 30	sx/dx	FC180101	AP
 YPSILON	1.2 16V, 1.4, 1.4 16V, 1.3 Multijet	2003->	203 x 38	sx/dx	FC203114	Bosch
 NEW YPSILON	Tutti i modelli	6/2011->	203 x 38	sx/dx	FC203121	ATE

Tutti i modelli s'intende come tutti i modelli con freni a tamburo

(*) = ad esaurimento scorte













	 		 			
LAND ROVER						
 DISCOVERY 3	Tutti i modelli (freno di stazionamento)	2004->	210 x 30	sx	FC210703	AP
			210 x 30	dx	FC210704	AP
 DISCOVERY 4	Tutti i modelli (freno di stazionamento)	2010->	210 x 30	sx	FC210703	AP
			210 x 30	dx	FC210704	AP
 RANGE ROVER SPORT	3.0 V6 Diesel, 3.6 V8 Diesel, 5.0 V8 motore aspirato (freno di stazionamento)	2010->	210 x 30	sx	FC210703	AP
			210 x 30	dx	FC210704	AP
	5.0 V8 Turbo (freno di stazionamento)	2010->	210 x 30	sx	FC210705 (*)	AP
			210 x 30	dx	FC210706 (*)	AP
MASERATI						
 GHIBLI	Tutti i modelli (freno di stazionamento)	2012->	184 x 30	sx/dx	FC184400 (*)	ATE
 QUATTROPORTE	Tutti i modelli (freno di stazionamento)	2012->	184 x 30	sx/dx	FC184400 (*)	ATE
MAZDA						
 MAZDA 2	1.2 16V, 1.25 i 16V 1.3 16V 1.4 16V, 1.4 CD 1.5 16V 1.6 16V	4/2003->	203 x 38	sx/dx	FC203203	AP
NISSAN						
 MICRA	1.0 16V, 1.2 16V, 1.4 16V, 1.5 dCi, 1.6 i 16V	2003->	203 x 38	sx/dx	FC203301	AP
 NOTE	1.4 16V, 1.6 16V, 1.5 dCi	2006->	203 x 38	sx/dx	FC203301	AP
OPEL						
 ADAM	1.2 70CV, 1.4 87CV	2013->	203 x 38	sx/dx	FC203601	ATE
	1.4 100CV	2013->	228 x 42	sx/dx	FC228601	ATE
 ASTRA	1.4, 1.6	2007->	230 x 40	sx/dx	FC230602 (*)	AP
 COMBO	1.3 CDTi , 1.6 CDTi passo corto	2012->	228 x 40	sx/dx	FC228120	AP
	1.3 CDTi , 1.6 CDTi passo lungo	2012->	254 x 57	sx	FC254021	AP
			254 x 57	dx	FC254022	AP
	1.4, 1.4 CNG, 2.0 CDTi	2012->	254 x 57	sx	FC254023	AP
254 x 57			dx	FC254024	AP	

Tutti i modelli s'intende come tutti i modelli con freni a tamburo

(*) = ad esaurimento scorte

	 		 			
OPEL						
 CORSA	1.0, 1.2 3 porte	2006→	203 x 38	sx/dx	FC203601	AP
	1.0, 1.2 5 porte, 1.4, 1.3 CDTi (3 e 5 porte)	2006→	228 x 40	sx/dx	FC228601	AP
	Corsa E	2014→	228 x 40	sx/dx	FC228601	ATE
PEUGEOT						
 BOXER	2.0 i, 2.0 HDi, 2.2 HDi, 2.8 HDi, 2.8 HDi 4x4 (senza ABS)	2002→	254 x 57	sx	FC254017	AP
			254 x 57	dx	FC254018	AP
	2.0 i, 2.0 HDi, 2.2 HDi, 2.8 HDi, 2.8 HDi 4x4 (con ABS)	2002→	254 x 57	sx	FC254019	AP
			254 x 57	dx	FC254020	AP
	Tutti i modelli escl. 4x4 (freno di stazionamento)	2002→	172 x 40	sx	FC172001	AP
			172 x 40	dx	FC172002	AP
	4x4 (freno di stazionamento)	2002→	172 x 40	sx/dx	FK172003 (kit freno)	AP
	Tutti i modelli (freno di stazionamento)	2006→	172 x 40	sx	FC172005	AP
172 x 40			dx	FC172006	AP	
PIAGGIO						
 PORTER	Tutti i modelli	95-2010	203 x 38	sx/dx	FK203901 (kit freno)	AP
		2010→	203 x 38	sx/dx	FK203901 (kit freno)	AP
 PORTER MAXXI	Tutti i modelli	2001→	254 x 57	sx	FC254019	AP
			254 x 57	dx	FC254020	AP
RENAULT						
 CLIO II	Tutti i modelli senza ABS	2013-2016	203 x 38	sx/dx	FC203304	ATE
	Tutti i modelli con ABS	2013-2016	203 x 38	sx/dx	FC203305	ATE
 CLIO III	1.2, 1.2 16V, 1.2 16V Hi-Flex, 1.4 16V, 1.5 dCi	2005→	203 x 38	sx/dx	FC203301	AP
 CLIO SPORTOUR	1.2 16V, 1.5dCi, 1.6 16V (100 CV)	2008→	203 x 38	sx/dx	FC203301	AP
					FC203302 (con masse antirumore)	AP
 MODUS	1.2 16V, 1.5 dCi	2004→	203 x 38	sx/dx	FC203301	AP
 NEW MODUS GRAND MODUS	1.2 16V, 1.5dCi	2008→	203 x 38	sx/dx	FC203301	AP
					FC203302 (con masse antirumore)	AP
 TWINGO II	Tutti i modelli senza ABS	2012→	203 x 38	sx/dx	FC203304	ATE
	Tutti i modelli con ABS	2012→	203 x 38	sx/dx	FC203305	ATE
 TWINGO III	SCe 1.0 70CV, Energy 0.9 TCe 90CV	2014→	228 x 42	sx/dx	FC228307	ATE

“Tutti i modelli” s’intende come tutti i modelli con freni a tamburo

						
SEAT						
 MARBELLA	Tutti i modelli	87->	185 x 30	sx/dx	FK185104 (*) (kit freno)	FIAT/AP
 TOLEDO	Tutti i modelli	2014->	228 x 32	sx/dx	FC228701	ATE
SKODA						
 RAPID	Tutti i modelli	2013->	228 x 32	sx/dx	FC228701	ATE
 ROOMSTER	Tutti i modelli	11/2012->	228 x 32	sx/dx	FC228701	ATE
SMART						
 forfour	Tutti i modelli	2014->	228 x 42	sx/dx	FC228307	ATE
 fortwo	Tutti i modelli	2014->	203 x 38	sx/dx	FC203306	ATE
TOYOTA						
 YARIS	Tutti i modelli	2005->	203 x 38	sx/dx	FC203501	AP
 YARIS mod. 2012	Tutti i modelli	2012->	203 x 38	sx/dx	FC203502	AP

"Tutti i modelli" s'intende come tutti i modelli con freni a tamburo

(*) = ad esaurimento scorte



- D** Abbildungen Trommelbremsenkit
- EN** Illustrations drum brake kits
- FR** Illustrations Jeu de freins à tambours
- IT** Illustrazioni freni a tamburo

CB5-I

Illustrazioni freni a tamburo

Illustrations drum brake kits

FIAT DUCATO - CITROEN JUMPER - PEUGEOT BOXER mod. 2001 (freno di stazionamento)

FC172001



SX

Ø 172 x 40 mm

FC172002



DX

FIAT DUCATO - CITROEN JUMPER - PEUGEOT BOXER mod. 2006 (freno di stazionamento)

FC172005



SX

Ø 172 x 40 mm

FC172006

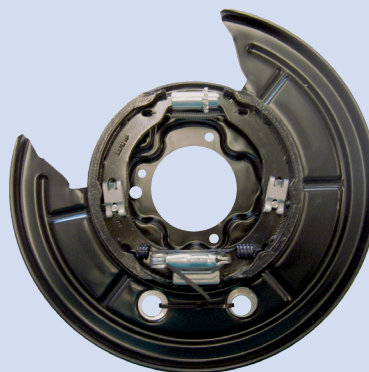

DX

FIAT PUNTO - LANCIA Y dal '93 (senza ABS)

FC180101

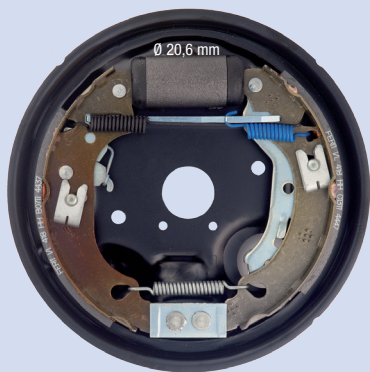

SX

Ø 180 x 30 mm

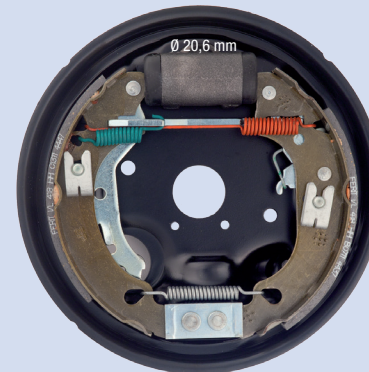

DX

FIAT BRAVO/A 1.2 16V - 1.4 - 1.9D (senza ABS)

FC180102

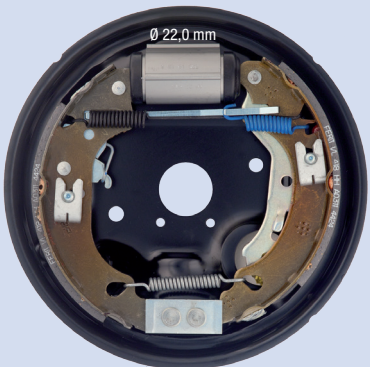

SX

Ø 180 x 30 mm

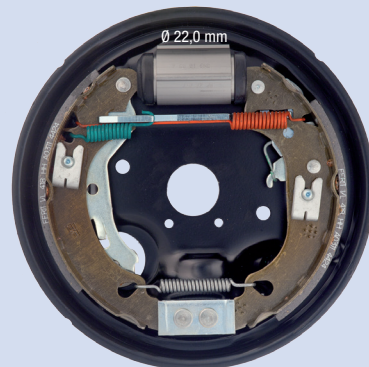

DX

Illustrazioni freni a tamburo

Illustrations drum brake kits

FIAT PUNTO 1.2 CAMBIO MANUALE dal '99 (senza ABS)

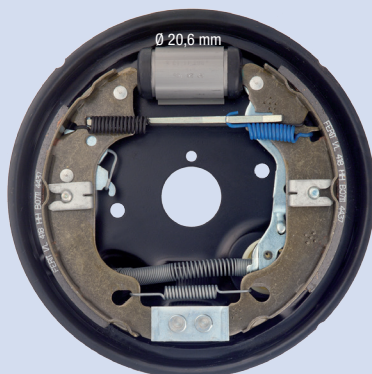

FC180111

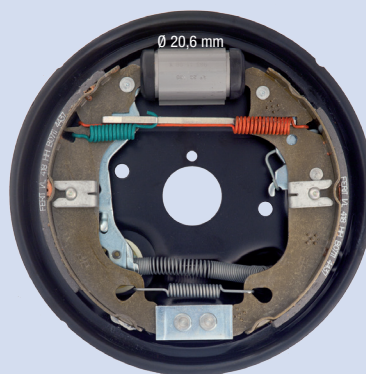

SX

Ø 180 x 30 mm

DX

FIAT PUNTO 1.2 CAMBIO MANUALE dal '99 - VAN dal '99 (con ABS)

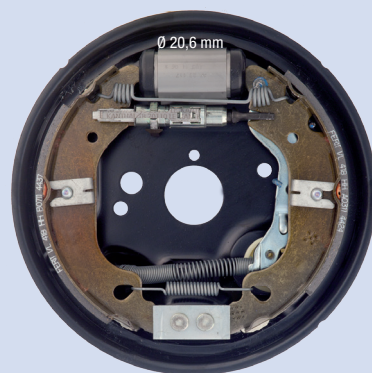

FC180112

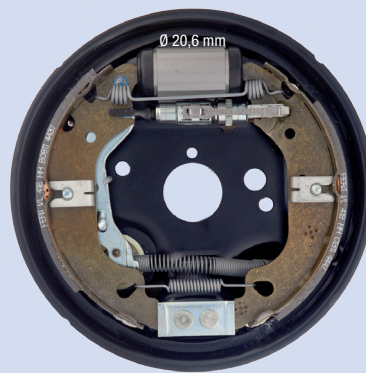

SX

Ø 180 x 30 mm

DX

FIAT PUNTO 1.2 CAMBIO AUTOMATICO - 1.9JTD - VAN - RESTYLING 1.3JTD - 1.9JTD dal '03 (senza ABS)

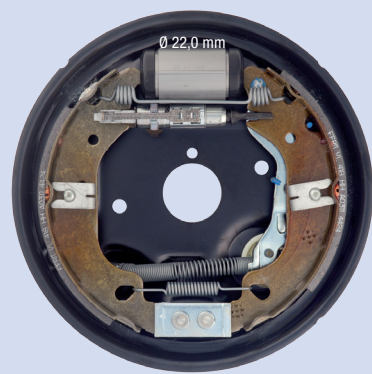

FC180113

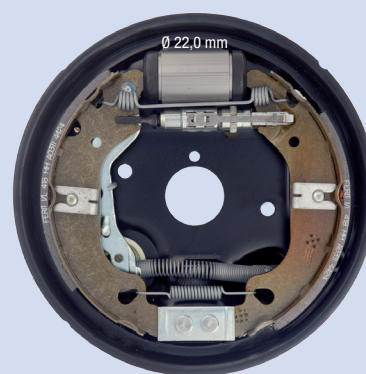

SX

Ø 180 x 30 mm

DX

FIAT PUNTO 1.2 CAMBIO AUTOMATICO - 1.9JTD - VAN - RESTYLING 1.3JTD - 1.9 JTD dal '03 (con ABS)

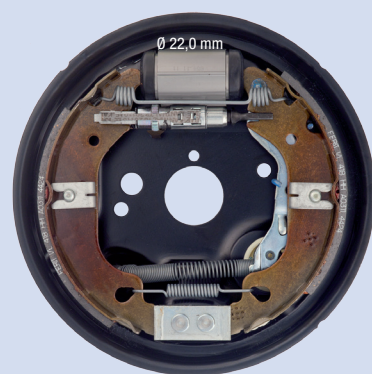

FC180114

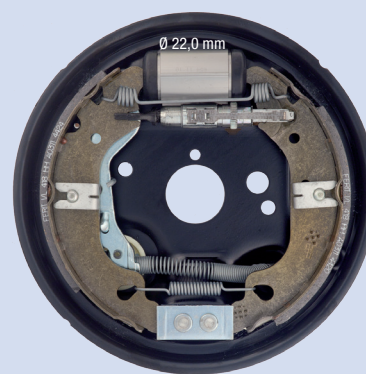

SX

Ø 180 x 30 mm

DX

Illustrazioni freni a tamburo

Illustrations drum brake kits

FIAT PUNTO VAN 1.2 8V dal 2000 (senza ABS)

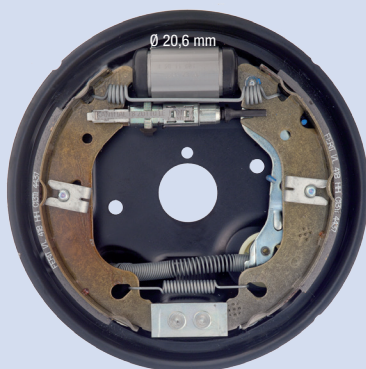

FC180115

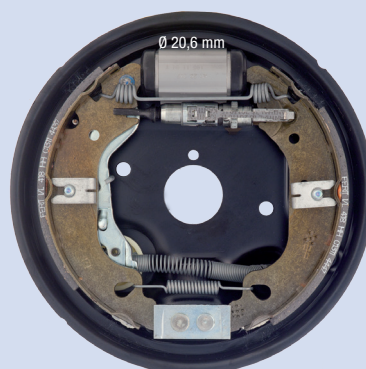

SX

Ø 180 x 30 mm

DX

FIAT PANDA (senza ABS) dal 2003

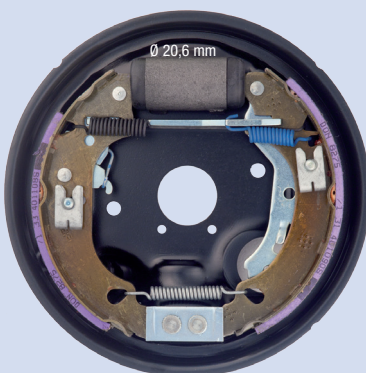

FC180117

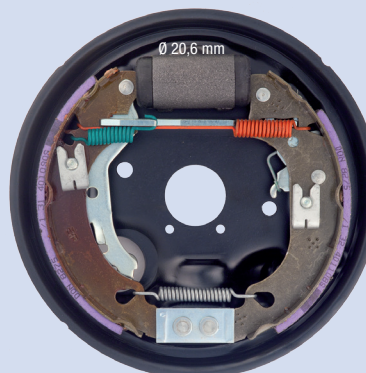

SX

Ø 180 x 30 mm

DX

FIAT 500 - FORD KA - FIAT PANDA (con ABS)

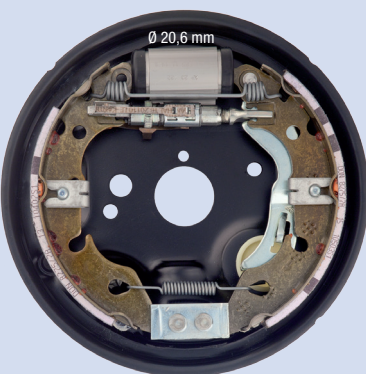

FC180119

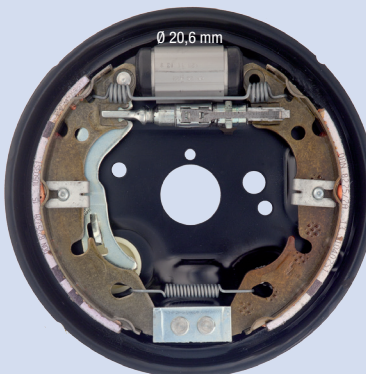

SX

Ø 180 x 30 mm

DX

FORD FIESTA - KA - PUMA dal '96 (senza ABS)

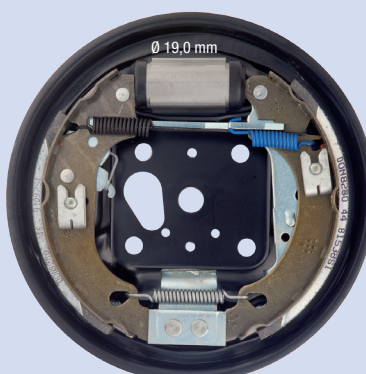

FC180201

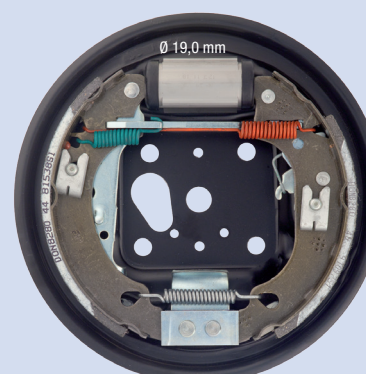

SX

Ø 180 x 30 mm

DX

Illustrazioni freni a tamburo

Illustrations drum brake kits

MASERATI GHIBLI - QUATTROPORTE (freno di stazionamento)

FC184400



SX

Ø 184 x 30 mm



DX

FIAT BRAVO - BRAVA - MAREA BERLINA (base e ABS Ø 13)

FC203105

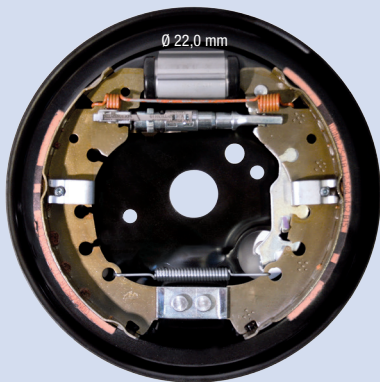

SX

Ø 203 x 38 mm

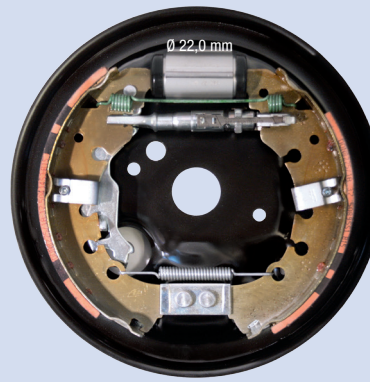

DX

FIAT BRAVO - BRAVA - MAREA BERLINA (con ABS Ø 21)

FC203106

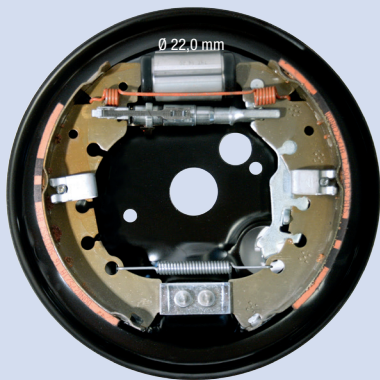

SX

Ø 203 x 38 mm

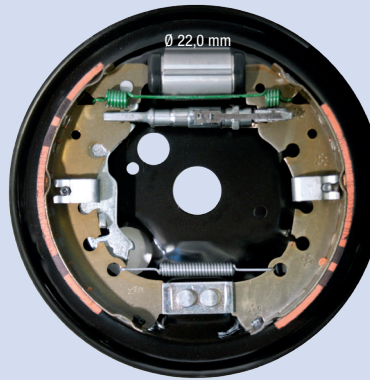

DX

FIAT PUNTO RESTYLING (dal 2003)

FC203111

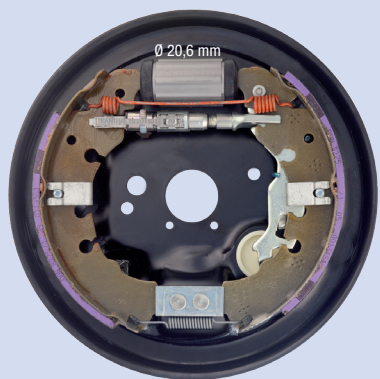

SX

Ø 203 x 38 mm

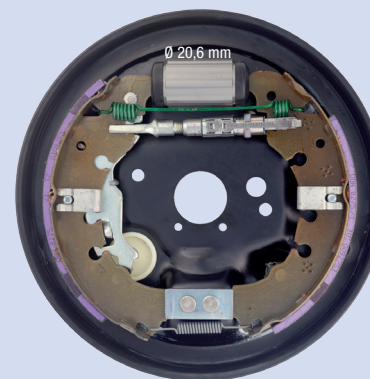

DX

Illustrazioni freni a tamburo

Illustrations drum brake kits

FIAT IDEA 1.2, 1.4, 1.3JTD - LANCIA MUSA

FC203112

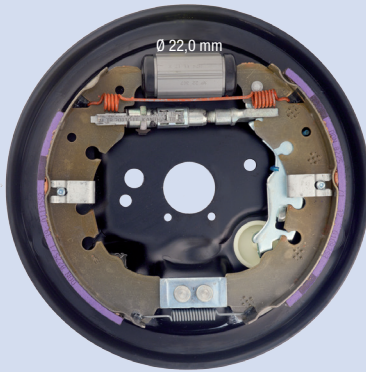

SX

Ø 203 x 38 mm

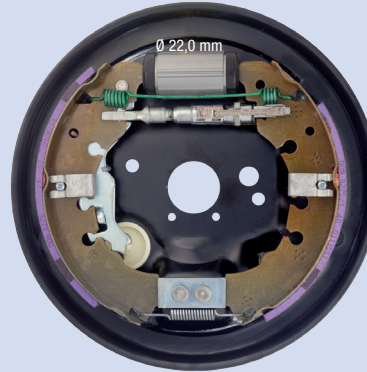

DX

FIAT GRANDE PUNTO 1.2 - PANDA NATURAL POWER- FIORINO '08 - QUBO - LANCIA YPSILON - CITROEN NEMO - PEUGEOT BIPPER (Ø 203)

FC203114

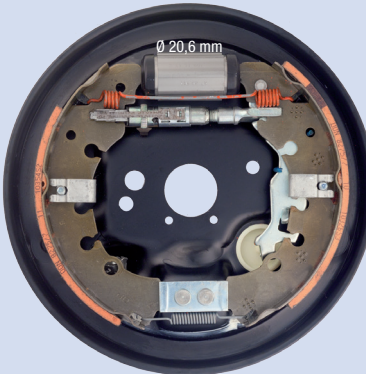

SX

Ø 203 x 38 mm

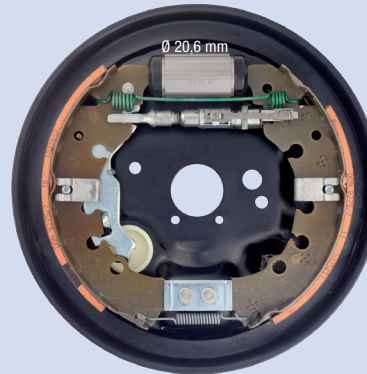

DX

FIAT PANDA mod. 2012 - LANCIA NEW YPSILON mod. 2011

FC203121

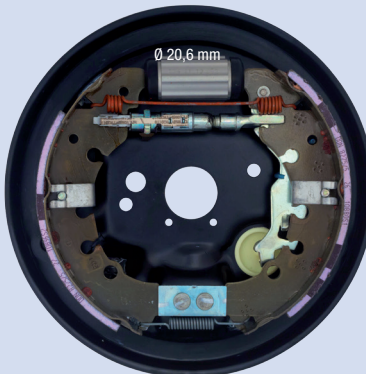

SX

Ø 203 x 38 mm

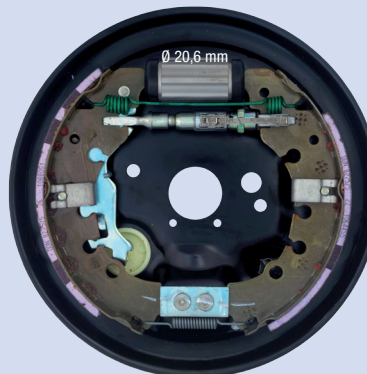

DX

FORD FIESTA (con ABS) - PUMA (con ABS) - SPORTKA - STREETKA

FC203202

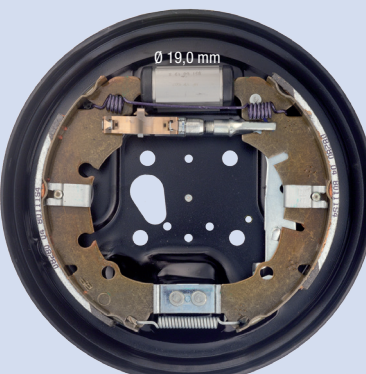

SX

Ø 203 x 38 mm

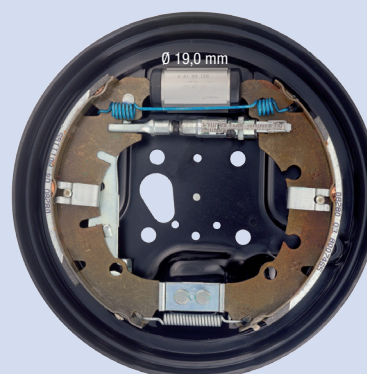

DX

Illustrazioni freni a tamburo

Illustrations drum brake kits

FORD FIESTA dal 2002 - FUSION - MAZDA 2

FC203203

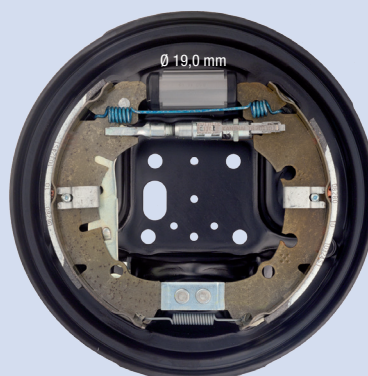
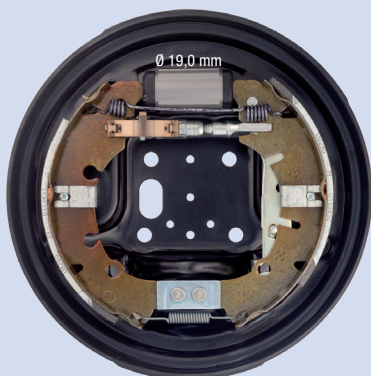

SX

Ø 203 x 38 mm

DX

NISSAN NOTE - MICRA dal 2003 - RENAULT MODUS - NEW MODUS - CLIO III

FC203301

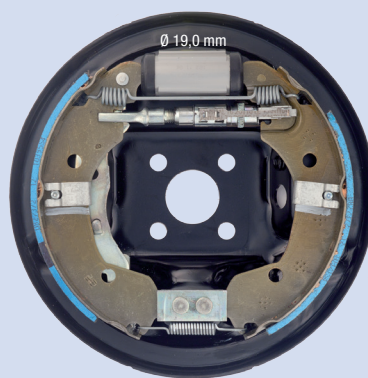
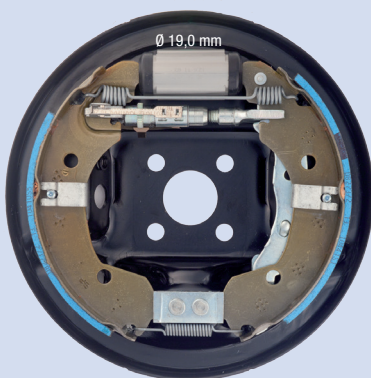

SX

Ø 203 x 38 mm

DX

RENAULT GRAND MODUS - CLIO SPORTOUR (con masse antirumore)

FC203302

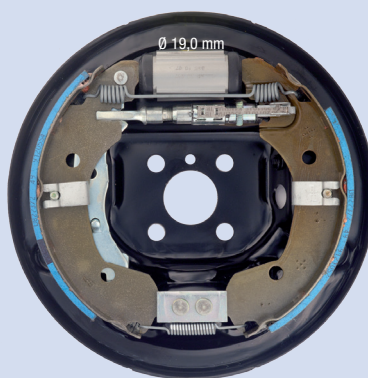
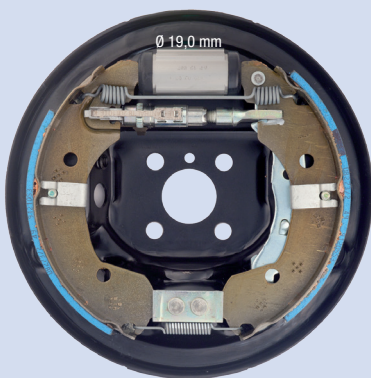

SX

Ø 203 x 38 mm

DX

RENAULT CLIO II (senza ABS)

FC203304

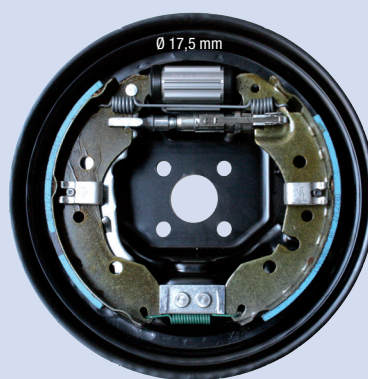
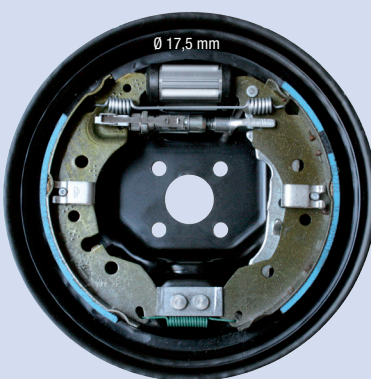

SX

Ø 203 x 38 mm

DX

Illustrazioni freni a tamburo

Illustrations drum brake kits

RENAULT TWINGO II (con ABS)

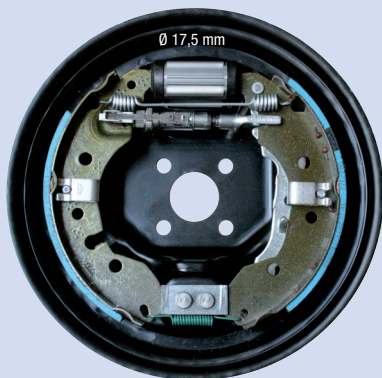

FC203305

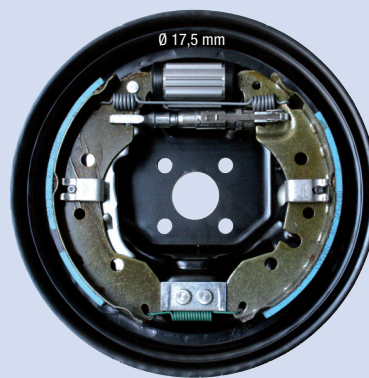

SX

Ø 203 x 38 mm

DX

SMART fortwo mod. 2014

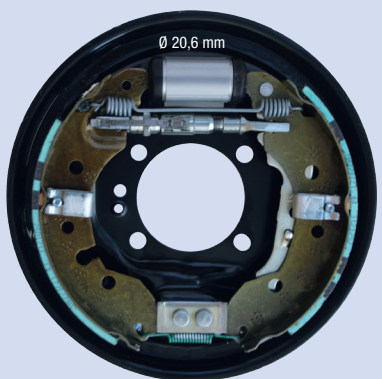

FC203306

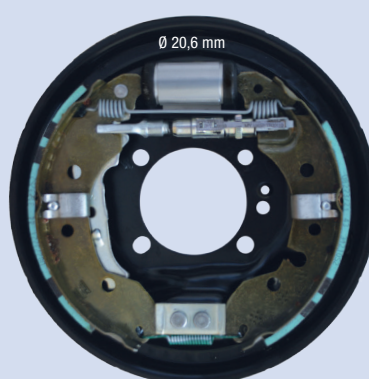

SX

Ø 203 x 38 mm

DX

TOYOTA YARIS mod. 2005

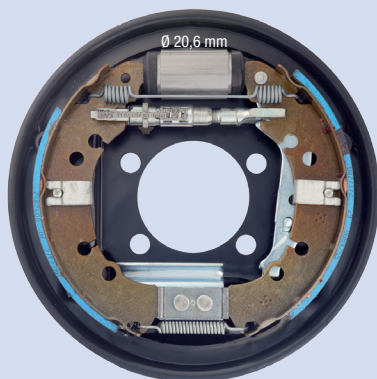

FC203501

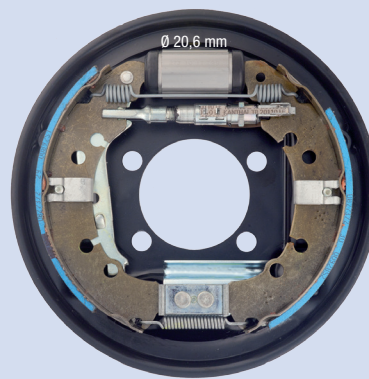

SX

Ø 203 x 38 mm

DX

TOYOTA YARIS mod. 2012

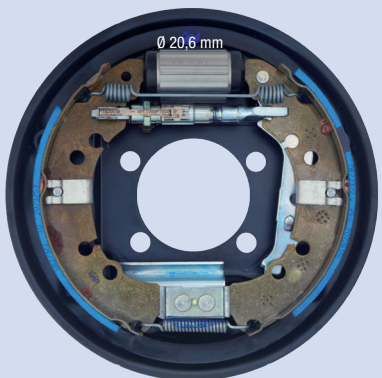

FC203502

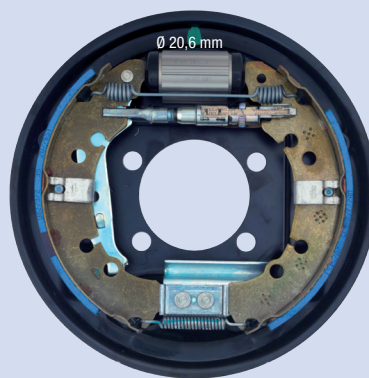

SX

Ø 203 x 38 mm

DX

Illustrazioni freni a tamburo

Illustrations drum brake kits

OPEL CORSA 1.0, 1.2 (3 porte) dal 2006 - ADAM

FC203601

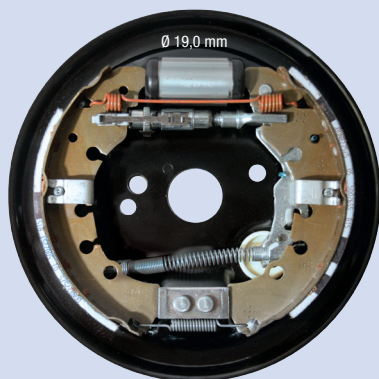

SX

Ø 203 x 38 mm

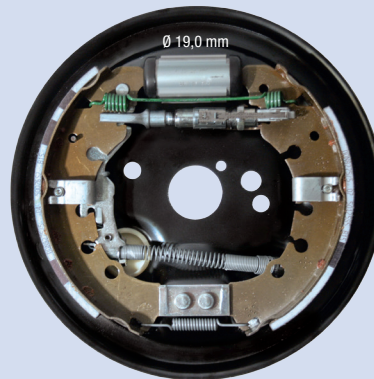

DX

LADA VESTA

FC203801

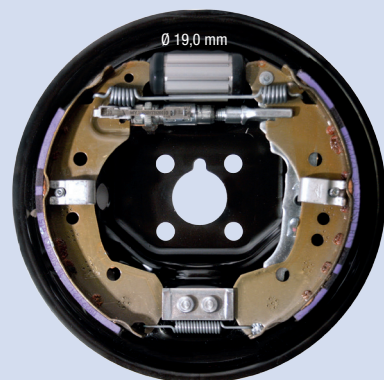

SX

Ø 203 x 38 mm

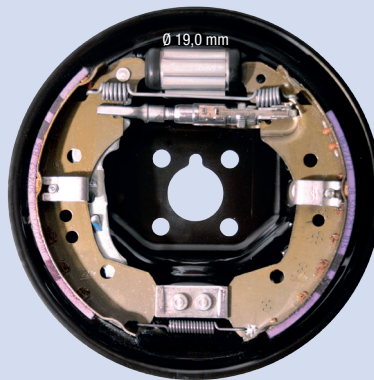

DX

LAND ROVER DISCOVERY 3 e 4 - RANGE ROVER SPORT mod. 2010

FC210703



SX

Ø 210 x 30 mm

FC210704

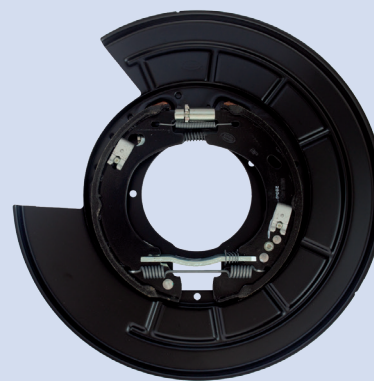

DX

RANGE ROVER SPORT mod. 2010 (freno di stazionamento)

FC210705



SX

Ø 210 x 30 mm

FC210706

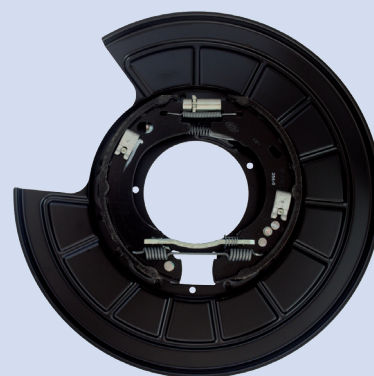

DX

Illustrazioni freni a tamburo

Illustrations drum brake kits

FIAT MAREA SW - MARENGO - MULTIPLA - PALIO SW

FC228108

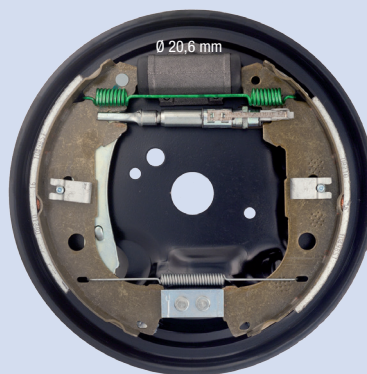
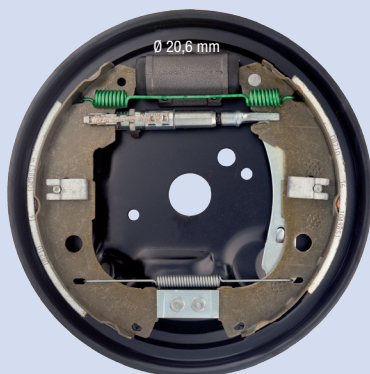

FIAT MAREA SW - PALIO SW - MARENGO (con ABS Ø 21)

FC228109

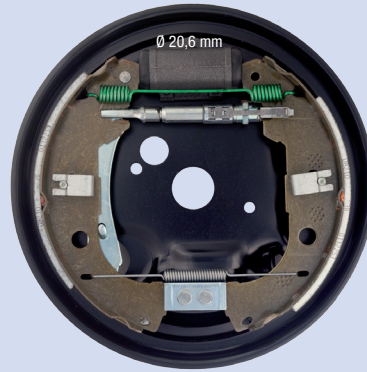
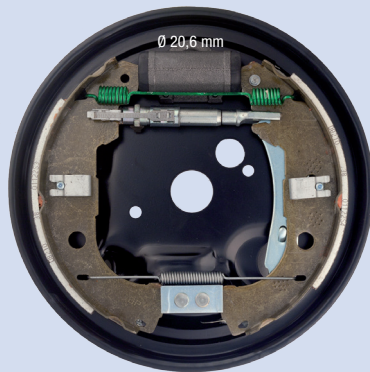

FIAT DOBLÒ

FC228111

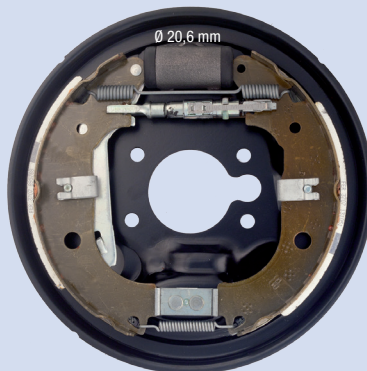
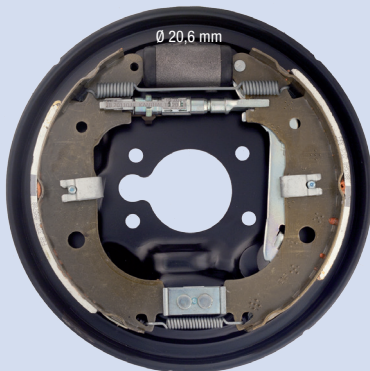

FIAT IDEA 1.3 D Multijet, 1.9 JTD - LANCIA MUSA

FC228112

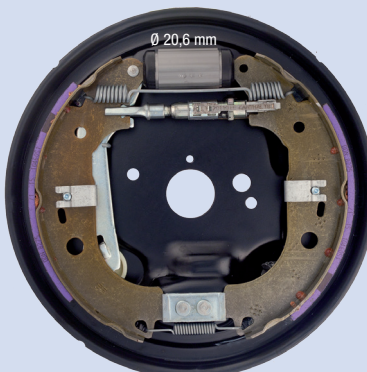
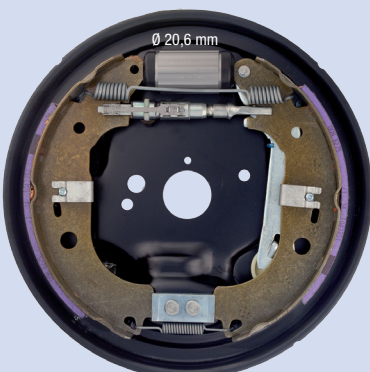

Illustrazioni freni a tamburo

Illustrations drum brake kits

FIAT DOBLÒ RESTYLING dal 2005

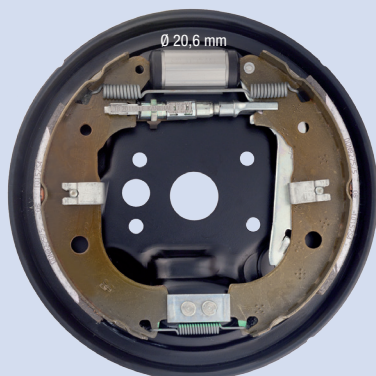

FC228113

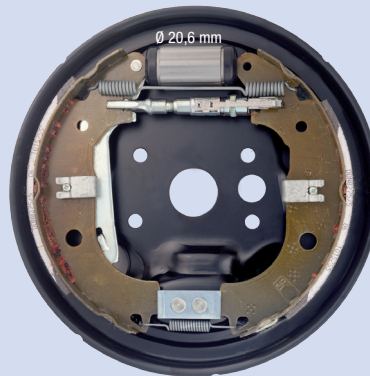

SX

Ø 228 x 40 mm

DX

FIAT GRANDE PUNTO E LINEA 1.3 MULTIJET - 1.4

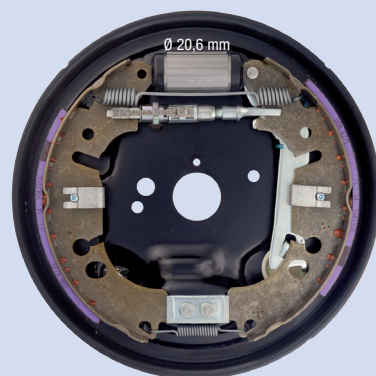

FC228114

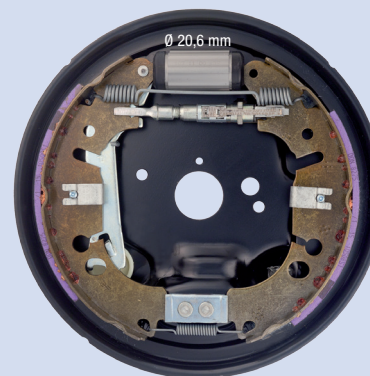

SX

Ø 228 x 40 mm

DX

FIAT FIORINO '08 - QUBO - CITROEN NEMO - PEUGEOT BIPPER (Ø 228)

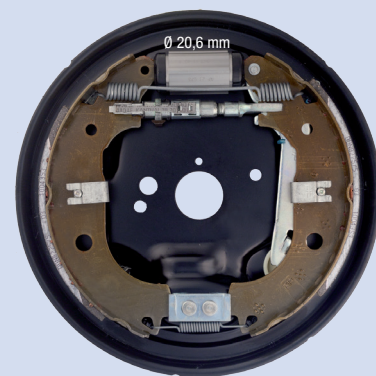

FC228115

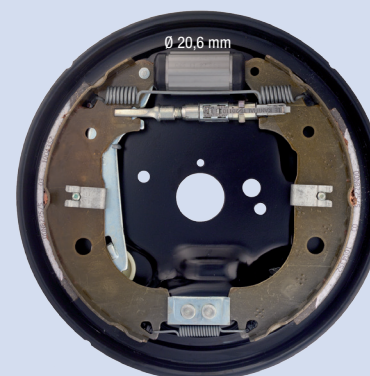

SX

Ø 228 x 40 mm

DX

FIAT DOBLÒ CARGO 7 q.li mod. 2009 - OPEL COMBO

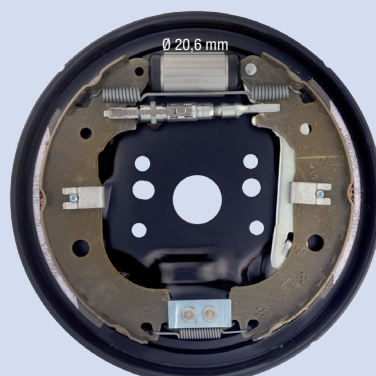

FC228120

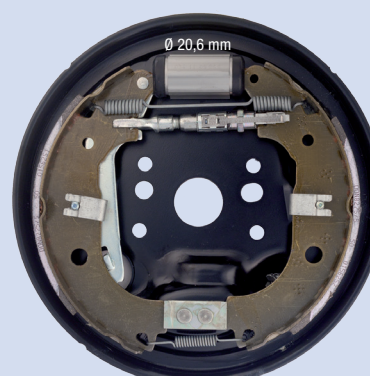

SX

Ø 228 x 40 mm

DX

Illustrazioni freni a tamburo

Illustrations drum brake kits

FIAT 500L

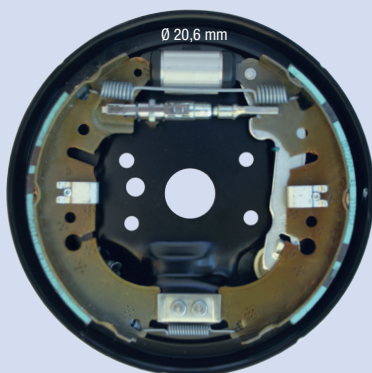

SX

FC228122

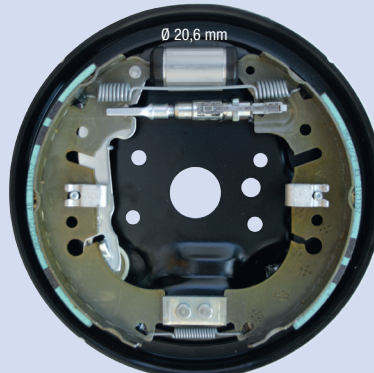

DX

Ø 228 x 42 mm

FIAT TIPO versione 3 volumi dal '16

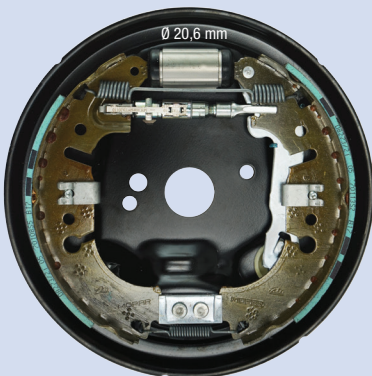

SX

FC228123

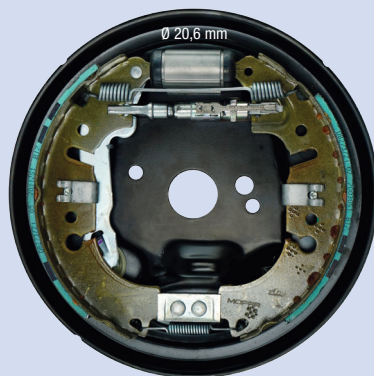

DX

Ø 228 x 40 mm

FIAT FIORINO Minicargo

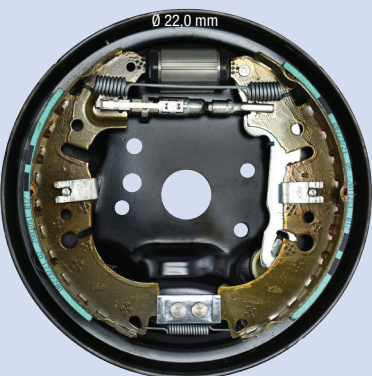

SX

FC228124

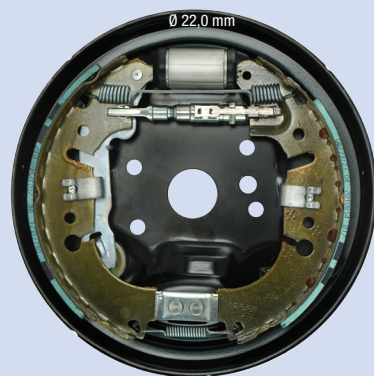

DX

Ø 228 x 40 mm

FORD FOCUS 2005-2013

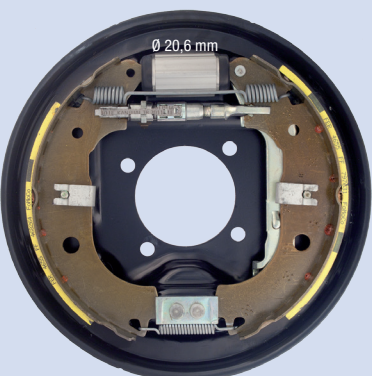

SX

FC228206

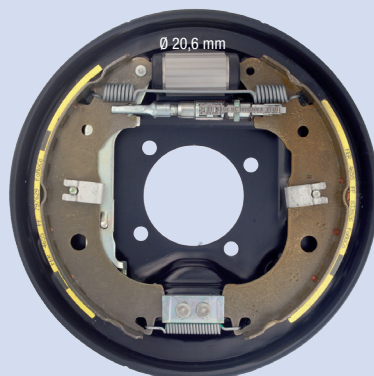

DX

Ø 228 x 40 mm

Illustrazioni freni a tamburo

Illustrations drum brake kits

RENAULT TWINGO III - SMART forfour mod. 2014

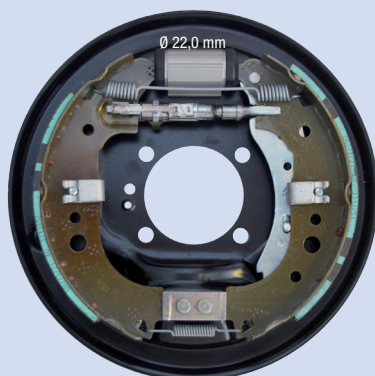

FC228307

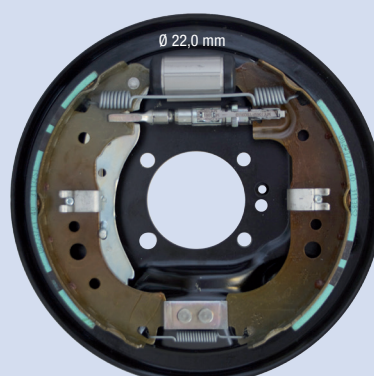

SX

Ø 228 x 42 mm

DX

OPEL CORSA 1.0 - 1.2 (5 porte) - 1.3 CDTI - 1.4 dal 2006 - ADAM 1.4 100CV - CORSA E

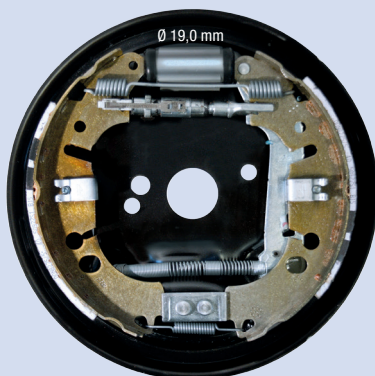

FC228601

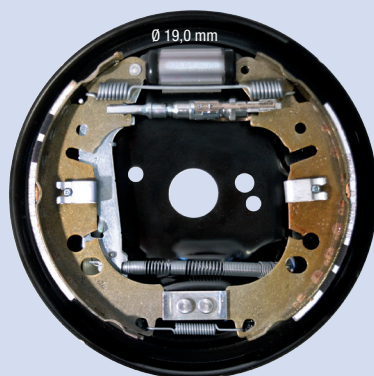

SX

Ø 228 x 40 mm

DX

SEAT TOLEDO - SKODA RAPID - ROOMSTER

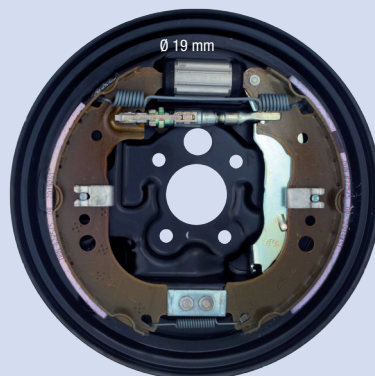

FC228701

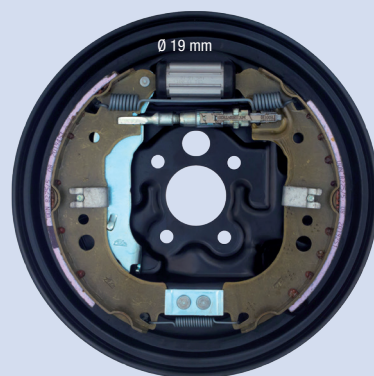

SX

Ø 228 x 32 mm

DX

OPEL ASTRA dal 2004

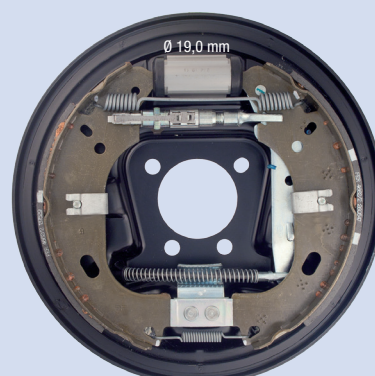

FC230602

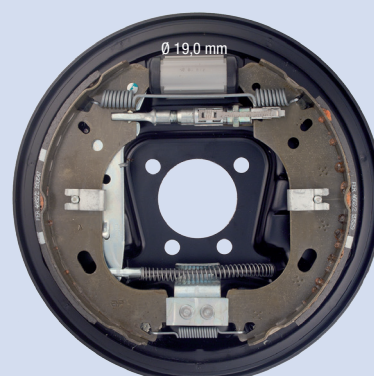

SX

Ø 230 x 40 mm

DX

Illustrazioni freni a tamburo

Illustrations drum brake kits

FIAT DUCATO (CIL. 25,4) DAL '94

FC254015

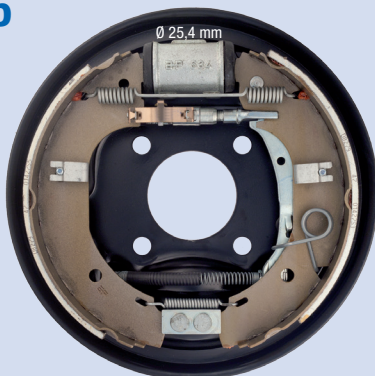

SX

Ø 254 x 57 mm

FC254016

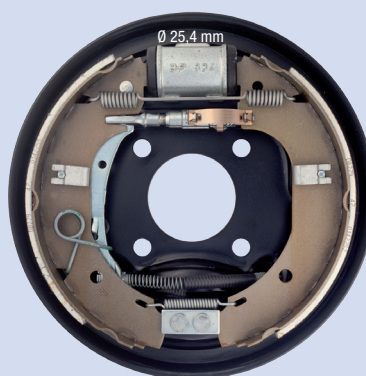

DX

FIAT DUCATO - CITROEN JUMPER - PEUGEOT BOXER (cil. 27,0) dal 2001

FC254017

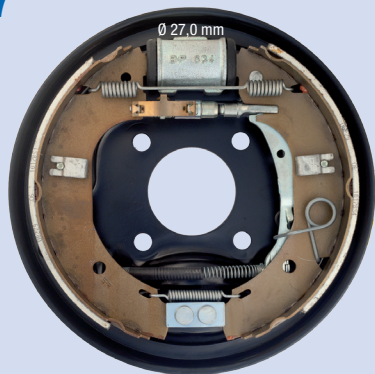

SX

Ø 254 x 57 mm

FC254018

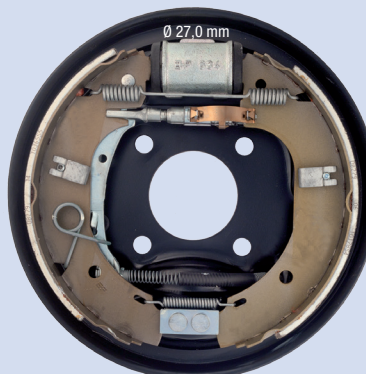

DX

FIAT DUCATO - CITROEN JUMPER - PEUGEOT BOXER (cil. 27,0) c/ABS dal 2001 - PIAGGIO PORTER MAXXI

FC254019

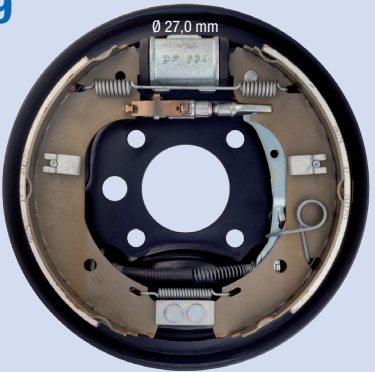

SX

Ø 254 x 57 mm

FC254020

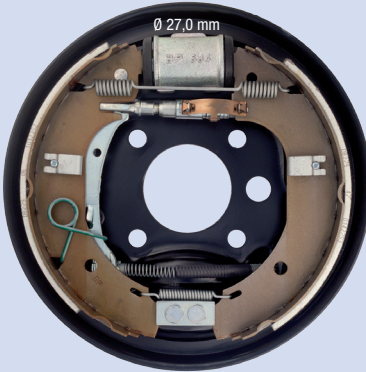

DX

FIAT DOBLÒ COMBI 7 q.li - PANORAMA 5p mod.2009 - OPEL COMBO

FC254021

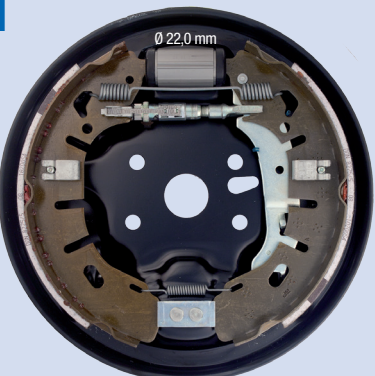

SX

Ø 254 x 57 mm

FC254022

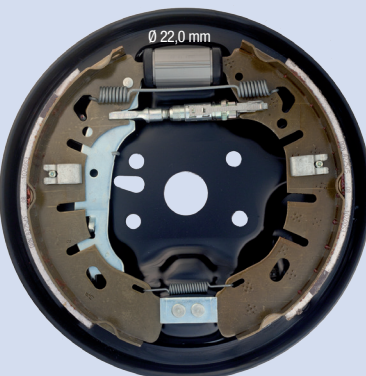

DX

Illustrazioni freni a tamburo

Illustrations drum brake kits

FIAT DOBLÒ COMBI e CARGO 10 q.li - PANORAMA 7p mod. 2009 - OPEL COMBO

FC254023

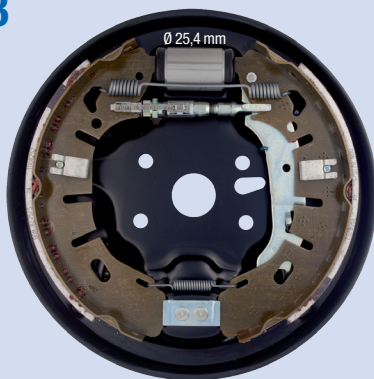

SX

Ø 254 x 57 mm

FC254024

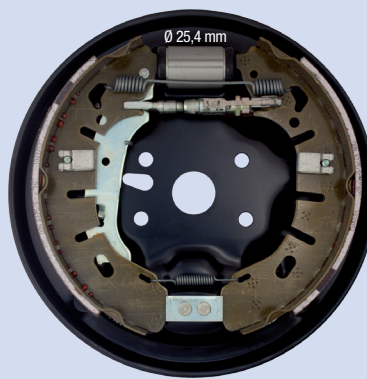

DX

FORD RANGER 4X2 (con ABS)

FC270207

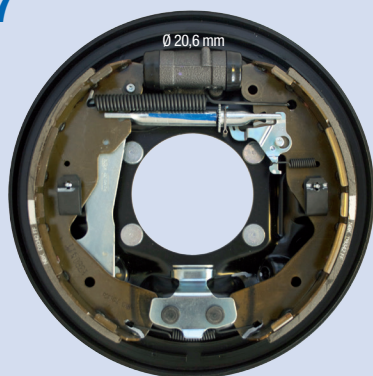

SX

Ø 270 x 56 mm

FC270208

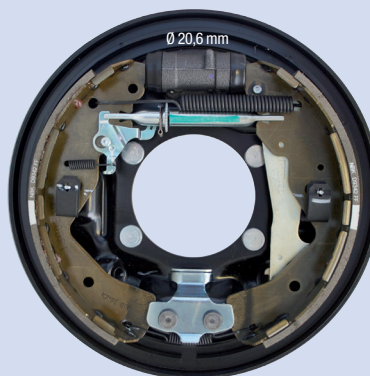

DX

FORD RANGER 4X2 (senza ABS)

FC270209

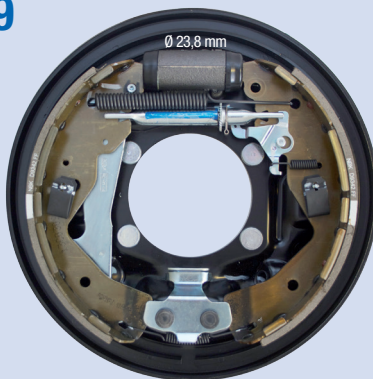

SX

Ø 270 x 56 mm

FC270210

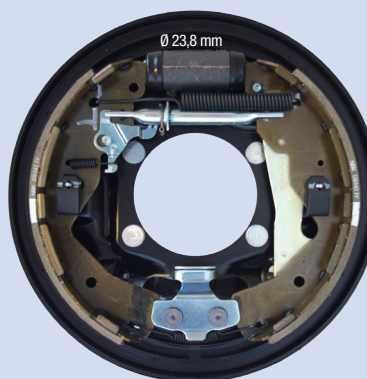

DX

FORD RANGER 4X4 (con ABS)

FC295211

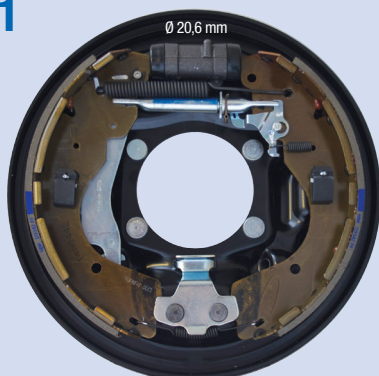

SX

Ø 295 x 56 mm

FC295212

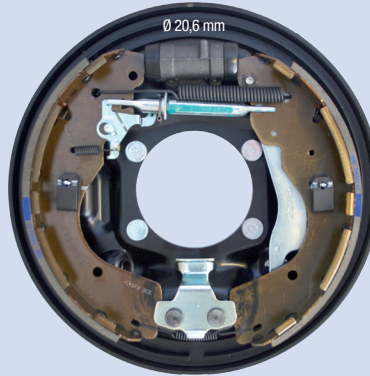

DX

Illustrazioni freni a tamburo

Illustrations drum brake kits

FORD RANGER 4X4 (senza ABS)

FC295213

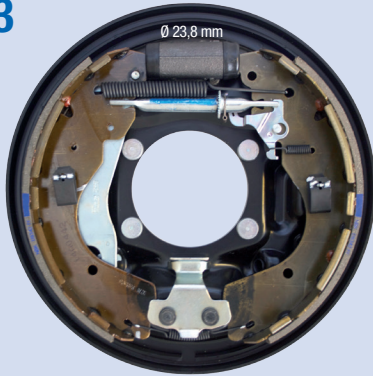

SX

FC295214

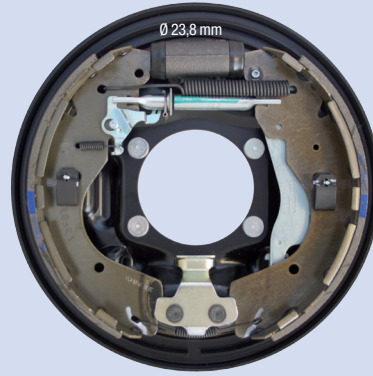

DX

Ø 295 x 56 mm

Illustrazioni kit freni

Illustrations drum brake kits (without back plate)

FIAT DUCATO - CITROEN JUMPER - PEUGEOT BOXER 4x4 mod. 2001

FK172003

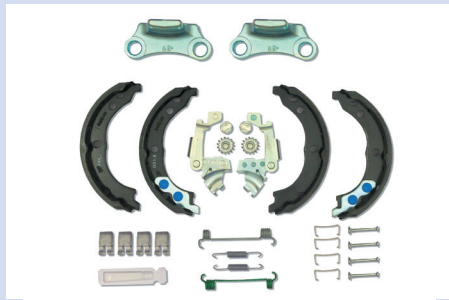

Ø 172 x 40 mm

FIAT PANDA - Y10 - UNO - FIORINO 1988-1993 - LANCIA DELTA

FK185103

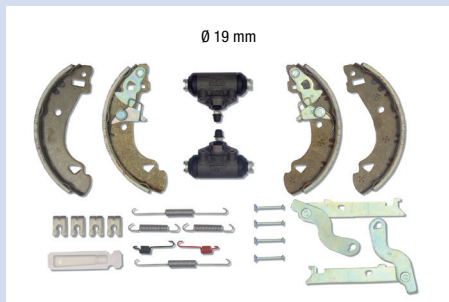

Ø 185 x 30 mm

FIAT PANDA 4X4 - Y10 4WD - SEAT MARBELLA

FK185104

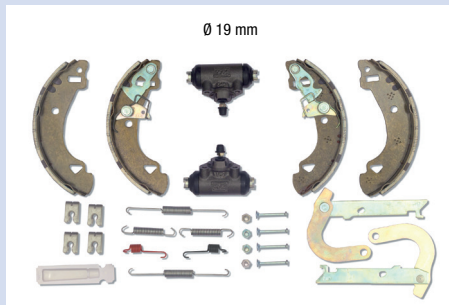

Ø 185 x 30 mm

PIAGGIO PORTER mod. 1995 e 2010

FK203901

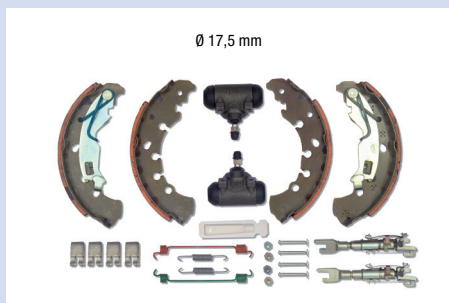

Ø 203 x 38 mm

FORD TRANSIT - TOURNEO CONNECT

FK228205

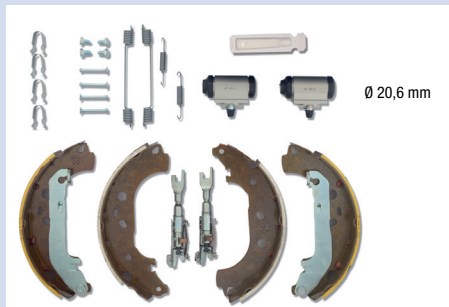

Ø 228 x 57 mm

ATE – A Trademark of the
Continental Corporation

Continental Aftermarket GmbH

Guerickestraße 7
D-60488 Frankfurt am Main
Tel. +49 (0) 69 7603-1
Fax +49 (0) 69 761061

www.ate.de

**Continental Automotive Trading
Italia S.r.l.**

Divisione ATE
Via Matteotti, 62
I-20092 Cinisello Balsamo (MI)
Tel. +39 02 35680 1
Fax +39 02 35680 325
E-Mail: info.consumatori@continental-corporation.com

www.ate-freni.it

Continental Brakes Italy S.p.A.

Divisione ATE
Corso Marconi, 160
I-17014 Cairo Montenotte (SV)
Tel. +39 0195071 1
Fax +39 0195071 242

www.ate-freni.it

Continental AutomotiveFrance SAS

Parc Ariane Bâtiment Vénus
Rue Hélène Boucher
F-78280 Guyancourt
Tél. +33 (0)1 39 44 10 30
Fax +33 (0)1 39 44 10 40
E-Mail: 07GYFMate-technique@continental-corporation.com

www.ate-freinage.fr

Continental Automotive Spain, S.A.

C/ Sepúlveda, 11
E-28108 Alcobendas (Madrid)
Phone +34 (0) 657 21 21
Fax +34 (0)91 657 21 49

www.frenos-ate.es