



# Nuovi particolari a magazzino

secondo applicazioni veicolo

07/2017

[www.ate.de](http://www.ate.de)





Descrizione

Codici OE -  
Codice ATE

Pre-codice / varie

## ALFA ROMEO

147 (01-10)	1,6 i 16V T,Spark			10.2010	28.0462-2145.1	BAR221	Discofreno ant.	5 69 086 , 95511282 , 71711447 , 71711434 , 60815938 , 60813443 , 60801722 , 52015291 , 51996238 , 51990127 , 71739567 , 71739568 , 60699518 , 60578093 , 60658565 , 82427592 , 82450539 , 60622077 , 60571548 , 60569163	
			01.2001	10.2010	28.0462-2145.1	BAR221	Discofreno ant.	5 69 086 , 95511282 , 71711447 , 71711434 , 60815938 , 60813443 , 60801722 , 52015291 , 51996238 , 51990127 , 71739567 , 71739568 , 60699518 , 60578093 , 60658565 , 82427592 , 82450539 , 60622077 , 60571548 , 60569163	
	1,9 JTD		01.2001	10.2010	28.0462-2145.1	BAR221	Discofreno ant.	5 69 086 , 95511282 , 71711447 , 71711434 , 60815938 , 60813443 , 60801722 , 52015291 , 51996238 , 51990127 , 71739567 , 71739568 , 60699518 , 60578093 , 60658565 , 82427592 , 82450539 , 60622077 , 60571548 , 60569163	
			06.2003	10.2010	28.0462-2145.1	BAR221	Discofreno ant.	5 69 086 , 95511282 , 71711447 , 71711434 , 60815938 , 60813443 , 60801722 , 52015291 , 51996238 , 51990127 , 71739567 , 71739568 , 60699518 , 60578093 , 60658565 , 82427592 , 82450539 , 60622077 , 60571548 , 60569163	



Descrizione

Codici OE -  
Codice ATE



Pre-codice / varie

## ALFA ROMEO

147 (01-10)	1,9 JTD 16V		11.2002	10.2010	28.0462-2145.1	BAR221	Discofreno ant.	5 69 086 , 95511282 , 71711447 , 71711434 , 60815938 , 60813443 , 60801722 , 52015291 , 51996238 , 51990127 , 71739567 , 71739568 , 60699518 , 60578093 , 60658565 , 82427592 , 82450539 , 60622077 , 60571548 , 60569163	
	1,9 JTDM 16V		07.2005	10.2010	28.0462-2145.1	BAR221	Discofreno ant.	5 69 086 , 95511282 , 71711447 , 71711434 , 60815938 , 60813443 , 60801722 , 52015291 , 51996238 , 51990127 , 71739567 , 71739568 , 60699518 , 60578093 , 60658565 , 82427592 , 82450539 , 60622077 , 60571548 , 60569163	
	1,9 JTDM 8V		07.2005	10.2010	28.0462-2145.1	BAR221	Discofreno ant.	5 69 086 , 95511282 , 71711447 , 71711434 , 60815938 , 60813443 , 60801722 , 52015291 , 51996238 , 51990127 , 71739567 , 71739568 , 60699518 , 60578093 , 60658565 , 82427592 , 82450539 , 60622077 , 60571548 , 60569163	
	2,0 i 16V T,Spark		01.2001	10.2010	28.0462-2145.1	BAR221	Discofreno ant.	5 69 086 , 95511282 , 71711447 , 71711434 , 60815938 , 60813443 , 60801722 , 52015291 , 51996238 , 51990127 , 71739567 , 71739568 , 60699518 , 60578093 , 60658565 , 82427592 , 82450539 , 60622077 , 60571548 , 60569163	



Descrizione

Codici OE -  
Codice ATE

Pre-codice / varie

## ALFA ROMEO

156 (97-05)	1,8 i 16V T,Spark		10.1997	07.2005	28.0462-2145.1	BAR221	Discofreno ant.	5 69 086 , 95511282 , 71711447 , 71711434 , 60815938 , 60813443 , 60801722 , 52015291 , 51996238 , 51990127 , 71739567 , 71739568 , 60699518 , 60578093 , 60658565 , 82427592 , 82450539 , 60622077 , 60571548 , 60569163	
	1,9 JTD 16V		11.2002	07.2005	28.0462-2145.1	BAR221	Discofreno ant.	5 69 086 , 95511282 , 71711447 , 71711434 , 60815938 , 60813443 , 60801722 , 52015291 , 51996238 , 51990127 , 71739567 , 71739568 , 60699518 , 60578093 , 60658565 , 82427592 , 82450539 , 60622077 , 60571548 , 60569163	
	2,0 16V T,Spark		10.1997	07.2005	28.0462-2145.1	BAR221	Discofreno ant.	5 69 086 , 95511282 , 71711447 , 71711434 , 60815938 , 60813443 , 60801722 , 52015291 , 51996238 , 51990127 , 71739567 , 71739568 , 60699518 , 60578093 , 60658565 , 82427592 , 82450539 , 60622077 , 60571548 , 60569163	
	2,0 JTS		03.2002	07.2005	28.0462-2145.1	BAR221	Discofreno ant.	5 69 086 , 95511282 , 71711447 , 71711434 , 60815938 , 60813443 , 60801722 , 52015291 , 51996238 , 51990127 , 71739567 , 71739568 , 60699518 , 60578093 , 60658565 , 82427592 , 82450539 , 60622077 , 60571548 , 60569163	



Descrizione

Codici OE -  
Codice ATE

Pre-codice / varie

## ALFA ROMEO

156 (97-05)	2,4 JTD		10.1997	10.2000	28.0462-2145.1	BAR221	Discofreno ant.	5 69 086 , 95511282 , 71711447 , 71711434 , 60815938 , 60813443 , 60801722 , 52015291 , 51996238 , 51990127 , 71739567 , 71739568 , 60699518 , 60578093 , 60658565 , 82427592 , 82450539 , 60622077 , 60571548 , 60569163	
			03.2002	07.2005	28.0462-2145.1	BAR221	Discofreno ant.	5 69 086 , 95511282 , 71711447 , 71711434 , 60815938 , 60813443 , 60801722 , 52015291 , 51996238 , 51990127 , 71739567 , 71739568 , 60699518 , 60578093 , 60658565 , 82427592 , 82450539 , 60622077 , 60571548 , 60569163	
			10.2000	07.2005	28.0462-2145.1	BAR221	Discofreno ant.	5 69 086 , 95511282 , 71711447 , 71711434 , 60815938 , 60813443 , 60801722 , 52015291 , 51996238 , 51990127 , 71739567 , 71739568 , 60699518 , 60578093 , 60658565 , 82427592 , 82450539 , 60622077 , 60571548 , 60569163	
			10.2003	07.2005	28.0462-2145.1	BAR221	Discofreno ant.	5 69 086 , 95511282 , 71711447 , 71711434 , 60815938 , 60813443 , 60801722 , 52015291 , 51996238 , 51990127 , 71739567 , 71739568 , 60699518 , 60578093 , 60658565 , 82427592 , 82450539 , 60622077 , 60571548 , 60569163	



Descrizione

Codici OE -  
Codice ATE

Pre-codice / varie

## ALFA ROMEO

156 (97-05)	2,5 V6 24V		10.1997	07.2005	28.0462-2145.1	BAR221	Discofreno ant.	5 69 086 , 95511282 , 71711447 , 71711434 , 60815938 , 60813443 , 60801722 , 52015291 , 51996238 , 51990127 , 71739567 , 71739568 , 60699518 , 60578093 , 60658565 , 82427592 , 82450539 , 60622077 , 60571548 , 60569163	
164 (92-98)	2,0 T,Spark		09.1991	09.1998	28.0461-0190.1	BAR101	Disco freno post.	60801753 , 60801390 , 16420.26100.01/00 , 46831042 , 46758715 , 60801755 , 82434070 , 82433859 , 82394418	
	2,0 Turbo		09.1991	09.1998	28.0462-2145.1	BAR221	Discofreno ant.	5 69 086 , 95511282 , 71711447 , 71711434 , 60815938 , 60813443 , 60801722 , 52015291 , 51996238 , 51990127 , 71739567 , 71739568 , 60699518 , 60578093 , 60658565 , 82427592 , 82450539 , 60622077 , 60571548 , 60569163	
GT (04-10)	1,8 TS		11.2003	07.2010	28.0462-2145.1	BAR221	Discofreno ant.	5 69 086 , 95511282 , 71711447 , 71711434 , 60815938 , 60813443 , 60801722 , 52015291 , 51996238 , 51990127 , 71739567 , 71739568 , 60699518 , 60578093 , 60658565 , 82427592 , 82450539 , 60622077 , 60571548 , 60569163	



Descrizione

Codici OE -  
Codice ATE

Pre-codice / varie

## ALFA ROMEO

GT (04-10)	1,9 JTD		05.2008	07.2010	28.0462-2145.1	BAR221	Discofreno ant.	5 69 086 , 95511282 , 71711447 , 71711434 , 60815938 , 60813443 , 60801722 , 52015291 , 51996238 , 51990127 , 71739567 , 71739568 , 60699518 , 60578093 , 60658565 , 82427592 , 82450539 , 60622077 , 60571548 , 60569163	
			11.2003	07.2010	28.0462-2145.1	BAR221	Discofreno ant.	5 69 086 , 95511282 , 71711447 , 71711434 , 60815938 , 60813443 , 60801722 , 52015291 , 51996238 , 51990127 , 71739567 , 71739568 , 60699518 , 60578093 , 60658565 , 82427592 , 82450539 , 60622077 , 60571548 , 60569163	
	2,0 JTS		11.2003	07.2010	28.0462-2145.1	BAR221	Discofreno ant.	5 69 086 , 95511282 , 71711447 , 71711434 , 60815938 , 60813443 , 60801722 , 52015291 , 51996238 , 51990127 , 71739567 , 71739568 , 60699518 , 60578093 , 60658565 , 82427592 , 82450539 , 60622077 , 60571548 , 60569163	
GTV (95-05)	2,0 i V6 Turbo		05.1995	12.2005	28.0462-2145.1	BAR221	Discofreno ant.	5 69 086 , 95511282 , 71711447 , 71711434 , 60815938 , 60813443 , 60801722 , 52015291 , 51996238 , 51990127 , 71739567 , 71739568 , 60699518 , 60578093 , 60658565 , 82427592 , 82450539 , 60622077 , 60571548 , 60569163	



					<p>Descrizione</p>	<p>Codici OE - Codice ATE</p>	 Pre-codice / varie
--	--	--	--	--	--------------------	-----------------------------------	------------------------

## ALFA ROMEO

SPIDER (95-05)	2,0 i V6 Turbo		05.1998	12.2005	28.0462-2145.1	BAR221	Discofreno ant.	5 69 086 , 95511282 , 71711447 , 71711434 , 60815938 , 60813443 , 60801722 , 52015291 , 51996238 , 51990127 , 71739567 , 71739568 , 60699518 , 60578093 , 60658565 , 82427592 , 82450539 , 60622077 , 60571548 , 60569163	
----------------	----------------	--	---------	---------	----------------	--------	-----------------	--	--





Descrizione

Codici OE -  
Codice ATE

Pre-codice / varie

## AUDI

A2 (00-05)	1,4 TDI	post.dx	11.2003	07.2005	24.3344-1710.5	240811	Pinza freno posteriore	6Q0 615 424 B , 6Q0 615 424 A	
	1,6 FSI	post.dx	05.2002	07.2005	24.3344-1710.5	240811	Pinza freno posteriore	6Q0 615 424 B , 6Q0 615 424 A	
A3 / A3 (8P) Sportback (03-13)	1,2 TSI	post.sx	04.2010	08.2013	24.3414-1709.5	240834	Pinza freno posteriore	1K0 615 423 M , 1K0 615 423 H , 1K0 615 423 C , 1K0 615 423	24.3414-1709.7
		post.dx	04.2010	08.2013	24.3414-1710.5	240835	Pinza freno posteriore	1K0 615 424 M , 1K0 615 424 H , 1K0 615 424 C , 1K0 615 424	24.3414-1710.7-
	1,4 TFSI	post.sx	07.2007	08.2013	24.3414-1709.5	240834	Pinza freno posteriore	1K0 615 423 M , 1K0 615 423 H , 1K0 615 423 C , 1K0 615 423	24.3414-1709.7
		post.dx	07.2007	08.2013	24.3414-1710.5	240835	Pinza freno posteriore	1K0 615 424 M , 1K0 615 424 H , 1K0 615 424 C , 1K0 615 424	24.3414-1710.7-
	1,6	post.sx	05.2003	08.2013	24.3414-1709.5	240834	Pinza freno posteriore	1K0 615 423 M , 1K0 615 423 H , 1K0 615 423 C , 1K0 615 423	24.3414-1709.7
		post.dx	05.2003	08.2013	24.3414-1710.5	240835	Pinza freno posteriore	1K0 615 424 M , 1K0 615 424 H , 1K0 615 424 C , 1K0 615 424	24.3414-1710.7-
	1,6 FSI	post.dx	08.2003	08.2013	24.3414-1710.5	240835	Pinza freno posteriore	1K0 615 424 M , 1K0 615 424 H , 1K0 615 424 C , 1K0 615 424	24.3414-1710.7-
		post.sx	08.2003	08.2013	24.3414-1709.5	240834	Pinza freno posteriore	1K0 615 423 M , 1K0 615 423 H , 1K0 615 423 C , 1K0 615 423	24.3414-1709.7
	1,6 TDI	post.sx	05.2009	08.2013	24.3414-1709.5	240834	Pinza freno posteriore	1K0 615 423 M , 1K0 615 423 H , 1K0 615 423 C , 1K0 615 423	24.3414-1709.7



Descrizione

Codici OE -  
Codice ATE

Pre-codice / varie

## AUDI

A3 / A3 (8P) Sportback (03-13)	1,6 TDI	post.dx	05.2009	08.2013	24.3414-1710.5	240835	Pinza freno posteriore	1K0 615 424 M , 1K0 615 424 H , 1K0 615 424 C , 1K0 615 424	24.3414-1710.7-
	1,8 TFSI	post.sx	01.2007	08.2013	24.3414-1709.5	240834	Pinza freno posteriore	1K0 615 423 M , 1K0 615 423 H , 1K0 615 423 C , 1K0 615 423	24.3414-1709.7
		post.dx	01.2007	08.2013	24.3414-1710.5	240835	Pinza freno posteriore	1K0 615 424 M , 1K0 615 424 H , 1K0 615 424 C , 1K0 615 424	24.3414-1710.7-
	1,8 TFSI quattro	post.sx	05.2008	08.2013	24.3414-1709.5	240834	Pinza freno posteriore	1K0 615 423 M , 1K0 615 423 H , 1K0 615 423 C , 1K0 615 423	24.3414-1709.7
		post.dx	05.2008	08.2013	24.3414-1710.5	240835	Pinza freno posteriore	1K0 615 424 M , 1K0 615 424 H , 1K0 615 424 C , 1K0 615 424	24.3414-1710.7-
	1,9 TDI	post.dx	06.2003	08.2013	24.3414-1710.5	240835	Pinza freno posteriore	1K0 615 424 M , 1K0 615 424 H , 1K0 615 424 C , 1K0 615 424	24.3414-1710.7-
		post.sx	06.2003	08.2013	24.3414-1709.5	240834	Pinza freno posteriore	1K0 615 423 M , 1K0 615 423 H , 1K0 615 423 C , 1K0 615 423	24.3414-1709.7
	2,0 FSI	post.dx	05.2003	08.2013	24.3414-1710.5	240835	Pinza freno posteriore	1K0 615 424 M , 1K0 615 424 H , 1K0 615 424 C , 1K0 615 424	24.3414-1710.7-
		post.sx	05.2003	08.2013	24.3414-1709.5	240834	Pinza freno posteriore	1K0 615 423 M , 1K0 615 423 H , 1K0 615 423 C , 1K0 615 423	24.3414-1709.7
	2,0 TDI	post.sx	05.2003	08.2013	24.3414-1709.5	240834	Pinza freno posteriore	1K0 615 423 M , 1K0 615 423 H , 1K0 615 423 C , 1K0 615 423	24.3414-1709.7
		post.sx	03.2006	08.2013	24.3414-1709.5	240834	Pinza freno posteriore	1K0 615 423 M , 1K0 615 423 H , 1K0 615 423 C , 1K0 615 423	24.3414-1709.7



Descrizione

Codici OE -  
Codice ATE

Pre-codice / varie

## AUDI

A3 / A3 (8P) Sportback (03-13)	2,0 TDI	post.dx	05.2003	08.2013	24.3414-1710.5	240835	Pinza freno posteriore	1K0 615 424 M , 1K0 615 424 H , 1K0 615 424 C , 1K0 615 424	24.3414-1710.7-
		post.sx	06.2006	06.2008	24.3414-1709.5	240834	Pinza freno posteriore	1K0 615 423 M , 1K0 615 423 H , 1K0 615 423 C , 1K0 615 423	24.3414-1709.7
		post.dx	06.2006	06.2008	24.3414-1710.5	240835	Pinza freno posteriore	1K0 615 424 M , 1K0 615 424 H , 1K0 615 424 C , 1K0 615 424	24.3414-1710.7-
		post.dx	03.2006	08.2013	24.3414-1710.5	240835	Pinza freno posteriore	1K0 615 424 M , 1K0 615 424 H , 1K0 615 424 C , 1K0 615 424	24.3414-1710.7-
	2,0 TDI quattro	post.dx	05.2003	08.2013	24.3414-1710.5	240835	Pinza freno posteriore	1K0 615 424 M , 1K0 615 424 H , 1K0 615 424 C , 1K0 615 424	24.3414-1710.7-
		post.dx	08.2004	08.2013	24.3414-1710.5	240835	Pinza freno posteriore	1K0 615 424 M , 1K0 615 424 H , 1K0 615 424 C , 1K0 615 424	24.3414-1710.7-
		post.sx	08.2004	08.2013	24.3414-1709.5	240834	Pinza freno posteriore	1K0 615 423 M , 1K0 615 423 H , 1K0 615 423 C , 1K0 615 423	24.3414-1709.7
		post.sx	05.2003	08.2013	24.3414-1709.5	240834	Pinza freno posteriore	1K0 615 423 M , 1K0 615 423 H , 1K0 615 423 C , 1K0 615 423	24.3414-1709.7
		post.sx	03.2006	08.2013	24.3414-1709.5	240834	Pinza freno posteriore	1K0 615 423 M , 1K0 615 423 H , 1K0 615 423 C , 1K0 615 423	24.3414-1709.7
		post.dx	03.2006	08.2013	24.3414-1710.5	240835	Pinza freno posteriore	1K0 615 424 M , 1K0 615 424 H , 1K0 615 424 C , 1K0 615 424	24.3414-1710.7-
	2,0 TFSI	post.dx	06.2004	08.2013	24.3414-1710.5	240835	Pinza freno posteriore	1K0 615 424 M , 1K0 615 424 H , 1K0 615 424 C , 1K0 615 424	24.3414-1710.7-



Descrizione

Codici OE -  
Codice ATE

Pre-codice / varie

## AUDI

A3 / A3 (8P) Sportback (03-13)	2,0 TFSI	post.sx	06.2004	08.2013	24.3414-1709.5	240834	Pinza freno posteriore	1K0 615 423 M , 1K0 615 423 H , 1K0 615 423 C , 1K0 615 423	24.3414-1709.7
	2,0 TFSI quattro	post.dx	06.2004	08.2013	24.3414-1710.5	240835	Pinza freno posteriore	1K0 615 424 M , 1K0 615 424 H , 1K0 615 424 C , 1K0 615 424	24.3414-1710.7-
		post.sx	06.2004	08.2013	24.3414-1709.5	240834	Pinza freno posteriore	1K0 615 423 M , 1K0 615 423 H , 1K0 615 423 C , 1K0 615 423	24.3414-1709.7
	3,2 quattro	post.dx	07.2003	08.2013	24.3414-1710.5	240835	Pinza freno posteriore	1K0 615 424 M , 1K0 615 424 H , 1K0 615 424 C , 1K0 615 424	24.3414-1710.7-
		post.sx	07.2003	08.2013	24.3414-1709.5	240834	Pinza freno posteriore	1K0 615 423 M , 1K0 615 423 H , 1K0 615 423 C , 1K0 615 423	24.3414-1709.7
A6 (4G2/C7) Limousine (11-)	1,8 TFSI	ant.dx	09.2014		24.3601-1732.5	240805	Pinza freno anteriore	4G0 615 124 C , 4G0 615 124	
		ant.sx	09.2014		24.3601-1731.5	240804	Pinza freno anteriore	4G0 615 123 C , 4G0 615 123	
		post.sx	09.2014		24.6243-1723.5	240798	Pinza freno posteriore	4G0 615 403 A	
	2,0 TDI	ant.dx	09.2014		24.3601-1732.5	240805	Pinza freno anteriore	4G0 615 124 C , 4G0 615 124	
		ant.dx	04.2011		24.3601-1732.5	240805	Pinza freno anteriore	4G0 615 124 C , 4G0 615 124	
		ant.dx	01.2012		24.3601-1732.5	240805	Pinza freno anteriore	4G0 615 124 C , 4G0 615 124	
		ant.sx	01.2012		24.3601-1731.5	240804	Pinza freno anteriore	4G0 615 123 C , 4G0 615 123	
		ant.sx	04.2011		24.3601-1731.5	240804	Pinza freno anteriore	4G0 615 123 C , 4G0 615 123	
		ant.sx	09.2014		24.3601-1731.5	240804	Pinza freno anteriore	4G0 615 123 C , 4G0 615 123	
		post.sx	01.2012		24.6243-1723.5	240798	Pinza freno posteriore	4G0 615 403 A	
		post.sx	04.2011		24.6243-1723.5	240798	Pinza freno posteriore	4G0 615 403 A	



Descrizione

Codici OE -  
Codice ATE

Pre-codice / varie

## AUDI

A6 (4G2/C7) Limousine (11-)	2,0 TDI	post.sx	09.2014		24.6243-1723.5	240798	Pinza freno posteriore	4G0 615 403 A	
	2,0 TDI quattro	post.sx	04.2015		24.6243-1723.5	240798	Pinza freno posteriore	4G0 615 403 A	
		ant.dx	04.2015		24.3601-1732.5	240805	Pinza freno anteriore	4G0 615 124 C , 4G0 615 124	
		ant.sx	04.2015		24.3601-1731.5	240804	Pinza freno anteriore	4G0 615 123 C , 4G0 615 123	
	2,0 TDI ultra	ant.sx	11.2013		24.3601-1731.5	240804	Pinza freno anteriore	4G0 615 123 C , 4G0 615 123	
		post.sx	11.2013		24.6243-1723.5	240798	Pinza freno posteriore	4G0 615 403 A	
		ant.dx	11.2013		24.3601-1732.5	240805	Pinza freno anteriore	4G0 615 124 C , 4G0 615 124	
	2,0 TFSI	ant.sx	09.2014		24.3601-1731.5	240804	Pinza freno anteriore	4G0 615 123 C , 4G0 615 123	
		ant.dx	09.2014		24.3601-1732.5	240805	Pinza freno anteriore	4G0 615 124 C , 4G0 615 124	
		post.sx	04.2011		24.6243-1723.5	240798	Pinza freno posteriore	4G0 615 403 A	
		post.sx	05.2013		24.6243-1723.5	240798	Pinza freno posteriore	4G0 615 403 A	
		post.sx	09.2014		24.6243-1723.5	240798	Pinza freno posteriore	4G0 615 403 A	
		ant.sx	05.2013		24.3601-1731.5	240804	Pinza freno anteriore	4G0 615 123 C , 4G0 615 123	
		ant.dx	04.2011		24.3601-1732.5	240805	Pinza freno anteriore	4G0 615 124 C , 4G0 615 124	
		ant.dx	05.2013		24.3601-1732.5	240805	Pinza freno anteriore	4G0 615 124 C , 4G0 615 124	
		ant.sx	04.2011		24.3601-1731.5	240804	Pinza freno anteriore	4G0 615 123 C , 4G0 615 123	
	2,0 TFSI hybrid	ant.dx	11.2011		24.3601-1732.5	240805	Pinza freno anteriore	4G0 615 124 C , 4G0 615 124	
		post.sx	11.2011		24.6243-1723.5	240798	Pinza freno posteriore	4G0 615 403 A	
		ant.sx	11.2011		24.3601-1731.5	240804	Pinza freno anteriore	4G0 615 123 C , 4G0 615 123	
	2,0 TFSI quattro	ant.dx	05.2014		24.3601-1732.5	240805	Pinza freno anteriore	4G0 615 124 C , 4G0 615 124	
		ant.sx	05.2014		24.3601-1731.5	240804	Pinza freno anteriore	4G0 615 123 C , 4G0 615 123	



Descrizione

Codici OE -  
Codice ATE

Pre-codice / varie

## AUDI

A6 (4G2/C7) Limousine (11-)	2,0 TFSI quattro	ant.sx	05.2013		24.3601-1731.5	240804	Pinza freno anteriore	4G0 615 123 C , 4G0 615 123	
		ant.sx	05.2012		24.3601-1731.5	240804	Pinza freno anteriore	4G0 615 123 C , 4G0 615 123	
		post.sx	05.2014		24.6243-1723.5	240798	Pinza freno posteriore	4G0 615 403 A	
		post.sx	05.2012		24.6243-1723.5	240798	Pinza freno posteriore	4G0 615 403 A	
		post.sx	05.2013		24.6243-1723.5	240798	Pinza freno posteriore	4G0 615 403 A	
		ant.dx	05.2013		24.3601-1732.5	240805	Pinza freno anteriore	4G0 615 124 C , 4G0 615 124	
		ant.dx	05.2012		24.3601-1732.5	240805	Pinza freno anteriore	4G0 615 124 C , 4G0 615 124	
	2,8 FSI	ant.sx	04.2011		24.3601-1731.5	240804	Pinza freno anteriore	4G0 615 123 C , 4G0 615 123	
		ant.dx	04.2011		24.3601-1732.5	240805	Pinza freno anteriore	4G0 615 124 C , 4G0 615 124	
		post.sx	04.2011		24.6243-1723.5	240798	Pinza freno posteriore	4G0 615 403 A	
	2,8 FSI quattro	ant.dx	09.2014		24.3601-1732.5	240805	Pinza freno anteriore	4G0 615 124 C , 4G0 615 124	
		ant.sx	09.2014		24.3601-1731.5	240804	Pinza freno anteriore	4G0 615 123 C , 4G0 615 123	
		ant.sx	04.2011		24.3601-1731.5	240804	Pinza freno anteriore	4G0 615 123 C , 4G0 615 123	
		ant.dx	04.2011		24.3601-1732.5	240805	Pinza freno anteriore	4G0 615 124 C , 4G0 615 124	
		post.sx	04.2011		24.6243-1723.5	240798	Pinza freno posteriore	4G0 615 403 A	
		post.sx	09.2014		24.6243-1723.5	240798	Pinza freno posteriore	4G0 615 403 A	
	3,0 TDI	ant.dx	09.2014		24.3601-1732.5	240805	Pinza freno anteriore	4G0 615 124 C , 4G0 615 124	
		ant.sx	09.2014		24.3601-1731.5	240804	Pinza freno anteriore	4G0 615 123 C , 4G0 615 123	
		ant.sx	04.2011		24.3601-1731.5	240804	Pinza freno anteriore	4G0 615 123 C , 4G0 615 123	
		ant.dx	04.2011		24.3601-1732.5	240805	Pinza freno anteriore	4G0 615 124 C , 4G0 615 124	
		post.sx	09.2014		24.6243-1723.5	240798	Pinza freno posteriore	4G0 615 403 A	



Descrizione

Codici OE -  
Codice ATE

Pre-codice / varie

## AUDI

A6 (4G2/C7) Limousine (11-)	3,0 TDI	post.sx	04.2011		24.6243-1723.5	240798	Pinza freno posteriore	4G0 615 403 A	
	3,0 TDI quattro	ant.sx	09.2014		24.3601-1731.5	240804	Pinza freno anteriore	4G0 615 123 C , 4G0 615 123	
		post.sx	09.2014		24.6243-1723.5	240798	Pinza freno posteriore	4G0 615 403 A	
		post.sx	05.2013		24.6243-1723.5	240798	Pinza freno posteriore	4G0 615 403 A	
		ant.sx	12.2011		24.3601-1731.5	240804	Pinza freno anteriore	4G0 615 123 C , 4G0 615 123	
		ant.sx	04.2011		24.3601-1731.5	240804	Pinza freno anteriore	4G0 615 123 C , 4G0 615 123	
		ant.sx	05.2013		24.3601-1731.5	240804	Pinza freno anteriore	4G0 615 123 C , 4G0 615 123	
		post.sx	04.2011		24.6243-1723.5	240798	Pinza freno posteriore	4G0 615 403 A	
		ant.dx	05.2013		24.3601-1732.5	240805	Pinza freno anteriore	4G0 615 124 C , 4G0 615 124	
		post.sx	12.2011		24.6243-1723.5	240798	Pinza freno posteriore	4G0 615 403 A	
		ant.dx	09.2014		24.3601-1732.5	240805	Pinza freno anteriore	4G0 615 124 C , 4G0 615 124	
		ant.dx	04.2011		24.3601-1732.5	240805	Pinza freno anteriore	4G0 615 124 C , 4G0 615 124	
		ant.dx	12.2011		24.3601-1732.5	240805	Pinza freno anteriore	4G0 615 124 C , 4G0 615 124	
	3,0 TFSI quattro	post.sx	04.2011		24.6243-1723.5	240798	Pinza freno posteriore	4G0 615 403 A	
		ant.sx	04.2011		24.3601-1731.5	240804	Pinza freno anteriore	4G0 615 123 C , 4G0 615 123	
		ant.dx	04.2011		24.3601-1732.5	240805	Pinza freno anteriore	4G0 615 124 C , 4G0 615 124	
		ant.dx	09.2014		24.3601-1732.5	240805	Pinza freno anteriore	4G0 615 124 C , 4G0 615 124	
		ant.sx	09.2014		24.3601-1731.5	240804	Pinza freno anteriore	4G0 615 123 C , 4G0 615 123	
		post.sx	09.2014		24.6243-1723.5	240798	Pinza freno posteriore	4G0 615 403 A	
	S6	post.sx	10.2014		24.6243-1723.5	240798	Pinza freno posteriore	4G0 615 403 A	
		ant.sx	10.2014		24.3601-1731.5	240804	Pinza freno anteriore	4G0 615 123 C , 4G0 615 123	



Descrizione

Codici OE -  
Codice ATE

Pre-codice / varie

## AUDI

A6 (4G2/C7) Limousine (11-)	S6	post.sx	04.2012		24.6243-1723.5	240798	Pinza freno posteriore	4G0 615 403 A	
		ant.dx	10.2014		24.3601-1732.5	240805	Pinza freno anteriore	4G0 615 124 C , 4G0 615 124	
		ant.dx	04.2012		24.3601-1732.5	240805	Pinza freno anteriore	4G0 615 124 C , 4G0 615 124	
		ant.sx	04.2012		24.3601-1731.5	240804	Pinza freno anteriore	4G0 615 123 C , 4G0 615 123	
A6 (4G5/C7) Avant (11-)	1,8 TFSI	ant.sx	09.2014		24.3601-1731.5	240804	Pinza freno anteriore	4G0 615 123 C , 4G0 615 123	
		post.sx	09.2014		24.6243-1723.5	240798	Pinza freno posteriore	4G0 615 403 A	
		ant.dx	09.2014		24.3601-1732.5	240805	Pinza freno anteriore	4G0 615 124 C , 4G0 615 124	
	2,0 TDI	post.sx	09.2014		24.6243-1723.5	240798	Pinza freno posteriore	4G0 615 403 A	
		post.sx	09.2011		24.6243-1723.5	240798	Pinza freno posteriore	4G0 615 403 A	
		post.sx	01.2012		24.6243-1723.5	240798	Pinza freno posteriore	4G0 615 403 A	
		ant.sx	09.2011		24.3601-1731.5	240804	Pinza freno anteriore	4G0 615 123 C , 4G0 615 123	
		ant.sx	09.2014		24.3601-1731.5	240804	Pinza freno anteriore	4G0 615 123 C , 4G0 615 123	
		ant.dx	09.2011		24.3601-1732.5	240805	Pinza freno anteriore	4G0 615 124 C , 4G0 615 124	
		ant.dx	09.2014		24.3601-1732.5	240805	Pinza freno anteriore	4G0 615 124 C , 4G0 615 124	
		ant.dx	01.2012		24.3601-1732.5	240805	Pinza freno anteriore	4G0 615 124 C , 4G0 615 124	
		ant.sx	01.2012		24.3601-1731.5	240804	Pinza freno anteriore	4G0 615 123 C , 4G0 615 123	
	2,0 TDI quattro	ant.dx	04.2015		24.3601-1732.5	240805	Pinza freno anteriore	4G0 615 124 C , 4G0 615 124	
		post.sx	04.2015		24.6243-1723.5	240798	Pinza freno posteriore	4G0 615 403 A	
		ant.sx	04.2015		24.3601-1731.5	240804	Pinza freno anteriore	4G0 615 123 C , 4G0 615 123	
	2,0 TDI ultra	post.sx	11.2013		24.6243-1723.5	240798	Pinza freno posteriore	4G0 615 403 A	
		ant.dx	11.2013		24.3601-1732.5	240805	Pinza freno anteriore	4G0 615 124 C , 4G0 615 124	





Descrizione

Codici OE -  
Codice ATE

Pre-codice / varie

## AUDI

A6 (4G5/C7) Avant (11-)	2,0 TDI ultra	ant.sx	11.2013		24.3601-1731.5	240804	Pinza freno anteriore	4G0 615 123 C , 4G0 615 123	
	2,0 TFSI	post.sx	06.2011		24.6243-1723.5	240798	Pinza freno posteriore	4G0 615 403 A	
		post.sx	09.2014		24.6243-1723.5	240798	Pinza freno posteriore	4G0 615 403 A	
		ant.sx	06.2011		24.3601-1731.5	240804	Pinza freno anteriore	4G0 615 123 C , 4G0 615 123	
		ant.sx	09.2014		24.3601-1731.5	240804	Pinza freno anteriore	4G0 615 123 C , 4G0 615 123	
		ant.dx	06.2011		24.3601-1732.5	240805	Pinza freno anteriore	4G0 615 124 C , 4G0 615 124	
		ant.dx	09.2014		24.3601-1732.5	240805	Pinza freno anteriore	4G0 615 124 C , 4G0 615 124	
	2,0 TFSI quattro	post.sx	05.2015		24.6243-1723.5	240798	Pinza freno posteriore	4G0 615 403 A	
		ant.sx	05.2015		24.3601-1731.5	240804	Pinza freno anteriore	4G0 615 123 C , 4G0 615 123	
		ant.dx	05.2015		24.3601-1732.5	240805	Pinza freno anteriore	4G0 615 124 C , 4G0 615 124	
	2,8 FSI	post.sx	09.2011		24.6243-1723.5	240798	Pinza freno posteriore	4G0 615 403 A	
		ant.sx	09.2011		24.3601-1731.5	240804	Pinza freno anteriore	4G0 615 123 C , 4G0 615 123	
		ant.dx	09.2011		24.3601-1732.5	240805	Pinza freno anteriore	4G0 615 124 C , 4G0 615 124	
	2,8 FSI quattro	post.sx	09.2014		24.6243-1723.5	240798	Pinza freno posteriore	4G0 615 403 A	
		post.sx	09.2011		24.6243-1723.5	240798	Pinza freno posteriore	4G0 615 403 A	
		ant.sx	09.2011		24.3601-1731.5	240804	Pinza freno anteriore	4G0 615 123 C , 4G0 615 123	
		ant.dx	09.2014		24.3601-1732.5	240805	Pinza freno anteriore	4G0 615 124 C , 4G0 615 124	
		ant.dx	09.2011		24.3601-1732.5	240805	Pinza freno anteriore	4G0 615 124 C , 4G0 615 124	
		ant.sx	09.2014		24.3601-1731.5	240804	Pinza freno anteriore	4G0 615 123 C , 4G0 615 123	
	3,0 TDI	ant.dx	09.2014		24.3601-1732.5	240805	Pinza freno anteriore	4G0 615 124 C , 4G0 615 124	
		post.sx	09.2014		24.6243-1723.5	240798	Pinza freno posteriore	4G0 615 403 A	



Descrizione

Codici OE -  
Codice ATE

Pre-codice / varie

## AUDI

A6 (4G5/C7) Avant (11-)	3,0 TDI	post.sx	09.2011		24.6243-1723.5	240798	Pinza freno posteriore	4G0 615 403 A	
		ant.dx	09.2011		24.3601-1732.5	240805	Pinza freno anteriore	4G0 615 124 C , 4G0 615 124	
		ant.sx	09.2014		24.3601-1731.5	240804	Pinza freno anteriore	4G0 615 123 C , 4G0 615 123	
		ant.sx	09.2011		24.3601-1731.5	240804	Pinza freno anteriore	4G0 615 123 C , 4G0 615 123	
	3,0 TDI quattro	ant.sx	09.2011		24.3601-1731.5	240804	Pinza freno anteriore	4G0 615 123 C , 4G0 615 123	
		post.sx	09.2014		24.6243-1723.5	240798	Pinza freno posteriore	4G0 615 403 A	
		post.sx	09.2011		24.6243-1723.5	240798	Pinza freno posteriore	4G0 615 403 A	
		post.sx	12.2011		24.6243-1723.5	240798	Pinza freno posteriore	4G0 615 403 A	
		ant.sx	09.2014		24.3601-1731.5	240804	Pinza freno anteriore	4G0 615 123 C , 4G0 615 123	
		ant.dx	12.2011		24.3601-1732.5	240805	Pinza freno anteriore	4G0 615 124 C , 4G0 615 124	
		ant.dx	09.2014		24.3601-1732.5	240805	Pinza freno anteriore	4G0 615 124 C , 4G0 615 124	
		ant.dx	09.2011		24.3601-1732.5	240805	Pinza freno anteriore	4G0 615 124 C , 4G0 615 124	
		ant.sx	12.2011		24.3601-1731.5	240804	Pinza freno anteriore	4G0 615 123 C , 4G0 615 123	
	3,0 TFSI quattro	ant.dx	09.2014		24.3601-1732.5	240805	Pinza freno anteriore	4G0 615 124 C , 4G0 615 124	
		ant.sx	09.2011		24.3601-1731.5	240804	Pinza freno anteriore	4G0 615 123 C , 4G0 615 123	
		ant.sx	09.2014		24.3601-1731.5	240804	Pinza freno anteriore	4G0 615 123 C , 4G0 615 123	
		post.sx	09.2014		24.6243-1723.5	240798	Pinza freno posteriore	4G0 615 403 A	
		post.sx	09.2011		24.6243-1723.5	240798	Pinza freno posteriore	4G0 615 403 A	
		ant.dx	09.2011		24.3601-1732.5	240805	Pinza freno anteriore	4G0 615 124 C , 4G0 615 124	
	S6	post.sx	09.2014		24.6243-1723.5	240798	Pinza freno posteriore	4G0 615 403 A	
		post.sx	04.2012		24.6243-1723.5	240798	Pinza freno posteriore	4G0 615 403 A	



Descrizione

Codici OE -  
Codice ATE

Pre-codice / varie

## AUDI

A6 (4G5/C7) Avant (11-)	S6	ant.sx	04.2012		24.3601-1731.5	240804	Pinza freno anteriore	4G0 615 123 C , 4G0 615 123	
		ant.dx	09.2014		24.3601-1732.5	240805	Pinza freno anteriore	4G0 615 124 C , 4G0 615 124	
		ant.dx	04.2012		24.3601-1732.5	240805	Pinza freno anteriore	4G0 615 124 C , 4G0 615 124	
		ant.sx	09.2014		24.3601-1731.5	240804	Pinza freno anteriore	4G0 615 123 C , 4G0 615 123	
A6 Allroad (12-)	3,0 TDI quattro	post.sx	01.2012		24.6243-1723.5	240798	Pinza freno posteriore	4G0 615 403 A	
		post.sx	09.2014		24.6243-1723.5	240798	Pinza freno posteriore	4G0 615 403 A	
		post.sx	11.2015		24.6243-1723.5	240798	Pinza freno posteriore	4G0 615 403 A	
	3,0 TFSI quattro	post.sx	01.2012		24.6243-1723.5	240798	Pinza freno posteriore	4G0 615 403 A	
		post.sx	09.2014		24.6243-1723.5	240798	Pinza freno posteriore	4G0 615 403 A	
A7 Sportback (10-)	1,8 TFSI	post.sx	04.2015		24.6243-1723.5	240798	Pinza freno posteriore	4G0 615 403 A	
		ant.dx	04.2015		24.3601-1732.5	240805	Pinza freno anteriore	4G0 615 124 C , 4G0 615 124	
		ant.sx	04.2015		24.3601-1731.5	240804	Pinza freno anteriore	4G0 615 123 C , 4G0 615 123	
	2,0 TFSI	post.sx	09.2014		24.6243-1723.5	240798	Pinza freno posteriore	4G0 615 403 A	
		ant.dx	09.2014		24.3601-1732.5	240805	Pinza freno anteriore	4G0 615 124 C , 4G0 615 124	
		ant.sx	09.2014		24.3601-1731.5	240804	Pinza freno anteriore	4G0 615 123 C , 4G0 615 123	
	2,0 TFSI quattro	post.sx	05.2015		24.6243-1723.5	240798	Pinza freno posteriore	4G0 615 403 A	
		ant.dx	05.2015		24.3601-1732.5	240805	Pinza freno anteriore	4G0 615 124 C , 4G0 615 124	
		ant.sx	05.2015		24.3601-1731.5	240804	Pinza freno anteriore	4G0 615 123 C , 4G0 615 123	
	2,8 FSI	ant.sx	05.2011		24.3601-1731.5	240804	Pinza freno anteriore	4G0 615 123 C , 4G0 615 123	
		ant.dx	05.2011		24.3601-1732.5	240805	Pinza freno anteriore	4G0 615 124 C , 4G0 615 124	
		post.sx	05.2011		24.6243-1723.5	240798	Pinza freno posteriore	4G0 615 403 A	



Descrizione

Codici OE -  
Codice ATE

Pre-codice / varie

## AUDI

A7 Sportback (10-)	2,8 FSI quattro	ant.dx	07.2010		24.3601-1732.5	240805	Pinza freno anteriore	4G0 615 124 C , 4G0 615 124	
		ant.sx	07.2010		24.3601-1731.5	240804	Pinza freno anteriore	4G0 615 123 C , 4G0 615 123	
		post.sx	07.2010		24.6243-1723.5	240798	Pinza freno posteriore	4G0 615 403 A	
	3,0 TDI	ant.sx	11.2015		24.3601-1731.5	240804	Pinza freno anteriore	4G0 615 123 C , 4G0 615 123	
		post.sx	11.2015		24.6243-1723.5	240798	Pinza freno posteriore	4G0 615 403 A	
		post.sx	11.2010		24.6243-1723.5	240798	Pinza freno posteriore	4G0 615 403 A	
		ant.dx	11.2015		24.3601-1732.5	240805	Pinza freno anteriore	4G0 615 124 C , 4G0 615 124	
		ant.dx	11.2010		24.3601-1732.5	240805	Pinza freno anteriore	4G0 615 124 C , 4G0 615 124	
		ant.sx	11.2010		24.3601-1731.5	240804	Pinza freno anteriore	4G0 615 123 C , 4G0 615 123	
	3,0 TDI quattro	ant.dx	11.2011		24.3601-1732.5	240805	Pinza freno anteriore	4G0 615 124 C , 4G0 615 124	
		post.sx	05.2013		24.6243-1723.5	240798	Pinza freno posteriore	4G0 615 403 A	
		post.sx	05.2014		24.6243-1723.5	240798	Pinza freno posteriore	4G0 615 403 A	
		post.sx	07.2010		24.6243-1723.5	240798	Pinza freno posteriore	4G0 615 403 A	
		post.sx	08.2014		24.6243-1723.5	240798	Pinza freno posteriore	4G0 615 403 A	
		post.sx	11.2011		24.6243-1723.5	240798	Pinza freno posteriore	4G0 615 403 A	
		post.sx	11.2015		24.6243-1723.5	240798	Pinza freno posteriore	4G0 615 403 A	
		ant.dx	05.2013		24.3601-1732.5	240805	Pinza freno anteriore	4G0 615 124 C , 4G0 615 124	
		ant.dx	05.2014		24.3601-1732.5	240805	Pinza freno anteriore	4G0 615 124 C , 4G0 615 124	
		ant.dx	07.2010		24.3601-1732.5	240805	Pinza freno anteriore	4G0 615 124 C , 4G0 615 124	
		ant.dx	08.2014		24.3601-1732.5	240805	Pinza freno anteriore	4G0 615 124 C , 4G0 615 124	
		ant.sx	05.2013		24.3601-1731.5	240804	Pinza freno anteriore	4G0 615 123 C , 4G0 615 123	



Descrizione

Codici OE -  
Codice ATE

Pre-codice / varie

## AUDI

A7 Sportback (10-)	3,0 TDI quattro	ant.sx	05.2014		24.3601-1731.5	240804	Pinza freno anteriore	4G0 615 123 C , 4G0 615 123	
		ant.sx	07.2010		24.3601-1731.5	240804	Pinza freno anteriore	4G0 615 123 C , 4G0 615 123	
		ant.sx	08.2014		24.3601-1731.5	240804	Pinza freno anteriore	4G0 615 123 C , 4G0 615 123	
		ant.sx	11.2011		24.3601-1731.5	240804	Pinza freno anteriore	4G0 615 123 C , 4G0 615 123	
		ant.sx	11.2015		24.3601-1731.5	240804	Pinza freno anteriore	4G0 615 123 C , 4G0 615 123	
		ant.dx	11.2015		24.3601-1732.5	240805	Pinza freno anteriore	4G0 615 124 C , 4G0 615 124	
	3,0 TDI ultra	post.sx	05.2014		24.6243-1723.5	240798	Pinza freno posteriore	4G0 615 403 A	
		ant.dx	05.2014		24.3601-1732.5	240805	Pinza freno anteriore	4G0 615 124 C , 4G0 615 124	
		ant.sx	05.2014		24.3601-1731.5	240804	Pinza freno anteriore	4G0 615 123 C , 4G0 615 123	
	3,0 TFSI quattro	post.sx	05.2014		24.6243-1723.5	240798	Pinza freno posteriore	4G0 615 403 A	
		ant.dx	07.2010		24.3601-1732.5	240805	Pinza freno anteriore	4G0 615 124 C , 4G0 615 124	
		post.sx	07.2010		24.6243-1723.5	240798	Pinza freno posteriore	4G0 615 403 A	
		ant.dx	05.2014		24.3601-1732.5	240805	Pinza freno anteriore	4G0 615 124 C , 4G0 615 124	
		ant.sx	07.2010		24.3601-1731.5	240804	Pinza freno anteriore	4G0 615 123 C , 4G0 615 123	
		ant.sx	05.2014		24.3601-1731.5	240804	Pinza freno anteriore	4G0 615 123 C , 4G0 615 123	
	S7	ant.sx	10.2011		24.3601-1731.5	240804	Pinza freno anteriore	4G0 615 123 C , 4G0 615 123	
		ant.sx	05.2014		24.3601-1731.5	240804	Pinza freno anteriore	4G0 615 123 C , 4G0 615 123	
		post.sx	10.2011		24.6243-1723.5	240798	Pinza freno posteriore	4G0 615 403 A	
		ant.dx	10.2011		24.3601-1732.5	240805	Pinza freno anteriore	4G0 615 124 C , 4G0 615 124	
		ant.dx	05.2014		24.3601-1732.5	240805	Pinza freno anteriore	4G0 615 124 C , 4G0 615 124	
		post.sx	05.2014		24.6243-1723.5	240798	Pinza freno posteriore	4G0 615 403 A	



Descrizione

Codici OE -  
Codice ATE

Pre-codice / varie

## AUDI

Q5 (08-16)	2,0 TDI	ant.sx	09.2015		24.3601-1729.5	240802	Pinza freno anteriore	8K0 615 123 J , 8K0 615 123 D , 8K0 615 123 E	
		ant.sx	08.2009		24.3601-1729.5	240802	Pinza freno anteriore	8K0 615 123 J , 8K0 615 123 D , 8K0 615 123 E	
		ant.sx	07.2011	05.2012	24.3601-1729.5	240802	Pinza freno anteriore	8K0 615 123 J , 8K0 615 123 D , 8K0 615 123 E	
		ant.sx	08.2009	06.2011	24.3601-1729.5	240802	Pinza freno anteriore	8K0 615 123 J , 8K0 615 123 D , 8K0 615 123 E	
		ant.dx	05.2013		24.3601-1730.5	240803	Pinza freno anteriore	8K0 615 124 J , 8K0 615 124 D , 8K0 615 124 E	
		ant.sx	05.2013		24.3601-1729.5	240802	Pinza freno anteriore	8K0 615 123 J , 8K0 615 123 D , 8K0 615 123 E	
		ant.dx	08.2009	06.2011	24.3601-1730.5	240803	Pinza freno anteriore	8K0 615 124 J , 8K0 615 124 D , 8K0 615 124 E	
		ant.dx	07.2011	05.2012	24.3601-1730.5	240803	Pinza freno anteriore	8K0 615 124 J , 8K0 615 124 D , 8K0 615 124 E	
		ant.dx	09.2015		24.3601-1730.5	240803	Pinza freno anteriore	8K0 615 124 J , 8K0 615 124 D , 8K0 615 124 E	
		ant.dx	08.2009		24.3601-1730.5	240803	Pinza freno anteriore	8K0 615 124 J , 8K0 615 124 D , 8K0 615 124 E	
	2,0 TDI quattro	ant.dx	03.2009	06.2011	24.3601-1730.5	240803	Pinza freno anteriore	8K0 615 124 J , 8K0 615 124 D , 8K0 615 124 E	
		ant.dx	08.2009	06.2011	24.3601-1730.5	240803	Pinza freno anteriore	8K0 615 124 J , 8K0 615 124 D , 8K0 615 124 E	
		ant.sx	05.2013		24.3601-1729.5	240802	Pinza freno anteriore	8K0 615 123 J , 8K0 615 123 D , 8K0 615 123 E	
		ant.sx	08.2009		24.3601-1729.5	240802	Pinza freno anteriore	8K0 615 123 J , 8K0 615 123 D , 8K0 615 123 E	



Descrizione

Codici OE -  
Codice ATE

Pre-codice / varie

## AUDI

Q5 (08-16)	2,0 TDI quattro	ant.sx	09.2012		24.3601-1729.5	240802	Pinza freno anteriore	8K0 615 123 J , 8K0 615 123 D , 8K0 615 123 E	
		ant.sx	07.2011	05.2012	24.3601-1729.5	240802	Pinza freno anteriore	8K0 615 123 J , 8K0 615 123 D , 8K0 615 123 E	
		ant.sx	03.2009	06.2011	24.3601-1729.5	240802	Pinza freno anteriore	8K0 615 123 J , 8K0 615 123 D , 8K0 615 123 E	
		ant.sx	08.2009	06.2011	24.3601-1729.5	240802	Pinza freno anteriore	8K0 615 123 J , 8K0 615 123 D , 8K0 615 123 E	
		ant.dx	09.2012		24.3601-1730.5	240803	Pinza freno anteriore	8K0 615 124 J , 8K0 615 124 D , 8K0 615 124 E	
		ant.dx	08.2009		24.3601-1730.5	240803	Pinza freno anteriore	8K0 615 124 J , 8K0 615 124 D , 8K0 615 124 E	
		ant.dx	03.2009		24.3601-1730.5	240803	Pinza freno anteriore	8K0 615 124 J , 8K0 615 124 D , 8K0 615 124 E	
		ant.sx	03.2009		24.3601-1729.5	240802	Pinza freno anteriore	8K0 615 123 J , 8K0 615 123 D , 8K0 615 123 E	
		ant.dx	05.2013		24.3601-1730.5	240803	Pinza freno anteriore	8K0 615 124 J , 8K0 615 124 D , 8K0 615 124 E	
		ant.dx	07.2011	05.2012	24.3601-1730.5	240803	Pinza freno anteriore	8K0 615 124 J , 8K0 615 124 D , 8K0 615 124 E	
	2,0 TFSI hybr,quattro	ant.sx	06.2011	06.2011	24.3601-1729.5	240802	Pinza freno anteriore	8K0 615 123 J , 8K0 615 123 D , 8K0 615 123 E	
		ant.dx	06.2011	06.2011	24.3601-1730.5	240803	Pinza freno anteriore	8K0 615 124 J , 8K0 615 124 D , 8K0 615 124 E	
		ant.dx	06.2011		24.3601-1730.5	240803	Pinza freno anteriore	8K0 615 124 J , 8K0 615 124 D , 8K0 615 124 E	
		ant.sx	06.2011		24.3601-1729.5	240802	Pinza freno anteriore	8K0 615 123 J , 8K0 615 123 D , 8K0 615 123 E	



Descrizione

Codici OE -  
Codice ATE

Pre-codice / varie

## AUDI

Q5 (08-16)	2,0 TFSI hybr,quattro	ant.sx	07.2011	05.2012	24.3601-1729.5	240802	Pinza freno anteriore	8K0 615 123 J , 8K0 615 123 D , 8K0 615 123 E	
		ant.dx	07.2011	05.2012	24.3601-1730.5	240803	Pinza freno anteriore	8K0 615 124 J , 8K0 615 124 D , 8K0 615 124 E	
	2,0 TFSI quattro	ant.dx	09.2012		24.3601-1730.5	240803	Pinza freno anteriore	8K0 615 124 J , 8K0 615 124 D , 8K0 615 124 E	
		ant.sx	09.2012		24.3601-1729.5	240802	Pinza freno anteriore	8K0 615 123 J , 8K0 615 123 D , 8K0 615 123 E	
		ant.sx	03.2009	06.2011	24.3601-1729.5	240802	Pinza freno anteriore	8K0 615 123 J , 8K0 615 123 D , 8K0 615 123 E	
		ant.sx	07.2011	05.2012	24.3601-1729.5	240802	Pinza freno anteriore	8K0 615 123 J , 8K0 615 123 D , 8K0 615 123 E	
		ant.dx	03.2009		24.3601-1730.5	240803	Pinza freno anteriore	8K0 615 124 J , 8K0 615 124 D , 8K0 615 124 E	
		ant.dx	05.2013		24.3601-1730.5	240803	Pinza freno anteriore	8K0 615 124 J , 8K0 615 124 D , 8K0 615 124 E	
		ant.dx	08.2015		24.3601-1730.5	240803	Pinza freno anteriore	8K0 615 124 J , 8K0 615 124 D , 8K0 615 124 E	
		ant.dx	07.2011	05.2012	24.3601-1730.5	240803	Pinza freno anteriore	8K0 615 124 J , 8K0 615 124 D , 8K0 615 124 E	
		ant.dx	03.2009	06.2011	24.3601-1730.5	240803	Pinza freno anteriore	8K0 615 124 J , 8K0 615 124 D , 8K0 615 124 E	
		ant.dx	08.2009	06.2011	24.3601-1730.5	240803	Pinza freno anteriore	8K0 615 124 J , 8K0 615 124 D , 8K0 615 124 E	
		ant.sx	08.2009	06.2011	24.3601-1729.5	240802	Pinza freno anteriore	8K0 615 123 J , 8K0 615 123 D , 8K0 615 123 E	
		ant.sx	08.2015		24.3601-1729.5	240802	Pinza freno anteriore	8K0 615 123 J , 8K0 615 123 D , 8K0 615 123 E	





Descrizione

Codici OE -  
Codice ATE

Pre-codice / varie

## AUDI

Q5 (08-16)	2,0 TFSI quattro	ant.sx	08.2009		24.3601-1729.5	240802	Pinza freno anteriore	8K0 615 123 J , 8K0 615 123 D , 8K0 615 123 E	
		ant.sx	05.2013		24.3601-1729.5	240802	Pinza freno anteriore	8K0 615 123 J , 8K0 615 123 D , 8K0 615 123 E	
		ant.sx	03.2009		24.3601-1729.5	240802	Pinza freno anteriore	8K0 615 123 J , 8K0 615 123 D , 8K0 615 123 E	
		ant.dx	08.2009		24.3601-1730.5	240803	Pinza freno anteriore	8K0 615 124 J , 8K0 615 124 D , 8K0 615 124 E	
	3,0 TDI quattro	ant.dx	09.2012		24.3601-1730.5	240803	Pinza freno anteriore	8K0 615 124 J , 8K0 615 124 D , 8K0 615 124 E	
		ant.dx	03.2009		24.3601-1730.5	240803	Pinza freno anteriore	8K0 615 124 J , 8K0 615 124 D , 8K0 615 124 E	
		ant.sx	03.2009	06.2011	24.3601-1729.5	240802	Pinza freno anteriore	8K0 615 123 J , 8K0 615 123 D , 8K0 615 123 E	
		ant.sx	03.2009		24.3601-1729.5	240802	Pinza freno anteriore	8K0 615 123 J , 8K0 615 123 D , 8K0 615 123 E	
		ant.dx	11.2013		24.3601-1730.5	240803	Pinza freno anteriore	8K0 615 124 J , 8K0 615 124 D , 8K0 615 124 E	
		ant.dx	03.2009	06.2011	24.3601-1730.5	240803	Pinza freno anteriore	8K0 615 124 J , 8K0 615 124 D , 8K0 615 124 E	
		ant.sx	07.2011	05.2012	24.3601-1729.5	240802	Pinza freno anteriore	8K0 615 123 J , 8K0 615 123 D , 8K0 615 123 E	
		ant.sx	09.2012		24.3601-1729.5	240802	Pinza freno anteriore	8K0 615 123 J , 8K0 615 123 D , 8K0 615 123 E	
		ant.sx	11.2013		24.3601-1729.5	240802	Pinza freno anteriore	8K0 615 123 J , 8K0 615 123 D , 8K0 615 123 E	
		ant.dx	07.2011	05.2012	24.3601-1730.5	240803	Pinza freno anteriore	8K0 615 124 J , 8K0 615 124 D , 8K0 615 124 E	



Descrizione

Codici OE -  
Codice ATE

Pre-codice / varie

## AUDI

Q5 (08-16)	3,0 TFSI quattro	ant.dx	09.2012		24.3601-1730.5	240803	Pinza freno anteriore	8K0 615 124 J , 8K0 615 124 D , 8K0 615 124 E	
		ant.sx	09.2012		24.3601-1729.5	240802	Pinza freno anteriore	8K0 615 123 J , 8K0 615 123 D , 8K0 615 123 E	
	3,2 FSI quattro	ant.dx	03.2009	06.2011	24.3601-1730.5	240803	Pinza freno anteriore	8K0 615 124 J , 8K0 615 124 D , 8K0 615 124 E	
		ant.sx	03.2009	06.2011	24.3601-1729.5	240802	Pinza freno anteriore	8K0 615 123 J , 8K0 615 123 D , 8K0 615 123 E	
		ant.sx	07.2011	05.2012	24.3601-1729.5	240802	Pinza freno anteriore	8K0 615 123 J , 8K0 615 123 D , 8K0 615 123 E	
		ant.sx	03.2009		24.3601-1729.5	240802	Pinza freno anteriore	8K0 615 123 J , 8K0 615 123 D , 8K0 615 123 E	
		ant.dx	07.2011	05.2012	24.3601-1730.5	240803	Pinza freno anteriore	8K0 615 124 J , 8K0 615 124 D , 8K0 615 124 E	
		ant.dx	03.2009		24.3601-1730.5	240803	Pinza freno anteriore	8K0 615 124 J , 8K0 615 124 D , 8K0 615 124 E	
TT Coupe (06-14)	2,0 quattro	post.sx	05.2008	06.2014	24.3414-1709.5	240834	Pinza freno posteriore	1K0 615 423 M , 1K0 615 423 H , 1K0 615 423 C , 1K0 615 423	24.3414-1709.7
		post.dx	05.2008	06.2014	24.3414-1710.5	240835	Pinza freno posteriore	1K0 615 424 M , 1K0 615 424 H , 1K0 615 424 C , 1K0 615 424	24.3414-1710.7-
	2,0 TDI quattro	post.sx	06.2008	06.2014	24.3414-1709.5	240834	Pinza freno posteriore	1K0 615 423 M , 1K0 615 423 H , 1K0 615 423 C , 1K0 615 423	24.3414-1709.7
		post.dx	06.2008	06.2014	24.3414-1710.5	240835	Pinza freno posteriore	1K0 615 424 M , 1K0 615 424 H , 1K0 615 424 C , 1K0 615 424	24.3414-1710.7-
	2,0 TFSI quattro	post.sx	05.2008	06.2014	24.3414-1709.5	240834	Pinza freno posteriore	1K0 615 423 M , 1K0 615 423 H , 1K0 615 423 C , 1K0 615 423	24.3414-1709.7



Descrizione

Codici OE -  
Codice ATE

Pre-codice / varie

## AUDI

TT Coupe (06-14)	2,0 TFSI quattro	post.sx	05.2010	06.2014	24.3414-1709.5	240834	Pinza freno posteriore	1K0 615 423 M , 1K0 615 423 H , 1K0 615 423 C , 1K0 615 423	24.3414-1709.7
		post.dx	05.2010	06.2014	24.3414-1710.5	240835	Pinza freno posteriore	1K0 615 424 M , 1K0 615 424 H , 1K0 615 424 C , 1K0 615 424	24.3414-1710.7-
		post.dx	05.2008	06.2014	24.3414-1710.5	240835	Pinza freno posteriore	1K0 615 424 M , 1K0 615 424 H , 1K0 615 424 C , 1K0 615 424	24.3414-1710.7-
	3,2 quattro	post.sx	07.2006	06.2014	24.3414-1709.5	240834	Pinza freno posteriore	1K0 615 423 M , 1K0 615 423 H , 1K0 615 423 C , 1K0 615 423	24.3414-1709.7
		post.dx	07.2006	06.2014	24.3414-1710.5	240835	Pinza freno posteriore	1K0 615 424 M , 1K0 615 424 H , 1K0 615 424 C , 1K0 615 424	24.3414-1710.7-
TT Roadster (07-14)	2,0 quattro	post.dx	05.2008	06.2014	24.3414-1710.5	240835	Pinza freno posteriore	1K0 615 424 M , 1K0 615 424 H , 1K0 615 424 C , 1K0 615 424	24.3414-1710.7-
		post.sx	05.2008	06.2014	24.3414-1709.5	240834	Pinza freno posteriore	1K0 615 423 M , 1K0 615 423 H , 1K0 615 423 C , 1K0 615 423	24.3414-1709.7
	2,0 TDI quattro	post.sx	06.2008	06.2014	24.3414-1709.5	240834	Pinza freno posteriore	1K0 615 423 M , 1K0 615 423 H , 1K0 615 423 C , 1K0 615 423	24.3414-1709.7
		post.dx	06.2008	06.2014	24.3414-1710.5	240835	Pinza freno posteriore	1K0 615 424 M , 1K0 615 424 H , 1K0 615 424 C , 1K0 615 424	24.3414-1710.7-
	2,0 TFSI quattro	post.sx	05.2010	06.2014	24.3414-1709.5	240834	Pinza freno posteriore	1K0 615 423 M , 1K0 615 423 H , 1K0 615 423 C , 1K0 615 423	24.3414-1709.7
		post.dx	05.2005	06.2014	24.3414-1710.5	240835	Pinza freno posteriore	1K0 615 424 M , 1K0 615 424 H , 1K0 615 424 C , 1K0 615 424	24.3414-1710.7-



				<b>Descrizione</b>	<b>Codici OE - Codice ATE</b>	 <b>Pre-codice / varie</b>
---	---	--	---	--------------------	-----------------------------------	---

## AUDI

TT Roadster (07-14)	2,0 TFSI quattro	post.dx	05.2010	06.2014	24.3414-1710.5	240835	Pinza freno posteriore	1K0 615 424 M , 1K0 615 424 H , 1K0 615 424 C , 1K0 615 424	24.3414-1710.7-
		post.sx	05.2005	06.2014	24.3414-1709.5	240834	Pinza freno posteriore	1K0 615 423 M , 1K0 615 423 H , 1K0 615 423 C , 1K0 615 423	24.3414-1709.7
	3,2 quattro	post.sx	02.2007	06.2014	24.3414-1709.5	240834	Pinza freno posteriore	1K0 615 423 M , 1K0 615 423 H , 1K0 615 423 C , 1K0 615 423	24.3414-1709.7
		post.dx	02.2007	06.2014	24.3414-1710.5	240835	Pinza freno posteriore	1K0 615 424 M , 1K0 615 424 H , 1K0 615 424 C , 1K0 615 424	24.3414-1710.7-



Descrizione

Codici OE -  
Codice ATE

Pre-codice / varie

## BMW

2er Reihe/F45 Active Tourer (14-)	214 d		03.2015		13.0460-7315.2	607315	Serie pastialie posteriori	34 21 6 859 917	v. foto
			03.2015		13.0470-7315.2	LD7315	Serie pastialie posteriori	34 21 6 859 917	
	216 d		10.2014		13.0460-7315.2	607315	Serie pastialie posteriori	34 21 6 859 917	v. foto
			10.2014		13.0470-7315.2	LD7315	Serie pastialie posteriori	34 21 6 859 917	
	216 i		11.2015		13.0460-7315.2	607315	Serie pastialie posteriori	34 21 6 859 917	v. foto
			11.2015		13.0470-7315.2	LD7315	Serie pastialie posteriori	34 21 6 859 917	
	218 d		10.2014		13.0460-7315.2	607315	Serie pastialie posteriori	34 21 6 859 917	v. foto
			09.2014		13.0460-7315.2	607315	Serie pastialie posteriori	34 21 6 859 917	v. foto
			09.2014		13.0470-7315.2	LD7315	Serie pastialie posteriori	34 21 6 859 917	
			10.2014		13.0470-7315.2	LD7315	Serie pastialie posteriori	34 21 6 859 917	
	218 d xDrive		11.2015		13.0460-7315.2	607315	Serie pastialie posteriori	34 21 6 859 917	v. foto
			11.2015		13.0470-7315.2	LD7315	Serie pastialie posteriori	34 21 6 859 917	
	218 i		10.2014		13.0460-7315.2	607315	Serie pastialie posteriori	34 21 6 859 917	v. foto
			10.2014		13.0470-7315.2	LD7315	Serie pastialie posteriori	34 21 6 859 917	
	220 d		11.2014		13.0460-7315.2	607315	Serie pastialie posteriori	34 21 6 859 917	v. foto
			10.2014		13.0460-7315.2	607315	Serie pastialie posteriori	34 21 6 859 917	v. foto
			10.2014		13.0470-7315.2	LD7315	Serie pastialie posteriori	34 21 6 859 917	
			11.2014		13.0470-7315.2	LD7315	Serie pastialie posteriori	34 21 6 859 917	
	220 d xDrive		11.2014		13.0460-7315.2	607315	Serie pastialie posteriori	34 21 6 859 917	v. foto
			10.2014		13.0460-7315.2	607315	Serie pastialie posteriori	34 21 6 859 917	v. foto
			10.2014		13.0470-7315.2	LD7315	Serie pastialie posteriori	34 21 6 859 917	



Descrizione

Codici OE -  
Codice ATE

Pre-codice / varie

**BMW**

2er Reihe/F45 Active Tourer (14-)	220 d xDrive		11.2014		13.0470-7315.2	LD7315	Serie pastiglie posteriori	34 21 6 859 917	
	220 i		10.2014		13.0460-7315.2	607315	Serie pastiglie posteriori	34 21 6 859 917	v. foto
			11.2014		13.0460-7315.2	607315	Serie pastiglie posteriori	34 21 6 859 917	v. foto
			10.2014		13.0470-7315.2	LD7315	Serie pastiglie posteriori	34 21 6 859 917	
			11.2014		13.0470-7315.2	LD7315	Serie pastiglie posteriori	34 21 6 859 917	
	225 i		10.2014		13.0460-7315.2	607315	Serie pastiglie posteriori	34 21 6 859 917	v. foto
			10.2014		13.0470-7315.2	LD7315	Serie pastiglie posteriori	34 21 6 859 917	
	225 i xDrive		10.2014		13.0460-7315.2	607315	Serie pastiglie posteriori	34 21 6 859 917	v. foto
			10.2014		13.0470-7315.2	LD7315	Serie pastiglie posteriori	34 21 6 859 917	
	225 xe xDrive		03.2016		13.0460-7315.2	607315	Serie pastiglie posteriori	34 21 6 859 917	v. foto
			03.2016		13.0470-7315.2	LD7315	Serie pastiglie posteriori	34 21 6 859 917	
2er Reihe/F46 Gran Tourer (15-)	214 d		03.2015		13.0460-7315.2	607315	Serie pastiglie posteriori	34 21 6 859 917	v. foto
			03.2015		13.0470-7315.2	LD7315	Serie pastiglie posteriori	34 21 6 859 917	
	216 d		03.2015		13.0460-7315.2	607315	Serie pastiglie posteriori	34 21 6 859 917	v. foto
			03.2015		13.0470-7315.2	LD7315	Serie pastiglie posteriori	34 21 6 859 917	
	216 i		07.2015		13.0460-7315.2	607315	Serie pastiglie posteriori	34 21 6 859 917	v. foto
			07.2015		13.0470-7315.2	LD7315	Serie pastiglie posteriori	34 21 6 859 917	
	218 d		03.2015		13.0460-7315.2	607315	Serie pastiglie posteriori	34 21 6 859 917	v. foto
			03.2015		13.0470-7315.2	LD7315	Serie pastiglie posteriori	34 21 6 859 917	
	218 d xDrive		03.2015		13.0460-7315.2	607315	Serie pastiglie posteriori	34 21 6 859 917	v. foto
			03.2015		13.0470-7315.2	LD7315	Serie pastiglie posteriori	34 21 6 859 917	



Descrizione

Codici OE -  
Codice ATE

Pre-codice / varie

## BMW

2er Reihe/F46 Gran Tourer (15-)	218 i		03.2015		13.0460-7315.2	607315	Serie pastiglie posteriori	34 21 6 859 917	v. foto
			03.2015		13.0470-7315.2	LD7315	Serie pastiglie posteriori	34 21 6 859 917	
	220 d		07.2015		13.0460-7315.2	607315	Serie pastiglie posteriori	34 21 6 859 917	v. foto
			07.2015		13.0470-7315.2	LD7315	Serie pastiglie posteriori	34 21 6 859 917	
	220 d xDrive		03.2015		13.0460-7315.2	607315	Serie pastiglie posteriori	34 21 6 859 917	v. foto
			03.2015		13.0470-7315.2	LD7315	Serie pastiglie posteriori	34 21 6 859 917	
	220 i		03.2015		13.0460-7315.2	607315	Serie pastiglie posteriori	34 21 6 859 917	v. foto
			03.2015		13.0470-7315.2	LD7315	Serie pastiglie posteriori	34 21 6 859 917	
i3/I01 (13-)	Electric		07.2013		13.0460-7315.2	607315	Serie pastiglie posteriori	34 21 6 859 917	v. foto
			07.2013		13.0470-7315.2	LD7315	Serie pastiglie posteriori	34 21 6 859 917	
	Electric Rex		07.2013		13.0460-7315.2	607315	Serie pastiglie posteriori	34 21 6 859 917	v. foto
			07.2013		13.0470-7315.2	LD7315	Serie pastiglie posteriori	34 21 6 859 917	
X1/F48 (15-)	sDrive 16d		09.2015		13.0460-7315.2	607315	Serie pastiglie posteriori	34 21 6 859 917	v. foto
			09.2015		13.0470-7315.2	LD7315	Serie pastiglie posteriori	34 21 6 859 917	
	sDrive 18d		09.2015		13.0460-7315.2	607315	Serie pastiglie posteriori	34 21 6 859 917	v. foto
			09.2015		13.0470-7315.2	LD7315	Serie pastiglie posteriori	34 21 6 859 917	
	sDrive 18i		09.2015		13.0460-7315.2	607315	Serie pastiglie posteriori	34 21 6 859 917	v. foto
			09.2015		13.0470-7315.2	LD7315	Serie pastiglie posteriori	34 21 6 859 917	
	sDrive 20d		11.2015		13.0460-7315.2	607315	Serie pastiglie posteriori	34 21 6 859 917	v. foto
			11.2015		13.0470-7315.2	LD7315	Serie pastiglie posteriori	34 21 6 859 917	
	sDrive 20i		09.2015		13.0460-7315.2	607315	Serie pastiglie posteriori	34 21 6 859 917	v. foto



Descrizione

Codici OE -  
Codice ATE



Pre-codice / varie

## BMW

Modello	Versione	Posto	Data Inizio	Data Fine	Codice OE	Codice ATE	Descrizione	Codice OE - Codice ATE	Pre-codice / varie
X1/F48 (15-)	sDrive 20i		09.2015		13.0470-7315.2	LD7315	Serie pastiglie posteriori	34 21 6 859 917	
	xDrive 18d		09.2015		13.0460-7315.2	607315	Serie pastiglie posteriori	34 21 6 859 917	v. foto
			09.2015		13.0470-7315.2	LD7315	Serie pastiglie posteriori	34 21 6 859 917	
	xDrive 20d		09.2015		13.0460-7315.2	607315	Serie pastiglie posteriori	34 21 6 859 917	v. foto
			11.2015		13.0460-7315.2	607315	Serie pastiglie posteriori	34 21 6 859 917	v. foto
			11.2015		13.0470-7315.2	LD7315	Serie pastiglie posteriori	34 21 6 859 917	
			09.2015		13.0470-7315.2	LD7315	Serie pastiglie posteriori	34 21 6 859 917	
	xDrive 20i		09.2015		13.0460-7315.2	607315	Serie pastiglie posteriori	34 21 6 859 917	v. foto
			09.2015		13.0470-7315.2	LD7315	Serie pastiglie posteriori	34 21 6 859 917	
	xDrive 25d		09.2015		13.0460-7315.2	607315	Serie pastiglie posteriori	34 21 6 859 917	v. foto
			09.2015		13.0470-7315.2	LD7315	Serie pastiglie posteriori	34 21 6 859 917	
	xDrive 25i		09.2015		13.0460-7315.2	607315	Serie pastiglie posteriori	34 21 6 859 917	v. foto
			09.2015		13.0470-7315.2	LD7315	Serie pastiglie posteriori	34 21 6 859 917	
X5/E53 (00-07)	3,0 d		05.2001	09.2003	24.5169-0480.3	331508	Tubo flessibile anteriore	34 30 1 166 118	83.6150-0481.3
			10.2003	12.2006	24.5169-0480.3	331508	Tubo flessibile anteriore	34 30 1 166 118	83.6150-0481.3
	3,0 i		04.2000	12.2006	24.5169-0480.3	331508	Tubo flessibile anteriore	34 30 1 166 118	83.6150-0481.3
	4,4 i		04.2000	09.2003	24.5169-0480.3	331508	Tubo flessibile anteriore	34 30 1 166 118	83.6150-0481.3
			10.2003	12.2006	24.5169-0480.3	331508	Tubo flessibile anteriore	34 30 1 166 118	83.6150-0481.3
	4,6 iS		12.2001	09.2003	24.5169-0480.3	331508	Tubo flessibile anteriore	34 30 1 166 118	83.6150-0481.3
	4,8 iS		03.2004	12.2006	24.5169-0480.3	331508	Tubo flessibile anteriore	34 30 1 166 118	83.6150-0481.3
Z3/E36 (95-02)	1,8	post.dx	10.1995	10.1998	24.3361-8506.5	240634	Pinza freno posteriore	34 21 1 164 398	11.3361-8506.2-





Descrizione

Codici OE -  
Codice ATE

Pre-codice / varie

**BMW**

Z3/E36 (95-02)	1,9	post.dx	10.1995	12.2002	24.3361-8506.5	240634	Pinza freno posteriore	34 21 1 164 398	11.3361-8506.2-
	2	post.dx	04.1999	08.2000	24.3361-8506.5	240634	Pinza freno posteriore	34 21 1 164 398	11.3361-8506.2-
	2,2	post.dx	10.2000	12.2002	24.3361-8506.5	240634	Pinza freno posteriore	34 21 1 164 398	11.3361-8506.2-
	2,8 Coupe	post.dx	07.1997	06.2000	24.3361-8506.5	240634	Pinza freno posteriore	34 21 1 164 398	11.3361-8506.2-
	2,8 Roadster	post.dx	05.1997	06.2000	24.3361-8506.5	240634	Pinza freno posteriore	34 21 1 164 398	11.3361-8506.2-
	3,0 Coupe	post.dx	06.2000	12.2002	24.3361-8506.5	240634	Pinza freno posteriore	34 21 1 164 398	11.3361-8506.2-
	3,0 Roadster	post.dx	06.2000	12.2002	24.3361-8506.5	240634	Pinza freno posteriore	34 21 1 164 398	11.3361-8506.2-



Descrizione

Codici OE -  
Codice ATE

Pre-codice / varie

## CHEVROLET

LACETTI (05-10)	1,4 i 16V	ant.sx	03.2005	12.2010	24.3541-1859.5	240735	Pinza freno anteriore	96549788	
		ant.dx	03.2005	12.2010	24.3541-1860.5	240736	Pinza freno anteriore	96549789	
	1,6 i 16V	ant.sx	03.2005	12.2010	24.3541-1859.5	240735	Pinza freno anteriore	96549788	
		ant.dx	03.2005	12.2010	24.3541-1860.5	240736	Pinza freno anteriore	96549789	
	1,8 i 16V	ant.dx	08.2005	12.2010	24.3541-1860.5	240736	Pinza freno anteriore	96549789	
		ant.dx	05.2003	12.2010	24.3541-1860.5	240736	Pinza freno anteriore	96549789	
		ant.sx	05.2003	12.2010	24.3541-1859.5	240735	Pinza freno anteriore	96549788	
		ant.sx	08.2005	12.2010	24.3541-1859.5	240735	Pinza freno anteriore	96549788	
	2,0 TDCi	ant.sx	01.2007	12.2010	24.3541-1859.5	240735	Pinza freno anteriore	96549788	
		ant.dx	01.2007	12.2010	24.3541-1860.5	240736	Pinza freno anteriore	96549789	
NUBIRA (05-10)	1,4 i 16V	ant.dx	01.2006	12.2010	24.3541-1860.5	240736	Pinza freno anteriore	96549789	
		ant.dx	01.2005	12.2010	24.3541-1860.5	240736	Pinza freno anteriore	96549789	
		ant.sx	01.2005	12.2010	24.3541-1859.5	240735	Pinza freno anteriore	96549788	
		ant.sx	01.2006	12.2010	24.3541-1859.5	240735	Pinza freno anteriore	96549788	
	1,5 i 16V	ant.dx	01.2005	12.2010	24.3541-1860.5	240736	Pinza freno anteriore	96549789	
		ant.sx	01.2005	12.2010	24.3541-1859.5	240735	Pinza freno anteriore	96549788	
	1,6 i 16V	ant.dx	03.2005	12.2010	24.3541-1860.5	240736	Pinza freno anteriore	96549789	
		ant.sx	03.2005	12.2010	24.3541-1859.5	240735	Pinza freno anteriore	96549788	
		ant.sx	01.2010	12.2010	24.3541-1859.5	240735	Pinza freno anteriore	96549788	
		ant.dx	01.2010	12.2010	24.3541-1860.5	240736	Pinza freno anteriore	96549789	
	1,8 i 16V	ant.dx	03.2005	12.2010	24.3541-1860.5	240736	Pinza freno anteriore	96549789	



Descrizione

Codici OE -  
Codice ATE

Pre-codice / varie

**CHEVROLET**

NUBIRA (05-10)	1,8 i 16V	ant.dx	08.2005	12.2010	24.3541-1860.5	240736	Pinza freno anteriore	96549789	
		ant.sx	03.2005	12.2010	24.3541-1859.5	240735	Pinza freno anteriore	96549788	
		ant.sx	08.2005	12.2010	24.3541-1859.5	240735	Pinza freno anteriore	96549788	
	2,0 i 16V	ant.sx	01.2005	12.2010	24.3541-1859.5	240735	Pinza freno anteriore	96549788	
		ant.dx	01.2005	12.2010	24.3541-1860.5	240736	Pinza freno anteriore	96549789	
	2,0 TCDi	ant.sx	01.2005	12.2010	24.3541-1859.5	240735	Pinza freno anteriore	96549788	
		ant.dx	01.2005	12.2010	24.3541-1860.5	240736	Pinza freno anteriore	96549789	

**CITROEN**

C1 (05-14)	1		06.2005	04.2014	28.0462-0180.1	BAR201	Discofreno ant.	43512-0H020 , 43512-0H010 , 4249 94 , 4249 54 , 4246 F0 , 4249 55 , 4246 J0	
	1,4 HDi		06.2005	12.2008	28.0462-0180.1	BAR201	Discofreno ant.	43512-0H020 , 43512-0H010 , 4249 94 , 4249 54 , 4246 F0 , 4249 55 , 4246 J0	
C1 (14-)	1,0 VTi 68		04.2014		28.0462-0180.1	BAR201	Discofreno ant.	43512-0H020 , 43512-0H010 , 4249 94 , 4249 54 , 4246 F0 , 4249 55 , 4246 J0	
	1,2 VTi 82		04.2014		28.0462-0180.1	BAR201	Discofreno ant.	43512-0H020 , 43512-0H010 , 4249 94 , 4249 54 , 4246 F0 , 4249 55 , 4246 J0	



Descrizione

Codici OE -  
Codice ATE

Pre-codice / varie

## Classic PKW

ALFA ROMEO 164 (87-91)	2,0 T,Spark		09.1987	08.1991	28.0461-0190.1	BAR101	Disco freno post.	60801753 , 60801390 , 16420.26100.01/00 , 46831042 , 46758715 , 60801755 , 82434070 , 82433859 , 82394418	
	2,0 Turbo		09.1987	08.1991	28.0462-2145.1	BAR221	Discofreno ant.	5 69 086 , 95511282 , 71711447 , 71711434 , 60815938 , 60813443 , 60801722 , 52015291 , 51996238 , 51990127 , 71739567 , 71739568 , 60699518 , 60578093 , 60658565 , 82427592 , 82450539 , 60622077 , 60571548 , 60569163	
	2,5 TD		09.1987	08.1991	28.0462-2145.1	BAR221	Discofreno ant.	5 69 086 , 95511282 , 71711447 , 71711434 , 60815938 , 60813443 , 60801722 , 52015291 , 51996238 , 51990127 , 71739567 , 71739568 , 60699518 , 60578093 , 60658565 , 82427592 , 82450539 , 60622077 , 60571548 , 60569163	
	3,0 i V6		09.1987	08.1991	28.0462-2145.1	BAR221	Discofreno ant.	5 69 086 , 95511282 , 71711447 , 71711434 , 60815938 , 60813443 , 60801722 , 52015291 , 51996238 , 51990127 , 71739567 , 71739568 , 60699518 , 60578093 , 60658565 , 82427592 , 82450539 , 60622077 , 60571548 , 60569163	



Descrizione

Codici OE -  
Codice ATE

Pre-codice / varie

## Classic PKW

ALFA ROMEO 164 (87-91)	3,0 i V6 Q,V,		07.1990	08.1991	28.0462-2145.1	BAR221	Discofreno ant.	5 69 086 , 95511282 , 71711447 , 71711434 , 60815938 , 60813443 , 60801722 , 52015291 , 51996238 , 51990127 , 71739567 , 71739568 , 60699518 , 60578093 , 60658565 , 82427592 , 82450539 , 60622077 , 60571548 , 60569163	
FIAT CROMA (85-90)	1,6		12.1985	10.1990	28.0461-0190.1	BAR101	Disco freno post.	60801753 , 60801390 , 16420.26100.01/00 , 46831042 , 46758715 , 60801755 , 82434070 , 82433859 , 82394418	
	1,9 TD		12.1988	10.1990	28.0461-0190.1	BAR101	Disco freno post.	60801753 , 60801390 , 16420.26100.01/00 , 46831042 , 46758715 , 60801755 , 82434070 , 82433859 , 82394418	
	2		12.1985	10.1990	28.0461-0190.1	BAR101	Disco freno post.	60801753 , 60801390 , 16420.26100.01/00 , 46831042 , 46758715 , 60801755 , 82434070 , 82433859 , 82394418	
	2,0 i,e,		12.1985	10.1990	28.0462-2145.1	BAR221	Discofreno ant.	5 69 086 , 95511282 , 71711447 , 71711434 , 60815938 , 60813443 , 60801722 , 52015291 , 51996238 , 51990127 , 71739567 , 71739568 , 60699518 , 60578093 , 60658565 , 82427592 , 82450539 , 60622077 , 60571548 , 60569163	
			12.1985	10.1990	28.0461-0190.1	BAR101	Disco freno post.	60801753 , 60801390 , 16420.26100.01/00 , 46831042 , 46758715 , 60801755 , 82434070 , 82433859 , 82394418	



Descrizione

Codici OE -  
Codice ATE

Pre-codice / varie

## Classic PKW

FIAT CROMA (85-90)	2,0 i,e,Turbo		12.1985	10.1990	28.0462-2145.1	BAR221	Discofreno ant.	5 69 086 , 95511282 , 71711447 , 71711434 , 60815938 , 60813443 , 60801722 , 52015291 , 51996238 , 51990127 , 71739567 , 71739568 , 60699518 , 60578093 , 60658565 , 82427592 , 82450539 , 60622077 , 60571548 , 60569163	
			12.1985	10.1990	28.0461-0190.1	BAR101	Disco freno post.	60801753 , 60801390 , 16420.26100.01/00 , 46831042 , 46758715 , 60801755 , 82434070 , 82433859 , 82394418	
	2,5 D		12.1985	10.1990	28.0461-0190.1	BAR101	Disco freno post.	60801753 , 60801390 , 16420.26100.01/00 , 46831042 , 46758715 , 60801755 , 82434070 , 82433859 , 82394418	
	2,5 TD		12.1985	10.1990	28.0461-0190.1	BAR101	Disco freno post.	60801753 , 60801390 , 16420.26100.01/00 , 46831042 , 46758715 , 60801755 , 82434070 , 82433859 , 82394418	
FIAT CROMA (91-96)	1,6		11.1990	12.1992	28.0461-0190.1	BAR101	Disco freno post.	60801753 , 60801390 , 16420.26100.01/00 , 46831042 , 46758715 , 60801755 , 82434070 , 82433859 , 82394418	
	1,9 TD		11.1990	10.1996	28.0461-0190.1	BAR101	Disco freno post.	60801753 , 60801390 , 16420.26100.01/00 , 46831042 , 46758715 , 60801755 , 82434070 , 82433859 , 82394418	



Descrizione

Codici OE -  
Codice ATE

Pre-codice / varie

## Classic PKW

FIAT CROMA (91-96)	2		11.1990	12.1992	28.0461-0190.1	BAR101	Disco freno post.	60801753 , 60801390 , 16420.26100.01/00 , 46831042 , 46758715 , 60801755 , 82434070 , 82433859 , 82394418	
	2,0 i,e,		11.1990	10.1996	28.0462-2145.1	BAR221	Discofreno ant.	5 69 086 , 95511282 , 71711447 , 71711434 , 60815938 , 60813443 , 60801722 , 52015291 , 51996238 , 51990127 , 71739567 , 71739568 , 60699518 , 60578093 , 60658565 , 82427592 , 82450539 , 60622077 , 60571548 , 60569163	
			11.1990	10.1996	28.0461-0190.1	BAR101	Disco freno post.	60801753 , 60801390 , 16420.26100.01/00 , 46831042 , 46758715 , 60801755 , 82434070 , 82433859 , 82394418	
	2,0 i,e, 16V		12.1992	10.1996	28.0461-0190.1	BAR101	Disco freno post.	60801753 , 60801390 , 16420.26100.01/00 , 46831042 , 46758715 , 60801755 , 82434070 , 82433859 , 82394418	
	2,0 i,e, Turbo		11.1990	10.1996	28.0461-0190.1	BAR101	Disco freno post.	60801753 , 60801390 , 16420.26100.01/00 , 46831042 , 46758715 , 60801755 , 82434070 , 82433859 , 82394418	
			11.1990	10.1996	28.0462-2145.1	BAR221	Discofreno ant.	5 69 086 , 95511282 , 71711447 , 71711434 , 60815938 , 60813443 , 60801722 , 52015291 , 51996238 , 51990127 , 71739567 , 71739568 , 60699518 , 60578093 , 60658565 , 82427592 , 82450539 , 60622077 , 60571548 , 60569163	



Descrizione

Codici OE -  
Codice ATE

Pre-codice / varie

## Classic PKW

FIAT CROMA (91-96)	2,5 i,e, V6		04.1993	10.1996	28.0461-0190.1	BAR101	Disco freno post.	60801753 , 60801390 , 16420.26100.01/00 , 46831042 , 46758715 , 60801755 , 82434070 , 82433859 , 82394418	
	2,5 TD		11.1990	10.1996	28.0461-0190.1	BAR101	Disco freno post.	60801753 , 60801390 , 16420.26100.01/00 , 46831042 , 46758715 , 60801755 , 82434070 , 82433859 , 82394418	
FORD MONDEO I (93-96)	1,6 i 16V		01.1993	09.1996	28.0462-0146.1	BAR201	Disco freno post.	4115996 , 1025911 , 5026786	
	1,8 i 16V		01.1993	09.1996	28.0462-0146.1	BAR201	Disco freno post.	4115996 , 1025911 , 5026786	
	1,8 TD		01.1993	09.1996	28.0462-0146.1	BAR201	Disco freno post.	4115996 , 1025911 , 5026786	
	2,0 i 16V		01.1993	09.1996	28.0462-0146.1	BAR201	Disco freno post.	4115996 , 1025911 , 5026786	
	2,0 i 16V 4x4		04.1993	09.1996	28.0462-0146.1	BAR201	Disco freno post.	4115996 , 1025911 , 5026786	
	2,5 i 24V		08.1994	09.1996	28.0462-0146.1	BAR201	Disco freno post.	4115996 , 1025911 , 5026786	
LANCIA THEMA (84-88)	2,0 i,e,		10.1984	01.1989	28.0462-2145.1	BAR221	Discofreno ant.	5 69 086 , 95511282 , 71711447 , 71711434 , 60815938 , 60813443 , 60801722 , 52015291 , 51996238 , 51990127 , 71739567 , 71739568 , 60699518 , 60578093 , 60658565 , 82427592 , 82450539 , 60622077 , 60571548 , 60569163	
			10.1984	01.1989	28.0461-0190.1	BAR101	Disco freno post.	60801753 , 60801390 , 16420.26100.01/00 , 46831042 , 46758715 , 60801755 , 82434070 , 82433859 , 82394418	





Descrizione

Codici OE -  
Codice ATE

Pre-codice / varie

## Classic PKW

LANCIA THEMA (84-88)	2,0 i,e, Turbo		10.1984	01.1989	28.0462-2145.1	BAR221	Discofreno ant.	5 69 086 , 95511282 , 71711447 , 71711434 , 60815938 , 60813443 , 60801722 , 52015291 , 51996238 , 51990127 , 71739567 , 71739568 , 60699518 , 60578093 , 60658565 , 82427592 , 82450539 , 60622077 , 60571548 , 60569163	
			10.1984	01.1989	28.0461-0190.1	BAR101	Disco freno post.	60801753 , 60801390 , 16420.26100.01/00 , 46831042 , 46758715 , 60801755 , 82434070 , 82433859 , 82394418	
	2,5 TD		10.1984	01.1989	28.0461-0190.1	BAR101	Disco freno post.	60801753 , 60801390 , 16420.26100.01/00 , 46831042 , 46758715 , 60801755 , 82434070 , 82433859 , 82394418	
	2,8 i,e, V6		10.1984	01.1989	28.0462-2145.1	BAR221	Discofreno ant.	5 69 086 , 95511282 , 71711447 , 71711434 , 60815938 , 60813443 , 60801722 , 52015291 , 51996238 , 51990127 , 71739567 , 71739568 , 60699518 , 60578093 , 60658565 , 82427592 , 82450539 , 60622077 , 60571548 , 60569163	
			10.1984	01.1989	28.0461-0190.1	BAR101	Disco freno post.	60801753 , 60801390 , 16420.26100.01/00 , 46831042 , 46758715 , 60801755 , 82434070 , 82433859 , 82394418	



Descrizione

Codici OE -  
Codice ATE

Pre-codice / varie

## Classic PKW

LANCIA THEMA (84-88)	2,9 i,e, 8,32		09.1987	01.1989	28.0462-2145.1	BAR221	Discofreno ant.	5 69 086 , 95511282 , 71711447 , 71711434 , 60815938 , 60813443 , 60801722 , 52015291 , 51996238 , 51990127 , 71739567 , 71739568 , 60699518 , 60578093 , 60658565 , 82427592 , 82450539 , 60622077 , 60571548 , 60569163	
LANCIA THEMA (89-92)	2,0 i,e,		02.1989	09.1992	28.0461-0190.1	BAR101	Disco freno post.	60801753 , 60801390 , 16420.26100.01/00 , 46831042 , 46758715 , 60801755 , 82434070 , 82433859 , 82394418	
			02.1989	09.1992	28.0462-2145.1	BAR221	Discofreno ant.	5 69 086 , 95511282 , 71711447 , 71711434 , 60815938 , 60813443 , 60801722 , 52015291 , 51996238 , 51990127 , 71739567 , 71739568 , 60699518 , 60578093 , 60658565 , 82427592 , 82450539 , 60622077 , 60571548 , 60569163	
	2,0 i,e, 16V		10.1989	09.1992	28.0462-2145.1	BAR221	Discofreno ant.	5 69 086 , 95511282 , 71711447 , 71711434 , 60815938 , 60813443 , 60801722 , 52015291 , 51996238 , 51990127 , 71739567 , 71739568 , 60699518 , 60578093 , 60658565 , 82427592 , 82450539 , 60622077 , 60571548 , 60569163	
			10.1989	09.1992	28.0461-0190.1	BAR101	Disco freno post.	60801753 , 60801390 , 16420.26100.01/00 , 46831042 , 46758715 , 60801755 , 82434070 , 82433859 , 82394418	



Descrizione

Codici OE -  
Codice ATE

Pre-codice / varie

## Classic PKW

LANCIA THEMA (89-92)	2,0 i,e, 16V Turbo		10.1989	09.1992	28.0461-0190.1	BAR101	Disco freno post.	60801753 , 60801390 , 16420.26100.01/00 , 46831042 , 46758715 , 60801755 , 82434070 , 82433859 , 82394418	
			10.1989	09.1992	28.0462-2145.1	BAR221	Discofreno ant.	5 69 086 , 95511282 , 71711447 , 71711434 , 60815938 , 60813443 , 60801722 , 52015291 , 51996238 , 51990127 , 71739567 , 71739568 , 60699518 , 60578093 , 60658565 , 82427592 , 82450539 , 60622077 , 60571548 , 60569163	
	2,0 i,e, Turbo		02.1989	09.1992	28.0461-0190.1	BAR101	Disco freno post.	60801753 , 60801390 , 16420.26100.01/00 , 46831042 , 46758715 , 60801755 , 82434070 , 82433859 , 82394418	
			02.1989	09.1992	28.0462-2145.1	BAR221	Discofreno ant.	5 69 086 , 95511282 , 71711447 , 71711434 , 60815938 , 60813443 , 60801722 , 52015291 , 51996238 , 51990127 , 71739567 , 71739568 , 60699518 , 60578093 , 60658565 , 82427592 , 82450539 , 60622077 , 60571548 , 60569163	
	2,5 TD		02.1989	09.1992	28.0461-0190.1	BAR101	Disco freno post.	60801753 , 60801390 , 16420.26100.01/00 , 46831042 , 46758715 , 60801755 , 82434070 , 82433859 , 82394418	



Descrizione

Codici OE -  
Codice ATE

Pre-codice / varie

## Classic PKW

LANCIA THEMA (89-92)	2,8 i,e, V6		02.1989	09.1992	28.0462-2145.1	BAR221	Discofreno ant.	5 69 086 , 95511282 , 71711447 , 71711434 , 60815938 , 60813443 , 60801722 , 52015291 , 51996238 , 51990127 , 71739567 , 71739568 , 60699518 , 60578093 , 60658565 , 82427592 , 82450539 , 60622077 , 60571548 , 60569163	
			02.1989	09.1992	28.0461-0190.1	BAR101	Disco freno post.	60801753 , 60801390 , 16420.26100.01/00 , 46831042 , 46758715 , 60801755 , 82434070 , 82433859 , 82394418	
	2,9 i,e, 8,32		02.1989	09.1992	28.0462-2145.1	BAR221	Discofreno ant.	5 69 086 , 95511282 , 71711447 , 71711434 , 60815938 , 60813443 , 60801722 , 52015291 , 51996238 , 51990127 , 71739567 , 71739568 , 60699518 , 60578093 , 60658565 , 82427592 , 82450539 , 60622077 , 60571548 , 60569163	
LANCIA THEMA (92-94)	2,0 i,e,		10.1992	12.1994	28.0461-0190.1	BAR101	Disco freno post.	60801753 , 60801390 , 16420.26100.01/00 , 46831042 , 46758715 , 60801755 , 82434070 , 82433859 , 82394418	
	2,0 i,e, 16V		10.1992	12.1994	28.0462-2145.1	BAR221	Discofreno ant.	5 69 086 , 95511282 , 71711447 , 71711434 , 60815938 , 60813443 , 60801722 , 52015291 , 51996238 , 51990127 , 71739567 , 71739568 , 60699518 , 60578093 , 60658565 , 82427592 , 82450539 , 60622077 , 60571548 , 60569163	



Descrizione

Codici OE -  
Codice ATE

Pre-codice / varie

## Classic PKW

Modello	Motori	10.1992	12.1994	28.0461-0190.1	BAR101	Descrizione	Codici OE - Codice ATE	Pre-codice / varie
LANCIA THEMA (92-94)	2,0 i,e, 16V					Disco freno post.	60801753 , 60801390 , 16420.26100.01/00 , 46831042 , 46758715 , 60801755 , 82434070 , 82433859 , 82394418	
	2,0 i,e, 16V Turbo					Disco freno post.	60801753 , 60801390 , 16420.26100.01/00 , 46831042 , 46758715 , 60801755 , 82434070 , 82433859 , 82394418	
						Discofreno ant.	5 69 086 , 95511282 , 71711447 , 71711434 , 60815938 , 60813443 , 60801722 , 52015291 , 51996238 , 51990127 , 71739567 , 71739568 , 60699518 , 60578093 , 60658565 , 82427592 , 82450539 , 60622077 , 60571548 , 60569163	
	2,5 TD					Disco freno post.	60801753 , 60801390 , 16420.26100.01/00 , 46831042 , 46758715 , 60801755 , 82434070 , 82433859 , 82394418	
	3,0 i,e, V6					Disco freno post.	60801753 , 60801390 , 16420.26100.01/00 , 46831042 , 46758715 , 60801755 , 82434070 , 82433859 , 82394418	
						Discofreno ant.	5 69 086 , 95511282 , 71711447 , 71711434 , 60815938 , 60813443 , 60801722 , 52015291 , 51996238 , 51990127 , 71739567 , 71739568 , 60699518 , 60578093 , 60658565 , 82427592 , 82450539 , 60622077 , 60571548 , 60569163	



Descrizione

Codici OE -  
Codice ATE

Pre-codice / varie

## Classic PKW

NISSAN 200 SX (S13) (88-94)	1,8 i Turbo		10.1991	03.1994	28.0462-2179.1	BAR221	Discofreno ant.	40206-2F501 , 40206-55F03 , 40206-55F01 , 40206-2F500	
-----------------------------	-------------	--	---------	---------	----------------	--------	-----------------	--	--

## DAEWOO

GENTRA (13-)	1,5	ant.sx	06.2013		24.3541-1859.5	240735	Pinza freno anteriore	96549788	
		ant.dx	06.2013		24.3541-1860.5	240736	Pinza freno anteriore	96549789	
LACETTI (04-05)	1,4 i 16V	ant.sx	06.2002	12.2004	24.3541-1859.5	240735	Pinza freno anteriore	96549788	
		ant.sx	02.2004	02.2005	24.3541-1859.5	240735	Pinza freno anteriore	96549788	
		ant.dx	06.2002	12.2004	24.3541-1860.5	240736	Pinza freno anteriore	96549789	
		ant.dx	02.2004	02.2005	24.3541-1860.5	240736	Pinza freno anteriore	96549789	
	1,6 i 16V	ant.dx	02.2004	02.2005	24.3541-1860.5	240736	Pinza freno anteriore	96549789	
		ant.sx	02.2004	02.2005	24.3541-1859.5	240735	Pinza freno anteriore	96549788	
	1,8 i 16V	ant.dx	02.2004	02.2005	24.3541-1860.5	240736	Pinza freno anteriore	96549789	
		ant.sx	02.2004	02.2005	24.3541-1859.5	240735	Pinza freno anteriore	96549788	
LACETTI (99-03)	1,6	ant.dx	06.2002	07.2003	24.3541-1860.5	240736	Pinza freno anteriore	96549789	
		ant.sx	06.2002	07.2003	24.3541-1859.5	240735	Pinza freno anteriore	96549788	
NUBIRA (99-05)	1,4 i 16V	ant.dx	10.2003	12.2004	24.3541-1860.5	240736	Pinza freno anteriore	96549789	
		ant.sx	10.2003	12.2004	24.3541-1859.5	240735	Pinza freno anteriore	96549788	
	2,0 CDX	ant.dx	01.2003	07.2003	24.3541-1860.5	240736	Pinza freno anteriore	96549789	
		ant.sx	01.2003	07.2003	24.3541-1859.5	240735	Pinza freno anteriore	96549788	



Descrizione

Codici OE -  
Codice ATE

Pre-codice / varie

## FIAT

500 (07-)	0,9		07.2010		03.0521-0520.3	690112	Topkit Originale Ate posteriori		
			09.2012		03.0521-0520.3	690112	Topkit Originale Ate posteriori		
	1,2 i		06.2010		03.0521-0520.3	690112	Topkit Originale Ate posteriori		
	1,2 LPG		12.2010		03.0521-0520.3	690112	Topkit Originale Ate posteriori		
	1,3 D Multijet		06.2016		03.0521-0520.3	690112	Topkit Originale Ate posteriori		
			06.2010		03.0521-0520.3	690112	Topkit Originale Ate posteriori		
500 C Cabrio (09-)	0,9		06.2010		03.0521-0520.3	690112	Topkit Originale Ate posteriori		
	1,2		06.2010		03.0521-0520.3	690112	Topkit Originale Ate posteriori		
	1,3 D Multijet		06.2010		03.0521-0520.3	690112	Topkit Originale Ate posteriori		
BRAVO (07-)	1,4 16V		04.2008		28.0461-0190.1	BAR101	Disco freno post.	60801753 , 60801390 , 16420.26100.01/00 , 46831042 , 46758715 , 60801755 , 82434070 , 82433859 , 82394418	
	1,4 i 16V		04.2007		28.0461-0190.1	BAR101	Disco freno post.	60801753 , 60801390 , 16420.26100.01/00 , 46831042 , 46758715 , 60801755 , 82434070 , 82433859 , 82394418	
	1,4 LPG		11.2009		28.0461-0190.1	BAR101	Disco freno post.	60801753 , 60801390 , 16420.26100.01/00 , 46831042 , 46758715 , 60801755 , 82434070 , 82433859 , 82394418	
	1,4 T-Jet		09.2007		28.0461-0190.1	BAR101	Disco freno post.	60801753 , 60801390 , 16420.26100.01/00 , 46831042 , 46758715 , 60801755 , 82434070 , 82433859 , 82394418	



Descrizione

Codici OE -  
Codice ATE

Pre-codice / varie

## FIAT

BRAVO (07-)	1,6 D Multijet		03.2008		28.0461-0190.1	BAR101	Disco freno post.	60801753 , 60801390 , 16420.26100.01/00 , 46831042 , 46758715 , 60801755 , 82434070 , 82433859 , 82394418	
	1,9 D Multijet		04.2007	12.2008	28.0461-0190.1	BAR101	Disco freno post.	60801753 , 60801390 , 16420.26100.01/00 , 46831042 , 46758715 , 60801755 , 82434070 , 82433859 , 82394418	
			04.2007		28.0461-0190.1	BAR101	Disco freno post.	60801753 , 60801390 , 16420.26100.01/00 , 46831042 , 46758715 , 60801755 , 82434070 , 82433859 , 82394418	
	2,0 D Multijet		09.2008		28.0461-0190.1	BAR101	Disco freno post.	60801753 , 60801390 , 16420.26100.01/00 , 46831042 , 46758715 , 60801755 , 82434070 , 82433859 , 82394418	
DOBLO (10-)	1,3 D Multijet		02.2010		28.0462-2145.1	BAR221	Discofreno ant.	5 69 086 , 95511282 , 71711447 , 71711434 , 60815938 , 60813443 , 60801722 , 52015291 , 51996238 , 51990127 , 71739567 , 71739568 , 60699518 , 60578093 , 60658565 , 82427592 , 82450539 , 60622077 , 60571548 , 60569163	
	1,4		02.2010		28.0462-2145.1	BAR221	Discofreno ant.	5 69 086 , 95511282 , 71711447 , 71711434 , 60815938 , 60813443 , 60801722 , 52015291 , 51996238 , 51990127 , 71739567 , 71739568 , 60699518 , 60578093 , 60658565 , 82427592 , 82450539 , 60622077 , 60571548 , 60569163	





Descrizione

Codici OE -  
Codice ATE

Pre-codice / varie

## FIAT

DOBLO (10-)	1,4		10.2011		28.0462-2145.1	BAR221	Discofreno ant.	5 69 086 , 95511282 , 71711447 , 71711434 , 60815938 , 60813443 , 60801722 , 52015291 , 51996238 , 51990127 , 71739567 , 71739568 , 60699518 , 60578093 , 60658565 , 82427592 , 82450539 , 60622077 , 60571548 , 60569163	
	1,4 Natural Power		02.2010		28.0462-2145.1	BAR221	Discofreno ant.	5 69 086 , 95511282 , 71711447 , 71711434 , 60815938 , 60813443 , 60801722 , 52015291 , 51996238 , 51990127 , 71739567 , 71739568 , 60699518 , 60578093 , 60658565 , 82427592 , 82450539 , 60622077 , 60571548 , 60569163	
	1,6 D Multijet		02.2010		28.0462-2145.1	BAR221	Discofreno ant.	5 69 086 , 95511282 , 71711447 , 71711434 , 60815938 , 60813443 , 60801722 , 52015291 , 51996238 , 51990127 , 71739567 , 71739568 , 60699518 , 60578093 , 60658565 , 82427592 , 82450539 , 60622077 , 60571548 , 60569163	
			03.2015		28.0462-2145.1	BAR221	Discofreno ant.	5 69 086 , 95511282 , 71711447 , 71711434 , 60815938 , 60813443 , 60801722 , 52015291 , 51996238 , 51990127 , 71739567 , 71739568 , 60699518 , 60578093 , 60658565 , 82427592 , 82450539 , 60622077 , 60571548 , 60569163	



Descrizione

Codici OE -  
Codice ATE

Pre-codice / varie

## FIAT

DOBLO (10-)	2,0 D Multijet		02.2010		28.0462-2145.1	BAR221	Discofreno ant.	5 69 086 , 95511282 , 71711447 , 71711434 , 60815938 , 60813443 , 60801722 , 52015291 , 51996238 , 51990127 , 71739567 , 71739568 , 60699518 , 60578093 , 60658565 , 82427592 , 82450539 , 60622077 , 60571548 , 60569163	
LINEA (07-11)	1,4 T-Jet		07.2007	05.2011	28.0461-0190.1	BAR101	Disco freno post.	60801753 , 60801390 , 16420.26100.01/00 , 46831042 , 46758715 , 60801755 , 82434070 , 82433859 , 82394418	
	1,6		07.2008	05.2011	28.0461-0190.1	BAR101	Disco freno post.	60801753 , 60801390 , 16420.26100.01/00 , 46831042 , 46758715 , 60801755 , 82434070 , 82433859 , 82394418	
	1,6 D Multijet		01.2009	05.2011	28.0461-0190.1	BAR101	Disco freno post.	60801753 , 60801390 , 16420.26100.01/00 , 46831042 , 46758715 , 60801755 , 82434070 , 82433859 , 82394418	
	1,9 16V		07.2008	05.2011	28.0461-0190.1	BAR101	Disco freno post.	60801753 , 60801390 , 16420.26100.01/00 , 46831042 , 46758715 , 60801755 , 82434070 , 82433859 , 82394418	
MULTIPLA (98-10)	1,6		09.2000	06.2010	28.0461-0190.1	BAR101	Disco freno post.	60801753 , 60801390 , 16420.26100.01/00 , 46831042 , 46758715 , 60801755 , 82434070 , 82433859 , 82394418	



Descrizione

Codici OE -  
Codice ATE



Pre-codice / varie

## FIAT

Modello	Versione								
MULTIPLA (98-10)	1,6 16V		04.2002	06.2010	28.0461-0190.1	BAR101	Disco freno post.	60801753 , 60801390 , 16420.26100.01/00 , 46831042 , 46758715 , 60801755 , 82434070 , 82433859 , 82394418	
	1,6 16V Bipower		04.1999	06.2010	28.0461-0190.1	BAR101	Disco freno post.	60801753 , 60801390 , 16420.26100.01/00 , 46831042 , 46758715 , 60801755 , 82434070 , 82433859 , 82394418	
	1,6 16V Bluepower		04.1999	06.2010	28.0461-0190.1	BAR101	Disco freno post.	60801753 , 60801390 , 16420.26100.01/00 , 46831042 , 46758715 , 60801755 , 82434070 , 82433859 , 82394418	
	1,9 JTD		04.2002	06.2010	28.0461-0190.1	BAR101	Disco freno post.	60801753 , 60801390 , 16420.26100.01/00 , 46831042 , 46758715 , 60801755 , 82434070 , 82433859 , 82394418	
PANDA (03-13)	1,1		06.2010	06.2013	03.0521-0520.3	690112	Topkit Originale Ate posteriori		
	1,2		06.2010	06.2013	03.0521-0520.3	690112	Topkit Originale Ate posteriori		
	1,3 D Multijet		06.2010	06.2013	03.0521-0520.3	690112	Topkit Originale Ate posteriori		
	1,3 JTD		06.2010	06.2013	03.0521-0520.3	690112	Topkit Originale Ate posteriori		
PANDA (12-)	0,9		02.2012		03.0521-0620.3	690111	Topkit Originale Ate posteriori		
	0,9 Natural Power		02.2012		03.0521-0620.3	690111	Topkit Originale Ate posteriori		
			07.2012		03.0521-0620.3	690111	Topkit Originale Ate posteriori		
	1,2		02.2012		03.0521-0620.3	690111	Topkit Originale Ate posteriori		
	1,2 LPG		02.2012		03.0521-0620.3	690111	Topkit Originale Ate posteriori		
	1,3 D Multijet		04.2015		03.0521-0620.3	690111	Topkit Originale Ate posteriori		
			02.2012		03.0521-0620.3	690111	Topkit Originale Ate posteriori		



Descrizione

Codici OE -  
Codice ATE

Pre-codice / varie

## FIAT

STILO / STILO Multi Wagon (01-08)	1,2 i 16V		02.2002	03.2008	28.0461-0190.1	BAR101	Disco freno post.	60801753 , 60801390 , 16420.26100.01/00 , 46831042 , 46758715 , 60801755 , 82434070 , 82433859 , 82394418	
	1,4 i 16V		01.2004	03.2008	28.0461-0190.1	BAR101	Disco freno post.	60801753 , 60801390 , 16420.26100.01/00 , 46831042 , 46758715 , 60801755 , 82434070 , 82433859 , 82394418	
	1,6 16V		04.2005	03.2008	28.0461-0190.1	BAR101	Disco freno post.	60801753 , 60801390 , 16420.26100.01/00 , 46831042 , 46758715 , 60801755 , 82434070 , 82433859 , 82394418	
			10.2001	03.2008	28.0461-0190.1	BAR101	Disco freno post.	60801753 , 60801390 , 16420.26100.01/00 , 46831042 , 46758715 , 60801755 , 82434070 , 82433859 , 82394418	
	1,8 16V		10.2001	03.2008	28.0461-0190.1	BAR101	Disco freno post.	60801753 , 60801390 , 16420.26100.01/00 , 46831042 , 46758715 , 60801755 , 82434070 , 82433859 , 82394418	
	1,9 D Multijet		09.2005	03.2008	28.0461-0190.1	BAR101	Disco freno post.	60801753 , 60801390 , 16420.26100.01/00 , 46831042 , 46758715 , 60801755 , 82434070 , 82433859 , 82394418	
	1,9 JTD		10.2001	03.2008	28.0461-0190.1	BAR101	Disco freno post.	60801753 , 60801390 , 16420.26100.01/00 , 46831042 , 46758715 , 60801755 , 82434070 , 82433859 , 82394418	



Descrizione

Codici OE -  
Codice ATE



Pre-codice / varie

## FIAT

Modello	Versione	02.2002	03.2008	28.0461-0190.1	BAR101	Descrizione	Codici OE - Codice ATE	Pre-codice / varie
STILO / STILO Multi Wagon (01-08)	1,9 JTD					Disco freno post.	60801753 , 60801390 , 16420.26100.01/00 , 46831042 , 46758715 , 60801755 , 82434070 , 82433859 , 82394418	
		01.2004	03.2008			Disco freno post.	60801753 , 60801390 , 16420.26100.01/00 , 46831042 , 46758715 , 60801755 , 82434070 , 82433859 , 82394418	
	2,4 20V	10.2001	03.2008			Disco freno post.	60801753 , 60801390 , 16420.26100.01/00 , 46831042 , 46758715 , 60801755 , 82434070 , 82433859 , 82394418	
TIPO (15-)	1,3 D Multijet	10.2015				Discofreno ant.	5 69 086 , 95511282 , 71711447 , 71711434 , 60815938 , 60813443 , 60801722 , 52015291 , 51996238 , 51990127 , 71739567 , 71739568 , 60699518 , 60578093 , 60658565 , 82427592 , 82450539 , 60622077 , 60571548 , 60569163	
	1,4	10.2015				Discofreno ant.	5 69 086 , 95511282 , 71711447 , 71711434 , 60815938 , 60813443 , 60801722 , 52015291 , 51996238 , 51990127 , 71739567 , 71739568 , 60699518 , 60578093 , 60658565 , 82427592 , 82450539 , 60622077 , 60571548 , 60569163	



Descrizione

Codici OE -  
Codice ATE

Pre-codice / varie

## FIAT

TIPO (15-)	1,4		03.2016		28.0462-2145.1	BAR221	Discofreno ant.	5 69 086 , 95511282 , 71711447 , 71711434 , 60815938 , 60813443 , 60801722 , 52015291 , 51996238 , 51990127 , 71739567 , 71739568 , 60699518 , 60578093 , 60658565 , 82427592 , 82450539 , 60622077 , 60571548 , 60569163	
	1,6		10.2015		28.0462-2145.1	BAR221	Discofreno ant.	5 69 086 , 95511282 , 71711447 , 71711434 , 60815938 , 60813443 , 60801722 , 52015291 , 51996238 , 51990127 , 71739567 , 71739568 , 60699518 , 60578093 , 60658565 , 82427592 , 82450539 , 60622077 , 60571548 , 60569163	
	1,6 D Multijet		10.2015		28.0462-2145.1	BAR221	Discofreno ant.	5 69 086 , 95511282 , 71711447 , 71711434 , 60815938 , 60813443 , 60801722 , 52015291 , 51996238 , 51990127 , 71739567 , 71739568 , 60699518 , 60578093 , 60658565 , 82427592 , 82450539 , 60622077 , 60571548 , 60569163	



Descrizione

Codici OE -  
Codice ATE

Pre-codice / varie

## FORD

Modello	Motori	Anno Inizio	Anno Fine	Codice OE	Codice ATE	Descrizione	Codici OE - Codice ATE
COUGAR (98-01)	2,0 i 16V	09.1998	12.2001	28.0462-0146.1	BAR201	Disco freno post.	4115996 , 1025911 , 5026786
	2,5 i V6	09.1998	12.2001	28.0462-0146.1	BAR201	Disco freno post.	4115996 , 1025911 , 5026786
FOCUS II (05-11)	2,5 RS	01.2009	02.2011	28.0461-1145.1	BAR111	Disco freno post.	LR027123 , 6G91-2A315-BA , 1385590 , 1405500 , 1379931
	2,5 RS 500	05.2010	02.2011	28.0461-1145.1	BAR111	Disco freno post.	LR027123 , 6G91-2A315-BA , 1385590 , 1405500 , 1379931
GALAXY II (06-)	1,6 EcoBoost	02.2011		28.0461-1145.1	BAR111	Disco freno post.	LR027123 , 6G91-2A315-BA , 1385590 , 1405500 , 1379931
	1,6 TDCi	02.2011		28.0461-1145.1	BAR111	Disco freno post.	LR027123 , 6G91-2A315-BA , 1385590 , 1405500 , 1379931
	1,8 TDCi	04.2006		28.0461-1145.1	BAR111	Disco freno post.	LR027123 , 6G91-2A315-BA , 1385590 , 1405500 , 1379931
	2,0 Flexifuel	05.2006		28.0461-1145.1	BAR111	Disco freno post.	LR027123 , 6G91-2A315-BA , 1385590 , 1405500 , 1379931
	2,0 i 16V	04.2006		28.0461-1145.1	BAR111	Disco freno post.	LR027123 , 6G91-2A315-BA , 1385590 , 1405500 , 1379931
	2,0 SCTi EcoBoost	03.2010		28.0461-1145.1	BAR111	Disco freno post.	LR027123 , 6G91-2A315-BA , 1385590 , 1405500 , 1379931
	2,0 TDCi	03.2010		28.0461-1145.1	BAR111	Disco freno post.	LR027123 , 6G91-2A315-BA , 1385590 , 1405500 , 1379931
		04.2006		28.0461-1145.1	BAR111	Disco freno post.	LR027123 , 6G91-2A315-BA , 1385590 , 1405500 , 1379931
		05.2006		28.0461-1145.1	BAR111	Disco freno post.	LR027123 , 6G91-2A315-BA , 1385590 , 1405500 , 1379931
		10.2007		28.0461-1145.1	BAR111	Disco freno post.	LR027123 , 6G91-2A315-BA , 1385590 , 1405500 , 1379931
	2,2 TDCi	04.2008		28.0461-1145.1	BAR111	Disco freno post.	LR027123 , 6G91-2A315-BA , 1385590 , 1405500 , 1379931



Descrizione

Codici OE -  
Codice ATE

Pre-codice / varie

## FORD

GALAXY II (06-)	2,2 TDCi		07.2010		28.0461-1145.1	BAR111	Disco freno post.	LR027123 , 6G91-2A315-BA , 1385590 , 1405500 , 1379931	
	2,3 i 16V		07.2007		28.0461-1145.1	BAR111	Disco freno post.	LR027123 , 6G91-2A315-BA , 1385590 , 1405500 , 1379931	
KA II (08-)	1,2 i 16V		06.2010		03.0521-0520.3	690112	Topkit Originale Ate posteriori		
	1,3 TDCi		06.2010		03.0521-0520.3	690112	Topkit Originale Ate posteriori		
KUGA I (08-12)	2,0 TDCi		04.2008	12.2012	28.0461-1145.1	BAR111	Disco freno post.	LR027123 , 6G91-2A315-BA , 1385590 , 1405500 , 1379931	
			03.2010	12.2012	28.0461-1145.1	BAR111	Disco freno post.	LR027123 , 6G91-2A315-BA , 1385590 , 1405500 , 1379931	
	2,0 TDCi 4x4		03.2010	12.2012	28.0461-1145.1	BAR111	Disco freno post.	LR027123 , 6G91-2A315-BA , 1385590 , 1405500 , 1379931	
			04.2008	12.2012	28.0461-1145.1	BAR111	Disco freno post.	LR027123 , 6G91-2A315-BA , 1385590 , 1405500 , 1379931	
	2,5 i		03.2009	12.2012	28.0461-1145.1	BAR111	Disco freno post.	LR027123 , 6G91-2A315-BA , 1385590 , 1405500 , 1379931	
	2,5 i 4x4		11.2008	12.2012	28.0461-1145.1	BAR111	Disco freno post.	LR027123 , 6G91-2A315-BA , 1385590 , 1405500 , 1379931	
MONDEO II (96-00)	1,6 i 16V		10.1996	09.2000	28.0462-0146.1	BAR201	Disco freno post.	4115996 , 1025911 , 5026786	
	1,8 i 16V		10.1996	09.2000	28.0462-0146.1	BAR201	Disco freno post.	4115996 , 1025911 , 5026786	
	1,8 TD		10.1996	09.2000	28.0462-0146.1	BAR201	Disco freno post.	4115996 , 1025911 , 5026786	
	2,0 i 16V		10.1996	09.2000	28.0462-0146.1	BAR201	Disco freno post.	4115996 , 1025911 , 5026786	
	2,5 i 24V		10.1996	09.2000	28.0462-0146.1	BAR201	Disco freno post.	4115996 , 1025911 , 5026786	
	2,5 ST 200		05.1999	09.2000	28.0462-0146.1	BAR201	Disco freno post.	4115996 , 1025911 , 5026786	
MONDEO IV (07-14)	1,6 EcoBoost		02.2011	09.2014	28.0461-1145.1	BAR111	Disco freno post.	LR027123 , 6G91-2A315-BA , 1385590 , 1405500 , 1379931	





Descrizione

Codici OE -  
Codice ATE

Pre-codice / varie

## FORD

MONDEO IV (07-14)	1,6 TDCi		02.2011	09.2014	28.0461-1145.1	BAR111	Disco freno post.	LR027123 , 6G91-2A315-BA , 1385590 , 1405500 , 1379931	
	1,6 Ti VCT		07.2010	09.2014	28.0461-1145.1	BAR111	Disco freno post.	LR027123 , 6G91-2A315-BA , 1385590 , 1405500 , 1379931	
			04.2007	09.2014	28.0461-1145.1	BAR111	Disco freno post.	LR027123 , 6G91-2A315-BA , 1385590 , 1405500 , 1379931	
	1,8 TDCi		04.2007	09.2014	28.0461-1145.1	BAR111	Disco freno post.	LR027123 , 6G91-2A315-BA , 1385590 , 1405500 , 1379931	
			06.2007	09.2014	28.0461-1145.1	BAR111	Disco freno post.	LR027123 , 6G91-2A315-BA , 1385590 , 1405500 , 1379931	
	2,0 EcoBoost		07.2010	09.2014	28.0461-1145.1	BAR111	Disco freno post.	LR027123 , 6G91-2A315-BA , 1385590 , 1405500 , 1379931	
	2,0 Flexifuel		03.2007	09.2014	28.0461-1145.1	BAR111	Disco freno post.	LR027123 , 6G91-2A315-BA , 1385590 , 1405500 , 1379931	
	2,0 i 16V		04.2007	09.2014	28.0461-1145.1	BAR111	Disco freno post.	LR027123 , 6G91-2A315-BA , 1385590 , 1405500 , 1379931	
	2,0 LPG		07.2009	09.2014	28.0461-1145.1	BAR111	Disco freno post.	LR027123 , 6G91-2A315-BA , 1385590 , 1405500 , 1379931	
	2,0 SCTi		03.2010	09.2014	28.0461-1145.1	BAR111	Disco freno post.	LR027123 , 6G91-2A315-BA , 1385590 , 1405500 , 1379931	
	2,0 TDCi		03.2010	09.2014	28.0461-1145.1	BAR111	Disco freno post.	LR027123 , 6G91-2A315-BA , 1385590 , 1405500 , 1379931	
			04.2007	09.2014	28.0461-1145.1	BAR111	Disco freno post.	LR027123 , 6G91-2A315-BA , 1385590 , 1405500 , 1379931	
			10.2007	09.2014	28.0461-1145.1	BAR111	Disco freno post.	LR027123 , 6G91-2A315-BA , 1385590 , 1405500 , 1379931	
			03.2007	09.2014	28.0461-1145.1	BAR111	Disco freno post.	LR027123 , 6G91-2A315-BA , 1385590 , 1405500 , 1379931	



Descrizione

Codici OE -  
Codice ATE

Pre-codice / varie

## FORD

MONDEO IV (07-14)	2,2 TDCi		11.2010	09.2014	28.0461-1145.1	BAR111	Disco freno post.	LR027123 , 6G91-2A315-BA , 1385590 , 1405500 , 1379931	
			04.2008	09.2014	28.0461-1145.1	BAR111	Disco freno post.	LR027123 , 6G91-2A315-BA , 1385590 , 1405500 , 1379931	
	2,3 i 16V		07.2007	09.2014	28.0461-1145.1	BAR111	Disco freno post.	LR027123 , 6G91-2A315-BA , 1385590 , 1405500 , 1379931	
	2,5 i 20V		04.2007	09.2014	28.0461-1145.1	BAR111	Disco freno post.	LR027123 , 6G91-2A315-BA , 1385590 , 1405500 , 1379931	
RANGER (11-)	2,2 TDCi		05.2015		24.3220-1749.3	020589	Cil.ruota posteriore	AB31-2261-AA , 1717333	
			11.2011		24.3220-1749.3	020589	Cil.ruota posteriore	AB31-2261-AA , 1717333	
	2,2 TDCI 4x4		11.2011		24.3220-1749.3	020589	Cil.ruota posteriore	AB31-2261-AA , 1717333	
			05.2015		24.3220-1749.3	020589	Cil.ruota posteriore	AB31-2261-AA , 1717333	
	3,2 TDCI 4x4		11.2011		24.3220-1749.3	020589	Cil.ruota posteriore	AB31-2261-AA , 1717333	
SCORPIO / GRANADA (GB) (95-98)	2,0 i Kombi		10.1994	08.1998	28.0462-0146.1	BAR201	Disco freno post.	4115996 , 1025911 , 5026786	
	2,3 i 16V Kombi		05.1996	08.1998	28.0462-0146.1	BAR201	Disco freno post.	4115996 , 1025911 , 5026786	
	2,5 TD Kombi		10.1994	08.1998	28.0462-0146.1	BAR201	Disco freno post.	4115996 , 1025911 , 5026786	
	2,9 i Kombi		01.1995	08.1998	28.0462-0146.1	BAR201	Disco freno post.	4115996 , 1025911 , 5026786	
S-MAX (06-)	1,6 EcoBoost		02.2011		28.0461-1145.1	BAR111	Disco freno post.	LR027123 , 6G91-2A315-BA , 1385590 , 1405500 , 1379931	
	1,6 TDCi		02.2011		28.0461-1145.1	BAR111	Disco freno post.	LR027123 , 6G91-2A315-BA , 1385590 , 1405500 , 1379931	
	1,8 TDCi		01.2007		28.0461-1145.1	BAR111	Disco freno post.	LR027123 , 6G91-2A315-BA , 1385590 , 1405500 , 1379931	
			04.2006		28.0461-1145.1	BAR111	Disco freno post.	LR027123 , 6G91-2A315-BA , 1385590 , 1405500 , 1379931	



Descrizione

Codici OE -  
Codice ATE

Pre-codice / varie

**FORD**

S-MAX (06-)	2,0 EcoBoost		07.2010		28.0461-1145.1	BAR111	Disco freno post.	LR027123 , 6G91-2A315-BA , 1385590 , 1405500 , 1379931	
	2,0 i 16V		04.2006		28.0461-1145.1	BAR111	Disco freno post.	LR027123 , 6G91-2A315-BA , 1385590 , 1405500 , 1379931	
	2,0 SCTi EcoBoost		03.2010		28.0461-1145.1	BAR111	Disco freno post.	LR027123 , 6G91-2A315-BA , 1385590 , 1405500 , 1379931	
	2,0 TDCi		05.2006		28.0461-1145.1	BAR111	Disco freno post.	LR027123 , 6G91-2A315-BA , 1385590 , 1405500 , 1379931	
			04.2006		28.0461-1145.1	BAR111	Disco freno post.	LR027123 , 6G91-2A315-BA , 1385590 , 1405500 , 1379931	
			10.2007		28.0461-1145.1	BAR111	Disco freno post.	LR027123 , 6G91-2A315-BA , 1385590 , 1405500 , 1379931	
			03.2010		28.0461-1145.1	BAR111	Disco freno post.	LR027123 , 6G91-2A315-BA , 1385590 , 1405500 , 1379931	
	2,2 TDCi		04.2008		28.0461-1145.1	BAR111	Disco freno post.	LR027123 , 6G91-2A315-BA , 1385590 , 1405500 , 1379931	
			07.2010		28.0461-1145.1	BAR111	Disco freno post.	LR027123 , 6G91-2A315-BA , 1385590 , 1405500 , 1379931	
	2,3 i 16V		07.2007		28.0461-1145.1	BAR111	Disco freno post.	LR027123 , 6G91-2A315-BA , 1385590 , 1405500 , 1379931	
	2,5 ST		04.2006		28.0461-1145.1	BAR111	Disco freno post.	LR027123 , 6G91-2A315-BA , 1385590 , 1405500 , 1379931	
TRANSIT (00-06)	2,0 DI		08.2000	04.2006	28.0462-4167.1	BAR241	Discofreno ant.	1C1J-1125-A2D , 1C1J-1125-A1D , 1C1J-1125-AD , 1C1J-1125-AC , 1C1J-1125-AB , 1C1W-1125-AB , 1738807 , 1568654 , 1520371 , 1473008 , 1456667 , 4395257 , 4041427	



Descrizione





Codici OE -  
Codice ATE

Pre-codice / varie

## FORD

TRANSIT (00-06)	2,0 TDCi		08.2002	04.2006	28.0462-4167.1	BAR241	Discofreno ant.	1C1J-1125-A2D , 1C1J-1125-A1D , 1C1J-1125-AD , 1C1J-1125-AC , 1C1J-1125-AB , 1C1W-1125-AB , 1738807 , 1568654 , 1520371 , 1473008 , 1456667 , 4395257 , 4041427	
	2,3 i 16V		04.2001	04.2006	28.0462-4167.1	BAR241	Discofreno ant.	1C1J-1125-A2D , 1C1J-1125-A1D , 1C1J-1125-AD , 1C1J-1125-AC , 1C1J-1125-AB , 1C1W-1125-AB , 1738807 , 1568654 , 1520371 , 1473008 , 1456667 , 4395257 , 4041427	
	2,4 DI		01.2000	04.2006	28.0462-4167.1	BAR241	Discofreno ant.	1C1J-1125-A2D , 1C1J-1125-A1D , 1C1J-1125-AD , 1C1J-1125-AC , 1C1J-1125-AB , 1C1W-1125-AB , 1738807 , 1568654 , 1520371 , 1473008 , 1456667 , 4395257 , 4041427	
	2,4 TDCi		03.2004	04.2006	28.0462-4167.1	BAR241	Discofreno ant.	1C1J-1125-A2D , 1C1J-1125-A1D , 1C1J-1125-AD , 1C1J-1125-AC , 1C1J-1125-AB , 1C1W-1125-AB , 1738807 , 1568654 , 1520371 , 1473008 , 1456667 , 4395257 , 4041427	
	2,4 TDE		11.2001	04.2006	28.0462-4167.1	BAR241	Discofreno ant.	1C1J-1125-A2D , 1C1J-1125-A1D , 1C1J-1125-AD , 1C1J-1125-AC , 1C1J-1125-AB , 1C1W-1125-AB , 1738807 , 1568654 , 1520371 , 1473008 , 1456667 , 4395257 , 4041427	



					<b>Descrizione</b>	<b>Codici OE - Codice ATE</b>	 <b>Pre-codice / varie</b>
---	---	---	--	---	--------------------	-----------------------------------	--

**HONDA**

JAZZ (08-15)	1,2 i-VTEC	post.sx	01.2009		24.5278-0254.3	331471	Tubo flessibile posteriore	01468-TF0-G00	
	1,3 Hybrid	post.sx	04.2011		24.5278-0254.3	331471	Tubo flessibile posteriore	01468-TF0-G00	
	1,4 Flexfuel	post.sx	11.2008		24.5278-0254.3	331471	Tubo flessibile posteriore	01468-TF0-G00	
	1,4 i 16V		07.2008		24.0109-0178.1	409178	Disco freno post.	42510-T5B-950 , 42510-TF0-000	
		post.sx	01.2009		24.5278-0254.3	331471	Tubo flessibile posteriore	01468-TF0-G00	
		post.sx	11.2008		24.5278-0254.3	331471	Tubo flessibile posteriore	01468-TF0-G00	
	1,5 Flexfuel	post.sx	01.2009		24.5278-0254.3	331471	Tubo flessibile posteriore	01468-TF0-G00	
	1,5 i 16V	post.sx	01.2009		24.5278-0254.3	331471	Tubo flessibile posteriore	01468-TF0-G00	
JAZZ (15-)	1,3 i-VTEC		09.2015		24.0109-0178.1	409178	Disco freno post.	42510-T5B-950 , 42510-TF0-000	



Descrizione

Codici OE -  
Codice ATE

Pre-codice / varie

## HYUNDAI

i30 (07-11)	1,4 16V	post.sx	10.2007	10.2011	24.5294-0293.3	331515	Tubo flessibile posteriore	58737-2L700	
	1,6 16V	post.sx	02.2008	10.2011	24.5294-0293.3	331515	Tubo flessibile posteriore	58737-2L700	
		post.sx	10.2007	10.2011	24.5294-0293.3	331515	Tubo flessibile posteriore	58737-2L700	
	1,6 CRDi	post.sx	02.2008	10.2011	24.5294-0293.3	331515	Tubo flessibile posteriore	58737-2L700	
		post.sx	10.2007	10.2011	24.5294-0293.3	331515	Tubo flessibile posteriore	58737-2L700	
	2,0 16V	post.sx	10.2007	10.2011	24.5294-0293.3	331515	Tubo flessibile posteriore	58737-2L700	
	2,0 CRDi	post.sx	02.2008	10.2011	24.5294-0293.3	331515	Tubo flessibile posteriore	58737-2L700	
		post.sx	10.2007	10.2011	24.5294-0293.3	331515	Tubo flessibile posteriore	58737-2L700	
i30 CW Kombi (08-12)	1,4 16V	post.sx	02.2008	06.2012	24.5294-0293.3	331515	Tubo flessibile posteriore	58737-2L700	
		post.sx	11.2009	06.2012	24.5294-0293.3	331515	Tubo flessibile posteriore	58737-2L700	
	1,6 16V	post.sx	01.2010	06.2012	24.5294-0293.3	331515	Tubo flessibile posteriore	58737-2L700	
		post.sx	02.2008	06.2012	24.5294-0293.3	331515	Tubo flessibile posteriore	58737-2L700	
	1,6 CRDi	post.sx	02.2008	06.2012	24.5294-0293.3	331515	Tubo flessibile posteriore	58737-2L700	
	2,0 16V	post.sx	02.2008	06.2012	24.5294-0293.3	331515	Tubo flessibile posteriore	58737-2L700	
	2,0 CRDi	post.sx	02.2008	06.2012	24.5294-0293.3	331515	Tubo flessibile posteriore	58737-2L700	
		post.sx	01.2010	06.2012	24.5294-0293.3	331515	Tubo flessibile posteriore	58737-2L700	



Descrizione

Codici OE -  
Codice ATE

Pre-codice / varie

## JAGUAR

XF (CC9) (08-)	2,0 16V		06.2012		24.8190-0960.2	620960	Serie pastiglie posteriori	C2D 2976	
	2,2 D		03.2012		24.8190-0960.2	620960	Serie pastiglie posteriori	C2D 2976	
			04.2011		24.8190-0960.2	620960	Serie pastiglie posteriori	C2D 2976	
			05.2011		24.8190-0960.2	620960	Serie pastiglie posteriori	C2D 2976	
	2,7 D				24.8190-0960.2	620960	Serie pastiglie posteriori	C2D 2976	
			03.2008		24.8190-0960.2	620960	Serie pastiglie posteriori	C2D 2976	
	3,0 D				24.8190-0960.2	620960	Serie pastiglie posteriori	C2D 2976	
			03.2009		24.8190-0960.2	620960	Serie pastiglie posteriori	C2D 2976	
	3,0 V6		03.2012		24.8190-0960.2	620960	Serie pastiglie posteriori	C2D 2976	
					24.8190-0960.2	620960	Serie pastiglie posteriori	C2D 2976	
			03.2008		24.8190-0960.2	620960	Serie pastiglie posteriori	C2D 2976	
	3,0 V6 AWD		10.2012		24.8190-0960.2	620960	Serie pastiglie posteriori	C2D 2976	
	4,2 V8		03.2008		24.8190-0960.2	620960	Serie pastiglie posteriori	C2D 2976	
			07.2009		24.8190-0960.2	620960	Serie pastiglie posteriori	C2D 2976	
					24.8190-0960.2	620960	Serie pastiglie posteriori	C2D 2976	
	4,2 V8 Kompressor				24.8190-0960.2	620960	Serie pastiglie posteriori	C2D 2976	
			03.2008		24.8190-0960.2	620960	Serie pastiglie posteriori	C2D 2976	
	5,0 V8				24.8190-0960.2	620960	Serie pastiglie posteriori	C2D 2976	
			03.2009		24.8190-0960.2	620960	Serie pastiglie posteriori	C2D 2976	
	5,0 V8 Kompressor				24.8190-0960.2	620960	Serie pastiglie posteriori	C2D 2976	
			01.2009		24.8190-0960.2	620960	Serie pastiglie posteriori	C2D 2976	



Descrizione

Codici OE -  
Codice ATE

Pre-codice / varie

## JAGUAR

XF (CC9) (08-)	5,0 V8 Kompressor		03.2009		24.8190-0960.2	620960	Serie pastiglie posteriori	C2D 2976	
	5,0 XFR-S		10.2012		24.8190-0960.2	620960	Serie pastiglie posteriori	C2D 2976	
XF Sportbrake (CC9) (12-)	2,2 D		09.2012		24.8190-0960.2	620960	Serie pastiglie posteriori	C2D 2976	
	3,0 D		09.2012		24.8190-0960.2	620960	Serie pastiglie posteriori	C2D 2976	
	5,0 XFR-S		02.2014		24.8190-0960.2	620960	Serie pastiglie posteriori	C2D 2976	
XJ (X350,X358) (03-09)	XJ6 2,7 D		03.2009		24.8190-0960.2	620960	Serie pastiglie posteriori	C2D 2976	
XJ (X351) (09-)	2,0 16V		05.2012		24.8190-0960.2	620960	Serie pastiglie posteriori	C2D 2976	
	3,0 V6		01.2011		24.8190-0960.2	620960	Serie pastiglie posteriori	C2D 2976	
			03.2012		24.8190-0960.2	620960	Serie pastiglie posteriori	C2D 2976	
	3,0 V6 AWD		10.2012		24.8190-0960.2	620960	Serie pastiglie posteriori	C2D 2976	
	3,0 V6 D		04.2015		24.8190-0960.2	620960	Serie pastiglie posteriori	C2D 2976	
			10.2009		24.8190-0960.2	620960	Serie pastiglie posteriori	C2D 2976	
	5,0 V8		10.2009		24.8190-0960.2	620960	Serie pastiglie posteriori	C2D 2976	
XK8 CABRIOLET (06-)	5,0 XKR				24.8190-0960.2	620960	Serie pastiglie posteriori	C2D 2976	
			01.2009		24.8190-0960.2	620960	Serie pastiglie posteriori	C2D 2976	
	5,0 XKR-S		01.2011		24.8190-0960.2	620960	Serie pastiglie posteriori	C2D 2976	
XK Coupe (06-)	5,0 XKR				24.8190-0960.2	620960	Serie pastiglie posteriori	C2D 2976	
			01.2009		24.8190-0960.2	620960	Serie pastiglie posteriori	C2D 2976	
			09.2010		24.8190-0960.2	620960	Serie pastiglie posteriori	C2D 2976	
	5,0 XKR-S		01.2011		24.8190-0960.2	620960	Serie pastiglie posteriori	C2D 2976	





					<b>Descrizione</b>	<b>Codici OE - Codice ATE</b>		<b>Pre-codice / varie</b>
--	--	--	--	--	--------------------	-----------------------------------	--	---------------------------

## JEEP

CHEROKEE (KJ) (01-08)	2,4 16V		09.2001	01.2008	24.3220-1751.3	020590	Cil.ruota posteriore	0 5066 158AA , 5066 158AA	
	2,4 16V Laredo		10.2001	09.2004	24.3220-1751.3	020590	Cil.ruota posteriore	0 5066 158AA , 5066 158AA	
	2,5 CRD		09.2001	01.2008	24.3220-1751.3	020590	Cil.ruota posteriore	0 5066 158AA , 5066 158AA	
	2,8 CRD		11.2004	01.2008	24.3220-1751.3	020590	Cil.ruota posteriore	0 5066 158AA , 5066 158AA	
	3,7 V6		09.2001	01.2008	24.3220-1751.3	020590	Cil.ruota posteriore	0 5066 158AA , 5066 158AA	
			08.2003	01.2008	24.3220-1751.3	020590	Cil.ruota posteriore	0 5066 158AA , 5066 158AA	
	3,7 V6 Laredo		10.2001	09.2004	24.3220-1751.3	020590	Cil.ruota posteriore	0 5066 158AA , 5066 158AA	
GRAND CHEROKEE IV (WK) (10-)	3,0 CRD V6 4x4		02.2011		24.0114-0120.1	414120	Disco freno post.	0 5212 4763AB , 5212 4763AB	
	3,6 V6 4x4		11.2010		24.0114-0120.1	414120	Disco freno post.	0 5212 4763AB , 5212 4763AB	
	3,6 V6 FlexFuel 4x4		11.2010		24.0114-0120.1	414120	Disco freno post.	0 5212 4763AB , 5212 4763AB	
	5,7 V8 4x4		11.2010		24.0114-0120.1	414120	Disco freno post.	0 5212 4763AB , 5212 4763AB	
	6,4 SRT8 4x4		03.2011		24.0114-0120.1	414120	Disco freno post.	0 5212 4763AB , 5212 4763AB	



	<b>i</b>			<b>Descrizione</b>	<b>Codici OE - Codice ATE</b>	<b>i</b> <b>Pre-codice / varie</b>
--	----------	--	--	--------------------	-----------------------------------	---------------------------------------

**KIA**

SPORTAGE (94-03)	2,0 i 16V		10.1999	08.2003	24.3220-1752.3	020591	Cil.ruota posteriore	0K045-26-610	
			10.2000	08.2003	24.3220-1752.3	020591	Cil.ruota posteriore	0K045-26-610	
	2,0 i 16V 4WD		10.2000	08.2003	24.3220-1752.3	020591	Cil.ruota posteriore	0K045-26-610	
			10.1999	08.2003	24.3220-1752.3	020591	Cil.ruota posteriore	0K045-26-610	
	2,0 TDi 4WD		10.1997	08.2003	24.3220-1752.3	020591	Cil.ruota posteriore	0K045-26-610	



Descrizione

Codici OE -  
Codice ATE

Pre-codice / varie

## LANCIA

Modello	Cilindrata	Versione	Data	Codice	Codice	Descrizione	Codici OE - Codice ATE	Pre-codice / varie
DELTA / Chrysler Delta (08-)	1,4 16V		07.2010	28.0461-0190.1	BAR101	Disco freno post.	60801753 , 60801390 , 16420.26100.01/00 , 46831042 , 46758715 , 60801755 , 82434070 , 82433859 , 82394418	
			08.2008	28.0461-0190.1	BAR101	Disco freno post.	60801753 , 60801390 , 16420.26100.01/00 , 46831042 , 46758715 , 60801755 , 82434070 , 82433859 , 82394418	
	1,4 16V Turbo		08.2008	28.0461-0190.1	BAR101	Disco freno post.	60801753 , 60801390 , 16420.26100.01/00 , 46831042 , 46758715 , 60801755 , 82434070 , 82433859 , 82394418	
	1,4 Bifuel		07.2011	28.0461-0190.1	BAR101	Disco freno post.	60801753 , 60801390 , 16420.26100.01/00 , 46831042 , 46758715 , 60801755 , 82434070 , 82433859 , 82394418	
	1,6 D Multijet		08.2008	28.0461-0190.1	BAR101	Disco freno post.	60801753 , 60801390 , 16420.26100.01/00 , 46831042 , 46758715 , 60801755 , 82434070 , 82433859 , 82394418	
			04.2011	28.0461-0190.1	BAR101	Disco freno post.	60801753 , 60801390 , 16420.26100.01/00 , 46831042 , 46758715 , 60801755 , 82434070 , 82433859 , 82394418	
	1,8 Di 16V		01.2009	28.0461-0190.1	BAR101	Disco freno post.	60801753 , 60801390 , 16420.26100.01/00 , 46831042 , 46758715 , 60801755 , 82434070 , 82433859 , 82394418	



Descrizione

Codici OE -  
Codice ATE

Pre-codice / varie

## LANCIA

DELTA / Chrysler Delta (08-)	1,9 D Multijet		08.2008		28.0461-0190.1	BAR101	Disco freno post.	60801753 , 60801390 , 16420.26100.01/00 , 46831042 , 46758715 , 60801755 , 82434070 , 82433859 , 82394418	
	2,0 D Multijet		08.2008		28.0461-0190.1	BAR101	Disco freno post.	60801753 , 60801390 , 16420.26100.01/00 , 46831042 , 46758715 , 60801755 , 82434070 , 82433859 , 82394418	
LYBRA (99-05)	1,6		10.2000	10.2005	28.0461-0190.1	BAR101	Disco freno post.	60801753 , 60801390 , 16420.26100.01/00 , 46831042 , 46758715 , 60801755 , 82434070 , 82433859 , 82394418	
	1,6 i 16V		10.1999	12.2005	28.0461-0190.1	BAR101	Disco freno post.	60801753 , 60801390 , 16420.26100.01/00 , 46831042 , 46758715 , 60801755 , 82434070 , 82433859 , 82394418	
	1,8 i 16V		10.1999	12.2005	28.0461-0190.1	BAR101	Disco freno post.	60801753 , 60801390 , 16420.26100.01/00 , 46831042 , 46758715 , 60801755 , 82434070 , 82433859 , 82394418	
	1,9 JTD		10.1999	12.2005	28.0461-0190.1	BAR101	Disco freno post.	60801753 , 60801390 , 16420.26100.01/00 , 46831042 , 46758715 , 60801755 , 82434070 , 82433859 , 82394418	
	2,0 i 20V		10.1999	12.2005	28.0461-0190.1	BAR101	Disco freno post.	60801753 , 60801390 , 16420.26100.01/00 , 46831042 , 46758715 , 60801755 , 82434070 , 82433859 , 82394418	



					<b>Descrizione</b>	<b>Codici OE - Codice ATE</b>	 <b>Pre-codice / varie</b>
--	--	--	--	--	--------------------	-----------------------------------	-------------------------------

## LANCIA

LYBRA (99-05)	2,4 20V		10.2001	12.2005	28.0461-0190.1	BAR101	Disco freno post.	60801753 , 60801390 , 16420.26100.01/00 , 46831042 , 46758715 , 60801755 , 82434070 , 82433859 , 82394418	
	2,4 JTD		10.1999	12.2005	28.0461-0190.1	BAR101	Disco freno post.	60801753 , 60801390 , 16420.26100.01/00 , 46831042 , 46758715 , 60801755 , 82434070 , 82433859 , 82394418	
YPSILON / Chrysler Ypsilon (11-)	0,9		12.2013		03.0521-0620.3	690111	Topkit Originale Ate posteriori		
	0,9 Twinair		05.2011		03.0521-0620.3	690111	Topkit Originale Ate posteriori		
	1,2		05.2011		03.0521-0620.3	690111	Topkit Originale Ate posteriori		
	1,2 Bifuel		04.2015		03.0521-0620.3	690111	Topkit Originale Ate posteriori		
			05.2011		03.0521-0620.3	690111	Topkit Originale Ate posteriori		
	1,3 D Multijet		05.2011		03.0521-0620.3	690111	Topkit Originale Ate posteriori		
			06.2016		03.0521-0620.3	690111	Topkit Originale Ate posteriori		



Descrizione

Codici OE -  
Codice ATE

Pre-codice / varie

**LAND ROVER**

RANGE ROVER EVOQUE (SAL) (11-)	2,0 16V 4x4		06.2011		28.0461-1145.1	BAR111	Disco freno post.	LR027123 , 6G91-2A315-BA , 1385590 , 1405500 , 1379931	
	2,0 eD4		06.2015		28.0461-1145.1	BAR111	Disco freno post.	LR027123 , 6G91-2A315-BA , 1385590 , 1405500 , 1379931	
	2,0 TD4 4x4		05.2015		28.0461-1145.1	BAR111	Disco freno post.	LR027123 , 6G91-2A315-BA , 1385590 , 1405500 , 1379931	
			06.2015		28.0461-1145.1	BAR111	Disco freno post.	LR027123 , 6G91-2A315-BA , 1385590 , 1405500 , 1379931	
	2,2 eD4		06.2011		28.0461-1145.1	BAR111	Disco freno post.	LR027123 , 6G91-2A315-BA , 1385590 , 1405500 , 1379931	
	2,2 SD4 4x4		06.2011		28.0461-1145.1	BAR111	Disco freno post.	LR027123 , 6G91-2A315-BA , 1385590 , 1405500 , 1379931	
	2,2 TD4 4x4		06.2011		28.0461-1145.1	BAR111	Disco freno post.	LR027123 , 6G91-2A315-BA , 1385590 , 1405500 , 1379931	
RANGE ROVER EVOQUE Cabriolet (16-)	2,0 16V 4x4		02.2016		28.0461-1145.1	BAR111	Disco freno post.	LR027123 , 6G91-2A315-BA , 1385590 , 1405500 , 1379931	
	2,0 TD4 4x4		02.2016		28.0461-1145.1	BAR111	Disco freno post.	LR027123 , 6G91-2A315-BA , 1385590 , 1405500 , 1379931	

**LEXUS**

GX 470 (URJ15) (09-)	4,7 V8		01.2010		24.0132-0174.1	432174	Discofreno ant.	43512-60190	
			11.2009		24.0132-0174.1	432174	Discofreno ant.	43512-60190	



Descrizione

Codici OE -  
Codice ATE

Pre-codice / varie

## MINI

F54 Clubman (15-)	Cooper		07.2015		13.0460-7315.2	607315	Serie pastialie posteriori	34 21 6 859 917	v. foto
			07.2015		13.0470-7315.2	LD7315	Serie pastialie posteriori	34 21 6 859 917	
	Cooper D		07.2015		13.0460-7315.2	607315	Serie pastialie posteriori	34 21 6 859 917	v. foto
			07.2015		13.0470-7315.2	LD7315	Serie pastialie posteriori	34 21 6 859 917	
	Cooper S		07.2015		13.0460-7315.2	607315	Serie pastialie posteriori	34 21 6 859 917	v. foto
			07.2015		13.0470-7315.2	LD7315	Serie pastialie posteriori	34 21 6 859 917	
	Cooper SD		11.2015		13.0460-7315.2	607315	Serie pastialie posteriori	34 21 6 859 917	v. foto
			11.2015		13.0470-7315.2	LD7315	Serie pastialie posteriori	34 21 6 859 917	
	Cooper SDX All4		01.2016		13.0460-7315.2	607315	Serie pastialie posteriori	34 21 6 859 917	v. foto
			01.2016		13.0470-7315.2	LD7315	Serie pastialie posteriori	34 21 6 859 917	
	Cooper SX All4		01.2016		13.0460-7315.2	607315	Serie pastialie posteriori	34 21 6 859 917	v. foto
			01.2016		13.0470-7315.2	LD7315	Serie pastialie posteriori	34 21 6 859 917	
	John Cooper Works		11.2015		13.0460-7315.2	607315	Serie pastialie posteriori	34 21 6 859 917	v. foto
			11.2015		13.0470-7315.2	LD7315	Serie pastialie posteriori	34 21 6 859 917	
	One		11.2015		13.0460-7315.2	607315	Serie pastialie posteriori	34 21 6 859 917	v. foto
			11.2015		13.0470-7315.2	LD7315	Serie pastialie posteriori	34 21 6 859 917	
	One D		11.2015		13.0460-7315.2	607315	Serie pastialie posteriori	34 21 6 859 917	v. foto
			11.2015		13.0470-7315.2	LD7315	Serie pastialie posteriori	34 21 6 859 917	
F60 Countryman (17-)	Cooper		10.2016		13.0460-7315.2	607315	Serie pastialie posteriori	34 21 6 859 917	v. foto
			10.2016		13.0470-7315.2	LD7315	Serie pastialie posteriori	34 21 6 859 917	
	Cooper All4		10.2016		13.0460-7315.2	607315	Serie pastialie posteriori	34 21 6 859 917	v. foto



					Descrizione	Codici OE - Codice ATE		Pre-codice / varie
--	--	--	--	--	-------------	---------------------------	--	--------------------

**MINI**

F60 Countryman (17-)	Cooper All4		10.2016		13.0470-7315.2	LD7315	Serie pastiglie posteriori	34 21 6 859 917	
	Cooper D		10.2016		13.0460-7315.2	607315	Serie pastiglie posteriori	34 21 6 859 917	v. foto
			10.2016		13.0470-7315.2	LD7315	Serie pastiglie posteriori	34 21 6 859 917	
	Cooper D All4		10.2016		13.0460-7315.2	607315	Serie pastiglie posteriori	34 21 6 859 917	v. foto
			10.2016		13.0470-7315.2	LD7315	Serie pastiglie posteriori	34 21 6 859 917	
	Cooper S		10.2016		13.0460-7315.2	607315	Serie pastiglie posteriori	34 21 6 859 917	v. foto
			10.2016		13.0470-7315.2	LD7315	Serie pastiglie posteriori	34 21 6 859 917	
	Cooper S All4		10.2016		13.0460-7315.2	607315	Serie pastiglie posteriori	34 21 6 859 917	v. foto
			10.2016		13.0470-7315.2	LD7315	Serie pastiglie posteriori	34 21 6 859 917	
	Cooper SD		10.2016		13.0460-7315.2	607315	Serie pastiglie posteriori	34 21 6 859 917	v. foto
			10.2016		13.0470-7315.2	LD7315	Serie pastiglie posteriori	34 21 6 859 917	
	Cooper SD All4		10.2016		13.0460-7315.2	607315	Serie pastiglie posteriori	34 21 6 859 917	v. foto
			10.2016		13.0470-7315.2	LD7315	Serie pastiglie posteriori	34 21 6 859 917	





Descrizione

Codici OE -  
Codice ATE

Pre-codice / varie

## NISSAN

ALMERA (N16) (00-06)	1,5 dCi		01.2003	11.2006	28.0462-2179.1	BAR221	Discofreno ant.	40206-2F501 , 40206-55F03 , 40206-55F01 , 40206-2F500	
	1,5 i		02.2000	11.2006	28.0462-2179.1	BAR221	Discofreno ant.	40206-2F501 , 40206-55F03 , 40206-55F01 , 40206-2F500	
			10.2002	11.2006	28.0462-2179.1	BAR221	Discofreno ant.	40206-2F501 , 40206-55F03 , 40206-55F01 , 40206-2F500	
			03.2000	03.2001	28.0462-2179.1	BAR221	Discofreno ant.	40206-2F501 , 40206-55F03 , 40206-55F01 , 40206-2F500	
	1,8 i		10.2002	11.2006	28.0462-2179.1	BAR221	Discofreno ant.	40206-2F501 , 40206-55F03 , 40206-55F01 , 40206-2F500	
			03.2000	03.2001	28.0462-2179.1	BAR221	Discofreno ant.	40206-2F501 , 40206-55F03 , 40206-55F01 , 40206-2F500	
			02.2000	11.2006	28.0462-2179.1	BAR221	Discofreno ant.	40206-2F501 , 40206-55F03 , 40206-55F01 , 40206-2F500	
	2,2 dCi		09.2003	11.2006	28.0462-2179.1	BAR221	Discofreno ant.	40206-2F501 , 40206-55F03 , 40206-55F01 , 40206-2F500	
	2,2 Di		03.2000	03.2001	28.0462-2179.1	BAR221	Discofreno ant.	40206-2F501 , 40206-55F03 , 40206-55F01 , 40206-2F500	
			02.2000	11.2006	28.0462-2179.1	BAR221	Discofreno ant.	40206-2F501 , 40206-55F03 , 40206-55F01 , 40206-2F500	
LEAF (EM61) (10-)	Electric		11.2010		24.0128-0268.1	428268	Discofreno ant.	40206-3NLOA , 40206-3NA0A	
NV 200 (M20) Kasten (10-)	e-NV		05.2014		24.0128-0268.1	428268	Discofreno ant.	40206-3NLOA , 40206-3NA0A	
NV 200 EVALIA (M20) Bus (10-)			07.2014		24.0128-0268.1	428268	Discofreno ant.	40206-3NLOA , 40206-3NA0A	
PRIMERA (P11E) Berlina (96-02)	1,6 i 16V		06.1999	02.2002	28.0462-2179.1	BAR221	Discofreno ant.	40206-2F501 , 40206-55F03 , 40206-55F01 , 40206-2F500	
	1,8 i 16V		06.1999	02.2002	28.0462-2179.1	BAR221	Discofreno ant.	40206-2F501 , 40206-55F03 , 40206-55F01 , 40206-2F500	



Descrizione

Codici OE -  
Codice ATE

Pre-codice / varie

## NISSAN

PRIMERA (P11E) Berlina (96-02)	2,0 i 16V		06.1996	02.2002	28.0462-2179.1	BAR221	Discofreno ant.	40206-2F501 , 40206-55F03 , 40206-55F01 , 40206-2F500	
			06.1999	02.2002	28.0462-2179.1	BAR221	Discofreno ant.	40206-2F501 , 40206-55F03 , 40206-55F01 , 40206-2F500	
	2,0 TD		06.1999	02.2002	28.0462-2179.1	BAR221	Discofreno ant.	40206-2F501 , 40206-55F03 , 40206-55F01 , 40206-2F500	
PRIMERA (W11) Station Wagon (98-02)	1,6 i 16V		04.1998	02.2002	28.0462-2179.1	BAR221	Discofreno ant.	40206-2F501 , 40206-55F03 , 40206-55F01 , 40206-2F500	
	1,8 i 16V		08.1999	02.2002	28.0462-2179.1	BAR221	Discofreno ant.	40206-2F501 , 40206-55F03 , 40206-55F01 , 40206-2F500	
	2,0 i 16V		08.1999	02.2002	28.0462-2179.1	BAR221	Discofreno ant.	40206-2F501 , 40206-55F03 , 40206-55F01 , 40206-2F500	
			04.1998	02.2002	28.0462-2179.1	BAR221	Discofreno ant.	40206-2F501 , 40206-55F03 , 40206-55F01 , 40206-2F500	
	2,0 TD		04.1998	02.2002	28.0462-2179.1	BAR221	Discofreno ant.	40206-2F501 , 40206-55F03 , 40206-55F01 , 40206-2F500	



Descrizione

Codici OE -  
Codice ATE

Pre-codice / varie

## OPEL

AGILA / Vauxhall Agila Mk I (00-07)	1			07.2007	28.0461-7106.1	BAR171	Discofreno ant.	55311-84E01 , 55311-86G02 , 5531186G02 , 47 07 288 , 93179462 , 93176389 , 47 06 749	
	1,0 12V			07.2007	28.0461-7106.1	BAR171	Discofreno ant.	55311-84E01 , 55311-86G02 , 5531186G02 , 47 07 288 , 93179462 , 93176389 , 47 06 749	
	1,2 16V			07.2007	28.0461-7106.1	BAR171	Discofreno ant.	55311-84E01 , 55311-86G02 , 5531186G02 , 47 07 288 , 93179462 , 93176389 , 47 06 749	
	1,2 16V Twinport			07.2007	28.0461-7106.1	BAR171	Discofreno ant.	55311-84E01 , 55311-86G02 , 5531186G02 , 47 07 288 , 93179462 , 93176389 , 47 06 749	
	1,3 CDTI			07.2007	28.0461-7106.1	BAR171	Discofreno ant.	55311-84E01 , 55311-86G02 , 5531186G02 , 47 07 288 , 93179462 , 93176389 , 47 06 749	
AGILA / Vauxhall Agila Mk II (08-)	1		01.2008		28.0462-0211.1	BAR202	Discofreno ant.	55311-62J00 , 95513700 , 93194988 , 47 00 455 , 47 10 944 , 93192978 , 47 08 241	
			07.2011		28.0462-0211.1	BAR202	Discofreno ant.	55311-62J00 , 95513700 , 93194988 , 47 00 455 , 47 10 944 , 93192978 , 47 08 241	
	1,2		01.2008		28.0462-0211.1	BAR202	Discofreno ant.	55311-62J00 , 95513700 , 93194988 , 47 00 455 , 47 10 944 , 93192978 , 47 08 241	
			11.2010		28.0462-0211.1	BAR202	Discofreno ant.	55311-62J00 , 95513700 , 93194988 , 47 00 455 , 47 10 944 , 93192978 , 47 08 241	



Descrizione

Codici OE -  
Codice ATE

Pre-codice / varie

## OPEL

Modello	Cilindrata	Posizione	Data Inizio	Data Fine	Codice OE	Codice ATE	Descrizione	Codici OE - Codice ATE	Pre-codice / varie
AGILA / Vauxhall Agila Mk II (08-)	1,3 CDTI		01.2008		28.0462-0211.1	BAR202	Discofreno ant.	55311-62J00 , 95513700 , 93194988 , 47 00 455 , 47 10 944 , 93192978 , 47 08 241	
ASTRA H / GTC / Vauxhall Astra Mk V (04-10)	1,2	post.dx	08.2005	11.2010	24.3387-1702.5	240827	Pinza freno posteriore	93179159 , 5 42 106	
	1,3 CDTI	post.dx	08.2005	11.2010	24.3387-1702.5	240827	Pinza freno posteriore	93179159 , 5 42 106	
	1,4	post.dx	01.2004	11.2010	24.3387-1702.5	240827	Pinza freno posteriore	93179159 , 5 42 106	
	1,6	post.dx	01.2004	11.2010	24.3387-1702.5	240827	Pinza freno posteriore	93179159 , 5 42 106	
		post.dx	01.2007	11.2010	24.3387-1702.5	240827	Pinza freno posteriore	93179159 , 5 42 106	
	1,6 Turbo	post.dx	01.2007	11.2010	24.3387-1702.5	240827	Pinza freno posteriore	93179159 , 5 42 106	
	1,7 CDTI	post.dx	04.2007	11.2010	24.3387-1702.5	240827	Pinza freno posteriore	93179159 , 5 42 106	
		post.dx	01.2004	11.2010	24.3387-1702.5	240827	Pinza freno posteriore	93179159 , 5 42 106	
	1,8	post.dx	01.2006	11.2010	24.3387-1702.5	240827	Pinza freno posteriore	93179159 , 5 42 106	
		post.dx	01.2004	11.2010	24.3387-1702.5	240827	Pinza freno posteriore	93179159 , 5 42 106	
	1,9 CDTI	post.dx	09.2005	11.2010	24.3387-1702.5	240827	Pinza freno posteriore	93179159 , 5 42 106	
		post.dx	09.2004	11.2010	24.3387-1702.5	240827	Pinza freno posteriore	93179159 , 5 42 106	
	2,0 Turbo	post.dx	09.2004	11.2010	24.3387-1702.5	240827	Pinza freno posteriore	93179159 , 5 42 106	
		post.dx	01.2004	11.2010	24.3387-1702.5	240827	Pinza freno posteriore	93179159 , 5 42 106	
ASTRA H Caravan/Vau. Astra MKV Estate (04-10)	1,2	post.dx	08.2005	11.2010	24.3387-1702.5	240827	Pinza freno posteriore	93179159 , 5 42 106	
	1,3 CDTI	post.dx	08.2005	11.2010	24.3387-1702.5	240827	Pinza freno posteriore	93179159 , 5 42 106	
	1,4	post.dx	08.2004	11.2010	24.3387-1702.5	240827	Pinza freno posteriore	93179159 , 5 42 106	
	1,6	post.dx	01.2007	11.2010	24.3387-1702.5	240827	Pinza freno posteriore	93179159 , 5 42 106	



Descrizione

Codici OE -  
Codice ATE

Pre-codice / varie

## OPEL

ASTRA H Caravan/Vau. Astra MKV Estate (04-10)	1,6	post.dx	08.2004	11.2010	24.3387-1702.5	240827	Pinza freno posteriore	93179159 , 5 42 106	
	1,6 LPG	post.dx	08.2009	11.2010	24.3387-1702.5	240827	Pinza freno posteriore	93179159 , 5 42 106	
	1,6 Turbo	post.dx	01.2007	11.2010	24.3387-1702.5	240827	Pinza freno posteriore	93179159 , 5 42 106	
	1,7 CDTI	post.dx	04.2007	11.2010	24.3387-1702.5	240827	Pinza freno posteriore	93179159 , 5 42 106	
		post.dx	08.2004	11.2010	24.3387-1702.5	240827	Pinza freno posteriore	93179159 , 5 42 106	
	1,7 TD	post.dx	08.2004	11.2010	24.3387-1702.5	240827	Pinza freno posteriore	93179159 , 5 42 106	
	1,8	post.dx	08.2005	11.2010	24.3387-1702.5	240827	Pinza freno posteriore	93179159 , 5 42 106	
		post.dx	09.2004	11.2010	24.3387-1702.5	240827	Pinza freno posteriore	93179159 , 5 42 106	
	1,9 CDTI	post.dx	08.2004	11.2010	24.3387-1702.5	240827	Pinza freno posteriore	93179159 , 5 42 106	
		post.dx	09.2004	11.2010	24.3387-1702.5	240827	Pinza freno posteriore	93179159 , 5 42 106	
		post.dx	09.2005	11.2010	24.3387-1702.5	240827	Pinza freno posteriore	93179159 , 5 42 106	
	2,0 Turbo	post.dx	08.2004	11.2010	24.3387-1702.5	240827	Pinza freno posteriore	93179159 , 5 42 106	
		post.dx	09.2004	11.2010	24.3387-1702.5	240827	Pinza freno posteriore	93179159 , 5 42 106	
ASTRA H TwinTop (06-10)	1,6	post.dx	03.2006	11.2010	24.3387-1702.5	240827	Pinza freno posteriore	93179159 , 5 42 106	
		post.dx	12.2006	11.2010	24.3387-1702.5	240827	Pinza freno posteriore	93179159 , 5 42 106	
	1,6 Turbo	post.dx	02.2007	11.2010	24.3387-1702.5	240827	Pinza freno posteriore	93179159 , 5 42 106	
	1,8	post.dx	03.2006	11.2010	24.3387-1702.5	240827	Pinza freno posteriore	93179159 , 5 42 106	
	1,9 CDTI	post.dx	03.2006	11.2010	24.3387-1702.5	240827	Pinza freno posteriore	93179159 , 5 42 106	
	2,0 Turbo	post.dx	03.2006	11.2010	24.3387-1702.5	240827	Pinza freno posteriore	93179159 , 5 42 106	
COMBO / Vauxhall Combo (01-11)	1,3 CDTI	post.dx	06.2003	10.2011	24.3387-1702.5	240827	Pinza freno posteriore	93179159 , 5 42 106	
	1,4 16V	post.dx	10.2001	10.2011	24.3387-1702.5	240827	Pinza freno posteriore	93179159 , 5 42 106	



Descrizione

Codici OE -  
Codice ATE

Pre-codice / varie

## OPEL

COMBO / Vauxhall Combo (01-11)	1,6	post.dx	10.2001	10.2011	24.3387-1702.5	240827	Pinza freno posteriore	93179159 , 5 42 106	
	1,6 CNG	post.dx	04.2005	10.2011	24.3387-1702.5	240827	Pinza freno posteriore	93179159 , 5 42 106	
	1,7 CDTI 16V	post.dx	06.2004	10.2011	24.3387-1702.5	240827	Pinza freno posteriore	93179159 , 5 42 106	
	1,7 DI 16V	post.dx	10.2001	10.2011	24.3387-1702.5	240827	Pinza freno posteriore	93179159 , 5 42 106	
	1,7 DTI 16V	post.dx	10.2001	10.2011	24.3387-1702.5	240827	Pinza freno posteriore	93179159 , 5 42 106	
COMBO D / Vauxhall Combo D (11-)	1,3 CDTi		03.2016		28.0462-2145.1	BAR221	Discofreno ant.	5 69 086 , 95511282 , 71711447 , 71711434 , 60815938 , 60813443 , 60801722 , 52015291 , 51996238 , 51990127 , 71739567 , 71739568 , 60699518 , 60578093 , 60658565 , 82427592 , 82450539 , 60622077 , 60571548 , 60569163	
			11.2011		28.0462-2145.1	BAR221	Discofreno ant.	5 69 086 , 95511282 , 71711447 , 71711434 , 60815938 , 60813443 , 60801722 , 52015291 , 51996238 , 51990127 , 71739567 , 71739568 , 60699518 , 60578093 , 60658565 , 82427592 , 82450539 , 60622077 , 60571548 , 60569163	
			03.2015		28.0462-2145.1	BAR221	Discofreno ant.	5 69 086 , 95511282 , 71711447 , 71711434 , 60815938 , 60813443 , 60801722 , 52015291 , 51996238 , 51990127 , 71739567 , 71739568 , 60699518 , 60578093 , 60658565 , 82427592 , 82450539 , 60622077 , 60571548 , 60569163	



Descrizione

Codici OE -  
Codice ATE

Pre-codice / varie

## OPEL

COMBO D / Vauxhall Combo D (11-)	1,4		11.2011		28.0462-2145.1	BAR221	Discofreno ant.	5 69 086 , 95511282 , 71711447 , 71711434 , 60815938 , 60813443 , 60801722 , 52015291 , 51996238 , 51990127 , 71739567 , 71739568 , 60699518 , 60578093 , 60658565 , 82427592 , 82450539 , 60622077 , 60571548 , 60569163	
	1,4 CNG		11.2011		28.0462-2145.1	BAR221	Discofreno ant.	5 69 086 , 95511282 , 71711447 , 71711434 , 60815938 , 60813443 , 60801722 , 52015291 , 51996238 , 51990127 , 71739567 , 71739568 , 60699518 , 60578093 , 60658565 , 82427592 , 82450539 , 60622077 , 60571548 , 60569163	
	1,6 CDTi		03.2015		28.0462-2145.1	BAR221	Discofreno ant.	5 69 086 , 95511282 , 71711447 , 71711434 , 60815938 , 60813443 , 60801722 , 52015291 , 51996238 , 51990127 , 71739567 , 71739568 , 60699518 , 60578093 , 60658565 , 82427592 , 82450539 , 60622077 , 60571548 , 60569163	
			11.2011		28.0462-2145.1	BAR221	Discofreno ant.	5 69 086 , 95511282 , 71711447 , 71711434 , 60815938 , 60813443 , 60801722 , 52015291 , 51996238 , 51990127 , 71739567 , 71739568 , 60699518 , 60578093 , 60658565 , 82427592 , 82450539 , 60622077 , 60571548 , 60569163	



Descrizione

Codici OE -  
Codice ATE

Pre-codice / varie

## OPEL

COMBO D / Vauxhall Combo D (11-)	2,0 CDTi		11.2011		28.0462-2145.1	BAR221	Discofreno ant.	5 69 086 , 95511282 , 71711447 , 71711434 , 60815938 , 60813443 , 60801722 , 52015291 , 51996238 , 51990127 , 71739567 , 71739568 , 60699518 , 60578093 , 60658565 , 82427592 , 82450539 , 60622077 , 60571548 , 60569163	
MERIVA A / Vauxhall Meriva Mk I (03-10)	1,3 CDTi	post.dx	04.2005	05.2010	24.3387-1702.5	240827	Pinza freno posteriore	93179159 , 5 42 106	
		post.dx	09.2003	05.2010	24.3387-1702.5	240827	Pinza freno posteriore	93179159 , 5 42 106	
	1,4 16V	post.dx	07.2004	05.2010	24.3387-1702.5	240827	Pinza freno posteriore	93179159 , 5 42 106	
	1,4 LPG	post.dx	07.2004	05.2010	24.3387-1702.5	240827	Pinza freno posteriore	93179159 , 5 42 106	
	1,6	post.dx	01.2006	05.2010	24.3387-1702.5	240827	Pinza freno posteriore	93179159 , 5 42 106	
	1,6 16V	post.dx		05.2010	24.3387-1702.5	240827	Pinza freno posteriore	93179159 , 5 42 106	
	1,7 CDTi	post.dx		05.2010	24.3387-1702.5	240827	Pinza freno posteriore	93179159 , 5 42 106	
		post.dx	09.2006	05.2010	24.3387-1702.5	240827	Pinza freno posteriore	93179159 , 5 42 106	
	1,7 DTI	post.dx		05.2010	24.3387-1702.5	240827	Pinza freno posteriore	93179159 , 5 42 106	
	1,7 DTI 16V	post.dx		05.2010	24.3387-1702.5	240827	Pinza freno posteriore	93179159 , 5 42 106	
	1,8 16V	post.dx		05.2010	24.3387-1702.5	240827	Pinza freno posteriore	93179159 , 5 42 106	





Descrizione

Codici OE -  
Codice ATE

Pre-codice / varie

## PEUGEOT

107 (05-14)	1		06.2005	05.2014	28.0462-0180.1	BAR201	Discofreno ant.	43512-0H020 , 43512-0H010 , 4249 94 , 4249 54 , 4246 F0 , 4249 55 , 4246 J0	
	1,4 HDi		06.2005	05.2014	28.0462-0180.1	BAR201	Discofreno ant.	43512-0H020 , 43512-0H010 , 4249 94 , 4249 54 , 4246 F0 , 4249 55 , 4246 J0	
108 (14-)	1,0 68 VTi		05.2014		28.0462-0180.1	BAR201	Discofreno ant.	43512-0H020 , 43512-0H010 , 4249 94 , 4249 54 , 4246 F0 , 4249 55 , 4246 J0	
	1,2 82 VTi		05.2014		28.0462-0180.1	BAR201	Discofreno ant.	43512-0H020 , 43512-0H010 , 4249 94 , 4249 54 , 4246 F0 , 4249 55 , 4246 J0	
508 SW (10-)	2,0 HDi 180		04.2014		24.0112-0216.1	412216	Disco freno post.	96 839 932 80	

## RENAULT

MASTER II Bus (JD_) (06-10)	2,5 dCi		08.2006	12.2010	24.5134-0469.3	331479	Tubo flessibile anteriore	82 00 673 552	
MASTER II Kasten (FD_) (06-10)			08.2006	12.2010	24.5134-0469.3	331479	Tubo flessibile anteriore	82 00 673 552	
MASTER II Pritsche/Fahrgestell (ED/HD/UD_) (06-10)			08.2006	12.2010	24.5134-0469.3	331479	Tubo flessibile anteriore	82 00 673 552	



Descrizione

Codici OE -  
Codice ATE

Pre-codice / varie

## SEAT

ALTEA (5P1) (04-15)	1,2 TSI	post.sx	04.2010		24.3414-1709.5	240834	Pinza freno posteriore	1K0 615 423 M , 1K0 615 423 H , 1K0 615 423 C , 1K0 615 423	24.3414-1709.7
		post.dx	04.2010		24.3414-1710.5	240835	Pinza freno posteriore	1K0 615 424 M , 1K0 615 424 H , 1K0 615 424 C , 1K0 615 424	24.3414-1710.7-
	1,4 i 16V	post.dx	05.2006		24.3414-1710.5	240835	Pinza freno posteriore	1K0 615 424 M , 1K0 615 424 H , 1K0 615 424 C , 1K0 615 424	24.3414-1710.7-
		post.sx	05.2006		24.3414-1709.5	240834	Pinza freno posteriore	1K0 615 423 M , 1K0 615 423 H , 1K0 615 423 C , 1K0 615 423	24.3414-1709.7
	1,4 TSI	post.sx	11.2007		24.3414-1709.5	240834	Pinza freno posteriore	1K0 615 423 M , 1K0 615 423 H , 1K0 615 423 C , 1K0 615 423	24.3414-1709.7
		post.dx	11.2007		24.3414-1710.5	240835	Pinza freno posteriore	1K0 615 424 M , 1K0 615 424 H , 1K0 615 424 C , 1K0 615 424	24.3414-1710.7-
	1,6 i 16V	post.sx	03.2004		24.3414-1709.5	240834	Pinza freno posteriore	1K0 615 423 M , 1K0 615 423 H , 1K0 615 423 C , 1K0 615 423	24.3414-1709.7
		post.dx	03.2004		24.3414-1710.5	240835	Pinza freno posteriore	1K0 615 424 M , 1K0 615 424 H , 1K0 615 424 C , 1K0 615 424	24.3414-1710.7-
	1,6 LPG	post.sx	09.2009		24.3414-1709.5	240834	Pinza freno posteriore	1K0 615 423 M , 1K0 615 423 H , 1K0 615 423 C , 1K0 615 423	24.3414-1709.7
		post.dx	09.2009		24.3414-1710.5	240835	Pinza freno posteriore	1K0 615 424 M , 1K0 615 424 H , 1K0 615 424 C , 1K0 615 424	24.3414-1710.7-
	1,6 TDI	post.dx	10.2009		24.3414-1710.5	240835	Pinza freno posteriore	1K0 615 424 M , 1K0 615 424 H , 1K0 615 424 C , 1K0 615 424	24.3414-1710.7-



Descrizione

Codici OE -  
Codice ATE

Pre-codice / varie

## SEAT

ALTEA (5P1) (04-15)	1,6 TDI	post.sx	10.2009		24.3414-1709.5	240834	Pinza freno posteriore	1K0 615 423 M , 1K0 615 423 H , 1K0 615 423 C , 1K0 615 423	24.3414-1709.7
	1,8 TFSI	post.dx	01.2007		24.3414-1710.5	240835	Pinza freno posteriore	1K0 615 424 M , 1K0 615 424 H , 1K0 615 424 C , 1K0 615 424	24.3414-1710.7-
		post.sx	01.2007		24.3414-1709.5	240834	Pinza freno posteriore	1K0 615 423 M , 1K0 615 423 H , 1K0 615 423 C , 1K0 615 423	24.3414-1709.7
	1,9 TDI	post.dx	03.2004		24.3414-1710.5	240835	Pinza freno posteriore	1K0 615 424 M , 1K0 615 424 H , 1K0 615 424 C , 1K0 615 424	24.3414-1710.7-
		post.sx	03.2004		24.3414-1709.5	240834	Pinza freno posteriore	1K0 615 423 M , 1K0 615 423 H , 1K0 615 423 C , 1K0 615 423	24.3414-1709.7
	2,0 FSI	post.dx	03.2004		24.3414-1710.5	240835	Pinza freno posteriore	1K0 615 424 M , 1K0 615 424 H , 1K0 615 424 C , 1K0 615 424	24.3414-1710.7-
		post.sx	03.2004		24.3414-1709.5	240834	Pinza freno posteriore	1K0 615 423 M , 1K0 615 423 H , 1K0 615 423 C , 1K0 615 423	24.3414-1709.7
	2,0 TDI	post.dx	03.2004		24.3414-1710.5	240835	Pinza freno posteriore	1K0 615 424 M , 1K0 615 424 H , 1K0 615 424 C , 1K0 615 424	24.3414-1710.7-
		post.dx	03.2006		24.3414-1710.5	240835	Pinza freno posteriore	1K0 615 424 M , 1K0 615 424 H , 1K0 615 424 C , 1K0 615 424	24.3414-1710.7-
		post.sx	03.2006		24.3414-1709.5	240834	Pinza freno posteriore	1K0 615 423 M , 1K0 615 423 H , 1K0 615 423 C , 1K0 615 423	24.3414-1709.7
		post.sx	03.2004		24.3414-1709.5	240834	Pinza freno posteriore	1K0 615 423 M , 1K0 615 423 H , 1K0 615 423 C , 1K0 615 423	24.3414-1709.7



Descrizione

Codici OE -  
Codice ATE

Pre-codice / varie

## SEAT

ALTEA (5P1) (04-15)	2,0 TFSI	post.dx	03.2006		24.3414-1710.5	240835	Pinza freno posteriore	1K0 615 424 M , 1K0 615 424 H , 1K0 615 424 C , 1K0 615 424	24.3414-1710.7-
		post.sx	03.2006		24.3414-1709.5	240834	Pinza freno posteriore	1K0 615 423 M , 1K0 615 423 H , 1K0 615 423 C , 1K0 615 423	24.3414-1709.7
CORDOBA III (6L2) (02-09)	1,2 i	post.dx	10.2002	06.2009	24.3344-1710.5	240811	Pinza freno posteriore	6Q0 615 424 B , 6Q0 615 424 A	
	1,4 i 16V	post.dx	10.2002	06.2009	24.3344-1710.5	240811	Pinza freno posteriore	6Q0 615 424 B , 6Q0 615 424 A	
	1,4 TDI	post.dx	10.2002	06.2009	24.3344-1710.5	240811	Pinza freno posteriore	6Q0 615 424 B , 6Q0 615 424 A	
	1,6 i 16V	post.dx	02.2003	06.2009	24.3344-1710.5	240811	Pinza freno posteriore	6Q0 615 424 B , 6Q0 615 424 A	
	1,9 SDI	post.dx	10.2002	06.2009	24.3344-1710.5	240811	Pinza freno posteriore	6Q0 615 424 B , 6Q0 615 424 A	
	1,9 TDI	post.dx	10.2002	06.2009	24.3344-1710.5	240811	Pinza freno posteriore	6Q0 615 424 B , 6Q0 615 424 A	
	2,0 i 16V	post.dx	10.2002	06.2009	24.3344-1710.5	240811	Pinza freno posteriore	6Q0 615 424 B , 6Q0 615 424 A	
IBIZA IV (6L1) (02-10)	1,2	post.dx	06.2007	05.2008	24.3344-1710.5	240811	Pinza freno posteriore	6Q0 615 424 B , 6Q0 615 424 A	
	1,2 i	post.dx	02.2002	02.2010	24.3344-1710.5	240811	Pinza freno posteriore	6Q0 615 424 B , 6Q0 615 424 A	
	1,2 i 12V	post.dx	05.2006	02.2010	24.3344-1710.5	240811	Pinza freno posteriore	6Q0 615 424 B , 6Q0 615 424 A	
	1,4 i 16V	post.dx	02.2002	02.2010	24.3344-1710.5	240811	Pinza freno posteriore	6Q0 615 424 B , 6Q0 615 424 A	
		post.dx	05.2006	02.2010	24.3344-1710.5	240811	Pinza freno posteriore	6Q0 615 424 B , 6Q0 615 424 A	



Descrizione

Codici OE -  
Codice ATE

Pre-codice / varie

## SEAT

IBIZA IV (6L1) (02-10)	1,4 TDI	post.dx	05.2005	02.2010	24.3344-1710.5	240811	Pinza freno posteriore	6Q0 615 424 B , 6Q0 615 424 A	
		post.dx	02.2002	02.2010	24.3344-1710.5	240811	Pinza freno posteriore	6Q0 615 424 B , 6Q0 615 424 A	
	1,6 i 16V	post.dx	02.2003	02.2010	24.3344-1710.5	240811	Pinza freno posteriore	6Q0 615 424 B , 6Q0 615 424 A	
	1,8 T Cupra R	post.dx	01.2004	02.2010	24.3344-1710.5	240811	Pinza freno posteriore	6Q0 615 424 B , 6Q0 615 424 A	
	1,8 T FR	post.dx	12.2003	02.2010	24.3344-1710.5	240811	Pinza freno posteriore	6Q0 615 424 B , 6Q0 615 424 A	
	1,9 SDI	post.dx	02.2002	02.2010	24.3344-1710.5	240811	Pinza freno posteriore	6Q0 615 424 B , 6Q0 615 424 A	
	1,9 TDI	post.dx	02.2002	02.2010	24.3344-1710.5	240811	Pinza freno posteriore	6Q0 615 424 B , 6Q0 615 424 A	
	1,9 TDI Cupra R	post.dx	03.2004	02.2008	24.3344-1710.5	240811	Pinza freno posteriore	6Q0 615 424 B , 6Q0 615 424 A	
	2	post.dx	04.2002	02.2010	24.3344-1710.5	240811	Pinza freno posteriore	6Q0 615 424 B , 6Q0 615 424 A	
IBIZA V (6J/6P) / ST / SC (08-17)	1,4 TSI	post.dx	06.2009		24.3344-1710.5	240811	Pinza freno posteriore	6Q0 615 424 B , 6Q0 615 424 A	
	1,4 TSI FR	post.dx	12.2013		24.3344-1710.5	240811	Pinza freno posteriore	6Q0 615 424 B , 6Q0 615 424 A	
LEON II (1P1) (05-12)	1,2 TSI	post.dx	02.2010	10.2012	24.3414-1710.5	240835	Pinza freno posteriore	1K0 615 424 M , 1K0 615 424 H , 1K0 615 424 C , 1K0 615 424	24.3414-1710.7-
		post.sx	02.2010	10.2012	24.3414-1709.5	240834	Pinza freno posteriore	1K0 615 423 M , 1K0 615 423 H , 1K0 615 423 C , 1K0 615 423	24.3414-1709.7



Descrizione

Codici OE -  
Codice ATE

Pre-codice / varie

## SEAT

LEON II (1P1) (05-12)	1,4 i 16V	post.dx	06.2006	10.2012	24.3414-1710.5	240835	Pinza freno posteriore	1K0 615 424 M , 1K0 615 424 H , 1K0 615 424 C , 1K0 615 424	24.3414-1710.7-
		post.sx	06.2006	10.2012	24.3414-1709.5	240834	Pinza freno posteriore	1K0 615 423 M , 1K0 615 423 H , 1K0 615 423 C , 1K0 615 423	24.3414-1709.7
	1,4 TSI	post.sx	11.2007	10.2012	24.3414-1709.5	240834	Pinza freno posteriore	1K0 615 423 M , 1K0 615 423 H , 1K0 615 423 C , 1K0 615 423	24.3414-1709.7
		post.dx	11.2007	10.2012	24.3414-1710.5	240835	Pinza freno posteriore	1K0 615 424 M , 1K0 615 424 H , 1K0 615 424 C , 1K0 615 424	24.3414-1710.7-
	1,6 i	post.sx	08.2005	10.2012	24.3414-1709.5	240834	Pinza freno posteriore	1K0 615 423 M , 1K0 615 423 H , 1K0 615 423 C , 1K0 615 423	24.3414-1709.7
		post.dx	08.2005	10.2012	24.3414-1710.5	240835	Pinza freno posteriore	1K0 615 424 M , 1K0 615 424 H , 1K0 615 424 C , 1K0 615 424	24.3414-1710.7-
	1,6 LPG / Multifuel	post.dx	12.2009	10.2012	24.3414-1710.5	240835	Pinza freno posteriore	1K0 615 424 M , 1K0 615 424 H , 1K0 615 424 C , 1K0 615 424	24.3414-1710.7-
		post.sx	12.2009	10.2012	24.3414-1709.5	240834	Pinza freno posteriore	1K0 615 423 M , 1K0 615 423 H , 1K0 615 423 C , 1K0 615 423	24.3414-1709.7
	1,6 TDI	post.dx	11.2010	10.2012	24.3414-1710.5	240835	Pinza freno posteriore	1K0 615 424 M , 1K0 615 424 H , 1K0 615 424 C , 1K0 615 424	24.3414-1710.7-
		post.sx	11.2010	10.2012	24.3414-1709.5	240834	Pinza freno posteriore	1K0 615 423 M , 1K0 615 423 H , 1K0 615 423 C , 1K0 615 423	24.3414-1709.7
	1,6 TDI Ecomotive	post.dx	02.2010	10.2012	24.3414-1710.5	240835	Pinza freno posteriore	1K0 615 424 M , 1K0 615 424 H , 1K0 615 424 C , 1K0 615 424	24.3414-1710.7-



Descrizione

Codici OE -  
Codice ATE

Pre-codice / varie

## SEAT

LEON II (1P1) (05-12)	1,6 TDI Ecomotive	post.sx	02.2010	10.2012	24.3414-1709.5	240834	Pinza freno posteriore	1K0 615 423 M , 1K0 615 423 H , 1K0 615 423 C , 1K0 615 423	24.3414-1709.7
	1,8 TSI	post.dx	06.2007	10.2012	24.3414-1710.5	240835	Pinza freno posteriore	1K0 615 424 M , 1K0 615 424 H , 1K0 615 424 C , 1K0 615 424	24.3414-1710.7-
		post.sx	06.2007	10.2012	24.3414-1709.5	240834	Pinza freno posteriore	1K0 615 423 M , 1K0 615 423 H , 1K0 615 423 C , 1K0 615 423	24.3414-1709.7
	1,9 TDI	post.dx	08.2005	10.2012	24.3414-1710.5	240835	Pinza freno posteriore	1K0 615 424 M , 1K0 615 424 H , 1K0 615 424 C , 1K0 615 424	24.3414-1710.7-
		post.sx	08.2005	10.2012	24.3414-1709.5	240834	Pinza freno posteriore	1K0 615 423 M , 1K0 615 423 H , 1K0 615 423 C , 1K0 615 423	24.3414-1709.7
	2,0 Cupra R	post.sx	11.2006	10.2012	24.3414-1709.5	240834	Pinza freno posteriore	1K0 615 423 M , 1K0 615 423 H , 1K0 615 423 C , 1K0 615 423	24.3414-1709.7
		post.dx	11.2006	10.2012	24.3414-1710.5	240835	Pinza freno posteriore	1K0 615 424 M , 1K0 615 424 H , 1K0 615 424 C , 1K0 615 424	24.3414-1710.7-
	2,0 FSI	post.dx	08.2005	10.2012	24.3414-1710.5	240835	Pinza freno posteriore	1K0 615 424 M , 1K0 615 424 H , 1K0 615 424 C , 1K0 615 424	24.3414-1710.7-
		post.sx	08.2005	10.2012	24.3414-1709.5	240834	Pinza freno posteriore	1K0 615 423 M , 1K0 615 423 H , 1K0 615 423 C , 1K0 615 423	24.3414-1709.7
	2,0 TDI	post.dx	02.2006	10.2012	24.3414-1710.5	240835	Pinza freno posteriore	1K0 615 424 M , 1K0 615 424 H , 1K0 615 424 C , 1K0 615 424	24.3414-1710.7-
		post.dx	08.2005	10.2012	24.3414-1710.5	240835	Pinza freno posteriore	1K0 615 424 M , 1K0 615 424 H , 1K0 615 424 C , 1K0 615 424	24.3414-1710.7-



Descrizione

Codici OE -  
Codice ATE

Pre-codice / varie

## SEAT

LEON II (1P1) (05-12)	2,0 TDI	post.sx	02.2006	10.2012	24.3414-1709.5	240834	Pinza freno posteriore	1K0 615 423 M , 1K0 615 423 H , 1K0 615 423 C , 1K0 615 423	24.3414-1709.7
		post.sx	08.2005	10.2012	24.3414-1709.5	240834	Pinza freno posteriore	1K0 615 423 M , 1K0 615 423 H , 1K0 615 423 C , 1K0 615 423	24.3414-1709.7
	2,0 TFSI	post.dx	09.2005	10.2012	24.3414-1710.5	240835	Pinza freno posteriore	1K0 615 424 M , 1K0 615 424 H , 1K0 615 424 C , 1K0 615 424	24.3414-1710.7-
		post.dx	08.2005	10.2012	24.3414-1710.5	240835	Pinza freno posteriore	1K0 615 424 M , 1K0 615 424 H , 1K0 615 424 C , 1K0 615 424	24.3414-1710.7-
		post.dx	11.2006	10.2012	24.3414-1710.5	240835	Pinza freno posteriore	1K0 615 424 M , 1K0 615 424 H , 1K0 615 424 C , 1K0 615 424	24.3414-1710.7-
		post.sx	08.2005	10.2012	24.3414-1709.5	240834	Pinza freno posteriore	1K0 615 423 M , 1K0 615 423 H , 1K0 615 423 C , 1K0 615 423	24.3414-1709.7
		post.sx	09.2005	10.2012	24.3414-1709.5	240834	Pinza freno posteriore	1K0 615 423 M , 1K0 615 423 H , 1K0 615 423 C , 1K0 615 423	24.3414-1709.7
		post.sx	11.2006	10.2012	24.3414-1709.5	240834	Pinza freno posteriore	1K0 615 423 M , 1K0 615 423 H , 1K0 615 423 C , 1K0 615 423	24.3414-1709.7
LEON III (5F) / SC / ST (12-)	1,0 TSI	post.dx	05.2015		24.3384-1760.5	240801	Pinza freno posteriore	5Q0 615 424 A	
		post.sx	05.2015		24.3384-1759.5	240800	Pinza freno posteriore	5Q0 615 423 A	
	1,2 TSI	post.sx	04.2014		24.3384-1759.5	240800	Pinza freno posteriore	5Q0 615 423 A	
		post.dx	04.2014		24.3384-1760.5	240801	Pinza freno posteriore	5Q0 615 424 A	
		post.dx	09.2012		24.3384-1760.5	240801	Pinza freno posteriore	5Q0 615 424 A	
		post.sx	09.2012		24.3384-1759.5	240800	Pinza freno posteriore	5Q0 615 423 A	





Descrizione

Codici OE -  
Codice ATE

Pre-codice / varie

## SEAT

Modello	Versione	Posto	Data	Codice OE	Codice ATE	Descrizione	Codice OE - Codice ATE	Pre-codice / varie
LEON III (5F) / SC / ST (12-)	1,4 TGI	post.sx	10.2013	24.3384-1759.5	240800	Pinza freno posteriore	5Q0 615 423 A	
		post.dx	10.2013	24.3384-1760.5	240801	Pinza freno posteriore	5Q0 615 424 A	
	1,4 TSI	post.dx	09.2012	24.3384-1760.5	240801	Pinza freno posteriore	5Q0 615 424 A	
		post.sx	05.2014	24.3384-1759.5	240800	Pinza freno posteriore	5Q0 615 423 A	
		post.dx	05.2014	24.3384-1760.5	240801	Pinza freno posteriore	5Q0 615 424 A	
		post.sx	09.2012	24.3384-1759.5	240800	Pinza freno posteriore	5Q0 615 423 A	
	1,6 TDI	post.sx	01.2017	24.3384-1759.5	240800	Pinza freno posteriore	5Q0 615 423 A	
		post.sx	09.2013	24.3384-1759.5	240800	Pinza freno posteriore	5Q0 615 423 A	
		post.sx	09.2012	24.3384-1759.5	240800	Pinza freno posteriore	5Q0 615 423 A	
		post.dx	09.2012	24.3384-1760.5	240801	Pinza freno posteriore	5Q0 615 424 A	
		post.dx	01.2017	24.3384-1760.5	240801	Pinza freno posteriore	5Q0 615 424 A	
		post.dx	09.2013	24.3384-1760.5	240801	Pinza freno posteriore	5Q0 615 424 A	
	1,6 TDI 4Drive	post.dx	11.2014	24.3384-1760.5	240801	Pinza freno posteriore	5Q0 615 424 A	
		post.dx	04.2014	24.3384-1760.5	240801	Pinza freno posteriore	5Q0 615 424 A	
		post.sx	04.2014	24.3384-1759.5	240800	Pinza freno posteriore	5Q0 615 423 A	
		post.sx	11.2014	24.3384-1759.5	240800	Pinza freno posteriore	5Q0 615 423 A	
	1,8 TSI	post.dx	09.2012	24.3384-1760.5	240801	Pinza freno posteriore	5Q0 615 424 A	
		post.sx	09.2012	24.3384-1759.5	240800	Pinza freno posteriore	5Q0 615 423 A	
	1,8 TSI 4Drive	post.sx	11.2014	24.3384-1759.5	240800	Pinza freno posteriore	5Q0 615 423 A	
		post.dx	11.2014	24.3384-1760.5	240801	Pinza freno posteriore	5Q0 615 424 A	
	2,0 Cupra	post.dx	10.2013	24.3384-1760.5	240801	Pinza freno posteriore	5Q0 615 424 A	



Descrizione

Codici OE -  
Codice ATE

Pre-codice / varie

## SEAT

LEON III (5F) / SC / ST (12-)	2,0 Cupra	post.sx	10.2013		24.3384-1759.5	240800	Pinza freno posteriore	5Q0 615 423 A	
	2,0 TDI	post.sx	09.2012		24.3384-1759.5	240800	Pinza freno posteriore	5Q0 615 423 A	
		post.dx	09.2012		24.3384-1760.5	240801	Pinza freno posteriore	5Q0 615 424 A	
		post.dx	05.2013		24.3384-1760.5	240801	Pinza freno posteriore	5Q0 615 424 A	
		post.sx	05.2013		24.3384-1759.5	240800	Pinza freno posteriore	5Q0 615 423 A	
	2,0 TDI 4Drive	post.sx	04.2014		24.3384-1759.5	240800	Pinza freno posteriore	5Q0 615 423 A	
		post.sx	11.2014		24.3384-1759.5	240800	Pinza freno posteriore	5Q0 615 423 A	
		post.dx	11.2014		24.3384-1760.5	240801	Pinza freno posteriore	5Q0 615 424 A	
		post.dx	04.2014		24.3384-1760.5	240801	Pinza freno posteriore	5Q0 615 424 A	
LEON III (5F) ST X-Perience (14-)	1,6 TDI	post.sx	09.2014		24.3384-1759.5	240800	Pinza freno posteriore	5Q0 615 423 A	
		post.dx	09.2014		24.3384-1760.5	240801	Pinza freno posteriore	5Q0 615 424 A	
	1,8 TSI	post.sx	09.2014		24.3384-1759.5	240800	Pinza freno posteriore	5Q0 615 423 A	
		post.dx	09.2014		24.3384-1760.5	240801	Pinza freno posteriore	5Q0 615 424 A	
	2,0 TDI	post.dx	09.2014		24.3384-1760.5	240801	Pinza freno posteriore	5Q0 615 424 A	
		post.sx	09.2014		24.3384-1759.5	240800	Pinza freno posteriore	5Q0 615 423 A	
TOLEDO III (5P2) (05-09)	1,4 16V	post.dx	05.2006	03.2009	24.3414-1710.5	240835	Pinza freno posteriore	1K0 615 424 M , 1K0 615 424 H , 1K0 615 424 C , 1K0 615 424	24.3414-1710.7-
		post.sx	05.2006	03.2009	24.3414-1709.5	240834	Pinza freno posteriore	1K0 615 423 M , 1K0 615 423 H , 1K0 615 423 C , 1K0 615 423	24.3414-1709.7
	1,4 TSI	post.sx	11.2007	03.2009	24.3414-1709.5	240834	Pinza freno posteriore	1K0 615 423 M , 1K0 615 423 H , 1K0 615 423 C , 1K0 615 423	24.3414-1709.7



Descrizione

Codici OE -  
Codice ATE

Pre-codice / varie

## SEAT

TOLEDO III (5P2) (05-09)	1,4 TSI	post.dx	11.2007	03.2009	24.3414-1710.5	240835	Pinza freno posteriore	1K0 615 424 M , 1K0 615 424 H , 1K0 615 424 C , 1K0 615 424	24.3414-1710.7-
	1,6 i 16V	post.dx	10.2004	03.2009	24.3414-1710.5	240835	Pinza freno posteriore	1K0 615 424 M , 1K0 615 424 H , 1K0 615 424 C , 1K0 615 424	24.3414-1710.7-
		post.sx	10.2004	03.2009	24.3414-1709.5	240834	Pinza freno posteriore	1K0 615 423 M , 1K0 615 423 H , 1K0 615 423 C , 1K0 615 423	24.3414-1709.7
	1,8 TFSI	post.dx	01.2007	03.2009	24.3414-1710.5	240835	Pinza freno posteriore	1K0 615 424 M , 1K0 615 424 H , 1K0 615 424 C , 1K0 615 424	24.3414-1710.7-
		post.sx	01.2007	03.2009	24.3414-1709.5	240834	Pinza freno posteriore	1K0 615 423 M , 1K0 615 423 H , 1K0 615 423 C , 1K0 615 423	24.3414-1709.7
	1,9 TDI	post.dx	10.2004	03.2009	24.3414-1710.5	240835	Pinza freno posteriore	1K0 615 424 M , 1K0 615 424 H , 1K0 615 424 C , 1K0 615 424	24.3414-1710.7-
		post.sx	10.2004	03.2009	24.3414-1709.5	240834	Pinza freno posteriore	1K0 615 423 M , 1K0 615 423 H , 1K0 615 423 C , 1K0 615 423	24.3414-1709.7
	2,0 FSI	post.sx	10.2004	03.2009	24.3414-1709.5	240834	Pinza freno posteriore	1K0 615 423 M , 1K0 615 423 H , 1K0 615 423 C , 1K0 615 423	24.3414-1709.7
		post.dx	10.2004	03.2009	24.3414-1710.5	240835	Pinza freno posteriore	1K0 615 424 M , 1K0 615 424 H , 1K0 615 424 C , 1K0 615 424	24.3414-1710.7-
	2,0 TDI	post.sx	01.2006	03.2009	24.3414-1709.5	240834	Pinza freno posteriore	1K0 615 423 M , 1K0 615 423 H , 1K0 615 423 C , 1K0 615 423	24.3414-1709.7
		post.sx	10.2004	03.2009	24.3414-1709.5	240834	Pinza freno posteriore	1K0 615 423 M , 1K0 615 423 H , 1K0 615 423 C , 1K0 615 423	24.3414-1709.7



				<b>Descrizione</b>	<b>Codici OE - Codice ATE</b>	 <b>Pre-codice / varie</b>
---	---	--	---	--------------------	-----------------------------------	---

## SEAT

TOLEDO III (5P2) (05-09)	2,0 TDI	post.dx	01.2006	03.2009	24.3414-1710.5	240835	Pinza freno posteriore	1K0 615 424 M , 1K0 615 424 H , 1K0 615 424 C , 1K0 615 424	24.3414-1710.7-
		post.dx	10.2004	03.2009	24.3414-1710.5	240835	Pinza freno posteriore	1K0 615 424 M , 1K0 615 424 H , 1K0 615 424 C , 1K0 615 424	24.3414-1710.7-
	2,0 TFSI	post.dx	11.2005	03.2009	24.3414-1710.5	240835	Pinza freno posteriore	1K0 615 424 M , 1K0 615 424 H , 1K0 615 424 C , 1K0 615 424	24.3414-1710.7-
		post.sx	11.2005	03.2009	24.3414-1709.5	240834	Pinza freno posteriore	1K0 615 423 M , 1K0 615 423 H , 1K0 615 423 C , 1K0 615 423	24.3414-1709.7



Descrizione

Codici OE -  
Codice ATE

Pre-codice / varie

## SKODA

OCTAVIA II (1Z) (04-13)	1,2 TSI	post.sx	02.2010	01.2013	24.3414-1709.5	240834	Pinza freno posteriore	1K0 615 423 M , 1K0 615 423 H , 1K0 615 423 C , 1K0 615 423	24.3414-1709.7
		post.dx	02.2010	01.2013	24.3414-1710.5	240835	Pinza freno posteriore	1K0 615 424 M , 1K0 615 424 H , 1K0 615 424 C , 1K0 615 424	24.3414-1710.7-
	1,4 i 16V	post.dx	06.2004	01.2013	24.3414-1710.5	240835	Pinza freno posteriore	1K0 615 424 M , 1K0 615 424 H , 1K0 615 424 C , 1K0 615 424	24.3414-1710.7-
		post.sx	06.2004	01.2013	24.3414-1709.5	240834	Pinza freno posteriore	1K0 615 423 M , 1K0 615 423 H , 1K0 615 423 C , 1K0 615 423	24.3414-1709.7
	1,4 TSI	post.dx	11.2008	01.2013	24.3414-1710.5	240835	Pinza freno posteriore	1K0 615 424 M , 1K0 615 424 H , 1K0 615 424 C , 1K0 615 424	24.3414-1710.7-
		post.sx	11.2008	01.2013	24.3414-1709.5	240834	Pinza freno posteriore	1K0 615 423 M , 1K0 615 423 H , 1K0 615 423 C , 1K0 615 423	24.3414-1709.7
	1,6	post.sx	09.2009	01.2013	24.3414-1709.5	240834	Pinza freno posteriore	1K0 615 423 M , 1K0 615 423 H , 1K0 615 423 C , 1K0 615 423	24.3414-1709.7
		post.dx	09.2009	01.2013	24.3414-1710.5	240835	Pinza freno posteriore	1K0 615 424 M , 1K0 615 424 H , 1K0 615 424 C , 1K0 615 424	24.3414-1710.7-
	1,6 FSI	post.sx	06.2004	01.2013	24.3414-1709.5	240834	Pinza freno posteriore	1K0 615 423 M , 1K0 615 423 H , 1K0 615 423 C , 1K0 615 423	24.3414-1709.7
		post.dx	06.2004	01.2013	24.3414-1710.5	240835	Pinza freno posteriore	1K0 615 424 M , 1K0 615 424 H , 1K0 615 424 C , 1K0 615 424	24.3414-1710.7-
	1,6 i 16V	post.dx	06.2004	01.2013	24.3414-1710.5	240835	Pinza freno posteriore	1K0 615 424 M , 1K0 615 424 H , 1K0 615 424 C , 1K0 615 424	24.3414-1710.7-



Descrizione

Codici OE -  
Codice ATE

Pre-codice / varie

## SKODA

OCTAVIA II (1Z) (04-13)	1,6 i 16V	post.sx	06.2004	01.2013	24.3414-1709.5	240834	Pinza freno posteriore	1K0 615 423 M , 1K0 615 423 H , 1K0 615 423 C , 1K0 615 423	24.3414-1709.7
	1,6 TDI	post.sx	06.2009	01.2013	24.3414-1709.5	240834	Pinza freno posteriore	1K0 615 423 M , 1K0 615 423 H , 1K0 615 423 C , 1K0 615 423	24.3414-1709.7
		post.dx	06.2009	01.2013	24.3414-1710.5	240835	Pinza freno posteriore	1K0 615 424 M , 1K0 615 424 H , 1K0 615 424 C , 1K0 615 424	24.3414-1710.7-
	1,6 TDI 4x4	post.sx	06.2009	01.2013	24.3414-1709.5	240834	Pinza freno posteriore	1K0 615 423 M , 1K0 615 423 H , 1K0 615 423 C , 1K0 615 423	24.3414-1709.7
		post.dx	06.2009	01.2013	24.3414-1710.5	240835	Pinza freno posteriore	1K0 615 424 M , 1K0 615 424 H , 1K0 615 424 C , 1K0 615 424	24.3414-1710.7-
	1,8 TSI	post.sx	06.2007	01.2013	24.3414-1709.5	240834	Pinza freno posteriore	1K0 615 423 M , 1K0 615 423 H , 1K0 615 423 C , 1K0 615 423	24.3414-1709.7
		post.dx	06.2007	01.2013	24.3414-1710.5	240835	Pinza freno posteriore	1K0 615 424 M , 1K0 615 424 H , 1K0 615 424 C , 1K0 615 424	24.3414-1710.7-
	1,8 TSI 4x4	post.sx	11.2008	01.2013	24.3414-1709.5	240834	Pinza freno posteriore	1K0 615 423 M , 1K0 615 423 H , 1K0 615 423 C , 1K0 615 423	24.3414-1709.7
		post.dx	11.2008	01.2013	24.3414-1710.5	240835	Pinza freno posteriore	1K0 615 424 M , 1K0 615 424 H , 1K0 615 424 C , 1K0 615 424	24.3414-1710.7-
	1,9 TDI	post.sx	06.2004	01.2013	24.3414-1709.5	240834	Pinza freno posteriore	1K0 615 423 M , 1K0 615 423 H , 1K0 615 423 C , 1K0 615 423	24.3414-1709.7
		post.dx	06.2004	01.2013	24.3414-1710.5	240835	Pinza freno posteriore	1K0 615 424 M , 1K0 615 424 H , 1K0 615 424 C , 1K0 615 424	24.3414-1710.7-



Descrizione

Codici OE -  
Codice ATE

Pre-codice / varie

## SKODA

OCTAVIA II (1Z) (04-13)	1,9 TDI 4x4	post.dx	11.2004	01.2013	24.3414-1710.5	240835	Pinza freno posteriore	1K0 615 424 M , 1K0 615 424 H , 1K0 615 424 C , 1K0 615 424	24.3414-1710.7-
		post.sx	11.2004	01.2013	24.3414-1709.5	240834	Pinza freno posteriore	1K0 615 423 M , 1K0 615 423 H , 1K0 615 423 C , 1K0 615 423	24.3414-1709.7
	2,0 FSI	post.dx	11.2004	01.2013	24.3414-1710.5	240835	Pinza freno posteriore	1K0 615 424 M , 1K0 615 424 H , 1K0 615 424 C , 1K0 615 424	24.3414-1710.7-
		post.sx	11.2004	01.2013	24.3414-1709.5	240834	Pinza freno posteriore	1K0 615 423 M , 1K0 615 423 H , 1K0 615 423 C , 1K0 615 423	24.3414-1709.7
	2,0 FSI 4x4	post.dx	11.2004	01.2013	24.3414-1710.5	240835	Pinza freno posteriore	1K0 615 424 M , 1K0 615 424 H , 1K0 615 424 C , 1K0 615 424	24.3414-1710.7-
		post.sx	11.2004	01.2013	24.3414-1709.5	240834	Pinza freno posteriore	1K0 615 423 M , 1K0 615 423 H , 1K0 615 423 C , 1K0 615 423	24.3414-1709.7
	2,0 TDI	post.dx	06.2004	01.2013	24.3414-1710.5	240835	Pinza freno posteriore	1K0 615 424 M , 1K0 615 424 H , 1K0 615 424 C , 1K0 615 424	24.3414-1710.7-
		post.dx	03.2010	01.2013	24.3414-1710.5	240835	Pinza freno posteriore	1K0 615 424 M , 1K0 615 424 H , 1K0 615 424 C , 1K0 615 424	24.3414-1710.7-
		post.sx	06.2004	01.2013	24.3414-1709.5	240834	Pinza freno posteriore	1K0 615 423 M , 1K0 615 423 H , 1K0 615 423 C , 1K0 615 423	24.3414-1709.7
		post.sx	03.2010	01.2013	24.3414-1709.5	240834	Pinza freno posteriore	1K0 615 423 M , 1K0 615 423 H , 1K0 615 423 C , 1K0 615 423	24.3414-1709.7
	2,0 TDi 4x4	post.dx	05.2011	01.2013	24.3414-1710.5	240835	Pinza freno posteriore	1K0 615 424 M , 1K0 615 424 H , 1K0 615 424 C , 1K0 615 424	24.3414-1710.7-



Descrizione

Codici OE -  
Codice ATE

Pre-codice / varie

## SKODA

OCTAVIA II (1Z) (04-13)	2,0 TDI 4x4	post.sx	07.2006	01.2013	24.3414-1709.5	240834	Pinza freno posteriore	1K0 615 423 M , 1K0 615 423 H , 1K0 615 423 C , 1K0 615 423	24.3414-1709.7
		post.dx	07.2006	01.2013	24.3414-1710.5	240835	Pinza freno posteriore	1K0 615 424 M , 1K0 615 424 H , 1K0 615 424 C , 1K0 615 424	24.3414-1710.7-
		post.sx	05.2011	01.2013	24.3414-1709.5	240834	Pinza freno posteriore	1K0 615 423 M , 1K0 615 423 H , 1K0 615 423 C , 1K0 615 423	24.3414-1709.7
OCTAVIA III (5E) (12-)	1,0 TSI	post.dx	05.2016		24.3384-1760.5	240801	Pinza freno posteriore	5Q0 615 424 A	
		post.sx	05.2016		24.3384-1759.5	240800	Pinza freno posteriore	5Q0 615 423 A	
	1,2 TSI	post.dx	02.2013		24.3384-1760.5	240801	Pinza freno posteriore	5Q0 615 424 A	
		post.dx	05.2015		24.3384-1760.5	240801	Pinza freno posteriore	5Q0 615 424 A	
		post.sx	02.2013		24.3384-1759.5	240800	Pinza freno posteriore	5Q0 615 423 A	
		post.sx	05.2015		24.3384-1759.5	240800	Pinza freno posteriore	5Q0 615 423 A	
	1,4 TSI	post.dx	05.2015		24.3384-1760.5	240801	Pinza freno posteriore	5Q0 615 424 A	
		post.sx	11.2012		24.3384-1759.5	240800	Pinza freno posteriore	5Q0 615 423 A	
		post.sx	05.2015		24.3384-1759.5	240800	Pinza freno posteriore	5Q0 615 423 A	
		post.dx	11.2012		24.3384-1760.5	240801	Pinza freno posteriore	5Q0 615 424 A	
	1,4 TSI G-TEC	post.sx	11.2013		24.3384-1759.5	240800	Pinza freno posteriore	5Q0 615 423 A	
		post.dx	11.2013		24.3384-1760.5	240801	Pinza freno posteriore	5Q0 615 424 A	
	1,6	post.dx	01.2014		24.3384-1760.5	240801	Pinza freno posteriore	5Q0 615 424 A	
		post.sx	01.2014		24.3384-1759.5	240800	Pinza freno posteriore	5Q0 615 423 A	
	1,6 TDI	post.dx	02.2013		24.3384-1760.5	240801	Pinza freno posteriore	5Q0 615 424 A	





Descrizione

Codici OE -  
Codice ATE

Pre-codice / varie

## SKODA

OCTAVIA III (5E) (12-)	1,6 TDI	post.sx	02.2013		24.3384-1759.5	240800	Pinza freno posteriore	5Q0 615 423 A	
	1,6 TDI 4x4	post.sx	05.2015		24.3384-1759.5	240800	Pinza freno posteriore	5Q0 615 423 A	
		post.sx	11.2012		24.3384-1759.5	240800	Pinza freno posteriore	5Q0 615 423 A	
		post.dx	05.2015		24.3384-1760.5	240801	Pinza freno posteriore	5Q0 615 424 A	
		post.dx	11.2012		24.3384-1760.5	240801	Pinza freno posteriore	5Q0 615 424 A	
	1,8 TSI	post.sx	11.2012		24.3384-1759.5	240800	Pinza freno posteriore	5Q0 615 423 A	
		post.dx	11.2012		24.3384-1760.5	240801	Pinza freno posteriore	5Q0 615 424 A	
	1,8 TSI 4x4	post.sx	11.2012		24.3384-1759.5	240800	Pinza freno posteriore	5Q0 615 423 A	
		post.dx	11.2012		24.3384-1760.5	240801	Pinza freno posteriore	5Q0 615 424 A	
	2,0 TDI	post.dx	02.2013		24.3384-1760.5	240801	Pinza freno posteriore	5Q0 615 424 A	
		post.dx	11.2012		24.3384-1760.5	240801	Pinza freno posteriore	5Q0 615 424 A	
		post.sx	02.2013		24.3384-1759.5	240800	Pinza freno posteriore	5Q0 615 423 A	
		post.sx	05.2013		24.3384-1759.5	240800	Pinza freno posteriore	5Q0 615 423 A	
		post.sx	11.2012		24.3384-1759.5	240800	Pinza freno posteriore	5Q0 615 423 A	
		post.dx	05.2013		24.3384-1760.5	240801	Pinza freno posteriore	5Q0 615 424 A	
	2,0 TDI 4x4	post.sx	09.2014		24.3384-1759.5	240800	Pinza freno posteriore	5Q0 615 423 A	
		post.dx	09.2014		24.3384-1760.5	240801	Pinza freno posteriore	5Q0 615 424 A	
		post.dx	11.2012		24.3384-1760.5	240801	Pinza freno posteriore	5Q0 615 424 A	
		post.sx	11.2012		24.3384-1759.5	240800	Pinza freno posteriore	5Q0 615 423 A	
	2,0 TSI RS	post.dx	05.2013		24.3384-1760.5	240801	Pinza freno posteriore	5Q0 615 424 A	
		post.dx	05.2015		24.3384-1760.5	240801	Pinza freno posteriore	5Q0 615 424 A	



Descrizione

Codici OE -  
Codice ATE

Pre-codice / varie

## SKODA

Modello	Versione	Posto	Data Inizio	Data Fine	Codice OE	Codice ATE	Descrizione	Codici OE - Codice ATE	Pre-codice / varie
OCTAVIA III (5E) (12-)	2,0 TSI RS	post.sx	05.2015		24.3384-1759.5	240800	Pinza freno posteriore	5Q0 615 423 A	
		post.sx	05.2013		24.3384-1759.5	240800	Pinza freno posteriore	5Q0 615 423 A	
SUPERB II (08-15)	1,4 TSI	post.dx	08.2008	02.2015	24.3414-1710.5	240835	Pinza freno posteriore	1K0 615 424 M, 1K0 615 424 H, 1K0 615 424 C, 1K0 615 424	24.3414-1710.7-
		post.sx	08.2008	02.2015	24.3414-1709.5	240834	Pinza freno posteriore	1K0 615 423 M, 1K0 615 423 H, 1K0 615 423 C, 1K0 615 423	24.3414-1709.7
	1,6 TDI	post.dx	09.2010	02.2015	24.3414-1710.5	240835	Pinza freno posteriore	1K0 615 424 M, 1K0 615 424 H, 1K0 615 424 C, 1K0 615 424	24.3414-1710.7-
		post.sx	09.2010	02.2015	24.3414-1709.5	240834	Pinza freno posteriore	1K0 615 423 M, 1K0 615 423 H, 1K0 615 423 C, 1K0 615 423	24.3414-1709.7
	1,8 TFSI	post.sx	08.2008	02.2015	24.3414-1709.5	240834	Pinza freno posteriore	1K0 615 423 M, 1K0 615 423 H, 1K0 615 423 C, 1K0 615 423	24.3414-1709.7
		post.dx	08.2008	02.2015	24.3414-1710.5	240835	Pinza freno posteriore	1K0 615 424 M, 1K0 615 424 H, 1K0 615 424 C, 1K0 615 424	24.3414-1710.7-
	1,9 TDI	post.sx	08.2008	02.2015	24.3414-1709.5	240834	Pinza freno posteriore	1K0 615 423 M, 1K0 615 423 H, 1K0 615 423 C, 1K0 615 423	24.3414-1709.7
		post.dx	08.2008	02.2015	24.3414-1710.5	240835	Pinza freno posteriore	1K0 615 424 M, 1K0 615 424 H, 1K0 615 424 C, 1K0 615 424	24.3414-1710.7-
	2,0 TDI	post.dx	08.2008	02.2015	24.3414-1710.5	240835	Pinza freno posteriore	1K0 615 424 M, 1K0 615 424 H, 1K0 615 424 C, 1K0 615 424	24.3414-1710.7-
		post.sx	08.2008	02.2015	24.3414-1709.5	240834	Pinza freno posteriore	1K0 615 423 M, 1K0 615 423 H, 1K0 615 423 C, 1K0 615 423	24.3414-1709.7



Descrizione

Codici OE -  
Codice ATE

Pre-codice / varie

## SKODA

SUPERB II (08-15)	2,0 TSI	post.dx	05.2010	02.2015	24.3414-1710.5	240835	Pinza freno posteriore	1K0 615 424 M , 1K0 615 424 H , 1K0 615 424 C , 1K0 615 424	24.3414-1710.7-
		post.sx	05.2010	02.2015	24.3414-1709.5	240834	Pinza freno posteriore	1K0 615 423 M , 1K0 615 423 H , 1K0 615 423 C , 1K0 615 423	24.3414-1709.7
SUPERB II Combi (09-15)	1,4 TSI	post.sx	11.2009	02.2015	24.3414-1709.5	240834	Pinza freno posteriore	1K0 615 423 M , 1K0 615 423 H , 1K0 615 423 C , 1K0 615 423	24.3414-1709.7
		post.dx	11.2009	02.2015	24.3414-1710.5	240835	Pinza freno posteriore	1K0 615 424 M , 1K0 615 424 H , 1K0 615 424 C , 1K0 615 424	24.3414-1710.7-
	1,6 TDI	post.sx	09.2010	02.2015	24.3414-1709.5	240834	Pinza freno posteriore	1K0 615 423 M , 1K0 615 423 H , 1K0 615 423 C , 1K0 615 423	24.3414-1709.7
		post.dx	09.2010	02.2015	24.3414-1710.5	240835	Pinza freno posteriore	1K0 615 424 M , 1K0 615 424 H , 1K0 615 424 C , 1K0 615 424	24.3414-1710.7-
	1,8 TSI	post.dx	11.2009	02.2015	24.3414-1710.5	240835	Pinza freno posteriore	1K0 615 424 M , 1K0 615 424 H , 1K0 615 424 C , 1K0 615 424	24.3414-1710.7-
		post.sx	11.2009	02.2015	24.3414-1709.5	240834	Pinza freno posteriore	1K0 615 423 M , 1K0 615 423 H , 1K0 615 423 C , 1K0 615 423	24.3414-1709.7
	1,8 TSI 4x4	post.sx	11.2009	02.2015	24.3414-1709.5	240834	Pinza freno posteriore	1K0 615 423 M , 1K0 615 423 H , 1K0 615 423 C , 1K0 615 423	24.3414-1709.7
		post.dx	11.2009	02.2015	24.3414-1710.5	240835	Pinza freno posteriore	1K0 615 424 M , 1K0 615 424 H , 1K0 615 424 C , 1K0 615 424	24.3414-1710.7-
	1,9 TDI	post.sx	10.2009	02.2015	24.3414-1709.5	240834	Pinza freno posteriore	1K0 615 423 M , 1K0 615 423 H , 1K0 615 423 C , 1K0 615 423	24.3414-1709.7



Descrizione

Codici OE -  
Codice ATE

Pre-codice / varie

## SKODA

SUPERB II Combi (09-15)	1,9 TDI	post.dx	10.2009	02.2015	24.3414-1710.5	240835	Pinza freno posteriore	1K0 615 424 M , 1K0 615 424 H , 1K0 615 424 C , 1K0 615 424	24.3414-1710.7-
	2,0 TDI	post.dx	11.2009	02.2015	24.3414-1710.5	240835	Pinza freno posteriore	1K0 615 424 M , 1K0 615 424 H , 1K0 615 424 C , 1K0 615 424	24.3414-1710.7-
		post.sx	11.2009	02.2015	24.3414-1709.5	240834	Pinza freno posteriore	1K0 615 423 M , 1K0 615 423 H , 1K0 615 423 C , 1K0 615 423	24.3414-1709.7
	2,0 TDI 4x4	post.sx	11.2009	02.2015	24.3414-1709.5	240834	Pinza freno posteriore	1K0 615 423 M , 1K0 615 423 H , 1K0 615 423 C , 1K0 615 423	24.3414-1709.7
		post.dx	11.2009	02.2015	24.3414-1710.5	240835	Pinza freno posteriore	1K0 615 424 M , 1K0 615 424 H , 1K0 615 424 C , 1K0 615 424	24.3414-1710.7-
	2,0 TSI	post.sx	05.2010	02.2015	24.3414-1709.5	240834	Pinza freno posteriore	1K0 615 423 M , 1K0 615 423 H , 1K0 615 423 C , 1K0 615 423	24.3414-1709.7
		post.dx	05.2010	02.2015	24.3414-1710.5	240835	Pinza freno posteriore	1K0 615 424 M , 1K0 615 424 H , 1K0 615 424 C , 1K0 615 424	24.3414-1710.7-
	3,6 V6 4x4	post.dx	11.2009	02.2015	24.3414-1710.5	240835	Pinza freno posteriore	1K0 615 424 M , 1K0 615 424 H , 1K0 615 424 C , 1K0 615 424	24.3414-1710.7-
		post.sx	11.2009	02.2015	24.3414-1709.5	240834	Pinza freno posteriore	1K0 615 423 M , 1K0 615 423 H , 1K0 615 423 C , 1K0 615 423	24.3414-1709.7
YETI (09-)	1,2 TSI	post.dx	09.2009		24.3414-1710.5	240835	Pinza freno posteriore	1K0 615 424 M , 1K0 615 424 H , 1K0 615 424 C , 1K0 615 424	24.3414-1710.7-
		post.sx	09.2009		24.3414-1709.5	240834	Pinza freno posteriore	1K0 615 423 M , 1K0 615 423 H , 1K0 615 423 C , 1K0 615 423	24.3414-1709.7



Descrizione

Codici OE -  
Codice ATE

Pre-codice / varie

## SKODA

YETI (09-)	1,4 TSI	post.dx	06.2010		24.3414-1710.5	240835	Pinza freno posteriore	1K0 615 424 M , 1K0 615 424 H , 1K0 615 424 C , 1K0 615 424	24.3414-1710.7-
		post.sx	06.2010		24.3414-1709.5	240834	Pinza freno posteriore	1K0 615 423 M , 1K0 615 423 H , 1K0 615 423 C , 1K0 615 423	24.3414-1709.7
	1,6 TDI	post.dx	11.2010		24.3414-1710.5	240835	Pinza freno posteriore	1K0 615 424 M , 1K0 615 424 H , 1K0 615 424 C , 1K0 615 424	24.3414-1710.7-
		post.sx	11.2010		24.3414-1709.5	240834	Pinza freno posteriore	1K0 615 423 M , 1K0 615 423 H , 1K0 615 423 C , 1K0 615 423	24.3414-1709.7
	1,8 TSI 4x4	post.sx	05.2009		24.3414-1709.5	240834	Pinza freno posteriore	1K0 615 423 M , 1K0 615 423 H , 1K0 615 423 C , 1K0 615 423	24.3414-1709.7
		post.sx	11.2009		24.3414-1709.5	240834	Pinza freno posteriore	1K0 615 423 M , 1K0 615 423 H , 1K0 615 423 C , 1K0 615 423	24.3414-1709.7
		post.dx	11.2009		24.3414-1710.5	240835	Pinza freno posteriore	1K0 615 424 M , 1K0 615 424 H , 1K0 615 424 C , 1K0 615 424	24.3414-1710.7-
		post.dx	05.2009		24.3414-1710.5	240835	Pinza freno posteriore	1K0 615 424 M , 1K0 615 424 H , 1K0 615 424 C , 1K0 615 424	24.3414-1710.7-
	2,0 TDI	post.dx	11.2011		24.3414-1710.5	240835	Pinza freno posteriore	1K0 615 424 M , 1K0 615 424 H , 1K0 615 424 C , 1K0 615 424	24.3414-1710.7-
		post.dx	11.2009		24.3414-1710.5	240835	Pinza freno posteriore	1K0 615 424 M , 1K0 615 424 H , 1K0 615 424 C , 1K0 615 424	24.3414-1710.7-
		post.sx	11.2011		24.3414-1709.5	240834	Pinza freno posteriore	1K0 615 423 M , 1K0 615 423 H , 1K0 615 423 C , 1K0 615 423	24.3414-1709.7



Descrizione

Codici OE -  
Codice ATE

Pre-codice / varie

## SKODA

YETI (09-)	2,0 TDI	post.sx	11.2009		24.3414-1709.5	240834	Pinza freno posteriore	1K0 615 423 M , 1K0 615 423 H , 1K0 615 423 C , 1K0 615 423	24.3414-1709.7
	2,0 TDI 4x4	post.sx	11.2009		24.3414-1709.5	240834	Pinza freno posteriore	1K0 615 423 M , 1K0 615 423 H , 1K0 615 423 C , 1K0 615 423	24.3414-1709.7
		post.dx	05.2009		24.3414-1710.5	240835	Pinza freno posteriore	1K0 615 424 M , 1K0 615 424 H , 1K0 615 424 C , 1K0 615 424	24.3414-1710.7-
		post.dx	11.2009		24.3414-1710.5	240835	Pinza freno posteriore	1K0 615 424 M , 1K0 615 424 H , 1K0 615 424 C , 1K0 615 424	24.3414-1710.7-
		post.sx	05.2009		24.3414-1709.5	240834	Pinza freno posteriore	1K0 615 423 M , 1K0 615 423 H , 1K0 615 423 C , 1K0 615 423	24.3414-1709.7

## SUBARU

JUSTY (G3X) (03-07)	1,3 i 16V 4WD		09.2003	08.2007	28.0461-7106.1	BAR171	Discofreno ant.	55311-84E01 , 55311-86G02 , 5531186G02 , 47 07 288 , 93179462 , 93176389 , 47 06 749	
	1,5 i 16V 4WD		09.2003	08.2007	28.0461-7106.1	BAR171	Discofreno ant.	55311-84E01 , 55311-86G02 , 5531186G02 , 47 07 288 , 93179462 , 93176389 , 47 06 749	
OUTBACK (09-)	2,5 16V 4x4		01.2013		24.0118-0159.1	418159	Disco freno post.	26310AA151	



Descrizione

Codici OE -  
Codice ATE

Pre-codice / varie

## SUZUKI

IGNIS II (03-12)	1,3 DDiS		09.2003	12.2012	28.0461-7106.1	BAR171	Discofreno ant.	55311-84E01 , 55311-86G02 , 5531186G02 , 47 07 288 , 93179462 , 93176389 , 47 06 749	
	1,3 i 16V		09.2003	12.2012	28.0461-7106.1	BAR171	Discofreno ant.	55311-84E01 , 55311-86G02 , 5531186G02 , 47 07 288 , 93179462 , 93176389 , 47 06 749	
	1,3 i 16V 4x4		09.2003	12.2012	28.0461-7106.1	BAR171	Discofreno ant.	55311-84E01 , 55311-86G02 , 5531186G02 , 47 07 288 , 93179462 , 93176389 , 47 06 749	
	1,5 i 16V		09.2003	12.2012	28.0461-7106.1	BAR171	Discofreno ant.	55311-84E01 , 55311-86G02 , 5531186G02 , 47 07 288 , 93179462 , 93176389 , 47 06 749	
	1,5 i 16V 4x4		09.2003	12.2012	28.0461-7106.1	BAR171	Discofreno ant.	55311-84E01 , 55311-86G02 , 5531186G02 , 47 07 288 , 93179462 , 93176389 , 47 06 749	
SPLASH (08-)	1,0 12V		01.2008		28.0462-0211.1	BAR202	Discofreno ant.	55311-62J00 , 95513700 , 93194988 , 47 00 455 , 47 10 944 , 93192978 , 47 08 241	
			06.2011		28.0462-0211.1	BAR202	Discofreno ant.	55311-62J00 , 95513700 , 93194988 , 47 00 455 , 47 10 944 , 93192978 , 47 08 241	
	1,2 16V		01.2008		28.0462-0211.1	BAR202	Discofreno ant.	55311-62J00 , 95513700 , 93194988 , 47 00 455 , 47 10 944 , 93192978 , 47 08 241	
	1,2 VVT		09.2010		28.0462-0211.1	BAR202	Discofreno ant.	55311-62J00 , 95513700 , 93194988 , 47 00 455 , 47 10 944 , 93192978 , 47 08 241	



Descrizione

Codici OE -  
Codice ATE

Pre-codice / varie

## SUZUKI

SPLASH (08-)	1,2 VVT		06.2011		28.0462-0211.1	BAR202	Discofreno ant.	55311-62J00 , 95513700 , 93194988 , 47 00 455 , 47 10 944 , 93192978 , 47 08 241	
			08.2012		28.0462-0211.1	BAR202	Discofreno ant.	55311-62J00 , 95513700 , 93194988 , 47 00 455 , 47 10 944 , 93192978 , 47 08 241	
	1,3 CDTi		01.2008		28.0462-0211.1	BAR202	Discofreno ant.	55311-62J00 , 95513700 , 93194988 , 47 00 455 , 47 10 944 , 93192978 , 47 08 241	
SWIFT III (05-10)	1,3 16V		02.2005	09.2010	28.0462-0211.1	BAR202	Discofreno ant.	55311-62J00 , 95513700 , 93194988 , 47 00 455 , 47 10 944 , 93192978 , 47 08 241	
	1,3 16V 4x4		02.2005	09.2010	28.0462-0211.1	BAR202	Discofreno ant.	55311-62J00 , 95513700 , 93194988 , 47 00 455 , 47 10 944 , 93192978 , 47 08 241	
			01.2006	09.2010	28.0462-0211.1	BAR202	Discofreno ant.	55311-62J00 , 95513700 , 93194988 , 47 00 455 , 47 10 944 , 93192978 , 47 08 241	
	1,3 DDiS		08.2005	09.2010	28.0462-0211.1	BAR202	Discofreno ant.	55311-62J00 , 95513700 , 93194988 , 47 00 455 , 47 10 944 , 93192978 , 47 08 241	
			08.2005	09.2007	28.0462-0211.1	BAR202	Discofreno ant.	55311-62J00 , 95513700 , 93194988 , 47 00 455 , 47 10 944 , 93192978 , 47 08 241	
	1,5 16V 4x4		02.2005	09.2010	28.0462-0211.1	BAR202	Discofreno ant.	55311-62J00 , 95513700 , 93194988 , 47 00 455 , 47 10 944 , 93192978 , 47 08 241	





Descrizione





Codici OE -  
Codice ATE

Pre-codice / varie

## SUZUKI

SWIFT III (05-10)	1,5 VVTi		02.2005	09.2010	28.0462-0211.1	BAR202	Discofreno ant.	55311-62J00 , 95513700 , 93194988 , 47 00 455 , 47 10 944 , 93192978 , 47 08 241	
VITARA (89-98)	1,6	post.sx	02.1993	01.1995	24.3223-1716.3	020592	Cil.ruota posteriore	53402-56B00	
		post.dx	02.1993	01.1995	24.3223-1717.3	020593	Cil.ruota posteriore	53401-56B00	
	1,6 Cabrio	post.dx	02.1993	01.1995	24.3223-1717.3	020593	Cil.ruota posteriore	53401-56B00	
		post.sx	02.1993	01.1995	24.3223-1716.3	020592	Cil.ruota posteriore	53402-56B00	
	1,6 i 16V	post.dx	02.1993	01.1995	24.3223-1717.3	020593	Cil.ruota posteriore	53401-56B00	
		post.sx	02.1993	01.1995	24.3223-1716.3	020592	Cil.ruota posteriore	53402-56B00	
	2,0 i V6	post.dx	12.1994	03.1998	24.3223-1717.3	020593	Cil.ruota posteriore	53401-56B00	
		post.sx	12.1994	03.1998	24.3223-1716.3	020592	Cil.ruota posteriore	53402-56B00	
WAGON R+ (00-08)	1,0 i 12V		06.2004	04.2008	28.0461-7106.1	BAR171	Discofreno ant.	55311-84E01 , 55311-86G02 , 5531186G02 , 47 07 288 , 93179462 , 93176389 , 47 06 749	
	1,2 i 16V		06.2004	04.2008	28.0461-7106.1	BAR171	Discofreno ant.	55311-84E01 , 55311-86G02 , 5531186G02 , 47 07 288 , 93179462 , 93176389 , 47 06 749	
	1,3 DDiS		09.2003	04.2008	28.0461-7106.1	BAR171	Discofreno ant.	55311-84E01 , 55311-86G02 , 5531186G02 , 47 07 288 , 93179462 , 93176389 , 47 06 749	
	1,3 i 16V		09.2003	04.2008	28.0461-7106.1	BAR171	Discofreno ant.	55311-84E01 , 55311-86G02 , 5531186G02 , 47 07 288 , 93179462 , 93176389 , 47 06 749	



				<b>Descrizione</b>	<b>Codici OE - Codice ATE</b>	 <b>Pre-codice / varie</b>
---	---	--	---	--------------------	-----------------------------------	---

## SUZUKI

WAGON R+ (00-08)	1,3 i 16V		08.2001	04.2008	28.0461-7106.1	BAR171	Discofreno ant.	55311-84E01 , 55311-86G02 , 5531186G02 , 47 07 288 , 93179462 , 93176389 , 47 06 749	
				04.2008	28.0461-7106.1	BAR171	Discofreno ant.	55311-84E01 , 55311-86G02 , 5531186G02 , 47 07 288 , 93179462 , 93176389 , 47 06 749	
	1,3 i 16V 4WD		09.2003	04.2008	28.0461-7106.1	BAR171	Discofreno ant.	55311-84E01 , 55311-86G02 , 5531186G02 , 47 07 288 , 93179462 , 93176389 , 47 06 749	
				12.2004	28.0461-7106.1	BAR171	Discofreno ant.	55311-84E01 , 55311-86G02 , 5531186G02 , 47 07 288 , 93179462 , 93176389 , 47 06 749	



Descrizione

Codici OE -  
Codice ATE

Pre-codice / varie

## TOYOTA

AURIS (06-12)	2,2 D-4D	post.dx	03.2007	09.2012	24.5275-0341.3	331382	Tubo flessibile posteriore	90947-W2017	
AVENSIS (09-)	1,6 i 16V	post.dx	02.2009	09.2012	24.5275-0341.3	331382	Tubo flessibile posteriore	90947-W2017	
	1,8 i 16V	post.dx	02.2009	09.2012	24.5275-0341.3	331382	Tubo flessibile posteriore	90947-W2017	
	2,0 D-4D	post.dx	02.2009	09.2012	24.5275-0341.3	331382	Tubo flessibile posteriore	90947-W2017	
		post.dx	11.2011	09.2012	24.5275-0341.3	331382	Tubo flessibile posteriore	90947-W2017	
	2,0 i 16V	post.dx	02.2009	09.2012	24.5275-0341.3	331382	Tubo flessibile posteriore	90947-W2017	
	2,2 D-4D	post.dx	02.2009	09.2012	24.5275-0341.3	331382	Tubo flessibile posteriore	90947-W2017	
AYGO (05-14)	1,0 i 12V		07.2005	06.2014	28.0462-0180.1	BAR201	Discofreno ant.	43512-0H020 , 43512-0H010 , 4249 94 , 4249 54 , 4246 F0 , 4249 55 , 4246 J0	
	1,0 i 12V GPL		07.2005	06.2014	28.0462-0180.1	BAR201	Discofreno ant.	43512-0H020 , 43512-0H010 , 4249 94 , 4249 54 , 4246 F0 , 4249 55 , 4246 J0	
	1,4 HDi		07.2005	08.2010	28.0462-0180.1	BAR201	Discofreno ant.	43512-0H020 , 43512-0H010 , 4249 94 , 4249 54 , 4246 F0 , 4249 55 , 4246 J0	
AYGO (14-)	1,0 12V		05.2014		28.0462-0180.1	BAR201	Discofreno ant.	43512-0H020 , 43512-0H010 , 4249 94 , 4249 54 , 4246 F0 , 4249 55 , 4246 J0	
	1,2		05.2014		28.0462-0180.1	BAR201	Discofreno ant.	43512-0H020 , 43512-0H010 , 4249 94 , 4249 54 , 4246 F0 , 4249 55 , 4246 J0	
HIACE (06-)	2,5 D-4D		09.2006		24.3225-1705.3	020594	Cil.ruota posteriore	47550-35260 , 47550-30140 , 47550-26130	
	2,5 D-4D 4x4		09.2006		24.3225-1705.3	020594	Cil.ruota posteriore	47550-35260 , 47550-30140 , 47550-26130	
HIACE (95-06)	2,0 (KLH12)		08.1995	04.1998	24.3225-1705.3	020594	Cil.ruota posteriore	47550-35260 , 47550-30140 , 47550-26130	



Descrizione

Codici OE -  
Codice ATE

Pre-codice / varie

## TOYOTA

Modello	Configurazione								
HIACE (95-06)	2,4 (RCH12/22)		08.1995	07.1996	24.3225-1705.3	020594	Cil.ruota posteriore	47550-35260 , 47550-30140 , 47550-26130	
			08.1996	04.1998	24.3225-1705.3	020594	Cil.ruota posteriore	47550-35260 , 47550-30140 , 47550-26130	
	2,4 4WD (RCH18/28)		08.1995	04.1998	24.3225-1705.3	020594	Cil.ruota posteriore	47550-35260 , 47550-30140 , 47550-26130	
	2,4 D (LXH12/18)		08.1995	07.1996	24.3225-1705.3	020594	Cil.ruota posteriore	47550-35260 , 47550-30140 , 47550-26130	
			08.1996	08.2001	24.3225-1705.3	020594	Cil.ruota posteriore	47550-35260 , 47550-30140 , 47550-26130	
	2,4 TD (LXH12/22)		08.1995	07.1996	24.3225-1705.3	020594	Cil.ruota posteriore	47550-35260 , 47550-30140 , 47550-26130	
			08.1996	08.2001	24.3225-1705.3	020594	Cil.ruota posteriore	47550-35260 , 47550-30140 , 47550-26130	
	2,4 TD 4WD (LXH18/28)		08.1995	08.2001	24.3225-1705.3	020594	Cil.ruota posteriore	47550-35260 , 47550-30140 , 47550-26130	
	2,5 D-4D (KLH1/2)		11.2001	08.2006	24.3225-1705.3	020594	Cil.ruota posteriore	47550-35260 , 47550-30140 , 47550-26130	
	2,5 D-4D 4WD (KLH1/2)		08.2001	08.2004	24.3225-1705.3	020594	Cil.ruota posteriore	47550-35260 , 47550-30140 , 47550-26130	
			11.2001	08.2006	24.3225-1705.3	020594	Cil.ruota posteriore	47550-35260 , 47550-30140 , 47550-26130	
	2,7 (RCH13/23)		04.1998	06.2006	24.3225-1705.3	020594	Cil.ruota posteriore	47550-35260 , 47550-30140 , 47550-26130	
	2,7 4WD (RCH19/29)		04.1998	06.2006	24.3225-1705.3	020594	Cil.ruota posteriore	47550-35260 , 47550-30140 , 47550-26130	
	3,0 D (RCH13)		08.2001	10.2003	24.3225-1705.3	020594	Cil.ruota posteriore	47550-35260 , 47550-30140 , 47550-26130	



Descrizione

Codici OE -  
Codice ATE

Pre-codice / varie

## TOYOTA

HILUX (97-05)	2,4 D		11.1998	01.2002	24.3225-1705.3	020594	Cil.ruota posteriore	47550-35260 , 47550-30140 , 47550-26130	
			08.1997	10.1998	24.3225-1705.3	020594	Cil.ruota posteriore	47550-35260 , 47550-30140 , 47550-26130	
	2,5 D-4D		11.2001	07.2005	24.3225-1705.3	020594	Cil.ruota posteriore	47550-35260 , 47550-30140 , 47550-26130	
LAND CRUISER 150 (10-)	2,7 4WD		01.2010		24.0132-0174.1	432174	Discofreno ant.	43512-60190	
	2,8 D-4D		06.2015		24.0132-0174.1	432174	Discofreno ant.	43512-60190	
	3,0 D-4D		03.2010		24.0132-0174.1	432174	Discofreno ant.	43512-60190	
			01.2010		24.0132-0174.1	432174	Discofreno ant.	43512-60190	
	3,0 TDi		01.2010		24.0132-0174.1	432174	Discofreno ant.	43512-60190	
	4,0 V6 Dual VVTi		01.2010		24.0132-0174.1	432174	Discofreno ant.	43512-60190	
	4,0 V6 VVTi		01.2010		24.0132-0174.1	432174	Discofreno ant.	43512-60190	
MR2 (00-07)	1,8 VVTi (ZZW30)		01.2000	06.2007	28.0462-0175.1	BAR201	Discofreno ant.	43512-0D050 , 43512-17120 , 43512-17131 , 43512-17130 , 43512-52040 , 43512-52090	
YARIS (99-05)	1,0 i 16V		08.1999	03.2003	28.0462-0175.1	BAR201	Discofreno ant.	43512-0D050 , 43512-17120 , 43512-17131 , 43512-17130 , 43512-52040 , 43512-52090	
			04.2003	08.2005	28.0462-0175.1	BAR201	Discofreno ant.	43512-0D050 , 43512-17120 , 43512-17131 , 43512-17130 , 43512-52040 , 43512-52090	
	1,3 i 16V		09.1999	10.2004	28.0462-0175.1	BAR201	Discofreno ant.	43512-0D050 , 43512-17120 , 43512-17131 , 43512-17130 , 43512-52040 , 43512-52090	



Descrizione

Codici OE -  
Codice ATE

Pre-codice / varie

## TOYOTA

YARIS (99-05)	1,3 i 16V		04.2002	08.2005	28.0462-0175.1	BAR201	Discofreno ant.	43512-0D050 , 43512-17120 , 43512-17131 , 43512-17130 , 43512-52040 , 43512-52090	
	1,4 D-4D		12.2001	08.2005	28.0462-0175.1	BAR201	Discofreno ant.	43512-0D050 , 43512-17120 , 43512-17131 , 43512-17130 , 43512-52040 , 43512-52090	
	1,5 VVTi Sport		01.2003	08.2005	28.0462-0175.1	BAR201	Discofreno ant.	43512-0D050 , 43512-17120 , 43512-17131 , 43512-17130 , 43512-52040 , 43512-52090	
			04.2001	03.2003	28.0462-0175.1	BAR201	Discofreno ant.	43512-0D050 , 43512-17120 , 43512-17131 , 43512-17130 , 43512-52040 , 43512-52090	
	1,5 VVTi Turbo Sport		04.2003	10.2004	28.0462-0175.1	BAR201	Discofreno ant.	43512-0D050 , 43512-17120 , 43512-17131 , 43512-17130 , 43512-52040 , 43512-52090	
YARIS VERSO (99-05)	1,3		11.1999	03.2003	28.0462-0175.1	BAR201	Discofreno ant.	43512-0D050 , 43512-17120 , 43512-17131 , 43512-17130 , 43512-52040 , 43512-52090	
			01.2003	09.2005	28.0462-0175.1	BAR201	Discofreno ant.	43512-0D050 , 43512-17120 , 43512-17131 , 43512-17130 , 43512-52040 , 43512-52090	
	1,4 D-4D		12.2001	09.2005	28.0462-0175.1	BAR201	Discofreno ant.	43512-0D050 , 43512-17120 , 43512-17131 , 43512-17130 , 43512-52040 , 43512-52090	
	1,5		05.2003	09.2005	28.0462-0175.1	BAR201	Discofreno ant.	43512-0D050 , 43512-17120 , 43512-17131 , 43512-17130 , 43512-52040 , 43512-52090	



				<b>Descrizione</b>	<b>Codici OE - Codice ATE</b>	 <b>Pre-codice / varie</b>
---	---	--	---	--------------------	-----------------------------------	---

## TOYOTA

YARIS VERSO (99-05)	1,5		03.2000	03.2003	28.0462-0175.1	BAR201	Discofreno ant.	43512-0D050 , 43512-17120 , 43512-17131 , 43512-17130 , 43512-52040 , 43512-52090	
	1,5 4WD		03.2000	09.2005	28.0462-0175.1	BAR201	Discofreno ant.	43512-0D050 , 43512-17120 , 43512-17131 , 43512-17130 , 43512-52040 , 43512-52090	



Descrizione

Codici OE -  
Codice ATE

Pre-codice / varie

## VOLKSWAGEN

EOS (06-)	1,4 TSI	post.dx	05.2008		24.3414-1710.5	240835	Pinza freno posteriore	1K0 615 424 M , 1K0 615 424 H , 1K0 615 424 C , 1K0 615 424	24.3414-1710.7-
		post.dx	10.2007		24.3414-1710.5	240835	Pinza freno posteriore	1K0 615 424 M , 1K0 615 424 H , 1K0 615 424 C , 1K0 615 424	24.3414-1710.7-
		post.sx	10.2007		24.3414-1709.5	240834	Pinza freno posteriore	1K0 615 423 M , 1K0 615 423 H , 1K0 615 423 C , 1K0 615 423	24.3414-1709.7
		post.sx	05.2008		24.3414-1709.5	240834	Pinza freno posteriore	1K0 615 423 M , 1K0 615 423 H , 1K0 615 423 C , 1K0 615 423	24.3414-1709.7
	1,6 FSI	post.dx	05.2006		24.3414-1710.5	240835	Pinza freno posteriore	1K0 615 424 M , 1K0 615 424 H , 1K0 615 424 C , 1K0 615 424	24.3414-1710.7-
		post.sx	05.2006		24.3414-1709.5	240834	Pinza freno posteriore	1K0 615 423 M , 1K0 615 423 H , 1K0 615 423 C , 1K0 615 423	24.3414-1709.7
	2,0 FSI	post.dx	05.2006		24.3414-1710.5	240835	Pinza freno posteriore	1K0 615 424 M , 1K0 615 424 H , 1K0 615 424 C , 1K0 615 424	24.3414-1710.7-
		post.sx	05.2006		24.3414-1709.5	240834	Pinza freno posteriore	1K0 615 423 M , 1K0 615 423 H , 1K0 615 423 C , 1K0 615 423	24.3414-1709.7
	2,0 TDI	post.sx	11.2010		24.3414-1709.5	240834	Pinza freno posteriore	1K0 615 423 M , 1K0 615 423 H , 1K0 615 423 C , 1K0 615 423	24.3414-1709.7
		post.dx	05.2006		24.3414-1710.5	240835	Pinza freno posteriore	1K0 615 424 M , 1K0 615 424 H , 1K0 615 424 C , 1K0 615 424	24.3414-1710.7-
		post.sx	05.2006		24.3414-1709.5	240834	Pinza freno posteriore	1K0 615 423 M , 1K0 615 423 H , 1K0 615 423 C , 1K0 615 423	24.3414-1709.7





Descrizione

Codici OE -  
Codice ATE

Pre-codice / varie

## VOLKSWAGEN

EOS (06-)	2,0 TDI	post.dx	11.2010		24.3414-1710.5	240835	Pinza freno posteriore	1K0 615 424 M , 1K0 615 424 H , 1K0 615 424 C , 1K0 615 424	24.3414-1710.7-
	2,0 TDI 16V	post.dx	05.2008		24.3414-1710.5	240835	Pinza freno posteriore	1K0 615 424 M , 1K0 615 424 H , 1K0 615 424 C , 1K0 615 424	24.3414-1710.7-
		post.sx	05.2008		24.3414-1709.5	240834	Pinza freno posteriore	1K0 615 423 M , 1K0 615 423 H , 1K0 615 423 C , 1K0 615 423	24.3414-1709.7
	2,0 TFSI	post.dx	05.2006		24.3414-1710.5	240835	Pinza freno posteriore	1K0 615 424 M , 1K0 615 424 H , 1K0 615 424 C , 1K0 615 424	24.3414-1710.7-
		post.sx	05.2006		24.3414-1709.5	240834	Pinza freno posteriore	1K0 615 423 M , 1K0 615 423 H , 1K0 615 423 C , 1K0 615 423	24.3414-1709.7
	2,0 TSI	post.sx	11.2009		24.3414-1709.5	240834	Pinza freno posteriore	1K0 615 423 M , 1K0 615 423 H , 1K0 615 423 C , 1K0 615 423	24.3414-1709.7
		post.dx	11.2009		24.3414-1710.5	240835	Pinza freno posteriore	1K0 615 424 M , 1K0 615 424 H , 1K0 615 424 C , 1K0 615 424	24.3414-1710.7-
	3,2 V6	post.sx	05.2006		24.3414-1709.5	240834	Pinza freno posteriore	1K0 615 423 M , 1K0 615 423 H , 1K0 615 423 C , 1K0 615 423	24.3414-1709.7
		post.dx	05.2006		24.3414-1710.5	240835	Pinza freno posteriore	1K0 615 424 M , 1K0 615 424 H , 1K0 615 424 C , 1K0 615 424	24.3414-1710.7-
	3,6 V6	post.dx	05.2009		24.3414-1710.5	240835	Pinza freno posteriore	1K0 615 424 M , 1K0 615 424 H , 1K0 615 424 C , 1K0 615 424	24.3414-1710.7-
		post.sx	05.2009		24.3414-1709.5	240834	Pinza freno posteriore	1K0 615 423 M , 1K0 615 423 H , 1K0 615 423 C , 1K0 615 423	24.3414-1709.7



Descrizione

Codici OE -  
Codice ATE

Pre-codice / varie

## VOLKSWAGEN

GOLF Plus (05-14)	1,2 TSI	post.sx	08.2009	01.2014	24.3414-1709.5	240834	Pinza freno posteriore	1K0 615 423 M , 1K0 615 423 H , 1K0 615 423 C , 1K0 615 423	24.3414-1709.7
		post.dx	08.2009	01.2014	24.3414-1710.5	240835	Pinza freno posteriore	1K0 615 424 M , 1K0 615 424 H , 1K0 615 424 C , 1K0 615 424	24.3414-1710.7-
	1,4 16V	post.dx	01.2005	01.2014	24.3414-1710.5	240835	Pinza freno posteriore	1K0 615 424 M , 1K0 615 424 H , 1K0 615 424 C , 1K0 615 424	24.3414-1710.7-
		post.sx	01.2005	01.2014	24.3414-1709.5	240834	Pinza freno posteriore	1K0 615 423 M , 1K0 615 423 H , 1K0 615 423 C , 1K0 615 423	24.3414-1709.7
	1,4 FSI	post.sx	07.2005	01.2014	24.3414-1709.5	240834	Pinza freno posteriore	1K0 615 423 M , 1K0 615 423 H , 1K0 615 423 C , 1K0 615 423	24.3414-1709.7
		post.dx	07.2005	01.2014	24.3414-1710.5	240835	Pinza freno posteriore	1K0 615 424 M , 1K0 615 424 H , 1K0 615 424 C , 1K0 615 424	24.3414-1710.7-
	1,4 TSI	post.dx	06.2008	01.2014	24.3414-1710.5	240835	Pinza freno posteriore	1K0 615 424 M , 1K0 615 424 H , 1K0 615 424 C , 1K0 615 424	24.3414-1710.7-
		post.dx	06.2007	01.2014	24.3414-1710.5	240835	Pinza freno posteriore	1K0 615 424 M , 1K0 615 424 H , 1K0 615 424 C , 1K0 615 424	24.3414-1710.7-
		post.sx	06.2008	01.2014	24.3414-1709.5	240834	Pinza freno posteriore	1K0 615 423 M , 1K0 615 423 H , 1K0 615 423 C , 1K0 615 423	24.3414-1709.7
		post.sx	05.2006	01.2014	24.3414-1709.5	240834	Pinza freno posteriore	1K0 615 423 M , 1K0 615 423 H , 1K0 615 423 C , 1K0 615 423	24.3414-1709.7
		post.dx	05.2006	01.2014	24.3414-1710.5	240835	Pinza freno posteriore	1K0 615 424 M , 1K0 615 424 H , 1K0 615 424 C , 1K0 615 424	24.3414-1710.7-



Descrizione

Codici OE -  
Codice ATE

Pre-codice / varie

## VOLKSWAGEN

GOLF Plus (05-14)	1,4 TSI	post.sx	06.2007	01.2014	24.3414-1709.5	240834	Pinza freno posteriore	1K0 615 423 M , 1K0 615 423 H , 1K0 615 423 C , 1K0 615 423	24.3414-1709.7
	1,6	post.sx	05.2005	01.2014	24.3414-1709.5	240834	Pinza freno posteriore	1K0 615 423 M , 1K0 615 423 H , 1K0 615 423 C , 1K0 615 423	24.3414-1709.7
		post.dx	05.2005	01.2014	24.3414-1710.5	240835	Pinza freno posteriore	1K0 615 424 M , 1K0 615 424 H , 1K0 615 424 C , 1K0 615 424	24.3414-1710.7-
	1,6 BiFuel	post.sx	05.2009	01.2014	24.3414-1709.5	240834	Pinza freno posteriore	1K0 615 423 M , 1K0 615 423 H , 1K0 615 423 C , 1K0 615 423	24.3414-1709.7
		post.dx	05.2009	01.2014	24.3414-1710.5	240835	Pinza freno posteriore	1K0 615 424 M , 1K0 615 424 H , 1K0 615 424 C , 1K0 615 424	24.3414-1710.7-
	1,6 FSI	post.sx	01.2005	01.2014	24.3414-1709.5	240834	Pinza freno posteriore	1K0 615 423 M , 1K0 615 423 H , 1K0 615 423 C , 1K0 615 423	24.3414-1709.7
		post.dx	01.2005	01.2014	24.3414-1710.5	240835	Pinza freno posteriore	1K0 615 424 M , 1K0 615 424 H , 1K0 615 424 C , 1K0 615 424	24.3414-1710.7-
	1,6 TDI	post.dx	02.2009	01.2014	24.3414-1710.5	240835	Pinza freno posteriore	1K0 615 424 M , 1K0 615 424 H , 1K0 615 424 C , 1K0 615 424	24.3414-1710.7-
		post.sx	02.2009	01.2014	24.3414-1709.5	240834	Pinza freno posteriore	1K0 615 423 M , 1K0 615 423 H , 1K0 615 423 C , 1K0 615 423	24.3414-1709.7
	1,9 TDI	post.dx	01.2005	01.2014	24.3414-1710.5	240835	Pinza freno posteriore	1K0 615 424 M , 1K0 615 424 H , 1K0 615 424 C , 1K0 615 424	24.3414-1710.7-
		post.sx	01.2005	01.2014	24.3414-1709.5	240834	Pinza freno posteriore	1K0 615 423 M , 1K0 615 423 H , 1K0 615 423 C , 1K0 615 423	24.3414-1709.7



Descrizione

Codici OE -  
Codice ATE

Pre-codice / varie

## VOLKSWAGEN

GOLF Plus (05-14)	1,9 TDI	post.dx	05.2005	01.2014	24.3414-1710.5	240835	Pinza freno posteriore	1K0 615 424 M , 1K0 615 424 H , 1K0 615 424 C , 1K0 615 424	24.3414-1710.7-
		post.sx	05.2005	01.2014	24.3414-1709.5	240834	Pinza freno posteriore	1K0 615 423 M , 1K0 615 423 H , 1K0 615 423 C , 1K0 615 423	24.3414-1709.7
	2,0 FSI	post.dx	05.2005	01.2014	24.3414-1710.5	240835	Pinza freno posteriore	1K0 615 424 M , 1K0 615 424 H , 1K0 615 424 C , 1K0 615 424	24.3414-1710.7-
		post.sx	05.2005	01.2014	24.3414-1709.5	240834	Pinza freno posteriore	1K0 615 423 M , 1K0 615 423 H , 1K0 615 423 C , 1K0 615 423	24.3414-1709.7
	2,0 TDI	post.dx	01.2005	01.2014	24.3414-1710.5	240835	Pinza freno posteriore	1K0 615 424 M , 1K0 615 424 H , 1K0 615 424 C , 1K0 615 424	24.3414-1710.7-
		post.sx	01.2005	01.2014	24.3414-1709.5	240834	Pinza freno posteriore	1K0 615 423 M , 1K0 615 423 H , 1K0 615 423 C , 1K0 615 423	24.3414-1709.7
		post.sx	05.2005	01.2014	24.3414-1709.5	240834	Pinza freno posteriore	1K0 615 423 M , 1K0 615 423 H , 1K0 615 423 C , 1K0 615 423	24.3414-1709.7
		post.dx	05.2005	01.2014	24.3414-1710.5	240835	Pinza freno posteriore	1K0 615 424 M , 1K0 615 424 H , 1K0 615 424 C , 1K0 615 424	24.3414-1710.7-
GOLF V (03-08)	1,4 16V	post.dx	10.2003	09.2008	24.3414-1710.5	240835	Pinza freno posteriore	1K0 615 424 M , 1K0 615 424 H , 1K0 615 424 C , 1K0 615 424	24.3414-1710.7-
		post.sx	10.2003	09.2008	24.3414-1709.5	240834	Pinza freno posteriore	1K0 615 423 M , 1K0 615 423 H , 1K0 615 423 C , 1K0 615 423	24.3414-1709.7
	1,4 FSI	post.dx	10.2003	09.2008	24.3414-1710.5	240835	Pinza freno posteriore	1K0 615 424 M , 1K0 615 424 H , 1K0 615 424 C , 1K0 615 424	24.3414-1710.7-



Descrizione

Codici OE -  
Codice ATE

Pre-codice / varie

## VOLKSWAGEN

GOLF V (03-08)	1,4 FSI	post.sx	10.2003	09.2008	24.3414-1709.5	240834	Pinza freno posteriore	1K0 615 423 M , 1K0 615 423 H , 1K0 615 423 C , 1K0 615 423	24.3414-1709.7
	1,4 TSI	post.dx	05.2006	09.2008	24.3414-1710.5	240835	Pinza freno posteriore	1K0 615 424 M , 1K0 615 424 H , 1K0 615 424 C , 1K0 615 424	24.3414-1710.7-
		post.dx	05.2007	09.2008	24.3414-1710.5	240835	Pinza freno posteriore	1K0 615 424 M , 1K0 615 424 H , 1K0 615 424 C , 1K0 615 424	24.3414-1710.7-
		post.sx	11.2005	09.2008	24.3414-1709.5	240834	Pinza freno posteriore	1K0 615 423 M , 1K0 615 423 H , 1K0 615 423 C , 1K0 615 423	24.3414-1709.7
		post.sx	05.2007	09.2008	24.3414-1709.5	240834	Pinza freno posteriore	1K0 615 423 M , 1K0 615 423 H , 1K0 615 423 C , 1K0 615 423	24.3414-1709.7
		post.sx	05.2006	09.2008	24.3414-1709.5	240834	Pinza freno posteriore	1K0 615 423 M , 1K0 615 423 H , 1K0 615 423 C , 1K0 615 423	24.3414-1709.7
		post.dx	11.2005	09.2008	24.3414-1710.5	240835	Pinza freno posteriore	1K0 615 424 M , 1K0 615 424 H , 1K0 615 424 C , 1K0 615 424	24.3414-1710.7-
	1,6 16V	post.dx	01.2004	09.2008	24.3414-1710.5	240835	Pinza freno posteriore	1K0 615 424 M , 1K0 615 424 H , 1K0 615 424 C , 1K0 615 424	24.3414-1710.7-
		post.sx	01.2004	09.2008	24.3414-1709.5	240834	Pinza freno posteriore	1K0 615 423 M , 1K0 615 423 H , 1K0 615 423 C , 1K0 615 423	24.3414-1709.7
	1,6 FSI	post.dx	10.2003	09.2008	24.3414-1710.5	240835	Pinza freno posteriore	1K0 615 424 M , 1K0 615 424 H , 1K0 615 424 C , 1K0 615 424	24.3414-1710.7-
		post.sx	10.2003	09.2008	24.3414-1709.5	240834	Pinza freno posteriore	1K0 615 423 M , 1K0 615 423 H , 1K0 615 423 C , 1K0 615 423	24.3414-1709.7



Descrizione

Codici OE -  
Codice ATE

Pre-codice / varie

## VOLKSWAGEN

GOLF V (03-08)	1,9 TDI	post.dx	05.2004	09.2008	24.3414-1710.5	240835	Pinza freno posteriore	1K0 615 424 M , 1K0 615 424 H , 1K0 615 424 C , 1K0 615 424	24.3414-1710.7-
		post.dx	10.2003	09.2008	24.3414-1710.5	240835	Pinza freno posteriore	1K0 615 424 M , 1K0 615 424 H , 1K0 615 424 C , 1K0 615 424	24.3414-1710.7-
		post.sx	10.2003	09.2008	24.3414-1709.5	240834	Pinza freno posteriore	1K0 615 423 M , 1K0 615 423 H , 1K0 615 423 C , 1K0 615 423	24.3414-1709.7
		post.sx	05.2004	09.2008	24.3414-1709.5	240834	Pinza freno posteriore	1K0 615 423 M , 1K0 615 423 H , 1K0 615 423 C , 1K0 615 423	24.3414-1709.7
	1,9 TDI 4motion	post.dx	08.2004	09.2008	24.3414-1710.5	240835	Pinza freno posteriore	1K0 615 424 M , 1K0 615 424 H , 1K0 615 424 C , 1K0 615 424	24.3414-1710.7-
		post.sx	08.2004	09.2008	24.3414-1709.5	240834	Pinza freno posteriore	1K0 615 423 M , 1K0 615 423 H , 1K0 615 423 C , 1K0 615 423	24.3414-1709.7
	2,0 FSI	post.dx	10.2003	09.2008	24.3414-1710.5	240835	Pinza freno posteriore	1K0 615 424 M , 1K0 615 424 H , 1K0 615 424 C , 1K0 615 424	24.3414-1710.7-
		post.sx	10.2003	09.2008	24.3414-1709.5	240834	Pinza freno posteriore	1K0 615 423 M , 1K0 615 423 H , 1K0 615 423 C , 1K0 615 423	24.3414-1709.7
	2,0 FSI 4motion	post.dx	08.2004	09.2008	24.3414-1710.5	240835	Pinza freno posteriore	1K0 615 424 M , 1K0 615 424 H , 1K0 615 424 C , 1K0 615 424	24.3414-1710.7-
		post.sx	08.2004	09.2008	24.3414-1709.5	240834	Pinza freno posteriore	1K0 615 423 M , 1K0 615 423 H , 1K0 615 423 C , 1K0 615 423	24.3414-1709.7
	2,0 GTI	post.dx	09.2004	09.2008	24.3414-1710.5	240835	Pinza freno posteriore	1K0 615 424 M , 1K0 615 424 H , 1K0 615 424 C , 1K0 615 424	24.3414-1710.7-



Descrizione

Codici OE -  
Codice ATE

Pre-codice / varie

## VOLKSWAGEN

GOLF V (03-08)	2,0 GTI	post.dx	09.2006	09.2008	24.3414-1710.5	240835	Pinza freno posteriore	1K0 615 424 M , 1K0 615 424 H , 1K0 615 424 C , 1K0 615 424	24.3414-1710.7-
		post.sx	09.2006	09.2008	24.3414-1709.5	240834	Pinza freno posteriore	1K0 615 423 M , 1K0 615 423 H , 1K0 615 423 C , 1K0 615 423	24.3414-1709.7
		post.sx	09.2004	09.2008	24.3414-1709.5	240834	Pinza freno posteriore	1K0 615 423 M , 1K0 615 423 H , 1K0 615 423 C , 1K0 615 423	24.3414-1709.7
	2,0 SDI	post.dx	01.2004	09.2008	24.3414-1710.5	240835	Pinza freno posteriore	1K0 615 424 M , 1K0 615 424 H , 1K0 615 424 C , 1K0 615 424	24.3414-1710.7-
		post.sx	01.2004	09.2008	24.3414-1709.5	240834	Pinza freno posteriore	1K0 615 423 M , 1K0 615 423 H , 1K0 615 423 C , 1K0 615 423	24.3414-1709.7
	2,0 TDI	post.dx	10.2003	09.2008	24.3414-1710.5	240835	Pinza freno posteriore	1K0 615 424 M , 1K0 615 424 H , 1K0 615 424 C , 1K0 615 424	24.3414-1710.7-
		post.dx	11.2005	09.2008	24.3414-1710.5	240835	Pinza freno posteriore	1K0 615 424 M , 1K0 615 424 H , 1K0 615 424 C , 1K0 615 424	24.3414-1710.7-
		post.sx	10.2003	09.2008	24.3414-1709.5	240834	Pinza freno posteriore	1K0 615 423 M , 1K0 615 423 H , 1K0 615 423 C , 1K0 615 423	24.3414-1709.7
		post.sx	11.2005	09.2008	24.3414-1709.5	240834	Pinza freno posteriore	1K0 615 423 M , 1K0 615 423 H , 1K0 615 423 C , 1K0 615 423	24.3414-1709.7
	2,0 TDI 4motion	post.dx	08.2004	09.2008	24.3414-1710.5	240835	Pinza freno posteriore	1K0 615 424 M , 1K0 615 424 H , 1K0 615 424 C , 1K0 615 424	24.3414-1710.7-
		post.sx	08.2004	09.2008	24.3414-1709.5	240834	Pinza freno posteriore	1K0 615 423 M , 1K0 615 423 H , 1K0 615 423 C , 1K0 615 423	24.3414-1709.7



Descrizione

Codici OE -  
Codice ATE

Pre-codice / varie

## VOLKSWAGEN

GOLF V (03-08)	3,2 R32	post.dx	11.2005	09.2008	24.3414-1710.5	240835	Pinza freno posteriore	1K0 615 424 M , 1K0 615 424 H , 1K0 615 424 C , 1K0 615 424	24.3414-1710.7-
		post.sx	11.2005	09.2008	24.3414-1709.5	240834	Pinza freno posteriore	1K0 615 423 M , 1K0 615 423 H , 1K0 615 423 C , 1K0 615 423	24.3414-1709.7
GOLF V Variant (07-09)	1,4	post.dx	06.2007	06.2009	24.3414-1710.5	240835	Pinza freno posteriore	1K0 615 424 M , 1K0 615 424 H , 1K0 615 424 C , 1K0 615 424	24.3414-1710.7-
		post.sx	06.2007	06.2009	24.3414-1709.5	240834	Pinza freno posteriore	1K0 615 423 M , 1K0 615 423 H , 1K0 615 423 C , 1K0 615 423	24.3414-1709.7
	1,4 TSI	post.dx	05.2007	06.2009	24.3414-1710.5	240835	Pinza freno posteriore	1K0 615 424 M , 1K0 615 424 H , 1K0 615 424 C , 1K0 615 424	24.3414-1710.7-
		post.dx	07.2008	06.2009	24.3414-1710.5	240835	Pinza freno posteriore	1K0 615 424 M , 1K0 615 424 H , 1K0 615 424 C , 1K0 615 424	24.3414-1710.7-
		post.dx	06.2007	06.2009	24.3414-1710.5	240835	Pinza freno posteriore	1K0 615 424 M , 1K0 615 424 H , 1K0 615 424 C , 1K0 615 424	24.3414-1710.7-
		post.sx	05.2007	06.2009	24.3414-1709.5	240834	Pinza freno posteriore	1K0 615 423 M , 1K0 615 423 H , 1K0 615 423 C , 1K0 615 423	24.3414-1709.7
		post.sx	06.2007	06.2009	24.3414-1709.5	240834	Pinza freno posteriore	1K0 615 423 M , 1K0 615 423 H , 1K0 615 423 C , 1K0 615 423	24.3414-1709.7
		post.sx	07.2008	06.2009	24.3414-1709.5	240834	Pinza freno posteriore	1K0 615 423 M , 1K0 615 423 H , 1K0 615 423 C , 1K0 615 423	24.3414-1709.7
	1,6	post.dx	05.2007	06.2009	24.3414-1710.5	240835	Pinza freno posteriore	1K0 615 424 M , 1K0 615 424 H , 1K0 615 424 C , 1K0 615 424	24.3414-1710.7-





Descrizione

Codici OE -  
Codice ATE

Pre-codice / varie

## VOLKSWAGEN

GOLF V Variant (07-09)	1,6	post.sx	05.2007	06.2009	24.3414-1709.5	240834	Pinza freno posteriore	1K0 615 423 M , 1K0 615 423 H , 1K0 615 423 C , 1K0 615 423	24.3414-1709.7
	1,9 TDI	post.dx	05.2007	06.2009	24.3414-1710.5	240835	Pinza freno posteriore	1K0 615 424 M , 1K0 615 424 H , 1K0 615 424 C , 1K0 615 424	24.3414-1710.7-
		post.sx	05.2007	06.2009	24.3414-1709.5	240834	Pinza freno posteriore	1K0 615 423 M , 1K0 615 423 H , 1K0 615 423 C , 1K0 615 423	24.3414-1709.7
	1,9 TDI 4motion	post.dx	12.2007	06.2009	24.3414-1710.5	240835	Pinza freno posteriore	1K0 615 424 M , 1K0 615 424 H , 1K0 615 424 C , 1K0 615 424	24.3414-1710.7-
		post.sx	12.2007	06.2009	24.3414-1709.5	240834	Pinza freno posteriore	1K0 615 423 M , 1K0 615 423 H , 1K0 615 423 C , 1K0 615 423	24.3414-1709.7
	2	post.dx	06.2007	06.2009	24.3414-1710.5	240835	Pinza freno posteriore	1K0 615 424 M , 1K0 615 424 H , 1K0 615 424 C , 1K0 615 424	24.3414-1710.7-
		post.sx	06.2007	06.2009	24.3414-1709.5	240834	Pinza freno posteriore	1K0 615 423 M , 1K0 615 423 H , 1K0 615 423 C , 1K0 615 423	24.3414-1709.7
	2,0 TDI	post.dx	05.2007	06.2009	24.3414-1710.5	240835	Pinza freno posteriore	1K0 615 424 M , 1K0 615 424 H , 1K0 615 424 C , 1K0 615 424	24.3414-1710.7-
		post.sx	05.2007	06.2009	24.3414-1709.5	240834	Pinza freno posteriore	1K0 615 423 M , 1K0 615 423 H , 1K0 615 423 C , 1K0 615 423	24.3414-1709.7
GOLF VI (08-)	1,2 TSI	post.dx	05.2009	10.2009	24.3414-1710.5	240835	Pinza freno posteriore	1K0 615 424 M , 1K0 615 424 H , 1K0 615 424 C , 1K0 615 424	24.3414-1710.7-
		post.sx	05.2009	10.2009	24.3414-1709.5	240834	Pinza freno posteriore	1K0 615 423 M , 1K0 615 423 H , 1K0 615 423 C , 1K0 615 423	24.3414-1709.7



Descrizione

Codici OE -  
Codice ATE

Pre-codice / varie

## VOLKSWAGEN

GOLF VI (08-)	1,4	post.dx	10.2008	10.2009	24.3414-1710.5	240835	Pinza freno posteriore	1K0 615 424 M , 1K0 615 424 H , 1K0 615 424 C , 1K0 615 424	24.3414-1710.7-
		post.sx	10.2008	10.2009	24.3414-1709.5	240834	Pinza freno posteriore	1K0 615 423 M , 1K0 615 423 H , 1K0 615 423 C , 1K0 615 423	24.3414-1709.7
	1,4 TSI	post.dx	10.2008	10.2009	24.3414-1710.5	240835	Pinza freno posteriore	1K0 615 424 M , 1K0 615 424 H , 1K0 615 424 C , 1K0 615 424	24.3414-1710.7-
		post.sx	10.2008	10.2009	24.3414-1709.5	240834	Pinza freno posteriore	1K0 615 423 M , 1K0 615 423 H , 1K0 615 423 C , 1K0 615 423	24.3414-1709.7
	1,6	post.dx	10.2008	10.2009	24.3414-1710.5	240835	Pinza freno posteriore	1K0 615 424 M , 1K0 615 424 H , 1K0 615 424 C , 1K0 615 424	24.3414-1710.7-
		post.sx	10.2008	10.2009	24.3414-1709.5	240834	Pinza freno posteriore	1K0 615 423 M , 1K0 615 423 H , 1K0 615 423 C , 1K0 615 423	24.3414-1709.7
	1,6 BiFuel	post.dx	03.2009	10.2009	24.3414-1710.5	240835	Pinza freno posteriore	1K0 615 424 M , 1K0 615 424 H , 1K0 615 424 C , 1K0 615 424	24.3414-1710.7-
		post.sx	03.2009	10.2009	24.3414-1709.5	240834	Pinza freno posteriore	1K0 615 423 M , 1K0 615 423 H , 1K0 615 423 C , 1K0 615 423	24.3414-1709.7
	1,6 TDI	post.dx	02.2009	10.2009	24.3414-1710.5	240835	Pinza freno posteriore	1K0 615 424 M , 1K0 615 424 H , 1K0 615 424 C , 1K0 615 424	24.3414-1710.7-
		post.sx	02.2009	10.2009	24.3414-1709.5	240834	Pinza freno posteriore	1K0 615 423 M , 1K0 615 423 H , 1K0 615 423 C , 1K0 615 423	24.3414-1709.7
	1,8 TSI	post.dx	06.2009	10.2009	24.3414-1710.5	240835	Pinza freno posteriore	1K0 615 424 M , 1K0 615 424 H , 1K0 615 424 C , 1K0 615 424	24.3414-1710.7-



Descrizione

Codici OE -  
Codice ATE

Pre-codice / varie

## VOLKSWAGEN

GOLF VI (08-)	1,8 TSI	post.sx	06.2009	10.2009	24.3414-1709.5	240834	Pinza freno posteriore	1K0 615 423 M , 1K0 615 423 H , 1K0 615 423 C , 1K0 615 423	24.3414-1709.7
	2,0 GTi	post.dx	04.2009	10.2009	24.3414-1710.5	240835	Pinza freno posteriore	1K0 615 424 M , 1K0 615 424 H , 1K0 615 424 C , 1K0 615 424	24.3414-1710.7-
		post.sx	04.2009	10.2009	24.3414-1709.5	240834	Pinza freno posteriore	1K0 615 423 M , 1K0 615 423 H , 1K0 615 423 C , 1K0 615 423	24.3414-1709.7
	2,0 TDI	post.dx	04.2009	10.2009	24.3414-1710.5	240835	Pinza freno posteriore	1K0 615 424 M , 1K0 615 424 H , 1K0 615 424 C , 1K0 615 424	24.3414-1710.7-
		post.dx	10.2008	10.2009	24.3414-1710.5	240835	Pinza freno posteriore	1K0 615 424 M , 1K0 615 424 H , 1K0 615 424 C , 1K0 615 424	24.3414-1710.7-
		post.sx	04.2009	10.2009	24.3414-1709.5	240834	Pinza freno posteriore	1K0 615 423 M , 1K0 615 423 H , 1K0 615 423 C , 1K0 615 423	24.3414-1709.7
		post.sx	10.2008	10.2009	24.3414-1709.5	240834	Pinza freno posteriore	1K0 615 423 M , 1K0 615 423 H , 1K0 615 423 C , 1K0 615 423	24.3414-1709.7
	2,0 TDI 4motion	post.dx	10.2008	10.2009	24.3414-1710.5	240835	Pinza freno posteriore	1K0 615 424 M , 1K0 615 424 H , 1K0 615 424 C , 1K0 615 424	24.3414-1710.7-
		post.sx	10.2008	10.2009	24.3414-1709.5	240834	Pinza freno posteriore	1K0 615 423 M , 1K0 615 423 H , 1K0 615 423 C , 1K0 615 423	24.3414-1709.7
GOLF VI Variant (09-)	1,2 TSI	post.dx	08.2009		24.3414-1710.5	240835	Pinza freno posteriore	1K0 615 424 M , 1K0 615 424 H , 1K0 615 424 C , 1K0 615 424	24.3414-1710.7-
		post.sx	08.2009		24.3414-1709.5	240834	Pinza freno posteriore	1K0 615 423 M , 1K0 615 423 H , 1K0 615 423 C , 1K0 615 423	24.3414-1709.7



Descrizione

Codici OE -  
Codice ATE

Pre-codice / varie

## VOLKSWAGEN

GOLF VI Variant (09-)	1,4	post.dx	07.2009		24.3414-1710.5	240835	Pinza freno posteriore	1K0 615 424 M , 1K0 615 424 H , 1K0 615 424 C , 1K0 615 424	24.3414-1710.7-
		post.sx	07.2009		24.3414-1709.5	240834	Pinza freno posteriore	1K0 615 423 M , 1K0 615 423 H , 1K0 615 423 C , 1K0 615 423	24.3414-1709.7
	1,4 TSI	post.dx	07.2009		24.3414-1710.5	240835	Pinza freno posteriore	1K0 615 424 M , 1K0 615 424 H , 1K0 615 424 C , 1K0 615 424	24.3414-1710.7-
		post.sx	07.2009		24.3414-1709.5	240834	Pinza freno posteriore	1K0 615 423 M , 1K0 615 423 H , 1K0 615 423 C , 1K0 615 423	24.3414-1709.7
	1,6	post.dx	07.2009		24.3414-1710.5	240835	Pinza freno posteriore	1K0 615 424 M , 1K0 615 424 H , 1K0 615 424 C , 1K0 615 424	24.3414-1710.7-
		post.sx	07.2009		24.3414-1709.5	240834	Pinza freno posteriore	1K0 615 423 M , 1K0 615 423 H , 1K0 615 423 C , 1K0 615 423	24.3414-1709.7
	1,6 MultiFuel	post.dx	07.2009		24.3414-1710.5	240835	Pinza freno posteriore	1K0 615 424 M , 1K0 615 424 H , 1K0 615 424 C , 1K0 615 424	24.3414-1710.7-
		post.sx	07.2009		24.3414-1709.5	240834	Pinza freno posteriore	1K0 615 423 M , 1K0 615 423 H , 1K0 615 423 C , 1K0 615 423	24.3414-1709.7
	1,6 TDI	post.dx	07.2009		24.3414-1710.5	240835	Pinza freno posteriore	1K0 615 424 M , 1K0 615 424 H , 1K0 615 424 C , 1K0 615 424	24.3414-1710.7-
		post.sx	07.2009		24.3414-1709.5	240834	Pinza freno posteriore	1K0 615 423 M , 1K0 615 423 H , 1K0 615 423 C , 1K0 615 423	24.3414-1709.7
	1,6 TDI 4motion	post.dx	07.2009		24.3414-1710.5	240835	Pinza freno posteriore	1K0 615 424 M , 1K0 615 424 H , 1K0 615 424 C , 1K0 615 424	24.3414-1710.7-



Descrizione

Codici OE -  
Codice ATE

Pre-codice / varie

## VOLKSWAGEN

GOLF VI Variant (09-)	1,6 TDI 4motion	post.sx	07.2009		24.3414-1709.5	240834	Pinza freno posteriore	1K0 615 423 M , 1K0 615 423 H , 1K0 615 423 C , 1K0 615 423	24.3414-1709.7
	2	post.dx	07.2009		24.3414-1710.5	240835	Pinza freno posteriore	1K0 615 424 M , 1K0 615 424 H , 1K0 615 424 C , 1K0 615 424	24.3414-1710.7-
		post.sx	07.2009		24.3414-1709.5	240834	Pinza freno posteriore	1K0 615 423 M , 1K0 615 423 H , 1K0 615 423 C , 1K0 615 423	24.3414-1709.7
	2,0 TDI	post.dx	07.2009		24.3414-1710.5	240835	Pinza freno posteriore	1K0 615 424 M , 1K0 615 424 H , 1K0 615 424 C , 1K0 615 424	24.3414-1710.7-
		post.sx	07.2009		24.3414-1709.5	240834	Pinza freno posteriore	1K0 615 423 M , 1K0 615 423 H , 1K0 615 423 C , 1K0 615 423	24.3414-1709.7
JETTA V (05-10)	1,4 TSI	post.dx	05.2007	10.2010	24.3414-1710.5	240835	Pinza freno posteriore	1K0 615 424 M , 1K0 615 424 H , 1K0 615 424 C , 1K0 615 424	24.3414-1710.7-
		post.dx	06.2006	10.2010	24.3414-1710.5	240835	Pinza freno posteriore	1K0 615 424 M , 1K0 615 424 H , 1K0 615 424 C , 1K0 615 424	24.3414-1710.7-
		post.sx	06.2006	10.2010	24.3414-1709.5	240834	Pinza freno posteriore	1K0 615 423 M , 1K0 615 423 H , 1K0 615 423 C , 1K0 615 423	24.3414-1709.7
		post.sx	05.2007	10.2010	24.3414-1709.5	240834	Pinza freno posteriore	1K0 615 423 M , 1K0 615 423 H , 1K0 615 423 C , 1K0 615 423	24.3414-1709.7
		post.sx	07.2008	10.2010	24.3414-1709.5	240834	Pinza freno posteriore	1K0 615 423 M , 1K0 615 423 H , 1K0 615 423 C , 1K0 615 423	24.3414-1709.7
		post.dx	07.2008	10.2010	24.3414-1710.5	240835	Pinza freno posteriore	1K0 615 424 M , 1K0 615 424 H , 1K0 615 424 C , 1K0 615 424	24.3414-1710.7-



Descrizione

Codici OE -  
Codice ATE

Pre-codice / varie

## VOLKSWAGEN

JETTA V (05-10)	1,6 FSI	post.dx	08.2005	10.2010	24.3414-1710.5	240835	Pinza freno posteriore	1K0 615 424 M , 1K0 615 424 H , 1K0 615 424 C , 1K0 615 424	24.3414-1710.7-
		post.sx	08.2005	10.2010	24.3414-1709.5	240834	Pinza freno posteriore	1K0 615 423 M , 1K0 615 423 H , 1K0 615 423 C , 1K0 615 423	24.3414-1709.7
	1,6 i 16V	post.dx	08.2005	10.2010	24.3414-1710.5	240835	Pinza freno posteriore	1K0 615 424 M , 1K0 615 424 H , 1K0 615 424 C , 1K0 615 424	24.3414-1710.7-
		post.sx	08.2005	10.2010	24.3414-1709.5	240834	Pinza freno posteriore	1K0 615 423 M , 1K0 615 423 H , 1K0 615 423 C , 1K0 615 423	24.3414-1709.7
	1,6 TDI	post.dx	06.2009	10.2010	24.3414-1710.5	240835	Pinza freno posteriore	1K0 615 424 M , 1K0 615 424 H , 1K0 615 424 C , 1K0 615 424	24.3414-1710.7-
		post.sx	06.2009	10.2010	24.3414-1709.5	240834	Pinza freno posteriore	1K0 615 423 M , 1K0 615 423 H , 1K0 615 423 C , 1K0 615 423	24.3414-1709.7
	1,9 TDI	post.dx	08.2005	10.2010	24.3414-1710.5	240835	Pinza freno posteriore	1K0 615 424 M , 1K0 615 424 H , 1K0 615 424 C , 1K0 615 424	24.3414-1710.7-
		post.sx	08.2005	10.2010	24.3414-1709.5	240834	Pinza freno posteriore	1K0 615 423 M , 1K0 615 423 H , 1K0 615 423 C , 1K0 615 423	24.3414-1709.7
	2,0 FSI	post.dx	08.2005	10.2010	24.3414-1710.5	240835	Pinza freno posteriore	1K0 615 424 M , 1K0 615 424 H , 1K0 615 424 C , 1K0 615 424	24.3414-1710.7-
		post.sx	08.2005	10.2010	24.3414-1709.5	240834	Pinza freno posteriore	1K0 615 423 M , 1K0 615 423 H , 1K0 615 423 C , 1K0 615 423	24.3414-1709.7
	2,0 TDI	post.dx	06.2006	10.2010	24.3414-1710.5	240835	Pinza freno posteriore	1K0 615 424 M , 1K0 615 424 H , 1K0 615 424 C , 1K0 615 424	24.3414-1710.7-



Descrizione

Codici OE -  
Codice ATE

Pre-codice / varie

## VOLKSWAGEN

JETTA V (05-10)	2,0 TDI	post.dx	09.2005	10.2010	24.3414-1710.5	240835	Pinza freno posteriore	1K0 615 424 M , 1K0 615 424 H , 1K0 615 424 C , 1K0 615 424	24.3414-1710.7-
		post.dx	08.2005	10.2010	24.3414-1710.5	240835	Pinza freno posteriore	1K0 615 424 M , 1K0 615 424 H , 1K0 615 424 C , 1K0 615 424	24.3414-1710.7-
		post.sx	09.2005	10.2010	24.3414-1709.5	240834	Pinza freno posteriore	1K0 615 423 M , 1K0 615 423 H , 1K0 615 423 C , 1K0 615 423	24.3414-1709.7
		post.sx	08.2005	10.2010	24.3414-1709.5	240834	Pinza freno posteriore	1K0 615 423 M , 1K0 615 423 H , 1K0 615 423 C , 1K0 615 423	24.3414-1709.7
		post.sx	06.2006	10.2010	24.3414-1709.5	240834	Pinza freno posteriore	1K0 615 423 M , 1K0 615 423 H , 1K0 615 423 C , 1K0 615 423	24.3414-1709.7
	2,0 TFSI	post.dx	10.2005	10.2010	24.3414-1710.5	240835	Pinza freno posteriore	1K0 615 424 M , 1K0 615 424 H , 1K0 615 424 C , 1K0 615 424	24.3414-1710.7-
		post.sx	10.2005	10.2010	24.3414-1709.5	240834	Pinza freno posteriore	1K0 615 423 M , 1K0 615 423 H , 1K0 615 423 C , 1K0 615 423	24.3414-1709.7
	2,5 FSI	post.dx	07.2008	10.2010	24.3414-1710.5	240835	Pinza freno posteriore	1K0 615 424 M , 1K0 615 424 H , 1K0 615 424 C , 1K0 615 424	24.3414-1710.7-
		post.sx	07.2008	10.2010	24.3414-1709.5	240834	Pinza freno posteriore	1K0 615 423 M , 1K0 615 423 H , 1K0 615 423 C , 1K0 615 423	24.3414-1709.7
POLO IV (02-09)	1,2	post.dx	11.2001	05.2009	24.3344-1710.5	240811	Pinza freno posteriore	6Q0 615 424 B , 6Q0 615 424 A	
		post.dx	04.2007	05.2009	24.3344-1710.5	240811	Pinza freno posteriore	6Q0 615 424 B , 6Q0 615 424 A	
	1,4 16V	post.dx	05.2006	05.2009	24.3344-1710.5	240811	Pinza freno posteriore	6Q0 615 424 B , 6Q0 615 424 A	



Descrizione

Codici OE -  
Codice ATE

Pre-codice / varie

## VOLKSWAGEN

POLO IV (02-09)	1,4 16V	post.dx	11.2001	05.2009	24.3344-1710.5	240811	Pinza freno posteriore	6Q0 615 424 B , 6Q0 615 424 A	
	1,4 FSI	post.dx	11.2001	05.2009	24.3344-1710.5	240811	Pinza freno posteriore	6Q0 615 424 B , 6Q0 615 424 A	
	1,4 TDI	post.dx	11.2001	05.2009	24.3344-1710.5	240811	Pinza freno posteriore	6Q0 615 424 B , 6Q0 615 424 A	
	1,6 16V	post.dx	05.2006	05.2009	24.3344-1710.5	240811	Pinza freno posteriore	6Q0 615 424 B , 6Q0 615 424 A	
	1,8 GTI	post.dx	09.2005	05.2009	24.3344-1710.5	240811	Pinza freno posteriore	6Q0 615 424 B , 6Q0 615 424 A	
		post.dx	06.2006	05.2009	24.3344-1710.5	240811	Pinza freno posteriore	6Q0 615 424 B , 6Q0 615 424 A	
	1,9 TDI	post.dx	10.2003	05.2009	24.3344-1710.5	240811	Pinza freno posteriore	6Q0 615 424 B , 6Q0 615 424 A	
		post.dx	11.2001	05.2009	24.3344-1710.5	240811	Pinza freno posteriore	6Q0 615 424 B , 6Q0 615 424 A	
	2	post.dx	04.2002	05.2009	24.3344-1710.5	240811	Pinza freno posteriore	6Q0 615 424 B , 6Q0 615 424 A	
SCIROCCO (08-)	1,4 TSI	post.dx	09.2008		24.3414-1710.5	240835	Pinza freno posteriore	1K0 615 424 M , 1K0 615 424 H , 1K0 615 424 C , 1K0 615 424	24.3414-1710.7-
		post.sx	09.2008		24.3414-1709.5	240834	Pinza freno posteriore	1K0 615 423 M , 1K0 615 423 H , 1K0 615 423 C , 1K0 615 423	24.3414-1709.7
		post.sx	11.2013		24.3414-1709.5	240834	Pinza freno posteriore	1K0 615 423 M , 1K0 615 423 H , 1K0 615 423 C , 1K0 615 423	24.3414-1709.7
		post.dx	11.2013		24.3414-1710.5	240835	Pinza freno posteriore	1K0 615 424 M , 1K0 615 424 H , 1K0 615 424 C , 1K0 615 424	24.3414-1710.7-





Descrizione

Codici OE -  
Codice ATE

Pre-codice / varie

## VOLKSWAGEN

SCIROCCO (08-)	1,4 TSI	post.dx	08.2008		24.3414-1710.5	240835	Pinza freno posteriore	1K0 615 424 M , 1K0 615 424 H , 1K0 615 424 C , 1K0 615 424	24.3414-1710.7-
		post.sx	08.2008		24.3414-1709.5	240834	Pinza freno posteriore	1K0 615 423 M , 1K0 615 423 H , 1K0 615 423 C , 1K0 615 423	24.3414-1709.7
	2,0 R	post.sx	11.2009		24.3414-1709.5	240834	Pinza freno posteriore	1K0 615 423 M , 1K0 615 423 H , 1K0 615 423 C , 1K0 615 423	24.3414-1709.7
		post.sx	08.2014		24.3414-1709.5	240834	Pinza freno posteriore	1K0 615 423 M , 1K0 615 423 H , 1K0 615 423 C , 1K0 615 423	24.3414-1709.7
		post.dx	11.2009		24.3414-1710.5	240835	Pinza freno posteriore	1K0 615 424 M , 1K0 615 424 H , 1K0 615 424 C , 1K0 615 424	24.3414-1710.7-
		post.dx	08.2014		24.3414-1710.5	240835	Pinza freno posteriore	1K0 615 424 M , 1K0 615 424 H , 1K0 615 424 C , 1K0 615 424	24.3414-1710.7-
	2,0 TDI	post.dx	10.2008		24.3414-1710.5	240835	Pinza freno posteriore	1K0 615 424 M , 1K0 615 424 H , 1K0 615 424 C , 1K0 615 424	24.3414-1710.7-
		post.dx	05.2009		24.3414-1710.5	240835	Pinza freno posteriore	1K0 615 424 M , 1K0 615 424 H , 1K0 615 424 C , 1K0 615 424	24.3414-1710.7-
		post.dx	01.2013		24.3414-1710.5	240835	Pinza freno posteriore	1K0 615 424 M , 1K0 615 424 H , 1K0 615 424 C , 1K0 615 424	24.3414-1710.7-
		post.dx	11.2013		24.3414-1710.5	240835	Pinza freno posteriore	1K0 615 424 M , 1K0 615 424 H , 1K0 615 424 C , 1K0 615 424	24.3414-1710.7-
		post.sx	11.2013		24.3414-1709.5	240834	Pinza freno posteriore	1K0 615 423 M , 1K0 615 423 H , 1K0 615 423 C , 1K0 615 423	24.3414-1709.7



Descrizione

Codici OE -  
Codice ATE

Pre-codice / varie

## VOLKSWAGEN

SCIROCCO (08-)	2,0 TDI	post.sx	05.2009		24.3414-1709.5	240834	Pinza freno posteriore	1K0 615 423 M , 1K0 615 423 H , 1K0 615 423 C , 1K0 615 423	24.3414-1709.7
		post.sx	10.2008		24.3414-1709.5	240834	Pinza freno posteriore	1K0 615 423 M , 1K0 615 423 H , 1K0 615 423 C , 1K0 615 423	24.3414-1709.7
		post.sx	01.2013		24.3414-1709.5	240834	Pinza freno posteriore	1K0 615 423 M , 1K0 615 423 H , 1K0 615 423 C , 1K0 615 423	24.3414-1709.7
	2,0 TSI	post.sx	11.2013		24.3414-1709.5	240834	Pinza freno posteriore	1K0 615 423 M , 1K0 615 423 H , 1K0 615 423 C , 1K0 615 423	24.3414-1709.7
		post.dx	08.2008		24.3414-1710.5	240835	Pinza freno posteriore	1K0 615 424 M , 1K0 615 424 H , 1K0 615 424 C , 1K0 615 424	24.3414-1710.7-
		post.dx	11.2013		24.3414-1710.5	240835	Pinza freno posteriore	1K0 615 424 M , 1K0 615 424 H , 1K0 615 424 C , 1K0 615 424	24.3414-1710.7-
		post.sx	11.2009		24.3414-1709.5	240834	Pinza freno posteriore	1K0 615 423 M , 1K0 615 423 H , 1K0 615 423 C , 1K0 615 423	24.3414-1709.7
		post.dx	11.2009		24.3414-1710.5	240835	Pinza freno posteriore	1K0 615 424 M , 1K0 615 424 H , 1K0 615 424 C , 1K0 615 424	24.3414-1710.7-
		post.sx	08.2008		24.3414-1709.5	240834	Pinza freno posteriore	1K0 615 423 M , 1K0 615 423 H , 1K0 615 423 C , 1K0 615 423	24.3414-1709.7
TOURAN I (03-15)	1,2 TSI	post.sx	05.2010		24.3414-1709.5	240834	Pinza freno posteriore	1K0 615 423 M , 1K0 615 423 H , 1K0 615 423 C , 1K0 615 423	24.3414-1709.7
		post.dx	05.2010		24.3414-1710.5	240835	Pinza freno posteriore	1K0 615 424 M , 1K0 615 424 H , 1K0 615 424 C , 1K0 615 424	24.3414-1710.7-



Descrizione

Codici OE -  
Codice ATE

Pre-codice / varie

## VOLKSWAGEN

TOURAN I (03-15)	1,4 TSI	post.sx	09.2006		24.3414-1709.5	240834	Pinza freno posteriore	1K0 615 423 M , 1K0 615 423 H , 1K0 615 423 C , 1K0 615 423	24.3414-1709.7
		post.sx	11.2006		24.3414-1709.5	240834	Pinza freno posteriore	1K0 615 423 M , 1K0 615 423 H , 1K0 615 423 C , 1K0 615 423	24.3414-1709.7
		post.dx	11.2006		24.3414-1710.5	240835	Pinza freno posteriore	1K0 615 424 M , 1K0 615 424 H , 1K0 615 424 C , 1K0 615 424	24.3414-1710.7-
		post.dx	09.2006		24.3414-1710.5	240835	Pinza freno posteriore	1K0 615 424 M , 1K0 615 424 H , 1K0 615 424 C , 1K0 615 424	24.3414-1710.7-
	1,4 TSI EcoFuel	post.dx	05.2009		24.3414-1710.5	240835	Pinza freno posteriore	1K0 615 424 M , 1K0 615 424 H , 1K0 615 424 C , 1K0 615 424	24.3414-1710.7-
		post.sx	05.2009		24.3414-1709.5	240834	Pinza freno posteriore	1K0 615 423 M , 1K0 615 423 H , 1K0 615 423 C , 1K0 615 423	24.3414-1709.7
	1,6	post.dx	07.2003		24.3414-1710.5	240835	Pinza freno posteriore	1K0 615 424 M , 1K0 615 424 H , 1K0 615 424 C , 1K0 615 424	24.3414-1710.7-
		post.sx	07.2003		24.3414-1709.5	240834	Pinza freno posteriore	1K0 615 423 M , 1K0 615 423 H , 1K0 615 423 C , 1K0 615 423	24.3414-1709.7
	1,6 FSI	post.dx	02.2003		24.3414-1710.5	240835	Pinza freno posteriore	1K0 615 424 M , 1K0 615 424 H , 1K0 615 424 C , 1K0 615 424	24.3414-1710.7-
		post.sx	02.2003		24.3414-1709.5	240834	Pinza freno posteriore	1K0 615 423 M , 1K0 615 423 H , 1K0 615 423 C , 1K0 615 423	24.3414-1709.7
	1,6 TDI	post.dx	05.2010		24.3414-1710.5	240835	Pinza freno posteriore	1K0 615 424 M , 1K0 615 424 H , 1K0 615 424 C , 1K0 615 424	24.3414-1710.7-



Descrizione

Codici OE -  
Codice ATE

Pre-codice / varie

## VOLKSWAGEN

TOURAN I (03-15)	1,6 TDI	post.sx	05.2010		24.3414-1709.5	240834	Pinza freno posteriore	1K0 615 423 M , 1K0 615 423 H , 1K0 615 423 C , 1K0 615 423	24.3414-1709.7
	1,9 TDI	post.dx	11.2004		24.3414-1710.5	240835	Pinza freno posteriore	1K0 615 424 M , 1K0 615 424 H , 1K0 615 424 C , 1K0 615 424	24.3414-1710.7-
		post.sx	08.2003		24.3414-1709.5	240834	Pinza freno posteriore	1K0 615 423 M , 1K0 615 423 H , 1K0 615 423 C , 1K0 615 423	24.3414-1709.7
		post.sx	02.2003		24.3414-1709.5	240834	Pinza freno posteriore	1K0 615 423 M , 1K0 615 423 H , 1K0 615 423 C , 1K0 615 423	24.3414-1709.7
		post.dx	08.2003		24.3414-1710.5	240835	Pinza freno posteriore	1K0 615 424 M , 1K0 615 424 H , 1K0 615 424 C , 1K0 615 424	24.3414-1710.7-
		post.sx	11.2004		24.3414-1709.5	240834	Pinza freno posteriore	1K0 615 423 M , 1K0 615 423 H , 1K0 615 423 C , 1K0 615 423	24.3414-1709.7
		post.dx	02.2003		24.3414-1710.5	240835	Pinza freno posteriore	1K0 615 424 M , 1K0 615 424 H , 1K0 615 424 C , 1K0 615 424	24.3414-1710.7-
	2,0 Eco Fuel	post.dx	02.2006		24.3414-1710.5	240835	Pinza freno posteriore	1K0 615 424 M , 1K0 615 424 H , 1K0 615 424 C , 1K0 615 424	24.3414-1710.7-
		post.sx	02.2006		24.3414-1709.5	240834	Pinza freno posteriore	1K0 615 423 M , 1K0 615 423 H , 1K0 615 423 C , 1K0 615 423	24.3414-1709.7
	2,0 FSI	post.dx	10.2003		24.3414-1710.5	240835	Pinza freno posteriore	1K0 615 424 M , 1K0 615 424 H , 1K0 615 424 C , 1K0 615 424	24.3414-1710.7-
		post.dx	10.2004		24.3414-1710.5	240835	Pinza freno posteriore	1K0 615 424 M , 1K0 615 424 H , 1K0 615 424 C , 1K0 615 424	24.3414-1710.7-



Descrizione

Codici OE -  
Codice ATE

Pre-codice / varie

## VOLKSWAGEN

TOURAN I (03-15)	2,0 FSI	post.sx	10.2003		24.3414-1709.5	240834	Pinza freno posteriore	1K0 615 423 M , 1K0 615 423 H , 1K0 615 423 C , 1K0 615 423	24.3414-1709.7
		post.sx	10.2004		24.3414-1709.5	240834	Pinza freno posteriore	1K0 615 423 M , 1K0 615 423 H , 1K0 615 423 C , 1K0 615 423	24.3414-1709.7
	2,0 TDI	post.sx	02.2003		24.3414-1709.5	240834	Pinza freno posteriore	1K0 615 423 M , 1K0 615 423 H , 1K0 615 423 C , 1K0 615 423	24.3414-1709.7
		post.dx	02.2003		24.3414-1710.5	240835	Pinza freno posteriore	1K0 615 424 M , 1K0 615 424 H , 1K0 615 424 C , 1K0 615 424	24.3414-1710.7-
		post.sx	08.2003		24.3414-1709.5	240834	Pinza freno posteriore	1K0 615 423 M , 1K0 615 423 H , 1K0 615 423 C , 1K0 615 423	24.3414-1709.7
		post.dx	02.2006		24.3414-1710.5	240835	Pinza freno posteriore	1K0 615 424 M , 1K0 615 424 H , 1K0 615 424 C , 1K0 615 424	24.3414-1710.7-
		post.dx	08.2003		24.3414-1710.5	240835	Pinza freno posteriore	1K0 615 424 M , 1K0 615 424 H , 1K0 615 424 C , 1K0 615 424	24.3414-1710.7-
		post.sx	02.2006		24.3414-1709.5	240834	Pinza freno posteriore	1K0 615 423 M , 1K0 615 423 H , 1K0 615 423 C , 1K0 615 423	24.3414-1709.7



Descrizione

Codici OE -  
Codice ATE

Pre-codice / varie

## VOLVO

V40 (12-)	D2		02.2015		24.0125-0203.1	425203	Discofreno ant.	31341642 , 31381374	
			09.2012		24.0125-0203.1	425203	Discofreno ant.	31341642 , 31381374	
	D3		09.2012		24.0125-0203.1	425203	Discofreno ant.	31341642 , 31381374	
	D4		05.2014		24.0125-0203.1	425203	Discofreno ant.	31341642 , 31381374	
			09.2012		24.0125-0203.1	425203	Discofreno ant.	31341642 , 31381374	
	T2		02.2015		24.0125-0203.1	425203	Discofreno ant.	31341642 , 31381374	
	T3		02.2015		24.0125-0203.1	425203	Discofreno ant.	31341642 , 31381374	
	T3 GTDi		09.2012		24.0125-0203.1	425203	Discofreno ant.	31341642 , 31381374	
	T4		08.2015		24.0125-0203.1	425203	Discofreno ant.	31341642 , 31381374	
	T4 GTDi		09.2012		24.0125-0203.1	425203	Discofreno ant.	31341642 , 31381374	
	T5		03.2013		24.0125-0203.1	425203	Discofreno ant.	31341642 , 31381374	
			05.2014		24.0125-0203.1	425203	Discofreno ant.	31341642 , 31381374	
	T5 AWD		05.2014		24.0125-0203.1	425203	Discofreno ant.	31341642 , 31381374	
			03.2013		24.0125-0203.1	425203	Discofreno ant.	31341642 , 31381374	

**13.0460-7315.2 607315**

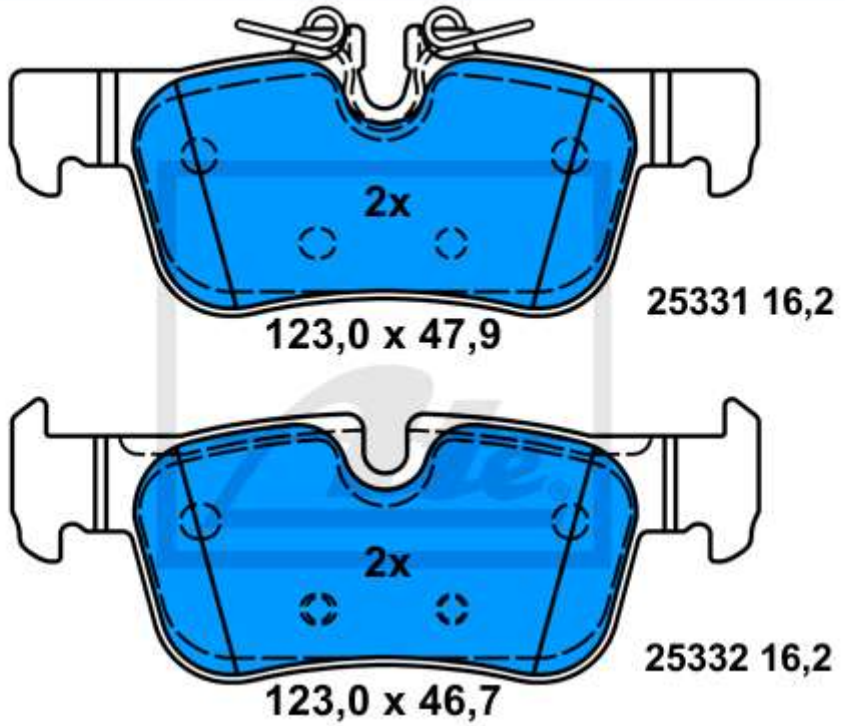

**Applicazioni:**

- BMW 2er Reihe/F45 Active Tourer (14-)
- BMW 2er Reihe/F46 Gran Tourer (15-)
- MINI F54 Clubman (15-)
- MINI F60 Countryman (17-)
- BMW i3/I01 (13-)
- BMW X1/F48 (15-)